



Liberty

AV Solutions

A DIVISION OF COMMUNICATIONS SUPPLY CORPORATION

INSTALLATION PRODUCTS for the AV Professional

2009 - 2010 Product Catalog #817 USD \$10.95 CAN \$16 UK £7.00
libertycable.com



THE LIBERTY ADVANTAGE

**Our Selection, Services, Solutions and Value
Keeps your Business Competitive and Profitable**



- Working with Liberty keeps your business competitive and profitable
- With 7,000 products, Liberty's selection is unmatched in the Pro AV industry
- Individualized attention at every level of customer support
- Custom options let you tailor Liberty's product and service to fit your needs



800-530-8998

libertycable.com

INTERNATIONAL: +1-719-388-7542



LIBERTY ADVANTAGE

Table of Contents 1-4
 Audio-At-A-Glance 5
 Video-At-A-Glance 6
 Selection/New Products From Liberty..... 7
 Services 8
 Value 9
 Green Connectivity™ 10-11
 Trends in AV 12-13
 Liberty Management 14-16

ASSEMBLIES: CUSTOM AND MOLDED

Molded Assembly Differentiation 17
 Cable Cross Reference Guide 18-19
 Audio Cables - Custom/Molded 20-21
 Composite Video Cables 22-23
 DVI Cables - Molded 24
 HDMI® Cables - Molded 25-26
 Install Cables - Custom 26-27
 Install Kits 28
 RGB Cables - Molded 29-30
 RS 232 Cables - Molded 30-31
 S-Video - Custom 31
 S-Video Cables - Molded 31-32
 USB Cables - Molded 32
 VGA Cables - Custom 32-33
 VGA Cables - Molded 33-34
 VGA/Audio Cables - Custom 34
 VGA Micro Cables - Molded 34-35
 VGA to BNC Breakout Cables - Molded 35-36
 XLR Microphone Cables - Custom 36
 EZLINX™ Termination System 38-39
 The Liberty Advantage: Interconnects 40
 DigitaLinx™ Pure Performance HDMI® Cable 41
 Z-500 Series Retail Packaging 41
 Z-300 Series Retail Packaging 41
 Z-500 THX™ Series 42-43
 Z-300 Series 44
 Z-250 Series 45
 Z-200 Series 45
 Z-200 Series "Y" Cables 46
 Z-100 Series 46-47
 TOSLink 47

BUNDLED TAPED SOLUTIONS 48

BULK WIRE: COMMERCIAL AUDIO CABLE

AES/EBU 110 Ohm Digital Audio Snake Cable 49
 Shielded Audio Cable 49
 Broadcast Quality EZ-Strip Audio Cable 50
 Shielded Audio Cable - Plenum 51
 Individually Shielded Audio Cable - Plenum 51

BULK WIRE: COMMERCIAL CATEGORY CABLE

Expand Your Category Solutions with Baluns 52-53
 Liberty Offers a Complete Line of Category Cable 54
 CAT 6E Enhanced 55
 RGB Over UTP Applications TRUphase™ Cable 55
 CATMaster™ Crimp Tool and Connector System 56

BULK WIRE: COMMERCIAL COAX CABLE

CATV/MATV Video Cable 57
 CATV/MATV Quad Video Cable 58
 CCTV and Baseband Video Cable 59
 Serial Digital Video Cable 60-61

BULK WIRE: COMMERCIAL CONTROL CABLE

LibertyLinx™ Universal Control Cables 62-67
 Control Cable Individually Shielded 67
 Control Cable Shielded 68
 Control Cable Unshielded 69
 Specialized Cables for Lighting Systems 70-73
 Specialized Cables for Systems - Vantage 73
 Specialized Cables for Control Systems - AMX AXlink™ ... 74
 Specialized Cables for Control Systems - ELAN 74

BULK WIRE: COMMERCIAL FIBER OPTIC

Fiber Optic Solutions 75
 Bulk Fiber 75
 Durable Fiber 75
 Bulk Connectors SC, ST, LC 75
 Corning™ Field Termination Kit 76
 Termination Kit Connectors 77
 Custom Manufactured Fiber Assemblies 78
 Molded Fiber Optic Cable Assemblies 79
 Single Mode Fiber Optic Assemblies 79

Solutions for the AV PROFESSIONAL
www.libertycable.com

800-530-8998
 INTERNATIONAL - CALL +1-719-388-7542



Ordering is fast & easy.



Call today!

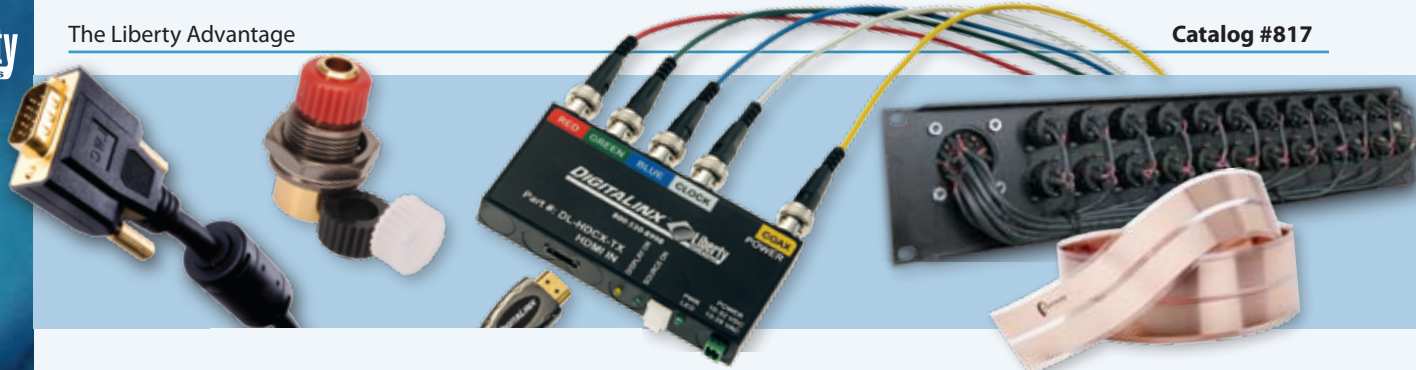

BULK WIRE: COMMERCIAL FIBER OPTIC *continued*

Multimode Fiber Optic Assemblies 50 / 125 μm..... 79-80
 Multimode Fiber Optic Assemblies 62.5 / 125 μm 80
 Multimode Fiber Optic Assemblies 10 Gig 50 / 125μm 81
 Additional Molded Fiber Optic Assemblies 81
 Structured Cables with Multimode Fiber 82
 HDMI Fiber Optic Extender 82
 Wall Plates For Fiber Optic Cables 82

BULK WIRE COMMERCIAL FIRE ALARM..... 83

BULK WIRE: COMMERCIAL RGB CABLE

RGBHV Mini 23 Solid AWG Cable 84-86
 RGBHV Mini 25 Solid AWG Composite Cable 86-87
 Solid 25 AWG Composite Cables 87-88
 Solid 25 AWG S-Video Cables 89
 Reduce Your Labor Costs 90-91
 RGBHV Mini and Composite Cables 92-93
 RGBHV Serial Digital Cables..... 94

BULK WIRE: COMMERCIAL SECURITY CABLE

Control Cable - Shielded & Unshielded 95
 CCTV and Baseband Video Cable 96

BULK WIRE: COMMERCIAL SPEAKER CABLE

TTP™ Premium Speaker Cable 97
 Commercial Speaker Cable..... 97
 Audio Connectec™ 98-99

BULK WIRE: COMMERCIAL TRAY CABLE 100

BULK WIRE: RESIDENTIAL AUDIO CABLE

AES/EBU 110 Ohm Digital Audio Snake Cable..... 101
 Broadcast Quality EZ-Strip Audio Cable -
 AUDIOCAT™ 102
 ExtraFlex™ Shielded Audio Cable 103
 Microphone X-Cross Cable 103

BULK WIRE - RESIDENTIAL: CATEGORY CABLE

Expand Your Category Solutions with Baluns..... 104-105
 Category Cable..... 106
 RGB Over UTP Applications TRUphase™
 Low-Skew Cable & CAT6A 107
 CATMaster™ Crimp Tool and Connector System..... 108

BULK WIRE: RESIDENTIAL COAX CABLE

E-Z Solutions: Retro-Fit..... 110-111
 CATV/MATV Direct Burial Video Cable 112
 CATV/MATV Video Cable..... 113
 CATV/MATV Quad Video Cable..... 114
 CCTV and Baseband Video Cable 115
 Mini Precision Video Cable..... 116
 RG58 50 Ohm Coax..... 116
 S-Video Cable..... 117
 Serial Digital Video Cable 118-119

BULK WIRE: RESIDENTIAL CONTROL CABLE

Control Cable Individually Shielded 120
 Control Cable Shielded 120

BULK WIRE: RESIDENTIAL FIBER OPTIC

Fiber Optic Solutions..... 121
 Bulk Fiber..... 121
 Durable Fiber 121
 Bulk Connectors SC, ST, LC 121
 Termination Kit Connectors..... 122
 Corning™ Field Termination Kit 123
 Custom Manufactured Fiber Assemblies..... 124
 Molded Fiber Optic Cable Assemblies..... 125
 Single Mode Fiber Optic Assemblies..... 125
 Multimode Fiber Optic Assemblies
 50 / 125 μm..... 125-126
 Multimode Fiber Optic Assemblies
 62.5 / 125 μm 126
 Multimode Fiber Optic Assemblies
 10 Gig 50 / 125μm..... 127
 Additional Molded Fiber Optic Assemblies 127
 Structured Cables with Multimode Fiber 128
 HDMI Fiber Optic Extender 128

Ordering is fast & easy.

Call today!

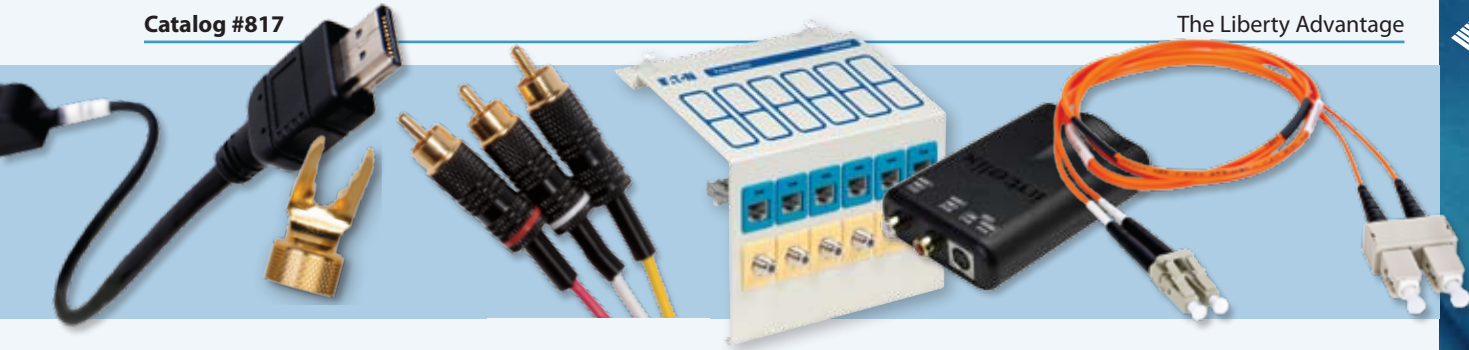

BULK WIRE: RESIDENTIAL HOMETRAX™

Speaker Cable 129
 AUDIOCAT Composite Cable..... 129
 CATV/MATV Quad Video Cable Non-Plenum 130
 Structured Cable: Everything to pre-wire a home! 130
 Unshielded Security Cable..... 131
 Category 5E UTP Cable..... 132
 CATMASTER™ Termination System for RJ45..... 132

BULK WIRE: RESIDENTIAL RGB CABLES

RGBHV Mini 23 Solid AWG Cable 133-135
 RGBHV Mini 25 Solid AWG Cable 136
 Solid 25 AWG Composite Cables 137
 Reduce Your Labor Costs 138-139
 RGBHV Mini Cable 140-141
 RGBHV Serial Digital Cables..... 142

BULK WIRE: RESIDENTIAL SECURITY CABLES

Control Cable - Shielded & Unshielded 143
 CCTV and Baseband Video Cable 144

BULK WIRE: RESIDENTIAL SPEAKER CABLE

Audio Connectec™ 146-147
 UltraCap™ Premium Speaker Cable 148
 ExtraFlex™ Premium Speaker Cable 148
 KO+™ Speaker Cable 149
 HomeTRAX™ Speaker Cable 149
 Direct Burial Speaker Cable 149
 Special Application Speaker Cable Clear Zip 150
 Special Application Speaker Cable Flat 150
 Commercial Speaker Cable..... 150

BULK WIRE: RESIDENTIAL STRUCTURED CABLE

Structured Cable..... 151-152
 AUDIOCAT™ Structured Cable by Liberty 153
 LibertyLinx™ Specialized Control Cable 153
 Low Voltage Mounting Brackets 153

CONNECTORS

Connex Crimper & BNC Connectors 155
 F Connector Termination Crimp Tool 155

CONNECTORS

Audio/Video Connectors 156
 Speaker Termination Connectors 156
 Audio Connectors and Adaptors 157
 Video Connectors and Adaptors..... 158
 Neutrik Connectors..... 159-160
 Connectec™ Termination System 161-167

DIRECT BURIAL

CAT5E..... 168
 CATV/MATV Direct Burial Video Cable 168
 LibertyLinx™ Universal Control Cables 169
 Direct Burial Speaker Cable 169
 Tray Cable..... 170

FLATWIRE™ SOLUTIONS

Flatwire Solutions..... 171-173

GREEN CONNECTIVITY

Halogen-Free Category Cable..... 175
 Halogen-Free Coax Cable 175-177
 Halogen-Free Speaker Cable..... 177

HDMI / DIGITAL SOLUTIONS

E-Z Solutions: HDMI..... 178-179
 DigitaLinx™ 180
 HDMI Over COAX 180-181
 HDMI Over Category Cable..... 182
 Stand Alone Wall Plates..... 182
 HDMI Repeaters, Amplifiers and Switchers..... 183
 HDMI Cables - Molded..... 184
 HDMI Switchers..... 185-186
 HDMI Extender 187
 Bulk Connectors SC, ST, LC 188
 HDMI Wall Plate Solutions 189
 DigitaLinx™ Pure Performance HDMI Cable 189

KITTING OPTIONS

..... 190

OEM

..... 191

Ordering is fast & easy.

Call today!



PANELCRAFTERS™

PanelCrafters Overview..... 192
 Design and Quoting Software Tools..... 193
 Proofing Process 194
 Plate and Panel Surface Finishes..... 195
 Alternative Gang Plate Options 196
 PanelCrafters™ Stock Plates 197
 Single Gang Plates 198-200
 Double Gang Plates..... 201-202
 Prewired Solutions 203
 Plate & Panel Solutions for Most Game Formats..... 204
 Plastic Decora-Style Plate Game Solutions 204
 Plate & Decora Solutions for Home Theater 205
 Standard Display & HDMI Solutions 206
 Which ActiveLinx™ Device Do You Need? 207
 Active Plates Available in All PanelCrafters™ Sizes 208
 ActiveLinx Testing Data & ActiveLinx™ USB Plates 208
 Extended Range Laptop & Desktop Solutions..... 210-211
 In-Wall Distribution Amplifier Solutions 211
 Bundled Breakout Solutions..... 212
 ActiveLinx™ HDMI/DVI Plates 212
 Custom Rack Panels..... 213
 Custom Plate Sizes 214
 PanelCrafters™ Connectors..... 215-218
 PanelCrafters™ Printed Products 219
 Custom Decora-Style Plates & Inserts 220-222
 Custom RackMate™ Header Panels..... 220
 Face Plates and Keystone Insert Jacks 223
 Decora and 106 Duplex Jack..... 223
 Additional Plates, Jacks and More..... 224-225
 PanelCrafters™ Printed Products 226

PROFESSIONAL ACCESSORIES

Magnepull Spider 227
 CATMASTER™ Termination System for RJ45..... 227
 Cable Ties..... 228
 Heat Shrink Tubing 229
 Connex Crimper 229
 F Connector Termination Crimp Tool 229

STRUCTURED CABLE SOLUTIONS

BY EATON..... 230 -233

TEKTONE™ COMPOSITE CABLE 234

TECHNICAL INFORMATION

Electrical Characteristics 235
 Residential Wire Schedule 236-237
 Commercial Plenum Wire Schedule 238-239
 NEC Cable Substitution and Hierarchy Chart..... 240
 Color Code Charts 241

INDEX BY PART NUMBER 249

ORDERING PRODUCTS

Placing Your Order With Liberty 250
 Website to Worksite:..... 252
 Order Form 253
 Credit Application 254-256

Ordering is fast & easy.



Call today!

Solutions for the AV PROFESSIONAL

www.libertycable.com

800-530-8998

INTERNATIONAL - CALL +1-719-388-7542



The Liberty **ADVANTAGE** ★★ ★

AV Professionals rely on Liberty's EXPERTISE, SELECTIONS & SERVICE.

Whether you are working in a simple residential installation or highly complicated commercial installation, Liberty recognizes that most AV projects are very customized. Yet these two pages provide a simplified view of the typical signal flow in both an audio and video installation which can assist in basic planning.

Our At-a-Glance Product guides, provide the AV professional with an easy to use map of which Liberty products provide the optimum solution for your AV project.

AUDIO-AT-A-GLANCE

Device to Device Interconnect

Pages.....40 – 47

Bulk Speaker Wire

Pages.....145 -150

Connectors

Pages.....154 - 167

Bulk Volume Control Cables

Page.....120

VIDEO-AT-A-GLANCE

Custom/Molded Cable Assemblies

Pages..... 18 – 39

Custom Wall Plates

Page..... 125

Bulk Coax and RGB Cables

Pages.....109-119 (Coax)

Pages..... 133-142 (RGB)

Connectors

Page..... 154 - 167

Most of our products are available in both Plenum and non-plenum configurations which are designed to work flawlessly in any residential or commercial environment. Flexibility and performance is why Liberty Wire and Cable products are the first choice of AV professionals world-wide.

These two simple schematics do not show all functional environments that an AV professional has to handle. To accommodate those AV professionals who work in an expanded capacity, Liberty does sell a broad selection of:

- Residential Bulk Audio Cables101
- Residential Bulk Category Cables.....104
- Residential Bulk Coax Cables109
- Residential Bulk Control Cables120
- Residential Bulk Fiber.....121
- Residential Bulk HomeTRAX™129
- Residential Bulk RGB Cables133
- Residential Bulk Security Cables143
- Residential Bulk Speaker Cables145
- Residential Bulk Structured Cables.....151

AUDIO AT-A-GLANCE

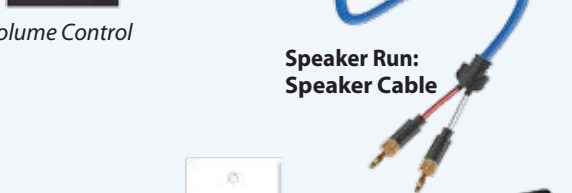

Audio At-A-Glance

Ordering is fast & easy.



Call today!

Solutions for the AV PROFESSIONAL
www.libertycable.com

800-530-8998
INTERNATIONAL - CALL +1-719-388-7542



Specifications Subject to Change

VIDEO AT-A-GLANCE

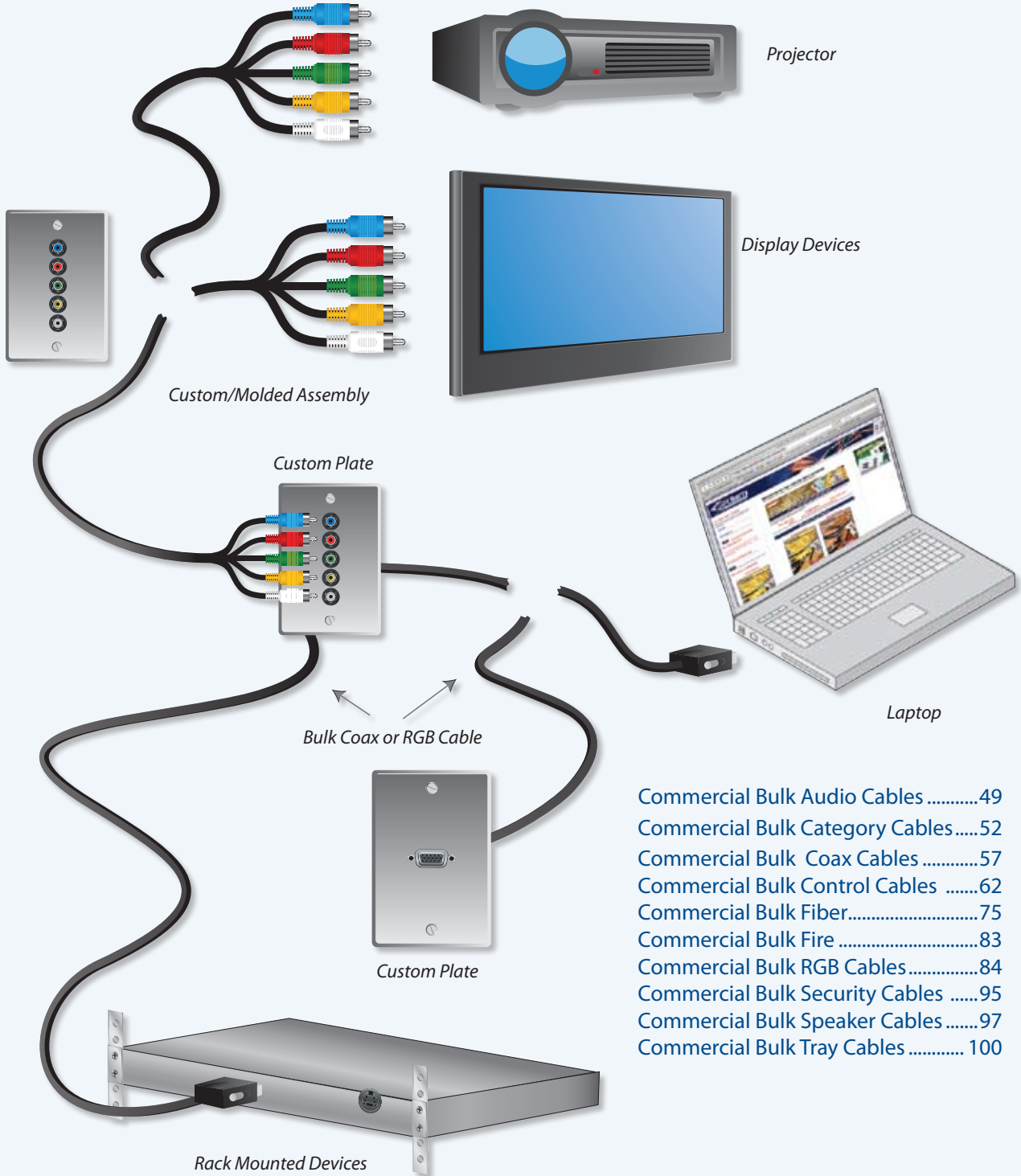

- Commercial Bulk Audio Cables49
- Commercial Bulk Category Cables.....52
- Commercial Bulk Coax Cables57
- Commercial Bulk Control Cables62
- Commercial Bulk Fiber.....75
- Commercial Bulk Fire83
- Commercial Bulk RGB Cables.....84
- Commercial Bulk Security Cables95
- Commercial Bulk Speaker Cables97
- Commercial Bulk Tray Cables 100

Ordering is fast & easy.



Call today!

**Solutions for the
AV PROFESSIONAL**
www.libertycable.com

800-530-8998
INTERNATIONAL - CALL +1-719-388-7542





Selection

With 7,000 products, Liberty's selection is unmatched in the Pro AV industry

- Products are offered in *Good, Better, Best* rankings to fit every project and budget
- Research and development of innovative products specifically for the Pro AV, Design-build and systems integration industry

- Expanded sample program provides actual product samples
- Products available worldwide: in 55 countries
- Highest quality products available

New Products From Liberty

FlatWire™ Solutions

Liberty is pleased to announce our innovative, patented paper thin wire that makes it possible to put Audio, Video and even Lighting exactly where you desire without tearing down dry wall or other wall surfaces.

See Page 171



Audio ConnectTec™

The same cutting-edge technology that Liberty developed for coax termination now makes this audio connector system an essential component of every residential audio installation.

See Page 161

Bundled Taped Solutions

Liberty's Taped Bundles allow you to design your own cables by combining any number of cables. See Page 59

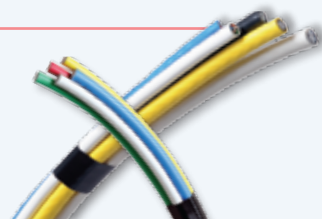

Kitting Solutions

Liberty's kitting takes the guess work out of your installation by making sure that you have the complete set of correct products for the project.

See Page 158

Structured Cable Solutions

Liberty presents Voice, Data, Video, Audio and Computer Networking Products from Eaton.

See Page 230

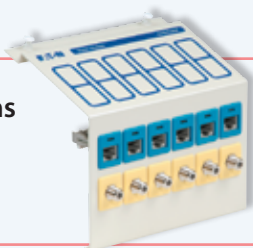

Product Categories Include:

- Audio Cables
- Bundled Taped Solutions
- Custom and Molded Copper Assemblies
- Custom Fiber Assemblies
- Category Cables
- Coax Cables
- ConneCTec™ Advanced Compression Connectors
- Standard Connectors/Adaptors
- Control Cables
- Digital Solutions - HDMI & DVI
- Fiber Optic Solutions
- Fire Alarm Cables
- FlatWire Solutions
- Halogen- Free Cable
- Kitting Solutions
- RGB Cables
- Security Cables
- Speaker Cables
- Structured Cable Solutions
- Tools
- Tray Cables
- Wall Plates and Rack Panels

Solutions for the AV PROFESSIONAL

www.libertycable.com

800-530-8998

INTERNATIONAL - CALL +1-719-388-7542



Ordering is fast & easy.



Call today!



Services

Individualized attention at every level of customer support

**Custom Installation Services:
Reduces Labor Time & Increases Efficiency**

- Custom Cable Printing with Dealer Name, Website and Key Information
- Custom Lengths
- Custom Cable Designs for Special Applications
- Custom Cable Bundling
- Custom Kitting
- Custom Copper Cable Assemblies
- Custom Fiber Assemblies
- Custom Cable Coloring: *Helps identify cables, signals, and applications more easily*
- PanelCrafter™ Plates and Panels Printed With with Dealer Logo: *Increases Brand Awareness*

Liberty's Advanced Product Services

- Patented Termination Solutions: *Proven labor saving solutions cuts install time by 70%*
- Cable Cutting and Printing Options
- Variety of Product Packaging Options
- Patented and Unique Molded Assemblies: *Labor Saving Solutions*
- Expanded Product Sample Program
- Green Products: *RoHS and Halogen-Free Compliant Products*

Quality Services

- Meet or Exceed all Published Specifications
- Constant Monitoring of NEC Codes, Rules and Regulations to provide the right product for your job
- Rigorous Documented Testing Procedures for All Products
- All products covered by Liberty's warranty

Account Services to Fit Every Business

- Multi-Layered Support: Customer Service Representatives, Territory Managers, Independent Manufacture Reps & Tech Support
- Competitive Project Pricing
- Free Ground Freight on Volume Orders
- Personal Attention
- Paperless Account Management Options
- Best Price
- Enhanced Return Policy
- Order and Shipping Confirmations
- Job Site Delivery Available
- Priority Plates/Panels Delivery Program: *Expedited Delivery*
- Published Liberty Recommended Wire Schedule: *Based Upon Applications*
- Custom Product Services

Web Services

- Live Webinars for termination, plate and panel design programs
- E-commerce site makes ordering and account management easy
- Plate and panel design software tools: CADBlox, CADQuote, Visio™ available for download
- Web-based plates and panels design tool, WebBlox needs no software

Ordering is fast & easy.



Call today!

Solutions for the AV PROFESSIONAL

www.libertycable.com

800-530-8998

INTERNATIONAL - CALL +1-719-388-7542





Value

Working with Liberty keeps your business competitive and profitable

Project Services

Regardless of the size of your installation project, Liberty makes it easier. Our staging program stages, labels and palletizes your individual project needs with all the installation materials including: bulk cables, bundled cables, connectors, custom assemblies, custom kits, tools, passive/active plates and panels. Liberty ships your pallets to any single or multiple job sites. Liberty project services reduce your cost, needed warehouse capacity, and ensures product availability and on-time delivery for your specified projects.

Inventory Services

Turn your warehouse into a Liberty warehouse. An on-site consigned inventory management program for all your offices: stocking potentially over 7,000 SKU's. Managed electronically with preset min./max. SKU levels, our inventory services ensures that your business has your specific day-to-day installation items in stock.

Liberty's inventory services reduces procurement and carrying costs: **maximizing your operational efficiency & increasing your productivity.**

Technical Services

- Consultative Technical Expertise
- Application and Product Support
- Cable Sample Book
- Conduit Master™ Fill Software
- Cross Reference Tools
- Product Spec Sheets

Reduce Your Cost, Increase Your Profit

- Take advantage of Liberty's volume & leveraged buying power
- Buy Factory Direct for Better Support
- Loyalty Programs
- Protect your business against copper & petroleum increases

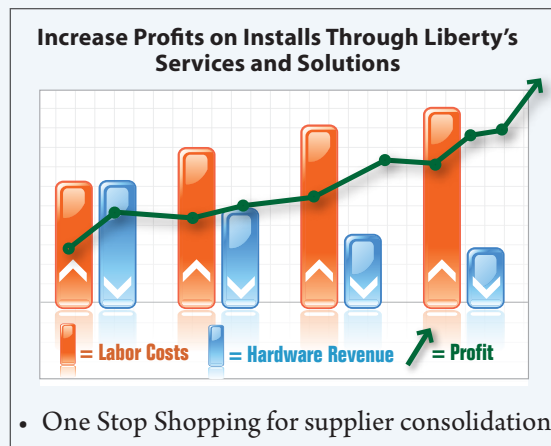
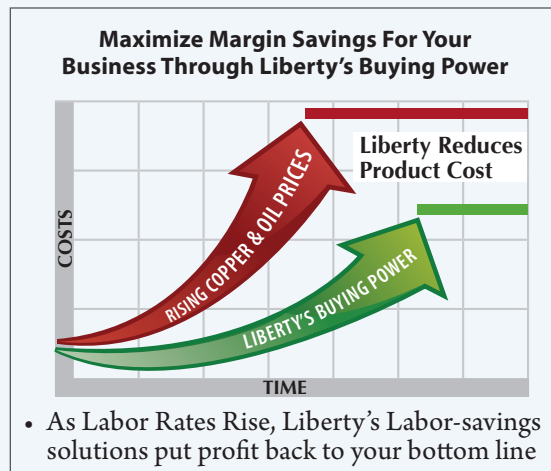

Ordering is fast & easy.



Call today!

Liberty Cares about the Environment and Your Business!

GREEN connectivity™

Liberty Wire & Cable's Green Connectivity™ initiative embraces environmentally sensitive corporate citizenship in both the AV products we manufacture as well as the way we do business.



Liberty has been a pioneer in developing green products – in most cases ahead of customer awareness and governmental legislation. In addition, our buildings and business processes are audited to reduce our overall energy consumption needs and increase our ability to recycle. Liberty Wire & Cable employs state of the art technologies to both monitor and reduce our energy consumption footprints, which helps to conserve our global resources.



Liberty Wire & Cable provides a broad selection of Green Connectivity™ solutions to the professional AV market: Solutions that both protect the environment and your business. Green Connectivity™ is how the professional AV industry stays connected.

Liberty Buildings and Facilities have a Green Footprint



Computer-Controlled Building Climate Controls

- > Turns off after normal business hours and turns on at 6 am
- > Automatically adjusts to the outside temperature

Computer-Controlled Lighting Controls

- > Automatically adjusts to daylight saving times
- > Interior illumination from high-efficiency fluorescent lamps

Computer-Controlled Drip Irrigation System

- > We only plant indigenous plants as they need less water
- > Rain sensors stop watering when it is raining

Recirculating Hot Water System

- > Uses only one hot water heater to conserve both water and energy

Low (E), Bronze-Glazed Windows

- > Reduces demand on our Climate Control System reducing both energy consumption and demand

Ordering is fast & easy.



Call today!

Solutions for the AV PROFESSIONAL

www.libertycable.com

800-530-8998

INTERNATIONAL - CALL +1-719-388-7542



Liberty Invests in **GREEN** connectivity TO BUILD YOUR BUSINESS

Liberty Wire & Cable is Committed to Constantly Expanding the Number of Environmentally Friendly Products We Manufacture

Halogen-Free Products

- › Low smoke halogen-free (LSZH) wire and cable products comply with spreading Green Market requirements for eliminating potentially dangerous chemicals.

Liberty's voluntary initiative comes as many governments, particularly in Europe and Japan, are considering LSZH legislation requiring the elimination of halogen as well as chlorine, fluorine, bromine and iodine. All are present in the PVC compounds widely used for more than half a century as insulation for wire and cable products.

Lead-Free Solder

- › Used in all custom and molded assemblies.

RoHS Compliant Products

- › Many countries are now implementing the Restriction of Hazardous Substance (RoHS) directive, mandating the reduction of Lead (Pb), Mercury (Hg), Cadmium (Cd), Hexavalent Chromium (Cr), Poly Brominated Biphenyl (PBB) and Polybrominated Diphenyl Ether (PBDE) in electronic and electrical equipment.

For several years, Liberty has been RoHS compliant with more than 90% of our products.

Liberty Warehouse Operations Deliver Green Initiatives



Warehouse Illumination

- › High-Efficiency Metal Halide-Lights use less energy

Forklifts

- › Eliminated all propane powered forklifts and replaced them with rechargeable battery units.

Reduced Packaging Materials

- › Eliminated plastic bubble wrap as packaging material, now we use recycled paper
- › All inbound pallets are reused
- › All corrugated cardboard packaging is recycled
- › Reduced box weights to reduce freight and fuel costs
- › Minimal use of plastic shrink wrap
- › All hand-held bar code scanners use rechargeable batteries

Liberty recycles all aluminum, copper, steel and plastic materials

- › Scrap material from Wall Plate, Rack Header, Rack Panel and Custom Assembly manufacturing operations is recycled.



Paperless Account Management Options

Liberty customers can request Paperless E-Invoices and E-Statements. Eliminating paper invoices and envelopes save over 17 trees per 2,000 pounds of paper.

Ordering is fast & easy.



Call today!

Solutions for the AV PROFESSIONAL
www.libertycable.com

800-530-8998
INTERNATIONAL - CALL +1-719-388-7542



Liberty's HDMI Solutions Keep You at the Cutting Edge: Trends in AV

We are at the beginning of the greatest change in video and computer display signal distribution since the computer was invented 50 years ago. What Digital Television (DTV) and the DVD™ did for the broadcast and video industries, HDMI™ is doing for the display industry.

The High-Definition Multimedia Interface (HDMI) includes High-bandwidth Digital Content Protection (HDCP™), digital audio and control in one cable and is backwards compatible.

HDMI is a digital signal distribution standard covering the electronic and mechanical specifications and licensing and is under the auspices of HDMI Licensing, LLC.

Source: In-Stat/MDR, 12/05

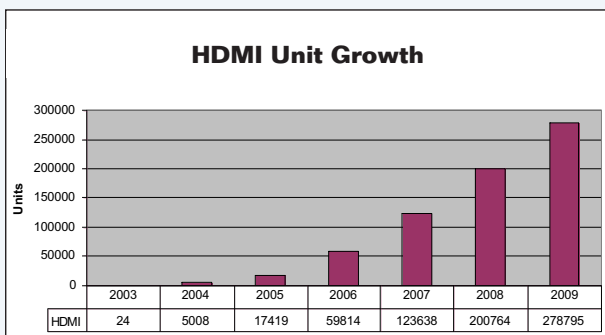

HDMI solves many of the challenges of analog signal distribution technologies such as composite, s-video, component, RGB, and CAT5 derivations of those signals. Unlike Serial Digital, MPEG, or FireWire™ technologies the signal is not compressed. Because of the inherent losses in Digital-to-Analog (DA) and Analog-to-Digital (AD) conversion, the benefits of HDMI are greatest with pixelated displays using such technologies as DLP, Plasma, LCD, and ILA. The images are improved for many reasons including compression/encoding errors, no DA or AD conversions, elimination of ground loops, and exact pixel-to-pixel mapping from source to display.

All images are produced using the primary colors; red, green and blue. To reduce storage and bandwidth transmission requirements these signals have been encoded (analog) and/or compressed (digitally) since we started seeing color television. Every time an analog signal is converted from RGB to composite, S-Video, or component and back, there is a visible loss of quality. Digital Compression (such as MPEG compression) also causes a visible loss of quality. Errors in the conversion process between Analog and Digital are also prone to visible errors.

Pixel mapping errors and scalers also result in a loss of resolution. Source and display should be set at the same resolution. If the pixels generated by source don't align exactly with the pixels in the display, the pixel's data is averaged between two adjacent pixels, dropping the resolution by half. Analog signals don't have pixel timing information and are subject to mis-adjustment and drift over time. This is more noticeable with computer sources than with video sources. Only a digital source such as HDMI offers the stability of one-to-one pixel mapping. Scaling has a similar effect as does the use of electronic keystone correction.

Digital signals are less subject to interference from outside the system. "Hum Bars" (wide horizontal bars which slowly roll through a picture) which are caused by grounding problems are non-existent. Cross-talk (ghosting) doesn't occur. You may still see these effects if the original material was created in an analog environment, but they aren't being caused by your system!

DVI and HDMI signals are compatible. That is to say that a simple cable is all you need to use the DVI digital output from your PC on your HDMI display. If you are going from an HDMI source to a DVI display, the DVI connector does not have the ability to transmit audio or control so don't expect the audio to work!

HDMI Solutions



Connectors:
• HDMI

Part #:
PC-1790



Connectors:
• HDMI
• RCA (Component)
• S-Video

Part #:
PC-G1250-S-P-B



Connectors:
• HDMI
• S-Video
• RCA (Video)
• RCA (Component)

Part #:
PC-G1254-S-P-B



Connectors:
• HDMI

Part #:
PCD-5850

Ordering is fast & easy.



Call today!

HDMI cable lengths from Liberty Wire are now limited to 115 feet (35 meters) without electronic repeaters for HDMI sources and displays. For longer runs, or where the cables must be terminated in the field, fiber optic repeaters are available to extend the length to several hundred feet. HDMI recommends that all electronics use external power (wall warts) – not the 5 volts available on the HDMI cable.

HDMI is a pure digital signal. The signal and image remains perfect up until the point of failure, then digital artifacts (sometimes called “sparklies”) and streaking start to appear. Just a few feet further the entire signal is lost. The Audio portion of the HDMI signal is usually the first component lost. The image will still be perfect but there will be no sound.

The other failure mode of HDMI systems is the HDCP handshake. The source, the display and all electronics in between must be HDCP compliant. Traditionally computers and computer displays are not HDCP compliant, although that is changing. If the handshake is not satisfactory, either the display will show a low resolution image, or a blue/blank screen. This varies from manufacturer to manufacturer.

At this catalog print the latest HDMI revision is specification 1.3. HDMI 1.3 has many features that may or may not be incorporated into HDMI equipment and these include the following:

- Higher speed: HDMI 1.3 increases its single-link bandwidth to 340 MHz (10.2 Gbps) to support the future demands, such as higher resolutions and high frame rates.
- Deep Color™: HDMI 1.3 supports 30-bit, 36-bit and 48-bit (RGB or YCbCr) color depths, up from the 24-bit depths in previous versions.
- Broader color space: HDMI 1.3 adds support for “xvYCC” color standard.
- New mini connector: With small portable devices such as HD camcorders and still cameras.

- Lip Sync: HDMI 1.3 incorporates automatic audio syncing capabilities that allows devices to perform this synchronization automatically.

HDMI 1.3 created a new cable specification. The previous HDMI 1.2 cable specification became Category 1 or Standard Speed. The new cable specification is Category 2 or High Speed. Standard Speed supports data rates up to 2.25 Gbps or resolutions up to 1080p24 deep color and includes 720p and 1080i. High Speed supports data rates up to 10.2 Gbps or resolutions up to 1440p60 or 1080p120.

Liberty has a complete line of HDMI cables and electronics for the commercial or residential installer.

Connector shape and signal data from HDMI Specifications:

Type A Connector >> Type A Connector

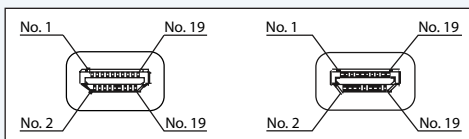

Table 4-8 Type A-to-Type A Cable Wire Assignment

Type A Pin	Signal Name	Wire	Type A Pin
1	TMDS Data 2+	A	1
2	TMDS Data 2 Shield	B	2
3	TMDS Data 2-	A	3
4	TMDS Data 1+	A	4
5	TMDS Data 1 Shield	B	5
6	TMDS Data 1-	A	6
7	TMDS Data 0+	A	7
8	TMDS Data 0 Shield	B	8
9	TMDS Data 0-	A	9
10	TMDS Clock+	A	10
11	TMDS Clock Shield	B	11
12	TMDS Clock-	A	12
13	CEC	C	13
14	Reserved (in cable but N.O. device)	C	14
15	SCL	C	15
16	SDA	C	16
17	DDC / CEC Ground	D	17
18	+5V Power	5V	18
19	Hot Plug Detect	C	19

HDMI Solutions



HDMI Cable
Part #: E-HDM-M-*



HDMI Plate

Connectors:
• 1 PMI-A6 (HDMI Repeater)
• 3 RCA

Part #:
PCA6-2C-326P



HDMI Extender Kit
Part #: E-HDM-M-HDR-*

Ordering is fast & easy.



Call today!

SECTION

1

The Liberty Advantage

	<p>John Dace General Manager</p> <p>John joined Liberty with 18 years experience building and leading sales operations for several Fortune status companies. Prior to joining Liberty, John served as National Sales Manager for Chief Manufacturing where he was responsible for 3 sales divisions with revenue projected over 60 M and 35% growth year over year. Before joining Chief, John was repeatedly</p>	<p>promoted for performance to Regional Manager at Nalco Chemical, a 2.9 Billion Fortune 1000 company, before becoming National Sales Manager at 3M Company, a 19 Billion Fortune 100 Company. John's background began with an intense engineering education (BS in Applied Science/Engineering) at the U.S. Naval Academy and subsequent commission as a Marine Officer.</p>
	<p>Ed Jankowski Vice President, Operations and Supply Chains</p> <p>Ed brings an extensive management background to Liberty. He was formerly Director of Strategic Planning for Image Micro Technology in San Jose, CA, providing emerging technology companies with supply chain and electronics manufacturing solutions. Prior to this, he was</p>	<p>the Division General Manager for Colorado for Rural/Metro Corporation. Ed also worked for the Arizona State Senate for three years. A Phoenix native, Ed received his business finance degree from the University of Arizona.</p>
	<p>Mike Brown Chief Financial Officer & Vice President of Finance</p> <p>Mike is uniquely qualified to help us take Liberty to the next level. For the past 5 years he has been the controller for the Smurfit-Stone container plant in Denver where he was responsible for all aspects of the accounting</p>	<p>operation. Mike has an extensive background in cost accounting as well as extensive experience with implementing financial systems and working with shipping & receiving operations.</p>
	<p>Kirk Horlbeck Senior Vice President of Corporate Marketing & International Business Development</p> <p>Kirk commands 30 years of Marketing and Sales Management experience. Prior to joining the Liberty team, Kirk worked as a professional management consultant developing a broad base of marketing and sales initiatives for a variety of corporate clients such as Abbott Laboratories, FedEx, Grainger Industrial Supply, IBM, Moore North America, Platinum Technology</p>	<p>and Reebok. In addition, his consulting practice serviced industrial clients in Brazil, China, Hong Kong, Philippines and Macau. Kirk was the Director of Marketing for the international advertising firm of J.L. Dearlove, Chicago as well as the Director of Marketing for LifeFitness. He holds both undergraduate and graduate degrees from the University of Illinois, Urbana.</p>
	<p>Arnold Wadlé Vice President of Operations</p> <p>Arnold has over 40 years experience in manufacturing and materials management. His business experience started in 1968 with IBM Corporation in Boulder, Colorado. His most recent position was Senior Purchasing</p>	<p>Manager for Omnipoint Technologies Corp. His expertise in supplier management and logistics has helped position Liberty Wire & Cable for continued growth.</p>
	<p>Dennis G. Whittaker Vice President of Product Services</p> <p>Dennis has over 20 years of manufacturing experience. He literally grew up in the family business that provided custom plates, panels and overlays to the electronic and aerospace industry since 1969. Dennis served as President of</p>	<p>WhiTronics, Inc. from 1992 through the sale of the business to Liberty in July 2001. His insight in work flow and product development are key resources in meeting Liberty's goals.</p>

Ordering is fast & easy.

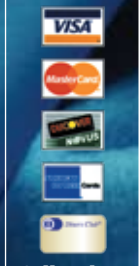







Call today!

Solutions for the AV PROFESSIONAL **800-530-8998** 

www.libertycable.com INTERNATIONAL - CALL +1-719-388-7542



	<p>James Blumhardt Vice President, Business Development and Consultant Relations</p> <p>James has over 27 years experience in the Pro AV, Broadcast and Systems Integration/Design Build Industry, working for a national integrator and multiple national/ multinational manufacturing companies in regional and national management positions. Prior to coming to Liberty, James has held positions of Sales Representative, AVI Systems, Regional Sales Manager, BARCO Display Systems, Director North America Sales,</p> <p>Hughes JVC Technology, Regional Sales Director SACO LED Displays, Eastern Zone Manager ,Sharp Electronics, LCD Products Group. James is based in Atlanta Georgia, where he directs, manages and positions Liberty's business development of connectivity solutions, products, services on a national scope with executive level management of Key Accounts, PSNI and the USAV Group.</p>
	<p>Cliff Wernet Western Region Director</p> <p>Cliff Wernet has 21 years of professional experience in the Audio Video industry. Cliff joined Liberty in 1998 as part of the team charged with establishing Liberty's commercial integration division. This division grew from a start up division to now accounting for 50% of Liberty's sales. Prior to joining the Liberty sales team, Cliff held positions as the inside sales technical manager for a large Audio/Video Representative firm in Northern California as well as the inside sales manager for the residential audiophile cable manufacturer Music Interface Technology (MIT). Cliff was promoted to Western Regional Manager for Liberty in 2007.</p>
	<p>Dan Reich Eastern Region Manager</p> <p>Dan Reich comes to Liberty with over a decade's worth of sales and management experience in a variety of industries. Prior to joining Liberty Wire & Cable, Dan was the Internet Sales Manager as well as the Subaru Sales Manager for John Marzolf Nissan Subaru, located in Pueblo, Colorado. Before selling cars, Mr. Reich held the position of Vice President of Operations for High State Capitol. Dan was instrumental</p> <p>in the development of a small business banking product which, within a year's time, had distribution in a 6 state region and a portfolio of over \$5 million. He was an integral part of the sale of High State Capital to a Fortune 500 Company based in California. This native of Colorado Springs holds a Bachelor of Business Administration from The University of Notre Dame.</p>
	<p>Kevin Cole Commercial National Accounts Manager</p> <p>Kevin, an 8 year veteran of Liberty Wire & Cable, started his career at Liberty with the team responsible for the development of Liberty's commercial business. Kevin has held increasingly more responsible roles at Liberty most recently holding the title of Regional Sales Manager for the Central Region.</p> <p>Kevin's leadership and sales management skills bring great focus to Liberty's National account responsibilities. Kevin holds a degree from Colorado State University.</p>
	<p>Dee Brady Residential National Accounts Manager</p> <p>Dee has been instrumental in the growth of Liberty Wire & Cable in her 10+ years with the company. She has managed several territories and helped implement new product launches and customer initiatives.</p> <p>Dee was promoted to Residential National Accounts Manager in 2006. The Colorado native has a BA from the University of Colorado.</p>
	<p>Gary Vlaeminck Distribution/OEM Sales Manager</p> <p>In 1994, after finishing school in England, Gary joined Lutron Electronics at their London office, where he became part of the field service team for Europe. With an in-depth knowledge of the products, Gary travelled to 30+ countries, programming and servicing Lutron's control systems, regularly working closely with other system integrators and contractors. In '98, Gary transferred to Lutron's corporate offices</p> <p>in PA and helped develop and grow their Pro A/V channel. In 2000, Gary's career returned to international territories when his responsibilities entailed the daily support of Lutron's local sales teams in the Middle East and Asia. Gary joined SpeakerCraft as their EMEA Sales Manager 2004, where he grew the territory almost 600% before joining Liberty in December of 2007.</p>

Solutions for the AV PROFESSIONAL
www.libertycable.com

800-530-8998
 INTERNATIONAL - CALL +1-719-388-7542



Ordering is fast & easy.



Call today!

SECTION

1

The Liberty Advantage

Bill Schripsema

Director of Product Management



Bill is an industry veteran with over 30 years of successful sales, management and technical endeavors in the Pro AV and Broadcast industry, most recently serving as the General Manager of Spinitar's Northern

California offices. Bill has successfully represented several manufacturers including Barco, Christie Digital and General Electric to AV Rental & Staging providers.

Mark Guillan

Sales Operations Manager



Mark has over 20 years experience managing the customer service function in several industries. He comes to Liberty Wire & Cable from a 10 year career with Xpedx Paper, a division of International Paper, where he was Store Manager and Colorado District Manager. Mark also was Customer Service Manager for Current

Inc. (check division), where he managed a large inbound national call center. He was Director of Visitor Services for Cheyenne Mountain Zoo. Mark has a BS in Business Administration from Colorado State University.

Ralph E. Parrett

Director of Quality and Technical Services



Ralph has over 25 years experience in signal processing technologies. A USMC veteran trained in COMSEC equipment maintenance and repair. He joined Amphenol Interconnect Products Corporation after his service completed and served in all levels of custom cable assembly manufacture. Ralph was recruited by Skyline Electronics to serve as the Production Supervisor over PCB manufacturing.

Ralph joined the Liberty team in 1997 and established the custom assembly department. He has an extensive quality background serving on two successful ISO implementation teams and working very closely with UL & CSA in product safety and performance certifications. Ralph is a member of the NFPA and a recognized expert on wire and cable code conformance

Anthony DiCesare

Warehouse Manager, Colorado Springs Headquarters



Anthony has over 15 years experience in warehousing and production management. He is knowledgeable in all areas of warehousing including inside and outside sales, working in customer service environments for over 20 years. Before becoming part of the Liberty Team, Anthony worked for Quantum Corporation. His many duties included working with the PSG,

MRB, and Component groups, as well as the Engineering departments. He worked closely with other divisions of Quantum, supplying Dundalk Ireland and Penang Malaysia with inventory. His customer service values help keep Liberty Wire & Cable a leader in the wire and cable industry.

BJ Sullivan

Assembly Production Manager



BJ has over 19 years of experience in manufacturing, product configuration, product support (field service & warranty return) and new product(s) introduction management. His Hi Tech journey started in 1982 with Digital Equipment Corp. in Springfield Massachusetts, then to Digital in Colorado Springs. Through the Quantum acquisition of Digital in 1993, he became the Process Configuration Manager

for Quantum with responsibilities in Colorado, Dundalk Ireland, and Penang Malaysia. Diverse experience in people management, team building, assembly processing, ISO-9000 preparation, work cell concepts and customer service help assist Liberty Wire and Cable to stay aggressive in cost, quality and delivery metrics through a solidly built and functional workforce.

Ordering is fast & easy.



Call today!

Solutions for the AV PROFESSIONAL

www.libertycable.com

800-530-8998

INTERNATIONAL - CALL +1-719-388-7542



Liberty Molded Assembly Differentiation

Details matter in the selection of components for your display system. Here's how Liberty components beat most of the competition. These differences have

significant costs. Do you want to take a chance with your presentation or home theater in order to save a couple dollars.



PART #: E-MVGAANM-M-*



PART #: D-VGAM-M-*

AWM vs CL & CM Ratings

Many competitive products use UL AWM ratings for molded assemblies. AWM cables are designed to be used inside appliances or between appliances, not inside the wall. AWM Ratings are not regulated by the NEC® and are not authorized as substitutions for CL & CM rated product. Liberty E series cables are CMG FT4 rated.

26 AWG Coax vs. 28 and 30 AWG Coax

Many Competitive products use very thin coaxial cables. The normal size for a professional installation is 26 AWG or larger. Thinner cables have less bandwidth and higher attenuation resulting in shorter distances and lower resolutions. Liberty full sized products use 26 AWG coaxial components.

75 Ohm Connectors vs. 50 Ohm Connectors

Most Video connections today use a 75 Ohm impedance circuit. It is always best practice to use matched impedance cable and connectors. Liberty has a full line of 75 Ohm BNC connectors matched to nearly every 75 Ohm coaxial cable commercially available. Many cheap and readily available molded products use 50 Ohm or non-specific impedance BNC connectors. At lower frequencies this may not create any issues but at the higher frequencies in the RGBHV world the 50 Ohm impedance mismatch can affect and reduce the quality of the signal. All Liberty molded interconnects use 75 BNC connectors.

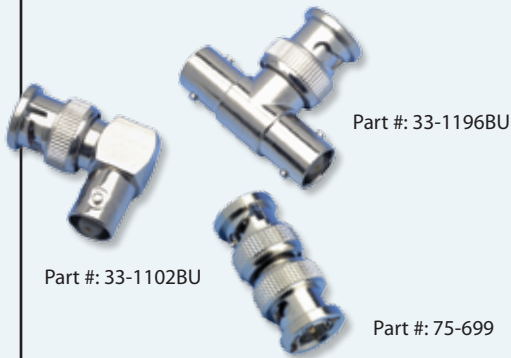

Part #: 33-1196BU

Part #: 33-1102BU

Part #: 75-699



Mechanical Strength and Strain Relief

Most system failures are a result of failures where the connector meets the cable: solder joints, bent and broken connectors and over-bent wire. Only mechanical strength from heavy duty plastic and metal can protect this vulnerable point in your system. Liberty cables are some of the strongest in the industry.

Ordering is fast & easy.



Call today!

Solutions for the AV PROFESSIONAL
www.libertycable.com

800-530-8998
INTERNATIONAL - CALL +1-719-388-7542



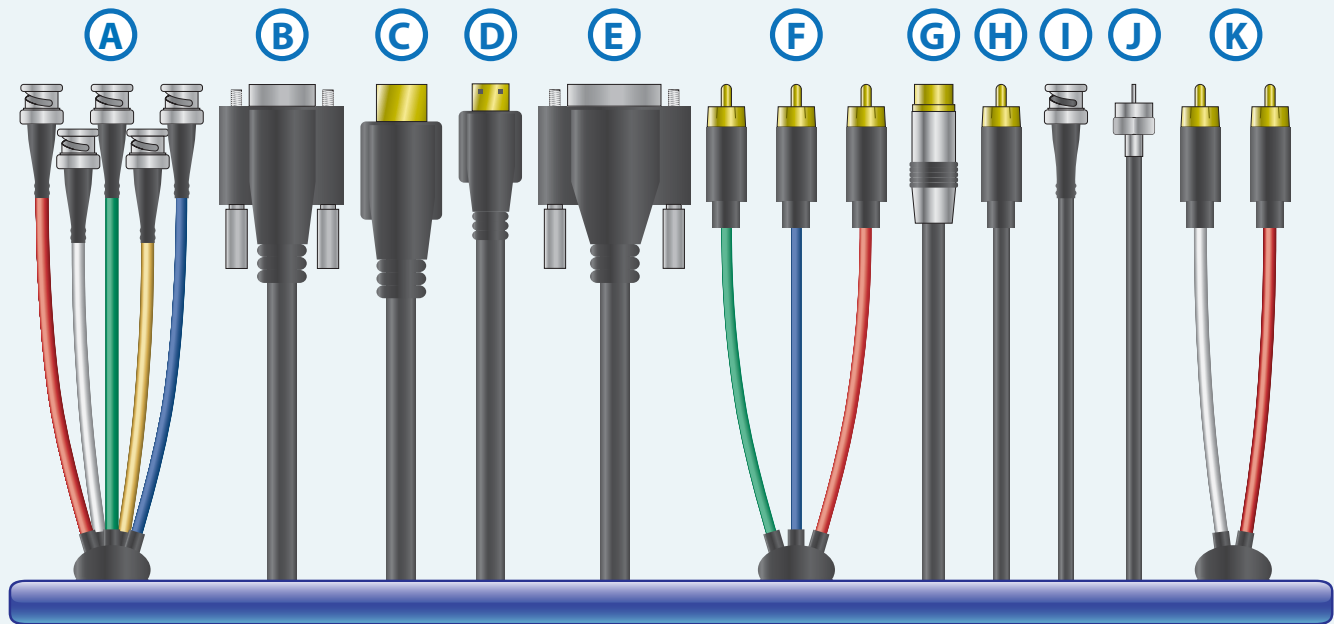
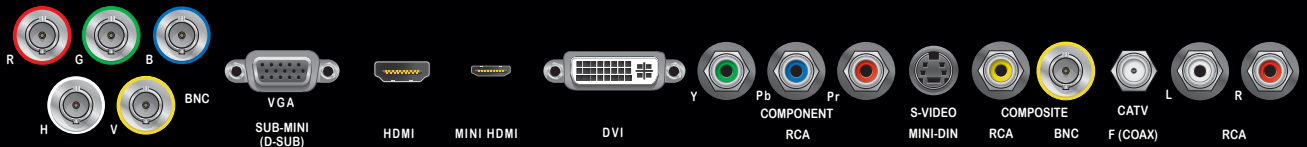

A RGB/HV Input
 RGB/HV inputs are typically used to connect Video scalers and PCs to plasma screens. Individual mini coax cables provide video and sync signals using true 75 ohm BNC connectors.
See Page 28

B VGA (Video Graphics Array), HDB15 Inputs
 VGA inputs are typically used to connect PCs to projectors and plasma screens.
See Page 26, 33, 34

C HDMI: High Definition Multimedia Interface
 This type of cable carries HDTV Digital Video, up to 7.1 channel digital audio, CEC IR communication between audio and video equipment.
See Page 25

D MINI HDMI: High Definition Multimedia Interface
 A smaller version of the standard HDMI connector typically used on portable devices like digital cameras and camcorders.

E DVI (Digital Video Interface) Inputs
 Can be either a digital only connection or a combination digital and analog connection.
See Page 24

F Component Video Inputs* (RCA or BNC) (Y,Pb,Pr)
 This is the highest Consumer Analog Television input for resolutions up to 720p/1080i.

G S-Video Inputs (4Pin Mini Din)
 Separates the luminance (white level) and chrominance (color information) minimizing distortion, increasing bandwidth.
See Page 32

H & I Composite Video Input 1, 2* (RCA or BNC)
 Standard "AV" connector. This is color coded Yellow for composite video.
See Page 23

J F Connector Input
 Used primarily for CATV, DBS, and Broadband signals.

K Analog Audio (L+R) Input RCA Jacks
See Page 20, 21

Ordering is fast & easy.



Call today!

Solutions for the AV PROFESSIONAL
www.libertycable.com

800-530-8998
 INTERNATIONAL - CALL +1-719-388-7542



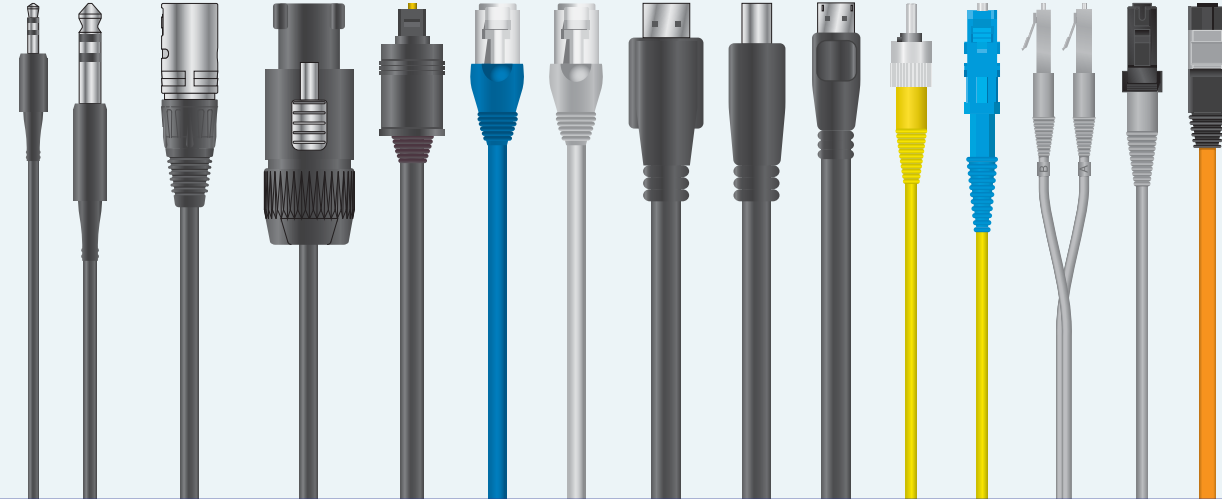
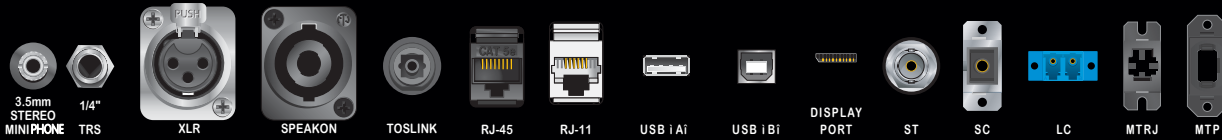

- L Mini Phone Jack, 3.5mm Stereo**
Used for headphones or computer audio output.
- M Phone Jack, 1/4" TRS Stereo**
Used for microphone and instrument inputs.
See Page 20, 21
- N 3 Pin Female XLR**
Used to carry balanced audio signals and microphone inputs.
See Page 36
- O Neutrik Speakon**
Available in 2,4 and 8 pole formats for speaker connections.
See Page 159, 160
- P Toslink Coupler**
Fiber optic cable for digital audio home use. *See Page 47*
- Q RJ-45 For CAT5e**
CAT5e-8 pin data and network connections.
- R RJ-11**
CAT3 phone type connections.
- S & T USB**
Used to connect computers to devices. Standard USB cables are "A" on one end and "B" on the other. *See Page 32*
- U Display Port**
Used to connect computers to keyboard, mouse and other peripheral devices.

FIBER OPTIC CONNECTOR TYPES
Over the years as fiber-optic communications have grown and changed, there have been many different types of connectors. Today there are four common connector types that are used in most fiber-optic applications. *See Pages 125 -127*

V ST Connector
Bayonet-style connector is similar to a coaxial BNC connector and is available for single-mode and multimode applications.

W SC Connector
Square snap-in-type connector and has gained popularity in the video and computer networking industries. Many applications typically require two fibers: one for transmitted data and one for received data traffic. Also available in Duplex format.

X LC Connector
An LC is approximately half the size of an SC connector. It is rectangular in shape and has a locking clip, common in newer AV equipment. Clips are available to join two LC connectors for duplex connections.

Y MT-RJ Connector
Small-form-factor connector package that doubles the density compared to standard SC connectors.

Z MT Connector
Multi-fiber connector housing up to 24 fibers in a single ferrule. The MT is also referred to as MTP®.

Ordering is fast & easy.

Call today!

Solutions for the AV PROFESSIONAL
www.libertycable.com

800-530-8998
INTERNATIONAL - CALL +1-719-388-7542



Custom and Molded Assemblies

Liberty provides the AV professional with the broadest selection of cable assemblies in the industry: offering both high-quality custom cable assembly solutions and high performance molded cable assemblies that are designed for any project and any budget.

Our hand-crafted custom cable assemblies are constructed with true broadcast quality components. Our custom manufactured assemblies are 100%

tested for quality and performance and carry the best warranty in the industry.

For non-plenum applications, Liberty PVC molded cable assemblies provide quality levels that are unmatched in the industry. Our molded cable assemblies have a professional high-end appearance accentuated by sleek design elements that include an excellent cable hand and durable strain relief.

Audio Cables - Custom and Molded

1. PVC 3.5 Male Stereo to 3.5 Male Stereo

Connection	Length (ft.)	Part #
3.5 Stereo Male to 3.5 Stereo Male	10	221P-3.5TRSM-M-10
	25	221P-3.5TRSM-M-25
	35	221P-3.5TRSM-M-35
	50	221P-3.5TRSM-M-50
	75	221P-3.5TRSM-M-75
	100	221P-3.5TRSM-M-100
	125	221P-3.5TRSM-M-125

Ships Same Day!

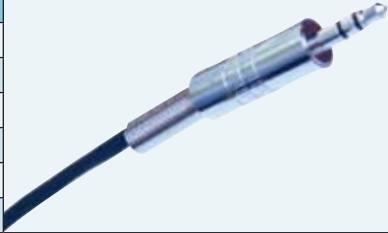

Standard lengths shown. Custom lengths available.

2. Plenum 3.5 Male Stereo to 3.5 Male Stereo

Connection	Length (ft.)	Part #
3.5 Stereo Male to 3.5 Stereo Male	10	P221P-3.5TRSM-M-10
	25	P221P-3.5TRSM-M-25
	35	P221 P-3.5TRSM-M-35
	50	P221P-3.5TRSM-M-50
	75	P221P-3.5TRSM-M-75
	100	P221P-3.5TRSM-M-100
	125	P221P-3.5TRSM-M-125

Ships Same Day!



Standard lengths shown. Custom lengths available.

3. PVC 3.5 Male to 3.5 Male

Connection	Length (ft.)	Part #
PVC 3.5 Male to 3.5 Male	3	E-3.5SM-M-3
	6	E-3.5SM-M-6
	12	E-3.5SM-M-12
	25	E-3.5SM-M-25
	35	E-3.5SM-M-35
	50	E-3.5SM-M-50
	75	E-3.5SM-M-75
	100	E-3.5SM-M-100

The Perfect Combo



Works perfectly with plate # PCD-5080 page 204



Ships Same Day!

Standard lengths shown. Custom lengths available.

4. Plenum 3.5 Male Stereo to 2 Male RCAs

Connection	Length (ft.)	Part #
3.5 Male Stereo to 2 Male RCAs	10	P222P-3.5SM-2RCAM-10
	25	P222P-3.5SM-2RCAM-25
	35	P222P-3.5SM-2RCAM-35
	50	P222P-3.5SM-2RCAM-50
	75	P222P-3.5SM-2RCAM-75
	100	P222P-3.5SM-2RCAM-100
	125	P222P-3.5SM-2RCAM-125



Standard lengths shown. Custom lengths available.

Ordering is fast & easy.



Call today!

Solutions for the AV PROFESSIONAL

www.libertycable.com

800-530-8998

INTERNATIONAL - CALL +1-719-388-7542



Custom and Molded Assemblies

5. PVC 3.5 Male Stereo to 2 Male RCAs		
Connection	Length (ft.)	Part #
2 RCA Male to 2 RCA Male	10	222P-3.5SM-2RCAM-10
	25	222P-3.5SM-2RCAM-25
	35	222P-3.5SM-2RCAM-35
	50	222P-3.5SM-2RCAM-50
	75	222P-3.5SM-2RCAM-75
	100	222P-3.5SM-2RCAM-100
	125	222P-3.5SM-2RCAM-125



Standard lengths shown. Custom lengths available.

6. Z100 3.5mm Stereo to L/R Audio Interconnect		
Connection	Length (ft.)	Part #
3.5 Male Stereo to L/R RCA Male	3	Z100AY3FT
	6	Z100AY6FT
	15	Z100AY15FT
	25	Z100AY25FT

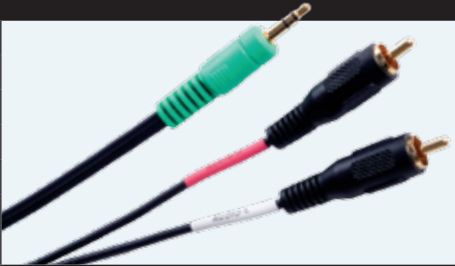

Standard lengths shown. Custom lengths available.

7. PVC 2 RCA Male to 2 RCA Male		
Connection	Length (ft.)	Part #
2 RCA Male to 2 RCA Male	10	222P-2RCAM-M-10
	25	222P-2RCAM-M-25
	35	222P-2RCAM-M-35
	50	222P-2RCAM-M-50
	75	222P-2RCAM-M-75
	100	222P-2RCAM-M-100
	125	222P-2RCAM-M-125



Standard lengths shown. Custom lengths available.

8. Plenum 2 RCA Male to 2 RCA Male		
Connection	Length (ft.)	Part #
2 RCA Male to 2 RCA Male	10	P222P-2RCAM-M-10
	25	P222P-2RCAM-M-25
	35	P222P-2RCAM-M-35
	50	P222P-2RCAM-M-50
	75	P222P-2RCAM-M-75
	100	P222P-2RCAM-M-100
	125	P222P-2RCAM-M-125



Standard lengths shown. Custom lengths available.



9. Z-100 Audio Interconnects (pair)		
Connection	Length (ft.)	Part #
3.5 Stereo Male to 3.5 Stereo Male	3	Z100A3FT
	6	Z100A6FT
	15	Z100A15FT
	25	Z100A25FT

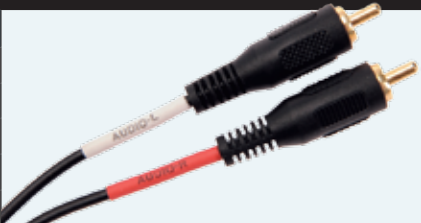

Ordering is fast & easy.



Call today!

Composite Video Cables - RG59/20 AWG - Custom

1. PVC RCA Male to RCA Male

Connection	Length (ft.)	Part #
RCA Male to RCA Male	10	RG59-RCAM-M-10
	25	RG59-RCAM-M-25
	35	RG59-RCAM-M-35
	50	RG59-RCAM-M-50
	75	RG59-RCAM-M-75
	100	RG59-RCAM-M-100
	125	RG59-RCAM-M-125

Ships Same Day!



Standard lengths shown. Custom lengths available.

2. Serial Digital Video Cable

Connection	Length (ft.)	Part #
RCA Male to RCA Male	10	20SD-RCAM-M-10
	25	20SD-RCAM-M-25
	35	20SD-RCAM-M-35
	50	20SD-RCAM-M-50
	75	20SD-RCAM-M-75
	100	20SD-RCAM-M-100
	125	20SD-RCAM-M-125

Ships Same Day!



Standard lengths shown. Custom lengths available.

3. Plenum Serial Digital Video Cable

Connection	Length (ft.)	Part #
RCA Male to RCA Male	10	P20SD-RCAM-M-10
	25	P20SD-RCAM-M-25
	35	P20SD-RCAM-M-35
	50	P20SD-RCAM-M-50
	75	P20SD-RCAM-M-75
	100	P20SD-RCAM-M-100
	125	P20SD-RCAM-M-125

Ships Same Day!



Standard lengths shown. Custom lengths available.

4. Plenum RCA Male to RCA Male

Connection	Length (ft.)	Part #
RCA Male to RCA Male	10	PRG59-RCAM-M-10
	25	PRG59-RCAM-M-25
	35	PRG59-RCAM-M-35
	50	PRG59-RCAM-M-50
	75	PRG59-RCAM-M-75
	100	PRG59-RCAM-M-100
	125	PRG59-RCAM-M-125

Ships Same Day!



Standard lengths shown. Custom lengths available.

5. PVC RCA Male to Male

Connection	Length (ft.)	Part #
RCA Male to RCA Male	10	E-RCAM-M-10
	25	E-RCAM-M-25
	35	E-RCAM-M-35
	50	E-RCAM-M-50
	75	E-RCAM-M-75
	100	E-RCAM-M-100
	125	E-RCAM-M-125



Standard lengths shown. Custom lengths available.

Ordering is fast & easy.



Call today!

**Solutions for the
AV PROFESSIONAL**
www.libertycable.com

800-530-8998
INTERNATIONAL - CALL +1-719-388-7542



Composite Video Cables - RG59/20 AWG - Custom

6. PVC RCA Male to Male		
Connection	Length (ft.)	Part #
RCA Male to RCA Male Non-UL Rated	3	Z100V-3
	6	Z100V-6
	15	Z100V-15
	25	Z100V-25

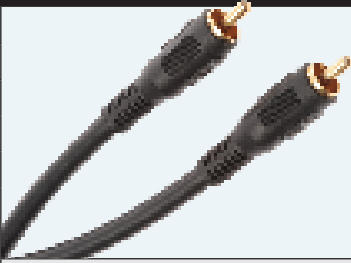

Standard lengths shown. Custom lengths available.

7. Serial Digital Video Cable		
Connection	Length (ft.)	Part #
BNC Male to BNC Male	10	20SD-BNCM-M-10
	25	20SD-BNCM-M-25
	35	20SD-BNCM-M-35
	50	20SD-BNCM-M-50
	75	20SD-BNCM-M-75
	100	20SD-BNCM-M-100
	125	20SD-BNCM-M-125



Standard lengths shown. Custom lengths available.

8. Plenum Serial Digital Video Cable		
Connection	Length (ft.)	Part #
BNC Male to BNC Male	10	P20SD-BNCM-M-10
	25	P20SD-BNCM-M-25
	35	P20SD-BNCM-M-35
	50	P20SD-BNCM-M-50
	75	P20SD-BNCM-M-75
	100	P20SD-BNCM-M-100
	125	P20SD-BNCM-M-125



Standard lengths shown. Custom lengths available.

9. PVC BNC Male to Male		
Connection	Length (ft.)	Part #
BNC Male to BNC Male	10	E-BNCM-M-10
	25	E-BNCM-M-25
	35	E-BNCM-M-35
	50	E-BNCM-M-50
	75	E-BNCM-M-75
	100	E-BNCM-M-100
	125	E-BNCM-M-125



Standard lengths shown. Custom lengths available.

Assemblies: Custom & Molded

Ordering is fast & easy.



Call today!

**Solutions for the
AV PROFESSIONAL**
www.libertycable.com

800-530-8998
INTERNATIONAL - CALL +1-719-388-7542



DVI (Digital Video Interface) Cables - Molded

High performance at highly competitive prices. Liberty meets the stringent demands of Digital Video Interface (DVI) standards in both copper and fiber optic platforms with a range of high performance products. From sleek, elegantly designed male-to-

male DVI assemblies to DVI to BNC breakout cables for projector installations, to high-speed and long-distance DVI signal transmission, Liberty DVI cable products meet exacting industry standards, while offering you highly competitive pricing.

1. Digital DVI Male to Digital DVI Male Dual Link

Connection	Length (m)	Part #
Digital DVI Male to DVI Male Link	1	Z400DVI-D/DL1
	2	Z400DVI-D/DL2
	4	Z400DVI-D/DL4
	6	Z400DVI-D/DL6
	8	Z400DVI-D/DL8
	10	Z400DVI-D/DL10
	12	Z400DVI-D/DL12
	15	Z400DVI-D/DL15



2. Digital DVI Male to Digital DVI Male Single Link

Connection	Length (m)	Part #
DVI Single Link Male to Male	1	E-DVIDSL-1
	2	E-DVIDSL-2
	4	E-DVIDSL-4
	6	E-DVIDSL-6
	8	E-DVIDSL-8
	10	E-DVIDSL-10



3. Analog DVI Male to 5 BNC Female Breakout

Connection	Length (ft.)	Part #
DVI-A Male to 5 BNC Female Breakout	1	E-DVI/A-5BNCF-1
	3	E-DVI/A-5BNCF-3
	6	E-DVI/A-5BNCF-6



4. Analog DVI Male to 5 BNC Male Breakout

Connection	Length (ft.)	Part #
DVI-A to 5 BNC Male Breakout	15	E-DVI/M-5BNCM-15



Ordering is fast & easy.



Call today!

Solutions for the AV PROFESSIONAL

www.libertycable.com

800-530-8998

INTERNATIONAL - CALL +1-719-388-7542



HDMI® (High-Definition Multimedia Interface) Cables - Molded

With the ability to run multi-channel video, audio and control down one cable, Liberty's HDMI cables offer the ultimate digital solution. Design details include a HDMI connector and HDCP

and EDID compliancy. Liberty also offers a HDMI to DVI breakout cable to connect A/V devices that might use the two different digital interface connections.

1. HDMI Cable		
Connection	Length (m)	Part #
HDMI Male to HDMI Male	.5	E-HDM-M-5
	1	E-HDM-M-1
	2	E-HDM-M-2
	3	E-HDM-M-3
	4	E-HDM-M-4
	5	E-HDM-M-5
	6	E-HDM-M-6
	8	E-HDM-M-8
	10	E-HDM-M-10
	12	E-HDM-M-12
	15	E-HDM-M-15
	20	E-HDM-M-20*
	25	E-HDM-M-25*
	30	E-HDM-M-30*
35	E-HDM-M-35*	



*Length may require to be used with DigitalINX HDMI Repeater





2. HDMI High Speed Cable		
Connection	Length (ft.)	Part #
HDMI 1.3 High Speed (10.2 Gbps) certified	1	E-HDSM-M-1
	1.5	E-HDSM-M-1.5
	2	E-HDSM-M-2
	3	E-HDSM-M-3
	4	E-HDSM-M-4
	5	E-HDSM-M-5
	6	E-HDSM-M-6
	8	E-HDSM-M-8
	10	E-HDSM-M-10

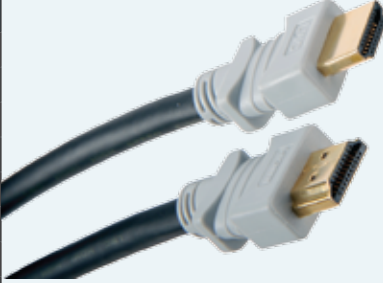

Standard lengths shown. Custom lengths available.



3. HDMI to DVI Single Link		
Connection	Length (m)	Part #
	1	E-HDM-DVI-1
	2	E-HDM-DVI-2
	3	E-HDM-DVI-3
	4	E-HDM-DVI-4
	5	E-HDM-DVI-5
	6	E-HDM-DVI-6
	8	E-HDM-DVI-8
	10	E-HDM-DVI-10
	12	E-HDM-DVI-12
	15	E-HDM-DVI-15
20	E-HDM-DVI-20	

Solutions for the AV PROFESSIONAL

www.libertycable.com

800-530-8998

INTERNATIONAL - CALL +1-719-388-7542

Ordering is fast & easy.



Call today!

HDMI® (High-Definition Multimedia Interface) Cables - Molded

4. HDMI Extender Kit

Connection	Length (ft.)	Part #
Kit includes long HDMI cable, repeater, and a 1 meter HDMI cable	20	E-HDM-M-HDR-20
	25	E-HDM-M-HDR-25
	30	E-HDM-M-HDR-30
	35	E-HDM-M-HDR-35



5. HDMI Repeater

Connection	Part #
Inputs : HDMI Female port Output : HDMI Female port HDCP compliant	DL-HDR



Install Cables - Custom

Liberty manufactures a number of customized “single cable” solutions to support our faceplate offerings. Under one jacket we can build solutions

to support multiple video, audio and control configurations to reduce the number of cables required to support your application.

1. PVC VGA, RCA Video + 3.5 Mini Stereo

Connection	Length (ft.)	Part #
VGA, RCA Video + 3.5 Mini Stereo	10	F-2V1A-10
	25	F-2V1A-25
	35	F-2V1A-35
	50	F-2V1A-50
	75	F-2V1A-75
	100	F-2V1A-100
	125	F-2V1A-125



Standard lengths shown. Custom lengths available.

2. Plenum VGA, RCA Video + 3.5 Mini Stereo

Connection	Length (ft.)	Part #
VGA, RCA Video + 3.5 Mini Stereo	10	G-2V1A-10
	25	G-2V1A-25
	35	G-2V1A-35
	50	G-2V1A-50
	75	G-2V1A-75
	100	G-2V1A-100
	125	G-2V1A-125

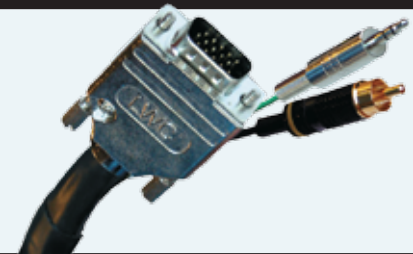

Standard lengths shown. Custom lengths available.

Ordering is fast & easy.



Call today!

Solutions for the AV PROFESSIONAL
www.libertycable.com

800-530-8998
INTERNATIONAL - CALL +1-719-388-7542



Install Cables - Custom

3. Plenum VGA, RCA Video + Stereo (L/R) Audio RCA's, 3.5 Mini Stereo

Connection	Length (ft.)	Part #
VGA, RCA Video + Stereo (L/R) Audio RCA's, 3.5 Mini Stereo	10	G-2V2A-C3-10
	25	G-2V2A-C3-25
	35	G-2V2A-C3-35
	50	G-2V2A-C3-50
	75	G-2V2A-C3-75
	100	G-2V2A-C3-100
	125	G-2V2A-C3-125

The Perfect Combo

Works perfectly with plate # PC-G1000 page 198

Ships Same Day!

Standard lengths shown. Custom lengths available.

4. Plenum VGA, S-Video + 2 ea. 3.5 Mini Stereo

Connection	Length (ft.)	Part #
VGA, S-Video + 2 ea. 3.5 Mini Stereo	10	G-2V2A-C2-10
	25	G-2V2A-C2-25
	35	G-2V2A-C2-35
	50	G-2V2A-C2-50
	75	G-2V2A-C2-75
	100	G-2V2A-C2-100
	125	G-2V2A-C2-125

Ships Same Day!

Standard lengths shown. Custom lengths available.

Perfect Combination of Assemblies and Plates

5. Plenum VGA + S-Video + RCA Video + Stereo (L/R) Audio RCA's + 3.5 Mini Stereo

Connection	Length (ft.)	Part #
VGA + S-Video + RCA Video + Stereo (L/R) Audio RCA's + 3.5 Mini Stereo	10	N-3V2A-C1-10
	25	N-3V2A-C1-25
	35	N-3V2A-C1-35
	50	N-3V2A-C1-50
	75	N-3V2A-C1-75
	100	N-3V2A-C1-100
	125	N-3V2A-C1-125

Standard lengths shown. Custom lengths available.

PC-G1020-*

Connectors

- HD-15 Female (VGA)
- Stereo-Mini
- RCA
- S-Video

Ships Same Day!

PC-G2040-*

Connectors

- HD-15 Female (VGA)
- Stereo-Mini
- S-Video
- RCA

Ordering is fast & easy.



Call today!

Install Kits - Custom

1. HD15 Male Installation Kit with 5 Compression BNC's

Connection	Length (ft.)	Part #
HD15 Male to Non-Terminated End	35	D-INSTALLKIT-CMP-35
	50	D-INSTALLKIT-CMP-50
	100	D-INSTALLKIT-CMP-100



2. Plenum HD15 Male Installation Kit with 5 Crimp Style BNC's

Connection	Length (ft.)	Part #
HD15 Male to Non-Terminated End	35	D-INSTALLKIT-CRP-35
	50	D-INSTALLKIT-CRP-50
	100	D-INSTALLKIT-CRP-100

Standard lengths shown. Custom lengths available.



3. Plenum HD15 Male To Non-Terminated End

Connection	Length (ft.)	Part #
HD15 Male to Non-Terminated End	40	D-VGAM-T-40
	50	D-VGAM-T-50
	65	D-VGAM-T-65
	75	D-VGAM-T-75

Standard lengths shown. Custom lengths available.



RGB Cables - Custom

Liberty's custom cable assemblies are hand made and 100% tested. These cables are constructed with true broadcast quality components suitable for residential and commercial applications. Assemblies available include

RGB (3 to 6 conductors), VGA, S-Video, Audio, Data and Triaxial in both PVC and Plenum jackets. Liberty is a custom house, so if you don't see what you need please call or email your request.

1. PVC RGBHV 5-Coax BNC to BNC, 450 MHz, 25 AWG Cable

Connection	Length (ft.)	Part #
5 BNC Male to 5 BNC Male	100	A-5BNCM-M-100
	125	A-5BNCM-M-125



Standard lengths shown. Custom lengths available.

Ordering is fast & easy.



Call today!

Solutions for the AV PROFESSIONAL
www.libertycable.com

800-530-8998
INTERNATIONAL - CALL +1-719-388-7542



RGB Cables - Custom

2. Plenum RGB 3-Coax RCA to RCA, 200 MHz, 26 AWG cable



Connection	Length (ft.)	Part #
3 RCA Male to 3 RCA Male Color Coded for Component Video	10	D-3RCAM-M-10
	25	D-3RCAM-M-25
	35	D-3RCAM-M-35
	50	D-3RCAM-M-50
	75	D-3RCAM-M-75
	100	D-3RCAM-M-100
	125	D-3RCAM-M-125

The Perfect Combo

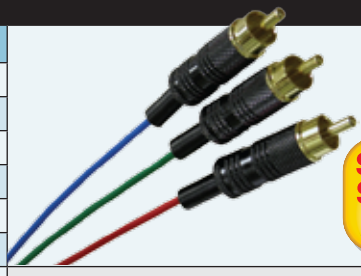

Works perfectly with plate # PC-G1240 page 198







Standard lengths shown. Custom lengths available.

3. Plenum RGB 3-Coax RCA to RCA, 200 MHz, 26 AWG cable

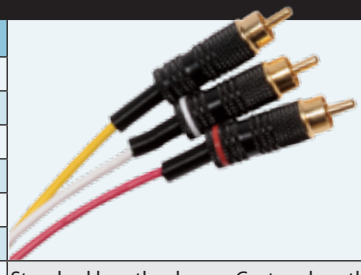
Connection	Length (ft.)	Part #
3 RCA Male to 3 RCA Male Color Coded for Component Video and Left/Right Audio	10	D-AV3RCAM-M-10
	25	D-AV3RCAM-M-25
	35	D-AV3RCAM-M-35
	50	D-AV3RCAM-M-50
	75	D-AV3RCAM-M-75
	100	D-AV3RCAM-M-100
	125	D-AV3RCAM-M-125





Standard lengths shown. Custom lengths available.

4. Plenum RGBHV 5-Coax BNC to BNC, 200 MHz, 26 AWG Cable

Connection	Length (ft.)	Part #
5 BNC Male to 5 BNC Male	10	D-5BNM-M-10
	25	D-5BNM-M-25
	35	D-5BNM-M-35
	50	D-5BNM-M-50
	75	D-5BNM-M-75
	100	D-5BNM-M-100
	125	D-5BNM-M-125

The Perfect Combo



Works perfectly with plate # PC-G1200 page 198





Standard lengths shown. Custom lengths available.

RGB Cables - Molded

1. PVC 5-Conductor, BNC Male to BNC Male

Connection	Length (ft.)	Part #
5-conductor, BNC Male to BNC Male	3	E-5BNM-M-3
	6	E-5BNM-M-6
	10	E-5BNM-M-10
	20	E-5BNM-M-20
	25	E-5BNM-M-25
	50	E-5BNM-M-50



The Perfect Combo

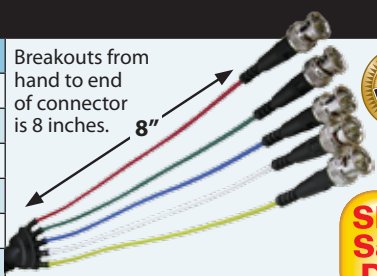

Works perfectly with plate # PC-G1200 page 198





Breakouts from hand to end of connector is 8 inches. 8"





2. PVC 3-Conductor, BNC Male to BNC Male

Connection	Length (ft.)	Part #
3-Conductor, BNC Male to BNC Male	3	E-3BNM-M-3
	6	E-3BNM-M-6
	10	E-3BNM-M-10
	25	E-3BNM-M-25
	50	E-3BNM-M-50
	100	E-3BNM-M-100





Ordering is fast & easy.







Call today!

RGB Cables - Molded

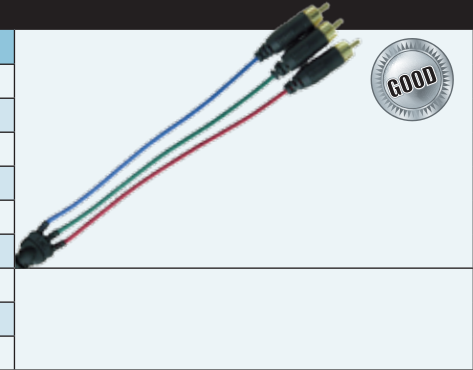
3. 3 RCA Male to 3 RCA Male

Connection	Length (ft.)	Part #
3 RCA Male to 3 RCA Male Color Coded for Component Video	1	E-3RCAM-M-1
	3	E-3RCAM-M-3
	6	E-3RCAM-M-6
	10	E-3RCAM-M-10
	15	E-3RCAM-M-15
	25	E-3RCAM-M-25
	35	E-3RCAM-M-35
	50	E-3RCAM-M-50
	75	E-3RCAM-M-75



RS 232 Cables - Molded

1. PVC DB9 Male/ Female Cable

Connection	Length (ft.)	Part #
PVC DB9 Male/Female	10	E-DB9M-F-10
	25	E-DB9M-F-25
	35	E-DB9M-F-35
	75	E-DB9M-F-75
	100	E-DB9M-F-100
	125	E-DB9M-F-125



2. PVC DB9 Male/Male

Connection	Length (ft.)	Part #
PVC DB9 Male to DB9 Male	10	E-DB9M-M-10
	25	E-DB9M-M-25
	35	E-DB9M-M-35
	75	E-DB9M-M-75
	100	E-DB9M-M-100
	125	E-DB9M-M-125



3. PVC DB9 Female/Female

Connection	Length (ft.)	Part #
PVC DB9 Female to DB9 Female	10	E-DB9F-F-10
	25	E-DB9F-F-25
	35	E-DB9F-F-35
	75	E-DB9F-F-75
	100	E-DB9F-F-100
	125	E-DB9F-F-125

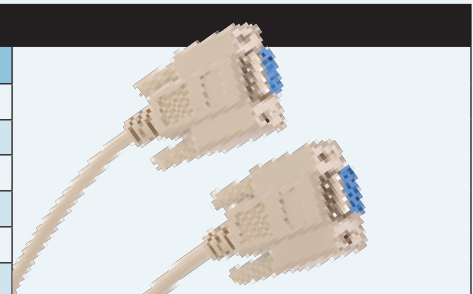

Ordering is fast & easy.



Call today!

Solutions for the AV PROFESSIONAL

www.libertycable.com

800-530-8998

INTERNATIONAL - CALL +1-719-388-7542



RS 232 Cables - Molded

4. PVC DB9 Female/Female Null Modem		
Connection	Length (ft.)	Part #
DB9 Female to DB9 Female wired Null Modem	10	E-DB9F-F-NULL-10
	25	E-DB9F-F-NULL-25
	35	E-DB9F-F-NULL-35
	75	E-DB9F-F-NULL-75
	100	E-DB9F-F-NULL-100
	125	E-DB9F-F-NULL-125

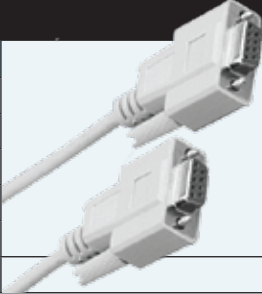

S-Video Cables - Custom

1. Plenum S-Video Male		
Connection	Length (ft.)	Part #
S-Video Male to S-Video Male	10	PSVM-M-10
	25	PSVM-M-25
	35	PSVM-M-35
	50	PSVM-M-50
	75	PSVM-M-75
	100	PSVM-M-100
	125	PSVM-M-125

The Perfect Combo



Works perfectly with plate # PC-G1820 page 200

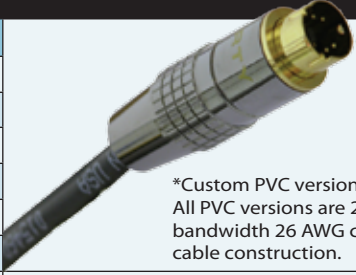

*Custom PVC versions available. All PVC versions are 200 MHz bandwidth 26 AWG coaxial cable construction.



S-Video Cables - Molded

1. S-Video Male to S-Video Male		
Connection	Length (ft.)	Part #
S-Video	3	E-SVM-M-3
	6	E-SVM-M-6
	15	E-SVM-M-15
	25	E-SVM-M-25
	35	E-SVM-M-35
	50	E-SVM-M-50



The Perfect Combo

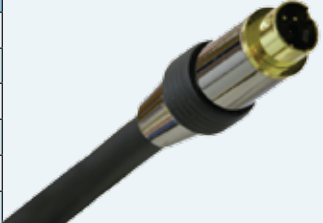

Works perfectly with plate # PC-G1820 page 200

2. S-Video to Male BNC Breakout Cables		
Connection	Length (ft.)	Part #
PVC, SV Male to 2 BNC Male Breakout	1	E-SVM-2BNCM-1
	3	E-SVM-2BNCM-3
	6	E-SVM-2BNCM-6
	12	E-SVM-2BNCM-12

Ordering is fast & easy.



Call today!

Solutions for the AV PROFESSIONAL
www.libertycable.com

800-530-8998
INTERNATIONAL - CALL +1-719-388-7542



Specifications Subject to Change

S-Video Cables - Molded

3. S-Video Female BNC Breakout Cables

Connection	Length (ft.)	Part #
S-Video Male to 2BNC Female	1	E-SVM-2BNCF-1
	3	E-SVM-2BNCF-3
	6	E-SVM-2BNCF-6
	12	E-SVM-2BNCF-12

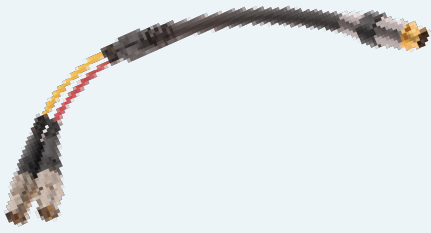

USB Cables - Molded

Liberty now offers USB 2.0 A to B cables. These cables are flexible, easy-to-use and very

economically priced. Compliant to 15 feet, AWM Rated.

1. Molded USB Cable

Connection	Length (ft.)	Part #
USB 2.0 A-B Male to Male	3	E-USBAB-3
	6	E-USBAB-6
	10	E-USBAB-10
	15	E-USBAB-15



2. Micro Projector-USB Cable

Connection	Length (ft.)	Part #
PVC HD15 Male with Audio & USB 2.0	6	E-MVGAPM-M-6



VGA Cables - Custom

Superior for computer, plasma or projection installation. Terminated with metal HD15

connectors, male or female. Thumb screws available with 200 MHz, 26 AWG cable.

1. PVC RGBHV 5-Coax HD15 to HD15 450 MHz, 25 AWG Cable*

Connection	Length (ft.)	Part #
HD15 Male to HD15 Male	10	A-VGAM-M-10
	25	A-VGAM-M-25
	35	A-VGAM-M-35
	50	A-VGAM-M-50
	75	A-VGAM-M-75
	100	A-VGAM-M-100
	125	A-VGAM-M-125
HD15 Male to HD15 Female	10	A-VGAM-F-10
	25	A-VGAM-F-25
	35	A-VGAM-F-35
	50	A-VGAM-F-50
	75	A-VGAM-F-75
	100	A-VGAM-F-100
	125	A-VGAM-F-125

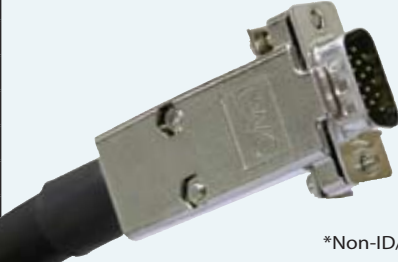

*Non-ID/DDC

Standard lengths shown. Custom lengths available.

Ordering is fast & easy.



Call today!

Solutions for the AV PROFESSIONAL
www.libertycable.com

800-530-8998
INTERNATIONAL - CALL +1-719-388-7542



VGA Cables - Custom

Assemblies: Custom & Molded

2. Plenum + RGBHV 5-Coax HD15 to HD15 200 MHz 26 AWG Cable*		
Connection	Length (ft.)	Part #
HD15 Male to HD15 Male <div style="border: 1px solid black; padding: 5px; width: fit-content;"> <p style="text-align: center; margin: 0;">The Perfect Combo</p>  <p style="font-size: small; margin: 0;">Works perfectly with plate # PC-G1720 page 200</p> </div>	10	D-VGAM-M-10
	25	D-VGAM-M-25
	35	D-VGAM-M-35
	50	D-VGAM-M-50
	75	D-VGAM-M-75
	100	D-VGAM-M-100
	125	D-VGAM-M-125
HD15 Male to HD15 Female <div style="border: 1px solid black; border-radius: 50%; padding: 10px; display: inline-block; background-color: yellow; color: red; font-weight: bold; text-align: center;"> Ships Same Day! </div>	10	D-VGAM-F-10
	25	D-VGAM-F-25
	35	D-VGAM-F-35
	50	D-VGAM-F-50
	75	D-VGAM-F-75
	100	D-VGAM-F-100
	125	D-VGAM-F-125



*Non-ID/DDC

Standard lengths shown. Custom lengths available.

3. Plenum RGBHV 6-Coax HD15 to HD15 200 MHz 26 AWG Cable		
Connection	Length (ft.)	Part #
HD15 Male to HD15 Male	10	G-VGAM-M-10
	25	G-VGAM-M-25
	35	G-VGAM-M-35
	50	G-VGAM-M-50
	75	G-VGAM-M-75
	100	G-VGAM-M-100
	125	G-VGAM-M-125
HD15 Male to HD15 Female <div style="border: 1px solid black; border-radius: 50%; padding: 10px; display: inline-block; background-color: yellow; color: red; font-weight: bold; text-align: center;"> Ships Same Day! </div>	10	G-VGAM-F-10
	25	G-VGAM-F-25
	35	G-VGAM-F-35
	50	G-VGAM-F-50
	75	G-VGAM-F-75
	100	G-VGAM-F-100
	125	G-VGAM-F-125



*ID BIT / DDC Compatible

Standard lengths shown. Custom lengths available.

VGA Cables - Molded

Terminated with molded HD15 hoods with thumbscrews.
Compliant with ID bit/DDC communication requirements.

1. HD15 Male to HD15 Male		
Connection	Length (ft.)	Part #
PVC, HD15 Male to HD15 Male <div style="border: 1px solid black; padding: 5px; width: fit-content;"> <p style="text-align: center; margin: 0;">The Perfect Combo</p>  <p style="font-size: small; margin: 0;">Works perfectly with plate # PC-G1720 page 200</p> </div>	6	E-VGAM-M-6
	10	E-VGAM-M-10
	15	E-VGAM-M-15
	25	E-VGAM-M-25
	35	E-VGAM-M-35
	50	E-VGAM-M-50
	75	E-VGAM-M-75
	100	E-VGAM-M-100



Ordering is fast & easy.



Call today!

Solutions for the AV PROFESSIONAL

www.libertycable.com

800-530-8998

INTERNATIONAL - CALL +1-719-388-7542

Specifications Subject to Change

VGA Cables - Molded

2. HD15 Male to HD15 Female

Connection	Length (ft.)	Part #
PVC, HD15 Male to HD15 Female In Wall Rating	6	E-VGAM-F-6
	10	E-VGAM-F-10
	15	E-VGAM-F-15
	25	E-VGAM-F-25
	35	E-VGAM-F-35
	50	E-VGAM-F-50



3. HD15 Male to Male w/ Computer Audio

Connection	Length (ft.)	Part #
PVC, HD15 Male with 3.5 Stereo Plug, each end In Wall Rating	3	E-VGAMAM-M-3
	6	E-VGAMAM-M-6
	12	E-VGAMAM-M-12
	15	E-VGAMAM-M-15
	25	E-VGAMAM-M-25

The Perfect Combo



Works perfectly
with plate
PC-G1520
page 199



VGA/Audio Cables - Custom

1. Plenum HD15 Male to Male with 3.5 Mini Audio*

Connection	Length (ft.)	Part #
HD15 Male to HD15 Male with 3.5 Mini Audio	10	G-VGAMAM-M-10
	25	G-VGAMAM-M-25
	35	G-VGAMAM-M-35
	50	G-VGAMAM-M-50
	75	G-VGAMAM-M-75
	100	G-VGAMAM-M-100
	125	G-VGAMAM-M-125

The Perfect Combo



Works perfectly
with plate
PC-G1520
page 199



**Ships
Same
Day!**

*ID/DDC Compliant

Standard lengths shown. Custom lengths available.

VGA Micro Cables - Molded

Out of wall use, AWM Rated.

1. Micro VGA Cable

Connection	Length (ft.)	Part #
HD15 Male to HD15 Male	3	E-MVGAM-M-3
	6	E-MVGAM-M-6
	12	E-MVGAM-M-12
	25	E-MVGAM-M-25
	Standard lengths to 25 feet are guaranteed to 1600x1200 resolution.	



Ordering is
fast & easy.



Call today!

**Solutions for the
AV PROFESSIONAL**
www.libertycable.com

800-530-8998
INTERNATIONAL - CALL +1-719-388-7542



VGA Micro Cables - Molded

2. Micro VGA + Audio Cable		
Connection	Length (ft.)	Part #
HD15 Male + 3.5" Mini Stereo Plug	3	E-MVGAMAM-M-3
	6	E-MVGAMAM-M-6
	12	E-MVGAMAM-M-12
	25	E-MVGAMAM-M-25
Standard lengths to 25 feet are guaranteed to 1600x1200 resolution.		

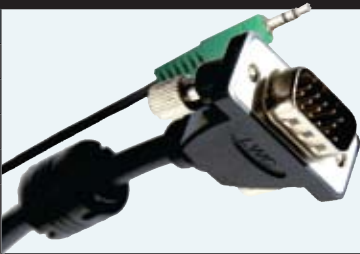

3. Micro ProjectorNet™ Cable		
Connection	Length (ft.)	Part #
PVC, HD15 Male with Audio & RJ45	3	E-MVGAANM-M-3
	6	E-MVGAANM-M-6
	12	E-MVGAANM-M-12
	25	E-MVGAANM-M-25
Standard lengths to 25 feet are guaranteed to 1600x1200 resolution.		



4. Micro Projector - USB Cable		
Connection	Length (ft.)	Part #
PVC, HD15 Male with Audio & USB 2.0	6	E-MVGAPM-M-6
	Standard lengths to 25 feet are guaranteed to 1600x1200 resolution.	



VGA to BNC Breakout Cables - Custom

Perfect for displaying your computer presentation on a projector or plasma monitor.

Terminated with high quality 75-ohm BNC connectors and metal HD15 connectors.

1. Plenum RGBHV 5-Coax HD15 to 5 BNC, 200 MHz, 26 AWG Cable		
Connection	Length (ft.)	Part #
HD15 Male to 5 BNC Male	10	D-VGAM-5BNM-10
	25	D-VGAM-5BNM-25
	35	D-VGAM-5BNM-35
	50	D-VGAM-5BNM-50
	75	D-VGAM-5BNM-75
	100	D-VGAM-5BNM-100
HD15 Male to 5 BNC Female	1	D-VGAM-5BNCF-1
	3	D-VGAM-5BNCF-3
	10	D-VGAM-5BNCF-10
Standard lengths shown. Custom lengths available.		



Ordering is fast & easy.



Call today!

VGA to BNC Breakout Cables - Molded

1. PVC, HD15 Male to 5 BNC Male

Connection	Length (ft.)	Part #
PVC, HD15 Male to 5 BNC Male	1	E-VGAM-5BNCM-1
	3	E-VGAM-5BNCM-3
	6	E-VGAM-5BNCM-6
For computer to projector or plasma connection.		



2. PVC, HD15 Female to 5 BNC Male

Connection	Length (ft.)	Part #
PVC, HD15 Female to 5 BNC Male	1	E-VGAF-5BNCM-1
	3	E-VGAF-5BNCM-3
	10	E-VGAF-5BNCM-10
	15	E-VGAF-5BNCM-15
For computer to projector or plasma connection.		



3. PVC, HD15 Male to 5 BNC Female

Connection	Length (ft.)	Part #
PVC, HD15 Male to 5 BNC Female	.5	E-VGAM-5BNCF-.5
	1	E-VGAM-5BNCF-1
	2	E-VGAM-5BNCF-2
	3	E-VGAM-5BNCF-3
	6	E-VGAM-5BNCF-6
For computer to projector or plasma connection.		



XLR Microphone Cables - Custom

1. XLR to XLR Low-Noise Microphone Cable

Connection	Length (ft.)	Part #
XLR Male to XLR Female	10	SQ-XLRM-F-10
	25	SQ-XLRM-F-25
	35	SQ-XLRM-F-35
	50	SQ-XLRM-F-50
	75	SQ-XLRM-F-75
	100	SQ-XLRM-F-100
	125	SQ-XLRM-F-125



Ordering is fast & easy.



Call today!

Solutions for the AV PROFESSIONAL

www.libertycable.com

800-530-8998

INTERNATIONAL - CALL +1-719-388-7542



Custom Cable Assemblies



SECTION

2

Assemblies: Custom & Molded



Highly Skilled Technicians Provide World-Class Service

→ Experience

We Ask the Right Questions to Guarantee Your Ideal Solution

→ Expertise

All Our Components and Products are 100% Tested

→ Excellence

Each and every order Liberty receives is treated with the same superior level of quality care. We can custom develop systems cables specifically designed to meet and exceed each manufacturer's exact stranding, shielding and performance requirements. Even if you're uncertain of your needs, Liberty's technical assistance ensures the right product for the right application.

On-Time Delivery. High Quality. Flawless Execution.

Liberty's customer service technicians don't just have the answers, they have the right ones. Our technicians have the expertise to ask the appropriate questions to guarantee your ideal solution. To accommodate your complex, well-planned integration requirements, or your "needed-yesterday" wiring emergency, Liberty's top-notch cable assembly team is here for you.

CONTROL

AMX Control
DB9/DB25
DIN
RS422/RS232

BROADCAST

AES/EBU
Audio Snakes
Digital Video
ENG/Tactical
Triax
Video Patch
Video Snake

AUDIO

AES/EBU Digital
Audio
Audio Snakes
Microphone
RCA Audio
Speaker
Sub Woofer Kits
XLR Audio

VIDEO

Component
Composite Video
Computer
Audio/Video
RGBHV
Serial Digital
S-Video
S-Video Breakout
VGA
VGA Breakout

OEM

Control Panel
Assemblies
Private Label
Assemblies
Speaker Wire
Assemblies
Touch-screen
Display Cables
*Custom Assemblies
for all OEM's*

Every Cable
Guaranteed
To Perform

All our components and products are 100% tested for quality performance — that's the Liberty Advantage.



Our highly skilled technicians handcraft your assemblies with reliability and accuracy every time.

Ordering is fast & easy.



Call today!

**Solutions for the
AV PROFESSIONAL**

www.libertycable.com

800-530-8998

INTERNATIONAL - CALL +1-719-388-7542





Specifications Subject to Change

Liberty's EZLINX™ system is comprised of two basic parts:

- The EZLINX™ cable, constructed with 26 AWG coax with a threaded 13-pin female connector on each end.

- 17 EZLINX™ Termination Options with a threaded male connector on one end and a broad selection of high-quality VGA, BNC, RCA, Analog DVI, S-Video and customizable options on the other.

EZLINX™ CABLE - PVC		
Connection	Length (ft.)	Part #
13-Pin EZLINX Female to 13-Pin EZLINX Female bulk cable	3	EZ-LINX-3
	6	EZ-LINX-6
	10	EZ-LINX-10
	25	EZ-LINX-25
	35	EZ-LINX-35
	50	EZ-LINX-50
The Perfect Combo  Works perfectly with plate # PCD-5600 page 222	75	EZ-LINX-75
	100	EZ-LINX-100

EZLINX™ CABLE - PLENUM		
Connection	Length (ft.)	Part #
13-Pin EZLINX Female to 13-Pin EZLINX Female bulk cable	3	EZ-LINX-P-3
	6	EZ-LINX-P-6
	10	EZ-LINX-P-10
	25	EZ-LINX-P-25
	35	EZ-LINX-P-35
	50	EZ-LINX-P-50
The Perfect Combo  Works perfectly with plate # PCD-5600 page 222	75	EZ-LINX-P-75
	100	EZ-LINX-P-100



EZLINX™ WALL PLATES & PANELS		
Connection	ITEM #	Part #
EZLINX 13-Pin Male/Male Panel Mount	1	PC-G1400-P-B
EZLINX 13-Pin Male/Female Panel Adapter	2	PC-G1425-P-B
EZLINX 13-Pin to VGA Female Panel Adapter	3	PC-G1450-P-B
EZLINX 13-Pin to VGA Male Panel Adapter	4	PC-G1475-P-B

EZLINX™ ACCESSORIES		
Connection	Length (ft.)	Part #
13-Pin EZLINX Female to 13-Pin EZLINX Female adapter	10	EZ-ADAPTER-F
13-Pin EZLINX Male to 13-Pin EZLINX Male adapter	10	EZ-ADAPTER-M
EZLINX metal pull-cap for cable pulling and end protection	N/A	EZ-LINX-CAP

MOLDED RCA CABLES		
Connection	Length (ft.)	Part #
5 RCA Male to 13-Pin EZLINX Male	20	EZ-5RCCAM
5 RCA Female to 13-Pin EZLINX Male	20	EZ-5RCCAF
3 RCA Male to 13-Pin EZLINX Male	20	EZ-3RCCAM
3 RCA Female to 13-Pin EZLINX Male	20	EZ-3RCCAF

Molded RCA connectors are constructed for optimum contact between plug and jack. Available in 3 and 5 conductors, with both male or female ends.



EZLINX™ WIRE PULL-CAP	
Liberty offers a convenient metal wire pull-cap that screws onto the ends of the EZLINX cable, allowing an installer to pull the cable through conduit or drywall by applying fishing tape through the hole on the end of the cap.	
EZLINX Metal Pull-Cap Part #:	EZ-LINX-CAP
Male to Male Part #:	EZ-BARREL-MM
Female to Female Part #:	EZ-BARREL-FF



Ordering is fast & easy.



Call today!

Solutions for the AV PROFESSIONAL
www.libertycable.com

800-530-8998
INTERNATIONAL - CALL +1-719-388-7542



Ordering is fast & easy.



Call today!

MOLDED BNC CABLES

Terminated with 75-ohm BNC molded connectors and available in 3 and 5 conductors with male or female ends.

Connection	Length (in.)	Part #
5 BNC Male to 13-Pin EZLINX Male	20	EZ-5BNCM
5 BNC Female to 13-Pin EZLINX Male	20	EZ-5BNCF
3 BNC Male to 13-Pin EZLINX Male	20	EZ-3BNCM
3 BNC Female to 13-Pin EZLINX Male	20	EZ-3BNCF
3 BNC Male + 2 RCA Male to 13-Pin EZLINX Male	20	EZ-3BNCM2RCA-M

MOLDED VGA CABLES

Terminated with molded HD15 hoods with thumbscrews. Compliant with ID bit/DDC communication requirements.

Connection	Length (in.)	Part #
HD15 Male to 13-Pin EZLINX Male	20	EZ-VGAM
HD15 Female to 13-Pin EZLINX Male	20	EZ-VGAF
HD15 Male w/Audio to 13-Pin EZLINX Male	20	EZ-VGAMAM

MOLDED ANALOG DVI CABLE

This new Digital Visual Interface (DVI) cable adheres to the industry DVI protocol for your analog video installation. DVI option is analog only.

Connection	Length (in.)	Part #
DVI-A Male to 13-Pin EZLINX Male	20	EZ-DVI/A

MOLDED S-VIDEO/RCA CABLE

This cable provides an ideal A/V solution. It includes S-Video and Left/Right Stereo Audio RCAs.

Connection	Length (in.)	Part #
2 RCA Male + S-V Male to 13 Pin EZLINX Male	20	EZ-SVM-L/R

MOLDED UNTERMINATED CABLES

This customizable solution allows the installer to terminate the cable end in the field with the appropriate connector needed for the job. Let our custom cable assembly area produce the correct termination for your project. Call us today for details.

Connection	Length (in.)	Part #
Untermated cable end EZ-CUSTOM to 13-Pin EZLINX Male	20	EZ-CUSTOM

BNC option
EZ-3BNCM2RCA-M
shown



VGA option
EZ-VGAM
shown



ANALOG DVI option
EZ-DVI/A
shown



VGA option
EZ-VGAMAM
shown



S-VIDEO/RCA option
EZ-SVM-L/R
shown



All EZLINX™ products have a low insertion loss of < 0.2 dB

Every option attaches in seconds



EZ-LINX 5RCAF option
EZ-LINX-CABLE shown

Solutions for the AV PROFESSIONAL
www.libertycable.com

800-530-8998
INTERNATIONAL - CALL +1-719-388-7542



The Liberty **ADVANTAGE** ★★ ★

AV Professionals rely on Liberty's **EXPERTISE, SELECTIONS & SERVICE.**

For 17 years, Liberty's expertise in designing residential interconnects combines high quality signal performance and bottom-line business value. Our interconnects keep your business both competitive and profitable.

AV professionals rely on Liberty's broad selection of interconnects to enhance AV signal performance and customer satisfaction. Liberty interconnect products provide connectivity to every type of installation:

- Audio
- Component
- Composite
- Digital
- HDMI
- S-Video
- Toslink
- VGA
- Video
- And more!

PRODUCTS FEATURES

- Liberty interconnect provide connectivity to every type of residential install
- All product specifications and performance guaranteed
- Highest quality standards in the industry
- Broad selection of product
- Good-Better-Best selection guide, make sure that your installation has the right solution
- Full technical support

5 LEVELS OF PRODUCTS: Premium to Value

Z-500

- Premium product designed for the highest fidelity for mid to high-end audiophile systems

Z-250

- Designed to improve performance in low to mid-range systems

Z-300

- Designed to provide high quality performance for mid to high-end home theater systems

Z-200

- Designed as a good upgrade to any system

Z-100

- Designed as a better than box option

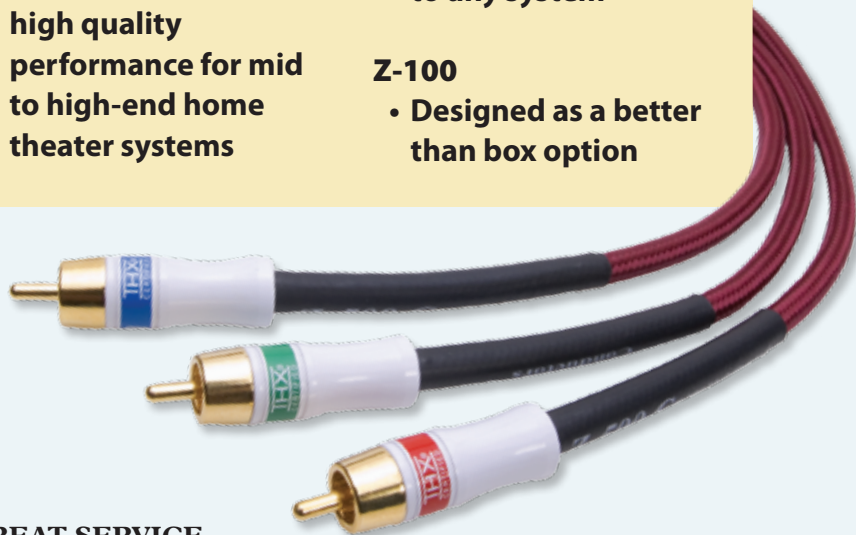

GREAT SERVICE

Strategically located around the US, our 5 mega-warehouses, ship ground delivery in 2 days to your door.

- No order minimums policy
- Order on our 24/7 website
- Job site delivery
- Order confirmation and a shipping confirmation
- Variety of shipping options including next day, 3 day, air and truck



Liberty's Good-Better-Best product selection guide equates interconnect construction with performance. Product line designed to help you up sell.

Liberty interconnects help you improve your profit margins:

- High end construction without the high-end price
- Priced for the AV professional
- Investment in quality product rather than fancy packaging



Ordering is fast & easy.



Call today!

Solutions for the AV PROFESSIONAL

www.libertycable.com

800-530-8998

INTERNATIONAL - CALL +1-719-388-7542



DigitaLinx™ Pure Performance HDMI® Cable

Liberty's newest DigitaLinx™ Pure Performance HDMI cables are High Speed Certified to the full 10.2 Gbps. These cables are designed for an aesthetic rugged appearance and solid function. With full Metal hoods and double shielding these cables will support anything HDMI for years to come.

The look and feel of the DLX-HD cable is enhanced by a braided fabric sheath jacket, and easy to grab plugs; making this cable both aesthetically stunning and easy to install.

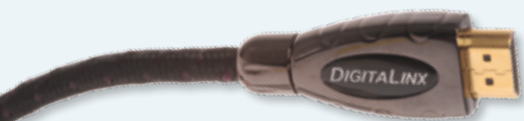

Length (meter)	Part #
1	DLX-HDSM-1M
2	DLX-HDSM-2M
3	DLX-HDSM-3M

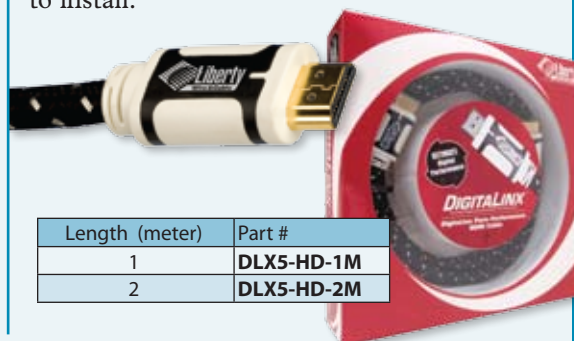

Length (meter)	Part #
1	DLX5-HD-1M
2	DLX5-HD-2M

Z-500 Series Retail Packaging

Designed for your audiophile customer in mind, Liberty's Z500 interconnect line is now packaged in an elegant retail-display box.

The jewelry-box presentation of Liberty's Z500 products sets the tone with your customer base. Easy to open and close, our new retail packaging provides the opportunity for your customers to examine the exquisite craftsmanship of our top-of-the-line interconnects.

The unique braided outer jacket of our Z500 products sets them apart from the competition.

If you are looking for alternatives to enhance your product merchandising opportunities, the uniform design of our compact gold-printed packaging allows you to easily create an eye-catching visual display on a wall rack or shelf.



Z-300 Series Retail Packaging

Residential installers know that one of the more profitable products are interconnects. Liberty Wire & Cable interconnects provide dealers with the cost and price-point advantage that delivers more margin dollars.

Our products are touchable without having to open a box or plastic clamshell package. Customers can inspect and admire the high-quality craftsmanship of Liberty interconnects easily and immediately.

This design feature eliminates wasteful non-reclosable interconnect boxes from ending up as non-sellable stock.

Our innovative card-pack facilitates interconnect inventory control both on an off the truck. Warehouse and truck managers like the fact that there is ample room on the back of the solid card to write on, or to directly apply a label. Information such as the job number, customer name, project barcode, or other specific project data is easily recorded to simplify installation. Truck managers enjoy the fact that after the product is taken off the truck and installed, the card is returned to the office for easy tracking and billing.

Additionally, for dealers who employ more advanced inventory control methods, the preprinted scannable bar-code provides streamlined truck or warehouse inventory management.



Ordering is fast & easy.



Call today!

Solutions for the AV PROFESSIONAL
www.libertycable.com

800-530-8998
INTERNATIONAL - CALL +1-719-388-7542



THX™ Certified Interconnects

Z-500 THX™ Series

AV Signals Degrade When Moving Through Multiple Copper Crystals

Liberty's Z-500 interconnects use a revolutionary process that make the entire copper wire one continuous copper crystal which dramatically improves signal integrity and performance. This high tech metallurgical casting process extrudes molten copper through a heated mold and quickly cools it which makes one continual crystal. The result is unparalleled signal fidelity, clarity and performance.

Liberty's Z-500 Universal 10 AWG Speaker Cables Set provides the very best cable construction for true sonic fidelity. The cable combines the purity and crispness of OCC and OFC copper materials.

The unique inter-changeable connectors allow for the simple and exact termination to perfectly match your equipment and speakers.

CONNECTORS INCLUDED:
8 SPADE, 8 BANANA,
AND 8 PIN.

1. Z-500 Universal Amplified Speaker Cable Set

Length (meter)	Part #
1	Z500UAA1
2	Z500UAA2
4	Z500UAA4
5	Z500UAA5



Designed to match the demands of the most sophisticated home theater components, Liberty's

Z-500 TOSLink Cable conducts digital audio signals with flawless precision.

2. Z-500 TOSLink Interconnect

Length (meter)	Part #
1	Z500TOS1
2	Z500TOS2
4	Z500TOS4
6	Z500TOS6
10	Z500TOS10
15	Z500TOS15



Videophiles agree that Ohno Continuous Cast Copper Conductors (OCC) take video performance to a new level of visual integrity.

Our new Z-500 S-video cable is an (OCC) cable and terminated with reliable heavy duty 4-pin, gold-plated connectors.

3. Z-500 S-Video Interconnect

Length (meter)	Part #
.5	Z500SV.5
1	Z500SV1
1.5	Z500SV1.5
2	Z500SV2
3	Z500SV3
4	Z500SV4



Ordering is fast & easy.



Call today!

Solutions for the AV PROFESSIONAL
www.libertycable.com

800-530-8998
INTERNATIONAL - CALL +1-719-388-7542

Liberty
AV Solutions

Z-500 THX™ Series

For sound and video performance that makes you feel as if you are right there! Our Z-500 series provide the ultimate level of sonic fidelity. Products are covered in a tight-fitting sensual nylon braid and terminated with white pearl/gold connectors.

Liberty Specs

Featuring OCC Ohno continuous cast copper 99.999% pure copper, reduced oxidation, & better fidelity.

4. Z-500 Audio Interconnects (pair)

Length (meter)	Part #
.5	Z500NA.5THX
1	Z500NA1THX
1.5	Z500NA1.5THX
2	Z500NA2THX
3	Z500NA3THX
4	Z500NA4THX

5. Z-500 Balanced Audio Interconnects (pair)

Length (meter)	Part #
.5	Z500NBA.5THX
1	Z500NBA1THX
1.5	Z500NBA1.5THX
2	Z500NBA2THX
3	Z500NBA3THX
4	Z500NBA4THX

6. Z-500 Video Interconnects (each)

Length (meter)	Part #
.5	Z500NV.5THX
1	Z500NV1THX
1.5	Z500NV1.5THX
2	Z500NV2THX
3	Z500NV3THX
4	Z500NV4THX

7. Z-500 Digital Audio Interconnect Cable

Length (meter)	Part #
.5	Z500ND.5THX
1	Z500ND1THX
1.5	Z500ND1.5THX
2	Z500ND2THX
3	Z500ND3THX
4	Z500ND4THX

8. Z-500 Component Video Interconnect Cable

Length (meter)	Part #
.5	Z500NCV.5THX
1	Z500NCV1THX
1.5	Z500NCV1.5THX
2	Z500NCV2THX
3	Z500NCV3THX
4	Z500NCV4THX

Solutions for the AV PROFESSIONAL **800-530-8998**

www.libertycable.com INTERNATIONAL - CALL +1-719-388-7542

Ordering is fast & easy.



Call today!

Z-300 Series

The Z-300 Series Interconnects provide quality THX™ Certified solutions at a competitive price point. They feature a high quality 99.99% OFC

Copper Center Conductor. This series is packaged in a solid color PVC jacket with an attractive black/gold connector.

1. Z-300 THX Approved Audio Interconnects (pair)

Length (meter)	Part #
.5	Z300NA.5THX
1	Z300NA1THX
1.5	Z300NA1.5THX
2	Z300NA2THX
3	Z300NA3THX
4	Z300NA4THX

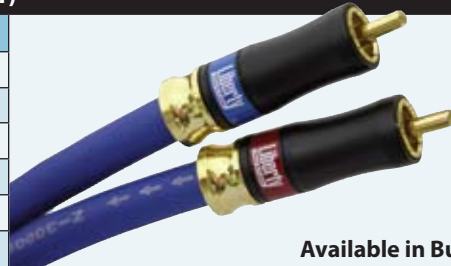

Available in Bulk

2. Z-300 Video Interconnects (each)

Length (meter)	Part #
.5	Z300NV.5THX
1	Z300NV1THX
1.5	Z300NV1.5THX
2	Z300NV2THX
3	Z300NV3THX



Available in Bulk

3. Z-300 Component Video Interconnects (each)

Length (meter)	Part #
.5	Z300NCV.5THX
1	Z300NCV1THX
1.5	Z300NCV1.5THX
2	Z300NCV2THX
3	Z300NCV3THX
4	Z300NCV4THX



4. Z-300 Digital Audio Interconnects (each)

Length (meter)	Part #
.5	Z300ND.5THX
1	Z300ND1THX
1.5	Z300ND1.5THX
2	Z300ND2THX
3	Z300ND3THX
4	Z300ND4THX

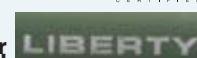

Price performer with metal connectors!

Audio/Video Connectors for Z-300



RCA Audio Plug Pair for Z300A THX
Part #: Z300AU-RCA



RCA 75 Ohm Video Plug for Z300V THX
Part #: Z300VI-75RCA



RCA 75 Ohm Digital Audio Plug for Z300D THX
Part #: Z300DI-75RCA



RCA 75 Ohm Component Video Set for Z300CV THX
Part #: Z300CO-75RCA-RGB

Ordering is fast & easy.



Call today!

Solutions for the AV PROFESSIONAL

www.libertycable.com

800-530-8998

INTERNATIONAL - CALL +1-719-388-7542



Z-250 Series

The Z-250 Series Audio/Video Interconnects share the same backbone as the Z-200 Series but are

terminated with high quality Metal RCA plugs for greater retention and durability.

1. Z-250 Audio/Video Interconnects (set)

Length (meter)	Part #
.5	Z250AV0.5
1	Z250AV1
2	Z250AV2
3	Z250AV3
4	Z250AV4
6	Z250AV6

2. Z-250 Audio Interconnects (set)

Length (meter)	Part #
.5	Z250A0.5
1	Z250A1
2	Z250A2
3	Z250A3
4	Z250A4
6	Z250A6

3. Z-250 Component Video (set)

Length (meter)	Part #
1	Z250CV1
2	Z250CV2
3	Z250CV3
4	Z250CV4
6	Z250CV6

Z-200 Series

InterFlex™ Z-200 Audio/Video interconnects strike the perfect balance between cost and performance.

This workhorse is perfect for truck-based inventory.

1. Z-200 Audio/Video Interconnects (set)

Length (meter)	Part #
1	Z200AV1
2	Z200AV2
3	Z200AV3
4	Z200AV4
6	Z200AV6

Available in Bulk Packages

2. Z-200 Audio Interconnects (pair)

Length (meter)	Part #
.5	Z200A.5
1	Z200A1
1.5	Z200A1.5
2	Z200A2
3	Z200A3
4	Z200A4
6	Z200A6

Available in Bulk Packages

Ordering is fast & easy.

Call today!

Solutions for the AV PROFESSIONAL **800-530-8998**

www.libertycable.com INTERNATIONAL - CALL +1-719-388-7542

Specifications Subject to Change

Z-200 Series "Y" Cables

1. Z-200 Audio/Video "Y" Cables

Length (in.)	Connection	Part #	Z200MM	Z200MF	Z200FM
9	1 Male to 2 Male RCA	Z200MM			
9	1 Male to 2 Female RCA	Z200MF			
9	1 Female to 2 Male RCA	Z200FM			

Z-100 Series

InterFlex™ Z-100 Audio/Video interconnects are modestly priced quality replacements.

1. Z-100 Audio/Video Interconnects (set)

Length (ft.)	Part #	
3	Z100AV3FT	
6	Z100AV6FT	
15	Z100AV15FT	
25	Z100AV25FT	

2. Z-100 Audio Interconnects (pair)

Length (ft.)	Part #	
3	Z100A3FT	
6	Z100A6FT	
15	Z100A15FT	
25	Z100A25FT	

3. Z100 3.5mm Stereo Interconnect

Length (ft.)	Part #	
3	Z100AM3FT	
6	Z100AM6FT	
15	Z100AM15FT	
25	Z100AM25FT	

4. Z100 3.5mm Stereo to L/R Audio Interconnect

Length (ft.)	Part #	
3	Z100AY3FT	
6	Z100AY6FT	
15	Z100AY15FT	
25	Z100AY25FT	

Ordering is fast & easy.



Call today!

Solutions for the AV PROFESSIONAL

www.libertycable.com



800-530-8998

INTERNATIONAL - CALL +1-719-388-7542





Z-100 Series

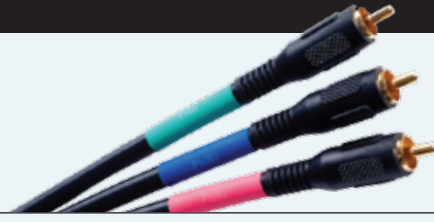

5. Z100 Composite Video Interconnect, 75 Ohm	
Length (ft.)	Part #
3	Z100V3FT
6	Z100V6FT
15	Z100V15FT
25	Z100V25FT

6. Z100 Component Video Interconnect (set), 75 Ohm	
Length (ft.)	Part #
3	Z100CV3FT
6	Z100CV6FT
15	Z100CV15FT
25	Z100CV25FT

7. Z100 S-Video Interconnect, 75 Ohm	
Length (ft.)	Part #
3	Z100SV3FT
6	Z100SV6FT
15	Z100SV15FT
25	Z100SV25FT
25	Z100SV25FT



8. Z100 VGA Interconnect	
Length (ft.)	Part #
3	Z100VGA3FT
6	Z100VGA6FT
15	Z100VGA15FT
25	Z100VGA25FT
35	Z100VGA35FT
50	Z100VGA50FT



TOSLink

Connectivity for optical digital audio devices.

1. Toslink Fiber Optic Interconnects (each)	
Length (meter)	Part #
1	ZTOS1
2	ZTOS2
4	ZTOS4
6	ZTOS6
10	ZTOS10
15	ZTOS15

Ordering is fast & easy.



Call today!

Bundled Taped Solutions

Tektone™ Nurse Call Bundle



TEKTONE-D2
TEKTONE-AUDIO
TEKTONE-P2
16-2C-BLK

Part # **Tektone - NC300**

Liberty provides AV professionals with the option of putting multiple cables together for easy installation. Our unique labor saving process can combine any number of cables into one, by taping them together at regular intervals. (bundled taped plenum cables are only taped at either end to comply with code requirements.)

By eliminating the outer jacket, our bundled taped cables can be made in smaller lengths reducing the order minimums to fit your project size. Typical lengths of taped bundles range from 250 feet to 1,000 feet.

As the number of cables and the overall length increase so does the spool construction. Most bundled taped cables are provided on sturdy wooden reels.

Saves Time

- Only one hole to drill
- Only cable to pull
- The entire installation is completed faster

Saves Labor

- One pull brings in all cables
- Less inventory to manage

Saves Money

- Less expensive than a custom cable with outer jacket
- Unlimited cable options
- Less product to warehouse at your facility



Taped Bundles allow you to design your own cables by combining any number of cables into one cable.

Designing your own bundled taped solutions is easy! Here are some common options:



Commercial

24-4P-L5-EN-YEL
24-4P-L5-EN-VIO
24-4P-L5-EN-GRY
14-2C-HT

Part # **44-20031**



Commercial & Residential Bundle

24-4P-L5-EN-GRN
24-4P-L5-EN-BLK
16-4C-EX+RBL

Part # **44-20062**

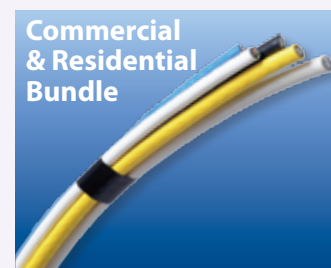

Commercial & Residential Bundle

QUADFLEX-WHT
BEL9118
QUADFLEX-YEL
24-4P-L5-EN-BLU
24-4P-L5SH-EN-WHT

Part # **44-20071**



Residential

QUADFLEX-BLK
24-4P-L5-EN-BLU
22-4C-SH-GRY
22-4C-SH-GRY

Part # **44-20075**



Commercial & Residential Security Bundle

20-CMP-VID-COAX-RED
20-CMP-VID-COAX-GRN
20-CMP-VID-COAX-BLU
20-CMP-VID-COAX-YEL
20-CMP-VID-COAX-WHT

Part # **44-20204**

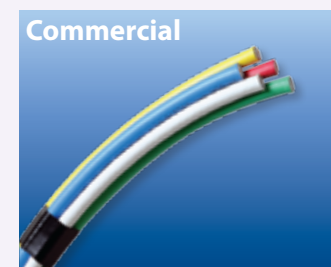

Commercial

18-CMP-VID-COAX-RED
18-CMP-VID-COAX-GRN
18-CMP-VID-COAX-BLU
18-CMP-VID-COAX-WHT
18-CMP-VID-COAX-YEL

Part # **44-20082**

Ordering is fast & easy.



Call today!

Solutions for the AV PROFESSIONAL

www.libertycable.com

800-530-8998

INTERNATIONAL - CALL +1-719-388-7542



AES/EBU 110 Ohm Digital Audio Snake Cable Non-Plenum and Plenum

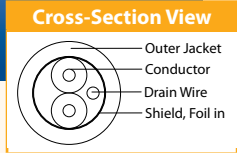

Individually Shielded and Jacketed Pairs

- UL Listed NEC Type CM or CMP
- Tinned Copper Stranded Conductors
- Foam PE or FEP insulation
- Meets or Exceeds All Performance Specifications for AES/EBU Digital Audio
- 100% Aluminum/Poly Shield

ASE/EBU 110 Ohm Flexible Digital Audio Snake Cable							
# of Pairs	AWG Size/ Stranding	NOM Insulation (Inches)	NOM Pair Jacket (Inches)	NOM Jacket (Inches)	NOM OD (Inches)	NOM Capacitance pF/ft	Part #
1	24 STR TC (7X32)	.023 FPE BLK-WHT	N/A	.030 BLK FR-PVC	.195	11.5	24-1P-DIG-AUDIO CM
1	24 STR TC (7X32)	.020 FFEP BLK-WHT	N/A	.015 BLK PLN-PVC	.165	11.5	24-1P-P-DIG-AUDIO CMP

Shielded Audio Cable - Non-Plenum - Overall Shielded & Individually Shielded

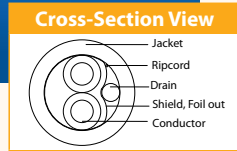

Our commercial non-plenum shielded audio cable is a price performer for the budget-conscious project. Made to basic industry standard dimensions, it's easy to cross to the specifying engineer's referenced cable specifications. All of these cables are sequentially footmarked to facilitate cable management and inventory control.

In-Wall Audio Cable, Shielded with Drain Wire

- UL Listed NEC Type CL3R or CMR
- Bare Copper Stranded Conductors
- PVC Insulation
- Gray PVC Jacket
- Sequential Footmarks
- Ripcord
- See Color Code Charts on page 241

Overall Foil Shielded with Stranded TC Drain						
# of Conductors	AWG Size/ Stranding	NOM Insulation (Inches)	NOM Jacket (Inches)	NOM OD (Inches)	NOM Capitance pF/ft	Part #
2	22 (7X30)	.010	.020	.141	48.2	22-2C-SH-GRY
4	22 (7X30)	.009	.020	.162	42.8	22-4C-SH-GRY
2	20 (7X28)	.010	.020	.152	42.8	20-2C-SH-GRY
2	18 (7X26)	.010	.020	.169	40	18-2C-SH-GRY

Each Pair Individually Foil Shielded with Stranded TC Drain						
# of Pairs	AWG Size/ Stranding	NOM Insulation (Inches)	NOM Jacket (Inches)	NOM OD (Inches)	NOM Capacitance pF/ft	Part #
2	22 (7X30)	.010	.020	.220	42.8	22-2P-INDSH-GRY
2	18 (7X26)	.010	.020	.281	40	18-2P-INDSH-GRY

*CMR and Plenum Rated products are available

Bulk Wire: Commercial Audio Cable

Ordering is fast & easy.



Call today!

Solutions for the AV PROFESSIONAL
www.libertycable.com

800-530-8998
INTERNATIONAL - CALL +1-719-388-7542



Broadcast Quality EZ-Strip Audio Cable Non-Plenum and Plenum

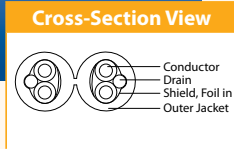
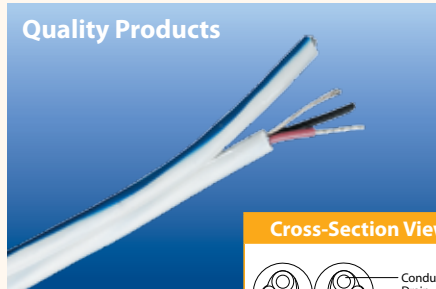

Liberty's exclusive new high-performance EZ-strip plenum and PVC broadcast audio cables. Our new plenum cables are the first to offer time saving EZ-Strip jackets. The foil is removed with the outer jacket in one easy strip. Our siamese EZ-strip plenum cable is the fastest way to install and terminate multiple audio runs. These cables feature a low capacitance rating to increase performance. Liberty's EZ-Strip audio cables save you time and improves cable performance.

Low Capacitance Audio Cable

- UL Listed NEC Type CM, CMR or CMP
- Tinned Copper Stranded Conductors
- Non-Plenum High Density Foam Polyethylene Insulation for Lower Capacitance
- Plenum Foamed FEP Insulation for Lower Capacitance
- Non-Plenum or Plenum PVC Jacket
- Sequential Footmarks
- Available in Multiple Jacket Colors
- See Color Code Charts on page 241

Non-Plenum Shielded UL CMR or CM						
# of Pairs	AWG Size/ Stranding	NOM Insulation (Inches)	NOM Jacket (Inches)	NOM OD (Inches)	NOM Capacitance pF/ft	Part #
1	24 STR TC (7X32)	.015 BLK/RED HDFPE	.015 BLK PVC	.140	21	24-1P-EZ-* CM *Available in Black, Brown, Orange, Red, or Yellow
1	22 STR TC (7X30)	.010 BLK/RED HDFPE	.020 BLK PVC	.145	21	22-1P-EZ-* CMR *Available in Black, Blue, Brown, Green, Gray, Orange, Purple, Red, Tan, White or Yellow
2	22 STR TC (7X30)	.010 BLK/RED HDFPE	.015 BLK PVC	.135X.275	21	22-2P-SIAM-EZ CM

Plenum Shielded UL CMP						
# of Pairs	AWG Size/ Stranding	NOM Insulation (Inches)	NOM Jacket (Inches)	NOM OD (Inches)	NOM Capacitance pF/ft	Part #
1	24 STR TC (7X32)	.015 BLK/RED FFEP	.015 WHT PLN-PVC	.140	21	24-1P-CMP-EZ-WHT CMP
1	22 STR TC (7X30)	.010 BLK/RED FFEP	.015 WHT PLN-PVC	.145	21	22-1P-CMP-EZ-* CMP *Available in Black, Blue, Green, Gray, Orange, Red, Violet, White or Yellow
2	22 STR TC (7X30)	.010 BLK/RED .010 BLK/WHT FFEP	.015 WHT PLN-PVC	.285X.140	21	22-2P-CMP-SIAMEZ CMP

Ordering is fast & easy.



Call today!

**Solutions for the
AV PROFESSIONAL**
www.libertycable.com

800-530-8998
INTERNATIONAL - CALL +1-719-388-7542



Shielded Audio Cable - Plenum

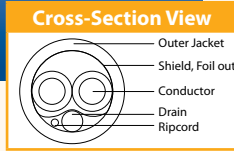

Our plenum individually shielded audio cable is a price performer for budget-conscious projects. Made to basic industry standard dimensions, it's easy to cross to the specifying engineer's referenced cable specifications.

Multi-Conductor/Overall Shield with Drain Wire

- UL Listed NEC Type CL3R or CMR
- Bare Copper Stranded Conductors
- Low Smoke PVC Insulation
- Overall Foil Shield with Stranded TC Drain
- Low Smoke White PVC Jacket
- Sequential Footmarks
- Ripcord
- See Color Code Charts on page 241

Plenum Shielded Audio Cable						
# of Conductors	AWG Size/ Stranding	NOM Insulation (Inches)	NOM Jacket (Inches)	NOM OD (Inches)	NOM Capittance pF/ft	Part #
2	22 (7X30)	.008	.015	.124	40.8	22-2C-PSH-WHT
2	20 (7X28)	.008	.015	.138	45.5	20-2C-PSH-WHT
2	18 (7X26)	.009	.015	.162	51.0	18-2C-PSH-WHT

Plenum Shielded Paired Low Cap Audio Cable							
# of Pairs	AWG Size/ Stranding	NOM Insulation (Inches)	Shield	NOM Jacket (Inches)	NOM OD (Inches)	NOM Capittance pF/ft	Part #
2	24 (7X32)	.010	100% AL/POLY w/Drain	.010	.159	15.5	24-2P-P-L5SH-WHT White, Blue, Gray
4	24 Solid BC	.010 FEP	100% AL/POLY w/Drain	.015 PL-PVC	.225	17.0	24-4P-P-L5SH-* White, Blue, Gray
4	23 Solid BC	.010 HDPE	100% AL/POLY w/Drain	.022 PVC	.287	14.0	24-4P-L6SH-* White, Blue, Gray

Individually Shielded Audio Cable - Plenum

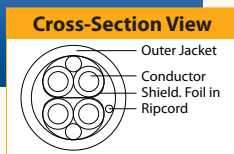
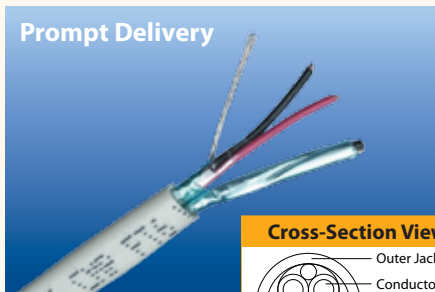

Our plenum individually shielded audio cable is a price performer for budget-conscious projects. Made to basic industry standard dimensions, it's easy to cross to the specifying engineer's referenced cable specifications.

Multi-Pair/Individually Shielded with Drain Wire

- UL Listed NEC Type CL3P and/or CMP
- Bare Copper Stranded Conductors
- Low Smoke PVC Insulation
- Each Pair Foil Shielded with Stranded TC Drain
- Low Smoke White PVC Jacket
- Sequential Footmarks
- Ripcord
- See Color Code Charts on page 241

Plenum Individual Shielded Audio Cable						
# of Pairs	AWG Size/ Stranding	NOM Insulation (Inches)	NOM Jacket (Inches)	NOM OD (Inches)	NOM Capittance pF/ft	Part #
2	22 (7X30)	.008	.015	.188	42.0	22-2P-PINDSH-WHT
2	18 (7X26)	.008	.015	.265	48.5	18-2P-PINDSH-WHT
3	22 (7X30)	.008	.015	.222	41.0	22-3P-PINDSH-WHT
3	18 (7X26)	.008	.015	.280	51.0	18-3P-PINDSH-WHT
4	22 (7X30)	.008	.015	.234	42.0	22-4P-PINDSH-WHT

All above cables can be produced with colored jackets. *Also available with a common axis drain wire - one drain wire for both pairs.

Ordering is fast & easy.

Call today!

Expand Your Category Solutions with Baluns

Balun, short for BALanced-UNbalanced. Balun technology has improved dramatically during the last decade and Liberty offers a full line of quality Balun solutions for those situations where a Balun makes sense. Passive Baluns require no external power and low frequency signals such as composite video and analog line level audio can literally be sent thousands of feet on standard category cable. Excellent for retrofits where pulling a single category cable is an

option, signals up to and including RGBHV can be sent using a passive Balun. Active Baluns incorporate circuitry to equalize and amplify signals and higher frequency signals such as WSXGA, HDMI and DVI can be sent significant distances using this technology. Shielded category cable is strongly recommended for active Baluns. Sold as singles for custom mix and match or in pre-packaged pairs – Liberty has the Balun solution for you.

Passive

 BALUN, L/R RCA AUDIO	Part #: AVO-A2-F L/R RCA Audio over Category Cable Passive Balun. Requires two to complete the circuit and the balun can transmit and receive.	 BALUN 3.5 STEREO SG FP WHT	Part #: AVO-A2MINI-WP-F 3.5mm Stereo Audio over Category Cable Balun mounted on a White Single Gang Faceplate. Requires two to complete the circuit and the balun can transmit or receive.
 BALUN SET, L/R RCA AUDIO	Part #: AVO-A2-PAC-F L/R RCA Audio over Category Cable Passive Transmit and Receive Balun complete set.	 BALU, L/R RCA AUDIO SG FP WHT	Part #: AVO-A2-WP-F L/R RCA Audio over Category Cable Passive Balun mounted on a white single gang faceplate. Requires two to complete the circuit and the balun can transmit and receive.
 BALUN, 2 X L/R RCA AUDIO	Part #: AVO-A4-F Dual L/R RCA Audio over Category Cable Passive Balun. Requires two to complete the circuit and the balun can transmit and receive.	 BALUN SET, 2 X L/R RCA 2-PAK	Part #: AVO-A4-PAC-F Dual L/R RCA Audio over Category Cable Passive Transmit and Receive Balun complete set.
 BALUN, 2 X L/R RCA SG FP WHT	Part #: AVO-A4-WP-F Dual L/R RCA Audio over Category Cable Passive Balun mounted on a white single gang faceplate. Requires two to complete the circuit and the balun can transmit and receive.	 BALUN, SV+L/R RCA AUDIO	Part #: AVO-SVA2-F S-Video and L/R RCA Audio over Category Cable Passive Balun. Requires two to complete the circuit and the balun can transmit or receive.
 BALUN, AVBNC L/R RCA	Part #: AVO-V1A2-F Composite Video BNC and L/R Audio RCA over Category Cable Passive Balun. Requires two to complete the circuit and the balun can transmit and receive.	 BALUN, AV RCA SG WHT	Part #: AVO-V1A2-WP-F Composite Video RCA and L/R Audio RCA over Category Cable Passive Balun mounted on a white single gang faceplate. Requires two to complete the circuit and the balun can transmit and receive.
 BALUN SET, BNC VIDEO	Part #: AVO-V1-PAC Composite Video BNC over Category Cable Passive Balun. Passive Transmit and Receive Balun complete set.	 BALUN, RCA VIDEO SG FP WHT	Part #: AVO-V1-WP-F Composite Video RCA over Category Cable Passive Balun mounted on a white single gang faceplate. Requires two to complete the circuit and the balun can transmit or receive.
 BALUN 2 VIDEO RCA L/R RCA	Part #: AVO-V2A2-F Dual Composite Video with L/R RCA Audio over Category Cable Passive Balun. Requires two to complete the circuit and the balun can transmit or receive.	 BALUN 4 RCA 2V2A SG FP WHT	Part #: AVO-V2A2-WP-F Dual Composite Video with L/R RCA Audio over Category Cable Passive Balun on a white single gang faceplate. Requires two to complete the circuit and the balun can transmit or receive.

Ordering is fast & easy.



Call today!

Solutions for the AV PROFESSIONAL
www.libertycable.com









800-530-8998
 INTERNATIONAL - CALL +1-719-388-7542



Expand Your Category Solutions with Baluns

Bulk Wire: Commercial Category Cable

Passive (Continued)

 BALUN HD-COMP+S/PDIF AUDIO	Part #: AVO-V3AD-F High Definition Component Video RCA and Coaxial Digital Audio (S/PDIF) over Category Cable Passive Balun. Requires two to complete the circuit and the balun can transmit and receive.	 BALUN, HD-COMP+S/PDIF SG FP WH	Part #: AVO-V3AD-WP-F High Definition Component Video RCA and Coaxial Digital Audio (S/PDIF) over Category Cable Passive Balun mounted on a white single gang faceplate. Requires two to complete the circuit and the balun can transmit and receive.
 BALUN HD-COMPONENT BNC	Part #: AVO-V3HD-F High Definition Component Video BNC over Category Cable Passive Balun. Requires two to complete the circuit and the balun can transmit and receive.	 BALUN, HD-COMP+IR CONTROL	Part #: AVO-V3PT-F High Definition Component Video RCA and Infrared (IR) control over Category Cable Passive Balun. Requires two to complete the circuit and the balun can transmit and receive.
 BALUN SET, PS/2 MOUSE/KYBD EXT	Part #: PS2-F PS/2 Mouse & Keyboard Extension over Category Cable Passive Balun complete set for distances up to 350 feet.	 BALUN, CATV F	Part #: RF-F Broadband CATV F over Category Cable Passive Balun. Transmit up to Channel 150 and 330 feet. Requires two to complete the circuit and the balun can transmit and receive.
 BALUN, CCTV VIDEO+PTZ	Part #: V1-PTZ-F Composite Video BNC and Coaxial Pan-Tilt-Zoom Passive Balun. Requires two to complete the circuit and the balun can transmit and receive.	 BALUN SET, VGA PASSIVE TO UTP	Part #: VGA-SR-F VGA (HD15) over Category Cable Passive Transmit and Receive Balun complete set. UXGA up to 350 feet.

Active

 BALUN SET, MIC & PANTOM PWR	Part #: AVO-MIC-F Active Microphone Level Audio and Phantom Power over Category Cable Balun complete set. Terminal Block connectivity for microphone.	 BALUN SET, XLR MIC SG FP WHT	Part #: AVO-MIC-WP-F Active Microphone Level Audio and Phantom Power over Category Cable Balun complete set. MIC side features white single gang faceplate with XLR connectivity for microphone.
 DIGITALLINX HDMI/CAT TX/RX SET	Part #: DL-HDCAT Active HDMI 1.3b Standard Speed transmit and receive complete balun set. Use Shielded Category Cable for best results of 1080p up to 20 meters and 1080i to 40 meters.	 DIGITALLINX HDMI/CAT TX/RX FP	Part #: DL-HDCAT-WP Active HDMI 1.3b Standard Speed transmit and receive complete balun set mounted on a white single gang faceplate. Use Shielded Category 6 Cable for best results of 1080p up to 50 meters and 1080i to 70 meters.
 BALUN SET, ACTIVE VGA OVER UTP	Part #: VGA-HR-F Active VGA (HD15) over Category Cable Transmit and Receive Balun complete set. SXGA up to 200 feet.	 BALUN SET, ACTIVE WSXGA TO UTP	Part #: VGA-UHR-F Active WSXGA HD15 over Category Cable Transmit and Receive balun set for distances up to 550 feet.
 BALUN SET, USB 2.0 LEX/REX	Part #: PMI-A5 USB High Speed (480 Mbps) over Category Cable Transmit and Receive Balun complete set. Uses USB power from the transmit device.		

Ordering is fast & easy.



Call today!

Solutions for the AV PROFESSIONAL
www.libertycable.com

800-530-8998
INTERNATIONAL - CALL +1-719-388-7542



Liberty Offers a Complete Line of Category Cable

Category 3

- CMR, CMP Rated • Sequential Footmarks • Tested to 16 MHz

Category 3						
# of Pairs	AWG Size	NOM Insulation (Inches)	NOM Jacket (Inches)	NOM OD (Inches)	NOM Capacitance pF/ft	Part #
4	24 Solid BC	.006 PE	.013 PVC	.140	12.5	24-4P-L3-* CM Non-Plenum *Available in Burgundy, Gray, Light-Blue or White
4	24 Solid BC	.005 PE	.013 PLN-PVC	.130	21	24-4P-P-L3-* CMP Plenum *Available in Blue, Green, Gray, White or Yellow
25	24 Solid BC	.020 Low Smoke	.364 PVC	.330	18	24-25P-P-L3-WHT CMP 25 Pair, Plenum

Category 5E

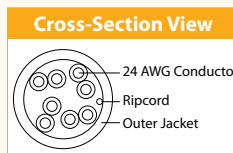
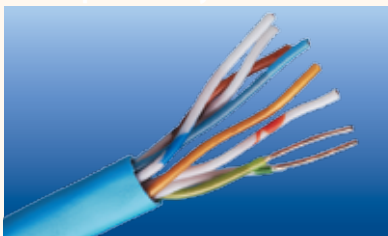

- CMR/CMP Rated
- Sequential Footmarks
- Tested to 350 MHz
- Several Colors Available
- 10/100 BaseT Network Compliant



See Direct Burial Page 168

Category 5E Enhanced						
# of Pairs	AWG Size	NOM Insulation (Inches)	NOM Jacket (Inches)	NOM OD (Inches)	NOM Capacitance pF/ft	Part #
4	24 Solid BC	.008 PE	.022 FR-PVC	.195	14	24-4P-L5-EN-* CMR CAT5 Riser *Available in Beige, Black, Blue, Green, Gray, Orange, Pink, Red, White or Yellow
4	24 Solid BC	.008 PE	.030 PE	.240	14	24-4P-L5-EN-DB Direct Burial CAT5
4	24 Solid BC	.010 FEP	.015 PL-PVC	.225	17	24-4P-P-L5SH-* CMP CAT5 Plenum Shielded *Available in White, Blue, Gray
4	24 STR BC	.008 PE	.022 FR-PVC	.195	14	24-4P-STR-L5-EN-* CMR CAT5 Riser Stranded *Available in Black, Blue, Green, Gray, Orange, Pink, Red, Violet, White or Yellow
4	24 Solid BC	.010 PE	.020 FR-PVC	.237	17	24-4P-L5SH-EN* CMR CAT5 Shielded Riser *Available in Blue, Green, Violet, Red, or White
8	24 Solid BC	.0095 PE	.022 PVC	190x390	17	24-8P-L5E-SIAM* CMR Siamese Riser *Available in Blue and Green
16	24 Solid BC	.008 PE	.020 FR-PVC	.187	17	CAT5E-4C-J CM (4) CAT5E Cable under one green jacket Overall Construction
20	24 Solid BC	.008 PE	.020 PVC	.630	17	CAT5E-5C-J CM (5) CAT5E Cable under one yellow jacket Overall Construction

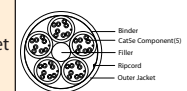
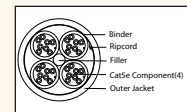

Ordering is fast & easy.



Call today!

Solutions for the AV PROFESSIONAL
www.libertycable.com

800-530-8998
INTERNATIONAL - CALL +1-719-388-7542



Category 6E

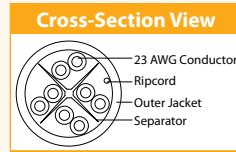

- CMR/CMP Rated
- Tested to 550 MHz
- 16dB Headroom over Cat 5
- Sequential Footmarks
- Several Colors Available
- 10/1000 BaseT Network Compliant

Category 6E Enhanced						
# of Pairs	AWG Size	NOM Insulation (Inches)	NOM Jacket (Inches)	NOM OD (Inches)	NOM Capacitance pF/ft	Part #
4	23 Solid BC	.008 PE	.020 FR-PVC	.240	14	24-4P-L6-EN-* CMR *Available in Blue, Green, Gray, Orange, White or Yellow
4	23 Solid BC	.007 FEP	.017 PL-PVC	.236	14	24-4P-P-L6-EN-* CMP *Available in Black, Blue, Green, Red, White or Yellow
4	23 Solid BC	.010 HDPE	.022 PVC	.287	14	24-4P-L6SH-* CMR *Available in White, Blue, Gray

Category 6A

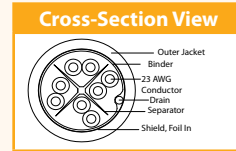

10 Gigabit Ethernet Copper Cabling, Category 6 Augmented tested and certified to 500 MHz per the newest TIA/EIA performance standard.

Category 6A Shielded							
# of Pairs	AWG Size	NOM Insulation (Inches)	Shield	NOM Jacket (Inches)	NOM OD (Inches)	NOM Capacitance pF/ft	Part #
4	23 AWG Solid BC	.009 PE	100% AL/ POLY w/Drain	.022 PVC	.287	14.0	24-4P-L6ASH White, Blue, Gray

RGB Over UTP Applications TRUphase™ Low-Skew Cable

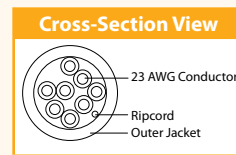

Liberty's TRUphase™ Low-Skew cable offering provides a high quality cable solution at a reasonable price for improving the quality and distance in RGB over UTP applications. No out of convergence images! It is available in both PVC and Plenum versions.

RGB Over UTP Applications TRUphase™ Low-Skew Cable							
# of Pairs	AWG Size	NOM Insulation (Inches)	NOM Jacket (Inches)	NOM OD (Inches)	Shield	NOM Capacitance (pF/ft)	Part #
4	23	.008 PE	.030 BLK	.230		16	TRUPHASE CMR
4	23	.007 PE	.015 BLK	.180		14	TRUPHASE-P CMP
4	23	.040 PE	.024 BRM	.225	Overall AL Poly w/ 24 AWG Drain	16	TRUPHASE-SH-BRN

Ordering is fast & easy.



Call today!

Solutions for the AV PROFESSIONAL
www.libertycable.com

800-530-8998
INTERNATIONAL - CALL +1-719-388-7542



CATMaster™ Crimp Tool and Connector System



CATMaster™ Crimp Tool

This high-quality crimp tool is designed to quickly crimp and cut the wires of the EZ-RJ45® Connector...in one easy operation! Works on most other RJ-11 and RJ-12 connectors.

Part #: 100 044LW

Replacement blades keep your cuts always sharp.



Part #: 100 004BL
EZ-RJ45 Crimp Tool Blade Pair (2 Blades in a retail blister package)

Punch-Down Tool



Our 110 Block punch-down is ergonomically designed so that it reduces wrist strain even with hours of use. Inserts and cuts terminations in one operation. Easy-to-use adjustable actuation setting accommodates termination requirements or user preference.

Part #: 13006

UTP Cable Jacket Stripper

This economical tool has been specifically designed to strip the cable jacket from UTP cables. Will not scratch the inner conductors.

Part #: 15010



EZ-RJ45® Connector

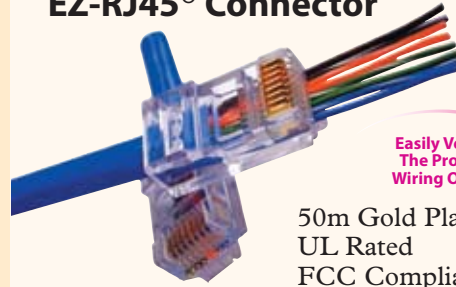

Easily Verify The Proper Wiring Order

50m Gold Plate
UL Rated
FCC Compliant

Connector Type	Package	Part #
Cat5e	100	100 003B
Cat6	30	100 011LW
RJ11/12	50	100 026LW
Cat5e Shielded	50	100020
Integrated Strain Relief Cat5e	50	100035
Integrated Strain Relief Cat6	50	100036
Colored Strain Relief Cat6	50	100030 (color)

Buy It As a Kit!



Part #: 100035

Metal Connector (Shielded)
Part #: 100020



Colored Boots
Part #: 100030-*

CATMaster™ Kits are available

Description	Part #
<ul style="list-style-type: none"> • 1 CATMaster RJ11/RJ45 Crimp Tool • 1 CATMaster Stripper • 1 Cable Cutter • 50 CATMaster RJ-45 Connectors 	90131LW

RJ45 Plates Combine Form & Function Popular Single and Double Gang Plates on page 202



Part #: PC-G1290

QTY CONNECTOR
1 HD-15 FEMALE
3 INSULATED RCA
2 RJ-45



Part #: PC-G2140

QTY CONNECTOR
2 HD-15 FEMALE
2 STEREO-MINI
2 RJ-45



Call for Details

Order Everything with Just One Call!

Ordering is fast & easy.



Call today!

Solutions for the
AV PROFESSIONAL
www.libertycable.com

800-530-8998
INTERNATIONAL - CALL +1-719-388-7542

CATV/MATV Video Cable Plenum

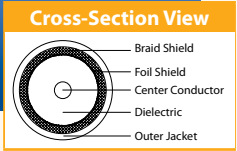

Coax - Double (Dual) Shielded

- UL Listed NEC Type CMP
- Copper Clad Steel Center Conductor
- Foamed FEP Dielectric
- Low Smoke PVC or PVDF Jackets
- 75 Ohm
- Sequential Footmarks

Plenum Video Cable - CATV/MATV																										
Type	AWG Center Conductor	NOM OD Dielectric (Inches)	Shield Construction	NOM Jacket (Inches)	NOM OD (Inches)	NOM Capacitance (Pf/ft)	NOM Velocity of Propagation	NOM Attenuation		Part #																
								MHz	db100'																	
RG6	18 Solid CCS	0.17 Foam FEP	Foil + 60% Alum Braid	0.016 PLN-PVC WHT	0.237	15.5	84%	1	0.25	RG6-P-CATV-BLK RG6-P-CATV-BLU RG6-P-CATV-WHT																
								10	0.71																	
								50	1.47																	
								100	2.01																	
								200	2.82																	
								400	4.13																	
								700	5.85																	
								900	6.87																	
								1000	7.36																	
								1450	8.86																	
1800	9.87																									
2200	10.95																									
<div style="border: 1px solid black; padding: 5px;"> <p>PERFECT TERMINATIONS</p> <table border="1"> <thead> <tr> <th>Item #</th> <th>Part #</th> <th>Item #</th> <th>Part #</th> </tr> </thead> <tbody> <tr> <td>19</td> <td>CM-RG6P-RCA</td> <td>22</td> <td>CM-RG6P-GBNC</td> </tr> <tr> <td>20</td> <td>CM-RG6P-GRCA</td> <td>23</td> <td>CM-RG6P-F</td> </tr> <tr> <td>21</td> <td>CM-RG6P-BNC</td> <td>24</td> <td>CM-RG6P-GF</td> </tr> </tbody> </table> <p>SEE PAGE 161</p> </div>											Item #	Part #	Item #	Part #	19	CM-RG6P-RCA	22	CM-RG6P-GBNC	20	CM-RG6P-GRCA	23	CM-RG6P-F	21	CM-RG6P-BNC	24	CM-RG6P-GF
Item #	Part #	Item #	Part #																							
19	CM-RG6P-RCA	22	CM-RG6P-GBNC																							
20	CM-RG6P-GRCA	23	CM-RG6P-F																							
21	CM-RG6P-BNC	24	CM-RG6P-GF																							
RG11	14 Solid CCS	0.28 Foam FEP	Foil + 60% Alum Braid	0.02 PVDF WHT	0.351	16	82%	1	0.2	RG11-P-CATV-WHT																
								10	0.45																	
								50	0.95																	
								100	1.35																	
								200	1.95																	
								400	3.02																	
								700	4.35																	
								900	5.19																	
								1000	5.59																	
								1450	6.69																	
1800	7.47																									

CCTV Direct Burial Video Cable

These cables are ideal for outside application or direct burial applications.

CCTV Direct Burial Cable Available

Direct Burial - Gel Filled

- Solid Bare Copper Center Conductor
- Foamed Polyethylene Insulation
- Black Polyethylene Jacket
- UV Rated for Sunlight Resistance
- Suitable for Direct Burial Applications
- 75 Ohm

Part #: RG6-DB-CCTV
Part #: RG59-DB-CCTV
Part #: RG11-DB-CCTV

Solutions for the AV PROFESSIONAL

www.libertycable.com

800-530-8998

INTERNATIONAL - CALL +1-719-388-7542

Bulk Wire: Commercial Coax Cable

Ordering is fast & easy.

Call today!

CATV/MATV Quad Video Cable Plenum

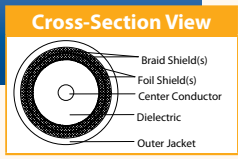

Coax - Quad (Four) Shielded

- UL Listed CMP
- Solid Copper Clad Steel Center Conductor
- Foamed FEP Dielectric
- 75 Ohm
- Sequential Footmarks

Plenum Video Cable - CATV/MATV																			
AWG Center Conductor	NOM OD Dielectric (Inches)	Shield Construction	NOM Jacket (Inches)	NOM OD (Inches)	NOM Capacitance (Pf/ft)	NOM Velocity of Propagation	NOM Attenuation		Part #										
							MHz	db100'											
18 Solid CCS	0.17 Foam FEP	2 Foils + 60% AL 40% AL Braid	0.016 PLN-PVC	0.264	16	84%	1	0.37	RG6-QUAD-CMP-WHT										
							10	0.95											
							50	2.01											
							100	2.72											
							200	3.80											
							400	5.40											
							700	7.00											
							900	8.05											
							1000	8.60											
							<div style="border: 1px solid black; padding: 5px;"> <p style="text-align: center; margin: 0;">PERFECT TERMINATIONS</p> <table border="1" style="width: 100%; border-collapse: collapse;"> <tr> <td style="width: 50%;"></td> <td style="width: 50%;"></td> </tr> <tr> <td>Item # Part #</td> <td>Item # Part #</td> </tr> <tr> <td>19 CM-RG6P-RCA</td> <td>22 CM-RG6P-GBNC</td> </tr> <tr> <td>20 CM-RG6P-GRCA</td> <td>23 CM-RG6P-F</td> </tr> <tr> <td>21 CM-RG6P-BNC22</td> <td>24 CM-RG6P-GF</td> </tr> </table> <p style="margin-top: 5px;">SEE PAGE 162</p> </div>												Item # Part #
Item # Part #	Item # Part #																		
19 CM-RG6P-RCA	22 CM-RG6P-GBNC																		
20 CM-RG6P-GRCA	23 CM-RG6P-F																		
21 CM-RG6P-BNC22	24 CM-RG6P-GF																		
14 Solid CCS	0.280 FFEP	2 Foils 60% + 40% AL Braid	.020 PVDF	.372	16.0	84%	50	0.90	RG11-QUAD-PL-WHT										
							100	1.28											
							400	2.75											
							700	3.92											
							1000	5.04											
							1800	7.71											
							2200	8.50											
							3000	9.93											

Ordering is fast & easy.



Call today!

Solutions for the AV PROFESSIONAL
www.libertycable.com

800-530-8998
INTERNATIONAL - CALL +1-719-388-7542



CCTV and Baseband Video Cable Plenum

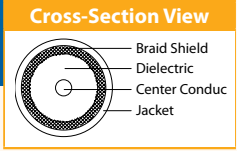

These cables are ideal for closed circuit TV applications or high quality analog video runs.

Coax - Single Shielded

- UL Listed NEC Type CMP/C(UL)CMP
- Solid Bare Copper Center Conductor
- Foamed FEP Dielectric
- Low Smoke White PVC Jacket
- 75 Ohm
- Sequential Footmarks

Plenum Video Cable - CCTV & BaseBand Video																	
AWG Center Conductor	NOM OD Dielectric (Inches)	Shield Construction	NOM Jacket (Inches)	NOM OD (Inches)	NOM Capacitance (Pf/ft)	NOM Velocity of Propagation	NOM Attenuation		Part #								
							MHz	db100'									
20 AWG Solid BC	0.146 FFEP	95% BC Braid	0.015 PL-PVC	0.198	16	82%	10 50 200 400 700 900 1000	0.24 0.85 2.92 6.27 8.47 9.82 10.47	RG59-CCTV-PL-BLK RG59-CCTV-PL-WHT RG59-CCTV-PL-YEL *Available in Black, White, or Yellow.								
PERFECT TERMINATIONS <table border="1"> <tr> <th>Item #</th> <th>Part #</th> </tr> <tr> <td>34</td> <td>CM-RG59PC-RCA</td> </tr> <tr> <td>35</td> <td>CM-RG59PC-BNC</td> </tr> <tr> <td>36</td> <td>CM-RG59PC-F</td> </tr> </table> SEE PAGE 161										Item #	Part #	34	CM-RG59PC-RCA	35	CM-RG59PC-BNC	36	CM-RG59PC-F
Item #	Part #																
34	CM-RG59PC-RCA																
35	CM-RG59PC-BNC																
36	CM-RG59PC-F																
18 Solid BC	0.17 FFEP	95% BC Braid	0.016	0.237 PLN-PVC	16	84%	1 10 100 400	0.21 0.65 2.04 4.46	RG6-CCTV-PL-BLK RG6-CCTV-PL-WHT *Available in Black or White.								
PERFECT TERMINATIONS <table border="1"> <tr> <th>Item #</th> <th>Part #</th> </tr> <tr> <td>31</td> <td>CM-RG6PC-RCA</td> </tr> <tr> <td>32</td> <td>CM-RG6PC-BNC</td> </tr> <tr> <td>33</td> <td>CM-RG6PC-F</td> </tr> </table> SEE PAGE 161										Item #	Part #	31	CM-RG6PC-RCA	32	CM-RG6PC-BNC	33	CM-RG6PC-F
Item #	Part #																
31	CM-RG6PC-RCA																
32	CM-RG6PC-BNC																
33	CM-RG6PC-F																
14 Solid BC	0.280 FPE	95% BC Braid	.020 PVDF	0.351	16.5	82%	50 100 200 400 700 900	0.9 1.4 2.2 3.6 4.6 5.4	RG11-CCTV-PL-WHT								
20 AWG Solid BC	0.135 FFEP	95% BC Braid	.014 PL-PVC	.200 x.380	16.2	83%	50 100 200 400 1000	2.00 2.70 3.70 6.30 10.10	RG59-18/2C-PS								
18 STR BC (7x26)	0.010 PL-PVC		.014 PL-PVC														
PERFECT TERMINATIONS <table border="1"> <tr> <th>Item #</th> <th>Part #</th> </tr> <tr> <td>34</td> <td>CM-RG59PC-RCA</td> </tr> <tr> <td>35</td> <td>CM-RG59PC-BNC</td> </tr> <tr> <td>36</td> <td>CM-RG59PC-F</td> </tr> </table> SEE PAGE 161										Item #	Part #	34	CM-RG59PC-RCA	35	CM-RG59PC-BNC	36	CM-RG59PC-F
Item #	Part #																
34	CM-RG59PC-RCA																
35	CM-RG59PC-BNC																
36	CM-RG59PC-F																

Bulk Wire: Commercial Coax Cable

Ordering is fast & easy.



Call today!

Solutions for the AV PROFESSIONAL
www.libertycable.com

800-530-8998
INTERNATIONAL - CALL +1-719-388-7542



Serial Digital Video Cable Non-Plenum and Plenum

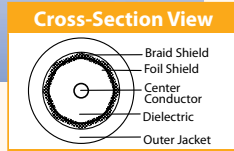

Liberty's Serial Digital video cable is the standard for speed, reliability and performance for all high-definition applications. Our specifications will meet or exceed any serial digital video requirement.

Serial Digital Video Cable

- UL Listed NEC Type CM, CMR or CMP
- *INTERFLEX cables are Non-UL Rated
- Solid Bare Copper Center Conductor
- 75 Ohm
- All SDI Coaxial Cables swept to 4.5 GHz

Serial Digital Video Cables - Non-Plenum																									
AWG Center Conductor	NOM OD Dielectric (Inches)	Shield Construction	Jacket (Inches)	NOM OD (Inches)	NOM Capacitance (Pf/ft)	NOM Velocity of Propagation	NOM Attenuation		Part #																
							MHz	db100'																	
23 Solid BC	0.101 FPE	100% Bonded Foil 95% TC Braid	.019 PVC	0.165	16.5	84%	1	0.38	23-MINI-SD-* CM Rated																
							3.58	0.77																	
							10	1.29																	
							135	4.18																	
							270	5.92																	
							720	9.47																	
							1000	11.16																	
							2000	15.78																	
							3000	19.33																	
							4000	22.32																	
4500	23.67																								
PERFECT CONNECTOR MATCHES <table border="1"> <tr> <th>ITEM #</th> <th>PART #</th> </tr> <tr> <td>1</td> <td>CM-RGB23-BNC</td> </tr> <tr> <td>2</td> <td>CM-RGB23-RCA</td> </tr> <tr> <td>3</td> <td>CM-RGB23-GRCA</td> </tr> </table>										ITEM #	PART #	1	CM-RGB23-BNC	2	CM-RGB23-RCA	3	CM-RGB23-GRCA								
ITEM #	PART #																								
1	CM-RGB23-BNC																								
2	CM-RGB23-RCA																								
3	CM-RGB23-GRCA																								
*Available in Ten Different Colors: Blue Purple Green Red Orange Black Yellow White Gray Brown																									
20 Solid BC	0.145 FPE	100% Bonded Foil 95% TC Braid	.032 PVC	.240	16.2	82%	1	0.38	INTERFLEX-SD-* Non-UL Rated Custom Interconnect manufacture and rack interconnection																
							3.58	0.77																	
							10	1.29																	
							135	4.18																	
							270	5.92																	
							720	9.47																	
							1000	11.16																	
							2000	15.78																	
							3000	19.33																	
							4000	22.32																	
4500	23.67																								
PERFECT TERMINATIONS <table border="1"> <tr> <th>Item #</th> <th>Part #</th> <th>Item #</th> <th>Part #</th> </tr> <tr> <td>25</td> <td>CM-RG59U-RCA</td> <td>28</td> <td>CM-RG59U-GBNC</td> </tr> <tr> <td>26</td> <td>CM-RG59U-GRCA</td> <td>29</td> <td>CM-RG59U-F</td> </tr> <tr> <td>27</td> <td>CM-RG59U-BNC</td> <td>30</td> <td>CM-RG-59U-GF</td> </tr> </table> SEE PAGE 162										Item #	Part #	Item #	Part #	25	CM-RG59U-RCA	28	CM-RG59U-GBNC	26	CM-RG59U-GRCA	29	CM-RG59U-F	27	CM-RG59U-BNC	30	CM-RG-59U-GF
Item #	Part #	Item #	Part #																						
25	CM-RG59U-RCA	28	CM-RG59U-GBNC																						
26	CM-RG59U-GRCA	29	CM-RG59U-F																						
27	CM-RG59U-BNC	30	CM-RG-59U-GF																						
*Available in Seven Different Colors: Blue Clear Green Red Orange Smokey Black Yellow																									
(2) 20 Solid BC	0.145 FPE	100% Foil + 95% TC Braid	.032 PVC	0.24	16.2	82%	1	0.38	IF-SD-*-100M Non-UL Rated Custom Interconnect manufacture and rack interconnection																
							3.58	0.77																	
							10	1.29																	
							135	4.18																	
							270	5.92																	
							720	9.47																	
							1000	11.16																	
							2000	15.78																	
							3000	19.33																	
							4000	22.32																	
4500	23.67																								
PERFECT TERMINATIONS <table border="1"> <tr> <th>Item #</th> <th>Part #</th> <th>Item #</th> <th>Part #</th> </tr> <tr> <td>25</td> <td>CM-RG59U-RCA</td> <td>28</td> <td>CM-RG59U-GBNC</td> </tr> <tr> <td>26</td> <td>CM-RG59U-GRCA</td> <td>29</td> <td>CM-RG59U-F</td> </tr> <tr> <td>27</td> <td>CM-RG59U-BNC</td> <td>30</td> <td>CM-RG-59U-GF</td> </tr> </table> SEE PAGE 162										Item #	Part #	Item #	Part #	25	CM-RG59U-RCA	28	CM-RG59U-GBNC	26	CM-RG59U-GRCA	29	CM-RG59U-F	27	CM-RG59U-BNC	30	CM-RG-59U-GF
Item #	Part #	Item #	Part #																						
25	CM-RG59U-RCA	28	CM-RG59U-GBNC																						
26	CM-RG59U-GRCA	29	CM-RG59U-F																						
27	CM-RG59U-BNC	30	CM-RG-59U-GF																						
International Available in same colors as INTERFLEX-SD above. 100 meter spool.																									
*Available in Seven Different Colors: Blue Clear Green Red Orange Smokey Black Yellow																									
(2) 20 Solid BC	0.145 FPE	100% Foil + 95% TC Braid	.032 PVC	0.24	16.2	82%	1	0.38	INTERFLEX-SIAM Non-UL Rated Siamesed INTERFLEX Red Jacket only																
							3.58	0.77																	
							10	1.29																	
							135	4.18																	
							270	5.92																	
							720	9.47																	
							1000	11.16																	
							2000	15.78																	
							3000	19.33																	
							4000	22.32																	
4500	23.67																								
PERFECT TERMINATIONS <table border="1"> <tr> <th>Item #</th> <th>Part #</th> <th>Item #</th> <th>Part #</th> </tr> <tr> <td>25</td> <td>CM-RG59U-RCA</td> <td>28</td> <td>CM-RG59U-GBNC</td> </tr> <tr> <td>26</td> <td>CM-RG59U-GRCA</td> <td>29</td> <td>CM-RG59U-F</td> </tr> <tr> <td>27</td> <td>CM-RG59U-BNC</td> <td>30</td> <td>CM-RG-59U-GF</td> </tr> </table> SEE PAGE 162										Item #	Part #	Item #	Part #	25	CM-RG59U-RCA	28	CM-RG59U-GBNC	26	CM-RG59U-GRCA	29	CM-RG59U-F	27	CM-RG59U-BNC	30	CM-RG-59U-GF
Item #	Part #	Item #	Part #																						
25	CM-RG59U-RCA	28	CM-RG59U-GBNC																						
26	CM-RG59U-GRCA	29	CM-RG59U-F																						
27	CM-RG59U-BNC	30	CM-RG-59U-GF																						
*Available in Seven Different Colors: Blue Clear Green Red Orange Smokey Black Yellow																									

Ordering is fast & easy.



Call today!

Solutions for the AV PROFESSIONAL
www.libertycable.com

800-530-8998
INTERNATIONAL - CALL +1-719-388-7542



Serial Digital Video Cable Non-Plenum and Plenum

Bulk Wire: Commercial Coax Cable

Serial Digital Video Cables, Non-Plenum																																	
AWG Center Conductor	NOM OD Dielectric (Inches)	Shield Construction	Jacket (Inches)	NOM OD (Inches)	NOM Capacitance (Pf/ft)	NOM Velocity of Propagation	NOM Attenuation		Part #																								
							MHz	db100'																									
20 Solid BC	0.145 FPE	100% Bonded Foil 95% TC Braid	.032 FR-PVC	240	16.2	82%	1	0.38	20-CMR-VIDEO-* CMR Rated																								
							3.58	0.77																									
							10	1.29																									
							135	4.18																									
							270	5.92																									
							720	9.47																									
							1000	11.16																									
							2000	15.78																									
							3000	19.33																									
							4000	22.32																									
							4500	23.67																									
							PERFECT TERMINATIONS <table border="1"> <thead> <tr> <th>Item #</th> <th>Part #</th> <th>Item #</th> <th>Part #</th> </tr> </thead> <tbody> <tr> <td>25</td> <td>CM-RG59U-RCA</td> <td>28</td> <td>CM-RG59U-GBNC</td> </tr> <tr> <td>26</td> <td>CM-RG59U-GRCA</td> <td>29</td> <td>CM-RG59U-F</td> </tr> <tr> <td>27</td> <td>CM-RG59U-BNC</td> <td>30</td> <td>CM-RG-59U-GF</td> </tr> </tbody> </table> <p>SEE PAGE 162</p>										Item #	Part #	Item #	Part #	25	CM-RG59U-RCA	28	CM-RG59U-GBNC	26	CM-RG59U-GRCA	29	CM-RG59U-F	27	CM-RG59U-BNC	30	CM-RG-59U-GF	
							Item #	Part #		Item #	Part #																						
25	CM-RG59U-RCA	28	CM-RG59U-GBNC																														
26	CM-RG59U-GRCA	29	CM-RG59U-F																														
27	CM-RG59U-BNC	30	CM-RG-59U-GF																														
18 Solid BC	0.180 FPE	100% Bonded Foil 95% TC Braid	.032 FR-PVC	0.272	16.2	82%	1	0.25	18-CMR-SD-* CMR Rated																								
							3.58	0.45																									
							10	0.72																									
							135	2.25																									
							270	3.10																									
							720	5.30																									
							1000	6.35																									
							2000	9.40																									
							3000	11.64																									
							4000	13.78																									
							4500	14.78																									
							PERFECT TERMINATIONS <table border="1"> <thead> <tr> <th>Item #</th> <th>Part #</th> <th>Item #</th> <th>Part #</th> </tr> </thead> <tbody> <tr> <td>7</td> <td>CM-RG6Q-RCA</td> <td>10</td> <td>CM-RG6Q-GBNC</td> </tr> <tr> <td>8</td> <td>CM-RG6Q-GRCA</td> <td>11</td> <td>CM-RG6Q-F</td> </tr> <tr> <td>9</td> <td>CM-RG6Q-BNC</td> <td>12</td> <td>CM-RG6Q-GF</td> </tr> </tbody> </table> <p>SEE PAGE 161</p>										Item #	Part #	Item #	Part #	7	CM-RG6Q-RCA	10	CM-RG6Q-GBNC	8	CM-RG6Q-GRCA	11	CM-RG6Q-F	9	CM-RG6Q-BNC	12	CM-RG6Q-GF	
							Item #	Part #		Item #	Part #																						
7	CM-RG6Q-RCA	10	CM-RG6Q-GBNC																														
8	CM-RG6Q-GRCA	11	CM-RG6Q-F																														
9	CM-RG6Q-BNC	12	CM-RG6Q-GF																														
14 Solid BC	0.285 FPE	Foil + 95% TC Braid	0.045 FR-PVC	0.405 BLK	16	82%	1	0.16	RG11-EX-SD CMR Rated																								
							3.6	0.30																									
							10	0.49																									
							71.5	1.12																									
							135	1.49																									
							270	2.10																									
							360	2.41																									
							720	3.48																									
							1000	4.30																									
							1500	5.27																									

Serial Digital Video Cables , Plenum																																	
AWG Center Conductor	NOM OD Dielectric (Inches)	Shield Construction	Jacket (Inches)	NOM OD (Inches)	NOM Capacitance (Pf/ft)	NOM Velocity of Propagation	NOM Attenuation		Part #																								
							MHz	db100'																									
20 Solid BC	0.135 FFEP	100% Foil 95% TC Braid	.016 PL-PVC	.207	16.1	84%	1	0.30	20-CMP-VID-COAX* CMP Rated																								
							3.58	0.54																									
							10	0.88																									
							135	2.90																									
							270	4.16																									
							720	7.61																									
							1000	9.31																									
							2000	13.99																									
							3000	18.24																									
							4000	21.06																									
							4500	22.34																									
							PERFECT TERMINATIONS <table border="1"> <thead> <tr> <th>Item #</th> <th>Part #</th> <th>Item #</th> <th>Part #</th> </tr> </thead> <tbody> <tr> <td>43</td> <td>CM-RG59P-RCA</td> <td>46</td> <td>CM-RG59P-GBNC</td> </tr> <tr> <td>44</td> <td>CM-RG59P-GRCA</td> <td>47</td> <td>CM-RG59P-F</td> </tr> <tr> <td>45</td> <td>CM-RG59P-BNC</td> <td>48</td> <td>CM-RG59P-GF</td> </tr> </tbody> </table> <p>SEE PAGE 162</p>										Item #	Part #	Item #	Part #	43	CM-RG59P-RCA	46	CM-RG59P-GBNC	44	CM-RG59P-GRCA	47	CM-RG59P-F	45	CM-RG59P-BNC	48	CM-RG59P-GF	
							Item #	Part #		Item #	Part #																						
43	CM-RG59P-RCA	46	CM-RG59P-GBNC																														
44	CM-RG59P-GRCA	47	CM-RG59P-F																														
45	CM-RG59P-BNC	48	CM-RG59P-GF																														
18 Solid BC	0.170 FFEP	100% Foil 95% TC Braid	0.015 PL-PVC	.237	16.1	84%	1	0.26	18-CMP-VID-COAX* CMP Rated																								
							3.58	0.47																									
							10	0.70																									
							135	2.39																									
							270	3.40																									
							720	6.05																									
							1000	7.45																									
							2000	10.26																									
							3000	13.07																									
							4000	15.09																									
							4500	16.01																									
							PERFECT TERMINATIONS <table border="1"> <thead> <tr> <th>Item #</th> <th>Part #</th> <th>Item #</th> <th>Part #</th> </tr> </thead> <tbody> <tr> <td>19</td> <td>CM-RG6P-RCA</td> <td>22</td> <td>CM-RG6P-GBNC</td> </tr> <tr> <td>20</td> <td>CM-RG6P-GRCA</td> <td>23</td> <td>CM-RG6P-F</td> </tr> <tr> <td>21</td> <td>CM-RG6P-BNC</td> <td>24</td> <td>CM-RG6P-GF</td> </tr> </tbody> </table> <p>SEE PAGE 162</p>										Item #	Part #	Item #	Part #	19	CM-RG6P-RCA	22	CM-RG6P-GBNC	20	CM-RG6P-GRCA	23	CM-RG6P-F	21	CM-RG6P-BNC	24	CM-RG6P-GF	
							Item #	Part #		Item #	Part #																						
19	CM-RG6P-RCA	22	CM-RG6P-GBNC																														
20	CM-RG6P-GRCA	23	CM-RG6P-F																														
21	CM-RG6P-BNC	24	CM-RG6P-GF																														
14 Solid BC	0.280 FFEP	100% Foil 95% TC Braid	.018 PVDF	.352	16.0	82%	1	0.11	RG11-EX-PLN																								
							3.58	0.28																									
							10	0.45																									
							135	1.54																									
							270	2.28																									
							720	4.23																									
							1000	5.39																									
							1500	7.30																									
							23 AWG Solid BC	0.100 FFEP		100% Foil 95% TC Braid	.016 PL-PVC	.159	16.4	83%	1	0.33	23-MINI-CMP-* CMP Rated (Black, White)																
															3.58	0.64																	
															10	1.07																	
															135	4.17																	
															270	6.08																	
720	10.58																																
1000	12.83																																
2000	19.51																																
3000	25.19																																
4000	29.09																																
4500	32.79																																

*Plenum & Non-Plenum Stocked in Six Different Colors:



Ordering is fast & easy.



Call today!

Solutions for the AV PROFESSIONAL
www.libertycable.com

800-530-8998
INTERNATIONAL - CALL +1-719-388-7542



LibertyLinx™ Universal Control Cables

LibertyLinx's family of universal control cables further adds to Liberty's dedication to saving our customers both time and money. It also strengthens our long-term commitment in providing our customers with the premier one-stop shopping experience for all their wire and cable needs.

For more than 16 years, Liberty has been providing the AV professional with the right wire

and cable products to build their business. Whether your business is a growing business or one that is well-established, Liberty's extensive product lines, unparalleled technical support, world-class customer service and on-time delivery provide the selection, performance and value that AV professionals expect and that the market demands—that's the Liberty Advantage.

LibertyLinx™ Universal Control Cables

LibertyLinx - CR™ Control Cable								
Description	Shield	NOM Insulation (Inches)	NOM Jacket (Inches)	NOM OD (Inches)	NOM Capacitance (pF/ft)	Color Code	Part #	
LibertyLinx™ + CAT5E							LLINX-CR	
Element 1: LibertyLinx™ Universal								
22 AWG 1 PR STR BC (7x30)	Foil+ 24 AWG STR TC Drain	.025 FPE			12.5	Blue White	Data	
18 AWG 2C STR BC (16x30)	N/A	.010 SR-PVC			N/A	Red Black	Power	
Overall Construction				.032	.244			
Element 2								
24 AWG 4 PR Solid BC	N/A	.005 PE	.022	.195	14	N/A	(1) CAT5E	
Overall Construction							Gray Jacket with Red Stripe	

LibertyLinx™ - D Control Cable								
Description	Shield	NOM Insulation (Inches)	NOM Jacket (Inches)	NOM OD (Inches)	NOM Capacitance (pF/ft)	Color Code	Part #	
LibertyLinx™ + (2) CAT5E							LLINX-D	
Element 1 LibertyLinx™ Universal								
22 AWG 1 PR STR BC (7x30)	Foil+ 24 AWG STR TC Drain	.025 FPE			12.5	Blue White	Data	
18 AWG 2C STR BC (16x30)	N/A	.010 SR-PVC			N/A	Red Black	Power	
Overall Construction				.032	.244			
Element 2								
24 AWG 4 PR Solid BC	N/A	.005 PE	.022 FR-PVC	.195	14	N/A	(2) CAT5E	
Overall Construction							Gray Jacket with Black Stripe	

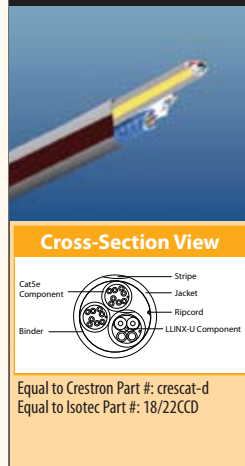
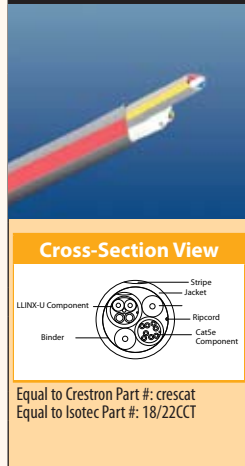

Ordering is fast & easy.



Call today!

Solutions for the AV PROFESSIONAL
www.libertycable.com

800-530-8998
INTERNATIONAL - CALL +1-719-388-7542



LibertyLinx™ Universal Control Cables

LibertyLinx™ - DC Control Cable									
Description	Shield	NOM Insulation (Inches)	NOM Jacket (Inches)	NOM OD (Inches)	NOM Capacitance (pF/ft)	NOM Velocity of Propagation	NOM Attenuation MHz db 100'		Part #
LibertyLinx™ + (2) CAT5E + (2) RG6 QUAD									LLINX-DC
Element 1: LibertyLinx™ Universal									
22 AWG 1 PR STR BC (7x30)	Foil+ 24 AWG STR TC Drain	.025 FPE		0.195	12.5	N/A	N/A		Data
18 AWG 2C STR BC (16x30)	N/A	.01 SR-PVC			N/A	N/A	N/A		Power
Overall Construction		.032	.244						
Element 2									
24 AWG 4 PR Solid BC	N/A	.005 PE	0.022 FR-PVC	.195	14	N/A	N/A		(2) CAT5E
Element 3									
18 AWG Solid BC	2 Foils + 60% AL 40% AL Braid	0.018	0.05	0.3	16.2	82%	10 50 200 400	0.81 1.46 2.83 4.05	2) RG6 Quad
Overall Construction			.045 FR-PVC	.800					Gray Jacket with Orange Stripe

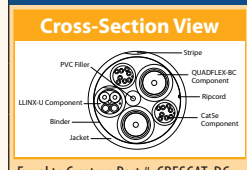

Equal to Crestron Part #: CRES-CAT-DC
Equal to Isotec Part #: 18/22CDC

LibertyLinx™ - Q Control Cable									
Description	Shield	NOM Insulation (Inches)	NOM Jacket (Inches)	NOM OD (Inches)	NOM Capacitance (pF/ft)	Color Code	Part #		
LibertyLinx™ + (4) CAT5E									LLINX-Q
Element 1: LibertyLinx™ Universal									
22 AWG 1 PR STR BC (7x30)	Foil+24 AWG STR TC Drain	.025 FPE			12.5	Blue White	Data		
18 AWG 2C STR BC (16x30)	N/A	.01 SR-PVC			N/A	Red Black	Power		
Overall Construction		.032	.244						
Element 2									
24 AWG 4 PR Solid BC	N/A	.005 PE	.022	.195	14	N/A	(4) CAT5E		
Overall Construction			.035 FR-PVC	.680			Gray Jacket with White Stripe		

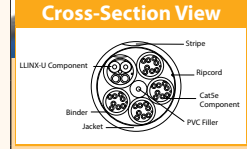
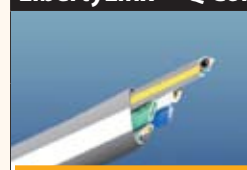

Equal to Crestron Part #: crescat-q
Equal to Isotec Part #: 18/22CCQ

Ordering is fast & easy.



Call today!

Solutions for the AV PROFESSIONAL
www.libertycable.com

800-530-8998
INTERNATIONAL - CALL +1-719-388-7542



Specifications Subject to Change

LibertyLinx™ Universal Control Cables

LibertyLinx™ - QM-Plenum Control Cable

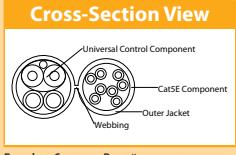
 Cross-Section View  Universal Control Component Cat5E Component Outer Jacket Webbing	Description	Shield	NOM Insulation (Inches)	NOM Jacket (Inches)	NOM OD (Inches)	NOM Capacitance (pF/ft)	Color Code	Part #
	LibertyLinx™ + TRUphase™ Low-Skew							
Element 1 LibertyLinx™ Universal								
22 AWG 1 PR STR BC (7x30)	Foil+ 24 AWG STR TC Drain		.025 FFEF	N/A	N/A	12.5	Blue White	Data
18 AWG 2C STR BC (16x30)	N/A		.009 PLN-PVC	N/A	N/A	N/A	Red Black	Power
Element 2								
24 AWG 4 PR Solid BC	N/A		.007 PLN-TPE	N/A	N/A	17		Low-Skew CAT5 UTP
Overall Construction								
				.025	.200x.400			Overall Siamesed Plenum Rated Jacket

Also available in PVC: Part #: LibertyLinx™-QM

LibertyLinx™ Universal Control Cable

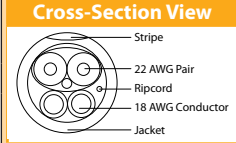
 Cross-Section View  Stripe 22 AWG Pair Ripcord 18 AWG Conductor Jacket	Description	Shield	NOM Insulation (Inches)	NOM Jacket (Inches)	NOM OD (Inches)	NOM Capacitance (pF/ft)	Color Code	Part #
	LibertyLinx™							
22 AWG 1 PR STR BC (7x30)	Foil+ 24 AWG STR TC Drain		.025 FPE			12.5	Blue White	Data
18 AWG 2C STR BC (16x30)	N/A		.010 SR-PVC			N/A	Red Black	Power
Overall Construction								
				0.032 FR-PVC	.246			Gray Jacket with Yellow Stripe

Equal to Crestron Part #: cresnet
 Equal to Extron Part #: 22-148-03
 Equal to Isotec Part #: 18/22CRT

LibertyLinx™ Universal (Direct Burial) Control Cable

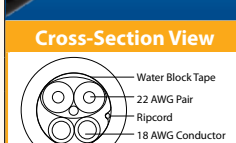
 Cross-Section View  Water Block Tape 22 AWG Pair Ripcord 18 AWG Conductor Jacket	Description	Shield	NOM Insulation (Inches)	NOM Jacket (Inches)	NOM OD (Inches)	NOM Capacitance (pF/ft)	Color Code	Part #
	LibertyLinx™-U-DB							
22 AWG 1 PR STR BC (7x30)	Foil + 24 AWG STR TC Drain		.025 FPE		.074	12.5	Blue White	Data
12 AWG 2C STR BC (16x30)	N/A		.016 SR-PVC		.122	N/A	Red Black	Power
Overall Construction								
				0.032 FR-PVC	.246			Black Only

Ordering is fast & easy.



Call today!

Solutions for the AV PROFESSIONAL
www.libertycable.com

800-530-8998
 INTERNATIONAL - CALL +1-719-388-7542



LibertyLinx™ Universal Control Cables

Bulk Wire: Commercial Control Cable

LibertyLinx™ Universal Plenum Control Cable								
Description	Shield	NOM Insulation (Inches)	NOM Jacket (Inches)	NOM OD (Inches)	NOM Capacitance (pF/ft)	Color Code	Part #	
							LLINX-U-P	
22 AWG 1 PR STR BC (7x30)	Foil+ 24 AWG STR TC Drain	.020 FFEF			12.5	Blue White	Data	
18 AWG 2C STR BC (16x30)	N/A	.010 PL-PVC			N/A	Red Black	Power	
Overall Construction								
			.015 PL-PVC	.205			Black Only	

Equal to Crestron Part #: cresnet-p
 Equal to Extron Part #: 22-119-03
 Equal to Isotec Part #: 18/22CRTP

LibertyLinx™ Universal Control Cables - High Power

12 AWG HIGH-POWER

LibertyLinx™- D (High-Power) Control Cable								
Description	Shield	NOM Insulation (Inches)	NOM Jacket (Inches)	NOM OD (Inches)	NOM Capacitance (pF/ft)	Color Code	Part #	
LibertyLinx™ + (2) CAT5E							LLINX-D-HP	USA Only
Element 1 LibertyLinx™ Universal								
22 AWG 1 PR STR BC (7x30)	Foil+ 24 AWG STR TC Drain	.025 FPE	.032	.246	12.5	Blue White	Data	
12 AWG 2C STR BC (16x30)	N/A	.016 SR-PVC		.122	N/A	Red Black	Power	
Overall Construction								
			.032	.246				
Element 2								
24 AWG 4 PR Solid BC	N/A	.008 PE	.020 FR-PVC	.197	14	N/A	(2) CAT5E	
Overall Construction								
			.044 FR-PVC	.625			Gray Jacket with Brown Stripe	

LibertyLinx™- Q (High-Power) Control Cable								
Description	Shield	NOM Insulation (Inches)	NOM Jacket (Inches)	NOM OD (Inches)	NOM Capacitance (pF/ft)	Color Code	Part #	
LibertyLinx™ + (4) CAT5E							LLINX-Q-HP	USA Only
Element 1: LibertyLinx™ Universal								
22 AWG 1 PR STR BC (7x30)	Foil+ 24 AWG STR TC Drain	.025 FPE	.032	.246	12.5	Blue White	Data	
12 AWG 2C STR BC (16x30)	N/A	.016 SR-PVC		.122	N/A	Red Black	Power	
Overall Construction								
		.032	.244					
Element 2								
24 AWG 4 PR Solid BC	N/A	.008 PE	.020	.197	14	N/A	(4) CAT5E	
Overall Construction								
			.044 FR-PVC	.680			Gray Jacket with Brown Stripe	

Ordering is fast & easy.



Call today!

Solutions for the AV PROFESSIONAL
www.libertycable.com

800-530-8998
 INTERNATIONAL - CALL +1-719-388-7542



LibertyLinx™ Universal Control Cables - High Power

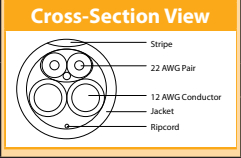

LibertyLinx™ Universal (High-Power) Control Cable

Description	Shield	NOM Insulation (Inches)	NOM Jacket (Inches)	NOM OD (Inches)	NOM Capacitance (pF/ft)	Color Code	Part #
							
LLINX-U-HP							
22 AWG 1 PR STR BC (7x30)	Foil + 24 AWG STR TC Drain	.025 FPE		.074	12.5	Blue White	Data
12 AWG 2C STR BC (16x30)	N/A	.016 SR-PVC		.122	N/A	Red Black	Power
Cross-Section View							
							
Overall Construction				0.032 FR-PVC	.246		Gray Jacket with Brown Stripe

LibertyLinx™ Universal (High-Power) Plenum Control Cable

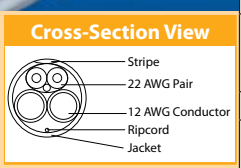
Description	Shield	NOM Insulation (Inches)	NOM Jacket (Inches)	NOM OD (Inches)	NOM Capacitance (pF/ft)	Color Code	Part #
							
LLINX-U-HPP							
22 AWG 1 PR STR BC (7x30)	Foil + 24 AWG STR TC Drain	.020 FFEP		.020	12.5	Blue White	Data
12 AWG 2C STR BC (16x30)	N/A	.010 PL-PVC			N/A	Red Black	Power
Cross-Section View							
							
Overall Construction				.015 PL-PVC	.246		White Jacket with Brown Stripe

Control Cable Individually Shielded - Plenum

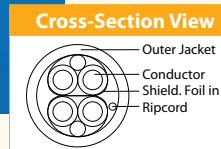

Multi-Pair/Individually Shielded w/Drain Wire

- UL Listed NEC Type CL2P, CMP or CL3P/CMP
- CMP Rated
- Bare Copper Stranded Conductors
- Low Smoke PVC or FEP Insulation
- Each Pair Foil Shielded with Stranded TC Drain
- Low Smoke White PVC Jacket
- Sequential Footmarks
- Ripcord
- See Color Code Charts on Page 241

Plenum Individually Shielded Control Cable

# of pairs	AWG Size/ Stranding	NOM Insulation (Inches)	NOM Jacket (Inches)	NOM OD (Inches)	Part #
2	18 (7x26)	0.008	0.015	0.265	18-2P-PINDSH-WHT*
3	18 (7x26)	0.008	0.015	0.28	18-3P-PINDSH-WHT
2	22 (7x30)	0.008	0.015	0.188	22-2P-PINDSH-WHT*
3	22 (7x30)	0.008	0.015	0.222	22-3P-PINDSH-WHT
4	22 (7x30)	0.008	0.015	0.234	22-4P-PINDSH-WHT
6	22 (7x30)	0.008	0.015	0.27	22-6P-PINDSH-WHT

All above cables can be produced with colored jackets as a special build. *Also available with a common axis drain wire - one drain wire for both pairs.

Ordering is fast & easy.



Call today!

Solutions for the AV PROFESSIONAL
www.libertycable.com

800-530-8998
INTERNATIONAL - CALL +1-719-388-7542



Control Cable Shielded - Plenum

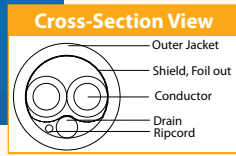

Multi-Conductor/Overall Shield w/Drain Wire

- UL Listed NEC Type CL3P/CMP
- Bare Copper Stranded Conductors
- Low Smoke PVC Insulation
- Overall Foil Shield with Stranded TC Drain
- Low Smoke White PVC Jacket
- Sequential Footmarks
- Ripcord
- See Color Code Charts on Page 241

Plenum Overall Shield with Braid

# of conductors	AWG Size/Stranding	NOM Insulation (Inches)	NOM Jacket (Inches)	NOM OD (Inches)	Part #
4	12 (19x25)	0.01	0.015	0.283	12-4C-PSH-WHT
2	14 (19x27)	0.01	0.015	0.220	14-2C-PSH-WHT
4	14 (19x27)	0.01	0.015	0.257	14-4C-PSH-WHT
2	16 (19x26)	0.009	0.015	0.186	16-2C-PSH-WHT
4	16 (19x29)	0.009	0.015	0.216	16-4C-PSH-WHT
2	18 (7x26)	0.009	0.015	0.162	18-2C-PSH-WHT
3	18 (7x26)	0.009	0.015	0.172	18-3C-PSH-WHT
4	18 (7x26)	0.009	0.015	0.188	18-4C-PSH-WHT
6	18 (7x26)	0.009	0.015	0.226	18-6C-PSH-WHT
2	20 (7x28)	0.008	0.015	0.138	20-2C-PSH-WHT
3	20 (7x28)	0.008	0.015	0.149	20-3C-PSH-WHT
2	22 (7x30)	0.008	0.015	0.124	22-2C-PSH-WHT
3	22 (7x30)	0.008	0.015	0.133	22-3C-PSH-WHT
4	22 (7x30)	0.008	0.015	0.142	22-4C-PSH-WHT
6	22 (7x30)	0.008	0.015	0.169	22-6C-PSH-WHT
8	22 (7x30)	0.008	0.015	0.183	22-8C-PSH-WHT
12	22 (7x30)	0.008	0.015	0.221	22-12C-PSH-WHT

Bulk Wire: Commercial Control Cable

Ordering is fast & easy.



Call today!

Solutions for the AV PROFESSIONAL
www.libertycable.com

800-530-8998
INTERNATIONAL - CALL +1-719-388-7542



Control Cable Unshielded - Plenum

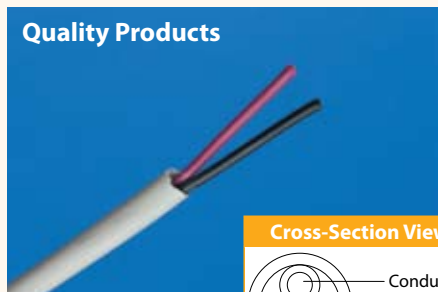

Quality Products

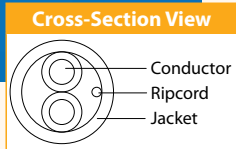

Multi-Conductor/Unshielded

- UL Listed NEC Type CL3P/CMP
- Bare Copper Stranded Conductors
- Low Smoke PVC Insulation
- Low Smoke White PVC Jacket
- Sequential Footmarks
- Ripcord
- See Color Code Charts on Page 241

Plenum Unshielded Control Cable

# of conductors	AWG Size/Stranding	NOM Insulation (Inches)	NOM Jacket (Inches)	NOM OD (Inches)	Part #
4	12 (19x25)	0.010	0.015	0.273	12-4C-P-WHT
4	14 (19x27)	0.010	0.015	0.253	14-4C-P-WHT
4	16 (19x29)	0.009	0.015	0.212	16-4C-P-WHT
2	18 (7x26)	0.009	0.015	0.158	18-2C-P-WHT
3	18 (7x26)	0.009	0.015	0.168	18-3C-P-WHT
4	18 (7x26)	0.008	0.015	0.184	18-4C-P-WHT
6	18 (7x26)	0.009	0.015	0.222	18-6C-P-WHT
8	18 (7x26)	0.009	0.015	0.240	18-8C-P-WHT
10	18 (7x26)	0.009	0.018	0.292	18-10C-P-WHT
12	18 (7x26)	0.009	0.018	0.302	18-12C-P-WHT
2	20 (7x28)	0.008	0.015	0.131	20-2C-P-WHT
3	20 (7x28)	0.008	0.015	0.145	20-3C-P-WHT
4	20 (7x28)	0.01	0.015	0.170	20-4C-P-WHT
2	22 (7x30)	0.008	0.015	0.120	22-2C-P-WHT
3	22 (7x30)	0.008	0.015	0.179	22-3C-P-WHT
4	22 (7x30)	0.008	0.015	0.138	22-4C-P-WHT
6	22 (7x30)	0.008	0.015	0.165	22-6C-P-WHT
8	22 (7x30)	0.008	0.015	0.179	22-8C-P-WHT
10	22 (7x30)	0.008	0.015	0.210	22-10C-P-WHT
12	22 (7x30)	0.008	0.015	0.217	22-12C-P-WHT
15	22 (7x30)	0.008	0.015	0.242	22-15C-P-WHT

Ordering is fast & easy.



Call today!

Solutions for the AV PROFESSIONAL
www.libertycable.com

800-530-8998
INTERNATIONAL - CALL +1-719-388-7542



Liberty Wire & Cable's broad selection of energy saving solutions for Lutron™ light control, window treatment control and occupant sensors help your customers reduce their energy costs and increase your profitability.

GREEN connectivity

Shade Controls Reduce Energy Demand

Sivoia™ shade controls allow customers to better manage solar radiation levels and reduce heat gain for conference rooms, meeting rooms and home theaters. Reducing solar radiation reduces your customer's energy consumption footprint. Standard length 1,000 feet.

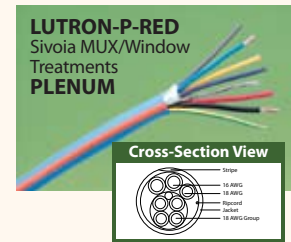
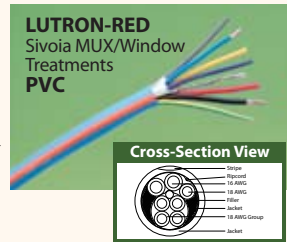

Occupant Sensors Automate Energy Savings

GRAFIK Eye™ occupant sensors systems turn the lights off when a space is not occupied. Your customers can reduce their electricity usage, in meeting rooms, home theaters and other spaces. Standard length 1,000 feet.

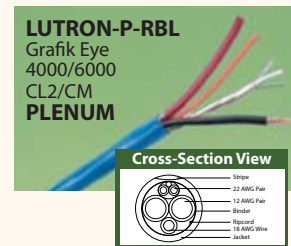
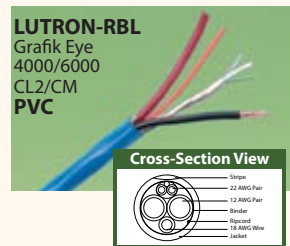
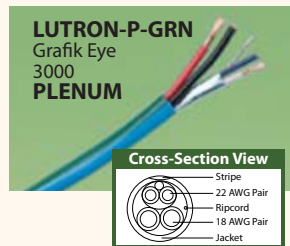
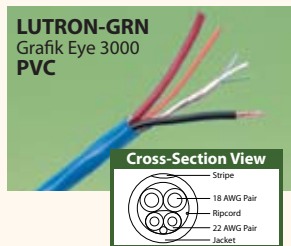

Light Controls Save Energy Standard length 1,000 feet.

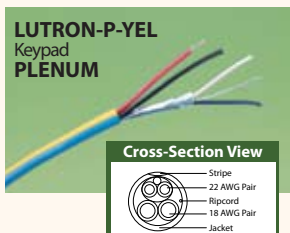
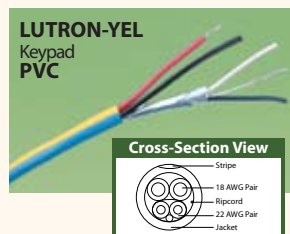
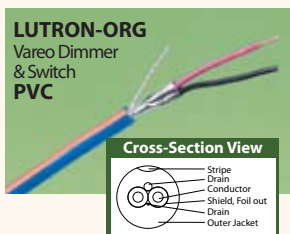
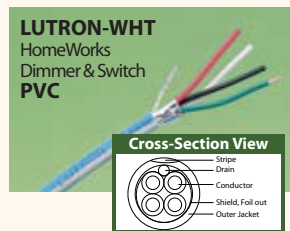
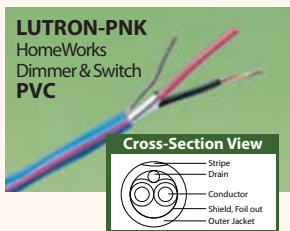

Help Your Customers Manage Energy Costs with Liberty

Electricity Usage in Office Buildings

Source: US Department of Energy

Lights consume the most energy in commercial buildings and schools. According to the US Department of Energy, lights can consume:

- 44% of all electricity
- 29% of all energy used

Liberty Provides Cables for Energy-Efficient Solutions

Ordering is fast & easy.

Call today!

Solutions for the AV PROFESSIONAL
www.libertycable.com

800-530-8998
INTERNATIONAL - CALL +1-719-388-7542

Specialized Cables for Lighting Systems - LUTRON

Liberty offers specialized lighting control cables for systems from leading manufacturers Lutron, Vantage and LiteTouch. Liberty works with these companies

to provide systems cables specifically designed to meet exact stranding, shielding and capacitance requirements.

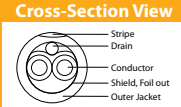
LUTRON Specialized Cables for Lighting Systems							
# of Conductors	AWG	Insulation	Shield	NOM Jacket	NOM OD	Ratings	Part #
2	18 AWG STR BC (7x26)	.015 PVC	100% AL/POLY	.029 PVC Blue w/Pink stripe	.213	CL3/CMG 60°C 300V	LUTRON-PNK HomeWorks Dimmer & Switch  
4	18 AWG STR BC (7x26)	.015 PVC	100% AL/POLY	.027 PVC Blue w/White stripe	.240	CL3/CMG 60°C 300V	LUTRON-WHT HomeWorks Dimmer & Switch  
2	Overall AL Mylar w/24 AWG TC Drain	.015 PVC	100% AL/POLY	.033 Blue w/Orange stripe	.187	CMR/CMR 60°C 300V	LUTRON-ORG Vareo Dimmer & Switch  
2	22 AWG STR BC (16x34)	.015 PVC	100% AL/POLY	.029 PVC Blue w/Yellow stripe	.228	CM/CMG 60°C	LUTRON-YEL Grafik Eye 3000 Keypad Cable. Equivalent to Lutron P/N GRX-CBL-346S  
2	18 AWG STR BC (41x34)	.015 SR-PVC	None				
2	22 AWG STR BC (16x34)	.009 PL-PVC	100% AL/POLY	.015 PL-PVC White w/Yellow stripe	.208	CMP/CMP 60°C 300V	LUTRON-P-YEL Grafik Eye 3000 Keypad Cable. Equivalent to Lutron P/N GRX-PCBL-346S  
2	18 AWG STR BC (16x34)	.009 PL-PVC	None				
2	22 AWG STR BC (16x34)	.015 SR-PVC	100% AL/POLY	.029 PVC Blue w/Green stripe	.228	CMP/CMP 60°C 300V	LUTRON-GRN Grafik Eye 3000 Equivalent to Lutron P/N GRX-CBL-346S  
2	18 AWG STR BC (41x34)	.015 SR-PVC	None				

Ordering is fast & easy.









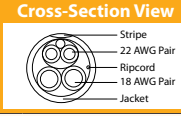

Call today!

Solutions for the AV PROFESSIONAL
www.libertycable.com

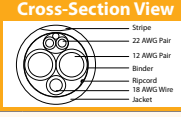
800-530-8998
INTERNATIONAL - CALL +1-719-388-7542

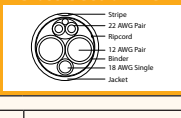

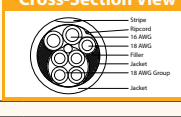
Specialized Cables for Lighting Systems - LUTRON

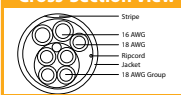
LUTRON Specialized Cables for Lighting Systems							
# of Conductors	AWG	Insulation	Shield	NOM Jacket	NOM OD	Ratings	Part #
2	22 AWG STR BC (16x34)	.009 PL-PVC	100% AL/POLY	.015 PL-PVC White w/Green stripe	.208	CMP/CMP 60°C 300V	LUTRON-P-GRN Grafik Eye 3000 Equivalent to Lutron P/N GRX-PCBL-3465 
2	18 AWG STR BC (16x34)	.009 PL-PVC	None				
2	22 AWG STR BC (7x30)	.010 SR-PVC	100% AL/POLY	.026 PVC Blue w/Royal Blue stripe	.299	CL3/CMG FT4 60°C 300V	LUTRON-RBL Grafik Eye 4000/6000 Equivalent to Lutron P/N GRX-CBL-465 
2	12 AWG STR BC (19x25)	.013 SR-PVC	None				
1	18 AWG STR BC (7x26)	.015 SR-PVC	None				
2	22 AWG STR BC (7x30)	.010 Halar	100% AL/POLY	.015 PL-PVC White w/Royal Blue stripe	.272	CL3P/CMP FT6 75°C 300V	LUTRON-P-RBL Grafik Eye 4000/6000 Equivalent to Lutron P/N GRX-PCBL-465 
2	12 AWG STR BC (19x25)	.010 PL-PVC	None				
1	18 AWG STR BC (7x26)	.008 PL-PVC	None				
4	18 AWG STR BC (7x26)	.014 SR-PVC	100% AL/POLY	.030 PVC Blue w/Red stripe	.341	CL3/CMG FT4 60°C 300V	LUTRON-RED Sivoia QED Shade Control Cable Equivalent to Lutron P/N SVQ-PCBL 
2	16 AWG STR BC (7x24)	.015 SR-PVC	None				
1	18 AWG STR BC (7x26)	.014 SR-PVC	None				
4	18 AWG STR BC (19x30)	.012 PL-PVC	100% AL/POLY	.020 PL-PVC White w/Red stripe	.322	CL3P/CMP FT6 75°C 300V	LUTRON-P-RED Sivoia QED Shade Control Cable Equivalent to Lutron P/N SVQ-PCBL 
2	16 AWG STR BC (7x24)	.012 PL-PVC	None				
1	18 AWG STR BC (19x30)	.012 PL-PVC	None				

Bulk Wire: Commercial Control Cable

Ordering is fast & easy.



Call today!

Solutions for the AV PROFESSIONAL
www.libertycable.com

800-530-8998
 INTERNATIONAL - CALL +1-719-388-7542



Specifications Subject to Change

Specialized Cables For Lighting Systems

LUTRON Eco Systems							
# of Conductors	AWG	Insulation	Shield	NOM Jacket	NOM OD	Ratings	Part #
2	16 AWG Solid	.030 PVC	None	.030 PVC Gray	.283	CM 75°C 300V or AWM 20811 105°C 600V	LUTRON-EBC EcoSystem™ Bus Cable equivalent to Lutron P/N C-CBL-216-GR
2	16 AWG Solid	.008 FEP	None	.012 PVDF Natural Clear	.158	CMP 125°C 300V	LUTRON-P-EBC EcoSystem™ Bus Cable equivalent to Lutron P/N C-PCBL-216
5	22 AWG Solid	.030 PVC	100% AL/ Poly	.030 PVC White	.293	CM 75°C 300V or AWM 20811 105°C 600V	LUTRON-ESC EcoSystem™ Sensor Cable equivalent to Lutron P/N C-CBL-522-WH
5	22 AWG Solid	.007 FEP	100% AL/ Poly	.012 PVDF Natural Clear	.134	CMP 125°C 300V	LUTRON-P-ESC EcoSystem™ Sensor Cable equivalent to Lutron P/N C-PCBL-522
2	22 AWG STR BC (16x34)	.015 PP	100% AL/ POLY	.029 PVC Blue w/White stripe	.228	CM/CMG 75°C	LUTRON-QSC Grafik Eye Quantum Series (QS) Equivalent to Lutron P/N QSH-CBL-S
2	18 AWG STR BC (41x34)	.015 SR-PVC	None				

EcoSystem™ is a registered trademark of Lutron Electronics, Inc.

Ordering is fast & easy.



Call today!

Solutions for the AV PROFESSIONAL
www.libertycable.com

800-530-8998
 INTERNATIONAL - CALL +1-719-388-7542



Lighting Control Cable for DMX 512 Systems and Applications

DMX 512 is an RS-485 based communications protocol that is used to control stage lighting and effects such as fogging and light motion.

- UL Listed NEC Type CM (non-Plenum) and CMP (Plenum)

Lighting Control Cable for DMX 512								
# of Conductors	AWG	Insulation	Shield	NOM Jacket	NOM OD	NOM Capacitance/FT	NOM Impedance	Part #
2	24 AWG STR TC (7x32)	.025 FPE	100% FL 90% TC Braid	.025 PVC	.260	11.2	120 Ω	24-2P-485 Gray, Black
2	24 AWG STR TC (7x32)	.022 FFEP	100% FL 90% TC Braid	.015 PL-PVC	.277	10.5	120 Ω	24-2P-P485 White

Specialized Cables For Lighting Systems - Vantage

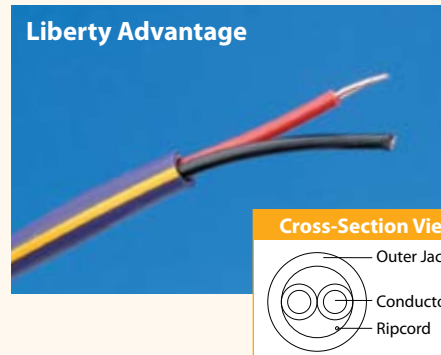

Vantage, a long term OEM partner of Liberty Wire and Cable, has revised their system specifications and applications to 16 AWG wire instead of the previous 18 AWG offerings. Partnering with Vantage again to design cables that maximize the performance of their control systems, Liberty offers the following new 16 AWG cables.

Vantage						
# of Conductors	AWG Size/ Stranding	NOM Insulation (Inches)	NOM Jacket (Inches)	NOM OD (Inches)	NOM Capacitance (pF/ft)	Part #
2	16 AWG BC (26x30)	.016 SR-PVC	.032 PVC	.252	28.6	16-2C-VAN
2	16 AWG BC (26x30)	.010 PL-PVC	.015 PL-PVC	.195	31.3	16-2C-P-VAN

Lite Touch						
# of Conductors	AWG Size/ Stranding	Shield	NOM Insulation (Inches)	NOM Jacket (Inches)	NOM OD (Inches)	Part #
4	16 AWG STR BC (65x34)	N/A	.015 PVC	.035 Orange	.300	LITE-TOUCH-SW Control Station Wire PLTC, CL3
4	22 AWG STR BC (7x30)	Overall AL Mylar w/TC Drain	.015 PVC	0.035 Green	.222	LITE-TOUCH-MODULE Control Module

Bulk Wire: Commercial Control Cable

Ordering is fast & easy.



Call today!

Specialized Cables for Control Systems - AMX AXlink™

Liberty Advantage

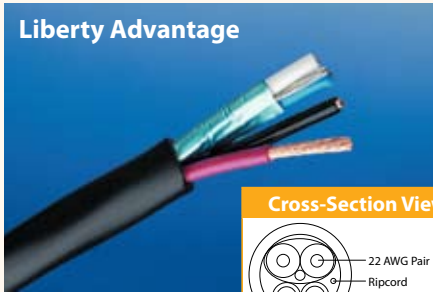

Cross-Section View

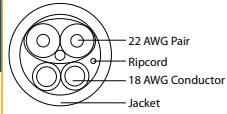

Plenum

- UL listed NEC Type CMP
- Foamed FEP Insulation on Data pair
- Black Low Smoke Flexible PVC Jacket

General Characteristics

- Bare Copper Stranded Conductors
- Temperature and Voltage Rating 75°C, 300V
- Low Capacitance Rating on Data Pair 12.5 pF/ft
- Data Pairs Shielded for Lowest Noise
- Sequential Footmarks

Non-Plenum

- UL Listed NEC Type CM, CEC Type CMG
- Foamed PE Insulation on Data pair
- Black Flame Retardant Flexible PVC Jacket

AXlink™ PVC

Description	Shield	NOM Insulation (Inches)	NOM Jacket (Inches)	NOM OD (Inches)	NOM Capacitance (pF/ft)	Color Code	Part #
							AXLINK
22 AWG 1 PR STR BC (7x30)	FOIL + 24 AWG STR TC Drain	.025 FPE			12.5	Blue white	Data
18 AWG 2C STR BC (16x30)	N/A	.010 SR-PVC			N/A	Red Black	Power
			0.032 FR-PVC	0.246			Overall Construction

AXlink™ Plenum

Description	Shield	NOM Insulation (Inches)	NOM Jacket (Inches)	NOM OD (Inches)	NOM Capacitance (pF/ft)	Color Code	Part #
							AXLINK-P
22 AWG 1 PR STR BC (7x30)	FOIL + 24 AWG STR TC Drain	.020 FFEP			12.5	Blue white	Data
18 AWG 2C STR BC (16x30)	N/A	.010 PL-PVC			N/A	Red Black	Power
			.015 PL-PVC	.205			Overall Construction

Specialized Cables for Control Systems - ELAN

ELAN Home Systems

# of Conductors	AWG Size/ Stranding	Shield	NOM Insulation (Inches)	NOM Jacket (Inches)	NOM OD (Inches)	Part #
						ELAN-CM-VIA
4	24 AWG STR TC (7x32)	Overall AL Mylar w/24 AWG STR TC Drain	0.038 FR PE	0.025 FR-PVC Drk Blue	0.21	Composite Cable
2	18 AWG STR BC (16x30)	N/A	PVC	N/A	0.173	Power Pair
	20 AWG Solid BC	95% BC Braid	FPE	N/A	0.242	RG59 Coax
8 (4 pair)	24 AWG Solid BC	N/A	PVC	N/A	0.205	Enhanced Cat 5e (350 MHz)
				0.03 PVC Lavender	0.453	Overall Construction
8 (4 pair)	24 AWG STR TC (7x32)	Overall AL Mylar w/24 AWG STR TC Drain	0.038 FR PE	0.025 FR-PVC Teal	0.21	24-4P-SH-LIBII TD System

Cross-Section View

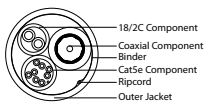

Ordering is fast & easy.



Call today!

Solutions for the AV PROFESSIONAL
www.libertycable.com

800-530-8998
INTERNATIONAL - CALL +1-719-388-7542



Fiber Optic Solutions

Whether you are working in a residential or commercial environment. Liberty offers a wide variety of AV Fiber Solutions which are designed to keep you both competitive and profitable.

Fiber Optic Solutions:

- Bulk Fiber
- Bulk Fiber Connectors
- Field Termination Kits
- Molded & Custom Fiber Assemblies
- Electronics Using Fiber Connections

No matter how complex or simple your installation needs are, Liberty has the expertise to provide you with the right products and information for both your fiber optic cable, custom or molded fiber optic assembly and fiber optic connector needs.

Liberty's team of skilled technicians and application engineers provide solutions that reduce your in-field labor headaches and guarantee flawless performance.

Bulk Fiber



Custom fiber optic cable is available in any unique or hard-to-find combination. Call for details so that we can provide a quote.

Liberty's Best Selling Bulk Break Out Fiber Cables	
Description:	Part #:
2 Multimode fiber, riser rated, indoor/outdoor rated, break out cable	2FRIOMM6-BO
4 Multimode fiber, riser rated, indoor/outdoor rated, break out cable	4FRIOMM6-BO

Liberty's Best Selling Bulk Distribution Fiber Cables	
Description:	Part #:
2 Multimode fiber, riser rated, indoor/outdoor rated, distribution cable	2FRIOMM6-D
4 Multimode fiber, riser rated, indoor/outdoor rated, distribution cable	4FRIOMM6-D
6 Multimode fiber, riser rated, indoor/outdoor rated, distribution cable	6FRIOMM6-D

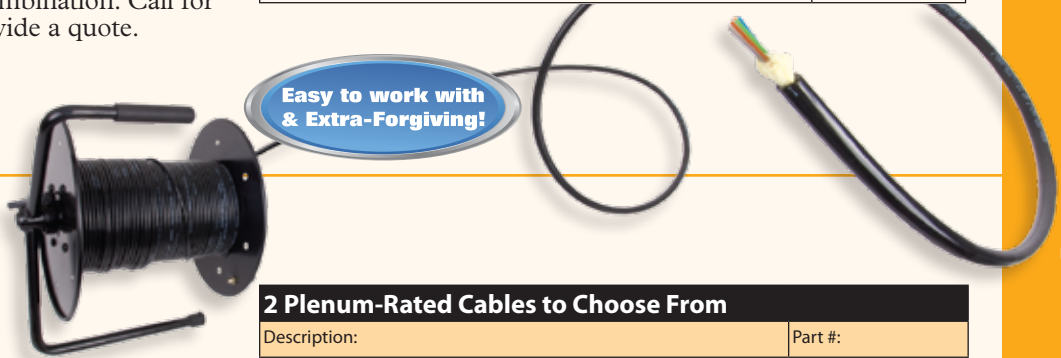

Durable Fiber

Liberty durable fiber optic cables are virtually unbreakable and are among the most flexible in the industry.



2 Plenum-Rated Cables to Choose From	
Description:	Part #:
6 multimode, plenum, indoor / outdoor rated, tight buffered	6FPIOMM6-D
6 multimode, plenum, interlocking armored, indoor/outdoor rated, no interduct needed, tight buffered	6FPIOMM6-DA

Bulk Connectors SC, ST, LC Connectors sold as singles or in bulk organizer packs of 25

SC Part # 95-000-41 	ST Part # 95-000-51 	LC Part # 95-000-99 
---	---	---

Fiber Connector Organizer Packs		
Connector	Description	Part #:
	Organizer Packs	
SC PLUG	UNICAM 62.5 MM 25-PK	95-000-41-Z
ST PLUG	UNICAM 62.5 MM 25-PK	95-000-51-Z
LC PLUG	UNICAM 62.5 MM 25-PK	95-000-99-Z



Bulk organizer packs of 25 provide a convenient reusable carrying-case for all fiber connectors

Ordering is fast & easy.



Call today!

Works Perfectly With Corning™ Field Termination Kit on Next Page

Solutions for the AV PROFESSIONAL
www.libertycable.com

800-530-8998
INTERNATIONAL - CALL +1-719-388-7542



Corning™ Field Termination Kit For Perfect Fiber Terminations

The UniCam Pretium™ Tool Kit can be used with multimode or single-mode LC, SC and ST® Compatible UniCam Connectors.

Everything You Need!

- Perfect fiber terminations in one minute.
- No Polishing • No Headaches!



Part #:
TKT-UNICAM-PFC



Step 1 : Place the Connector in the Tool



Step 2 : Prepare the Fiber



Step 3 : Clean the Fiber



Step 4 : Cut Fiber to Proper Length



Step 5 : Crimp the Connectors onto the Fiber



Step 6 : Test for Your Perfect Termination

UniCam Pretium Tool Kit includes:

- | | |
|--|---------------------|
| 1) Durable Kit | 6) Fiber Wipes |
| 2) Detailed instructions and DVD | 7) Fiber Cleaner |
| 3) Hook allows the kit to hang on the job site | 8) Marking Pen |
| 4) Hand-Held Termination Tool | 9) Crimp Tool |
| 5) Hand-Held Fiber Cleaver | 10) Kevlar Scissors |
| | 11) T-stripper |
| | 12) Buffer Stripper |

Ordering is fast & easy.



Call today!

Solutions for the AV PROFESSIONAL
www.libertycable.com

800-530-8998
INTERNATIONAL - CALL +1-719-388-7542



Termination Kit Connectors

SC Connectors	
95-000-41	UniCam Pretium-Performance SC Connector 62.5µm, Ceramic Ferrule , Logo, Single Pack
95-000-41-Z	UniCam Pretium-Performance SC Connector 62.5µm, Ceramic Ferrule , Logo, Organizer Pack of 25
95-050-41	UniCam Pretium-Performance SC Connector 50µm, Ceramic Ferrule , Logo, Single Pack
95-050-41-X	UniCam Pretium-Performance SC Connector 50µm SX+, Ceramic Ferrule , Logo, Single Pack
95-050-41-X-Z	UniCam Pretium-Performance SC Connector 50µm SX+, Ceramic Ferrule , Logo, Organizer Pack of 25
95-050-41-Z	UniCam Pretium-Performance SC Connector 50µm, Ceramic Ferrule , Logo, Organizer Pack of 25
95-200-41	UniCam Pretium-Performance SC Connector SM SPC, Ceramic Ferrule , Logo, Single Pack
95-200-41-Z	UniCam Pretium-Performance SC Connector SM SPC, Ceramic Ferrule , Logo, Organizer Pack of 25
95-200-42	UniCam Pretium-Performance SC Connector SM UPC, Ceramic Ferrule , Logo, Single Pack
ST® Compatible Connectors	
95-000-51	UniCam Pretium-Performance ST Connector 62.5µm, Ceramic Ferrule , Logo, Single Pack
95-000-51-Z	UniCam Pretium-Performance ST Connector 62.5µm, Ceramic Ferrule , Logo, Organizer Pack of 25
95-050-51	UniCam Pretium-Performance ST Connector 50µm, Ceramic Ferrule , Logo, Single Pack
95-050-51-X	UniCam Pretium-Performance ST Connector 50µm SX+, Ceramic Ferrule , Logo, Single Pack
95-050-51-Z	UniCam Pretium-Performance ST Connector 50µm, Ceramic Ferrule , Logo, Organizer Pack of 25
95-200-51	UniCam Pretium-Performance ST Connector SM SPC, Ceramic Ferrule , Logo, Single Pack
95-200-51-Z	UniCam Pretium-Performance ST Connector SM SPC, Ceramic Ferrule , Logo, Organizer Pack of 25
95-200-52	UniCam Pretium-Performance ST Connector SM UPC, Ceramic Ferrule , Logo, Single Pack
LC Connectors	
95-000-99	UniCam Pretium-Performance LC Connector 62.5µm, Ceramic Ferrule, Logo, Single Pack
95-000-99-Z	UniCam Pretium-Performance LC Connector 62.5µm, Ceramic Ferrule, Logo, Organizer Pack of 25
95-050-99	UniCam Pretium-Performance LC Connector 50µm, Ceramic Ferrule, Logo, Single Pack
95-050-99-X	UniCam Pretium-Performance LC Connector 50µm SX+, Ceramic Ferrule, Logo, Single Pack
95-050-99-X-Z	UniCam Pretium-Performance LC Connector 50µm SX+, Ceramic Ferrule, Logo, Organizer Pack of 25
95-050-99-Z	UniCam Pretium-Performance LC Connector 50µm, Ceramic Ferrule, Logo, Organizer Pack of 25
95-200-99	UniCam Pretium-Performance LC Connector SM UPC, Ceramic Ferrule, Logo, Single Pack
95-200-99-Z	UniCam Pretium-Performance LC Connector SM UPC, Ceramic Ferrule, Logo, Organizer Pack of 25

**Don't see the connector you need?
Liberty offers a full line of Corning Pretium Connectors.
Contact your Liberty representative for
part numbers and selection.**

Bulk Wire: Commercial Fiber Optic

Ordering is fast & easy.



Call today!

Custom Manufactured Fiber Assemblies

Liberty removes the guess work when working with fiber assemblies. Our fiber optic products are manufactured to standards that consistently perform above industry standards.

As a Certified Corning Gold™ manufacturer, Liberty's custom fiber assemblies are unmatched in the AV industry for performance, reliability and value.

Custom Fiber Optic Features:

- Each assembly is 100% tested
- Kitting Options are available
- All products carry a full warranty
- Designed for easy Plug & Play

1. Custom Patch Cords

- Available in any length
- Simplex and duplex jumpers
- Pigtailed available
- Unparalleled selection of connector types
- Corning Gold™ assemblies available
- Standard PC polish
- Ultra-PC polish
- Angled PC available



2. Multi-Fiber Cable Assemblies

- Available in any length
- 50 / 125 μm 10Gbps multimode
- 50 / 125 μm multimode
- 62.5 / 125 μm multimode
- 100 / 140 μm multimode
- Single mode available
- Pulling sheaths are available



Custom Fiber Optic Project Services

Liberty's team of experienced sales professionals and trained fiber technicians can design solutions that will work for every type of fiber optic installation.

We can accommodate:

- High Fiber Counts
- Standard and Nonstandard Lengths Requirements
- Unusual and Usual Jacket Requirements
- Packaging Demands
- Kitting Options

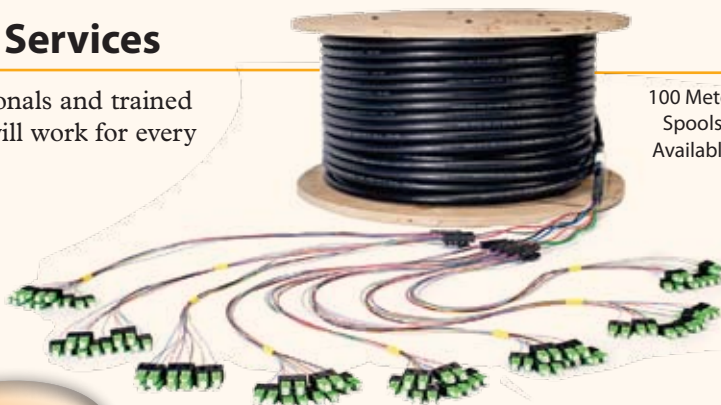

100 Meter Spools Available

NO REQUEST TOO EXTREME!

Our highly trained staff works from any type of specification, layout or project need.

Call us today to discuss your next fiber project.

WE PROVIDE FREE PROJECT ASSISTANCE!

Ordering is fast & easy.



Call today!

Solutions for the AV PROFESSIONAL
www.libertycable.com

800-530-8998
INTERNATIONAL - CALL +1-719-388-7542



Molded Fiber Optic Cable Assemblies

Professional's Top Choice for Single and Multimode Fiber Assemblies

Liberty's molded fiber optic assemblies are an economic solution to your installation's fiber optic needs. Designed for flawless performance, our molded fiber optic assemblies provide maximum efficiency to your installation.

Liberty's Molded Fiber Optic Assemblies:

- 100% tested
- Cost Effective
- Available in most common formats

Single Mode Fiber Optic Assemblies

1. SC to SC

Length	Part #
1 meter	DSMSCSC-001M
2 meter	DSMSCSC-002M
3 meter	DSMSCSC-003M
5 meter	DSMSCSC-005M
10 meter	DSMSCSC-010M



4. LC to LC

Length	Part #
1 meter	DSMLCLC-001M
2 meter	DSMLCLC-002M
3 meter	DSMLCLC-003M
5 meter	DSMLCLC-005M
10 meter	DSMLCLC-010M

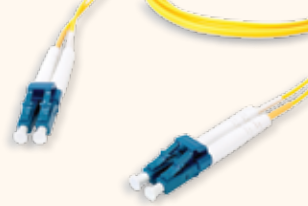

2. ST to ST

Length	Part #
1 meter	DSMSTST-001M
2 meter	DSMSTST-002M
3 meter	DSMSTST-003M
5 meter	DSMSTST-005M
10 meter	DSMSTST-010M



5. LC to SC

Length	Part #
1 meter	DSMLCSC-001M
2 meter	DSMLCSC-002M
3 meter	DSMLCSC-003M
5 meter	DSMLCSC-005M
10 meter	DSMLCSC-010M



3. ST to SC

Length	Part #
1 meter	DSMSTSC-001M
2 meter	DSMSTSC-002M
3 meter	DSMSTSC-003M
5 meter	DSMSTSC-005M
10 meter	DSMSTSC-010M



6. LC to ST

Length	Part #
1 meter	DSMLCST-001M
2 meter	DSMLCST-002M
3 meter	DSMLCST-003M
5 meter	DSMLCST-005M
10 meter	DSMLCST-010M



Multimode Fiber Optic Assemblies 50 / 125 μm

1. SC to SC 50 / 125 μm

Length	Part #
1 meter	DMM5SCSC-001M
2 meter	DMM5SCSC-002M
3 meter	DMM5SCSC-003M
5 meter	DMM5SCSC-005M
10 meter	DMM5SCSC-010M

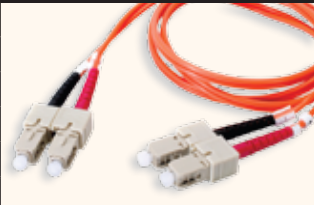

3. ST to SC 50 / 125 μm

Length	Part #
1 meter	DMM5STSC-001M
2 meter	DMM5STSC-002M
3 meter	DMM5STSC-003M
5 meter	DMM5STSC-005M
10 meter	DMM5STSC-010M



2. ST to ST 50 / 125 μm

Length	Part #
1 meter	DMM5STST-001M
2 meter	DMM5STST-002M
3 meter	DMM5STST-003M
5 meter	DMM5STST-005M
10 meter	DMM5STST-010M

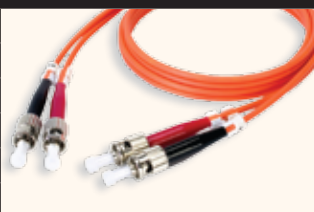

4. LC to LC 50 / 125 μm

Length	Part #
1 meter	DMM5LCLC-001M
2 meter	DMM5LCLC-002M
3 meter	DMM5LCLC-003M
5 meter	DMM5LCLC-005M
10 meter	DMM5LCLC-010M



Bulk Wire: Commercial Fiber Optic



Multimode Fiber Optic Assemblies 50 / 125 μ m

5. LC to SC 50 / 125 μ m

Length	Part #
1 meter	DMM5LCSC-001M
2 meter	DMM5LCSC-002M
3 meter	DMM5LCSC-003M
5 meter	DMM5LCSC-005M
10 meter	DMM5LCSC-010M

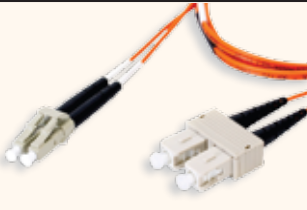

6. LC to ST 50 / 125 μ m

Length	Part #
1 meter	DMM5LCST-001M
2 meter	DMM5LCST-002M
3 meter	DMM5LCST-003M
5 meter	DMM5LCST-005M
10 meter	DMM5LCST-010M

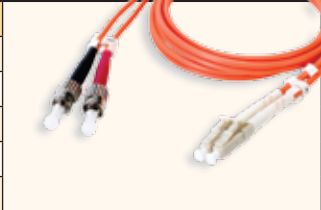

Multimode Fiber Optic Assemblies 62.5 / 125 μ m

1. SC to SC 62.5 / 125 μ m

Length	Part #
1 meter	DMM6SCSC-001M
2 meter	DMM6SCSC-002M
3 meter	DMM6SCSC-003M
5 meter	DMM6SCSC-005M
10 meter	DMM6SCSC-010M

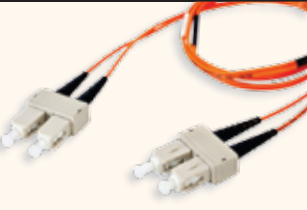

6. MTRJ to SC 62.5 / 125 μ m

Length	Part #
1 meter	DMM6MTSC-001M
2 meter	DMM6MTSC-002M
3 meter	DMM6MTSC-003M
5 meter	DMM6MTSC-005M
10 meter	DMM6MTSC-010M

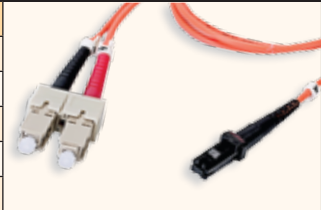

2. ST to ST 62.5 / 125 μ m

Length	Part #
1 meter	DMM6STST-001M
2 meter	DMM6STST-002M
3 meter	DMM6STST-003M
5 meter	DMM6STST-005M
10 meter	DMM6STST-010M



7. LC to LC 62.5mm / 125 μ m

Length	Part #
1 meter	DMM6LCLC-001M
2 meter	DMM6LCLC-002M
3 meter	DMM6LCLC-003M
5 meter	DMM6LCLC-005M
10 meter	DMM6LCLC-010M

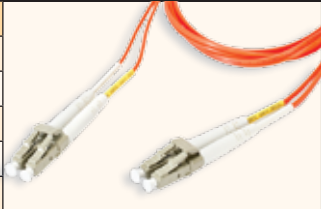

3. ST to SC 62.5 / 125 μ m

Length	Part #
1 meter	DMM6STSC-001M
2 meter	DMM6STSC-002M
3 meter	DMM6STSC-003M
5 meter	DMM6STSC-005M
10 meter	DMM6STSC-010M



8. LC to SC 62.5 / 125 μ m

Length	Part #
1 meter	DMM6LCSC-001M
2 meter	DMM6LCSC-002M
3 meter	DMM6LCSC-003M
5 meter	DMM6LCSC-005M
10 meter	DMM6LCSC-010M



4. MTRJ to MTRJ 62.5 / 125 μ m

Length	Part #
1 meter	DMM6MTMT-001M
2 meter	DMM6MTMT-002M
3 meter	DMM6MTMT-003M
5 meter	DMM6MTMT-005M
10 meter	DMM6MTMT-010M



9. LC to ST 62.5 / 125 μ m

Length	Part #
1 meter	DMM6LCST-001M
2 meter	DMM6LCST-002M
3 meter	DMM6LCST-003M
5 meter	DMM6LCST-005M
10 meter	DMM6LCST-010M



5. MTRJ to ST 62.5 / 125 μ m

Length	Part #
1 meter	DMM6MTST-001M
2 meter	DMM6MTST-002M
3 meter	DMM6MTST-003M
5 meter	DMM6MTST-005M
10 meter	DMM6MTST-010M

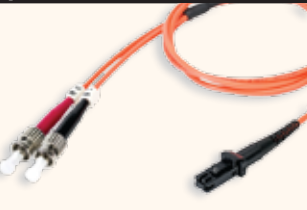

Custom fiber assemblies are available in any connector or length!

Ordering is fast & easy.



Call today!

Solutions for the AV PROFESSIONAL
www.libertycable.com

800-530-8998
INTERNATIONAL - CALL +1-719-388-7542



Multimode Fiber Optic Assemblies 10 Gig 50 / 125µm

1. SC to SC 10 Gig 50mm / 125µm

Length	Part #
1 meter	DMM10SCSC-001M
2 meter	DMM10SCSC-002M
3 meter	DMM10SCSC-003M
5 meter	DMM10SCSC-005M
10 meter	DMM10SCSC-010M

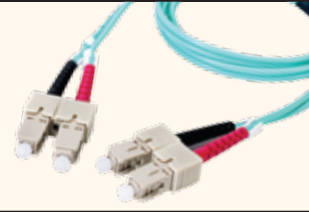

2. ST to ST 10 Gig 50mm / 125µm

Length	Part #
1 meter	DMM10STST-001M
2 meter	DMM10STST-002M
3 meter	DMM10STST-003M
5 meter	DMM10STST-005M
10 meter	DMM10STST-010M



3. ST to SC 10 Gig 50 / 125µm

Length	Part #
1 meter	DMM10STSC-001M
2 meter	DMM10STSC-002M
3 meter	DMM10STSC-003M
5 meter	DMM10STSC-005M
10 meter	DMM10STSC-010M



4. LC to LC 10 Gig 50mm / 125µm

Length	Part #
1 meter	DMM10LCLC-001M
2 meter	DMM10LCLC-002M
3 meter	DMM10LCLC-003M
5 meter	DMM10LCLC-005M
10 meter	DMM10LCLC-010M

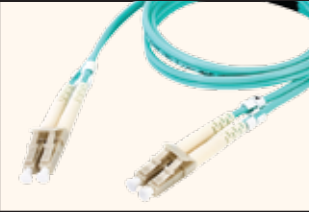

5. LC to SC 10 Gig 50mm / 125µm

Length	Part #
1 meter	DMM10LCSC-001M
2 meter	DMM10LCSC-002M
3 meter	DMM10LCSC-003M
5 meter	DMM10LCSC-005M
10 meter	DMM10LCSC-010M



6. LC to ST 10 Gig 50mm / 125µm

Length	Part #
1 meter	DMM10LCST-001M
2 meter	DMM10LCST-002M
3 meter	DMM10LCST-003M
5 meter	DMM10LCST-005M
10 meter	DMM10LCST-010M

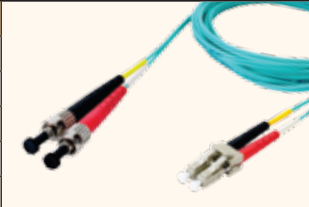

Additional Molded Fiber Optic Assemblies

1. Toslink Fiber Optic Interconnects (each)

Length (m)	Part #
1	ZTOS1
2	ZTOS2
4	ZTOS4
6	ZTOS6
10	ZTOS10
15	ZTOS15



2. Z-500 TOSLink Interconnect

Length (m)	Part #
1	Z500TOS1
2	Z500TOS2
4	Z500TOS4
6	Z500TOS6
10	Z500TOS10
15	Z500TOS15



3. Fiber Optic DVI Cables

Length (m)	Part #
10	DL-DVIDFO-10M
20	DL-DVIDFO-20M
30	DL-DVIDFO-30M
40	DL-DVIDFO-40M
50	DL-DVIDFO-50M
60	DL-DVIDFO-60M
70	DL-DVIDFO-70M
100	DL-DVIDFO-100M



DVI-D Single Link -Single Link

4. Fiber Optic HDMI Cables

Length (m)	Part #
10	DL-HDMFO-10M
20	DL-HDMFO-20M
30	DL-HDMFO-30M
40	DL-HDMFO-40M
50	DL-HDMFO-50M
60	DL-HDMFO-60M
70	DL-HDMFO-70M
100	DL-HDMFO-100M



HDMI Male - HDMI Male

Ordering is fast & easy.



Call today!

Structured Cables with Multimode Fiber

1. Multimode Fiber - Structured Cable

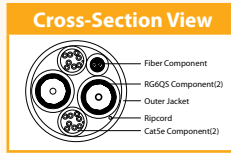
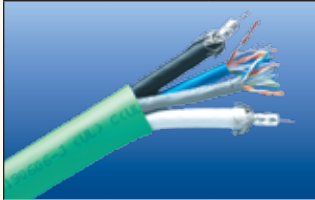

- UL Listed NEC Type CMG
- Flexible PVC Jacket
- Enhanced Category 5E Cables (350 MHz)
- Sequential Foot Marks
- Separate Multimode Fiber Optic Cables

AWG Center Conductor	NOM OD Dielectric (Inches)	Shield Construction	NOM Jacket (Inches)	NOM OD (Inches)	NOM Capacitance (Pf/ft)	NOM Velocity of Propagation	NOM Attenuation MHz db100'		Part #
18 AWG Solid BC	0.18 FPE	2 Foils +60% AL 40% AL Braid	0.026	0.287	16.2	82%	10	0.81	Element 1 2 ea QUADFLEX-BC
24 AWG Solid BC	0.036 PE		0.020	0.197	14	71%	50	1.46	
62.5/125	900 micron		0.027	0.150			200	2.83	Element 2 2 ea 24-4P-L5-EN (350 MHz)
			0.033	0.600			400	4.05	
							700	5.6	Element 3 2 Fiber tight buffer
							1000	6.59	
							1450	7.94	Overall Construction
							2200	9.77	

(2) Optical Fiber 62.5/125um Indoor Fiber Multimode Outer Diameter: .10in.

2. HDMI Fiber Optic Extender

Part # **DL-HDFO**

This unique HDMI/DVI fiber optical cable system lets your digital display (Plasma TV, Digital Projectors, LCD Monitors, HDTV, etc.) be located up to 1640 ft. (500 meters) away from the video and audio sources based on using the HDMI or DVI standard.

Our patented optical conversion technology enables noise-free and high-res (up to UXGA or 1080p) extension up to 1640 ft. (500 meters). Ideal for fishing through small conduits or other openings as the LC connectors are detachable from the device which requires only a 1/2 inch opening.



Wall Plates For Fiber Optic Cables

Liberty provides the finishing touches for any fiber optic cable installation with our custom designed and stock plates solutions.

WebBlox™ design and quoting tools let you design your own wall plates from your desktop without any software. Go from concept to completed plate design in a matter of minutes. Contact your sales professional to get started.



- Connectors:
- Quad Multi-mode LC Fiber Couplers
 - 2 Pin Phoenix Screw Terminal
 - BNC Female (75 Ohm)

Part #: **PC-G2260-E-P-C**



- Connectors:
- Duplex Multi-mode LC Fiber Couplers
 - 2 Pin Phoenix Screw Terminal

Part #: **PC-G1850-E-P-C**

Ordering is fast & easy.



Call today!

Solutions for the AV PROFESSIONAL
www.libertycable.com

800-530-8998
INTERNATIONAL - CALL +1-719-388-7542



Power-Limited Fire Protective Signaling Cable

Non-Plenum & Plenum

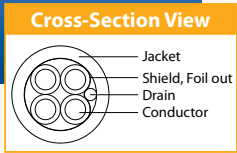
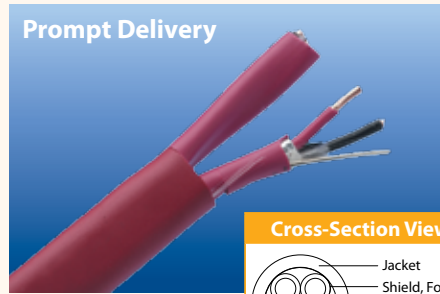

- UL Listed NEC Type FPLR or FPLP Article 760
- Solid Bare Copper Conductors
- PVC Insulation, Red PVC Jacket
- Max 60°C - 75°C
- Sequential Footmarks
- See Color Code Charts on page 241

Multi-Conductor/Shielded w/Drain Wire Riser Rated					
# of Conductors	AWG Size/ Stranding	NOM Insulation (Inches)	NOM Jacket (Inches)	NOM OD (Inches)	Part #
2 (1 Pair)	18 Solid	0.010	0.020	0.160	18-2C-FPLRSH-RED
2 (1 Pair)	16 Solid	0.010	0.020	0.170	16-2C-FPLRSH-RED
2 (1 Pair)	14 Solid	0.012	0.030	0.211	14-2C-FPLRSH-RED
2 (1 Pair)	12 Solid	0.012	0.030	0.240	12-2C-FPLRSH-RED
4	18 Solid	0.010	0.025	0.190	18-4C-FPLRSH-RED
4	16 Solid	0.010	0.025	0.217	16-4C-FPLRSH-RED
4	14 Solid	0.012	0.030	0.284	14-4C-FPLRSH-RED

Multi-Conductor/Unshielded					
# of Conductors	AWG Size/ Stranding	NOM Insulation (Inches)	NOM Jacket (Inches)	NOM OD (Inches)	Part #
2 (1 Pair)	18 Solid	0.009	0.015	0.146	18-2C-FPLP-RED
2 (1 Pair)	16 Solid	0.009	0.015	0.168	16-2C-FPLP-RED
2 (1 Pair)	14 Solid	0.010	0.015	0.198	14-2C-FPLP-RED
2 (1 Pair)	12 Solid	0.010	0.015	0.232	12-2C-FPLP-RED
4	18 Solid	0.009	0.015	0.171	18-4C-FPLP-RED
4	16 Solid	0.009	0.015	0.196	16-4C-FPLP-RED
4	14 Solid	0.010	0.015	0.233	14-4C-FPLP-RED
4	12 Solid	0.010	0.015	0.273	12-4C-FPLP-RED
6	22 Solid	0.009	0.015	0.159	22-6C-FPLP-RED
6	18 Solid	0.009	0.015	0.205	18-6C-FPLP-RED
8	22 Solid	0.009	0.015	0.173	22-8C-FPLP-RED
8	18 Solid	0.009	0.015	0.223	18-8C-FPLP-RED

Multi-Conductor/Shielded w/Drain Wire					
# of Conductors	AWG Size/ Stranding	NOM Insulation (Inches)	NOM Jacket (Inches)	NOM OD (Inches)	Part #
2 (1 Pair)	18 Solid	0.009	0.015	0.150	18-2C-FPLPSH-RED
2 (1 Pair)	16 Solid	0.009	0.015	0.172	16-2C-FPLPSH-RED
2 (1 Pair)	14 Solid	0.010	0.015	0.202	14-2C-FPLPSH-RED
2 (1 Pair)	12 Solid	0.010	0.015	0.236	12-2C-FPLPSH-RED
4	18 Solid	0.010	0.015	0.175	18-4C-FPLPSH-RED
4	16 Solid	0.009	0.015	0.200	16-4C-FPLPSH-RED
4	14 Solid	0.010	0.015	0.237	14-4C-FPLPSH-RED
4	12 Solid	0.010	0.015	0.283	12-4C-FPLPSH-RED
6	18 Solid	0.009	0.015	0.209	18-6C-FPLPSH-RED
8	18 Solid	0.009	0.015	0.227	18-8C-FPLPSH-RED
10	18 Solid	0.009	0.015	0.267	18-10C-FPLPSH-RED

Bulk Wire: Commercial Fire Alarm Cable

Ordering is fast & easy.



Call today!

Solutions for the AV PROFESSIONAL
www.trendsinc.com

877-946-9225
COMPLETE NATIONAL COVERAGE



CANADA'S PREMIER AV SUPPLIER

RGBHV Mini 23 Solid AWG Cable Non-Plenum & Plenum

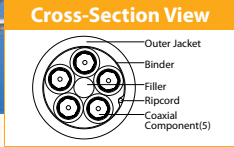
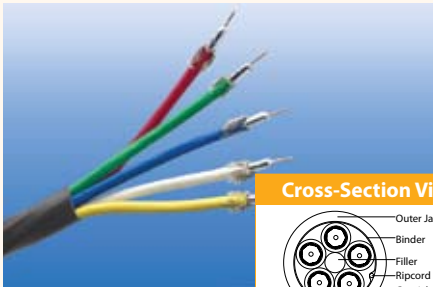

The solid center conductor construction provides better performance, in regards to signal distance and frequency response, than the typical stranded center conductor cables in the market. The solid 23 AWG cable is great for longer RGBHV cable runs and the solid 23 AWG RGBHV cable is swept to 3 GHz. The 23 AWG cable is perfect for short run, HD applications and offers premium performance for all analog video applications.

SOLID 23 AWG RGBHV CABLE - NON-PLENUM

Part#: RGB5C-23-CM CM Rated	# of Conductors	AWG Center Conductor	NOM Dielectric (Inches)	Shield Construction	NOM Jacket (Inches)	NOM OD (Inches)	NOM Capacitance (pF/ft)	NOM Velocity of Propagation	NOM Attenuation	
									MHz	db/100'
	5	23 AWG Solid BC	.100 FPE	100% Foil 95% TC Braid	.019 PVC	.165	16.5	84%	1	.38
									3.58	.77
									10	1.29
									135	4.18
									270	5.92
									720	9.47
									1000	11.16
2000	15.78									
3000	19.33									
Overall Construction 5 coaxes cabled and jacketed					.054 PVC	.540				

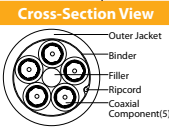

PERFECT CONNECTOR MATCHES

ITEM #	PART #
1	CM-RGB23-BNC
2	CM-RGB23-RCA
3	CM-RGB23-GRCA

SOLID 23 AWG RGBHV CABLE - PLENUM

Part#: RGB5C-23-CMP CMP Rated	# of Conductors	AWG Center Conductor	NOM Dielectric (Inches)	Shield Construction	NOM Jacket (Inches)	NOM OD (Inches)	NOM Capacitance (pF/ft)	NOM Velocity of Propagation	NOM Attenuation	
									MHz	db/100'
	5	23 AWG Solid BC	.101 FFEP	100% Foil 95% TC Braid	.017 PVDF	.159	16.4	83%	1	.33
									10	1.07
									100	3.55
									270	6.08
									750	10.84
									1000	12.83
									2000	19.51
3000	25.19									
Overall Construction 5 coaxes cabled and jacketed					.018 PVDF	.465				

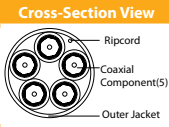

PERFECT CONNECTOR MATCHES

ITEM #	PART #
1	CM-RGB23-BNC
2	CM-RGB23-RCA
3	CM-RGB23-GRCA

SOLID 23 AWG RGB CABLE - NON-PLENUM

Part#: RGB3C-23-CM	# of Conductors	AWG Center Conductor	NOM Dielectric (Inches)	Shield Construction	NOM Jacket (Inches)	NOM OD (Inches)	NOM Capacitance (pF/ft)	NOM Velocity of Propagation	NOM Attenuation	
									MHz	db/100'
	3	23 AWG Solid BC	.100 FPE	100% Foil 95% TC Braid	.019 PVC	.165	16.5	84%	1	.38
									3.58	.77
									10	1.29
									135	4.18
									270	5.92
									720	9.47
									1000	11.16
2000	15.78									
3000	19.33									
Overall Construction 3 coaxes cabled and jacketed					.054 PVC	.415				

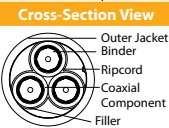

PERFECT CONNECTOR MATCHES

ITEM #	PART #
1	CM-RGB23-BNC
2	CM-RGB23-RCA
3	CM-RGB23-GRCA

Ordering is fast & easy.



Call today!

Solutions for the AV PROFESSIONAL
www.libertycable.com

800-530-8998
INTERNATIONAL - CALL +1-719-388-7542





RGBHV Mini 23 Solid AWG Cable Non-Plenum & Plenum



Bulk Wire: Commercial RGB Cable

SOLID 23 AWG RGB CABLE - PLENUM										
Part#: RGB3C-23-CMP CMP Rated	# of Conductors	AWG Center Conductor	NOM Dielectric (Inches)	Shield Construction	NOM Jacket (Inches)	NOM OD (Inches)	NOM Capacitance (pF/ft)	NOM Velocity of Propagation	NOM Attenuation	
									MHz	db/100'
	3	23 AWG Solid BC	.101 FFPE	100% Foil 95% TC Braid	.017 PVDF	.159	16.4	83%	1	.33
									10	1.07
									100	3.55
									270	6.08
									750	10.84
									1000	12.83
								2000	19.51	
								3000	25.19	
Overall Construction 3 coaxes cabled and jacketed					.018 PVDF	.379				

SOLID 23 AWG RGBHV COMPOSITE CABLE - NON-PLENUM										
Part#: RGB6C-23-2L5E	# of Conductors	AWG Center Conductor	NOM Dielectric (Inches)	Shield Construction	NOM Jacket (Inches)	NOM OD (Inches)	NOM Capacitance (pF/ft)	NOM Velocity of Propagation	NOM Attenuation	
									MHz	db/100'
	6	23 AWG Solid BC	.100 FPE	100% Foil 95% TC Braid	.019 PVC	.165	16.5	84%	1	.38
									3.58	.77
									10	1.29
									135	4.18
									270	5.92
									720	9.47
								1000	11.16	
								2000	15.78	
								3000	19.33	
Cat5e UTP	4Pair	24 AWG	.036	N/A	.020	.197	14	71	350 MHz test	
Overall Construction 6 Coaxes + 2 Cat5e cabled and jacketed					.035 PVC	.627				

SOLID 23 AWG SERIAL DIGITAL VIDEO CABLES - NON-PLENUM										
Part#: 23-MINI-SD-* CM Rated	# of Conductors	AWG Center Conductor	NOM Dielectric (Inches)	Shield Construction	NOM Jacket (Inches)	NOM OD (Inches)	NOM Capacitance (pF/ft)	NOM Velocity of Propagation	NOM Attenuation	
									MHz	db/100'
	1	23 AWG Solid BC	.101 FPE	100% Foil 95% TC Braid	.019 PVC	.165	16.5	84%	1	.38
									3.58	1.29
									10	4.18
									135	5.92
									270	9.47
									720	11.16
								1000	15.78	
								2000	19.33	
								3000	22.32	
								4000	23.67	
*Available in Ten Different Colors: BLUE PURPLE GREEN RED ORANGE BLACK YELLOW WHITE GRAY BROWN										

SOLID 23 AWG SERIAL DIGITAL VIDEO CABLES - PLENUM										
Part#: 23-MINI-CMP-*	AWG Center Conductor	NOM Dielectric (Inches)	Shield Construction	NOM Jacket (Inches)	NOM OD (Inches)	NOM Capacitance (pF/ft)	NOM Velocity of Propagation	NOM Attenuation		
								MHz	db/100'	
	23 Solid BC	.101 FFPE	100% Bonded Aluminum Poly 95% 36 AWG TC Braid	.016 PL-PVC	.159	16.4	83%	135	4.17	
								270	6.08	
								720	10.58	
								1000	12.83	
								2000	19.51	
								3000	20.50	
							4500	32.79		
*Available in Two Different Colors: BLACK WHITE										

Ordering is fast & easy.



Call today!

Solutions for the AV PROFESSIONAL
www.libertycable.com

800-530-8998
INTERNATIONAL - CALL +1-719-388-7542



Specifications Subject to Change

RGBHV Mini 23 Solid AWG Cable Non-Plenum & Plenum



SOLID 23 AWG S-VIDEO CABLE - NON-PLENUM

Part#: 23-YCLL-SIAM	AWG Center Conductor	NOM Dielectric (Inches)	Shield Construction	NOM Jacket (Inches)	NOM OD (Inches)	NOM Capacitance (pF/ft)	NOM Velocity of Propagation	NOM Attenuation	
								MHz	db/100'
	(2) 23 SOL BC	.100 FPE	100% Bonded Aluminum Poly 95% 36 AWG TC Braid	.013 FR-PVC	.159 x .328	16.5	84%	1	.38
								3.6	.77
								10	1.29
								71.5	3.04
								135	4.18
								270	5.92
								360	6.70
								720	9.47
								1000	11.16
								3000	20.5

Cross-Section View

PERFECT CONNECTOR MATCHES

ITEM #	PART #
1	CM-RGB23-BNC
2	CM-RGB23-RCA
3	CM-RGB23-GRCA

RGBHV Mini 25 Solid AWG Cable - Non-Plenum & Plenum

SOLID 25 AWG RGBHV CABLE - NON-PLENUM

Part#: RGB5C-25-CM CM Rated	# of Conductors	AWG Center Conductor	NOM Dielectric (Inches)	Shield Construction	NOM Jacket (Inches)	NOM OD (Inches)	NOM Capacitance (pF/ft)	NOM Velocity of Propagation	NOM Attenuation	
									MHz	db/100'
	5	25 AWG Solid BC	.077 FPE	90% TC Spiral 100% Foil	.009 PVC	.109	18.0	78%	100	5.10
									200	7.10
									400	10.50
									1000	17.90
									Overall Construction 5 coaxes cabled and jacketed	

Cross-Section View

PERFECT CONNECTOR MATCHES

ITEM #	PART #
4	CM-RGB25S-BNC
5	CM-RGB25S-RCA
6	CM-RGB25S-GRCA

SOLID 25 AWG RGBHV CABLE - PLENUM

Part#: RGB5C-25-CMP CMP Rated	# of Conductors	AWG Center Conductor	NOM Dielectric (Inches)	Shield Construction	NOM Jacket (Inches)	NOM OD (Inches)	NOM Capacitance (pF/ft)	NOM Velocity of Propagation	NOM Attenuation	
									MHz	db/100'
	5	25 AWG Solid BC	.074 FFEP	100% Aluminum Poly 98% 38 AWG TC Spiral Braid	.016	.315	16.0	83%	100	5.10
									200	7.10
									400	10.50
									1000	17.90
									Overall Construction 5 coaxes cabled and jacketed	

Cross-Section View

PERFECT CONNECTOR MATCHES

ITEM #	PART #
4	CM-RGB25S-BNC
5	CM-RGB25S-RCA
6	CM-RGB25S-GRCA

**ORDER YOUR
CONNECTEC
SOLID 23 AWG
CONNECTORS**

**1-PIECE
RCA & BNC
CONNECTORS!**



Part #: CM-RGB23-BNC

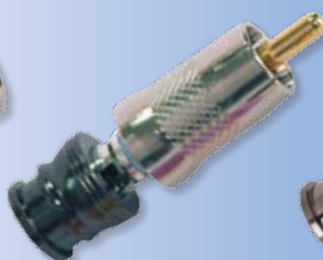

Part #: CM-RGB23-RCA

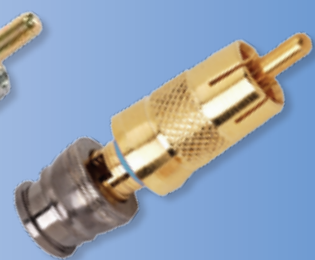

Part #: CM-RGB23-GRCA

Ordering is fast & easy.



Call today!

**Solutions for the
AV PROFESSIONAL**
www.libertycable.com

800-530-8998
INTERNATIONAL - CALL +1-719-388-7542



RGBHV Mini 25 Solid AWG Cable Plenum



SOLID 25 AWG RGBHV COMPOSITE CABLE - PLENUM												
Part#: RGB6C-25/22-2P-CMP CMP Rated	# of Conductors	AWG Center Conductor	NOM Dielectric (Inches)	Shield Construction	NOM Jacket (Inches)	NOM OD (Inches)	NOM Capacitance (pF/ft)	NOM Velocity of Propagation	NOM Attenuation			
	6	25 AWG Solid BC	.074 FFEP	90% TC Spiral 100% Foil	.010 PL-PVC	.106	16.0	83%	100 200 400 1000	5.10 7.10 10.50 17.90		
	4 (2 pair)	22 AWG (7x30)	.007 PL-PVC	100% Foil + 22 AWG	.008 PL-PVC	.102						
	Cross-Section View		PERFECT CONNECTOR MATCHES									
											ITEM # PART #	
											4 CM-RGB25S-BNC	
											5 CM-RGB25S-RCA	
											6 CM-RGB25S-GRCA	
Overall Construction 6 coaxes cabled and jacketed										.015 PL-PVC	.388	

Solid 25 AWG Composite Cables Plenum



SOLID 25 AWG RGBHV COMPOSITE CABLE - PLENUM												
Part#: RGB7C/22-3P-PLN	# of Conductors	AWG Center Conductor	NOM Dielectric (Inches)	Shield Construction	NOM Jacket (Inches)	NOM OD (Inches)	NOM Capacitance (pF/ft)	NOM Velocity of Propagation	NOM Attenuation			
	7	25 AWG Solid BC	.074 FFEP	90% TC Spiral 100% Foil	.010 PL-PVC	.106	16.0	83%	100 200 400 1000	5.10 7.10 10.50 17.90		
	6 (3 pair)	22 STR TC (7x30)	.007 PL-PVC	100% AL Foil + 22 AWG TC Drain	.008 PL-PVC	.102						
	Cross-Section View		PERFECT CONNECTOR MATCHES									
											ITEM # PART #	
											4 CM-RGB25S-BNC	
											5 CM-RGB25S-RCA	
											6 CM-RGB25S-GRCA	
Overall Construction 7 coaxes cabled and jacketed										.015 PL-PVC	.400	

ORDER YOUR
CONNECTEC™
SOLID 25 AWG
CONNECTORS

1-PIECE
RCA & BNC
CONNECTORS!

Part #:
CM-RGB25S-BNC

Part #:
CM-RGB25S-RCA

Part #:
CM-RGB25S-GRCA

Solutions for the
AV PROFESSIONAL
www.libertycable.com

800-530-8998
INTERNATIONAL - CALL +1-719-388-7542

Bulk Wire: Commercial RGB Cable

Ordering is fast & easy.

Call today!

Solid 25 AWG Composite Cables Non-Plenum



SOLID 25 AWG RGBHV COMPOSITE Cable - NON-PLENUM

Part#: RGB6C-25-2L5E (6) 25 AWG Solid Coaxes + (2) CAT5E	# of Conductors	AWG Center Conductor	NOM Dielectric (Inches)	Shield Construction	NOM Jacket (Inches)	NOM OD (Inches)	NOM Capacitance (pF/ft)	NOM Velocity of Propagation	NOM Attenuation		
	6	25 AWG Solid BC	.077 FPE	90% TC Spiral 100% Foil	.009 PVC	.109	18.0	78%	100 MHz	5.10 db/100'	
	8 (4 Pair)	24 AWG Solid BC	.008 HDPE	None	.020 PVC	.197	14.0	71%	Cat5e 350 MHz		
Cross-Section View 					PERFECT CONNECTOR MATCHES						
					ITEM #	PART #					
					4	CM-RGB25S-BNC					
					5	CM-RGB25S-RCA					
					6	CM-RGB25S-GRCA					
Overall Construction 6 coaxes and 2 Cat5e UTP cabled and jacketed							.015 PL-PVC	.400			

Taped Bundles

Taped Bundles allow you to design your own cables by combining any number of cables into one cable.

Part #: Tektone - NC300

- TEKTONE-D2
- TEKTONE-AUDIO
- TEKTONE-P2
- 16-2C-BLK



See Page 48

CONNECTTEC™ Termination System Tools & Accessories

ConnecTec™ Termination Kit



Part #: CM-TOOL-PAC

Case Includes:

- (1) Compression Tool
- (1) 23/25 Solid AWG Coax Stripper
- (1) 25/26 Stranded AWG Coax Stripper
- (1) RG59/6 Coax Stripper
- (1) Cable Cutter
- (1) Holster

Our kit does not include connectors. Call today to pick the right combination of connectors for your project.

ConnecTec™ Compression Tool

Part #: CM-TOOL

Milled from a solid piece of NASA-grade aluminum, our tool is light weight yet highly durable.

Anodized in an easy-to-find red finish, this exclusive tool is easy to work with.



Part #: CM-TOOL-DIE

Extra Dies

ConnecTec™ Stripper & Replacement Blades

Part # CM-23/25



Part#: CM-23/25-BLADE



Ordering is fast & easy.



Call today!

Solutions for the
AV PROFESSIONAL

www.libertycable.com

800-530-8998



INTERNATIONAL - CALL +1-719-388-7542





Solid 25 AWG S-Video Cables Non-Plenum & Plenum

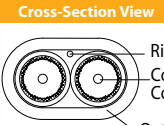

Bulk Wire: Commercial RGB Cable

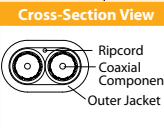
SOLID 25 AWG S-VIDEO CABLE - NON-Plenum																	
Part#: SV-25-CM	AWG Center Conductor	NOM Dielectric (Inches)	Shield Construction	NOM Jacket (Inches)	Overall NOM OD (Inches)	NOM Capacitance (pF/ft)	NOM Velocity of Propagation	NOM Attenuation									
	(2) 25 AWG Solid BC	.077 FPE	100% Al/Poly Tape + 90% TC Spiral Braid	.026 PVC	.163 x .269	18.0	78%	100	5.10								
								200	7.10								
								400	10.50								
								1000	17.90								
					PERFECT CONNECTOR MATCHES <table border="1"> <tr> <th>ITEM #</th> <th>PART #</th> </tr> <tr> <td>4</td> <td>CM-RGB25S-BNC</td> </tr> <tr> <td>5</td> <td>CM-RGB25S-RCA</td> </tr> <tr> <td>6</td> <td>CM-RGB25S-GRCA</td> </tr> </table>					ITEM #	PART #	4	CM-RGB25S-BNC	5	CM-RGB25S-RCA	6	CM-RGB25S-GRCA
ITEM #	PART #																
4	CM-RGB25S-BNC																
5	CM-RGB25S-RCA																
6	CM-RGB25S-GRCA																

Solid 25 AWG S-VIDEO CABLE - PLENUM																	
Part#: SV-25-CMP	AWG Center Conductor	NOM Dielectric (Inches)	Shield Construction	NOM Jacket (Inches)	Overall NOM OD (Inches)	NOM Capacitance (pF/ft)	NOM Velocity of Propagation	NOM Attenuation									
	(2) 25 AWG Solid BC	.074 FFEP	100% Al/Poly Tape + 90% TC Spiral Braid	.015 PL-PVC	.141 x .245	16.0	83%	100	5.10								
								200	7.10								
								400	10.50								
								1000	17.90								
					PERFECT CONNECTOR MATCHES <table border="1"> <tr> <th>ITEM #</th> <th>PART #</th> </tr> <tr> <td>4</td> <td>CM-RGB25S-BNC</td> </tr> <tr> <td>5</td> <td>CM-RGB25S-RCA</td> </tr> <tr> <td>6</td> <td>CM-RGB25S-GRCA</td> </tr> </table>					ITEM #	PART #	4	CM-RGB25S-BNC	5	CM-RGB25S-RCA	6	CM-RGB25S-GRCA
ITEM #	PART #																
4	CM-RGB25S-BNC																
5	CM-RGB25S-RCA																
6	CM-RGB25S-GRCA																

ORDER YOUR
CONNECTEC™
SOLID 25 AWG
CONNECTORS

1-PIECE
RCA & BNC
CONNECTORS!



Part #:
CM-RGB25S-BNC

Part #:
CM-RGB25S-RCA

Part #:
CM-RGB25S-GRCA

Ordering is fast & easy.



Call today!

Solutions for the AV PROFESSIONAL
www.libertycable.com

800-530-8998
INTERNATIONAL - CALL +1-719-388-7542



Specifications Subject to Change

REDUCE YOUR LABOR COSTS \$266³⁶ ON YOUR NEXT INSTALL

by using Liberty's 23 & 25 AWG



Liberty is committed to keeping your business profitable and competitive.

Our 23 & 25 AWG QuickLinx™ products are more efficient to work with than stranded cables that need a multipart connector. Installation efficiencies translate to higher profits for your business.

Using both a single piece connector and our 23 and 25 AWG solid center core coax solutions helps you terminate more cables in less time.

Here are a few examples of how Liberty's 23 & 25 AWG QuickLinx™ solutions, using the single piece connector can help you maximize your labor:

Running a business is hard work. Making the switch to higher profits is easy. Liberty's 23 & 25 AWG solutions with solid coax and single piece connectors will help keep your business both competitive and profitable. Your business is worth making the switch.

LABOR SAVINGS PER CABLE	LABOR SAVINGS IN THE WAREHOUSE
<p>Labor saving for terminating a typical cable 5BNC to 5BNC for a display device:</p> <ul style="list-style-type: none"> • Average install with 3 display devices • Reduce labor by 10 minutes • More than 3 times faster than using the stranded product 	<ul style="list-style-type: none"> • NO more lost labor looking for multiple connector pieces. With a one piece connector no parts to lose! • Fewer parts mean reduced warehouse and storage costs
LABOR SAVINGS PER RACK	LABOR SAVINGS PER INSTALL
<p>Labor savings for off-site rack wiring and terminations. Average rack has 50 connectors</p> <ul style="list-style-type: none"> • Reduce labor by 1 hour 	<ul style="list-style-type: none"> • With a one piece connector reduced need for cable/connection troubleshooting • Fewer parts mean fewer headaches on the install

Put Our 23 and 25 AWG Solid Solutions to Work for You Today... *And Start Saving!*

Solid 23 AWG RGBHV Cables Non-Plenum & Plenum

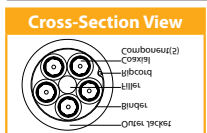

500 ft. Spools

Type	AWG	Jacket	Part #
RGB	23	PVC	RGB5C-23-CM
RGB	23	Plenum	RGB5C-23-CMP

Connectors:	
	Part #: CM-RGB23-BNC
	Part #: CM-RGB23-RCA
	Part #: CM-RGB23-GRCA

Solid 25 AWG RGBHV Cables Non-Plenum & Plenum

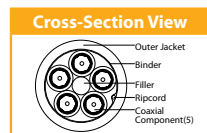
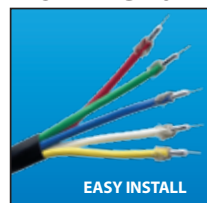

500 ft. Spools

Type	AWG	Jacket	Part #
RGB	25	PVC	RGB5C-25-CM
RGB	25	Plenum	RGB5C-25-CMP

Connectors:	
	Part #: CM-RGB25S-BNC
	Part #: CM-RGB25S-RCA
	Part #: CM-RGB25S-GRCA

QuickLinx™ solid cables available in one to seven conductor combinations. See Liberty's "Solid Solutions" brochure for complete offering.

Ordering is fast & easy.



Call today!

Solutions for the AV PROFESSIONAL
www.libertycable.com

800-530-8998
INTERNATIONAL - CALL +1-719-388-7542



SOLID Solutions **QuickLinx™** SOLID COAX CABLES

Solid Center Conductor 23 & 25 AWG Mini RGBHV Cable and Connector Solutions



REDUCE YOUR LABOR COSTS \$266³⁶
ON YOUR NEXT INSTALL
by using Liberty's 23 & 25 AWG solid solutions!

On-Site Display Device Termination Comparison	Stranded Core 25 & 26 AWG	Solid Core RGB 23 & 25 AWG	Solid Savings in minutes
CABLE PREP: CUT, STRIP AND DRESS			
Stranded cable prep 40 seconds	.67		
Solid Cable prep 15 seconds		0.25	
Connector Terminating			
Average time to use multi-piece connector for stranded cable 1.5 minutes per connector. 5 cables times 2 ends is 10 connectors is 15 minutes per cable	15.00		
Average time to use one-piece connector for solid cable 0.5 minutes per connector. 5 cables times 2 ends is 10 connectors is 5 minutes per cable		5.00	
Total on-site labor savings per display	15.67	5.25	
Total on-site labor savings per installation for three displays	47.00	15.75	31.25
Off-Site Rack Wiring and Termination Comparison			
AVERAGE NUMBER OF RACK-BASED TERMINATIONS 50			
Stranded: 1.5 minutes per connector. 50 ends equates to 75 minutes	75.00		
Solid: 0.5 minutes per connector. 50 ends equates to 25 minutes		25.00	
Total off-site labor savings per installation for rack	75.00	25.00	50.00
Warehousing and Storage			
Stranded: Average time for picking 3-5 products, loading van, inventory management : 45 minutes	45.00		
Solid: Average time for picking 2 products, loading van, inventory management: 29 minutes (Due to complete product offering from 23-SD-Mini to RGBHV)		29.00	
Warehouse Labor savings	45.00	29.00	16.00
Troubleshooting Cable Integrity			
Stranded: Multi-piece connectors can make poor contact and loose strands can short: 90 minutes	90.00		
Solid: One-piece connectors are more reliable: 90 minutes		45.00	
Troubleshooting Labor savings	90.00	45.00	45.00
Total Solid Savings per Installation			142.25
Hours of Savings			2.37
AVERAGE LABOR COST (PER HOUR) RANGES FROM			
\$50 dollars per hour			\$118.54
\$100 dollars per hour			\$237.08
\$150 dollars per hour			\$355.63
ADDITIONAL COST SAVINGS:			
Lost components w/ multi-piece connectors 10% of total. MSRP 3.66 / connector	\$29.28		
No loss w/ one-piece connector		\$0.00	
	\$29.28	\$0.00	\$29.28
\$50 dollars per hour			\$147.82
\$100 dollars per hour			\$266.36
\$150 dollars per hour			\$384.91

Bulk Wire: Commercial RGB Cable



Ordering is fast & easy.



Call today!

Solutions for the AV PROFESSIONAL
www.libertycable.com

800-530-8998
INTERNATIONAL - CALL +1-719-388-7542



RGBHV Mini and Composite Cables - Plenum



Our new multi-purpose “Projector Plus” Cable contains six (26 AWG) coaxes plus two pairs (22 AWG) of jacketed-shielded audio/control cables, and comes in a soft plenum “Lead-Free” flexible jacket.

- UL Listed NEC Type CL2P/CMP
- Stranded Center Conductor
- FFEP Dielectric
- Flexible Lead-Free (XPbP) Plenum Jackets

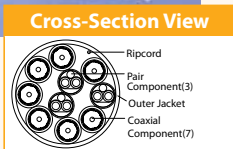

Plenum Stranded RGBHV 75 Ohm Cable

# of Conductors	AWG Center Conductor	NOM Dielectric (Inches)	Shield Construction	NOM Jacket (Inches)	NOM OD (Inches)	NOM Capacitance (pF/ft)	NOM Velocity of Propagation	NOM Attenuation		Part #										
								MHz	db/100'											
5	26 STR TC (7x34)	.072 FFEP	95% TC Spiral + Foil	.016 XPbP (Lead-Free)	.31	16	83%	100 200 400 1000	5.1 7.4 11.8 21.4	RGB5C-PLN CL2/CMP, Lead-Free Soft Plenum										
<div style="display: flex; justify-content: space-between;"> <div style="width: 45%;"> <p>PERFECT TERMINATIONS</p> <table border="1"> <tr><th>Item #</th><th>Part #</th></tr> <tr><td>59</td><td>CM-RGB26-BNC</td></tr> <tr><td>60</td><td>CM-RGB26-GBNC</td></tr> <tr><td>61</td><td>CM-RGB26-RCA</td></tr> <tr><td>62</td><td>CM-RGB26-GRCA</td></tr> </table> <p>SEE PAGE 163</p> </div> <div style="width: 45%; text-align: right;"> <p>Cross-Section View</p> </div> </div>											Item #	Part #	59	CM-RGB26-BNC	60	CM-RGB26-GBNC	61	CM-RGB26-RCA	62	CM-RGB26-GRCA
Item #	Part #																			
59	CM-RGB26-BNC																			
60	CM-RGB26-GBNC																			
61	CM-RGB26-RCA																			
62	CM-RGB26-GRCA																			

(2) 26 STR TC (7x34)	0.072 FFEP	Foil + 95% TC Spiral	.009 PLN-PVC	.240	16	83%	100 200 400 1000	5.1 7.4 11.8 21.4		SV-PLN Plenum rated YC mini Hi-Res for S-Video and L/R audio applications										
<div style="display: flex; justify-content: space-between;"> <div style="width: 45%;"> <p>PERFECT TERMINATIONS</p> <table border="1"> <tr><th>Item #</th><th>Part #</th></tr> <tr><td>59</td><td>CM-RGB26-BNC</td></tr> <tr><td>60</td><td>CM-RGB26-GBNC</td></tr> <tr><td>61</td><td>CM-RGB26-RCA</td></tr> <tr><td>62</td><td>CM-RGB26-GRCA</td></tr> </table> <p>SEE PAGE 163</p> </div> <div style="width: 45%; text-align: right;"> <p>Cross-Section View</p> </div> </div>											Item #	Part #	59	CM-RGB26-BNC	60	CM-RGB26-GBNC	61	CM-RGB26-RCA	62	CM-RGB26-GRCA
Item #	Part #																			
59	CM-RGB26-BNC																			
60	CM-RGB26-GBNC																			
61	CM-RGB26-RCA																			
62	CM-RGB26-GRCA																			

RGBHV 75 Ohm CABLE - PLENUM

# of Conductors	AWG Center Conductor	NOM Dielectric (Inches)	Shield Construction	NOM Jacket (Inches)	NOM OD (Inches)	NOM Capacitance (pF/ft)	NOM Velocity of Propagation	NOM Attenuation		Part #										
								MHz	db/100'											
6	26 STR TC (7x34)	.072 FFEP	Foil + 95% TC Spiral	.011 XPbP (Lead-Free)		16.0	85%	100 200 400 1000	5.1 7.4 11.8 21.45	RGB6C/22-2P-PLN CL2/CMP, Lead-Free Soft Plenum										
<div style="display: flex; justify-content: space-between;"> <div style="width: 45%;"> <p>PERFECT TERMINATIONS</p> <table border="1"> <tr><th>Item #</th><th>Part #</th></tr> <tr><td>59</td><td>CM-RGB26-BNC</td></tr> <tr><td>60</td><td>CM-RGB26-GBNC</td></tr> <tr><td>61</td><td>CM-RGB26-RCA</td></tr> <tr><td>62</td><td>CM-RGB26-GRCA</td></tr> </table> <p>SEE PAGE 163</p> </div> <div style="width: 45%; text-align: right;"> </div> </div>											Item #	Part #	59	CM-RGB26-BNC	60	CM-RGB26-GBNC	61	CM-RGB26-RCA	62	CM-RGB26-GRCA
Item #	Part #																			
59	CM-RGB26-BNC																			
60	CM-RGB26-GBNC																			
61	CM-RGB26-RCA																			
62	CM-RGB26-GRCA																			
4(2) Pair			Foil + 22 AWG STR TC Drain	.006 XPbP (Lead-Free)						Projector Cable										
				.016 XPbP	.370					Overall Construction										

Ordering is fast & easy.

Call today!

Solutions for the AV PROFESSIONAL **800-530-8998**

www.libertycable.com INTERNATIONAL - CALL +1-719-388-7542

Specifications Subject to Change

RGBHV Mini Composite Cables - Plenum



Part #: AVC-18-PLN

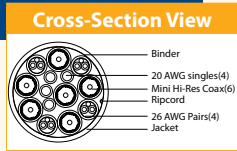

Liberty's (AVC) Plenum cable incorporates six coaxes for RGBHV + composite video, four 26 AWG shielded pairs for audio and four 20 AWG singles for control. This cable is an ideal replacement for multiple runs or where wall plates are being used. Our improved AVC cable now has a super soft & flexible plenum jacket design.

- UL Listed NEC Type CL2P/CMP
- Stranded Tinned Copper Conductors
- FFEP Dielectric
- FEP Insulation

18 Conductor Audio, Video, Control Cable-Plenum								
AWG Center Conductor	NOM Dielectric (Inches)	Shield Construction	NOM Jacket (Inches)	NOM OD (Inches)	NOM Capacitance (pF/ft)	NOM Attenuation		Part #
						MHz	db/100'	
								AVC-18-PLN
(6) 26 STR TC (7x34)	0.072 FFEP	95% TC Spiral + Foil	0.010 PVDF	0.102	16	10 100 200 400 1000	1.7 5.1 7.4 11.8 21.4	Coaxes (Video)75 Ohm
(4 Pairs) 26 STR TC (7x34)	0.006 FEP	Foil w/Drain Wire	.010 PVDF	0.086				Shielded Pairs (Audio)
(4) 20 STR TC (7x28)	0.006 FEP	Color Code: Red, Green, Blue, White, Yellow, Black						20 AWG Singles (Control)
			0.019 PLN-PVC	0.410				Overall Construction

PERFECT TERMINATIONS

Item #	Part #
59	CM-RGB26-BNC
60	CM-RGB26-GBNC
61	CM-RGB26-RCA
62	CM-RGB26-GRCA

SEE PAGE 163



THESE PLATES IN-STOCK, ORDERS SHIP SAME DAY!

PANEL CRAFTERS

See Page 197

Bulk Wire: Commercial RGB Cable

Ordering is fast & easy.

Call today!

Solutions for the AV PROFESSIONAL
www.libertycable.com

800-530-8998
INTERNATIONAL - CALL +1-719-388-7542



Specifications Subject to Change

RGBHV Serial Digital Cables

Non-Plenum

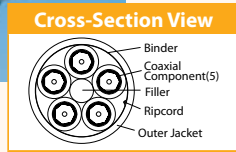

Liberty has taken their high performance serial digital HDTV cables and combined them into a one-jacket RGB construction. These cables provide excellent speed and reliability for maximum frequency response over long runs.

- UL Listed NEC Type CMR
- Solid Bare Copper Center Conductor, Black TPE
- Foamed PE Dielectric
- FR-PVC Coax Jacket
- Sequential Footmarks
- Black TPE Jacket

Available in 250, 500 & 1,000 foot lengths.

Non-Plenum and Plenum RGBHV 75 Ohm Cable																										
# of Conductors	AWG Size	NOM Dielectric (Inches)	Shield Construction	NOM Jacket (Inches)	NOM OD (Inches)	NOM Capacitance (pF/ft)	NOM Velocity of Propagation	NOM Attenuation		Part #																
								MHz	db/100'																	
5	20 Solid BC	.145 FPE	100% Foil + 95% TC Braid	.055 TPE	.780	16.3	83%	10 100 270 540 750 1000 2000 3000	.87 2.58 3.8 5.47 6.5 7.6 11.9 14.9	RGB5C-20-CMR Serial Digital CMR																
<div style="display: flex; justify-content: space-between;"> <div style="width: 45%;"> <p>PERFECT TERMINATIONS</p> <table border="1"> <tr> <th>Item #</th> <th>Part #</th> <th>Item #</th> <th>Part #</th> </tr> <tr> <td>25</td> <td>CM-RG59U-RCA</td> <td>28</td> <td>CM-RG59U-GBNC</td> </tr> <tr> <td>26</td> <td>CM-RG59U-GRCA</td> <td>29</td> <td>CM-RG59U-F</td> </tr> <tr> <td>27</td> <td>CM-RG59U-BNC</td> <td>30</td> <td>CM-RG59U-GF</td> </tr> </table> <p>SEE PAGE 163</p> </div> <div style="width: 45%; text-align: center;"> <p>Cross-Section View</p> </div> </div>											Item #	Part #	Item #	Part #	25	CM-RG59U-RCA	28	CM-RG59U-GBNC	26	CM-RG59U-GRCA	29	CM-RG59U-F	27	CM-RG59U-BNC	30	CM-RG59U-GF
Item #	Part #	Item #	Part #																							
25	CM-RG59U-RCA	28	CM-RG59U-GBNC																							
26	CM-RG59U-GRCA	29	CM-RG59U-F																							
27	CM-RG59U-BNC	30	CM-RG59U-GF																							
6	20 AWG Solid BC	.145 FPE	100% Foil + 95% TC Braid	.032 FR-PVC	.240	16.3	83%	10 100 270 540 750 1000 2000 3000	.87 2.58 3.8 5.47 6.5 7.6 10.9 13.4	RGB6C-20/2L5E (6) RG59 Serial Digital Coaxes + (2) CAT5E RG59 Serial Digital Coaxes																
<div style="display: flex; justify-content: space-between;"> <div style="width: 45%;"> <p>PERFECT TERMINATIONS</p> <table border="1"> <tr> <th>Item #</th> <th>Part #</th> <th>Item #</th> <th>Part #</th> </tr> <tr> <td>25</td> <td>CM-RG59U-RCA</td> <td>28</td> <td>CM-RG59U-GBNC</td> </tr> <tr> <td>26</td> <td>CM-RG59U-GRCA</td> <td>29</td> <td>CM-RG59U-F</td> </tr> <tr> <td>27</td> <td>CM-RG59U-BNC</td> <td>30</td> <td>CM-RG59U-GF</td> </tr> </table> <p>SEE PAGE 163</p> </div> <div style="width: 45%; text-align: center;"> <p>Cross-Section View</p> </div> </div>											Item #	Part #	Item #	Part #	25	CM-RG59U-RCA	28	CM-RG59U-GBNC	26	CM-RG59U-GRCA	29	CM-RG59U-F	27	CM-RG59U-BNC	30	CM-RG59U-GF
Item #	Part #	Item #	Part #																							
25	CM-RG59U-RCA	28	CM-RG59U-GBNC																							
26	CM-RG59U-GRCA	29	CM-RG59U-F																							
27	CM-RG59U-BNC	30	CM-RG59U-GF																							
8 (4 pair)	24 AWG Solid BC	.008 FPE	N/A	.22 FR-PVC	.210					Enhanced Cat 5E (350 MHz)																
<p>Overall Construction</p>																										
3	20 Solid BC	.145 FPE	100 % Foil + 95% TC Braid	.055 TPE	.630	16.3	83%	10 100 270 540 750 1000 2000 3000	.87 2.58 3.8 5.47 6.5 7.6 10.9 13.4	RGB3C-20-CMR Serial Digital CMR																
<div style="display: flex; justify-content: space-between;"> <div style="width: 45%;"> <p>PERFECT TERMINATIONS</p> <table border="1"> <tr> <th>Item #</th> <th>Part #</th> <th>Item #</th> <th>Part #</th> </tr> <tr> <td>25</td> <td>CM-RG59U-RCA</td> <td>28</td> <td>CM-RG59U-GBNC</td> </tr> <tr> <td>26</td> <td>CM-RG59U-GRCA</td> <td>29</td> <td>CM-RG59U-F</td> </tr> <tr> <td>27</td> <td>CM-RG59U-BNC</td> <td>30</td> <td>CM-RG59U-GF</td> </tr> </table> <p>SEE PAGE 163</p> </div> <div style="width: 45%; text-align: center;"> <p>Cross-Section View</p> </div> </div>											Item #	Part #	Item #	Part #	25	CM-RG59U-RCA	28	CM-RG59U-GBNC	26	CM-RG59U-GRCA	29	CM-RG59U-F	27	CM-RG59U-BNC	30	CM-RG59U-GF
Item #	Part #	Item #	Part #																							
25	CM-RG59U-RCA	28	CM-RG59U-GBNC																							
26	CM-RG59U-GRCA	29	CM-RG59U-F																							
27	CM-RG59U-BNC	30	CM-RG59U-GF																							
5	18 Solid BC	.180 FPE	Foil + 96% TC Braid	.055 TPE	.860	16.2	78%	10 100 270 540 750 1000 2000 3000	.72 1.84 2.97 4.25 5.00 5.89 8.57 10.67	RGB5C Serial Digital CMR																
<div style="display: flex; justify-content: space-between;"> <div style="width: 45%;"> <p>PERFECT TERMINATIONS</p> <table border="1"> <tr> <th>Item #</th> <th>Part #</th> <th>Item #</th> <th>Part #</th> </tr> <tr> <td>25</td> <td>CM-RG6Q-RCA</td> <td>28</td> <td>CM-RG6Q-GBNC</td> </tr> <tr> <td>26</td> <td>CM-RG6Q-GRCA</td> <td>29</td> <td>CM-RG6Q-F</td> </tr> <tr> <td>27</td> <td>CM-RG6Q-BNC</td> <td>30</td> <td>CM-RG6Q-GF</td> </tr> </table> <p>SEE PAGE 163</p> </div> <div style="width: 45%; text-align: center;"> <p>Cross-Section View</p> </div> </div>											Item #	Part #	Item #	Part #	25	CM-RG6Q-RCA	28	CM-RG6Q-GBNC	26	CM-RG6Q-GRCA	29	CM-RG6Q-F	27	CM-RG6Q-BNC	30	CM-RG6Q-GF
Item #	Part #	Item #	Part #																							
25	CM-RG6Q-RCA	28	CM-RG6Q-GBNC																							
26	CM-RG6Q-GRCA	29	CM-RG6Q-F																							
27	CM-RG6Q-BNC	30	CM-RG6Q-GF																							

Ordering is fast & easy.



Call today!

Solutions for the AV PROFESSIONAL
www.libertycable.com

800-530-8998
INTERNATIONAL - CALL +1-719-388-7542



Control Cable - Shielded Plenum

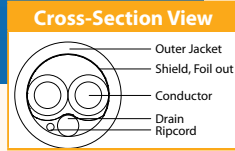

Multi-Conductor/Overall Shield w/Drain Wire

- UL Listed NEC Type CL3P/CMP
- Bare Copper Stranded Conductors
- Low Smoke PVC Insulation
- Overall Foil Shield with Stranded TC Drain
- Low Smoke White PVC Jacket
- Sequential Footmarks
- Ripcord
- See Color Code Charts on page 241

Plenum Shielded Control Cable					
# of conductors	AWG Size/ Stranding	NOM Insulation (Inches)	NOM Jacket (Inches)	NOM OD (Inches)	Part #
2	22 (7x30)	0.008	0.015	0.124	22-2C-PSH-WHT
4	22 (7x30)	0.008	0.015	0.142	22-4C-PSH-WHT
6	22 (7x30)	0.008	0.015	0.169	22-6C-PSH-WHT
8	22 (7x30)	0.008	0.015	0.183	22-8C-PSH-WHT
10	22 (7x30)	0.008	0.015	0.210	22-10C-PSH-WHT

All above cables can be produced with colored jackets.

Control Cable - Unshielded Plenum

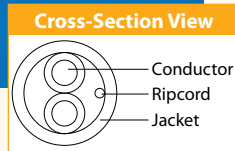
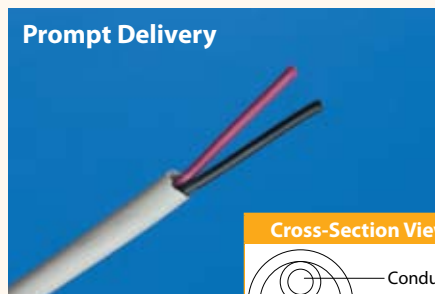

Multi-Conductor/Unshielded

- UL Listed NEC Type CL3P/CMP
- Bare Copper Stranded Conductors
- Low Smoke PVC Insulation
- Low Smoke White PVC Jacket
- Sequential Footmarks
- Ripcord
- See Color Code Charts on page 241

Plenum Unshielded Control Cable					
# of conductors	AWG Size/ Stranding	NOM Insulation (Inches)	NOM Jacket (Inches)	NOM OD (Inches)	Part #
2	22 (7x30)	0.008	0.015	0.12	22-2C-P-WHT
4	22 (7x30)	0.008	0.015	0.138	22-4C-P-WHT
6	22 (7x30)	0.008	0.015	0.165	22-6C-P-WHT
8	22 (7x30)	0.008	0.015	0.179	22-8C-P-WHT
10	22 (7x30)	0.008	0.015	0.21	22-10C-P-WHT
12	22 (7x30)	0.008	0.015	0.217	22-12C-P-WHT

All above cables can be produced with colored jackets. Data grade available in these cables using Polyethylene or Polypropylene insulations.

Bulk Wire: Commercial Security Cable

Ordering is fast & easy.



Call today!

CCTV and Baseband Video Cable

Plenum

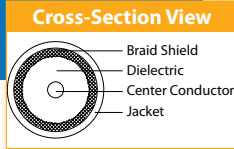
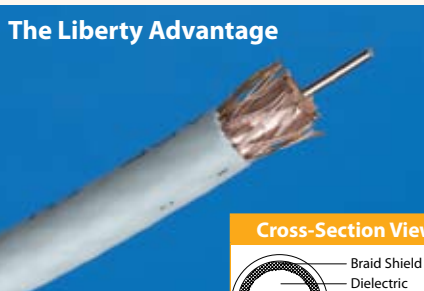

These cables are ideal for closed circuit TV applications or high quality analog video runs.

Coax - Single Shielded

- UL Listed NEC Type CMP/C(UL)CMP
- Solid Bare Copper Center Conductor
- Foamed FEP Dielectric
- Low Smoke White PVC Jacket
- 75 Ohm
- Sequential Footmarks

Plenum Video Cable - CCTV & BaseBand Video

AWG Center Conductor	NOM OD Dielectric (Inches)	Shield Construction	NOM Jacket (Inches)	NOM OD (Inches)	NOM Capacitance (Pf/ft)	NOM Velocity of Propagation	NOM Attenuation		Part #
							MHz	db100'	
20 AWG Solid BC	0.146 FFEP	95% BC Braid	.015 PL-PVC	.198	16	82%	10	0.24	RG59-CCTV-PL-WHT CMP
							50	0.85	
							200	2.92	
							400	6.27	
							700	8.47	
							900	9.82	
1000	10.47								
PERFECT TERMINATIONS									
SEE PAGE 162									
Item #	Part #								
34	CM-RG59PC-RCA								
35	CM-RG59PC-BNC								
36	CM-RG59PC-F								
18 Solid BC	0.170 FFEP	95% BC Braid	.016	.237 PLN-PVC	16	84%	1	0.21	RG6-CCTV-PL-WHT CMP
							10	0.65	
							100	2.04	
							400	4.46	
14 Solid BC	0.280 FFEP	95% BC Braid	.020 PVDF	.351	16	84%	50	0.9	RG11-CCTV-PL-WHT CMP
							100	1.4	
							200	2.2	
							400	3.6	
							700	4.6	
							900	5.4	
20 Solid BC	0.138 FPE	95% BC Braid	.020 PL-PVC	.226 x .364	16.3	83%	50	2.0	RG59-18/2C-PS Siamese Construction CMP
							100	2.7	
							200	3.7	
							400	6.3	
							1000	10.1	
18 STR BC (7x30)	0.008 PL-PVC		.015 PL-PVC						Cross-Section View 18 AWG Conductor Jacket Conductor Dielectric Braid Shield

Expand your CCTV Sales opportunities with custom designed control room plates, panels & work surfaces with PanelCrafters™ products.

For Details See page 213



Ordering is fast & easy.



Call today!

Solutions for the AV PROFESSIONAL
www.libertycable.com

800-530-8998
INTERNATIONAL - CALL +1-719-388-7542



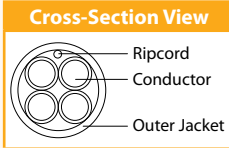
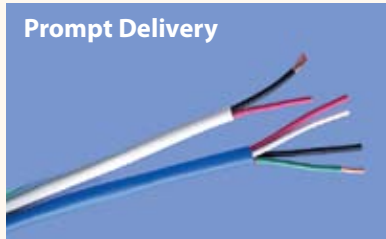

TTP™ Premium Speaker Cable - Plenum

TTP™ stands for Tight Tube Plenum, Liberty's unique design to ensure rounder cable for ease of installation combined with higher strand counts for greater flexibility.

- UL Listed NEC type CL3P or CEC CMP
- Bare Copper Stranded Conductors
- PL-PVC Insulation
- Thicker PL-PVC Jackets
- Sequential Foot marks
- Ripcord
- See Color Code Charts on Page 241

AWG/ Conductors	Stranding	Part#
18/4	16x30	18-4C-TTP-*
16/2	26x30	16-2C-TTP-* <small>*Available in black, blue or white</small>
16/4	26x30	16-4C-TTP-* <small>*Available black, blue, green, gray or white</small>
14/2	41x30	14-2C-TTP-* <small>*Available in blue, gray or white</small>
12/2	65x30	12-2C-TTP-* <small>*Available in blue or white</small>
10/2	105x30	10-2C-TTP-*

Asterisk (*) equals color. See color abbreviations. Example: **15-FSC-162 -GRY**

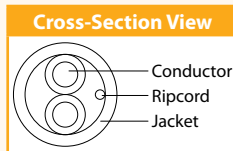
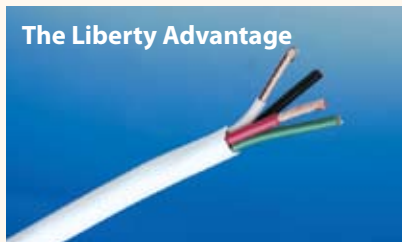

Commercial Speaker Cable - Plenum

- UL Listed NEC Type CL3P/CMP
- Bare Copper Stranded Conductors
- Low Smoke PVC Jacket
- Sequential Foot marks
- Ripcord
- See Color Code Charts on Page 241

AWG/ Conductors	Stranding	Part#
22/2	7x30	22-2C-P-*
22/4	7x30	22-4C-P-*
20/2	7x28	20-2C-P-*
20/4	7x28	20-4C-P-*
18/2	7x26	18-2C-P-*
18/4	7x26	18-4C-P-*
16/2	19x29	16-2C-P-*
16/4	19x29	16-4C-P-*
14/2	19x27	14-2C-P-*
14/4	19x27	14-4C-P-*

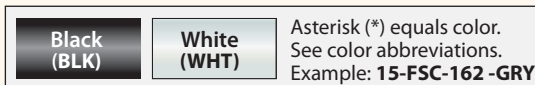

Ordering is fast & easy.



Call today!

Audio ConnecTec™ is Liberty's Revolutionary Compression Audio Connector Solution.

The same cutting-edge technology that Liberty developed for coax termination now makes this audio connector system an essential component of every commercial audio installation.

Audio ConnecTec™ connectors slip on easily to the speaker cable conductor and compress on effortlessly with the easy-to-use ConnecTec™ tool.

Unique and ultra precise Sound Cone™ design fuses the audio connector directly to the speaker cable providing the lowest DB loss of any audio connector resulting in improved sonic fidelity and speaker performance.

PRODUCT HIGHLIGHTS

- Strip-Free
- Connector bases are available in 2 sizes: 10-12AWG or 14-16 AWG
- Works with all Liberty speaker cable
- 3 gold plated screw-on tips: banana, spade lug and angled pin
- Works with any speaker plug-in plate format or design
- For in-wall and non in-wall audio applications



DESCRIPTION	PART #
10 -12 AWG Connector base	CM-A-12
14 AWG Connector base	CM-A-14
16 AWG Connector base	CM-A-16
Banana Plug Tip Gold plated	CM-APBA
Spade Lug Tip Gold plated	CM-APSL
Angle Pin Tip Gold plated	CM-APAP
Banana Jack	CM-APBJ
All items sold separately and in 25 pkg.	

CONNECTEC COMPRESSION TOOL

Perfect for all gauges of Liberty's speaker cables.

Part #: CM-TOOL



HEAT SHRINK & BOOTS

Tight and smooth edges. Available in black only. 25 pkg

Part #: HSK-3:1BK-1/2



Perfect for finishing off your termination. Available in black. 25 pkg

Part #: CM-BOOT-BLK

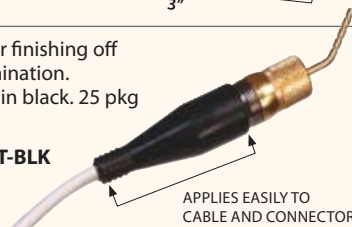

APPLIES EASILY TO CABLE AND CONNECTOR

5 EASY STEPS!



STEP 1

Cut the outer jacket away leaving the desired conductor length. Slide heat shrink tube in to position and shrink.



STEP 2

Slide connector boots over each conductor.



STEP 3

Without stripping, twist the correct AWG connector base clockwise on to the conductor.



STEP 4

Using the ConnecTec Tool- with the die set to the F connector position - compress the connector to the cable.



STEP 5

Slide boot over the connector base and screw the tip option on to the threaded connector base.

Ordering is fast & easy.



Call today!

Solutions for the AV PROFESSIONAL
www.libertycable.com

800-530-8998
INTERNATIONAL - CALL +1-719-388-7542



Audio ConneTec™ Banana Jack CM-APBJ Installation and Use Instructions.

The CM-APBJ Banana jack is an attachment for the Audio ConneTec™ Speaker connector series. The CM-APBJ will fit the CM-A-12, CM-A-14, and CM-A-16 Audio ConneTec™ speaker connectors.

The CM-APBJ has a variety of possible installation possibilities and is packaged to allow the installer to choose mounting and color coding.

The CM-APBJ is packaged in a 25 PC master pack and each is individually packaged. Each individual package contains:

- Connector Body with isolated pass through jack.
- Lock Washer and retaining nut for direct panel mounting in a ½ inch D cut.
- Three colored snap on rings (Red, White, Black) for color coding + and – terminals.

5 EASY STEPS!



One Connector Package .
Terminate the Audio ConneTec™ Speaker Base on the appropriate wire.



Speaker Base terminated .
If mounting in a Keystone Plate – preload the CM-APBJ into the insert.

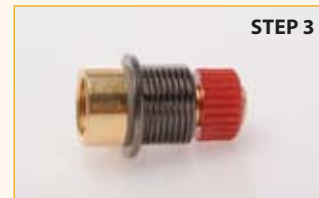

Color Ring mounted .
Screw the CM-APBJ onto the Speaker Base Connector.



Mounted into Keystone insert .
Insert the CM-APBJ into the pre-cut D hole or the loaded Keystone insert into the plate and apply fastening hardware where applicable.



Mounted into Faceplate .
The color code ring can be applied at anytime in the process.

CONNECTOR BODY

SNAP ON RINGS

RETAINING NUT

LOCK WASHER

BANANA JACK FULLY ASSEMBLED
PART #: CM-APBJ



PERFECT FIT!
PART #:
PC-G2405

INSTALLATION EXAMPLES:

- Mounted in a plate with a ½" D cut. Available through Panelcrafters in single and dual Banana formats. Standard plate and Decora options. Connector is isolated for loading in conductive plates or panels.
- Mounted in the Keystone inserts above and snapped into standard Keystone wall plates. Liberty has standard plates in 1-4, 6, 8, and 12 port formats under part numbers WP-N*-color where * = # of ports and Decora inserts in 2, 4 and 6 port formats under part numbers WJ-DEC*-color where * = # of ports. The 2-Port item is WJ-DEC-color.

Unloaded Keystone Inserts specifically for the CM-APBJ are available in:

DESCRIPTION	PART #
White	ISKM-BNC-00WH40N
Ivory	ISKM-BNC-00IV40N
Almond	ISKM-BNC-00AD40N
All items sold separately and in 25 pkg.	

Bulk Wire: Commercial Speaker Cable

Ordering is fast & easy.



Call today!

Tray Cable

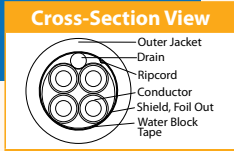
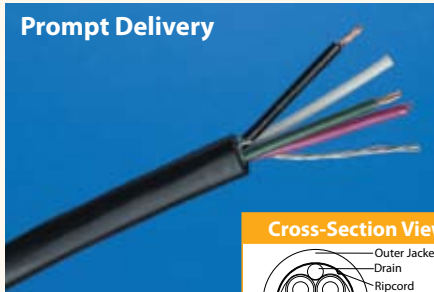

High Voltage Tray rated cables with dual listings for outdoor and underground speaker applications. Liberty's Ultrablock series combine the benefits of Tray jacketing with water blocking technology for true extreme condition speaker and control applications.

- UL Listed NEC Type CL3/CM - Article 725 and 800
- Insulation PVC
- Overall Ultra Block™ Moisture Blocking Barrier Construction
- PVC Jackets
- Sunlight Resistant and Direct Burial
- Ripcord
- Color Code Charts on page 241

Tray Cable - Shielded 600 Volt UL NEC TC					
# of Conductors	AWG Size/ Conductors	NOM Insulation (Inches)	NOM Jacket (Inches)	NOM Jacket (Inches)	Part #
2	18 AWG 7/.0152 BC	.016 PVC	.005		18-2C-TRSH
		20 AWG (7/28) TC Drain 100% Aluminum/Mylar	.047	.270	Overall Construction
4	18 AWG 7/.0152 BC	.016 PVC	.005		18-4C-TRSH
			.050	.321	Overall Construction

Power Limited Tray Cable - UltraBlock™ Unshielded UL PLTC CL3/CM 300 Volt						
# of Conductors	AWG Size	NOM Insulation (Inches)	NOM Jacket (Inches)	NOM * Capacitance (Pf/ft)	NOM Jacket (Inches)	Part #
2 (1 pair)	18(7x26)	.015 PVC .005 Nylon	.035	25	0.270	UB18-2C-BLK
4	18(7x26)	.015 PVC .005 Nylon	0.04	25	0.327	UB18-4C-BLK
2 (1 pair)	16(7x24)	.015 PVC .005 Nylon	0.04	28	0.285	UB16-2C-BLK
2	14(19x27)	.015 PVC .005 Nylon	0.04	32	0.310	UB14-2C-BLK
2	12(19x25)	.015 PVC .005 Nylon	0.04	36	0.340	UB12-2C-BLK

Power Limited Tray Cable - UltraBlock™ Overall Shielded 300 Volt						
# of Conductors	AWG Size	NOM Insulation (Inches)	NOM Jacket (Inches)	NOM * Capacitance (Pf/ft)	NOM OD (Inches)	Part #
2 (1 pair)	18(7x26)	.015 PVC .005 Nylon	0.04	32	0.310	UB18-2C-SH-BLK
4	18(7x26)	.015 PVC .005 Nylon	0.04	32	0.371	UB18-4C-SH-BLK
2 (1 pair)	16(7x24)	.015 PVC .005 Nylon	0.04	37	0.328	UB16-2C-SH-BLK
2 (1 pair)	12(19x25)	.015 PVC .005 Nylon	0.04	54	0.375	UB12-2C-SH-BLK

Ordering is fast & easy.



Call today!

Solutions for the AV PROFESSIONAL
www.libertycable.com

800-530-8998
INTERNATIONAL - CALL +1-719-388-7542



AES/EBU 110 Ohm Digital Audio Snake Cable Non-Plenum and Plenum

The Liberty Advantage

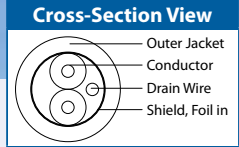
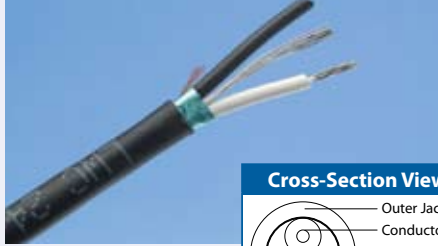

Individually Shielded and Jacketed Pairs

- UL Listed NEC Type CM or CMP
- Tinned Copper Stranded Conductors
- Foam PE or FEP insulation
- Meets or Exceeds All Performance Specifications for AES/EBU Digital Audio
- 100% Aluminum/Poly Shield

AES/EBU 110 Ohm Flexible Digital Audio Snake Cable							
# of Pairs	AWG Size/ Stranding	NOM Insulation (Inches)	NOM Pair Jacket (Inches)	NOM Jacket (Inches)	NOM OD (Inches)	NOM Capacitance pF/ft	Part #
1	24 STR TC (7X32)	.023 FPE BLK-WHT	N/A	.030 BLK FR-PVC	.195	11.5	24-1P-DIG-AUDIO CM
1	24 STR TC (7X32)	.020 FFEP BLK-WHT	N/A	.015 BLK PLN-PVC	.165	11.5	24-1P-P-DIG-AUDIO CMP

Broadcast Quality EZ-Strip Audio Cable - Non-Plenum and Plenum

Quality Products

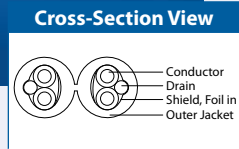

Low Capacitance Audio Cable

- UL Listed NEC Type CM, CMR or CMP
- Tinned Copper Stranded Conductors
- Non-Plenum High Density Foam Polyethylene Insulation for Lower Capacitance
- Plenum Foamed FEP Insulation for Lower Capacitance
- Non-Plenum or Plenum PVC Jacket
- Sequential Footmarks
- Available in Multiple Jacket Colors
- See Color Code Charts on page 241

Non-Plenum Shielded UL CMR or CM							
# of Pairs	AWG Size/ Stranding	NOM Insulation (Inches)	NOM Jacket (Inches)	NOM OD (Inches)	NOM Capacitance pF/ft	Part #	
1	24 STR TC (7X32)	.015 BLK/RED HDFPE	.015 BLK PVC	.140	21	24-1P-EZ-* CM *Available in Black, Brown, Orange, Red, or Yellow	
1	22 STR TC (7X30)	.010 BLK/RED HDFPE	.020 BLK PVC	.145	21	22-1P-EZ-* CM *Available in Black, Blue, Brown, Green, Gray, Orange, Purple, Red, Tan, White or Yellow	
2	22 STR TC (7X30)	.010 BLK/RED HDFPE	.015 BLK PVC	.135X.275	21	22-2P-SIAM-EZ CM	

Plenum Shielded UL CMP							
# of Pairs	AWG Size/ Stranding	NOM Insulation (Inches)	NOM Jacket (Inches)	NOM OD (Inches)	NOM Capacitance pF/ft	Part #	
1	24 STR TC (7X32)	.015 BLK/RED FFEP	.015 WHT PLN-PVC	.140	21	24-1P-CMP-EZ-WHT CMP	
1	22 STR TC (7X30)	.010 BLK/RED FFEP	.015 WHT PLN-PVC	.145	21	22-1P-CMP-EZ-* CMP *Available in Black, Blue, Green, Gray, Orange, Red, Violet, White or Yellow	
2	22 STR TC (7X30)	.010 BLK/RED .010 BLK/ WHT FFEP	.015 WHT PLN-PVC	.285X.140	21	22-2P-CMP-SIAMEZ CMP	

Solutions for the AV PROFESSIONAL
www.libertycable.com

800-530-8998
INTERNATIONAL - CALL +1-719-388-7542



Ordering is fast & easy.



Call today!

AUDIOCAT™ Non-Plenum, Siamese

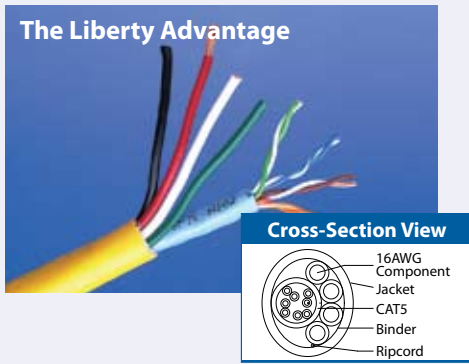

AUDIOCAT™ Composite Cable by Liberty

Liberty AUDIOCAT products are designed for installer efficiency and audio quality on Whole Home Audio projects. These cables include TIA/EIA-568B.2 certified CAT5e cables for control and four 14 or 16 AWG conductors to power your speakers. We offer a variety of grades, consistent with our Good, Better, Best strategy. AUDIOCAT-14 is our best product featuring 14 AWG speaker cables. Our better product, AUDIOCAT+ uses Oxygen-Free Copper for great performance with 16 AWG conductors. AUDIOCAT-HT and AUDIOCAT Siamese are our Good products, giving the installer the ability to choose between a siamese cable and a round cable. Both feature 16 AWG copper conductors.

AUDIOCAT™					
# of Conductors	AWG Size/ Stranding	NOM Insulation (Inches)	NOM Jacket (Inches)	NOM OD (Inches)	Part #
AUDIOCAT+					
8 (4 pair)	24 AWG Solid BC	.008 PE	.020 PVC	.197	Cat 5e (350 MHz)
4	16 AWG Oxygen-Free Copper (105x36)	.016 PVC			Speaker Cables
			.035 PVC Gold	.394	Overall Construction
AUDIOCAT-14					
8 (4 pair)	24 AWG Solid BC	.008 PE	.022 PVC	.206	Cat 5e (350 MHz)
4	14 AWG BC (105x34)	0.15 PVC			Speaker Cables
			.040 PVC Blue	.415	Overall Construction
AUDIOCAT-HT					
8 (4 pair)	24 AWG Solid BC	.008 PE	.02 FR-PVC	.197	Enhanced Cat 5e (350 MHz)
4	16 AWG STR BC (65x34)	.016 PVC	N/A	N/A	Speaker Cables
			.035 PVC Purple	.393	Overall Construction
AUDIOCAT-SIAMESE					
8 (4 pair)	24 AWG Solid BC	.008 PE	.020 PVC	.197	Cat5e (350 MHz)
4	16 AWG BC (65x34)	0.16 PVC	.031 PVC		Speaker Cables
			PV Mauve	.283 x .504	Overall Construction

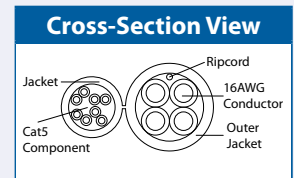

Ordering is fast & easy.



Call today!

Solutions for the AV PROFESSIONAL
www.libertycable.com

800-530-8998
INTERNATIONAL - CALL +1-719-388-7542



ExtraFlex™ Shielded Audio Cable Non-Plenum Overall Shielded and Individually Shielded

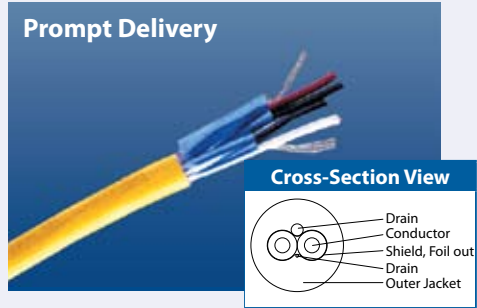

ExtraFlex™ Non-Plenum Shielded Audio Cable

- UL Listed NEC Type CL3/CM
- Bare Copper High Strand Conductors
- PVC Insulation
- Tight Twist for Better Sonic Quality
- Pressure Extruded Extra-Flex™ PVC Jacket
- Sequential Footmarks
- Ripcord
- See Color Code Charts on page 241

Overall Foil Shielded with Stranded TC Drain					
# of Conductors	AWG Size/ Stranding	NOM Insulation (Inches)	NOM Jacket (Inches)	NOM OD (Inches)	Part #
2	22 (16X34)	.015	.030	.187	22-2C-EX-PUR

Each Pair Individually Shielded with Stranded TC Drain					
# of Pairs	AWG Size/ Stranding	NOM Insulation (Inches)	NOM Jacket (Inches)	NOM OD (Inches)	Part #
2	22 (16X34)	.015	.025	.255	22-2P-SHEX-* *Available in Pink, Purple, Yellow, or White
3	22 (16X34)	.015	.025	.297	22-3P-SHEX-YEL

Microphone X-Cross Cable - Non-Plenum

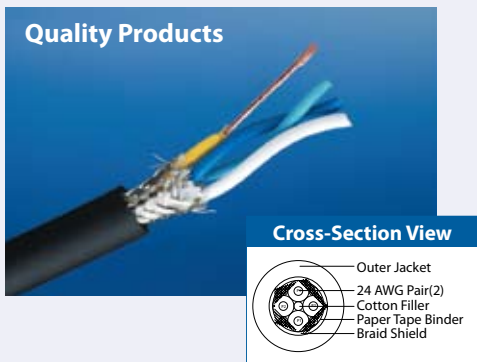

Liberty's X-Cross Cables have soft but tough tactical jackets. They are extremely flexible and have the "right" feel. We took them one step further and use four different colors to identify the four 24 AWG conductors to make alternative wiring schemes easy. They have 95% braid shielding.

The Industry Workhorse

- Extra Flexible!
- Tinned Copper Stranded Conductors
- Low Density Polyethylene Insulation
- PVC Jacket
- Short Twist Lengths

Non-Plenum Microphone X-Cross Cable								
# of Pairs	AWG Size/ Stranding	NOM Insulation (Inches)	NOM Pair Jacket (Inches)	NOM Jacket (Inches)	NOM OD (Inches)	NOM Capacitance (pF/ft)		Part #
						a)	b)	
2	24 STR TC (40X40)	.016 Blu-Wht Lt. Blu-Yel LDPE	95% TC Braid +	.035 Blk, Red PVC	.237	46	57	24-2P-STAR CM *Available in Black

a) Capacitance between conductors. b) Capacitance between one conductor and the other connected to the shield.



Expand Your Category Solutions with Baluns

Balun, short for BALanced-UNbalanced. Balun technology has improved dramatically during the last decade and Liberty offers a full line of quality Balun solutions for those situations where a Balun makes sense. Passive Baluns require no external power and low frequency signals such as composite video and analog line level audio can literally be sent thousands of feet on standard category cable. Excellent for retrofits where pulling a single category cable is an

option, signals up to and including RGBHV can be sent using a passive Balun. Active Baluns incorporate circuitry to equalize and amplify signals and higher frequency signals such as WSXGA, HDMI and DVI can be sent significant distances using this technology. Shielded category cable is strongly recommended for active Baluns. Sold as singles for custom mix and match or in pre-packaged pairs – Liberty has the Balun solution for you.

Passive

 BALUN, L/R RCA AUDIO	Part #: AVO-A2-F L/R RCA Audio over Category Cable Passive Balun. Requires two to complete the circuit and the balun can transmit and receive.	 BALUN 3.5 STEREO SG FP WHT	Part #: AVO-A2MINI-WP-F 3.5mm Stereo Audio over Category Cable Balun mounted on a White Single Gang Faceplate. Requires two to complete the circuit and the balun can transmit or receive.
 BALUN SET, L/R RCA AUDIO	Part #: AVO-A2-PAC-F L/R RCA Audio over Category Cable Passive Transmit and Receive Balun complete set.	 BALU, L/R RCA AUDIO SG FP WHT	Part #: AVO-A2-WP-F L/R RCA Audio over Category Cable Passive Balun mounted on a white single gang faceplate. Requires two to complete the circuit and the balun can transmit and receive.
 BALUN, 2 X L/R RCA AUDIO	Part #: AVO-A4-F Dual L/R RCA Audio over Category Cable Passive Balun. Requires two to complete the circuit and the balun can transmit and receive.	 BALUN SET, 2 X L/R RCA 2-PAK	Part #: AVO-A4-PAC-F Dual L/R RCA Audio over Category Cable Passive Transmit and Receive Balun complete set.
 BALUN, 2 X L/R RCA SG FP WHT	Part #: AVO-A4-WP-F Dual L/R RCA Audio over Category Cable Passive Balun mounted on a white single gang faceplate. Requires two to complete the circuit and the balun can transmit and receive.	 BALUN, SV+L/R RCA AUDIO	Part #: AVO-SVA2-F S-Video and L/R RCA Audio over Category Cable Passive Balun. Requires two to complete the circuit and the balun can transmit or receive.
 BALUN, AVBNC L/R RCA	Part #: AVO-V1A2-F Composite Video BNC and L/R Audio RCA over Category Cable Passive Balun. Requires two to complete the circuit and the balun can transmit and receive.	 BALUN, AV RCA SG WHT	Part #: AVO-V1A2-WP-F Composite Video RCA and L/R Audio RCA over Category Cable Passive Balun mounted on a white single gang faceplate. Requires two to complete the circuit and the balun can transmit and receive.
 BALUN SET, BNC VIDEO	Part #: AVO-V1-PAC Composite Video BNC over Category Cable Passive Balun. Passive Transmit and Receive Balun complete set.	 BALUN, RCA VIDEO SG FP WHT	Part #: AVO-V1-WP-F Composite Video RCA over Category Cable Passive Balun mounted on a white single gang faceplate. Requires two to complete the circuit and the balun can transmit or receive.
 BALUN 2 VIDEO RCA L/R RCA	Part #: AVO-V2A2-F Dual Composite Video with L/R RCA Audio over Category Cable Passive Balun. Requires two to complete the circuit and the balun can transmit or receive.	 BALUN 4 RCA 2V2A SG FP WHT	Part #: AVO-V2A2-WP-F Dual Composite Video with L/R RCA Audio over Category Cable Passive Balun on a white single gang faceplate. Requires two to complete the circuit and the balun can transmit or receive.

Ordering is fast & easy.



Call today!

Solutions for the AV PROFESSIONAL

Expand Your Category Solutions with Baluns

Passive (Continued)



Part #: AVO-V3AD-F
High Definition Component Video RCA and Coaxial Digital Audio (S/PDIF) over Category Cable Passive Balun. Requires two to complete the circuit and the balun can transmit and receive.

BALUN HD-COMP+S/PDIF AUDIO



Part #: AVO-V3AD-WP-F
High Definition Component Video RCA and Coaxial Digital Audio (S/PDIF) over Category Cable Passive Balun mounted on a white single gang faceplate. Requires two to complete the circuit and the balun can transmit and receive.

BALUN, HD-COMP+S/PDIF SG FP WH



Part #: AVO-V3HD-F
High Definition Component Video BNC over Category Cable Passive Balun. Requires two to complete the circuit and the balun can transmit and receive.

BALUN HD-COMPONENT BNC



Part #: AVO-V3PT-F
High Definition Component Video RCA and Infrared (IR) control over Category Cable Passive Balun. Requires two to complete the circuit and the balun can transmit and receive.

BALUN, HD-COMP+IR CONTROL



Part #: PS2-F
PS/2 Mouse & Keyboard Extension over Category Cable Passive Balun complete set for distances up to 350 feet.

BALUN SET, PS/2 MOUSE/KYBD EXT



Part #: RF-F
Broadband CATV F over Category Cable Passive Balun. Transmit up to Channel 150 and 330 feet. Requires two to complete the circuit and the balun can transmit and receive.

BALUN, CATV F



Part #: V1-PTZ-F
Composite Video BNC and Coaxial Pan-Tilt-Zoom Passive Balun. Requires two to complete the circuit and the balun can transmit and receive.

BALUN, CCTV VIDEO+PTZ



Part #: VGA-SR-F
VGA (HD15) over Category Cable Passive Transmit and Receive Balun complete set. UXGA up to 350 feet.

BALUN SET, VGA PASSIVE TO UTP

Active



Part #: AVO-MIC-F
Active Microphone Level Audio and Phantom Power over Category Cable Balun complete set. Terminal Block connectivity for microphone.

BALUN SET, MIC & PANTOM PWR



Part #: AVO-MIC-WP-F
Active Microphone Level Audio and Phantom Power over Category Cable Balun complete set. MIC side features white single gang faceplate with XLR connectivity for microphone.

BALUN SET, XLR MIC SG FP WHT



Part #: DL-HDCAT
Active HDMI 1.3b Standard Speed transmit and receive complete balun set. Use Shielded Category Cable for best results of 1080p up to 20 meters and 1080i to 40 meters.

DIGITALLINX HDMI/CAT TX/RX SET



Part #: DL-HDCAT-WP
Active HDMI 1.3b Standard Speed transmit and receive complete balun set mounted on a white single gang faceplate. Use Shielded Category Cable for best results of 1080p up to 20 meters and 1080i to 40 meters.

DIGITALLINX HDMI/CAT TX/RX FP



Part #: VGA-HR-F
Active VGA (HD15) over Category Cable Transmit and Receive Balun complete set. SXGA up to 200 feet.

BALUN SET, ACTIVE VGA OVER UTP



Part #: VGA-UHR-F
Active WSXGA HD15 over Category Cable Transmit and Receive balun set for distances up to 550 feet.

BALUN SET, ACTIVE WSXGA TO UTP



Part #: PMI-A5
USB High Speed (480 Mbps) over Category Cable Transmit and Receive Balun complete set. Uses USB power from the transmit device.

BALUN SET, USB 2.0 LEX/REX

Ordering is fast & easy.



Call today!

Solutions for the AV PROFESSIONAL

Liberty Offers a Complete Line of Category Cable

Category 3

- CMR, CMP Rated • Sequential Footmarks • Tested to 16 MHz

Category 3						
# of Pairs	AWG Size	NOM Insulation (Inches)	NOM Jacket (Inches)	NOM OD (Inches)	NOM Capacitance pF/ft	Part #
4	24 Solid BC	.006 PE	.013 PVC	.140	12.5	24-4P-L3-* CM Non-Plenum *Available in Burgundy, Gray, Light-Blue or White
4	24 Solid BC	.005 PE	.013 PLN-PVC	.130	21	24-4P-P-L3-* CMP Plenum *Available in Blue, Green, Gray, White or Yellow
25	24 Solid BC	.020 Low Smoke	.364 PVC	.330	18	24-25P-P-L3-WHT CMP 25 Pair, Plenum

Category 5E

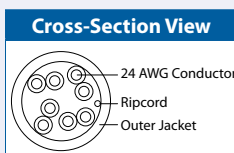
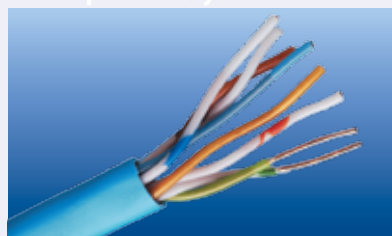

- CMR/CMP Rated
- Sequential Footmarks
- Tested to 350 MHz
- Several Colors Available
- 10/100 BaseT Network Compliant

Call for Details
See Direct Burial Page 168

Category 5E Enhanced							
# of Pairs	AWG Size	NOM Insulation (Inches)	NOM Jacket (Inches)	NOM OD (Inches)	NOM Capacitance pF/ft	Part #	
4	24 Solid BC	.008 PE	.022 FR-PVC	.195	14	24-4P-L5-EN-* CMR CAT5 Riser *Available in Beige, Black, Blue, Green, Gray, Orange, Pink, Red, White or Yellow	
4	24 Solid BC	.008 PE	.030 PE	.240	14	24-4P-L5-EN-DB Direct Burial CAT5	
4	24 Solid BC	.010 FEP	.015 PL-PVC	.225	17	24-4P-P-L5SH-* CMP CAT5 Plenum Shielded *Available in White, Blue, Gray	
4	24 STR BC	.008 PE	.022 FR-PVC	.195	14	24-4P-STR-L5-EN-* CMR CAT5 Riser Stranded *Available in Black, Blue, Green, Gray, Orange, Pink, Red, Violet, White or Yellow	
4	24 Solid BC	.010 PE	.020 FR-PVC	.237	17	24-4P-L5SH-EN* CMR CAT5 Shielded Riser *Available in Blue, Green, Violet, Red, or White	
8	24 Solid BC	.0095 PE	.022 PVC	190x390	17	24-8P-L5E-SIAM* CMR Siamese Riser *Available in Blue and Green	
16	24 Solid BC	.008 PE	.020 FR-PVC	.187	17	CAT5E-4C-J CM (4) CAT5E Cable under one green jacket Overall Construction	
20	24 Solid BC	.008 PE	.020 PVC	.630	17	CAT5E-5C-J CM (5) CAT5E Cable under one yellow jacket Overall Construction	

Ordering is fast & easy.



Call today!

Solutions for the AV PROFESSIONAL

Category 6E

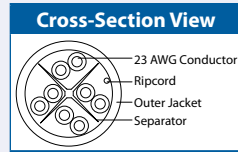

- CMR/CMP Rated
- Tested to 550 MHz
- 16dB Headroom over Cat 5
- Sequential Footmarks
- Several Colors Available
- 10/1000 BaseT Network Compliant

Category 6E Enhanced							
# of Pairs	AWG Size	NOM Insulation (Inches)	NOM Jacket (Inches)	NOM OD (Inches)	NOM Capacitance pF/ft	Part #	
4	23 Solid BC	.008 PE	.020 FR-PVC	.240	14	24-4P-L6-EN-* CMR *Available in Blue, Green, Gray, Orange, White or Yellow	
4	23 Solid BC	.007 FEP	.017 PL-PVC	.236	14	24-4P-P-L6-EN-* CMP *Available in Black, Blue, Green, Red, White or Yellow	
4	23 Solid BC	.010 HDPE	.022 PVC	.287	14	24-4P-L6SH-* CMR *Available in White, Blue, Gray	

Category 6A

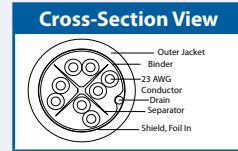

10 Gigabit Ethernet Copper Cabling, Category 6 Augmented tested and certified to 500 MHz per the newest TIA/EIA performance standard.

Category 6A Shielded							
# of Pairs	AWG Size	NOM Insulation (Inches)	Shield	NOM Jacket (Inches)	NOM OD (Inches)	NOM Capacitance pF/ft	Part #
4	23 AWG Solid BC	.009 PE	100% AL/ POLY w/Drain	.022 PVC	.287	14.0	24-4P-L6ASH White, Blue, Gray

RGB Over UTP Applications TRUphase™ Low-Skew Cable

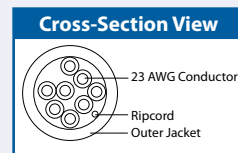

Liberty's TRUphase™ Low-Skew cable offering provides a high quality cable solution at a reasonable price for improving the quality and distance in RGB over UTP applications. No out of convergence images! It is available in both PVC and Plenum versions.

RGB Over UTP Applications TRUphase™ Low-Skew Cable							
# of Pairs	AWG Size	NOM Insulation (Inches)	NOM Jacket (Inches)	NOM OD (Inches)	Shield	NOM Capacitance (pF/ft)	Part #
4	23	.008 PE	.030 BLK	.230		16	TRUPHASE CMR
4	23	.007 PE	.015 BLK	.180		14	TRUPHASE-P CMP
4	23	.040 PE	.024 BRN	.225	Overall AL Poly w/ 24 AWG Drain	16	TRUPHASE-SH-BRN

Solutions for the AV PROFESSIONAL

Ordering is fast & easy.



Call today!

CATMaster™ Crimp Tool and Connector System



CATMaster™ Crimp Tool

This high-quality crimp tool is designed to quickly crimp and cut the wires of the EZ-RJ45® Connector...in one easy operation! Works on most other RJ-11 and RJ-12 connectors.

Part #: 100 044LW

Replacement blades keep your cuts always sharp.



Part #: 100 004BL
EZ-RJ45 Crimp Tool Blade Pair (2 Blades in a retail blister package)

Punch-Down Tool



Our 110 Block punch-down is ergonomically designed so that it reduces wrist strain even with hours of use. Inserts and cuts terminations in one operation. Easy-to-use adjustable actuation setting accommodates termination requirements or user preference.

Part #: 13006

UTP Cable Jacket Stripper

This economical tool has been specifically designed to strip the cable jacket from UTP cables. Will not scratch the inner conductors.

Part #: 15010



EZ-RJ45® Connector

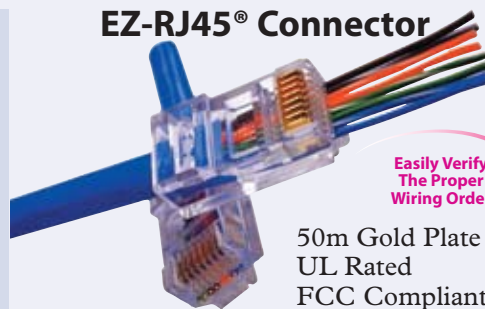

Easily Verify The Proper Wiring Order

50m Gold Plate
UL Rated
FCC Compliant

Connector Type	Package	Part #
Cat5e	100	100 003B
Cat6	30	100 011LW
RJ11/12	50	100 026LW
Cat5e Shielded	50	100020
Integrated Strain Relief Cat5e	50	100035
Integrated Strain Relief Cat6	50	100036
Colored Strain Relief Cat6	50	100030 (color)

Buy It As a Kit!



Part #: 100035

Metal Connector (Shielded)
Part #: 100020



Colored Boots
Part #: 100030-*

CATMaster™ Kits are available

Description	Part #
<ul style="list-style-type: none"> • 1 CATMaster RJ11/RJ45 Crimp Tool • 1 CATMaster Stripper • 1 Cable Cutter • 50 CATMaster RJ-45 Connectors 	90131LW

RJ45 Plates Combine Form & Function Popular Single and Double Gang Plates on page 202



Part #: PC-G1290

QTY CONNECTOR
1 HD-15 FEMALE
3 INSULATED RCA
2 RJ-45



Part #: PC-G2140

QTY CONNECTOR
2 HD-15 FEMALE
2 STEREO-MINI
2 RJ-45

Ordering is fast & easy.



Call today!



Order Everything with Just One Call!

Solutions for the
AV PROFESSIONAL

Why Use Liberty's Serial Digital Coax?

One reel of Liberty's Serial Digital coaxial cable can eliminate multiple reels of product.

Highly Flexible
10 Different Colors



One cable for all your installation needs:

- HDTV
- **Broadband** – Cable TV, RF, DBS
- **Baseband** – Component Video, Composite Video, S-Video, VGA, RGB
- **Line-Level Audio**

Cable features that provide big benefits:

- Custom interconnects to exact lengths
- Reduce stocking multiple product types
- Carry only what's needed to the job

	BASEBAND					BROADBAND			AUDIO	
	VGA	RGB	Composite	Component	S-Video	CATV	RF	DBS	Analog	Digital
Liberty Serial Digital	✓	✓	✓	✓	✓	✓	✓	✓	✓	✓
CCTV Coax	✓	✓	✓	✓					✓	✓
CATV Coax						✓	✓	✓		✓

Liberty's Serial Digital cables raise the standard for speed, reliability and performance for all high definition applications. Our specifications will meet or exceed any requirement. These cables are a cost-effective way to upgrade to a state-of-the-art Serial Digital backbone.

Two types of serial digital coax for all your installation needs:

Serial Digital Coax (RG6 and RG59)

Superior performance for exacting audio/video applications — in-wall rated, sweep tested to 3 GHz!

Type	AWG	Riser	Plenum	Part #
RG6	18	✓		18-CMR-SD-*
RG6	18		✓	18-CMP-VID-COAX-*
RG59	20	✓		20-CMR-VIDEO-*
RG59	20		✓	20-CMP-VID-COAX-*

Standard 1,000 ft. reels, 500 ft. available.

Available in six different colors: black, blue, green, red, white and yellow.

Type	AWG	Jacket	Part #
RG59	20	PVC	INTERFLEX-SD-*

Standard 1,000 ft. reels, 500 ft. and 250 ft. available.

Available in seven different colors: blue, clear, green, red, orange, smokey black and yellow.

InterFlex™ Serial Digital Coax (RG59)

Superior flexibility—sweep tested to 3 GHz! See page 118 for colors!



Solutions for the AV PROFESSIONAL

www.libertycable.com

800-530-8998

INTERNATIONAL - CALL +1-719-388-7542



Ordering is fast & easy.



Call today!

E-Z Solutions: Retro-Fit



This couple has decided to upgrade & Retro-Fit. Are you ready?

As the residential marketplace adjusts to current economic conditions, AV professionals are finding an increase in opportunities in the residential retro-fit marketplace. Generally the retro-fit market has been overlooked by most AV professionals as being either too difficult to work in or being too busy with new construction projects to consider a retro-fit. Yet that is quickly changing.

The softening housing market has positioned the residential retro-fit as one of the next growing markets where homeowners are investing. Homeowners are looking to invest in a wide variety of home upgrades many of which include AV upgrades ranging from a new plasma display, security system and distributed audio. Retro-fit opportunities can be found in your AV customer base as well as from new non AV customers.

Although working in a retro-fit installation has a few more concerns than an open stud environment, most AV professionals find that with the right approach to the installation it can be as easy as a new construction environment.

Liberty's EZ Solutions for retro-fits provides insights and products that support a cost effective approach for AV professionals who are designing and installing AV systems in existing structures.

Getting Started

Talk with your insurance agent before you start a retro-fit project to assess if your current insurance policy provides the correct amount of coverage.

One of the first things to think about is your professional image. Creating a sense of professionalism will go a long way in making the homeowner feel comfortable and confident that you can do the work. A polo shirt with a logo rather than the traditional installation tee shirt can go a long way in adding to your professional image.

Retro-fit projects are different from new construction projects as the homeowner will often be in the home and could be watching the work as it happens. The project schedule will be at the convenience of the homeowner so be sensitive to both start times and when you leave the job site. Punctuality is important to home owners. Also most homeowners would expect you to not use their washroom facilities.

A retro-fit project can have various levels of difficulty that could require partnering with different professional trades such as drywall contractors, plumbers, painters and/or residential electricians. You can bring these trades together and have each one bill under your invoice with a markup or you can have them bill the homeowner directly.

Ordering is fast & easy.



Call today!

**Solutions for the
AV PROFESSIONAL**

www.libertycable.com

800-530-8998

INTERNATIONAL - CALL +1-719-388-7542





Liberty's products provide the professional AV installer with the right products for any retro-fit installation: products that keep your business both competitive and profitable.

Either way your overall project will be judged by the quality of each of these business partners so you will want to find the best in each category.

Before the retro project starts you should sit down with the homeowner and carefully review what the job will entail for each step of the process and also review what each professional trade will be responsible for executing. Each professional trade should be aware of what residential building codes apply to their work.

Often the male of the household will be very interested in the AV functionality of the retro-fit and the female member of the household will be concerned about the potential mess created, disturbance to their family, clean up procedures and the overall final aesthetics of the project. It would be wise to pay careful attention to these details and be able to clearly communicate what steps will be taken to raise the homeowner's confidence in your abilities.



RETRO-FIT APPLICATIONS:

Here is a List of Typical Retro-Fit Projects That Would Utilize AV Solutions

- Additions to the Home
- Basement Finish
- Bathroom or Kitchen Remodel
- Control Systems
- Distributed Audio
- Energy Efficiency Upgrades:
 - Lutron Systems
- Home Theater
- Empty Nest Remodel
- Home Office Conversion
- Multi-Room Video
- Outdoor Speakers
- Upgrades/Installs

**To Start Your
Retro-Fit
Call Us Today!**

RETRO-FIT PRODUCTS:

Liberty has a complete line of products designed to provide AV solutions for existing and future technology for the retro-fit market. Liberty products have a proven track record: installing easily and performing flawlessly in any type of retro-fit environment.

The Typical Bulk Cable Products Include a Broad Range of Options for:

- Category, Coax, Control, Lighting & Speaker Cables
- Connectors
- Tools
- Wall plates

We Also Provide an Expanded Range of New Solutions for New Technologies Including:

- Baluns
- Direct Burial
- Flatwire
- HDMI over Category
- HDMI over COAX
- HDMI over Fiber
- RGB6 with 2 Cat5e's in three Coaxial Sizes

**Solutions for the
AV PROFESSIONAL**
www.libertycable.com

800-530-8998
INTERNATIONAL - CALL +1-719-388-7542



Ordering is fast & easy.



Call today!

CATV/MATV/DBS Direct Burial Video Cable Non-Plenum

Quality Products

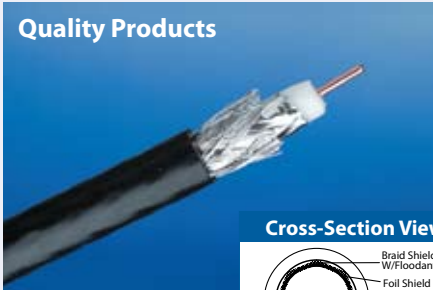

Cross-Section View

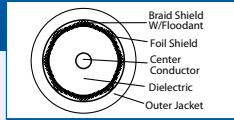

Coax-Double (Dual) Shielded

- Flooded Braid
- CATV/MATV/DBS
- Foamed Polyethylene Dielectric
- Black Polyethylene Jacket
- UV Rated for Sunlight Resistance
- Suitable for Direct Burial Applications
- 75 Ohm

Coax - CATV/MATV Direct Burial - Gel-Filled

AWG Center Conductor	NOM OD Dielectric (Inches)	Shield Construction	NOM Jacket (Inches)	NOM OD (Inches)	NOM Capacitance (Pf/ft)	NOM Velocity of Propagation	NOM Attenuation		Part #
							MHz	db100'	
18 Solid CCS	0.18 FPE	Foil +60% Alum Braid	0.03 PE	0.272	16	82%	1	0.26	RG6-CATV-DB
							10	0.81	
							50	1.46	
							100	2.05	
							200	2.83	
							400	4.05	
							700	5.06	
							900	6.23	
1000	6.08								
18 Solid BC	0.180 FPE	Foil + 60% Alum Braid	.030 PE	.272	16.2	82%	50	1.41	RG6-BC-CATV-DB Perfect for DBS/Satellite
							100	1.92	
							400	3.73	
							700	5.05	
							1000	6.11	
							1800	8.43	
							2200	9.35	
							3000	10.92	
14 AWG Solid BC	0.28 PE	100% Bonded Aluminum/ Poly Alum + 60% 34 AWG Alum Braid	.040 PE	.395	16	82%	1	.10	RG11-BC-CATV-DB Perfect for DBS/Satellite
							10	.45	
							100	1.21	
							200	1.68	
							400	2.37	
							700	3.27	
							1000	3.95	
							2200	5.75	
14 Solid CCS	0.28 FPE	Foil + 90% Alum Braid	0.042 BLK PE	.405	16.2	83%	1	.172	RG11-CATV-DB
							10	0.55	
							50	1.25	
							100	1.08	
							200	2.06	
							400	3.77	
							700	5.14	
							900	5.92	
1000	6.28								

PERFECT TERMINATIONS

Item #	Part #	Item #	Part #
1	CM-RG6U-RCA	4	CM-RG6U-GBNC
2	CM-RG6U-GRCA	5	CM-RG6U-F
3	CM-RG6U-BNC	6	CM-RG6U-GF

SEE PAGE 161

FLAWLESS PERFORMANCE
in the harshest of environments!



DIRECT BURIAL PRODUCTS

Liberty's complete offering of direct burial cables provides a solution for every application!

See Page 168 for a complete listing of Direct Burial cables.

Ordering is fast & easy.



Call today!

Solutions for the AV PROFESSIONAL
www.libertycable.com

800-530-8998
INTERNATIONAL - CALL +1-719-388-7542



CATV/MATV/DBS Dual Shield Video Cable Non-Plenum

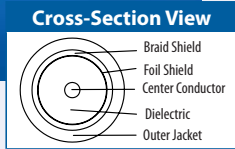
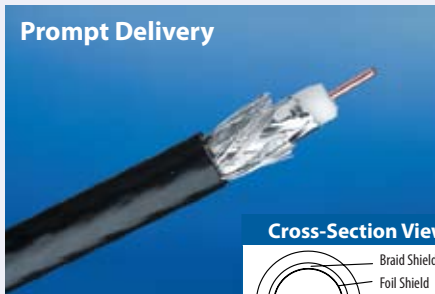

Liberty offers the highest performance and most specified CATV cable available. We can help you cross any CATV cable you require.

Coax - Double (Dual) Shielded

- UL Listed NEC/CEC Type CM
- Solid Copper Clad Steel Center Conductor
- Foamed Polyethylene Dielectric
- Black FR-PVC Jacket
- 75 Ohm
- Sequential Footmarks
- All items feature a 3.0 GHz Sweep

Non-Plenum Video Cable - CATV/MATV																									
AWG Center Conductor	NOM OD Dielectric (Inches)	Shield Construction	NOM Jacket (Inches)	NOM OD (Inches)	NOM Capacitance (Pf/ft)	NOM Velocity of Propagation	NOM Attenuation		Part #																
							MHz	db100'																	
18 Solid CCS	0.18 FPE	Foil + 60% Alum Braid	0.03 FR-PVC	0.272	16	82%	1	0.26	RG6-CM-BLK RG6-CM-WHT *Available in Black or White.																
							10	0.81																	
							50	1.46																	
							100	2.05																	
							200	2.83																	
							400	4.05																	
							700	5.60																	
							900	6.23																	
							1000	6.80																	
							PERFECT TERMINATIONS <table border="1"> <tr> <th>Item #</th> <th>Part #</th> <th>Item #</th> <th>Part #</th> </tr> <tr> <td>1</td> <td>CM-RG6U-RCA</td> <td>4</td> <td>CM-RG6U-GBNC</td> </tr> <tr> <td>2</td> <td>CM-RG6U-GRCA</td> <td>5</td> <td>CM-RG6U-F</td> </tr> <tr> <td>3</td> <td>CM-RG6U-BNC</td> <td>6</td> <td>CM-RG6U-GF</td> </tr> </table>										Item #	Part #	Item #	Part #	1	CM-RG6U-RCA	4	CM-RG6U-GBNC	2
Item #	Part #	Item #	Part #																						
1	CM-RG6U-RCA	4	CM-RG6U-GBNC																						
2	CM-RG6U-GRCA	5	CM-RG6U-F																						
3	CM-RG6U-BNC	6	CM-RG6U-GF																						
18 Solid CCS	0.18 FPE	Foil + 60% Alum Braid	0.03 FR-PVC	0.272	16	82%	1	0.26	RG6-CM-SIAM-BLK																
							10	0.81																	
							50	1.46																	
							100	2.05																	
							200	2.83																	
							400	4.05																	
							700	5.60																	
							900	6.23																	
							1000	6.80																	
							PERFECT TERMINATIONS <table border="1"> <tr> <th>Item #</th> <th>Part #</th> <th>Item #</th> <th>Part #</th> </tr> <tr> <td>1</td> <td>CM-RG6U-RCA</td> <td>4</td> <td>CM-RG6U-GBNC</td> </tr> <tr> <td>2</td> <td>CM-RG6U-GRCA</td> <td>5</td> <td>CM-RG6U-F</td> </tr> <tr> <td>3</td> <td>CM-RG6U-BNC</td> <td>6</td> <td>CM-RG6U-GF</td> </tr> </table>										Item #	Part #	Item #	Part #	1	CM-RG6U-RCA	4	CM-RG6U-GBNC	2
Item #	Part #	Item #	Part #																						
1	CM-RG6U-RCA	4	CM-RG6U-GBNC																						
2	CM-RG6U-GRCA	5	CM-RG6U-F																						
3	CM-RG6U-BNC	6	CM-RG6U-GF																						
14 Solid CCS	0.28 FPE	Foil + 60% Alum Braid	0.045 FR-PVC	0.405	16.2	82%	1	0.22	RG11-CATV-BLK RG11-CATV-WHT *Available in Black or White.																
							10	0.49																	
							50	0.98																	
							100	1.29																	
							200	1.84																	
							400	2.68																	
							700	3.67																	
							900	4.25																	
							1000	4.52																	
							PERFECT TERMINATIONS <table border="1"> <tr> <th>Item #</th> <th>Part #</th> </tr> <tr> <td>63</td> <td>CM-RG11-N</td> </tr> <tr> <td>64</td> <td>CM-RG11-BNC</td> </tr> <tr> <td>65</td> <td>CM-RG11-F</td> </tr> </table>										Item #	Part #	63	CM-RG11-N	64	CM-RG11-BNC	65	CM-RG11-F	
Item #	Part #																								
63	CM-RG11-N																								
64	CM-RG11-BNC																								
65	CM-RG11-F																								

CONNECTEC™ SOLID Solutions SEE PAGE 133
QuickLinx™ Solid Center Conductor 23 & 25 AWG
 SOLID AWG CABLES Mini RGBHV Cable and Connector Solutions

Solutions for the AV PROFESSIONAL **800-530-8998**

www.libertycable.com INTERNATIONAL - CALL +1-719-388-7542

Bulk Wire: Residential Coax Cable

Ordering is fast & easy.



Call today!

CATV/MATV/DBS Quad Shield Video Cable

Non-Plenum

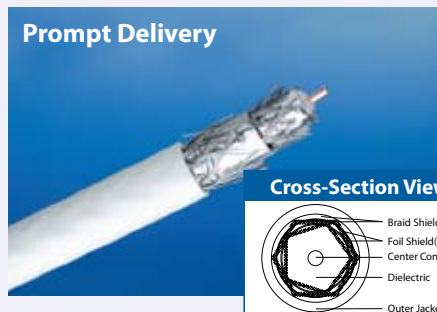

Coax - Quad (Four) Shielded

- UL Listed NEC Type CM
- Foamed Polyethylene Dielectric
- FR-PVC Jacket
- All items feature a 3.0 GHz Sweep

Non-Plenum Video Cable - CATV/MATV									
AWG Center Conductor	NOM OD Dielectric (Inches)	Shield Construction	NOM Jacket (Inches)	NOM OD (Inches)	NOM Capacitance (Pf/ft)	NOM Velocity of Propagation	NOM Attenuation		Part #
							MHz	db100'	
18 Solid CCS	0.18 FPE	2 Foils + 60% AL 40% AL Braid	0.026 PVC	0.287	16.2	82%	10	0.85	QUADFLEX-BLK QUADFLEX-BLU QUADFLEX-RED QUADFLEX-WHT QUADFLEX-YEL *Available in Black, Blue, Red, White or Yellow.
							50	1.00	
							100	1.30	
							200	2.05	
							400	3.05	
							700	5.95	
							1000	7.55	
							1500	10.30	
							1450	10.10	
							2500	12.20	
3000	13.48								
18 Solid BC	0.18 FPE	2 Foils + 60% AL 40% AL Braid	0.026 PVC	0.287	16.2	82%	10	0.81	QUADFLEX-BC-BLK QUADFLEX-BC-WHT *Available in Black or White.
							50	1.46	
							200	2.83	
							400	4.05	
							700	5.60	
							1000	6.59	
							1450	7.94	
							2200	9.77	

RG6 Quad Shield Non-Plenum CATV/DBS/MATV Video Cable									
AWG Center Conductor	NOM OD Dielectric (Inches)	Shield Construction	NOM Jacket (Inches)	NOM OD (Inches)	NOM Capacitance (Pf/ft)	NOM Velocity of Propagation	NOM Attenuation		Part #
							MHz	db100'	
18 Solid BC	0.180 FPE	2 Foils 60% + 40% AL Braid	.030 PVC	.295 x .614	16.2	82%	50	1.46	QUADFLEX-BC-SIAM
							100	2.04	
							400	4.05	
							700	5.05	
							1000	6.59	
							1800	8.83	
							2200	9.76	
							3000	11.40	

Siamese RG6 Quad Shield CATV/DBS/MATV Video Cable									
AWG Center Conductor	NOM OD Dielectric (Inches)	Shield Construction	NOM Jacket (Inches)	NOM OD (Inches)	NOM Capacitance (Pf/ft)	NOM Velocity of Propagation	NOM Attenuation		Part #
							MHz	db100'	
18 Solid CCS	0.18 FPE	2 Foils + 60% AL 40% AL Braid	0.03 FR-PVC	0.3 x 0.614	16.2	82%	5	0.81	RG6Q-CM-SIAM-BLK RG6Q-CM-SIAM-WHT *Available in Black or White.
							55	1.60	
							250	3.36	
							400	4.30	
							500	6	
							750	7	
							1000	7.62	
							1450	8.38	

Ordering is fast & easy.

Call today!

Solutions for the AV PROFESSIONAL **800-530-8998**

www.libertycable.com INTERNATIONAL - CALL +1-719-388-7542

Specifications Subject to Change

CCTV and Baseband Video Cable - Non-Plenum

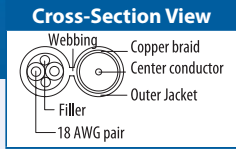
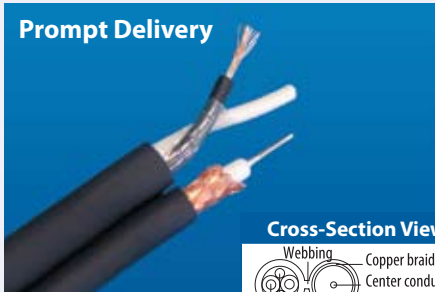

These cables are ideal for closed circuit TV (CCTV) applications or high-quality analog video runs.

Coax - Single Shield

- UL Listed NEC Type CL2/CM
- Solid or Stranded Bare Copper Center Conductor
- Foam Polyethylene Dielectric
- Black PVC or FR-PVC Jacket
- 75 Ohm
- Sequential Footmarks

Non-Plenum Video Cable - CCTV & BaseBand Video																																					
AWG Center Conductor	NOM OD Dielectric (Inches)	Shield Construction	NOM Jacket (Inches)	NOM OD (Inches)	NOM Capacitance (Pf/ft)	NOM Velocity of Propagation	NOM Attenuation		Part #																												
							MHz	db100'																													
20 Solid BC	0.144 FPE	95% BC Braid	0.032 FR-PVC	.242x.484	16.2	82%	1	0.24	RG59CM-18-2C Siamese Construction																												
18	0.01 Twisted Pair	N/A STR BC (16x30)	0.025 FR-PVC PVC	N/A	N/A	10	0.76	2.76																													
										100	6.02																										
												400	6.02																								
<div style="display: flex; align-items: center;"> <table border="1" style="font-size: 8px;"> <thead> <tr> <th colspan="4">PERFECT TERMINATIONS</th> </tr> <tr> <th>Item #</th> <th>Part #</th> <th>Item #</th> <th>Part #</th> </tr> </thead> <tbody> <tr> <td>37</td> <td>CM-RG59C-RCA</td> <td>40</td> <td>CM-RG59C-GBNC</td> </tr> <tr> <td>38</td> <td>CM-RG59C-GRCA</td> <td>41</td> <td>CM-RG59C-F</td> </tr> <tr> <td>39</td> <td>CM-RG59C-BNC</td> <td>42</td> <td>CM-RG59C-GF</td> </tr> </tbody> </table> </div>										PERFECT TERMINATIONS				Item #	Part #	Item #	Part #	37	CM-RG59C-RCA	40	CM-RG59C-GBNC	38	CM-RG59C-GRCA	41	CM-RG59C-F	39	CM-RG59C-BNC	42	CM-RG59C-GF								
PERFECT TERMINATIONS																																					
Item #	Part #	Item #	Part #																																		
37	CM-RG59C-RCA	40	CM-RG59C-GBNC																																		
38	CM-RG59C-GRCA	41	CM-RG59C-F																																		
39	CM-RG59C-BNC	42	CM-RG59C-GF																																		
20 Solid BC	0.144 FPE	95% BC Braid	0.037 FR-PVC	0.24	16	82%	1	0.24	RG59-CCTV-CM-BLK																												
							10	0.82																													
							100	2.76																													
							400	6.02																													
							700	9.04																													
							900	10.83																													
							1000	12.39																													
							<div style="display: flex; align-items: center;"> <table border="1" style="font-size: 8px;"> <thead> <tr> <th colspan="4">PERFECT TERMINATIONS</th> </tr> <tr> <th>Item #</th> <th>Part #</th> <th>Item #</th> <th>Part #</th> </tr> </thead> <tbody> <tr> <td>37</td> <td>CM-RG59C-RCA</td> <td>40</td> <td>CM-RG59C-GBNC</td> </tr> <tr> <td>38</td> <td>CM-RG59C-GRCA</td> <td>41</td> <td>CM-RG59C-F</td> </tr> <tr> <td>39</td> <td>CM-RG59C-BNC</td> <td>42</td> <td>CM-RG59C-GF</td> </tr> </tbody> </table> </div>										PERFECT TERMINATIONS				Item #	Part #	Item #	Part #	37	CM-RG59C-RCA	40	CM-RG59C-GBNC	38	CM-RG59C-GRCA	41	CM-RG59C-F	39	CM-RG59C-BNC	42	CM-RG59C-GF	
							PERFECT TERMINATIONS																														
							Item #	Part #		Item #	Part #																										
							37	CM-RG59C-RCA	40	CM-RG59C-GBNC																											
38	CM-RG59C-GRCA	41	CM-RG59C-F																																		
39	CM-RG59C-BNC	42	CM-RG59C-GF																																		
22 STR BC (7x30)	0.143 PE	95% BC Braid	0.036 PVC	0.242	17.4	78%	50	2.1	RG59-STR-BLK RG59-STR-YEL *Available in Black or Yellow.																												
							100	3.4																													
							200	4.8																													
							400	6.7																													
							900	10.2																													
							1000	11																													
18 Solid BC	0.175 FPE	95% BC Braid	0.032 FR-PVC	.278	17.3	78%	10	0.8	RG6-18-2C																												
							50	1.5																													
							100	2.1																													
							200	3.1																													
							400	4.5																													
							700	5.9																													
							1000	7.3																													
							<div style="display: flex; align-items: center;"> <table border="1" style="font-size: 8px;"> <thead> <tr> <th colspan="4">PERFECT TERMINATIONS</th> </tr> <tr> <th>Item #</th> <th>Part #</th> <th>Item #</th> <th>Part #</th> </tr> </thead> <tbody> <tr> <td>13</td> <td>CM-RG6C-RCA</td> <td>16</td> <td>CM-RG6C-GBNC</td> </tr> <tr> <td>14</td> <td>CM-RG6C-GRCA</td> <td>17</td> <td>CM-RG6C-F</td> </tr> <tr> <td>15</td> <td>CM-RG6C-BNC</td> <td>18</td> <td>CM-RG6C-GF</td> </tr> </tbody> </table> </div>										PERFECT TERMINATIONS				Item #	Part #	Item #	Part #	13	CM-RG6C-RCA	16	CM-RG6C-GBNC	14	CM-RG6C-GRCA	17	CM-RG6C-F	15	CM-RG6C-BNC	18	CM-RG6C-GF	
							PERFECT TERMINATIONS																														
							Item #	Part #		Item #	Part #																										
13	CM-RG6C-RCA	16	CM-RG6C-GBNC																																		
14	CM-RG6C-GRCA	17	CM-RG6C-F																																		
15	CM-RG6C-BNC	18	CM-RG6C-GF																																		
18 Solid CCS	0.18 FPE	95% BC Braid	0.028 PVC	0.264	16.2	82%	1	0.19	RG6-CCTV-CM-BLK																												
							10	0.65																													
							100	2.16																													
							400	4.55																													
							700	7.13																													
							900	7.95																													
							1000	8.69																													
14 Solid BC	0.285 FPE	95% BC Braid	0.045 FR-PVC	0.405	16	82%	1	0.16	RG11-CCTV-BLK CM Rated																												
							10	0.46																													
							50	0.93																													
							100	1.45																													
							200	1.83																													
							400	2.77																													
							700	4.06																													
							900	4.66																													
							1000	4.82																													
							<div style="display: flex; align-items: center;"> <table border="1" style="font-size: 8px;"> <thead> <tr> <th colspan="4">PERFECT TERMINATIONS</th> </tr> <tr> <th>Item #</th> <th>Part #</th> <th>Item #</th> <th>Part #</th> </tr> </thead> <tbody> <tr> <td>13</td> <td>CM-RG6C-RCA</td> <td>16</td> <td>CM-RG6C-GBNC</td> </tr> <tr> <td>14</td> <td>CM-RG6C-GRCA</td> <td>17</td> <td>CM-RG6C-F</td> </tr> <tr> <td>15</td> <td>CM-RG6C-BNC</td> <td>18</td> <td>CM-RG6C-GF</td> </tr> </tbody> </table> </div>										PERFECT TERMINATIONS				Item #	Part #	Item #	Part #	13	CM-RG6C-RCA	16	CM-RG6C-GBNC	14	CM-RG6C-GRCA	17	CM-RG6C-F	15	CM-RG6C-BNC	18	CM-RG6C-GF	
PERFECT TERMINATIONS																																					
Item #	Part #	Item #	Part #																																		
13	CM-RG6C-RCA	16	CM-RG6C-GBNC																																		
14	CM-RG6C-GRCA	17	CM-RG6C-F																																		
15	CM-RG6C-BNC	18	CM-RG6C-GF																																		

Bulk Wire: Residential Coax Cable

Ordering is fast & easy.



Call today!

Solutions for the AV PROFESSIONAL
www.libertycable.com

800-530-8998
INTERNATIONAL - CALL +1-719-388-7542



Mini Precision Video Cable - Non-Plenum

Prompt Delivery

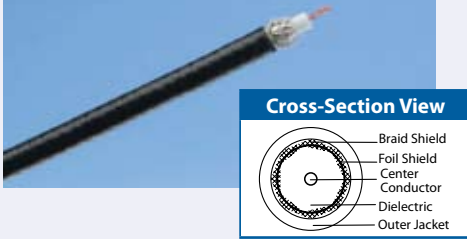

This convenient 25 AWG mini precision video cable has a very flexible PVC jacket and can be used for a variety of applications.

Mini Video Cables

- UL Listed NEC Type CMR
- FEP Dielectric
- Stranded Bare Copper Center Conductor
- Non-Plenum Jackets
- 75 Ohm
- Sequential Footmarks



Perfect For...

- Baseband Video
- S-Video
- Left/Right Audio
- Bit-Stream Digital Audio
- Field Fabricated Interconnects

Mini Precision Video Cable, Non-Plenum

AWG Center Conductor	NOM OD Dielectric (Inches)	Shield Construction	NOM Jacket (Inches)	NOM OD (Inches)	NOM Capacitance (Pf/ft)	NOM Velocity of Propagation	NOM Attenuation		Part #
							MHz	db100'	
25 STR BC (19x37)	.094 FPE	100% Foil + 95% TC Braid	0.017 FR-PVC	0.150	16.5	83%	1	0.43	25-CMR-BLK
							5	1.10	
							10	1.57	
							100	4.80	
							270	7.10	
							720	11.76	
							1000	13.78	
							2000	20.32	
							3000	25.48	

PERFECT TERMINATIONS

Item #	Part #
55	CM-RGB25-BNC
56	CM-RGB25-GBNC
57	CM-RGB25-RCA
58	CM-RGB25-GRCA

SEE PAGE 161

RG58 50 Ohm Coax - Non-Plenum and Plenum

Quality Products

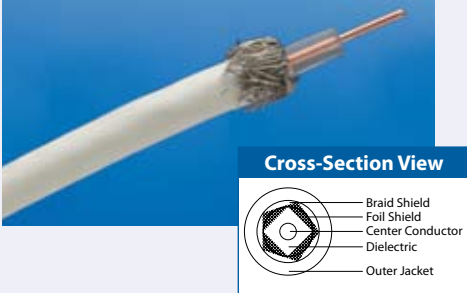

RG58 cable is commonly used for XM™ and Sirius™ antenna and wireless microphones. Our RG58 cable offers fast error-free network data transmission.

RG58 50 Ohm Coax

- UL Listed
- Low Loss
- Solid Foam Center Conductor
- PE or FEP Dielectric
- Black FR-PVC or PLN-PVC Jackets
- 50 Ohm
- Sequential Footmarks

RG58 50 Ohm Coax, Non-Plenum

AWG Center Conductor	NOM OD Dielectric (Inches)	Shield Construction	NOM Jacket (Inches)	NOM OD (Inches)	NOM Capacitance (pF/ft)	NOM Velocity of Propagation	NOM Attenuation		Part #
							MHz	db100'	
19 Solid BC	.144 FPE	+ 95% Braid	.028 FR-PVC	.252	24.3	80%	30	2.00	RG58-CMR-BLK
							50	2.60	
							150	4.40	
							220	5.40	
							450	7.80	
							900	11.10	
							1500	14.50	
							1800	16.00	
							2000	16.90	
							2500	19.00	

RG58 50 Ohm Low Loss Coax, Plenum

AWG Center Conductor	NOM OD Dielectric (Inches)	Shield Construction	NOM Jacket (Inches)	NOM OD (Inches)	NOM Capacitance (pF/ft)	NOM Velocity of Propagation	NOM Attenuation		Part #
							MHz	db100'	
19 AWG Solid BC	0.110 FFEP	Bonded Foil + 90% TC Braid	.016 PL-PVC	.178	27.0	69.5%	30	2.05	RG58-CMP-WHT
							50	2.58	
							150	4.34	
							450	8.00	
							900	12.50	
							1800	19.60	
							2500	23.60	

Ordering is fast & easy.



Call today!

Solutions for the AV PROFESSIONAL

www.libertycable.com

800-530-8998

INTERNATIONAL - CALL +1-719-388-7542



S-Video Cable Non-Plenum & Plenum

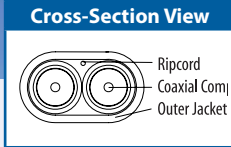

Liberty carries a full line of S-Video cable. We build our high-performance S-Video breakout cable with Z400NSV, the same cable used in our Z400 S-Video interconnect. It is a premium cable made from Oxygen-Free copper with a super flexible jacket. Liberty's Siamese serial digital S-Video cable carries an in-wall CM rating and gives the maximum performance for in-wall S-Video runs.

Liberty has two new S-Video cables in the QuickLinx™ line. A solid core 25 AWG plenum and non-plenum version offer 25% more bandwidth than the traditional stranded 26 AWG versions. These are designed for our one-piece mini compression connectors to facilitate quicker installations

S-Video Cable - Non-Plenum & Plenum										
AWG Center Conductor	NOM OD Dielectric (Inches)	Shield Construction	NOM Jacket Single Final (inches)	NOM OD Single Final (inches)	NOM Capacitance (pF/ft)	NOM Velocity of Propagation	NOM Attenuation (db/100m)			Part #
							60Hz	1Khz	20Khz	
28 AWG 10/.12mm OFC	0.087 FPE	98% OFC Braid	.012 PVC .040 PVC	.126 .335	57	78%	1.15	1.28	12.08	Z400NSV (100 meter Spool)
(2) 23 SOL BC	0.99 FPE	Foil + 93% TC Braid	0.013 FR-PVC	.159 x .328	16.5	84%	1 3.6 10 71.5 135 270 360 720 1000	0.38 0.77 1.29 3.04 4.18 5.92 6.70 9.47 11.16	23-YCLL-SIAM	
PERFECT TERMINATIONS			Cross-Section View							
Item # Part # 49 CM-RGB23-BNC 50 CM-RGB23-RCA 51 CM-RGB23-GRCA SEE PAGE 163			Ripcord Coaxial Component Outer Jacket							
(2) 25 AWG Solid BC	.018 FPE	100% Al/Poly Tape + 90% TC Spiral Braid	.026 PVC	.163 x .269	18	78%	100 200 400 1000	5.10 7.10 10.50 17.90	SV-25-CM	
PERFECT TERMINATIONS			Cross-Section View							
Item # Part # 52 CM-RGB25-BNC 53 CM-RGB25-RCA 54 CM-RGB25-GRCA SEE PAGE 163			Ripcord Coaxial Component Outer Jacket							
(2) 26 STR TC (7x34)	0.077 FEP	95% TC Spiral +Foil	0.011 PVC	0.27	18	78%	100 200 400 1000	5.10 7.40 11.80 21.40	SV-PVC	
PERFECT TERMINATIONS			Cross-Section View							
Item # Part # 59 CM-RGB26-BNC 60 CM-RGB26-GBNC 61 CM-RGB26-RCA 62 CM-RGB26-GRCA SEE PAGE 163			Coaxial Component Outer Jacket							
(2) 25 AWG Solid BC	.028 FFEP	100% AL/Poly Tape + 90% TC Spiral Braid	.015 PL-PVC	.141 x .245	16	83%	100 200 400 1000	5.10 7.10 10.50 17.90	SV-25-CMP	
PERFECT TERMINATIONS			Cross-Section View							
Item # Part # 52 CM-RGB25-BNC 53 CM-RGB25-RCA 54 CM-RGB25-GRCA SEE PAGE 163			Ripcord Coaxial Component Outer Jacket							
(2) 26 STR TC (7x34)	0.072 FFEP	95% TC Spiral + Foil	.009 PLN-PVC	.240	16	83%	100 200 400 1000	5.10 7.40 11.80 21.40	SV-PLN	
PERFECT TERMINATIONS			Cross-Section View							
Item # Part # 59 CM-RGB26-BNC 60 CM-RGB26-GBNC 61 CM-RGB26-RCA 62 CM-RGB26-GRCA SEE PAGE 163			Ripcord Coaxial Component Outer Jacket							

Bulk Wire: Residential Coax Cable

Ordering is fast & easy.



Call today!

Solutions for the AV PROFESSIONAL
www.libertycable.com

800-530-8998
INTERNATIONAL - CALL +1-719-388-7542



Serial Digital Video Cable Non-Plenum and Plenum

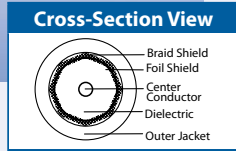

Liberty's Serial Digital video cable is the standard for speed, reliability and performance for all high-definition applications. Our specifications will meet or exceed any serial digital video requirement.

Serial Digital Video Cable

- UL Listed NEC Type CM, CMR or CMP
*INTERFLEX cables are Non-UL Rated
- Solid Bare Copper Center Conductor
- 75 Ohm
- All SDI Coaxial Cables swept to 4.5 GHz

Serial Digital Video Cables - Non-Plenum																									
AWG Center Conductor	NOM OD Dielectric (Inches)	Shield Construction	Jacket (Inches)	NOM OD (Inches)	NOM Capacitance (Pf/ft)	NOM Velocity of Propagation	NOM Attenuation		Part #																
							MHz	db100'																	
23 Solid BC	0.101 FPE	100% Bonded Foil 95% TC Braid	.019 PVC	0.165	16.5	84%	1	0.38	23-MINI-SD-* CM Rated																
							3.58	0.77																	
							10	1.29																	
							135	4.18																	
							270	5.92																	
							720	9.47																	
							1000	11.16																	
							2000	15.78																	
							3000	19.33																	
							4000	22.32																	
4500	23.67																								
<div style="display: flex; align-items: center;"> <div style="border: 1px solid black; padding: 2px; margin-right: 5px;"> PERFECT CONNECTOR MATCHES <table border="1"> <thead> <tr> <th>ITEM #</th> <th>PART #</th> </tr> </thead> <tbody> <tr> <td>1</td> <td>CM-RGB23-BNC</td> </tr> <tr> <td>2</td> <td>CM-RGB23-RCA</td> </tr> <tr> <td>3</td> <td>CM-RGB23-GRCA</td> </tr> </tbody> </table> </div> </div>										ITEM #	PART #	1	CM-RGB23-BNC	2	CM-RGB23-RCA	3	CM-RGB23-GRCA								
ITEM #	PART #																								
1	CM-RGB23-BNC																								
2	CM-RGB23-RCA																								
3	CM-RGB23-GRCA																								
*Available in Ten Different Colors: 																									
20 Solid BC	0.145 FPE	100% Bonded Foil 95% TC Braid	.032 PVC	.240	16.2	82%	1	0.38	INTERFLEX-SD-* Non-UL Rated Custom Interconnect manufacture and rack interconnection																
							3.58	0.77																	
							10	1.29																	
							135	4.18																	
							270	5.92																	
							720	9.47																	
							1000	11.16																	
							2000	15.78																	
							3000	19.33																	
							4000	22.32																	
4500	23.67																								
<div style="display: flex; align-items: center;"> <div style="border: 1px solid black; padding: 2px; margin-right: 5px;"> PERFECT TERMINATIONS <table border="1"> <thead> <tr> <th>Item #</th> <th>Part #</th> <th>Item #</th> <th>Part #</th> </tr> </thead> <tbody> <tr> <td>25</td> <td>CM-RG59U-RCA</td> <td>28</td> <td>CM-RG59U-GBNC</td> </tr> <tr> <td>26</td> <td>CM-RG59U-GRCA</td> <td>29</td> <td>CM-RG59U-F</td> </tr> <tr> <td>27</td> <td>CM-RG59U-BNC</td> <td>30</td> <td>CM-RG-59U-GF</td> </tr> </tbody> </table> </div> </div>										Item #	Part #	Item #	Part #	25	CM-RG59U-RCA	28	CM-RG59U-GBNC	26	CM-RG59U-GRCA	29	CM-RG59U-F	27	CM-RG59U-BNC	30	CM-RG-59U-GF
Item #	Part #	Item #	Part #																						
25	CM-RG59U-RCA	28	CM-RG59U-GBNC																						
26	CM-RG59U-GRCA	29	CM-RG59U-F																						
27	CM-RG59U-BNC	30	CM-RG-59U-GF																						
*Available in Seven Different Colors: 																									
(2) 20 Solid BC	0.145 FPE	100% Foil + 95% TC Braid	.032 PVC	0.24	16.2	82%	1	0.38	IF-SD-*-100M Non-UL Rated Custom Interconnect manufacture and rack interconnection																
							3.58	0.77																	
							10	1.29																	
							135	4.18																	
							270	5.92																	
							720	9.47																	
							1000	11.16																	
							2000	15.78																	
							3000	19.33																	
							4000	22.32																	
4500	23.67																								
<div style="display: flex; align-items: center;"> <div style="border: 1px solid black; padding: 2px; margin-right: 5px;"> PERFECT TERMINATIONS <table border="1"> <thead> <tr> <th>Item #</th> <th>Part #</th> <th>Item #</th> <th>Part #</th> </tr> </thead> <tbody> <tr> <td>25</td> <td>CM-RG59U-RCA</td> <td>28</td> <td>CM-RG59U-GBNC</td> </tr> <tr> <td>26</td> <td>CM-RG59U-GRCA</td> <td>29</td> <td>CM-RG59U-F</td> </tr> <tr> <td>27</td> <td>CM-RG59U-BNC</td> <td>30</td> <td>CM-RG-59U-GF</td> </tr> </tbody> </table> </div> <div style="margin-left: 20px;"> <p>International Available in same colors as INTERFLEX-SD above. 100 meter spool.</p> </div> </div>										Item #	Part #	Item #	Part #	25	CM-RG59U-RCA	28	CM-RG59U-GBNC	26	CM-RG59U-GRCA	29	CM-RG59U-F	27	CM-RG59U-BNC	30	CM-RG-59U-GF
Item #	Part #	Item #	Part #																						
25	CM-RG59U-RCA	28	CM-RG59U-GBNC																						
26	CM-RG59U-GRCA	29	CM-RG59U-F																						
27	CM-RG59U-BNC	30	CM-RG-59U-GF																						
<div style="display: flex; align-items: center;"> <div style="border: 1px solid black; padding: 2px; margin-right: 5px;"> PERFECT TERMINATIONS <table border="1"> <thead> <tr> <th>Item #</th> <th>Part #</th> <th>Item #</th> <th>Part #</th> </tr> </thead> <tbody> <tr> <td>25</td> <td>CM-RG59U-RCA</td> <td>28</td> <td>CM-RG59U-GBNC</td> </tr> <tr> <td>26</td> <td>CM-RG59U-GRCA</td> <td>29</td> <td>CM-RG59U-F</td> </tr> <tr> <td>27</td> <td>CM-RG59U-BNC</td> <td>30</td> <td>CM-RG-59U-GF</td> </tr> </tbody> </table> </div> </div>										Item #	Part #	Item #	Part #	25	CM-RG59U-RCA	28	CM-RG59U-GBNC	26	CM-RG59U-GRCA	29	CM-RG59U-F	27	CM-RG59U-BNC	30	CM-RG-59U-GF
Item #	Part #	Item #	Part #																						
25	CM-RG59U-RCA	28	CM-RG59U-GBNC																						
26	CM-RG59U-GRCA	29	CM-RG59U-F																						
27	CM-RG59U-BNC	30	CM-RG-59U-GF																						

Ordering is fast & easy.



Call today!

Solutions for the AV PROFESSIONAL
www.libertycable.com

800-530-8998
INTERNATIONAL - CALL +1-719-388-7542



Serial Digital Video Cable Non-Plenum and Plenum

Bulk Wire: Residential Coax Cable

Serial Digital Video Cables, Non-Plenum																																	
AWG Center Conductor	NOM OD Dielectric (Inches)	Shield Construction	Jacket (Inches)	NOM OD (Inches)	NOM Capacitance (Pf/ft)	NOM Velocity of Propagation	NOM Attenuation		Part #																								
							MHz	db100'																									
20 Solid BC	0.145 FPE	100% Bonded Foil 95% TC Braid	.032 FR-PVC	240	16.2	82%	1	0.38	20-CMR-VIDEO-* CMR Rated																								
							3.58	0.77																									
							10	1.29																									
							135	4.18																									
							270	5.92																									
							720	9.47																									
							1000	11.16																									
							2000	15.78																									
							3000	19.33																									
							4000	22.32																									
							4500	23.67																									
							PERFECT TERMINATIONS <table border="1"> <thead> <tr> <th>Item #</th> <th>Part #</th> <th>Item #</th> <th>Part #</th> </tr> </thead> <tbody> <tr> <td>25</td> <td>CM-RG59U-RCA</td> <td>28</td> <td>CM-RG59U-GBNC</td> </tr> <tr> <td>26</td> <td>CM-RG59U-GRCA</td> <td>29</td> <td>CM-RG59U-F</td> </tr> <tr> <td>27</td> <td>CM-RG59U-BNC</td> <td>30</td> <td>CM-RG-59U-GF</td> </tr> </tbody> </table>										Item #	Part #	Item #	Part #	25	CM-RG59U-RCA	28	CM-RG59U-GBNC	26	CM-RG59U-GRCA	29	CM-RG59U-F	27	CM-RG59U-BNC	30	CM-RG-59U-GF	
							Item #	Part #		Item #	Part #																						
25	CM-RG59U-RCA	28	CM-RG59U-GBNC																														
26	CM-RG59U-GRCA	29	CM-RG59U-F																														
27	CM-RG59U-BNC	30	CM-RG-59U-GF																														
18 Solid BC	0.180 FPE	100% Bonded Foil 95% TC Braid	.032 FR-PVC	0.272	16.2	82%	1	0.25	18-CMR-SD-* CMR Rated																								
							3.58	0.45																									
							10	0.72																									
							135	2.25																									
							270	3.10																									
							720	5.30																									
							1000	6.35																									
							2000	9.40																									
							3000	11.64																									
							4000	13.78																									
							4500	14.78																									
							PERFECT TERMINATIONS <table border="1"> <thead> <tr> <th>Item #</th> <th>Part #</th> <th>Item #</th> <th>Part #</th> </tr> </thead> <tbody> <tr> <td>7</td> <td>CM-RG6Q-RCA</td> <td>10</td> <td>CM-RG6Q-GBNC</td> </tr> <tr> <td>8</td> <td>CM-RG6Q-GRCA</td> <td>11</td> <td>CM-RG6Q-F</td> </tr> <tr> <td>9</td> <td>CM-RG6Q-BNC</td> <td>12</td> <td>CM-RG6Q-GF</td> </tr> </tbody> </table>										Item #	Part #	Item #	Part #	7	CM-RG6Q-RCA	10	CM-RG6Q-GBNC	8	CM-RG6Q-GRCA	11	CM-RG6Q-F	9	CM-RG6Q-BNC	12	CM-RG6Q-GF	
							Item #	Part #		Item #	Part #																						
7	CM-RG6Q-RCA	10	CM-RG6Q-GBNC																														
8	CM-RG6Q-GRCA	11	CM-RG6Q-F																														
9	CM-RG6Q-BNC	12	CM-RG6Q-GF																														
14 Solid BC	0.285 FPE	Foil + 95% TC Braid	0.045 FR-PVC	0.405 BLK	16	82%	1	0.16	RG11-EX-SD CMR Rated																								
							3.6	0.30																									
							10	0.49																									
							71.5	1.12																									
							135	1.49																									
							270	2.10																									
							360	2.41																									
							720	3.48																									
							1000	4.30																									
							1500	5.27																									

Serial Digital Video Cables, Plenum																																	
AWG Center Conductor	NOM OD Dielectric (Inches)	Shield Construction	Jacket (Inches)	NOM OD (Inches)	NOM Capacitance (Pf/ft)	NOM Velocity of Propagation	NOM Attenuation		Part #																								
							MHz	db100'																									
20 Solid BC	0.135 FFEP	100% Foil 95% TC Braid	.016 PL-PVC	.207	16.1	84%	1	0.30	20-CMP-VID-COAX* CMP Rated																								
							3.58	0.54																									
							10	0.88																									
							135	2.90																									
							270	4.16																									
							720	7.61																									
							1000	9.31																									
							2000	13.99																									
							3000	18.24																									
							4000	21.06																									
							4500	22.34																									
							PERFECT TERMINATIONS <table border="1"> <thead> <tr> <th>Item #</th> <th>Part #</th> <th>Item #</th> <th>Part #</th> </tr> </thead> <tbody> <tr> <td>43</td> <td>CM-RG59P-RCA</td> <td>46</td> <td>CM-RG59P-GBNC</td> </tr> <tr> <td>44</td> <td>CM-RG59P-GRCA</td> <td>47</td> <td>CM-RG59P-F</td> </tr> <tr> <td>45</td> <td>CM-RG59P-BNC</td> <td>48</td> <td>CM-RG59P-GF</td> </tr> </tbody> </table>										Item #	Part #	Item #	Part #	43	CM-RG59P-RCA	46	CM-RG59P-GBNC	44	CM-RG59P-GRCA	47	CM-RG59P-F	45	CM-RG59P-BNC	48	CM-RG59P-GF	
							Item #	Part #		Item #	Part #																						
43	CM-RG59P-RCA	46	CM-RG59P-GBNC																														
44	CM-RG59P-GRCA	47	CM-RG59P-F																														
45	CM-RG59P-BNC	48	CM-RG59P-GF																														
18 Solid BC	0.170 FFEP	100% Foil 95% TC Braid	0.015 PL-PVC	.237	16.1	84%	1	0.26	18-CMP-VID-COAX* CMP Rated																								
							3.58	0.47																									
							10	0.70																									
							135	2.39																									
							270	3.40																									
							720	6.05																									
							1000	7.45																									
							2000	10.26																									
							3000	13.07																									
							4000	15.09																									
							4500	16.01																									
							PERFECT TERMINATIONS <table border="1"> <thead> <tr> <th>Item #</th> <th>Part #</th> <th>Item #</th> <th>Part #</th> </tr> </thead> <tbody> <tr> <td>19</td> <td>CM-RG6P-RCA</td> <td>22</td> <td>CM-RG6P-GBNC</td> </tr> <tr> <td>20</td> <td>CM-RG6P-GRCA</td> <td>23</td> <td>CM-RG6P-F</td> </tr> <tr> <td>21</td> <td>CM-RG6P-BNC</td> <td>24</td> <td>CM-RG6P-GF</td> </tr> </tbody> </table>										Item #	Part #	Item #	Part #	19	CM-RG6P-RCA	22	CM-RG6P-GBNC	20	CM-RG6P-GRCA	23	CM-RG6P-F	21	CM-RG6P-BNC	24	CM-RG6P-GF	
							Item #	Part #		Item #	Part #																						
19	CM-RG6P-RCA	22	CM-RG6P-GBNC																														
20	CM-RG6P-GRCA	23	CM-RG6P-F																														
21	CM-RG6P-BNC	24	CM-RG6P-GF																														
14 Solid BC	0.280 FFEP	100% Foil 95% TC Braid	.018 PVDF	.352	16.0	82%	1	0.11	RG11-EX-PLN CMP Rated																								
							3.58	0.28																									
							10	0.45																									
							135	1.54																									
							270	2.28																									
							720	4.23																									
							1000	5.39																									
1500	7.30																																
23 AWG Solid BC	0.100 FFEP	100% Foil 95% TC Braid	.016 PL-PVC	.159	16.4	83%	1	0.33	23-MINI-CMP-* CMP Rated (Black, White)																								
							3.58	0.64																									
							10	1.07																									
							135	4.17																									
							270	6.08																									
							720	10.58																									
							1000	12.83																									
							2000	19.51																									
							3000	25.19																									
							4000	29.09																									
4500	32.79																																

*Plenum & Non-Plenum Stocked in Six Different Colors:



Ordering is fast & easy.



Call today!

Solutions for the AV PROFESSIONAL
www.libertycable.com

800-530-8998
INTERNATIONAL - CALL +1-719-388-7542



Control Cable Individually Shielded - Non - Plenum

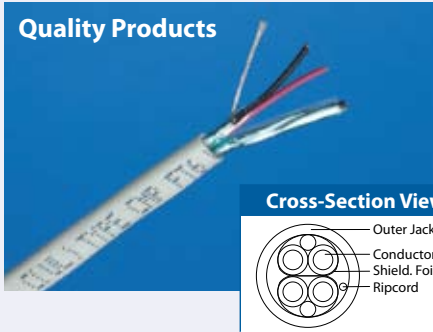

Multi-Pair/Individually Shielded w/Drain Wire

- UL Listed NEC Type CL3R or CMR
- Bare Copper Stranded Conductors
- PVC Insulation
- Each Pair Foil Shielded with Stranded TC Drain
- Gray PVC Jacket
- Sequential Footmarks
- Ripcord
- See Color Code Charts on Page 241

Non-Plenum Individually Shielded Control Cable

# of pairs	AWG Size/ Stranding	NOM Insulation (Inches)	NOM Jacket (Inches)	NOM OD (Inches)	Part #
2	18 (7x26)	0.01	0.020	0.281	18-2P-INDSH-GRY
3	18 (7x26)	0.01	0.020	0.299	18-3P-INDSH-GRY
6	18 (7x26)	0.01	0.025	0.395	18-6P-INDSH-GRY
2	20 (7x28)	0.01	0.020	0.250	20-2P-INDSH-GRY
3	20 (7x28)	0.01	0.020	0.268	20-3P-INDSH-GRY
2	22 (7x30)	0.01	0.020	0.220	22-2P-INDSH-GRY
3	22 (7x30)	0.01	0.020	0.234	22-3P-INDSH-GRY
4	22 (7x30)	0.01	0.025	0.266	22-4P-INDSH-GRY
6	22 (7x30)	0.01	0.025	0.318	22-6P-INDSH-GRY

All above cables can be produced with colored jackets.

Control Cable Shielded - Non - Plenum

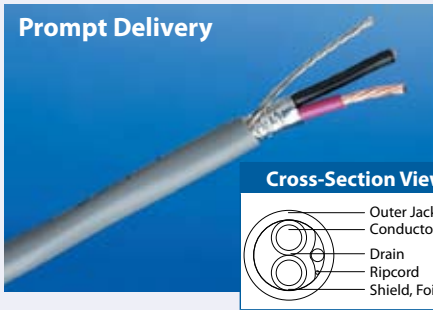

Non-Plenum/Overall Shield w/Drain Wire

- UL Listed NEC Type CL3R or CMR
- Bare Copper Stranded Conductors
- Overall Foil Shield with Stranded TC Drain
- PVC Insulation
- Gray PVC Jacket
- Sequential Footmarks
- Ripcord
- See Color Code Charts on Page 241

Non-Plenum/Overall Shield w/Drain Wire

# of conductors	AWG Size/ Stranding	NOM Insulation (Inches)	NOM Jacket (Inches)	NOM OD (Inches)	Part #
2	12 (19x25)	0.014	0.025	0.282	12-2C-SH-GRY
2	14 (19x27)	0.014	0.025	0.248	14-2C-SH-GRY
2	16 (19x29)	0.01	0.020	0.192	16-2C-SH-GRY
4	16 (19x29)	0.01	0.020	0.245	16-4C-SH-GRY
2	18 (7x26)	0.01	0.020	0.169	18-2C-SH-GRY
3	18 (7x26)	0.01	0.025	0.289	18-3C-SH-GRY
4	18 (7x26)	0.01	0.025	0.316	18-4C-SH-GRY
5	18 (7x26)	0.01	0.020	0.224	18-5C-SH-GRY
6	18 (7x26)	0.01	0.020	0.253	18-6C-SH-GRY
2	20 (7x28)	0.01	0.020	0.152	20-2C-SH-GRY
3	20 (7x28)	0.01	0.025	0.262	20-3C-SH-GRY
4	20 (7x28)	0.01	0.025	0.286	20-4C-SH-GRY
3	22 (7x30)	0.01	0.020	0.224	22-3C-SH-GRY
6	22 (7x30)	0.01	0.020	0.197	22-6C-SH-GRY

All of the above cables can be produced with colored jackets. Data grade available in these cables using Polyethylene or Polypropylene insulations.

Ordering is fast & easy.



Call today!

Solutions for the
AV PROFESSIONAL

www.libertycable.com

800-530-8998

INTERNATIONAL - CALL +1-719-388-7542



Fiber Optic Solutions

Whether you are working in a residential or commercial environment. Liberty offers a wide variety of AV Fiber Solutions which are designed to keep you both competitive and profitable.

Fiber Optic Solutions:

- Bulk Fiber
- Bulk Fiber Connectors
- Field Termination Kits
- Molded & Custom Fiber Assemblies
- Electronics Using Fiber Connections

No matter how complex or simple your installation needs are, Liberty has the expertise to provide you with the right products and information for both your fiber optic cable, custom or molded fiber optic assembly and fiber optic connector needs.

Liberty's team of skilled technicians and application engineers provide solutions that reduce your in-field labor headaches and guarantee flawless performance.

Bulk Fiber



Custom fiber optic cable is available in any unique or hard-to-find combination. Call for details so that we can provide a quote.

Liberty's Best Selling Bulk Break Out Fiber Cables	
Description:	Part #:
2 Multimode fiber, riser rated, indoor/outdoor rated, break out cable	2FRIOMM6-BO
4 Multimode fiber, riser rated, indoor/outdoor rated, break out cable	4FRIOMM6-BO

Liberty's Best Selling Bulk Distribution Fiber Cables	
Description:	Part #:
2 Multimode fiber, riser rated, indoor/outdoor rated, distribution cable	2FRIOMM6-D
4 Multimode fiber, riser rated, indoor/outdoor rated, distribution cable	4FRIOMM6-D
6 Multimode fiber, riser rated, indoor/outdoor rated, distribution cable	6FRIOMM6-D

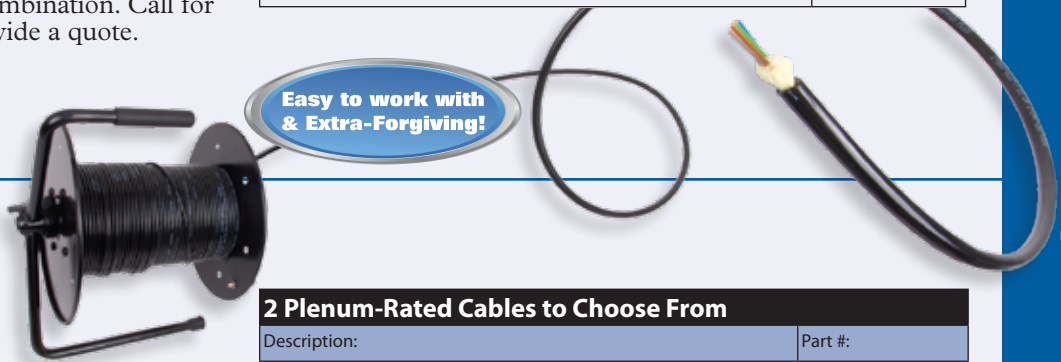

Durable Fiber

Liberty durable fiber optic cables are virtually unbreakable and are among the most flexible in the industry.

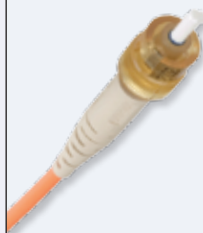

2 Plenum-Rated Cables to Choose From	
Description:	Part #:
6 multimode, plenum, indoor / outdoor rated, tight buffered	6FPIOMM6-D
6 multimode, plenum, interlocking armored, indoor/outdoor rated, no interduct needed, tight buffered	6FPIOMM6-DA

Bulk Connectors SC, ST, LC Connectors sold as singles or in bulk organizer packs of 25

SC Part # 95-000-41 	ST Part # 95-000-51 	LC Part # 95-000-99 
---	---	---

Fiber Connector Organizer Packs		
Connector	Description	Part #:
	Organizer Packs	
SC PLUG	UNICAM 62.5 MM 25-PK	95-000-41-Z
ST PLUG	UNICAM 62.5 MM 25-PK	95-000-51-Z
LC PLUG	UNICAM 62.5 MM 25-PK	95-000-99-Z



Bulk organizer packs of 25 provide a convenient reusable carrying-case for all fiber connectors

Works Perfectly With Corning™ Field Termination Kit on Next Page

Ordering is fast & easy.



Call today!

Solutions for the AV PROFESSIONAL
www.libertycable.com

800-530-8998
INTERNATIONAL - CALL +1-719-388-7542



Corning™ Field Termination Kit For Perfect Fiber Terminations

The UniCam Pretium™ Tool Kit can be used with multimode or single-mode LC, SC and ST® Compatible UniCam Connectors.

Everything You Need!

- Perfect fiber terminations in one minute.
- No Polishing • No Headaches!



Part #: TKT-UNICAM-PFC



Step 1 : Place the Connector in the Tool



Step 2 : Prepare the Fiber



Step 3 : Clean the Fiber



Step 4 : Cut Fiber to Proper Length



Step 5 : Crimp the Connectors onto the Fiber



Step 6 : Test for Your Perfect Termination

UniCam Pretium Tool Kit includes:

- | | |
|--|---------------------|
| 1) Durable Kit | 6) Fiber Wipes |
| 2) Detailed instructions and DVD | 7) Fiber Cleaner |
| 3) Hook allows the kit to hang on the job site | 8) Marking Pen |
| 4) Hand-Held Termination Tool | 9) Crimp Tool |
| 5) Hand-Held Fiber Cleaver | 10) Kevlar Scissors |
| | 11) T-stripper |
| | 12) Buffer Stripper |

Ordering is fast & easy.



Call today!

Solutions for the AV PROFESSIONAL
www.libertycable.com

800-530-8998
INTERNATIONAL - CALL +1-719-388-7542



Termination Kit Connectors

SC Connectors	
95-000-41	UniCam Pretium-Performance SC Connector 62.5µm, Ceramic Ferrule , Logo, Single Pack
95-000-41-Z	UniCam Pretium-Performance SC Connector 62.5µm, Ceramic Ferrule , Logo, Organizer Pack of 25
95-050-41	UniCam Pretium-Performance SC Connector 50µm, Ceramic Ferrule , Logo, Single Pack
95-050-41-X	UniCam Pretium-Performance SC Connector 50µm SX+, Ceramic Ferrule , Logo, Single Pack
95-050-41-X-Z	UniCam Pretium-Performance SC Connector 50µm SX+, Ceramic Ferrule , Logo, Organizer Pack of 25
95-050-41-Z	UniCam Pretium-Performance SC Connector 50µm, Ceramic Ferrule , Logo, Organizer Pack of 25
95-200-41	UniCam Pretium-Performance SC Connector SM SPC, Ceramic Ferrule , Logo, Single Pack
95-200-41-Z	UniCam Pretium-Performance SC Connector SM SPC, Ceramic Ferrule , Logo, Organizer Pack of 25
95-200-42	UniCam Pretium-Performance SC Connector SM UPC, Ceramic Ferrule , Logo, Single Pack
ST® Compatible Connectors	
95-000-51	UniCam Pretium-Performance ST Connector 62.5µm, Ceramic Ferrule , Logo, Single Pack
95-000-51-Z	UniCam Pretium-Performance ST Connector 62.5µm, Ceramic Ferrule , Logo, Organizer Pack of 25
95-050-51	UniCam Pretium-Performance ST Connector 50µm, Ceramic Ferrule , Logo, Single Pack
95-050-51-X	UniCam Pretium-Performance ST Connector 50µm SX+, Ceramic Ferrule , Logo, Single Pack
95-050-51-Z	UniCam Pretium-Performance ST Connector 50µm, Ceramic Ferrule , Logo, Organizer Pack of 25
95-200-51	UniCam Pretium-Performance ST Connector SM SPC, Ceramic Ferrule , Logo, Single Pack
95-200-51-Z	UniCam Pretium-Performance ST Connector SM SPC, Ceramic Ferrule , Logo, Organizer Pack of 25
95-200-52	UniCam Pretium-Performance ST Connector SM UPC, Ceramic Ferrule , Logo, Single Pack
LC Connectors	
95-000-99	UniCam Pretium-Performance LC Connector 62.5µm, Ceramic Ferrule, Logo, Single Pack
95-000-99-Z	UniCam Pretium-Performance LC Connector 62.5µm, Ceramic Ferrule, Logo, Organizer Pack of 25
95-050-99	UniCam Pretium-Performance LC Connector 50µm, Ceramic Ferrule, Logo, Single Pack
95-050-99-X	UniCam Pretium-Performance LC Connector 50µm SX+, Ceramic Ferrule, Logo, Single Pack
95-050-99-X-Z	UniCam Pretium-Performance LC Connector 50µm SX+, Ceramic Ferrule, Logo, Organizer Pack of 25
95-050-99-Z	UniCam Pretium-Performance LC Connector 50µm, Ceramic Ferrule, Logo, Organizer Pack of 25
95-200-99	UniCam Pretium-Performance LC Connector SM UPC, Ceramic Ferrule, Logo, Single Pack
95-200-99-Z	UniCam Pretium-Performance LC Connector SM UPC, Ceramic Ferrule, Logo, Organizer Pack of 25

**Don't see the connector you need?
Liberty offers a full line of Corning Pretium Connectors.
Contact your Liberty representative for
part numbers and selection.**

Bulk Wire: Residential Fiber Optic

Ordering is fast & easy.



Call today!

**Solutions for the
AV PROFESSIONAL**
www.libertycable.com

800-530-8998
INTERNATIONAL - CALL +1-719-388-7542



Custom Manufactured Fiber Assemblies

Liberty removes the guess work when working with fiber assemblies. Our fiber optic products are manufactured to standards that consistently perform above industry standards.

As a Certified Corning Gold™ manufacturer, Liberty's custom fiber assemblies are unmatched in the AV industry for performance, reliability and value.

Custom Fiber Optic Features:

- Each assembly is 100% tested
- Kitting Options are available
- All products carry a full warranty
- Designed for easy Plug & Play

1. Custom Patch Cords

- Available in any length
- Simplex and duplex jumpers
- Pigtailed available
- Unparalleled selection of connector types
- Corning Gold™ assemblies available
- Standard PC polish
- Ultra-PC polish
- Angled PC available



2. Multi-Fiber Cable Assemblies

- Available in any length
- 50 / 125 μm 10Gbps multimode
- 50 / 125 μm multimode
- 62.5 / 125 μm multimode
- 100 / 140 μm multimode
- Single mode available
- Pulling sheaths are available



Custom Fiber Optic Project Services

Liberty's team of experienced sales professionals and trained fiber technicians can design solutions that will work for every type of fiber optic installation.

We can accommodate:

- High Fiber Counts
- Standard and Nonstandard Lengths Requirements
- Unusual and Usual Jacket Requirements
- Packaging Demands
- Kitting Options

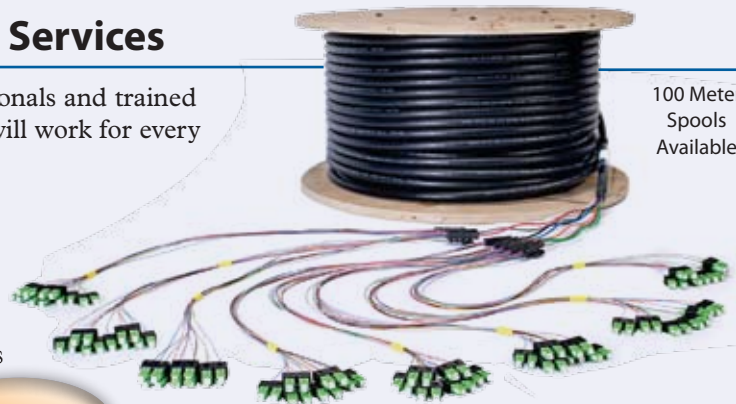

100 Meter
Spools
Available

**NO REQUEST
TOO EXTREME!**

Our highly trained staff works from any type of specification, layout or project need.

Call us today to discuss your next fiber project.

WE PROVIDE FREE PROJECT ASSISTANCE!

Ordering is fast & easy.



Call today!

**Solutions for the
AV PROFESSIONAL**
www.libertycable.com

800-530-8998
INTERNATIONAL - CALL +1-719-388-7542

Molded Fiber Optic Cable Assemblies

Professional's Top Choice for Single and Multimode Fiber Assemblies

Liberty's molded fiber optic assemblies are an economic solution to your installation's fiber optic needs. Designed for flawless performance, our molded fiber optic assemblies provide maximum efficiency to your installation.

Liberty's Molded Fiber Optic Assemblies:

- 100% tested
- Cost Effective
- Available in most common formats

Single Mode Fiber Optic Assemblies

1. SC to SC

Length	Part #
1 meter	DSMSCSC-001M
2 meter	DSMSCSC-002M
3 meter	DSMSCSC-003M
5 meter	DSMSCSC-005M
10 meter	DSMSCSC-010M



4. LC to LC

Length	Part #
1 meter	DSMLCLC-001M
2 meter	DSMLCLC-002M
3 meter	DSMLCLC-003M
5 meter	DSMLCLC-005M
10 meter	DSMLCLC-010M

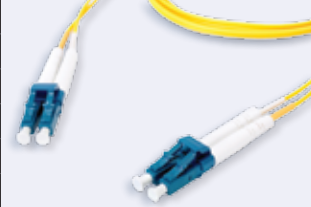

2. ST to ST

Length	Part #
1 meter	DSMSTST-001M
2 meter	DSMSTST-002M
3 meter	DSMSTST-003M
5 meter	DSMSTST-005M
10 meter	DSMSTST-010M



5. LC to SC

Length	Part #
1 meter	DSMLCSC-001M
2 meter	DSMLCSC-002M
3 meter	DSMLCSC-003M
5 meter	DSMLCSC-005M
10 meter	DSMLCSC-010M



3. ST to SC

Length	Part #
1 meter	DSMSTSC-001M
2 meter	DSMSTSC-002M
3 meter	DSMSTSC-003M
5 meter	DSMSTSC-005M
10 meter	DSMSTSC-010M



6. LC to ST

Length	Part #
1 meter	DSMLCST-001M
2 meter	DSMLCST-002M
3 meter	DSMLCST-003M
5 meter	DSMLCST-005M
10 meter	DSMLCST-010M



Multimode Fiber Optic Assemblies 50 / 125 μm

1. SC to SC 50 / 125 μm

Length	Part #
1 meter	DMM5SCSC-001M
2 meter	DMM5SCSC-002M
3 meter	DMM5SCSC-003M
5 meter	DMM5SCSC-005M
10 meter	DMM5SCSC-010M



3. ST to SC 50 / 125 μm

Length	Part #
1 meter	DMM5STSC-001M
2 meter	DMM5STSC-002M
3 meter	DMM5STSC-003M
5 meter	DMM5STSC-005M
10 meter	DMM5STSC-010M



2. ST to ST 50 / 125 μm

Length	Part #
1 meter	DMM5STST-001M
2 meter	DMM5STST-002M
3 meter	DMM5STST-003M
5 meter	DMM5STST-005M
10 meter	DMM5STST-010M



4. LC to LC 50 / 125 μm

Length	Part #
1 meter	DMM5LCLC-001M
2 meter	DMM5LCLC-002M
3 meter	DMM5LCLC-003M
5 meter	DMM5LCLC-005M
10 meter	DMM5LCLC-010M



Ordering is fast & easy.

Call today!

Solutions for the AV PROFESSIONAL **800-530-8998** **Liberty AV Solutions**

www.libertycable.com INTERNATIONAL - CALL +1-719-388-7542

Specifications Subject to Change

Multimode Fiber Optic Assemblies 50 / 125 μ m

5. LC to SC 50 / 125 μ m

Length	Part #
1 meter	DMM5LCSC-001M
2 meter	DMM5LCSC-002M
3 meter	DMM5LCSC-003M
5 meter	DMM5LCSC-005M
10 meter	DMM5LCSC-010M



6. LC to ST 50 / 125 μ m

Length	Part #
1 meter	DMM5LCST-001M
2 meter	DMM5LCST-002M
3 meter	DMM5LCST-003M
5 meter	DMM5LCST-005M
10 meter	DMM5LCST-010M

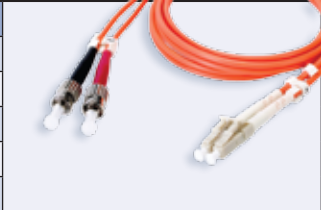

Multimode Fiber Optic Assemblies 62.5 / 125 μ m

1. SC to SC 62.5 / 125 μ m

Length	Part #
1 meter	DMM6SCSC-001M
2 meter	DMM6SCSC-002M
3 meter	DMM6SCSC-003M
5 meter	DMM6SCSC-005M
10 meter	DMM6SCSC-010M



6. MTRJ to SC 62.5 / 125 μ m

Length	Part #
1 meter	DMM6MTSC-001M
2 meter	DMM6MTSC-002M
3 meter	DMM6MTSC-003M
5 meter	DMM6MTSC-005M
10 meter	DMM6MTSC-010M



2. ST to ST 62.5 / 125 μ m

Length	Part #
1 meter	DMM6STST-001M
2 meter	DMM6STST-002M
3 meter	DMM6STST-003M
5 meter	DMM6STST-005M
10 meter	DMM6STST-010M



7. LC to LC 62.5mm / 125 μ m

Length	Part #
1 meter	DMM6LCLC-001M
2 meter	DMM6LCLC-002M
3 meter	DMM6LCLC-003M
5 meter	DMM6LCLC-005M
10 meter	DMM6LCLC-010M



3. ST to SC 62.5 / 125 μ m

Length	Part #
1 meter	DMM6STSC-001M
2 meter	DMM6STSC-002M
3 meter	DMM6STSC-003M
5 meter	DMM6STSC-005M
10 meter	DMM6STSC-010M



8. LC to SC 62.5 / 125 μ m

Length	Part #
1 meter	DMM6LCSC-001M
2 meter	DMM6LCSC-002M
3 meter	DMM6LCSC-003M
5 meter	DMM6LCSC-005M
10 meter	DMM6LCSC-010M



4. MTRJ to MTRJ 62.5 / 125 μ m

Length	Part #
1 meter	DMM6MTMT-001M
2 meter	DMM6MTMT-002M
3 meter	DMM6MTMT-003M
5 meter	DMM6MTMT-005M
10 meter	DMM6MTMT-010M



9. LC to ST 62.5 / 125 μ m

Length	Part #
1 meter	DMM6LCST-001M
2 meter	DMM6LCST-002M
3 meter	DMM6LCST-003M
5 meter	DMM6LCST-005M
10 meter	DMM6LCST-010M



5. MTRJ to ST 62.5 / 125 μ m

Length	Part #
1 meter	DMM6MTST-001M
2 meter	DMM6MTST-002M
3 meter	DMM6MTST-003M
5 meter	DMM6MTST-005M
10 meter	DMM6MTST-010M



Custom fiber assemblies are available in any connector or length!

Ordering is fast & easy.



Call today!

Solutions for the AV PROFESSIONAL

www.libertycable.com

800-530-8998

INTERNATIONAL - CALL +1-719-388-7542



Multimode Fiber Optic Assemblies 10 Gig 50 / 125µm

1. SC to SC 10 Gig 50mm / 125µm

Length	Part #
1 meter	DMM10SCSC-001M
2 meter	DMM10SCSC-002M
3 meter	DMM10SCSC-003M
5 meter	DMM10SCSC-005M
10 meter	DMM10SCSC-010M

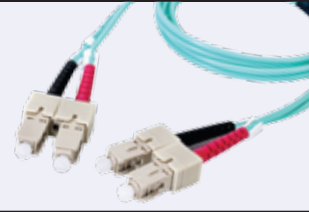

2. ST to ST 10 Gig 50mm / 125µm

Length	Part #
1 meter	DMM10STST-001M
2 meter	DMM10STST-002M
3 meter	DMM10STST-003M
5 meter	DMM10STST-005M
10 meter	DMM10STST-010M



3. ST to SC 10 Gig 50 / 125µm

Length	Part #
1 meter	DMM10STSC-001M
2 meter	DMM10STSC-002M
3 meter	DMM10STSC-003M
5 meter	DMM10STSC-005M
10 meter	DMM10STSC-010M



4. LC to LC 10 Gig 50mm / 125µm

Length	Part #
1 meter	DMM10LCLC-001M
2 meter	DMM10LCLC-002M
3 meter	DMM10LCLC-003M
5 meter	DMM10LCLC-005M
10 meter	DMM10LCLC-010M



5. LC to SC 10 Gig 50mm / 125µm

Length	Part #
1 meter	DMM10LCSC-001M
2 meter	DMM10LCSC-002M
3 meter	DMM10LCSC-003M
5 meter	DMM10LCSC-005M
10 meter	DMM10LCSC-010M



6. LC to ST 10 Gig 50mm / 125µm

Length	Part #
1 meter	DMM10LCST-001M
2 meter	DMM10LCST-002M
3 meter	DMM10LCST-003M
5 meter	DMM10LCST-005M
10 meter	DMM10LCST-010M



Additional Molded Fiber Optic Assemblies

1. Toslink Fiber Optic Interconnects (each)

Length (m)	Part #
1	ZTOS1
2	ZTOS2
4	ZTOS4
6	ZTOS6
10	ZTOS10
15	ZTOS15



2. Z-500 TOSLink Interconnect

Length (m)	Part #
1	Z500NTOS1
2	Z500NTOS2
4	Z500NTOS4
6	Z500NTOS6
10	Z500NTOS10
15	Z500NTOS15



3. Fiber Optic DVI Cables

Length (m)	Part #
10	DL-DVIDFO-10M
20	DL-DVIDFO-20M
30	DL-DVIDFO-30M
40	DL-DVIDFO-40M
50	DL-DVIDFO-50M
60	DL-DVIDFO-60M
70	DL-DVIDFO-70M
100	DL-DVIDFO-100M



DVI-D Single Link -Single Link

4. Fiber Optic HDMI Cables

Length (m)	Part #
10	DL-HDMFO-10M
20	DL-HDMFO-20M
30	DL-HDMFO-30M
40	DL-HDMFO-40M
50	DL-HDMFO-50M
60	DL-HDMFO-60M
70	DL-HDMFO-70M
100	DL-HDMFO-100M



HDMI Male - HDMI Male

Structured Cables with Multimode Fiber

1. Multimode Fiber - Structured Cable

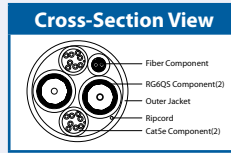
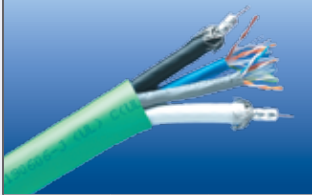

- UL Listed NEC Type CMG
- Flexible PVC Jacket
- Enhanced Category 5E Cables (350 MHz)
- Sequential Foot Marks
- Separate Multimode Fiber Optic Cables

AWG Center Conductor	NOM OD Dielectric (Inches)	Shield Construction	NOM Jacket (Inches)	NOM OD (Inches)	NOM Capacitance (Pf/ft)	NOM Velocity of Propagation	NOM Attenuation		Part #
							MHz	db100'	
18 AWG Solid BC	0.18 FPE	2 Foils +60% AL 40% AL Braid	0.026	0.287	16.2	82%	10	0.81	Element 1 2 ea QUADFLEX-BC
24 AWG Solid BC	0.036 PE		0.020	0.197	14	71%	50	1.46	Element 2 2 ea 24-4P-L5-EN (350 MHz)
							200	2.83	
							400	4.05	
							700	5.6	
62.5/125	900 micron		0.027	0.150			1000	6.59	Element 3 2 Fiber tight buffer
			0.033	0.600			1450	7.94	Overall Construction
							2200	9.77	

(2) Optical Fiber 62.5/125um Indoor Fiber Multimode Outer Diameter: .10in.

2. HDMI Fiber Optic Extender

Part # **DL-HDFO**

This unique HDMI/DVI fiber optical cable system lets your digital display (Plasma TV, Digital Projectors, LCD Monitors, HDTV, etc.) be located up to 1640 ft. (500 meters) away from the video and audio sources based on using the HDMI or DVI standard.

Our patented optical conversion technology enables noise-free and high-res (up to UXGA or 1080p) extension up to 1640 ft. (500 meters). Ideal for fishing through small conduits or other openings as the LC connectors are detachable from the device which requires only a 1/2 inch opening.



Wall Plates For Fiber Optic Cables

Liberty provides the finishing touches for any fiber optic cable installation with our custom designed and stock plates solutions.

WebBlox™ design and quoting tools let you design your own wall plates from your desktop without any software. Go from concept to completed plate design in a matter of minutes. Contact your sales professional to get started.



- Connectors:
- Quad Multi-mode LC Fiber Couplers
 - 2 Pin Phoenix Screw Terminal
 - BNC Female (75 Ohm)

Part #: **PC-G2260-E-P-C**



- Connectors:
- Duplex Multi-mode LC Fiber Couplers
 - 2 Pin Phoenix Screw Terminal

Part #: **PC-G1850-E-P-C**

WebBlox™

DESIGN AND QUOTING SOFTWARE TOOLS

Go from concept to completed plate design in a matter of minutes!

www.panelcrafters.com/cad.html

Ordering is fast & easy.



Call today!

Solutions for the AV PROFESSIONAL
www.libertycable.com

800-530-8998
INTERNATIONAL - CALL +1-719-388-7542



Speaker Cable

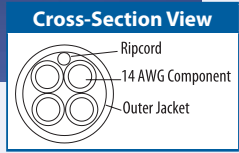
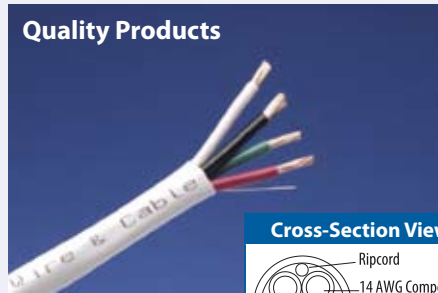

Our HomeTRAX™ speaker cable is a price performer for budget-conscious projects. Our versatile cable exceeds industry standards. All of these cables are sequentially footmarked to facilitate cable management and inventory control.

Non-Plenum Unshielded Cable

- For Distributed Audio Applications and Signal Control Installations in Accordance with NEC Article 725.
- UL Listed NEC Type CL3 or CMG
- Bare Copper Stranded Conductors
- SR-PVC Insulation, White PVC Jacket
- Sequential Footmarks
- Ripcord
- Standard 500 ft. Nested Box Packaging
- Re-Model

HomeTRAX™ Speaker Cable					
# of Conductors	AWG Size/ Stranding	NOM Insulation (Inches)	NOM Jacket (Inches)	NOM OD (Inches)	Part #
2	14 (41X30)	.010	.017	.222	14-2C-HT
4	14 (41X30)	.010	.017	.262	14-4C-HT
2	16 (41X32)	.010	.017	.191	16-2C-HT*
4	16 (41X32)	.010	.017	.224	16-4C-HT

*16-2C-HT comes in 1,000 ft. Put-ups.

AUDIOCAT Composite Cable

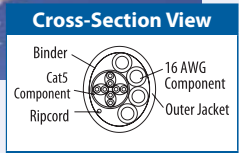
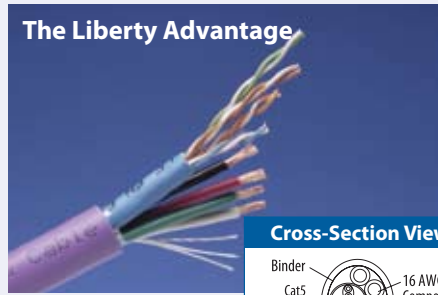

This flexibly jacketed composite cable has an Enhanced Category 5 cable sweep tested to 350 MHz and 4 conductors of high strand count 16 AWG speaker cable.

- UL Listed NEC Type CMG
- Standard 500 ft. Reel

HomeTRAX™ AUDIOCAT Composite Cable					
# of Conductors	AWG Size/ Stranding	NOM Insulation (Inches)	NOM Jacket (Inches)	NOM OD (Inches)	Part #
					AUDIOCAT-HT
8 (4 pair)	24 AWG Solid BC	.008 PE	0.02 FR-PVC	.197	Enhanced Cat 5e (350 MHz)
4	16 AWG STR BC (65x34)	.016 PVC	N/A	N/A	Speaker Cables
			.035 PVC Purple	.393	Overall Construction

Solutions for the AV PROFESSIONAL
www.libertycable.com

800-530-8998
INTERNATIONAL - CALL +1-719-388-7542



Ordering is fast & easy.



Call today!

CATV/MATV/DBS Quad Shield Video Cable

Non-Plenum

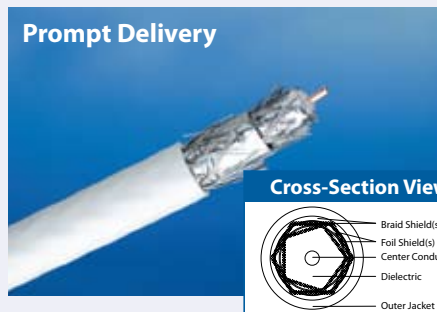

Coax - Quad (Four) Shielded

- UL Listed NEC Type CM
- Foamed Polyethylene Dielectric
- FR-PVC Jacket
- All items feature a 3.0 GHz Sweep

Non-Plenum Video Cable - CATV/MATV																									
AWG Center Conductor	NOM OD Dielectric (Inches)	Shield Construction	NOM Jacket (Inches)	NOM OD (Inches)	NOM Capacitance (Pf/ft)	NOM Velocity of Propagation	NOM Attenuation		Part #																
							MHz	db100'																	
18 Solid CCS	0.18 FPE	2 Foils + 60% AL 40% AL Braid	0.026 PVC	0.287	16.2	82%	10	0.85	QUADFLEX-BLK QUADFLEX-BLU QUADFLEX-RED QUADFLEX-WHT QUADFLEX-YEL *Available in Black, Blue, Red, White or Yellow.																
							50	1.00																	
							100	1.30																	
							200	2.05																	
							400	3.05																	
							700	5.95																	
							1000	7.55																	
							1500	10.30																	
							1450	10.10																	
							2500	12.20																	
3000	13.48																								
PERFECT TERMINATIONS <table border="1"> <tr> <th>Item #</th> <th>Part #</th> <th>Item #</th> <th>Part #</th> </tr> <tr> <td>7</td> <td>CM-RG6Q-RCA</td> <td>10</td> <td>CM-RG6Q-GBNC</td> </tr> <tr> <td>8</td> <td>CM-RG6Q-GRCA</td> <td>11</td> <td>CM-RG6Q-F</td> </tr> <tr> <td>9</td> <td>CM-RG6Q-BNC</td> <td>12</td> <td>CM-RG6Q-GF</td> </tr> </table>										Item #	Part #	Item #	Part #	7	CM-RG6Q-RCA	10	CM-RG6Q-GBNC	8	CM-RG6Q-GRCA	11	CM-RG6Q-F	9	CM-RG6Q-BNC	12	CM-RG6Q-GF
Item #	Part #	Item #	Part #																						
7	CM-RG6Q-RCA	10	CM-RG6Q-GBNC																						
8	CM-RG6Q-GRCA	11	CM-RG6Q-F																						
9	CM-RG6Q-BNC	12	CM-RG6Q-GF																						
18 Solid BC	0.18 FPE	2 Foils + 60% AL 40% AL Braid	0.026 PVC	0.287	16.2	82%	10	0.81	QUADFLEX-BC-BLK QUADFLEX-BC-WHT *Available in Black or White.																
							50	1.46																	
							200	2.83																	
							400	4.05																	
							700	5.60																	
							1000	6.59																	
							1450	7.94																	
							2200	9.77																	

Structured Cable: Everything to pre-wire a home!

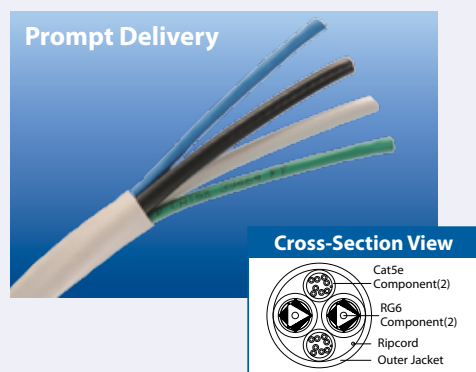

Jacketed Cable

- All Cables UL Listed NEC Type CMG
- Flexible PVC Outer Jacket
- Enhanced Category 5E Cables (350 MHz)
- Sequential Footmarks
- Standard 500 ft. Reel

The Advantage

This is the Answer for Phone, Fax, Computer and More!

Structured Cable									
AWG Center Conductor	NOM OD Dielectric (Inches)	Shield Construction	NOM Jacket (Inches)	NOM OD (Inches)	NOM Capacitance (Pf/ft)	NOM Velocity of Propagation	NOM Attenuation		Part #
							MHz	db100'	
									CEBUS-HT CMG rated
18 AWG Solid BC	0.180 FPE	100% AL Foil 60% AL Braid	.030	.272	16.2	82%	1	0.26	Element 1 RG6-BC
							50	1.46	
							200	2.83	
							400	4.05	
24 AWG Solid BC	0.036 PE		0.020	.197	14	71%	1000	6.59	Element 2 24-4P-L5-EN
							1450	8.04	
							2200	9.77	
							3000	13.26	
			0.033	.670					Overall Construction

Solutions for the AV PROFESSIONAL
www.libertycable.com

800-530-8998
 INTERNATIONAL - CALL +1-719-388-7542



Ordering is fast & easy.



Call today!

Unshielded Security Cable

The Liberty Advantage



Cross-Section View

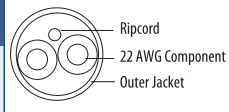

Multi-Conductor/Unshielded

- Unshielded Security, Control and Communications Wire
- UL Listed NEC Type CMG
- Bare Copper Stranded or Solid Conductors
- SR-PVC Insulation
- Sequential Footmarks
- Ripcord
- Standard 1,000 feet Nested Box

HomeTRAX™ Unshielded Security Cable

# of Conductors	AWG Size/ Stranding	NOM Insulation (Inches)	NOM Jacket (Inches)	NOM OD (Inches)	Color code	Part #
2	22 Solid BC	.010 SR-PVC	.017	.130	Red, Green	22-2C-SO-HT
2	22 STR BC(7x30)	.010 SR-PVC	0.02	.138	Red, Black	22-2C-ST-HT
4	22 Solid BC	.010 SR-PVC	.017	.142	Red, Black, Green, Yellow	22-4C-SO-HT
4	22 STR BC(7x30)	.010 SR-PVC	.017	.152	Red, Black, Green, White	22-4C-ST-HT
6	22 STR BC(7X30)	.010 SR-PVC	.017	.193	Red, Black, Green, White, Brown, and Blue	22-6C-ST-HT
8	22 STR BC(7X30)	.010 SR-PVC	.017	.214	Red, Black, Green, White, Brown, Blue, Orange, and Yellow	22-8C-ST-HT

Decora-Style Inserts & Plates provide both form and function

A project's small details are often the most noticeable to your customers and are a constant reminder of your quality standards.

Your customers expect an elegant and well-designed AV installation to have a unified look and appearance—especially when it comes to the small details of the project like wall plates. Customers expect all AV plates to match the look and feel of the electrical plates and switches in the installation.

Designed to blend in perfectly—in either a residential or commercial environment—Liberty's new Decora-Style inserts and blank plates match industry-standard colors: Almond, Black, Ivory and White.

Custom Decora-Style INSERTS & PLATES



PC-5000* PC-5100* PC-5300* PC-5600* PC-5800* PC-5850*

See Page 220-222 For Our Complete Line of Decora Inserts and Plates.

Ordering is fast & easy.



Call today!

Solutions for the AV PROFESSIONAL

www.libertycable.com

800-530-8998

INTERNATIONAL - CALL +1-719-388-7542



Category 5E UTP Cable

The Liberty Advantage

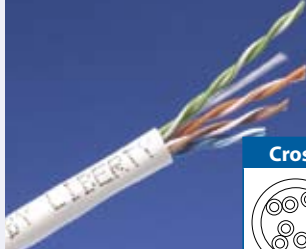

Cross-Section View



The Advantage

This is the Answer for Phone, Fax, Computer and More!

Liberty re-introduces its HomeTRAX™ line of Category UTP cable. Our new cable is tested to 100 MHz and has a CMX rating. This cable is perfect for high-speed data transmission, LAN and voice applications in residential installations only, per NEC code. A lower cost alternative to riser-rated cables, this product still is designed to meet or exceed most UTP cable application requirements.

Features and Benefits

- UL Listed NEC Type CMX
- Category 5E Tested to 100 MHz
- Exceeds TIA-EIA performance requirements
- Available in Blue or White
- Offered in a pull-box package

See Page 104

For Category Cables!

Category 5E Enhanced UTP Cable

# of Pairs	AWG Size	NOM Insulation (Inches)	NOM Jacket (Inches)	NOM OD (Inches)	NOM Capacitance Pf/ft	Part #
4	24 Solid BC	.008 PE	.0208 FR-PVC	.197	17	CAT5E-HT-BLU
4	24 Solid BC	.008 PE	.0208 FR-PVC	.197	17	CAT5E-HT-WHT

CATMASTER™ Termination System for RJ45

CATMaster™ Crimp Tool

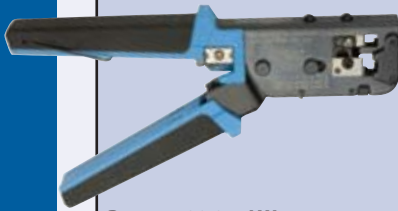

Part #: 100 044LW

This high quality crimp tool is designed to quickly crimp and cut the wires of the EZ-RJ45® Connector...in one easy simple operation! Will also work on all other RJ-11, RJ-12 and RJ-45 connectors.

- Precision ground crimp dies.
- Straight action cut and crimp performs the best crimp.
- Full cycle ratcheting mechanism provides consistent terminations every time.
- Crimps and cuts the wire in one cycle.
- Built in wire cutter and stripper.
- High strength, long life steel frame.
- Rust resistant black oxide coating.
- Superior quality at an economical price.

UTP Cable Jacket Stripper



Part #: 15010

This economical tool has been specifically designed to strip the cable jacket from UTP cables. Will not nick the inner conductors.

EZ-RJ45® Connector

The new patented EZ-RJ45® connector simplifies twisted pair terminations by allowing the wires to be inserted through the connector and out the front. This allows the technician to easily verify the proper wiring order. Electrical performance of the termination is optimized by pulling the connector down over the cable jacket and seating it tightly in the rear of the connector. Reducing the distance between the wire twists and contacts improves performance!

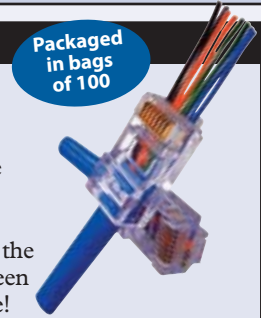

CATMaster™ Kits are Available

CATMaster™ Kits are available	
Description	Part #
<ul style="list-style-type: none"> • 1 CATMaster RJ11/RJ45 Crimp Tool • 1 CATMaster Stripper • 1 Cable Cutter • 50 CATMaster RJ-45 Connectors 	90131LW



Ordering is fast & easy.



Call today!

Solutions for the AV PROFESSIONAL

www.libertycable.com

800-530-8998

INTERNATIONAL - CALL +1-719-388-7542



RGBHV Mini 23 Solid AWG Cable Non-Plenum & Plenum

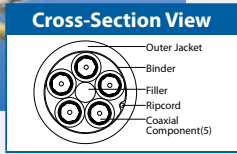
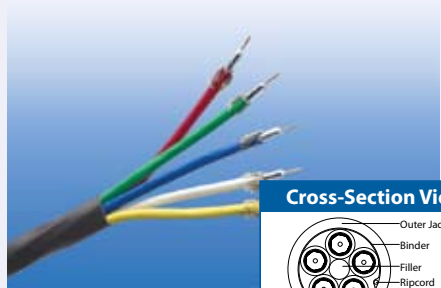

The solid center conductor construction provides better performance, in regards to signal distance and frequency response, than the typical stranded center conductor cables in the market. The solid 23 AWG cable is great for longer RGBHV cable runs and the solid 23 AWG RGBHV cable is swept to 3 GHz. The 23 AWG cable is perfect for short run, HD applications and offers premium performance for all analog video applications.

SOLID 23 AWG RGBHV CABLE - NON-PLENUM

Part#: RGB5C-23-CM CM Rated	# of Conductors	AWG Center Conductor	NOM Dielectric (Inches)	Shield Construction	NOM Jacket (Inches)	NOM OD (Inches)	NOM Capacitance (pF/ft)	NOM Velocity of Propagation	NOM Attenuation	
									MHz	db/100'
	5	23 AWG Solid BC	.100 FPE	100% Foil 95% TC Braid	.019 PVC	.165	16.5	84%	1	.38
									3.58	.77
									10	1.29
									135	4.18
									270	5.92
									720	9.47
									1000	11.16
2000	15.78									
3000	19.33									
Overall Construction 5 coaxes cabled and jacketed					.054 PVC	.540				

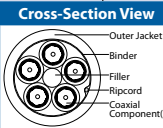

PERFECT CONNECTOR MATCHES

ITEM #	PART #
1	CM-RGB23-BNC
2	CM-RGB23-RCA
3	CM-RGB23-GRCA

SOLID 23 AWG RGBHV CABLE - PLENUM

Part#: RGB5C-23-CMP	# of Conductors	AWG Center Conductor	NOM Dielectric (Inches)	Shield Construction	NOM Jacket (Inches)	NOM OD (Inches)	NOM Capacitance (pF/ft)	NOM Velocity of Propagation	NOM Attenuation	
									MHz	db/100'
	5	23 AWG Solid BC	.101 FFEP	100% Bonded Aluminum Poly 95% 36 AWG TC Braid	.018	.465	16.4	83%	135	4.17
									270	6.08
									720	10.58
									1000	12.83
									2000	19.51
									3000	20.50

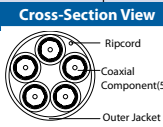

PERFECT CONNECTOR MATCHES

ITEM #	PART #
1	CM-RGB23-BNC
2	CM-RGB23-RCA
3	CM-RGB23-GRCA

ORDER YOUR
CONNECTEC
SOLID 23 AWG
CONNECTORS

1-PIECE
RCA & BNC
CONNECTORS!

Part #: CM-RGB23-BNC

Part #: CM-RGB23-RCA

Part #: CM-RGB23-GRCA

Ordering is fast & easy.



Call today!

RGBHV Mini 23 Solid AWG Cable

Non-Plenum & Plenum



SOLID 23 AWG RGB CABLE - NON-PLENUM																			
Part#: RGB3C-23-CM	# of Conductors	AWG Center Conductor	NOM Dielectric (Inches)	Shield Construction	NOM Jacket (Inches)	NOM OD (Inches)	NOM Capacitance (pF/ft)	NOM Velocity of Propagation	NOM Attenuation										
	3	23 AWG Solid BC	.100 FPE	100% Foil 95% TC Braid	.019 PVC	.165	16.5	84%	MHz	db/100'									
<div style="display: flex; justify-content: space-around;"> <div style="border: 1px solid black; padding: 5px;"> <p>Cross-Section View</p> <ul style="list-style-type: none"> Outer Jacket Binder Ripcord Coaxial Component Filler </div> <div style="border: 1px solid black; padding: 5px;"> <p>PERFECT CONNECTOR MATCHES</p> <table border="1"> <thead> <tr> <th>ITEM #</th> <th>PART #</th> </tr> </thead> <tbody> <tr> <td>1</td> <td>CM-RGB23-BNC</td> </tr> <tr> <td>2</td> <td>CM-RGB23-RCA</td> </tr> <tr> <td>3</td> <td>CM-RGB23-GRCA</td> </tr> </tbody> </table> </div> </div>										ITEM #	PART #	1	CM-RGB23-BNC	2	CM-RGB23-RCA	3	CM-RGB23-GRCA	1	.38
										ITEM #	PART #								
										1	CM-RGB23-BNC								
										2	CM-RGB23-RCA								
										3	CM-RGB23-GRCA								
										3.58	.77								
										10	1.29								
135	4.18																		
270	5.92																		
720	9.47																		
1000	11.16																		
2000	15.78																		
3000	19.33																		
Overall Construction					.054	.415													
3 coaxes cabled and jacketed					PVC														

SOLID 23 AWG RGB CABLE - PLENUM																			
Part#: RGB3C-23-CMP	# of Conductors	AWG Center Conductor	NOM Dielectric (Inches)	Shield Construction	NOM Jacket (Inches)	NOM OD (Inches)	NOM Capacitance (pF/ft)	NOM Velocity of Propagation	NOM Attenuation										
CMP Rated	5	23 AWG Solid BC	.101 FPE	100% Foil 95% TC Braid	.017 PVDF	.159	16.4	83%	MHz	db/100'									
<div style="display: flex; justify-content: space-around;"> <div style="border: 1px solid black; padding: 5px;"> <p>Cross-Section View</p> <ul style="list-style-type: none"> Outer Jacket Binder Ripcord Coaxial Component Filler </div> <div style="border: 1px solid black; padding: 5px;"> <p>PERFECT CONNECTOR MATCHES</p> <table border="1"> <thead> <tr> <th>ITEM #</th> <th>PART #</th> </tr> </thead> <tbody> <tr> <td>1</td> <td>CM-RGB23-BNC</td> </tr> <tr> <td>2</td> <td>CM-RGB23-RCA</td> </tr> <tr> <td>3</td> <td>CM-RGB23-GRCA</td> </tr> </tbody> </table> </div> </div>										ITEM #	PART #	1	CM-RGB23-BNC	2	CM-RGB23-RCA	3	CM-RGB23-GRCA	1	.33
										ITEM #	PART #								
										1	CM-RGB23-BNC								
										2	CM-RGB23-RCA								
										3	CM-RGB23-GRCA								
										10	1.07								
										100	3.55								
270	6.08																		
750	10.84																		
1000	12.83																		
2000	19.51																		
3000	25.19																		
Overall Construction					.018	.465													
3 coaxes cabled and jacketed					PVDF														

SOLID 23 AWG RGBHV COMPOSITE CABLE - NON-PLENUM																			
Part#: RGB6C-23-2L5E	# of Conductors	AWG Center Conductor	NOM Dielectric (Inches)	Shield Construction	NOM Jacket (Inches)	NOM OD (Inches)	NOM Capacitance (pF/ft)	NOM Velocity of Propagation	NOM Attenuation										
	6	23 AWG Solid BC	.100 FPE	100% Foil 95% TC Braid	.019 PVC	.165	16.5	84%	MHz	db/100'									
<div style="display: flex; justify-content: space-around;"> <div style="border: 1px solid black; padding: 5px;"> <p>Cross-Section View</p> <ul style="list-style-type: none"> Coaxial Component(6) Ripcord Binder LAN Component(2) Outer Jacket </div> <div style="border: 1px solid black; padding: 5px;"> <p>PERFECT CONNECTOR MATCHES</p> <table border="1"> <thead> <tr> <th>ITEM #</th> <th>PART #</th> </tr> </thead> <tbody> <tr> <td>1</td> <td>CM-RGB23-BNC</td> </tr> <tr> <td>2</td> <td>CM-RGB23-RCA</td> </tr> <tr> <td>3</td> <td>CM-RGB23-GRCA</td> </tr> </tbody> </table> </div> </div>										ITEM #	PART #	1	CM-RGB23-BNC	2	CM-RGB23-RCA	3	CM-RGB23-GRCA	1	.38
										ITEM #	PART #								
										1	CM-RGB23-BNC								
										2	CM-RGB23-RCA								
										3	CM-RGB23-GRCA								
										3.58	.77								
										10	1.29								
135	4.18																		
270	5.92																		
720	9.47																		
1000	11.16																		
2000	15.78																		
3000	19.33																		
Cat5e UTP	4Pair	24 AWG	.036	N/A	.020	.197	14	71	350 MHz test										
Overall Construction					.035	.627													
6 Coaxes + 2 Cat5e cabled and jacketed					PVC														

Ordering is fast & easy.



Call today!

Solutions for the
AV PROFESSIONAL

www.libertycable.com

800-530-8998

INTERNATIONAL - CALL +1-719-388-7542



RGBHV Mini 23 Solid AWG Cable Non-Plenum & Plenum



Bulk Wire: Residential RGB Cable

SOLID 23 AWG SERIAL DIGITAL VIDEO CABLES - NON-PLENUM										
Part#: 23-MINI-SD-* CM Rated	# of Conductors	AWG Center Conductor	NOM Dielectric (Inches)	Shield Construction	NOM Jacket (Inches)	NOM OD (Inches)	NOM Capacitance (pF/ft)	NOM Velocity of Propagation	NOM Attenuation	
	1	23 AWG Solid BC	.100 FPE	100% Foil 95% TC Braid	.019 PVC	.165	16.5	84%	MHz	db/100'
									1	.38
									3.58	.77
									10	1.29
									135	4.18
									270	5.92
									720	9.47
									1000	11.16
								2000	15.78	
								3000	19.33	

Cross-Section View

PERFECT CONNECTOR MATCHES

ITEM #	PART #
1	CM-RGB23-BNC
2	CM-RGB23-RCA
3	CM-RGB23-GRCA

***Available in Ten Different Colors:** BLUE PURPLE GREEN RED ORANGE BLACK YELLOW WHITE GRAY BROWN

SOLID 23 AWG SERIAL DIGITAL VIDEO CABLES - PLENUM										
Part#: 23-MINI-CMP-*	AWG Center Conductor	NOM Dielectric (Inches)	Shield Construction	NOM Jacket (Inches)	NOM OD (Inches)	NOM Capacitance (pF/ft)	NOM Velocity of Propagation	NOM Attenuation		
	23 Solid BC	.101 FFPE	100% Bonded Aluminum Poly 95% 36 AWG TC Braid	.016 PL-PVC	.159	16.4	83%	MHz	db/100'	
								135	4.17	
								270	6.08	
								720	10.58	
								1000	12.83	
								2000	19.51	
								3000	20.50	
								4500	32.79	

Cross-Section View

PERFECT CONNECTOR MATCHES

ITEM #	PART #
1	CM-RGB23-BNC
2	CM-RGB23-RCA
3	CM-RGB23-GRCA

***Available in Two Different Colors:** BLACK WHITE

SOLID 23 AWG S-VIDEO CABLE - NON-PLENUM										
Part#: 23-YCLL-SIAM	AWG Center Conductor	NOM Dielectric (Inches)	Shield Construction	NOM Jacket (Inches)	NOM OD (Inches)	NOM Capacitance (pF/ft)	NOM Velocity of Propagation	NOM Attenuation		
	(2) 23 SOL BC	.100 FPE	100% Bonded Aluminum Poly 95% 36 AWG TC Braid	.013 FR-PVC	.159 x .328	16.5	84%	MHz	db/100'	
								1	.38	
								3.6	.77	
								10	1.29	
								71.5	3.04	
								135	4.18	
								270	5.92	
								360	6.70	
								720	9.47	
								1000	11.16	
								3000	20.5	

Cross-Section View

PERFECT CONNECTOR MATCHES

ITEM #	PART #
1	CM-RGB23-BNC
2	CM-RGB23-RCA
3	CM-RGB23-GRCA

ORDER YOUR

CONNECTEC

SOLID 25 AWG CONNECTORS

**1-PIECE
RCA & BNC
CONNECTORS!**

Part #:
CM-RGB25S-BNC

Part #:
CM-RGB25S-RCA

Part #:
CM-RGB25S-GRCA

Solutions for the AV PROFESSIONAL

www.libertycable.com

800-530-8998

INTERNATIONAL - CALL +1-719-388-7542

Ordering is fast & easy.

Call today!

RGBHV Mini 25 Solid AWG Cable Non-Plenum & Plenum



SOLID 25 AWG RGBHV CABLE - NON-PLENUM

Part#: RGB5C-25-CM	# of Conductors	AWG Center Conductor	NOM Dielectric (Inches)	Shield Construction	NOM Jacket (Inches)	NOM OD (Inches)	NOM Capacitance (pF/ft)	NOM Velocity of Propagation	NOM Attenuation	
									MHz	db/100'
	5	25 AWG Solid BC	.077 FPE	100% Aluminum Poly 90% 38 AWG TC Spiral Braid	.026	.340	18.0	78%	100	5.10
									200	7.10
									400	10.50
									1000	17.90

Cross-Section View

Ripcord
Coaxial Component(5)
Outer Jacket

PERFECT CONNECTOR MATCHES

ITEM #	PART #
4	CM-RGB25S-BNC
5	CM-RGB25S-RCA
6	CM-RGB25S-GRCA

SOLID 25 AWG RGBHV CABLE - PLENUM

Part#: RGB5C-25-CMP	# of Conductors	AWG Center Conductor	NOM Dielectric (Inches)	Shield Construction	NOM Jacket (Inches)	NOM OD (Inches)	NOM Capacitance (pF/ft)	NOM Velocity of Propagation	NOM Attenuation	
									MHz	db/100'
	5	25 AWG Solid BC	.074 FFEP	100% Aluminum Poly 98% 38 AWG TC Spiral Braid	.016	.315	16.0	83%	100	5.10
									200	7.10
									400	10.50
									1000	17.90

Cross-Section View

Ripcord
Coaxial Component(5)
Outer Jacket

PERFECT CONNECTOR MATCHES

ITEM #	PART #
4	CM-RGB25S-BNC
5	CM-RGB25S-RCA
6	CM-RGB25S-GRCA

RGBHV Mini 25 Solid AWG Cable Plenum



SOLID 25 AWG RGBHV COMPOSITE CABLE - PLENUM

Part#: RGB6C-25/22-2P-CMP	# of Conductors	AWG Center Conductor	NOM Dielectric (Inches)	Shield Construction	NOM Jacket (Inches)	NOM OD (Inches)	NOM Capacitance (pF/ft)	NOM Velocity of Propagation	NOM Attenuation	
									MHz	db/100'
	6	25 AWG Solid BC	.074 FFEP	100% Aluminum/ Poly Tape + 90% TC Spiral Braid	.010 PL-PVC	.106	16.0	83%	100	5.10
									200	7.10
									400	10.50
									1000	17.90
	4 (2 pair)	22 STR TC (7x30)	.007 PL-PVC	100% Foil + 22 AWG TC Drain	.008 PL-PVC	.102				

Cross-Section View

Pair Component(2)
Coaxial Component(6)
Outer Jacket
Ripcord

PERFECT CONNECTOR MATCHES

ITEM #	PART #
4	CM-RGB25S-BNC
5	CM-RGB25S-RCA
6	CM-RGB25S-GRCA

Overall Construction

**ORDER YOUR
CONNECTEC
SOLID 25 AWG
CONNECTORS**

**1-PIECE
RCA & BNC
CONNECTORS!**

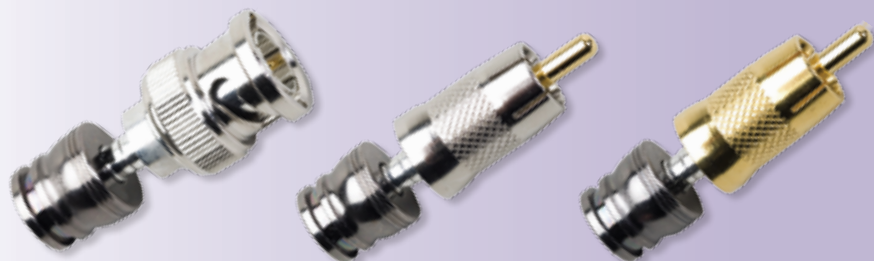

Part #: CM-RGB25S-BNC

Part #: CM-RGB25S-RCA

Part #: CM-RGB25S-GRCA

**Solutions for the
AV PROFESSIONAL**
www.libertycable.com

800-530-8998
INTERNATIONAL - CALL +1-719-388-7542



Ordering is fast & easy.



Call today!

Solid 25 AWG Composite Cables Plenum



Bulk Wire: Residential RGB Cable

SOLID 25 AWG RGBHV COMPOSITE CABLE - PLENUM

Part#: RGB7C/22-3P-PLN	# of Conductors	AWG Center Conductor	NOM Dielectric (Inches)	Shield Construction	NOM Jacket (Inches)	NOM OD (Inches)	NOM Capacitance (pF/ft)	NOM Velocity of Propagation	NOM Attenuation MHz	db/100'								
	7	25 AWG Solid BC	.074 FFEP	100% Aluminum/ Poly Tape + 90% TC Spiral Braid	.010 PL-PVC	.106	16.0	83%	100 200 400 1000	5.10 7.10 10.50 17.90								
	6 (3 pair)	22 STR TC (7x30)	.007 PL-PVC	100% Foil + 22 AWG TC	.008 PL-PVC	.102												
Cross-Section View		PERFECT CONNECTOR MATCHES																
		<table border="1"> <thead> <tr> <th>ITEM #</th> <th>PART #</th> </tr> </thead> <tbody> <tr> <td>4</td> <td>CM-RGB25S-BNC</td> </tr> <tr> <td>5</td> <td>CM-RGB25S-RCA</td> </tr> <tr> <td>6</td> <td>CM-RGB25S-GRCA</td> </tr> </tbody> </table>									ITEM #	PART #	4	CM-RGB25S-BNC	5	CM-RGB25S-RCA	6	CM-RGB25S-GRCA
ITEM #	PART #																	
4	CM-RGB25S-BNC																	
5	CM-RGB25S-RCA																	
6	CM-RGB25S-GRCA																	
Overall Construction					.015	.400												

SOLID 25 AWG RGBHV COMPOSITE Cable - NON-PLENUM

Part#: RGB6C-25-2L5E (6) 25 AWG Solid Coaxes + (2) CAT5E	# of Conductors	AWG Center Conductor	NOM Dielectric (Inches)	Shield Construction	NOM Jacket (Inches)	NOM OD (Inches)	NOM Capacitance (pF/ft)	NOM Velocity of Propagation	NOM Attenuation MHz	db/100'
	6	25 AWG Solid BC	.077 FPE	100% Aluminum Poly 90% 38 AWG TC Spiral Braid	.009	.109	16.0	83%	100 200 400 1000	5.10 7.10 10.50 17.90
	8 (4 Pair)	24 AWG Solid BC	.008	N/A	.020	.197				
Enhanced Cat 5E (350 MHz)	8 (4 Pair)	24 AWG Solid BC	.008	N/A	.020	.197				
Overall Construction					.048	.533				

Liberty Cares about the Environment...and your business!



As a leading global supplier of wire and cable, Liberty is at the forefront of manufacturing environmentally friendly products.

Many countries are now implementing the Restriction of Hazardous Substance (RoHS) directive mandating the reduction of Lead (Pb), Mercury (Hg), Cadmium (Cd), Hexavalent Chromium (Cr), Poly brominated biphenyl (PBB) and Polybrominated diphenyl ether (PBDE) in electronic and electrical equipment.

For several years now, Liberty has been offering a broad spectrum of our products that are RoHS compliant. Liberty Wire & Cable is committed to constantly expanding the number of environmentally friendly products we manufacture.

- Liberty Wire & Cable is Committed to Expanding the Number of Environmentally Friendly Products
- Reducing Our Carbon Footprint Saves Our Customers' Money
- Liberty Buildings and Facilities have a Green Footprint
- Broad Selection of Energy-Saving Product Solutions
- Paperless Account Management Options



Ordering is fast & easy.



Call today!

Solutions for the AV PROFESSIONAL
www.libertycable.com

800-530-8998
INTERNATIONAL - CALL +1-719-388-7542



REDUCE YOUR LABOR COSTS \$266³⁶ ON YOUR NEXT INSTALL

by using Liberty's 23 & 25 AWG



Liberty is committed to keeping your business profitable and competitive.

Our 23 & 25 AWG QuickLinX™ products are more efficient to work with than stranded cables that need a multipart connector. Installation efficiencies translate to higher profits for your business.

Using both a single piece connector and our 23 and 25 AWG solid center core coax solutions helps you terminate more cables in less time.

Here are a few examples of how Liberty's 23 & 25 AWG QuickLinX™ solutions, using the single piece connector can help you maximize your labor:

Running a business is hard work. Making the switch to higher profits is easy. Liberty's 23 & 25 AWG solutions with solid coax and single piece connectors will help keep your business both competitive and profitable. Your business is worth making the switch.

LABOR SAVINGS PER CABLE		LABOR SAVINGS IN THE WAREHOUSE	
Labor saving for terminating a typical cable 5BNC to 5BNC for a display device: <ul style="list-style-type: none"> • Average install with 3 display devices • Reduce labor by 10 minutes • More than 3 times faster than using the stranded product 		<ul style="list-style-type: none"> • NO more lost labor looking for multiple connector pieces. With a one piece connector no parts to lose! • Fewer parts mean reduced warehouse and storage costs 	
LABOR SAVINGS PER RACK		LABOR SAVINGS PER INSTALL	
Labor savings for off-site rack wiring and terminations. Average rack has 50 connectors <ul style="list-style-type: none"> • Reduce labor by 1 hour 		<ul style="list-style-type: none"> • With a one piece connector reduced need for cable/connection troubleshooting • Fewer parts mean fewer headaches on the install 	

Put Our 23 and 25 AWG Solid Solutions to Work for You Today... *And Start Saving!*

Solid 23 AWG RGBHV Cables Non-Plenum & Plenum

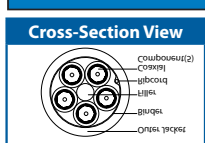

500 ft. Spools

Type	AWG	Jacket	Part #
RGB	23	PVC	RGB5C-23-CM
RGB	23	Plenum	RGB5C-23-CMP

Connectors:	
	Part #: CM-RGB23-BNC
	Part #: CM-RGB23-RCA
	Part #: CM-RGB23-GRCA

QuickLinX™ solid cables available in one to seven conductor combinations. See Liberty's "Solid Solutions" brochure for complete offering.

Solid 25 AWG RGBHV Cables Non-Plenum & Plenum

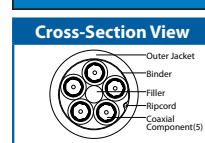
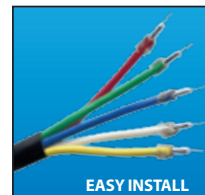

500 ft. Spools

Type	AWG	Jacket	Part #
RGB	25	PVC	RGB5C-25-CM
RGB	25	Plenum	RGB5C-25-CMP

Connectors:	
	Part #: CM-RGB25-BNC
	Part #: CM-RGB25-RCA
	Part #: CM-RGB25-GRCA

Ordering is fast & easy.



Call today!

Solutions for the AV PROFESSIONAL
www.libertycable.com

800-530-8998
INTERNATIONAL - CALL +1-719-388-7542



SOLID Solutions **QuickLinx™** SOLID COAX CABLES

Solid Center Conductor 23 & 25 AWG Mini RGBHV Cable and Connector Solutions



REDUCE YOUR LABOR COSTS \$266³⁶
ON YOUR NEXT INSTALL
by using Liberty's 23 & 25 AWG solid solutions!

On-Site Display Device Termination Comparison	Stranded Core 25 & 26 AWG	Solid Core RGB 23 & 25 AWG	Solid Savings in minutes
CABLE PREP: CUT, STRIP AND DRESS			
Stranded cable prep 40 seconds	.67		
Solid Cable prep 15 seconds		0.25	
Connector Terminating			
Average time to use multi-piece connector for stranded cable 1.5 minutes per connector. 5 cables times 2 ends is 10 connectors is 15 minutes per cable	15.00		
Average time to use one-piece connector for solid cable 0.5 minutes per connector. 5 cables times 2 ends is 10 connectors is 5 minutes per cable		5.00	
Total on-site labor savings per display	15.67	5.25	
Total on-site labor savings per installation for three displays	47.00	15.75	31.25
Off-Site Rack Wiring and Termination Comparison			
AVERAGE NUMBER OF RACK-BASED TERMINATIONS 50			
Stranded: 1.5 minutes per connector. 50 ends equates to 75 minutes	75.00		
Solid: 0.5 minutes per connector. 50 ends equates to 25 minutes		25.00	
Total off-site labor savings per installation for rack	75.00	25.00	50.00
Warehousing and Storage			
Stranded: Average time for picking 3-5 products, loading van, inventory management : 45 minutes	45.00		
Solid: Average time for picking 2 products, loading van, inventory management: 29 minutes (Due to complete product offering from 23-SD-Mini to RGBHV)		29.00	
Warehouse Labor savings	45.00	29.00	16.00
Troubleshooting Cable Integrity			
Stranded: Multi-piece connectors can make poor contact and loose strands can short: 90 minutes	90.00		
Solid: One-piece connectors are more reliable: 90 minutes		45.00	
Troubleshooting Labor savings	90.00	45.00	45.00
Total Solid Savings per Installation			142.25
Hours of Savings			2.37
AVERAGE LABOR COST (PER HOUR) RANGES FROM			
\$50 dollars per hour			\$118.54
\$100 dollars per hour			\$237.08
\$150 dollars per hour			\$355.63
ADDITIONAL COST SAVINGS:			
Lost components w/ multi-piece connectors 10% of total. MSRP 3.66 / connector	\$29.28		
No loss w/ one-piece connector		\$0.00	
	\$29.28	\$0.00	\$29.28
\$50 dollars per hour			\$147.82
\$100 dollars per hour			\$266.36
\$150 dollars per hour			\$384.91

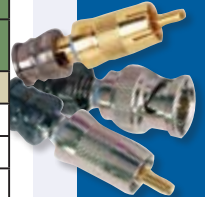

Ordering is fast & easy.



Call today!

Solutions for the AV PROFESSIONAL
www.libertycable.com

800-530-8998
INTERNATIONAL - CALL +1-719-388-7542



Mini Cable for RGB, Component and S-Video Non-Plenum

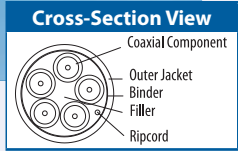

Liberty offers an extensive line of mini high resolution PVC RGB cable. These cables are flexible, easy to install, and perform flawlessly. Available in 3, 5 or 6 conductors, Liberty has the right solution for your project.

- UL Listed NEC Type CL2/CMH or CM
- Stranded Center Conductors
- FPE or LD PE Dielectric
- Sequential Footmarks
- PVC Insulation
- Flexible Black Matte PVC Jacket
- Color Code: Red, Green, Blue, White, Yellow

Non-Plenum Stranded RGBHV 75 Ohm Cable											
# of Conductors	AWG Center Conductor	NOM Dielectric (Inches)	Shield Construction	NOM Jacket (Inches)	NOM OD (Inches)	NOM Capacitance (pF/ft)	NOM Velocity of Propagation	NOM Attenuation		Part #	
								MHz	db/100'		
5	25 STR BC (7x33)	.099 FPE	93% TC Braid	.054 TPE	.508	17.3	78%	50	3.2	RGB5-MINI-75OHM-COAX 1000 MHz CMR	
								100	4.6		
200	6.44										
400	9.18										
700	12.14										
900	13.77										
1000	14.51										
PERFECT TERMINATIONS SEE PAGE 163								Cross-Section View 			
3	25 STRBC (7x33)	.016	93% TC Braid	.099 FPD	.385	17.3	78%	50	3.2		RGB3-MINI-75OHM-COAX CMR Rated
								100	4.6		
200	6.44										
400	9.18										
700	12.14										
900	13.77										
1000	14.51										
PERFECT TERMINATIONS SEE PAGE 163								Cross-Section View 			
5	26 STR TC (7x34)	.029 FPE	Foil + 95% TC Braid	.027 PVC	.350	18	78%	100	5.1		RGB5C-PVC CL2/CMH CM Rated
								200	7.4		
400	11.8										
1000	21.4										
PERFECT TERMINATIONS SEE PAGE 163								Cross-Section View 			

Ordering is fast & easy.



Call today!

Solutions for the AV PROFESSIONAL
www.libertycable.com

800-530-8998
 INTERNATIONAL - CALL +1-719-388-7542



RGBHV Mini Cable Non-Plenum

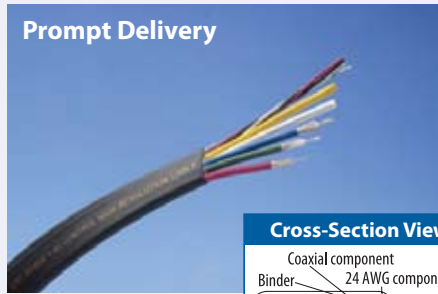

Prompt Delivery

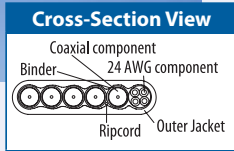

Liberty's new low-profile RGBHV Cable is perfect for installations involving tight spaces such as desktop applications, etc. This highly flexible cable can be run in baseboard conduit and in conduit beneath carpet. This cable also offers 4 conductors of 24 AWG wire for control or IR.

Bulk Wire: Residential RGB Cable

Non-Plenum RGBHV Mini Cables																				
# of Conductors	AWG Center Conductor	NOM Dielectric (Inches)	Shield Construction	NOM Jacket (Inches)	NOM OD (Inches)	NOM Capacitance (pF/ft)	NOM Velocity of Propagation	NOM Attenuation		Part #										
								MHz	db/100'											
5	26 STR TC (7x34)	.077 FPE	Foil + 95% TC SPIRAL	.011 PVC	.107	18	78%	100 200 400 1000	5.1 7.4 11.8 21.4	RGB5C/24-4C-FLAT CL2 Rated										
4	24 STR TC (7x32)			0.085 SR-PVC																
PERFECT TERMINATIONS SEE PAGE 162 <table border="1"> <tr><th>Item #</th><th>Part #</th></tr> <tr><td>59</td><td>CM-RGB26-BNC</td></tr> <tr><td>60</td><td>CM-RGB26-GBNC</td></tr> <tr><td>61</td><td>CM-RGB26-RCA</td></tr> <tr><td>62</td><td>CM-RGB26-GRCA</td></tr> </table>			Item #	Part #	59	CM-RGB26-BNC	60	CM-RGB26-GBNC	61	CM-RGB26-RCA	62	CM-RGB26-GRCA			.160x.670			Cross-Section View 		Overall Construction
Item #	Part #																			
59	CM-RGB26-BNC																			
60	CM-RGB26-GBNC																			
61	CM-RGB26-RCA																			
62	CM-RGB26-GRCA																			
6	26 STR TC (7x34)	.077 FPE	Foil + 95% TC Braid	.011 PVC	.385	18	78%	100 200 400 1000	5.1 7.4 11.8 21.4	RGB6C-PVC-YEL CM Rated										
PERFECT TERMINATIONS SEE PAGE 162 <table border="1"> <tr><th>Item #</th><th>Part #</th></tr> <tr><td>59</td><td>CM-RGB26-BNC</td></tr> <tr><td>60</td><td>CM-RGB26-GBNC</td></tr> <tr><td>61</td><td>CM-RGB26-RCA</td></tr> <tr><td>62</td><td>CM-RGB26-GRCA</td></tr> </table>			Item #	Part #	59	CM-RGB26-BNC	60	CM-RGB26-GBNC	61	CM-RGB26-RCA	62	CM-RGB26-GRCA						Cross-Section View 		
Item #	Part #																			
59	CM-RGB26-BNC																			
60	CM-RGB26-GBNC																			
61	CM-RGB26-RCA																			
62	CM-RGB26-GRCA																			
6	26 STR TC (7x34)	.077 FPE	Foil + 95% TC Spiral		.016	18	78%	100 200 400 1000	5.1 7.4 11.8 21.4	RGB6C/22-2P CM Rated Projector Cable										
4 (2 pair)	22 STR TC (7x30)		Foil + 95% TC Braid	.006 PVC				Cross-Section View 												
PERFECT TERMINATIONS SEE PAGE 162 <table border="1"> <tr><th>Item #</th><th>Part #</th></tr> <tr><td>59</td><td>CM-RGB26-BNC</td></tr> <tr><td>60</td><td>CM-RGB26-GBNC</td></tr> <tr><td>61</td><td>CM-RGB26-RCA</td></tr> <tr><td>62</td><td>CM-RGB26-GRCA</td></tr> </table>			Item #	Part #	59	CM-RGB26-BNC	60	CM-RGB26-GBNC	61	CM-RGB26-RCA	62	CM-RGB26-GRCA		.022 PVC	.405					Overall Construction
Item #	Part #																			
59	CM-RGB26-BNC																			
60	CM-RGB26-GBNC																			
61	CM-RGB26-RCA																			
62	CM-RGB26-GRCA																			

Ordering is fast & easy.



Call today!

Solutions for the AV PROFESSIONAL
www.libertycable.com

800-530-8998
INTERNATIONAL - CALL +1-719-388-7542



RGBHV Serial Digital Cables

Non-Plenum and Plenum

Quality Products

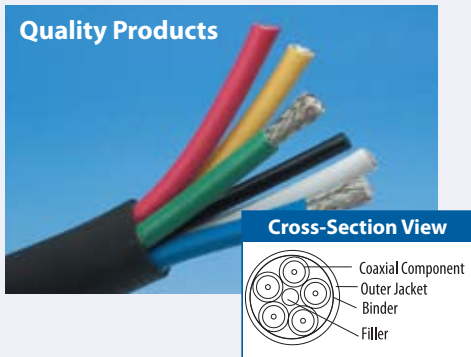

Liberty has taken their high performance serial digital HDTV cables and combined them into a one-jacket RGB construction. These cables provide excellent speed and reliability for maximum frequency response over long runs.

- UL Listed NEC Type CMR/CMP
- Solid Bare Copper Center Conductor, Black TPE
- Foamed PE Dielectric
- FR-PVC Coax Jacket
- Sequential Footmarks
- Black TPE Jacket

Non-Plenum and Plenum RGBHV 75 Ohm Cable																									
# of Conductors	AWG Size	NOM Dielectric (Inches)	Shield Construction	NOM Jacket (Inches)	NOM OD (Inches)	NOM Capacitance (pF/ft)	NOM Velocity of Propagation	NOM Attenuation		Part #															
								MHz	db/100'																
5	20 Solid BC	.145 FPE	100% Foil + 95% TC Braid	.055 TPE	.780	16.3	83%	10 100 270 540 750 1000 2000 3000	.87 2.58 3.8 5.47 6.5 7.6 11.9 14.9	RGB5C-20-CMR Serial Digital CMR Rated															
PERFECT TERMINATIONS SEE PAGE 162 <table border="1"> <tr> <th>Item #</th> <th>Part #</th> <th>Item #</th> <th>Part #</th> </tr> <tr> <td>25</td> <td>CM-RG59U-RCA</td> <td>28</td> <td>CM-RG59U-GBNC</td> </tr> <tr> <td>26</td> <td>CM-RG59U-GRCA</td> <td>29</td> <td>CM-RG59U-F</td> </tr> <tr> <td>27</td> <td>CM-RG59U-BNC</td> <td>30</td> <td>CM-RG59U-GF</td> </tr> </table>						Item #	Part #	Item #	Part #	25	CM-RG59U-RCA	28	CM-RG59U-GBNC	26	CM-RG59U-GRCA	29	CM-RG59U-F	27	CM-RG59U-BNC	30	CM-RG59U-GF	Cross-Section View 			
Item #	Part #	Item #	Part #																						
25	CM-RG59U-RCA	28	CM-RG59U-GBNC																						
26	CM-RG59U-GRCA	29	CM-RG59U-F																						
27	CM-RG59U-BNC	30	CM-RG59U-GF																						
6	20 AWG Solid BC	.145 FPE	100% Foil + 95% TC Braid	.032 FR-PVC	.240	16.3	83%	10 100 270 540 750 1000 2000 3000	.87 2.58 3.8 5.47 6.5 7.6 10.9 13.4	RGB6C-20/2L5E (6) RG59 Serial Digital Coaxes + (2) CAT5E RG59 Serial Digital Coaxes CMR Rated															
PERFECT TERMINATIONS SEE PAGE 162 <table border="1"> <tr> <th>Item #</th> <th>Part #</th> <th>Item #</th> <th>Part #</th> </tr> <tr> <td>25</td> <td>CM-RG59U-RCA</td> <td>28</td> <td>CM-RG59U-GBNC</td> </tr> <tr> <td>26</td> <td>CM-RG59U-GRCA</td> <td>29</td> <td>CM-RG59U-F</td> </tr> <tr> <td>27</td> <td>CM-RG59U-BNC</td> <td>30</td> <td>CM-RG59U-GF</td> </tr> </table>						Item #	Part #	Item #	Part #	25	CM-RG59U-RCA	28	CM-RG59U-GBNC	26	CM-RG59U-GRCA	29	CM-RG59U-F	27	CM-RG59U-BNC	30	CM-RG59U-GF	Cross-Section View 			
Item #	Part #	Item #	Part #																						
25	CM-RG59U-RCA	28	CM-RG59U-GBNC																						
26	CM-RG59U-GRCA	29	CM-RG59U-F																						
27	CM-RG59U-BNC	30	CM-RG59U-GF																						
8 (4 pair)	24 AWG Solid BC	.008 FPE	N/A	.22 FR-PVC	.210					Enhanced Cat 5E (350 MHz)															
						Overall Construction 																			
3	20 Solid BC	.145 FPE	100 % Foil + 95% TC Braid	.055 TPE	.630	16.3	83%	10 100 270 540 750 1000 2000 3000	.87 2.58 3.8 5.47 6.5 7.6 10.9 13.4	RGB3C-20-CMR Serial Digital CMR															
PERFECT TERMINATIONS SEE PAGE 162 <table border="1"> <tr> <th>Item #</th> <th>Part #</th> <th>Item #</th> <th>Part #</th> </tr> <tr> <td>25</td> <td>CM-RG59U-RCA</td> <td>28</td> <td>CM-RG59U-GBNC</td> </tr> <tr> <td>26</td> <td>CM-RG59U-GRCA</td> <td>29</td> <td>CM-RG59U-F</td> </tr> <tr> <td>27</td> <td>CM-RG59U-BNC</td> <td>30</td> <td>CM-RG59U-GF</td> </tr> </table>						Item #	Part #	Item #	Part #	25	CM-RG59U-RCA	28	CM-RG59U-GBNC	26	CM-RG59U-GRCA	29	CM-RG59U-F	27	CM-RG59U-BNC	30	CM-RG59U-GF	Cross-Section View 			
Item #	Part #	Item #	Part #																						
25	CM-RG59U-RCA	28	CM-RG59U-GBNC																						
26	CM-RG59U-GRCA	29	CM-RG59U-F																						
27	CM-RG59U-BNC	30	CM-RG59U-GF																						
5	18 Solid BC	.180 FPE	Foil + 96% TC Braid	.055 TPE	.860	16.2	78%	10 100 270 540 750 1000 2000 3000	.72 1.84 2.97 4.25 5.00 5.89 8.57 10.67	RGB5C Serial Digital CMR															
PERFECT TERMINATIONS SEE PAGE 162 <table border="1"> <tr> <th>Item #</th> <th>Part #</th> <th>Item #</th> <th>Part #</th> </tr> <tr> <td>25</td> <td>CM-RG6Q-RCA</td> <td>28</td> <td>CM-RG6Q-GBNC</td> </tr> <tr> <td>26</td> <td>CM-RG6Q-GRCA</td> <td>29</td> <td>CM-RG6Q-F</td> </tr> <tr> <td>27</td> <td>CM-RG6Q-BNC</td> <td>30</td> <td>CM-RG6Q-GF</td> </tr> </table>						Item #	Part #	Item #	Part #	25	CM-RG6Q-RCA	28	CM-RG6Q-GBNC	26	CM-RG6Q-GRCA	29	CM-RG6Q-F	27	CM-RG6Q-BNC	30	CM-RG6Q-GF	Cross-Section View 			
Item #	Part #	Item #	Part #																						
25	CM-RG6Q-RCA	28	CM-RG6Q-GBNC																						
26	CM-RG6Q-GRCA	29	CM-RG6Q-F																						
27	CM-RG6Q-BNC	30	CM-RG6Q-GF																						
(2) 26 STR TC (7x34)	0.072 FFEP	95% TC Spiral + Foil		.009 PLN-PVC	.240	16	83%	100 200 400 1000	5.10 7.40 11.80 21.40	SV-PLN															
PERFECT TERMINATIONS SEE PAGE 163 <table border="1"> <tr> <th>Item #</th> <th>Part #</th> </tr> <tr> <td>59</td> <td>CM-RGB26-BNC</td> </tr> <tr> <td>60</td> <td>CM-RGB26-GBNC</td> </tr> <tr> <td>61</td> <td>CM-RGB26-RCA</td> </tr> <tr> <td>62</td> <td>CM-RGB26-GRCA</td> </tr> </table>						Item #	Part #	59	CM-RGB26-BNC	60	CM-RGB26-GBNC	61	CM-RGB26-RCA	62	CM-RGB26-GRCA	Cross-Section View 									
Item #	Part #																								
59	CM-RGB26-BNC																								
60	CM-RGB26-GBNC																								
61	CM-RGB26-RCA																								
62	CM-RGB26-GRCA																								

Ordering is fast & easy.



Call today!

Solutions for the AV PROFESSIONAL
www.libertycable.com

800-530-8998
INTERNATIONAL - CALL +1-719-388-7542



Control Cable - Unshielded Non-Plenum

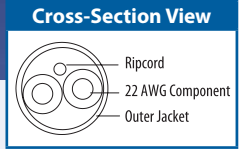

Multi-Conductor

- UL Listed NEC Type or CMG
- Bare Copper Stranded Conductors
- PVC Insulation
- Gray PVC Jacket
- Sequential Footmarks
- Ripcord

Multi-Conductor/Overall Shield w/Drain Wire					
# of conductors	AWG Size/ Stranding	NOM Insulation (Inches)	NOM Jacket (Inches)	NOM OD (Inches)	Part #
2	22 (7x30)	0.010	0.020	0.141	22-2C-ST-HT
2	22 (7x30)	0.009	0.020	0.162	22-4C-ST-HT
6	22 (7x30)	0.010	0.020	0.197	22-2C-SO-HT
8	22 (7x30)	0.006	0.014	0.167	22-2C-SO-GHT
10	22 (7x30)	0.006	0.014	0.195	22-10C-SH-GRY-BX

All above cables can be produced with colored jackets. Data grade available in these cables using Polyethylene or Polypropylene insulations.
*CMR and Plenum Rated products are available.

Control Cable - Unshielded Non-Plenum

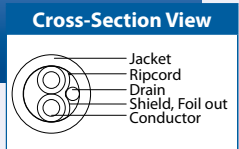
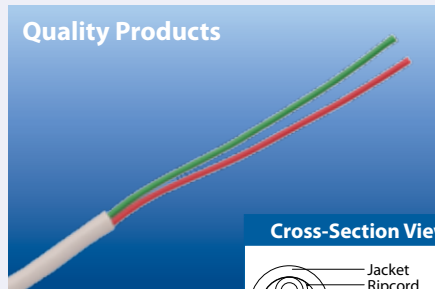

Multi-Conductor/Unshielded

- UL Listed NEC Type, CL3 or CM*
- Bare Copper Stranded Conductors
- PVC Insulation
- Gray PVC Jacket
- Sequential Footmarks
- Ripcord
- See Color Code Charts 241

See Page 98

For our HomeTrax™ line of Security Cable.

Non-Plenum Unshielded Control Cable					
# of conductors	AWG Size/ Stranding	NOM Insulation (Inches)	NOM Jacket (Inches)	NOM OD (Inches)	Part #
2	22 (7x30)	0.010	0.020	0.137	22-2C-GRY
4	22 (7x30)	0.010	0.020	0.163	22-4C-GRY
6	22 (7x30)	0.010	0.020	0.193	22-6C-GRY
8	22 (7x30)	0.010	0.025	0.222	22-8C-GRY
10	22 (7x30)	0.010	0.025	0.253	22-10C-GRY
12	22 (7x30)	0.010	0.025	0.261	22-12C-GRY

All above cables can be produced with colored jackets. Data grade available in these cables using Polyethylene or Polypropylene insulations.
*CMR and Plenum Rated products are available.

Bulk Wire: Residential Security Cables

Ordering is fast & easy.



Call today!

Solutions for the AV PROFESSIONAL
www.libertycable.com

800-530-8998
INTERNATIONAL - CALL +1-719-388-7542



CCTV and Baseband Video Cable

Non-Plenum

The Liberty Advantage

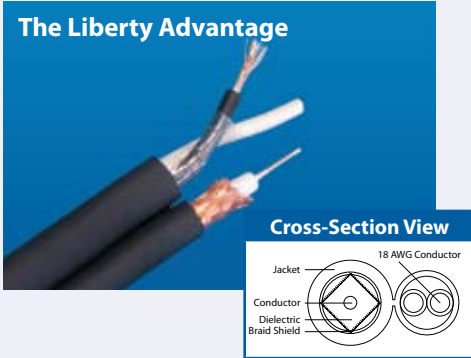

These cables are ideal for closed circuit TV (CCTV) applications or high-quality analog video runs.

Coax - Single Shield

- UL Listed NEC Type CL2/CM
- Solid or Stranded Bare Copper Center Conductor
- Foam Polyethylene Dielectric
- Black PVC or FR-PVC Jacket
- 75 Ohm
- Sequential Footmarks

Non-Plenum Video Cable - CCTV & BaseBand Video

AWG Center Conductor	NOM OD Dielectric (Inches)	Shield Construction	NOM Jacket (Inches)	NOM OD (Inches)	NOM Capacitance (Pf/ft)	NOM Velocity of Propagation	NOM Attenuation		Part #																
							MHz	db100'																	
20 Solid BC	0.144 FPE	95% BC Braid	0.032 FR-PVC	.242 x .484	16.2	82%	1	0.24	RG59CM-18-2C Siamese Construction CM																
							10	0.76																	
18	0.01 Twisted Pair	N/A STR BC (16x30)	0.025 FR-PVC PVC		N/A	N/A	100	2.76																	
							400	6.02																	
20 Solid BC	0.144 FPE	95% BC Braid	0.037 FR-PVC	0.240	16	82%	1	0.24		RG59-CCTV-CM-BLK CM															
							10	0.82																	
<div style="border: 1px solid black; padding: 2px;"> PERFECT TERMINATIONS <table border="1"> <tr> <th>Item #</th> <th>Part #</th> <th>Item #</th> <th>Part #</th> </tr> <tr> <td>37</td> <td>CM-RG59C-RCA</td> <td>40</td> <td>CM-RG59C-GBNC</td> </tr> <tr> <td>38</td> <td>CM-RG59C-GRCA</td> <td>41</td> <td>CM-RG59C-F</td> </tr> <tr> <td>39</td> <td>CM-RG59C-BNC</td> <td>42</td> <td>CM-RG59C-GF</td> </tr> </table> <p>SEE PAGE 162</p> </div>							Item #	Part #	Item #		Part #	37	CM-RG59C-RCA	40	CM-RG59C-GBNC	38	CM-RG59C-GRCA	41	CM-RG59C-F	39	CM-RG59C-BNC	42	CM-RG59C-GF	100	2.76
							Item #	Part #	Item #		Part #														
							37	CM-RG59C-RCA	40		CM-RG59C-GBNC														
							38	CM-RG59C-GRCA	41	CM-RG59C-F															
39	CM-RG59C-BNC	42	CM-RG59C-GF																						
700	9.04																								
900	10.83																								
1000	12.39																								
22 STR BC (7x30)	0.143 PE	95% BC Braid	0.036 PVC	0.242	17.4	78%	50	2.1	RG59-STR-BLK CM - Yellow Jacket Available																
18 Solid BC	0.175 FPE	95% BC Braid	0.032 FR-PVC	0.278	17.3	78%	100	3.4																	
							200	4.8																	
							400	6.7																	
							900	10.2																	
1000	11																								
18	0.01 Twisted Pair	N/A STR BC (16x30)	0.025 FR-PVC PVC		N/A	N/A	10	0.8	RG6-18-2C CL2																
							50	1.5																	
18	0.18 FPE	95% BC Braid	0.028 PVC	0.264	16.2	82%	100	2.16																	
							400	4.55																	
							700	7.13																	
							900	7.95																	
1000	8.69																								
<div style="border: 1px solid black; padding: 2px;"> PERFECT TERMINATIONS <table border="1"> <tr> <th>Item #</th> <th>Part #</th> <th>Item #</th> <th>Part #</th> </tr> <tr> <td>13</td> <td>CM-RG6C-RCA</td> <td>16</td> <td>CM-RG6C-GBNC</td> </tr> <tr> <td>14</td> <td>CM-RG6C-GRCA</td> <td>17</td> <td>CM-RG6C-F</td> </tr> <tr> <td>15</td> <td>CM-RG6C-BNC</td> <td>18</td> <td>CM-RG6C-GF</td> </tr> </table> <p>SEE PAGE 161</p> </div>							Item #	Part #	Item #	Part #	13	CM-RG6C-RCA	16	CM-RG6C-GBNC	14	CM-RG6C-GRCA	17	CM-RG6C-F	15	CM-RG6C-BNC	18	CM-RG6C-GF	1000	8.69	
							Item #	Part #	Item #	Part #															
							13	CM-RG6C-RCA	16	CM-RG6C-GBNC															
							14	CM-RG6C-GRCA	17	CM-RG6C-F															
15	CM-RG6C-BNC	18	CM-RG6C-GF																						
14 Solid BC	0.285 FPE	95% BC Braid	0.045 FR-PVC	0.405	16	82%	1	0.16	RG11-CCTV-BLK CL2/CMH CM																
14 Solid BC	0.285 FPE	95% BC Braid	0.045 FR-PVC	0.405	16	82%	10	0.46																	
							50	0.93																	
							100	1.45																	
							200	1.83																	
							400	2.77																	
							700	4.06																	
							900	4.66																	
1000	4.82																								

Ordering is fast & easy.



Call today!

Solutions for the AV PROFESSIONAL

www.libertycable.com

800-530-8998

INTERNATIONAL - CALL +1-719-388-7542



The Liberty ADVANTAGE ★★ ★

AV Professionals rely on Liberty's **EXPERTISE, SELECTIONS & SERVICE.**

Liberty's Complete AUDIO SOLUTION



AUDIO EXPERTISE

For more than 17 years Liberty Wire & Cable has been at the forefront of residential audio solutions combining advanced speaker cable engineering with high-performance connectors that make your residential install perform flawlessly.

EASY TO INSTALL

- Abrasion resistant jackets
- Easy to pull
- Rugged corrugated cardboard boxes hold together
- Durable spools

GREAT PRODUCT FEATURES

Speaker cable audio signal transmission is unmatched in the industry.

- All cables are UL listed, splice-free and sequential foot marked
- Available in 16,14,12 and 10 AWG options, and 2 and 4 conductor constructions, in a wide spectrum of colors
- Custom imprinting available: print the name of your business, project name/number, application information or all three
- Good-Better-Best product guide makes it easy to find the right audio solution for your residential installation

GREAT SELECTION

Liberty provides the complete solution for any residential audio installation:

- Direct Burial: great for outdoors, gardens, gazebos, pool areas, guest houses, conduit runs
- HomeTRAX™: ideal for MDU projects and tract homes
- KO+™: perfect for large apartments and production homes
- ExtraFlex™: best seller for multi-room audio, and large homes
- UltraCap™: premiere cable for home theater, THX™ certified
- AudioCat: Volume Control: Distributed Audio
- Line-Level control: stereo and mono applications
- Serial digital coax: Make your own interconnects
- Traditional audio connectors, the revolutionary Audio ConneCTec™
- Plastic Wall Plates, Rack Headers, Rack Panels, Pre-wire Tools

GREAT SERVICE

Strategically located around the US, our 5 mega-warehouses, ship ground delivery in 2 days to your door.

- No order minimums policy
- Order on our 24/7 website
- Order confirmation and a shipping confirmation
- Variety of shipping options including next day, 3 day, air and truck
- Job site delivery



Liberty's "Good to Best" product guide equates strandcount with performance.

Bulk Wire: Residential Speaker Cable

Ordering is fast & easy.



Call today!

Solutions for the AV PROFESSIONAL
www.libertycable.com

800-530-8998
INTERNATIONAL - CALL +1-719-388-7542



Audio ConnecTec™ is Liberty's Revolutionary Compression Audio Connector Solution.

The same cutting-edge technology that Liberty developed for coax termination now makes this audio connector system an essential component of every commercial audio installation.

Audio ConnecTec™ connectors slip on easily to the speaker cable conductor and compress on effortlessly with the easy-to-use ConnecTec™ tool.

Unique and ultra precise Sound Cone™ design fuses the audio connector directly to the speaker cable providing the lowest DB loss of any audio connector resulting in improved sonic fidelity and speaker performance.

PRODUCT HIGHLIGHTS

- Strip-Free
- Connector bases are available in 2 sizes: 10-12AWG or 14-16 AWG
- Works with all Liberty speaker cable
- 3 gold plated screw-on tips: banana, spade lug and angled pin
- Works with any speaker plug-in plate format or design
- For in-wall and non in-wall audio applications



DESCRIPTION	PART #
10 -12 AWG Connector base	CM-A-12
14 AWG Connector base	CM-A-14
16 AWG Connector base	CM-A-16
Banana Plug Tip Gold plated	CM-APBA
Spade Lug Tip Gold plated	CM-APSL
Angle Pin Tip Gold plated	CM-APAP
Banana Jack	CM-APBJ
All items sold separately and in 25 pkg.	

CONNECTEC COMPRESSION TOOL

Perfect for all gauges of Liberty's speaker cables.

Part #: CM-TOOL



HEAT SHRINK & BOOTS

Tight and smooth edges. Available in black only. 25 pkg

Part #: HSK-3:1BK-1/2



Perfect for finishing off your termination. Available in black. 25 pkg

Part #: CM-BOOT-BLK

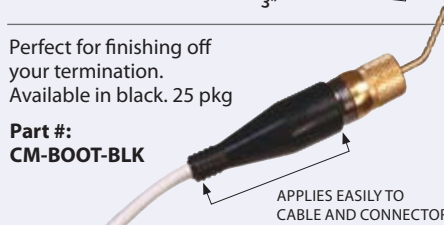

APPLIES EASILY TO CABLE AND CONNECTOR

5 EASY STEPS!



STEP 1

Cut the outer jacket away leaving the desired conductor length. Slide heat shrink tube in to position and shrink.



STEP 2

Slide connector boots over each conductor.



STEP 3

Without stripping, twist the correct AWG connector base clockwise on to the conductor.



STEP 4

Using the ConnecTec Tool- with the die set to the F connector position - compress the connector to the cable .



STEP 5

Slide boot over the connector base and screw the tip option on to the threaded connector base.

Ordering is fast & easy.



Call today!

Solutions for the AV PROFESSIONAL
www.libertycable.com

800-530-8998
INTERNATIONAL - CALL +1-719-388-7542



Audio ConneCTec™ Banana Jack CM-APBJ Installation and Use Instructions.

The CM-APBJ Banana jack is an attachment for the Audio ConneCTec™ Speaker connector series. The CM-APBJ will fit the CM-A-12, CM-A-14, and CM-A-16 Audio ConneCTec™ speaker connectors.

The CM-APBJ has a variety of possible installation possibilities and is packaged to allow the installer to choose mounting and color coding.

The CM-APBJ is packaged in a 25 PC master pack and each is individually packaged. Each individual package contains:

- Connector Body with isolated pass through jack.
- Lock Washer and retaining nut for direct panel mounting in a ½ inch D cut.
- Three colored snap on rings (Red, White, Black) for color coding + and – terminals.

5 EASY STEPS!



One Connector Package .
Terminate the Audio ConneCTec™ Speaker Base on the appropriate wire.



Speaker Base terminated .
If mounting in a Keystone Plate – preload the CM-APBJ into the insert.



Color Ring mounted .
Screw the CM-APBJ onto the Speaker Base Connector.



Mounted into Keystone insert .
Insert the CM-APBJ into the pre-cut D hole or the loaded Keystone insert into the plate and apply fastening hardware where applicable.



Mounted into Faceplate .
The color code ring can be applied at anytime in the process.

CONNECTOR BODY

SNAP ON RINGS

RETAINING NUT

LOCK WASHER

BANANA JACK FULLY ASSEMBLED
PART #: CM-APBJ



PERFECT FIT!
PART #:
PC-G2405

INSTALLATION EXAMPLES:

- Mounted in a plate with a ½" D cut. Available through Panelcrafters in single and dual Banana formats. Standard plate and Decora options. Connector is isolated for loading in conductive plates or panels.
- Mounted in the Keystone inserts above and snapped into standard Keystone wall plates. Liberty has standard plates in 1-4, 6, 8, and 12 port formats under part numbers WP-N*-color where * = # of ports and Decora inserts in 2, 4 and 6 port formats under part numbers WJ-DEC*-color where * = # of ports. The 2-Port item is WJ-DEC-color.

Unloaded Keystone Inserts specifically for the CM-APBJ are available in:

DESCRIPTION	PART #
White	ISKM-BNC-00WH40N
Ivory	ISKM-BNC-00IV40N
Almond	ISKM-BNC-00AD40N
All items sold separately and in 25 pkg.	

Bulk Wire: Residential Speaker Cable

Ordering is fast & easy.



Call today!

Solutions for the AV PROFESSIONAL
www.libertycable.com

800-530-8998
INTERNATIONAL - CALL +1-719-388-7542



SECTION 5

Bulk Wire: Residential Speaker Cable

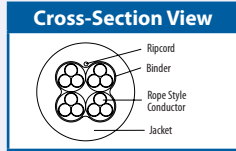

When Audio ConneCTec™ is combined with Liberty's UltraCap THX™ certified speaker cable for use with external speakers, sonic fidelity is noticeably enhanced.

UltraCap™ Premium Speaker Cable Non-Plenum, THX™ Certified

- Liberty's premier speaker cable
- THX™ certification assures sonic integrity
- Exceptional high strand count
- Tight inner conductor twisting
- Low capacitance
- The jacket on this cable has a superior feel
- Very easy to work with
- UL listed NEC type CL3 or CM
- Available in 2 colors

AWG/Pairs	Stranding	Color	Put-up	Part#
16/1	105 x 36	White	1,000 ft.	16-1P-UC-WHT
14/1	168 x 36	White	1,000 ft.	14-1P-UC-WHT
14/1	168 x 36	Black	1,000 ft.	14-1P-UC-BLK
14/2	168 x 36	Black	500 ft.	14-2P-UC-WHT
12/1	261 x 36	White	1,000 ft.	12-1P-UC-WHT
12/1	261 x 36	Black	1,000 ft.	12-1P-UC-BLK
12/2	261 x 36	White	500 ft.	12-2P-UC-WHT

See Page 42 - 44

THX Interconnects are Available!

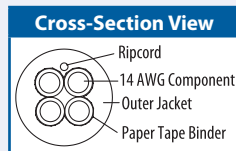

Why OFC is Better

When audio signals move through a normal piece of copper cable they encounter layers of copper crystals which act as a barrier reflecting and degrading the signal. OFC copper reduces the amount of crystals in the copper for a clearer signal.



ExtraFlex™ Premium Speaker Cable Non-Plenum

- Best selling speaker cable
- Oxygen-free Copper (OFC)
- High strand counts
- Extra thick extruded PVC compound outer cable jacket
- Extremely flexible
- Perfectly round
- Jacket keeps conductor twists in place to protect the sonic fidelity
- Exceptionally easy to pull
- Designed for heavy duty distributed audio applications
- UL listed NEC type CL3 or CM
- Available in 6 colors

AWG/Conductors	Stranding	Color	Put-up	Part#
16/2	105 x 36	Black, Green, Pink, Royal Blue, Teal, or White	1,000 ft.	16-2C-EX+ -*
16/4	105 x 36	Black, Green, Pink, Royal Blue, or White	1,000 ft. or 500 ft.	16-4C-EX+ -*
14/2	105 x 34	Green, Pink or White	1,000 ft.	14-2C-EX+ -*
14/4	105 x 34	Green, Pink or White	500 ft.	14-4C-EX+ -*
12/2	105 x 32	Teal or White	500 ft.	12-2C-EX+ -*
12/4	105 x 32	Teal or White	500 ft.	12-4C-EX+ -*
10/2	105 x 30	White	500 ft.	10-2C-EX+ -WHT

Asterisk (*) equals color. See color abbreviations. Example: 12-4C-EX+ -TEA

Black (BLK)	Green (GRN)	Pink (PNK)	Royal Blue (RBL)	Teal (TEA)	White (WHT)
-------------	-------------	------------	------------------	------------	-------------

Ordering is fast & easy.



Call today!

Solutions for the AV PROFESSIONAL
www.libertycable.com

800-530-8998
INTERNATIONAL - CALL +1-719-388-7542





KO+™ Speaker Cable Non-Plenum

- Higher strand count than HomeTRAX™
- Residential audio workhorse
- Designed for medium duty
- Available in 5 colors
- Heavier than industry standard jacketing for greater durability
- Meets a variety of in-wall distributed audio requirements.
- UL Listed NEC Type CL3 or CMG

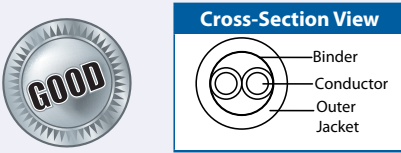

AWG/Conductors	Stranding	Color	Put-up	Part#
16/2	65 x 34	Light Blue or White	1,000 ft.	16-2C-KO+ -*
16/4	65 x 34	Gray, Light Green or White	1,000 ft. or 500 ft.	16-4C-KO+ -*
14/2	65 x 32	Black or White	1,000 ft.	14-2C-KO+ -*
14/4	65 x 32	White	500 ft.	14-4C-KO+ - WHT

Asterisk (*) equals color. See color abbreviations. Example: **16-2C-KO+ -LBL**

Black
(BLK)

Gray
(GRY)

Light Blue
(LBL)

Light Green
(LGN)

White
(WHT)

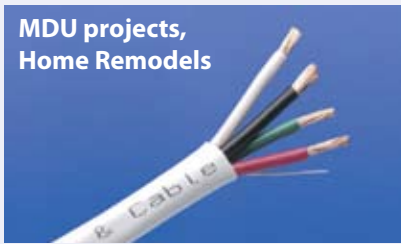

HomeTRAX™ Speaker Cable Non-Plenum

- Bid on and win production home pre-wires
- Lower strand count is designed for budget conscious projects
- Price performer for budget conscious projects
- UL listed NEC type CL3 or CM
- Available in one color: white

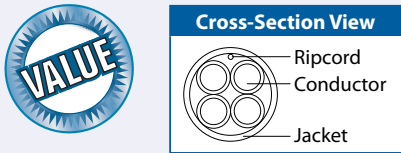

AWG/Conductors	Stranding	Put-up	Part#
16/2	41 x 32	1,000 ft.	16-2C-HT
16/4	41 x 32	500 ft.	16-4C-HT
14/2	41 x 30	500 ft.	14-2C-HT
14/4	41 x 30	500 ft.	14-4C-HT



Direct Burial Speaker Cable Non-Plenum

- Designed for outdoor applications
- PE installation provides protection from underground moisture
- UL rating is suitable for indoor use
- Available in black only
- UL listed NEC type CL3 or CM

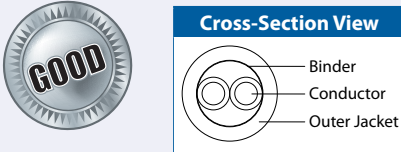

AWG/Conductors	Stranding	Put-up	Part#
16/2	19 x 29	1,000 ft.	16-2C-DB-BLK
16/4	19 x 29	1,000 ft.	16-4C-DB-BLK
14/2	19 x 25	1,000 ft.	14-2C-DB-BLK
14/4	19 x 25	1,000 ft.	14-4C-DB-BLK
12/2	19 x 25	1,000 ft.	12-2C-DB-BLK
12/4	19 x 25	500 ft.	12-4C-DB-BLK



The Liberty Advantage

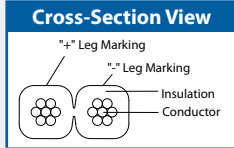

Special Application Speaker Cable
Clear Zip Speaker Cable

- High Strand Conductors
- Oxygen Free Copper
- Spool Length 1,000 ft. rolls
- Non-UL rated

AWG/ Conductors	Stranding	Put-up	Part#
16/2	7x23x40	1,000 ft.	16-2C-ZIP-CLR
14/2	7x37x40	1,000 ft.	14-2C-ZIP-CLR
12/2	7x60x40	1,000 ft.	12-2C-ZIP-CLR

Quality Products

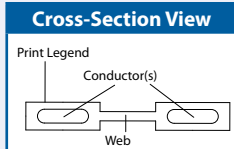

Special Application Speaker Cable
Flat Speaker Cable

- High Strand Conductors
- Oxygen Free Copper
- Paintable Jacket

AWG/ Conductors	Stranding	Put-up	Part#
16/2	14x12x.01mm	100 meter	15-FSC-162

Prompt Delivery

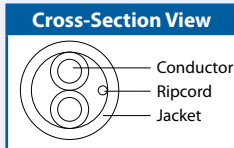

Commercial Speaker Cable
Plenum

- UL Listed NEC Type CL3P/CMP
- Bare Copper Stranded Conductors
- Low Smoke PVC Jacket
- Sequential Foot marks
- Ripcord
- See Color Code Charts 241

AWG/ Conductors	Stranding	Part#
22/2	7x30	22-2C-P-WHT
22/4	7x30	22-4C-P-WHT
20/2	7x28	20-2C-P-WHT
20/4	7x28	20-4C-P-WHT
18/2	7x26	18-2C-P-WHT
18/4	7x26	18-4C-P-WHT
16/2	19x29	16-2C-P-WHT
16/4	19x29	16-4C-P-WHT
14/2	19x27	14-2C-P-WHT
14/4	19x27	14-4C-P-WHT
12/2	19x25	12-2C-P-WHT
12/4	19x25	12-4C-P-WHT

Ordering is fast & easy.



Call today!

Solutions for the
AV PROFESSIONAL
www.libertycable.com

800-530-8998
INTERNATIONAL - CALL +1-719-388-7542



Structured Cable



Cross-Section View

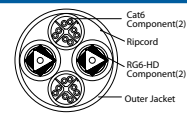

Get homes ready for the future today with Liberty's ultimate structured wire combinations. Whether it's ISDN cable modems, broadband or digital communications, Liberty's structured wire combinations handle it with ease. Our jacketed combinations allow one manageable cable for multiple signal distribution.

Jacketed Cable

- All Cables UL Listed NEC Type CMG
- Flexible PVC Jacket
- Enhanced Category 5E Cables (350 MHz)
- Sequential Foot marks

Quality Products

See Page 129

Check Out our HomeTrax™ Line!

Structured Cable									
AWG Center Conductor	NOM OD Dielectric (Inches)	Shield Construction	NOM Jacket (Inches)	NOM OD (Inches)	NOM Capacitance (Pf/ft)	NOM Velocity of Propagation	NOM Attenuation		Part #
							MHz	db100'	
									CEBUS-CM-F-J
18 AWG Solid BC	0.180 FPE	100% AL Foil 60% AL Braid 100% AL Foil 40% AL Braid	.026 PVC	.287	16.2	82%	50 200 400 700 1000 1450 2200 3000	1.46 2.83 4.05 5.60 6.59 7.94 9.77 13.26	Element 1 2 ea QUADFLEX-BC
24 AWG Solid BC	.036 PE		.020 PVC	0.197	14	71%			Element 2 2 ea 24-4P-L5-EN 350 MHz
62.5/125	900 micron	N/A	.027 PVC	.150	N/A	N/A			Element 3 Multimode Fiber
			.033 PVC Green	.669					Overall Construction
(2) Optical Fiber 62.5/125um Indoor Fiber Multimode Outer Diameter: .10in.									

									CEBUS-2N2-J-LBL
18 AWG Solid BC	0.180 FPE	100% AL Foil 60% AL Braid 100% AL Foil 40% AL Braid	.026 PVC	.287	16.2	82%	50 200 400 700 1000 1450 2200 3000	1.46 2.83 4.05 5.60 6.59 7.94 9.77 13.26	Element 1 QUADFLEX-BC
24 AWG Solid BC	.008 PE		.020 PVC	.197	14	71%			Element 2 24-4P-L5-EN 350 MHz
			.033 PVC Blue	.650					Overall Construction

Bulk Wire: Residential Structured Cable

Ordering is fast & easy.



Call today!

Solutions for the AV PROFESSIONAL
www.libertycable.com

800-530-8998
INTERNATIONAL - CALL +1-719-388-7542



Structured Cable

Structured Cable										
AWG Center Conductor	NOM OD Dielectric (Inches)	Shield Construction	NOM Jacket (Inches)	NOM OD (Inches)	NOM Capacitance (Pf/ft)	NOM Velocity of Propagation	NOM Attenuation MHz db100'		Part #	
									CEBUS+2N2	
23 AWG (4 Pair) Solid BC	.008 PE		.017 PVC	.244			1	.27	Element 1 2 ea. Cat6 UTP	
18 AWG Solid BCC	.180 FPE	100% Al Mylar Tape + 95% TC Braid	.031 PVC	.272			10	.81		
							50	1.46		
							100	2.05		
							400	4.05		
			.044 PVC	.689	14		900	6.23	Element 2 2 ea. RG6 High Def Coax	
							1000	6.59		
							1450	8.03		
							2200	9.77	Overall Construction	
							3000	13.11		
CEBUS-CM-1N1-SIAM CMG rated										
18 AWG Solid BC	0.018 FPE	2 Foils + 60% AL 40% AL Braid	0.026	0.287	16.2	82%	10	0.81	Element 1 1 ea. QUADFLEX-BC	
							50	1.46		
							200	2.83		
24 AWG Solid BC	0.036 PE		0.02	0.197	14	71%	400	4.05	Element 2 1 ea. 24-4P-L5 EN	
							700	5.6		
							1000	6.59		
			0.04	0.512			1450	7.94	Overall Construction	
							2200	9.77		
CEBUS-HT CMG rated										
18 AWG Solid BC	0.18 FPE	100% AL Foil 60% AL Braid	.030	.272	16.2	82%	1	.26	Element 1 RG6-BC	
							50	1.46		
							200	2.83		
24 AWG Solid BC	0.036 PE		0.020	.197	14	71%	400	4.05	Element 2 24-4P-L5-EN	
							1000	6.59		
							1450	8.04		
			0.033	.670			2200	9.77	Overall Construction	
							3000	13.26		

Ordering is fast & easy.



Call today!

Solutions for the AV PROFESSIONAL

www.libertycable.com

800-530-8998

INTERNATIONAL - CALL +1-719-388-7542



Audiocat Plus™ Structured Cable by Liberty

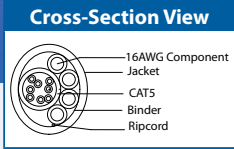
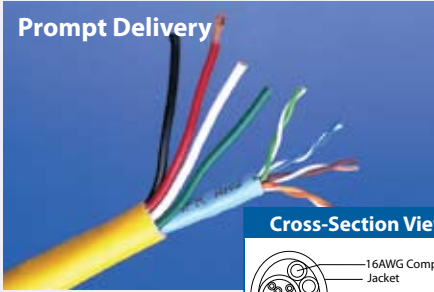

Liberty now offers Audiocat Plus™. This flexibly jacketed composite cable has an Enhanced Category 5 cable sweep tested to 350 MHz and 4 conductors of oxygen-free copper, high strand count 16 AWG speaker cable. AUDIOCAT™ is perfect for every keypad and volume control you need to pull to.

AUDIOCAT™						
# of Conductors	AWG Size/ Stranding	NOM Insulation (Inches)	NOM Jacket (Inches)	NOM OD (Inches)	Part #	
AUDIOCAT+						
CONSTRUCTION						
8 (4 pair)	24 AWG Solid BC	0.008 PE	0.021 PVC	0.197	Enhanced Cat 5e (350 MHz) CMG	
4	16 AWG STR BC (oxygen-free copper) (105x36)		N/A	0.091	Speaker Cables	
			0.032 PVC Matte Gold	0.385	Overall Construction	

See Page 63

LibertyLinx™ Designed with Versatility in Mind



For our complete line of LibertyLinx™ Control Cables.

LibertyLinx™ Specialized Control Cable							
# of Conductors	AWG Size/ Stranding	Shield	NOM Insulation (Inches)	NOM Jacket (Inches)	NOM OD (Inches)	Part #	
							LLINX Composite Cable
4 (2 pair)	18 AWG STR TC (7x26)	Overall AL Poly w/ 20 AWG STR TC Drain	0.020 FPE	0.030 FR-PVC	0.250	Control Pair Shielded Low Cap	
1	20 AWG Solid BC	100% Foil+ 95% TC Braid	0.145 FPE	0.032 FR-PVC	.240	RG59 Serial Digital Coax	
8 (4 pair)	24 AWG Solid BC	N/A	0.008 PE	0.021 FR-PVC	0.205	Enhanced Cat 5e	
				0.045 PVC Teal	.650	Overall Construction	

Low Voltage Mounting Brackets

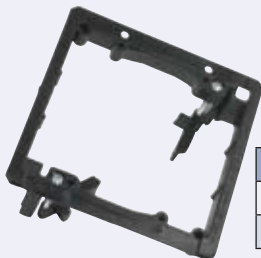

LV2 Shown

Description	Part #
Single Gang Bracket for Retrofit	LV1
Double Gang Bracket for Retrofit	LV2

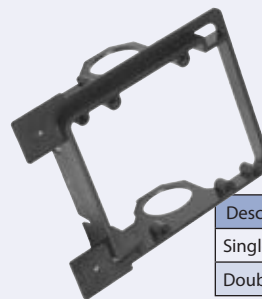

LVMB2 Shown

Description	Part #
Single Gang Bracket for New Construction	LVMB1
Double Gang Bracket for New Construction	LVMB2

Solutions for the AV PROFESSIONAL
www.libertycable.com

800-530-8998
INTERNATIONAL - CALL +1-719-388-7542



Ordering is fast & easy.



Call today!

**Ships
Same
Day!**

**THESE PLATES IN-STOCK,
ORDERS SHIP SAME DAY!**



PC-G1000-*



PC-G1020-*



PC-G1060-*



PC-G1080-*



PC-G1240-*



PC-G1260-*



PC-G1300-*



PC-G1520-*



PC-G1540-*



PC-G1600-*



PC-G1720-*



PC-G1760-*



PC-G2000-*



PC-G2020-*



PC-G2040-*



PC-G1940-*



PC-G1960-*

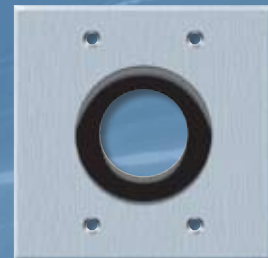

PC-G2900-*

PAGE 197

PANEL CRAFTERS

Ordering is
fast & easy.



Call today!

**Solutions for the
AV PROFESSIONAL**

www.libertycable.com

800-530-8998

INTERNATIONAL - CALL +1-719-388-7542



BNC Connectors

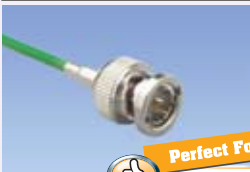

BNC Male
Part #: 112491-10

Perfect For...
All Liberty 26 AWG Stranded RGB Cables — PVC & Plenum



BNC Female
Part #: 112559



Connex BNC Plug
RG59-PLN
Part #: 112975



BNC Plug, RG58 PLN
Crimp 3-PC
Part #: 112124



Connex BNC Jack for
RG59 PVC
Part #: 112973



Female BNC for
RGB5C-PLN
Part #: 112161-10



Connex BNC Crimp Plug
for #9913
Part #: 112563

Connex Crimper



Part #: 47-10000

Tool and Connector Cross Reference

Cable P/N's	Item #	Die P/N	Frame Part #
18-CMP-VID-COAX, RG6-CCTV-PL	112966 (Jack)	47-20001	47-10000
	112519	47-20001	47-10000
18-CMR-VIDEO, RG6-CCTV, RG6-CM	112957	47-20001	47-10000
20-CMP-VID-COAX, RG59-P-CATV, RG59-CCTV-PL, RG59-18/2C-PS	112645 (Jack)	47-20001	47-10000
	112975	47-20001	47-10000
20-CMR-VIDEO, RG59-CCTV-CM, RG59CM-18/2C, RG59-CATV	112973 (Jack)	47-20001	47-10000
	112951	47-20001	47-10000
RG58-CMP	112152 (Jack)	47-20000	47-10000
	112128	47-20000	47-10000
RG58-CMR	112116	47-20000	47-10000
RG8-IIIVSAT-P-KYNAR	112627	47-20029	47-10000
RGB3-MINI, RGB5-MINI, 25-CMR, 23-MINI-SD, 23-MINI-CMP, RGB5C-STAGE	112559 (Jack)	47-20002	47-10000
	112955	47-20002	47-10000
RGB5C-PLN, RGB5C-PVC, RGB6C/22-2P, RGB6C/22-2P-PLN, SV-PLN, SV-PVC, AVC-18-PLN, RGB5C-25-CMP, SV-25-CMP, RGB6C-25/22-2P-PLN	112161-10 (Jack)	47-20250, 47-20004	47-10000
	112491-10	47-20250, 47-20004	47-10000
	112491-11	47-20250	47-10000
WBC-400, WBC-400R	112563	47-20027	47-10000

**HAVE TOOLING QUESTIONS?
CALL US TODAY!**

F Connector Termination Crimp Tool

Liberty Weather-Proof F Connectors for RTC360 Tool:

Description	Part #
RG6 F Connector with External O-Ring	RG6WRO
RG6 Quad F Connector with External O-Ring	RG6NRO
RG59 F Connector with External O-Ring	RG59WRO



Part #: RTC360

Ordering is fast & easy.



Call today!

Audio/Video Connectors



RCA Audio Plug Pair for Z300A THX
Part #: Z300AU-RCA



RCA 75 Ohm Video Plug for Z300V THX
Part #: Z300VI-75RCA



RCA 75 Ohm Digital Audio Plug for Z300D THX
Part #: Z300DI-75RCA



RCA 75 Ohm Component Video Set for Z300CV THX
Part #: Z300CO-75RCA-RGB



RCA for Z-200 Chrome Barrel Plug Available with Red or Black Polarity Indications – 7.0mm
Part #: ZD01



RCA for RG6, RG59 (Video) Black Metal Barrel Plug with Rubber Finger Grip and Yellow Stripe – 7.5mm
Part #: ZD03



S-Video Connector for 23-YCLL-SIAM Slim-Profile Chrome Barrel with Gold-Plated Pins – Solder Cups.
Part #: ZD05-SLM



Gold-Plated RCA for STP and COAX Black, Red, White, or Yellow Finish Barrel with Spring Strain Relief – 4.0mm. Red, White, Yellow
Part #: ZD06



Gold-Plated Solderless RCA for STP and COAX Chrome Barrel with Crimped Ground – 7.0mm
Part #: ZE07

Speaker Termination Connectors



Crimp Spade Lug
Part #: ZA01-II



Crimp Spade Lug set for 16-12 AWG speaker wire.
Part #: ZA02



Compression Spade Lug Gold-Plated, All Metal. Fits 12 to 18 AWG Cables
Part #: ZA02-II



Plastic Barrel Banana Plastic Barrel Banana with High Contact Lams for 10 to 12 AWG Cables
Part #: ZB01



Plastic Barrel Banana Plastic Barrel Banana for 14 to 18 AWG Cables
Part #: ZB02



Compression Banana Gold-Plated, All Metal. Fits 12 to 18 AWG Cables
Part #: ZB03



Dual Banana Dual Plug Assembly with Standard Spacing for 12 to 18 AWG Cables
Part #: ZB04



Flex Braid OFC Copper Flex Braid Connection for use with Screw Terminals
Part #: ZC01



Universal Audio Connector Set for Z500 UAA THX and any 10 or 12 AWG Speaker Cable
Part #: Z500UAK

Set Includes:

- (1) Spade
- (1) Banana
- (1) Angle Pin

Audio Connectec™ is Liberty's Revolutionary Compression Audio Connector Solution.



CONNECTEC™ COMPRESSION TOOL
Part #: CM-TOOL



Part #: CM-A-12 Part #: CM-A-14 Part #: CM-A-16 Part #: CM-APSL Part #: CM-APAP Part #: CM-APBA Part #: CM-APBJ

DESCRIPTION	PART #
10 -12 AWG Connector base	CM-A-12
14 AWG Connector base	CM-A-14
16 AWG Connector base	CM-A-16
Banana Plug Tip Gold plated	CM-APBA
Spade Lug Tip Gold plated	CM-APSL
Angle Pin Tip Gold plated	CM-APAP
Banana Jack	CM-APBJ
All items sold separately and in 25 pkg.	

Ordering is fast & easy.



Call today!

Solutions for the AV PROFESSIONAL
www.libertycable.com

800-530-8998
INTERNATIONAL - CALL +1-719-388-7542



Audio Connectors and Adaptors



3.5mm Mini Male to 1/4" Standard Phone Female
Part #: 35-506



RCA Male to 3.5mm Mini Female
Part #: 35-539



1/4" Standard Phone Male
Part #: 30-402-BK



1/4" Standard Stereo Phone Male
Part #: 30-401-BK



3.5mm Stereo Mini Male
Part #: 30-484



3.5mm Mini Male to RCA Female
Part #: 35-538



2.5mm Mini Male Mono
Part #: 30-485A



2.5mm Sub-Mini Male
Part #: 30-423A



1/4" Standard Stereo Phone Female, Chassis Mount Stereo
Part #: PC-P7



1/4" Standard Stereo Phone Female, Chassis Mount Mono
Part #: PC-P13



3.5mm Mini Female, Chassis Mount
Part #: 30-422



1/4TR-RCA Jack Adapter
Part #: 35-517



3.5mm Mini Mono Male
Part #: 30-421



RCA Female to Female Coupler
Part #: 30-470BU



Right Angle RCA Male to RCA Female Adapter
Part #: 30-474



Shielded RCA Phone Jack, Gold
Part #: 30-391



3.5mm Mini Male to 1/4" Standard Phone Female
Part #: 35-506-P



RCA Male to 3.5mm Mini Female
Part #: 35-539-P



WebBlox™

WebBlox is the premier custom plate and panel design tool in the AV industry. This free design and quoting tool gives you complete control over designing your own custom plate and panel layouts. All of PanelCrafters' standard panel sizes are available via simple drop-down boxes. Drag-and-drop any of our standard connectors into your design, specify the text you want, even add your logo, all in WebBlox's user-friendly environment. All of the panels you design are stored in your password protected account.

WebBlox requires no expensive software or hardware, just a web browser and internet connection. This flexible design tool allows you to design, quote and proof your plate designs from your desktop 24 hours a day. When you're ready to order, submit as you would for any other order using the part number and pricing from your WebBlox account.



Ordering is fast & easy.



Call today!

Solutions for the AV PROFESSIONAL
www.libertycable.com

800-530-8998
INTERNATIONAL - CALL +1-719-388-7542



Video Connectors and Adapters



75 Ohm Female to Male Right Angle BNC Adapter
Part #: 33-1102BU



75 Ohm Female to Male Female BNC "T" Splitter
Part #: 33-1196BU



75 Ohm Male BNC Terminator
Part #: 33-1175BU



BNC Female to RCA Female Adapter
Part #: 75-629



75 Ohm "F" Male Terminator
Part #: 32-0436BU



75 Ohm 3 Female BNC "T" Splitter
Part #: 33-1197BU



"F" Female to BNC Male
Part #: 32-3104BU



75 Ohm BNC Female to Female Chassis Mount, Barrel
Part #: 75-696



"F" Male to RCA Female Adapter
Part #: 32-3108BU



75 Ohm BNC Male to Male Barrel
Part #: 75-699



"F" Female to Female Chassis Mount, Barrel
Part #: 75-520-WH



BNC Female to Female
Part #: 31-305



RCA Female to "F" Female
Part #: 75-556



"F" Female to BNC Female
Part #: 32-4000-BU



High Quality F-Connector with Weather-Proof Boot
RG59, RG6, RG6Q
Part #: 31-SNS



BNC Female to RCA Male Adapter
Part #: 32-3121BU



"F" Female to RCA Male Adapter
Part #: 32-3102-BU



RCA Male to "F" Male
Part #: 75-523



HD15 Female to HD15 Female Splice
Part #: 45-564-BU



S-Video Female to Female Barrel
Part #: 35-496-4



BNC Jack to F Plug Adapter
Part #: 32-3120BU



F-Type Male to Male Coupler
Part #: 32-3007BU



BNC Female to Female Adapter
Part #: 32-3119-BU



RCA Jack to BNC Plug Adapter
Part #: 32-3109BU



Part #: SLC6Q



Part #: SLC6

Ordering is fast & easy.



Call today!

Solutions for the AV PROFESSIONAL

www.libertycable.com

800-530-8998

INTERNATIONAL - CALL +1-719-388-7542



Neutrik Connectors



XLR and 1/4" Connectors



Receptacle DL1 series 3 pin female - solder cups- nickel/silver. Also available with 4 & 5 pins.
Part #: NC3FD-L-1



Receptacle D series 3 pin female - screw terminal - black/gold. Also available with 4 & 5 pins.
Part #: NC3FD-S-1-B



Cable end X series 3 pin female - nickel/silver. Also available with 4 & 5 pins.
Part #: NC3FX



Also available with 4 & 5 pins.
Part #: NC3FX-EMC



Cable end X-S series 3 pin female - nickel/gold. Also available with 4 & 5 pins.
Part #: NC3FXS



Cable end XX series 3 pin female - nickel/silver. Also available with 4 & 5 pins.
Part #: NC3FXF



Also available with 4 & 5 Pins IDC XLR connector.
Part #: NC3FEZY-NI



Receptacle DL1 series 3 pin male - solder cups- nickel/silver. Also available with 4 & 5 pins.
Part #: NC3MD-L-1



Receptacle D series 3 pin male - screw terminal - black/gold. Also available with 4 & 5 pins.
Part #: NC3MD-S-1-B



Cable end X series 3 pin male - nickel/silver. Also available with 4 & 5 pins.
Part #: NC3MX



Also available with 4 & 5 pins.
Part #: NC3MX-EMC



Cable end XX series 3 pin male - nickel/silver. Also available with 4 & 5 pins.
Part #: NC3MXX



Also available with 4 & 5 Pins IDC XLR connector.
Part #: NC3MEZY-NI



Combo - stereo switching jack - PCB Vertical.
Part #: NCJ9FI-V



Jack 1/4" stereo locking - D style - solder - nickel/silver.
Part #: NJ3FP6C



Jack 1/4" stereo locking - D style - solder - black/silver.
Part #: NJ3FP6C-BAG

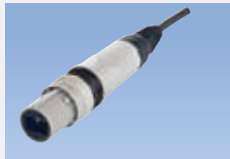

These are Opticon Cable assemblies. 75 M are not available, 3, 10, 30, 150 and 300 M are. See to right.
Part #: NKO2M-4S75



Plug 1/4" mono PX Series - nickel/silver connector.
Part #: NP2X



Plug 1/4" stereo PX Series - nickel/silver
Part #: NP3X



Plug 3.5mm right angle - black plastic/nickel.
Part #: NTP3RC

Other Connectors



Feed through Fire Wire 6 - black
Part #: NA1394-6-B



Adapter - NL4FC to 1/4 Inch 2-pole jack, wiring: +1 to TIP and -1 to SLEEVE - pre-wired
Part #: NA4LJX



Cable end - Powercon - power in (blue)
Part #: NAC3FCA



Cable end - Powercon - power out (gray)
Part #: NAC3FCB



Receptacle - Powercon - power in (blue)
Part #: NAC3MPA



Neutrik Connectors

Other Connectors



Receptacle - Powercon - power out (gray)

Part #: NAC3MPB



Feed through USB

Part #: NAUSB



Receptacle - BNC - D style - feedthrough - grounded - black

Part #: NBB75DFGB



Receptacle Ethercon D series - feedthrough - nickel - w/screws.

Part #: NE8FDP



Receptacle Ethercon D series - 110 punchdown-BIK - w/screws.

Part #: NE8FDV-Y110-B



Cable carrier Ethercon - nickel - w/BSE boot-needs RJ45 cable.

Part #: NE8MC



Cable carrier Ethercon - black - w/BSX boot-needs RJ45 cable.

Part #: NE8MC-1-B



Jacks RCA D series-style - yellow - nickel

Part #: NF2D-4



Cable end Speakon® 2 pole.

Part #: NL2FC



Receptacle Speakon® 2 pole - solder tabs.

Part #: NL2MP



Cable end Speakon® SPX 4 pole - right angle.

Part #: NL4FRX



Receptacle Speakon® 4 pole - square flange - solder.

Part #: NL4MP



Cable end Speakon® 8 pole

Part #: NL8FC



Receptacle Speakon® 8 pole - solder - NLT style - nickel - WITH SQUARE FLANGE - NOT ROUND

Part #: NL8MPR



Receptacle Speakon® STX - 4 pole female - solder cups - black/silver.

Part #: NLT4FP-BAG



Cable end Speakon® STX - 4 pole female - black.

Part #: NLT4FX-BAG



Receptacle Speakon® STX - 4 pole male - solder tabs - nickel/silver.

Part #: NLT4MP



Cable end Speakon® STX - 4 pole male - nickel/silver.

Part #: NLT4MX



Cable end Speakon® STX - 4 pole male - nickel/silver.

Part #: NLT4MX



Opticalcon Chassis Optalloy

Part #: NO2-4FD



Opticalcon Chassis Ruthenium.

Part #: NO2-4FD-R

See Page 203

Our Perfect Plates for XLR Connectors.

XLR Plates

Part #: PC-G1320

Part #: PC-G1300

Ordering is fast & easy.



Call today!

Solutions for the AV PROFESSIONAL
www.libertycable.com

800-530-8998
INTERNATIONAL - CALL +1-719-388-7542



CONNECTEC™ Termination System

68 Connectors for 43 Cables!

Coaxial connectors play a critical role in signal transmission. That's why Liberty is pleased to introduce our new ConneTec™ Termination System with a full product offering of advanced-engineered RCA, BNC and F connectors to fit most of our RG59, RG6 and RG6 Quad coax cables perfectly.

Designed with space-age technology, our compression connectors are revolutionary in design and exceptional in performance. With over 60 different styles of RCA, BNC and F connectors, Liberty's ConneTec™ Termination System offers the AV professional the broadest connector selection in the industry.











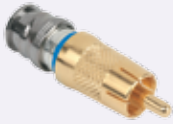



Our ergonomically designed ConneTec™ compression tool and coaxial strippers round out our termination system, providing the AV professional with a complete coaxial product solution that combines engineering sophistication with full functionality and reliability.

Here are the unique features of Liberty's exclusive ConneTec™ line of high-quality coaxial connectors:

- Works flawlessly on RG59, RG6 and RG6 Quad
- Single piece RCAs
- Mini RCAs and BNCs for 23, 25 and 26 AWG Coax
- Color O-rings simplify matching cables with the proper connector
- Color Banding, for instant application identification, available in 7 colors: black, blue, green, orange, red, white, and yellow
- Innovative inspection window assures perfect termination
- All-metal construction for maximum durability

All of our connectors work with Liberty's CoaxMaster™ system with use of the CM-Adaptor so there is no need to re-tool.

Connectors: ConneTec™

RG6 CATV		RG6 CATV QUAD		RG6 CCTV
 1	 2	 7	 8	 13
PVC CATV Compression RCA Part #: CM-RG6U-RCA	PVC CATV Compression RCA Part #: CM-RG6U-GRCA	PVC CATV Compression RCA Part #: CM-RG6Q-RCA	PVC CATV Compression RCA Part #: CM-RG6Q-GRCA	PVC CCTV Compression RCA Part #: CM-RG6C-RCA
 3	 4	 9	 10	 15
PVC CATV Compression BNC Part #: CM-RG6U-BNC	PVC CATV Compression BNC Part #: CM-RG6U-GBNC	PVC CATV Compression BNC Part #: CM-RG6Q-BNC	PVC CATV Compression BNC Part #: CM-RG6Q-GBNC	PVC CCTV Compression BNC Part #: CM-RG6C-BNC
 5	 6	 11	 12	 17
PVC CATV Compression F Part #: CM-RG6U-F	PVC CATV Compression F Part #: CM-RG6U-GF	PVC CATV Compression F Part #: CM-RG6Q-F	PVC CATV Compression F Part #: CM-RG6Q-GF	PVC CCTV Compression F Part #: CM-RG6C-F

Ordering is fast & easy.



Call today!

Solutions for the AV PROFESSIONAL
www.libertycable.com

800-530-8998
INTERNATIONAL - CALL +1-719-388-7542



Specifications Subject to Change

RG6 PLENUM	
 19 PLENUM Compression RCA Part #: CM-RG6P-RCA	 20 PLENUM Compression RCA Part #: CM-RG6P-GRCA
 21 PLENUM Compression BNC Part #: CM-RG6P-BNC22	 22 PLENUM Compression BNC Part #: CM-RG6P-GBNC
 23 PLENUM Compression F Part #: CM-RG6P-F	 24 PLENUM Compression F Part #: CM-RG6P-GF

RG59 CATV	
 25 PVC CATV Compression RCA Part #: CM-RG59U-RCA	 26 PVC CATV Compression RCA Part #: CM-RG59U-GRCA
 27 PVC CATV Compression BNC Part #: CM-RG59U-BNC	 28 PVC CATV Compression BNC Part #: CM-RG59U-GBNC
 29 PVC CATV Compression F Part #: CM-RG59U-F30	 30 PVC CATV Compression F Part #: CM-RG59U-GF

CCTV PLENUM	
RG6	RG59
 31 PLENUM CATV Compression RCA Part #: CM-RG6PC-RCA	 34 PLENUM CATV Compression RCA Part #: CM-RG59PC-RCA
 32 PLENUM CATV Compression BNC Part #: CM-RG6PC-BNC	 35 PLENUM CATV Compression BNC Part #: CM-RG59PC-BNC
 33 PLENUM CATV Compression F Part #: CM-RG6PC-F	 36 PLENUM CATV Compression F Part #: CM-RG59PC-F37

RG59 CCTV	
 37 PVC CCTV Compression RCA Part #: CM-RG59C-RCA	 38 PVC CCTV Compression RCA Part #: CM-RG59C-GRCA
 39 PVC CCTV Compression BNC Part #: CM-RG59C-BNC	 40 PVC CCTV Compression BNC Part #: CM-RG59C-GBNC
 41 PVC CATV Compression F Part #: CM-RG59C-F	 42 PVC CATV Compression F Part #: CM-RG59C-GF

RG59 PLENUM	
 43 PLENUM Compression RCA Part #: CM-RG59P-RCA	 44 PLENUM Compression RCA Part #: CM-RG59P-GRCA
 45 PLENUM Compression BNC Part #: CM-RG59P-BNC	 46 PLENUM Compression BNC Part #: CM-RG59P-GBNC
 47 PLENUM CATV Compression F Part #: CM-RG59P-F	 48 PLENUM CATV Compression F Part #: CM-RG59P-GF

COLOR BANDS

Color Banding for instant application identification.

- Fits Snuggly on Every ConnectTec™ Connector

*Available in 7 colors: black, blue, green, orange, red, white or yellow

Part #: CM-R-*

90° BNC
Part# CM-RGB23-RABNC

F Connector also available

Ordering is fast & easy.



Call today!



Termination System

68 Connectors for 43 Cables!

Adding to its extensive line of connectivity solutions, Liberty is pleased to introduce its new line of QuickLinx™ Solid center conductor 25 and 23 AWG Mini RGBHV cables and ConneTec™ 25 and 23 AWG single piece compression connectors.

The solid center conductor construction provides better performance, in regards to signal distance and frequency response, than the typical stranded center conductor cables in the market. The solid 25 AWG cable is great for longer RGBHV cable runs and the solid 23 AWG RGBHV cable is swept to 3 GHz. The 23 AWG cable is perfect for short run, HD applications and offers premium performance for all analog video applications.

Liberty also has a 23 AWG serial digital single coax legacy product, from which the RGBHV design is based upon. This HD cable is swept to 4.5 GHz.

The solid center conductor allows the use of a 1-piece connector as in our successful ConneTec™ RG59 and RG6 series. Usually, mini RGB cables have stranded center conductors and need a 3 – 4 piece connector for successful termination. The one-piece connector enables an installer to realize the time savings enjoyed on the RG59/6 cables. The ConneTec™ BNC connectors for these new cables are available in nickel plated versions and the RCA connectors are available in both nickel and gold plated versions.

23 AWG SOLID	25 AWG SOLID	25 AWG STRANDED	26 AWG STRANDED
 49 Part #: CM-RGB23-BNC	 52 Part #: CM-RGB25S-BNC	 55 Part #: CM-RGB25-BNC	 59 Part #: CM-RGB26-BNC
QuickLinx™ SOLID COAX CABLES			
 50 Part #: CM-RGB23-RCA	 53 Part #: CM-RGB25S-RCA	 56 Part #: CM-RGB25-GBNC	 60 Part #: CM-RGB26-GBNC
 51 Part #: CM-RGB23-GRCA	 54 Part #: CM-RGB25S-GRCA	 57 Part #: CM-RGB25-RCA	 61 Part #: CM-RGB26-RCA
 Part #: RGB5C-23-CM	 Part #: RGB5C-25-CMP	 58 Part #: CM-RGB25-GRCA	 62 Part #: CM-RGB26-GRCA

Connectors: ConneTec™

Ordering is fast & easy.



Call today!

CONNECTec™ Termination System

Speaker Cable Compression Connectors

Audio ConneCTec™ is Liberty's Revolutionary Compression Audio Connector Solution.



NEW

Liberty's new Banana jack for Audio ConneCTec™ is ideally suited for use with Liberty speaker cables. Simply install the CM-A* base on your cable, screw the jack onto the base and install the jack onto your plate. The jack can then be installed into a custom PanelCrafters™ Plate or snapped into an industry standard keystone plate to finish any speaker installation.

For More Details, See Page 146-147

DESCRIPTION	PART #
10-12 AWG Connector base	CM-A-12
14 AWG Connector base	CM-A-14
16 AWG Connector base	CM-A-16
Banana Plug Tip Gold plated	CM-APBA
Spade Lug Tip Gold plated	CM-APSL
Angle Pin Tip Gold plated	CM-APAP
Banana Jack	CM-APBJ
All items sold separately and in 25 pkg.	

5 EASY STEPS!



STEP 1
Cut the outer jacket away leaving the desired conductor length. Slide heat shrink tube in to position and shrink.



STEP 2
Slide connector boots over each conductor.



STEP 3
Without stripping, twist the correct AWG connector base clockwise on to the conductor.



STEP 4
Using the ConneCTec Tool - with the die set to the F connector position - compress the connector to the cable.



STEP 5
Slide boot over the connector base and screw the tip option on to the threaded connector base.

Works Perfectly with our Premium Line of Speaker Cables:

UltraCap™ Premium Speaker Cable Non-Plenum, THX™ Certified



Home Theaters & THX™ Certified Installations

AWG/Pairs	Stranding	Color	Put-up	Part#
16/1	105 x 36	White	1,000 ft.	16-1P-UC-WHT
14/1	168 x 36	White	1,000 ft.	14-1P-UC-WHT
14/1	168 x 36	Black	1,000 ft.	14-1P-UC-BLK
14/2	168 x 36	White	500 ft.	14-2P-UC-WHT
12/1	261 x 36	White	1,000 ft.	12-1P-UC-WHT
12/1	261 x 36	Black	1,000 ft.	12-1P-UC-BLK
12/2	261 x 36	White	500 ft.	12-2P-UC-WHT

ExtraFlex™ Premium Speaker Cable Non-Plenum



Multi-Room Audio, Single-Room Audio & Large Homes

AWG/Conductors	Stranding	Color	Put-up	Part#
16/2	105 x 36	Black, Green, Pink, Royal Blue, Teal, or White	1,000 ft.	16-2C-EX+ -*
16/4	105 x 36	Black, Green, Pink, Royal Blue, or White	1,000 ft.	16-4C-EX+ -*
14/2	105 x 34	Green, Pink or White	1,000 ft.	14-2C-EX+ -*
14/4	105 x 34	Green, Pink or White	500 ft.	14-4C-EX+ -*
12/2	105 x 32	Teal or White	500 ft.	12-2C-EX+ -*
12/4	105 x 32	Teal or White	500 ft.	12-4C-EX+ -*
10/2	105 x 30	White	500 ft.	10-2C-EX+ -WHT

Ordering is fast & easy.



Call today!

Solutions for the AV PROFESSIONAL
www.libertycable.com

800-530-8998
INTERNATIONAL - CALL +1-719-388-7542



CONNECTEC™ Termination System

Additional Connectors and Tools

CONNECTEC COMPRESSION TOOL

An integral part of the ConneTec™ termination system is our ergonomically designed compression tool.

Milled from a solid piece of NASA-grade aluminum, our tool is light weight yet highly durable.

Anodized in an easy-to-find red finish, this exclusive tool is easy to work with.

Unlike other tools in the market, the ConneTec™ compression tool terminates BNC, F and RCA connectors without using any adaptors.

The plunger of the tool effortlessly adjusts to accommodate the entire line of ConneTec™ Connectors—even the mini RCAs and BNCs. It's incredible and a must have for every tool bag.

Part #: CM-TOOL



Extra Dies
Part #: CM-TOOL-DIE

CONNECTEC STRIPPERS

Part #: CM-59/6	Part #: CM-MINI	Part #: CM-23/25
 Accurately strips RG59, RG6, or RG6 Quad cables.	 Perfect for RGB 25 & 26 AWG mini coax.	 Perfect for RGB 23 & 25 Solid AWG mini coax.
 Replacement Blade Part#: CM-59/6-BLADE	 Replacement Blade Part#: CM-MINI-BLADE	 Replacement Blade Part#: CM-23/25-BLADE

RG11 SOLUTIONS

63
Part #: CM-RG11-N



64
PVC Compression BNC
Part #: CM-RG11-BNC



65
PVC Compression F
Part #: CM-RG11-F



NEW

RG11 Compression Tool
Part #: CM-TOOL-11



RG11 Stripper
Part #: PS11



EUROPEAN SOLUTIONS

66
RG6 Coaxial Plug
Part #: CM-RG6-IECM



67
RG59 Coaxial Jack (female)
Part #: CM-RG59-IECF



68
RG59 Coaxial Plug (male)
Part #: CM-RG59-IECM



Part # CM-TOOL-IEC
Our new ConneTec™ compression tool terminates European style IEC plug and jack connectors for RG59 and RG6 Coax.



Solutions for the AV PROFESSIONAL
www.libertycable.com

800-530-8998
INTERNATIONAL - CALL +1-719-388-7542



Ordering is fast & easy.



Call today!



Termination System

Additional Connectors and Tools

Connectors: ConnectTec™



Everything An Installer Needs in One Convenient Case!

Case Includes:

- (1) Compression Tool
- (1) 25/26 AWG Stripper (stranded)
- (1) 23/25 AWG Stripper (solid)
- (1) RG59/6 Stripper
- (1) Cable Cutter
- (1) Holster

Part #: CM-TOOL-PAC

Stock it with which ever connectors you need.

Refer to pages 51-54 for the correct connector you need.

CONNECTEC CABLE CUTTER

Perfect for cutting steel cable.
Part #: CM-206-L

New Design!

CONNECTEC INSERTION TOOL

Helps insert connector onto stripped cable end without using your fingers.
Part #: CM-CGT-FBR

BOOTS

Perfect for finishing off your RGBHV termination. Available in black.
Part #: CM-BOOT-BLK

NEW

Applies easily to cable and connector.

Ordering is fast & easy.

Call today!

Solutions for the AV PROFESSIONAL
www.libertycable.com

800-530-8998
INTERNATIONAL - CALL +1-719-388-7542



Specifications Subject to Change

TO FIND THE RIGHT CONNECTOR FOR YOUR CABLE, MATCH CABLE WITH CONNECTOR ITEM NUMBER. ITEM NUMBERS ARE BOXED WITH CONNECTORS OVER TO THE LEFT.

CABLE APPLICATION	ITEM#	PART#
RG6 DUAL SHIELD NON-PLENUM: RG6, RG6-CM	1	CM-RG6U-RCA
	2	CM-RG6U-GRCA
	3	CM-RG6U-BNC
	4	CM-RG6U-GBNC
	5	CM-RG6U-F
	6	CM-RG6U-GF
RG6 QUAD SHIELD NON-PLENUM: RG6-QUAD, QUADFLEX, 18-CMR, RGB5C	7	CM-RG6Q-RCA
	8	CM-RG6Q-GRCA
	9	CM-RG6Q-BNC
	10	CM-RG6Q-GBNC
	11	CM-RG6Q-F
	12	CM-RG6Q-GF
RG6 SINGLE SHIELD NON-PLENUM: RG6-CCTV PVC	13	CM-RG6C-RCA
	14	CM-RG6C-GRCA
	15	CM-RG6C-BNC
	16	CM-RG6C-GBNC
	17	CM-RG6C-F
	18	CM-RG6C-GF
RG6 DUAL SHIELD PLENUM: 18-CMP-VID, RG6-P-CATV	19	CM-RG6P-RCA
	20	CM-RG6P-GRCA
	21	CM-RG6P-BNC
	22	CM-RG6P-GBNC
	23	CM-RG6P-F
	24	CM-RG6P-GF
RG59 DUAL SHIELD NON-PLENUM: RG59-CATV, 20-CMR, INTERFLEX-SD, RGB5C-20-CMR, RGB3C-20-CMR, RGB6C/20-2L5E	25	CM-RG59U-RCA
	26	CM-RG59U-GRCA
	27	CM-RG59U-BNC
	28	CM-RG59U-GBNC
	29	CM-RG59U-F
	30	CM-RG59U-GF
RG6 SINGLE SHIELD PLENUM: RG6-CCTV-PL	31	CM-RG6PC-RCA
	32	CM-RG6PC-BNC
	33	CM-RG6PC-F
RG59 CCTV SINGLE SHIELD PLENUM: RG59-CCTV-PL	34	CM-RG59PC-RCA
	35	CM-RG59PC-BNC
	36	CM-RG59PC-F

CABLE APPLICATION	ITEM#	PART#
RG59 CCTV SINGLE SHIELD NON-PLENUM: RG59-CCTV, RG59-18-2C, ELAN-CM-VIA	37	CM-RG59C-RCA
	38	CM-RG59C-GRCA
	39	CM-RG59C-BNC
	40	CM-RG59C-GBNC
	41	CM-RG59C-F
	42	CM-RG59C-GF
RG59 DUAL SHIELD PLENUM: 20-CMP-VID, RG59-CATV-PL	43	CM-RG59P-RCA
	44	CM-RG59P-GRCA
	45	CM-RG59P-BNC
	46	CM-RG59P-GBNC
	47	CM-RG59P-F
	48	CM-RG59P-GF
23 AWG SOLID MINI: 23-MINI-SD, RGB5C-23-CM, RGB3C-23-CM, RGB6C-23-2L5E	49	CM-RGB23-BNC
	50	CM-RGB23-RCA
	51	CM-RGB23-GRCA
25 AWG SOLID MINI: RGB5C-25-CMP, RGB5C-25-CM, RGB6C-25-2L5E	52	CM-RGB25S-BNC
	53	CM-RGB25S-RCA
	54	CM-RGB25S-GRCA
25 AWG STRANDED MINI: RGB5-MINI, RGB3-MINI, 25-CMR	55	CM-RGB25-BNC
	56	CM-RGB25-GBNC
	57	CM-RGB25-RCA
	58	CM-RGB25-GRCA
26 AWG STRANDED MINI: RGB5C-PLN, RGB5C-PVC, RGB6C/22-2P, RGB6C-PVC, AVC-18-PLN, SV-PVC, SV-PLN	59	CM-RGB26-BNC
	60	CM-RGB26-GBNC
	61	CM-RGB26-RCA
	62	CM-RGB26-GRCA
RG11 DUAL SHIELD NON-PLENUM: RG11-CATV	63	CM-RG11-N
	64	CM-RG11-BNC
	65	CM-RG11-F
RG6 DUAL SHIELD NON-PLENUM: RG6, RG6-CM	66	CM-RG6-IECM
RG59 DUAL SHIELD NON-PLENUM: RG59-CATV, 20-CMR, INTERFLEX-SD, RGB5C-20-CMR, RGB3C-20-CMR, RGB6C/20-2L5E	67	CM-RG59-IECF
	68	CM-RG59-IECM

IDENTIFICATION BAND COLOR	
Cable	Color
RG6	Blue
RG6Q	Green
RG6 CCTV	Gray
RG6 CCTV PLN	Fuscia
RG6 Plenum	Brown
RG59	Red
RG59Q	Yellow
RG59 Plenum	White

Cable	Color
RG59 CCTV	Black
RG59 CCTV PLN	Chartreuse
RG11	Black
23 AWG Solid	Sky Blue
25 AWG Solid	No Color
25 AWG MINI	Purple
26 AWG MINI	Orange

Identification Bands Make Cable and Connector Matching Easy!

Our simple identification O-Ring design lets you immediately match the right cable with the right connector.

Solutions for the AV PROFESSIONAL **800-530-8998**

www.libertycable.com INTERNATIONAL - CALL +1-719-388-7542

Ordering is fast & easy.



Call today!

CAT5E

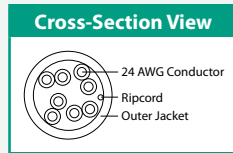

- CMR/CMP Rated
- Sequential Footmarks
- Tested to 350 MHz
- Several Colors Available
- 10/100 BaseT Network Compliant

Category 5E Enhanced

# of Pairs	AWG Size	NOM Insulation (Inches)	NOM Jacket (Inches)	NOM OD (Inches)	NOM Capacitance pF/ft	Part #
4	24 Solid BC	.008 PE	.030 PE	.240	14	24-4P-L5-EN-DB Direct Burial

CATV/MATV Direct Burial Video Cable - Non-Plenum

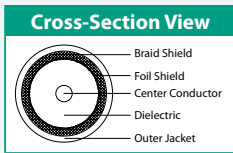

Non-Plenum Unshielded Cable

- Flooded Braid
- MATV, Broadband
- Foamed Polyethylene Dielectric
- Polyethylene Jacket
- UV Rated for Sunlight Resistance
- Suitable for Direct Burial Applications
- 75 Ohm

Coax - CATV/MATV Direct Burial - Gel-Filled

AWG Center Conductor	NOM OD Dielectric (Inches)	Shield Construction	NOM Jacket (Inches)	NOM OD (Inches)	NOM Capacitance (Pf/ft)	NOM Velocity of Propagation	NOM Attenuation		Part #
							MHz	db100'	
18 Solid CCS	0.18 FPE	Foil +60% Alum Braid	0.03 BLK PE	0.272	16	82%	1	0.26	RG6-CATV-DB
							10	0.81	
							50	1.46	
							100	2.05	
							200	2.83	
							400	4.05	
							700	5.06	
900	6.23								
1000	6.08								
18 Solid BC	0.180 FPE	Foil + 60% AL Braid	.030 PE	.272	16.2	82%	50	1.41	RG6-BC-CATV-DB
							100	1.92	
							400	3.73	
							700	5.05	
							1000	6.11	
							1800	8.43	
							2200	9.35	
3000	10.92								
14 AWG Solid BC	0.28 PE	100% Bonded Aluminum/ Poly Alum + 60% 34 AWG Alum Braid	.040 PE	.395	16	82%	1	.100	RG11-BC-CATV-DB Perfect for DBS/Satellite
							10	.450	
							100	1.21	
							200	1.68	
							400	2.37	
							700	3.27	
							1000	3.95	
2200	5.75								
14 Solid CCS	0.28 FPE	Foil + 90% Alum Braid	0.042 BLK PE	.405	16.2	83%	1	0.172	RG11-CATV-DB
							10	0.55	
							50	1.25	
							100	1.08	
							200	2.06	
							400	3.77	
							700	5.14	
900	5.92								
1000	6.28								

Ordering is fast & easy.



Call today!

Solutions for the AV PROFESSIONAL

www.libertycable.com

800-530-8998

INTERNATIONAL - CALL +1-719-388-7542



LibertyLinx™ Universal Control Cables

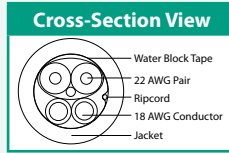
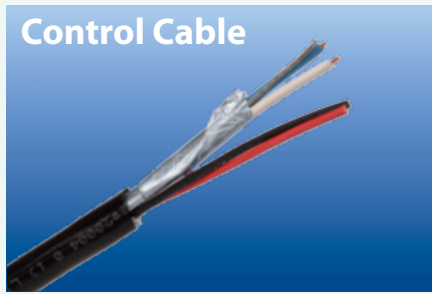

- Perfect for Crestron-style and AMX
- Easy to work with
- UV rated for sunlight resistance
- Perfect for guest houses and pool areas
- Lutron Grafik Eye and Keypad, Quantum Series Control

LibertyLinx™ Universal (Direct Burial) Control Cable							
Description	Shield	NOM Insulation (Inches)	NOM Jacket (Inches)	NOM OD (Inches)	NOM Capacitance (pF/ft)	Color Code	Part #
							LLINX-U-DB
22 AWG 1 PR STR BC (7x30)	FOIL + 24 AWG STR TC Drain	.025 FPE		.074	12.5	Blue White	Data
12 AWG 2C STR BC (16x30)	N/A	.016 SR-PVC		.122	N/A	Red Black	Power
Overall Construction							
			0.032 FR-PVC	.246			Black Only

Direct Burial Speaker Cable - Non-Plenum

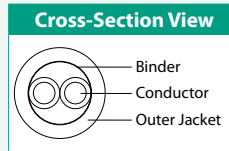

- Designed for outdoor applications
- PE insulation provides protection from underground moisture
- UL rating is suitable for indoor use
- Available in black only
- UL listed CL3

AWG/ Conductors	Stranding	Put-up	Part#
16/2	19 x 29	1,000 ft.	16-2C-DB-BLK
16/4	19 x 29	1,000 ft.	16-4C-DB-BLK
14/2	19 x 25	1,000 ft.	14-2C-DB-BLK
14/4	19 x 25	1,000 ft.	14-4C-DB-BLK
12/2	19 x 25	1,000 ft.	12-2C-DB-BLK
12/4	19 x 25	500 ft.	12-4C-DB-BLK

OUTDOOR HDMI APPLICATIONS

Liberty's new weather resistant HDMI cables are perfect for outdoor and tactical applications. The unique screw lock connector housing offers a water-tight seal and positive latching. The receptacle side is configured for either an in-line application or panel mount applications up to 1/8th inch thick. The total cable length is not recommended to exceed 10m without support electronics. Maximum cable length is 10 meters.

- Great for:**
- Patio Bars
 - Outdoor Restaurants
 - Sporting Arenas
 - Outdoor Residential Applications



Have an outside HDMI application? Call today to get details on our new outdoor HDMI solutions.

Ordering is fast & easy.



Call today!

Solutions for the AV PROFESSIONAL
www.libertycable.com

800-530-8998
INTERNATIONAL - CALL +1-719-388-7542



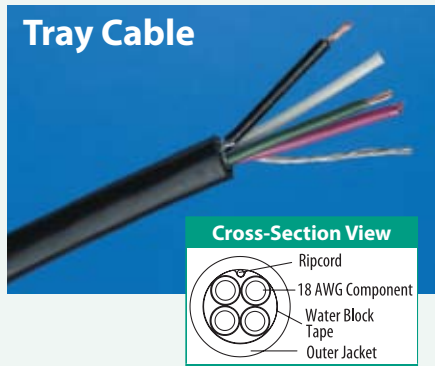

High Voltage Tray rated cables with dual listings for outdoor and underground speaker applications. Liberty's Ultrablock series combine the benefits of Tray jacketing with water blocking technology for true extreme condition speaker and control applications.

- UL Listed NEC type TC or PLTC/CL3
- PVC/Nylon insulation
- Overall Ultra Block™ Moisture Blocking Barrier Construction
- Heavy Duty UV stabilized PVC Jackets
- Sunlight Resistant and Direct Burial
- Ripcord
- Color Code Charts on page 241

Tray Cable - Shielded 600 Volt UL NEC TC						
# of Conductors	AWG Size/ Conductors	NOM Insulation (Inches)	NOM Jacket (Inches)	NOM Jacket (Inches)		Part #
2	18 AWG 7/.0152 BC	.016 PVC	.005			18-2C-TRSH
		20 AWG (7/28) TC Drain 100% Aluminum/Mylar	.047	.270		Overall Construction
4	18 AWG 7/.0152 BC	.016 PVC	.005			18-4C-TRSH
			.050	.321		Overall Construction

Power Limited Tray Cable - UltraBlock™ Unshielded UL PLTC CL3/CM 300 Volt						
# of Conductors	AWG Size	NOM Insulation (Inches)	NOM Jacket (Inches)	NOM * Capacitance (Pf/ft)	NOM Jacket (Inches)	Part #
2 (1 pair)	18(7x26)	.015 PVC .005 Nylon	0.035	25	0.27	UB18-2C-BLK
4	18(7x26)	.015 PVC .005 Nylon	0.04	25	0.327	UB18-4C-BLK
2 (1 pair)	16(7x24)	.015 PVC .005 Nylon	0.04	28	0.285	UB16-2C-BLK
2	14(19x27)	.015 PVC .005 Nylon	0.04	32	0.31	UB14-2C-BLK
2	12(19x25)	.015 PVC .005 Nylon	0.04	36	0.34	UB12-2C-BLK

Power Limited Tray Cable - UltraBlock™ Overall Shielded 300 Volt						
# of Conductors	AWG Size	NOM Insulation (Inches)	NOM Jacket (Inches)	NOM * Capacitance (Pf/ft)	NOM OD (Inches)	Part #
2 (1 pair)	18(7x26)	.015 PVC .005 Nylon	0.04	32	0.31	UB18-2C-SH-BLK
4	18(7x26)	.015 PVC .005 Nylon	0.04	32	0.371	UB18-4C-SH-BLK
2 (1 pair)	16(7x24)	.015 PVC .005 Nylon	0.04	37	0.328	UB16-2C-SH-BLK
2 (1 pair)	12(19x25)	.015 PVC .005 Nylon	0.04	54	0.375	UB12-2C-SH-BLK

Ordering is fast & easy.



Call today!

**Solutions for the
AV PROFESSIONAL**
www.libertycable.com

800-530-8998
INTERNATIONAL - CALL +1-719-388-7542



FlatWire™

As the dynamics of the residential retro-fit market increase both the retro-fit market size and customers expectations for product performance, FlatWire has become the number one choice for AV professionals.

FlatWire products by Liberty provide your business with a great opportunity to differentiate yourself in the retro-fit marketplace. FlatWire is both cool and sexy and best of all—it works! FlatWire developed technology enables the product to sit on the wall surface where it can be easily mudded, painted over and becoming invisible on the wall. FlatWire connects to a sleek low profile and unobtrusive wall mount that is easy to install and connect.



Before: FlatWire audio speaker products make installing a surround sound system both cost effective and as easy as painting a room.

FlatWire Installs in 4 Easy Steps!

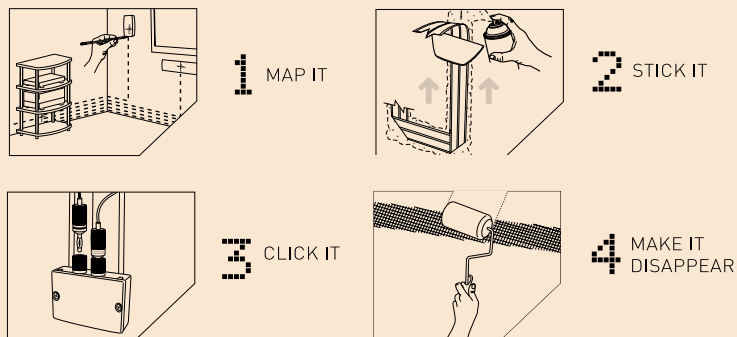

FlatWire will help you service your retrofit customers by being:

- Economical alternative to a “tear the walls apart” AV retrofit installation
- Easy to Install
- Safe
- High Performance
- Cost Effective

Our innovative, patented paper thin wire makes it possible to put Audio, Video and even Lighting exactly where you desire without tearing down dry wall or other wall surfaces. Using FlatWire also eliminates visible/unsightly wires, and the need for conduit, or decorative molding.



After: A surface mount system allows wire to blend into walls and be painted over, becoming virtually invisible and suitable for any room!

Ordering is fast & easy.



Call today!

1. Speaker Wire



Length: 25', 50', 100', 500'
Width: 2.274"

Gauge	Resistance	Capacitance	Inductance	Impedance	Part #
18AWG	0.24 Ω (25')	0.17 nF (25')	3.2 uH (25')	137.2 Ω (25')	FLT-SPK-18-*
14AWG	0.117 Ω (25')	0.17 nF (25')	3.2 uH (25')	137.2 Ω (25')	FLT-SPK-14-*
12AWG	0.046 Ω (25')	0.17 nF (25')	3.2 uH (25')	137.2 Ω (25')	FLT-SPK-12-*

* = length (25, 32, 50, 82, 100, 500)

2. Banana Plug: Straight



Part #: FLT-CON-BAN

- Gold-plated connectors
- Removable plastic sleeve
- Red & black coloring to identify separate speaker leads
- Includes anchor to secure FlatWire to wall at speaker location/audio source
- L 2.5 x W 0.375 x H 0.375

3. Banana Plug: Right Angle



Part #: FLT-CON-BANRA

- Gold-plated connectors
- Removable plastic sleeve
- Red & black coloring to identify separate speaker leads
- Includes anchor to secure FlatWire to wall at speaker location/audio source
- L 1.75 x W .375 x H 1.5625

4. Pin Connector

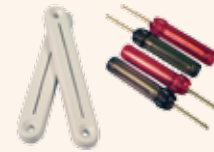

Part #: FLT-CON-PIN

- Gold-plated connectors
- Removable plastic sleeve
- Red & black coloring to identify separate speaker leads
- Includes anchor to secure FlatWire to wall at speaker location/audio source
- L 2.45 x W 0.42 x H 0.42

5. 5-Way Binding Post



Part #: FLT-CON-5WBP

- Gold-plated connectors
- Paintable plastic box
- Red & black coloring indicates positive and negative speaker terminals.
- L 2.025 x W 2.95 x H .959

6. Component Video



Length	Part #
10'	FLT-WIR-3CH-10
20'	FLT-WIR-3CH-20

Use with Component Video Connector

- Skin Gauge Equivalent: 12AWG
- Pattern Wave Technology shielding
- 100% Oxygen Free Copper
- Quick Links Technology™ connectivity
- Impedance: 75 Ω

7. Component Video Connector



Part #: FLT-CON-CVRCA

- RCA connectivity with red, blue, and green color coding
- Powder-coated steel shield
- Impedance: 75 Ω
- L 1.66 x W 3.43 x H 0.93

Ordering is fast & easy.



Call today!

Solutions for the AV PROFESSIONAL
www.libertycable.com

800-530-8998
INTERNATIONAL - CALL +1-719-388-7542



8. Audio, Video & Data 1



Length	Part #
10'	FLT-WIR-1CH-10
20'	FLT-WIR-1CH-20

Use with RCA Connector for Subwoofer, Digital COAX and Composite Video, also goes with Cable Modem Connector.

- Skin Gauge Equivalent: 12AWG
- Pattern Wave Technology shielding
- 100% Oxygen Free Copper
- Quick Links Technology™ connectivity
- Impedance: 75 Ω

9. Coaxial Emulation

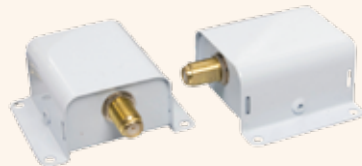

Part #: FLT-CON-F

- F style connectivity
- Powder-coated steel shield
- Impedance: 75 Ω
- L 2.5 x W 2.43 x H 1

10. RCA Connector



Part #: FLT-CON-RCA1

Use for Subwoofer, Digital COAX, and Composite Video

- RCA connectivity with black color coding
- Powder-coated steel shield
- Impedance: 75 Ω
- L 2.175 x W 2.43 x H 1

11. Audio, Video & Data 2

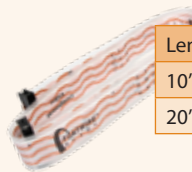

Length	Part #
10'	FLT-WIR-2CH-10
20'	FLT-WIR-2CH-20

Use with Audio L/R, S-Video, Audio/Video and 2-Pair Ethernet Connectors

- Skin Gauge Equivalent: 12AWG
- Pattern Wave Technology shielding
- 100% Oxygen Free Copper
- Quick Links Technology™ connectivity
- Impedance: 75 Ω

12. Audio/Video Connector

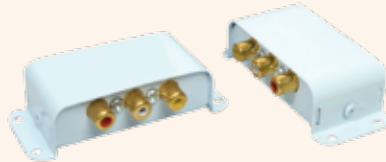

Part #: FLT-CON-A/VRCA

- RCA connectivity with red, white, and yellow color coding
- Powder-coated steel shield
- Impedance: 75 Ω
- L 2.45 x W 0.42 x H 0.42

13. 2-Pair Ethernet Connectors



Part #: FLT-CON-RJ45

- RJ45 connectivity
- Powder-coated steel shield
- L 2 x W 2.43 x H 1

14. S-Video Connector



Part #: FLT-CON-SV

- 4-pin mini-Din connectivity
- Powder-coated steel shield
- Impedance: 75 Ω
- L 1.95 x W 2.43 x H 1

15. Audio L/R Connector

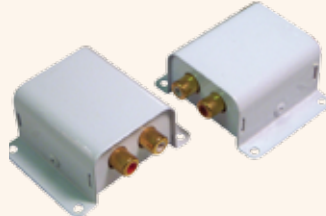

Part #: FLT-CON-LRRCA

- RCA connectivity with red and white color coding
- Powder-coated steel shield
- Impedance: 75 Ω
- L 1.66 x W 3.43 x H 0.93

16. Accessories



12oz. CFC Free

SPRAY ADHESIVE
Part #: FLT-GLUE



Width 3" Length 50'

MESH TAPE
Part #: FLT-MESH

Ordering is fast & easy.



Call today!

GREEN connectivity

As a leading global supplier of wire and cable, Liberty is at the forefront of manufacturing environmentally friendly products.

Chromium (Cr), Poly brominated biphenyl (PBB) and Polybrominated diphenyl ether (PBDE) in electronic and electrical equipment.

Many countries are now implementing the Restriction of Hazardous Substance (RoHS) directive mandating the reduction of Lead (Pb), Mercury (Hg), Cadmium (Cd), Hexavalent

For several years now, Liberty has been offering a broad spectrum of our products that are RoHS compliant. Liberty Wire and Cable is committed to constantly expanding the number of environmentally friendly products we manufacture.

Shade Controls Reduce Energy Demand

Sivoia™ shade controls allow customers to better manage solar radiation levels and reduce heat gain for conference rooms, meeting rooms and home theaters. Reducing solar radiation reduces your customer's energy consumption footprint. Standard length 1,000 feet.

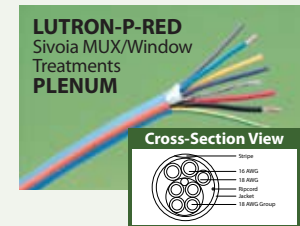
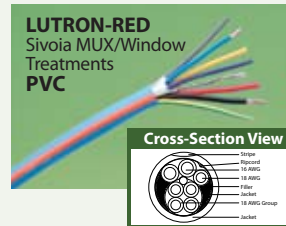

Occupant Sensors Automate Energy Savings

GRAFIK Eye™ occupant sensors systems turn the lights off when a space is not occupied. Your customers can

reduce their electricity usage, in meeting rooms, home theaters and other spaces. Standard length 1,000 feet.

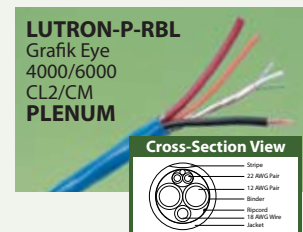
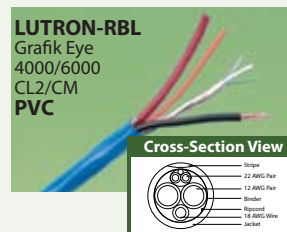
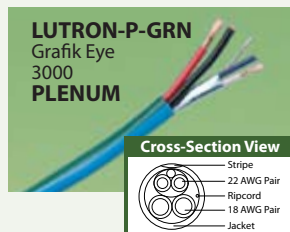
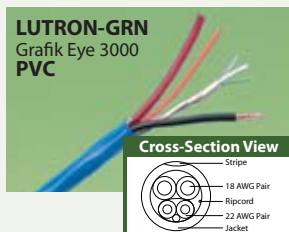

Light Controls Save Energy

Standard length 1,000 feet.

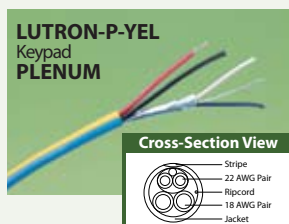
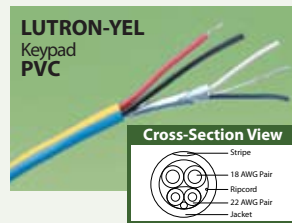
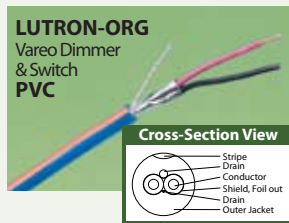
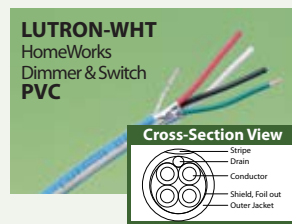
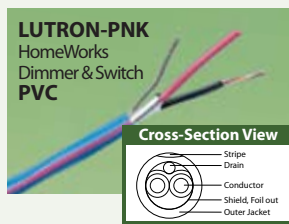

Help Your Customers Manage Energy Costs with Liberty

Electricity Usage in Office Buildings

Source: US Department of Energy

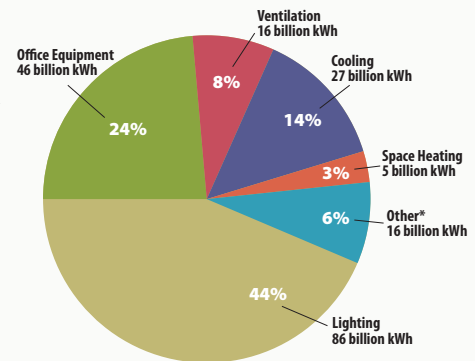

Lights consume the most energy in commercial buildings and schools. According to the US Department of Energy, lights can consume:

- 44% of all electricity
- 29% of all energy used

Liberty Provides Cables for Energy-Efficient Solutions

Ordering is fast & easy.



Call today!

Solutions for the AV PROFESSIONAL

www.libertycable.com

800-530-8998

INTERNATIONAL - CALL +1-719-388-7542



Halogen-Free Category Cable

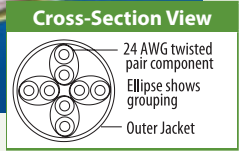
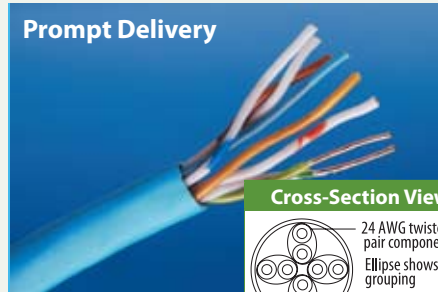

Stranded UTP patch cable for high speed data transmission, LAN, and voice installations in accordance with Halogen-Free requirements.

Features and Benefits

- Each pair twisted in a varying lay from the other pairs
- IEC Rated for Halogen Free, Low Smoke, and Fire Retardant
- 10/100 BaseT
- Category 5e verified performance
- Color Code - Pair 1: Blue and white/blue, Pair 2: Orange and white/orange, Pair 3: Green and white/green, Pair 4: Brown and white/brown

Halogen-Free Category Cable						
# of Pairs	AWG Size/ Stranding	NOM Insulation (Inches)	NOM Jacket (Inches)	NOM OD (Inches)	NOM Capacitance (pF/ft)	Part #
4	24 STR BC (7x32)	.008 HD-PE	.022 LSZH PO	.245	17	CAT5E-STR-HF-* *Available in Blue, Green, Gray, Red, White or Yellow

Halogen-Free Coax Cable

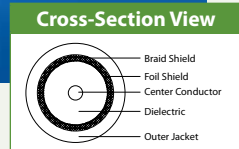
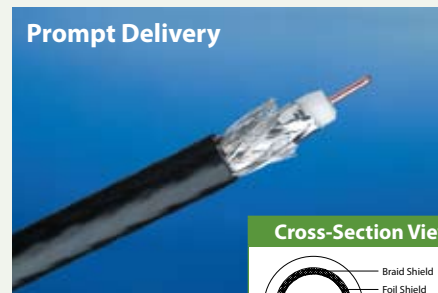

RG6 Dual-shield and Quad-shield drop cables for CATV/MATV installations in accordance with IEC Halogen-Free requirements.



Halogen-Free RG6 and RG6 Quad Coax Cable									
AWG Center Conductor	NOM OD Dielectric (Inches)	Shield Construction	NOM OD Jacket (Inches)	NOM OD (Inches)	NOM Capacitance (Pf/ft)	NOM Velocity of Propagation	NOM Attenuation		Part #
							MHz	db100'	
18 Solid CCS	0.18 FPE	100% Foil 60% Al Braid	.032 LSZH PO	.275	16.3	83%	5	.54	RG6-HF-* 75 Ohm *Available in Black and Yellow
							10	.72	
							55	1.45	
							270	2.97	
							500	4.09	
							700	4.92	
1000	5.99								
18 Solid BC	0.18 FPE	100% Foil Inner + 60% Al Braid 2nd Inner + 100% Foil + 60% Al Braid	.032 LSZH PO	.310	16.2	83%	5	.54	RG6Q-HF-* 75 Ohm *Available in Black, Green and White
							50	1.32	
							360	3.65	
							720	5.20	
							1000	6.95	
							1450	8.20	
							1800	9.40	
							2250	10.49	

Ordering is fast & easy.



Call today!

Solutions for the AV PROFESSIONAL **800-530-8998** **Liberty AV Solutions**
www.libertycable.com INTERNATIONAL - CALL +1-719-388-7542

Specifications Subject to Change

Halogen-Free Coax Cable

The Liberty Advantage

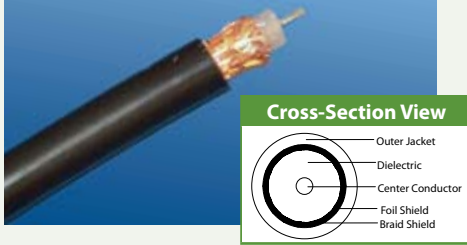

Features and Benefits

- RG11/AU coaxial cable for radio frequency, data, and video transmission.
- RG11/U dual shield drop cable for CATV/MATV installations in accordance with IEC 60332.3 Category C Halogen-Free requirements.
- RG213 Coaxial cable for RF transmission and data applications and installations in accordance with IEC 60332.3 Category C Halogen-Free requirements

Halogen-Free RG11 and RG213 Coax Cable

AWG Center Conductor	NOM OD Dielectric (Inches)	Shield Construction	NOM OD Jacket (Inches)	NOM OD (Inches)	NOM Capacitance (Pf/ft)	NOM Velocity of Propagation	NOM Attenuation		Part #
							MHz	db100'	
18 STR TC (7x26)	.285 Solid PE	95% 33 AWG Copper Braid	.045 FR-LSZH	.405	20.5	66%	10	.59	RG11/AU-HF-BLK 75 Ohm
							50	1.36	
							100	1.98	
							200	2.93	
							400	4.42	
							800	6.93	
1000	8.11								
14 Solid BC	.280 FPE	100% Foil + 60% Al Braid	.043 LSZH PO	.404	16.2	83%	5	.38	RG11-HF-WHT 75 Ohm
							55	1.03	
							211	2.01	
							330	2.55	
							550	3.36	
							750	3.99	
1000	4.67								
STR TC (7x30)	.285 Solid PE	97% BC Braid	.043 LSZH	.405	30.8	66%	1	.16	RG213-HF-BLK 55 Ohm
							5	.36	
							10	.58	
							50	1.23	
							100	1.81	
							200	2.68	
							400	4.07	
							900	6.47	
							1000	6.88	
							2000	10.44	
							4000	16.18	

Maritime Halogen-Free Custom Bundles

International maritime standards require the use of halogen-free cables for AV solutions. Liberty is the global leader in providing custom designed halogen-free bundles for marine use.

Our engineers design and build your cable to meet both regulatory and naval architecture requirements.

Liberty's expertise in manufacturing custom halogen-free bundles can help you save labor and installation time for your next maritime installation. Contact Liberty for a free custom halogen-free bundle design consultation.



Ordering is fast & easy.



Call today!

Solutions for the AV PROFESSIONAL

www.libertycable.com

800-530-8998

INTERNATIONAL - CALL +1-719-388-7542



Halogen-Free Coax Cable

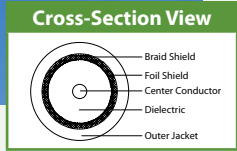

RG59 and RG6 precision video coaxial cable for analog audio/video, digital audio/video, HDTV/SDI, broadcast, broadband video, baseband video, and head end applications.

International
This product is a favorite with our International customers

Halogen-Free RG59 RG6 Serial Digital Coax Cable									
AWG Center Conductor	NOM OD Dielectric (Inches)	Shield Construction	NOM OD Jacket (Inches)	NOM OD (Inches)	NOM Capacitance (Pf/ft)	NOM Velocity of Propagation	NOM Attenuation		Part #
							MHz	db100'	
20 Solid BC	.145 FPE	100% Foil + 95% TC Braid	.032 LSZH	.237	16.3	83%	10	.87	RG59-SD-HF-BLK CMR 75 Ohm
							71.5	2.10	
							135	2.70	
							270	3.80	
							360	4.42	
							720	6.36	
							1000	7.60	
2000	10.90								
3000	13.40								
18 Solid BC	0.18 FPE	100% Foil + 95% TC Braid	.032 LSZH	.275	16.2	83%	5	.54	RG6-SD-HF-* CMR 75 Ohm *Available in Black or Yellow
							71.5	1.60	
							135	2.10	
							270	2.97	
							540	4.25	
							750	5.00	
							1000	5.89	
							2000	8.57	
							3000	10.67	

Halogen-Free Speaker Cable

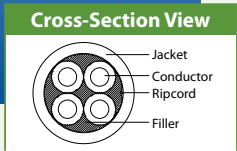

Multi-conductor control and speaker wire for distributed audio applications installed in accordance with Halogen-Free requirements.

Halogen-Free Speaker Cable					
# of Conductors	AWG Size/ Stranding	NOM Insulation (Inches)	NOM Jacket (Inches)	NOM OD (Inches)	Part #
2	14 (41x30)	.022	.035	.310	14-2C-HFSH
4	14 (41x30)	.022	.035	.350	14-4C-HFSH
2	16 (65x34)	.022	.035	.276	16-2C-HFSH
4	16 (65x34)	.022	.035	.323	16-4C-HFSH

Green Connectivity™

Ordering is fast & easy.



Call today!

Solutions for the AV PROFESSIONAL
www.libertycable.com

800-530-8998
INTERNATIONAL - CALL +1-719-388-7542



E-Z Solutions: HDMI



Whole House Distribution of HDMI Signals

Liberty is at the leading edge of managing whole house HDMI signal distribution for residential installations.

Whether you are working on a new installation or a retro-fit project, our combination of both standard and high speed HDMI cables combined with our HDMI devices including: matrix switchers and non-matrix distribution amplifiers and switchers provides the professional AV installer with unmatched flexibility.

Liberty's state-of-the-art solutions for HDMI over COAX, HDMI over Category and HDMI over Fiber provide flawless performance for any installation. Liberty's new HDMI solutions provide both the opportunity to "Future Proof" any current installation and seamlessly integrate and upgrade any retro-fit project.

The finishing touches of our custom or standard wall plates and rack mounted solution create an aesthetically pleasing and highly functional environment.

Unlike our competitor's products, Liberty's HDMI products are put through rigorous testing processes, assuring product performance and inter-operability. Our extensive real world testing and engineering provides confidence that the source, AV receiver and display device will work seamlessly together.

Liberty's research and development teams monitor current and future HDMI compatibility issues across the AV marketplace allowing our products to evolve as market dynamics change.

Liberty invests in our people with continuing education and training on our products and their applications. Our highly trained sales force understands the needs of your most complicated or most simple AV installations. Liberty's highly skilled sales force combined with our world-class technical support teams provide you with the right products for the right job. It is like having your own private AV project consultant.

Buying factory direct eliminates excess cost from your HDMI project, allowing you to keep more of your hard earned margin. Liberty's full line of high quality, reliable products is available only through our dealer network, protecting your business and keeping it competitive.

Ordering is fast & easy.



Call today!

**Solutions for the
AV PROFESSIONAL**

www.libertycable.com

800-530-8998

INTERNATIONAL - CALL +1-719-388-7542





HDMI Over Coax
Part #: DL-HDCX



DigitalLinX HDMI High Speed
Part #: DLX-HDSM-*



Stand Alone
Wall Plates
Part #: DL-HDCAT-WP



8X8 Switcher
Part # DL-HDM88



6X6 Switcher
Part # DL-HDM66

Liberty's products provide the professional AV installer with the right products for any HDMI installation: products that keep your business both competitive and profitable.



THE LIBERTY ADVANTAGE:

Sales and Technical Support:

- Extensive testing of product performance and inter-operability
- Extensive knowledge base of current and future HDMI compatibility
- Highly trained sales force that understands your complicated installations
- Full line of high quality reliable products
- Internal technical support
- Real world engineering and test data
- Distributed through dealer network
- Inventory availability

HDMI PRODUCTS:

Liberty carries the most comprehensive line of HDMI products, all designed to work and play together. These products include:

- Matrix Switchers
- Distribution Amplifiers and Switchers (non-matrix)
- A Variety of Cable solutions (Standard Speed, High Speed)
- HDMI over COAX "Future Proof"
- HDMI over CAT
- HDMI over Fiber "Future Proof"
- Electronic Extenders
- Custom or Standard Wall Plates
- Rack Systems

To Start Your HDMI Project Call Us Today!

Ordering is fast & easy.



Call today!

Solutions for the AV PROFESSIONAL
www.libertycable.com

800-530-8998
INTERNATIONAL - CALL +1-719-388-7542



DIGITALINX™

Complete Digital Solutions for the AV Professional

HDMI Over COAX

Liberty's revolutionary HDMI over COAX devices transmit a true HDMI signal, not an analog version of a digital signal. Short HDMI cables are used to connect the transmitter and receiver to the source and display respectively with coax cables between the transmitter and receiver.

Future Proof Your Current Installations

It's easy to install and use, works perfectly with the RGBHV COAX cables typically used for VGA or component signals, and provides A/V professionals with unparalleled flexibility. Consisting of a transmitter and a receiver, the system uses conventional HDMI cables to connect to sources and displays. 4 or 5 conductor coax cable is then used to connect the transmitter to the receiver. Power can be provided on either end. There are LED status indicators for Display, Source and Power.

Liberty's RGB cables are the perfect Match for HDMI

Part #	Cable Characteristics	1080p / 60 w/ HDCP Distance in feet
RGB5C-PVC/PLN	26 awg Stranded	150'
RGB5-25-MINI	25 awg Stranded	165'
RGB5C-25-CMP	25 AWG solid	175'
RGB5C-23-CM	23 AWG Serial Digital	300'
RGB5C-20-CMR	20 AWG Serial Digital	400'
RGB5C	18 AWG Serial Digital	600'

The Right Connection With Liberty's New 1.3 High-Speed HDMI Cables

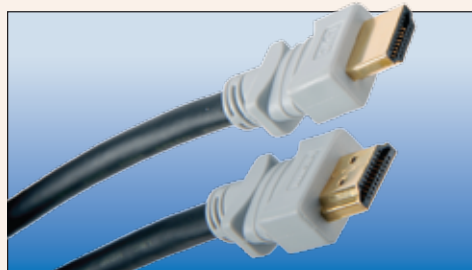

Description	Part#:
DIGITALINX HDMI HIGH SPEED 1M	DLX-HDSM-1M
DIGITALINX HDMI HIGH SPEED 2M	DLX-HDSM-2M
DIGITALINX HDMI HIGH SPEED 3M	DLX-HDSM-3M

Description	Part#:
HDMI HIGH SPEED CABLE 1M	E-HDSM-M-1
HDMI HIGH SPEED CABLE 1.5M	E-HDSM-M-1.5
HDMI HIGH SPEED CABLE 2M	E-HDSM-M-2
HDMI HIGH SPEED CABLE 3M	E-HDSM-M-3
HDMI HIGH SPEED CABLE 4M	E-HDSM-M-4
HDMI HIGH SPEED CABLE 5M	E-HDSM-M-5
HDMI HIGH SPEED CABLE 6M	E-HDSM-M-6
HDMI HIGH SPEED CABLE 8M	E-HDSM-M-8
HDMI HIGH SPEED CABLE 10M	E-HDSM-M-10



Ideal for Retrofits

HDMI over COAX allows A/V professionals to move their current analog customer base to HDMI signal distribution by executing a Liberty HDMI upgrade. With a simple on-site visit, they will be able to extend the life-spans of their customers' current analog installations while providing AV professionals with opportunities to upgrade displays, entertainment sources, cables and switchers.

Main Features

- HDMI 1.3 High Speed / category 2 compliant
- Single-link bandwidth to 10.2 Gbps with Pixel Clock, up to 340 MHz
- Deep color: 12-bit, (RGB or YCbCr) color depths for stunning rendering of over one billion colors in unprecedented detail
- Higher screen resolutions to 1440p
- HDCP, CEC & DDC Compliant
- DVI Compatible

- Send HDMI 1080p hundreds of feet over common coax
- Reliable & Flexible
- Simple Field Termination

Ordering is fast & easy.



Call today!

Solutions for the AV PROFESSIONAL
www.libertycable.com

800-530-8998
INTERNATIONAL - CALL +1-719-388-7542



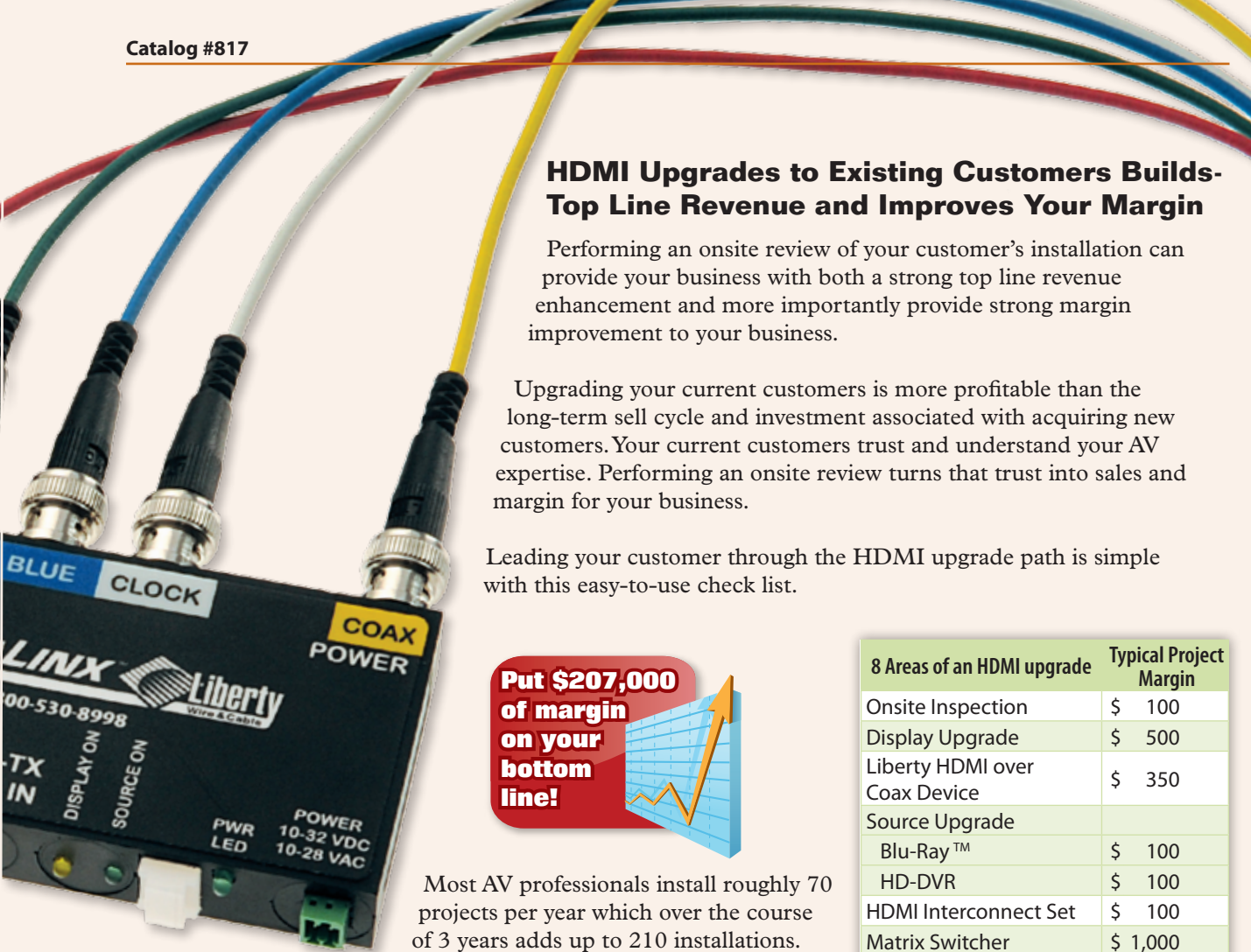

HDMI Upgrades to Existing Customers Builds-Top Line Revenue and Improves Your Margin

Performing an onsite review of your customer's installation can provide your business with both a strong top line revenue enhancement and more importantly provide strong margin improvement to your business.

Upgrading your current customers is more profitable than the long-term sell cycle and investment associated with acquiring new customers. Your current customers trust and understand your AV expertise. Performing an onsite review turns that trust into sales and margin for your business.

Leading your customer through the HDMI upgrade path is simple with this easy-to-use check list.

Put \$207,000 of margin on your bottom line!

Most AV professionals install roughly 70 projects per year which over the course of 3 years adds up to 210 installations. One assumes that roughly 30% of these installations would be ready for an HDMI upgrade. As the chart shows below 30% equates to \$207,000 of margin.

8 Areas of an HDMI upgrade	Typical Project Margin
Onsite Inspection	\$ 100
Display Upgrade	\$ 500
Liberty HDMI over Coax Device	\$ 350
Source Upgrade	
Blu-Ray™	\$ 100
HD-DVR	\$ 100
HDMI Interconnect Set	\$ 100
Matrix Switcher	\$ 1,000
Power Conditioning	\$ 50
Installation Labor	\$ 1,000
Total Margin Contribution per HDMI upgrade:	\$ 3,300

Sold as a set, including transmitter, receiver and power supply.
Part # DL-HDCX

The Basic Facts		Target HDMI Upgrade % with Margin Targets				
Installs per year	3 years installs	100%	30.00%	20.00%	10.00%	5.00%
70	210	210	63	42	21	11
HDMI Margin \$3,300		\$693,000	\$207,900	\$41,580	\$20,790	\$34,650

Example estimates margin performance, actuals may vary slightly.

Market Trends Driving HDMI Acceptance

- Corporate and residential customers are expecting HDMI connectivity
- Switch from analog to digital accelerating
- Blu-Ray™ and 1080p are being rapidly adopted as the new standard in the AV industry
- High-definition Games and Media formats are migrating to these new standards
- High-definition Cable and Satellite Broadcasting and Off-Air Television broadcasts
- Proliferation of in-home and corporate movie viewing with high definition Blu-Ray™ and other High Def. sources
- Rapid adoption of High Definition Pay per View and Digital Content Downloads from the Internet
- Costs are decreasing
- Digital outputs on PC's becoming more common

Ordering is fast & easy.



Call today!

Solutions for the AV PROFESSIONAL
www.libertycable.com

800-530-8998
INTERNATIONAL - CALL +1-719-388-7542



HDMI Over Category Cable

Part #: DL-HDCAT

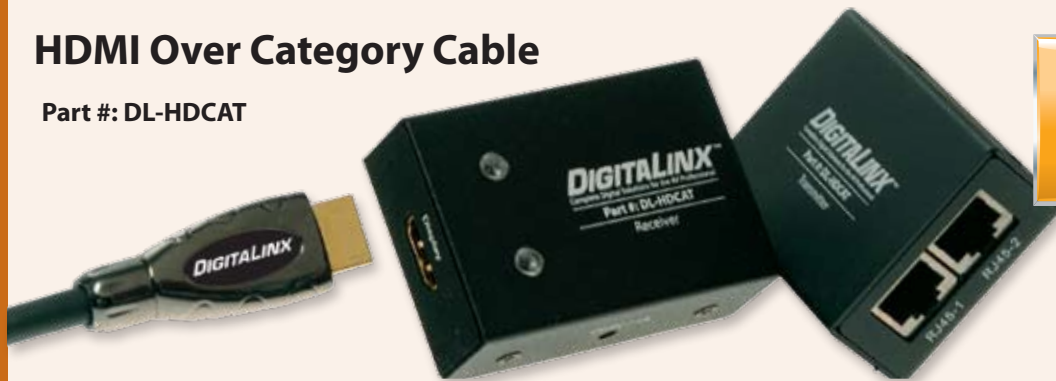

Ideal for Home Theater and Digital Signage up to 250 feet

HDMI over Category Cable

Liberty's new HDMI over Category Cable extender is perfect for simple installations where cost is critical. The low cost of Category cable (available in both plenum and non-plenum versions) makes this the perfect solution for many applications.

The quality of the cable is critical. Use of Category 6 cable will extend distances especially for 1080p signals and shielded category cables will reduce EMI issues. Low Skew UTP cables are not recommended. This is a practical application chart with recommended, safe design distances as well as measured successful transmission distances. Perfect for shorter distances.

Category Cable Performance Expectations

Cable / Resolution	720p /60 - 1080i /30	1080p /60
Cat 5e UTP	60m (197')	20m (66')
Cat 5e Shielded	60m (197')	20m (66')
Cat 6	80m (260')	50m (165')

Main Features

- High performance built-in TMDS signal amplifier
 - Performs at HDTV and PC resolutions
 - 12 bit Deep Color Compliant
 - HDCP Compliant (High-bandwidth Digital Content Protection)
 - Wall mount and stand alone versions
 - Can be built into custom wall plates
 - Comes with external power supply for North America
 - An international version is equipped with a DC power adapter compatible with the EU, UK and Australia
- Part #: DL-HDCAT-INT

Stand Alone Wall Plates

Ideal for a basic home theater or for digital signage applications Liberty has a solution to meet your requirements. Easy to install wall plate versions or stand alone boxes are powered at the display with a wall wart for simple installation.

Part #: DL-HDCAT-WP



Liberty provides a broad selection of category cables in over 10 colors. Cat5e, Cat6, shielded and unshielded versions. All cables work perfectly with Liberty's CatMaster™ termination kit.



CATMaster™ Crimp Tool
Part #: 100 044LW



Shielded EZ-RJ45 Connector
Part #: 100020

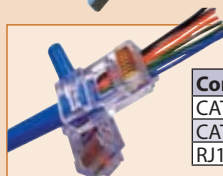

EZ-RJ45® Connector

Connector Type	Part #
CAT5E	100 003B
CAT6	100 011LW
RJ11/12	100 026LW



UTP Category Cable Jacket Stripper
Part #: 15010

Ordering is fast & easy.



Call today!

Solutions for the AV PROFESSIONAL

www.libertycable.com

800-530-8998

INTERNATIONAL - CALL +1-719-388-7542



Perfect For...
 • HDMI Whole House Distribution System



6X6 Switcher

PART # DL-HDM66

The DL-HDM66 is designed to route up to 6 sources independently to up to 6 displays.

Fully HDCP compliant and supports resolutions up to 1080p. Controllable via RS-232, IR, LAN or manual input.

Perfect For...
 • HDMI Whole House Distribution System



8X8 Switcher

PART # DL-HDM88

The DL-HDM88 is designed to route up to 8 sources independently to up to 8 displays.

Fully HDCP compliant, supports resolutions up to 1080p. Controllable via RS-232, IR, LAN or manual input.

Perfect For...
 • Modular System Will Grow with Your Requirements



Call for Details
 Call Today for More Information

18X18 Switcher

PART # DL-HDM1818

Modular Matrix switcher with up to 18 inputs and 18 outputs. Available with

HDMI, DVI or Display port module. 3 inputs/outputs per module.

Ordering is fast & easy.



Call today!

Solutions for the AV PROFESSIONAL
 www.libertycable.com

800-530-8998
 INTERNATIONAL - CALL +1-719-388-7542



Specifications Subject to Change

HDMI® (High-Definition Multimedia Interface) Cables - Molded

With the ability to run multi-channel video, audio and control down one cable, Liberty's HDMI cables offer the ultimate digital solution. Design details include a HDMI connector and HDCP

and EDID compliancy. Liberty also offers a HDMI to DVI breakout cable to connect A/V devices that might use the two different digital interface connections.

1. HDMI Cable

Length (m)	Connection	Part #
.5	HDMI Male to HDMI Male	E-HDM-M-.5
1		E-HDM-M-1
2		E-HDM-M-2
3		E-HDM-M-3
4		E-HDM-M-4
5		E-HDM-M-5
6		E-HDM-M-6
8		E-HDM-M-8
10		E-HDM-M-10
12		E-HDM-M-12
15		E-HDM-M-15
20		E-HDM-M-20*
25		E-HDM-M-25*
30		E-HDM-M-30*
35		E-HDM-M-35*



*Lengths to 20 meters tested to 1080p without extenders

See Page 80

For More High Speed Cables and Details

HDMI Repeaters, Amplifiers and Switchers



Perfect For...

• New Smaller Size Repeater with DC Power

HDMI REPEATER

PART #: DL-HDR

Liberty's HDMI Repeater extends the length of any HDMI or DVI cable by regenerating the digital signal before it outputs to the HDMI or DVI

monitor or projector. HDMI Repeater enables you to relocate your video sources or computer to a safe, quiet and hidden location.

Main Features

- Connects DVD, Blue Ray, set-top boxes, games and computers with HDMI/DVI graphic cards to HDMI/DVI compatible monitors or projectors
- Supports high resolution up to UXGA (1600*1200) at 60Hz refresh rate, 480p, 720p, 1080i/p
- Supports DDWG standard for DVI compliant monitors
- HDCP compliant

Technical Information

- Frequency Bandwidth : 1.65 GHz
- Video Resolution : Up to UXGA (1600*1200), HD signal up to 1080i/p
- Inputs : HDMI Female port / Output : HDMI Female port
- Power Supply : External DC 5v supply included, use as needed
- Dimensions (W*D*H, in) : 2*2*0.75 - Weight (lb) : 0.5
- AC Adapter Provided

Devices Available with DVI Connections

Ordering is fast & easy.



Call today!

Solutions for the AV PROFESSIONAL
www.libertycable.com

800-530-8998
INTERNATIONAL - CALL +1-719-388-7542





FRONT



Perfect For...

- Monitoring System
- Home Theaters with Multiple Displays



HDMI 1 IN, 5 OUT DISTRIBUTION AMPLIFIER

PART #: DL-HDD15

Liberty's Distribution Amplifier allows one digital HDMI or DVI video or computer source to be displayed on up to five HDMI displays. The built-in

extender function enables HDMI and DVI signal distribution without any signal loss for maximum cable length.

Main Features

- Built-In dip switch, adjusts DDC Signal Conflict
- Supports HDTV Resolution : 480p, 720p, 1080i/p
- Supporting resolution: VGA(640*480) , XGA (1024*768), SXGA(1280*1024), UXGA(1600*1200)

Devices Available with DVI Connections

Technical Information

- Frequency Bandwidth : 1.65 GHz
- Video Resolution : Up to UXGA (1600*1200), HD signal up to 1080i/p
- Audio Sampling rates : Up to 24bit / 192KHz
- Inputs : 1 HDMI "A" TYPE Female connector
- Outputs : 5 HDMI "A" TYPE Female connector
- Power Supply : DC 5V, 2A Power supply adapter included
- Dimensions (W*D*H, in) : 11*3.9*1.2 -Weight (lb) : 2.98



FRONT



Perfect For...

- Monitoring System
- Home Theaters with Multiple Displays



BACK

HDMI 2 IN, 5 OUT DISTRIBUTION AMPLIFIER

PART #: DL-HDD25

Liberty's Distribution Amplifier allows two digital HDMI or DVI video or computer source to be displayed on up to five HDMI displays.

The built-in extender function enables HDMI and DVI signal distribution without any signal loss for maximum cable length.

Main Features

- High Quality Picture - No Signal Loss and Digital Noise Free
- Signal Amplification for signal reliability and long length signal transmission.
- Easy switching between two HDMI sources.
- DL-HDD25 enables daisy chain connection up to 4 layer distributors
- HDCP Compliant at all output channels

Technical Information

- Frequency Bandwidth : 1.65 GHz
- Supports Resolution: HDTV signal 480p,720p,1080i/p
- Inputs : 2 HDMI "A" TYPE Female connector
- Outputs : 5 HDMI "A" TYPE Female connector
- Dimensions (in) : 12.2*5.7*1 -Weight (lb) : 2.65

Devices Available with DVI Connections

Ordering is fast & easy.



Call today!

Solutions for the AV PROFESSIONAL
www.libertycable.com

800-530-8998
INTERNATIONAL - CALL +1-719-388-7542





Perfect For...

- Monitoring System
- Home Theaters with Multiple Displays

HDMI 1 IN, 10 OUT DISTRIBUTION AMPLIFIER

PART #: DL-HDD110

Liberty's Distribution Amplifier allow one digital video and audio source to be displayed on up to into ten digital displays.

The built-in extender function enables HDMI signal distribution without signal loss.

Main Features

- High Quality Picture
- Signal Amplification for signal reliability and long length signal transmission
- Select External EDID Data
- HDCP compliant at all channels

Technical Information

- Frequency Bandwidth : 1.65 GHz
- Supports Resolution: Up to 1920x1080@60Hz, ATSC HDTV signal up to 1080p
- Inputs : 1 HDMI "A" TYPE Female connector
- Outputs : 10 HDMI "A" TYPE Female connector
- Signals & Connectors: Input & Output HDMI Type A Single Link Connector
- Dimensions (W*D*H, in) : 12.2*5.7*2.2 - Weight (lb) : 3.3

Devices Available with DVI Connections



Easy-To-Use Switcher Remote
Selects the signal from source devices.

Perfect For...

- Home Theater System Integration
- Easy switching between two digital video sources
- LED display of video source channel selections

All switches are RS-232 controllable



HDMI 4 IN, 1 OUT SWITCHER

PART #: DL-HDS41

Liberty's HDMI Switcher allows four different digital (audio/video) sources to share one video display. Liberty's unique switch allows easy switching

between four different digital sources using remote control unit or the manual switch in front. Perfect for home theater systems.

Main Features

- Connects audio & video to HDMI compatible HDTV, LCD monitors or digital projectors
- Supports high resolution up to UXGA (1600*1200) at 60Hz refresh rate, 480p, 720p, 1080i/p
- Built-in RS-232C port for remote switching control
- HDCP compliant

Technical Information

- Frequency Bandwidth : 1.65 GHz
- Video Resolution : Up to UXGA (1600*1200), HD signal up to 1080i/p
- Audio Sampling rates : Up to 24bit / 192KHz
- Inputs : 4 HDMI "A" TYPE Female connector
- Outputs : 1 HDMI "A" TYPE Female connector
- Power Supply : DC 5V, 2A Power supply adapter included
- IR Remote Control Unit Included

Devices Available with DVI Connections

Ordering is fast & easy.



Call today!

Solutions for the AV PROFESSIONAL
www.libertycable.com

800-530-8998
INTERNATIONAL - CALL +1-719-388-7542



Perfect For...



- Home Theater System Integration
- Easy switching between two digital video sources
- LED display of video source channel selections



FRONT



REMOTE

Easy-To-Use Switcher Remote

Selects the signal from source devices.



BACK

HDMI 2 IN, 1 OUT Switcher

PART #: DL-HDS21

Liberty's HDMI Switcher allows two different digital (audio/video) sources to share one video display. Liberty's unique switch allows easy switching

between two different digital sources using remote control unit or the manual switch in front. Perfect for home theater systems.

Main Features

- Connects audio & video to HDMI compatible HDTV, LCD Monitors or Digital projectors
- Supports high resolution upto 1920 x 1080 at 60Hz, HDTV - 480p, 720p, 1080i/p
- HDCP compliant

Technical Information

- Frequency Bandwidth : 1.65 GHz
- Supports Resolution : Upto 1920x1080@60hz, HD signal up to 1080p
- Audio Sampling rates : Upto 24bit /192KHz
- Inputs : HDMI "A" Type Female 2 ports
- Outputs : HDMI "A" Type Female 1 port
- Power from HDMI source (pin#18 DC 5V) equipments
- Dimensions (W*D*H, in) : 5.9*4.1*1 - Weight (lb) : 3.3

All switches are RS-232 controllable

Devices Available with DVI Connections

Corning™ Field Termination Kit

Part #: TKT-UNICAM-PFC

The UniCam Pretium Tool Kit can be used with multimode or single-mode LC, SC and ST® Compatible UniCam Connectors.

UniCam Pretium Tool Kit includes:

- 1) Durable Kit
- 2) Detailed instructions and DVD
- 3) Hook allows the kit to hang on the job site
- 4) Hand-Held Termination Tool
- 5) Hand-Held Fiber Cleaver
- 6) Fiber Wipes
- 7) Fiber Cleaner
- 8) Marking Pen
- 9) Crimp Tool
- 10) Kevlar Scissors
- 11) T-stripper
- 12) Buffer Stripper



Ordering is fast & easy.



Call today!

Solutions for the AV PROFESSIONAL
www.libertycable.com

800-530-8998
INTERNATIONAL - CALL +1-719-388-7542





FRONT



BACK



Perfect For...

- Video Wall System
- Large LED Sign Board
- Medical Imaging Equipment
- Airplane On-board Video System
- Home Theater
- TV Broadcast Station
- Auditorium
- Conference Room Video Equipment
- Church Video System

HDMI Fiber Optic Extender

PART #: DL-HDFO

This unique HDMI/DVI fiber optical cable extender lets your digital display (Plasma TV, Digital Projectors, LCD Monitors, HDTV, etc.) be located up to 3,000 ft. (1,000 meters) away from the video and audio sources using the HDMI or DVI standard. Liberty's patented optical conversion technology enables noise-free and high-res (up to

UXGA or 1080p) extension up to 1640 ft. (500m). Ideal for fishing through small conduits or other openings as the cables are detachable from the device (requires only 1/2 inch opening) and are much smaller than the DVI connectors used with Liberty's DL-DVIDFO-XXM. Liberty's HDMI fiber extender uses LC connectors.

Main Features

- Optimized for high definition multimedia (HDCP - Compliant and true DDC line)
- Separate HDMI transmission and reception boxes are connected with LC connectors
- Ideal to run through small conduits or small openings as the transmitter and receiver are detachable from the cables (requires only 1/2 inch opening)
- Supports high resolutions up to UXGA (1,600*1,200), 480p, 720p, 1080i, 1080p
- Extends up to 330ft.(100m) with true DDC connection
- External 12V power supply adapter included

Technical Information

- Data Rate: 1.65 GHz
- Supporting Graphic Resolution & Distance: Up to UXGA(1,600 * 1,200)@60Hz,480p,720p,1080i and 1080p/320ft.(100m)
- Audio sampling rate: up to 24bit /192KHZ
- Connector Type: HDMI "A" type / LC / RJ-45 Connector
- Power Consumption: Transmitter 1.1 Watts (Max. Size) Receiver 0.83 Watts (Max. Size)
- Optical source: 850nm Vcsel
- Optical Cable Type: 50/125 or 62.5/125 LC Multi-mode Fiber
- Power Supply : DC 12V, 3A Adapter

Devices Available with DVI Connections

Bulk Connectors SC, ST, LC

Connectors sold as singles or in bulk organizer packs of 25

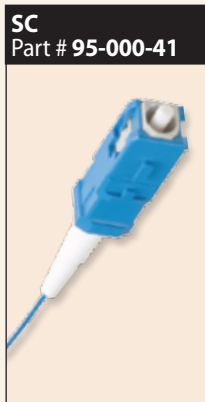

SC
Part # 95-000-41



ST
Part # 95-000-51



LC
Part # 95-000-99

Fiber Connector Organizer Packs

Bulk organizer packs of 25 provide a convenient reusable carrying-case for all fiber connectors



Connector	Description	Part #:
	Organizer Packs	
SC PLUG	UNICAM 62.5 MM 25-PK	95-000-41-Z
ST PLUG	UNICAM 62.5 MM 25-PK	95-000-51-Z
LC PLUG	UNICAM 62.5 MM 25-PK	95-000-99-Z

Ordering is fast & easy.



Call today!

Solutions for the AV PROFESSIONAL
www.libertycable.com

800-530-8998
INTERNATIONAL - CALL +1-719-388-7542



HDMI Wall Plate Solutions

ActiveLinx™ HDMI/DVI Plates (PMI-A6)



Connectors:
 • 1 PMI-A6 (HDMI Repeater)
 • 2 RCA
 • 1 RCA to BNC
Part #:
 PCA6-2C-200P



Connectors:
 • 1 PMI-A6 (HDMI Repeater)
 • 2 RCA
 • 1 S-Video
Part #:
 PCA6-2C-220P



Connectors:
 • 1 PMI-A6 (HDMI Repeater)
 • 3 RCA
Part #:
 PCA6-2C-326P

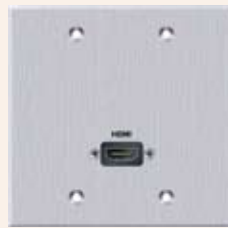

Connectors:
 • 1 PMI-A6 (HDMI Repeater)
Part #:
 PCA6-2C

HDMI Plates: Stock and Custom Plates



Connectors:
 • HDMI
 • RCA (Component)
 • S-Video
Part #:
 PC-G1250-S-P-B



Connectors:
 • HDMI
Part #:
 PC-1790



Connectors:
 • HDMI
 • S-Video
 • RCA (Video)
 • RCA (Component)
Part #:
 PC-G1254-S-P-B



Connectors:
 • HDMI
Part #:
 PCD-5850

DIGITALINX™

Complete Digital Solutions for the AV Professional

DigitalinX™ Pure Performance HDMI® Cables



Liberty's newest DigitalinX™ Pure Performance HDMI cables are High Speed Certified to the full 10.2 Gbps. These cables are designed for an aesthetic rugged appearance and solid function. With full Metal hoods and double shielding these cables will support anything HDMI for years to come.

Length (meter)	Part #
1	DLX-HDSM-1M
2	DLX-HDSM-2M
3	DLX-HDSM-3M



The look and feel of the DLX-HD cable is enhanced by a braided fabric sheath jacket, and easy to grab plugs; making this cable both aesthetically stunning and easy to install.

Length (meter)	Part #
1	DLX5-HD-1M
2	DLX5-HD-2M

Ordering is fast & easy.



Call today!

Solutions for the AV PROFESSIONAL
 www.libertycable.com

800-530-8998
 INTERNATIONAL - CALL +1-719-388-7542



Custom Kitting Options

Kitting is a service that many customers take advantage of to streamline the management of their installations. Liberty's kitting takes the guess work out of your installation by making sure that you have the complete set of correct products for the project. Why waste billable time of your installation crews having them look for product when Liberty can have the products kitted and ready to install on the job site.

Some common examples of how to use Liberty kitting services might be if you are working on a medium to large sized K-12 project and need the same products for certain class room types. Or you might be working in another type of complex commercial project or residential track home AV installation that needs replicatable success. Liberty can kit these various products for you: saving you installation time and money.

Our kitting operations provide an individual box with the correctly labeled individual AV components. Both the inside and outside of the box, as well as the components, can be labeled with the room number, room type, project name, component name, part number and project number.



Liberty can assemble pallet shipments of pre-kitted boxes for larger projects saving both installation time and money.

A typical kit for a K-12 classroom that is labeled inside and outside the box; the wall plates and assemblies are also labeled ensuring the right product is at the right place



Liberty can also assemble pallet shipments of pre-kitted boxes for larger projects. Kitting is an everyday occurrence for our warehouse professionals so if there is special attention needed for the box order stacking or content is not a problem.

We can also provide custom printed kit packaging for you with your colors, your business name and project information if needed. In addition we can provide your logo and information on all components in the kit as well. This is perfect for many of our OEM customers. Kitting is an essential part of our business and one of the ways that we make it easy to do business with Liberty. We can easily add additional products to the bill of materials or remove items.

We can create the kit and use your part numbers for the order. That way it is your part number from the time it is ordered to the time it is installed-making your project accounting easy. Also we can pre-build your kits and hold them for scheduled distribution to your locations: eliminating the cost to store and to manage project inventory.

Typical Kits that Liberty builds generally include:

- A Set of Your Instructions or Information
- Bulk Wire
- Connectors
- Custom or Molded Assemblies
- Fiber Assemblies
- Rack Headers Plates
- Tools
- Wall Plates

Ordering is fast & easy.



Call today!

**Solutions for the
AV PROFESSIONAL**
www.libertycable.com

800-530-8998
INTERNATIONAL - CALL +1-719-388-7542



OEM Connectivity Products

Liberty specializes in producing a broad range of solutions for the international OEM marketplace. Our refined engineering processes design and develop quality products at every stage of production.

We Specialize In Custom Products:

- Bulk Cable
- Bundled Cables
- Cable Assembly
- Fiber Cables
- Rack Panels
- Specialty Printing
- Wall Plates

OEM projects are carefully planned out with our customers, in conjunction with our our customers' engineering teams Liberty's trained professionals conduct a careful needs assessment, survey the correct options, then propose the right decision for the product. This simple format leads to flawless execution.

Markets We Serve:

- Automotive
- Consumer Electronics
- Control Systems
- Industrial Environments
- Medical Technology
- Mobile Command
- Professional Electronics
- Projector Manufacturer
- Ship Building
- Speaker Manufacturer

Liberty products are designed to meet all regulatory standards for the installation environment that your product will perform in.



Complete Production Line Partnership

Competent supply line management is a legitimate concern for every OEM business partner. Our high quality standards for product development are only surpassed by our ability to handle complex delivery needs. Liberty's long history of integrating with global manufacturing assembly lines and production lines minimizes the risk to your production flow.

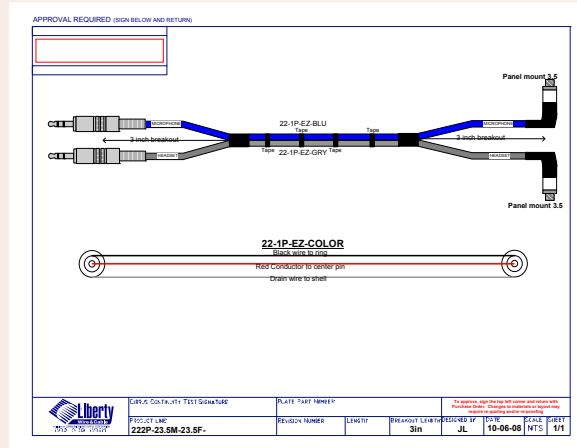

Liberty's OEM manufacturing process provides a variety of production proof check points for flawless execution.

OEM packaging needs are often highly variable and complex. Liberty can design packaging to meet any packaging criterion including adding your instructions or product information, providing tamper proof bags and security tapes.

Our production process lot numbers, batch numbers, UPC codes, certificates of compliance, export documentation and all relevant production information comply with the most rigorous receiving protocols.

OEM Capabilities Include:

- Confidential Research & Development
- Short Turn-Around Time
- Highly Cost-Competitive
- No-Order Minimum or Maximum
- Product Application Review and Assessments
- Environment Assessments
- Manufacturing Expertise
- Prototype Construction
- Pre-Production proof of article for color, connectivity and electrical performance
- Packaging Options are available from simple to complex
- On-time scheduled delivery... each time... every time!

Ordering is fast & easy.



Call today!

Solutions for the AV PROFESSIONAL
www.libertycable.com

800-530-8998
INTERNATIONAL - CALL +1-719-388-7542





PanelCrafters™ Overview

PanelCrafters™ products are manufactured with the most advanced CAD/CAM technology available. Our drawings are developed and designed by skilled CAD operators to guarantee that your proof is executed with the utmost care and precision.

Computerized milling centers precisely manufacture your custom plates and panels. We assure that dedication to quality is in every step of the process to deliver a perfect product to you, and we guarantee it. Our facility is ISO Certified.

Value-Added Services

We can work off your CAD drawings or we can design your plates and panels for you. Additionally, we can incorporate your logo or the logo of your customer for a unique and totally personalized product. Many of our customers find that adding their logo to a rack panel, header panel or even on a wall plate provides a unique advertising opportunity that is both sophisticated and durable.

Our plates and panels can be delivered fully wired with any length and style of cable that is required for your project. Many customers find our turnkey prewired options to be a convenient and effective solution.

Broad Connector Selection

Our plates and panels can be populated with both the most common and uncommon connectors. Most connectors are available in either solder back or pass through style or a combination of both.

Our connectors are the highest quality connectors available in the marketplace to ensure that your A/V signals are free of noise, distortion or degradation.

Of course you can order your plates and panels unpopulated if you wish to populate them yourself at a later time. Yet, many of our customers find it to be both more cost effective for them and a better use of their time, to have us deliver the finished product fully populated and ready to install.



On-line access to custom design your own A/V wall plates and rack panels anywhere, anytime with PanelCrafter's WebBlox, V-Series and CADQuote from Liberty Wire & Cable. WebBlox and CADQuote are easy to use and available 24/7. Put the benefits of this advanced technology to work for your business today!



Click on www.panelcrafters.com to begin reducing your cycle times today!

Ordering is fast & easy.



Call today!

**Solutions for the
AV PROFESSIONAL**
www.libertycable.com

800-530-8998
INTERNATIONAL - CALL +1-719-388-7542



Design and Quoting Software Tools

WebBlox™

GO FROM CONCEPT TO COMPLETED PLATE DESIGN IN A MATTER OF MINUTES

WebBlox is the premier custom plate and panel design tool in the AV industry. This free design and quoting tool gives you complete control over designing your own custom plate and panel layouts. All of PanelCrafters' standard panel sizes are available via simple drop-down boxes. Drag-and-drop any of our standard connectors into your design, specify the text you want, even add your logo, all in WebBlox's user-friendly environment. All of the panels you design are stored in your password protected account.

WebBlox even provides a personalized proof page that you can print and provide to your customer for approval. Best of all, once your account is approved you'll have instant access to the part number and your dealer pricing for all the plates you design.

WebBlox requires no expensive software or hardware, just a web browser and internet connection. This flexible design tool allows you to design, quote and proof your plate designs from your desktop 24 hours a day. When you're ready to order, submit as you would for any other order using the part number and pricing from your WebBlox account.

Now WebBlox allows you to create custom cable assemblies too! Using the same straight-forward approach, Liberty has added custom cable assembly design to the powerful WebBlox platform. Have a specialized application or need a custom length not found in our catalog? WebBlox is the answer! You can assign both plates and cables to projects for easy sorting, and combine them all onto one quote for easy purchasing.

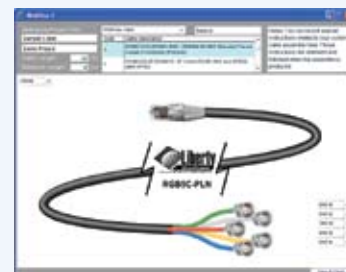

Prefer to work in AutoCAD or Visio? We have a solution for you as well...



CADBlox is an AutoCAD block library. It contains pre-engineered blocks for all of our standard connectors and panel sizes. Using the alignment grids designed into the panel blocks along with AutoCAD's "OSNAP" makes designing your custom plates and panels a "Snap". A full or LT version of AutoCAD is required to use this library.



CADQuote is a companion application for experienced CADBlox users. It allows CADBlox users to generate quotes from their custom panel designs and save them in their password protected account. Proofs are also auto-generated and include material listings (BOM's) for each panel. Quote pages can be generated (for purchasing) combining any quantity of parts stored in your account. A full version of AutoCAD is required to run this application.



CADBlox V-Series is a design template for Microsoft Visio 2003 (and higher). It includes pre-engineered shapes grouped into Visio stencils by connector or panel type. The stencils load each time you open the PanelCrafters template. Using Visio's built-in drag-and-drop shape capabilities, designing your own custom plates and panels is simple.

Ordering is fast & easy.



Call today!

Solutions for the AV PROFESSIONAL
www.libertycable.com

800-530-8998
INTERNATIONAL - CALL +1-719-388-7542





Proofing Process

PanelCrafters™ offers the most streamlined and accurate proofing process in the industry. Proofs are consistent between our on-line quoting programs and quotes produced by PanelCrafters staff. PanelCrafters up-front proofing process makes the quote-to-order process fast and easy.

Up-front proofing ensures that we produce your panels exactly as you requested so your highest quality plates and panels are on-time – every time. Requests that include non-stock materials or require additional engineering may be quoted and returned without design proofs. When ordered, these parts will be engineered and proofs will be submitted prior to production. No ordered product can be manufactured without your signed proof.

Submit drawings to sales@panelcrafters.com to obtain quote with proof.

We guarantee a flawless product each time and every time.
 PanelCrafters™ quotes and up-front proofs provide the following features:

APPROVAL REQUIRED (sign below and return)			
①			
P.O. NUMBER:			
Connector List:			
Qty	P/N	Description	
Material: 0.125 inch 6061T6 Aluminum			
1	S1	SVMD4PB 4 PIN S-VIDEO SOLDERBACK	
1	R11RED	YS-R ISOLATED RCA SOLDERBACK	
1	R11WHT	YS-R ISOLATED RCA SOLDERBACK	
1	R11YEL	YS-R ISOLATED RCA SOLDERBACK	
1	P3	30-493A ISOLATED 3.5MM STEREO-MINI SOLDERBACK	
1	V5	30-587 HD-15 FEMALE FEEDTHRU	
②			

PanelCrafters 2 gang

	Reference: ④ Catalog Plate	Company Name: Liberty Wire & Cable	Engraved Units: (characters & lines) 34
by Liberty Wire & Cable, Inc. libertycable.com - 800-530-8998 - fx.602-437-1182	Part Number: PC-G2040-E-S- ⑤	Panel Color: Ivory ⑥	Text Color: Black ⑥
	Panel Size: 2GANG ⑥	Designed by JKerns	Date 11-29-2005
		Scale NTS	Sheet 1/1

To approve, sign top left corner and return with Purchase Order. Changes to materials or layout may require quoting and/or re-proofing.

- ① • Approval box for you to sign when ordering plates.
- ② • Itemized material list including connector descriptions.
- ③ • Precise graphical representation of the finished plate.
 - Lead time and pricing breakdowns by requested quantity.
- ④ • Company and project reference information (provided by you).
 - Full dimensions are shown when needed to ensure accuracy.
- ⑤ • Unique part number for each plate or panel design (for easy ordering and reordering).
- ⑥ • Plate specifications including plate material, thickness, color and finish.

Ordering is fast & easy.



Call today!

Solutions for the AV PROFESSIONAL
 www.libertycable.com

800-530-8998
 INTERNATIONAL - CALL +1-719-388-7542



Plate and Panel Surface Finishes

We offer five different categories in plate finishes: anodized, painted/powder coated, plastic/nylon, stainless steel and specialty.

Each of these styles provides a high-end finish to fit a variety of applications.

ANODIZED

PanelCrafters recommends clear anodized (brushed aluminum) and black anodized, our most common finishes, for typical commercial applications. They provide unsurpassed quality and appearance. Gold anodized and brushed brass finishes are also available for special applications.

PAINTED/POWDER COATED

PanelCrafters offers white, ivory and almond in flat painted plates. For increased durability we recommend powder coated finishes, available in black, gray, white, ivory and almond. Custom color matching is available.

- | | |
|-----------------------|--------------------|
| Color Options: | Almond Powder Coat |
| Black Powder Coat | Gray Powder Coat |
| Ivory Powder Coat | White Powder Coat |

PLASTIC / NYLON

PanelCrafters offers black, white, ivory and almond in nylon 1 & 2 gang plates and decora inserts.

STAINLESS STEEL

PanelCrafters offers stainless steel 1 through 6 gang plates for the ultimate in strength and durability.

SPECIALTY

PanelCrafters offers a variety of specialty finishes including digitally printed polycarbonate overlays. This capability provides unequalled color and pattern matching capabilities. Provide your own artwork or let our graphic design department assist you with your special project needs. Our overlays are reverse printed making the full color image scratch and wear proof.

Custom Color Matching

Ordering is fast & easy.



Call today!

Alternative Gang Plate Options

PanelCrafters™ offers a variety of custom gang plate options including: plastic and aluminum decora inserts, stainless steel plates and international configurations.

All custom gang plates are available populated with connectors and in a variety of colors and finishes. Contact your professional sales representative for more information.

Plastic and Decora Style

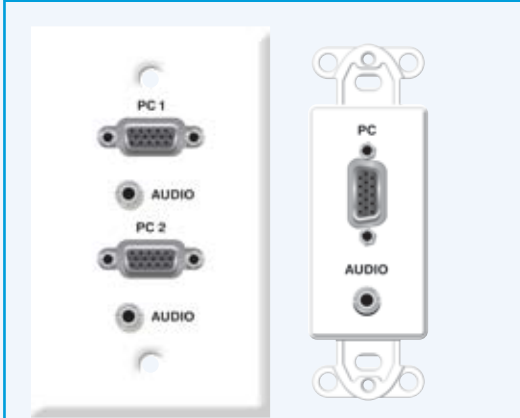

Stainless Steel Plates

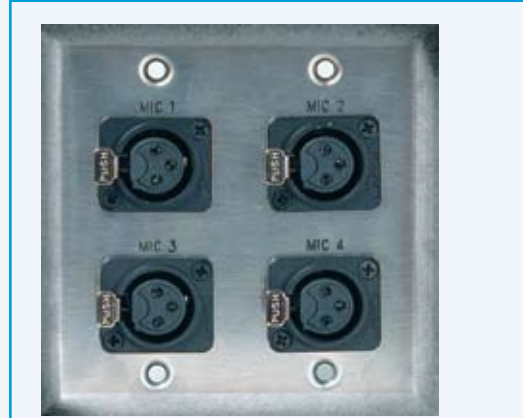

PanelCrafters™ Packaging

PanelCrafters™ unique packaging is designed so that you can more easily manage and view your panel and plate inventories. A CAD drawing is located on the top of the package with an additional information label on the side of each package. The information label is also printed with the name of your particular job or the application that you are working on. In addition, the label can also be printed with the job number and/or your P.O.

number so that the product can be quickly tracked and registered for cost accounting purposes.

Our packaging protects the plate surface and installed connectors during shipping and storage. The front and back of each package is open, which allows for easy viewing and inspection of the product face and back. These features allow for enhanced inventory and project management.

Easy Identification Without Unwrapping



CAD Drawings and Part Numbers on Our Labels Make Product Identification Easy



Front and Back of Packages are Open for Easy Viewing and Inspection



**Solutions for the
AV PROFESSIONAL**
www.libertycable.com

800-530-8998
INTERNATIONAL - CALL +1-719-388-7542



Ordering is fast & easy.



Call today!

PanelCrafters™ Stock Plates

PanelCrafters™ single and double gang plates provide a wide variety of A/V solutions to accommodate both commercial and residential installations. Combining form and function, our selection of gang plates provide high-quality solutions for your device-to-device or device-to-control connections needs. Our at-a-glance guide provides

Adapter Plates

Adapter plates have a variety of termination styles which convert pass thru connectors to captive screw, breakout and other terminating options. Please see plate pictures and descriptions for details.

Change Text Options

Change or remove text on any catalog plate and/or add your company logo screen-printed for a nominal fee. Quantity discount available when ordering multiple stock plates with text changes. Custom logos require a one-time art set-up fee for design, tooling and color match. Please contact your sales representative for details. Ordering the right plate style for your application is super easy!

EZ-Build Stock Plate Part Numbers

Ordering the right plate style for your application is super easy!

Each product shows an * which is replaced by the text style, connector style and plate color options.



you with an easy-to-use snapshot of our single and double gang plate product offerings. If your project or application requires a plate that is not listed in our guide, we can design and manufacture a custom plate for you that matches the exact specifications of your project. Contact us for details.



Let's take a look at this example.

You need a single gang plate with pass through connectors, and the plate should have engraved text and be on clear aluminum.

The picture to the left shows what the product will look like and as one follows the arrow to the right choosing the right option is a snap.

Of course you can change the text and add a logo without any hassles.

EZ BUILD PLATE NUMBERS

BASE PLATE NUMBER: **PC-G1020-E-P-C** ADD LOGO*

TEXT	CONNECTORS	PLATE COLOR
E-Engraved	P-Passthru	C-Clear Anodized
S-Screened	S-Solderback	B-Black Anodized
C-Change Text*	A-Adapter**	W-White Painted
		K-Blk. Powder Coated
		Y-Gry. Powder Coated

Change text on any catalog part for \$5.00

Ordering is fast & easy.



Call today!

Single Gang Plates

Fits Perfectly With G-2V2A-C3-* PG. 27

Ships Same Day!

Connectors:
 • HD-15 Female (VGA)
 • Stereo-Mini
 • RCA

Part #: PC-G1000-*

Fits Perfectly With N-3V2A-C1-* PG. 27

Ships Same Day!

Connectors:
 • HD-15 Female (VGA)
 • Stereo-Mini
 • RCA
 • S-Video

Part #: PC-G1020-*

Connectors:
 • HD-15 Female (VGA)
 • Stereo-Mini
 • RCA
 • S-Video

Part #: PC-G1040-*

Fits Perfectly With N-3V2A-C1-* PG. 27

Ships Same Day!

Connectors:
 • HD-15 Female (VGA)
 • RCA
 • S-Video

Part #: PC-G1060-*

Fits Perfectly With G-2V1A-C2-* PG. 26

Ships Same Day!

Connectors:
 • HD-15 Female (VGA)
 • RCA

Part #: PC-G1080-*

Connectors:
 • HD-15 Female (VGA)
 • RCA

Part #: PC-G1100-*

Connectors:
 • HD-15 Female (VGA)
 • S-Video
 • RCA

Part #: PC-G1120-*

Connectors:
 • HD-15 Female (VGA)
 • Stereo-Mini

Part #: PC-G1140-*

Connectors:
 • F (COAX)
 • RCA

Part #: PC-G1160-*

Connectors:
 • S-Video
 • RCA

Part #: PC-G1180-*

Connectors:
 • S-Video
 • RCA

Part #: PC-G1190-*

Fits Perfectly With D-5BNCM-M-* PG. 30

Connectors:
 • BNC Female

Part #: PC-G1200-*

Ships Same Day!

Connectors:
 • F (COAX)
 • RCA

Part #: PC-G1240-*

Ships Same Day!

Connectors:
 • HD-15 Female (VGA)
 • Stereo-Mini
 • RCA
 • RJ-45 (CAT5e)

Part #: PC-G1260-*

Connectors:
 • HD-15 Female (VGA)
 • RCA
 • RJ-45 (CAT5e)
 • RJ-11 (CAT3)

Part #: PC-G1280-*

Connectors:
 • HD-15 Female (VGA)
 • RCA
 • RJ-45 (CAT5e)

Part #: PC-G1290-*

UK Style plates and International sizes available on every plate.



- Designed and engineered to fit 46mm deep single gang and double gang British Standard backboxes.
- Available in several plastic and metal finishes including white, brushed aluminium and antique black. Other finishes available upon request.

- Select "best sellers" available from stock.
- Custom configurations available upon request.
- Custom company branding available upon request.



Ordering is fast & easy.



Call today!







Solutions for the AV PROFESSIONAL
 www.libertycable.com

800-530-8998
 INTERNATIONAL - CALL +1-719-388-7542

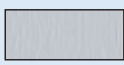

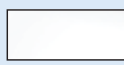
Single Gang Plates

 <p>Ships Same Day!</p> <p>Connectors: • 3 Pin XLR F</p> <p>Part #: PC-G1300.*</p>	 <p>Connectors: • 3 Pin XLR F</p> <p>Part #: PC-G1320.*</p>	 <p>Connectors: • 3 Pin XLR M</p> <p>Part #: PC-G1330.*</p>	 <p>Connectors: • 3 Pin XLR F 1/4" TRS Combo Jack</p> <p>Part #: PC-G1340.*</p>
 <p>Connectors: • NL4MP 4 Pole Speakon</p> <p>Part #: PC-G1350.*</p>	 <p>Connectors: • NL2MP 2 Pole Speakon</p> <p>Part #: PC-G1360.*</p>	 <p>Connectors: • NL8MPR 8 Pole Speakon</p> <p>Part #: PC-G1370.*</p>	 <p>Connectors: • HD-15 Female (VGA) • Stereo-Mini • DB-9 Female</p> <p>Part #: PC-G1500.*</p>
<p>Fits Perfectly With G-VGAMAM-M.* Pg. 34</p>  <p>Ships Same Day!</p> <p>Connectors: • HD-15 Female (VGA) • Stereo-Mini</p> <p>Part #: PC-G1520.*</p>	<p>Ships Same Day!</p>  <p>Connectors: • HD-15 Female (VGA) • RCA</p> <p>Part #: PC-G1540.*</p>	 <p>Connectors: • HD-15 Female (VGA) • S-Video</p> <p>Part #: PC-G1560.*</p>	 <p>Connectors: • HD-15 Female (VGA)</p> <p>Part #: PC-G1580.*</p>
 <p>Ships Same Day!</p> <p>Connectors: • HD-15 Female (VGA) • Stereo-Mini • RJ-45 (CAT5e)</p> <p>Part #: PC-G1600.*</p>	 <p>Connectors: • HD-15 Female (VGA) • RJ-45 (CAT5e)</p> <p>Part #: PC-G1620.*</p>	 <p>Connectors: • RJ-45 (CAT5e)</p> <p>Part #: PC-G1640.*</p>	 <p>Connectors: • RJ-45 (CAT5e)</p> <p>Part #: PC-G1660.*</p>

Plate and Panel Surface Finishes			Stock Plate Part Numbers																			
<p>ANODIZED</p>  BRUSHED ALUMINUM  BLACK	<p>POWDER COATED</p>  WHITE  GRAY	<p>SPECIALTY PRINTED</p>  SPECIAL  WOOD GRAIN	<p>EZ BUILD PLATE NUMBERS</p> <p>BASE PLATE NUMBER — PC-G1020-E-P-C — ADD LOGO*</p> <table border="1"> <tr> <th>TEXT</th> <th>CONNECTORS</th> <th>PLATE COLOR</th> </tr> <tr> <td>E-Engraved</td> <td>P-Passthru</td> <td>C-Clear Anodized</td> </tr> <tr> <td>S-Screened</td> <td>S-Solderback</td> <td>B-Black Anodized</td> </tr> <tr> <td>C-Change Text*</td> <td>A-Adapter**</td> <td>W-White Painted</td> </tr> <tr> <td></td> <td></td> <td>K-Blk. Powder Coated</td> </tr> <tr> <td></td> <td></td> <td>Y-Gry. Powder Coated</td> </tr> </table> <p><small>Change text on any catalog part for \$5.00</small></p>		TEXT	CONNECTORS	PLATE COLOR	E-Engraved	P-Passthru	C-Clear Anodized	S-Screened	S-Solderback	B-Black Anodized	C-Change Text*	A-Adapter**	W-White Painted			K-Blk. Powder Coated			Y-Gry. Powder Coated
TEXT	CONNECTORS	PLATE COLOR																				
E-Engraved	P-Passthru	C-Clear Anodized																				
S-Screened	S-Solderback	B-Black Anodized																				
C-Change Text*	A-Adapter**	W-White Painted																				
		K-Blk. Powder Coated																				
		Y-Gry. Powder Coated																				

Ordering is fast & easy.







Call today!

Solutions for the AV PROFESSIONAL **800-530-8998** 

www.libertycable.com INTERNATIONAL - CALL +1-719-388-7542

Specifications Subject to Change

Single Gang Plates (continued)

 <p>Fits Perfectly With P20SD-RCAM-M-* Pg. 22</p> <p>Connectors: • RCA</p> <p>Part #: PC-G1700*</p>	 <p>Fits Perfectly With D-VGAM-M-* Pg. 33</p> <p>Ships Same Day!</p> <p>Connectors: • HD-15 Female (VGA)</p> <p>Part #: PC-G1720*</p>	 <p>Connectors: • DB-9 Female</p> <p>Part #: PC-G1740*</p>	 <p>Ships Same Day!</p> <p>Connectors: • USB A to B PT</p> <p>Part #: PC-G1760*</p>
 <p>Connectors: • DVI F PT (Universal) A, I, D compatible</p> <p>Part #: PC-G1780*</p>	 <p>Connectors: • F (COAX) PT</p> <p>Part #: PC-G1800*</p>	 <p>Fits Perfectly With PSVM-M-* Pg. 31</p> <p>Connectors: • S-Video</p> <p>Part #: PC-G1820*</p>	 <p>Connectors: • S-Video • RCA</p> <p>Part #: PC-G1840*</p>
 <p>Connectors: • BNC Female (75 Ohm)</p> <p>Part #: PC-G1860*</p>	 <p>Connectors: • BNC Female (75 Ohm)</p> <p>Part #: PC-G1870*</p>	 <p>Connectors: • BNC Female (75 Ohm) • S-Video</p> <p>Part #: PC-G1880*</p>	 <p>Connectors: • BNC Female (75 Ohm) • S-Video • RCA</p> <p>Part #: PC-G1890*</p>
 <p>Connectors: • Rubber Grommet 3/8" Opening</p> <p>Part #: PC-G1900*</p>	 <p>Connectors: • Rubber Grommet 5/8" Opening</p> <p>Part #: PC-G1920*</p>	 <p>Ships Same Day!</p> <p>Connectors: • Rubber Grommet 1" Opening</p> <p>Part #: PC-G1940*</p>	 <p>Ships Same Day!</p> <p>Connectors: • Rubber Grommet 1 7/8" Opening</p> <p>Part #: PC-G1960*</p>

UK Style plates and International sizes available on every plate.



- Designed and engineered to fit 46mm deep single gang and double gang British Standard backboxes.
- Available in several plastic and metal finishes including white, brushed aluminium and antique black. Other finishes available upon request.

- Select "best sellers" available from stock.
- Custom configurations available upon request.
- Custom company branding available upon request.



Ordering is fast & easy.



Call today!

Solutions for the
AV PROFESSIONAL
www.libertycable.com

800-530-8998
INTERNATIONAL - CALL +1-719-388-7542

Liberty
AV Solutions

Double Gang Plates



Ships Same Day!

- Connectors:
- HD-15 Female (VGA)
 - Stereo-Mini
 - RCA

Part #: PC-G2000*



Fits Perfectly With G-2V2A-C3* Pg. 27

Ships Same Day!

- Connectors:
- HD-15 Female (VGA)
 - Stereo-Mini
 - RCA

Part #: PC-G2020*



Fits Perfectly With N-3V2A-C1* Pg. 27

Ships Same Day!

- Connectors:
- HD-15 Female (VGA)
 - Stereo-Mini
 - S-Video
 - RCA

Part #: PC-G2040*



- Connectors:
- HD-15 Female (VGA)
 - Stereo-Mini
 - S-Video
 - RCA

Part #: PC-G2060*



- Connectors:
- HD-15 Female (VGA)
 - Stereo-Mini
 - S-Video
 - RCA
 - DB-9 Female

Part #: PC-G2080*



- Connectors:
- HD-15 Female (VGA)
 - Stereo-Mini
 - S-Video
 - RCA

Part #: PC-G2100*



- Connectors:
- HD-15 Female (VGA)
 - Stereo-Mini
 - RCA
 - RJ-45 (CAT5e)

Part #: PC-G2120*



- Connectors:
- HD-15 Female (VGA)
 - Stereo-Mini
 - RJ-45 (CAT5e)

Part #: PC-G2140*



Fits Perfectly With N-3V2A-C1* Pg. 27

- Connectors:
- HD-15 Female (VGA)
 - Stereo-Mini
 - BNC Female (75 Ohm)
 - RCA
 - S-Video

Part #: PC-G2160*



Fits Perfectly With D-5BNCM-M* Pg. 30

- Connectors:
- BNC Female (75 Ohm)

Part #: PC-G2200*

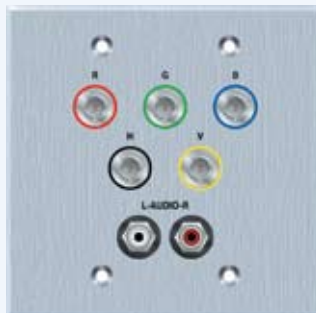

- Connectors:
- BNC Female (75 Ohm)
 - RCA

Part #: PC-G2220*



- Connectors:
- RCA
 - RJ-45 (CAT5e)
 - Stereo-Mini

Part #: PC-G2240*

Plate and Panel Surface Finishes

ANODIZED	POWDER COATED	SPECIALTY PRINTED
BRUSHED ALUMINUM	WHITE	SPECIAL
BLACK	GRAY	WOOD GRAIN

Stock Plate Part Numbers

EZ BUILD PLATE NUMBERS

BASE PLATE NUMBER: **PC-G1020-E-P-C** ADD LOGO*

TEXT	CONNECTORS	PLATE COLOR
E-Engraved	P-Passthru	C-Clear Anodized
S-Screened	S-Solderback	B-Black Anodized
C-Change Text*	A-Adapter**	W-White Painted
<small>Change text on any catalog part for \$5.00</small>		
		K-Blk. Powder Coated
		Y-Gry. Powder Coated

Double Gang Plates (continued)



Connectors:
• 3 Pin XLR F

Part #:
PC-G2300-*



Connectors:
• 3 Pin XLR F

Part #:
PC-G2320-*



Connectors:
• NL2MP 2 Pole
Speakon SB

Part #:
PC-G2350-*



Connectors:
• 3 Pin XLR F
• RCA
• RJ-45 (CAT5e)

Part #:
PC-G2370-*



Connectors:
• Binding Post
• RCA

Part #:
PC-G2405-*

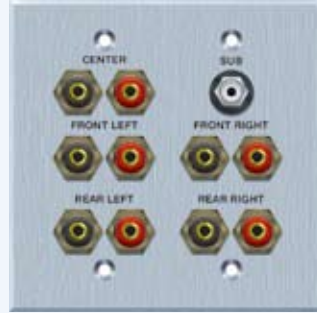

Connectors:
• CM-APBJ
(Connectec
Banana Jack)
(Requires
Connectec
CM-A-1P or
CM-A-2P on
speaker cables)
• RCA
(SUB)

Part #:
PC-G2415-*



Connectors:
• HD-15 Female
(VGA)
• DB-9 Female

Part #:
PC-G2460-*



Connectors:
• HD-15 Female
(VGA)

Part #:
PC-G2480-*



Connectors:
• HD-15 Female
(VGA)
• RCA
• S-Video

Part #:
PC-G2500-*



Connectors:
• HDMI Female
• DVI Female
• Toslink
• RCA
• S-Video

Part #:
PC-G2600-*

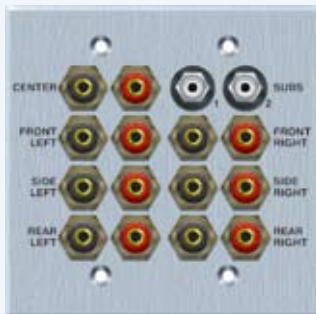

Connectors:
• CM-APBJ
(Connectec
Banana Jack)
(Requires
Connectec
CM-A-1P or
CM-A-2P on
speaker
cables)
• RCA
(SUB)

Part #:
PC-G2417-*



Ships
Same
Day!

Connectors:
• Rubber
Grommet
1 1/2" Opening

Part #:
PC-G2900-*

UK Style plates and International sizes available on every plate.

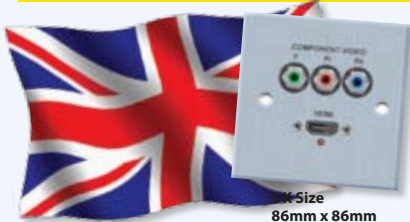

- Designed and engineered to fit 46mm deep single gang and double gang British Standard backboxes.
- Available in several plastic and metal finishes including white, brushed aluminium and antique black. Other finishes available upon request.

- Select "best sellers" available from stock.
- Custom configurations available upon request.
- Custom company branding available upon request.



Ordering is
fast & easy.



Call today!

Solutions for the
AV PROFESSIONAL

www.libertycable.com

800-530-8998

INTERNATIONAL - CALL +1-719-388-7542



Prewired Solutions

Have Liberty prewire plates and panels to save time, money and ease installation. Liberty's full service custom cable assembly department can incorporate short leads on plates all the way up to multi-foot prewired assemblies and snakes cables.



Liberty's Cable Assembly Team

All cable assemblies are fully tested prior to arriving at your job site. Liberty's custom cable assemblies offer professional appearance and leads can be numerically identified to ease installation.

Cable assembly ends can be tinned, blunt cut, or terminated with the appropriate connector. Cable assembly termination proof is provided to customers prior to manufacturing.



Our plates and panels can be delivered fully wired with any length and style of cable that is required for your project. Many customers find our turnkey prewired options to be a convenient and effective solution.

Flanged Panels and Soldering

Let Liberty solder jumpers between connectors create an easier installation. Flanged Panels are available made by PanelCrafters™ or we can machine into stock Middle Atlantic Panels or other customer supplied panels.



Ordering is fast & easy.



Call today!

Solutions for the AV PROFESSIONAL
www.libertycable.com

800-530-8998
INTERNATIONAL - CALL +1-719-388-7542



Plate & Panel Solutions for Most Game Formats



- Connectors:
- HDMI
 - RJ-45 (Data)
 - Toslink
 - RCA (Digital)
 - RCA (Component)
 - S-Video
 - RCA (Video)
 - RCA (Audio)

Part #:
PC-GC2G-P



- Connectors:
- HDMI
 - RJ-45 (Data)
 - Toslink
 - RCA (Digital)
 - RCA (Component)
 - S-Video
 - RCA (Video)
 - RCA (Audio)

Part #:
PC-GC2G-W



- Connectors:
- S-Video
 - RCA (Video)
 - RCA (Audio)

Part #:
PC-G1180



Part #: PC-GC1R-P



Part #: PC-GC1R-W

Plastic Decora-Style Plate Game Solutions



- Connectors:
- 1 S-Video
 - 2 RCA

Part #:
PCD-5010



- Connectors:
- 1 RJ-45

Part #:
PCD-5460

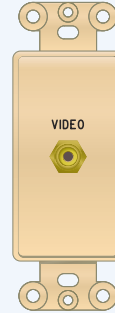

- Connectors:
- 1 RCA

Part #:
PCD-5070



Fits Perfectly With
P221P-3.STRSM-M**

pg. 20

- Connectors:
- 1 Mono-Mini

Part #:
PCD-5080



- Connectors:
- 2 HD-15
 - 2 RCA

Part #:
PCD-5120

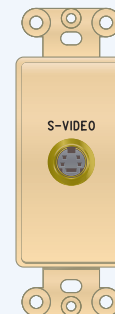

- Connectors:
- 1 S-Video

Part #:
PCD-5060

Ordering is
fast & easy.

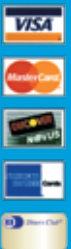

Call today!

Solutions for the
AV PROFESSIONAL
www.libertycable.com

800-530-8998
INTERNATIONAL - CALL +1-719-388-7542



Plate & Decora Solutions for Home Theater



Connectors:
 • RCA (Video)
 • CATV
 • RCA (Audio)
 • RCA (Digital)
 • RCA (Component)
Part #:
PC-G1160



Connectors:
 • RCA (Video)
 • RCA (Audio)
Part #:
PC-G1240

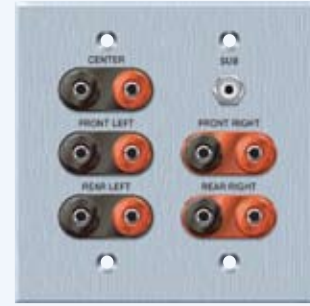

Connectors:
 • RCA (Sub)
 • Binding Post / Banana Jack (Audio)
Part #:
PC-G2405



Connectors:
 • HD-15 Female (VGA)
 • RCA (Video)
 • RCA (Component)
 • S-Video
 • Stereo-mini (Audio)
 • RCA (Digital)
 • Toslink
 • HDMI
Part #:
PC-G2610-S-P-B



Connectors:
 • RCA (Component)
 • RCA (Audio)
 • RJ-45 (Data)
 • Stereo-mini (IR)
Part #:
PC-G2240



Connectors:
 • CATV
Part #:
PCD-5020



Connectors:
 • CATV (Dual)
Part #:
PCD-5030



Connectors:
 • BNC (Video)
Part #:
PCD-5040

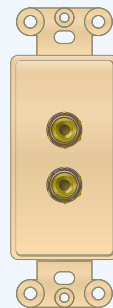

Connectors:
 • Binding Post / Banana Jack (Audio)
Part #:
PCD-5500

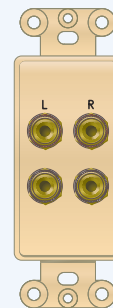

Connectors:
 • Binding Post / Banana Jack (Audio)
Part #:
PCD-5520

Audio Connectec™ is Liberty's Revolutionary Compression Audio Connector Solution.



NEW

CONNECTEC™ COMPRESSION TOOL
Part #: **CM-TOOL**



Part #: CM-A-12P Part #: CM-A-14P Part #: CM-A-16P Part #: CM-APSL Part #: CM-APAP Part #: CM-APBA Part #: CM-APBJ

DESCRIPTION	PART #
10 -12 AWG Connector base	CM-A-12
14 AWG Connector base	CM-A-14
16 AWG Connector base	CM-A-16
Banana Plug Tip Gold plated	CM-APBA
Spade Lug Tip Gold plated	CM-APSL
Angle Pin Tip Gold plated	CM-APAP
Banana Jack	CM-APBJ
All items sold separately and in 25 pkg.	

Ordering is fast & easy.



Call today!

Solutions for the AV PROFESSIONAL
 www.libertycable.com

800-530-8998
 INTERNATIONAL - CALL +1-719-388-7542



Going further than 25'? See page 211

Standard Display Solutions



- Connectors:
- HD-15 Female (VGA)
 - RCA (Video)
 - S-Video

Part #: PC-G1125-S-P-B

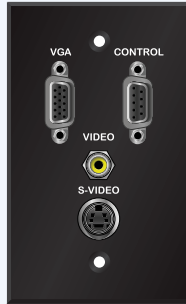

- Connectors:
- HD-15 Female (VGA)
 - DB-9 Female (Video)
 - RCA (Video)
 - S-Video

Part #: PC-G1128-S-P-B



- Connectors:
- HD-15 Female (VGA)
 - RCA (Component)
 - S-Video

Part #: PC-G1150-S-P-B

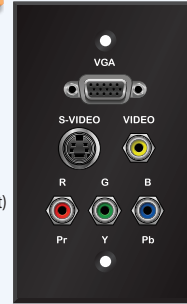

- Connectors:
- HD-15 Female (VGA)
 - S-Video
 - RCA (Video)
 - RCA (Component)

Part #: PC-G1154-S-P-B



- Connectors:
- RCA (Video)
 - RCA (Component)
 - S-Video

Part #: PC-G1156-S-P-B



- Connectors:
- HDMI
 - RCA (Component)
 - S-Video

Part #: PC-G1250-S-P-B



- Connectors:
- S-Video
 - RCA (Video)
 - RCA (Component)

Part #: PC-G1254-S-P-B



- Connectors:
- BNC (RGBHV)

Part #: PC-G1200

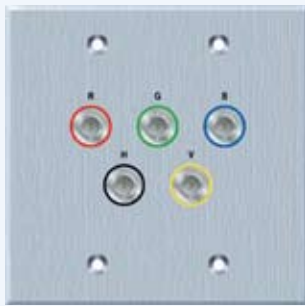

- Connectors:
- BNC (RGBHV)

Part #: PC-G2200



- Connectors:
- RCA (Video)
 - RCA (Audio)

Part #: PCD-5000



- Connectors:
- Stereo-mini (IR)

Part #: PCD-5080

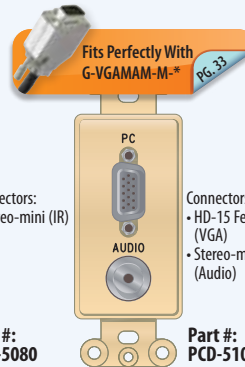

- Connectors:
- HD-15 Female (VGA)
 - Stereo-mini (Audio)

Part #: PCD-5100

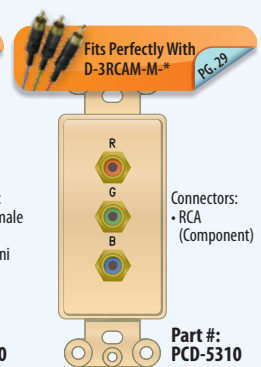

- Connectors:
- RCA (Component)

Part #: PCD-5310

HDMI Solutions

Going further than 6'? See page 216

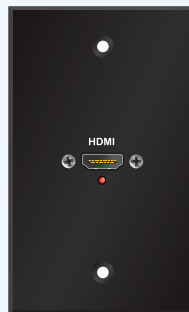

- Connectors:
- HDMI

Part #: PC-1790



- Connectors:
- HDMI
 - RCA (Component)
 - S-Video

Part #: PC-G1250-S-P-B



- Connectors:
- HDMI
 - S-Video
 - RCA (Video)
 - RCA (Component)

Part #: PC-G1254-S-P-B



- Connectors:
- HDMI

Part #: PCD-5850

Ordering is fast & easy.

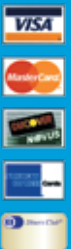

Call today!

Solutions for the AV PROFESSIONAL
www.libertycable.com

800-530-8998
INTERNATIONAL - CALL +1-719-388-7542



Which ActiveLinx™ Device Do You Need?

Application	PMI-A2	PMI-A3	PMI-A4	PMI-P1
XGA over 35'*				
Desktop Computer	●	○	○	○
Laptop	●	●	○	○
XGA under 65'				
Desktop Computer	●	○	●	○
Laptop	●	●	●	●

● **Best**
○ **Not Recommended**

*Recommendations based on XGA (1024 x 768) signals with 25 AWG solid cable from Liberty. Higher resolutions and poorer cable may demand the A2 and A3 at shorter distances. The A4 and P1 may be acceptable at longer distances with one of Liberty's premium cables.

PMI-A2*

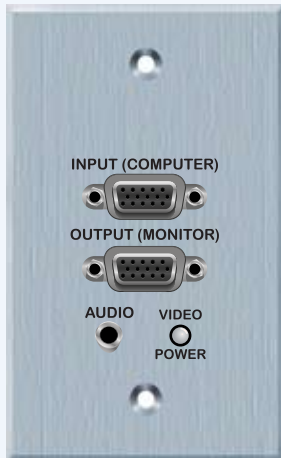

PC-A2100-S-P-C

PMI-A3*



PC-A3100-S-P-C

PMI-A4

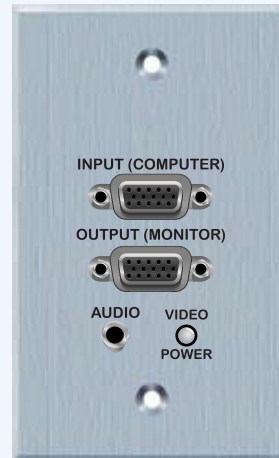

PC-A4100-S-P-C

PMI-P1



PC-P1100-S-P-C

For ActiveLinx™ Devices

- Ideally suited for gang plates, rack panels and custom applications
- Easy installation into floor and wall boxes

For ActiveLinx™ Devices A2 and A3 only

- Level switches allow adjustment of distance compensation*
- Supports up to UXGA (1600 X 1200 pixels)*
- Active audio balancing to prevent extraneous noise*

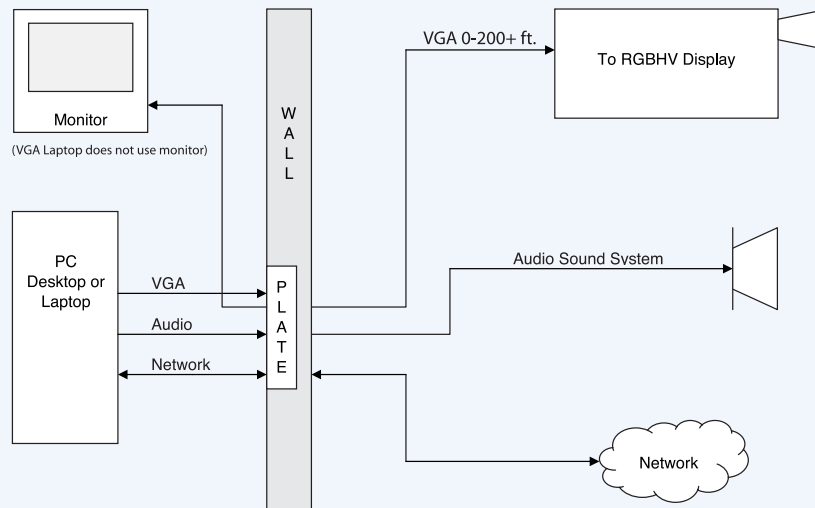

Solutions for the AV PROFESSIONAL
www.libertycable.com

800-530-8998
INTERNATIONAL - CALL +1-719-388-7542

Ordering is fast & easy.



Call today!

Additional Active Plate Options

Active Plates Available in All PanelCrafters™ Sizes

Single Gang	
PC-A2100-S-P-C	
Part #	PC-A2100-S-P-C
Connectors:	<ul style="list-style-type: none"> • 1 PMI-A2 (VGA/XGA/Audio)

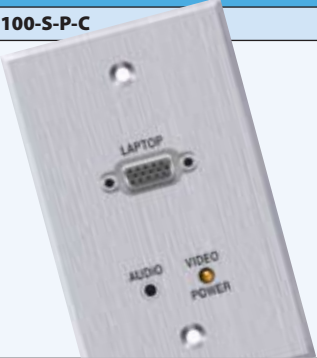
Single Gang	
PC-A3100-S-P-C	
Part #	PC-A3100-S-P-C
Connectors:	<ul style="list-style-type: none"> • 1 PMI-A3 (VGA/XGA/Audio)

Double Gang	
PCA6-2C-220P	

Four Gang	
PCA5-4C-181S-245S	

ActiveLinx Testing Data

Bandwidth

Defined as the frequency range +/- 3db at which an electronic device operates. Inadequate bandwidth results in loss of detail, pixel tracking noise with digital display devices and mis-matched brightness when comparing vertical and horizontal lines.

Industry experts recommend a bandwidth of 240 MHz (for XGA) and 450 MHz (for SXGA).

Interface Comparison - 200' cables

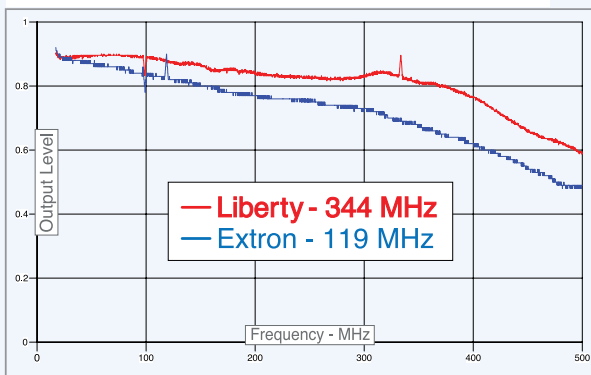

VGA Active Interface Competitive Matrix

	Extron RGB-46x	FSR CI-5BWPA	Liberty Desktop / Laptop	Summary
Bandwidth				
- Device	381	406	542	Better Bandwidth means sharper images and less noise in the image
- 50'	241	360	400	
- 100'	159	331	394	
- 150'	160	200	407	
- 200'	119	171	344	
Digital Display Sync Processing	Y	N	Y / N	May reduce image noise with pixelated displays such LCD, DLP or Plasma
Sync Processing	Y	N	Y	Stabilizes the image for long cable lengths
Gain / EQ settings	3		4	Optimizes performance for longer distances and more accurate adjustments. Test instruments required for potentiometer adjustments
Balanced Audio Out / Connector	Y 5 pole Screw	Y 5 pole Screw	Y 6 Pole Phoenix	Phoenix connector for quick repair and easier connection of 4 wires and 2 shields
AC / DC Power	N	N	Y	Works regardless of power or polarity of power supply
Custom Plate Design	Y - AAP	N	Y - milled plate	Allows any additional connectors to be installed on plate with this interface
Low Cost Modifications to Custom Plate	N	N	10+	Modification of the plate will allow you to reuse connectors and be less expensive than purchasing Extron AAP plates
Custom Finishes	3	2		Anodized, powder coated or printed finishes on aluminum or stainless steel
Custom Label	Y	N	Y	No additional cost or time
Custom Logo	N	N	Y	Show your logo / contact information on these plates, not the manufacturer's
Power / Sync LED	N	N	Y	2 color LED: orange - power, green - signal
MSRP	\$740 +	\$349	\$349+	Liberty is Price / Value Leader!

Ordering is fast & easy.



Call today!

Solutions for the AV PROFESSIONAL
www.libertycable.com

800-530-8998
INTERNATIONAL - CALL +1-719-388-7542



ActiveLinx™ USB Plates

Our USB module allows the PC and the USB device to be placed up to 330 feet apart. In-wall cables are CAT5E, either plenum or

non-plenum. Both a LEX (at the PC) and a REX (at the USB device) are required. No configuration is required.

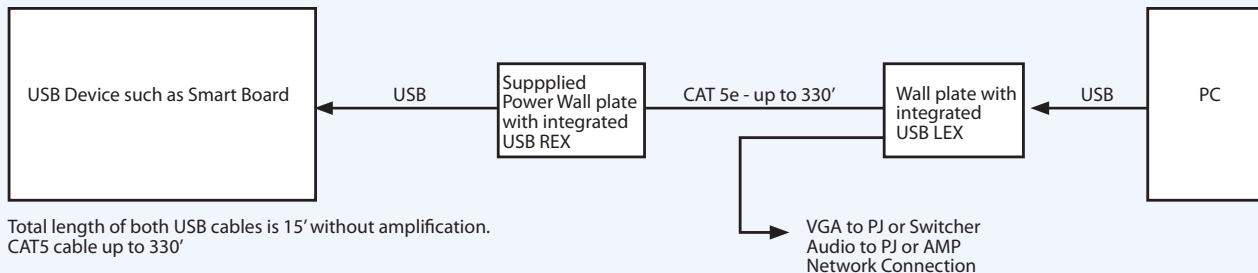

Total length of both USB cables is 15' without amplification. CAT5 cable up to 330'

- Available in two, three & four-gang plate configurations.
- Our USB Active Device extends the range of USB up to 330 ft. using Category 5 Cable.
- Transmits power and data over the same Category 5 cable.
- System includes local and remote units, power supply, USB cable and user guide.



Connectors:
 • 1 PMI-A5 (USB Extender)
 • 1 VGA Female
 • 1 Stereo-Mini

Part #:
PCAS-3C-1815



Connectors:
 • 1 PMI-A5 (USB Extender)
 • 1 VGA Female
 • 1 Stereo-Mini
 • 1 RJ-45

Part #:
PCAS-3C-1815-2455

SPECIFICATIONS FOR ACTIVELINX™ USB PLATES:	
Range (over Category 5E UTP cable).....	100 meters (330 ft)
# USB device ports (at REX)	1
USB device support (connected directly to LEX) ...	Any high-speed (480 Mb/s) or low-speed (1.5 Mb/s) device
USB hub support	Up to 4 hubs can be connected in series
Maximum power available to USB at REX	500 mA
USB cable	2 meters (6.6 ft)
LEX connector (upstream)	1 x USB Type A Connector
REX connector (downstream)	1 x RJ-45
LEX connector (upstream)	1 x RJ-45
REX connector (downstream)	1 x USB Type A Port
LEX dimensions	43.72mm x 87mm x 21.57mm (1.72" x 3.43" x 0.85")
LEX weight.....	0.1 kg (0.2 lb)
REX dimensions	43.72mm x 87mm x 21.57mm (1.72" x 3.43" x 0.85")
REX weight.....	.06 kg (.111 lb)
Temperature range	0 - 50°C
Regulatory testing	FCC Class A, CE Class A

Design Plates with Adapter Connectors!

www.panelcrafters.com

For AutoCAD™ Users
 For AutoCAD™ Users
 For Visio™ Users
 For Non-Program Users

Solutions for the AV PROFESSIONAL

www.libertycable.com

800-530-8998

INTERNATIONAL - CALL +1-719-388-7542

Ordering is fast & easy.



Call today!

See Page 211 for Device Info

Extended Range Desktop Solutions (PMI-A2)

Extended Range Laptop Solutions (PMI-A3)

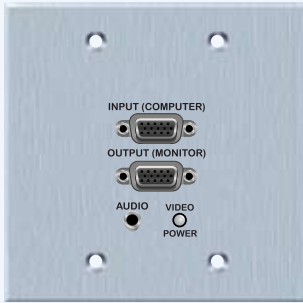

Connectors:
 • PMI-A2 VGA Extender / Audio Buffer
 • Other finish options available

Part #:
PC-A2200-S-P-C



Connectors:
 • PMI-A3 VGA Extender / Audio Buffer
 • Other finish options available

Part #:
PC-A3200-S-P-C

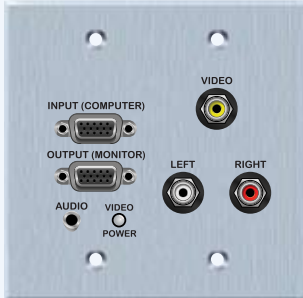

Connectors:
 • PMI-A2
 • Passive RCA Video & Audio
 • Other finish options available

Part #:
PC-A2201-S-P-C

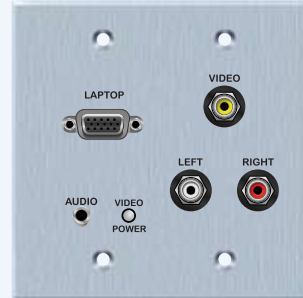

Connectors:
 • PMI-A3
 • Passive RCA Video & Audio
 • Other finish options available

Part #:
PC-A3201-S-P-C

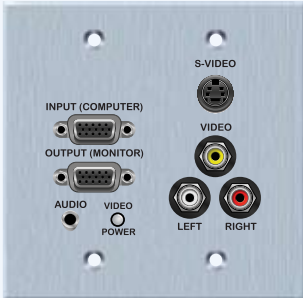

Connectors:
 • PMI-A2
 • Passives-Video
 • RCA Video & Audio
 • Other finish options available

Part #:
PC-A2202-S-P-C

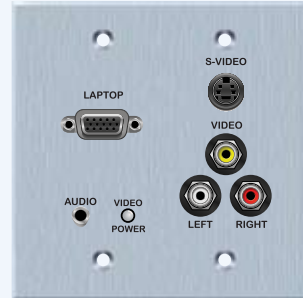

Connectors:
 • PMI-A3
 • Passive S-Video, RCA Video & Audio
 • Other finish options available

Part #:
PC-A3202-S-P-C

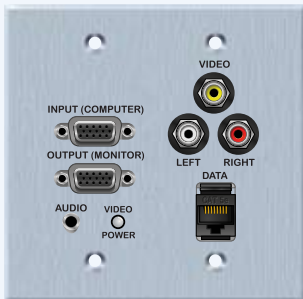

Connectors:
 • PMI-A2
 • Passive RCA Video & Audio + RJ-45
 • Other finish options available

Part #:
PC-A2203-S-P-C



Connectors:
 • PMI-A3
 • Passive RCA Video & Audio + RJ-45
 • Other finish options available

Part #:
PC-A3203-S-P-C

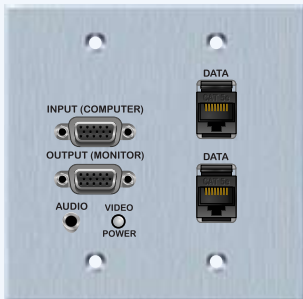

Connectors:
 • PMI-A2
 • Passive Dual RJ-45
 • Other finish options available

Part #:
PC-A2204-S-P-C

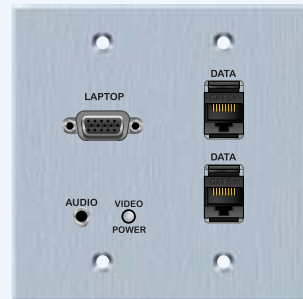

Connectors:
 • PMI-A3
 • Dual RJ-45
 • Other finish options available

Part #:
PC-A3204-S-P-C

Ordering is fast & easy.



Call today!

Solutions for the AV PROFESSIONAL

800-530-8998



www.libertycable.com

INTERNATIONAL - CALL +1-719-388-7542

Extended Range Desktop Solutions (PMI-A2)

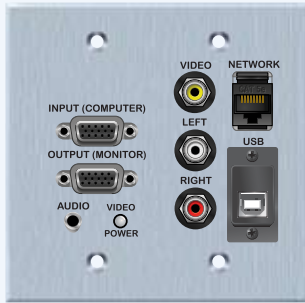

- Connectors:
- PMI-A2
 - Passive RCA Video & Audio
 - RJ-45 & USB B-A
 - Other finish options available

Part #: PC-A2205-S-P-C

Extended Range Laptop Solutions (PMI-A3)



- Connectors:
- PMI-A3
 - Passive RCA Video & Audio, RJ-45 & USB B-A
 - Other finish options available

Part #: PC-A3205-S-P-C

In-Wall Distribution Amplifier Solutions (with Passive Audio)

See Page 211 for Device Info

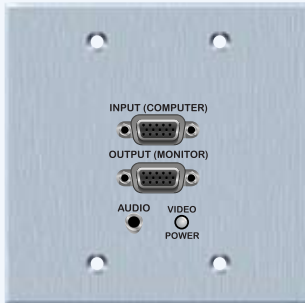

- Connectors:
- PMI-A4 VGA Extender
 - Other finish options available

Part #: PC-A4200-S-P-C

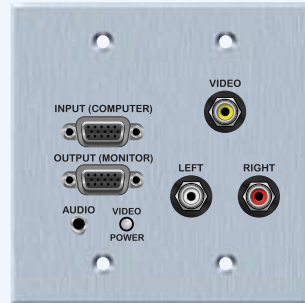

- Connectors:
- PMI-A4
 - Passive RCA Video & Audio
 - Other finish options available

Part #: PC-A4201-S-P-C

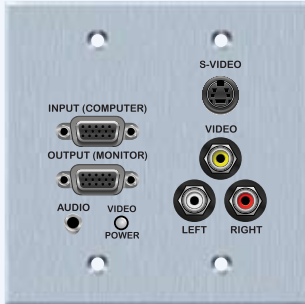

- Connectors:
- PMI-A4
 - Passive S-Video, RCA Video & Audio
 - Other finish options available

Part #: PC-A4202-S-P-C

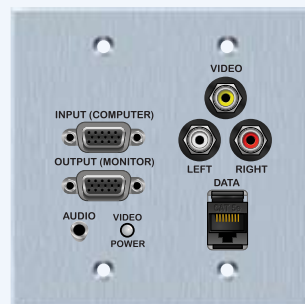

- Connectors:
- PMI-A4
 - Passive RCA Video & Audio + RJ-45
 - Other finish options available

Part #: PC-A4203-S-P-C

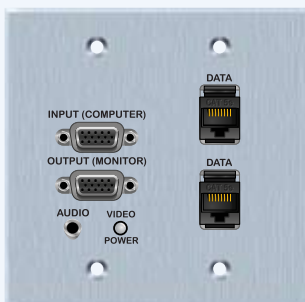

- Connectors:
- PMI-A4
 - Passive Dual RJ-45
 - Other finish options available

Part #: PC-A4204-S-P-C

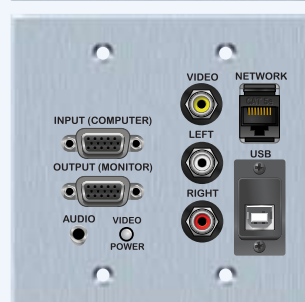

- Connectors:
- PMI-A4
 - Passive RCA Video & Audio, RJ-45 & USB B-A
 - Other finish options available

Part #: PC-A4205-S-P-C

Plate and Panel Surface Finishes			Stock Plate Part Numbers																			
<p>ANODIZED</p> <p>BRUSHED ALUMINUM</p> <p>BLACK</p>	<p>POWDER COATED</p> <p>WHITE</p> <p>BLACK</p> <p>GRAY</p>	<p>SPECIALTY PRINTED</p> <p>SPECIAL</p> <p>WOOD GRAIN</p>	<p>EZ BUILD PLATE NUMBERS</p> <p>BASE PLATE NUMBER: PC-G1020-E-P-C <small>ADD LOGO*</small></p> <table border="1"> <tr> <th>TEXT</th> <th>CONNECTORS</th> <th>PLATE COLOR</th> </tr> <tr> <td>E-Engraved</td> <td>P-Passthru</td> <td>C-Clear Anodized</td> </tr> <tr> <td>S-Screened</td> <td>S-Solderback</td> <td>B-Black Anodized</td> </tr> <tr> <td>C-Change Text*</td> <td>A-Adapter**</td> <td>W-White Painted</td> </tr> <tr> <td></td> <td></td> <td>K-Blk. Powder Coated</td> </tr> <tr> <td></td> <td></td> <td>Y-Gry. Powder Coated</td> </tr> </table> <p><small>Change text on any catalog part for \$5.00</small></p>		TEXT	CONNECTORS	PLATE COLOR	E-Engraved	P-Passthru	C-Clear Anodized	S-Screened	S-Solderback	B-Black Anodized	C-Change Text*	A-Adapter**	W-White Painted			K-Blk. Powder Coated			Y-Gry. Powder Coated
TEXT	CONNECTORS	PLATE COLOR																				
E-Engraved	P-Passthru	C-Clear Anodized																				
S-Screened	S-Solderback	B-Black Anodized																				
C-Change Text*	A-Adapter**	W-White Painted																				
		K-Blk. Powder Coated																				
		Y-Gry. Powder Coated																				

Ordering is fast & easy.

Call today!

Solutions for the AV PROFESSIONAL **800-530-8998** **Liberty AV Solutions**

www.libertycable.com INTERNATIONAL - CALL +1-719-388-7542

Specifications Subject to Change

See Page 211 for Device Info

Bundled Breakout Solutions (PMI-P1)



Connectors:
 • PMI-P1
 • Other finish options available

Part #: PC-P1200-S-P-C

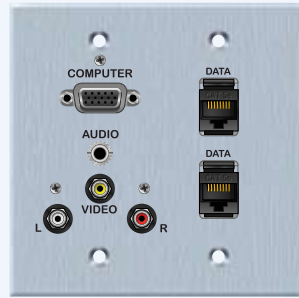

Connectors:
 • PMI-P1
 • DUAL RJ-45
 • Other finish options available

Part #: PC-P1204-S-P-C

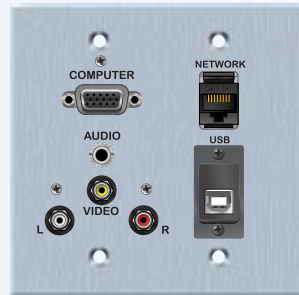

Connectors:
 • PMI-P1
 • Passive RCA Video & Audio, RJ-45 & USB B-A
 • Other finish options available

Part #: PC-P1205-S-P-C



Connectors:
 • PMI-P1
 • Other finish options available

Part #: PC-P1100-S-P-C

ActiveLinx™ HDMI/DVI Plates (PMI-A6)

This module is designed for support of digital signals used to drive displays. It extends the distance between

the source and the display up to about 75'. Liberty offers other devices to go beyond those distances.



Connectors:
 • 1 PMI-A6 (HDMI Repeater)
 • 2 RCA
 • 1 S-Video

Part #: PCA6-2C-220P



Connectors:
 • 1 PMI-A6 (HDMI Repeater)
 • 3 RCA

Part #: PCA6-2C-326P



Connectors:
 • 1 PMI-A6 (HDMI Repeater)

Part #: PCA6-2C



Connectors:
 • 1 PMI-A6 (HDMI Repeater)
 • 2 RCA
 • 1 RCA to BNC

Part #: PCA6-2C-200P

UK Style plates and International sizes available on every plate.



UK Size
86mm x 86mm

- Designed and engineered to fit 46mm deep single gang and double gang British Standard backboxes.
- Available in several plastic and metal finishes including white, brushed aluminium and antique black. Other finishes available upon request.

- Select "best sellers" available from stock.
- Custom configurations available upon request.
- Custom company branding available upon request.



Ordering is fast & easy.



Call today!

Solutions for the AV PROFESSIONAL
 www.libertycable.com

800-530-8998
 INTERNATIONAL - CALL +1-719-388-7542



Custom Rack Panels

PanelCrafters™ Custom Rack Panels are used in a broad base of residential and commercial installations from corporate board rooms, to

medical facilities to high-end home theatre. We can provide panels that are engraved, screen printed or a combination of both.

Standard Rack Panels

PanelCrafters™ stocks black anodized flat 1/8" aluminum rack panels in 1RU through 9RU sizes and Middle Atlantic black anodized 1/16" Flanged aluminum rack panels in 1RU through 4RU sizes. Larger sizes and other colors are available by special order.

PanelCrafters also offers durable labels and overlays that can be applied to any panel to enhance the graphic appeal. These overlays are reverse printed on polycarbonate and are scratch and wear proof. Our full color printing capabilities make the possibilities endless.

PanelCrafters™ can custom manufacture panels that not only accommodate connectors and modules but also: LED displays, control cutouts, membrane switches, touch screens and more. Screen printing logos and contact information is also an option.



Hinged Rack Panels

PanelCrafters™ offers hinged rack panels featuring side or bottom hinges. Hinged panels make termination and troubleshooting a breeze providing easy access to the front and rear of the panel.

Try our innovative 90 degree Rack Stops! In concert with our bottom hinge panels, these rack stops turn the top panel into a tabletop for quick and easy termination. No more propping or climbing in the rack to terminate! Ask for A133H, A133S (Two Piece Rack Stop) & HNGBT (Bottom Hinge Assembly) to add a new dimension to your custom rack panels.



Panel Termination

PanelCrafters™ can terminate your custom panels for you. Let us solder jumpers or complete cable assemblies to the back of your custom plate or panel. You can provide the termination specifications or let us recommend a solution for you.



Lacing Bars

PanelCrafters™ offers a variety of lacing bars to help in dressing out your terminations. These attractive black aluminum bars can be mounted on the front or rear of the panel.

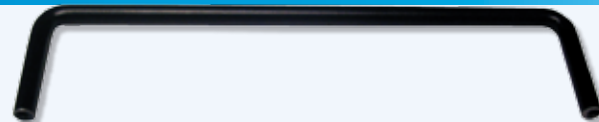

Integrated Sound Control Panels

Controlling sound levels in retail environments, houses of worship or restaurants is easier with PanelCrafters™ custom designed wall plates. Wall plates can be outfitted with any type of volume control.

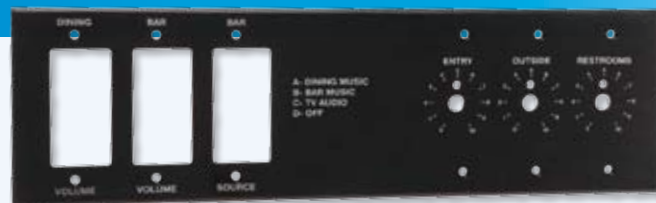

**Solutions for the
AV PROFESSIONAL**
www.libertycable.com

800-530-8998
INTERNATIONAL - CALL +1-719-388-7542



Ordering is fast & easy.



Call today!

Custom Plate Sizes (available in stock)

Whatever you are installing — PanelCrafters™ can make a plate to fit it.

ACE Half Pocket Style



ACE Super Pocket Style Also Available

Part #:
CBUF1
3 11/16 x 4 1/2

ACE Full Pocket Style



Part #:
CBUF2
7 3/8 x 4 1/2

Steel City Floor Box Size



Part #:
AFP-6B60 9 x 3 1/2

Steel City Floor Box Size



Part #:
AFP-4B60
6 x 3 1/2

Nema Style (shown in table at right)



Plate Size	Box Size	Color	P/N
6 x 6	6 x 6	Clear Anodized	CCUN6
7 x 7	6 x 6	Clear Anodized	CCUN7
8 x 8	8 x 8	Clear Anodized	CCUN8
9 x 9	8 x 8	Clear Anodized	CCUN9
10 x 10	10 x 10	Clear Anodized	CCUN0
11 x 11	10 x 10	Clear Anodized	CCUN1
12 x 12	12 x 12	Clear Anodized	CCUN2
13 x 13	12 x 12	Clear Anodized	CCUN3

Part #:
CCUN6 & CBUN6 6 x 6
Available in Black and Clear Anodized

FSR FL-1500 Style

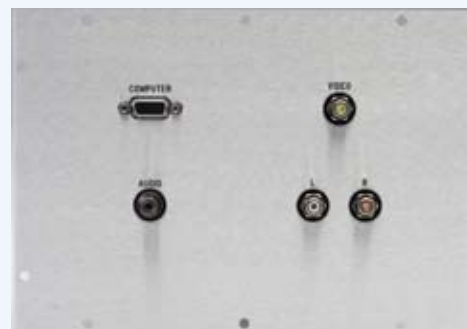

Part #:
CCUF6
8 7/8 x 6 3/16

Custom Fabrication



PanelCrafters™ can manufacture a plate of any size or dimension to fit your specific needs. We specialize in odd sizes.

Mystery Moduline Style



Part #:
CBUF3
4 1/2 x 2 1/2

Ordering is fast & easy.



Call today!

Solutions for the AV PROFESSIONAL
www.libertycable.com

800-530-8998
INTERNATIONAL - CALL +1-719-388-7542



PanelCrafters™ Connectors

All of our connectors are subjected to rigorous testing and advanced quality inspections which guarantees both the fit and functionality. We have traveled the world to find the best value on quality high-end connectors. Every new connector is systematically implemented into our unique coding system that not only identifies the connector, but also the price, hole geometry, and standard text locations. What could be easier? AutoCad™ blocks are generated and show the connector profile

on proofs, ensuring that everything fits like a glove upon completion of your order. The proven performance record of PanelCrafters™ connectors is the reason why they are the first choice of A/V professionals worldwide.

Our design approach to all our connectors combines high mechanical strength with high durability to insure years of trouble-free use and performance.

Fiber Connectors



Part #: PC-B22 TOSlink Coupler
Part #: PC-F7 Fiber Coupler - Metal Multi-Mode ST
Part #: PC-F18 Fiber Coupler - Ceramic Single-Mode ST
Part #: PC-F19 Fiber Coupler - Bronze Multi-Mode SC
Part #: PC-F14 Fiber Coupler - Ceramic Single-Mode - LC

Fiber Connectors Mini-Din Connectors



Part #: PC-F15 Fiber Coupler - Bronze Duplex Multi-Mode SC
Part #: PC-S5 PS/2 6 Pin Feedthru
Part #: PC-S6 S-Video 4 Pin Passthru Available Silver or Gold
Part #: PC-S13 S-Video to Terminal Block 4 Pin with Bezel
Part #: PC-S54 S-Video to 2 BNCs

Miscellaneous



Part #: PC-A23 Neutrik Future Cover
Part #: PC-A35 Canare Future Cover
Part #: PC-A30-6 110 Power Outlet with 6' cord
Part #: PC-A58 Lacing Bar - 4.125 inch Multiple sizes available
Part #: PC-R20 USB A to B Feedthru B to A & A to A also available

Multi-Pin Connectors Miscellaneous



Part #: MP-6212-39S
Part #: PC-R33 IEEE 1394 Firewire Passthru
Part #: PC-V44 3 Pin Phoenix Conn Assy 3-16 Pin available
Part #: PC-X45 PowerCon - Power Out
Part #: PC-X46 PowerCon - Power In

Additional Multi-Pin Connectors

Description	Part #
Female 39 pin Panel Mount	MP-6212-39S
Male 39 pin Panel Mount	MP-6256-39P
Female 61 pin Panel Mount	MP-6212-61S
Male 61 pin Panel Mount	MP-6256-61P

RJ Connectors



Part #: PC-R17 RJ-11 6 Pin Punchdown CAT3
Part #: PC-R18 RJ-45 CAT5e Passthru bezel mount available
Part #: PC-R29 RJ-45 CAT5 Punchdown Neutrik D Series (110)

Solutions for the AV PROFESSIONAL **800-530-8998** **Liberty AV Solutions**

www.libertycable.com INTERNATIONAL - CALL +1-719-388-7542

Specifications Subject to Change

Ordering is fast & easy.

Call today!

PanelCrafters™ Connectors

Some connectors require isolation to avoid the connector grounding to the plate. This is especially true of bulkhead connectors like BNC's, F-connectors and some RCA's and TRS connectors. Most XLR's, mini-din and d-sub type connectors are internally isolated or do not require isolation. For those connectors that do require isolation we use plastic or rubber bushings. Part of the value-added service that we offer our customers is to provide isolation whether the customer specifically requests

it or not. Some of our customers prefer to solder their cabling to their connectors, while others prefer the quick-connect ability of pass through connectors.

Whether your project requires solder back or pass through connectors the high quality and functionality of the end product is the same.

PanelCrafters puts the most advanced connector only a phone call away.

RJ Connectors			RCA/BNC/F-Connectors	
Part #: PC-R35 RJ-45 CAT6 Passthru	Part #: PC-R38 RJ-45 CAT5 Passthru Neutrik D Series	Part #: PC-R41 RJ-11 6 Pin Feedthru	Part #: PC-B2 BNC 75 Ohm Passthru, Various colored washers available	Part #: PC-B3 Recessed BNC Passthru 75 Ohm
RCA/BNC/F-Connectors				
Part #: PC-B16 BNC 50 Ohm Passthru	Part #: PC-F16 F connector Feedthru Also available recessed	Part #: PC-R4 Recessed RCA to BNC Various colors available	Part #: PC-R10 RCA passthru Various colors available	Part #: PC-R11 RCA solderback Various colors available
RCA/BNC/F-Connectors			Submini (D-Sub) Connectors	
Part #: PC-R21 RCA to BNC Various colors available	Part #: PC-R22 RCA w/pigtail Various colors available	Part #: PC-R28 RCA to F - Feedthru	Part #: PC-V5 HD15 Female Feedthru	Part #: PC-V11 DB9 Female Passthru
Submini (D-Sub) Connectors				
Part #: PC-V20 HD15 Female Terminal Block	Part #: PC-V21 DB9 Male Feedthru	Part #: PC-V36 DB9 Female Terminal Block	Part #: PC-V65 HD-15 Male Terminal Block	Part #: PC-V66 HD-15 Female Terminal Block
Submini (D-Sub) Connectors			Switches and Controls	
Part #: PC-V43 DVI Female Universal	Part #: PC-V68 HDMI Female Feedthru	Part #: PC-V54 HD15 to 5 BNCs with 5 inch pigtail, Also avail w/out pigtail	Part #: PC-A27 Attenuator Atlas AT-35	Part #: PC-A40 25W Attenuator

Ordering is fast & easy.



Call today!

Solutions for the AV PROFESSIONAL
www.libertycable.com

800-530-8998
INTERNATIONAL - CALL +1-719-388-7542



Specifications Subject to Change

PanelCrafters™ Connectors

Switches and Controls



Part #: PC-A59 10k Potentiometer **Part #: PC-A64** Key Switch **Part #: PC-A111** 10k Attenuator Atlas AT-10 **Part #: PC-S22** SPDT Momentary Mini Pushbutton with Red or Green LED **Part #: PC-S30** DPDT Momentary Pushbutton w/Red or Green LED

Switches and Controls



Part #: PC-S32 DPDT Latching 2 Position Toggle Switch **Part #: PC-S41** DPDT Latching Pushbutton w/Red or Green LED **Part #: PC-S43** DPDT Latching 3 Position Mini Rocker **Part #: PC-B15** Binding Post / Banana Jack, Gold **Part #: PC-P2** 1/4 inch Stereo Recessed TRS Locking Solderback

TRS Connectors

Audio Connectors



Part #: PC-P3 3.5MM Stereo Mini Isolated Solderback **Part #: PC-P3P** 3.5MM Stereo Mini with 5 inch pigtail **Part #: PC-P7** 1/4 inch Stereo Phone Jack TRS Solderback **Part #: PC-P9** 3.5MM Stereo Mini Passthru **Part #: PC-P48** Binding Post / Banana Jack

Audio Connectors



Part #: PC-S2 Speakon 2 Pole **Part #: PC-S3** Speakon 4 Pole **Part #: PC-X39** 3 Pin Female combo XLR / 1/4 phone jack

XLR Configurations - Available in Black & Nickel

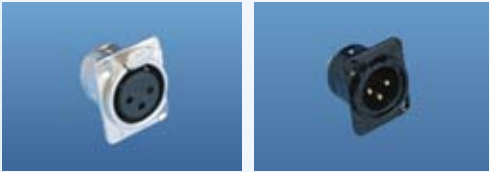

Part #: PC-X2 Female XLR 3 Pin Silver **Part #: PC-X4** Male XLR 3 Pin Black

Additional XLR Configurations

*Liberty stocks complete Amphenol and Neutrik lines.

Description	Part #
Black 3 Pin Female XLR	PC-X1
Nickel 3 pin Female XLR	PC-X2
Black 3 pin Male XLR	PC-X4
Nickel 3 Pin Male XLR	PC-X5
Black 4 Pin Female XLR	PC-X7
Black 4 Pin Male XLR	PC-X10
Black 5 Pin Female XLR	PC-X13
Black 5 Pin Male XLR	PC-X16
Black 6 Pin Female XLR	PC-X19
Black 6 Pin Male XLR	PC-X22
Nickel 3 Pin Female Mini	PC-X29

*Other mini's available



CONNECTORS
More Connectors Available! See Pages 154 - 167

Solutions for the AV PROFESSIONAL
www.libertycable.com

800-530-8998
INTERNATIONAL - CALL +1-719-388-7542



Ordering is fast & easy.



Call today!

PanelCrafters™ Adapter Connectors

PanelCrafters™ Adapter Connectors offer alternative termination options designed to simplify and speed installation. All adapter connectors can be specified into PanelCrafters catalog plates, Active

Plates, and any custom plate or panel. Adapter connectors are also available in WebBlox for easy design and proofing which leads to an accurate plate every time.

- Most captive screw connectors offer a zip tie for strain relief and durability.
- Maintain signal quality by utilizing our quality breakout connectors making installations easier and faster.
- Utilize our VGA to BNC, S-Video to BNC, and other PCB board connectors for quick and solid installations.
- Liberty's Connectec Termination System is compatible with PanelCrafters adapter connectors.

PanelCrafters™ Adapter Connectors



Part #: PC-P20*
BNC to PCB mount Screw Terminal



Part #: PC-S13
Chassis mount S-Video to Screw Terminal

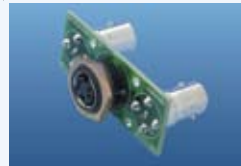

Part #: PC-S54
S-Video Female to Two PCB Mount Female BNC



Part #: PC-S94
4 Pole Speakon to Screw Terminal



Part #: PC-S98
S-Video to Screw Terminal



Part #: PC-S99
RCA to Screw Terminal



Part #: PC-S100
BNC to Screw Terminal



Part #: PC-V20
HD-15 Female to Screw Terminal (use 18-30 AWG)



Part #: PC-V36
DB-9 to Screw Terminal



Part #: PC-V42
HD-15 Female to Five PCB Mount Female BNC



Part #: PC-V54
HD15 to 5 BNCs with 5 inch pigtail, Also avail w/out pigtail



Part #: PC-X57
3 Pin Male XLR to Screw Terminal

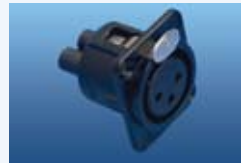

Part #: PC-X56
3 Pin Female XLR to Screw Terminal



Part #: PC-V65
HD-15 Male to Screw Terminal (use 25-30 AWG)

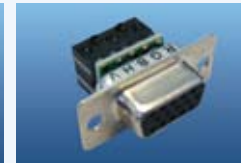

Part #: PC-V66
HD-15 Female to Screw Terminal (use 25-30 AWG)



Part #: PC-S1P
S-Video Female to Two Female BNC 4" Pigtail

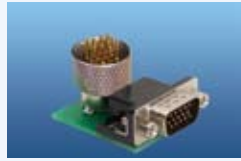

Part #: PC-M47
EZLINX 13-Pin Male/VGA Male Panel Adapter



Part #: PC-M48
EZLINX 13-Pin Male/VGA Female Panel Adapter



Part #: PC-M49
EZLINX 13-Pin Male/Male Panel Mount

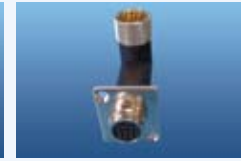

Part #: PC-M50
EZLINX 13-Pin Male/Female Panel Mount

Design Plates with Adapter Connectors!

www.panelcrafters.com

an engineering tool for audio/visual professionals
For AutoCAD™ Users

For AutoCAD™ Users

For Visio™ Users

For Non-Program Users

Solutions for the AV PROFESSIONAL
www.libertycable.com

800-530-8998
INTERNATIONAL - CALL +1-719-388-7542



Specifications Subject to Change

Ordering is fast & easy.



Call today!

PanelCrafters™ Printed Products

AV professionals require more than just wire products to compete and win in today's competitive marketplace. With that in mind, Liberty offers a full range of specialty printed products for the

AV industry that get the job done. We can manufacture your highly durable products on a wide range of materials from polycarbonate, vinyl, aluminum and plastics.

Domed Name Plate Labels

These flexible domed adhesive back labels are a must-have. The dome acts as a magnifier enlarging the printed information beneath it making your logo or business name impressively clear. Whether you are using them as a refined business card on a rack or as a component identification our domed name plate label provide you form and function.

Standard sizes are 0.75" x 1.50" ellipse (LLDO-1) and 1.25" x 2.25" ellipse (LLDO-2). Custom sizes and shapes available for any applications. Need help? We can design the entire label for you!

Call today for details! Standard sizes come in packages of 25.

Part #: LLDO-1
Part #: LLDO-2



Common Uses for Domed Logo Labels:

- Easy branding of non-rack installations
- Calling card for smaller systems
- Mask equipment manufacturers' logos
- Attractive promotional item for Tradeshows and Demos
- Tag and Brand your rental equipment

*Add the smaller, LLDO-1, to any existing wall plate for a unique and easy logo solution.

EVERYTHING FOR THE AV PROFESSIONAL

- Assemblies
- Bulk Cables
- Connectors
- Digital Solutions
- PanelCrafters
- Tools

THE LIBERTY ADVANTAGE

Liberty Wire & Cable is proud to serve customers in over 48 countries. Whether you are working on a residential or commercial installation, Liberty is the professional's first choice! Contact Liberty today!

A DIVISION OF COMMUNICATIONS SUPPLY CORPORATION

Solutions for the AV PROFESSIONAL

www.libertycable.com

800-530-8998

INTERNATIONAL - CALL +1-719-388-7542

Ordering is fast & easy.



Call today!

Custom Decora-Style Plates

Liberty's revolutionary blank plate Decora-Style option provides more room to place a greater variety

of connectors than our single gang Decora-Style inserts.



Connectors:
• RCA

Part #:
PCD-1000*



Connectors:
• S-Video
• RCA

Part #:
PCD-1050*



Connectors:
• HD-15 Female
• RCA

Part #:
PCD-1100.*



Connectors:
• HDMI Female

Part #:
PCD-1500.*

Custom RackMate™ Header Panels

Custom RackMate™ Header Panels designed and manufactured by PanelCrafters™ are the perfect choice to show the quality and pride that went into your custom installations. These permanent calling cards make it easy for your customer to contact you for future projects and upgrades.

They let anyone who sees them know you're proud of the work you do. These single-rack space panels are available in the Classic, Image and DCL Series. RackMate™ Header Panels are available up to a maximum size of 24" x 30".

Classic Series

The Classic RackMate™ Header is brushed anodized aluminum or black anodized. Available with text or logos engraved or screen printed to your specifications.



Brushed Aluminum
Part # RHCC

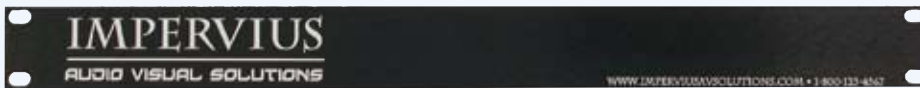

Black Anodized
Part # RHCB

Image Series

The Image RackMate Header is a 1RU rack panel with text, logos and graphics screen or digitally printed on .010" polycarbonate. Provide your own graphics or let our creative art department put something stunning together for you.



Screen or Digitally Printed
Part # RHIM

Ordering is fast & easy.



Call today!

Custom Rack Business Card

Hold on to your customers longer and make it easy for them to contact you. Allow your rack header with business name, logo and phone number to act as your salesperson.

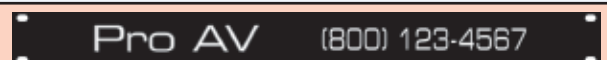

The Advantage
Professional & Elegant
Most Customers order 25 and above at one time.

Solutions for the AV PROFESSIONAL
www.libertycable.com

800-530-8998
INTERNATIONAL - CALL +1-719-388-7542



Specifications Subject to Change

Custom Decora-Style Inserts

A project's small details are often the most noticeable to your customers and are a constant reminder of your quality standards.

Your customers expect an elegant and well-designed AV installation to have a unified look and appearance especially when it comes to the small details of the project like wall plates. Designed to blend in perfectly — in either a residential or commercial environment.

Liberty's Decora-Style inserts match industry standard colors: Almond, Ivory, White and Black. Now providing your customers with a complete solution of color matched customizable Decora-Style plastic insert options have never been easier...or more profitable.

Liberty's Decora-Style inserts are available in a variety of standard options populated with connector sets commonly requested by AV professionals.

<p>Part #: PCD-5000*</p>	<p>Part #: PCD-5010*</p>	<p>Part #: PCD-5020*</p>	<p>Part #: PCD-5030*</p>	<p>Part #: PCD-5040*</p>
<p>Part #: PCD-5050*</p>	<p>Part #: PCD-5060*</p>	<p>Part #: PCD-5070*</p>	<p>Part #: PCD-5080*</p>	<p>Part #: PCD-5100*</p>
<p>Part #: PCD-5120*</p>	<p>Part #: PCD-5150*</p>	<p>Part #: PCD-5200*</p>	<p>Part #: PCD-5280*</p>	<p>Part #: PCD-5300*</p>

Fits Perfectly With
D-VGAM-M-*

Pg. 33

Ordering is fast & easy.



Call today!

Solutions for the AV PROFESSIONAL
www.libertycable.com

800-530-8998
INTERNATIONAL - CALL +1-719-388-7542



Specifications Subject to Change

Custom Decora-Style Inserts



Connectors:
• 3 RCA

Part #: PCD-5310*

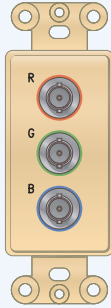

Connectors:
• 3 BNC

Part #: PCD-5350*

Fits Perfectly With
PP20SD-BNCM-M* PG. 22



Connectors:
• 1 RJ-45
• 1 BNC

Part #: PCD-5380*

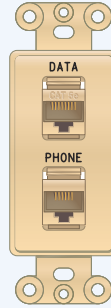

Connectors:
• 1 RJ-45
• 1 RJ-11

Part #: PCD-5400*



Connectors:
• 2 RJ-11

Part #: PCD-5420*



Connectors:
• 1 RJ-45

Part #: PCD-5460*



Connectors:
• 1 RJ-11

Part #: PCD-5480*

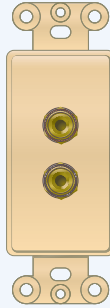

Connectors:
• 1 Binding Post Pair

Part #: PCD-5500*

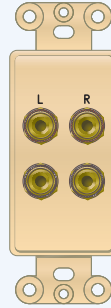

Connectors:
• 2 Binding Post Pair

Part #: PCD-5520*

Fits Perfectly With
EZ-LINX-P.* PG. 38



Connectors:
• 1 EZ-LINX (M-M)

Part #: PCD-5600*

Fits Perfectly With
EZ-LINX-P.* PG. 38



Connectors:
• 1 EZ-LINX (F-M)

Part #: PCD-5650*

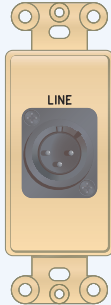

Connectors:
• 13 Pin XLR (Male)

Part #: PCD-5700*



Connectors:
• 13 Pin XLR (Female)

Part #: PCD-5750*

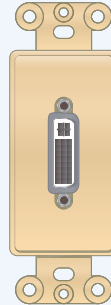

Connectors:
• 1 DVI

Part #: PCD-5800*



Connectors:
• 1 HDMI

Part #: PCD-5850*



Connectors:
• 1 Grommet 3/8" Hole

Part #: PCD-5900*



Connectors:
• 1 Grommet 5/8" Hole

Part #: PCD-5910*

Matches all common household electrical and wall switch plates



All custom Decora-Style inserts and plates are available in: almond, white, black and ivory.

The option of Passthu or Solderback connectors is also available where appropriate. Contact your sales professional for ordering assistance.

Our inserts are sold as a set with the matching color face plate.

Ordering is fast & easy.



Call today!

Solutions for the
AV PROFESSIONAL
www.libertycable.com

800-530-8998
INTERNATIONAL - CALL +1-719-388-7542



Face Plates and Keystone Insert Jacks

X = Color

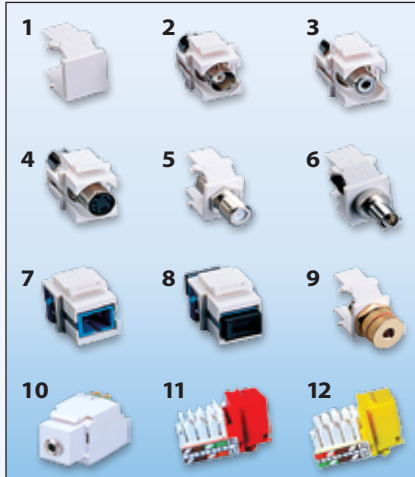

Keystone Snap-In Modules			
#	Description	Colors	Part #
1	Blank module	Almond, Ivory, White	ISK-*
2	BNC connector	Almond, Ivory, White	ISK-BNC-*
3	RCA female to female connector	Red (AL, IV, WH), White (AL, IV, WH), Yellow (AL, IV, WH)	ISK-RCAF-*
4	Mini DIN 4 pin connector	Almond, Ivory, White	ISK-MD-*
5	F connector female to female	Almond, Ivory, White	ISK-F-*
6	ST adapter multi-mode	White	ISK-ST
7	SC adapter multi-mode	White	ISK-SC
8	MT-RJ adaptor	White	ISK-MT
9	Banana jack (Binding Post)	Black, Red, (Insert = AL, IV, WH)	ISK-BJ-*
10	3.5mm stereo adaptor works with IR or Audio system	Ivory, White	ISK-35S-*
11	6 Position Cat 3 Keystone w/ Dust Cover	Almond, Ivory, White	KX-6-*
12	Cat 5 Keystone w/ 3 Dust Covers	Almond, Black, Blue, Green, Grey, Ivory, Orange, Red, White	K5-8PE-*

Faceplates		
#	Description	Part #
1	One port wall plate	WP-N1
2	Two port wall plate	WP-N2
3	Three port wall plate	WP-N3
4	Four port wall plate	WP-N4
5	Six port wall plate	WP-N6
6	Eight port wall plate	WP-N8
7	Twelve port wall plate	WP-N12

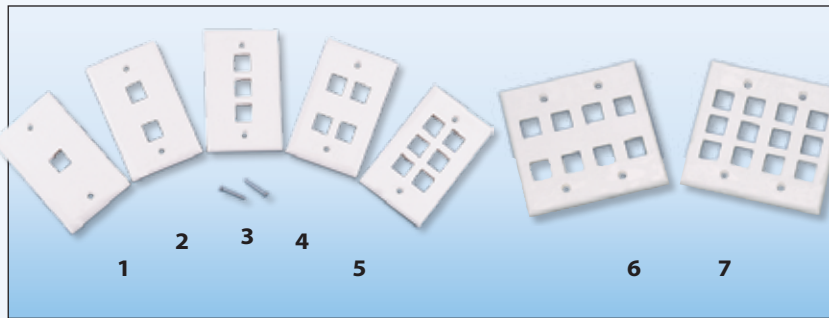

Decora and 106 Duplex Jack

Liberty offers two standard styles of designer's Decora and NEMA 106 duplex jacks that fit standard electrical wall boxes and floor boxes making installation easier and cost effective.

The Decora and 106 NEMA duplex jack uses "Series 1 Snap-in Modules" for different combinations of keystone jacks and other connectors.

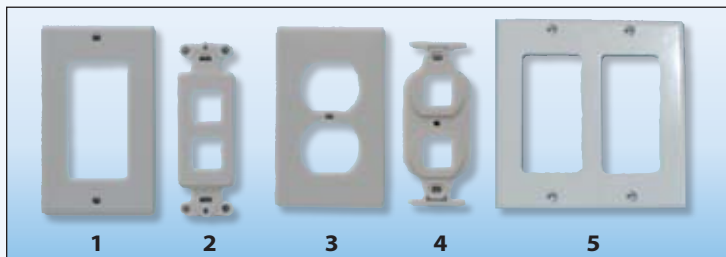

Decora		
#	Description	Part #
1	Wall Plate for Decora Duplex Jacks	WP-DEC-WH
2	2 Port Decora Insert	WJ-DEC-WH
3	Double Gang Decora Wall Plate	WP-DEC2-WH
4	2 port Nema Insert	WJ-106-WH
5	Double Gang Decora Wall Plate	WP-DEC2-WH

Ordering is fast & easy.



Call today!

Additional Plates, Jacks and More

A. CAT5E Keystone Jacks

Color	Part #
Black	K5-8PE-BK
Blue	K5-8PE-BL
Gray	K5-8PE-GY
Ivory	K5-8PE-IV
Orange	K5-8PE-OR
Red	K5-8PE-RD
White	K5-8PE-WH
Yellow	K5-8PE-YL

B. Shielded Cat5e STP RJ-45 In-Line Coupler

Color	Part #
Silver	CP-8S

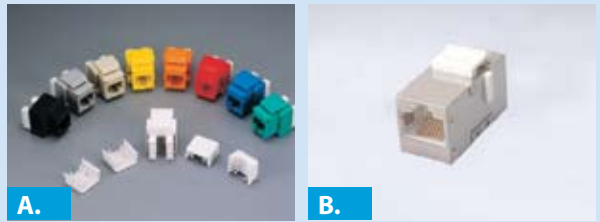

C. CAT6 Jacks

Color	Part #
Ivory	K6-8KP-IV
White	K6-8KP-WH
Gray	K6-8KP-GY
Black	K6-8KP-BK
Red	K6-8KP-RD
Orange	K6-8KP-OR
Blue	K6-8KP-BL
Green	K6-8KP-GN
Yellow	K6-8KP-YL

D. RJ45 Color Boots

Color	Part #
White	BOOT-S-WH
Black	BOOT-S-BK
Green	BOOT-S-GN
Red	BOOT-S-RD
Yellow	BOOT-S-YL
Blue	BOOT-S-BL
Gray	BOOT-S-GY



E. UTP RJ-45 in Line Coupler

Additional Plates, Jacks and More

Color	Description	Part #
White	Cat5e, Panel Mount Type	CP-8-WH
Ivory	Cat5e, Panel Mount Type	CP-8-IV
White	Cat6, Panel Mount Type	CP-8B-WH
Ivory	Cat6, Panel Mount Type	CP-8B-IV

F. Shielded Cat6 Keystone Jack

Color	Part #
Silver	K6-8KPS
Silver	K6-8SE



G. Decora Gang Plates

Color	Description	Part #
White	Single Gang	WP-DEC-WH
Ivory	Single Gang	WP-DEC-IV
Almond	Single Gang	WP-DEC-AL
White	Double Gang	WP-DEC2-WH
Ivory	Double Gang	WP-DEC2-IV
Almond	Double Gang	WP-DEC2-AL
White	Triple Gang	WP-DEC3-WH
Ivory	Triple Gang	WP-DEC3-IV
Almond	Triple Gang	WP-DEC3-AL

H. Decora Inserts

Color	Description	Part #
White	2 Port	WJ-DEC-WH
Ivory	2 Port	WJ-DEC-IV
Almond	2 Port	WJ-DEC-AL
White	4 Port	WJ-DEC4-WH
Ivory	4 Port	WJ-DEC4-IV
Almond	4 Port	WJ-DEC4-AL
White	6 Port	WJ-DEC6-WH
Ivory	6 Port	WJ-DEC6-IV
Almond	6 Port	WJ-DEC6-AL

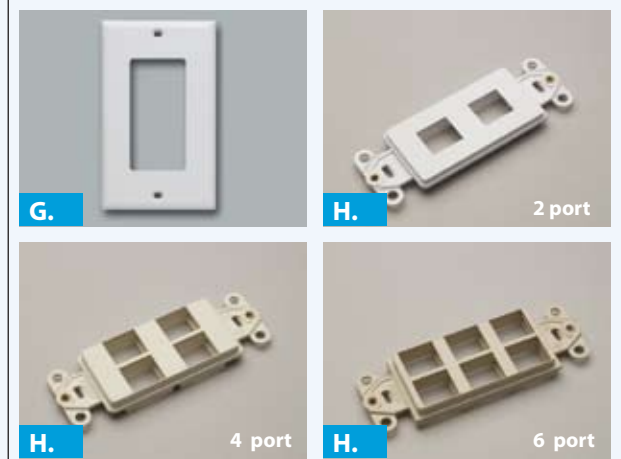

Ordering is fast & easy.



Call today!

Solutions for the AV PROFESSIONAL

www.libertycable.com

800-530-8998

INTERNATIONAL - CALL +1-719-388-7542



International Styles

A. British Wall Plates

Color	Description	Part #
Ivory	1 Flat Module	WP-BS-IV
White	1 Flat Module	WP-BS-WH
Ivory	2 Flat Modules	WP-BS2-IV
White	2 Flat Modules	WP-BS2-WH
Ivory	1 Angled Module	WP-BSA-IV
White	1 Angled Module	WP-BSA-WH

B. European Wall Plates

Color	Description	Part #
Ivory	plate with metal gaske	WP-ES-IV
White	plate with metal gaske	WP-ES-WH

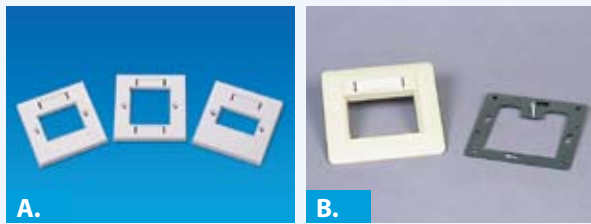

C. Wall Boxes British

Color	Part #
Ivory	SB-BS-IV
White	SB-BS-WH

D. Wall Boxes European

Color	Part #
Ivory	SB-ES-IV
White	SB-ES-WH

E. NEMA 106 Duplex Wall Plates

Color	Part #
White	WP-106-WH
Ivory	WP-106-IV
Almond	WP-106-AL

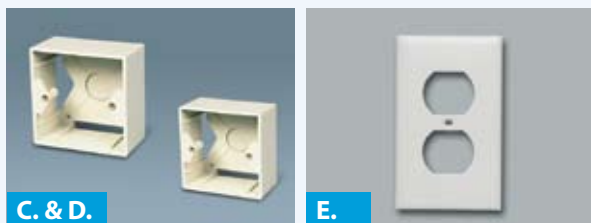

F. NEMA 106 Duplex Inserts

Color	Part #
White	WJ-106-WH
Ivory	WJ-106-IV
Almond	WJ-106-AL

G. Single Gang Wall Box

Color	Part #
Ivory	SB-S1-IV
White	SB-S1-WH

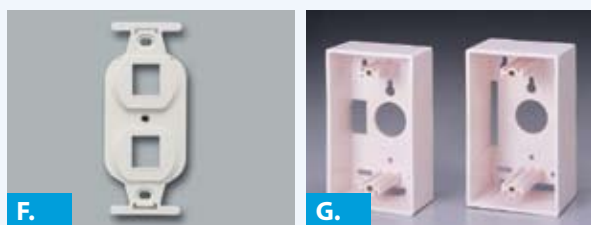

Installation Accessories

A. Series II Inserts- 1 1/2" Blank Module

Color	Description	Part #
Ivory	with one snap-in hole	ISA-U1-IV
White	with one snap-in hole	ISA-U1-WH
Ivory	with two snap-in hole	ISA-U2-IV
White	with two snap-in hole	ISA-U2-WH

B. Flush Mount Wall Plates/Mounting Brackets

Description	Part #
Single Gang	MB-SM
Double Gang	MB-DM

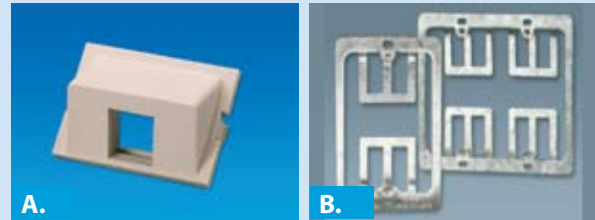

C. Wall Box for Fiber

Color	Part #
Ivory	SB-S3-IV
White	SB-S3-WH

D. Series II Inserts - 1" Blank Module

Color	Description	Part #
Ivory	with one snap-in hole	ISF-U1-IV
White	with one snap-in hole	ISF-U1-WH
Ivory	with two snap-in hole	ISF-U2-IV
White	with two snap-in hole	ISF-U2-WH

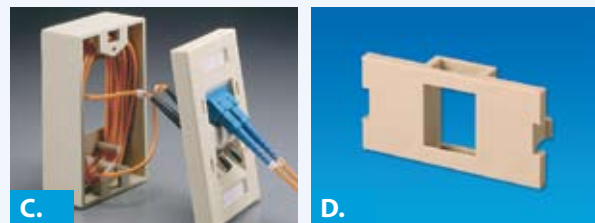

E. Modular Wall Phone Jacks

Color	Description	Part #
Stainless Steel	stainless steel wall jack	630-ES6
Ivory	plastic wall jack	630E-IV
White	plastic wall jack	630E-WH



Ordering is fast & easy.



Call today!

Solutions for the AV PROFESSIONAL
www.libertycable.com

800-530-8998
INTERNATIONAL - CALL +1-719-388-7542



PanelCrafters™ Printed Products

Custom Application Label Sets

End line identification confusion by putting the perfect solution for marking multiple inputs, outputs and wire feeds to work for your business. Our easy-to-use application label sets will reduce installation time and identification headaches.

Digitally printed labels result in crisp, clean and readable text. Reverse printed on a polycarbonate surface means the labels are scratch and smudge proof. Computer controlled cutting machines ensure that your labels are perfectly cut and consistently uniform in dimension and appearance. You have the choice of executing your custom label sets in two easy ways:

1. Use our simple-to-use AutoCAD™ or Visio™ formats which allows you to input the label information yourself then send it to us for production.
2. Send us the label content information via email or fax and we will design and manufacture your label sets to your exact specifications. What could be easier?

Standard label set available as shown, sets of 5.



Ordering is fast & easy.



Call today!

**Solutions for the
AV PROFESSIONAL**

www.libertycable.com

800-530-8998

INTERNATIONAL - CALL +1-719-388-7542



Magnepull Spider

How it Works!

New Design, Convenient Case!



Part #: MAGNEPULL SPIDER

Magnepull Spider cable retrieval system reduces cable installations time as much as 70% as compared to a standard fish tape. This new tool magnetically couples the cable-pulling device through drywall and allows the technicians to have complete control. The system was developed to work with metal studs and in insulated walls.

Benefits of The Magnepull Spider*:

- Simple! Reduces Wire Installation Labor to Minutes
- Works well in wood or metal studs and conduits
- Light weight — less than 1.5 lbs
- No need for large hole — the unit will retrieve through a hole as small as 1 1/4"
- Powerful magnet will couple through wall board as thick as 3/4"

Residential Instructions

DROP

LOCATE

CONNECT

RETRIEVE

Commercial Instructions

INSERT

CONNECT

FEED

RETRIEVE

CATMASTER™ Termination System for RJ45

CATMaster™ Crimp Tool

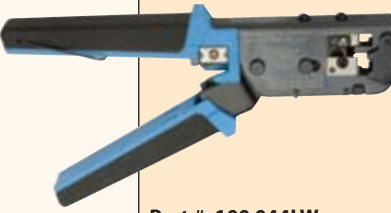

Part #: 100 044LW

This high quality crimp tool is designed to quickly crimp and cut the wires of the EZ-RJ45® Connector...in one easy simple operation! Will also work on all other RJ-11, RJ-12 and RJ-45 connectors.

- Precision ground crimp dies.
- Straight action cut and crimp performs the best crimp.
- Full cycle ratcheting mechanism provides consistent terminations every time.
- Crimps and cuts the wire in one cycle.
- Built in wire cutter and stripper.
- High strength, long life steel frame.
- Rust resistant black oxide coating.
- Superior quality at an economical price.

UTP Cable Jacket Stripper



Part #: 15010

This economical tool has been specifically designed to strip the cable jacket from UTP cables. Will not nick the inner conductors.

EZ-RJ45® Connector

The new patented EZ-RJ45® connector simplifies twisted pair terminations by allowing the wires to be inserted through the connector and out the front. This allows the technician to easily verify the proper wiring order. Electrical performance of the termination is optimized by pulling the connector down over the cable jacket and seating it tightly in the rear of the connector. Reducing the distance between the wire twists and contacts improves performance!

Packaged in bags of 100



CATMaster™ Kits are Available

CATMaster™ Kits are available	
Description	Part #
<ul style="list-style-type: none"> • 1 CATMaster RJ11/RJ45 Crimp Tool • 1 CATMaster Stripper • 1 Cable Cutter • 50 CATMaster RJ-45 Connectors 	90131LW

Colored Boots
Part #: 100030-*

Metal Connector
Part #: 100020

Ordering is fast & easy.

Call today!

Solutions for the AV PROFESSIONAL
www.libertycable.com

800-530-8998
INTERNATIONAL - CALL +1-719-388-7542

Specifications Subject to Change

Cable Ties

Standard Cable Ties



Available in
Packages of 100.

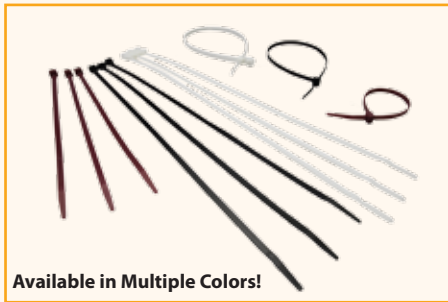

Available in Multiple Colors!

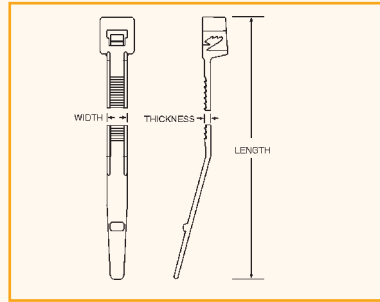

Standard Cable Ties		
Inches	PVC/Plenum	Part #
4.5	PVC	CT-4.5
8	PVC	CT-8
11	PVC	CT-11
14	PVC	CT-14
4	Plenum	CT-P-4
8	Plenum	CT-P-8
11	Plenum	CT-P-11
14	Plenum	CT-P-14

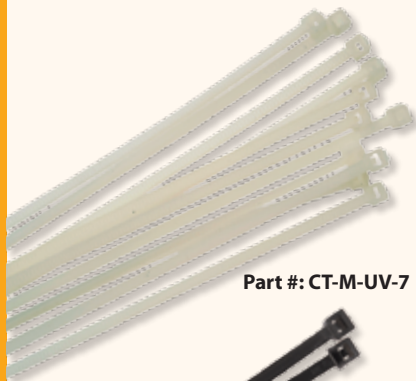

Part #: CT-M-UV-7

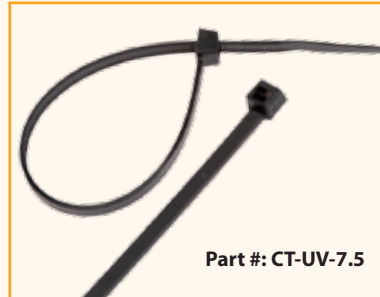

Part #: CT-UV-7.5

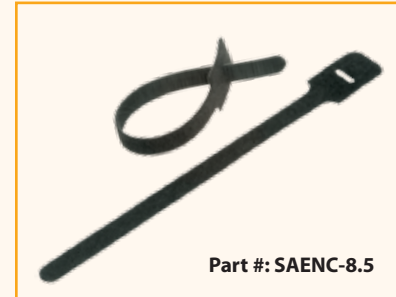

Part #: SAENC-8.5



Part #: CT-11.25

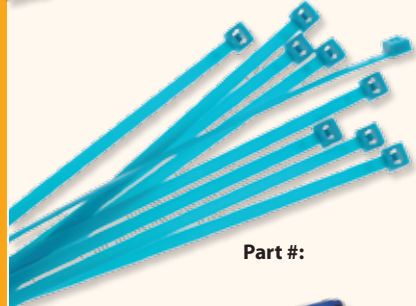

Part #:



Cable Tie Gun
Part #: 15-991

PART #	DESCRIPTION
Cable Tie installation Tool	
15-991	CABLE TIE GUN
Non-Plenum Cable Ties	
CT-11	CABLE TIE, 11" 50LB WHITE
CT-11.25	CABLE TIE, 11.25" 30LB WHITE
CT-12	CABLE TIE, 11.375" 40LB WHITE
CT-14.5	CABLE TIE, 14.5" 50LB WHITE
CT-4	CABLE TIE, 4" 18LB WHITE
CT-6	CABLE TIE, 6" 18LB WHITE
CT-8	CABLE TIE, 8" 40LB WHITE
Non-Plenum Cable Ties w/Screw Mount Hole	
CT-M-11	CABLE TIE, 11" 50LB W/SCREW WH
UV Rated Cable Ties	
CT-UV-11	CABLE TIE, 11" 50LB BLACK UV

PART #	DESCRIPTION
CT-UV-14	CABLE TIE, 14" 50LB BLACK UV
CT-UV-4	CABLE TIE, 4" 18LB BLACK UV
CT-UV-5.5	CABLE TIE, 5.5" 40LB BLACK UV
CT-UV-6	CABLE TIE, 6" 18LB BLACK UV
CT-UV-7	CABLE TIE, 7" 50LB BLACK UV
CT-UV-7.5	CABLE TIE, 7.5" 40LB BLACK UV
CT-UV-8	CABLE TIE, 8" 40LB BLACK UV
UV Rated Cable Ties w/Screw Mount Hole	
CT-M-UV-11	CABLE TIE, 11" 50LB W/SCREW BK
CT-M-UV-14	CABLE TIE, 14" 50LB W/SCREW BK
CT-M-UV-7	CABLE TIE, 7" 50LB W/SCREW BLK
Plenum Rated Cable Ties	
CT-P-12	CABLE TIE, 12" 50LB PLENUM
CT-P-14	CABLE TIE, 14" 50LB PLENUM VIO
CT-P-4	CABLE TIE, 4" 18LB PLENUM RED
CT-P-8	CABLE TIE, 8" 50LB PLENUM VIO
Velcro Cable Ties	
SAENC-8.5	CABLE TIE, 8.5" VELCRO

Ordering is fast & easy.



Call today!

**Solutions for the
AV PROFESSIONAL**
www.libertycable.com

800-530-8998
INTERNATIONAL - CALL +1-719-388-7542

Heat Shrink Tubing

Custom Kits and Lengths Available

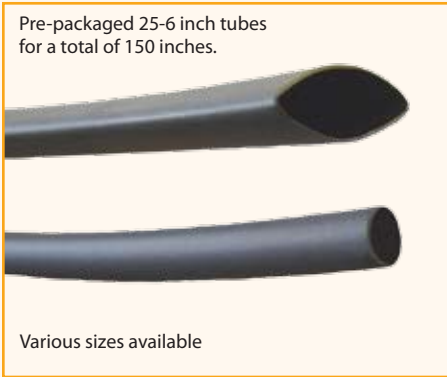

Additional XLR Configurations	
Part # (Non-Adhesive)	Part # (With Adhesive)
HSK-2:1BK-1	HSAK-2:1BK-1
HSK-2:1BK-1/2	HSAK-2:1BK-1/2
HSK-2:1BK-1/4	HSAK-2:1BK-1/4
HSK-2:1BK-1/8	HSAK-2:1BK-1/8
HSK-2:1BK-3/16	HSAK-2:1BK-3/16
HSK-2:1BK-3/4	HSAK-2:1BK-3/4
HSK-2:1BK-3/8	HSAK-2:1BK-3/8

Available Colors				
Black	Blue	Brown	Clear	Gray
Green	Purple	Red	White	Yellow

Connex Crimper



HAVE TOOLING QUESTIONS? CALL US TODAY!

Tool and Connector Cross Reference			
Cable P/N's	Item #	Die P/N	Frame Part #
18-CMP-VID-COAX, RG6-CCTV-PL	112966 (Jack)	47-20001	47-10000
	112519	47-20001	47-10000
18-CMR-VIDEO, RG6-CCTV, RG6-CM	112957	47-20001	47-10000
20-CMP-VID-COAX, RG59-P-CATV, RG59-CCTV-PL, RG59-18/2C-PS	112645 (Jack)	47-20001	47-10000
	112975	47-20001	47-10000
20-CMR-VIDEO, RG59-CCTV-CM, RG59CM-18/2C, RG59-CATV	112973 (Jack)	47-20001	47-10000
	112951	47-20001	47-10000
RG58-CMP	112152 (Jack)	47-20000	47-10000
	112128	47-20000	47-10000
RG58-CMR	112116	47-20000	47-10000
RG8-III VSAT-P-KYNAR	112627	47-20029	47-10000
RGB3-MINI, RGB5-MINI, 25-CMR, 23-MINI-SD, 23-MINI-CMP, RGB5C-STAGE	112559 (Jack)	47-20002	47-10000
	112955	47-20002	47-10000
RGB5C-PLN, RGB5C-PVC, RGB6C/22-2P, RGB6C/22-2P-PLN, SV-PLN, SV-PVC, AVC-18-PLN, RGB5C-25-CMP, SV-25-CMP, RGB6C-25/22-2P-PLN	112161-10 (Jack)	47-20250, 47-20004	47-10000
	112491-10	47-20250, 47-20004	47-10000
	112491-11	47-20250	47-10000
WBC-400, WBC-400R	112563	47-20027	47-10000

F Connector Termination Crimp Tool

Liberty Weather-Proof F Connectors for RTC360 Tool:	
Description	Part #
RG6 F Connector with External O-Ring	RG6WRO
RG6 Quad F Connector with External O-Ring	RG6NRO
RG59 F Connector with External O-Ring	RG59WRO

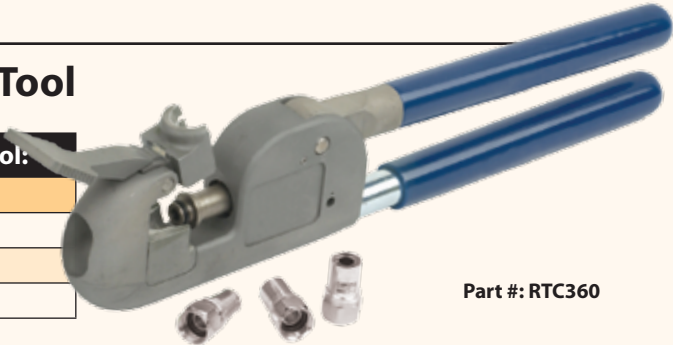

Ordering is fast & easy.



Call today!

Solutions for the AV PROFESSIONAL
www.libertycable.com

800-530-8998
INTERNATIONAL - CALL +1-719-388-7542



Specifications Subject to Change

Structured Wire Boxes and Modules by Eaton

Liberty offers structured wire boxes and modules from EATON. EATON's long standing expertise in all aspects of electrical equipment design and manufacture make EATON's structured wire boxes and modules recognized as the leader in the industry.

Well designed and highly functional, our structured wire boxes fit perfectly with any type of AV installation where space might be at a premium and a rack-based solution is not the right answer.

All modules are color coded making signal identification and overall installation simple and convenient. With a broad set of module-based solutions your system can be designed for today's needs as well as the increased system demands of tomorrow.

With technical assistance available at every step of the installation, our structured wire boxes are easy to set up and outfit with the correct combination of modules providing your systems with flawless performance.

Ordering Guide for Enclosures and Matching Covers

Covers Sold Separately

Item	Enclosures Part #	Height	Depth	Width	Standard Cover Part #	Hinged Cover Part #
1	ESWI5400	54"	3.75"	14.5"	ESWC5400	ESWC5400H
2	ESWI3600	36"	3.75"	14.5"	ESWC3600	ESWC3600H
3	ESWI2400	24"	3.75"	14.5"	ESWC2400	ESWC2400H
4	ESWI1800	18"	3.75"	14.5"	ESWC1800	ESWC1800H
5	ESWI1200	12"	3.75"	14.5"	ESWC1200	n/a



Standard Cover



Hinged Cover



Hinged Cover For Items 1 and 2

All covers include venting for protection of installed electronic equipment.

All enclosures come with a 110 V. duplex electrical outlet as standard.

2 large and 2 small grommets and ground bar included.

For international customers, 220 V. duplex electrical outlets are available upon request.

Ordering is fast & easy.



Call today!

Solutions for the AV PROFESSIONAL

www.libertycable.com

800-530-8998

INTERNATIONAL - CALL +1-719-388-7542



Basic Panels: Prekitted and Ready To Go

1		2	
Part #: ESWB100 Distributes 4 incoming telephone lines to 6 locations and 1 incoming video signal to 4 locations.		Part #: ESWB100P Distributes 4 incoming telephone lines to 12 locations, can be wired as two 4 x 6 telephone modules.	

Combo Modules: Video, Telephone and Satellite *Powered Products Come With Power Supply

1	2	3	4	5	6
Part #: ESWD40800	Part #: ESWD40800P	Part #: ESWD80800	Part #: ESWD80800P	Part #: ESWD80800A	Part #: ESWD80800AP
4x8 Passive Coax/Phone Distribution Module Distributes 1 incoming video signal to 4 locations, 4 telephone lines to 8 locations, RJ31X jack for security, and 2 pass through connections for SATV. Available as either 110 punchdown or RJ45 connectors.		8 x 8 Passive Coax/Phone Distribution Module Distributes 1 incoming video signal to 8 locations, 4 telephone lines to 8 locations, RJ31X jack for security, and 2 pass through connections for SATV. Available as either 110 punchdown or RJ45 connectors.		8 x 8 Amplified Coax/Phone Distribution Module Distributes 1 video signal to 8 locations with built-in amplification and surge suppression, 2 pass through for SATV, 4 telephone lines to 8 locations with a RJ31X Security Jack. Available as either 110 punchdown or RJ45 connectors.	

Video Modules: Amplified and Passive *Powered Products Come With Power Supply

1	2	3	4	5	6
Part #: ESWV10400	Part #: ESWV10800	Part #: ESWV10800A	Part #: ESWV50800A	Part #: ESWV51200A	Part #: ESWV51600A
1 x 4 - 2Ghz Passive Coax Module 1 incoming video signal to 4 locations 4 pass through connections for SATV.	1 x 8 - 2Ghz Passive Coax Module 1 incoming video signal to 8 locations 4 pass through connections for SATV.	1 x 8 - 1Ghz Amplified Coax Module 1 incoming video signal to 8 locations with a 12db bi-directional amplifier and 4 pass through connections for SATV.	12" 5 x 8 - 1Ghz Amplified Coax Module 5 Video inputs to 8 locations, bi-directional amplifier, built-in surge suppression and 4 pass through connections for SATV.	12" 5 x 16 - 1Ghz Amplified Coax Module 5 Video inputs to 8 locations, bi-directional amplifier, built-in surge suppression and 4 pass through connections for SATV.	12" 5 x 16 - 1Ghz Amplified Coax Module 5 Video inputs to 16 locations, bi-directional amplifier, built-in surge suppression and 4 pass through connections for SATV.

Telephone Modules

1	2	3	4	5	6
Part #: ESWT41200P	Part #: ESWT40800	Part #: ESWT41600	Part #: ESWTB48800	Part #: ESWTB800	Part #: ESWTB00
4 x 12 Telephone Module Distributes 4 incoming lines to 12 Location 110 Punchdown style Telephone Module with an RJ31X Security Jack and Jumper Port	4 x 8 Telephone Module Distributes 4 incoming lines to 8 Location RJ45 style Telephone Module with an RJ31X Security Jack and Jumper Port	4 x 16 Telephone Module Distributes 4 incoming lines to 16 Location RJ45 style Telephone Module with an RJ31X Security Jack and Jumper Port	4 x 8 Telephone Break Out Module Distributes 4 incoming telephone lines to 8 locations, RJ45 style, 8 break out ports, 4-line pass through. Breakout configurations: 1-2, 2-1, 3-4, 4-3	8 Location Non Bridged Phone Module 8-RJ45 jacks connected directly to 8-110 punch down connectors, (one-to-one) can be bridged together, great for Ethernet switches and routers	Telephone Line Break Out Device Connects up to 4 devices (phone, fax, DSL, etc) to a single CAT5e jack, with one pass through connection for all four lines Breakout configurations: 1-2, 2-1, 3-4, 4-3

Ordering is fast & easy.







Call today!

Solutions for the AV PROFESSIONAL
www.libertycable.com



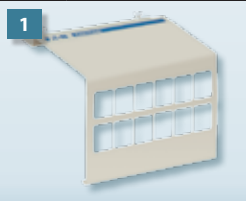
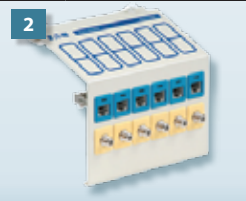





800-530-8998
INTERNATIONAL - CALL +1-719-388-7542

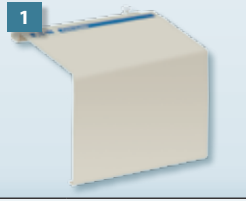
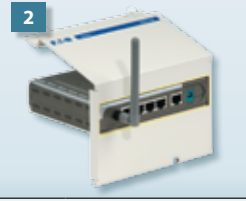



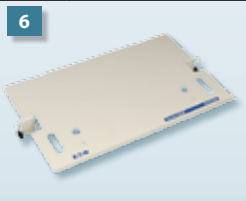

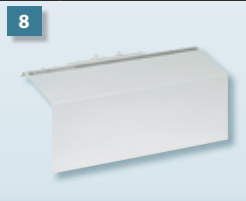
Patch Modules and Inserts

				
Part #: ESWP100	Part #: ESWMP300	Part #: ESWML5B	Part #: ESWMLC	Part #: ESWBLB
Blank Patch Module 12 open ports for Coax or CAT5e jacks	3-Zone Patch Module Includes 6 CAT5e connectors and 6 RG6 connectors	CAT5e Insert and Blue Bezel for Distribution Modules 12 Pack Also in: Orange - Part #: ESWML5O	Coax Insert for Distribution Modules 12 Pack	Blank Insert for Distribution Modules 12 Pack Also in: Red - Part #: ESWBLR White - Part #: ESWBLW Yellow - Part #: ESWBLY

Optional Modules *Powered Products Come With Power Supply

				
Part #: ESWF001	Part #: ESWN100	Part #: ESWN400	Part #: ESWN800	Part #: ESWMS100
Blank Filler Module Used to hide cables in the panel	4 Port 10/100 Wireless Firewall Router Distributes DSL/Broadband service up to 4 computer locations, Also provides wireless connectivity	4 Port 10/100 Firewall Router Distributes DSL/Broadband service, up to 4 computer locations	8 Port 10/100 Firewall Router Distributes DSL/Broadband service, up to 8 computer locations	Product Shelf 14" x 4" Can be mounted anywhere in the panel. Allows for third party products to be mounted in the panel. (Modems, power strips, etc.)
				
Part #: ESWMS200	Part #: ESWMS300	Part #: ESWMSC300	Part #: ESWMS300	Part #: ESWMOD3
Service Shelf 14" x 8" Can be mounted anywhere in the panel. Designed as a work shelf for the installer	12" Blank Mounting Shelf Stand off hole placements for Ademco, First Alert, Caddx, DSC, and Electronics Line security panels	12" Blank Mounting Shelf Cover Designed to fit over the ESWMS300	3 Channel Camera Modulator Distributes up to 3 video signals (camera, DVD, SATV, CATV) to any Television in the home	3 Channel Stand Alone Modulator Distributes up to 3 video signals (camera, DVD, SATV, CATV) to any Television in the home 1 Channel Available - Part #: ESWMOD1

CAT5 Intercom *Powered Products Come With Power Supply

				
Part #: ESWABI100	Part #: ESWABI200	Part #: ESWABI300	Part #: ESWABI400	Part #: ESWABI200PA
2-Door 8-Room Intercom Module This module is the core of the income system. Includes 2-door station outputs and 8 room locations	Mini Master Room Keypad Also Available in Almond Part #: ESWABI200A	Control Center (Master Keypad) Also Available in Almond Part #: ESWABI300A	Door Station Also Available in Almond Part #: ESWABI400A Upgrade Cover Plates Available: Brass - Part #: ESWABI500B Aluminum - Part #: ESWABI500A	Outdoor Keypad Also Available in Brass Part #: ESWABI200PB

Ordering is fast & easy.



Call today!

Solutions for the AV PROFESSIONAL
www.libertycable.com

800-530-8998
INTERNATIONAL - CALL +1-719-388-7542



Basic Audio

1		2	
Part #: ESWA75W		Part #: ESWAM800	
Non-Impedance/Impedance Matching Volume Control Also in Almond Part #: ESWA75A		8 Location Audio Dist. Module Distributes 1 signal to 8 stereo locations via traditional speaker wire	

A-BUS Audio *Powered Products Come With Power Supply

1		2		3		4		5	
Part #: ESWAM600C		Part #: ESWAM4800C <small>Requires additional power supply (ESWAP) if distributing to more than 4 locations.</small>		Part #: ESWA200CW		Part #: ESWA300CW		Part #: ESWA400CW	
1-Source 6-Zone A-BUS Module Distributes 1 audio source to 6 locations via single Cat5 to each location. Includes module and power supply. May be daisy chained for additional locations.		4-Source 8 Zone A-BUS Module Distributes 4 audio sources to 8 locations via single Cat5 to each location. Includes module, power supply, 4 audio input plates, and multi-function remote control.		Standard A-Bus Volume Control (Decora Faceplate Not Included) Also in Almond Part #: ESWA200CA		Standard A-Bus Volume Control w/IR (Decora Faceplate Not Included) Also in Almond Part #: ESWA300CA		2-Button A-Bus Volume Control w/IR (Decora Faceplate Not Included) Also in Almond Part #: ESWA400CA	
6		7		8		9		10	
Part #: ESWA4500CW		Part #: ESWA700CW		Part #: ESWA500C		Part #: ESWA100CR		Part #: ESWA200CR	
4-Position Backlit Multi-Source w/IR A-Bus Volume Control (Decora Faceplate Not Included) Also in Almond Part #: ESWA4500CA		A-Bus Local Source Input (Decora Faceplate Not Included) Also in Almond Part #: ESWA700CA		Line Output to CAT5 Transition Device		4 Button Remote Control For use with all A-Bus volume controls with IR inputs. Controls volume and source inputs		Multi-Function Remote Control 6 Device universal remote with A-Bus controls for volume and source inputs	

Additional A-BUS Power Supply Available.
Part #: ESWAP

A-BUS is a Whole New Way of Looking at Whole House Audio

Music is carried over Cat5 cable at line levels and is amplified in each room with the volume control. This makes the system simple to design and install for single or multiple sources, while also delivering high quality audio and keeping the cost affordable.

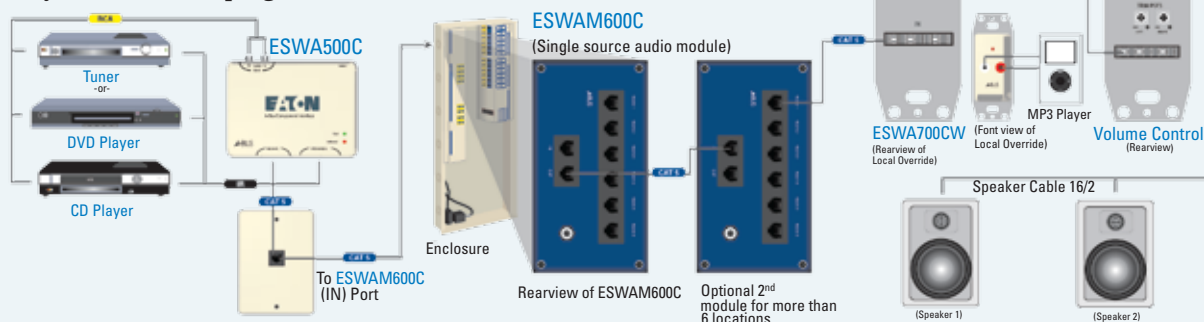

Ordering is fast & easy.



Call today!

Solutions for the AV PROFESSIONAL
www.libertycable.com

800-530-8998
INTERNATIONAL - CALL +1-719-388-7542



Specialized Cables for Control Systems

Tektone™ Nurse Call Systems Composite Cable

Plenum and Non-Plenum

Non-Plenum

- UL Listed NEC Type CMR/CL3R 75°C
- Bare Copper Conductors

PVC -TekTone NC300							
Description	Shielding	NOM Insulation (Inches)	NOM Jacket (Inches)	NOM Jacket/Color	NOM Capacitance pF/ft	Conductor Colors	Part #
							TEKTONE-NC300
18 AWG, 3 Cond, 7 Str. BC	100% Alum Mylar w/20 AWG TC Drain Wire	.017 PE	0.032	0.245 Orange	24	Orange, Yellow Green	TEKTONE-D2 (Data)
18 AWG, 3 Cond, 7 Str. BC	100% Alum Mylar w/20 AWG TC Drain Wire	.009 PE	0.015	0.175 Green	43	Brown, Red Blue	TEKTONE-P2 (Power)
18 AWG, 2 Cond, 7 Str. BC	100% Alum Mylar w/20 AWG TC Drain Wire	.017 PE	0.032	0.235 Gray	24	Violet, Gray	TEKTONE-AUDIO
16 AWG, 2 Cond, 26 Str. BC	N/A	0.01 PVC	0.02	0.183 Black	N/A	Red, Black	16-2C-BLK
Cables are bundled in a quick pull combination. The above cables have been approved by Tektone Engineering for use on their Nurse Call System. This products is taped every 12 inches for easy installation.							

This products is taped every 12 inches for easy installation.

Plenum

- UL Listed NEC Type CL2P or CL3P/CMP
- Bare Copper Conductors

Description	Shielding	NOM Insulation (Inches)	NOM Jacket (Inches)	NOM Jacket/Color	NOM Capacitance pF/ft	Conductor Colors	Part #
							TEKTONE-PLN-BUND Tektone-PLN-Data (Data)
18 AWG, 3 Cond, 7 Str. BC	100% Alum Mylar w/20 AWG TC Drain Wire	.008 ECTFE	0.015	0.175 Green	43	Brown, Red, Blue	TEKTONE-PLN-POWER (Power)
18 AWG, 2 Cond, 7 Str. BC	100% Alum Mylar w/20 AWG TC Drain Wire	.012 FEP	0.015	0.180 Gray	21	Violet, Gray	TEKTONE-PLN-AUDIO
18 AWG, 2 Cond, 7 Str. BC	N/A	0.007 PVC	0.014	0.154 Black	N/A	N/A	18-2C-P-BLK
18 AWG, 3 Cond, 7 Str. BC	100% Alum Mylar w/20 AWG TC Drain Wire	.012 PE	0.015	0.190 Orange	21	Orange, Yellow, Green	TEKTONE-PLN-DATA

Ordering is fast & easy.



Call today!

Solutions for the AV PROFESSIONAL
www.libertycable.com

800-530-8998
INTERNATIONAL - CALL +1-719-388-7542



Electrical Characteristics

Capacitance

Capacitance is a measurement of energy absorbed by the cable. It is caused by the difference in electrical potential of the conductors and is measured in picofarads per foot (pF/ft). It is related to the inner and outer conductor sizes and the core dielectric constant. In a given cable design, capacitance and impedance are inversely proportional. The fewer the picofarad per foot, the better the cable performance.

Capacitance is determined by the formula $\frac{7.354 E_r}{\log_{10} \frac{D}{ad}}$
Where E_r is the dielectric constant of the cable core, D is the dielectric diameter, d is the conductor diameter and a is the conductor stranding factor.

Impedance

Characteristic impedance is a measurement of resistance impedance and capacitance of a cable. It is measured in units called Ohms (ZO) and is directly related to the ratio between inner conductor dimension and the outer conductor dimension, and inversely related to the dielectric constant of the cable core. CTA specific frequency, unlike conductor resistance, impedance does not vary with cable length. For a system to work at maximum efficiency, the nominal impedance of the transmitter, receiver and cable must precisely match. An incorrect match will produce reflection loss.

Nominal impedance is determined by the formula $\Omega (W) = \frac{138.2}{\sqrt{E_r}} \log_{10} \frac{D}{ad}$
The factors are the same as they are for capacitance above.

Structural Return Loss

Structural return loss is the measure of power loss on a cable or system and is caused by discontinuities in the cable conductor or dielectric. If these discontinuities are regularly spaced along a cable, they can cause severe transmission losses for frequencies whose wavelengths are twice that of the distance between these discontinuities.

Structural return loss is an unfavorable characteristic of poorly made cable, although careless installation can cause it as well. Liberty offers cable from manufacturing lines that are constantly computer monitored to avoid irregularities in the manufacturing process that could cause these flaws.

Velocity of Propagation

Nominal velocity of propagation is the speed of the signal in a given cable. In a vacuum, electromagnetic radiation (light, radio waves, etc.) travels at the speed of light. In a cable, it travels somewhat slower and in direct inverse proportion to the dielectric constant; the lower the dielectric constant, the closer to the speed of light the signal travels.

Velocity of propagation is given as a percent figure of the speed of light and is calculated by $\frac{1}{\sqrt{E_r}} \times 100$ where E_r is the dielectric constant of the cable core.

C(UL/Canadian Electrical Code Certifications

UL/NEC-Approved cables may also be C(UL)/CEC-Approved as communications cables meeting the requirements of the Bi-National Standard CSA C22.2 No. 214/UL 444 and Section 60 of the Canadian Electrical Code, Part 1 (CEC). The C(UL) cable designation (and its meaning) would be one of the following:

1. **CMP**—Cable meeting CSA FT6 or UL 910
2. **CMR**—Cable meeting UL 1666
3. **CMG**—Cable meeting CSA FT4
4. **CM**—Cable meeting UL 1581, Sec. 1160 (Vertical-Tray)
5. **CMX**—meeting UL 1581, Sec. 1080 (VW-1)
6. **CMH**—Cable meeting CSA FT1

**Solutions for the
AV PROFESSIONAL**
www.libertycable.com

800-530-8998
INTERNATIONAL - CALL +1-719-388-7542

Liberty
AV Solutions

Ordering is
fast & easy.



Call today!

RESIDENTIAL WIRE SCHEDULE

Signal	Type	LWC P/N	Description (Fixed Install)	Diameter (Inch)	Diameter (mm)	Rating	Grade	Mating Connector	Crimp BNC
Audio (Non-Speaker)	Balanced or Unbalanced	22-2P-SIAM-EZ	22 AWG 2 Pair Individually shielded Zip Broadcast Audio	0.275	7.0	CM	Best	Balanced	Unbalanced
Analog Audio	Balanced or Unbalanced	22-2P-SHEX	22 AWG 2 Pair Individually shielded ExtraFlex™	0.260	6.6	CL3R	Better	NC3FX, NC3MX	ZD06-color
Analog Audio	Balanced or Unbalanced	22-2P-INDSH	22 AWG 2 Pair Individually shielded General Purpose	0.175	4.4	CMR	Good	NC3FX, NC3MX	ZD06-color
Digital or Analog Audio	Unbalanced (Coaxial)	18-CMR-SD	RG6/U High Definition Serial Digital Coaxial Cable	0.272	6.9	CMR	Best	N/A	CM-RG6Q series
Digital or Analog Audio	Unbalanced (Coaxial)	20-CMR-VIDEO	RG59/U High Definition Serial Digital Coaxial Cable	0.236	6.0	CMR	Better	N/A	CM-RG59U series
Digital or Analog Audio	Unbalanced (Coaxial)	23-MINI-SD	Mini RG59/U High Definition Serial Digital Coaxial Cable	0.165	4.2	CM	Good	N/A	CM-RGB23 series
Control									
Universal Control	AMX/CRESTRON	LLINX-U	UltraLow Capacitance 105Ω twisted shielded pair with 18/2 power	0.246	6.2	CM	Best	OEM specific	
General Control	RS-232 Control	24-4P-SH-LIBLI	Low Capacitance 24/4P stranded shielded control/data cable	0.210	5.3	CM	Best	DB9M, DB9F	
DATA									
Non LAN Data	RS232-RS485	24-2P-485	24 AWG 2 Pair twisted double shielded low capacitance 120Ω	0.326	8.3	CM	Best	NC5MX, NC5FX	
Non LAN Data	Control	24-4P-SH-LIBLI	Low Capacitance 24/4P stranded shielded control/data cable	0.210	5.3	CM	Good	DB9M, DB9F	
LAN Data	Category 6	24-4P-L6-EN	23 AWG 4 Pair UTP Third Party verified Category 6	0.220	5.6	CMR	Best	100 011LW	
LAN Data	Category 5e	24-4P-L5-EN	24 AWG 4 Pair UTP Third Party verified Category 5e	0.197	5.0	CMR	Good	100 003B	
Fiber									
Single Mode Fiber	Riser Single Mode	*FRIO SM-	* = Fiber count, Suffix D = Distribution, BO = Breakout, many styles	Varies	Varies	OFNR	Best	95-200 series	
Multi Mode OM3	Riser 62.5/125 Style	*FRIO MM6-	* = Fiber count, Suffix D = Distribution, BO = Breakout, many styles	Varies	Varies	OFNR	Best	95-000 series	
Multi Mode OM4	Riser 50/125 Style	*FRIO MM5-	* = Fiber count, Suffix D = Distribution, BO = Breakout, many styles	Varies	Varies	OFNR	Best	95-050 series	
Intercom									
Analog Audio	Under 1000 Feet	20-2C-SH	20 AWG 2 Conductor twisted shielded general purpose	0.154	3.9	CMR	Good	NC3FX, NC3MX	ZD06-color
Analog Audio	Over 1000 Feet	18-2C-SH	18 AWG 2 Conductor twisted shielded general purpose	0.169	4.3	CMR	Good	NC3FX, NC3MX	ZD06-color
DC Power									
Remote Power Supply	Dependent wattage + distance	22-2C-GRY	22 AWG 1 Pair twisted unshielded general purpose	0.137	3.5	CMR	Good		
Remote Power Supply	Dependent wattage + distance	18-2C-GRY	18 AWG 2 Conductor twisted unshielded general purpose	0.169	4.3	CMR	Good		
RF									
Low Loss 50 Ohm	Wireless Networking	RG58-CMR	19 AWG Low Loss RG58 Riser, 500'	0.195	5.0	CMR	Best	N/A	112116
Low Loss 50 Ohm	Wireless Networking	WBC-400R	Low Loss flexible Coaxial WBC series in outdoor, Riser constructions	0.405	10.3	CMR	Best	N/A	112563
Video									
Analog Video	Composite Video	RG6-CCTV-CM	RG6/U Base Band Video Cable	0.264	6.7	CM	Best	N/A	CM-RG6C series
Analog Video	Composite Video	RG59-CCTV-CM	RG59/U Base Band Video Coaxial Cable	0.242	6.1	CM	Best	N/A	CM-RG59C series
Analog Video	S-Video	23-YCLL-SIAM	Mini RG59/U 23 AWG High Definition Serial Digital Coaxial Cable x 2	0.328	8.3	CM	Best	N/A	CM-RGB23 series
Analog Video	S-Video	SV-25-CM	25 AWG Solid 2 Coaxial Jacketed S-Video Cable (flat)	0.270	6.9	CM	Best	N/A	CM-RGB25 series
Analog Video	S-Video	SV-PVC	26 AWG Stranded 2 Coaxial Jacketed S-Video Cable (flat)	0.270	6.9	CL2	Best	N/A	CM-RGB26 series
Analog Video	YPbPr Component and HD Component	RGB3C-20-CMR	RG59/U High Definition Serial Digital x 3 Conductor Jacketed	0.630	16.0	CMR	Best	N/A	CM-RG59U series
Analog Video	YPbPr Component and HD Component	RGB3C-23-CM	Mini RG59/U High Definition Serial Digital Coaxial Cable x 3 Jacketed	0.415	10.5	CM	Better	N/A	CM-RGB23 series
Analog Video	YPbPr Component and HD Component	RGB3C-MINI	Mini RG59/U base band Coaxial Cable x 3 Jacketed	0.401	10.2	CMR	Best	N/A	CM-RGB25 series
Analog Video	RGBHV Video non-ID/DDC Compliant	RGB3C-23-CM	Mini RG59/U High Definition Serial Digital Coaxial Cable x 5 Jacketed	0.550	14.0	CM	Best	N/A	CM-RGB23 series
Analog Video	RGBHV Video non-ID/DDC Compliant	RGB5-MINI	Mini RG59/U base band Coaxial Cable x 5 Jacketed	0.350	12.7	CMR	Best	N/A	CM-RGB25 series
Analog Video	RGBHV Video non-ID/DDC Compliant	RGB5C-PVC	26 AWG Stranded 5 Coaxial Jacketed RGBHV Cable	0.500	8.9	CL2	Best	N/A	CM-RGB26 series
Analog Video	RGBHV Video ID/DDC Compliant	RGB6C/22-2P	26 AWG stranded 6 Coaxial plus 2 pair control	0.410	10.4	CL2	Best	N/A	CM-RGB26 series
Analog Video	Low Skew UTP	TRU PHASE	23 AWG 4 Pair UTP Low Skew Video Cable	0.205	5.2	CMR	Best	100 011LW	N/A
Analog Video	CATV	RG6-CM	RG6/U CCS Dual Shield CATV 3.0 GHz	0.272	6.9	CM	Best	N/A	CM-RG6U series
Digital Video	QUAD/Broadband	QUAD-FLEX-BC	RG6/U Quad Shield Bare Copper CATV 3.0 GHz	0.287	7.3	CM	Best	N/A	CM-RG6Q series
Digital Video	SMPTE Standards	18-CMR-SD	RG6/U High Definition Serial Digital Coaxial Cable	0.272	6.9	CMR	Best	N/A	CM-RG6Q series
Digital Video	SMPTE Standards	20-CMR-VIDEO	RG59/U High Definition Serial Digital Coaxial Cable	0.236	6.0	CMR	Best	N/A	CM-RG59U series
Voice/Phone									
Telephone/Voice	Low speed Data, telephone, DSL	24-4P-L5-EN	24 AWG 4 Pair UTP Third Party verified Category 5e	0.197	5.0	CMR	Best	100 003B	N/A
Telephone/Voice	Low speed Data, telephone, DSL	24-2P-L3	24 AWG 2 Pair UTP Third Party verified Category 3	0.150	3.8	CMR	Better	100 026LW	
Telephone/Voice	Low speed Data, telephone, DSL	22-4C-50-HT	22 AWG 4 Conductor Solid Station wire	0.152	3.9	CMG	Best		
Security									
Camera	Pan-Tilt-Zoom (PTZ) Applications	RG59CM-18-2C	Baseband RG59/U siamesed with 18/2C Control/Power	0.468	11.9	CM	Best	N/A	CM-RG59C series
Sensor/General	DC Power, Sensor, System	22-4C-ST-HT	22 AWG 4 Conductor twisted unshielded general purpose	0.142	3.6	CMG	Best		

Ordering is fast & easy.



Call today!

Solutions for the AV PROFESSIONAL
www.libertycable.com

800-530-8998
INTERNATIONAL - CALL +1-719-388-7542



RESIDENTIAL WIRE SCHEDULE - Continued

Contact your sales professional to obtain a complete Wire Schedule including the Commercial Non-Plenum Schedule and the Shipboard Schedule

RESIDENTIAL WIRE SCHEDULE - Continued

Signal	Type	LWC/P/N	Description (Fixed Install)	Diameter (inch)	Diameter (mm)	Rating NEC	Grade	Mating Connector	Crimp BNC
Speaker	Amplified Audio	12-1P-UC	THX™ Certified 12 AWG 1 Pair Ultra-Low Capacitance twisted unshielded	0.389	9.9	CL3R	Best	Balanced	CM-A-12
Speaker	Amplified Audio	12-2P-UC	THX™ Certified 12 AWG 2 Pair Ultra-Low Capacitance twisted unshielded	0.478	12.1	CL3R	Best		CM-A-12
Speaker	Amplified Audio	14-1P-UC	THX™ Certified 14 AWG 1 Pair Ultra-Low Capacitance twisted unshielded	0.347	8.8	CL3R	Best		CM-A-14
Speaker	Amplified Audio	14-2P-UC	THX™ Certified 14 AWG 2 Pair Ultra-Low Capacitance twisted unshielded	0.408	10.4	CL3R	Best		CM-A-14
Speaker	Amplified Audio	16-1P-UC	THX™ Certified 16 AWG 1 Pair Ultra-Low Capacitance twisted unshielded	0.283	7.2	CMR	Best		CM-A-16
Speaker	Amplified Audio	10-2C-EX+	10 AWG 2 Conductor High Strand OFC twisted unshielded	0.412	10.5	CL2	Better		CM-A-12
Speaker	Amplified Audio	12-2C-EX+	12 AWG 2 Conductor High Strand OFC twisted unshielded	0.327	8.3	CL3	Better		CM-A-12
Speaker	Amplified Audio	12-4C-EX+	12 AWG 4 Conductor High Strand OFC twisted unshielded	0.378	9.6	CL3	Better		CM-A-12
Speaker	Amplified Audio	14-2C-EX+	14 AWG 2 Conductor High Strand OFC twisted unshielded	0.287	7.3	CL3	Better		CM-A-14
Speaker	Amplified Audio	14-4C-EX+	14 AWG 4 Conductor High Strand OFC twisted unshielded	0.335	8.5	CL3	Better		CM-A-14
Speaker	Amplified Audio	16-2C-EX+	16 AWG 2 Conductor High Strand OFC twisted unshielded	0.255	6.5	CM	Better		CM-A-16
Speaker	Amplified Audio	16-4C-EX+	16 AWG 4 Conductor High Strand OFC twisted unshielded	0.291	7.4	CM	Better		CM-A-16
Speaker	Amplified Audio	14-2C-KO+	14 AWG 2 Conductor High Strand KnockOut twisted unshielded	0.268	6.8	CL3	Better		CM-A-14
Speaker	Amplified Audio	14-4C-KO+	14 AWG 4 Conductor High Strand KnockOut twisted unshielded	0.313	8.0	CL3	Better		CM-A-14
Speaker	Amplified Audio	16-2C-KO+	16 AWG 2 Conductor High Strand KnockOut twisted unshielded	0.231	5.9	CM	Better		CM-A-16
Speaker	Amplified Audio	16-4C-KO+	16 AWG 4 Conductor High Strand KnockOut twisted unshielded	0.280	7.1	CM	Better		CM-A-16
Speaker	Amplified Audio	14-2C-HT	14 AWG 2 Conductor HomeTrax™ twisted unshielded	0.222	5.6	CL3	Good		CM-A-14
Speaker	Amplified Audio	14-4C-HT	14 AWG 4 Conductor HomeTrax™ twisted unshielded	0.262	6.7	CL3	Good		CM-A-14
Speaker	Amplified Audio	16-2C-HT	16 AWG 2 Conductor HomeTrax™ twisted unshielded	0.191	4.9	CMG	Good		CM-A-16
Speaker	Amplified Audio	16-4C-HT	16 AWG 4 Conductor HomeTrax™ twisted unshielded	0.224	5.7	CMG	Good		CM-A-16
Specialty									
Multipurpose	Projector Application	RGB6C/22-2P	26 AWG stranded 6 Coaxial plus 2 pair control Jacketed	0.410	10.4	CL2	Best		CM-RGB26 series 11 2491-10
Multipurpose	Retrofit Applications	RGB6C-25-2L5E	25 AWG Solid 6 Coaxial+ 2 Cat5e UTP Jacketed	0.533	13.5	CM	Best		CM-RGB25 series 11 2491-10
Multipurpose	Retrofit Applications	RGB6C-20/2L5E	20 AWG Solid 6 Coaxial+ 2 Cat5e UTP Jacketed	0.960	24.4	CMR	Best		CM-RG59U series 11 2951
Multipurpose	Rack Interconnection	23-MINI-SD	Mini RG59/U 23 AWG High Definition Serial Digital Coaxial Cable	0.165	4.2	CM	Best		CM-RGB23 series 11 2955
Analog Audio	Microphone	24-2P-STAR-BLK	24 AWG 2 Pair Star Quad style extra flexible Mic cable	0.240	6.1	CM	Best	NC3MX, NC3FX	
Lighting Control									
Lighting Control	Lutron Systems Grafik Eye	LUTRON-RBL	22 AWG Shielded Pair+18 AWG Pair Green Stripe	0.230	5.8	CM	Best		
Lighting Control	Lutron Systems Grafik Eye-4000/5000/6000	LUTRON-RGN	22 AWG Shielded Pair+18 AWG Pair+18 AWG Sensor Blue stripe	0.300	7.6	CL3	Best		
Lighting Control	Lutron Systems Sivoia QED Control	LUTRON-RED	18 AWG Shielded Quad+18 AWG Sensor+16 AWG Pair Red Stripe	0.340	8.6	CL3	Best		
Lighting Control	Lutron Systems Keypad	LUTRON-YEL	22 AWG Shielded Pair + 18 AWG Pair Yellow Stripe	0.230	5.8	CM	Best		
Lighting Control	Lutron System EcoSystem™ Bus Cable	LUTRON-EBC	16 AWG 1 Pair twisted unshielded White jacket (Dual AWM 600V rating)	0.283	7.2	CM	Best		
Lighting Control	Lutron System EcoSystem™ Sensor Cable	LUTRON-ESC	22 AWG 5 Conductor twisted shielded white jacket (Dual AWM 600V rating)	0.293	7.4	CM	Best		
Lighting Control	DMX Control	24-2P-485	24 AWG 2 Pair twisted double shielded low capacitance 120Ω	0.326	8.3	CM	Best	NC5MX, NC5FX	
Composite									
Structured Cabling	Smart Home Composite	CEBUS+-2N2	2xRG6 High Def+2xCat6 UTP Jacketed	0.689	17.5	CM	Best	100 011LW	CM-RG6Q series
Structured Cabling	Smart Home Composite	CEBUS-2N2-J-LBI	2xRG6 Bare Copper Quad+2xCat5e UTP Jacketed	0.670	17.0	CMG	Better	100 003B	CM-RG6Q series
Structured Cabling	Smart Home Composite	CEBUS-CM-F-J	2xRG6 Bare Copper Quad+2xCat5e UTP+2 Multimode Fiber Jacketed	0.670	17.0	CMG	Best	100 003B	CM-RG6Q series
Specialty									
Multipurpose	Rack Interconnection	INTERFLEX-SD	RG59/U High Definition Serial Digital Coaxial Cable	0.236	6.0	N/A	Best		CM-RG59U Series 11 2951
Coax Connectors									
Compression Style	Connect™ Quicklink™ Mini 25 AWG	CM-RGB25-xxx	Nickel Plated RCA, Nickel Plated BNC, and Gold Plated RCA						
Compression Style	Connect™ Mini Hi-Res 25 AWG	CM-RGB25-xxx	Nickel and Gold Plated RCA, Nickel and Gold Plated BNC						
Compression Style	Connect™ Mini Hi-Res 26 AWG	CM-RGB26-xxx	Nickel and Gold Plated RCA, Nickel and Gold Plated BNC						
Compression Style	Connect™ Dual shield RG59	CM-RG59U-xxx	Nickel and Gold Plated RCA, BNC, and F						
Compression Style	Connect™ Plenum single shield RG6	CM-RGB23-xxx	Nickel and Gold Plated RCA, BNC, and F						
Crimp Style	Amphenol Connex	112491-10	4-Piece 75 Ohm Crimp BNC for 26 AWG mini Hi-Res Coaxial						
Crimp Style	Amphenol Connex	112955	3-Piece 75 Ohm Crimp BNC for 25 & 23 AWG mini Hi-Res Coaxial						
Crimp Style	Amphenol Connex	112951	3-Piece 75 Ohm Crimp BNC for RG59 Dual Shield						
Crimp Style	Amphenol Connex	112957	3-Piece 75 Ohm Crimp BNC for RG6 Dual Shield						
Solder Style	Full Metal Shell RCA Plug	ZD06-*	4mm Solder RCA plug in Red, White, and Yellow Bands						

Technical Information

Ordering is fast & easy.

Call today!

Solutions for the AV PROFESSIONAL
www.libertycable.com

800-530-8998
INTERNATIONAL - CALL +1-719-388-7542

Specifications Subject to Change

COMMERCIAL PLENUM WIRE SCHEDULE

Contact your sales professional to obtain a complete Wire Schedule including the Commercial Non-Plenum Schedule and the Shipboard Schedule

COMMERCIAL PLENUM WIRE SCHEDULE

Signal	Type	LWCP/N	Description (Fixed Install)	Diameter (inch)	Diameter (mm)	Rating	Grade	Mating Connector	Crimp BNC
Audio (Non Speaker)									
Audio	Balanced or Unbalanced	24-1P-P-DIG-AUDIO	24 AWG 1 Pair twisted shielded ultra-low capacitance AES/EBU	0.170	4.3	NEC	Best	Balanced	Unbalanced
Analog Audio	Balanced or Unbalanced	22-1P-CMP-EZ	22 AWG 1 Pair twisted shielded Low Capacitance Broadcast Audio	0.130	3.3	CMP	Better	NC3FX, NC3MX	ZD06-color
Analog Audio	Balanced or Unbalanced	22-2C-P5H	22 AWG 1 Pair twisted shielded plenum	0.116	2.9	CMP	Good	NC3FX, NC3MX	ZD06-color
Digital or Analog Audio	Unbalanced (Coaxial)	18-CMP-VID-COAX	RG6/U High Definition Serial Digital Coaxial Cable	0.237	6.0	CMP	Best		CM-RG6P series
Digital or Analog Audio	Unbalanced (Coaxial)	20-CMP-VID-COAX	RG59/U High Definition Serial Digital Coaxial Cable	0.207	5.3	CMP	Better		CM-RG59P series
Digital or Analog Audio	Unbalanced (Coaxial)	23-MINI-CMP	Mini RG59/U Serial Digital Coaxial Cable	0.159	4.0	CMP	Good		CM-RGB23 series
Digital Audio	Balanced	24-1P-P-DIG-AUDIO	24 AWG 1 Pair twisted shielded ultra-low capacitance AES/EBU	0.170	4.3	CMP	Best	NC3FX, NC3MX	ZD06-color
Control									
Universal Control	AMX/CRESTRON	LINUX-U-P	Low Capacitance 105Ω twisted shielded pair with 18/2 power	0.205	5.2	CMP	Best		
General Control	RS-232 Control	24-4P-PLC5H	Low Capacitance 24/4P stranded shielded control/data cable	0.210	5.3	CMP	Best	DB9M, DB9F	
General Control	RS-232 Control	22-2C-P5H	22 AWG 1 Pair twisted shielded plenum	0.116	2.9	CMP	Good	DB9M, DB9F	ZD06-color
DATA									
Non LAN Data	RS232-RS485	24-2P-P485-WHT	24 AWG 2 Pair twisted double shielded Ultra-low capacitance 120Ω	0.277	7.0	CMP	Best	DB9M, DB9F	
Non LAN Data	RS-232 Control	24-4P-PLC5H	Low Capacitance 24/4P stranded shielded control/data cable	0.210	5.3	CMP	Best	DB9M, DB9F	
LAN Data	Category 6	24-4P-P-L6-EN	23 AWG 4 Pair UTP Third Party verified Category 6	0.215	5.5	CMP	Best	100 011LW	
LAN Data	Category 5e	24-4P-P-L5-EN	24 AWG 4 Pair UTP Third Party verified Category 5e	0.180	4.6	CMP	Best	100 003B	
Fiber									
Single Mode Fiber	Plenum Single Mode	*FP15M-	* = Fiber count, Suffix D = Distribution, BO = Breakout, many styles	Varies		OFNP	Best	95-200 series	
Multi Mode OM3 Fiber	Plenum 62.5/125 Style	*FP15M6-	* = Fiber count, Suffix D = Distribution, BO = Breakout, many styles	Varies		OFNP	Best	95-000 series	
Multi Mode OM4 Fiber	Plenum 50/125 Style	*FP15M5-	* = Fiber count, Suffix D = Distribution, BO = Breakout, many styles	Varies		OFNP	Best	95-050 series	
Intercom									
Analog Audio	Under 1000 Feet	22-1P-CMP-EZ	22 AWG 1 Pair twisted shielded Low Capacitance Broadcast Audio	0.130	3.3	CMP	Best	NC3FX, NC3MX	ZD06-color
Analog Audio	Under 1000 Feet	20-2C-P5H	20 AWG 2 Conductor twisted shielded plenum	0.130	3.3	CMP	Better	NC3FX, NC3MX	ZD06-color
Analog Audio	Over 1000 Feet	18-1P-P5H	18 AWG 1 Pair twisted shielded Mid Capacitance plenum	0.180	4.6	CMP	Best	NC3FX, NC3MX	ZD06-color
Analog Audio	Over 1000 Feet	18-2C-P5H	18 AWG 2 Conductor twisted shielded plenum	0.156	4.0	CMP	Better	NC3FX, NC3MX	ZD06-color
DC Power									
Remote Power Supply	Dependent wattage + distance	22-2C-P	22 AWG 1 Pair twisted unshielded plenum	0.114	2.9	CMP	Good		
Remote Power Supply	Dependent wattage + distance	18-2C-P	18 AWG 2 Conductor twisted unshielded plenum	0.154	3.9	CMP	Good		
RF									
Low Loss 50 Ohm	Wireless Networking	RG58-CMP	19 AWG Low Loss RG58 Plenum 50Ω	0.178	4.5	CMP	Best		112128
Low Loss 50 Ohm	Wireless Networking	WBC-400P	Low Loss flexible Coaxial WBC RG8 Plenum	0.355	9.0	CMP	Best		112627
Video									
Analog Video	Composite Video	RG6-CCTV-PL	RG6/U Base Band Video Cable	0.229	5.8	CMP	Best		CM-RG6P series
Analog Video	Composite Video	RG59-CCTV-PL	RG59/U Base Band Video Coaxial Cable	0.193	4.9	CMP	Better		CM-RG59P series
Analog Video	S-Video	SV-25-CMP	25 AWG Solid 2 Coaxial jacketed S-Video Cable (flat)	0.240	6.1	CMP	Best		CM-RGB25S series
Analog Video	S-Video	SV-PLN	26 AWG Stranded 2 Coaxial jacketed S-Video Cable (flat)	0.230	5.8	CL2P	Better		CM-RGB26 series
Analog Video	RGBHV Video non-ID/DDC Compliant	RGB5C-25-CMP	Mini RG59/U base band Coaxial Cable x 5 Jacketed	0.315	8.0	CMP	Best		CM-RGB25S series
Analog Video	RGBHV Video non-ID/DDC Compliant	RGB5C-PLN	26 AWG Stranded 5 Coaxial jacketed RGBHV Cable	0.300	7.6	CMP	Better		CM-RGB26 series
Analog Video	RGBHV Video ID/DDC Compliant	RGB6C-25-2P-CMP	25 AWG solid 6 Coaxial plus 2 pair control	0.370	9.4	CMP	Best		CM-RGB25S series
Analog Video	RGBHV Video ID/DDC Compliant	RGB6C/22-2P-PLN	26 AWG stranded 6 Coaxial plus 2 pair control	0.370	9.4	CMP	Better		CM-RGB26 series
Analog Video	No Skew UTP	TRUPHASE-P	23 AWG 4 Pair UTP Low Skew Video Cable	0.170	4.3	CMP	Best		100 011LW
Analog Video	CATV	RG6-QUAD-CMP	RG6/U CCS Quad Shield CATV 3.0 GHz	0.268	6.8	CMP	Best		CM-RG6P series
Analog Video	CATV	RG6-P-CATV	RG6/U CCS Dual Shield CATV 3.0 GHz	0.239	6.1	CMP	Best		CM-RG6P series

Ordering is fast & easy.



Call today!

Solutions for the AV PROFESSIONAL
www.libertycable.com

800-530-8998
INTERNATIONAL - CALL +1-719-388-7542



COMMERCIAL PLENUM WIRE SCHEDULE - Continued

Contact your sales professional to obtain a complete Wire Schedule including the Commercial Non-Plenum Schedule and the Shipboard Schedule

COMMERCIAL PLENUM WIRE SCHEDULE

Signal	Type	LWC/P/N	Description (Fixed Install)	Diameter	Rating	Grade	Mating Connector
Digital Video	SMPT-E Standards/DBS Broadband	18-CMP-VID-COAX	RG6/U High Definition Serial Digital Coaxial Cable	0.237	CMP	Best	CM-RG6P series
Digital Video	SMPT-E Standards/DBS Broadband	20-CMP-VID-COAX	RG59/U High Definition Serial Digital Coaxial Cable	0.207	CMP	Best	CM-RG59P series
Voice/Phone							
Telephone/Voice	Low speed Data, telephone, DSL	24-4P-P-L5-EN	24 AWG 4 Pair UTP Third Party verified Category 5e	0.180	CMP	Best	100 003B
Telephone/Voice	Low speed Data, telephone, DSL	24-2P-P-L3	24 AWG 2 Pair UTP Third Party verified Category 3	0.133	CMP	Better	100 026LW
Telephone/Voice	Low speed Data, telephone, DSL	22-4C-SOL-P	22 AWG 4 Conductor Solid Station wire	0.117	CMP	Good	
Security							
Camera	Pan-Tilt-Zoom (PTZ) Applications	RG59-18/2C-PS	Baseband RG59/U sameshed with 18/2C Control/Power (Zip)	0.380	CMP	Best	CM-RG59PC series
Sensor/General	DC Power, Sensor, System	22-4C-P	22 AWG 4 Conductor twisted unshielded plenum	0.144	CMP	Good	
Speaker							
Speaker	Amplified Audio	10-2C-TTP	10 AWG 2 Conductor twisted unshielded plenum	0.323	CL2P	Best	CM-A-12
Speaker	Amplified Audio	12-2C-TTP	12 AWG 2 Conductor twisted unshielded Tight-Tube plenum	0.257	CL2P	Best	CM-A-12
Speaker	Amplified Audio	12-2C-P	12 AWG 2 Conductor twisted unshielded plenum	0.258	CL3P	Better	CM-A-12
Speaker	Amplified Audio	14-2C-TTP	14 AWG 2 Conductor twisted unshielded Tight-Tube plenum	0.216	CL2P	Best	CM-A-14
Speaker	Amplified Audio	14-2C-P	14 AWG 2 Conductor twisted unshielded plenum	0.210	CL3P	Better	CM-A-14
Speaker	Amplified Audio	16-4C-TTP	16 AWG 4 Conductor twisted unshielded Tight-Tube plenum	0.217	CMP	Best	CM-A-16
Speaker	Amplified Audio	16-2C-P	16 AWG 2 Conductor twisted unshielded plenum	0.190	CMP	Better	CM-A-16
Speaker	Amplified Audio	18-4C-TTP	18 AWG 4 Conductor twisted unshielded plenum	0.195	CMP	Best	
Speaker	Amplified Audio	18-2C-P	18 AWG 2 Conductor twisted unshielded plenum	0.154	CMP	Better	
Specialty							
Multipurpose	Projector Application	RGB7C/22-3P-PLN	25 AWG Solid 7 Coaxial plus 3 pair control	0.400	CL2P	Best	CM-RGB25S series
Multipurpose	Projector Application	RGB6C-25/22-2P-CMP	25 AWG Solid 6 Coaxial plus 2 pair control	0.370	CL2P	Better	CM-RGB25S series
Multipurpose	Projector Application	RGB6C/22-2P-PLN	26 AWG stranded 6 Coaxial plus 2 pair control	0.370	CL2P	Good	CM-RGB26 series
Lighting Control							
Lighting Control	Lutron Systems Grafik Eye	LUTRON-P-GRN	22 AWG Shielded Pair+ 18 AWG Pair Green Stripe	0.195	CMP	Best	
Lighting Control	Lutron Systems Grafik Eye 4000/5000/6000	LUTRON-P-RBL	22 AWG Shielded Pair+ 12 AWG Pair+ 18 AWG Sensor Blue stripe	0.272	CL3P	Best	
Lighting Control	Lutron Systems Sivoia QED Control	LUTRON-P-RED	18 AWG Shielded Quad+ 18 AWG Sensor+ 16 AWG Pair Red Stripe	0.322	CL3P	Best	
Lighting Control	Lutron Systems Grafik Eye Keypad	LUTRON-P-YEL	22 AWG Shielded Pair + 18 AWG Pair Yellow Stripe	0.195	CMP	Best	
Lighting Control	Lutron System EcoSystem™ Bus Cable	LUTRON-P-EBC	16 AWG 1 Pair twisted unshielded plenum clear jacket	0.158	CL3P	Best	
Lighting Control	Lutron System EcoSystem™ Sensor Cable	LUTRON-P-ESC	22 AWG 5 Conductor twisted shielded plenum clear jacket	0.134	CMP	Best	
Lighting Control	Vantage	16-2C-P-VAN	16 AWG Mid Capacitance twisted pair	0.195	CMP	Best	
Lighting Control	DMX Control	24-2P-P485-WHT	24 AWG 2 pair dual shielded RS-485 Cable	0.277	CMP	Best	NCSMX, NCSFX
Coax Connectors							
Compression Style	Connectec™ Quicklink™ Mini 25 AWG	CM-RGB255-xxx	Nickel Plated RCA, Nickel Plated BNC, and Gold Plated RCA				
Compression Style	Connectec™ Mini Hi-Res 26 AWG	CM-RGB26-xxx	Nickel and Gold Plated RCA, Nickel and Gold Plated BNC				
Compression Style	Connectec™ Plenum Dual shield RG59	CM-RG59P-xxx	Nickel and Gold Plated RCA, BNC, and F				
Compression Style	Connectec™ Plenum Dual shield RG6	CM-RG6P-xxx	Nickel and Gold Plated RCA, BNC, and F				
Compression Style	Connectec™ Plenum single shield RG59	CM-RG59PC-xxx	Nickel Plated RCA, BNC, and F				
Compression Style	Connectec™ Plenum single shield RG6	CM-RG6PC-xxx	Nickel Plated RCA, BNC, and F				
Crimp Style	Amphenol Connex	112491-10	4-Piece 75 Ohm Crimp BNC for 26 AWG mini Hi-Res Coaxial				
Crimp Style	Amphenol Connex	112955	3-Piece 75 Ohm Crimp BNC for 23-MINI-CMP				
Crimp Style	Amphenol Connex	112975	3-Piece 75 Ohm Crimp BNC for 20-CMP-VIDEO				
Crimp Style	Amphenol Connex	112958	3-Piece 75 Ohm Crimp BNC for 18-CMP-VID-COAX				

Technical Information

Ordering is fast & easy.

Call today!

Solutions for the AV PROFESSIONAL
www.libertycable.com

800-530-8998
INTERNATIONAL - CALL +1-719-388-7542

NEC Cable Substitution and Hierarchy Chart

NEC Cable Substitution and Hierarchy Chart									
Fire Resistance level highest to lowest	NEC Reference Article							Canada*	
Test Requirements	800	725	760	820	770		830	Comm.	PCC
Plenum	CMP		FPLP		OFNP		BLP	CMP	FT6
NFPA 262, CSA FT6		CL3P		CATVP		OFCP			
UL-910 Steiner Tunnel		CL2P							
Riser	CMR		FPLR		OFNR		BMR	CMR	
UL-1666		CL3R		CATVR		OFNR	BLR		
Vertical Shaft		CL2R							
General Purpose	CMG	PLTC	FPL		OFNG		BM	CMG	FT4
UL-1685 or CSA FT4	CM	CL3		CATV	OFN	OFNG	BL	CM	
Vertical Tray or CSA FT4		CL2				OFC			
Dwellings	CMX							CMX	
UL-1581 or VW-1		CL3X		CATVX					
Vertical Flame		CL2X					BLX		
								CMH	FT1

*In 1996 Canada and the US Harmonized the fire codes for Communications Cables. 16 AWG and smaller cable sizes can be certified (UL) and C(UL) CMP, CMR, CMG, CM and CMX for similar applications in the US. The PCC FT code does not need to be marked on the cable in these instances. C(UL), C(ETL), CSA marking, or other approved certification agency marking is required to use these codes.

Rating	Approved Substitutions
CMP	No substitutions
CL3P	CMP
CL2P	CMP, CL3P
FPLP	CMP
CATVP	CMP, BLP
OFNP	No substitutions
OFCP	OFNP
BLP	CMP, CL3P
CMR	CMP
CL3R	CMP, CL3P, CMR
CL2R	CMP, CL3P, CL2P, CMR, CL3R
FPLR	CMP, CMR, FPLP
CATVR	CMP, CATVP, BLP, CMR, BLR
OFNR	OFNP
OFNR	OFNP, OFCP, OFNR
BMR	No substitutions
BLR	CMP, CL3P, CMR, CL3R, BMR
CMG	CMP, CMR

Rating	Approved Substitutions
CM	CMP, CMR, CMG
PLTC	No substitutions
CL3	CMP, CL3P, CMR, CL3R, CMG, CM, PLTC
CL2	CMP, CL3P, CL2P, CMR, CL3R, CL2R, CMG, CM, PLTC, CM
FPL	CMP, FPLP, CMR, FPLR, CMG, CM,
CATV	CMP, CATVP, BLP, BMR, BLR, CATVR, CMG, CM, BL
OFNG	OFNP, OFNR
OFN	OFNP, OFNR, OFNG
OFNG	OFNP, OFCP, OFNR, OFCR, OFN
OFC	OFNP, OFCP, OFNR, OFCR, OFN, OFCG
BM	BMR
BL	CMP, CL3P, BLP, CMR, CL3R, BMR, BLR, CMG, CM, CL3, BM
CMX	CMP, CMR, CMG, CM

Rating	Approved Substitutions
CL3X	CMP, CL3P, CMR, CL3R, CMG, CM, PLTC, CL3, CMX
CL2X	CMP, CL3P, CL2P, CMR, CL3R, CL2R, CMG, CM, PLTC, CL3, CL2, CMX, CL3X
CATVX	CMP, CATVP, BLP, BMR, BLR, CATVR, CMG, CM, BL, BLX
BLX	CMP, CL3P, BLP, CMR, CL3R, BMR, BLR, CMG, CM, CL3, BM, BL

Temperature: 60°C, 75°C, 105°C, 125°C. Higher temperature is OK to substitute for lower temperature rating

No temperature on jacket is equal to 60°C per NEC code

Special Note: Ratings MPP, MPR, MPG, and MP were phased out effective July 1, 2003

Liberty Wire & Cable Abbreviation Key

- | | | | |
|--------|-----------------------|------|--------------------|
| BC: | Bare Copper | P: | Plenum |
| (#)C: | Conductors | PLN: | Plenum |
| CCS: | Copper Clad Steel | Q: | Quad |
| DB: | Direct Burial | SH: | Shielded or Shield |
| CMP: | Communications Plenum | STR: | Stranded |
| CMR: | Communications Riser | TC: | Tinned Copper |
| EX: | ExtraFlex | TTP: | Tight Tube Plenum |
| INDSH: | Individual Shield | UN: | Unshielded |
| (#) P: | Pair | VID: | Video |

Ordering is fast & easy.

Call today!

Solutions for the AV PROFESSIONAL **800-530-8998**

www.libertycable.com INTERNATIONAL - CALL +1-719-388-7542

Color Code Charts

ICEA Color Code for Multiconductor audio, computer									
Cond #	Insulation color	Cond #	Insulation color	Cond #	Insulation color	Cond #	Insulation color	Cond #	Insulation color
1	Black	13	Red/Green	25	White/Black/Red	37	White/Red/Blue	49	White/Blue/Blue
2	Red	14	Red/Yellow	26	White/Black/Green	38	White/Red/Brown	50	White/Blue/Brown
3	White	15	Red/Black	27	White/Black/Yellow	39	White/Red/Violet		
4	Green	16	White/Black	28	White/Black/Blue	40	White/Green/Black		
5	Brown	17	White/Red	29	White/Black/Brown	41	White/Green/Red		
6	Blue	18	White/Green	30	White/Black/Orange	42	White/Green/Green		
7	Orange	19	White/Yellow	31	White/Black/Grey	43	White/Green/Blue		
8	Yellow	20	White/Blue	32	White/Black/Violet	44	White/Green/Brown		
9	Purple	21	White/Brown	33	White/Black/Black	45	White/Green/Violet		
10	Gray (Slate)	22	White/Orange	34	White/Red/Black	46	White/Blue/Black		
11	Pink	23	White/Grey	35	White/Red/Red	47	White/Blue/Red		
12	Tan	24	White/Violet	36	White/Red/Green	48	White/Blue/Green		

ICEA Color code for paired wires							
Pair #	Cond.#1 color	Cond #1 tracer	Cond. #2 color	Pair #	Cond.#1 color	Cond #1 tracer	Cond. #2 color
1	Black		White	12	Red	White	White
2	Red		White	13	Green	White	White
3	Green		White	14	Blue	White	White
4	Orange		White	15	Black	Red	White
5	Blue		White	16	White	Red	White
6	White	Black	White	17	Orange	Red	White
7	Red	Black	White	18	Blue	Red	White
8	Green	Black	White	19	Red	Green	White
9	Orange	Black	White	20	Orange	Green	White
10	Blue	Black	White	21	Black		White
11	Black	White	White				

Data/LAN Paired Color Code					
Pair #	Cond. #1	Cond. #2	Pair #	Cond. #1	Cond. #2
1	White/Blue	Blue	14	Black/Brown	Brown
2	White/Orange	Orange	15	Black/Slate	Slate
3	White/Green	Green	16	Yellow/Blue	Blue
4	White/Brown	Brown	17	Yellow/Orange	Orange
5	White/Slate	Slate	18	Yellow/Green	Green
6	Red/Blue	Blue	19	Yellow/Brown	Brown
7	Red/Orange	Orange	20	Yellow/Slate	Slate
8	Red/Green	Green	21	Violet/Blue	Blue
9	Red/Brown	Brown	22	Violet/Orange	Orange
10	Red/Slate	Slate	23	Violet/Green	Green
11	Black/Blue	Blue	24	Violet/Brown	Brown
12	Black/Orange	Orange	25	Violet/Slate	Slate
13	Black/Green	Green			

Note: More than 25 pairs the color code repeats and has colored or imprinted binders separating groups

TIA-598-A FiberOptic Color Code			
Fiber#	Insulation color	Fiber#	Insulation color
1	Blue	7	Red
2	Orange	8	Black
3	Green	9	Yellow
4	Brown	10	Violet
5	Slate	11	Rose
6	White	12	Aqua

Note: More than 12 Fibers the color code repeats and have striped subgroups

Fire Alarm Color Code 2			
Cond. #	Insulation color	Cond. #	Insulation color
1	Black	7	Purple
2	Red	8	Green
3	Brown		
4	Blue		
5	Orange		
6	Yellow		

EVERYTHING FOR THE AV PROFESSIONAL

- Assemblies
- Bulk Cables
- Connectors
- Digital Solutions
- PanelCrafters
- Tools

THE LIBERTY ADVANTAGE

Liberty Wire & Cable is proud to serve customers in over 48 countries. Whether you are working on a residential or commercial installation, Liberty is the professional's first choice! Contact Liberty today!

Ordering is fast & easy.

Call today!

Solutions for the AV PROFESSIONAL

www.libertycable.com

800-530-8998

INTERNATIONAL - CALL +1-719-388-7542

SECTION 18

Index By Part Number

PART #	PAGE #
13006	56
13006	108
15010	56
15010	108
15010	132
15010	182
15010	227
100020	56
100020	56
100020	108
100020	108
100020	132
100020	227
100030	56
100030	108
100035	56
100035	56
100035	108
100035	108
100035	132
100036	56
100036	108
112559	155
112563	155
112973	155
10-2C-EX+ -WHT	148
10-2C-TTP-*	97
100 003B	56
100 003B	108
100 003B	182
100 004BL	56
100 004BL	108
100 011LW	56
100 011LW	108
100 011LW	182
100 020	182
100 026LW	56
100 026LW	108
100 026LW	182
100 044LW	56
100 044LW	108
100 044LW	132
100 044LW	182
100 044LW	227
100030-*	56
100030-*	108
100030-*	227
112491-10	155
12-1P-UC-BLK	148
12-1P-UC-WHT	148
12-2C-DB-BLK	149
12-2C-DB-BLK	169
12-2C-EX+ -*	148
12-2C-FPLP-RED	83
12-2C-FPLP-RED	83
12-2C-P-WHT	150
12-2C-SH-GRY	120
12-2C-TTP-*	97
12-2C-ZIP-CLR	150
12-2P-UC-WHT	148
12-4C-DB-BLK	149
12-4C-DB-BLK	169
12-4C-EX+ -*	148
12-4C-FPLP-RED	83
12-4C-FPLP-RED	83
12-4C-P-WHT	68
12-4C-P-WHT	150
12-4C-PSH-WHT	67
14-1P-UC-BLK	148
14-1P-UC-WHT	148
14-2C-DB-BLK	149
14-2C-EX+ -*	148
14-2C-FPLP-RED	83
14-2C-FPLP-RED	83
14-2C-HT	129

PART #	PAGE #
14-2C-HT	149
14-2C-KO+ -*	149
14-2C-P-*	97
14-2C-P-*	97
14-2C-P-WHT	150
14-2C-PSH-WHT	67
14-2C-SH-GRY	120
14-2C-TTP-*	97
14-2C-ZIP-CLR	150
14-2P-UC-WHT	148
14-4C-DB-BLK	149
14-4C-DB-BLK	169
14-4C-EX+ -*	148
14-4C-FPLP-RED	83
14-4C-FPLP-RED	83
14-4C-HFSH	177
14-4C-HT	129
14-4C-HT	149
14-4C-KO+ -WHT	149
14-4C-P-*	97
14-4C-P-WHT	68
14-4C-P-WHT	150
14-4C-PSH-WHT	67
15-991	228
15-991	228
15-FSC-162	150
16-1P-UC-WHT	148
16-2C-BLK	234
16-2C-DB-BLK	149
16-2C-DB-BLK	169
16-2C-EX+ -*	148
16-2C-FPLP-RED	83
16-2C-FPLP-RED	83
16-2C-HFSH	177
16-2C-HT	149
16-2C-HT*	129
16-2C-KO+ -*	149
16-2C-P-*	97
16-2C-P-*	97
16-2C-P-VAN	73
16-2C-P-WHT	150
16-2C-PSH-WHT	67
16-2C-SH-GRY	120
16-2C-TTP-*	97
16-2C-VAN	73
16-2C-ZIP-CLR	150
16-4C-DB-BLK	149
16-4C-DB-BLK	169
16-4C-EX+ -*	148
16-4C-FPLP-RED	83
16-4C-FPLP-RED	83
16-4C-HFSH	177
16-4C-HT	129
16-4C-HT	149
16-4C-KO+ -*	149
16-4C-P-*	97
16-4C-P-*	97
16-4C-P-WHT	68
16-4C-P-WHT	150
16-4C-PSH-WHT	67
16-4C-SH-GRY	120
16-4C-TTP-*	97
18-10C-FPLP-RED	83
18-10C-P-WHT	68
18-12C-P-WHT	68
18-2C-FPLP-RED	83
18-2C-FPLP-RED	83
18-2C-P-*	97
18-2C-P-*	97
18-2C-P-BLK	234
18-2C-P-WHT	68
18-2C-P-WHT	150
18-2C-PSH-WHT	51
18-2C-PSH-WHT	67
18-2C-SH-GRY	120
18-2C-SH-GRY	120

PART #	PAGE #
18-2C-TRSH	100
18-2C-TRSH	170
18-2P-INDSH-GRY	49
18-2P-INDSH-GRY	120
18-2P-PINDSH-WHT	51
18-2P-PINDSH-WHT*	66
18-3C-P-WHT	68
18-3C-PSH-WHT	67
18-3C-SH-GRY	120
18-3P-INDSH-GRY	120
18-3P-PINDSH-WHT	51
18-3P-PINDSH-WHT	66
18-4C-FPLP-RED	83
18-4C-FPLP-RED	83
18-4C-P-*	97
18-4C-P-*	97
18-4C-P-WHT	68
18-4C-P-WHT	150
18-4C-PSH-WHT	67
18-4C-SH-GRY	120
18-4C-TRSH	100
18-4C-TRSH	170
18-4C-TTP-*	97
18-5C-SH-GRY	120
18-6C-FPLP-RED	83
18-6C-FPLP-RED	83
18-6C-P-WHT	68
18-6C-PSH-WHT	67
18-6C-SH-GRY	120
18-6P-INDSH-GRY	120
18-8C-FPLP-RED	83
18-8C-FPLP-RED	83
18-8C-P-WHT	68
18-CMP-VID-COAX*	109
18-CMP-VID-COAX*	61
18-CMP-VID-COAX*	119
18-CMR-SD-*	61
18-CMR-SD-*	109
18-CMR-SD-*	119
20-2C-P-*	97
20-2C-P-*	97
20-2C-P-WHT	68
20-2C-P-WHT	150
20-2C-PSH-WHT	51
20-2C-PSH-WHT	67
20-2C-SH-GRY	49
20-2C-SH-GRY	120
20-2P-INDSH-GRY	120
20-3C-P-WHT	68
20-3C-PSH-WHT	67
20-3C-SH-GRY	120
20-3P-INDSH-GRY	120
20-4C-P-*	97
20-4C-P-*	97
20-4C-P-WHT	68
20-4C-P-WHT	150
20-4C-SH-GRY	120
20-CMP-VID-COAX*	109
20-CMP-VID-COAX*	61
20-CMP-VID-COAX*	119
20-CMR-VIDEO*	61
20-CMR-VIDEO*	109
20-CMR-VIDEO*	119
20SD-BNCM-M-10	23
20SD-BNCM-M-100	23
20SD-BNCM-M-125	23
20SD-BNCM-M-25	23
20SD-BNCM-M-35	23
20SD-BNCM-M-50	23
20SD-BNCM-M-75	23
20SD-RCAM-M-10	22
20SD-RCAM-M-100	22
20SD-RCAM-M-125	22
20SD-RCAM-M-25	22
20SD-RCAM-M-35	22
20SD-RCAM-M-50	22
20SD-RCAM-M-75	22

PART #	PAGE #
22-10C-GRY	143
22-10C-P-WHT	68
22-10C-P-WHT	95
22-10C-PSH-WHT	95
22-10C-SH-GRY-BX	143
22-12C-GRY	143
22-12C-P-WHT	68
22-12C-P-WHT	95
22-12C-PSH-WHT	67
22-15C-P-WHT	68
22-1P-CMP-EZ*	50
22-1P-EZ*	50
22-1P-EZ*	101
22-2C-EX-PUR	103
22-2C-GRY	143
22-2C-P-*	97
22-2C-P-*	97
22-2C-P-WHT	68
22-2C-P-WHT	95
22-2C-P-WHT	150
22-2C-PSH-WHT	51
22-2C-PSH-WHT	67
22-2C-PSH-WHT	95
22-2C-SH-GRY	49
22-2C-SO-GHT	143
22-2C-SO-HT	131
22-2C-SO-HT	143
22-2C-ST-HT	131
22-2C-ST-HT	143
22-2P-CMP-SIAMEZ	50
22-2P-CMP-SIAMEZ	101
22-2P-INDSH-GRY	49
22-2P-INDSH-GRY	120
22-2P-PINDSH-WHT	51
22-2P-PINDSH-WHT*	66
22-2P-SHEX*	103
22-2P-SIAM-EZ	50
22-2P-SIAM-EZC	101
22-3C-P-WHT	68
22-3C-PSH-WHT	67
22-3C-SH-GRY	120
22-3P-INDSH-GRY	120
22-3P-PINDSH-WHT	51
22-3P-PINDSH-WHT	66
22-3P-SHEX-YEL	103
22-4C-GRY	143
22-4C-P-*	97
22-4C-P-*	97
22-4C-P-WHT	68
22-4C-P-WHT	95
22-4C-P-WHT	150
22-4C-PSH-WHT	67
22-4C-PSH-WHT	95
22-4C-SH-GRY	49
22-4C-SO-HT	131
22-4C-ST-HT	131
22-4C-ST-HT	143
22-4P-INDSH-GRY	120
22-4P-PINDSH-WHT	51
22-4P-PINDSH-WHT	66
22-6C-FPLP-RED	83
22-6C-GRY	143
22-6C-P-WHT	68
22-6C-P-WHT	95
22-6C-PSH-WHT	67
22-6C-PSH-WHT	95
22-6C-SH-GRY	120
22-6C-ST-HT	131
22-6P-INDSH-GRY	120
22-6P-PINDSH-WHT	66
22-8C-FPLP-RED	83
22-8C-GRY	143
22-8C-P-WHT	68
22-8C-P-WHT	95
22-8C-PSH-WHT	67
22-8C-PSH-WHT	95
22-8C-ST-HT	131

Ordering is fast & easy.



Call today!

Solutions for the AV PROFESSIONAL
www.libertycable.com

800-530-8998
INTERNATIONAL - CALL +1-719-388-7542





PART #	PAGE #
DMM10STSC-001M	81
DMM10STSC-001M	127
DMM10STSC-002M	81
DMM10STSC-002M	127
DMM10STSC-003M	81
DMM10STSC-003M	127
DMM10STSC-005M	81
DMM10STSC-005M	127
DMM10STSC-010M	81
DMM10STSC-010M	127
DMM10STST-001M	81
DMM10STST-001M	127
DMM10STST-002M	81
DMM10STST-002M	127
DMM10STST-003M	81
DMM10STST-003M	127
DMM10STST-005M	81
DMM10STST-005M	127
DMM10STST-010M	81
DMM10STST-010M	127
DMM5LCLC-001M	79
DMM5LCLC-001M	125
DMM5LCLC-002M	79
DMM5LCLC-002M	125
DMM5LCLC-003M	79
DMM5LCLC-003M	125
DMM5LCLC-005M	79
DMM5LCLC-005M	125
DMM5LCLC-010M	79
DMM5LCLC-010M	125
DMM5LCSC-001M	80
DMM5LCSC-001M	126
DMM5LCSC-002M	80
DMM5LCSC-002M	126
DMM5LCSC-003M	80
DMM5LCSC-003M	126
DMM5LCSC-005M	80
DMM5LCSC-005M	126
DMM5LCSC-010M	80
DMM5LCSC-010M	126
DMM5LCST-001M	80
DMM5LCST-001M	126
DMM5LCST-002M	80
DMM5LCST-002M	126
DMM5LCST-003M	80
DMM5LCST-003M	126
DMM5LCST-005M	80
DMM5LCST-005M	126
DMM5LCST-010M	80
DMM5LCST-010M	126
DMM5SCSC-001M	79
DMM5SCSC-001M	125
DMM5SCSC-002M	79
DMM5SCSC-002M	125
DMM5SCSC-003M	79
DMM5SCSC-003M	125
DMM5SCSC-005M	79
DMM5SCSC-005M	125
DMM5SCSC-010M	79
DMM5SCSC-010M	125
DMM5STSC-001M	125
DMM5STSC-002M	79
DMM5STSC-002M	125
DMM5STSC-003M	79
DMM5STSC-003M	125
DMM5STSC-005M	79
DMM5STSC-005M	125
DMM5STSC-010M	79
DMM5STSC-010M	125
DMM5STST-001M	79
DMM5STST-001M	125
DMM5STST-002M	79
DMM5STST-002M	125
DMM5STST-003M	79
DMM5STST-003M	125
DMM5STST-005M	79

PART #	PAGE #
DMM5STST-005M	125
DMM5STST-010M	79
DMM5STST-010M	125
DMM6LCLC-001M	80
DMM6LCLC-001M	126
DMM6LCLC-002M	80
DMM6LCLC-002M	126
DMM6LCLC-003M	80
DMM6LCLC-003M	126
DMM6LCLC-005M	80
DMM6LCLC-005M	126
DMM6LCLC-010M	80
DMM6LCLC-010M	126
DMM6LCSC-001M	80
DMM6LCSC-001M	126
DMM6LCSC-002M	80
DMM6LCSC-002M	126
DMM6LCSC-003M	80
DMM6LCSC-003M	126
DMM6LCSC-005M	80
DMM6LCSC-005M	126
DMM6LCSC-010M	80
DMM6LCSC-010M	126
DMM6LCST-001M	80
DMM6LCST-001M	126
DMM6LCST-002M	80
DMM6LCST-002M	126
DMM6LCST-003M	80
DMM6LCST-003M	126
DMM6LCST-005M	80
DMM6LCST-005M	126
DMM6LCST-010M	80
DMM6LCST-010M	126
DMM6MTMT-001M	80
DMM6MTMT-001M	126
DMM6MTMT-002M	80
DMM6MTMT-002M	126
DMM6MTMT-003M	80
DMM6MTMT-003M	126
DMM6MTMT-005M	80
DMM6MTMT-005M	126
DMM6MTMT-010M	80
DMM6MTMT-010M	126
DMM6MTSC-001M	80
DMM6MTSC-001M	126
DMM6MTSC-002M	80
DMM6MTSC-002M	126
DMM6MTSC-003M	80
DMM6MTSC-003M	126
DMM6MTSC-005M	80
DMM6MTSC-005M	126
DMM6MTSC-010M	80
DMM6MTSC-010M	126
DMM6MTST-001M	80
DMM6MTST-001M	126
DMM6MTST-002M	80
DMM6MTST-002M	126
DMM6MTST-003M	80
DMM6MTST-003M	126
DMM6MTST-005M	80
DMM6MTST-005M	126
DMM6MTST-010M	80
DMM6MTST-010M	126
DMM6SCSC-001M	80
DMM6SCSC-001M	126
DMM6SCSC-002M	80
DMM6SCSC-002M	126
DMM6SCSC-003M	80
DMM6SCSC-003M	126
DMM6SCSC-005M	80
DMM6SCSC-005M	126
DMM6SCSC-010M	80
DMM6SCSC-010M	126
DMM6STSC-001M	80
DMM6STSC-001M	126
DMM6STSC-002M	80
DMM6STSC-002M	126

PART #	PAGE #
DMM6STSC-003M	80
DMM6STSC-003M	126
DMM6STSC-005M	80
DMM6STSC-005M	126
DMM6STSC-010M	80
DMM6STSC-010M	126
DMM6STST-001M	80
DMM6STST-001M	126
DMM6STST-002M	80
DMM6STST-002M	126
DMM6STST-003M	80
DMM6STST-003M	126
DMM6STST-005M	80
DMM6STST-005M	126
DMM6STST-010M	80
DMM6STST-010M	126
DSMLCLC-001M	79
DSMLCLC-001M	125
DSMLCLC-002M	79
DSMLCLC-002M	125
DSMLCLC-003M	79
DSMLCLC-003M	125
DSMLCLC-005M	79
DSMLCLC-005M	125
DSMLCLC-010M	79
DSMLCLC-010M	125
DSMLCSC-001M	79
DSMLCSC-001M	125
DSMLCSC-002M	79
DSMLCSC-002M	125
DSMLCSC-003M	79
DSMLCSC-003M	125
DSMLCSC-005M	79
DSMLCSC-005M	125
DSMLCSC-010M	79
DSMLCSC-010M	125
DSMLCST-001M	79
DSMLCST-001M	125
DSMLCST-002M	79
DSMLCST-002M	125
DSMLCST-003M	79
DSMLCST-003M	125
DSMLCST-005M	79
DSMLCST-005M	125
DSMLCST-010M	79
DSMLCST-010M	125
DSMSCSC-001M	79
DSMSCSC-001M	125
DSMSCSC-002M	79
DSMSCSC-002M	125
DSMSCSC-003M	79
DSMSCSC-003M	125
DSMSCSC-005M	79
DSMSCSC-005M	125
DSMSCSC-010M	79
DSMSCSC-010M	125
DSMSTSC-001M	79
DSMSTSC-001M	125
DSMSTSC-002M	79
DSMSTSC-002M	125
DSMSTSC-003M	79
DSMSTSC-003M	125
DSMSTSC-005M	79
DSMSTSC-005M	125
DSMSTSC-010M	79
DSMSTSC-010M	125
E-3.5SM-M-100	20

PART #	PAGE #
E-3.5SM-M-125	20
E-3.5SM-M-25	20
E-3.5SM-M-3	20
E-3.5SM-M-35	20
E-3.5SM-M-50	20
E-3.5SM-M-6	20
E-3.5SM-M-75	20
E-3BNCM-M-10	29
E-3BNCM-M-100	29
E-3BNCM-M-25	29
E-3BNCM-M-3	29
E-3BNCM-M-50	29
E-3BNCM-M-6	29
E-3RCAM-M-1	30
E-3RCAM-M-10	30
E-3RCAM-M-15	30
E-3RCAM-M-25	30
E-3RCAM-M-3	30
E-3RCAM-M-35	30
E-3RCAM-M-50	30
E-3RCAM-M-6	30
E-3RCAM-M-75	30
E-5BNCM-M-10	29
E-5BNCM-M-20	29
E-5BNCM-M-25	29
E-5BNCM-M-3	29
E-5BNCM-M-50	29
E-5BNCM-M-6	29
E-5BNCM-M-10	29
E-BNCM-M-10	23
E-BNCM-M-100	23
E-BNCM-M-125	23
E-BNCM-M-25	23
E-BNCM-M-35	23
E-BNCM-M-50	23
E-BNCM-M-75	23
E-BNCM-M-75	23
E-DB9F-F-10	30
E-DB9F-F-100	30
E-DB9F-F-125	30
E-DB9F-F-25	30
E-DB9F-F-35	30
E-DB9F-F-75	30
E-DB9F-F-NULL-10	31
E-DB9F-F-NULL-100	31
E-DB9F-F-NULL-125	31
E-DB9F-F-NULL-25	31
E-DB9F-F-NULL-35	31
E-DB9F-F-NULL-75	31
E-DB9M-F-10	30
E-DB9M-F-100	30
E-DB9M-F-125	30
E-DB9M-F-25	30
E-DB9M-F-35	30
E-DB9M-F-75	30
E-DB9M-M-10	30
E-DB9M-M-100	30
E-DB9M-M-125	30
E-DB9M-M-25	30
E-DB9M-M-35	30
E-DB9M-M-75	30
E-DVI/A-5BNCF-1	24
E-DVI/A-5BNCF-3	24
E-DVI/A-5BNCF-6	24
E-DVI/M-5BNCF-15	24
E-DVIDSL-1	24
E-DVIDSL-10	24
E-DVIDSL-2	24
E-DVIDSL-4	24
E-DVIDSL-6	24
E-DVIDSL-8	24
E-HDM-DVI-1	25
E-HDM-DVI-10	25
E-HDM-DVI-12	25
E-HDM-DVI-15	25
E-HDM-DVI-2	25
E-HDM-DVI-20	25
E-HDM-DVI-3	25
E-HDM-DVI-4	25

Solutions for the AV PROFESSIONAL
www.libertycable.com

800-530-8998
INTERNATIONAL - CALL +1-719-388-7542



Ordering is fast & easy.



Call today!

SECTION 18

Index By Part Number

PART #	PAGE #
E-HDM-DVI-5	25
E-HDM-DVI-6	25
E-HDM-DVI-8	25
E-HDM-M-6	25
E-HDM-M-6	184
E-HDM-M-8	25
E-HDM-M-8	184
E-HDM-M-5	25
E-HDM-M-5	184
E-HDM-M-1	25
E-HDM-M-1	184
E-HDM-M-10	25
E-HDM-M-10	184
E-HDM-M-12	25
E-HDM-M-12	184
E-HDM-M-15	25
E-HDM-M-15	184
E-HDM-M-2	25
E-HDM-M-2	184
E-HDM-M-20	184
E-HDM-M-20*	25
E-HDM-M-25	184
E-HDM-M-25*	25
E-HDM-M-3	25
E-HDM-M-3	184
E-HDM-M-30	184
E-HDM-M-30*	25
E-HDM-M-35	184
E-HDM-M-35*	25
E-HDM-M-4	25
E-HDM-M-4	184
E-HDM-M-5	25
E-HDM-M-5	184
E-HDM-M-HDR-20	26
E-HDM-M-HDR-25	26
E-HDM-M-HDR-30	26
E-HDM-M-HDR-35	26
E-HDSM-M-1	25
E-HDSM-M-1	180
E-HDSM-M-1.5	180
E-HDSM-M-10	25
E-HDSM-M-10	180
E-HDSM-M-2	25
E-HDSM-M-2	180
E-HDSM-M-3	25
E-HDSM-M-3	180
E-HDSM-M-4	25
E-HDSM-M-4	180
E-HDSM-M-5	25
E-HDSM-M-5	180
E-HDSM-M-6	25
E-HDSM-M-6	180
E-HDSM-M-8	25
E-HDSM-M-8	180
E-MVGAANM-M*	17
E-MVGAANM-M-12	35
E-MVGAANM-M-25	35
E-MVGAANM-M-3	35
E-MVGAANM-M-6	35
E-MVGAM-M-12	34
E-MVGAM-M-25	34
E-MVGAM-M-3	34
E-MVGAM-M-6	34
E-MVGAMAM-M-12	35
E-MVGAMAM-M-25	35
E-MVGAMAM-M-3	35
E-MVGAMAM-M-6	35
E-MVGAPM-M-6	32
E-MVGAPM-M-6	35
E-RCAM-M-10	22
E-RCAM-M-100	22
E-RCAM-M-125	22
E-RCAM-M-25	22
E-RCAM-M-35	22
E-RCAM-M-50	22
E-RCAM-M-75	22
E-SVM-2BNCF-1	32

PART #	PAGE #
E-SVM-2BNCF-12	32
E-SVM-2BNCF-3	32
E-SVM-2BNCF-6	32
E-SVM-2BNCF-1	31
E-SVM-2BNCF-12	31
E-SVM-2BNCF-3	31
E-SVM-2BNCF-6	31
E-SVM-2BNCF-1	31
E-SVM-2BNCF-3	31
E-SVM-2BNCF-6	31
E-SVM-M-15	31
E-SVM-M-25	31
E-SVM-M-3	31
E-SVM-M-35	31
E-SVM-M-50	31
E-SVM-M-6	31
E-USBAB-10	32
E-USBAB-15	32
E-USBAB-3	32
E-USBAB-6	32
E-VGAF-5BNCF-15	36
E-VGAF-5BNCF-3	36
E-VGAF-5BNCF-1	36
E-VGAF-5BNCF-10	36
E-VGAF-5BNCF-2	36
E-VGAM-5BNCF-3	36
E-VGAM-5BNCF-6	36
E-VGAM-5BNCF-5	36
E-VGAM-5BNCF-1	36
E-VGAM-5BNCF-6	36
E-VGAM-F-10	34
E-VGAM-F-15	34
E-VGAM-F-25	34
E-VGAM-F-35	34
E-VGAM-F-50	34
E-VGAM-F-6	34
E-VGAM-M-10	33
E-VGAM-M-100	33
E-VGAM-M-15	33
E-VGAM-M-25	33
E-VGAM-M-35	33
E-VGAM-M-50	33
E-VGAM-M-6	33
E-VGAM-M-75	33
E-VGAMAM-M-12	34
E-VGAMAM-M-15	34
E-VGAMAM-M-25	34
E-VGAMAM-M-3	34
E-VGAMAM-M-6	34
ELAN-CM-VIA	74
EZ-3BNCF	39
EZ-3BNCF	39
EZ-3BNCFM2RCA-M	39
EZ-3RCAM	38
EZ-3RCAM	38
EZ-5BNCF	39
EZ-5BNCFM	39
EZ-5RCAM	38
EZ-5RCAM	38
EZ-ADAPTER-F	38
EZ-ADAPTER-M	38
EZ-BARREL-FF	38
EZ-BARREL-MM	38
EZ-CUSTOM	39
EZ-DVI/A	39
EZ-LINX-10	38
EZ-LINX-100	38
EZ-LINX-25	38
EZ-LINX-3	38
EZ-LINX-35	38
EZ-LINX-50	38
EZ-LINX-6	38
EZ-LINX-75	38
EZ-LINX-CAP	38
EZ-LINX-CAP	38
EZ-LINX-P-10	38
EZ-LINX-P-100	38
EZ-LINX-P-25	38

PART #	PAGE #
EZ-LINX-P-3	38
EZ-LINX-P-35	38
EZ-LINX-P-50	38
EZ-LINX-P-6	38
EZ-LINX-P-75	38
EZ-RJ45*	182
EZ-SVM-L/R	39
EZ-VGAF	39
EZ-VGAM	39
EZ-VGAMAM	39
F-2V1A-10	26
F-2V1A-100	26
F-2V1A-125	26
F-2V1A-25	26
F-2V1A-35	26
F-2V1A-50	26
F-2V1A-75	26
FLT-CON-SWBP	172
FLT-CON-A/VRCA	173
FLT-CON-BAN	172
FLT-CON-BANRA	172
FLT-CON-CVRCA	172
FLT-CON-F	173
FLT-CON-LRCCA	173
FLT-CON-PIN	172
FLT-CON-RCA1	173
FLT-CON-RJ45	173
FLT-CON-SV	173
FLT-GLUE	173
FLT-MESH	173
FRIGID	42
G-2V1A-10	26
G-2V1A-100	26
G-2V1A-125	26
G-2V1A-25	26
G-2V1A-35	26
G-2V1A-50	26
G-2V1A-75	26
G-2V2A-C2-10	27
G-2V2A-C2-100	27
G-2V2A-C2-25	27
G-2V2A-C2-35	27
G-2V2A-C2-50	27
G-2V2A-C2-75	27
G-2V2A-C3-10	27
G-2V2A-C3-100	27
G-2V2A-C3-125	27
G-2V2A-C3-125	27
G-2V2A-C3-25	27
G-2V2A-C3-35	27
G-2V2A-C3-50	27
G-2V2A-C3-75	27
G-VGAM-F-10	33
G-VGAM-F-100	33
G-VGAM-F-125	33
G-VGAM-F-25	33
G-VGAM-F-35	33
G-VGAM-F-50	33
G-VGAM-F-75	33
G-VGAM-M-10	33
G-VGAM-M-100	33
G-VGAM-M-125	33
G-VGAM-M-25	33
G-VGAM-M-35	33
G-VGAM-M-50	33
G-VGAM-M-75	33
G-VGAMAM-M-10	34
G-VGAMAM-M-100	34
G-VGAMAM-M-125	34
G-VGAMAM-M-25	34
G-VGAMAM-M-35	34
G-VGAMAM-M-50	34
G-VGAMAM-M-75	34
HEATED MOLD	42
HSK-2:1BK-1	229
HSK-2:1BK-1/2	229
HSK-2:1BK-1/4	229

PART #	PAGE #
HSK-2:1BK-1/8	229
HSK-2:1BK-3/16	229
HSK-2:1BK-3/4	229
HSK-2:1BK-3/8	229
HSK-2:1BK-1	229
HSK-2:1BK-1/2	229
HSK-2:1BK-1/4	229
HSK-2:1BK-1/8	229
HSK-2:1BK-3/16	229
HSK-2:1BK-3/4	229
HSK-2:1BK-3/8	229
HSK-3:1BK-1/2	98
HSK-3:1BK-1/2	146
IF-SD-*100M	60
IF-SD-*100M	118
INTERFLEX-SD*	60
INTERFLEX-SD*	109
INTERFLEX-SD*	118
INTERFLEX-SIAM	60
INTERFLEX-SIAM	118
ISA-U1-IV	225
ISA-U1-WH	225
ISA-U2-IV	225
ISA-U2-WH	225
ISF-U1-IV	225
ISF-U1-WH	225
ISF-U2-IV	225
ISF-U2-WH	225
ISK*	223
ISK-35S*	223
ISK-BJ*	223
ISK-BNC*	223
ISK-F*	223
ISK-MD*	223
ISK-MT	223
ISK-RCAF*	223
ISK-SC	223
ISK-ST	223
K5-8PE*	223
K5-8PE-BK	224
K5-8PE-BL	224
K5-8PE-GY	224
K5-8PE-IV	224
K5-8PE-OR	224
K5-8PE-RD	224
K5-8PE-WH	224
K5-8PE-YL	224
K6-8KP-BK	224
K6-8KP-BL	224
K6-8KP-GN	224
K6-8KP-GY	224
K6-8KP-IV	224
K6-8KP-OR	224
K6-8KP-RD	224
K6-8KP-WH	224
K6-8KP-YL	224
K6-8KPS	224
K6-8SE	224
KX-6*	223
LITE-TOUCH-MODULE	73
LITE-TOUCH-SW	73
LLDO-1	219
LLDO-2	219
LLINX	153
LLINX-CR	62
LLINX-D	62
LLINX-D-HP	65
LLINX-DC	63
LLINX-Q	63
LLINX-Q-HP	65
LLINX-QM-P	64
LLINX-U	64
LLINX-U-DB	64
LLINX-U-DB	169
LLINX-U-HP	66
LLINX-U-HPP	66
LLINX-U-P	65

Ordering is fast & easy.



Call today!

Solutions for the AV PROFESSIONAL
www.libertycable.com

800-530-8998
INTERNATIONAL - CALL +1-719-388-7542





PART #	PAGE #
LS-CST	226
LS-STK	226
LUTRON-GRN	69
LUTRON-GRN	70
LUTRON-GRN	174
LUTRON-ORG	69
LUTRON-ORG	70
LUTRON-ORG	174
LUTRON-P-EBC	72
LUTRON-P-ESC	72
LUTRON-P-GRN	69
LUTRON-P-GRN	71
LUTRON-P-GRN	174
LUTRON-P-RBL	69
LUTRON-P-RBL	71
LUTRON-P-RBL	174
LUTRON-P-RED	69
LUTRON-P-RED	71
LUTRON-P-RED	174
LUTRON-P-YEL	69
LUTRON-P-YEL	174
LUTRON-PNK	69
LUTRON-PNK	70
LUTRON-PNK	174
LUTRON-QSC	72
LUTRON-RBL	69
LUTRON-RBL	174
LUTRON-RED	69
LUTRON-RED	174
LUTRON-WHT	69
LUTRON-WHT	70
LUTRON-WHT	174
LUTRON-YEL	69
LUTRON-YEL	174
LV1	153
LV2	153
LVMB1	153
LVMB2	153
M-TOOL-11	165
MAGNEPULL SPIDER	227
MB-DM	225
MB-SM	225
METAL	42
MOLTEN	42
MP-6212-39S	215
MP-6212-39S	215
MP-6212-61S	215
MP-6256-39P	215
MP-6256-61P	215
N-3V2A-C1-10	27
N-3V2A-C1-100	27
N-3V2A-C1-125	27
N-3V2A-C1-25	27
N-3V2A-C1-35	27
N-3V2A-C1-50	27
N-3V2A-C1-75	27
NA1394-6-B	159
NA4LJX	159
NAC3FCA	159
NAC3FCB	159
NAC3MPA	159
NAC3MPB	160
NAUSB	160
NBB75DFGB	160
NJ9FI-V	159
NE8FDP	160
NE8FDV-Y110-B	160
NE8BMC	160
NE8MC-1-B	160
NF2D-4	160
NJ3FP6C	159
NJ3FP6C-BAG	159
NKO2M-4575	159
NL2MP	160
NL4FRX	160
NL4MP	160
NL8FC	160

PART #	PAGE #
NL8MPR	160
NLT4FP-BAG	160
NLT4FX-BAG	160
NLT4MP	160
NLT4MX	160
NLT4MX	160
NO2-4FD	160
NO2-4FD-R	160
NP2X	159
NP3X	159
NTP3RC	159
P20SD-BNCM-M-10	23
P20SD-BNCM-M-100	23
P20SD-BNCM-M-125	23
P20SD-BNCM-M-25	23
P20SD-BNCM-M-35	23
P20SD-BNCM-M-50	23
P20SD-BNCM-M-75	23
P20SD-RCAM-M-10	22
P20SD-RCAM-M-100	22
P20SD-RCAM-M-125	22
P20SD-RCAM-M-25	22
P20SD-RCAM-M-35	22
P20SD-RCAM-M-50	22
P20SD-RCAM-M-75	22
P221 P-3.5TRSM-M-35	20
P221P-3.5TRSM-M-10	20
P221P-3.5TRSM-M-100	20
P221P-3.5TRSM-M-125	20
P221P-3.5TRSM-M-25	20
P221P-3.5TRSM-M-50	20
P221P-3.5TRSM-M-75	20
P222P-2RCAM-M-10	21
P222P-2RCAM-M-100	21
P222P-2RCAM-M-125	21
P222P-2RCAM-M-25	21
P222P-2RCAM-M-35	21
P222P-2RCAM-M-50	21
P222P-2RCAM-M-75	21
P222P-3.5SM-2RCAM-10	20
P222P-3.5SM-2RCAM-100	20
P222P-3.5SM-2RCAM-125	20
P222P-3.5SM-2RCAM-25	20
P222P-3.5SM-2RCAM-35	20
P222P-3.5SM-2RCAM-50	20
P222P-3.5SM-2RCAM-75	20
PC-P13	157
PC-1790	189
PC-1790	206
PC-A111	217
PC-A2100-S-P-C	207
PC-A2100-S-P-C	208
PC-A2200-S-P-C	210
PC-A2201-S-P-C	210
PC-A2202-S-P-C	210
PC-A2203-S-P-C	210
PC-A2204-S-P-C	210
PC-A2205-S-P-C	211
PC-A23	215
PC-A27	216
PC-A30-6	215
PC-A3100-S-P-C	207
PC-A3100-S-P-C	208
PC-A3200-S-P-C	210
PC-A3201-S-P-C	210
PC-A3202-S-P-C	210
PC-A3203-S-P-C	210
PC-A3204-S-P-C	210
PC-A3205-S-P-C	211
PC-A35	215
PC-A40	216
PC-A4100-S-P-C	207
PC-A4200-S-P-C	211
PC-A4201-S-P-C	211
PC-A4202-S-P-C	211
PC-A4203-S-P-C	211
PC-A4204-S-P-C	211

PART #	PAGE #
PC-A4205-S-P-C	211
PC-A58	215
PC-A59	217
PC-A64	217
PC-B15	217
PC-B16	216
PC-B2	216
PC-B22	215
PC-B3	216
PC-F14	215
PC-F15	215
PC-F16	216
PC-F18	215
PC-F19	215
PC-F7	215
PC-G1000*	93
PC-G1000*	198
PC-G1020*	27
PC-G1020*	93
PC-G1020*	198
PC-G1040*	198
PC-G1060*	93
PC-G1060*	198
PC-G1080*	93
PC-G1080*	198
PC-G1100*	198
PC-G1120*	198
PC-G1125-S-P-B	206
PC-G1128-S-P-B	206
PC-G1140*	198
PC-G1150-S-P-B	206
PC-G1154-S-P-B	206
PC-G1156-S-P-B	206
PC-G1160*	198
PC-G1180	204
PC-G1180*	198
PC-G1190*	198
PC-G1200	206
PC-G1200*	198
PC-G1240*	93
PC-G1240*	198
PC-G1250-S-P-B	189
PC-G1250-S-P-B	206
PC-G1250-S-P-B	206
PC-G1254-S-P-B	189
PC-G1254-S-P-B	206
PC-G1254-S-P-B	206
PC-G1260*	93
PC-G1260*	198
PC-G1280*	198
PC-G1290	56
PC-G1290	108
PC-G1290*	198
PC-G1300*	93
PC-G1300*	199
PC-G1320*	199
PC-G1330*	199
PC-G1340*	199
PC-G1350*	199
PC-G1360*	199
PC-G1370*	199
PC-G1400-PB	38
PC-G1425-PB	38
PC-G1450-PB	38
PC-G1475-PB	38
PC-G1500*	199
PC-G1520*	93
PC-G1520*	199
PC-G1540*	93
PC-G1540*	199
PC-G1560*	199
PC-G1580*	199
PC-G1600*	93
PC-G1600*	199
PC-G1620*	199
PC-G1640*	199
PC-G1700*	200

PART #	PAGE #
PC-G1720*	93
PC-G1720*	200
PC-G1740*	200
PC-G1760*	93
PC-G1760*	200
PC-G1780*	200
PC-G1800*	200
PC-G1820*	200
PC-G1840*	200
PC-G1850-E-P-C	82
PC-G1850-E-P-C	128
PC-G1860*	200
PC-G1870*	200
PC-G1880*	200
PC-G1890*	200
PC-G1900*	200
PC-G1920*	200
PC-G1940*	93
PC-G1940*	200
PC-G1960*	93
PC-G1960*	200
PC-G2000*	93
PC-G2000*	201
PC-G2020*	93
PC-G2020*	201
PC-G2040*	27
PC-G2040*	93
PC-G2040*	201
PC-G2060*	201
PC-G2080*	201
PC-G2100*	201
PC-G2120*	201
PC-G2140	56
PC-G2140	108
PC-G2140*	201
PC-G2160*	201
PC-G2200	206
PC-G2200*	201
PC-G2220*	201
PC-G2240*	201
PC-G2260-E-P-C	82
PC-G2260-E-P-C	128
PC-G2300*	202
PC-G2320*	202
PC-G2350*	202
PC-G2370*	202
PC-G2405	205
PC-G2405*	202
PC-G2415*	202
PC-G2417*	202
PC-G2460*	202
PC-G2480*	202
PC-G2500*	202
PC-G2600*	202
PC-G2610-S-P-B	205
PC-G2900*	93
PC-G2900*	202
PC-GC1R-P	204
PC-GC2G-P	204
PC-GC2G-W	204
PC-M47	218
PC-M48	218
PC-M49	218
PC-M50	218
PC-P1100-S-P-C	207
PC-P1100-S-P-C	212
PC-P1200-S-P-C	212
PC-P1204-S-P-C	212
PC-P1205-S-P-C	212
PC-P2	217
PC-P20*	218
PC-P3	217
PC-P3P	217
PC-P48	217
PC-P7	157
PC-P7	217
PC-P9	217

Solutions for the AV PROFESSIONAL
www.libertycable.com

800-530-8998
INTERNATIONAL - CALL +1-719-388-7542



Ordering is fast & easy.



Call today!

SECTION 18

Index By Part Number

PART #	PAGE #
PC-R10	216
PC-R11	216
PC-R17	215
PC-R18	215
PC-R20	215
PC-R21	216
PC-R22	216
PC-R28	216
PC-R29	215
PC-R33	215
PC-R35	216
PC-R38	216
PC-R4	216
PC-R41	216
PC-S100	218
PC-S13	215
PC-S13	218
PC-S1P	218
PC-S2	217
PC-S22	217
PC-S3	217
PC-S30	217
PC-S32	217
PC-S41	217
PC-S43	217
PC-S5	215
PC-S54	215
PC-S54	218
PC-S6	215
PC-S94	218
PC-S98	218
PC-S99	218
PC-V11	216
PC-V20	216
PC-V20	218
PC-V21	216
PC-V36	216
PC-V36	218
PC-V42	218
PC-V43	216
PC-V44	215
PC-V5	216
PC-V54	216
PC-V54	218
PC-V65	216
PC-V65	218
PC-V66	216
PC-V66	218
PC-V68	216
PC-X1	217
PC-X10	217
PC-X13	217
PC-X16	217
PC-X19	217
PC-X2	217
PC-X2	217
PC-X22	217
PC-X29	217
PC-X39	217
PC-X4	217
PC-X4	217
PC-X45	215
PC-X46	215
PC-X5	217
PC-X56	218
PC-X57	218
PC-X7	217
PCA5-3C-1815	209
PCA5-3C-1815-2455	209
PCA5-4C-1815-2455	208
PCA6-2C	189
PCA6-2C	212
PCA6-2C-200P	189
PCA6-2C-200P	212
PCA6-2C-220P	189
PCA6-2C-220P	208
PCA6-2C-220P	212

PART #	PAGE #
PCA6-2C-326P	189
PCA6-2C-326P	212
PCD-1000*	220
PCD-1050*	220
PCD-1100-*	220
PCD-1500-*	220
PCD-5000	206
PCD-5000*	221
PCD-5010	204
PCD-5010*	221
PCD-5020	205
PCD-5020*	221
PCD-5030	205
PCD-5030*	221
PCD-5040	205
PCD-5040*	221
PCD-5050*	221
PCD-5060	204
PCD-5060*	221
PCD-5070	204
PCD-5070*	221
PCD-5080	204
PCD-5080	206
PCD-5080*	221
PCD-5100	206
PCD-5100*	221
PCD-5120	204
PCD-5120*	221
PCD-5150*	221
PCD-5200*	221
PCD-5280*	221
PCD-5300*	221
PCD-5310	206
PCD-5310*	222
PCD-5350*	222
PCD-5380*	222
PCD-5400*	222
PCD-5420*	222
PCD-5460	204
PCD-5460*	222
PCD-5480*	222
PCD-5500	205
PCD-5500*	222
PCD-5520	205
PCD-5520*	222
PCD-5600*	222
PCD-5650*	222
PCD-5700*	222
PCD-5750*	222
PCD-5800*	222
PCD-5850	189
PCD-5850	206
PCD-5850*	222
PCD-5900*	222
PCD-5910*	222
PMI-A2*	207
PMI-A3*	207
PMI-A4	207
PMI-A5	53
PMI-A5	105
PMI-P1	207
PRG59-RCAM-M-10	22
PRG59-RCAM-M-100	22
PRG59-RCAM-M-125	22
PRG59-RCAM-M-25	22
PRG59-RCAM-M-35	22
PRG59-RCAM-M-50	22
PRG59-RCAM-M-75	22
PS11	165
PS2-F	53
PS2-F	105
PSVM-M-10	31
PSVM-M-100	31
PSVM-M-125	31
PSVM-M-25	31
PSVM-M-35	31
PSVM-M-50	31

PART #	PAGE #
PSVM-M-75	31
QSH-CBL-S	72
QUADFLEX-BC-BLK	114
QUADFLEX-BC-BLK	130
QUADFLEX-BC-WHT	114
QUADFLEX-BC-WHT	130
QUADFLEX-BLK	114
QUADFLEX-BLK	130
QUADFLEX-BLU	114
QUADFLEX-BLU	130
QUADFLEX-RED	114
QUADFLEX-RED	130
QUADFLEX-WHT	114
QUADFLEX-WHT	130
QUADFLEX-YEL	114
QUADFLEX-YEL	130
RF-F	53
RF-F	105
RG11-BC-CATV-DB	112
RG11-BC-CATV-DB	168
RG11-CATV-BLK	113
RG11-CATV-DB	112
RG11-CATV-DB	168
RG11-CATV-WHT	113
RG11-CCTV-BLK	115
RG11-CCTV-BLK	144
RG11-CCTV-PL-WHT	59
RG11-CCTV-PL-WHT	96
RG11-EX-PLN	61
RG11-EX-PLN	119
RG11-EX-SD	61
RG11-EX-SD	119
RG11-HF-WHT	176
RG11-P-CATV-WHT	57
RG11-QUAD-PL-WHT	58
RG11/AU-HF-BLK	176
RG213-HF-BLK	176
RG58-CMP-WHT	116
RG58-CMR-BLK	116
RG59-18/2C-PS	59
RG59-18/2C-PS	96
RG59-CCTV-CM-BLK	115
RG59-CCTV-CM-BLK	144
RG59-CCTV-PL-BLK	59
RG59-CCTV-PL-WHT	59
RG59-CCTV-PL-WHT	96
RG59-CCTV-PL-YEL	59
RG59-RCAM-M-10	22
RG59-RCAM-M-100	22
RG59-RCAM-M-125	22
RG59-RCAM-M-25	22
RG59-RCAM-M-35	22
RG59-RCAM-M-50	22
RG59-RCAM-M-75	22
RG59-SD-HF-BLK	176
RG59-STR-BLK	115
RG59-STR-BLK	144
RG59-STR-YEL	115
RG59CM-18-2C	115
RG59CM-18-2C	144
RG59WRO	155
RG59WRO	229
RG6-18-2C	115
RG6-18-2CCL2	144
RG6-BC-CATV-DB	112
RG6-BC-CATV-DB	168
RG6-CATV-DB	112
RG6-CATV-DB	168
RG6-CCTV-CM-BLK	115
RG6-CCTV-CM-BLK	144
RG6-CCTV-PL-BLK	59
RG6-CCTV-PL-WHT	59
RG6-CCTV-PL-WHT	96
RG6-CM-BLK	113
RG6-CM-SIAM-BLK	113
RG6-CM-WHT	113
RG6-HF-*	175

PART #	PAGE #
RG6-P-CATV-BLK	57
RG6-P-CATV-BLU	57
RG6-P-CATV-WHT	57
RG6-QUAD-CMP-WHT	58
RG6-SD-HF-*	177
RG6NRO	155
RG6NRO	229
RG6Q-CM-SIAM-BLK	114
RG6Q-CM-SIAM-WHT	114
RG6Q-HF-*	175
RG6WRO	155
RG6WRO	229
RGB3-MINI-	140
RGB3C-20-CMR	94
RGB3C-20-CMR	142
RGB3C-23-CM	84
RGB3C-23-CM	134
RGB3C-23-CMP	134
RGB3C-23-CMP	85
RGB5-MINI-	140
RGB5C	94
RGB5C	142
RGB5C-20-CMR	94
RGB5C-20-CMR	142
RGB5C-23-CM	84
RGB5C-23-CM	90
RGB5C-23-CM	133
RGB5C-23-CM	138
RGB5C-23-CM	163
RGB5C-23-CMP	84
RGB5C-23-CMP	90
RGB5C-23-CMP	133
RGB5C-23-CMP	138
RGB5C-25-CM	90
RGB5C-25-CM	138
RGB5C-25-CMP	90
RGB5C-25-CMP	138
RGB5C-25-CMP	163
RGB5C-PLN	92
RGB5C-PVC	140
RGB5C/24-4C-FLAT	141
RGB6C-20/2LSE	94
RGB6C-20/2LSE	142
RGB6C-23-2LSE	134
RGB6C-23-2LSE	85
RGB6C-25-2LSE	137
RGB6C-25-2LSE	88
RGB6C-PVC-YEL	141
RGB6C/22-2P	141
RGB6C/22-2P-PLN	92
RGB7C/22-3P-PLN	87
RGB7C/22-3P-PLN	137
RHCB	220
RHCC	220
RHIM	220
RTC360	155
RTC360	229
SAENC-8.5	228
SAENC-8.5	228
SB-BS-IV	225
SB-BS-WH	225
SB-ES-IV	225
SB-ES-WH	225
SB-S1-IV	225
SB-S1-WH	225
SB-S3-IV	225
SB-S3-WH	225
SLC6	158
SOLIDIFIED METAL	42
SQ-XLRM-F-10	36
SQ-XLRM-F-100	36
SQ-XLRM-F-125	36
SQ-XLRM-F-25	36
SQ-XLRM-F-35	36
SQ-XLRM-F-50	36
SQ-XLRM-F-75	36
SUPER	42

Ordering is fast & easy.



Call today!

Solutions for the AV PROFESSIONAL
www.libertycable.com

800-530-8998
INTERNATIONAL - CALL +1-719-388-7542





PART #	PAGE #
SV-25-CM	89
SV-25-CM	117
SV-25-CMP	117
SV-25-CMP	89
SV-PLN	92
SV-PLN	117
SV-PLN	142
SV-PVC	117
TEKTONE-AUDIO	227
TEKTONE-D2	227
TEKTONE-NC300	48
TEKTONE-NC300	88
TEKTONE-NC300	227
TEKTONE-P2	227
TEKTONE-PLN-AUDIO	227
TEKTONE-PLN-BUND	227
TEKTONE-PLN-DATA	227
TEKTONE-PLN-DATA	227
TEKTONE-PLN-POWER	227
TKT-UNICAM-PFC	76
TKT-UNICAM-PFC	122
TKT-UNICAM-PFC	187
TRUPHASE	55
TRUPHASE	107
TRUPHASE-P	55
TRUPHASE-P	107
TRUPHASE-SH-BRN	55
TRUPHASE-SH-BRN	107
UB12-2C-BLK	100
UB12-2C-BLK	170
UB12-2C-SH-BLK	100
UB12-2C-SH-BLK	170
UB14-2C-BLK	100
UB14-2C-BLK	170
UB16-2C-BLK	100
UB16-2C-BLK	170
UB16-2C-SH-BLK	100
UB16-2C-SH-BLK	170
UB18-2C-BLK	100
UB18-2C-BLK	170
UB18-2C-SH-BLK	100
UB18-2C-SH-BLK	170
UB18-4C-BLK	100
UB18-4C-BLK	170
UB18-4C-SH-BLK	100
UB18-4C-SH-BLK	170
UNIDIRECTIONALLY	42
V1-PTZ-F	53
V1-PTZ-F	105
VGA-HR-F	53
VGA-HR-F	105
VGA-SR-F	53
VGA-SR-F	105
VGA-UHR-F	53
VGA-UHR-F	105
WHITE, BLUE, GRAY	107
WJ-106-AL	225
WJ-106-IV	225
WJ-106-WH	223
WJ-106-WH	225
WJ-DEC-AL	224
WJ-DEC-IV	224
WJ-DEC-WH	223
WJ-DEC-WH	224
WJ-DEC4-AL	224
WJ-DEC4-IV	224
WJ-DEC4-WH	224
WJ-DEC6-AL	224
WJ-DEC6-IV	224
WJ-DEC6-WH	224
WP-106-AL	225
WP-106-IV	225
WP-106-WH	225
WP-BS-IV	225
WP-BS-WH	225
WP-BS2-IV	225
WP-BS2-WH	225

PART #	PAGE #
WP-BSA-WH	225
WP-DEC-AL	224
WP-DEC-IV	224
WP-DEC-WH	223
WP-DEC-WH	224
WP-DEC2-AL	224
WP-DEC2-IV	224
WP-DEC2-WH	223
WP-DEC2-WH	223
WP-DEC2-WH	224
WP-DEC3-AL	224
WP-DEC3-IV	224
WP-DEC3-WH	224
WP-ES-IV	225
WP-ES-WH	225
WP-N1	223
WP-N12	223
WP-N2	223
WP-N3	223
WP-N4	223
WP-N6	223
WP-N8	223
XGA OVER 35"	207
XGA UNDER 65"	207
Z100A15FT	21
Z100A15FT	46
Z100A25FT	21
Z100A25FT	46
Z100A3FT	21
Z100A3FT	46
Z100A6FT	21
Z100A6FT	46
Z100AM15FT	46
Z100AM25FT	46
Z100AM3FT	46
Z100AM6FT	46
Z100AV15FT	46
Z100AV25FT	46
Z100AV3FT	46
Z100AV6FT	46
Z100AY15FT	21
Z100AY15FT	46
Z100AY25FT	21
Z100AY25FT	46
Z100AY3FT	21
Z100AY3FT	46
Z100AY6FT	21
Z100AY6FT	46
Z100CV15FT	47
Z100CV25FT	47
Z100CV3FT	47
Z100CV6FT	47
Z100SV15FT	47
Z100SV25FT	47
Z100SV25FT	47
Z100SV3FT	47
Z100SV6FT	47
Z100V-15	23
Z100V-25	23
Z100V-3	23
Z100V-6	23
Z100V15FT	47
Z100V25FT	47
Z100V3FT	47
Z100V6FT	47
Z100VGA15FT	47
Z100VGA25FT	47
Z100VGA35FT	47
Z100VGA3FT	47
Z100VGA50FT	47
Z100VGA6FT	47
Z200A.5	45
Z200A1	45
Z200A1.5	45
Z200A2	45
Z200A3	45

PART #	PAGE #
Z200A4	45
Z200A6	45
Z200AV1	45
Z200AV2	45
Z200AV3	45
Z200AV4	45
Z200AV6	45
Z200FM	46
Z200MF	46
Z200MM	46
Z250A0.5	45
Z250A1	45
Z250A2	45
Z250A3	45
Z250A4	45
Z250A6	45
Z250AV0.5	45
Z250AV1	45
Z250AV2	45
Z250AV3	45
Z250AV4	45
Z250AV6	45
Z250CV1	45
Z250CV2	45
Z250CV3	45
Z250CV4	45
Z250CV6	45
Z300AU-RCA	156
Z300CO-75RCA-RGB	44
Z300CO-75RCA-RGB	156
Z300DI-75RCA	44
Z300NA.5THX	44
Z300NA1.5THX	44
Z300NA1THX	44
Z300NA2THX	44
Z300NA3THX	44
Z300NA4THX	44
Z300NCV.5THX	44
Z300NCV1.5THX	44
Z300NCV1THX	44
Z300NCV2THX	44
Z300NCV3THX	44
Z300NCV4THX	44
Z300ND.5THX	44
Z300ND1.5THX	44
Z300ND1THX	44
Z300ND2THX	44
Z300ND3THX	44
Z300ND4THX	44
Z300NV.5THX	44
Z300NV1.5THX	44
Z300NV1THX	44
Z300NV2THX	44
Z300NV3THX	44
Z300VI-75RCA	44
Z400DVI-D/DL1	24
Z400DVI-D/DL10	24
Z400DVI-D/DL12	24
Z400DVI-D/DL15	24
Z400DVI-D/DL2	24
Z400DVI-D/DL4	24
Z400DVI-D/DL6	24
Z400DVI-D/DL8	24
Z400NSV	117
Z500NA.5THX	43
Z500NA1.5THX	43
Z500NA1THX	43
Z500NA2THX	43
Z500NA3THX	43
Z500NA4THX	43
Z500NBA.5THX	43
Z500NBA1.5THX	43
Z500NBA1THX	43
Z500NBA2THX	43
Z500NBA3THX	43
Z500NBA4THX	43
Z500NCV.5THX	43

PART #	PAGE #
Z500NCV1.5THX	43
Z500NCV1THX	43
Z500NCV2THX	43
Z500NCV3THX	43
Z500NCV4THX	43
Z500ND.5THX	43
Z500ND1.5THX	43
Z500ND1THX	43
Z500ND2THX	43
Z500ND3THX	43
Z500ND4THX	43
Z500NTOS1	42
Z500NTOS1	81
Z500NTOS1	127
Z500NTOS10	42
Z500NTOS10	81
Z500NTOS10	127
Z500NTOS15	42
Z500NTOS15	81
Z500NTOS15	127
Z500NTOS2	42
Z500NTOS2	81
Z500NTOS2	127
Z500NTOS4	42
Z500NTOS4	81
Z500NTOS4	127
Z500NTOS6	42
Z500NTOS6	81
Z500NTOS6	127
Z500NV.5THX	43
Z500NV1.5THX	43
Z500NV1THX	43
Z500NV2THX	43
Z500NV3THX	43
Z500NV4THX	43
Z500SV.5	42
Z500SV1	42
Z500SV1.5	42
Z500SV2	42
Z500SV3	42
Z500SV4	42
Z500UAA1	42
Z500UAA2	42
Z500UAA4	42
Z500UAA5	42
Z500UAK	156
ZB01	156
ZB03	156
ZB04	156
ZC01	156
ZD01	156
ZD03	156
ZTOS1	47
ZTOS1	81
ZTOS1	127
ZTOS10	47
ZTOS10	81
ZTOS10	127
ZTOS15	47
ZTOS15	81
ZTOS15	127
ZTOS2	47
ZTOS2	81
ZTOS2	127
ZTOS4	47
ZTOS4	81
ZTOS4	127
ZTOS6	47
ZTOS6	81
ZTOS6	127

Ordering is fast & easy.



Call today!

Solutions for the AV PROFESSIONAL
www.libertycable.com

800-530-8998
INTERNATIONAL - CALL +1-719-388-7542



Placing Your Order With Liberty

Placing Your Order with Liberty

Liberty Wire & Cable is the premier supplier of wire and cable products worldwide. Our combination of the best people and products in the industry ensure that your order is consistently filled correctly and delivered on time.

There is no minimum order size or product mix that you are required to buy. You buy only what you need, when you need it. This protects your cash flow as well as your inventory space requirements.

Our business philosophy is simple: we want to make your business simultaneously competitive and profitable. With that in mind, we make it easy to do business with us—that is the **Liberty Advantage**.

New Customers

If you are a new customer with Liberty, placing your order for our quality products is easy.

First-time customers have the convenience of using a credit card for their purchase. Liberty accepts American Express, MasterCard and Visa.

One can also pay with a cashier's check, money order or by personal/corporate check. However, if you pay by check, the check must clear the bank prior to release of your order. Liberty does not offer the payment option of COD.

Credit Terms

Credit terms with Liberty Wire & Cable may be requested by submitting a completed credit application form located on pages 223 and 224. Please send the documents to our Corporate Headquarters by fax: 719-260-0075, or mail to Liberty Wire & Cable, 11675 Ridgeline Drive, Colorado Springs, CO 80921. Our standard payment term is net 30 days.

Domestic Shipping

We ship your order within 48 hours to most destinations in the continental United States. We regularly ship bulk product orders the same day that they are placed. Liberty does have 2pm (MST) cut-off time for same-day shipments.

For more information, contact your Liberty Wire & Cable sales professional.

A variety of shipping methods are available:

- Common Carrier (LTL)
- FedEx
- UPS

Special requests for lift gates, hand trucks or even job site delivery are easily accommodated. Let your sales professional know what your special needs are when placing your order.

Liberty's shipping specialists can economically expedite your order, if necessary. Ask your sales professional for details on how this option can work for your order today.

International Customers

Liberty Wire & Cable is proud to serve customers in over 34 countries. Whether you are working on a residential or commercial installation, Liberty is the professional's first choice. As the premier worldwide-supplier of wire and cable products, we are well versed in getting your order to its destination efficiently and economically. With that in mind, there are many payment term options available to our international customers:

• Cash for Documents

Cash for Documents (CD) shipments are those whereby Liberty is liable for the shipment until the shipment reaches the destination country. The dealer will not receive the shipment from their customs operations until payment is made to Liberty. Cash for Documents requires you to provide complete banking information. Our international dealers who do not qualify for terms often use our Cash for Documents option.

• Cash in Advance

Cash in Advance (CI) shipments are those in which the dealer pays for the product in advance. Funds can be wired directly to our bank.

continued...

Ordering is
fast & easy.



Call today!

**Solutions for the
AV PROFESSIONAL**

www.libertycable.com

800-530-8998

INTERNATIONAL - CALL +1-719-388-7542



...continued

• **Credit Card**

Credit Card (CC) shipments are those where the dealer pays for the product in advance with a credit card. At this time, we accept Visa, American Express, MasterCard, Discover and Diner's Club.

• **Terms**

Our terms depend on payment history, country and the customer.

International Shipping:

Liberty Wire & Cable's staff of highly trained shipping specialists understands the complexities and demands of international shipments.

Typically, international orders are transported three ways: ocean freight, airfreight, or ground freight. Some orders could have a combination of two. Most international orders must ship complete, this keeps your shipping cost to a minimum. However, when required, we can expedite parts of your order for a nominal fee.

Our customer service professionals are knowledgeable on international shipping methods and can advise you on how to best ship your Liberty products by air or surface to best meet your needs.



PANEL CRAFTERS

Our complete line of single & double gang plates and rack panels are available populated or unpopulated. Our custom plates and panels are used in a broad base of Residential and Commercial installations.

SEE PAGE 196

Custom and Stock Plates & Panels

Solutions for the AV PROFESSIONAL

www.libertycable.com

800-530-8998

INTERNATIONAL - CALL +1-719-388-7542

Ordering is fast & easy.

Call today!



Website to Worksite:

We understand that often times you are trying to juggle sales, installations and product ordering for your company—all at the same time.

Our new website allows you to browse our entire product catalog as well as place your orders online. You can access and order Liberty products from any web-enabled PDA, web-connected laptop or desktop computer.

The convenience of our new website allows you to place your order from the worksite or from your home after business hours.

www.libertycable.com. In addition to 24/7 order placement, you will find numerous time-saving and business-building features on our website ranging from PanelCrafter's Custom Plates and Panels, custom cables, and new product introductions. Plus, our easy-to-use "My Account Center" provides a convenient way to manage your account online.

Liberty provides over 6,000 products - all of which are available on our website in complete detail. Our new website provides the professional A/V installer with the correct tools designed to keep you simultaneously competitive and profitable.

Ordering is fast & easy.



Call today!

Solutions for the AV PROFESSIONAL
www.libertycable.com

800-530-8998
INTERNATIONAL - CALL +1-719-388-7542



**New Customer Profile**

Company Name: _____

Billing Address: _____

City: _____ State: _____ Zip: _____

Company Phone: (____) _____ Fax: (____) _____

Company Website: _____

Date Business Opened: Month _____ Year _____

Shipping Address (if different than above)Address: _____

City: _____ State: _____ Zip: _____

Primary Contact: _____ Title: _____

Direct Phone #: (____) _____ Ext. _____ Email: _____

Describe your type of Business: _____

Primary Focus (select only one): Residential Commercial/Integration

FED Tax ID#: _____ State Tax Exemption #: _____

* Please note that we will need a copy of your Federal Tax ID Certificate and Sales Tax Exemption Certificate (if applicable) before we can process your new account.

How did you hear about Liberty Wire & Cable?

- Trade Show Rep Word of Mouth
 Internet Other Describe _____

 I will pay for my purchases with a Credit Card: I am requesting open terms.

- Must be in business six (6) months and in good credit standing.
- Please complete Credit Application.

TO BE COMPLETED BY TM Liftgate Special Hours of Delivery _____

Fax the Completed Form to 719-260-0075 Attention: _____

Ordering is
fast & easy.

Call today!

**Solutions for the
AV PROFESSIONAL**

www.libertycable.com

800-530-8998

INTERNATIONAL - CALL +1-719-388-7542





Liberty Wire & Cable Credit Application

Credit terms may be extended to established businesses in good credit standing. Newly established businesses (less than six (6) months) must use a Credit Card.

Company: _____ Phone: _____

Address: _____

Fax: _____

City: _____ State: _____ Zip: _____

E-mail: _____

Principals

Name: _____ Title: _____ Phone: _____

Name: _____ Title: _____ Phone: _____

Type of Business: _____

Primarily Servicing (Select only one) Residential Commercial

Estimated Yearly Purchases: _____ Credit Line Requested _____

Date Business Opened: Month _____ Year _____ Federal Tax ID # _____

Business is: Privately Owned Publicly Owned
 Corporation Partnership Proprietorship

Tax Status Taxable Tax Exempt *Certificate must be attached*

Trade References *(Fax Numbers Required for Application to be Processed)*

Name: _____ Phone: _____

Account #: _____ Fax: _____

Name: _____ Phone: _____

Account #: _____ Fax: _____

Name: _____ Phone: _____

Account #: _____ Fax: _____

Ordering is fast & easy.



Call today!

Solutions for the AV PROFESSIONAL
www.libertycable.com

800-530-8998
INTERNATIONAL - CALL +1-719-388-7542





Bank Reference		
Name: _____	Phone: _____	
Address: _____	Fax: _____	
City: _____	State: _____	Zip: _____
Contact: _____	Account Number: _____	

I hereby:

1. Authorize LibertyWire and Cable, Inc. to investigate any credit references herein listed or to contact a credit bureau or investigative agency to do the same on LibertyWire and Cable, Inc.'s behalf.
2. Agree to abide by LibertyWire and Cable, Inc.'s terms stated on all invoices unless otherwise agreed in writing. Furthermore, I understand that if my account is past due, LibertyWire and Cable, Inc. may cease shipments until the time my account is current. LibertyWire and Cable, Inc. has the right to charge interest on any past due balance at the rate of 1.5% monthly or 18% annually.
3. Agree any claims for defects, damages or for nonperformance by LibertyWire and Cable, Inc. must be made in writing within a period of thirty (30) days from invoice date. Damages are limited to replacement cost of the product sold. Failure to make such written claims within the stated period shall constitute irrevocable acceptance and an admission that all terms, conditions and specifications have been met.
4. Agree that, if any legal action is instituted to collect past due amounts, LibertyWire and Cable, Inc. shall be entitled to recover, in addition to all said past due amounts, any damages, legal interest, collection costs and reasonable attorney's fee. All legal action will be pursued in the State of Colorado.

Officer's Signature	Officer's Printed Name	Date
---------------------	------------------------	------

All information is strictly confidential

GUARANTEE		
<i>The undersigned hereby personally guarantee all terms and conditions of this Credit Agreement and, upon demand by LibertyWire and Cable, Inc. will promptly pay any and all sums due and owing by the above corporation/partnership.</i>		
Officer's Signature	Officer's Printed Name	Date

H:\data\forms\2008 Credit App. doc
September 18, 2008

Ordering is fast & easy.



Call today!

**Solutions for the
AV PROFESSIONAL**
www.libertycable.com

800-530-8998
INTERNATIONAL - CALL +1-719-388-7542





Commercial
Integration



Residential



Residential



Global reach with a local connection

Broadcast



Professional Installers Worldwide Rely
on Liberty as Their Single Source for:

- Connector
- Custom Assemblies
- Custom Bundles
- Custom Plates & Panels
- Interconnects
- Wire & Cable

Liberty Products are
Available in More than 48
Countries Worldwide



For a Distributor Near You Call
800-530-8998



INSTALLATION PRODUCTS for the AV Professional

A DIVISION OF COMMUNICATIONS SUPPLY CORPORATION

2009 - 2010 Product Catalog #817 USD \$10.95 CAN \$16 UK £7.00
libertycable.com

ASSEMBLIES:
PAGE 17

PANEL CRAFTERS™
PAGE 192

SECTION	2009 - 2010 PRODUCT CATALOG	PAGE
1	LIBERTY ADVANTAGE	1
2	ASSEMBLIES/INTERCONNECTS	17
3	BUNDLED TAPED SOLUTIONS	48
4	BULK WIRE COMMERCIAL	49
5	BULK WIRE RESIDENTIAL	101
6	CONNECTORS	154
7	DIRECT BURIAL	168
8	FLAT WIRE	171
9	GREEN CONNECTIVITY	174
10	HDMI/DIGITAL SOLUTIONS	178
11	KITTING OPTIONS	190
12	OEM	191
13	PANELCRAFTERS™	192
14	PROFESSIONAL ACCESSORIES	227
15	STRUCTURED CABLE SOLUTIONS	230
16	TEKTONE COMPOSITE CABLE	234
17	TECHNICAL INFORMATION	235
18	INDEX BY PART NUMBER	242
19	PLACING YOUR ORDER	250



BULK FIBER
CONNECTORS
PAGE 75 & 121

HDMI/DIGITAL SOLUTIONS
PAGE 178

CONTROL CABLE
PAGE 120

CONNECTEC™
PAGE 163



800-530-8998

libertycable.com

A DIVISION OF COMMUNICATIONS SUPPLY CORPORATION

INTERNATIONAL: +1-719-388-7542

11675 Ridgeline Drive • Colorado Springs, CO 80921

**Contact
Your Sales Professional Today!**