

2011 Silverado/Sierra Hybrid

In Brief	1-1	Infotainment System	7-1	Jump Starting	10-15
Initial Drive Information	1-1	Introduction	7-1	Towing	10-19
Hybrid Features	1-2	Climate Controls	8-1	Appearance Care	10-24
Seats and Restraints	3-1	Climate Control Systems	8-1	Service and Maintenance ...	11-1
Rear Seats	3-1	Driving and Operating	9-1	Recommended Fluids,	
Airbag System	3-1	Driving Information	9-1	Lubricants, and Parts	11-2
Storage	4-1	Starting and Operating	9-2	Technical Data	12-1
Additional Storage Features ...	4-1	Engine Exhaust	9-4	Vehicle Data	12-2
Instruments and Controls	5-1	Automatic Transmission	9-5	Index	i-1
Warning Lights, Gauges, and		Brakes	9-8		
Indicators	5-2	Towing	9-9		
Information Displays	5-11	Vehicle Care	10-1		
Vehicle Messages	5-11	Vehicle Checks	10-2		
		Electrical System	10-13		

ii Introduction

The names, logos, emblems, slogans, vehicle model names, and vehicle body designs appearing in this manual including, but not limited to, GM, the GM logo, CHEVROLET, GMC, the CHEVROLET and GMC Truck Emblems, SILVERADO, Z71, and SIERRA are trademarks and/or service marks of General Motors LLC, its subsidiaries, affiliates, or licensors.

This manual describes features that may or may not be on your specific vehicle either because they are options that you did not purchase or due to changes subsequent to the printing of this owner manual. Please refer to the purchase documentation relating to your specific vehicle to confirm each of the features found on your vehicle. For vehicles first sold in Canada, substitute the name "General Motors of Canada Limited" for Pontiac Motor Division wherever it appears in this manual.

Litho in U.S.A.
Part No. 25965922 A First Printing

Keep this manual in the vehicle for quick reference.

Your hybrid pickup is designed to be more fuel efficient than the standard pickup, which results in reduced carbon dioxide emissions.

Canadian Vehicle Owners

Propriétaires Canadiens

A French language copy of this manual can be obtained from your dealer or from:

On peut obtenir un exemplaire de ce guide en français auprès du concessionnaire ou à l'adresse suivante:

Helm, Incorporated
P.O. Box 07130
Detroit, MI 48207
1-800-551-4123
Numéro de poste 6438 de langue
française
www.helminc.com

Using this Supplement

This supplement contains information specific to the unique components of the vehicle. It does not explain everything you need to know about the vehicle. Read this supplement along with the owner manual to learn about the vehicle's features and controls.

Index

A good place to look for what you need is the Index in back of this supplement. It is an alphabetical list of what is in the supplement, and the page number where you will find it.

In Brief

Initial Drive Information

Transmission 1-1

Hybrid Features

High Voltage Safety
 Information 1-2
 Fuel Economy Gauge 1-2
 Automatic Engine Start/Stop
 Feature 1-3
 Regenerative Braking 1-4
 Battery 1-4
 Service 1-4

Initial Drive Information

Transmission

Range Selection Mode

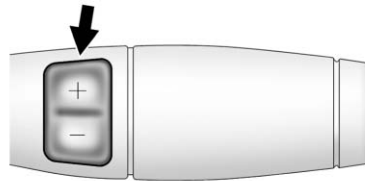

The Range Selection Mode switch is located on the shift lever. To enable the Range Selection feature,

move the column shift lever to the M (Manual) position. The current range will appear next to the M. This is the highest attainable range with all lower gears accessible. As an example, when 3 (Third) gear is selected, 1 (First) through 3 (Third) gears are available.

Press the plus/minus buttons, located on the steering column shift lever, to select the desired range of gears for current driving conditions. See Automatic Transmission Operation in the owner manual.

Cruise control can be used while the vehicle is in Range Selection Mode. See *Manual Mode on page 9-7.*

Hybrid Features

High Voltage Safety Information

This vehicle has a standard 12-volt battery and a high voltage hybrid battery. Only a trained service technician with the proper knowledge and tools should inspect, test, or replace the hybrid battery. See your dealer if the hybrid battery needs service.

The 12-volt battery cables, in the engine compartment, are clearly labeled. In emergency situations, first responders can cut those cables to disable the high voltage hybrid battery system.

Fuel Economy Gauge



United States

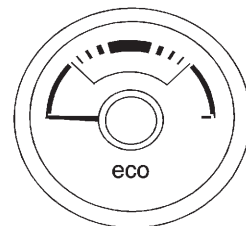

Canada

This gauge indicates fuel efficiency. To obtain the best fuel efficiency, operate the vehicle so that the indicator is in the high efficiency band.

Modifying both braking and acceleration behavior to keep the indicator in the center of the gauge will result in the best system efficiency and fuel economy.

See *Fuel Economy Gauge* on page 5-4.

Automatic Engine Start/Stop Feature

Start the engine as you would any other engine. See “Starting the Engine” in the owner manual for more information on starting. The hybrid system provides very quiet engine starting. If pulling a trailer with trailer brakes, see *Trailer Towing on page 9-9* for more information.

Auto Stop

The vehicle has an Auto Stop feature. After a successful engine start, the engine may turn off and operate in the Auto Stop mode.

Keep your foot firmly on the brake pedal until you are ready for the vehicle to move.

Engine OFF and AUTO STOP modes are indicated on the tachometer display. When the tachometer needle indicates OFF, the engine is not running and will remain off until the ignition key is placed in the START position or a remote vehicle start is performed. When the tachometer needle indicates AUTO STOP, the hybrid system is on, the engine is not running, but may Auto Start at any time without notice. See *Tachometer on page 5-3* for more information.

A chime will sound if the driver door is opened while in Auto Stop as a reminder that the ignition switch is not in the LOCK/OFF position. Always turn the ignition switch to LOCK/OFF and remove the key from the ignition switch when exiting the vehicle.

Auto Start

The vehicle also has an Auto Start feature. The engine will remain off while in Auto Stop mode until vehicle conditions require the engine to run. The near-instant starting of the engine from Auto Stop mode is called Auto Start.

EV Mode

The vehicle also has an EV mode which uses only the electric motor to move the vehicle. With light acceleration, the vehicle will drive in EV mode. EV mode is unavailable when the vehicle is out of fuel.

For more information on Auto Stop, Auto Start, and EV Mode, see *Starting the Vehicle on page 9-2*.

Regenerative Braking

Regenerative braking enables the electric drive motor to operate as a generator when coasting or braking. Energy from the moving vehicle recharges the hybrid battery.

The hydraulic disc brakes work with the regenerative braking to insure effective braking.

The braking system is computer controlled and blends the regenerative braking with the conventional hydraulic disc brakes to meet any requirements for deceleration. Because the controller applies the hydraulic brakes through its high pressure accumulator, you may occasionally hear the motor driven pump when it recharges the system. This is normal. In the event of a controller problem, the brake pedal may be harder to push and the stopping distance may be longer.

See *Regenerative Braking* on page 9-8.

Battery

This vehicle has a standard 12-volt battery and a high voltage hybrid battery. When a new standard 12-volt battery is needed, see your dealer for one that has the replacement number shown on the original battery's label. Only a trained service technician with the proper knowledge and tools should inspect, test, or replace the hybrid battery. See your dealer if the hybrid battery needs service. See *Battery* on page 10-12.

Service

Never try to do your own service on hybrid components. You can be injured and the vehicle can be damaged if you try to do your own service work. Service and repair of these hybrid components should only be performed by a trained service technician with the proper knowledge and tools. See *Doing Your Own Service Work* on page 10-2.

Seats and Restraints

Rear Seats

Rear Seats 3-1

Airbag System

Replacing Airbag System Parts
After a Crash 3-1

Rear Seats

Folding Rear Seat

Notice: Folding a rear seat with the safety belts still fastened may cause damage to the seat or the safety belts. Always unbuckle the safety belts and return them to their normal stowed position before folding a rear seat.

Make sure that nothing is on the seat.

To fold the seat, slowly pull the seat cushion up.

To return the seat to the normal seating position, slowly pull the seat cushion down.

Make sure the safety belts are not twisted or caught in the seat cushion.

Airbag System

Replacing Airbag System Parts After a Crash

If an airbag inflates or the vehicle has been in a crash, the vehicle's sensing system may command the automatic hybrid battery disconnect to open. When the battery disconnect is open, the hybrid battery will be off and the vehicle will not start. The airbag readiness light and/or SERVICE HYBRID SYSTEM warning message may come on in the Driver Information Center (DIC). See "Airbag Readiness Light" in the owner manual and *Driver Information Center (DIC)* on page 5-11 for more information.

To operate the vehicle, the automatic hybrid battery disconnect must be reconnected by a qualified service technician and sensing system parts will need to be replaced. Have the vehicle serviced right away.

Storage

Additional Storage Features

Tonneau Cover (Hard Tonneau)	4-1
Tonneau Cover (Soft Tonneau)	4-6

Additional Storage Features

Tonneau Cover (Hard Tonneau)

Installing the Cover

⚠ CAUTION

An improperly stored cargo cover could be thrown about the vehicle during a collision or sudden maneuver. Someone could be injured. If the cover is removed, always store it in the proper storage location. After positioning the cargo cover back on the vehicle, always be sure that it is securely reattached by properly securing the straps and latches.

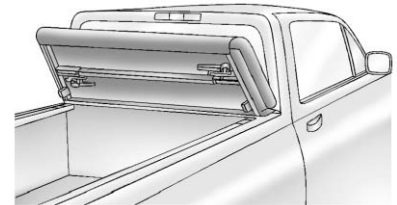

1. Position the tonneau cover onto the top of the pickup box with the locator tabs positioned into the front stake pockets.

If equipped, remove the front stake pocket covers from the bed rail protectors. The locators must fully seat into the stake pocket.
2. Align the front edge of the cover with the front edge of the bed rail so that it is centered on each side of the truck bed.
3. Lower the front clamp from its storage position.

4-2 Storage

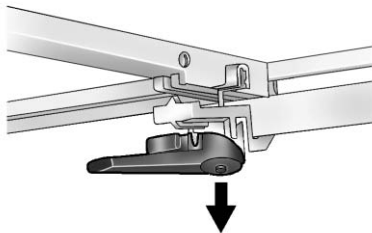

4. Tilt the clamp assembly so that the locator is in the slot, pull down on the assembly, and slide the clamp under the edge of the inner lip of the bed rail.

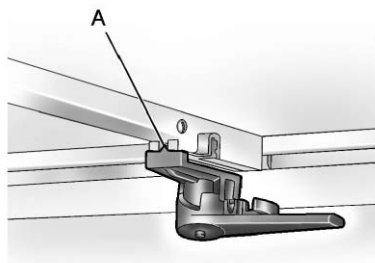

5. Pull the handle toward the rear of the truck to engage the clamp. Make sure the locator is secure into the slot (A). If unable to completely engage clamp, see the tightening and loosening procedures later in this section.
6. The clamp should be securely engaged. Shake the handle assembly to make sure the handle does not move.

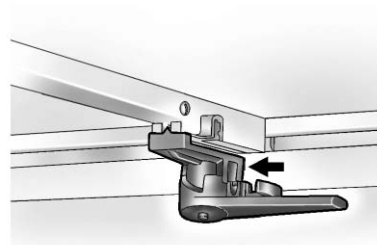

7. There are locking features on the front clamps only. With the handle in the clamped position, push the locking tab to engage the lock.
8. Repeat the clamp attachment steps 3 through 7 for the opposite side.

Closing the Cover

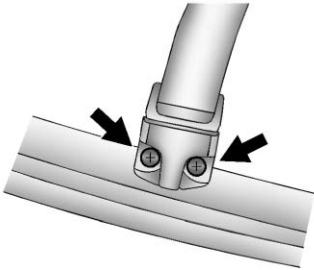

1. Release both the retention straps located on the top of the cover behind the cab and press into the stored position.
2. Unfold the tonneau cover to the closed position.
3. Lower the rear set of clamp assemblies from the stored position.

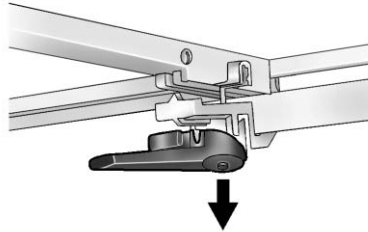

4. Tilt the clamp assembly so that the locator is in the slot, pull down on the assembly, and slide the clamp under the edge of the inner lip on the bed rail.

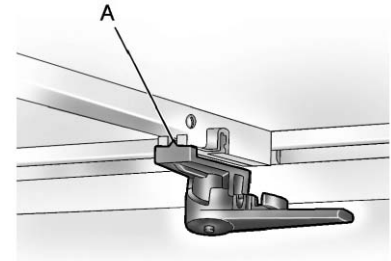

5. Pull the handle toward the rear of the truck to engage the clamp. Make sure the locator is secured into the slot (A). If unable to completely engage clamp, see the tightening and loosening procedures later in this section.
6. The clamp should be securely engaged. Shake the handle assembly to make sure the handle does not move.
7. Repeat the clamp attachment steps 3 through 6 for the opposite side.
8. Close the endgate.

4-4 Storage

Opening the Tonneau Cover

1. Turn both of the rear handles inward to release compression.
2. Pull the clamp down and turn the assemblies to disengage them from the lip of the pickup box.
3. Open the cover to expose the handles.

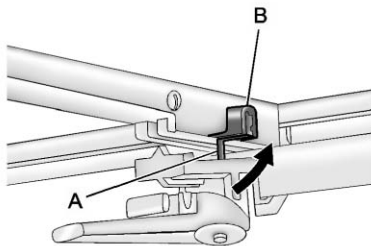

4. Align the clamp assembly bolt (A) with the retention feature (B).

5. Turn the handle assembly and clamp assembly bolt sideways (A) into the slot of the retention feature (B).

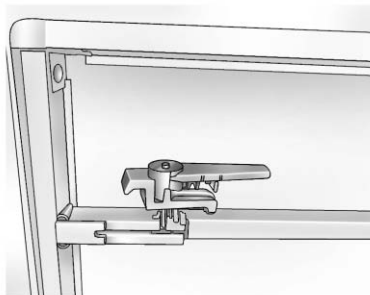

6. The handle should lie flat on the panel with the handles facing inward. Press firmly to secure.

This step must be done before stowing the cover.

7. Fold the cover forward.

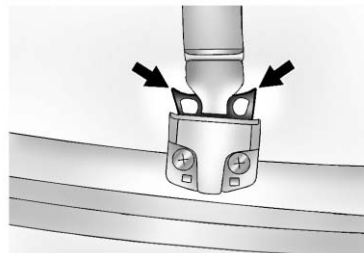

8. Remove the retaining strap from the bow. Connect the retention buckle ends. One end is located on the front of the tonneau cover behind the cab and the other end is on the tonneau cover
9. Pull on each strap to make sure both buckles are attached.

Removing the Tonneau Cover

1. Open the cover by following the procedure described previously, under "Opening the Tonneau Cover".

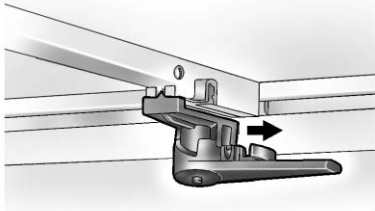

2. Disengage the locking tabs, located on the front handles, by pulling them rearward.
3. Turn the handles inward to release.

4. Pull the clamp down and turn the assembly to disengage it from the lip of the truck box.
5. Turn the cover to expose the handles.

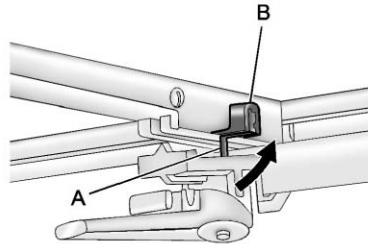

6. Align the clamp assembly bolt (A), with the retention feature (B).
7. Turn the handle assembly sideways by tilting the assembly bolt (A) into the slot of the retention feature (B).

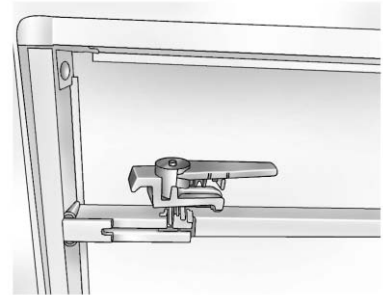

8. The handle should lie flat on the panel with the handles facing inward. Press firmly to secure.
9. Remove the tonneau cover from the vehicle.

4-6 Storage

Tightening the Clamp

1. Push the handle forward to release it from the clamped position.
2. Disengage the clamp from the inner edge of the bed rail and slide the assembly inward.
3. Adjust the clamp height on the bolt by turning the entire clamp assembly counter-clockwise.
4. Attach the clamps as indicated in steps 4 and 5 of Installing the Cover.

Loosening the Clamp

1. Return the handle to the fully disengaged position.
2. Disengage the clamp from the inner edge of the bed rail and slide the assembly inward.
3. Adjust the clamp height by turning the entire clamp assembly clockwise.
4. Reattach the clamps as indicated in steps 4 and 5 of Installing the Cover.

Tonneau Cover (Soft Tonneau)

Side Rail

WARNING

An improperly stored cargo cover could be thrown about the vehicle during a collision or sudden maneuver. Someone could be injured. If the cover is removed, always store it in the proper storage location. After positioning the cargo cover back on the vehicle, always be sure that it is securely reattached by properly securing the straps and latches.

Installation

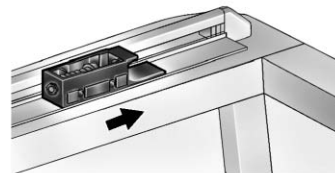

1. The adjuster screw end of each side rail should point in the direction of the cab.
2. Place each side rail on top of the truck box.

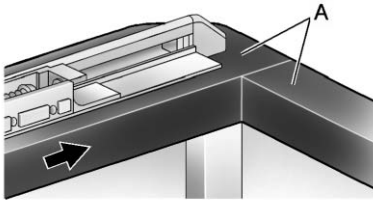

3. Align the front edge of the side rail with the front inside edge of pickup box.

Clamp Installation

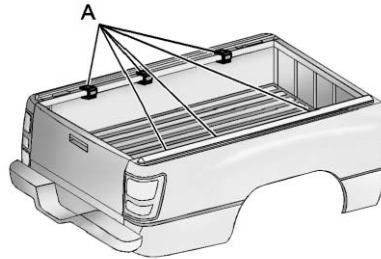

1. Position three outer clamps (A), on each side rail. The positions on the siderails are marked CLAMP.

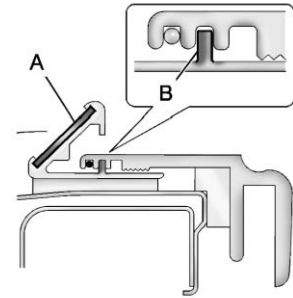

2. Position the grooves of the clamps on the side rails (A) using the center groove (B).

4-8 Storage

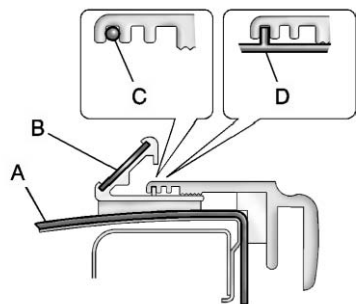

3. If the pickup box has molded bed rail protectors (A), remove the insert (C) from the outer groove on the clamp, and position the clamp on the side rail (B) using the outer groove (D).

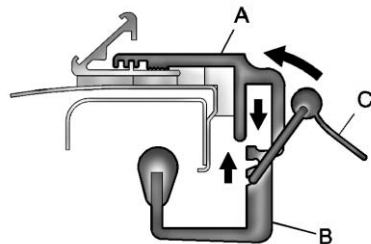

4. Slide the inner clamp (B) into the outer clamp (A).
5. Turn the latch (C) onto the outer clamp.

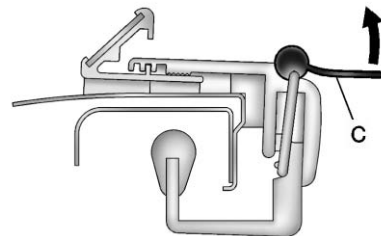

6. Tighten the clamp by turning the latch (C) toward the side rail. Make sure there is no gap between the rubber clamp pad and the side rail.
7. If the truck box has a molded bed rail protector, insert the latch into the top notch on the inner clamp.
8. Clean the vehicle's painted surface below the pull strap using a 50/50 mixture of rubbing alcohol and tap water.

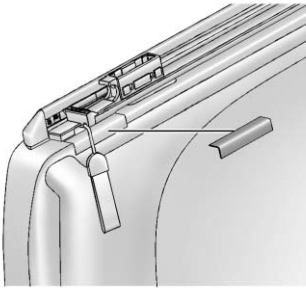

9. Remove the paper from the provided clear tape strip and apply to the painted surface below the pull strap.

Adjustment

If there is excessive sideways movement of the crossrails, move and re-install the clamps on the loose areas using the inner groove of the clamp.

Cover Installation

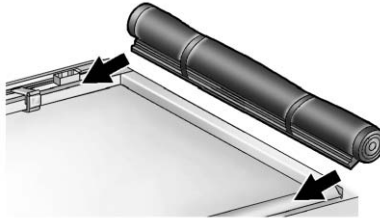

1. Place the cover assembly into the front pivot mounts firmly against the adjustment screws.

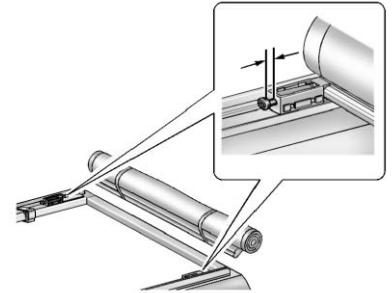

2. Verify the gap between the adjuster screws and pivot mounts is $\frac{3}{16}$ inch. Adjust if needed.

4-10 Storage

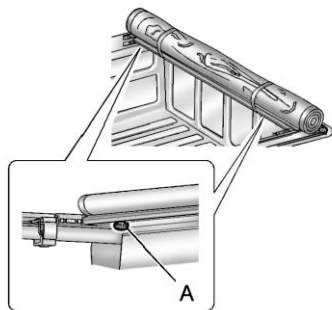

3. Loosen the wing bolt (A), then slide the latch outboard into the side rail. Tighten down the wing bolt (A). Do this on both sides. Both latches must remain engaged and the wing bolts tightened while the cover is on the vehicle. Make sure by lifting up on each end of the cover assembly.

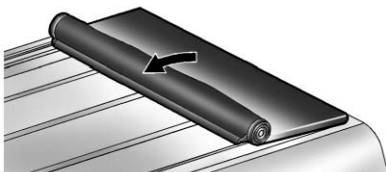

4. Unbuckle both straps and roll the cover out. Make sure that each bow falls in between the side rails. If the bows do not fit between the side rails, verify that the clamps are pushed fully outboard without any gaps between the clamp pad and

pickup box. If additional clearance is required, remove the clamp closest to the interference. Remove the orange strip to allow access to the outer slot of the upper clamp. Reinstall the clamp using the outer groove of the upper clamp. If bows are too loose, adjust the clamp closest to the bow with the excessive clearance to the inner groove of the upper clamp.

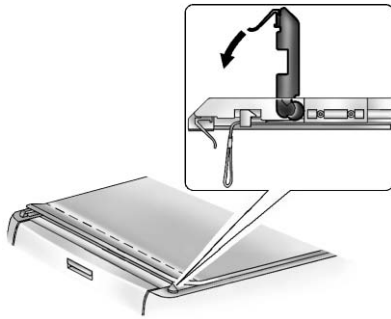

5. When the cover is rolled out, place the rear rail into the rear pivot mounts. Firmly press down on each side of the cover, until the latches are secured into the side rails. If latch is too tight, loosen the tension adjustment screws. If the latch is not securely holding the rear rail, tighten the tension adjustment screws. Only the driver's side has a latch.

6. Secure the driver side Velcro® of the cover to the side rail. Then pull the cover tight across the bed and fasten the Velcro® on the passenger side.



7. Secure the buckles by folding them once, then slide them under the cord located on the cover.

Secure in Open Position

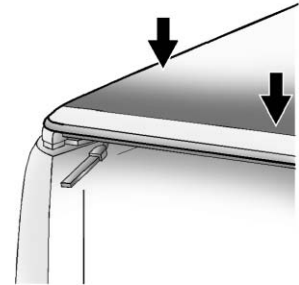

1. To open the cover, open tailgate and push down on the cover. The pull back on pull strap.
2. From the drivers side, roll the cover up tightly.
3. When the cover is rolled up, buckle both tie-down straps. Pull both straps tight.

4-12 Storage

Removal

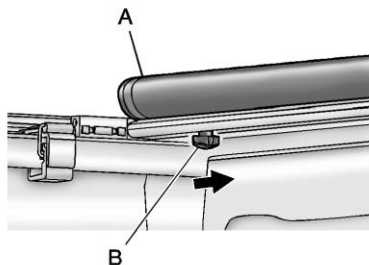

1. Secure the cover (A) into the open position.
2. Loosen wing bolts (B) on both driver and passenger side of front rail, then slide latches inboard until released from the side rail.

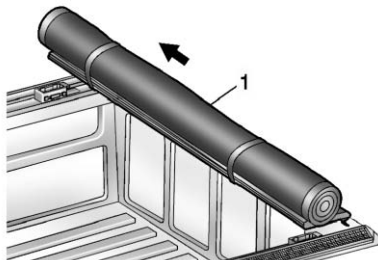

3. Pick the cover assembly up on the driver side and pull the whole assembly off the truck box.

Adjustment

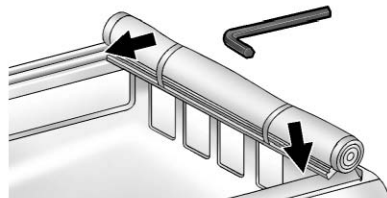

1. If the cover is too loose, turn the tensioning screw clockwise to tighten the tension of the vinyl. This makes it harder to operate the rear release latch. The tensioning screws are located on each side rail. Use the provided 1/4 inch key to turn the tensioning screws.
2. Adjust the screws on both sides to the same tension.

Instruments and Controls

Warning Lights, Gauges, and Indicators

Instrument Cluster	5-2
Tachometer	5-3
Fuel Gauge	5-3
Fuel Economy Gauge	5-4
Engine Oil Pressure Gauge ...	5-5

Engine Coolant Temperature Gauge	5-7
Charging System Light	5-7
Brake System Warning Light	5-8
Antilock Brake System (ABS) Warning Light	5-9
StabiliTrak [®] Indicator Light	5-9
Engine Oil Pressure Light	5-10

Information Displays

Driver Information Center (DIC)	5-11
---------------------------------------	------

Vehicle Messages

Vehicle Messages	5-11
Battery Voltage and Charging Messages	5-12
Brake System Messages	5-12
Door Ajar Messages	5-12
Engine Oil Messages	5-12
Service Vehicle Messages ...	5-12

5-2 Instruments and Controls

Warning Lights, Gauges, and Indicators

Instrument Cluster

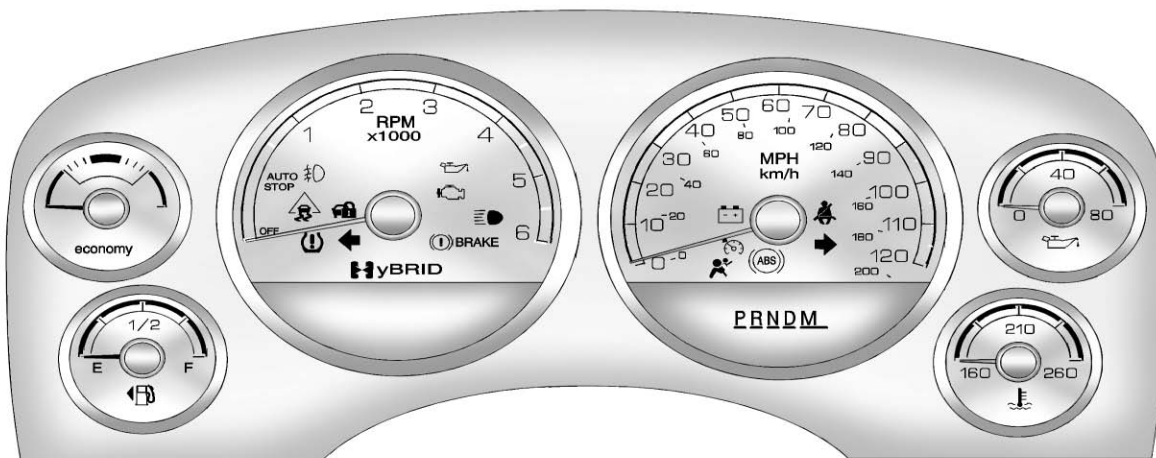

English version shown, Metric similar

Tachometer

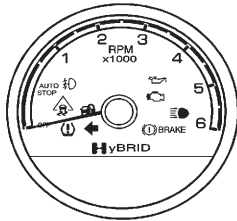

English Version shown, Metric similar

When the gas engine is off and the key is in the ON/RUN position, the position of the tachometer indicator shows the state of the vehicle:

- AUTO STOP position indicates that the vehicle is still able to move and the engine could restart, by an Auto Start, at any time.
- OFF position indicates that the vehicle is off.

When the engine is on, the tachometer indicator shows the engine's revolutions per minute (rpm).

Fuel Gauge

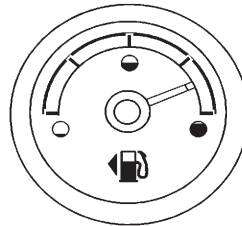

Metric

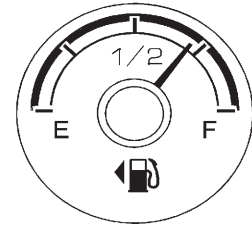

English

When the ignition is on, the fuel gauge shows approximately how much fuel is left in the fuel tank. An arrow on the fuel gauge indicates the side of the vehicle the fuel door is on. The gauge first indicates E (empty) before the vehicle is out of fuel, but the vehicle should be refueled as soon as possible.

5-4 Instruments and Controls

Listed are four situations that may occur with the fuel gauge, none of these indicate a problem:

- At the gas station, the fuel pump shuts off before the gauge reads F (full).
- It takes a little more or less fuel to fill up than the fuel gauge indicated. For example, the gauge may have indicated the tank was half full, but it actually took a little more or less than half the tank's capacity to fill the tank.
- The gauge moves a little while turning a corner or while accelerating.
- The gauge does not go back to E (empty) when the ignition is turned off.

Fuel Economy Gauge

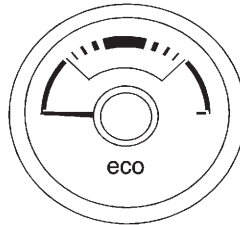

Metric

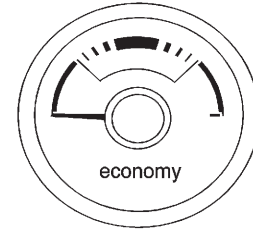

English

This gauge shows displays how efficiently the vehicle is being driven.

There are three zones on the drive efficiency gauge.

Green Zone: Fuel efficient driving behavior makes the indicator display in the green zone on the gauge.

White Zones: Decreased fuel efficiency driving behavior makes the indicator display in the two white zones. The indicator in the white zone on the left side of the gauge indicates decreased fuel efficiency with a large amount of decelerations. The indicator in the white zone on the right side of the gauge indicates decreased fuel efficiency with a large amount of accelerations.

Engine Oil Pressure Gauge

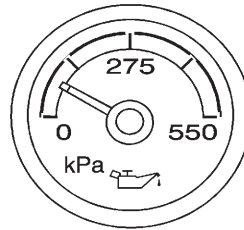

Metric

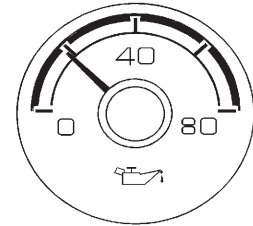

English

The oil pressure gauge shows the engine oil pressure in psi (pounds per square inch) when the engine is running. Canadian vehicles indicate pressure in kPa (kilopascals).

5-6 Instruments and Controls

Oil pressure should be 200 to 550 kPa (29 to 80 psi). In certain situations, such as long extended idles on hot days, it could read as low as 105 kPa (15 psi) and still be considered normal.

A reading in the low pressure zone may be caused by a dangerously low oil level or some other problem causing low oil pressure. Check the oil as soon as possible.



WARNING

Do not keep driving if the oil pressure is low. The engine can become so hot that it catches fire. Someone could be burned. Check the oil as soon as possible and have the vehicle serviced.

Notice: Lack of proper engine oil maintenance can damage the engine. The repairs would not be covered by the vehicle warranty. Always follow the maintenance schedule for changing engine oil.

AUTO STOP

When the engine goes into Automatic Engine Stop, the oil pressure gauge drops to zero when the tachometer is at the AUTO STOP position. This is normal and oil pressure returns to the normal operating range once the engine starts.

See *Starting the Vehicle on page 9-2* for more information.

AUTO STOP displays in the Driver Information Center (DIC) when the vehicle speed is zero. See *Driver Information Center (DIC) on page 5-11* for more information.

Engine Coolant Temperature Gauge

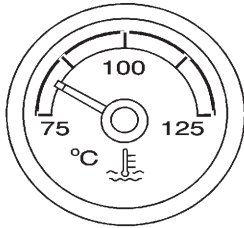

Metric

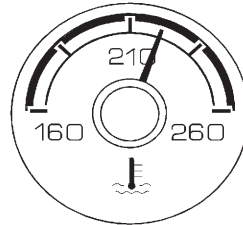

English

This gauge shows the engine coolant temperature.

It also provides an indicator of how hard the vehicle is working. During a majority of the operation, the gauge reads 100°C (210°F) or less. If a load is being pulled or going up hills, it is normal for the temperature to fluctuate and go over the 113°C (235°F) mark. However, if the gauge reaches the 125°C (260°F) mark, it indicates that the cooling system is working beyond its capacity.

Charging System Light

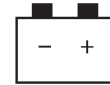

This 12-volt battery light comes on briefly when the ignition is turned to ON/RUN, but the engine is not running, as a check to show it is working.

It should go out once the engine has been started. If it stays on, or comes on while driving, there could be a problem with the 12-volt charging system. Have the vehicle serviced by your dealer. A 12-volt charging system Driver Information Center (DIC) message may also appear. See *Driver Information Center (DIC)* on page 5-11 for more information. This light could indicate that there are electrical problems.

5-8 Instruments and Controls

Have it checked right away. If a short distance must be driven with the light on, be certain to turn off all the accessories.

Brake System Warning Light

With the ignition in ON/RUN, the brake system warning light comes on when the parking brake is set. If the vehicle is driven with the parking brake engaged, a chime sounds when the vehicle speed is greater than 8 km/h (5 mph).

The vehicle brake system consists of two hydraulic circuits. If one circuit is not working, the remaining circuit can still work to stop the vehicle. For normal braking performance, both circuits need to be working.

If the warning light comes on and a chime sounds there could be a brake problem. Have the brake system inspected right away.

This light also comes on due to low brake fluid. See the owner manual for more information.



Metric



BRAKE

English

This light should come on briefly when the ignition key is turned to ON/RUN. If it does not come on then, have it fixed so it will be ready to warn if there is a problem.

WARNING

The brake system might not be working properly if the brake system warning light is on. Driving with the brake system warning light on can lead to a crash. If the light is still on after the vehicle has been pulled off the road and carefully stopped, have the vehicle towed for service.

If the light comes on while driving, pull off the road and stop carefully. The pedal might be harder to push or can go closer to the floor. It may take longer to stop. If the light does not go out, have the vehicle towed for service. See *General Towing Information on page 9-9*.

Antilock Brake System (ABS) Warning Light



For vehicles with the Antilock Brake System (ABS), this light comes on briefly when the engine is in ON/RUN.

That is normal. If the light does not come on then, have it fixed so it will be ready to warn if there is a problem.

If the ABS light stays on, turn the ignition off, if the light comes on while driving, stop as soon as it is safely possible and turn the ignition off. Then start the engine again to reset the system. If the ABS light still stays on, or comes on again while driving, the vehicle needs service. If the regular brake system warning light is not on, the vehicle still has brakes, but not antilock brakes. If the regular brake system warning light is also on, the vehicle does not have antilock brakes and there is a problem with the regular brakes. See *Brake System Warning Light on page 5-8*.

For vehicles with a Driver Information Center (DIC), see *Driver Information Center (DIC) on page 5-11* for all brake related DIC messages.

StabiliTrak[®] Indicator Light



For vehicles with StabiliTrak, this warning light comes on briefly when the ignition is in ON/RUN.

If it does not, have the vehicle serviced by your dealer. If the system is working normally the indicator light goes off.

5-10 Instruments and Controls

If the light comes on and stays on while driving, there could be a problem with the StabiliTrak system and the vehicle might need service. When this warning light is on, the StabiliTrak system is off and does not limit wheel spin.

The light flashes if the system is active and is working to assist the driver with directional control of the vehicle in difficult driving conditions.

See the owner manual for more information.

Engine Oil Pressure Light



WARNING

Do not keep driving if the oil pressure is low. The engine can become so hot that it catches fire. Someone could be burned. Check the oil as soon as possible and have the vehicle serviced.

Notice: Lack of proper engine oil maintenance can damage the engine. The repairs would not be covered by the vehicle warranty. Always follow the maintenance schedule for changing engine oil.



This light comes on briefly as a check it works, when the ignition is in ON/RUN . If it does not, have the vehicle serviced.

If the light comes on and stays on, it means that oil is not flowing through the engine properly. The vehicle could be low on oil and might have some other system problem.

During an AUTO STOP there is zero oil pressure, but this light will not come on.

Information Displays

Driver Information Center (DIC)

Trip/Fuel Menu Items

Press the trip/fuel button to display the Trip/Fuel Menu items. For more items see "Driver Information Center (DIC)" in the owner manual.

BATTERY VOLTAGE

This display shows the current battery voltage. If the voltage is in the normal range, the value will display. For example, the display may read BATTERY VOLTAGE 13 VOLTS. Your vehicle's charging system regulates voltage based on

the state of the battery. The battery voltage may fluctuate when viewing this information on the DIC. This is normal. See "Charging System Light" in the owner manual for more information. If there is a problem with the battery charging system, the DIC will display a message. See *Battery Voltage and Charging Messages on page 5-12*.

INST ECON (Instantaneous Economy)

This display normally shows instantaneous fuel economy. When the vehicle is in Auto Stop mode AUTO STOP or IFE = 0 L/100km or IFE = 99 MPG will be displayed. See *Starting the Vehicle on page 9-2* for more information.

Vehicle Messages

Messages displayed on the DIC indicate the status of the vehicle or some action may be needed to correct a condition. Multiple messages may appear one after another.

The messages that do not require immediate action can be acknowledged and cleared by pressing ✓ (Set/Reset).

The messages that require immediate action cannot be cleared until that action is performed.

All messages should be taken seriously. Clearing the message does not correct the problem.

The following are the possible messages for the Hybrid and some information about them. For information on other DIC messages, see "Vehicle Messages" in the owner manual.

Battery Voltage and Charging Messages

SERVICE BATTERY CHARGING SYSTEM

If the 12V battery system faults or fails this message will appear on the DIC. The battery/charging system light will appear in the instrument panel cluster. See “Battery Warning Light” in the owner manual. Driving with this message on could drain the battery. Have the electrical system checked as soon as possible.

Brake System Messages

SERVICE BRAKE SYSTEM

This message will be displayed if there is a problem with the brake system. You will still be able to brake, but it will be noticeably more difficult. Pull off the road to a safe location and have your vehicle

towed to the nearest dealer for service. See “Brakes,” “Brake System Warning Light,” and “ABS Brake System Warning Light” in the owner manual.

Door Ajar Messages

HOOD OPEN

If the hood is not fully closed or there is a problem with the hood switch, this message will be displayed. Close the hood to clear the message. If the HOOD OPEN message continues to be displayed after verifying the hood is closed, you should have the hood switch serviced. Failure to service the hood switch properly can result in an Auto Start condition.

Auto Stops will be disabled when this message is displayed. If the vehicle is in auto stop mode when this message appears, the engine will instantly start.

Engine Oil Messages

OIL PRESSURE LOW STOP ENGINE

If engine oil pressure is low, this message will be displayed on the DIC. Stop the vehicle as soon as safely possible and do not operate it until the cause of the low oil pressure has been corrected. Check your oil level as soon as possible and have your vehicle serviced. See “Engine Oil” in the owner manual.

Service Vehicle Messages

SERVICE HYBRID SYSTEM

If this message is displayed on the DIC, the vehicle may continue to operate, but you need to have it serviced as soon as possible.

SERVICE POWER STEERING

This message displays if a problem has been detected with the electric power steering. Have your vehicle serviced by your dealer immediately.

Infotainment System

Introduction

Introduction 7-1

Introduction

For vehicles with a navigation radio system, see the Navigation System manual for more information.

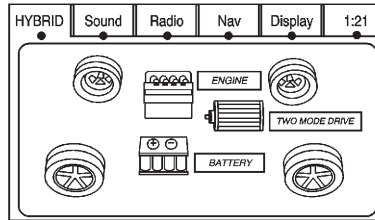

To view the hybrid screen, press the MENU button on the radio. The hybrid screen displays when entering the Configuration Menu.

The display shows:

- Auto Stop
- Battery Charging
- Engine Idle
- 2-Wheel and 4-Wheel Drive Modes for:
 - Engine Power
 - Battery Power
 - Hybrid Power

Climate Controls

Climate Control Systems

Climate Control Systems 8-1

Climate Control Systems

For more information on the vehicle's climate control system, see "Climate Control System" in the owner manual.

Electric Air Conditioning Compressor

This hybrid vehicle has an electrically powered air conditioning compressor. This allows for continuous air conditioning operation and passenger comfort, even while the hybrid engine cycles on and off.

When operating the climate control system, select the AUTO mode and the desired temperature setting. The climate control system automatically

adjusts the fan speed and airflow direction. The climate control system continues to adjust the climate control settings chosen for best use of electrical power.

At mild temperatures, select a warmer air conditioner temperature or turn the air conditioner off to get maximum fuel economy. Continuous air conditioner use can cause the vehicle to Auto Start more frequently. During hot weather, driving with the windows closed and the air conditioner set to Auto mode, will result in better Hybrid system performance.

Some noise may be heard occasionally from the compressor, especially when air conditioning use is high and the engine has turned off.

Driving and Operating

Driving Information

Steering 9-1

Starting and Operating

Starting the Vehicle 9-2

Engine Coolant Heater 9-3

Engine Exhaust

Running the Vehicle While

Parked 9-4

Automatic Transmission

Automatic Transmission 9-5

Manual Mode 9-7

Brakes

Regenerative Braking 9-8

Towing

General Towing Information ... 9-9

Trailer Towing 9-9

Towing Equipment 9-10

Driving Information

Steering

This vehicle has On-Demand Electric-Assist Power Steering instead of conventional full-time hydraulic power steering. It uses electricity supplied by the same battery which is re-charged by the regenerative braking system.

Because the system is On-Demand Electric-Assist, energy is used only when the steering wheel is turned, or when the steering gear is used to help isolate the forces of rough roads. This system does not use power steering fluid, making it maintenance-free.

Starting and Operating

Starting the Vehicle

WARNING

Exiting the vehicle, without first shifting into P (Park), may cause the vehicle to move, and you or others can be seriously injured. Because the vehicle has the Automatic Engine Start/Stop feature, the vehicle's engine might seem to be shut off when you come to a complete stop. However, once the brake pedal is released, the vehicle can move. The vehicle's engine can also restart at any time.

Shift to P (Park) and turn the ignition to LOCK/OFF, before exiting the vehicle.

Start the engine as you would any other engine. See "Starting the Engine" in the owner manual for more information on starting. If pulling a trailer with trailer brakes, see *Towing Equipment on page 9-10* for more information.

Auto Stop

The vehicle has an Auto Stop feature. After a successful engine start, the engine may turn off and operate in the Auto Stop mode. Some of the vehicle conditions that allow the engine to stop running and enter the Auto Stop mode are:

- Ignition switch is in the ON/RUN position.
- The hood is closed.
- The gear selector is in P (Park), R (Reverse), N (Neutral) or D (Drive).
- The hybrid battery is at an acceptable state of charge.

- The hybrid battery voltage, temperature or power limits are not exceeded. In very hot conditions, Auto Stop may be unavailable until the hybrid battery has cooled.
- The engine is at operating temperature.
- The vehicle may enter Auto Stop after a remote vehicle start.

With your foot off the brake and the vehicle on level ground, the hybrid drive motor may cause the vehicle to roll slowly forward, even when the engine is in Auto Stop.

Keep your foot firmly on the brake pedal until you are ready for the vehicle to move.

Engine OFF and AUTO STOP modes are indicated on the tachometer display. When the tachometer needle indicates OFF, the engine is not running and will remain off until the ignition key is placed in the START position or a remote vehicle start is performed. When the tachometer needle

indicates AUTO STOP, the hybrid system is on, the engine is not running, but may Auto Start at any time without notice. See *Tachometer on page 5-3* for more information. A chime will sound if the driver door is opened while in Auto Stop as a reminder that the ignition switch is not in the LOCK/OFF position. Always turn the ignition switch to LOCK/OFF and remove the key from the ignition switch when exiting the vehicle.

Auto Start

The vehicle also has an Auto Start feature. The engine will remain off while in Auto Stop mode until vehicle conditions require the engine to run. The near-instant starting of the engine from Auto Stop mode is called Auto Start. Some of the vehicle conditions that may cause the engine to Auto Start are:

- The hood is opened.
- The gear selector is in M (Manual Mode).

- The hybrid battery state of charge is too low.
- The hybrid battery voltage, temperature or power limits are exceeded.
- A remote vehicle start has been requested.
- The engine is not at operating temperature.
- Acceleration demands require the use of the engine.

EV Mode

The vehicle also has an Electric Vehicle (EV) mode which uses only the electric motor to move the vehicle. With light acceleration, the vehicle will drive in EV mode. EV mode is unavailable when the vehicle is out of fuel.

If increased acceleration is required, or the vehicle reaches approximately 40 km/h (30 mph), the engine will start automatically.

The engine shuts off at speeds below 40 km/h (25 mph) unless the transmission is in M (Manual Mode) or Auto Stop is disabled.

During heavy acceleration, both the engine and hybrid electric motors supply power. A sensation similar to a transmission gear change can be felt as the transmission changes modes. Engine RPM may remain above 4,000 RPM for a longer period during hard acceleration.

Engine Coolant Heater

The engine coolant heater can provide easier starting and better fuel economy during engine warm-up in cold weather conditions at or below -18°C (0°F). Vehicles with an engine heater should be plugged in at least four hours before starting. An internal thermostat in the plug-end of the cord may exist which will prevent engine coolant heater operation at temperatures above -18°C (0°F).

9-4 Driving and Operating

Using the Engine Coolant Heater

1. Turn off the engine.
2. Open the hood and unwrap the electrical cord. The cord is secured to a wiring harness between the engine and the Hybrid Auxiliary Underhood Fuse Block with a clip. Carefully remove the wire tie which secures the electrical cord. Do not cut the electrical cord.
3. Plug the cord into a normal, grounded 110-volt AC outlet.

WARNING

Plugging the cord into an ungrounded outlet could cause an electrical shock. Also, the wrong kind of extension cord could overheat and cause a fire.

(Continued)

WARNING (Continued)

You could be seriously injured. Plug the cord into a properly grounded three-prong 110-volt AC outlet. If the cord will not reach, use a heavy-duty three-prong extension cord rated for at least 15 amps.

4. Before starting the engine, be sure to unplug and store the cord as it was before to keep it away from moving engine parts. If you do not, it could be damaged.

The length of time the heater should remain plugged in depends on several factors. Ask a dealer in the area where you will be parking the vehicle for the best advice on this.

Engine Exhaust

Running the Vehicle While Parked

It is better not to park with the engine running. But if you ever have to, here are some things to know.

WARNING

Exiting the vehicle, without first shifting into P (Park), may cause the vehicle to move, and you or others can be seriously injured. Because the vehicle has the Automatic Engine Start/Stop feature, the vehicle's engine might seem to be shut off when you come to a complete stop. However, once the brake pedal is released, the vehicle can move. The vehicle's engine can also restart at any time.

(Continued)

WARNING (Continued)

Shift to P (Park) and turn the ignition to LOCK/OFF, before exiting the vehicle.

Follow the proper steps to be sure the vehicle will not move. See “Shifting Into Park” in the owner manual for more information.

If pulling a trailer, see “Driving Characteristics and Towing Tips” in the owner manual.

Automatic Transmission

The vehicle has an electronic shift position indicator within the instrument panel cluster.

There are several different positions for the shift lever.



See “Range Selection Mode” in this section.

P (Park): This position locks the rear wheels. It is the best position to use when you start the engine because the vehicle cannot move easily.

When parked on a hill, especially when the vehicle has a heavy load, you may notice an increase in the effort to shift out of P (Park).

See “Shifting Into Park” in the Index of vehicle’s owner manual for more information.

WARNING

It is dangerous to get out of the vehicle if the shift lever is not fully in P (Park) with the parking brake firmly set. The vehicle can roll.

Do not leave the vehicle when the engine is running unless you have to. If you have left the engine running, the vehicle can move suddenly. You or others could be injured. To be sure the vehicle will not move, even when you are on fairly level ground, always set the parking brake and move the shift lever to P (Park). See “Shifting Into Park” in the owner manual. If you are pulling a trailer, see “Driving Characteristics and Towing Tips” in the owner manual.

WARNING

If you have Four-Wheel Drive, the vehicle will be free to roll — even if the shift lever is in P (Park) — if the transfer case is in Neutral. So, be sure the transfer case is in a drive gear, Two-Wheel Drive High or Four-Wheel Drive High or Four-Wheel Drive Low — not in Neutral. See “Shifting Into Park” in the owner manual.

R (Reverse): Use this gear to back up.

Notice: Shifting to R (Reverse) while the vehicle is moving forward could damage the transmission. The repairs would not be covered by the vehicle warranty. Shift to R (Reverse) only after the vehicle is stopped.

To rock the vehicle back and forth to get out of snow, ice, or sand without damaging the transmission, see “If the Vehicle is Stuck” in the Index of the vehicle’s owner manual.

N (Neutral): In this position, the engine and transmission are not connected with the wheels. To restart the engine when the vehicle is already moving, use N (Neutral) only.

WARNING

Shifting into a drive gear while the engine is running at high speed is dangerous. Unless your foot is firmly on the brake pedal, the vehicle could move very rapidly. You could lose control and hit people or objects. Do not shift into a drive gear while the engine is running at high speed.

Notice: Shifting out of P (Park) or N (Neutral) with the engine running at high speed may damage the transmission. The repairs would not be covered by the vehicle warranty. Be sure the engine is not running at high speed when shifting the vehicle.

D (Drive): This position is for normal driving. It provides the best fuel economy. If you need more power for passing, and you are:

- Going less than about 55 km/h (35 mph), push the accelerator pedal about halfway down.
- Going about 55 km/h (35 mph) or more, push the accelerator all the way down.

D (Drive) or M (Manual Mode) can be used when towing a trailer, carrying a heavy load, driving on steep hills, or for off-road driving. You may want to shift the transmission to a lower gear selection if the transmission shifts too often.

Downshifting the transmission in slippery road conditions could result in skidding. See “Skidding” under “Loss of Control” in the owner manual for more information.

When temperatures are very cold, the transmission's gear shifting may be delayed, providing more stable shifts until the engine warms up. Shifts may be more noticeable with a cold transmission. This difference in shifting is normal.

M (Manual Mode): This position lets drivers select the range of gears appropriate for current driving conditions. If the vehicle has this feature, see *Manual Mode* on page 9-7.

Notice: Spinning the tires or holding the vehicle in one place on a hill using only the accelerator pedal may damage the transmission. The repair will not be covered by the vehicle warranty. If you are stuck, do not spin the tires. When stopping on a hill, use the brakes to hold the vehicle in place.

The vehicle has a shift stabilization feature that adjusts the transmission shifting to the current driving conditions to reduce rapid upshifts and downshifts. If the shift stabilization feature determines that a current vehicle speed cannot be maintained, the transmission does not upshift. In some cases, this may appear to be a delayed shift, however the transmission is operating normally.

Manual Mode

Range Selection Mode

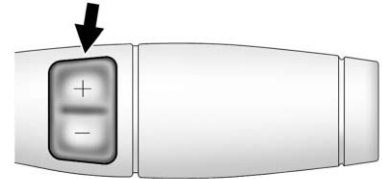

The Range Selection Mode controls the vehicle's transmission.

To use this feature:

1. Move the shift lever to the M (Manual Mode).
2. Press the plus/minus button to upshift or downshift selecting the desired range of gears.

9-8 Driving and Operating

A number displays next to the M, indicating the current gear that has been selected. The number displayed in the gear indicator is the highest gear that can be used. The vehicle can automatically shift to lower gears as it adjusts to driving conditions. When 3 (Third) is selected, 1 (First) through 3 (Third) gears are automatically shifted by the vehicle, but 4 (Fourth) cannot be used until it is selected.

The Range Selection Mode controls the vehicle and engine speed while driving down a hill or towing a trailer, by allowing you to select a desired range of gears.

When you move the shift lever into M, the transmission will default to M4. In this gear range, effective engine braking occurs at speeds above 72 km/h (45 mph).

Pushing the minus (-) button on the shift lever reduces the gear range.

In the M3 gear range, effective engine braking occurs at speeds above 56 km/h (35 mph).

In the M2 gear range, effective engine braking occurs at speeds above 40 km/h (25 mph).

In the M1 gear range, effective engine braking occurs at speeds above 16 km/h (10 mph).

When operating in M (Manual Mode), Auto Stop is disabled. For better vehicle efficiency, operate the vehicle in D (Drive) not M (Manual Mode).

Cruise control can be used while using the Range Selection Mode.

Brakes

Regenerative Braking

Regenerative braking is a hybrid technology that enables the electric drive motor to operate as a generator when coasting or braking. Energy from the moving vehicle recharges the hybrid battery.

The hydraulic disc brakes work with the regenerative braking to insure effective braking, such as when a high braking demand is requested.

The braking system is computer controlled and blends the regenerative braking with the conventional hydraulic disc brakes to meet any requirements for deceleration. The controller interprets the braking request and uses regenerative braking, conventional hydraulic braking or a combination of both as necessary.

Because the controller applies the hydraulic brakes through its high pressure accumulator, you may occasionally hear the motor driven pump when it recharges the system. This is normal.

In the event of a controller problem, the brake pedal may be harder to push and the stopping distance may be longer.

Towing

General Towing Information

Consult your dealer or a professional towing service if the disabled vehicle needs to be towed.

Trailer Towing

For more information, see "Trailer Towing" in the owner manual.

Weight of the Trailer

How heavy can a trailer safely be?

It depends on how the rig is used. For example, speed, altitude, road grades, outside temperature and how much the vehicle is used to pull

a trailer are all important. It can depend on any special equipment on the vehicle, and the amount of tongue weight the vehicle can carry.

Maximum trailer weight is calculated assuming only the driver is in the tow vehicle and it has all the required trailering equipment. The weight of additional optional equipment, passengers and cargo in the tow vehicle must be subtracted from the maximum trailer weight.

9-10 Driving and Operating

Use the following charts to determine how much the vehicle can weigh, based upon the vehicle model and options.

Vehicle	Axle Ratio	Maximum Trailer Weight	GCWR*
2WD 6.0 L V8	3.08	2 767 kg (6,100 lbs)	5 443 kg (12,000 lbs)
4WD 6.0 L V8	3.08	2 676 kg (5,900 lbs)	5 443 kg (12,000 lbs)

*The Gross Combination Weight Rating (GCWR) is the total allowable weight of the completely loaded vehicle and trailer including any passengers, cargo, equipment and conversions. The GCWR for the vehicle should not be exceeded.

Towing Equipment

Trailer Brakes

If a trailer is being towed that has trailer brakes and the trailer brakes are manually applied while driving slower than 40 km/h (25 mph), the vehicle may go into auto stop mode

even if the brakes are not being pressed. Using the trailer brake system manually can make the hybrid vehicle perform as if the brake pedal in the vehicle is being pressed. The trailer brake operation check will still work. If the trailer brakes are manually applied for an extended period of time, the

SERVICE BRAKE SYSTEM message comes on in the Driver Information Center. The message goes off after the trailer brakes have been released. No other action is necessary. For more information, see "Towing Equipment" in the owner manual.

Vehicle Care

Vehicle Checks

Doing Your Own
Service Work 10-2

Engine Compartment
Overview 10-4

Automatic Transmission
Fluid 10-5

Drive Motor/Generator Control
Module (DMCM) Coolant
Surge Tank
Pressure Cap 10-8

Drive Motor/Generator Control
Module (DMCM) Cooling
System 10-8

Power Steering Fluid 10-12

Battery 10-12

Electrical System

High Voltage Devices and
Wiring 10-13

Fuses and Circuit
Breakers 10-13

Engine Compartment Fuse
Block 10-14

Jump Starting

Jump Starting 10-15

Towing

Recreational Vehicle
Towing 10-19

Appearance Care

Exterior Care 10-24

Vehicle Checks

Doing Your Own Service Work

 **WARNING**

Never try to do your own service on hybrid components. You can be injured and the vehicle can be damaged if you try to do your own service work. Service and repair of these hybrid components should only be performed by a trained service technician with the proper knowledge and tools.

 **WARNING**

You can be injured and the vehicle could be damaged if you try to do service work on a vehicle without knowing enough about it.

- Be sure you have sufficient knowledge, experience, the proper replacement parts, and tools before attempting any vehicle maintenance task.
- Be sure to use the proper nuts, bolts, and other fasteners. English and metric fasteners can be easily confused. If the wrong fasteners are used, parts can later break or fall off. You could be hurt.

If doing some of your own service work, use the proper service manual. It tells you much more about how to service the vehicle than this manual can. To order the proper service manual, see “Service Publications Ordering Information” in the owner manual.

This vehicle has an airbag system. Before attempting to do your own service work, see “Airbag System Check” in the owner manual.

Keep a record with all parts receipts and list the mileage and the date of any service work performed. See “Maintenance Records” in the owner manual.

10-4 Vehicle Care

Engine Compartment Overview

6.0 L V8 Engine

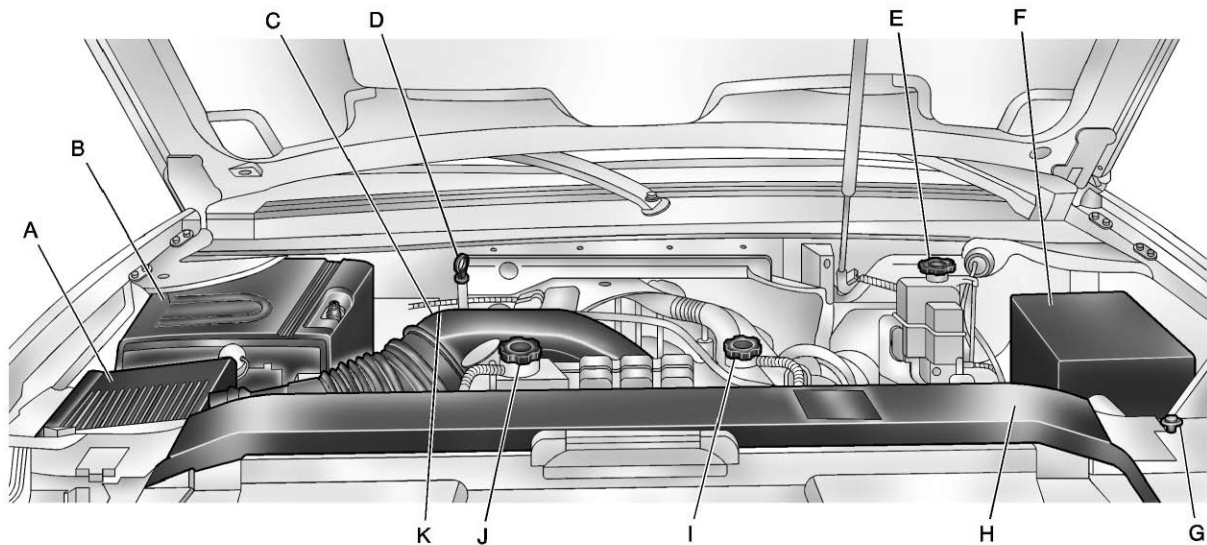

- A. See “Engine Air Cleaner/Filter” in the owner manual.
- B. Drive Motor/Generator Control Module (DMCM). See *Drive Motor/Generator Control Module (DMCM) Cooling System on page 10-8*.
- C. Engine Oil Dipstick (Out of View). See “Engine Oil” in the owner manual.
- D. Automatic Transmission Fluid Dipstick. See *Automatic Transmission Fluid on page 10-5*.
- E. Brake Fluid Reservoir. See “Brakes” in the owner manual.
- F. See “Engine Compartment Fuse Block” in the owner manual.
- G. Windshield Washer Fluid Reservoir. See “Washer Fluid” in the owner manual.
- H. Hybrid Auxiliary Fuse Block (Out of View). See *Engine Compartment Fuse Block on page 10-14*.

- I. DMCM Coolant Surge Tank Pressure Cap. See *Drive Motor/Generator Control Module (DMCM) Coolant Surge Tank Pressure Cap on page 10-8*.
- J. Coolant Surge Tank Pressure Cap. See “Engine Coolant” in the owner manual.
- K. Engine Oil Fill Cap (Out of View). See “Engine Oil” in the owner manual.

Automatic Transmission Fluid

When to Check and Change Automatic Transmission Fluid

It is usually not necessary to check the transmission fluid level. The only reason for fluid loss is a transmission leak or overheating the transmission. If a small leak is suspected, then use the following checking procedures to check the

fluid level. However, if there is a large leak, then it may be necessary to have the vehicle towed to a dealer service department and have it repaired before driving the vehicle further.

Notice: Use of the incorrect automatic transmission fluid may damage the vehicle, and the damages may not be covered by the vehicle warranty. Always use the automatic transmission fluid listed in *Recommended Fluids and Lubricants on page 11-2*.

Change the fluid and filter at the scheduled maintenance intervals listed in Scheduled Maintenance. Be sure to use the transmission fluid listed in *Recommended Fluids and Lubricants on page 11-2*.

How to Check Automatic Transmission Fluid

Notice: Too much or too little fluid can damage the transmission. Too much can mean that some of the fluid could come out and fall on hot engine parts or exhaust system parts, starting a fire. Too little fluid could cause the transmission to overheat. Be sure to get an accurate reading if checking the transmission fluid.

Before checking the fluid level, prepare the vehicle as follows:

1. Start the engine and park the vehicle on a level surface. Keep the engine running.
2. Apply the parking brake and place the shift lever in P (Park).

3. With your foot on the brake pedal, move the shift lever through each gear range, pausing for about three seconds in each range. Then, move the shift lever back to P (Park).
4. Allow the engine to idle (500–800 RPM) for at least one minute. Slowly release the brake pedal.
5. Keep the engine running and press the Trip/Fuel button or trip odometer reset stem until TRANS TEMP (Transmission Temperature) displays on the Driver Information Center (DIC).
6. Using the TRANS TEMP reading, determine and perform the appropriate check procedure. If the TRANS TEMP reading is not within the required temperature ranges, allow the vehicle to cool, or operate the vehicle until the appropriate transmission fluid temperature is reached.

Cold Check Procedure

Use this procedure only as a reference to determine if the transmission has enough fluid to be operated safely until a hot check procedure can be made. The hot check procedure is the most accurate method to check the fluid level. Perform the hot check procedure at the first opportunity. Use this cold check procedure to check fluid level when the transmission temperature is between 24°C and 34°C (75°F and 93°F).



1. Locate the transmission dipstick at the rear of the engine compartment, on the passenger side of the vehicle. See *Engine Compartment Overview* on page 10-4 for more information.

2. Pull out the dipstick and wipe it with a clean rag or paper towel.
3. Install the dipstick by pushing it back in all the way, wait three seconds, and then pull it back out again.
4. Check both sides of the dipstick and read the lower level. Repeat the check procedure to verify the reading.



5. If the fluid level is below the COLD check band, add only enough fluid as necessary to bring the level into the COLD band. It does not take much fluid, generally less than 0.5 Liter (1 Pint). Do not overfill.

6. Perform a hot check at the first opportunity after the transmission reaches a normal operating temperature between 60°C and 75°C (140°F and 167°F).
7. If the fluid level is in the acceptable range, push the dipstick back in all the way.

Hot Check Procedure

Use this procedure to check the transmission fluid level when the transmission fluid temperature is between 60°C and 75°C (140°F and 167°F).

The hot check is the most accurate method to check the fluid level. The hot check should be performed at the first opportunity in order to verify the cold check. The fluid level rises as fluid temperature increases, so it is important to ensure the transmission temperature is within range.



1. Locate the transmission dipstick at the rear of the engine compartment, on the passenger side of the vehicle.

See *Engine Compartment Overview on page 10-4* for more information.

2. Pull out the dipstick and wipe it with a clean rag or paper towel.
3. Install the dipstick by pushing it back in all the way, wait three seconds, and then pull it back out again.
4. Check both sides of the dipstick and read the lower level. Repeat the check procedure to verify the reading.



5. Safe operating level is within the HOT cross hatch band on the dipstick. If the fluid level is not within the HOT band, and the transmission temperature is between 60°C and 75°C (140°F and 167°F), add or drain fluid as necessary to bring the level into the HOT band. If the fluid level is low, add only enough fluid to bring the level into the HOT band. It does not take much fluid, generally less than 0.5 Liter (1 Pint). Do not overfill.
6. If the fluid level is in the acceptable range, push the dipstick back in all the way.

Consistency of Readings

Always check the fluid level at least twice using the procedure described previously. Consistency (repeatable readings) is important to maintaining proper fluid level. If readings are still inconsistent, contact your dealer.

Drive Motor/Generator Control Module (DMCM) Coolant Surge Tank Pressure Cap



See *Engine Compartment Overview on page 10-4* for more information on location.

The Drive Motor/Generator Control Module (DMCM) coolant surge tank pressure cap must be fully installed on the hybrid coolant surge tank.

Notice: If the pressure cap is not tightly installed, coolant loss and possible damage to the Drive Motor/Generator Control Module (DMCM) may occur. Be sure the cap is properly and tightly secured.

Drive Motor/Generator Control Module (DMCM) Cooling System

In addition to the regular cooling system, the vehicle also has a cooling system for the DMCM system. This system is serviced differently than the vehicle's main cooling system. The DMCM cooling system includes the DMCM coolant surge tank, DMCM surge tank pressure cap, DMCM cooling pumps, hybrid cooling radiator and the Drive Motor/Generator Control Module (DMCM). The DMCM cooling system uses a 50/50 pre-mixed DEX-COOL[®] coolant and deionized water available at your

dealer. See “Engine Coolant” and “Cooling System” in the owner manual for more information.

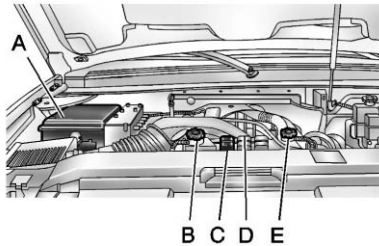

When it is safe to lift the hood:

- A. Drive Motor/Generator Control Module (DMCM)
- B. Engine Coolant Surge Tank Pressure Cap
- C. DMCM Coolant Surge Tank/ Engine Coolant Surge Tank

- D. DMCM Cooling Hoses (Out of View)
- E. DMCM Coolant Tank Pressure Cap

If the coolant inside the DMCM coolant surge tank is boiling, do not do anything else until it cools down.

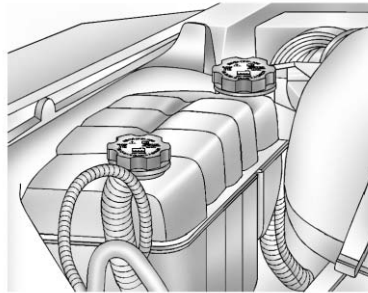

The coolant level should be at or above the FULL COLD mark with the vehicle parked on a level surface. If it is not, there might be a

leak at the DMCM cooler core, DMCM pressure cap, DMCM cooler hoses, DMCM cooling pump or somewhere else in the DMCM cooling system.

Notice: Running the engine when there is a leak in the hybrid cooling system can cause the hybrid cooling system to lose all coolant and can damage the system. Get any leak fixed before you drive the vehicle or run the engine.

How to Add Coolant to the DMCM Coolant Surge Tank

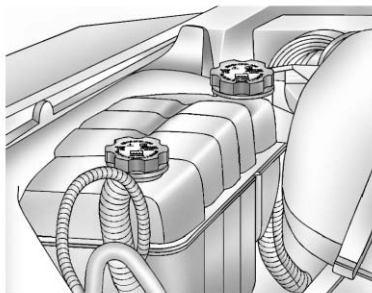

If no problem has been found yet, check to see if coolant is visible in the DMCM coolant surge tank. If coolant is visible, add pre-mixed DEX-COOL coolant, available at your dealer, at the DMCM coolant surge tank, but be sure the DMCM cooling system, including the DMCM coolant surge tank pressure cap, is cool before you do it. Use the procedure following.

WARNING

Steam and scalding liquids from a hot cooling system can blow out and burn you badly. They are under pressure, and if you turn the coolant surge tank pressure cap — even a little — they can come out at high speed. Never turn the cap when the cooling system, including the coolant surge tank pressure cap, is hot. Wait for the cooling system and coolant surge tank pressure cap to cool if you ever have to turn the pressure cap.

Notice: Using coolant other than a pre-mixed DEX-COOL, available at your dealer, may damage your vehicle. Any repairs would not be covered by your warranty. Always use a pre-mixed DEX-COOL (silicate-free) coolant in your vehicle.

WARNING

You can be burned if you spill coolant on hot engine parts. Coolant contains ethylene glycol and it will burn if the engine parts are hot enough. Do not spill coolant on a hot engine.

If the DMCM coolant is empty, the vehicle must be serviced by your dealer and a special fill procedure must be followed.

Notice: Attempting to fill the DMCM cooling surge tank yourself when the fluid level is empty can damage your vehicle. Your vehicle must be serviced.

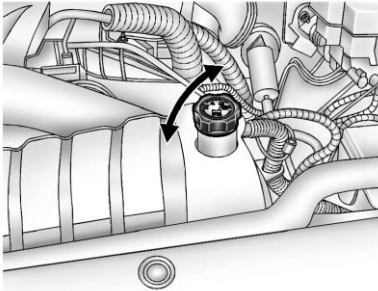

1. Park the vehicle on a level surface and turn the vehicle off. Remove the DMCM coolant surge tank pressure cap when the DMCM cooling system, including the DMCM coolant surge tank pressure cap and DMCM cooling hoses, are no longer hot. Turn the DMCM coolant surge tank pressure cap slowly counterclockwise (left) about one full turn. Wait 30 seconds.

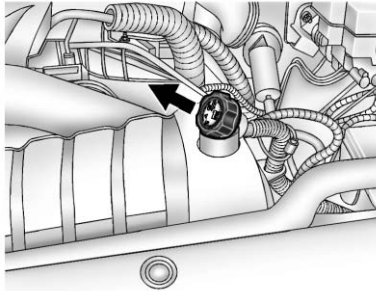

2. Then keep turning the DMCM coolant surge tank pressure cap slowly, and remove it.
3. Add the pre-mixed DEX-COOL, available at your dealer, to the DMCM coolant surge tank until the level reaches the FULL COLD mark.

4. Turn the ignition to ON/RUN without starting the engine. The hybrid cooling pumps will run and any trapped air will purge to the surge tank.
5. Add the pre-mixed DEX-COOL, available at your dealer, until the coolant level is maintained at the FULL COLD mark. This should take no longer than two minutes of hybrid cooling pump operation.

If the level cannot be kept at the FULL COLD level, the vehicle may need service. See your dealer.



6. Then replace the DMCM coolant surge tank pressure cap. Be sure the pressure cap is hand-tight and fully seated.

Notice: Using tap water, cooling system sealers or conditioners in an attempt to stop coolant leaks can damage the DMCM and engine cooling systems. Never use tap water, cooling system sealers or conditioners in your cooling system.

Power Steering Fluid

The vehicle has electric power steering and does not use power steering fluid.

Battery

This vehicle has a standard 12-volt battery and a high voltage hybrid battery.

Refer to the replacement number on the original battery label when a new standard 12-volt battery is needed.

Only a trained service technician with the proper knowledge and tools should inspect, test, or replace the hybrid battery. See your dealer if the hybrid battery needs service. The dealer has information on how to recycle the hybrid battery. There is also information available at <http://www.recyclemybattery.com>.

If an airbag inflates or the vehicle has been in a crash, the vehicle's sensing system might command the automatic hybrid battery disconnect to open. See *Replacing Airbag System Parts After a Crash* on page 3-1 for more information.

DANGER

Battery posts, terminals, and related accessories contain lead and lead compounds, chemicals known to the State of California to cause cancer and reproductive harm. Wash hands after handling.

Vehicle Storage

WARNING

Batteries have acid that can burn you and gas that can explode. You can be badly hurt if you are not careful. See *Jump Starting on page 10-15* for tips on working around a battery without getting hurt.

Infrequent Usage: Remove the 12-volt battery black, negative (-) cable from the battery to keep the battery from running down.

Extended Storage: Remove the 12-volt battery black, negative (-) cable from the battery or use a battery trickle charger.

Remember to reconnect the battery when ready to drive the vehicle.

Electrical System

High Voltage Devices and Wiring

WARNING

Exposure to high voltage can cause shock, burns, and even death. The high voltage systems in your vehicle can only be serviced by technicians with special training.

High voltage devices are identified by labels. Do not remove, open, take apart, or modify these devices. High voltage cable or wiring has orange covering. Do not probe, tamper with, cut, or modify high voltage cable or wiring.

Fuses and Circuit Breakers

The wiring circuits in the vehicle are protected from short circuits by a combination of fuses, circuit breakers and fusible thermal links. This greatly reduces the chance of fires caused by electrical problems.

Be sure you replace a bad fuse with a new one of the identical size and rating.

If you ever have a problem on the road and do not have a spare fuse, you can borrow one that has the same amperage. Just pick some feature of the vehicle that you can get along without, like the radio or cigarette lighter, and use its fuse, if it is the correct amperage. Replace it as soon as you can.

10-14 Vehicle Care

The vehicle also has a special fuse in the battery box for the 300-volt batteries. If this fuse has failed and needs to be replaced, the vehicle will be disabled and you will need to have the vehicle repaired by your dealer. Do not attempt to self-service this fuse.

Engine Compartment Fuse Block

Hybrid Auxiliary Engine Compartment Fuse Block

The hybrid auxiliary engine compartment fuse block is located in the engine compartment near the front of the vehicle. Lift the cover for access to the fuse/relay block. See *Engine Compartment Overview on page 10-4* for more information on its location. For more information on the main underhood fuse block, see “Engine Compartment Fuse Block” in the owner manual.

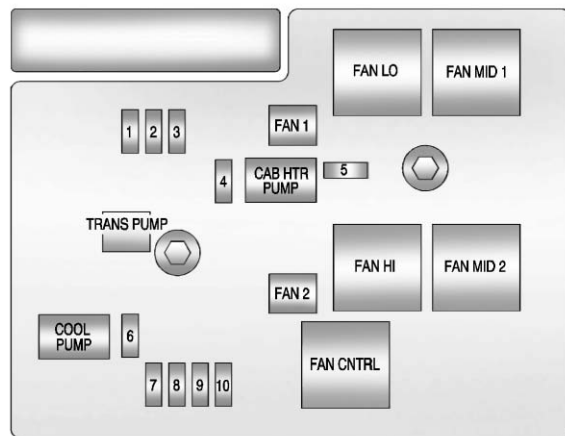

Fuses	Usage
1	ACPO (SUV Only)
2	BECM FAN
3	ACCM

Fuses	Usage
4	CAB HTR PMP
5	EMPTY
6	COOL PUMP

Fuses	Usage
7	EPS
8	Drive Motor/Generator Control Module 1
9	Drive Motor/Generator Control Module 2
10	BECM

J-Case	Usage
FAN 1	Cooling Fan 1
TRANS PUMP	Auxiliary Transmission Fluid Pump
FAN 2	Cooling Fan 2
CAB HTR PMP	Cab Heater Pump

Relays	Usage
CAB HTR PUMP	Cabin Heater Pump
COOL PUMP	Coolant Pump
FAN LOW	Cooling Fan Low Speed Relay
FAN MID 1	Cooling Fan Mid 1
FAN HI	Cooling Fan High Speed Relay
FAN MID 2	Cooling Fan Mid 2
FAN CNTRL	Cooling Fan Control

Jump Starting

 **WARNING**

Personal injury, death, or damage to the vehicle can result if you try jump starting or using a battery charger on the high voltage hybrid battery. Use only the 12-volt battery for jump starting and charging.

For more information about the vehicle's batteries, see *Battery* on page 10-12.

10-16 Vehicle Care

If the vehicle's 12-volt battery has run down, you may want to use another vehicle and some jumper cables to start your vehicle. Use the following steps to do it safely.

WARNING

Batteries can hurt you. They can be dangerous because:

- They contain acid that can burn you.
- They contain gas that can explode or ignite.
- They contain enough electricity to burn you.

If you do not follow these steps exactly, some or all of these things can hurt you.

Notice: Ignoring these steps could result in costly damage to the vehicle that would not be covered by the warranty.

Trying to start the vehicle by pushing or pulling it will not work, and it could damage the vehicle.

1. Check the other vehicle. It must have a 12-volt battery with a negative ground system.

Notice: Only use vehicles with 12-volt systems with negative grounds to jump start your vehicle. If the other vehicle's system is not a 12-volt system with a negative ground, both vehicles can be damaged.

2. Get the vehicles close enough so the jumper cables can reach, but be sure the vehicles are not touching each other. It could cause a ground connection you do not want. You would not be able to start your vehicle, and the bad grounding could damage the electrical systems.

To avoid the possibility of the vehicles rolling, set the parking brake firmly on both vehicles involved in the jump start procedure. Put the automatic transmission in P (Park) or a manual transmission in N (Neutral) before setting the parking brake. If you have a four-wheel-drive vehicle, be sure the transfer case is in a drive gear, not in N (Neutral).

Notice: If you leave the radio or other accessories on during the jump starting procedure, they could be damaged. The repairs would not be covered by the warranty. Always turn off the radio and other accessories when jump starting the vehicle.

3. Turn off the ignition on both vehicles. Unplug unnecessary accessories plugged into the cigarette lighter or the accessory power outlets. Turn off the radio and all the lamps that are not needed.

This avoids sparks and helps save both batteries. It could save the radio!

4. Open the hood on the other vehicle and locate the positive (+) and negative (-) terminal locations on that vehicle.

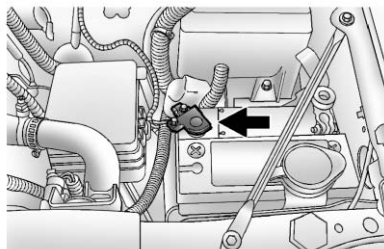

The positive (+) connection is located under a red plastic cover at the positive battery post. To uncover the remote positive (+) terminal, open the red plastic cover.

5. The remote negative (-) is a solid engine ground.

⚠ WARNING

An electric fan can start up even when the engine is not running and can injure you. Keep hands, clothing and tools away from any underhood electric fan.

⚠ WARNING

Using an open flame near a battery can cause battery gas to explode. People have been hurt doing this, and some have been blinded. Use a flashlight if you need more light.

Be sure the battery has enough water. You do not need to add water to the battery installed in your new vehicle. But if a battery has filler caps, be sure the right

(Continued)

WARNING (Continued)

amount of fluid is there. If it is low, add water to take care of that first. If you do not, explosive gas could be present.

Battery fluid contains acid that can burn you. Do not get it on you. If you accidentally get it in your eyes or on your skin, flush the place with water and get medical help immediately.

⚠ WARNING

Fans or other moving engine parts can injure you badly. Keep your hands away from moving parts once the engine is running.

6. Check that the jumper cables do not have loose or missing insulation. If they do, you could get a shock. The vehicles could be damaged too.

10-18 Vehicle Care

Before you connect the cables, here are some basic things you should know. Positive (+) goes to positive (+) or to a remote positive (+) terminal if the vehicle has one. Negative (-) will go to a heavy, unpainted metal engine part or a solid engine ground.

Do not connect positive (+) to negative (-) or you will get a short that would damage the battery and maybe other parts too. Do not connect the negative (-) cable to the negative (-) terminal on the dead battery because this can cause sparks.

7. Connect the red positive (+) cable to the positive (+) terminal of the vehicle with the dead battery. Use a remote positive (+) if the vehicle has one.

8. Do not let the other end touch metal. Connect it to the positive (+) terminal of the good battery. Use a remote positive (+) if the vehicle has one.

9. Now connect the black negative (-) cable to the negative (-) terminal of the good battery. Use a remote negative (-) if the vehicle has one.

Do not let the other end touch anything until the next step. The other end of the negative (-) cable does not go to the dead battery. It goes to a heavy, unpainted metal engine part or to the remote negative (-) terminal on the vehicle with the dead battery.

10. Connect the other end of the negative (-) cable to the remote negative (-) terminal, on the vehicle with the dead battery.
11. Now start the vehicle with the good battery and run the engine for a while.
12. Try to start the vehicle that had the dead battery. If it will not start after a few tries, it probably needs service.

Notice: If the jumper cables are connected or removed in the wrong order, electrical shorting may occur and damage the vehicle. The repairs would not be covered by the vehicle warranty. Always connect and remove the jumper cables in the correct order, making sure that the cables do not touch each other or other metal.

Jumper Cable Removal

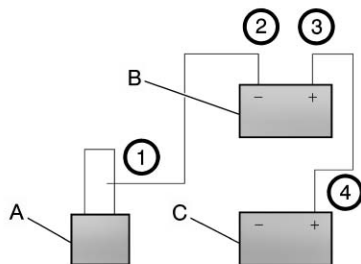

- A. Heavy, Unpainted Metal Engine Part or Remote Negative (-) Terminal
- B. Good Battery or Remote Positive (+) and Remote Negative (-) Terminals
- C. Dead Battery or Remote Positive (+) Terminal

To disconnect the jumper cables from both vehicles:

1. Disconnect the black negative (-) cable from the vehicle that had the bad battery.
2. Disconnect the black negative (-) cable from the vehicle with the good battery.
3. Disconnect the red positive (+) cable from the vehicle with the good battery.
4. Disconnect the red positive (+) cable from the other vehicle.
5. Return the remote positive (+) terminal cover to its original position.

Towing

Recreational Vehicle Towing

Recreational vehicle towing means towing the vehicle behind another vehicle – such as behind a motorhome. The two most common types of recreational vehicle towing are known as dinghy towing and dolly towing. Dinghy towing is towing the vehicle with all four wheels on the ground. Dolly towing is towing the vehicle with two wheels on the ground and two wheels up on a device known as a dolly.

10-20 Vehicle Care

Here are some important things to consider before recreational vehicle towing:

- What is the towing capacity of the towing vehicle? Be sure to read the tow vehicle manufacturer's recommendations.
- What is the distance that will be travelled? Some vehicles have restrictions on how far and how long they can tow.
- Is the proper towing equipment going to be used? See your dealer or trailering professional for additional advice and equipment recommendations.
- Is the vehicle ready to be towed? Just as preparing the vehicle for a long trip, make sure the vehicle is prepared to be towed.

Dinghy Towing

Two-Wheel Drive Vehicles

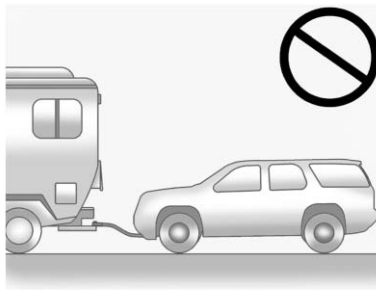

Notice: If the vehicle is towed with all four wheels on the ground, the drivetrain components could be damaged.

The repairs would not be covered by the vehicle warranty. Do not tow the vehicle with all four wheels on the ground.

Two-wheel drive vehicles should not be towed with all four wheels on the ground. Two-wheel drive transmissions have no provisions for internal lubrication while being towed.

Four-Wheel Drive Vehicles

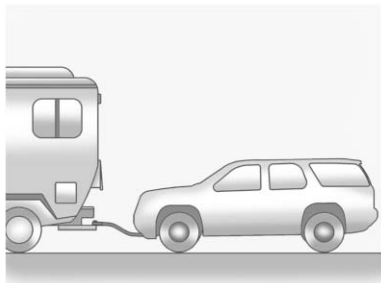

Use the following procedure to dinghy tow a four-wheel drive vehicle:

1. Position the vehicle being towed behind the tow vehicle and shift the transmission to P (Park).
2. Turn the engine off and firmly set the parking brake. See "Parking Brake" in the owner manual.
3. Securely attach the vehicle being towed to the tow vehicle.

⚠ WARNING

Shifting a four-wheel-drive vehicle's transfer case into N (Neutral) can cause the vehicle to roll even if the transmission is in P (Park). The driver or others could be injured. Make sure the parking brake is firmly set before the transfer case is shifted to N (Neutral).

4. Shift the transfer case to N (Neutral). For more information on "Shifting into N (Neutral)", see "Four Wheel Drive" in the owner manual.
5. Release the parking brake only after the vehicle being towed is firmly attached to the towing vehicle.
6. Turn the ignition to LOCK/OFF and remove the key — the steering wheel will still turn.

Dolly Towing – Front Towing (Front Wheels Off the Ground)

Two-Wheel Drive Vehicles



Notice: If a two-wheel-drive vehicle is towed with the rear wheels on the ground, the transmission could be damaged. The repairs would not be covered by the vehicle warranty. Never tow the vehicle with the rear wheels on the ground.

Two-wheel drive vehicles should not be towed with the rear wheels on the ground. Two-wheel drive

10-22 Vehicle Care

transmissions have no provisions for internal lubrication while being towed.

To dolly tow a two-wheel drive vehicle, the vehicle must be towed with the rear wheels on the dolly. See “Rear Towing (Rear Wheels Off the Ground)” in this section for more information.

Four-Wheel Drive Vehicles

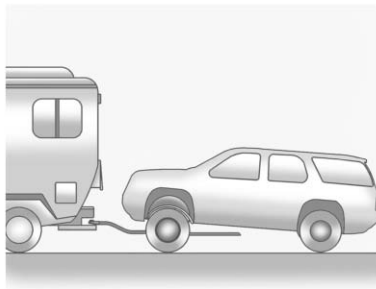

Use the following procedure to dolly tow a four-wheel drive vehicle from the front:

1. Attach the dolly to the tow vehicle following the dolly manufacturer's instructions.
2. Drive the front wheels onto the dolly.

3. Shift the transmission to P (Park).
4. Firmly set the parking brake. See “Parking Brake” in the owner manual.

WARNING

Shifting a four-wheel-drive vehicle's transfer case into N (Neutral) can cause the vehicle to roll even if the transmission is in P (Park). The driver or others could be injured. Make sure the parking brake is firmly set before the transfer case is shifted to N (Neutral).

5. Shift the transfer case to N (Neutral). For more information on “Shifting into N (Neutral)”, see “Four Wheel Drive” in the owner manual.

6. Secure the vehicle to the dolly following the manufacturer's instructions.
7. Release the parking brake only after the vehicle being towed is firmly attached to the towing vehicle.
8. Turn the ignition to LOCK/OFF.

After towing, see "Shifting Out of N (Neutral)" under "Four Wheel Drive" in the owner manual.

Dolly Towing – Rear Towing (Rear Wheels Off the Ground)

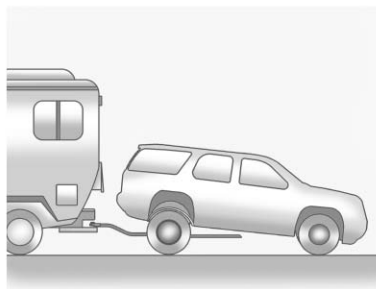

Two-Wheel Drive Vehicles

Use the following procedure to dolly tow a two-wheel-drive vehicle from the rear:

1. Attach the dolly to the tow vehicle following the dolly manufacturer's instructions.
2. Drive the rear wheels onto the dolly.

3. Firmly set the parking brake. See "Parking Brake" in the owner manual.
4. Put the transmission in P (Park).
5. Secure the vehicle to the dolly following the manufacturer's instructions.
6. Use an adequate clamping device designed for towing to ensure that the front wheels are locked into the straight position.
7. Turn the ignition to LOCK/OFF.

Four-Wheel Drive Vehicles

Use the following procedure to dolly tow a four-wheel drive vehicle from the rear:

1. Attach the dolly to the tow vehicle following the dolly manufacturer's instructions.
2. Drive the rear wheels onto the dolly.

10-24 Vehicle Care

3. Firmly set the parking brake. See "Parking Brake" in the owner manual.
4. Put the transmission in P (Park).
5. Secure the vehicle to the dolly following the manufacturer's instructions.
6. Use an adequate clamping device designed for towing to ensure that the front wheels are locked into the straight position.

WARNING

Shifting a four-wheel-drive vehicle's transfer case into N (Neutral) can cause the vehicle to roll even if the transmission is in P (Park). The driver or others could be injured. Make sure the parking brake is firmly set before the transfer case is shifted to N (Neutral).

7. Shift the transfer case to N (Neutral). For more information on "Shifting into N (Neutral)", see "Four Wheel Drive" in the owner manual.
8. Turn the ignition to LOCK/OFF.

After towing, see "Shifting Out of N (Neutral)" under "Four Wheel Drive" in the owner manual.

Appearance Care

Exterior Care

When scraping the windshield glass to remove ice and snow, stay clear of the hybrid decal.

To have the hybrid decals removed from the vehicle, please see your dealer.

Service and Maintenance

Recommended Fluids, Lubricants, and Parts

Recommended Fluids and Lubricants 11-2

11-2 Service and Maintenance

Recommended Fluids, Lubricants, and Parts

Recommended Fluids and Lubricants

Fluids identified below are specific to the hybrid vehicle and can be obtained from your dealer. See the owner manual for the other fluids and lubricants recommended for the vehicle.

Usage	Fluid/Lubricant
Drive Motor/Generator Control Module (DMCM) Cooling System	Always use the pre-mixed 50/50 mixture of de-ionized water and DEX-COOL [®] (silicate-free) coolant available at your dealer. See <i>Drive Motor/Generator Control Module (DMCM) Cooling System</i> on page 10-8.

Technical Data

Vehicle Data

- Capacities and Specifications 12-2
- Engine Drive Belt Routing ... 12-3

Vehicle Data

Capacities and Specifications

Application	Capacities	
	Metric	English
Automatic Transmission* (Pan Removal and Filter Replacement)	10.9 L	11.5 qt
Cooling System		
Drive Motor Generator Control Module Cooling System	2.7 L	2.9 qt
6.0L V8 Engine Cooling System	16.3 L	17.2 qt
Fuel Tank	98.4 L	26.0 gal
*See <i>Automatic Transmission Fluid on page 10-5</i> for information on checking fluid level.		
All capacities are approximate. Recheck fluid level after filling.		

Engine Specifications

Engine	VIN Code	Transmission	Spark Plug Gap
6.0L V8	J	Automatic	1.02 mm (0.040 in)

Engine Drive Belt Routing

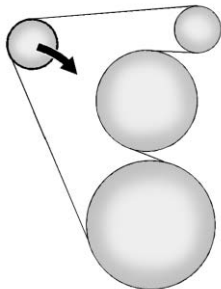

A

Antilock Brake System (ABS)
 Warning Light 5-9

Appearance Care
 Exterior 10-24

Automatic Transmission 9-5

Fluid 10-5

Manual Mode 9-7

B

Battery 10-12

Jump Starting 10-15

Voltage and Charging
 Messages 5-12

Brakes
 Regenerative Braking 9-8

System Messages 5-12

C

Canadian Vehicle Owners ii

Capacities and
 Specifications 12-2

Charging System Light 5-7

Circuit Breakers 10-13

Cleaning
 Exterior Care 10-24

Climate Control Systems 8-1

Air Conditioning 8-1

Heating 8-1

Cluster, IP 5-2

Coolant
 Engine Temperature Gauge ... 5-7

Coolant Surge Tank
 Pressure Cap, (DMCM) 10-8

Cooling System, (DMCM) 10-8

Covers
 Tonneau 4-1, 4-6

D

Door
 Ajar Messages 5-12

Drive Motor/Generator
 Control Module (DMCM)
 Coolant Surge Tank
 Pressure Cap 10-8

Drive Motor/Generator
 Control Module (DMCM)
 Cooling System 10-8

Driver Information
 Center (DIC) 5-11

E

Electrical System	
Engine Compartment	
Fuse Block	10-14
Fuses and Circuit	
Breakers	10-13
Engine	
Compartment Overview	10-4
Coolant Heater	9-3
Coolant Temperature Gauge ...	5-7
Drive Belt Routing	12-3
Oil Pressure Gauge	5-5
Pressure Light	5-10
Running While Parked	9-4
Engine Oil	
Messages	5-12
Equipment, Towing	9-10

F

Fluid	
Automatic Transmission	10-5
Power Steering	10-12
Fuel	
Gauge	5-3
Fuel Economy Gauge	5-4
Fuses	
Engine Compartment	
Fuse Block	10-14
Fuses and Circuit	
Breakers	10-13

G

Gauges	
Engine Coolant	
Temperature	5-7
Engine Oil Pressure	5-5
Fuel	5-3
Fuel Economy	5-4
Tachometer	5-3
General Information	
Towing	9-9

H

Heater	
Engine Coolant	9-3
Heating and Air Conditioning ...	8-1
High Voltage Devices and	
Wiring	10-13

I

Instrument Cluster 5-2
 Introduction ii, 7-1

J

Jump Starting 10-15

L

Lights
 Antilock Brake System
 (ABS) Warning 5-9
 Charging System 5-7
 Engine Oil Pressure 5-10
 StabiliTrak[®] Indicator 5-9

M

Maintenance Schedule
 Recommended Fluids and
 Lubricants 11-2
 Manual Mode 9-7
 Messages
 Battery Voltage and
 Charging 5-12
 Brake System 5-12
 Door Ajar 5-12
 Engine Oil 5-12
 Service Vehicle 5-12
 Vehicle 5-11

O

Oil
 Engine Oil Pressure Gauge 5-5
 Messages 5-12
 Pressure Light 5-10

P

Power
 Steering Fluid 10-12

R

Rear Seats 3-1
 Recommended Fluids and
 Lubricants 11-2
 Recreational Vehicle
 Towing 10-19
 Regenerative Braking 9-8
 Replacement Parts
 Airbags 3-1
 Replacing Airbag System 3-1
 Routing, Engine Drive Belt 12-3
 Running the Vehicle While
 Parked 9-4

S

Seats
Rear 3-1

Service
Doing Your Own Work 10-2
Vehicle Messages 5-12

Specifications and
Capacities 12-2

StabiliTrak® Indicator Light 5-9

Starting the Vehicle 9-2

Steering 9-1
Fluid, Power 10-12

Supplement
Using ii

T

Tachometer 5-3

Tonneau Cover 4-1, 4-6

Towing
Equipment 9-10
General Information 9-9
Recreational Vehicle 10-19
Trailer 9-9

Trailer Towing 9-9

Transmission
Automatic 9-5
Fluid, Automatic 10-5

U

Using this Supplement ii

V

Vehicle
Canadian Owners ii
Messages 5-11
Starting 9-2

Voltage Devices, and
Wiring 10-13

W

Wiring, High Voltage
Devices 10-13