

## Table of Contents

<b>Introduction</b>	<b>4</b>
<b>Instrument Cluster</b>	<b>12</b>
Warning lights and chimes	12
Gauges	17
Trip computer	17
Message center	18
Multifunction display	19
<b>Entertainment Systems</b>	<b>23</b>
AM/FM stereo with CD	23
Auxiliary input jack (Line in)	31
USB port	33
Satellite radio information	36
SYNC®	39
SYNC® voice recognition feature	42
SYNC® phone features	47
Pairing your phone for the first time	49
SYNC® media features	75
<b>Climate Controls</b>	<b>103</b>
Manual heating and air conditioning	103
Rear window defroster	105
<b>Lights</b>	<b>106</b>
Headlamps	106
Turn signal control	109
Bulb replacement	111
<b>Driver Controls</b>	<b>121</b>
Windshield wiper/washer control	121
Steering wheel adjustment	122
Power windows	123
Mirrors	125
Speed control	127

## Table of Contents

<b>Locks and Security</b>	<b>132</b>
Keys	132
Locks	133
Anti-theft system	144
<b>Seating and Safety Restraints</b>	<b>147</b>
Seating	147
Safety restraints	153
Airbags	167
Child restraints	182
<b>Tires, Wheels and Loading</b>	<b>201</b>
Tire information	201
Tire inflation	203
Tire Pressure Monitoring System (TPMS)	216
Vehicle loading	221
Trailer towing	227
Recreational towing	227
<b>Driving</b>	<b>230</b>
Starting	230
Brakes	237
AdvanceTrac®	239
Transmission operation	246
<b>Roadside Emergencies</b>	<b>254</b>
Getting roadside assistance	254
Hazard flasher control	255
Fuel pump shut-off	255
Fuses and relays	256
Changing tires	263
Wheel lug nut torque	268
Jump starting	270
Wrecker towing	273

## Table of Contents

<b>Customer Assistance</b>	<b>275</b>
Reporting safety defects (U.S. only)	282
Reporting safety defects (Canada only)	282
<b>Cleaning</b>	<b>283</b>
<b>Maintenance and Specifications</b>	<b>291</b>
Engine compartment	293
Engine oil	295
Battery	297
Engine coolant	299
Fuel information	304
Air filter(s)	317
Part numbers	320
Maintenance product specifications and capacities	321
Engine data	323
<b>Accessories</b>	<b>327</b>
<b>Ford Extended Service Plan</b>	<b>329</b>
<b>Scheduled Maintenance Guide</b>	<b>333</b>
Normal scheduled maintenance and log	338
<b>Index</b>	<b>350</b>

All rights reserved. Reproduction by any means, electronic or mechanical including photocopying, recording or by any information storage and retrieval system or translation in whole or part is not permitted without written authorization from Ford Motor Company. Ford may change the contents without notice and without incurring obligation.

Copyright © 2010 Ford Motor Company

3

## Introduction

### CONGRATULATIONS

Congratulations on acquiring your new Ford Motor Company product. Please take the time to get well acquainted with your vehicle by reading this handbook. The more you know and understand about your vehicle, the greater the safety and pleasure you will derive from driving it.

For more information on Ford Motor Company and its products visit the following website:

- In the United States: [www.ford.com](http://www.ford.com)
- In Canada: [www.ford.ca](http://www.ford.ca)
- In Mexico: [www.ford.com.mx](http://www.ford.com.mx)
- In Australia: [www.ford.com.au](http://www.ford.com.au)

Additional owner information is given in separate publications.

This vehicle's Owner's Guide describes every option and model variant available and therefore some of the items covered may not apply to your particular vehicle. Furthermore, due to printing cycles it may describe options before they are generally available.

Remember to pass on this vehicle's Owner's Guide when reselling the vehicle. It is an integral part of the vehicle.

### SAFETY AND ENVIRONMENT PROTECTION

#### **Warning symbols in this guide**

How can you reduce the risk of personal injury to yourself or others? In this guide, answers to such questions are contained in comments highlighted by the warning triangle symbol. These comments should be read and observed.

#### **Warning symbols on your vehicle**

When you see this symbol, it is imperative that you consult the relevant section of this guide before touching or attempting adjustment of any kind.



## Introduction

### Protecting the environment

We must all play our part in protecting the environment. Correct vehicle usage and the authorized disposal of waste, cleaning and lubrication materials are significant steps towards this aim. Information in this respect is highlighted in this guide with the tree symbol.



### CALIFORNIA Proposition 65 Warning



**WARNING:** Engine exhaust, some of its constituents, and certain vehicle components contain or emit chemicals known to the State of California to cause cancer and birth defects or other reproductive harm. In addition, certain fluids contained in vehicles and certain products of component wear contain or emit chemicals known to the State of California to cause cancer and birth defects or other reproductive harm.

### PERCHLORATE MATERIAL

Certain components of this vehicle such as airbag modules, seat belt pretensioners, and button cell batteries may contain Perchlorate Material – Special handling may apply for service or vehicle end of life disposal. See [www.dtsc.ca.gov/hazardouswaste/perchlorate](http://www.dtsc.ca.gov/hazardouswaste/perchlorate).

### BREAKING-IN YOUR VEHICLE

Your vehicle does not need an extensive break-in. Try not to drive continuously at the same speed for the first 1,000 miles (1,600 km) of new vehicle operation. Vary your speed frequently in order to give the moving parts a chance to break in.

Do not add friction modifier compounds or special break-in oils since these additives may prevent piston ring seating. See *Engine oil* in the *Maintenance and Specifications* chapter for more information on oil usage.

### SPECIAL NOTICES

#### New Vehicle Limited Warranty

For a detailed description of what is covered and what is not covered by your vehicle's New Vehicle Limited Warranty, refer to the *Warranty Guide* that is provided to you along with your Owner's Guide.

5

## Introduction

### Special instructions

For your added safety, your vehicle is fitted with sophisticated electronic controls.



**WARNING:** Please read the section *Airbag Supplemental Restraint System (SRS)* in the *Seating and Safety Restraints* chapter. Failure to follow the specific warnings and instructions could result in personal injury.



**WARNING:** Front seat mounted rear-facing child or infant seats should **NEVER** be placed in front of an active passenger airbag.

## DATA RECORDING

### Service Data Recording

Service data recorders in your vehicle are capable of collecting and storing diagnostic information about your vehicle. This potentially includes information about the performance or status of various systems and modules in the vehicle, such as engine, throttle, steering or brake systems. In order to properly diagnose and service your vehicle, Ford Motor Company, Ford of Canada, and service and repair facilities may access or share among them vehicle diagnostic information received through a direct connection to your vehicle when diagnosing or servicing your vehicle. For U.S. only (if equipped), if you choose to use the SYNC<sup>®</sup> Vehicle Health Report, you consent that certain diagnostic information may also be accessed electronically by Ford Motor Company and Ford authorized service facilities, and that the diagnostic information may be used for any purpose. See your SYNC<sup>®</sup> supplement for more information.

### Event Data Recording

**This vehicle is equipped with an event data recorder (EDR). The main purpose of an EDR is to record, in certain crash or near crash-like situations, such as an airbag deployment or hitting a road obstacle; this data will assist in understanding how a vehicle's systems performed. The EDR is designed to record data related to vehicle dynamics and safety systems for a short period of time, typically 30 seconds or less. The EDR in this vehicle is designed to record such data as:**

- **How various systems in your vehicle were operating;**
- **Whether or not the driver and passenger seatbelts were buckled/fastened;**

6

## Introduction

- How far (if at all) the driver was depressing the accelerator and/or the brake pedal; and
- How fast the vehicle was travelling; and
- Where the driver was positioning the steering wheel.

This data can help provide a better understanding of the circumstances in which crashes and injuries occur.

**Note:** EDR data is recorded by your vehicle only if a non-trivial crash situation occurs; no data is recorded by the EDR under normal driving conditions and no personal data or information (e.g., name, gender, age, and crash location) is recorded (see limitations regarding 911 Assist and Traffic, directions and Information privacy below). However, parties, such as law enforcement, could combine the EDR data with the type of personally identifying data routinely acquired during a crash investigation.

To read data recorded by an EDR, special equipment is required, and access to the vehicle or the EDR is needed. In addition to the vehicle manufacturer, other parties, such as law enforcement, that have such special equipment, can read the information if they have access to the vehicle or the EDR. Ford Motor Company and Ford of Canada do not access event data recorder information without obtaining consent, unless pursuant to court order or where required by law enforcement, other government authorities or other third parties acting with lawful authority. Other parties may seek to access the information independently of Ford Motor Company and Ford of Canada.

**Note:** Including to the extent that any law pertaining to Event Data Recorders applies to SYNC® or its features, please note the following: Once 911 Assist (if equipped) is enabled (set ON), 911 Assist may, through any paired and connected cell phone, disclose to emergency services that the vehicle has been in a crash involving the deployment of an airbag or, in certain vehicles, the activation of the fuel pump shut-off. Certain versions or updates to 911 Assist may also be capable of being used to electronically or verbally provide to 911 operators the vehicle location (such as latitude and longitude), and/or other details about the vehicle or crash or personal information about the occupants to assist 911 operators to provide the most appropriate emergency services. If you do not want to disclose this information, do not activate the 911 Assist feature. See your SYNC® supplement for more information.

7

## Introduction

**Additionally, when you connect to Traffic, Directions and Information (if equipped, U.S. only) the service uses GPS technology and advanced vehicle sensors to collect the vehicle's current location, travel direction, and speed ("vehicle travel information") only to help provide you with the directions, traffic reports, or business searches your request. If you do not want Ford or its vendors to receive this information, do not activate the service. Ford Motor Company and the vendors it uses to provide you with this information do not store your vehicle travel information. For more information, see Traffic, Directions and Information, Terms and Conditions. See your SYNC® supplement for more information.**

### CELL PHONE USE

The use of Mobile Communications Equipment has become increasingly important in the conduct of business and personal affairs. However, drivers must not compromise their own or others' safety when using such equipment. Mobile Communications can enhance personal safety and security when appropriately used, particularly in emergency situations. Safety must be paramount when using mobile communications equipment to avoid negating these benefits.

Mobile Communication Equipment includes, but is not limited to, cellular phones, pagers, portable email devices, text messaging devices and portable two-way radios.



**WARNING:** Driving while distracted can result in loss of vehicle control, accident and injury. Ford strongly recommends that you use extreme caution when using any device or feature that may take your focus off the road. Your primary responsibility is the safe operation of your vehicle. We recommend against the use of any handheld device while driving and that you comply with all applicable laws.



## Introduction









### **EXPORT UNIQUE (NON-UNITED STATES/CANADA) VEHICLE SPECIFIC INFORMATION**

For your particular global region, your vehicle may be equipped with features and options that are different from the features and options that are described in this Owner's Guide. A market unique supplement may be supplied that complements this book. By referring to the market unique supplement, if provided, you can properly identify those features, recommendations and specifications that are unique to your vehicle. This Owner's Guide is written primarily for the U.S. and Canadian Markets. Features or equipment listed as standard may be different on units built for Export. **Refer to this Owner's Guide for all other required information and warnings.**

## Introduction





















These are some of the symbols you may see on your vehicle.

### Vehicle Symbol Glossary

Safety Alert		See Owner's Guide	
Fasten Safety Belt		Airbag - Front	
Airbag - Side		Child Seat Lower Anchor	
Child Seat Tether Anchor		Brake System	
Anti-Lock Brake System		Parking Brake System	
Brake Fluid - Non-Petroleum Based		Parking Aid System	
Stability Control System		Speed Control	
Master Lighting Switch		Hazard Warning Flasher	
Fog Lamps-Front		Fuse Compartment	
Fuel Pump Reset		Windshield Wash/Wipe	
Windshield Defrost/Demist		Rear Window Defrost/Demist	

## Introduction

### Vehicle Symbol Glossary

Power Windows Front/Rear		Power Window Lockout	
Child Safety Door Lock/Unlock		Interior Luggage Compartment Release	
Panic Alarm		Engine Oil	
Engine Coolant		Engine Coolant Temperature	
Do Not Open When Hot		Battery	
Avoid Smoking, Flames, or Sparks		Battery Acid	
Explosive Gas		Fan Warning	
Power Steering Fluid		Maintain Correct Fluid Level	
Service Engine Soon		Engine Air Filter	
Passenger Compartment Air Filter		Jack	
Check Fuel Cap		Low Tire Pressure Warning	

## Instrument Cluster

### WARNING LIGHTS AND CHIMES

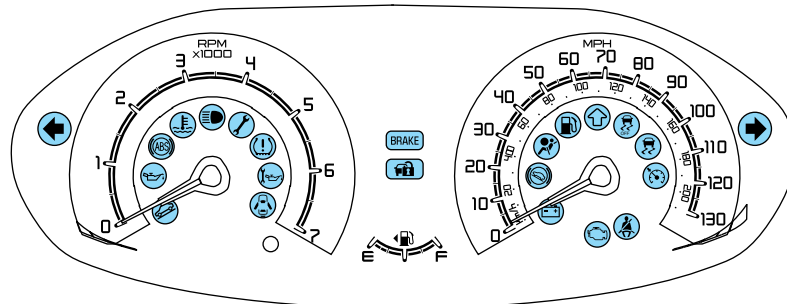

Warning lights can alert you to a vehicle condition that may become serious enough to cause expensive repairs. A warning light may illuminate when a problem exists with one of your vehicle's functions. Many lights will illuminate when you start your vehicle to make sure the bulb works. If any light remains on after starting the vehicle, refer to the respective system warning light for additional information.

**Service engine soon:** The service engine soon indicator illuminates when the ignition is first turned to the on position to check

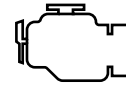

the bulb and to indicate whether the vehicle is ready for Inspection/Maintenance (I/M) testing. Normally, the service engine soon indicator will stay on until the engine is cranked, then turn itself off if no malfunctions are present. However, if after 15 seconds the service engine soon indicator blinks eight times, it means that the vehicle is not ready for I/M testing. See the *Readiness for Inspection/Maintenance (I/M) testing* in the *Maintenance and Specifications* chapter.

Solid illumination after the engine is started indicates the on-board diagnostics system (OBD-II) has detected a malfunction. Refer to *On-board diagnostics (OBD-II)* in the *Maintenance and Specifications* chapter. If the light is blinking, engine misfire is occurring which could damage your catalytic converter. Drive in a moderate fashion (avoid heavy acceleration and deceleration) and have your vehicle serviced immediately by your authorized dealer.

12

## Instrument Cluster



**WARNING:** Under engine misfire conditions, excessive exhaust temperatures could damage the catalytic converter, the fuel system, interior floor coverings or other vehicle components, possibly causing a fire.

**Low fuel:** Displays when the fuel level in the fuel tank is at or near empty (refer to *Fuel gauge* in this chapter).



**Powertrain malfunction/Reduced power/Electronic throttle control:**

Displays when the engine has defaulted to a “limp-home” operation or when a transmission problem has been detected and shifting may be restricted. If the light remains on, have the system serviced immediately by your authorized dealer.



**Brake system warning light:** To confirm the brake system warning light is functional, it will momentarily illuminate when the ignition is turned to the on position when the engine is not running, or in a position between on and start, or by applying the parking brake when the ignition is turned to the on position.

## BRAKE

If the brake system warning light does not illuminate at this time, seek service immediately from your authorized dealer. Illumination after releasing the parking brake indicates low brake fluid level and the brake system should be inspected immediately by your authorized dealer.



**WARNING:** Driving a vehicle with the brake system warning light on is dangerous. A significant decrease in braking performance may occur. It will take you longer to stop the vehicle. Have the vehicle checked by your authorized dealer. Driving extended distances with the parking brake engaged can cause brake failure and the risk of personal injury.

## Instrument Cluster

**Anti-lock brake system:** If the ABS light stays illuminated or continues to flash, a malfunction has been detected, have the system serviced immediately by your authorized dealer. Normal braking is still functional unless the brake warning light also is illuminated.

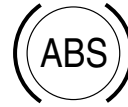

**Airbag readiness:** If this light fails to illuminate when the ignition is turned to on, continues to flash or remains on, have the system serviced immediately by your authorized dealer. A chime will sound if there is a malfunction in the indicator light.



**Safety belt:** Reminds you to fasten your safety belt. A Belt-Minder® chime will also sound to remind you to fasten your safety belt. Refer to the *Seating and Safety Restraints* chapter to activate/deactivate the Belt-Minder® chime feature.



**Charging system:** Illuminates when the battery is not charging properly. If it stays on while the engine is running, there may be a malfunction with the charging system. Contact your authorized dealer as soon as possible. This indicates a problem with the electrical system or a related component.



**Engine oil pressure:** Displays when the oil pressure falls below the normal range. Refer to *Engine oil* in the *Maintenance and Specifications* chapter.

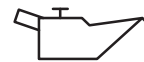

**Oil change reminder:** Displays when the engine oil life has expired. Refer to *Oil life monitoring system reset* later in this chapter.



**Door ajar:** Displays when the ignition is in the on position and any door is not completely closed.



14

## Instrument Cluster

### Engine coolant temperature:

Illuminates when the engine coolant temperature is high. Stop the vehicle as soon as possible, switch off the engine and let cool. Refer to *Engine coolant* in the *Maintenance and Specifications* chapter.



**WARNING:** Never remove the coolant reservoir cap while the engine is running or hot.

### Low tire pressure warning:

Illuminates when your tire pressure is low. If the light remains on at start up or while driving, the tire pressure should be checked. Refer to *Inflating your tires* in the *Tires, Wheels and Loading* chapter. When the ignition is first turned to on, the light will illuminate for three seconds to ensure the bulb is working. If the light does not turn on, have the system inspected by your authorized dealer. For more information on this system, refer to *Tire pressure monitoring system (TPMS)* in the *Tires, Wheels and Loading* chapter.

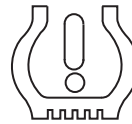

### Hill start assistance

**(if equipped):** Displays when using hill start assist is not available. Refer to the *Driving* chapter for transmission function and operation.



### Overdrive cancel and grade

**assist (if equipped):** Illuminates when the overdrive function of the transmission has been turned off and the grade assist function has been turned on, refer to the *Driving* chapter.



### Upshift (manual transmission):

To maximize fuel economy, this light illuminates when the manual transmission should be shifted to the next highest gear. Refer to the *Driving* chapter for more information.



## Instrument Cluster

**AdvanceTrac®/Traction control (if equipped):** Displays when the AdvanceTrac®/Traction control is active. If the light remains on, have the system serviced immediately, refer to the *Driving* chapter for more information.



**AdvanceTrac®/Traction control off light (if equipped):** Illuminates when AdvanceTrac®/Traction control has been disabled by the driver. Refer to the *Driving* chapter for more information.



**Speed control (if equipped):** Illuminates when the speed control system is in use.

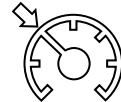

**Anti-theft system:** Flashes when the SecuriLock® Passive Anti-theft System has been activated.



**Turn signal:** Illuminates when the left or right turn signal or the hazard lights are turned on. If the indicators stay on or flash faster, check for a burned out bulb.



**High beams:** Illuminates when the high beam headlamps are turned on.



**Key-in-ignition warning chime:** Sounds when the key is left in the ignition in the off or accessory position and the driver's door is opened.

**Headlamps on warning chime:** Sounds when the headlamps or parking lamps are on, the ignition is off (the key is not in the ignition) and the driver's door is opened.



## Instrument Cluster

### GAUGES

Shown in standard measure. Metric similar.

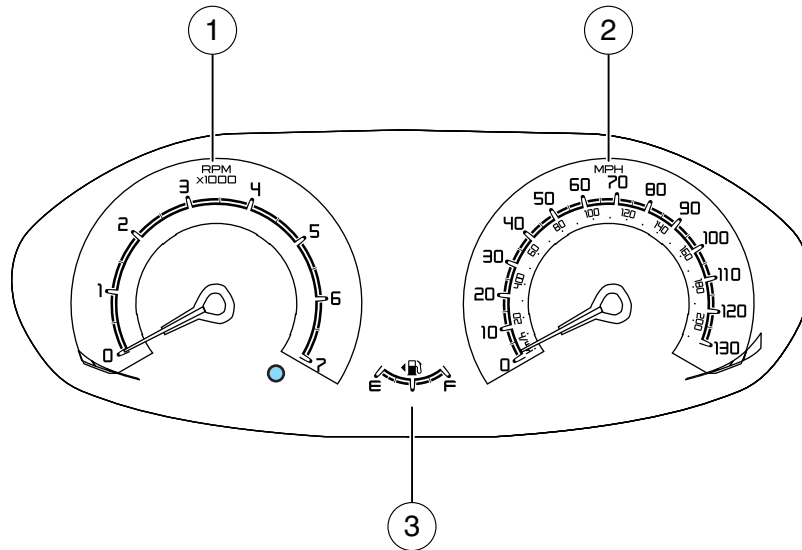

1. **Tachometer:** Indicates the engine speed in revolutions per minute. Driving with your tachometer pointer continuously at the top of the scale may damage the engine.

Refer to *Filling the tank* in the *Maintenance and Specifications* chapter for more information.

2. **Speedometer:** Indicates the current vehicle speed.

3. **Fuel gauge:** Indicates approximately how much fuel is left in the fuel tank (when the ignition is in the on position). The fuel gauge may vary slightly when the vehicle is in motion or on a grade. The fuel icon and arrow indicates which side of the vehicle the fuel filler door is located.

### TRIP COMPUTER (IF EQUIPPED)

The trip computer and odometer information will display in the instrument cluster.

Press the end of the lever, located on the left side of the steering wheel to scroll through the trip computer displays.

**mi (km) — Odometer:** Registers the total miles (kilometers) of the vehicle.

## Instrument Cluster

**mi (km) TRIP — Trip odometer:** Registers the mileage of individual journeys.

**mi (km) TO E — Distance to empty (if equipped):** Indicates the approximate distance the vehicle will travel on the fuel remaining in the tank. Changes in driving pattern may cause the value to vary.

**AVG MPG (l/100km) — Average fuel consumption (if equipped):** Indicates the average fuel consumption since the function was last reset.

**AVG MPH (KM/H) — Average speed (if equipped):** Indicates the average speed calculated since the function was last reset.

**XXX °F (°C) — Outside air temperature (if equipped):** Shows the outside air temperature.

To reset the trip odometer and average speed, scroll to the required display and press and hold the end of the multifunction lever.

### MULTIFUNCTION DISPLAY

Your vehicle's multifunction display is capable of monitoring many vehicle systems and will alert you to potential vehicle problems and various conditions with an informational message. You can also program various vehicle settings using the message center.

The display is located in the center stack.

Certain settings can be changed through the multifunction display. Press MENU on the audio system to access the settings screen.

Press ▲ / ▼ / ◀ / ▶ to move through the display screen. The following settings can be changed:



**Audio:** See *Audio systems* in the *Entertainment Systems* chapter for more information.

**Vehicle:** Select Vehicle then move right to enter into the menu. Scroll up or down to select from:

- **Traction Control:** Move right to enter the menu and then move up or down to select from on or off. Press OK to confirm.
- **Chimes:** Move right to enter the menu, then up or down to select from warning chimes or info chimes. Press OK to confirm.
- **Lane change indicator/Turn indicator:** Move right to enter the menu and then move up or down to select from flash once or flash three times. Press OK to confirm.

18

## Instrument Cluster

- **Chimes:** Move right to enter the menu, then up or down to select from warning chimes or info chimes. Press OK to confirm.

**Clock:** Select Clock then move right to enter the menu. Scroll up or down to select from to select from:

- **Set time:** Move right to enter the menu and adjust the time.
- **Set date:** Move right to enter the menu and adjust the date.
- **24 hour mode:** Move right to enter the menu to choose 24-hour mode.

The clock can also be set through the audio system. See *Audio systems* in the *Entertainment Systems* chapter for more information.

**Display:** Select Display then move right to enter the menu. Scroll up or down to select from:



- **Units of measure:** Move right to enter the menu then move up or down to select Fahrenheit or Celsius.
- **Language:** Move right to enter the menu then move up or down to select the desired language.

**Messages:** Select messages, then move up/down to view stored messages.

**Compass (if equipped):** If your vehicle is equipped with SYNC®, the compass heading is displayed to the left of the clock in the upper portion of the multifunction display.

### Information messages

 : The message indicator will illuminate when there is a new message stored in the multifunction display.

Message	Warning Lamp at Instrument Cluster	System
<b>ABS MALFUNCTION SERVICE NOW</b>		ABS
<b>ESP OFF</b>	—	ABS
<b>ESP MALFUNCTION NEXT SERVICE</b>	—	ABS
<b>BRAKE SYSTEM MALFUNCTION STOP SAFELY</b>	BRAKE or 	Brakes
<b>ALARM SYSTEM MALFUNCTION NEXT SERVICE</b>	—	Anti-theft security system







## Instrument Cluster

Message	Warning Lamp at Instrument Cluster	System
<b>INTERIOR SCAN DEACTIVATED</b>	—	Anti-theft security system
<b>IMMOBILIZER MALFUNCTION SERVICE NOW</b>	—	Anti-theft security system
<b>ALARM TRIGGERED CHECK VEHICLE</b>	—	Anti-theft security system
<b>LEFT/RIGHT INDICATOR MALFUNCTION CHANGE BULB</b>	—	Lights
<b>HILL START ASSIST NOT AVAILABLE</b>		Transmission
<b>STEERING LOCK ENGAGED TURN STEERING WHEEL</b>	—	Passive Entry/Passive Start
<b>STEERING MALFUNCTION SERVICE NOW</b>	—	Passive Entry/Passive Start
<b>STEERING MALFUNCTION STOP SAFELY</b>	—	Passive Entry/Passive Start
<b>POWER STEERING MALFUNCTION SERVICE NOW</b>	—	Power Steering
<b>KEY NOT DETECTED</b>	—	Passive entry/passive start system
<b>TURN IGNITION OFF USE POWER BUTTON</b>	—	Passive entry/passive start system
<b>KEY OUTSIDE CAR</b>	—	Passive entry/passive start system

## Instrument Cluster

Message	Warning Lamp at Instrument Cluster	System
<b>KEY BATTERY LOW REPLACE BATTERY</b>	—	Passive entry/passive start system
<b>TO START PRESS BRAKE</b>	—	Passive Entry/Passive Start
<b>CLOSE TRUNK OR USE SPARE KEY</b>	—	Trunk
<b>TO START PRESS CLUTCH</b>	—	Passive Entry/Passive Start
<b>ENGINE MALFUNCTION SERVICE NOW</b>		Engine
<b>TRANSMISSION MALFUNCTION SERVICE NOW</b>	—	Transmission
<b>TRANSMISSION HOT STOP SAFELY</b>	—	Transmission
<b>TRANSMISSION HOT STOP OR SPEED UP</b>	—	Transmission
<b>USE BRAKE STOP SAFELY</b>	—	Transmission
<b>TRANSMISSION HOT WAIT X MINUTE</b>	—	Transmission
<b>TRANSMISSION HOT WAIT...</b>	—	Transmission
<b>TRANSMISSION READY</b>	—	Transmission
<b>HILL START ASSIST ACTIVE</b>	—	Transmission
<b>HILL START ASSIST OFF</b>	—	Transmission

## Instrument Cluster

Message	Warning Lamp at Instrument Cluster	System
<b>VEHICLE NOT IN PARK SELECT P</b>	—	Starting/Transmission
<b>VEHICLE NOT IN PARK SELECT P</b>	—	Starting/Transmission
<b>DOOR OPEN APPLY BRAKE</b>	—	Doors
<b>X DOOR OPEN</b>		Doors
<b>TRUNK OPEN</b>		Doors
<b>HOOD OPEN</b>		Hood
<b>AIRBAG MALFUNCTION SERVICE NOW</b>		Airbag
<b>ENGINE OIL CHANGE DUE NEXT SERVICE</b>		Engine Oil (See <i>Oil life monitoring system reset</i> later in this section)
<b>ENGINE OIL PRESSURE LOW STOP SAFELY</b>		Engine Oil
<b>BRAKE FLUID LEVEL LOW SERVICE NOW</b>	BRAKE or 	Brakes

### ***Oil life monitoring system reset***

To reset the oil service light and clear the oil change message after servicing use the following procedure:

1. Begin with the ignition off.
2. Turn the key to the accessory position for keyed vehicles and for push button start vehicles press the Start/Stop button once quickly. DO NOT attempt to start the engine.
3. Press the accelerator and brake pedals fully for 20 seconds.
4. **ENGINE OIL CHANGE DUE NEXT SERVICE** and  will display.
5. Turn the vehicle off. The message and lights will be cleared.

22

## Entertainment Systems

### AUDIO SYSTEMS

#### AM/FM stereo or AM/FM stereo single CD/MP3 (if equipped)

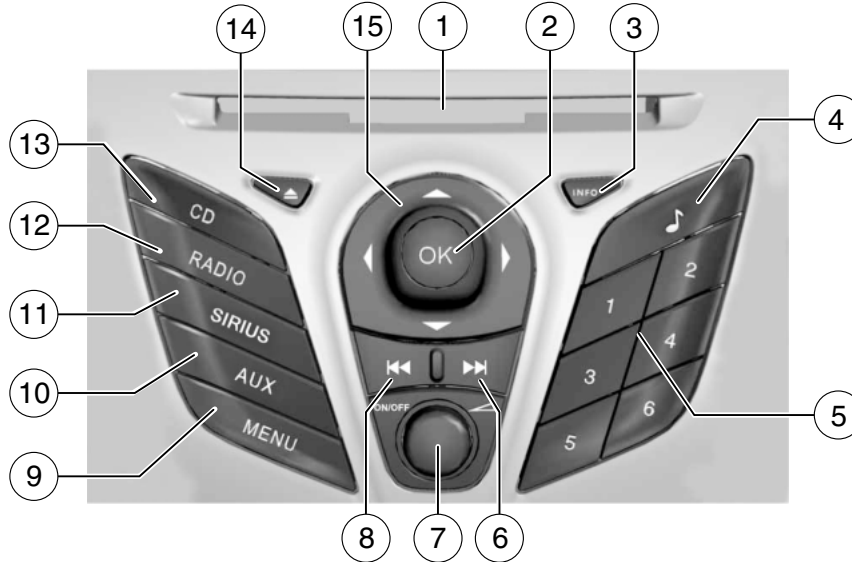

**!** **WARNING:** Driving while distracted can result in loss of vehicle control, accident and injury. Ford strongly recommends that drivers use extreme caution when using any device or feature that may take their focus off the road. Your primary responsibility is the safe operation of the vehicle. We recommend against the use of any handheld device while driving, encourage the use of voice-operated systems when possible and that you become aware of applicable state and local laws that may affect use of electronic devices while driving.

**One hour mode:** Press the ON/OFF control to operate the system with the ignition turned off; the system will automatically turn off after one hour.

**Setting the clock:** Press the H or M buttons on the outside of the multifunction display to access the clock settings. Once you are in the clock setting, press the H or M button repeatedly until the desired number appears. Press OK to confirm and close.

## Entertainment Systems

**Display icons:** Your system's display will illuminate icons for the mode which is currently active, such as:

Radio



CD



Auxiliary input



Settings: This icon will illuminate in red to indicate that the settings can be updated in the menu.



1. **CD slot (if equipped):** Insert a CD, label side up.
2. **OK:** Use in various menu selections to select or un-select your choice.
3. **INFO:** Press to access any available radio or CD information.
4. **Sound menu:** Press to access Treble, Bass, Middle, Fade (if equipped) and Balance menu options. Use ▲ / ▼ to cycle through the various options. When the desired option is chosen, press ◀ / ▶ to increase or decrease the levels. Press OK to set or press MENU to exit. Sound settings can be set for each audio source independently.
5. **Memory presets:** To save a station, tune to the desired station. Press and hold a preset button until sound returns.
6. **Fast forward:** Press to access the next track. Press and hold to fast forward through track.
7. **On/Off/Volume:** Press to turn the system on or off. Turn to adjust the volume.
8. **Reverse:** Press to access the previous track. Press and hold for a fast reverse through the track.
9. **MENU:** Press to access the following features:  
**Note:** To scroll through the following menus and make adjustments, press ▲ / ▼ or ◀ / ▶. Press ◀ to return to the previous screen or ▶ to advance to the next screen.  
**Note:** At any time, you can press MENU to close the menu screen.

24



## Entertainment Systems

- **Sirius (if equipped):** Scroll to select Sirius and then press OK to enter the menu. Scroll to select from SAT1, SAT2 or SAT3 modes.  
**Note:** Sirius must be the selected audio source for this option to appear in the menu.
- **Radio:** Scroll to select Radio mode and then move right to enter the menu. Scroll to select from:
  - **Manual Tune:** Press OK to select and press ◀ / ▶ to tune manually.
  - **Scan:** Press OK to activate scan mode for a brief sampling of stations.
  - **Autostore:** Press OK to activate the autostore feature. This allows you to store the six strongest local stations available from the AM and FM frequency bands. When the search is complete, the sound will return and the six strongest stations will be stored in the memory presets (and overwrite any stations previously stored in the AST band.) You can also manually store stations in the AST band. When the AST band is active, simply tune to the desired station and press and hold a memory preset. The new station will be saved and will override the previously saved station.
- **CD (if equipped):** Scroll to select CD options and then move right to enter the menu. Scroll to select from the following. **Note:** CD must be the selected audio source for this option to appear in the menu.
  - **Normal mode:** Scroll to select Normal Mode and press OK.
  - **Repeat:** Press OK to Repeat the current song. For MP3 discs, you can select from Repeat Title or Repeat Folder.
  - **Shuffle:** Press OK to shuffle songs. For MP3 discs, you can select from Shuffle Folder or Shuffle CD.
  - **Scan:** Press OK to activate scan mode for a brief sampling of songs. For MP3 discs, you can select from Scan Folder or Scan CD.
- **Audio:** Scroll to select Audio and then move right to enter the menu. Scroll to select from:
  - **SCV:** Scroll to select Speed Compensated Volume (SCV) and press OK to enter the menu. SCV automatically adjusts the system's volume to compensate for speed and wind noise. You can set the system between off and +7.
  - **Sound:** Scroll to select Sound and press OK to enter the menu. Scroll to select from Treble, Bass, Middle, Fade and Balance options. When the desired option is chosen, scroll to increase or decrease the levels. sound settings can be set for each audio source independently.

## Entertainment Systems

- **Occupancy mode:** Scroll to select Occupancy mode and move right or press OK to enter. Then, scroll to select from Optimize All or Optimize Driver. Occupancy mode optimizes sound quality for the chosen seating position. Press OK to confirm your selection.
  - **DSP Equalizer:** Scroll to select DSP Equalizer and scroll to select from Rock, Pop, Classic, Voice and Equalizer off. Press OK to confirm your selection.
  - **Vehicle:** Refer to Multi-function display in the *Instrument Cluster* chapter for more information.
  - **Clock:** Refer to Multi-function display in the *Instrument Cluster* chapter for more information.
  - **Display:** Refer to Multi-function display in the *Instrument Cluster* chapter for more information.
  - **Messages:** Refer to Multi-function display in the *Instrument Cluster* chapter for more information.
10. **AUX** Press to access LINE IN (auxiliary input jack) mode.
11. **SIRIUS** Press repeatedly to access SAT1, SAT2 and SAT3 satellite radio modes (if equipped).
12. **RADIO:** Press repeatedly to select AM/FM1/FM2 frequency bands. Press RADIO to return to the radio base screen when browsing. While listening to radio, you can navigate to other presets and modes by pressing ◀/▶. When the desired selection is chosen, press OK to tune to the selection or press RADIO to go back to current station.
- Autostore feature:** The autostore feature allows you to store the six strongest local stations available from the AM and FM frequency bands. To use, select AST. The display will read 'Hold to start autostore'. Continue holding the button until 'Autostoring' appears in the display. When the search is complete, the sound will return and the six strongest stations will be stored in the memory presets (and overwrite any stations previously stored in the AST band).
- Note:** You can also manually store stations in the AST band. When the AST band is active, simply tune to the desired station and press and hold a memory preset. The new station will be saved and will override the previously saved station.
13. **CD:** Press to enter CD mode (if equipped). While in CD mode, press ◀/▶ to navigate to other tracks/folders or Radio bands/stations. When your desired selection is chosen, press OK to select or press CD to return to the current track.
- Note:** If CD DRIVE HIGH TEMP appears in the display, the ambient temperature is too hot and the CD unit will not operate until it has cooled down.

26

## Entertainment Systems

14. ▲ **(Eject):** Press to eject a CD (if equipped.)

15. **Cursor controls:** Use to cycle through various menu selections.

**Note:** You can either press the arrows or move the OK knob in the desired direction.

**AM/FM stereo single CD/MP3 SYNC® compatible (if equipped)**

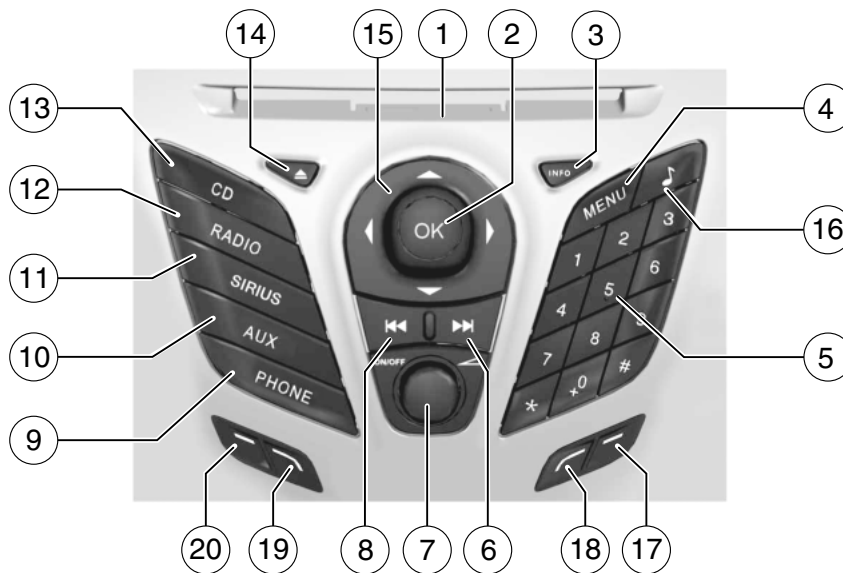

**WARNING:** Driving while distracted can result in loss of vehicle control, accident and injury. Ford strongly recommends that drivers use extreme caution when using any device or feature that may take their focus off the road. Your primary responsibility is the safe operation of the vehicle. We recommend against the use of any handheld device while driving, encourage the use of voice-operated systems when possible and that you become aware of applicable state and local laws that may affect use of electronic devices while driving.

**One hour mode:** Press the ON/OFF control to operate the system with the ignition turned off; the system will automatically turn off after one hour.

## Entertainment Systems

**Setting the clock:** Press the H or M buttons on the outside of the multifunction to access the clock settings. Once you are in the clock setting, press the H or M button repeatedly until the desired number appears. Press OK to confirm and close.

**Display icons:** Your system's display will illuminate icons for the mode which is currently active, such as:

Radio



CD



Auxiliary input



Phone



Settings: This icon will illuminate in green to indicate that the settings can be updated in the menu.



1. **CD slot:** Insert a CD, label side up.
2. **OK:** Use in various menu selections to select or deselect your choice.
3. **INFO:** Press to access any available radio or CD information.
4. **MENU:** Press to access the following features:

**Note:** To scroll through the following menus and make adjustments, press ▲ / ▼ or ◀ / ▶ . Press ◀ to return to the previous screen or ▶ to advance to the next screen.

**Note:** At any time, you can press MENU to close the menu screen.

- **Sirius (if equipped):** Scroll to select Sirius and then press OK to enter the menu. Scroll to select from SAT1, SAT2 or SAT3 modes.  
**Note:** Sirius must be the selected audio source to access this menu.
- **SYNC media (if equipped):** Scroll to select Mediaplayer Menu and then press OK to enter the menu. Refer to the SYNC® section in this chapter for more information. **Note:** SYNC audio must be the selected audio source to access this menu.

## Entertainment Systems

- **SYNC phone (if equipped):** Scroll to select Phone Menu and then press OK to enter the menu. Refer to the SYNC® section in this chapter for more information. **Note:** SYNC Phone must be the selected feature to access this menu.
- **Audio:** Scroll to select Audio and then move right to enter the menu. Scroll to select from:
  - **SCV:** Scroll to select Speed Compensated Volume (SCV) and press OK to enter the menu. SCV automatically adjusts the system's volume to compensate for speed and wind noise. You can set the system between off and +7.
  - **Sound:** Scroll to select Sound and move right to enter the menu. Scroll to select from Treble, Bass, Middle, Fade and Balance options. When the desired option is chosen, scroll to increase or decrease the levels. Sound settings can be set for each audio source independently.
  - **Occupancy mode:** Select Occupancy mode and scroll to select from optimize All Seats or Driver's Seat. Occupancy mode optimizes sound quality for the chosen seating position. Press OK to confirm your selection.
  - **DSP Equalizer:** Scroll to select DSP Equalizer and scroll to select from Rock, Pop, Classic, Voice and Equalizer off. Press OK to confirm your selection.
- **Vehicle:** Refer to Multi-function display in the *Instrument Cluster* chapter for more information.
- **Clock:** Refer to Multi-function display in the *Instrument Cluster* chapter for more information.
- **Display:** Refer to Multi-function display in the *Instrument Cluster* chapter for more information.

**Messages** Press ▲ / ▼ to view the saved vehicle messages.

5. **Memory presets:** To save a station, tune to the desired station. Press and hold a preset button until the information pop-up timer expires and stored preset # pop-up appears.

6. **▶▶ (Fast forward):** Press to access the next track. Press and hold to fast forward through track.

7. **On/Off/Volume:** Press to turn the system on or off. Turn to adjust the volume.

8. **◀◀ (Reverse):** Press to access the previous track. Press and hold for a fast reverse through the track.

## Entertainment Systems

9. **PHONE:** Press to access SYNC® phone features if available. Refer to the SYNC® section for more information. If your vehicle is not equipped with SYNC®, the display will read MUTE and will mute the playing media.

10. **AUX** Press to access LINE IN (auxiliary input jack) mode or SYNC® media mode.

11. **SIRIUS** Press repeatedly to access SAT1, SAT2 and SAT3 satellite radio modes (if equipped).

12. **RADIO:** Press repeatedly to select AM1/AM2AST/FM1/FM2AST frequency bands. Press RADIO to return to the radio base screen when browsing. While listening to radio, you can also navigate to other preset modes, CD tracks and folders by pressing ◀/▶. When the desired selection is chosen, press OK to tune to the selection or press RADIO to return to the current station. You can also select SIRIUS (if equipped) or AUX to change to the audio source.

**Autostore feature:** The autostore feature allows you to store the 10 strongest local stations available from the AM and FM frequency bands. To use, press the AST soft key at the bottom of the screen. The display will read 'Hold to start autostore'. Continue holding the button until 'Autostoring' appears in the display. When the search is complete, the sound will return and the 10 strongest stations will be stored in the memory presets (and overwrite any stations previously stored in the AST band). You can also manually store stations in the AST band. When the AST band is active, simply tune to the desired station and press and hold a memory preset. The new station will be saved and will override the previously saved station.

13. **CD:** Press to enter CD mode. Press the soft keys to Scan, repeat, shuffle or pause. In MP3 mode, you can Scan folder or CD, Repeat Track or Folder and Shuffle Folder or CD. While in CD mode, press ◀/▶ to navigate to other tracks/folders or radio modes/stations. When the desired selection is chosen, press OK to select or press CD to return to the current track. You can also select SIRIUS (if equipped), or AUX to change audio sources.

**Note:** If CD DRIVE HIGH TEMP appears in the display, the ambient temperature is too hot and the CD unit will not operate until it has cooled down.

14. **▲ (Eject):** Press to eject a CD.

15. **Cursor controls:** Use to cycle through various menu selections.

**Note:** You can either press the arrows or move the OK knob in the desired direction.

30

## Entertainment Systems

16. **Sound menu:** Press access Treble, Bass, Fade (if equipped) and Balance menu options. Use ▲ / ▼ to cycle through the various options. When the desired option is chosen, press ◀ / ▶ to increase or decrease the levels. Press OK to set or MENU to exit. Sound settings can be set for each audio source independently.

17–20 **Soft keys:** Press these soft keys to access the corresponding functions on the screen.

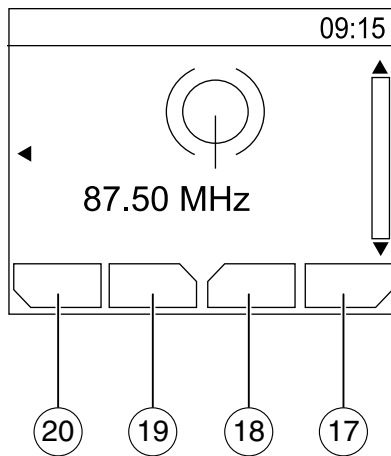

### Auxiliary input jack (Line in)



**WARNING:** Driving while distracted can result in loss of vehicle control, accident and injury. Ford strongly recommends that drivers use extreme caution when using any device or feature that may take their focus off the road. Your primary responsibility is the safe operation of the vehicle. We recommend against the use of any handheld device while driving, encourage the use of voice-operated systems when possible and that you become aware of applicable state and local laws that may affect use of electronic devices while driving.

## Entertainment Systems

The auxiliary input jack (AIJ) provides a way to connect your portable music player to the in-vehicle audio system. This allows the audio from a portable music player to be played through the vehicle speakers with high fidelity. To achieve optimal performance, please observe the following instructions when attaching your portable music device to the audio system.

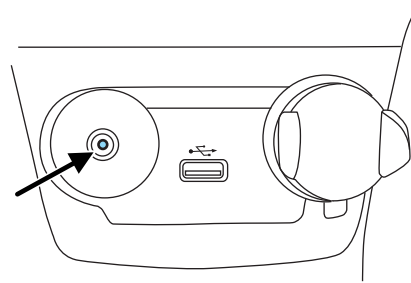

### Required equipment:

1. Any portable music player designed to be used with headphones
2. An audio extension cable with stereo male 1/8 in. (3.5 mm) connectors at each end

### To play your portable music player using the auxiliary input jack:

1. Begin with the vehicle parked and the radio turned off.
2. Ensure that the battery in your portable music player is new or fully charged and that the device is turned off.
3. Attach one end of the audio extension cable to the headphone output of your player and the other end of the audio extension cable to the AIJ in your vehicle.
4. Turn the radio on, using either a tuned FM station or a CD loaded into the system. Adjust the volume to a comfortable listening level.
5. Turn the portable music player on and adjust the volume to 1/2 the volume.
6. Press AUX on the vehicle radio repeatedly until LINE, LINE IN or SYNC LINE IN appears in the display.  
You should hear audio from your portable music player although it may be low.
7. Adjust the sound on your portable music player until it reaches the level of the FM station or CD by switching back and forth between the AUX and FM or CD controls.



**WARNING:** For safety reasons, do not connect or adjust the settings on your portable music player while the vehicle is moving.



## Entertainment Systems

 **WARNING:** Store the portable music player in a secure location, such as the center console or the glove box, when the vehicle is in motion. Hard objects may become projectiles in a collision or sudden stop, which may increase the risk of serious injury. The audio extension cable must be long enough to allow the portable music player to be safely stored while the vehicle is in motion.

### USB port (if equipped)

 **WARNING:** Driving while distracted can result in loss of vehicle control, accident and injury. Ford strongly recommends that drivers use extreme caution when using any device or feature that may take their focus off the road. Your primary responsibility is the safe operation of the vehicle. We recommend against the use of any handheld device while driving, encourage the use of voice-operated systems when possible and that you become aware of applicable state and local laws that may affect the use of electronic devices while driving.

Your vehicle may be equipped with a USB port. This feature allows you to plug in media playing devices, memory sticks, and also to charge devices if they support this feature. For further information on this feature, refer to the *SYNC*<sup>®</sup> supplement.

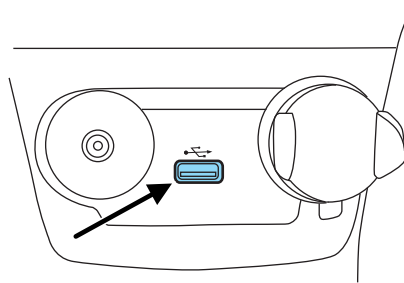

### GENERAL AUDIO INFORMATION

#### Radio frequencies:

AM and FM frequencies are established by the Federal Communications Commission (FCC) and the Canadian Radio and Telecommunications Commission (CRTC). Those frequencies are:

AM: 530, 540–1700, 1710 kHz

FM: 87.7, 87.9–107.7, 107.9 MHz

## Entertainment Systems

### Radio reception factors:

There are three factors that can affect radio reception:

- Distance/strength: The further you travel from an FM station, the weaker the signal and the weaker the reception.
- Terrain: Hills, mountains, tall buildings, power lines, electric fences, traffic lights and thunderstorms can interfere with your reception.
- Station overload: When you pass a broadcast tower, a stronger signal may overtake a weaker one and play while the weak station frequency is displayed.

### CD/CD player care

Do:

- Handle discs by their edges only. (Never touch the playing surface).
- Inspect discs before playing.
- Clean only with an approved CD cleaner.
- Wipe discs from the center out.

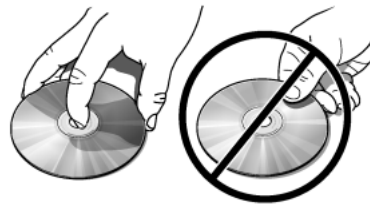

Don't:

- Expose discs to direct sunlight or heat sources for extended periods of time.
- Clean using a circular motion.

**CD units are designed to play commercially pressed 4.75 in (12 cm) audio compact discs only. Due to technical incompatibility, certain recordable and re-recordable compact discs may not function correctly when used in Ford CD players.**

## Entertainment Systems

**Do not use any irregular shaped CDs or discs with a scratch protection film attached.**

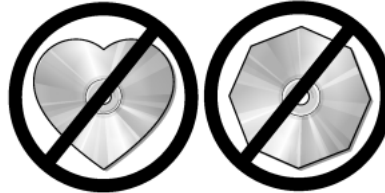

**CDs with homemade paper (adhesive) labels should not be inserted into the CD player as the label may peel and cause the CD to become jammed. It is recommended that homemade CDs be identified with permanent felt tip marker rather than adhesive labels. Ballpoint pens may damage CDs. Please contact your authorized dealer for further information.**

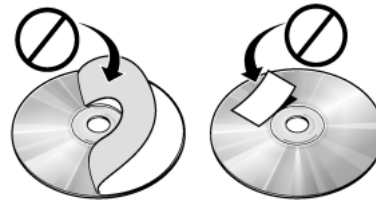

### **Audio system warranty and service**

Refer to the *Warranty Guide* for audio system warranty information. If service is necessary, see your dealer or qualified technician.

### **MP3 track and folder structure**

Your MP3 system recognizes MP3 individual tracks and folder structure as follows:

- There are two different modes for MP3 disc playback: MP3 track mode (system default) and MP3 folder mode. For more information on track and folder mode, refer to *Sample MP3 structure* in the following section.
- MP3 track mode ignores any folder structure on the MP3 disc. The player numbers each MP3 track on the disc (noted by the .mp3 file extension) from T001 to a maximum of T255.  
**Note:** The maximum number of playable MP3 files may be less depending on the structure of the CD and exact model of radio present.
- MP3 folder mode represents a folder structure consisting of one level of folders. The CD player numbers all MP3 tracks on the disc (noted by the .mp3 file extension) and all folders containing MP3 files, from F001 (folder) T001 (track) to F253 T255.
- Creating discs with only one level of folders will help with navigation through the disc files.

## Entertainment Systems

### Sample MP3 structure

If you are burning your own MP3 discs, it is important to understand how the system will read the structures you create. While various files may be present, (files with extensions other than mp3), only files with the .mp3 extension will be played. Other files will be ignored by the system. This enables you to use the same MP3 disc for a variety of tasks on your work computer, home computer and your in-vehicle system.

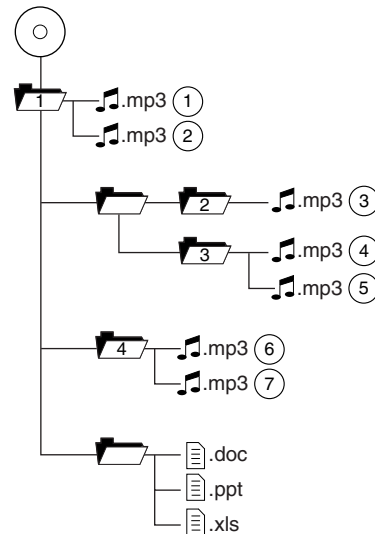

In track mode, the system will display and play the structure as if it were only one level deep (all .mp3 files will be played, regardless of being in a specific folder). In folder mode, the system will only play the .mp3 files in the current folder.

### Satellite radio information (if equipped)

**Satellite radio channels:** SIRIUS® broadcasts a variety of music, news, sports, weather, traffic and entertainment satellite radio channels. For more information and a complete list of SIRIUS® satellite radio channels, visit [www.sirius.com](http://www.sirius.com) in the United States, [www.sirius-canada.ca](http://www.sirius-canada.ca) in Canada, or call SIRIUS® at 1-888-539-7474.

**Satellite radio reception factors:** To receive the satellite signal, your vehicle has been equipped with a satellite radio antenna located on the roof of your vehicle. The vehicle roof provides the best location for an unobstructed, open view of the sky, a requirement of a satellite radio system. Like AM/FM, there are several factors that can affect satellite radio reception performance:

- **Antenna obstructions:** For optimal reception performance, keep the antenna clear of snow and ice build-up and keep luggage and other material as far away from the antenna as possible.

36

## Entertainment Systems

- **Terrain:** Hills, mountains, tall buildings, bridges, tunnels, freeway overpasses, parking garages, dense tree foliage and thunderstorms can interfere with your reception.
- **Station overload:** When you pass a ground based broadcast repeating tower, a stronger signal may overtake a weaker one and result in an audio mute.

Unlike AM/FM audible static, you will hear an audio mute when there is a satellite radio signal interference. Your radio display may display NO SIGNAL to indicate the interference.

**SIRIUS® satellite radio service:** SIRIUS® Satellite Radio is a subscription based satellite radio service that broadcasts music, sports, news and entertainment programming. A service fee is required in order to receive SIRIUS® service. Vehicles that are equipped with a factory installed SIRIUS® Satellite Radio system include:

- Hardware and limited subscription term, which begins on the date of sale or lease of the vehicle.

For information on extended subscription terms, the online media player and other SIRIUS® features, please contact SIRIUS® at 1-888-539-7474.

**Note:** SIRIUS® reserves the unrestricted right to change, rearrange, add or delete programming including canceling, moving or adding particular channels, and its prices, at any time, with or without notice to you. Ford Motor Company shall not be responsible for any such programming changes.

**Satellite Radio Electronic Serial Number (ESN):** This 12-digit Satellite Serial Number is needed to activate, modify or track your satellite radio account. You will need this number when communicating with SIRIUS. While in Satellite Radio mode, you can view this number on the radio display by pressing the SIRIUS and Preset 1 buttons at the same time.

## Entertainment Systems

Radio Display	Condition	Action Required
ACQUIRING	Radio requires more than two seconds to produce audio for the selected channel.	No action required. This message should disappear shortly.
SAT FAULT	Internal module or system failure present.	If this message does not clear within a short period of time, or with an ignition key cycle, your receiver may have a fault. See your authorized dealer for service.
INVALID CHNL	Channel no longer available.	This previously available channel is no longer available. Tune to another channel. If the channel was one of your presets, you may choose another channel for that preset button.
UNSUBSCRIBED	Subscription not available for this channel.	Contact SIRIUS® at 1-888-539-7474 to subscribe to the channel or tune to another channel.
NO TEXT	Artist information not available.	Artist information not available at this time on this channel. The system is working properly.

## Entertainment Systems

Radio Display	Condition	Action Required
NO TEXT	Song title information not available.	Song title information not available at this time on this channel. The system is working properly.
NO TEXT	Category information not available.	Category information not available at this time on this channel. The system is working properly.
NO SIGNAL	Loss of signal from the SIRIUS® satellite or SIRIUS® tower to the vehicle antenna.	You are in a location that is blocking the SIRIUS® signal (i.e., tunnel, under an overpass, dense foliage, etc). The system is working properly. When you move into an open area, the signal should return.
UPDATING	Update of channel programming in progress.	No action required. The process may take up to three minutes.
CALL SIRIUS 1-888-539-7474	Satellite service has been deactivated by SIRIUS® Satellite Radio.	Call SIRIUS® at 1-888-539-7474 to re-activate or resolve subscription issues.

### **SYNC® (IF EQUIPPED)**

Thank you for purchasing SYNC®!

SYNC® is a hands-free communications and entertainment system that literally 'syncs up' with all other multimedia systems in your vehicle. SYNC® delivers convenience with voice activated calling and hands-free conversations, digital media player command and control as well as easy to use voice commands. The world outside your vehicle cabin may be chaotic, but inside, with SYNC®, it's always a smooth ride. All you have to do is sync it and stow it. We'll take care of the rest.

## Entertainment Systems

Welcome to the new world of ingenuity and passion - technology that is both fun and functional. Welcome to SYNC®.

For more information, please visit [www.SyncMyRide.com](http://www.SyncMyRide.com).

### Export unique (Non-United States/Canada) information

For your particular global region, your vehicle may be equipped with features and options that are different from the features and options that are described in this supplement.

### Safety information



**WARNING:** Driving while distracted can result in loss of vehicle control, accident and injury. Ford strongly recommends that drivers use extreme caution when using any device that may take their focus off the road. Your primary responsibility is the safe operation of the vehicle. We recommend against the use of any handheld device while driving and that you comply with all applicable laws.

- Do not attempt to service or repair SYNC®. See your authorized dealer.
- Do not operate playing devices if the power cords and/or cables are broken, split or damaged. Carefully place cords and/or cables where they will not be stepped on or interfere with the operation of pedals, seats and/or compartments, or safe driving abilities.
- Do not leave playing devices in the vehicle in extreme conditions as it could cause damage to your device. Refer to your device's user guide for further information.
- For your safety, some SYNC® functions are speed dependent and cannot be performed when the vehicle is traveling at speeds greater than 3 mph (5 km/h).
- Ensure that you review your device's user guide before using with SYNC®.

### Privacy information

When a cellular phone is connected to SYNC®, SYNC® creates a profile within your vehicle that is linked to that cellular phone. This profile is created in order to offer you more cellular features and to operate more efficiently. Among other things, this profile may contain data about your cellular phone book, text messages (read and unread), and call history, including history of calls when your cell phone was not connected to

40



## Entertainment Systems

SYNC®. In addition, if you connect a media device, SYNC® creates and retains an index of media content supported by SYNC®. SYNC® also records a short development log of approximately 10 minutes of all recent SYNC® activity. The log profile and other SYNC® data may be used to improve SYNC® and help diagnose any problems that may occur.

The cellular profile, media device index, and development log will remain in the vehicle unless you delete it and are generally accessible only in the vehicle when the cellular phone or media player is connected. If you no longer plan to use SYNC® or the vehicle, we recommend you perform a Master Reset to erase all information stored in SYNC®.

SYNC® data cannot be accessed without special equipment and access to the vehicle's SYNC® module. Ford Motor Company and Ford of Canada will not access SYNC® data for any purpose other than as described absent consent, a court order, or where required by law enforcement, other government authorities, or other third parties acting with lawful authority. Other parties may seek to access the information independently of Ford Motor Company and Ford of Canada. For further privacy information, see the sections on 911 Assist™ (if equipped), Vehicle Health Report (if equipped), and Traffic, Directions and Information (if equipped).

### Phone dependent features

While SYNC® supports a variety of features, many are dependent upon the functionality of your cell phone with *Bluetooth*® wireless technology. At a minimum, most cellular phones with *Bluetooth* wireless technology support the following functions:

- Answering an incoming call
- Ending a call
- Using privacy mode
- Dial a number
- Redial
- Call waiting notification
- Caller ID

Other features, such as text messaging via *Bluetooth*, and automatic phone book download are phone dependent features. To ensure that you have a compatible cellular phone, refer to your phone's user manual and visit [www.SyncMyRide.com](http://www.SyncMyRide.com) or [www.syncmaroute.ca](http://www.syncmaroute.ca).

## Entertainment Systems

### **SYNC® voice recognition feature**

SYNC® is equipped with an advanced interactive Voice Recognition (VR) system. This system allows you to perform many operations by “speaking” certain commands to the system. The system will respond with a series of audible tones, prompts, questions and spoken confirmations depending on the situation and the chosen level of dialogue interaction.

### **Feedback through audible tones**

Your VR system will respond through various audible tones. You may hear a tone at the following times:

- When you press .
- When you access the help feature.
- When the VR system does not understand your request.
- When a VR session is completed successfully.
- When a VR session is ended unsuccessfully.
- When a speed dependent feature has been accessed.
- When a new device is connected.

SYNC® has five different audible tones that will play depending on the circumstance.

- Initial: Sounds when you are entering a new mode.
- Positive: Sounds for a positive recognition or a successful VR session completion.
- Negative: Sounds for a negative recognition, an unsuccessful VR session, or when a speed dependent feature has been accessed.
- Listening: Sounds when the system is ready to listen for a command.
- Help: Sounds when you ask for 'Help'.

### **Confirmation prompts**

Confirmation prompts are short questions asked by the system when the system has not clearly understood your request or when there are many possible responses to your request. For example, if you have Confirmation prompts ON, the system may say, “Phone, is that correct?”. The system will then listen for a “Yes” or “No” confirmation from you. If you say “Yes”, the system will proceed. If you say “No”, the system will ask you to say the command again. If you have Confirmation prompts OFF, the system will simply make a best guess as to what you requested.

42

## Entertainment Systems

If the system has a low confidence level of what was asked, it will prompt you to try again or ask for help.

**Note:** Even with Confirmation prompts turned OFF, you may be asked to confirm certain settings occasionally.

### **Clarification through candidate lists**

Candidate lists are created when the system has several possible options of similar level of confidence as a result of your request. The system will submit back to you as many as four possibilities for your clarification. This may happen either with your phone book and/or music selections.

#### **Example #1:**

You want to call John Doe at home, so you say, "Call John Doe at home". If the system has a similar confidence level for a few items, it may respond with:

- (initial tone) "Say 1 after the tone to call John Doe at home. Say 2 after the tone to call Johnny Doe on mobile. Say 3 after the tone to call Jane Doe at home." (listen tone)

#### **Example #2:**

You want to listen to a certain artist, so you say, "Play Artist John". If the system has a similar confidence level for two possible options, it may respond with:

- (initial tone) "Say 1 after the tone to play John Doe. Say 2 after the tone to play Johnny Doe." (listen tone)

### **Using voice commands with SYNC®**

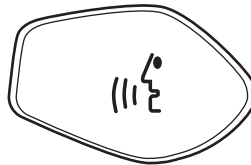

There is a push to talk button on the stalk on your steering wheel labeled as . Press this button to activate Voice Recognition. You will hear a tone and LISTENING will appear in the radio display signaling that the system is ready to accept your command. Speak the command clearly to ensure that the system is able to recognize and perform the desired function.



### **For the best voice recognition performance:**

- Ensure that the interior of the vehicle is as quiet as possible. Wind noise from open windows and road vibrations may prevent the system from correctly recognizing spoken voice commands.

## Entertainment Systems

- After pressing , wait until the tone sounds and LISTENING appears in the radio display before speaking a command. Any command spoken prior to this will not register with the system.
- At any time, you can interrupt the system while it is speaking by pressing . The system will respond with a listening tone and allow you to speak a command.
- Speak naturally without large pauses in between words.

**At any time, you may say these commands:**

- USB
- Bluetooth Audio
- Phone
- Cancel
- Help
- SYNC
- Line in
- Voice settings
- Vehicle health report (if equipped, U.S. only)
- Services (if equipped, U.S. only)

**USB:** Say to access the device connected to the USB port.

**SYNC:** Say to return to the main menu.

**Bluetooth audio:** Say to access/use streaming music from your cellular phone enabled with *Bluetooth* wireless technology.

**Line in:** Say to access the device plugged into your auxiliary input jack.

**Phone:** Say to access hands-free phone mode.

**Voice settings:** Say to access the voice settings menu. Refer to *Commands for voice settings* in the following section.

**Help:** Say at any time for options in a specific mode. SYNC will list various options for you audibly. The 'help' request is always available.

**Cancel:** Say to cancel the requested action.

**Vehicle health report (U.S. only, if activated):** Say to request to run a vehicle health report on your vehicle.

**Services (U.S. only, if activated):** Say to place a call to the information services portal where you can access Traffic, Directions and Information.

## Entertainment Systems

### **Commands for voice settings**

In voice settings, you can customize the level of system interaction, help and feedback. The system default settings include standard interaction as well as candidate lists and confirmation prompts as all provide the most guidance and feedback.

**At any time, while in voice settings, you may say these commands to adjust the voice settings:**

- Interaction mode advanced
- Confirmation prompts on
- Media candidate lists on
- Phone candidate lists on
- Interaction mode standard
- Confirmation prompts off
- Media candidate lists off
- Phone candidate lists off

**Interaction mode standard/advanced:** Standard interaction mode provides more detailed interaction and guidance while the advanced mode has less audible interaction and more tone prompts.

**Confirmation prompts on/off:** Confirmation prompts are short questions asked by the system when the system has not clearly heard or understood your request. **Note:** Even with Confirmation prompts turned OFF, you may be asked to confirm settings occasionally.

**Phone/media candidate lists on/off:** Candidate lists are a list of possible results from your voice commands. These occur when SYNC® has equal confidence of several possible results from your voice command.



For voice commands available in SYNC® phone mode, refer to *Voice commands in phone mode* in the Phone chapter.

For voice commands available in SYNC® media mode, refer to *Voice commands in media mode* in the Media chapter.

### **Quick reference chart**

The following chart is a quick summary of controls as well as their respective function(s).

## Entertainment Systems

Radio control	Steering wheel / stalk control	Function
PHONE		Press to activate SYNC® hands-free calling or to answer an incoming call. When in phone mode, press to send a call, text message, to put a call on hold and answer another call, or to initiate a multi-party call. Press and hold to end a call. Press and hold to cancel a call to emergency services when using the 911 Assist feature (if equipped). Press and hold to exit phone mode when not in an active call.
N/A		Press to activate Voice Recognition. Press and hold to end an active voice session. Refer to <i>Voice recognition system overview</i> for further information.
		Press to scroll through various menus and selections.
OK	OK	Press to confirm your selection.
MENU	N/A	Press while in an active call to access SYNC® active call options. Refer to <i>Active call menu options</i> in the <i>SYNC® phone features</i> section Press while in media to access SYNC® MEDIA MENU. Refer to the <i>SYNC® media features</i> section for further information.
AUX	N/A	Press repeatedly to cycle through available auxiliary sources. For further information, refer to <i>Using your media menu</i> in the <i>SYNC® media features</i> section.

## Entertainment Systems

### Voice commands in phone mode



**WARNING:** Driving while distracted can result in loss of vehicle control, accident and injury. Ford strongly recommends that drivers use extreme caution when using any device that may take their focus off the road. Your primary responsibility is the safe operation of the vehicle. We recommend against the use of any handheld device while driving and that you comply with all applicable laws.

### While in phone mode, you may say any of the following commands:

- Dial
- Call <name> at home
- Call <name> at work OR Call <name> in office
- Phone book <name> at home<sup>1</sup>
- Phone book <name> on mobile OR cell<sup>1</sup>
- Call history outgoing<sup>1</sup>
- Phone book <name> on Other<sup>1</sup>
- Call history missed<sup>1</sup>
- Menu<sup>1</sup>
- Join
- Call <name>
- Call <name> on mobile OR cell
- Call <name> on other
- Phone book <name><sup>1</sup>
- Phone book <name> at work OR Phone book <name> at office<sup>1</sup>
- Call history incoming<sup>1</sup>
- Connections<sup>1</sup>
- Go to privacy
- Hold

<sup>1</sup> Voice commands are not available until downloading phone information via *Bluetooth* is complete.

**Phone book commands:** When you ask SYNC® to access a phone book name, number, etc., the requested information will appear in the display to view. Press  or PHONE or say “Call” to call the contact.

**Note:** In the above possible commands, “<name>” is a dynamic listing in that it could be any desired name from your phone book.

## Entertainment Systems

**While in phone mode, you may also say “Menu” and then any of the following commands:**

- [Phone] settings [message] notification on
- [Phone] settings [message] notification off
- [Phone] connections
- Phone name
- Signal
- Battery
- [Phone] settings [set] phone ringer
- [Phone] settings [set] ringer 1
- [Phone] settings [set] ringer 2
- [Phone] settings [set] ringer 3
- Text message inbox
- [Phone] settings [set] ringer off

**Note:** With the above commands, words in ( ) are optional and do not have to be spoken for the system to understand the command.

**You may also say “Dial” to access any of the following commands:**

- <number> 0–9
- Dial
- Delete (deletes one digit)
- Clear (deletes all entered digits)
- Plus
- Star
- Asterisk (\*)
- 800 (eight hundred)
- 700 (seven hundred)
- 900 (nine hundred)
- 411 (four-one-one), 911 (nine-one-one), etc.
- # / (pound, slash)

**Note:** To exit Dial mode, press and hold  or PHONE or press MENU to go to the PHONE MENU.

### ***Voice commands when connecting devices***

**When attempting to connect a phone to SYNC®, you may say any of the following commands:**

- Connect <device name>
- Bluetooth ON
- Bluetooth OFF
- Delete <device name>

**Note:** You can only connect a device to SYNC® after it has successfully gone through the pairing process.

**Note:** In the above possible commands, “<name>” is a dynamic listing in that it could be the name of any previously paired device.



## Entertainment Systems

### At any time, you may say these commands:

- SYNC
- Line in
- Phone
- Cancel
- Help
- USB
- Bluetooth Audio
- Voice settings
- Vehicle health report (if equipped, U.S. only)
- Services (if equipped, U.S. only)

### **Voice commands when using Traffic, Directions & Information services (if equipped, U.S. only)**

When connected to services, you may say any of the following commands:

- Services
- Go back
- Help
- Repeat

Available services (and voice commands) include:

- Traffic
- Business search
- News
- Favorites
- Travel
- Movies
- Directions
- Sports
- Weather
- Stocks
- Entertainment
- Horoscopes

For a complete list of services, say, “What are my choices?” when in the services menu.

When directions are downloaded and route guidance is active, press  and say any of the following voice commands:

- Next turn
- Route summary
- Update route
- Voice guidance OFF
- Route status
- Cancel route
- Voice guidance ON
- Guidance display on/off (late availability, if equipped)\*

\* **Note:** These voice commands are only available on vehicles that have a center integrated display.

### **Pairing your phone for the first time**

**Note:** For your safety, this procedure cannot be completed when the vehicle is traveling at speeds greater than 3 mph (5 km/h). Please read all safety information prior to operating the system.

## Entertainment Systems

The first thing you must do to use the system is to 'pair' your Bluetooth® enabled phone with your vehicle's SYNC® system. This process allows your phone to wirelessly communicate with the hands-free SYNC® system and ensures that other phones cannot inadvertently do so. To pair your phone for the first time:

1. Ensure that the vehicle ignition and audio system are on and that your vehicle is in P (Park).
2. Press PHONE to enter the phone menu. SYNC will attempt to connect and the display will indicate no phone is paired.
3. When *Add Bluetooth Device* appears, press OK. The system will aid you with voice prompts to complete the process.
4. When *Find SYNC* appears in the display, press OK. Follow the instructions in your cellular phone's guide to put your phone into Bluetooth Discovery mode. A six digit PIN will appear in the display.
5. When prompted on your phone's display, enter the six digit PIN provided by SYNC.
6. The display will read *Connected* when the pairing process is successful.
7. Depending on your phone's capability, you may be prompted with additional options such as setting the phone as your primary and downloading your phone book. Press OK for yes and follow the prompts as necessary.

**Note:** Your setting for the phone book will be saved in the system. If you choose to download the phone book, the phone book will be downloaded each time your phone is reconnected to the system (upon each ignition cycle).

**Note:** Depending on the size of your phone book, it may take a few moments for the system to fully download the entire phone book.

### Making a call

Making a hands-free phone call using SYNC® is easy.

1. Press **106**.
2. When prompted, say, "Call <name>" or say the desired number and then say "Dial".

**To erase the last spoken digit,** say "Delete".

**To erase all spoken digits,** say "Clear".

3. Once the desired number/contact is on the screen, either say "Call" or "Dial". The system will connect to the desired number.

**Note:** Once the call is placed, it will be logged into your outgoing call history folder.

50

## Entertainment Systems

**Note:** You can also manually enter the desired number by pressing the presets (0–9).

### Ending a call

At any time, you can end an active phone call by pressing and holding  or PHONE.

### Exiting phone mode

When in phone mode but not in an active call, press and hold  or PHONE to exit phone mode.

### Answering an incoming call

An incoming call interacts with SYNC® in much the same way it interacts with your *Bluetooth* enabled cellular phone. During an incoming call:

- An audible ring tone will sound. If available, call information will appear in the display.
- Select from the following options:

**Accept the call** by pressing  or PHONE. The call will be transferred to hands-free and logged into the incoming call history folder.

**Ignore the call** by doing nothing. SYNC® will log the call as a missed call.

**Reject the call** by pressing and holding  or PHONE. SYNC® will log the call.

### Incoming new text message

**Note:** This is a phone dependent feature.

If your *Bluetooth* enabled phone is connected and supports downloading text messages via *Bluetooth*, you can receive incoming text messages. When you are being sent a text message, an audible tone will sound and the display will indicate that you have a new message. You can say “Read Message” and SYNC® will read the message to you.

**Note:** To scroll, press ▲ / ▼ .

1. Press OK to receive and open the text message or do nothing and the message will go into your text message inbox. Press OK again and SYNC® will read your message aloud as you are not able to view the message. You can then also choose whether you'd like to reply or forward the message.
2. Press OK and scroll to toggle between *Reply to Text Message* or *Forward Text Message*.

## Entertainment Systems

3. When the desired selection appears in the display, press OK.

If you choose *Reply to Text Message*, SYNC® will take you back to the text messaging menu and allow you to again cycle through the list of predefined messages to send.

If you choose *Forward Text Message*, SYNC® will take you to your calling options. Choose to forward the message to anyone in your *Phonebook*, *Call History*, or you can choose *Enter Number*.

**Note:** Forwarding a text message is a speed dependent feature and can only be done when the vehicle is traveling at 3 mph (5 km/h) or less.

**Note:** Only one recipient is allowed per text message.

### Active call menu options

Once a call is active within SYNC®, the following menu options are available:

- *Privacy*
- *Call Hold*
- *Enter Tones*
- *Join Calls*
- *Phonebook*
- *Call History*
- *Return*

Refer to the following sections for further information.

### Using privacy mode

SYNC® allows you to easily switch a call from an active hands-free environment to your *Bluetooth* enabled cellular phone for a more private conversation. To turn privacy mode on/off:

**Note:** To scroll, press ▲ / ▼ .

1. Press MENU. The radio display will read *Active Call Menu*.
2. Scroll repeatedly until *Privacy* appears in the radio display.
3. Press OK. The radio display will read *Turn Privacy On/Off?*
4. Press OK to activate privacy mode. The radio display will read *In Privacy* and the system will transfer the call to your *Bluetooth* enabled cellular phone.

**Note:** Some phones will disconnect from SYNC® and transfer the active call directly to the connected phone.

52

## Entertainment Systems

### **Putting a call on/off hold**

You can put an active phone call on hold to have a private conversation within the vehicle cabin, or to answer another incoming call. To put an active call on hold:

**Note:** To scroll, press ▲ / ▼ .

1. Press MENU. The display will read *Active Call Menu* .
2. Scroll until *Call Hold* is selected and press OK.
3. Scroll until *Place Call On Hold?* is selected and press OK.

**Note:** If you are putting the current call on hold to answer another call, press PHONE to answer the incoming call. Each subsequent press of PHONE will put the active call on hold and reactivate the call on hold.

### **Enter tones**

While in an active call, SYNC® allows you to enter tones (i.e. entering numbers for passwords), using the radio display.

**Note:** To scroll, press ▲ / ▼ .

1. When on an active call, press MENU.
2. Scroll until *Enter Tones* is selected and press OK.
3. Scroll until the desired number appears in the radio display and press OK. An audible tone will sound as confirmation. Repeat the process as many times as necessary.

### **Joining two calls (multiparty /conference call)**

To join two separate calls and speak to both through SYNC®:

**Note:** To scroll, press ▲ / ▼ .

1. When on an active call, press PHONE. This will put your first call on hold.
2. Place the second call by accessing the contact information through SYNC® or by using voice recognition and saying the contact name or number and placing the call.
3. Once you are actively in the second call, press MENU. *Active Call Menu* will appear.
4. Scroll until *Join Calls* is selected and press OK.
5. When *Join Calls?* appears, press OK.

The system will join both calls into one and you will be able to speak to both parties at the same time. The display will indicate that your conference call is active.

## Entertainment Systems

**Note:** SYNC® supports a maximum of three callers on a multiparty/conference call.

### **Accessing your call history and phone book during an active call**

**Note:** Accessing your phone book is a speed dependent feature. The vehicle must be moving less than 3 mph (5 km/h) to use this feature.

You can access your call history and phone book while on an active call.

**Note:** To scroll, press ▲ / ▼ .

1. Press MENU. The display will read *Active Call Menu*.
2. Scroll until *Call History / Phonebook* is selected and press OK. The system will take you to the chosen menu item.

Refer to *Call History* and *Accessing your phone book* for further details on making selections in those menus.

### **How SYNC® interacts with your Bluetooth enabled cellular phone**

While SYNC® has a variety of features, many of them are dependent on your device's functionality. To ensure that you have a compatible device or to check which features are compatible with SYNC®, please check your device's user guide and also visit [www.SyncMyRide.com](http://www.SyncMyRide.com).

One of the main features of SYNC® is hands-free calling which works in conjunction with your *Bluetooth* enabled cellular phone to offer many options within the SYNC® *Phone Menu*.

Press  or PHONE to access the following items when you are not in an active call:

#### **Phone Menu**

**Note:** *Phone Menu* will appear briefly to indicate that you are in the *Phone Menu*.

- *Phone Redial*
- *Call History*
- *Phonebook*
- *Text Message*
- *Phone Settings*
- *Services (if equipped, U.S. only)*
- *911 Assist™ (if equipped)*
- *Vehicle Health (if equipped, U.S. only)*
- *Applications (if available)*
- *System Settings*
- *Exit Phone Menu*

54

## Entertainment Systems

### Phone redial

Phone redial will prompt your cellular phone with *Bluetooth* wireless technology to redial the last number called (if available).

**Note:** To scroll, press ▲ / ▼ .

1. Press PHONE to enter *Phone Menu*.
2. When *Phone Redial* is selected, press OK.
3. When *Redial?* appears, press OK. *Redialing...* will appear as it is placing the call.

### Call history

**Note:** This is a phone dependent feature. If your phone doesn't support downloading call history via *Bluetooth*, SYNC® will keep track of calls made with SYNC®.

You can access any previously dialed, received or missed calls while your *Bluetooth* enabled phone has been connected to SYNC®.

**Note:** To scroll, ▲ / ▼ .

1. Press PHONE to enter *Phone Menu*.
2. Scroll until *Call History* is selected and press OK.
3. Scroll to select either *Call History Incoming*, *Call History Outgoing* or *Call History Missed* calls and press OK.
4. Scroll until the desired call is selected.
5. Press OK or PHONE to call the desired selection.

**Note:** SYNC® will attempt to automatically re-download your phone book/call history each time your phone connects to SYNC® (if the auto download feature is on and if your *Bluetooth* enabled cellular phone supports this feature).

### Accessing your phone book

**Note:** This is a phone dependent feature.

**Note:** This is a speed dependent feature. The vehicle must be moving less than 3 mph (5 km/h) to browse your phone book. However, if your phone supports phone book downloads, you can access your contacts at any time by pressing  and saying the contact's name.

When you pair your phone with SYNC®, you can choose to download your cellular phone book. SYNC® can support downloading up to approximately 2,000 entries per *Bluetooth* enabled phone.

## Entertainment Systems

**Note:** To scroll, press ▲ / ▼ .

1. Press PHONE to enter *Phone Menu*.
2. Scroll until *Phonebook* is selected and press OK.  
If there are fewer than 255 listings, SYNC® will list them alphabetically in flat file mode. If there are more than 255 entries listed, SYNC® will organize them into quick select alphabetical categories (i.e. AAAAA-MMMMM and MMMMN — ZZZZZ). The number of categories will vary depending on the number of entries downloaded.
3. If there are more than 255 entries, scroll to cycle through these categories until the desired category appears in the radio display.
4. Press OK to confirm.
5. Scroll to cycle through the contacts.
6. Once the desired entry is reached, press OK to view the number and then press OK or PHONE to place the call.

For further information, refer to *Modifying your phone book*.

**Note:** If the auto download feature is on, SYNC® will automatically re-download your phone book/call history every time your *Bluetooth* enabled cellular phone connects to SYNC®.

### Text messaging

**Note:** Downloading and sending text messages via *Bluetooth* is a phone dependent feature.

To access the text messaging menu:

**Note:** To scroll, press ▲ / ▼ .

1. Press PHONE to enter *Phone Menu*.
2. Scroll until *Text Message* is selected and press OK. If SYNC® detects that your *Bluetooth* enabled cellular phone does not support downloading text messaging via *Bluetooth*, *Unsupported* will appear in the radio display and SYNC® will return you to the main menu.
3. The display will indicate the number of messages in your inbox.
4. Press OK to have SYNC® read your message back to you.
5. Scroll to cycle through:
  - *Send Text Message?*
  - *Download Unread Msgs*
  - *Delete All Messages?*

56



## Entertainment Systems

- *Return*

6. Once your desired choice is selected, press OK. Refer to the following specific section(s) for further details on these options.

### **Sending new text messages**

**Note:** This is a speed dependent feature. The vehicle must be moving less than 3 mph (5 km/h) to use this feature.

SYNC® allows you to send new text messages using a predefined set of 15 messages. To access and choose from these messages:

**Note:** To scroll, press ▲ / ▼ .

1. Press PHONE to enter the *Phone Menu*.
2. Scroll until *Text Message* is selected and press OK. If SYNC® detects that your *Bluetooth* enabled cellular phone does not support downloading text messaging via *Bluetooth*, *Unsupported* will appear in the radio display and SYNC® will return you to the main menu.
3. The display will indicate the number of messages in your inbox.
4. Scroll until *Send Text Message?* is selected and press OK.
5. Scroll to cycle through the following predefined messages:
  - Can't talk right now
  - Call you later
  - Be there in 20 minutes
  - No
  - Thanks
  - I need more directions
  - Too funny
  - I'm stuck in traffic
  - Call me
  - Be there in 10 minutes
  - Yes
  - Why?
  - Where R you?
  - I love you
  - Can't wait to see you
6. When the desired choice is selected, press OK.
7. Now select to whom you would like to send the message by scrolling to select either:
  - *Phonebook*: Allows you to select a name within your phone book to send the message.
  - *Call History*: Allows you to select from your recent calls.
  - *Enter Number*: Allows you to audibly enter phone numbers.
8. When the desired choice is selected, press OK and scroll to cycle through the selections to reach the desired phone number.

57

## Entertainment Systems

9. When the system asks if you want to send the message, press OK. SYNC® will take you back to your inbox.

**Note:** Each text message sent by SYNC® will be followed by the signature: “This message was sent from my \_\_\_”. The message will say either Ford, Lincoln or Mercury, depending on your vehicle.

### **Downloading your unread text messages**

If your phone supports downloading text messages via *Bluetooth* wireless technology, you can download your unread text messages to SYNC®.

**Note:** SYNC® does not download read text messages from your phone.

**Note:** Once the messages are downloaded, they will be noted as ‘read’ in your *Bluetooth* enabled cellular phone.

**Note:** To scroll, press ▲ / ▼ .

1. Press PHONE to enter *Phone Menu*.
2. Scroll until *Text Message* is selected and press OK to see the number of messages in your inbox.
3. Scroll until *Download Unread Msgs* is selected and press OK.
4. Once the downloaded text messages have been retrieved, SYNC® will take you into your inbox.

### **Deleting all your text messages**

You can delete all your current text messages from SYNC®.

**Note:** This will not delete messages from your *Bluetooth* enabled cellular phone.

**Note:** To scroll, press ▲ / ▼ .

1. Press PHONE to enter *Phone Menu*.
2. Scroll until *Text Message* is selected and press OK. The display will indicate the number of messages in your inbox.
3. Press OK to confirm the selection.
4. Scroll until *Delete All Messages?* is selected and press OK. The system will return you to the Text Message menu.

**Note:** SYNC® does not automatically download all of your unread text messages at every connection cycle (as it does with call history and phone book if automatic download is on).

### **Phone settings**

**Note:** These are phone dependent features.

58

## Entertainment Systems

Under the phone settings menu on SYNC®, you can view the status of your paired phone with *Bluetooth* wireless technology, select from various ring tones, select message notification on/off, change phone book entries and auto download your cellular phone book among other features. To access the phone settings menu:

**Note:** To scroll, press ▲ / ▼ .

1. Press PHONE to enter *Phone Menu*.
2. Scroll until *Phone Settings* is selected and press OK.
3. Scroll to cycle through the following selections:
  - *Phone Status*
  - *Message Notification*
  - *Auto Download*
  - *Set Ringer*
  - *Modify Phonebook*
  - *Return*

### **Phone status**

**Note:** This is a phone dependent feature.

This feature shows you the provider, name, signal power, battery power and roaming status of the connected phone. To view your phone's status:

**Note:** To scroll, press ▲ / ▼ .

1. Press PHONE to access the *Phone Menu*.
2. Scroll until *Phone Settings* is selected and press OK.
3. Scroll until *Phone Status* is selected and press OK.
4. Scroll to view the paired phone's *name*, signal level, battery level and roaming status.

After viewing any of these selections, press the Exit soft key to return to the *Phone Status* menu.

### **Setting a ring tone**

SYNC® allows you to select from three ring tones or your cellular phone's ring tone. To access:

**Note:** To scroll, press ▲ / ▼ .

1. Press PHONE to enter *Phone Menu*.
2. Scroll until *Phone Settings* is selected and press OK.
3. Scroll until *Set Ringer* is selected and press OK.
4. Scroll to cycle through and hear *Ringer 1*, *Ringer 2*, *Ringer 3* and *Phone Ringer*.

## Entertainment Systems

**Note:** In-band ringing is a phone dependent feature. If your phone supports in-band ringing, your phone's ringer will play through the vehicle audio system when *Phone Ringer* is chosen.

### **Message notification**

**Note:** This is a phone dependent feature.

SYNC® gives you the option of choosing if you'd like to hear an audible tone to notify you of an incoming text message. To turn this feature on/off:

**Note:** To scroll, press ▲ / ▼ .

1. Press PHONE to access *Phone Menu*.
2. Scroll until *Phone Settings* is selected and press OK.
3. Scroll until *Message Notification* is selected and press OK. The system will take you to the chosen menu item.
4. Scroll to select *Message Notification On* or *Message Notification Off* and press OK.

### **Modifying your phone book**

**Note:** This is a phone dependent feature.

SYNC® allows you to modify the contents of your downloaded phone book (i.e. adding/deleting contacts). To access:

**Note:** To scroll, press ▲ / ▼ .

1. Press PHONE to enter *Phone Menu*.
2. Scroll until *Phone Settings* is selected and press OK.
3. Scroll until *Modify Phonebook* is selected and press OK.
4. Scroll to cycle through contact(s):
  - **Add Contacts:** Press OK when *Add Contacts* appears in the radio display to add more contacts from your phone book. 'Push' the desired contact(s) on your *Bluetooth* enabled cellular phone. The radio display will read USE PHONE TO SEND. **Note:** Refer to your phone's user guide on how to 'push' contact(s).  
**Note:** This is a speed dependent feature and cannot be operated if the vehicle is traveling at speeds greater than 3 mph (5 km/h).
  - **Delete Phonebook:** Press OK to select when *Delete Phonebook* appears in the display to delete the current phone book and call history. Press OK when prompted. The system will confirm the entry was deleted and SYNC® will take you back to the *Phone Settings* menu.

60

## Entertainment Systems

- **Download Phonebook:** When *Download Phonebook* appears in the radio display, press OK. When *Download?* will appears in the display, press OK. The display will indicate when the download is complete.
- **Delete Contact:** When *Delete Contact* appears in the radio display, press OK to delete a specific contact. Press OK when SELECT CONTACT appears and scroll until the desired name appears in the radio display. Press OK to select. *Delete Contact?* will appear in the radio display. Press OK to confirm.  
**Note:** If Automatic download is on, the contact may appear on the next download from your *Bluetooth* enabled cellular phone.  
**Note:** This is a speed dependent feature and cannot be operated if the vehicle is traveling at speeds greater than 3 mph (5 km/h).
- **Return:** Select to go back.

### **Automatically downloading your phone book**

**Note:** This is a phone dependent feature.

SYNC® allows you to automatically download your *Bluetooth* enabled cellular phone's phone book with location type (i.e., cell, work, other), if supported, each time your phone connects with SYNC®.

**Note:** Your phone book, call history and text messages can only be accessed when your specific *Bluetooth* enabled cellular phone is connected.

**Note:** To scroll, press ▲ / ▼ .

1. Press PHONE to access the *Phone Menu*.
2. Scroll until *Phone Settings* is selected and press OK.
3. Scroll until *Auto Download* is selected and press OK.
4. When *Auto Download On?* appears, press OK. Auto Download set to on will appear and your phone book will be automatically downloaded each time your *Bluetooth* enabled cellular phone connects with SYNC®. Or, select Auto Download Off and press OK. Your phone book will not be automatically downloaded each time your phone connects with SYNC®.

**Note:** Downloading times are phone and quantity dependent.

**Note:** If you choose to automatically download your cellular phone's phone book every time your *Bluetooth* enabled phone reconnects to SYNC®, any changes, additions or deletions that have been saved since your last download will be deleted.

### **Traffic, Directions and Information (if equipped, U.S. only)**

**Note: Your Traffic, Directions and Information feature requires activation prior to use. Visit [www.SyncMyRide.com](http://www.SyncMyRide.com) to register.**

61

## Entertainment Systems

There is a free introductory period associated with the Traffic, Directions and Information feature, but you **must** register to use this feature.

Stay connected — even in your car. Using advanced vehicle sensors, integrated GPS technology and comprehensive map and traffic data, SYNC® with Traffic, Directions and Information connects you to personalized traffic reports, precise turn-by-turn directions, business search, news, sports and weather. For a complete list of services, or to learn more, please visit [www.SyncMyRide.com](http://www.SyncMyRide.com).

**Note:** To scroll, press ▲ / ▼ .

### To connect using voice commands:

1. Press .
2. When prompted, say, “Services”.
3. Once connected, follow the voice prompts to request your desired service such as “Traffic” or “Directions”. You can also say, “What are my choices?” to receive a complete list of available services from which to choose.
4. To return to the services menu, say “Services” or for help, simply say, “Help”.

### To connect using the phone menu:

1. Press PHONE to enter *Phone Menu*.
2. Scroll until *Services* is selected and press OK.
3. Scroll until *Connect* is selected and press OK. SYNC® will initiate the call to the services portal.
4. Once connected, follow the voice prompts to request your desired Service such as Traffic or Directions. You can also say, “What are my choices?” to receive a complete list of available services from which to choose.
5. To return to the services menu, say “Services” or for help, simply say, “Help”.

**To disconnect**, press and hold PHONE.

### Receiving Turn by Turn Directions

To begin receiving directions:

1. Connect using either the voice commands or phone menu above.
2. When prompted, say, “Directions”.
3. Follow the voice prompts to identify your desired destination.

62

## Entertainment Systems

4. Once your destination is selected, a route is downloaded to your vehicle.

### **Turn by Turn Direction features**

Once directions are downloaded, you can then access other features such as: Next turn, Route status, Route summary, cancel route, update route and also voice guidance.

### **To access these features through the phone menu:**

**Note:** To scroll, press ▲ / ▼ .

1. Press PHONE to enter *Phone Menu*.
2. Scroll until *Services* is selected and press OK.
3. Scroll to cycle through:
  - *Next turn*: Repeats the next turn instruction.
  - *Route status*: Provides the number of miles and approximate time to your destination.
  - *Route summary*: Provides the full list of remaining turn instructions.
  - *Cancel route*: Cancels the turn by turn driving directions.
  - *Update route*: Downloads an updated route to your destination.
  - *Voice guidance on/off*: When voice guidance is set to on, the system will provide spoken directions and a visual display of the directions. When voice guidance is turned off, the system will provide turn-by-turn tones and a visual display of the directions without spoken guidance.
  - *Guidance display (if equipped)*: If your vehicle is equipped with a center integrated display, you can set this feature to 'Always on' and the system will display your next guidance direction in the center integrated display.
4. When your desired feature appears in the display, press OK to confirm and initiate the feature.

**Note:** If you select Voice Guidance, scroll until the desired selection (YES or NO) appears in the display. Press OK to confirm.

**Accessing these features using voice commands:** Press  and, when prompted, say any of the above commands.

## Entertainment Systems

### **Personalizing Traffic, Directions and Information:**

Your Traffic, Directions and Information Services can be personalized to provide quicker access to your most used or favorite information. You can save address points such as, 'work' or 'home'. You can also save favorite information like sports teams or a news category. To learn more, log onto [www.SyncMyRide.com](http://www.SyncMyRide.com).

**Push to interrupt:** You can, at any time, press  to interrupt a voice prompt (or sports report for example) and provide your next voice command.

**Portable:** Simply connect your phone to any vehicle equipped with Traffic, Directions and Information and continue enjoying your personalized services.

**Note:** The driver is ultimately responsible for the safe operation of the vehicle, and therefore, must evaluate whether it is safe to follow the suggested directions. Any navigation features are provided only as an aid. Make your driving decisions based on your observations of local conditions and existing traffic regulations. Do not follow the route suggestions if doing so would result in an unsafe or illegal maneuver, if you would be placed in an unsafe situation, or if you would be directed into an area that you consider unsafe. Maps used by this system may be inaccurate because of errors, changes in roads, traffic conditions or driving conditions.

**Note:** When you connect to Traffic, Directions and Information, the service uses GPS technology and advanced vehicle sensors to collect the vehicle's current location, travel direction and speed to help provide you with the directions, traffic reports, or business searches you request. Further, to provide the services you request and for continuous improvement, the service may collect and record call details and voice communications. For more information, see Traffic, Directions and Information, Terms and Conditions at [www.SyncMyRide.com](http://www.SyncMyRide.com). If you do not want Ford or its service providers to collect the vehicle travel information or other information identified in the Terms and Conditions, do not activate or use the service.

**Note:** SYNC® with Traffic, Directions & Information Services requires activation prior to use. Standard phone and message rates may apply. Subscription may be required. To register and check your eligibility for free services, log onto [www.SyncMyRide.com](http://www.SyncMyRide.com).



## Entertainment Systems

### 911 Assist™ (if equipped)

**For 911 Assist™ to function properly, the vehicle must have battery power after the crash, the cell phone must be previously paired, connected to SYNC®, and continue to function properly with the ability to make and maintain a 911 call initiated by SYNC®, and the 911 Assist™ feature must be previously enabled (set to ON).**



**WARNING:** Do not wait for 911 Assist™ to initiate an emergency call if you are capable yourself. Dial emergency services immediately to avoid delayed response time, which could increase the risk of serious injury or death after a crash. If you do not hear 911 Assist™ within 5 seconds after the crash, the system or phone may be damaged or non-functional.

**The cell phone or 911 Assist™ hardware may become damaged in a crash, the vehicle may lose battery power, or the cell phone may be thrown from the vehicle, which could prevent operation. Additionally, every cell phone operates differently. While SYNC®, 911 Assist™ works with most cell phones, some may have trouble using this feature. Finally, not all crashes deploy an airbag or, in certain vehicles, activate the fuel pump shut-off which are the criteria to initiate 911 Assist™.**

Airbags generally deploy in certain frontal, near frontal, side and rollover crashes, and the deployment of any airbag is intended to act as a 911 Assist™ trigger if those events occur. For more information about airbag deployment, see the *Seating and Safety Restraints* chapter of your Owner Guide. The fuel pump shut-off, in certain vehicles, is intended to act as a trigger for 911 Assist™ in rear-end crashes, in which airbags generally do not deploy. To determine if your vehicle has this trigger, check the *Roadside Emergency* chapter in your Owner's Guide. If your Owner Guide describes a "Fuel Pump Shut-off", it will trigger 911 Assist™. If your Owner Guide describes a "Fuel Pump Shut-off *Switch*", it will not trigger 911 Assist™.



**WARNING:** Always place cell phone in a secure location to prevent it from becoming a projectile or becoming damaged in the event of a collision. Failure to do so may cause serious injury or damage the phone which could prevent 911 Assist from functioning properly.

## Entertainment Systems

**911 ASSIST™ PRIVACY NOTICE:** Once 911 Assist™ is enabled (set to ON), 911 Assist™ may, through any paired and connected cell phone, disclose to emergency services that the vehicle has been in a crash involving the deployment of an airbag or, in certain vehicles, the activation of the fuel pump shut-off. Certain versions or updates to 911 Assist™ may also be capable of electronically or verbally disclosing to 911 operators the vehicle location, and/or other details about the vehicle or crash to assist 911 operators to provide the most appropriate emergency services. If you do not want to disclose this information, do not enable (set to ON) the feature.

**Note:** If 911 Assist™ is enabled/disabled by any user, the current setting will apply for all paired phones. If the 911 Assist™ setting is disabled (set to OFF), a voice message and/or display item will inform the vehicle occupants when a previously paired phone connects to SYNC® at vehicle start up.

In the event of a crash involving the deployment of an airbag or the activation of the fuel pump shut-off, in certain vehicles, SYNC® is designed to assist occupants in attempting to contact emergency services by dialing 911 through the occupant's paired and connected *Bluetooth* enabled cellular phone. In the event that a connected cellular phone is damaged or loses connection to SYNC®, SYNC® will search for and connect to any available, previously paired cell phone and attempt to place the call to 911. Before initiating the call, SYNC® provides a short window of time (approximately 10 seconds) that allows the driver or passenger to decide whether to cancel the call by pressing and holding  or PHONE on the steering wheel controls or on the audio system. Before initiating the 911 call for the occupants, SYNC® will say the following or a similar message:

“SYNC® will attempt to call 911. If you wish to cancel the call, press and hold the phone button.”

If the call is not cancelled and a successful call is made, a pre-recorded message will be played for the 911 operator and then the occupant(s) in the vehicle will be able to communicate with the 911 operator.

**Note:** Failure to cancel the call as described above will result in SYNC® dialing 911.

**Note:** When you are connected to the 911 operator, be prepared to provide your name, phone number and location immediately, because not all 911 systems are capable of receiving this information electronically.

## Entertainment Systems

The following steps are required for the 911 Assist™ feature to perform properly:

- SYNC® is on and functioning properly at the time of the incident and throughout feature activation and use.
- SYNC® 911 Assist™ feature is set to ON prior to the incident.
- A *Bluetooth* enabled and compatible cellular phone is paired and connected to SYNC®.
- A connected *Bluetooth* enabled cellular phone that has the ability to make and maintain an outgoing call at the time of the incident.
- A connected *Bluetooth* enabled cellular phone that has adequate network coverage, battery power and signal strength.
- The vehicle is located in the U.S. or Canada or in a territory in which 911 is the emergency number.



**WARNING:** Unless 911 Assist™ is previously configured to ON prior to a crash, 911 Assist™ will not dial for help during an emergency, which could delay response time, increasing the risk of serious injury or death after a crash.

The 911 Assist™ feature is initially set to OFF. To access the setting:

1. Press PHONE to enter *Phone Menu*.
2. Scroll until *911 Assist* is selected and press OK.
3. Press ▲ or ▼ to toggle between *On* and *Off* selections.
4. Press OK when the desired option appears in the display.

**Note:** Off selections include: Off with reminder and Off without reminder. Off with reminder provides a display and voice reminder at phone connection at vehicle start. Off without reminder provides a display reminder only without a voice reminder.

For more information, please visit [www.SyncMyRide.com](http://www.SyncMyRide.com).

**Note: Before enabling (setting to ON), review the 911 Assist™ Privacy Notice.**

## Entertainment Systems

### Vehicle health report (if equipped, U.S. only)

 **WARNING:** Always follow scheduled maintenance instructions, regularly inspect your vehicle, and seek repair for any damage or problem you suspect. Vehicle Health Reports supplements, but cannot replace normal maintenance and vehicle inspection. Vehicle Health Report only monitors certain systems that are electronically monitored by the vehicle and will not monitor or report the status of any other system, (i.e., brake lining wear). Failure to perform scheduled maintenance and regularly inspect your vehicle may result in vehicle damage and serious injury.

**Note: Your Vehicle Health Report feature requires activation prior to use. Visit [www.SyncMyRide.com](http://www.SyncMyRide.com) to register.** There is no fee or subscription associated with Vehicle Health Report, but you **must** register to use this feature.

SYNC® allows you to check your vehicle's overall 'health' in the form of diagnostic report card. The vehicle health report contains valuable information such as:

- Vehicle Diagnostic Information
- Scheduled maintenance
- Open Recalls and Field Service Actions
- Unserviced items from vehicle inspections by your authorized dealer

**VEHICLE HEALTH REPORT PRIVACY NOTICE: When you run a Vehicle Health Report, Ford Motor Company may collect your cell phone number (to process your report request) and diagnostic information about your vehicle. Certain versions or updates to Vehicle Health Report may also collect additional vehicle information. Ford may use the vehicle information it collects for any purpose. If you do not want to disclose your cell phone number or vehicle information, do not run the feature or set up your Vehicle Health Report profile at [www.SyncMyRide.com](http://www.SyncMyRide.com). Refer to [www.SyncMyRide.com](http://www.SyncMyRide.com) — Vehicle Health Report Terms and Conditions, and Privacy Statement — for more information.**

You can initiate a Vehicle Health Report in the vehicle and view the complete report with all information listed above on [SyncMyRide.com](http://SyncMyRide.com). You can also choose for SYNC® to automatically remind you to run reports at specific mileage intervals. After you've registered for the Vehicle Health Report service and established your preferences at [www.SyncMyRide.com](http://www.SyncMyRide.com), you can then request a Vehicle Health Report (in

## Entertainment Systems

your vehicle) and return to your account at [www.SyncMyRide.com](http://www.SyncMyRide.com) to view your report. Cell phone airtime usage may apply when reporting.

To access and run a report (after the vehicle has been running a minimum of 60 seconds):

**Note:** To scroll, press ▲ / ▼ .

1. Press PHONE to enter *Phone Menu*.
2. Scroll until *Vehicle Health* is selected and press OK.
3. User Pref will appear in the display. Scroll until 'Run Report' is selected and press OK.  
SYNC® will run a health report of vehicle diagnostic systems and send the results to Ford where it will be combined with scheduled maintenance information, open recalls and other field service actions and un-serviced vehicle inspection items from your authorized dealer to complete your Vehicle Health Report.

**Note:** This feature may not function properly if you have enabled caller ID blocking on your mobile phone. Before running a report, review Vehicle Health Report Privacy Notice.

### **Automatic reports (if equipped, U.S. only)**

You can choose to have SYNC® automatically prompt you to run a health report at certain mileage intervals. To do so, you must first turn on the automatic report feature. To access:

**Note:** To scroll, press ▲ / ▼ .

1. Press PHONE to enter *Phone Menu*.
2. Scroll until *Vehicle Health* is selected and press OK.
3. When *User Preferences* is selected, press OK.
4. Scroll until *Automatic Reports* is selected and press OK.
5. Scroll to select the desired setting *Automatic Reports On/Off?* is chosen and press OK.

### **Mileage interval (if equipped, U.S. only)**

Once you have turned on the automatic report feature, you can then choose at which mileage intervals you would like to be prompted to run a health report. To access:

**Note:** To scroll, press ▲ / ▼ .

1. Press PHONE to enter *Phone Menu*.

## Entertainment Systems

2. Scroll until *Vehicle Health* is selected and press OK.
3. When *User Preferences* is selected, press OK.
4. When *Automatic Reports* is selected, press OK.
5. When the desired mile interval is selected (5000, 7500, or 10000), press OK.

When the chosen mileage is reached, SYNC® will automatically prompt you and ask if you would like to run a health report. You can then accept and SYNC® will send you an e-mail with the information or you can choose to have SYNC® remind you later.

### Applications

The applications listing will show you any software applications that have been downloaded to SYNC®. To access:

**Note:** To scroll, press ▲ / ▼ .

1. Press PHONE to enter PHONE MENU.
2. Scroll until the desired application is selected and press OK.

### System settings

To access the System Settings for Bluetooth Devices and Advanced Settings:

**Note:** To scroll, press ▲ / ▼ .

1. Press PHONE to enter *Phone Menu*.
2. Scroll until *System Settings* is selected and press OK.
3. Scroll to select *Bluetooth Devices* and press OK to access:

- *Add Bluetooth Device*
- *Connect Bluetooth Device*
- *Set Primary Phone*
- *Set Bluetooth On/Off*
- *Delete Device*
- *Delete All Devices*
- *Return*

Scroll to select *Advanced* and press OK to access:

- *Prompts*
- *Factory Defaults*
- *Install Application?*
- *Return*
- *Languages*
- *Master Reset*
- *System Info*

Refer to the following sections for further information.

70

## Entertainment Systems

### **Adding (pairing) a phone**

**Note:** This is a speed dependent feature and cannot be performed when the vehicle is traveling at speeds greater than 3 mph (5 km/h).

**Note:** SYNC® can store up to 12 previously paired devices.

To add/pair an additional *Bluetooth* enabled device(s) to SYNC®:

**Note:** To scroll, press ▲ / ▼ .

1. Press PHONE to enter the *Phone Menu*
2. Scroll until *System Settings* is selected and press OK.
3. Scroll until *Bluetooth Devices* is selected and press OK.
4. Scroll until *Add Bluetooth Device* is selected and press OK.
5. When *Find SYNC* appears in the display, press OK. Follow the instructions in your device's user guide to put your phone into discovery mode. A six digit PIN will appear in the radio display.
6. When prompted on your phone display, enter the six digit PIN.
7. Once pairing is successful, the device name and then *Connecting...* and then *Connected* will appear in the radio display. Depending on the functionality of your phone, you may be asked additional questions.
8. SYNC® will ask if you would like to set this phone as a Primary phone. (This means that SYNC® will automatically attempt to connect to this phone with every connection cycle.) Press OK.
9. Scroll to toggle between *Yes?* and *NO?*. When the appropriate response is in the display, press OK. If you choose *Yes*, *Primary Set* will appear in the radio display. If you choose *NO?* , the system will confirm that the phone was not set as the primary.
10. If you selected this as your primary phone, SYNC® may ask if you would like to download your *Bluetooth* enabled cellular phone's phone book/call history (if supported).
11. Scroll to toggle between *Yes?* and *NO?* When the appropriate response is in the radio display, press OK.
12. If you choose *Yes*, the display will indicate that the phone book is downloading and will confirm when it is downloaded. SYNC® will take you back to the main menu.

### **Connecting a phone**

To connect a previously paired *Bluetooth* enabled phone:

**Note:** To scroll, press ▲ / ▼ .

## Entertainment Systems

1. Press PHONE to enter *Phone Menu*.
  2. Scroll until *System Settings* is selected and press OK.
  3. Scroll until *Bluetooth Devices* is selected and press OK.
  4. Scroll until *Connect Bluetooth Device* is selected and press OK. A list of previously paired phones will display.
  5. Select the desired device and press OK to connect to the phone.
- Note:** Only one device can be connected at a time. When another phone is connected, the previous one will be disconnected.

### **Setting a phone as primary**

To set a previously paired phone as your primary phone:

**Note:** To scroll, press ▲ / ▼ .

1. Press PHONE to enter *Phone Menu*.
2. Scroll until *System Settings* is selected and press OK.
3. Scroll until *Bluetooth Devices* is selected and press OK.
4. Scroll until *Set Primary Phone* is selected and press OK.
5. Scroll to select the desired phone and press OK. *Set As Primary Phone?* will appear.
6. Press OK. *Primary Set* will appear in the display.

SYNC® will now attempt to connect to this primary *Bluetooth* enabled phone with each connection cycle.

**Note:** When a phone is selected as primary, it will appear first in the list and also be marked with an \*.

### **Bluetooth on/off**

To turn the *Bluetooth* feature on SYNC® on/off:

**Note:** To scroll, press ▲ / ▼ .

1. Press PHONE to enter *Phone Menu*.
2. Scroll until *System Settings* is selected and press OK.
3. Scroll until *Bluetooth Devices* is selected and press OK.
4. Scroll until *Set Bluetooth On/Off* is selected and press OK.
5. Scroll until the desired choice is selected and press OK.

**Note:** Turning Bluetooth Off will disconnect all *Bluetooth* devices and deactivate all *Bluetooth* features.

72



## Entertainment Systems

### **Deleting a phone**

To delete a paired phone from SYNC®:

**Note:** To scroll, press ▲ /▼ .

1. Press PHONE to enter *Phone Menu*
2. Scroll until *System Settings* is selected and press OK.
3. Scroll until *Bluetooth Devices* is selected and press OK.
4. Scroll until *Delete Device* is selected and press OK.
5. Scroll to select the previously paired device to delete and press OK to confirm.

### **Deleting all phones**

To delete all previously paired phones from SYNC®:

**Note:** To scroll, press ▲ /▼ .

1. Press PHONE to enter *Phone Menu*.
2. Scroll until *System Settings* is selected and press OK.
3. Scroll until *Bluetooth Devices* is selected and press OK.
4. Scroll until *Delete All Devices* is selected and press OK.

**Note:** Deleting a phone will also delete all information in SYNC® originally saved with that phone.

### **Turning prompts on/off**

Prompts from SYNC® can help guide you via questions, helpful hints or ask you for a specific action. To turn prompts on/off:

**Note:** To scroll, press ▲ /▼ .

1. Press PHONE to enter the *Phone Menu*.
2. Scroll until *System Settings* is selected and press OK.
3. Scroll until *Advanced* is selected and press OK.
4. Scroll until *Prompts* is selected and press OK.
5. Scroll to toggle between *Prompts On?* or *Prompts Off?*. (The default setting is ON).
6. Press OK when the desired selection appears in the radio display. Prompts Set On or Prompts Set Off will appear in the radio display as a confirmation. SYNC® will then take you back to the *Advanced* menu.

## Entertainment Systems

### **Changing the language setting**

SYNC® allows you to select from three languages: English, French and Spanish. Once selected, all radio display messages and prompts will be in the selected language. To access the language menu:

**Note:** To scroll, press ▲ / ▼ .

1. Press PHONE to enter the *Phone Menu*.
2. Scroll until *System Settings* is selected and press OK.
3. Scroll until *Advanced* is selected and press OK.
4. Scroll until *Languages* is selected and press OK.
5. Scroll to cycle through *English*, *Francais* and *Espanol*.
6. Press OK when the desired selection is selected. If you have changed the language setting, the display will indicate the system is updating. Once the change is complete, SYNC® will confirm the change audibly and in the radio display. SYNC® will then take you back to the *Languages* menu.

### **Returning to the factory defaults**

SYNC® allows you to return to its factory defaults settings. This selection will not erase your downloaded phone book, call history, text messages, etc. If you wish to erase all information, refer to *Performing a master reset*.

**Note:** To scroll, press ▲ / ▼ .

1. Press PHONE to enter *Phone Menu*.
2. Scroll until *System Settings* is selected and press OK.
3. Scroll until *Advanced* is selected and press OK.
4. Scroll until *Factory Defaults* is selected and press OK.
5. Restore Defaults? will appear. Press OK to confirm. The display will read Defaults Set. SYNC® will take you back to the *Factory Defaults* menu.

### **Performing a master reset**

A master reset allows you to completely erase all information stored in SYNC® (all phone book, call history and text message information as well as all previously paired phones) and return to the factory default settings. To perform a master reset:

**Note:** To scroll, press ▲ / ▼ .

74

## Entertainment Systems

1. Press PHONE to enter the *Phone Menu*.
2. Scroll until *System Settings* is selected and press OK.
3. Scroll until *Advanced* is selected and press OK.
4. Scroll until *Master Reset* is selected and press OK.
5. Press OK to confirm when prompted. The display will confirm when the reset is complete. SYNC® will take you back to the *Advanced* menu.

**Note:** Once a master reset has been completed, you must re-insert your USB device to access its contents.

### **Installing new vehicle applications**

You can download new software applications (if available) and then load the desired applications onto SYNC® through your USB port. Please refer to [www.SyncMyRide.com](http://www.SyncMyRide.com) for further information.

### **System information**

The system information feature allows you to access the AutoVersion number as well as the FDN number. To access:

**Note:** To scroll, press ▲ / ▼ .

1. Press PHONE to enter the *Phone Menu*.
2. Scroll until *System Settings* is selected and press OK.
3. Scroll until *Advanced* is selected and press OK.
4. Scroll until *System Info* is selected and press OK.
5. Scroll until the desired choice is selected and press OK.

### **Voice commands in media mode**



**WARNING:** Driving while distracted can result in loss of vehicle control, accident and injury. Ford strongly recommends that drivers use extreme caution when using any device or feature that may take their focus off the road. Your primary responsibility is the safe operation of the vehicle. We recommend against the use of any handheld device while driving and that you comply with all applicable laws.

## Entertainment Systems

### **Voice commands when using the USB port**

**When using the USB port, you may say any of the following commands:**

- Play all
- Pause
- Play next track
- Play song <name>
- Play next song
- Refine song <name>
- Play next folder<sup>2</sup>
- Autoplay on
- Repeat off
- Shuffle on
- Play genre <name><sup>1</sup>
- Play album <name><sup>1</sup>
- Play track <name><sup>1</sup>
- Search genre <name><sup>1</sup>
- Search album <name><sup>1</sup>
- Refine artist <name><sup>1</sup>
- Connections
- Play
- What's playing?
- Play previous track
- Search song <name>
- Play previous song
- Similar music
- Play previous folder<sup>2</sup>
- Autoplay off
- Repeat on
- Shuffle off
- Play playlist <name><sup>1</sup>
- Play artist <name><sup>1</sup>
- Search artist <name><sup>1</sup>
- Search track <name><sup>1</sup>
- Refine album <name><sup>1</sup>
- Refine track <name><sup>1</sup>

<sup>1</sup> Voice commands are not available until indexing is complete.

<sup>2</sup> Voice commands only available in folder mode. For more information, refer to *Exploring the USB device* later in this chapter.

**Note:** In the above possible commands, “<name>” is a dynamic listing in that it could be the name of any desired group, artist, etc.

**Autoplay:** With this feature ON, SYNC® allows you to listen to music which has already been randomly indexed during the indexing process. With this feature OFF, SYNC® will not begin to play any of your music until all media has all been indexed.

**Note:** The larger the number of songs the system has to index, the longer indexing will take. Indexing times can vary from device to device.

**Search/Play Genre:** You can search for and play a specific genre (type) of music. SYNC® will search all the data from your indexed music and, if available, will begin to play that type of music.

**Note:** You can only play genres of music which are present in the GENRE metadata tags that you have on your digital media player.

76

## Entertainment Systems

**Similar music:** You can tell the system to play music ‘similar’ to what you are currently playing from the USB port. SYNC® will use the metadata information of each indexed song to compile a playlist for you.

**Search/play artist/track/album:** You can search for a specific artist/track or album from the music SYNC® has indexed through the USB port.

**Refine:** This allows you to ‘refine’ your previous commands. For example, if you told SYNC® to search and play all music by a certain artist, you could then tell SYNC® to “refine album” and choose a specific album from the list to view. If you then select ‘Play’, the system will only play music from that specific album.

### ***Voice commands while using Line in***

**While using the Line in feature (Auxiliary input jack), you may speak the following commands:**

- SYNC
- Bluetooth Audio
- Phone
- Line in
- Cancel
- Voice settings

### ***Voice commands when in Bluetooth audio mode***

**When in Bluetooth audio mode, you may use the following commands:**

- Play
- Pause
- Play previous track
- Play previous song
- Connections
- Play next track
- Play next song

**Note:** Please refer to your device’s user guide to see if these commands are supported for *Bluetooth* audio.

**At any time, you may say these commands:**

- SYNC
- Help
- Line in
- Voice settings
- Cancel
- USB
- Bluetooth Audio
- Phone
- Read Message

### ***Connecting a digital media player to SYNC® via the USB port***

**Note:** If your digital media player has an on/off switch, ensure that the device is on.

## Entertainment Systems

1. Plug the device into the vehicle's USB port.
2. Press AUX repeatedly until SYNC® USB appears in the radio display.
3. Depending on how many digital media files are on your connected device, *Indexing* may appear in the radio display until indexing is complete. You will then be taken to the *Play Menu*. Press OK.
4. Press ▲ / ▼ to cycle through selections of: *Play All*, *Albums*, *Genres*, *Playlists*, *Tracks*, *Explore USB*, *Similar Music* and *Return*.
5. When the desired *Play Menu* selection appears in the radio display, press OK to build your desired music selection.

### **Connecting a digital media player to SYNC® using voice commands**

**Note:** If your digital media player has an on/off switch, ensure that the device is on.

1. Ensure that the vehicle ignition and radio are on.
2. Plug the device into the USB port.

**Note:** If your digital media player has an on/off switch, ensure that the device is turned on.

3. Press .

**Note:** If your digital media player contains many media files, *Indexing* may appear in the display. When the indexing process is complete, you may access the media content in your digital media player using voice commands.

4. When prompted, say “USB”.
5. Play music by saying any of the following commands: Play all, Play artist <name>, Play album <name>, Play genre <name>, Play playlist <name> or Play track <name>.

**Note:** At any time, press  and say, “Help” for more options.

### **What's playing?**

At any time while a track is playing, you can press  or VOICE and say, “What's playing?”. SYNC® will read the metadata tags of the playing track to you (if populated).

### **Using your media menu**

The Select Source menu allows you to select from various possible SYNC® media sources, such as: SYNC USB, Bluetooth Audio or SYNC Line In (Auxiliary Input jack).

78

## Entertainment Systems

To access:

**Note:** To scroll, press ▲ / ▼ .

1. Press AUX repeatedly until SYNC® appears.
2. Press MENU to enter the *Media Player Menu*.
3. Scroll to cycle through:
  - *Play Menu* (Refer to *Using SYNC®'s play menu* later in this chapter).
  - *Select Source*
  - *Media Settings*
  - *Application*
  - *System Settings*
  - *Exit Media Menu*
4. When the desired choice is selected, press OK. Refer to the following sections for further information on these selections.

### **Selecting different media sources**

The Media Player Menu allows you to select and play music from different media sources (SYNC USB, Bluetooth Audio or SYNC LINE IN - Auxiliary Input jack). Once accessed, you can then play music, shuffle, access your playlists, etc. To access this menu:

**Note:** To scroll, ▲ / ▼ .

1. Press AUX repeatedly until SYNC appears.
2. Press MENU. When *Media Player Menu* appears, press OK.
3. Scroll until *Select Source* is selected and press OK.
4. Scroll to select from:
  - *SYNC USB*
  - *Bluetooth Audio* **Note:** This is a device dependent feature.
  - *SYNC Line In*
  - *Return*

### **Accessing and using your USB port**

You can use the USB port to plug in and access media devices as well as charge devices (if supported by your device). For a list of compatible media players, refer to [www.SyncMyRide.com](http://www.SyncMyRide.com).

## Entertainment Systems

**Note:** Since your USB port allows you to charge your device (if supported by your device), SYNC® will not automatically change media modes when something is initially plugged into the USB port. To access the USB port through your SYNC® system:

**Note:** To scroll, press ▲ / ▼ .

1. Ensure that the desired device is plugged into the USB port and is turned ON.
2. Press AUX repeatedly until SYNC appears.
3. Press MENU. When *Media Player Menu* is selected, press OK.
4. Scroll Select source is selected and press OK.
5. Scroll until *SYNC USB* is selected and press OK.

If the connected device and media content is supported, SYNC® will begin indexing available media files. If there are no readable media files for SYNC® to play, the display will indicate that no media is available. If there are readable media files, *Indexing* may appear in the radio display. If Autoplay is ON, SYNC® gives you the ability to access media files randomly as they are indexed. If Autoplay is OFF, indexed media is not available until the indexing process is complete. The display will indicate when indexing is complete and SYNC® will take you to the *Play Menu*.

**Note:** The time required to complete the indexing process is dependent upon the size of the media content being indexed.

**Note:** SYNC® is capable of indexing thousands of average size media files. SYNC® will notify you once maximum indexing file size is reached.

**If your playing device becomes disconnected from the USB port at any time,** the display will indicate that the USB was removed.

### ***Streaming music from your Bluetooth enabled phone***

**Note:** This is a phone dependent feature. Refer to your phone's user guide for further information on how to stream *Bluetooth* audio.

SYNC® allows you to stream music from your *Bluetooth* enabled cellular phone to play through SYNC®.

To access:

**Note:** To scroll, press ▲ / ▼ .

1. Ensure that the desired music is playing on your paired phone and your phone is in *Bluetooth* audio streaming mode.
2. Press AUX repeatedly until SYNC appears.
3. Press MENU. When *Media Player Menu* is selected, press OK.

80



## Entertainment Systems

4. Scroll until *Select Source* is selected and press OK.
5. Scroll until *Bluetooth Audio* is selected and press OK. The display will show the name of the *Bluetooth* enabled cellular phone currently connected to SYNC®. *Bluetooth Media Stream* will appear in the radio display.

While the music is streaming through your audio system you can also use the following functions (if supported by your device):

Press **◀◀ / ▶▶** to access the previous/next track.

**If your phone becomes disconnected from the system at any time,** the display will read *Bluetooth Disconnected*.

### **Using Line in (auxiliary input jack) with SYNC®**

The auxiliary input jack allows you to plug and play your portable music player over the vehicle speakers.

To access:

**Note:** To scroll, press **▲ / ▼**.

1. Press AUX repeatedly until SYNC appears.
2. Press MENU. When *Media Player Menu* is selected, press OK.
3. Scroll until *Select Source* is selected and press OK.
4. Scroll until *SYNC Line In* is selected and press OK. Ensure that your device is plugged into the auxiliary input jack and is playing.

**Note:** If you already have a device connected to the USB port, you cannot access the LINE IN feature. Some digital media players require both USB and LINE IN ports to stream data and music separately.

### **Using the media settings in media menu**

SYNC® allows you to change the way you listen to your playing media. Through the media settings menu, you can access Shuffle, Repeat and Autoplay. To access these settings:

**Note:** To scroll, press **▲ / ▼**.

1. Press AUX repeatedly until SYNC® appears.
2. Press MENU. When *Media Player Menu* is selected, press OK.
3. Scroll until *Media Settings* is selected and press OK.
4. Scroll to select from:

**Shuffle:** Allows you to shuffle available media files in the current playlist.

**Note:** To shuffle all media tracks, you must first select *Play All* and then select Shuffle.

## Entertainment Systems

**Repeat:** Allows you to repeat any song.

**Autoplay:** Allows you to listen to music which has already been randomly indexed during the indexing process.

**Note:** Depending on the amount of files on your device, SYNC® may take awhile to index all the metadata information.

5. When the desired choice is selected, press OK.

**Note:** Once turned on, these menu selections will remain on until they are turned off. Some digital media players require both USB and LINE IN ports to stream data and music separately.

### **Accessing your vehicle applications (if available)**

SYNC® allows you to view any SYNC® applications which have been downloaded via the USB port. To access:

**Note:** To scroll, press ▲ / ▼ .

1. Press AUX repeatedly until SYNC appears.
2. Press MENU. When *Media Player Menu* is selected, press OK.
3. To access the downloaded applications, scroll until the desired application is selected.

For further information on possible applications, please visit [www.SyncMyRide.com](http://www.SyncMyRide.com).

### **SYNC® AppLink™(if equipped, U.S. only)**

SYNC® AppLink™ is a software application which allows you to connect to and use applications on your smartphone such as Pandora and Stitcher via your SYNC system provided your phone is compatible with these features. To check your phone's compatibility and available applications, please visit [www.SyncMyRide.com](http://www.SyncMyRide.com).

**Note: To use this feature, you must first visit [www.SyncMyRide.com](http://www.SyncMyRide.com) to register an account and download the update.** There is no fee or subscription associated with SYNC® AppLink,® but you **must** register and download the update to use this feature. The [www.SyncMyRide.com](http://www.SyncMyRide.com) website will walk you through the process of downloading the update to your USB and installing it in your vehicle. Simply follow the directions on the website to download your update.

**Once you have downloaded your AppLink™ update, *Mobile Apps* will appear as an option in your Media menu.**

## Entertainment Systems

### To access:

1. Press AUX.
2. Press MENU.
3. When MediaPlayer Menu appears in the display, press OK.
4. Use ▲ / ▼ to cycle through the following options:
  - *Play menu*
  - *Select Source*
  - *Media Settings*
  - *Mobile Apps*
  - *System Settings*
  - *Exit Menu*
5. When *Mobile Apps* appears in the display, press OK to enter the menu and view a list of available applications (for example, Stitcher).
6. Once started, you may then press MENU to access MediaPlayer Menu.
7. Use ▲ / ▼ to scroll to access the desired application menu (for example, Stitcher Menu) and press OK.

From here, you can access the features which accompany the application such as Thumbs up, Thumbs Down, etc. For more information, please visit [www.SyncMyRide.com](http://www.SyncMyRide.com)

### Accessing your media system settings

**Note:** To scroll, press ▲ / ▼ .

1. Press AUX repeatedly until SYNC appears.
2. Press MENU. When *Media Player Menu* is selected, press OK.
3. Scroll until *System Settings* is selected and press OK
4. When *Bluetooth Devices* is selected, press OK to select from:
  - *Add Bluetooth Device*
  - *Connect Bluetooth Device*
  - *Set Bluetooth On/Off*
  - *Delete Device*
  - *Delete All Devices*
  - *Return*

## Entertainment Systems

5. When *Advanced* is selected, press OK to select from:

- *Prompts*
- *Languages*
- *Factory Defaults*
- *Master Reset*
- *Install Application?*
- *System Info*
- *Return*

Refer to the following sections for further information.

### **Adding a Bluetooth media device which is in discovery mode**

**Note:** This is a speed dependent feature. Your vehicle must be moving less than 3 mph (5 km/h) to use this feature.

**Note:** If your phone supports streaming *Bluetooth* audio and has already been paired with SYNC® as a phone, you do not have to go through the pairing process again.

**Note:** To scroll, press ▲ / ▼ .

1. Press AUX repeatedly until SYNC appears.
2. Press MENU. When *Media Player Menu* is selected, press OK.
3. Scroll until *System Settings* is selected and press OK.
4. Scroll until *Bluetooth Devices* is selected and press OK.
5. Scroll until *Add Bluetooth Device* is selected and press OK.
6. When *Find SYNC* appears in the display, press OK. Follow the instructions in your device's user guide to put your phone into discovery mode. A six digit PIN will appear in the radio display.
7. When prompted on your phone's display, enter the six digit PIN in the radio display.
8. Once pairing is successful, the device name and then *Connecting...* and then *Connected* will appear in the radio display.

You can now change SYNC® sources to Bluetooth Audio and stream music from your device.

### **Adding a Bluetooth media device which is in discoverable mode**

**Note:** This is a speed dependent feature. Your vehicle must be moving less than 3 mph (5 km/h) to use this feature.

**Note:** If your phone supports streaming *Bluetooth* audio and has already been paired with SYNC® as a phone, you do not have to go through the pairing process again.

**Note:** Use this process when your device generates the PIN instead of SYNC®.

84

## Entertainment Systems

**Note:** To scroll, press ▲ / ▼ .

1. Press AUX repeatedly until SYNC appears.
2. Press MENU. When *Media Player Menu* is selected, press OK.
3. Scroll until *System Settings* is selected and press OK.
4. Scroll until *Bluetooth Devices* is selected and press OK.
5. Scroll until *Add Bluetooth Device* is selected and press OK.
6. When *Find SYNC* appears in your radio display, press OK.
7. After the search for active *Bluetooth Devices* is complete, scroll to find the desired device. Press OK to confirm.
8. Refer to your device's user guide for instructions on how to put your device into discoverable mode. When your media device gives you a PIN, enter that PIN into SYNC® using voice commands (or using the 0–9 memory presets on your audio system, if equipped), when prompted.
9. When you have entered your last digit via voice, say “Enter”.
10. When the process is complete, SYNC® will display *Connected* and the name of the device will appear in the radio display.

You can now change SYNC® sources to Bluetooth Audio and stream music from your device.

### **Connecting a Bluetooth media device**

To connect a previously paired *Bluetooth* device:

**Note:** To scroll, press ▲ / ▼ .

1. Press AUX repeatedly until SYNC appears.
2. Press MENU. When *Media Player Menu* is selected, press OK.
3. Scroll until *System Settings* is selected and press OK.
4. Scroll until *Bluetooth Devices* is selected and press OK.
5. Scroll until *Add Bluetooth Device* is selected and press OK.
6. Select the desired device and press OK to connect to the device.

### **Bluetooth on/off**

To turn the *Bluetooth* feature on SYNC® on/off:

**Note:** To scroll, press ▲ / ▼ .

1. Press AUX repeatedly until SYNC appears.
2. Press MENU. When *Media Player Menu* is selected, press OK.

## Entertainment Systems

3. Scroll until *System Settings* is selected and press OK.
  4. Scroll until *Bluetooth Devices* is selected and press OK.
  5. Scroll until *Set Bluetooth On/Off* is selected.
  6. When the desired selection appears in the display, press OK.
- Note:** Selecting Bluetooth Off will disconnect all *Bluetooth* devices and deactivate all *Bluetooth* features.

### **Deleting a device**

To delete a previously paired media device from SYNC®:

**Note:** To scroll, press ▲ / ▼ .

1. Press AUX repeatedly until SYNC appears.
2. Press MENU. When *Media Player Menu* is selected, press OK.
3. Scroll until *System Settings* is selected and press OK.
4. Scroll until *Bluetooth Devices* is selected and press OK.
5. Scroll until *Delete Device* is selected and press OK.
6. Scroll to select a previously paired device to delete and press OK to confirm.

### **Deleting all devices**

To delete all previously paired devices from SYNC®:

**Note:** To scroll, press ▲ / ▼ .

1. Press AUX repeatedly until SYNC appears.
2. Press MENU. When *Media Player Menu* is selected, press OK.
3. Scroll until *System Settings* is selected and press OK.
4. Scroll until *Bluetooth Devices* is selected and press OK.
5. Scroll until *Delete All Devices* is selected and press OK. The display will confirm when complete.

### **Turning prompts on/off**

Prompts from SYNC® can help guide you via questions, helpful hints or ask you for a specific action. To turn prompts on/off:

**Note:** To scroll, press ▲ / ▼ .

1. Press AUX repeatedly until SYNC appears.
2. Press MENU. When *Media Player Menu* is selected, press OK.

86

## Entertainment Systems

3. Scroll until *System Settings* is selected and press OK.
4. Scroll until *Advanced* is selected and press OK.
5. Scroll until *Prompts* is selected and press Ok.
6. Scroll to toggle between *Prompts On?* or *Prompts Off?* (The default setting is ON).
7. Press OK when the desired selection is chosen. SYNC® will then take you back to the *Advanced* menu.

### **Changing the SYNC® language setting**

SYNC allows you to select from three languages: English, French and Spanish. Once selected, all of SYNC®'s radio displays and prompts will be in the selected language. To access the language menu:

**Note:** To scroll, press or ▲ / ▼ .

1. Press AUX repeatedly until SYNC appears.
2. Press MENU. When *Media Player Menu* is selected, press OK.
3. Scroll until *System Settings* is selected and press OK.
4. Scroll until *Advanced* is selected and press OK.
5. Scroll until *Languages* is selected and press OK.
6. Scroll to cycle through *English*, *Francais* and *Espanol*.
7. Press OK when the desired selection is chosen. If you have changed the language setting, the display will indicate the system is updating. Once the change is complete, SYNC® will confirm the change audibly and in the radio display. SYNC® will then take you back to the *Advanced* menu.

### **Returning to the factory defaults**

SYNC® allows you to return to the factory defaults settings. This selection will not erase your indexed information. If you wish to erase all information, refer to *Performing a master reset*.

**Note:** To scroll, press ▲ / ▼ .

1. Press AUX repeatedly until SYNC appears.
2. Press MENU. When *Media Player Menu* is selected, press OK.
3. Scroll until *System Settings* is selected and press OK.
4. Scroll until *Advanced* is selected and press OK.
5. Scroll until *Factory Defaults* is selected and press OK.

## Entertainment Systems

6. When the system asks if you would like to restore the defaults press OK. The display will then confirm when they are restored. SYNC® will take you back to the *Advanced* menu.

### **Performing a master reset**

A master reset allows you to completely erase all information stored in SYNC® (all phone book, call history and text message information as well as all paired devices) and return to the factory default settings.

**Note:** Once a mast reset has been completed, you must re-insert your USB device to access the contents.

**Note:** To scroll, press ▲ / ▼ .

1. Press AUX repeatedly until SYNC appears.
2. Press MENU. When *Media Player Menu* is selected, press OK.
3. Scroll until *System Settings* is selected and press OK.
4. Scroll until *Advanced* is selected and press OK.
5. Scroll until *Master Reset* is selected and press OK.
6. Press OK to confirm. The display will indicate when the reset is complete and will take you back to the *Advanced* menu.

### **Installing new vehicle applications**

You can download new software applications (if available) and then load the desired applications onto SYNC® through your USB port. Please refer to [www.SyncMyRide.com](http://www.SyncMyRide.com) for further information.

### **Using SYNC®'s play menu**

The SYNC® PLAY MENU allows you to play your music by playing all selections, by artist listing, album listing, genre listing, playlists, tracks, or by selecting similar music to what is currently playing. You can also choose to 'Explore USB' which will allow you to explore supported digital music files on your playing device.



**WARNING:** SYNC® PLAY MENU manual control is a backup interface to voice commands. Do not use SYNC® PLAY MENU manual control while driving.

**Note:** The *Play Menu* is only available for indexable media through the USB port. This is not available for LINE IN and BT AUDIO.



## Entertainment Systems

SYNC® is able to organize and sort your indexed media from your playing device by metadata tags. Metadata tags are descriptive software identifiers embedded in your media files which provide information about the media file. SYNC® supports the following metadata tags:

- Artist
- Album
- Genre
- Track

If your indexed media files contain no information embedded in these metadata tags, SYNC® will automatically classify the empty metadata tags as UNKNOWN.

To access the SYNC® *Play Menu*:

**Note:** To scroll, press ▲ / ▼ .

1. Ensure that your playing device is plugged into the USB port and is ON.
2. Press AUX repeatedly until SYNC appears.
3. Press MENU. When *Media Player Menu* is selected, press OK.
4. If there are no media files to access, the display will read *No Media Files*.
5. In the SYNC® *Play Menu*, scroll repeatedly to select from the following options:

- *Play All*
- *Artists*
- *Albums*
- *Genres*
- *Playlists*
- *Tracks*
- *Explore USB*
- *Similar Music*
- *Return*

Refer to the following sections for further explanation on these features.

### **Using the Play all feature**

The Play all feature in SYNC® will play all indexed media (tracks) from your playing device in flat file mode, one at a time in numerical order. To use this feature:

**Note:** To scroll, press ▲ / ▼ .

1. Ensure that your playing device is plugged into the USB port and is ON.
2. Press AUX repeatedly until *SYNC USB* appears.
3. Press MENU. When *Media Player Menu* is selected, press OK.

89

## Entertainment Systems

4. Scroll until *Play Menu* is selected and press OK. The system will begin to play all the indexed media alphabetically. The first track title will appear in the radio display.

Refer to *Using the media settings in your media menu* earlier in this chapter for further information on making adjustments to your playing music (i.e., Seek, Shuffle, Autoplay and Repeat).

### **Selecting and playing specific artists**

SYNC® allows you to sort all indexed media by artists. Once selected, the system will list and then play all artists and tracks alphabetically. If you have fewer than 255 indexed artists, SYNC® will list them alphabetically in flat file mode. If there are more than 255 indexed artists, SYNC® will organize them into quick select alphabetical categories (i.e., AAAAA-MMMMM and MMMMN-ZZZZZ). The number of categories will depend on the number of indexed artists.

To access:

**Note:** To scroll, press ▲ / ▼ .

1. Ensure that your playing device is plugged into the USB port and is ON.
2. Press AUX repeatedly until *SYNC USB* appears.
3. Press MENU. When *Media Player Menu* is selected, press OK.
4. Scroll until *Play Menu* is selected and press Ok.
5. Scroll until *Artists* is selected and press OK. You can now select from playing *All Artists*, or from any indexed artist.
6. Scroll to cycle through all indexed artists and press OK when the desired artist is selected.
7. You can play all tracks by that artist by selecting *Play All* or scroll to see specific albums. If there are multiple albums by the same artist indexed, SYNC® will ask you to select from the various indexed albums by that artist.
8. Press OK to confirm and begin to play the first track of the selected album.

Refer to *Using the media settings in your media menu* earlier in this chapter for further information on making adjustments to your music (i.e., Seek, Shuffle, Autoplay and Repeat).

## Entertainment Systems

### **Selecting and playing specific albums**

SYNC® allows you view and play indexed media by ALBUMS. If you have fewer than 255 indexed albums, SYNC® will list them alphabetically in flat file mode. If there are more than 255 indexed albums, SYNC® will organize them into quick select alphabetical categories (i.e., AAAAA-MMMMM and MMMMN-ZZZZZ). The number of categories will depend on the number of indexed albums.

To access:

**Note:** To scroll, press ▲ / ▼ .

1. Ensure that your playing device is plugged into the USB port and is ON.
2. Press AUX repeatedly until *SYNC USB* appears.
3. Press MENU. When *Media Player Menu* is selected, press OK.
4. Scroll until *Play Menu* is selected and press OK.
5. Scroll until *Play All* is selected and press OK.
6. Scroll until *Albums* is selected and press OK. Select to play All Albums or any individual indexed album.
7. Scroll to cycle through all indexed albums and press OK when the desired album is chosen.
8. Press OK to confirm and begin to play the first track of the selected album.

Refer to *Using the media settings in your media menu* earlier in this chapter for further information on making adjustments to your music (i.e., Seek, Shuffle, Autoplay and Repeat).

### **Selecting from different genres**

SYNC® allows you to sort indexed music by genre (category) type. SYNC® will automatically categorize your indexed music according to the available genres. If you have fewer than 255 indexed genres, SYNC® will list them alphabetically in flat file mode. If there are more than 255 indexed genres, SYNC® will organize them into quick select alphabetical categories (i.e., AAAAA-MMMMM and MMMMN-ZZZZZ). The number of categories will depend on the number of indexed genres.

To access:

**Note:** To scroll, press ▲ / ▼ .

1. Ensure that your playing device is plugged into the USB port and is ON.

## Entertainment Systems

2. Press AUX repeatedly until *SYNC USB* appears.
3. Press MENU. When *Media Player Menu* is selected, press Ok.
4. Scroll until *Play Menu* is selected and press OK.
5. When *Play All* appears. scroll until *Genres* is selected and press OK.
6. Scroll and press OK when the desired genre is selected. SYNC® will then take you to the *Albums* menu.
7. Scroll to cycle through all indexed albums and press OK when the desired selected is chosen.

Refer to *Using the media settings in your media menu* earlier in this chapter for further information on making adjustments to your music (i.e., Seek, Shuffle, Autoplay and Repeat).

### Accessing your playlists

SYNC® supports playing many playlist formats (such as .ASX, .M3U, .WPL, .MTP). Please refer to [www.SyncMyRide.com](http://www.SyncMyRide.com) for more information.

If you have fewer than 255 indexed playlists, SYNC® will list them alphabetically in flat file mode. If there are more than 255 indexed playlists, SYNC® will organize them into quick select alphabetical categories (i.e., AAAAA-MMMMM and MMMMN-ZZZZZ). The number of categories will depend on the number of indexed playlists.

To access:

**Note:** To scroll, press ▲ / ▼ .

1. Ensure that your playing device is plugged into the USB port and is ON.
2. Press AUX repeatedly until *SYNC USB* appears.
3. Press MENU. When *Media Player Menu* is selected, press OK.
4. Scroll until *Play Menu* is selected, press OK.
5. When Play All appears, scroll until *Playlists* is selected and press OK.
6. Scroll to cycle through all indexed playlists.
7. Press OK when the desired playlist is selected.

Refer to *Using the media settings in your media menu* earlier in this chapter for further information on making adjustments to your playing music (i.e., Seek, Shuffle, Autoplay and Repeat).

## Entertainment Systems

### **Playing a specific track**

SYNC® will allow you to search for and play a specific track which has been indexed. If you have fewer than 255 indexed tracks, SYNC® will list them alphabetically in flat file mode. If there are more than 255 indexed tracks, SYNC® will organize them into quick select alphabetical categories (i.e., AAAAA-MMMMM and MMMMN-ZZZZZ). The number of categories will depend on the number of indexed tracks.

To access:

**Note:** To scroll, press ◀ SEEK ▶ or ▲ / ▼ .

1. Ensure that your playing device is plugged into the USB port and is ON.
2. Press AUX repeatedly until *SYNC USB* appears.
3. Press MENU. When *Media Player Menu* is selected, press OK.
4. Scroll until *Play Menu* is selected and press OK.
5. When *Play All* appears, scroll until *Tracks* is selected and press OK.
6. Scroll to cycle through all indexed tracks.
7. Press OK when the desired track is selected. The track will begin to play and appear in the radio display.

Refer to *Using the media settings in your media menu* earlier in this chapter for further information on making adjustments to your music (i.e., Seek, Shuffle, Autoplay and Repeat).

### **Exploring the USB device**

SYNC® allows you to explore through all supported digital media on your media device which is connected through the USB port.

**Note:** When searching through various folders, you will only be able to view media content which is compatible with SYNC®. You may have other files saved with various extensions, power point presentations for example, but they will not be visible.

To access:

**Note:** To scroll, press ▲ / ▼ .

1. Ensure that your playing device is plugged into the USB port and is ON.
2. Press AUX repeatedly until *SYNC USB* appears.
3. Press MENU. When *Media Player Menu* is selected, press OK.

## Entertainment Systems

4. Scroll until *Play Menu* is selected and press OK.
5. When *Play All* appears, scroll until *Explore USB* is selected and press OK.
6. Scroll to cycle through all available folders on your media device. An “F” will precede folders and “T” will precede tracks in the radio display.
7. Press OK when the desired folder or track is selected.
8. Scroll to cycle through all subfolders and/or tracks in the selected folder.

**Note:** When you are playing USB SYNC MEDIA using the *Explore USB* feature, and you folders saved on your playing device, you are in folder mode. In folder mode, you can say “Play next folder” or “Play previous folder” to advance within your saved folders. Press OK to select a folder and scroll repeatedly through all subfolders and/or tracks in the selected folder.

**Note:** *Play All* will appear in every subfolder, giving you quick access to play all tracks in the particular folder.

Refer to *Using the media settings in your media menu* earlier in this chapter for further information on making adjustments to your music (i.e., Seek, Shuffle, Autoplay and Repeat).

### **Playing similar music**

SYNC® allows you to play music similar to what is currently playing from the USB port. The system will use the metadata information of each song to compile a playlist for you. To access:

**Note:** To scroll, press ▲ / ▼ .

1. Ensure that your playing device is plugged into the USB port and is ON.
2. Ensure that you are listening to an indexed track.
3. Press AUX repeatedly until *SYNC USB* appears.
4. Press MENU. When *Media Player Menu* is selected, press OK.
5. Scroll until *Play Menu* is selected and press OK.
6. When *Play All* appears in the display, scroll until SIMILAR is selected and press OK. The system will create a new list of similar songs and begin playing.

**Note:** Your metadata tags must be populated in order for the *Similar Music* feature to include each *Tracks*.

94

## Entertainment Systems

**Note:** With certain playing devices, if your metadata tags (Artist, Album, Track, Genre) are not populated, the tracks won't be available in voice recognition, the *Play Menu* or *Similar Music*. However, if you place these tracks with unpopulated metadata tags onto your playing device in "Mass Storage Device mode", these tracks will be available in voice recognition, *Play Menu* browsing or *Similar Music*. UNKNOWN will be placed into any unpopulated metadata tag.

Refer to *Using the media settings in your media menu* earlier in this chapter for further information on making adjustments to your music (i.e., Seek, Shuffle, Autoplay and Repeat).

### Glossary of terms

**Autoplay:** With Autoplay turned ON, SYNC® allows you to listen to music which has already been randomly indexed during the indexing process. With Autoplay turned off, the chosen music will not begin to play until all of the music has been indexed by SYNC®. Depending on the size of the material, this may take a few minutes.

**Bluetooth enabled cellular phone:** Any cellular phone which has the *Bluetooth* wireless technology which will enable the phone to connect with SYNC® and exchange information wirelessly.

**Digital media player / USB Device:** This is a generic term used to signify any of the following media devices: iPod®, Zune™, "Plays from device" players, and most USB drives (thumb drives, flash drives, PEN drives, etc.)

**Discoverable mode:** A mode which allows other *Bluetooth* enabled devices to find your *Bluetooth* enabled device.

**Discovery mode:** A mode which allows your *Bluetooth* enabled device to search for other 'discoverable' *Bluetooth* enabled devices.

**In-band ringing:** This is a phone dependent feature. If your *Bluetooth* enabled cellular phone supports this feature, SYNC® can play your ring tone during incoming calls.

**Indexing:** A process in which SYNC® builds a voice recognition grammar for the media content of your digital media player. While indexing, SYNC® will play already indexed media if Autoplay is on. However, voice recognition is not available for the media until the indexing process is complete.

**Metadata:** Descriptive tags embedded in your digital media which provide SYNC® with information such as ARTIST, ALBUM, GENRE and TRACK.

## Entertainment Systems

**Pairing:** To use your *Bluetooth* enabled cellular phone with SYNC®, you must go through a pairing (bonding) process. “Pairing” is a special process used when two devices connect for the first time. The pairing process is used to generate a link key that is used for authentication purposes during subsequent *Bluetooth* connections between the two devices.

**PIN (Personal Identification number):** This six digit number (sometimes referred to as a passkey) will be shown in the radio display during the pairing process with your *Bluetooth* enabled device. You do not need to write down this number as it will only be used for that specific pairing procedure.

### SYNC® End User License Agreement (EULA)

- You have acquired a device (“DEVICE”) that includes software licensed by FORD MOTOR COMPANY from an affiliate of Microsoft Corporation (“MS”). Those installed software products of MS origin, as well as associated media, printed materials, and “online” or electronic documentation (“MS SOFTWARE”) are protected by international intellectual property laws and treaties. The MS SOFTWARE is licensed, not sold. All rights reserved.
- The MS SOFTWARE may interface with and/or communicate with, or may be later upgraded to interface with and/or communicate with additional software and/or systems provided by FORD MOTOR COMPANY. The additional software and systems of FORD MOTOR COMPANY origin, as well as associated media, printed materials, and “online” or electronic documentation (“FORD SOFTWARE”) are protected by international intellectual property laws and treaties. The FORD SOFTWARE is licensed, not sold. All rights reserved.
- The MS SOFTWARE and/or FORD SOFTWARE may interface with and/or communicate with, or may be later upgraded to interface with and/or communicate with additional software and/or systems provided by third party software and service suppliers. The additional software and services of third party origin, as well as associated media, printed materials, and “online” or electronic documentation (“THIRD PARTY SOFTWARE”) are protected by international intellectual property laws and treaties. The THIRD PARTY SOFTWARE is licensed, not sold. All rights reserved.
- The MS SOFTWARE, FORD SOFTWARE and THIRD PARTY SOFTWARE hereinafter collectively and individually will be referred to as “SOFTWARE.”



## Entertainment Systems

**IF YOU DO NOT AGREE TO THIS END USER LICENSE AGREEMENT (“EULA”), DO NOT USE THE DEVICE OR COPY THE SOFTWARE. ANY USE OF THE SOFTWARE, INCLUDING BUT NOT LIMITED TO USE ON THE DEVICE, WILL CONSTITUTE YOUR AGREEMENT TO THIS EULA (OR RATIFICATION OF ANY PREVIOUS CONSENT).**

**GRANT OF SOFTWARE LICENSE:** This EULA grants you the following license:

- You may use the SOFTWARE as installed on the DEVICE and as otherwise interfacing with systems and/or services provide by or through FORD MOTOR COMPANY or its third party software and service providers.

### **DESCRIPTION OF OTHER RIGHTS AND LIMITATIONS:**

- **Speech Recognition:** If the SOFTWARE includes speech recognition component(s), you should understand that speech recognition is an inherently statistical process and that recognition errors are inherent in the process. Neither FORD MOTOR COMPANY nor its suppliers shall be liable for any damages arising out of errors in the speech recognition process.
- **Limitations on Reverse Engineering, Decompilation and Disassembly:** You may not reverse engineer, decompile, or disassemble nor permit others to reverse engineer, decompile or disassemble the SOFTWARE, except and only to the extent that such activity is expressly permitted by applicable law notwithstanding this limitation.
- **Limitations on Distributing, Copying, Modifying and Creating Derivative Works:** You may not distribute, copy, make modifications to or create derivative works based on the SOFTWARE, except and only to the extent that such activity is expressly permitted by applicable law notwithstanding this limitation.
- **Single EULA:** The end user documentation for the DEVICE and related systems and services may contain multiple EULAs, such as multiple translations and/or multiple media versions (e.g., in the user documentation and in the software). Even if you receive multiple EULAs, you are licensed to use only one (1) copy of the SOFTWARE.
- **SOFTWARE Transfer:** You may permanently transfer your rights under this EULA only as part of a sale or transfer of the DEVICE, provided you retain no copies, you transfer all of the SOFTWARE (including all component parts, the media and printed materials, any upgrades, and, if applicable, the Certificate(s) of Authenticity), and

97

## Entertainment Systems

the recipient agrees to the terms of this EULA. If the SOFTWARE is an upgrade, any transfer must include all prior versions of the SOFTWARE.

- **Termination:** Without prejudice to any other rights, FORD MOTOR COMPANY or MS may terminate this EULA if you fail to comply with the terms and conditions of this EULA.
- **Security Updates/Digital Rights Management:** Content owners use the WMDRM technology included in your DEVICE to protect their intellectual property, included copyrighted content. Portions of the SOFTWARE on your DEVICE use WMDRM software to access WMDRM-protected content. If the WMDRM software fails to protect the content, content owners may ask Microsoft to revoke the SOFTWARE's ability to use WMDRM to play or copy protected content. This action does not affect unprotected content. When your DEVICE downloads licenses for protected content, you agree that Microsoft may include a revocation list with the licenses. Content owners may require you to upgrade the SOFTWARE on your DEVICE to access their content. If you decline an upgrade, you will not be able to access content that requires the upgrade.
- **Consent to Use of Data:** You agree that MS, Microsoft Corporation, FORD MOTOR COMPANY, third party software and systems suppliers, their affiliates and/or their designated agent may collect and use technical information gathered in any manner as part of product support services related to the SOFTWARE or related services. MS, Microsoft Corporation, FORD MOTOR COMPANY, third party software and services suppliers, their affiliates and/or their designated agent may use this information solely to improve their products or to provide customized services or technologies to you. MS, Microsoft Corporation, FORD MOTOR COMPANY, third party software and systems suppliers, their affiliates and/or their designated agent may disclose this information to others, but not in a form that personally identifies you.
- **Internet-Based Services Components:** The SOFTWARE may contain components that enable and facilitate the use of certain Internet-based services. You acknowledge and agree that MS, Microsoft Corporation, FORD MOTOR COMPANY, third party software and service suppliers, their affiliates and/or their designated agent may automatically check the version of the SOFTWARE and/or its components that you are utilizing and may provide upgrades or supplements to the SOFTWARE that may be automatically downloaded to your DEVICE.

98

## Entertainment Systems

- **Additional Software/Services:** The SOFTWARE may permit FORD MOTOR COMPANY, third party software and service suppliers, MS, Microsoft Corporation, their affiliates and/or their designated agent to provide or make available to you SOFTWARE updates, supplements, add-on components, or Internet-based services components of the SOFTWARE after the date you obtain your initial copy of the SOFTWARE (“Supplemental Components”).

If FORD MOTOR COMPANY or third party software and services suppliers provide or make available to you Supplemental Components and no other EULA terms are provided along with the Supplemental Components, then the terms of this EULA shall apply.

If MS, Microsoft Corporation, their affiliates and/or their designated agent make available Supplemental Components, and no other EULA terms are provided, then the terms of this EULA shall apply, except that the MS, Microsoft Corporation or affiliate entity providing the Supplemental Component(s) shall be the licensor of the Supplemental Component(s).

FORD MOTOR COMPANY, MS, Microsoft Corporation, their affiliates and/or their designated agent reserve the right to discontinue without liability any Internet-based services provided to you or made available to you through the use of the SOFTWARE.

- **Links to Third Party Sites:** The MS SOFTWARE may provide you with the ability to link to third party sites through the use of the SOFTWARE. The third party sites are not under the control of MS, Microsoft Corporation, their affiliates and/or their designated agent. Neither MS nor Microsoft Corporation nor their affiliates nor their designated agent are responsible for (i) the contents of any third party sites, any links contained in third party sites, or any changes or updates to third party sites, or (ii) webcasting or any other form of transmission received from any third party sites. If the SOFTWARE provides links to third party sites, those links are provided to you only as a convenience, and the inclusion of any link does not imply an endorsement of the third party site by MS, Microsoft Corporation, their affiliates and/or their designated agent.
- **Obligation to Drive Responsibly:** You recognize your obligation to drive responsibly and keep attention on the road. You will read and abide with the DEVICE operating instructions particularly as they pertain to safety and assumes any risk associated with the use of the DEVICE.

## Entertainment Systems

**UPGRADES AND RECOVERY MEDIA:** If the SOFTWARE is provided by FORD MOTOR COMPANY separate from the DEVICE on media such as a ROM chip, CD ROM disk(s) or via web download or other means, and is labeled “For Upgrade Purposes Only” or “For Recovery Purposes Only” you may install one (1) copy of such SOFTWARE onto the DEVICE as a replacement copy for the existing SOFTWARE, and use it in accordance with this EULA, including any additional EULA terms accompanying the upgrade SOFTWARE.

**INTELLECTUAL PROPERTY RIGHTS:** All title and intellectual property rights in and to the SOFTWARE (including but not limited to any images, photographs, animations, video, audio, music, text and “applets,” incorporated into the SOFTWARE), the accompanying printed materials, and any copies of the SOFTWARE, are owned by MS, Microsoft Corporation, FORD MOTOR COMPANY, or their affiliates or suppliers. The SOFTWARE is licensed, not sold. You may not copy the printed materials accompanying the SOFTWARE. All title and intellectual property rights in and to the content which may be accessed through use of the SOFTWARE is the property of the respective content owner and may be protected by applicable copyright or other intellectual property laws and treaties. This EULA grants you no rights to use such content. All rights not specifically granted under this EULA are reserved by MS, Microsoft Corporation, FORD MOTOR COMPANY, third party software and service providers, their affiliates and suppliers. Use of any on-line services which may be accessed through the SOFTWARE may be governed by the respective terms of use relating to such services. If this SOFTWARE contains documentation that is provided only in electronic form, you may print one copy of such electronic documentation.

**EXPORT RESTRICTIONS:** You acknowledge that the SOFTWARE is subject to U.S. and European Union export jurisdiction. You agree to comply with all applicable international and national laws that apply to the SOFTWARE, including the U.S. Export Administration Regulations, as well as end-user, end-use and destination restrictions issued by U.S. and other governments. For additional information, see <http://www.microsoft.com/exporting/>.

**TRADEMARKS:** This EULA does not grant you any rights in connection with any trademarks or service marks of FORD MOTOR COMPANY, MS, Microsoft Corporation, third party software or service providers, their affiliates or suppliers.

## Entertainment Systems

**PRODUCT SUPPORT:** Product support for the SOFTWARE is not provided by MS, its parent corporation Microsoft Corporation, or their affiliates or subsidiaries. For product support, please refer to FORD MOTOR COMPANY instructions provided in the documentation for the DEVICE. Should you have any questions concerning this EULA, or if you desire to contact FORD MOTOR COMPANY for any other reason, please refer to the address provided in the documentation for the DEVICE.

**No Liability for Certain Damages:** EXCEPT AS PROHIBITED BY LAW, FORD MOTOR COMPANY, ANY THRID PARTY SOFTWARE OR SERVICES SUPPLIERS, MS, MICROSOFT CORPORATION AND THEIR AFFILIATES SHALL HAVE NO LIABILITY FOR ANY INDIRECT, SPECIAL, CONSEQUENTIAL OR INCIDENTAL DAMAGES ARISING FROM OR IN CONNECTION WITH THE USE OR PERFORMANCE OF THE SOFTWARE. THIS LIMITATION SHALL APPLY EVEN IF ANY REMEDY FAILS OF ITS ESSENTIAL PURPOSE. IN NO EVENT SHALL MS, MICROSOFT CORPORATION AND/OR THEIR AFFILIATES BE LIABLE FOR ANY AMOUNT IN EXCESS OF U.S. TWO HUNDRED FIFTY DOLLARS (U.S.\$250.00).

- THERE ARE NO WARRANTIES OTHER THAN THOSE THAT MAY EXPRESSLY BE PROVIDED FOR YOUR NEW VEHICLE.

### End user notice

#### **Microsoft® Windows® Mobile for Automotive Important Safety Information**

This system Ford SYNC™ contains software that is licensed to Manufacturer FORD MOTOR COMPANY by an affiliate of Microsoft Corporation pursuant to a license agreement. Any removal, reproduction, reverse engineering or other unauthorized use of the software from this system in violation of the license agreement is strictly prohibited and may subject you to legal action.

### Read and follow instructions

Before using your Windows Automotive-based system, read and follow all instructions and safety information provided in this end user manual (“User’s Guide”). Not following precautions found in this User’s Guide can lead to an accident or other serious consequences.

### Keep User’s Guide in Vehicle

When kept in the vehicle, the User’s Guide will be a ready reference for you and other users unfamiliar with the Windows Automotive-based system. Please make certain that before using the system for the first time, all persons have access to the User’s Guide and read its instructions and safety information carefully.

101

## Entertainment Systems



**WARNING:** Operating certain parts of this system while driving can distract your attention away from the road, and possibly cause an accident or other serious consequences. Do not change system settings or enter data non-verbally (using your hands) while driving. Stop the vehicle in a safe and legal manner before attempting these operations. This is important since while setting up or changing some functions you might be required to distract your attention away from the road and remove your hands from the wheel.

### General operation

#### Voice Command Control

Functions within the Windows Automotive-based system may be accomplished using only voice commands. Using voice commands while driving allows you to operate the system without removing your hands from the wheel.

#### Prolonged Views of Screen

Do not access any function requiring a prolonged view of the screen while you are driving. Pull over in a safe and legal manner before attempting to access a function of the system requiring prolonged attention. Even occasional short scans to the screen may be hazardous if your attention has been diverted away from your driving task at a critical time.

#### Volume Setting

Do not raise the volume excessively. Keep the volume at a level where you can still hear outside traffic and emergency signals while driving. Driving while unable to hear these sounds could cause an accident.

#### Use of Speech Recognition Functions





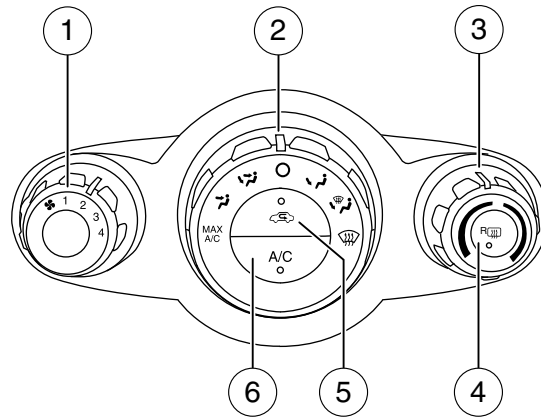

Speech recognition software is inherently a statistical process which is subject to errors. It is your responsibility to monitor any speech recognition functions included in the system and address any errors.

## Climate Controls



### MANUAL HEATING AND AIR CONDITIONING SYSTEM



Manual system with A/C shown; heater only system similar.



-  : Turn to select the desired fan speed.
- Air flow selections:** Controls the direction of the airflow in the vehicle. See the following for a brief description on each control setting:
  - MAX A/C (if equipped):** Distributes recirculated air through the instrument panel vents to cool the vehicle. This re-cooling of the interior air is more economical and efficient than normal A/C mode. Recirculated air may also help reduce undesirable odors from entering the vehicle.
  -  : Distributes air through the instrument panel vents.
  -  : Distributes air through the instrument panel vents, demister vents, floor vents and rear seat floor vents.
  -  : Turns the climate control system off. When the system is off, outside air is prevented from entering the vehicle.
  -  : Distributes air through the floor vents and rear seat floor vents.  
**Note:** You may notice a small amount of air flowing from the demister and defroster vents.
  -  : Distributes air through the windshield defroster vents, demisters vents, floor vents and rear seat floor vents.



## Climate Controls

 : Distributes outside air through the windshield defroster and demister vents. Can be used to clear thin ice or fog from the windshield. The system will automatically provide outside air to reduce window fogging. To exit  select another mode.



3. **Temperature:** Controls the temperature of the airflow in the vehicle. For optimum defrosting performance, set the dial to the hottest setting.

4.  : Press to activate/deactivate the rear window defroster. Refer to *Rear window defroster* later in this chapter for more information. If your vehicle is equipped with both rear defroster and heated mirrors, the same button will activate both.

5.  : Press to activate/deactivate air recirculation in the vehicle cabin. Recirculated air may reduce the amount of time required to cool down the interior of the vehicle and may also help reduce undesired odors from reaching the interior of the vehicle. Recirculated air engages automatically when MAX A/C is selected or can be engaged manually in any airflow mode except  (defrost).

6. **A/C (if equipped):** Press to activate/deactivate air conditioning. Use with recirculated air to improve cooling performance and efficiency. Engages automatically in  (defrost),  (floor/defrost) or MAX A/C.

### Operating tips

- To reduce fog build-up on the windshield during humid weather, select  (defrost) or  (floor/defrost).
- To reduce humidity build-up inside the vehicle, do not drive with the system off or with  (recirculated air) engaged and A/C off.
- Do not put objects under the front seats that will interfere with the airflow to the back seats.
- Remove any snow, ice or leaves from the air intake area at the base of the windshield.
- To improve the time to reach comfort in hot weather, drive with the windows slightly open for 2-3 minutes after start up or until the vehicle has been “aired out.”
- A small amount of air may be felt from the floor vent regardless of the air distribution setting that is selected.

During extreme high ambient temperatures when idling stationary for extended periods of time in gear, it is recommended to run the A/C in the MAX A/C position, reduce blower fan speed from the highest setting

104



## Climate Controls

and put the vehicle's transmission into the P (Park) gear position (automatic transmission only) to continue to receive cool air from your A/C system.

### **For maximum cooling performance in MAX A/C mode:**

1. Select MAX A/C.
2. Select the coolest temperature setting.
3. Set the fan to the highest speed initially. As the interior starts to cool down, adjust the fan speed to maintain comfort.

### **To aid in side window defogging/demisting in cold weather:**

1. Select .
2. Select A/C.
3. Adjust the temperature control to maintain comfort.
4. Set the fan speed to the highest setting.
5. Direct the outer instrument panel vents towards the side windows.

To increase airflow to the outer instrument panel vents, close the vents located in the middle of the instrument panel.

### **REAR WINDOW DEFROSTER**

The rear defroster control is located on the climate control panel and works to clear the rear window of fog and thin ice.

The engine must be running to operate the rear window defroster.

Press  to turn the rear window defroster on. An indicator light on the control will illuminate when active. The rear window defroster turns off automatically after a predetermined amount of time, if a low battery condition is detected or when the ignition is turned off or to the accessory position. To manually turn off the rear window defroster at any time, press the control again.

If your vehicle is equipped with both rear defroster and heated mirrors, the same control will activate both. Refer to *Heated outside mirrors* in the *Driver Controls* chapter.

**Do not use razor blades or other sharp objects to clean the inside of the rear window or to remove decals from the inside or the rear window. This may cause damage to the heated grid lines and will not be covered by your warranty.**

## Lights

### HEADLAMP CONTROL

- Turns the lamps off.
- P☞ Turns on the parking lamps, instrument panel lamps, license plate lamps and tail lamps.
- ☞ Turns the low beam headlamps on.

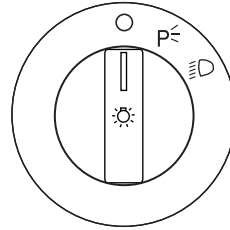

### High beams

Pull the lever fully past the detent to activate. Pull the lever fully again to deactivate.



### Flash-to-pass

Pull the lever toward you slightly to activate and release to deactivate.

### Headlamp exit delay

Switch the ignition off and pull the lever toward you slightly to activate. You will hear a short tone.

The headlamps will turn off automatically after 3 minutes with any door open or 30 seconds after the last door has been closed. With all doors closed, but within the 30 second delay, opening any door will result in the three minute timer starting again.

The headlamp exit delay can be cancelled by either pulling the lever towards the steering wheel again or by turning the ignition switch on.

## Lights

### Daytime running lamps (DRL) (if equipped)

Turns the headlamps on with a reduced output.

To activate:

- the ignition must be in the on position and
- the headlamp control is in the off or parking lamp position.



**WARNING:** Always remember to turn on your headlamps at dusk or during inclement weather. The Daytime Running Lamp (DRL) system does not activate the tail lamps and generally may not provide adequate lighting during these conditions. Failure to activate your headlamps under these conditions may result in a collision.

### PANEL DIMMER CONTROL

Use to adjust the brightness of the instrument panel and all applicable lit components in the vehicle during headlamp and parking lamp operation.

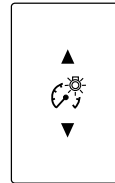

- Tap the top or bottom of the control to brighten/dim all interior lit components incrementally, or
- Press and hold at the first position the top or bottom of the control until the desired lighting level is reached.

### AIMING THE HEADLAMPS

The headlamps on your vehicle are properly aimed at the assembly plant. If your vehicle has been in an accident, the alignment of your headlamps should be checked by your authorized dealer.

#### Vertical aim adjustment

1. Park the vehicle directly in front of a wall or screen on a level surface, approximately 25 feet (7.6 meters) away.

## Lights

- (1) 8 feet (2.4 meters)
- (2) Center height of lamp to ground
- (3) 25 feet (7.6 meters)
- (4) Horizontal reference line

2. Measure the height from the center of your headlamp to the ground and mark an 8 foot (2.4 meter) horizontal reference line on the vertical wall or screen at this height (a piece of masking tape works well).

3. Turn on the low beam headlamps to illuminate the wall or screen and open the hood.

4. On the wall or screen you will observe an area of high intensity light. The top of the high intensity area should touch the horizontal reference line. If not, the beam will need to be adjusted.

5. Locate the vertical adjuster on each headlamp, then use a Phillips #2 screwdriver or 10 mm wrench/socket to adjust the headlamp up or down.

6. Close the hood and turn off the lamps.

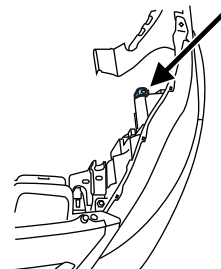
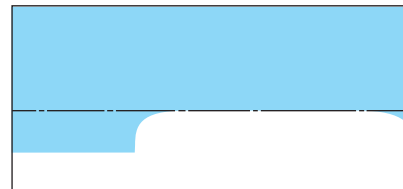
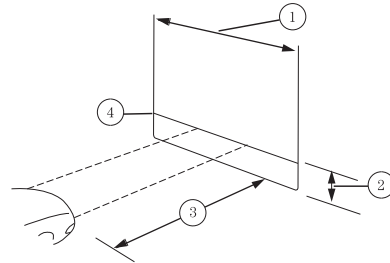

HORIZONTAL AIM IS NOT REQUIRED FOR THIS VEHICLE AND IS NON-ADJUSTABLE.

## Lights

### TURN SIGNAL CONTROL

- Push down to activate the left turn signal.
- Push up to activate the right turn signal.



When changing lanes, the turn signal indicator can be programmed to flash either one or three times when the stalk is tapped. See *Multifunction display* in the *Instrument cluster* section for more information.

### INTERIOR LAMPS

#### Dome lamps and map lamps with moon roof

Press the buttons to turn the map lamps on/off.

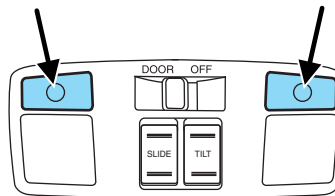

The dome lamp switch has two modes:

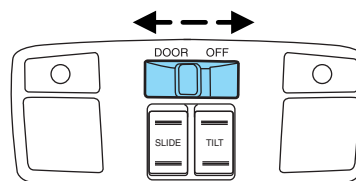

- OFF: The dome lamps will not come on when the doors are opened.
- DOOR: The dome lamps come on when a door is opened.

## Lights

### ***Dome lamps and map lamps, rear lamps***

Press the buttons to turn the map lamps on/off.

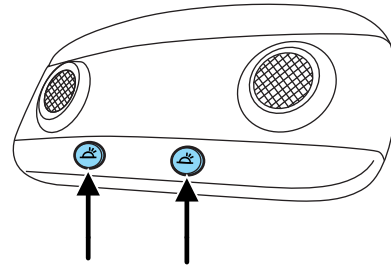

### **Ambient lighting (if equipped)**

Illuminates footwells, cupholders and the instrument panel with a choice of several colors. The ambient lighting control switch is located on the instrument panel. To activate, press and release the control to cycle through the color choices plus the off state.

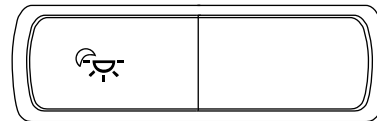

The lights come on whenever the ignition is in either the on or accessory position.

**Note:** The ambient lights will stay on until the ignition is placed in the off position and either of the front doors are opened or the accessory delay timer expires.

### **Battery saver feature (interior lamps)**

The battery saver feature will turn off the interior lamps 10 minutes after the ignition has been turned to the 1 (off) position and one of the vehicle doors has been opened.

**Note:** The battery saver feature will turn off the map lamps after 30 minutes if left in the on position.

## Lights

### BULB REPLACEMENT

#### Lamp assembly condensation

Exterior lamps are vented to accommodate normal changes in pressure. Condensation can be a natural by-product of this design. When moist air enters the lamp assembly through the vents, there is a possibility that condensation can occur when the temperature is cold. When normal condensation occurs, a thin film of mist can form on the interior of the lens. The thin mist eventually clears and exits through the vents during normal operation. Clearing time may take as long as 48 hours under dry weather conditions.

Examples of acceptable condensation are:

- Presence of thin mist (no streaks, drip marks or droplets)
- Fine mist covers less than 50% of the lens

Examples of unacceptable moisture (usually caused by a lamp water leak) are:

- Water puddle inside the lamp
- Large water droplets, drip marks or streaks present on the interior of the lens

Take your vehicle to a dealer for service if any of the above conditions of unacceptable moisture are present.

#### Using the right bulbs

Replacement bulbs are specified in the chart below. Headlamp bulbs must be marked with an authorized "D.O.T." for North America and an "E" for Europe to ensure lamp performance, light brightness and pattern and safe visibility. The correct bulbs will not damage the lamp assembly or void the lamp assembly warranty and will provide quality bulb burn time.

Function	Number of bulbs	Trade number
Headlamp (low beam)	1	H11B
Headlamp (high beam)	1	HB3-9005LL
Headlamp (park/turn)	1	3157NAK (amber)
Headlamp (side marker)	1	168
4-door rear bodyside lamp (park/turn/sidemarker)	1	3157K

111

## Lights

Function	Number of bulbs	Trade number
4-door rear deck lamp (backup)	1	921
5-door rear lamp (stop/reverse)	2	3157K
5-door rear lamp (turn)	1	3157A (amber)
License plate lamp	1	W5W
* High-mount brake lamp	1	LED
Interior lamp	1	W6W
Reading lamp	1	W5W
Luggage compartment lamp	1	W5W
To replace all instrument panel lights - see your authorized dealer.		
All replacement bulbs are clear in color, except where noted.		
* To replace these lamps, see your authorized dealer.		

### Replacing interior bulbs

Check the operation of all bulbs frequently.

### Replacing exterior bulbs

Check the operation of all the bulbs frequently.

### Replacing bulbs

**Note:** Before changing bulb, verify the corresponding fuse is not blown.

The low beam headlamps, high beam headlamps, front turn signals and side marker lamps are located in the lamp assembly and can be replaced individually by removing the lamp assembly as a unit.

### Removing the front lamp assembly

**Note:** The front lamp assembly must be removed in order to replace bulbs.



## Lights

1. Make sure the headlamp control is in the off position, then open the hood.
2. Remove the screws and pushpin holding the lamp assembly (1). (Driver side shown)

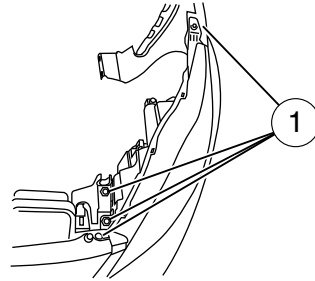

3. Detach the lamp harness clips from the lamp assembly and disconnect the electrical connectors (2).
4. Remove the lamp assembly (3).  
**Note:** When lamp is removed, you will hear a clicking sound.
5. Reverse the procedure to install the lamp assembly.

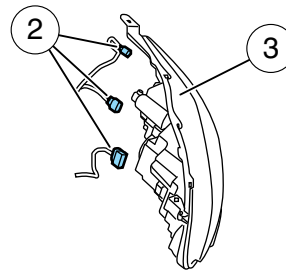

**Note:** When installing the front lamp assembly, the front flange must be placed under the fascia. Ensure that the bottom tab gets placed into the white clip.

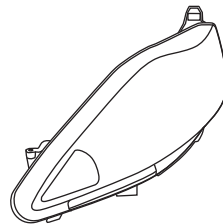

### **Replacing the low beam headlamps**

**Note:** The low beam headlamp is the outboard lamp.

**Note:** Never hold a bulb by the glass. This is particularly valid for halogen bulbs as the intensity of the light may be reduced if the hands touch the bulb. If the glass has been handled, clean it with alcohol.

## Lights

1. Remove the bulb cover.

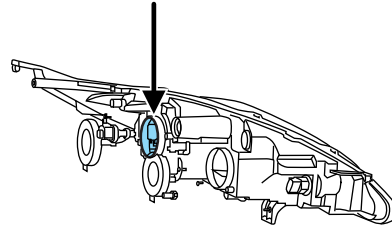

2. Turn the bulb holder counterclockwise and remove it.

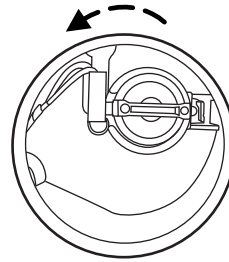

3. Disconnect the electrical connector.
4. Reverse the procedure to install the new bulb.

### **Replacing the high beam headlamps**

**Note:** The high beam headlamp is the inboard lamp.

**Note:** Never hold a bulb by the glass. This is particularly valid for halogen bulbs as the intensity of the light may be reduced if the hands touch the bulb. If the glass has been handled, clean it with alcohol.

1. Remove the bulb cover.

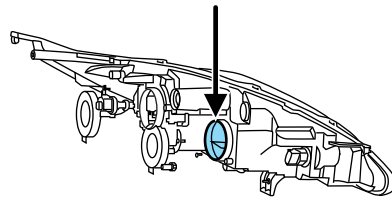

## Lights

2. Turn the bulb holder counterclockwise and remove it.

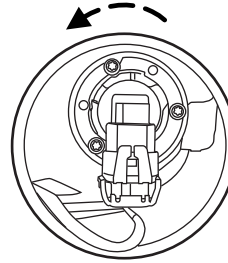

3. Disconnect the electrical connector.
4. Reverse the procedure to install the new bulb.

### **Replacing the park/turn signals**

1. Turn the bulb holder counterclockwise and remove it.

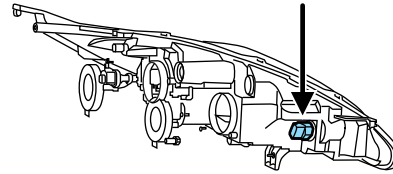

2. Remove the bulb from the bulb holder.

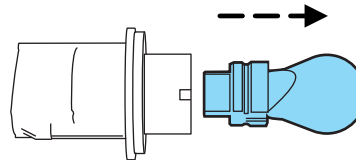

3. Reverse the procedure to install the new bulb.

## Lights

### **Replacing the side marker lamps**

1. Turn the bulb holder clockwise and remove it.

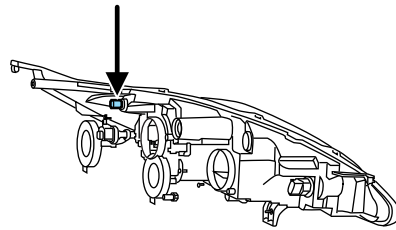

2. Remove the bulb from the bulb holder.

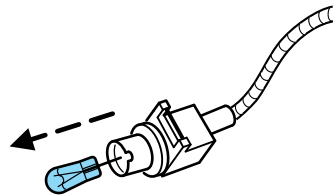

3. Reverse the procedure to install the new bulb.

### **Replacing the signal indicator mirror bulbs (if equipped)**

For bulb replacement, see your authorized dealer.

### **Replacing the rear lamps (5-door)**

1. Open the liftgate.
2. Remove the screws holding the lamp assembly.

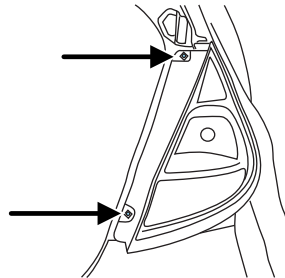

## Lights

### **Replacing the rear stop lamp (5-door)**

1. Turn the bulb holder counterclockwise and remove it.

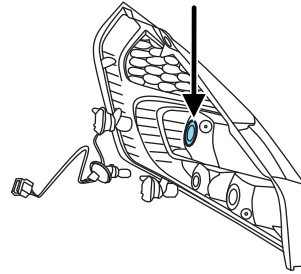

2. Remove the bulb from the holder.

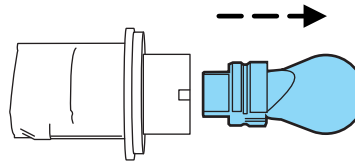

3. Reverse the procedure to install the new bulb.

### **Replacing the reverse signal rear lamp (5-door)**

1. Turn the bulb holder counterclockwise and remove it.

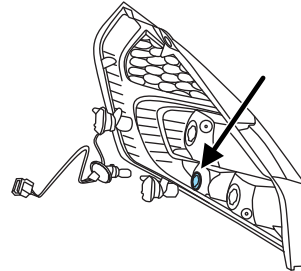

## Lights

2. Remove the bulb from the holder.

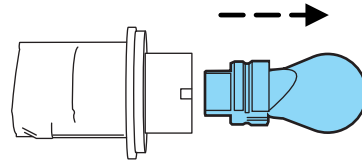

3. Reverse the procedure to install the new bulb.

### ***Replacing the turn signal rear lamp (5-door)***

1. Turn the bulb holder counterclockwise and remove it.

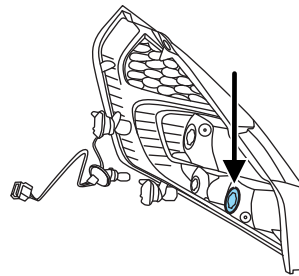

2. Remove the bulb from the holder.

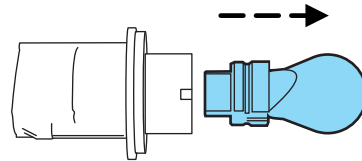

3. Reverse the procedure to install the new bulb.

## Lights

### **Replacing bodyside rear lamp bulb (4-door)**

1. Open the deck lid and remove the interior bodyside carpet.
2. Turn the bulb holder counterclockwise and remove it (2).

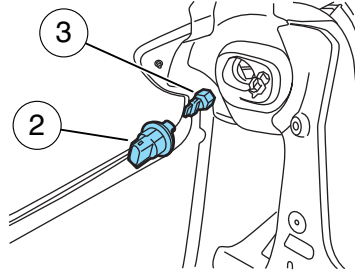

3. Remove the bulb (3) from the holder.

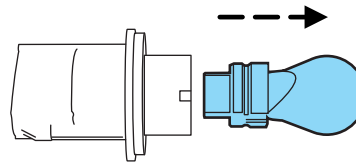

4. Reverse the procedure to install the new bulb.

### **Replacing the decklid mounted reverse lamp bulb (4-door)**

1. Open the deck lid and remove its interior carpet.
2. Turn the bulb holder counterclockwise and remove it (2).

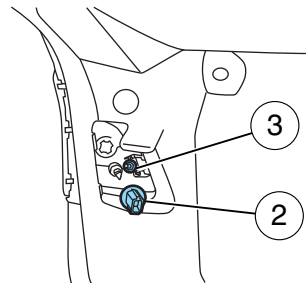

## Lights

3. Remove the bulb (3) from the holder.

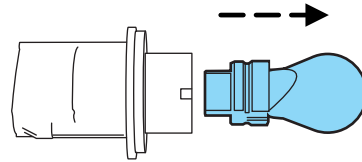

4. Reverse the procedure to install the new bulb.

5. Reinstall the carpet.

### ***Replacing the license plate lamps***

1. Carefully release the spring clip (1).
2. Remove the lamp (2).
3. Remove the bulb (3).

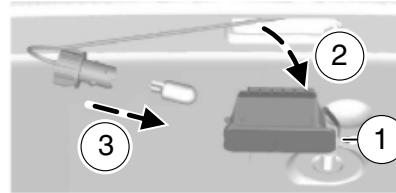

### ***Replacing the high-mounted brake lamp***

For replacement, see your authorized dealer.



## Driver Controls

### WINDSHIELD WIPERS

Move the lever down for a single wipe.

 For intermittent operation, move control up one position and adjust the rotary control to the desired speed.

 For normal operation, move control up two positions and up three positions for high-speed wiping.



### Windshield washer

 To activate the windshield washer, press the windshield washer control in. Release control to stop washer fluid spray. The wipers will operate for a short time after the wash is turned off.

**Note:** Do not operate the washer when the washer reservoir is empty. This may cause the washer pump to overheat. Check the washer fluid level frequently. Do not operate the wipers when the windshield is dry. This may scratch the glass, damage the wiper blades and cause the wiper motor to burn out. Before operating the wiper on a dry windshield, always use the windshield washer. In freezing weather, be sure the wiper blades are not frozen to the windshield before operating the wipers.

### Rear window wiper/washer (if equipped)

#### Wiper

 Pull the lever towards you for intermittent wiping.

#### Washer

 Pull the lever farther to operate the washer. The wiper will operate for a short time and will activate once more after pausing to clear the windshield.

## Driver Controls

### TILT/TELESCOPE STEERING WHEEL

To adjust the steering wheel:

1. Pull the lever down to unlock the steering column.
2. While the lever is in the down position, move the steering wheel up or down and in or out until you find the desired position.
3. While holding the steering wheel in place, pull the lever up to its original position to lock the steering column.

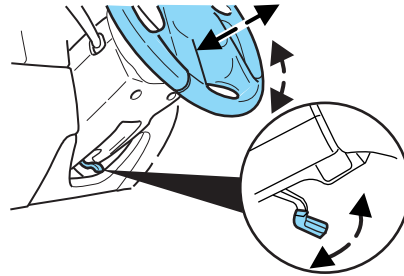

**WARNING:** Never adjust the steering wheel when the vehicle is moving.

### CENTER CONSOLE

Your vehicle has a variety of console features. These include:

- Front cupholders
- Rear cupholder insert
- Coin holders



**WARNING:** Use only soft cups in the cupholder. Hard objects can injure you in a collision.

### AUXILIARY POWER POINT (12V DC)

**Power outlet is designed for accessory plugs only. Do not insert any other object in the power outlet as this will damage the outlet and blow the fuse. Do not hang any type of accessory or accessory bracket from the plug. Improper use of the power outlet can cause damage not covered by your warranty.**

The auxiliary power points can be found in the following locations:

- On the rear of the center console
- On the instrument panel (if equipped)

Do not use the power point for operating the cigarette lighter element (if equipped).

122

## Driver Controls

**Note:** Do not plug optional electrical accessories into the cigarette lighter socket (if equipped). Improper use of the lighter can cause damage not covered by your warranty, and can result in fire or serious injury.

To prevent the fuse from being blown, do not use the power point(s) over the vehicle capacity of 12V DC/180W. If the power point or cigar lighter socket is not working, a fuse may have blown. Refer to *Fuses and relays* in the *Roadside Emergencies* chapter for information on checking and replacing fuses.

To have full capacity usage of your power point, the engine is required to be running to avoid unintentional discharge of the battery. To prevent the battery from being discharged:

- do not use the power point longer than necessary when the engine is not running,
- do not leave battery chargers, video game adapters, computers and other devices plugged in overnight or when the vehicle is parked for extended periods.

Always keep the power point caps closed when not being used.

### POWER WINDOWS (IF EQUIPPED)



**WARNING:** Do not leave children unattended in the vehicle and do not let children play with the power windows. They may seriously injure themselves.



**WARNING:** When closing the power windows, you should verify they are free of obstructions and ensure that children and/or pets are not in the proximity of the window openings.

## Driver Controls

Press and pull the window switches to open and close windows.

- Press down (to the first detent) and hold the switch to open.
- Pull up (to the first detent) and hold the switch to close.

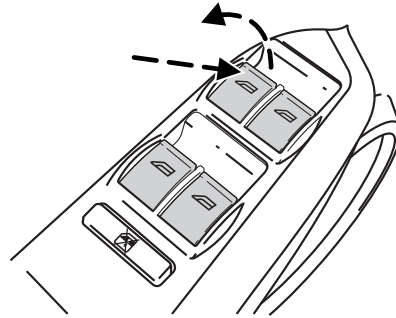

**Rear Window Buffeting:** When one or both of the rear windows are open, the vehicle may demonstrate a wind throb or buffeting noise. This noise can be alleviated by lowering a front window approximately 2–3 inches (5–8 cm).

### **One-touch up or down (driver's window only)**

This feature allows the driver's window to open or close fully without holding the control down.

To operate one-touch down, press the switch completely down to the second detent and release quickly. The window will open fully. Momentarily press the switch to any position to stop the window operation.

To operate one-touch up, pull the switch completely up to the second detent and release quickly. The window will close fully. Momentarily press the switch to any position to stop the window operation.

### **Bounce-back (driver's window only)**

When an obstacle has been detected in the window opening as the window is moving upward, the window will automatically move down and stop at a predetermined position.

### **Overriding the bounce-back feature**

To override this protection function when there is a resistance, e.g. in the winter, proceed as follows:

1. Close the window twice until it reaches the resistance and let it reverse.
2. Close the window a third time to the resistance. The bounce-back function is disabled and you cannot close the window automatically. The window will override the resistance and you can close it fully.

124

## Driver Controls

3. If the window does not close after the third attempt, contact your authorized dealer as soon as possible.

### **Resetting the bounce-back feature**



**WARNING:** The bounce-back function is deactivated until you have reset the memory.

After the battery has been disconnected from the vehicle you must reset the bounce-back memory:

1. Pull up the switch and hold until the window is fully closed then release the switch.
2. Pull up the switch again for one more second.
3. Press and hold the switch until the window is fully open, then release the switch.
4. Pull up the switch and hold until the window is fully closed.
5. Open the window and try to close it automatically.
6. Reset and repeat procedure if the window does not close automatically.

### **Window lock**

The window lock feature allows only the driver and front passenger to operate the power windows.

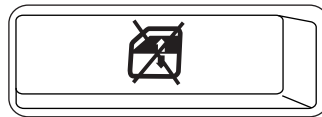

To lock out all window controls (except the driver's and front passenger's) press the control. Press it again to restore the window controls.

**Note:** The rear window switches will not illuminate when the window control is in the locked position.

### **INTERIOR MIRROR**

The interior rear view mirror has two pivot points on the support arm which lets you adjust the mirror up or down and from side to side.



**WARNING:** Do not adjust the mirror while the vehicle is in motion.

## Driver Controls

### Automatic dimming interior rear view mirror (if equipped)

The interior rear view mirror has an auto-dimming function. The electronic day/night mirror will change from the normal (high reflective) state to the non-glare (darkened) state when bright lights (glare) reach the mirror. When the mirror detects bright light from behind the vehicle, it will automatically adjust (darken) to minimize glare.

The mirror will automatically return to the normal state whenever the vehicle is placed in R (Reverse) to ensure a bright clear view when backing up.

**Do not block the sensors on the front and back of the interior rear view mirror since this may impair proper mirror performance.**

**Note:** A rear center passenger and/or raised rear center headrest (if equipped) may also block the light from reaching the sensor.

**Do not clean the housing or glass of any mirror with harsh abrasives, fuel or other petroleum-based cleaning products.**

## EXTERIOR MIRRORS

### Power side view mirrors (if equipped)



**WARNING:** Do not adjust the mirror while the vehicle is in motion.

To adjust your mirrors:

1. Rotate the control clockwise to adjust the right mirror and rotate the control counterclockwise to adjust the left mirror.
2. Move the control in the direction you wish to tilt the mirror.
3. Return to the center position to lock mirrors in place.

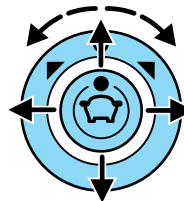

### Blind spot mirrors

Your vehicle is equipped with blind spot mirrors. Refer to *Blind spot mirrors* in the *Driving* chapter.

## Driver Controls

### Heated outside mirrors (if equipped)

Both mirrors are heated automatically to remove ice, mist and fog when the rear window defrost is activated.

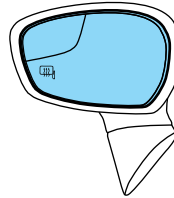

**Do not remove ice from the mirrors with a scraper or attempt to readjust the mirror glass if it is frozen in place.**

**These actions could cause damage to the glass and mirrors.**

**Do not clean the housing or glass of any mirror with harsh abrasives, fuel or other petroleum-based cleaning products.**

### Signal indicator mirrors (if equipped)

When the turn signal is activated, the outer portion of the appropriate mirror housing will blink.

This provides an additional warning to other drivers that your vehicle is about to turn.

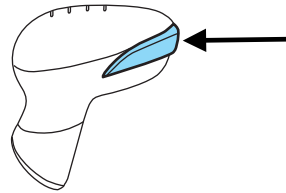

### SPEED CONTROL (IF EQUIPPED)

With speed control set, you can maintain a set speed without keeping your foot on the accelerator pedal.



**WARNING:** Do not use the speed control in heavy traffic or on roads that are winding, slippery or unpaved.

## Driver Controls

### Using speed controls

The speed controls are located on the steering wheel. The following buttons work with speed control:

**SET+:** Press to set a speed or to increase a set speed.

**CAN (Cancel)/RES (Resume):** Press to cancel or resume a set speed.

**SET-:** Press to decrease a set speed.

**OFF:** Press to turn speed control off.

**ON:** Press to turn speed control on.



### Setting speed control

To set speed control:

4. Press and release ON.
5. Accelerate to the desired speed.
6. Press and release SET+.
7. Take your foot off the accelerator pedal.
8. The indicator  light on the instrument cluster will turn on.

### Note:

- Vehicle speed may vary momentarily when driving up and down a steep hill.
- If the vehicle speed increases above the set speed on a downhill, you may want to apply the brakes to reduce the speed.
- If the vehicle speed decreases more than 10 mph (16 km/h) below your set speed on an uphill, your speed control will disengage.

### Disengaging speed control

To disengage speed control, tap the brake pedal or clutch pedal (if equipped) or press CAN.

Disengaging the speed control will not erase the previous set speed.

**Note:** When you use the clutch pedal to disengage the speed control, the engine speed may briefly increase, this is normal.

### Resuming a set speed

Press and release RES. This will automatically return the vehicle to the previously set speed.

128



## Driver Controls

### **Increasing speed while using speed control**

To increase the set speed:

- Press and hold SET+ until you get to the desired speed, then release. You can also use SET+ to operate the tap-up function. Press and release SET+ to increase the vehicle set speed in 1 mph (1.6 km/h) increments.
- Use the accelerator pedal to get to the desired speed then press and release SET+.

### **Reducing speed while using speed control**

To reduce the set speed:

- Press and hold SET- until you get to the desired speed, then release. You can also use SET- to operate the tap-down function. Press and release SET- to decrease the vehicle set speed in 1 mph (1.6 km/h) increments.
- Press the brake pedal or the clutch pedal (if equipped) until the desired vehicle speed is reached then press SET+.



### **Turning off speed control**

To turn off the speed control, press OFF or turn off the ignition.



**Note:** When you turn off the speed control or the ignition, your speed control set speed memory is erased.

## **STEERING WHEEL CONTROLS (IF EQUIPPED)**

### **SYNC® system hands free control feature**

Press  (located on the multi-function lever) briefly to use the voice command feature. You will hear a tone and LISTENING will appear in the radio display. Press and hold  to exit voice command.



Press  to activate phone mode or answer a phone call. Press and hold  to end a call or exit phone mode.

Press  to scroll through various menus and selections. Press OK to confirm your selection.

When SYNC® is not in use, press and release  to select the previous or next radio station preset, CD track or satellite preset (if equipped). Press and hold to move forward or backward to a desired frequency.

## Driver Controls

**M (Mode):** Press repeatedly to scroll through available audio modes. For further information on the SYNC® system, refer to the SYNC® supplement.

### MOON ROOF (IF EQUIPPED)

The moon roof control is located on the overhead console.



**WARNING:** Do not let children play with the moon roof or leave children unattended in the vehicle. They may seriously hurt themselves.



**WARNING:** When closing the moon roof, you should verify that it is free of obstructions and ensure that children and/or pets are not in the proximity of the moon roof opening.

**To open the moon roof:** Press and release the rear of the SLIDE control and the glass will open automatically. If the sliding shade is closed, it will open along with the moon roof.

**To close the moon roof:** Press and hold the front of the SLIDE control.

**To vent the moon roof:** Press and hold the rear of the TILT control. Press and hold the front of the TILT control to close the moon roof.

The moon roof has a built-in sliding shade that can be manually opened or closed when the glass panel is shut.

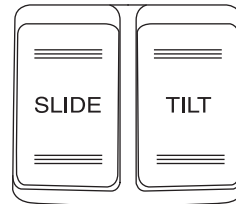

## Driver Controls

### POSITIVE RETENTION FLOOR MAT

 **WARNING:** Do not install additional floor mats on top of the factory installed floor mats as they may interfere with the accelerator or the brake pedals.

Position the floor mat so that the eyelets are over the retention posts and press down to lock in. Make sure that the mat does not interfere with the operation of the accelerator or the brake pedal. To remove the floor mat, reverse the installation procedure.

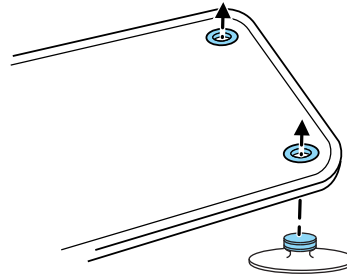

## Locks and Security

### KEYS

#### Integrated keyhead transmitters (IKTs) (If equipped)

Your vehicle may be equipped with two integrated keyhead transmitters (IKTs). The key blade starts the vehicle and unlocks/locks all the doors. The transmitter portion functions as the remote entry transmitter.

Your IKTs are programmed to your vehicle; using a non-programmed key will not permit your vehicle to start. If you lose one or both of your IKTs, replacements are available through your authorized dealer. Standard SecuriLock® keys without remote entry transmitter functionality can also be purchased from your authorized dealer if desired.

Always carry a spare key with you in case of an emergency.

For more information regarding programming replacement IKTs, refer to the *SecuriLock® passive anti-theft system* section later in this chapter.

**Note:** Your vehicle's IKTs were issued with a security tag that provides important vehicle key cut information. It is recommended that you keep the tag in a safe place for future reference.

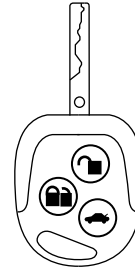

#### Intelligent Access Key (IA key) (if equipped)

Your vehicle may be equipped with two intelligent access keys which operate the power locks and the remote entry system. You have to have the IA key in the vehicle to activate the push button start system.



## Locks and Security

The IA key also contains a removable mechanical key blade that can be used to unlock the driver door. To release the mechanical key blade, press the release buttons on the edge of the transmitter and remove the key blade.

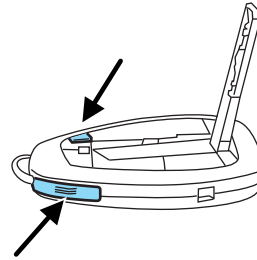

Your IA keys are programmed to your vehicle. You cannot enter or start your vehicle with an unprogrammed key. If you lose one or both of your IA keys, replacements are available from your authorized dealer. For more information on programming replacement IA keys, refer to the *SecuriLock® passive anti-theft system* section in this chapter.

**Note:** Your vehicle's IA backup keys were issued with a security tag that provides important vehicle key cut information. It is recommended that you keep the tag in a safe place for future reference.



### POWER DOOR LOCKS

The power door lock control is located on the instrument panel near the radio.



Press the control to lock/unlock the doors. When the light on the button is on it indicates that all doors and the trunk are locked. When the light is off it indicates one or more doors are unlocked.

### Rear door unlocking/opening

Pull the interior door release handle twice to unlock/open the rear door. The first pull unlocks the door and the second pull will unlatch the door.

### Smart locks

This feature helps to prevent you from locking yourself out of the vehicle.

If the interior power door lock control is pressed while the driver or front passenger door is open with the key in the ignition, all door locks will lock, and then unlock.

## Locks and Security

If both front doors are closed, the vehicle can be locked by any method, regardless of whether the key is in the ignition or not.

### Smart locks for intelligent access keys (IA key) (if equipped)

This feature is intended to prevent you from unintentionally locking your IA key inside your vehicle.

If your vehicle's perimeter alarm is in the armed state, the smart locks feature will not allow you to lock your IA key inside the vehicle. When the alarm is armed, if the IA key is detected in the vehicle, the vehicle will automatically unlock. The exterior lights will flash and the horn will chirp twice to indicate the IA key is inside. If your IA key is detected in the trunk (if equipped), the trunk lid will reopen though there will be no feedback from the horn or lights.

### Central locking/unlocking

To centrally lock/unlock all doors (from the driver's side only) using the key from the outside when they are closed:

- Turn the key counterclockwise to lock all doors. The turn signal lamps will flash twice.
- Turn the key clockwise once to unlock the driver's door or twice to unlock all doors. The turn signal lamps will flash once.

If the central locking function fails to operate, the doors can be individually locked using the key in the position shown.

On the driver's side, turn the key clockwise to lock, and on the passenger's side turn the key counterclockwise to lock.

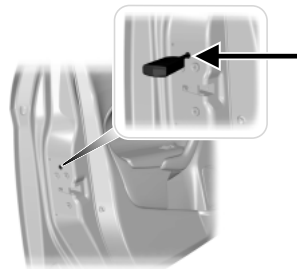

### Delayed Locking

If you try to electrically lock the doors while they are open, they will not lock until the doors are closed. This feature only works when smart locks are not active. See *Smart locks* in this section for more information

### Autolock (if equipped)

The autolock feature will lock all the doors when:

- all doors are closed,

134

## Locks and Security

- the ignition is on,
- you shift into any gear putting the vehicle in motion, and
- the vehicle attains a speed greater than 12 mph (20 km/h).

If a door(s) is unlocked, the autolock feature will repeat when:

- the vehicle slows below 12 mph (20 km/h) and then attains a speed greater than 12 mph (20 km/h).

### **Autounlock (if equipped)**

If the doors have been autolocked, the doors will autounlock only when:

- the ignition is turned off or to accessory,
- the driver door is opened within 10 minutes of the ignition being switched from on to off or accessory.

**Note:** If you use the power door lock button to lock the doors before an autolock event, the doors **will not** autounlock.

### **Deactivating/activating autolock/autounlock**

**Note:** When programming the autolock feature, carry out the following steps within 30 seconds or the procedure needs to be repeated. If the procedure needs to be repeated, wait 30 seconds between programming sessions.

1. Turn the ignition on.
2. Press the power door lock control three times.
3. Turn the ignition off.
4. Press the power door lock control three times.
5. Turn the ignition on. The module is now in programming mode.

**Note:** A chime sounds as acknowledgement that the programming mode has been entered. The safety belt must be engaged otherwise the Belt-Minder® chime will take priority over other chimes.

6. Once in programming mode, the autolock or autounlock feature can be programmed independently of each other.
  - To program the autolock feature, press the power door lock control for **greater than 2 seconds** and release. Each long press of the power door lock control toggles the state of the autolocking feature between enabled and disabled. A chime sounds when the feature is enabled or disabled.

## Locks and Security

- To program the autounlock feature, press the power door lock control for **less than 1 second** and release. Each short press of the power door lock control toggles the state of the autounlocking feature between enabled and disabled. A chime sounds when the feature is enabled or disabled.
7. Turn the ignition off to exit programming. If a setting was toggled, a chime will be heard.

### CHILDPROOF DOOR LOCKS

- When these locks are set, the rear doors cannot be opened from the inside.
- The rear doors can be opened from the outside when the childproof door locks are set, but the doors are unlocked.



The childproof locks are located on the rear edge of each rear door and must be set separately for each

door. Setting the lock for one door will not automatically set the lock for both doors.

- On the driver side, turn counterclockwise to lock and clockwise to unlock.
- On the passenger side, turn clockwise to lock and counterclockwise to unlock.

### INTERIOR LUGGAGE COMPARTMENT RELEASE (4-DOOR ONLY)

Your vehicle is equipped with a mechanical interior luggage compartment release handle that provides a means of escape for children and adults in the event they become locked inside the luggage compartment.

Adults are advised to familiarize themselves with the operation and location of the release handle.



## Locks and Security

To open the luggage compartment door (lid) from within the luggage compartment, pull the illuminated “T” shaped handle and push up on the trunk lid. The handle is composed of a material that will glow for hours in darkness following brief exposure to ambient light.

The “T” shaped handle will be located either on the luggage compartment door (lid) or inside the luggage compartment near the tail lamps.

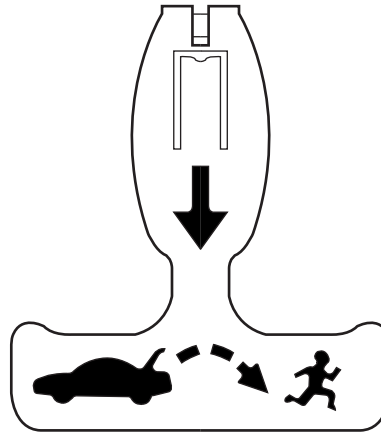

**WARNING:** Keep vehicle doors and luggage compartment locked and keep keys and remote transmitters out of a child's reach. Unsupervised children could lock themselves in the trunk and risk injury. Children should be taught not to play in vehicles.

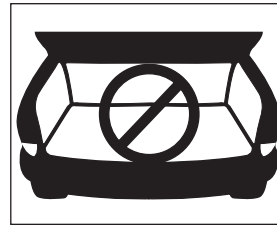

**WARNING:** Do not leave children, unreliable adults, or animals unattended in the vehicle. On hot days, the temperature in the trunk or vehicle interior can rise very quickly. Exposure of people or animals to these high temperatures for even a short time can cause death or serious heat-related injuries, including brain damage. Small children are particularly at risk.

### REMOTE ENTRY SYSTEM (IF EQUIPPED)

FCC ID: LXP-RX4318	IC: 2298A-RX4318
--------------------	------------------

## Locks and Security

The integrated keyhead transmitters (IKTs) and intelligent access keys (IA key) comply with part 15 of the FCC rules and with RSS-210 of Industry Canada. Operation is subject to the following two conditions: (1) This device may not cause harmful interference, and (2) This device must accept any interference received, including interference that may cause undesired operation.

**Changes or modifications not expressly approved by the party responsible for compliance could void the user's authority to operate the equipment.**

### Integrated keyhead transmitters

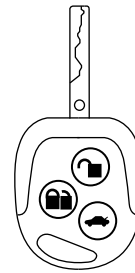

### Intelligent access key



The typical operating range for your transmitter is approximately 66 feet (20 meters). A decrease in operating range could be caused by:

- weather conditions,
- nearby radio towers,
- structures around the vehicle, or
- other vehicles parked next to your vehicle.

The transmitter allows you to:

- remotely unlock the vehicle doors.
- remotely lock all the vehicle doors.
- remotely open the trunk.

138

## Locks and Security

- arm and disarm the perimeter anti-theft system.
- operate the illuminated entry feature.

The remote entry lock/unlock feature operates in any ignition position except when the engine is running and vehicle speed is more than 4 mph (7 km/h).

If there are problems with the remote entry system, make sure to take **ALL integrated keyhead transmitters or intelligent access keys** with you to the authorized dealer in order to aid in troubleshooting the problem.

### Intelligent Access (if equipped)

Your vehicle will allow you to unlock and enter your vehicle without actively using a key or transmitter. You can use the intelligent access feature at the driver door, passenger front door or at the trunk. You can activate the intelligent access feature as long as you have one of your intelligent access keys within range of the driver door, passenger front door or the trunk.

**Activating intelligent access at the front doors:** If your IA key is within 3 feet (1 meter) of the driver's door or passenger front door, you can activate your intelligent access system by pressing the lock button.

To lock the doors, press the lock button.

To unlock the doors, press the lock button again.

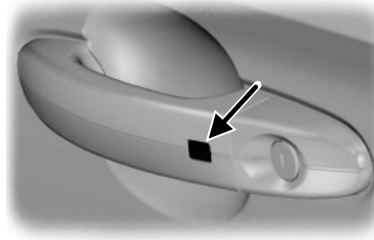

**Activating intelligent access at the trunk:** If your IA key is within 3 feet (1 meter) of the trunk, you can activate your intelligent access system by pressing the exterior trunk release button, located above the license plate. The trunk will release and open.

Refer to the *Remote entry system* in this section for more details on how to use the lock, unlock, panic or trunk buttons on the transmitter.

Your intelligent access system uses a radio frequency (RF) signal to communicate with your vehicle and authorize your vehicle to unlock when commanded (either by pressing any keyless entry keypad button, the trunk button, or a button on the transmitter itself). If excessive RF interference is present in the area, or if your vehicle battery is low, it



## Locks and Security

may be necessary to mechanically unlock your door. The mechanical key blade in your IA key can be used to open the driver's door in this situation (refer to *Intelligent access key* in this chapter for more information on the location and use of the mechanical key blade).

A mechanical key is needed for access if the IA key battery or vehicle battery is low.



**Push button start:** Your vehicle is equipped with a push button start system, which allows you to start your vehicle without using a key. To operate the push button start system and start your vehicle, your IA key must be present inside the vehicle, either in the passenger compartment or in the trunk. Refer to *Push button start system* in the *Driving* chapter.

### Unlocking the doors/two-stage unlock

1. Press  and release to unlock the driver's door. **Note:** The interior lamps will illuminate and the parking lamps will flash.
2. Press  and release again within three seconds to unlock all the doors.

### Two-stage unlock disable

Disabling two-stage unlock allows all vehicle doors to unlock simultaneously.

Two-stage unlocking may be disabled or re-enabled by simultaneously pressing the  and  controls on the transmitter for three seconds. The park lamps will illuminate twice to indicate that two-stage unlock was enabled or disabled.

### Locking the doors

- Press  and release to lock all the doors. If all doors are closed the turn signal lamps will flash twice.

### Opening the luggage compartment

Press  twice (within 3 seconds) to open the luggage compartment.

**Note:** This feature will not operate when the engine is running and vehicle speed is more than 4 mph (7 km/h).

- Ensure that the trunk is closed and latched before driving your vehicle. Failure to properly latch the trunk may cause objects to fall out or block the driver's rear view.

### Replacing the battery

The remote entry transmitter uses one coin type three-volt lithium battery CR2032 or equivalent.

140

## Locks and Security

To replace the battery:

### Integrated Keyhead Transmitter (IKT)

1. Carefully insert a flat object (e.g. a screwdriver) into the recess on the back of the key and remove the key blade.
2. Release the retaining clips with a flat object and separate the two halves of the transmitter.

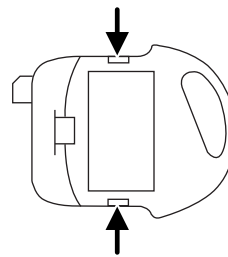
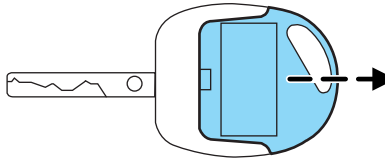

3. Carefully pry out the battery with a flat object. Be careful not to touch the battery contacts or the printed circuit board with the flat object.

**Note:** Please refer to local regulations when disposing of transmitter batteries.

4. Insert the new battery with the + facing upwards.
5. Snap the two halves of the transmitter back together.

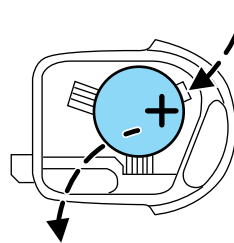

### Intelligent Access key (IA key)

1. Press and hold the push buttons on the edges of the transmitter to release the cover. Carefully remove the cover.
2. Remove the key blade.

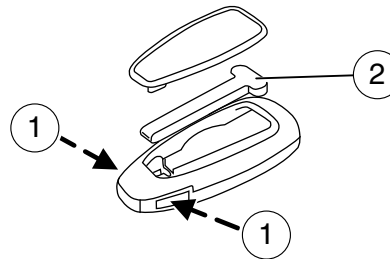

## Locks and Security

3. Twist a flat object in the position shown to separate the two halves of the transmitter.

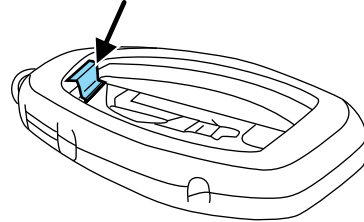

4. Carefully insert a flat object in the position shown to open the transmitter.

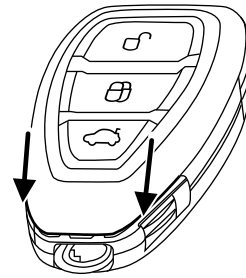

5. Carefully pry out the battery with a flat object.

**Note:** Please refer to local regulations when disposing of transmitter batteries.

6. Install a new battery with the + facing downwards.

7. Assemble the two halves of the transmitter back together.

8. Install the key blade.

### Replacing lost remote entry transmitters—integrated keyhead transmitters (IKTs)

If you would like to have your remote entry transmitter reprogrammed because you lost one, or would like to buy additional remote entry transmitters, you can either reprogram them yourself, or take **all remote entry transmitters** to your authorized dealer for reprogramming.

#### Tips:

- You must have two previously programmed coded keys (keys that already operate your vehicle's engine) and the new unprogrammed key(s) readily accessible.
- If two previously programmed coded keys are not available, you must take your vehicle to your authorized dealer to have the spare key(s) programmed.

142

## Locks and Security

Please read and understand the entire procedure before you begin.

### **To reprogram the remote entry transmitters:**

1. Insert the first programmed key into the ignition and turn the key from off to run (maintain the key in run for approximately 3 seconds).
2. Turn the first key to off and remove it from the ignition.
3. Within 10 seconds of turning the key to off, insert a second programmed key into the ignition and turn the key from off to run (maintain the key in run for approximately 3 seconds).
4. Turn the second key to off and remove it from the ignition.
5. Within 10 seconds of turning the second key to off, insert the new, unprogrammed key into the ignition and turn the key from off to run (maintain the key in run for approximately 3 seconds).

If you would like to program additional key(s) (up to a total of 8 keys can be programmed), repeat Steps 1-5 for each additional key.

6. The Securilock® passive anti-theft system portion of the key is now programmed. To program the remote keyless entry functions of the key follow Steps 1-3 below.

**Note:** When programming remote keyless entry functions, you will delete previous programming of all current keys so you must program all the keys you need every time you do the process.

1. Turn the ignition switch from off to run four times in rapid succession (within six seconds), with the fourth turn ending in off. If the program mode is successfully entered, a chime will sound.

**Note:** If no action is taken within 10 seconds after a transmitter has been programmed, the programming sequence ends.

2. Within 10 seconds, press any button on the transmitter to be programmed. A chime will sound to confirm that the transmitter is programmed. Repeat this step for each transmitter.

**Note:** There is NO chime or any other confirmation upon exiting the programming mode.

3. Exiting the programming mode is accomplished if one of the following occurs:

- The ignition is turned to run.
- Ten seconds have passed since entering programming mode or since the last transmitter was programmed.
- The maximum number (eight) of transmitters has been programmed.

### **Programming spare Intelligent Access Keys (IA keys)**

You cannot program spare keys for your IA keys. If you would like to program spare key transmitters, take **all transmitters** to your authorized dealer for reprogramming.

143

## Locks and Security

### Illuminated entry

The interior lamps illuminate for 25 seconds when:

- the vehicle is unlocked by any method other than the interior power door lock control.
- a door has been opened or closed.

The lamps will turn off:

- if the ignition is turned on.
- if the vehicle is locked by any method other than the interior power door lock control.
- after 25 seconds of illumination.

### Illuminated exit

The interior lamps and parking lamps will illuminate for 25 seconds when:

- the ignition is turned off.
- an IKT is removed from, or reinserted into, the ignition.
- after 25 seconds of illumination.

The lamps will turn off:

- if the ignition is turned off.
- if the vehicle is locked by any method other than the power door lock control.
- after 25 seconds of illumination.

### SECURILOCK® PASSIVE ANTI-THEFT SYSTEM

SecuriLock® passive anti-theft system is an engine immobilization system. This system is designed to help prevent the engine from being started unless a **coded key programmed to your vehicle** is used. The use of the wrong type of coded key may lead to a “no-start” condition.

Your vehicle comes with two coded keys; additional coded keys may be purchased from and programmed by your authorized dealer.

**Note:** The SecuriLock® passive anti-theft system is not compatible with non-Ford aftermarket remote start systems. Use of these systems may result in vehicle starting problems and a loss of security protection.

**Note:** Large metallic objects, electronic devices that are used to purchase gasoline or similar items, or a second coded key on the same key chain may cause vehicle starting issues. You need to prevent these

144



## Locks and Security

objects from touching the coded key while starting the engine. These objects will not cause damage to the coded key, but may cause a momentary issue if they are too close to the key when starting the engine. If a problem occurs, turn the ignition off, remove all objects on the key chain away from the coded key and restart the engine.

**Note: Do not leave a duplicate coded key in the vehicle. Always take your keys and lock all doors when leaving the vehicle.**

### Anti-theft indicator

The anti-theft indicator is located in the instrument cluster.

- When the ignition is off, the indicator will flash once every two seconds to indicate the SecuriLock® system is functioning as a theft deterrent.
- When the ignition is on, the indicator will glow for three seconds, then turn off, to indicate normal system functionality.



If a problem occurs with the SecuriLock® system, the indicator will flash rapidly or glow steadily when the ignition is in the on position. If this occurs, turn the ignition off then back on to make sure there was no electronic interference with the programmed key. If the vehicle doesn't start, try to start it with the 2nd programmed key and if successful contact your authorized dealership for key replacement. If the indicator still flashes rapidly or glows steadily, and the vehicle will not start, contact your authorized dealer as soon as possible for service.

### Automatic arming

The vehicle is armed immediately after switching the ignition to the off position.

### Automatic disarming

Switching the ignition to the on position with a **coded key** disarms the vehicle.

### Replacement keys

If your keys are lost or stolen and you don't have an extra coded key, you will need to have your vehicle towed to an authorized dealer. The key codes need to be erased from your vehicle and new coded keys will need to be programmed.

## Locks and Security

Replacing coded keys can be very costly. Store an extra programmed key away from the vehicle in a safe place to help prevent any inconveniences. Please visit an authorized dealer to purchase additional spare or replacement keys.

### PERIMETER ALARM SYSTEM (IF EQUIPPED)

The perimeter anti-theft system will warn you in the event of an unauthorized entry to your vehicle.

If there is any potential perimeter anti-theft problem with your vehicle, ensure **ALL remote entry transmitters** are taken to the authorized dealer to aid in troubleshooting.

#### Arming the system

When armed, this system will respond if unauthorized entry is attempted. When unauthorized entry occurs, the system will flash the park/turn lamps and will sound the horn.

The system is ready to arm whenever the key is removed from the ignition. Either of the following actions will prearm the alarm system:

- Press the lock control on the remote entry transmitter.
- Open a door and press the power door lock control to lock all the doors, and then close the door.

#### Disarming the system

You can disarm the system by any of the following actions:

- Unlock the doors by pressing the  control on your remote entry transmitter.
- Unlock the doors with a key. Turn the key full travel (toward the front of the vehicle) to ensure the alarm disarms.
- Turn the ignition to the on or start position with a programmed coded ignition key.

Pressing the power door unlock control within the 20 second pre-armed mode will return the vehicle to a disarmed state.

#### Triggering the anti-theft system

The armed system will be triggered if any door, trunk or the hood is opened without using the key or the remote entry transmitter.

## Seating and Safety Restraints

### FRONT SEATS

**!** **WARNING:** Reclining the seatback can cause an occupant to slide under the seat's safety belt, resulting in severe personal injuries in the event of a collision.

**!** **WARNING:** Do not pile cargo higher than the seatbacks to reduce the risk of injury in a collision or sudden stop.

**!** **WARNING:** Before returning the seatback to its original position, make sure that cargo or any objects are not trapped behind the seatback. After returning the seatback to its original position, pull on the seatback to ensure that it has fully latched. An unlatched seat may become dangerous in the event of a sudden stop or collision.

### Adjustable head restraints

Your vehicle is equipped with front row outboard head restraints that are vertically adjustable.

**!** **WARNING:** To minimize the risk of neck injury in the event of a crash, the driver and passenger occupants should not sit in and/or operate the vehicle, until the head restraint is placed in its proper position. The driver should never adjust the head restraint while the vehicle is in motion.

The adjustable head restraints consist of :

- a trimmed energy absorbing foam and structure (1),
- two steel stems (2),
- a guide sleeve adjust release button (3),
- and a guide sleeve unlock/remove button (4).

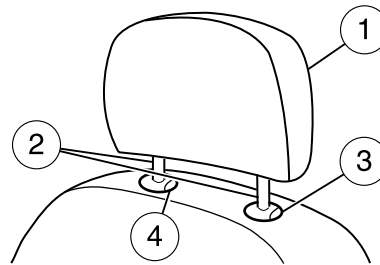

To adjust the head restraint, do the following:

1. Adjust the seatback to an upright driving/riding position.
2. Raise the head restraint by pulling up on the head restraint (1).

147

## Seating and Safety Restraints

3. Lower the head restraint by pressing and holding the guide sleeve adjust release button (3) and pushing down on the head restraint (1).

Properly adjust the head restraint so that the top of the head restraint is even with the top of your head and positioned as close as possible to the back of your head. For occupants of extremely tall stature, adjust the head restraint to its full up position.



**WARNING:** The adjustable head restraint is a safety device. Whenever possible it should be installed and properly adjusted when the seat is occupied.

To remove the adjustable head restraint, do the following:

1. Pull up the head restraint until it reaches the highest adjustment position.
2. Simultaneously press and hold both the adjust/release button (3) and the unlock/remove button (4), then pull up on the head restraint.

To reinstall the adjustable head restraint, do the following:

1. Insert the two stems into the guide sleeve collars.
2. Push the head restraint down until it locks.

Properly adjust the head restraint so that the top of the head restraint is even with the top of your head and positioned as close as possible to the back of your head. For occupants of extremely tall stature, adjust the head restraint to its full up position.



**WARNING:** To minimize the risk of neck injury in the event of a crash, head restraints must be installed properly.

## Adjusting the front manual seat



**WARNING:** Sitting improperly out of position or with the seat back reclined too far can take off weight from the seat cushion and affect the decision of the passenger sensing system, resulting in serious injury or death in a crash. Always sit upright against your seatback, with your feet on the floor.

## Seating and Safety Restraints

 **WARNING:** To reduce the risk of possible serious injury: Do not hang objects off seat back or stow objects in map pocket (if equipped) when a child is in the front passenger seat. Do not place objects underneath the front passenger seat or between the seat and the center console (if equipped). Check the “passenger airbag off” or “pass airbag off” indicator lamp for proper airbag status. Refer to *Front passenger sensing system* chapter for additional details. Failure to follow these instructions may interfere with the front passenger seat sensing system.

- Fore-aft adjustment

Pull the lever located under the front edge of the seat to move the seat forward or backward.

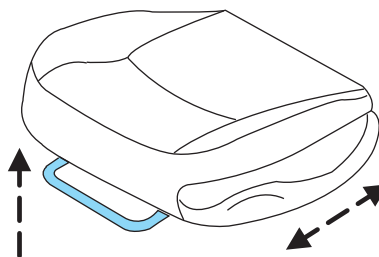

- Up-down seat adjustment (driver side only)

Pull up on the control to raise the seat and push down on the control to lower the seat.

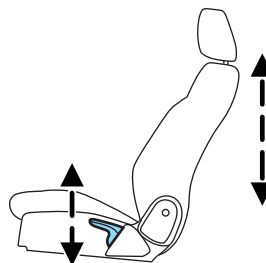

## Seating and Safety Restraints

- Recline adjustment

Lift the control to adjust the angle of the seatback.

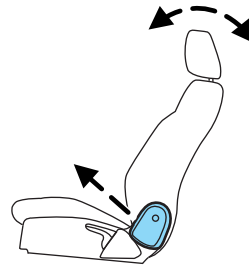

**WARNING:** Reclining the seatback can cause an occupant to slide under the seat's safety belt, resulting in severe personal injuries in the event of a collision.

### Heated seats (if equipped)

**WARNING:** Persons who are unable to feel pain to the skin because of advanced age, chronic illness, diabetes, spinal cord injury, medication, alcohol use, exhaustion, or other physical conditions, must exercise care when using the seat heater. The seat heater may cause burns even at low temperatures, especially if used for long periods of time. Do not place anything on the seat that insulates against heat, such as a blanket or cushion, because this may cause the seat heater to overheat. Do not puncture the seat with pins, needles, or other pointed objects because this may damage the heating element which may cause the seat heater to overheat. An overheated seat may cause serious personal injury.

**Note:** Do not do the following:

- Place heavy objects on the seat
- Operate the seat heater if water or any other liquid is spilled on the seat. Allow the seat to dry thoroughly.

## Seating and Safety Restraints

To operate the heated seats:

- Press the button located on the instrument panel to activate.
- Press again to deactivate.



The heated seats will activate when the ignition is in the on position and the engine is running.

### REAR SEATS

#### Second row head restraints

Your vehicle is equipped with rear seat outboard and center head restraints that look differently than the front head restraints, but function similarly.



**WARNING:** To minimize the risk of neck injury in the event of a crash, the driver and passenger occupants should not sit in and/or operate the vehicle, until the head restraint is placed in its proper position. The driver should never adjust the head restraint while the vehicle is in motion.

For details about how to raise, lower and remove the second row head restraints, refer to *Adjustable head restraints* at the beginning of this chapter.

#### Folding down the rear seat

One or both rear seatbacks can be folded down to provide additional cargo space.

**Note:** Before lowering the seatbacks, lower, or remove, the outboard head restraints to the lowest position.

## Seating and Safety Restraints

To lower the seatback(s) from inside the vehicle, do the following:

1. Press the unlock buttons (1) down and hold them there.
2. Push the seatback forward.

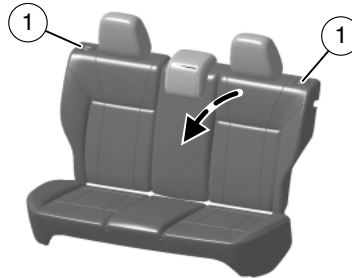

3. Stow the safety belt in the belt stowage clip. This will prevent the safety belt from getting caught in the seat latch.

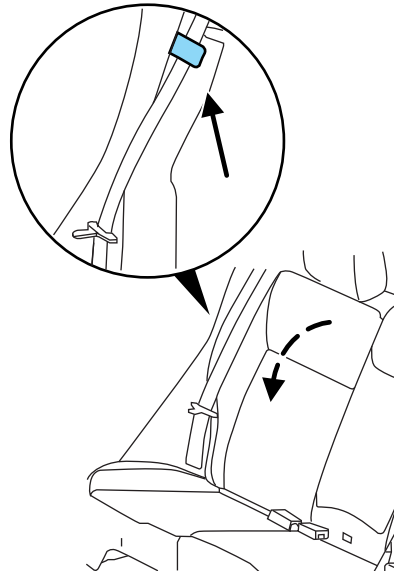

When raising the seatback(s), make sure you hear the seat latch into place.



## Seating and Safety Restraints



**WARNING:** Before returning the seatback to its original position, make sure that cargo or any objects are not trapped behind the seatback. Make sure that the safety belt is not laying on the seat latch. After returning the seatback to its original position, pull on the seatback to ensure that it has fully latched. An unlatched seat may become dangerous in the event of a sudden stop or collision.

### SAFETY RESTRAINTS

#### Personal Safety System™

The Personal Safety System provides an improved overall level of frontal crash protection to front seat occupants and is designed to help further reduce the risk of airbag-related injuries. The system is able to analyze different occupant conditions and crash severity before activating the appropriate safety devices to help better protect a range of occupants in a variety of frontal crash situations.

Your vehicle's Personal Safety System consists of:

- Driver and passenger dual-stage airbag supplemental restraints.
- Front safety belts with pretensioners, energy management retractors, and safety belt usage sensors.
- Driver's seat position sensor.
- Front crash severity sensor.
- Front passenger sensing system.
- "Passenger airbag off" or "pass airbag off" indicator lamp.
- Restraints Control Module (RCM) with impact and safing sensors.
- Restraint system warning light and back-up tone.
- The electrical wiring for the airbags, crash sensor(s), safety belt pretensioners, front safety belt usage sensors, driver seat position sensor, and indicator lights.

#### ***How does the Personal Safety System work?***

The Personal Safety System can adapt the deployment strategy of your vehicle's safety devices according to crash severity and conditions. A collection of crash sensors provides information to the Restraints Control Module (RCM). During a crash, the RCM may activate the safety belt pretensioners and/or either none, one, or both stages of the dual-stage airbag supplemental restraints based on crash severity and conditions.

153

## Seating and Safety Restraints

The fact that the pretensioners or airbags did not activate for both front seat occupants in a collision does not mean that something is wrong with the system. Rather, it means the Personal Safety System determined the accident conditions (crash severity, belt usage, etc.) were not appropriate to activate these safety devices. Front airbags are designed to activate only in frontal and near-frontal collisions, not rollovers, side-impacts, or rear-impacts unless the collision causes sufficient longitudinal deceleration.

### ***Driver and passenger dual-stage airbag supplemental restraints***

The dual-stage airbags offer the capability to tailor the level of airbag inflation energy. A lower, less forceful energy level is provided for more common, moderate-severity impacts. A higher energy level is used for the most severe impacts. Refer to *Airbag supplemental restraints (SRS)* section in this chapter.

### ***Front crash severity sensor***

The front crash severity sensor enhances the ability to detect the severity of an impact. Positioned up front, it provides valuable information early in the crash event on the severity of the impact. This allows your Personal Safety System to distinguish between different levels of crash severity and modify the deployment strategy of the dual-stage airbags and safety belt pretensioners.

### ***Driver's seat position sensor***

The driver's seat position sensor allows your Personal Safety System to tailor the deployment level of the driver dual-stage airbag based on seat position. The system is designed to help protect smaller drivers sitting close to the driver airbag by providing a lower airbag output level.

### ***Front passenger sensing system***

For airbags to do their job they must inflate with great force, and this force can pose a potentially deadly risk to occupants that are very close to the airbag when it begins to inflate. For some occupants, like infants in rear-facing child seats, this occurs because they are initially sitting very close to the airbag. For other occupants, this occurs when the occupant is not properly restrained by safety belts or child safety seats and they move forward during pre-crash braking. The most effective way to reduce the risk of unnecessary injuries is to make sure all occupants are properly restrained. Accident statistics suggest that children are much safer when properly restrained in the rear seating positions than in the front.

154

## Seating and Safety Restraints



**WARNING:** Air bags can kill or injure a child in a child seat. **NEVER** place a rear-facing child seat in front of an active air bag. If you must use a forward-facing child seat in the front seat, move the seat all the way back.



**WARNING:** Always transport children 12 years old and under in a rear seating position and always properly use appropriate child restraints.

The front passenger sensing system can automatically turn off the passenger front airbag. The system is designed to help protect small (child size) occupants from airbag deployments when they are improperly seated or restrained in the front passenger seat contrary to proper child-seating or restraint usage recommendations. Even with this technology, parents are **STRONGLY** encouraged to always properly restrain children in the rear seat. The sensor also turns off the airbag when the passenger seat is empty to prevent unnecessary replacement of the airbag(s) after a collision.

When the front passenger seat is occupied and the sensing system has turned off the passenger's frontal airbag, the "pass airbag off" indicator will light and stay lit to remind you that the front passenger frontal airbag is off. See *Front passenger sensing system* in the *Airbag supplemental restraints (SRS)* section of this chapter.

### **Front safety belt usage sensors**

The front safety belt usage sensors detect whether or not the driver and front outboard passenger safety belts are fastened. This information allows your Personal Safety System to tailor the airbag deployment and safety belt pretensioner activation depending upon safety belt usage.

### **Front outboard safety belt pretensioners**

The safety belt pretensioners at the front outboard seating positions are designed to tighten the safety belts firmly against the occupant's body during frontal collisions, and in side collisions when the side air curtain system activates. This helps increase the effectiveness of the safety belts. In frontal collisions, the safety belt pretensioners can be activated alone or, if the collision is of sufficient severity, together with the front airbags.

## Seating and Safety Restraints

### **Front outboard safety belt energy management retractors**

The front safety belt energy management retractors allow webbing to be pulled out of the retractor in a gradual and controlled manner in response to the occupant's forward momentum. This helps reduce the risk of force-related injuries to the occupant's chest by limiting the load on the occupant.

### **Determining if the Personal Safety System is operational**

The Personal Safety System uses a warning light in the instrument cluster or a backup tone to indicate the condition of the system. Refer to the *Warning lights and chimes* section in the *Instrument Cluster* chapter. Routine maintenance of the Personal Safety System is not required.

The Restraints Control Module (RCM) monitors its own internal circuits and the circuits for the airbag supplemental restraints, crash sensor(s), safety belt pretensioners, front safety belt buckle sensors, front passenger sensing system, and the driver seat position sensor. In addition, the RCM also monitors the restraints warning light in the instrument cluster. A difficulty with the system is indicated by one or more of the following.

- The warning light will either flash or stay lit.
- The warning light will not illuminate immediately after ignition is turned on.
- A series of five beeps will be heard. The tone pattern will repeat periodically until the problem and warning light are repaired.

If any of these things happen, even intermittently, have the Personal Safety System serviced at an authorized dealer immediately. Unless serviced, the system may not function properly in the event of a collision.

### **Safety restraints precautions**





**WARNING:** Always drive and ride with your seatback upright and the lap belt snug and low across the hips.





**WARNING:** To reduce the risk of injury, make sure children sit where they can be properly restrained.

## Seating and Safety Restraints

 **WARNING:** Never let a passenger hold a child on his or her lap while the vehicle is moving. The passenger cannot protect the child from injury in a collision.

 **WARNING:** All occupants of the vehicle, including the driver, should always properly wear their safety belts, even when an air bag supplemental restraint system (SRS) is provided.

 **WARNING:** It is extremely dangerous to ride in a cargo area, inside or outside of a vehicle. In a collision, people riding in these areas are more likely to be seriously injured or killed. Do not allow people to ride in any area of your vehicle that is not equipped with seats and safety belts. Be sure everyone in your vehicle is in a seat and using a safety belt properly.

 **WARNING:** In a rollover crash, an unbelted person is significantly more likely to die than a person wearing a seat belt.

 **WARNING:** Each seating position in your vehicle has a specific safety belt assembly which is made up of one buckle and one tongue that are designed to be used as a pair. 1) Use the shoulder belt on the outside shoulder only. Never wear the shoulder belt under the arm. 2) Never swing the safety belt around your neck over the inside shoulder. 3) Never use a single belt for more than one person.

 **WARNING:** When possible, all children 12 years old and under should be properly restrained in a rear seating position.

 **WARNING:** Safety belts and seats can become hot in a vehicle that has been closed up in sunny weather; they could burn a small child. Check seat covers and buckles before you place a child anywhere near them.

 **WARNING:** Front and rear seat occupants, including pregnant women, should wear safety belts for optimum protection in an accident.

## Seating and Safety Restraints

### Combination lap and shoulder belts

The front outboard and rear safety restraints in the vehicle are combination lap and shoulder belts.

1. Insert the belt tongue into the proper buckle (the buckle closest to the direction the tongue is coming from) until you hear a snap and feel it latch. Make sure the tongue is securely fastened in the buckle.

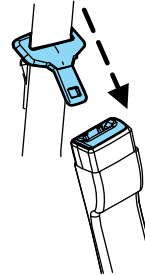

2. To unfasten, press the release button and remove the tongue from the buckle.

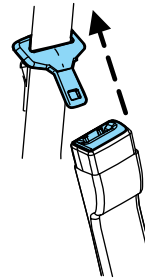

### Restraint of pregnant women



**WARNING:** Always ride and drive with your seatback upright and the safety belt properly fastened. The lap portion of the safety belt should fit snug and be positioned low across the hips. The shoulder portion of the safety belt should be positioned across the chest. Pregnant women should also follow this practice. See figure below.

## Seating and Safety Restraints

Pregnant women should always wear their safety belt. The lap belt portion of a combination lap and shoulder belt should be positioned low across the hips below the belly and worn as tight as comfort will allow. The shoulder belt should be positioned to cross the middle of the shoulder and the center of the chest.



### Safety Belt Locking Modes

All safety restraints in the vehicle are combination lap and shoulder belts. The driver safety belt has the first locking mode and the front outboard passenger and rear seat safety belts have both types of locking modes described as follows:

#### Vehicle sensitive mode

This is the normal retractor mode, which allows free shoulder belt length adjustment to your movements and locking in response to vehicle movement. For example, if the driver brakes suddenly or turns a corner sharply, or the vehicle receives an impact of approximately 5 mph (8 km/h) or more, the combination safety belts will lock to help reduce forward movement of the driver and passengers.

In addition, the retractor is designed to lock if the webbing is pulled out too quickly. If this occurs, let the belt retract slightly and pull webbing out again in a slow and controlled manner.

#### Automatic locking mode

In this mode, the shoulder belt is automatically pre-locked. The belt will still retract to remove any slack in the shoulder belt. The automatic locking mode is not available on the driver safety belt.

#### When to use the automatic locking mode

This mode should be used **any time** a child safety seat, except a booster, is installed in passenger front or rear seating positions. Children 12 years old and under should be properly restrained in a rear seating position whenever possible. Refer to *Safety restraints for children* or *Safety seats for children* later in this chapter.

## Seating and Safety Restraints

### *How to use the automatic locking mode*

1. Buckle the combination lap and shoulder belt.
2. Grasp the shoulder portion and pull downward until the entire belt is pulled out.

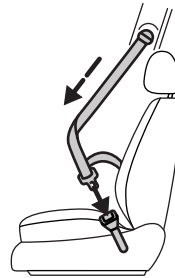

- Allow the belt to retract. As the belt retracts, you will hear a clicking sound. This indicates the safety belt is now in the automatic locking mode.

### **How to disengage the automatic locking mode**

Disconnect the combination lap/shoulder belt and allow it to retract completely to disengage the automatic locking mode and activate the vehicle sensitive (emergency) locking mode.



**WARNING:** After any vehicle collision, the safety belt system at all passenger seating positions must be checked by an authorized dealer to verify that the “automatic locking retractor” feature for child seats is still functioning properly. In addition, all safety belts should be checked for proper function.



**WARNING:** BELT AND RETRACTOR ASSEMBLY MUST BE REPLACED if the safety belt assembly “automatic locking retractor” feature or any other safety belt function is not operating properly when checked by an authorized dealer. Failure to replace the belt and retractor assembly could increase the risk of injury in collisions.

### **Safety belt extension assembly**

If the safety belt is too short when fully extended, there is an 8 inch (20 cm) safety belt extension assembly that can be added (part number 611C22). This assembly can be obtained from an authorized dealer.



## Seating and Safety Restraints

Use only extensions manufactured by the same supplier as the safety belt. Manufacturer identification is located at the end of the webbing on the label. Also, use the safety belt extension only if the safety belt is too short for you when fully extended.



**WARNING:** Do not use extensions to change the fit of the shoulder belt across the torso.

### Safety belt height adjustment

Your vehicle has safety belt height adjustments at the front outboard seating positions. Adjust the height of the shoulder belt so the belt rests across the middle of your shoulder.

To adjust the shoulder belt height, pull the button and slide the height adjuster down. Release the button and pull down on the height adjuster to make sure it is locked in

place. To adjust the belt upward, slide the adjuster up. Pull down on the height adjuster to make sure it is locked in place.

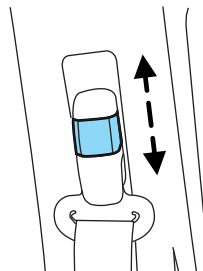

**WARNING:** Position the safety belt height adjusters so that the belt rests across the middle of your shoulder. Failure to adjust the safety belt properly could reduce the effectiveness of the safety belt and increase the risk of injury in a collision.

### Safety belt warning light and indicator chime

The safety belt warning light illuminates in the instrument cluster and a chime sounds to remind the occupants to fasten their safety belts.

## Seating and Safety Restraints

### Conditions of operation

If...	Then...
The driver's safety belt is not buckled before the ignition switch is turned to the on position...	The safety belt warning light illuminates 1-2 minutes and the warning chime sounds 4-8 seconds.
The driver's safety belt is buckled while the indicator light is illuminated and the warning chime is sounding...	The safety belt warning light and warning chime turn off.
The driver's safety belt is buckled before the ignition switch is turned to the on position...	The safety belt warning light and indicator chime remain off.

### Belt-Minder®

The Belt-Minder® feature is a supplemental warning to the safety belt warning function. This feature provides additional reminders by intermittently sounding a chime and illuminating the safety belt warning light in the instrument cluster when the driver's and front passenger's safety belt is unbuckled.

The Belt-Minder® feature uses information from the front passenger sensing system to determine if a front seat passenger is present and therefore potentially in need of a warning. To avoid activating the Belt-Minder® feature for objects placed in the front passenger seat, warnings will only be given to large front seat occupants as determined by the front passenger sensing system.

Both the driver's and passenger's safety belt usages are monitored and either may activate the Belt-Minder® feature. The warnings are the same for the driver and the front passenger. If the Belt-Minder® warnings have expired (warnings for approximately five minutes) for one occupant (driver or front passenger), the other occupant can still activate the Belt-Minder® feature.

## Seating and Safety Restraints

If...	Then...
The driver's and front passenger's safety belts are buckled before the ignition switch is turned to the on position or less than 1-2 minutes have elapsed since the ignition switch has been turned to on...	The Belt-Minder® feature will not activate.
The driver's or front passenger's safety belt is not buckled when the vehicle has reached at least 6 mph (9.7 km/h) and 1-2 minutes have elapsed since the ignition switch has been turned to on...	The Belt-Minder® feature is activated - the safety belt warning light illuminates and the warning chime sounds for six seconds every 30 seconds, repeating for approximately five minutes or until the safety belts are buckled.
The driver's or front passenger's safety belt becomes unbuckled for approximately one minute while the vehicle is traveling at least 6 mph (9.7 km/h) and more than 1-2 minutes have elapsed since the ignition switch has been turned to on...	The Belt-Minder® feature is activated - the safety belt warning light illuminates and the warning chime sounds for six seconds every 30 seconds, repeating for approximately five minutes or until the safety belts are buckled.

## Seating and Safety Restraints

The following are reasons most often given for not wearing safety belts  
(All statistics based on U.S. data):

Reasons given...	Consider...
“Crashes are rare events”	<b>36700 crashes occur every day.</b> The more we drive, the more we are exposed to “rare” events, even for good drivers. <i>1 in 4 of us will be seriously injured in a crash during our lifetime.</i>
“I’m not going far”	<b>3 of 4</b> fatal crashes occur within <b>25</b> miles (40 km) of home.
“Belts are uncomfortable”	We design our safety belts to enhance comfort. If you are uncomfortable - try different positions for the safety belt upper anchorage and seatback which should be as upright as possible; this can improve comfort.
“I was in a hurry”	<b>Prime time for an accident.</b> Belt-Minder® reminds us to take a few seconds to buckle up.
“Safety belts don’t work”	<b>Safety belts</b> , when used properly, <b>reduce risk of death</b> to front seat occupants by <b>45% in cars</b> , and by <b>60% in light trucks</b> .
“Traffic is light”	<b>Nearly 1 of 2 deaths occur in single-vehicle crashes</b> , many when no other vehicles are around.
“Belts wrinkle my clothes”	Possibly, but a serious crash can do much more than wrinkle your clothes, particularly if you are unbelted.
“The people I’m with don’t wear belts”	Set the example, teen deaths occur 4 times more often in vehicles with <b>TWO or MORE</b> people. Children and younger brothers/sisters imitate behavior they see.

## Seating and Safety Restraints

Reasons given...	Consider...
“I have an airbag”	Airbags offer greater protection when used with safety belts. Frontal airbags are not designed to inflate in rear and side crashes or rollovers.
“I’d rather be thrown clear”	Not a good idea. <b>People</b> who are <b>ejected are 40 times more likely to DIE</b> . Safety belts help prevent ejection, WE CAN’T “PICK OUR CRASH”.



**WARNING:** Do not sit on top of a buckled safety belt or insert a latchplate into the buckle to avoid the Belt-Minder® chime. To do so may adversely affect the performance of the vehicle’s airbag system.

### ***Deactivating/activating the Belt-Minder® feature (if equipped)***

**The driver and front passenger Belt-Minder® are deactivated/activated independently. When deactivating/activating one seating position, do not buckle the other position as this will terminate the process.**

*Read Steps 1 - 4 thoroughly before proceeding with the deactivation/activation programming procedure.*

**Note:** The driver and front passenger Belt-Minder® features must be disabled/enabled separately. Both cannot be disabled/enabled during the same key cycle.

The driver and front passenger Belt-Minder® features can be deactivated/activated by performing the following procedure:

Before following the procedure, make sure that:

- The parking brake is set
- The gearshift is in P (Park) (automatic transmission) and in neutral (manual transmission)
- The ignition is off
- The driver and front passenger safety belts are unbuckled

## Seating and Safety Restraints



**WARNING:** While the design allows you to deactivate your Belt-Minder®, this system is designed to improve your chances of being safely belted and surviving an accident. We recommend you leave the Belt-Minder® system activated for yourself and others who may use the vehicle. To reduce the risk of injury, do not deactivate/activate the Belt-Minder® feature while driving the vehicle.

1. Turn the ignition on. DO NOT START THE ENGINE.
2. Wait until the safety belt warning light turns off (approximately one minute).
  - Step 3 must be completed within 30 seconds after the safety belt warning light turns off.
3. For the seating position being disabled, buckle then unbuckle the safety belt three times at a moderate speed, ending in the unbuckled state.
  - After Step 3, the safety belt warning light will be turned on for three seconds.
4. Within approximately seven seconds of the light turning off, buckle then unbuckle the safety belt.
  - This will disable the Belt-Minder feature for that seating position if it is currently enabled. As confirmation, the safety belt warning light will flash four times per second for three seconds.
  - This will enable the Belt-Minder® feature for that seating position if it is currently disabled. As confirmation, the safety belt warning light will flash four times per second for three seconds, followed by three seconds with the light off, then followed by the safety belt warning light flashing one time per second for three seconds again.

## Seating and Safety Restraints

### AIRBAG SUPPLEMENTAL RESTRAINT SYSTEM (SRS)





The supplemental restraint system is designed to work with the safety belt to help protect the driver and right front passenger from certain upper body injuries.

 **WARNING:** Airbags **DO NOT** inflate slowly or gently, and the risk of injury from a deploying airbag is the greatest close to the trim covering the airbag module.

#### Important SRS precautions

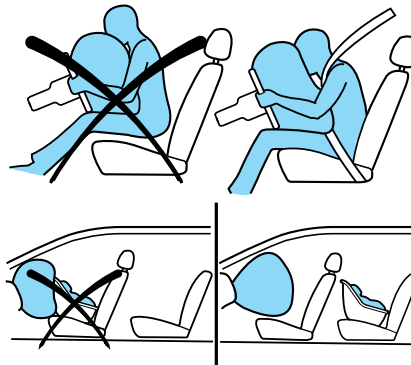
The SRS is designed to work with the safety belt to help protect the driver and right front passenger from certain upper body injuries. Airbags **DO NOT** inflate slowly; there is a risk of injury from a deploying airbag.



 **WARNING:** All occupants of the vehicle, including the driver, should always properly wear their safety belts, even when an air bag supplemental restraint system (SRS) is provided.

## Seating and Safety Restraints



**WARNING:** When possible, all children 12 years old and under should be properly restrained in a rear seating position.



**WARNING:** The National Highway Traffic Safety Administration (NHTSA) recommends a minimum distance of at least 10 inches (25 cm) between an occupant's chest and the driver airbag module.



**WARNING:** Never place your arm over the airbag module as a deploying airbag can result in serious arm fractures or other injuries.

To properly position yourself away from the airbag:

- Move your seat to the rear as far as you can while still reaching the pedals comfortably.
- Recline the seat slightly one or two degrees from the upright position.



**WARNING:** Do not put anything on or over the airbag module. Placing objects on or over the airbag inflation area may cause those objects to be propelled by the airbag into your face and torso causing serious injury.



**WARNING:** Do not attempt to service, repair, or modify the airbag supplemental restraint systems or its fuses. Contact your authorized dealer as soon as possible.



## Seating and Safety Restraints

### Children and airbags

Children must always be properly restrained. Accident statistics suggest that children are safer when properly restrained in the rear seating positions than in the front seating position. Failure to follow these instructions may increase the risk of injury in a collision.

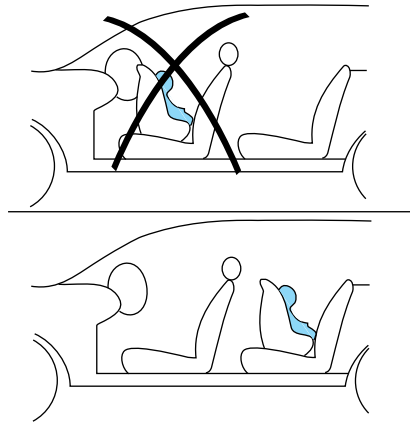

**!** **WARNING:** Airbags can kill or injure a child in a child seat. **NEVER** place a rear-facing child seat in front of an active airbag. If you must use a forward-facing child seat in the front seat, move the seat all the way back.

### How does the safety belt pretensioner and airbag supplemental restraint system work?

The safety belt pretensioner and airbag SRS are designed to activate when the vehicle sustains longitudinal deceleration sufficient to cause the sensors to close an electrical circuit that initiates pretensioner activation and airbag inflation.

The fact that the pretensioners and airbags did not activate in a collision does not mean that something is wrong with the system. Rather, it means the forces were not of the type sufficient to cause activation. Front airbags are designed to activate in frontal and near-frontal collisions, not rollover, side-impact, or rear-impacts unless the collision causes sufficient longitudinal deceleration.

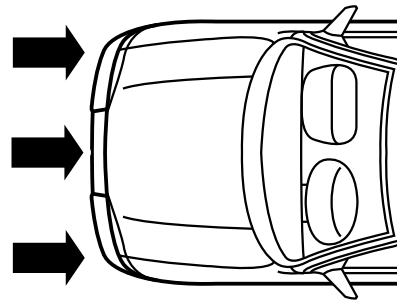

## Seating and Safety Restraints

The airbags inflate and deflate rapidly upon activation. After airbag deployment, it is normal to notice a smoke-like, powdery residue or smell the burnt propellant. This may consist of cornstarch, talcum powder (to lubricate the bag) or sodium compounds (e.g., baking soda) that result from the combustion process that inflates the airbag. Small amounts of sodium hydroxide may be present which may irritate the skin and eyes, but none of the residue is toxic.



While the system is designed to help reduce serious injuries, contact with a deploying airbag may also cause abrasions, swelling or temporary hearing loss. Because airbags must inflate rapidly and with considerable force, there is the risk of death or serious injuries such as fractures, facial and eye injuries or internal injuries, particularly to occupants who are not properly restrained or are otherwise out of position at the time of airbag deployment. Thus, it is extremely important that occupants be properly restrained as far away from the airbag module as possible while maintaining vehicle control.



**WARNING:** Several air bag system components get hot after inflation. Do not touch them after inflation.



**WARNING:** If the air bag has deployed, **the air bag will not function again and must be replaced immediately.** If the air bag is not replaced, the unrepaired area will increase the risk of injury in a collision.

The SRS consists of:

- driver and passenger airbag modules (which include the inflators and airbags)
- seat-mounted side airbags. Refer to *Seat-mounted side airbag system* later in this chapter
- safety belt pretensioners
- one or more impact and safing sensors

170

## Seating and Safety Restraints

- a readiness light and tone
- and the electrical wiring which connects the components
- Side curtain airbag system. Refer to *Side curtain airbag system* later in this chapter.
- Front passenger sensing system. Refer to *Front passenger sensing system* later in this chapter.
- “Passenger airbag off” or “pass airbag off” indicator lamp. Refer to *Front passenger sensing system* later in this chapter.
- Driver’s side knee airbag module.

The diagnostic module monitors its own internal circuits and the supplemental airbag electrical system wiring (including the impact sensors), the system wiring, the airbag system readiness light, the airbag backup power, the airbag ignitors and safety belt pretensioners.

### **Knee airbag system (driver’s side only)**

The knee airbag is located under the instrument panel. The system works along with the driver’s front airbag to help reduce injury to the legs. When the driver’s airbag activates in a collision, the knee airbag deploys from under the instrument panel.

As with front and side airbags, it is important to be properly seated and restrained to reduce the risk of death or serious injury.

### **Front passenger sensing system**

The front passenger sensing system is designed to meet the regulatory requirements of Federal Motor Vehicle Safety Standard (FMVSS) 208 and is designed to disable (will not inflate) the front passenger’s frontal airbag under certain conditions.

The front passenger sensing system works with sensors that are part of the front passenger’s seat and safety belt. The sensors are designed to detect the presence of a properly seated occupant and determine if the front passenger’s frontal airbag should be enabled (may inflate) or disabled (will not inflate).

The front passenger sensing system will disable (will not inflate) the front passenger’s frontal airbag if:

- the front passenger seat is unoccupied, or has small/medium objects in the front seat,
- the system determines that an infant is present in a rear-facing infant seat that is installed according to the manufacturer’s instructions,

171

## Seating and Safety Restraints

- the system determines that a small child is present in a forward-facing child restraint that is installed according to the manufacturer's instructions,
- the system determines that a small child is present in a booster seat,
- a front passenger takes his/her weight off of the seat for a period of time,
- a child or a small person occupies the front passenger seat.

**Note:** When the passenger airbag off light is illuminated, the passenger (seat mounted) side airbag may be disabled to avoid the risk of airbag deployment injuries.

The front passenger sensing system uses a "passenger airbag off" or "pass airbag off" indicator which will illuminate and stay lit to remind you that the front passenger frontal

**PASS  
AIRBAG  
OFF**

airbag is disabled. The indicator lamp is located at the bottom central portion of the instrument panel below the Hazard warning indicator and above the climate controls.

**Note:** The indicator lamp will illuminate for a short period of time when the ignition is turned to the on position to confirm it is functional.

When the front passenger seat is not occupied (empty seat) or in the event that the front passenger frontal airbag is enabled (may inflate), the indicator lamp will be unlit.

The front passenger sensing system is designed to disable (will not inflate) the front passenger's frontal airbag when a rear facing infant seat, a forward-facing child restraint, or a booster seat is detected.

- When the front passenger sensing system disables (will not inflate) the front passenger frontal airbag, the indicator lamp will illuminate and stay lit to remind you that the front passenger frontal airbag is disabled.
- If the child restraint has been installed and the indicator lamp is not lit, then turn the vehicle off, remove the child restraint from the vehicle and reinstall the restraint following the child restraint manufacturer's instructions.

The front passenger sensing system is designed to enable (may inflate) the front passenger's frontal airbag anytime the system senses that a person of adult size is sitting properly in the front passenger seat.

- When the front passenger sensing system enables the front passenger frontal airbag (may inflate), the indicator will be unlit and stay unlit.

172

## Seating and Safety Restraints

If a person of adult size is sitting in the front passenger's seat, but the "passenger airbag off" or "pass airbag off" indicator lamp is lit, it is possible that the person isn't sitting properly in the seat. If this happens:

- Turn the vehicle off and ask the person to place the seatback in the full upright position.
- Have the person sit upright in the seat, centered on the seat cushion, with the person's legs comfortably extended.
- Restart the vehicle and have the person remain in this position for about two minutes. This will allow the system to detect that person and enable the passenger's frontal airbag.
- If the indicator lamp remains lit even after this, the person should be advised to ride in the rear seat.

Occupant	Pass Airbag Off Indicator Lamp	Passenger Airbag
Empty seat	Unlit	Disabled
Small child in child safety seat or booster	Lit	Disabled
Small child with safety belt buckled or unbuckled	Lit	Disabled
Adult	Unlit	Enabled

 **WARNING:** Even with Advanced Restraints Systems, children 12 and under should be properly restrained in a rear seating position.

After all occupants have adjusted their seats and put on safety belts, it's very important that they continue to sit properly. A properly seated occupant sits upright, leaning against the seat back, and centered on the seat cushion, with their feet comfortably extended on the floor. Sitting improperly can increase the chance of injury in a crash event. For example, if an occupant slouches, lies down, turns sideways, sits forward, leans forward or sideways, or puts one or both feet up, the chance of injury during a crash is greatly increased.

 **WARNING:** Sitting improperly out of position or with the seat back reclined too far can take off weight from the seat cushion and affect the decision of the front passenger sensing system, resulting in serious injury or death in a crash. Always sit upright against your seatback, with your feet on the floor.

## Seating and Safety Restraints

The front passenger sensing system may detect small or medium objects placed on the seat cushion. For most objects that are in the front passenger seat, the passenger airbag will be disabled. Even though the passenger airbag is disabled, the "pass airbag off" lamp may or may not be illuminated according to the table below.

Objects	Pass Airbag Off Indicator Lamp	Passenger Airbag
Small (i.e. three-ring binder, small purse, bottled water)	Unlit	Disabled
Medium (i.e. heavy briefcase, fully packed luggage)	Lit	Disabled
Empty seat, or small to medium object with safety belt buckled	Lit	Disabled

If you think that the status of the passenger airbag off indicator lamp is incorrect, check for the following:

- Objects lodged underneath the seat
- Objects between the seat cushion and the center console (if equipped)
- Objects hanging off the seat back
- Objects stowed in the seatback map pocket (if equipped)
- Objects placed on the occupant's lap
- Cargo interference with the seat
- Other passengers pushing or pulling on the seat
- Rear passenger feet and knees resting or pushing on the seat

The conditions listed above may cause the weight of a properly seated occupant to be incorrectly interpreted by the passenger sensing system. The person in the front passenger seat may appear heavier or lighter due to the conditions described in the list above.

## Seating and Safety Restraints



**WARNING:** To reduce the risk of possible serious injury:

Do not stow objects in seat back map pocket (if equipped) or hang objects off seat back if a child is in the front passenger seat. Do not place objects underneath the front passenger seat or between the seat and the center console (if equipped). Check the “passenger airbag off” or “pass airbag off” indicator lamp for proper airbag Status. Failure to follow these instructions may interfere with the passenger seat sensing system.

In case there is a problem with the front passenger sensing system, the airbag readiness lamp in the instrument cluster will stay lit.



**If the airbag readiness lamp is lit, do the following:**

The driver and/or adult passengers should check for any objects that may be lodged underneath the front passenger seat or cargo interfering with the seat.

If objects are lodged and/or cargo is interfering with the seat; please take the following steps to remove the obstruction:

- Pull the vehicle over.
- Turn the vehicle off.
- Driver and/or adult passengers should check for any objects lodged underneath the front passenger seat or cargo interfering with the seat.
- Remove the obstruction(s) (if found).
- Restart the vehicle.
- Wait at least two minutes and verify that the airbag readiness lamp is no longer illuminated
- If the airbag readiness lamp remains illuminated, this may or may/not be a problem due to the front passenger sensing system.

DO NOT attempt to repair or service the system; take your vehicle immediately to an authorized dealer.

If it is necessary to modify an advanced front airbag system to accommodate a person with disabilities, contact the Ford Customer Relationship Center at the phone number shown in the *Customer Assistance* section of this owner's guide.

175

## Seating and Safety Restraints



**WARNING:** Any alteration/modification to the front passenger seat may affect the performance of the front passenger sensing system.

### ***Determining if the system is operational***

The supplemental restraint system uses a warning indicator light in the instrument cluster or a backup tone to indicate the condition of the system. Refer to the *Warning lights and chimes* section in the *Instrument Cluster* chapter. Routine maintenance of the airbag is not required.

A difficulty with the system is indicated by one or more of the following:

- The readiness light (same light for front and side airbag system) will either flash or stay lit.
- The readiness light will not illuminate immediately after ignition is turned on.
- A series of five beeps will be heard. The tone pattern will repeat periodically until the problem and/or light are repaired.



If any of these things happen, even intermittently, have the supplemental restraint system serviced at an authorized dealer immediately. Unless serviced, the system may not function properly in the event of a collision.

### **Seat-mounted side airbag system**



**WARNING:** Do not place objects or mount equipment on or near the airbag cover on the side of the seatbacks of the front seats or in front seat areas that may come into contact with a deploying airbag. Failure to follow these instructions may increase the risk of personal injury in the event of a collision.



**WARNING:** Do not use accessory seat covers. The use of accessory seat covers may prevent the deployment of the side airbags and increase the risk of injury in an accident.



**WARNING:** Do not lean your head on the door. The side airbag could injure you as it deploys from the side of the seatback.



## Seating and Safety Restraints

 **WARNING:** Do not attempt to service, repair, or modify the airbag SRS, its fuses or the seat cover on a seat containing an airbag. Contact your authorized dealer as soon as possible.

 **WARNING:** All occupants of the vehicle should always wear their safety belts even when an airbag SRS is provided.

### **How does the side airbag system work?**

The design and development of the side airbag system included recommended testing procedures that were developed by a group of automotive safety experts known as the Side Airbag Technical Working Group. These recommended testing procedures help reduce the risk of injuries related to the deployment of side airbags.

The side airbag system consists of the following:

- An inflatable bag (airbag) with an inflator concealed behind the outboard bolster of the driver and front passenger seatbacks.
- A special seat cover designed to allow airbag deployment.
- The same warning light, electronic control and diagnostic unit as used for the front airbags.
- Crash sensors located on the front doors and C pillars (one sensor on each pillar on each side of the vehicle).

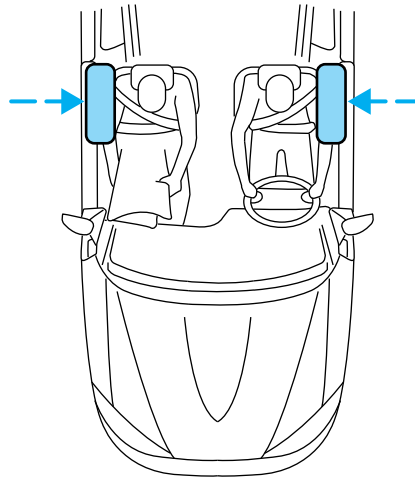

Side airbags, in combination with safety belts, can help reduce the risk of severe injuries in the event of a significant side impact collision.

The side airbags are fitted on the outboard side of the seatbacks of the front seats. In certain lateral collisions, the airbag on the side affected by the collision will be inflated. The airbag was designed to inflate between the door panel and occupant to further enhance the protection provided occupants in side impact collisions.

The airbag SRS is designed to activate when the vehicle sustains lateral deceleration sufficient to cause the sensors to close an electrical circuit that initiates airbag inflation.

177

## Seating and Safety Restraints

The fact that the airbags did not inflate in a collision does not mean that something is wrong with the system. Rather, it means the forces were not of the type sufficient to cause activation. Side airbags are designed to inflate in side-impact collisions, not roll-over, rear-impact, frontal or near-frontal collisions, unless the collision causes sufficient lateral deceleration.



**WARNING:** Several air bag system components get hot after inflation. Do not touch them after inflation.



**WARNING:** If the side airbag has deployed, **the airbag will not function again. The side airbag system (including the seat) must be inspected and serviced by an authorized dealer.** If the airbag is not replaced, the unrepaired area will increase the risk of injury in a collision.

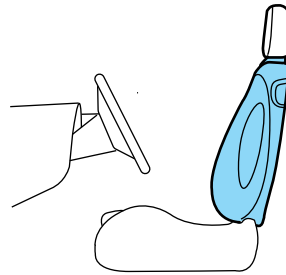

### Side-curtain airbag system



**WARNING:** Do not place objects or mount equipment on or near the headliner at the siderail that may come into contact with a deploying side air curtain. Failure to follow these instructions may increase the risk of personal injury in the event of a collision.

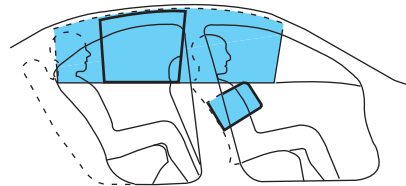

**WARNING:** Do not place objects or mount equipment on or near the side air curtain cover.

## Seating and Safety Restraints



**WARNING:** Do not lean your head on the door. The side airbag could injure you as it deploys from the seat.



**WARNING:** Do not attempt to service, repair, or modify the side air curtain system, its fuses, the A, B, or C pillar trim, or the headliner on a vehicle containing a side air curtain. See your authorized dealer.



**WARNING:** All occupants of the vehicle, including the driver, should always wear their safety belts even when an inflatable curtain is provided.



**WARNING:** To reduce the risk of injury, do not obstruct or place objects in the deployment zone of the inflatable curtain.

## Seating and Safety Restraints

### ***How does the side air curtain system work?***

The design and development of the side air curtain system included recommended testing procedures that were developed by a group of automotive safety experts known as the Side Airbag Technical Working Group. These recommended testing procedures help reduce the risk of injuries related to the deployment of side airbags (including side air curtain systems).

The side air curtain system consists of the following:

- An inflatable curtain with a gas generator concealed behind the headliner and above the doors.
- The headliner will flex to open above the side doors to allow air curtain deployment.
- The same warning light, electronic control and diagnostic unit as used for the front airbags.
- Two pressure sensors located in the front doors.
- Two crash sensors located on the rocker panel between the “C” pillar.

Side air curtains and side airbags, in combination with safety belts, can help reduce the risk of severe injuries in the event of a significant side impact collision.

Children 12 years old and under should always be properly restrained in the rear seats. The side air curtain will not interfere with children restrained using a properly installed child or booster seat because it is designed to inflate downward from the headliner above the doors along the side window openings.

The side air curtains are mounted to the sheet metal above the first and second row seats. In certain lateral collisions, the air curtain and seat-mounted side airbag on the side affected by the collision will be inflated, except that the passenger sensing system will deactivate the passenger seat-mounted side airbag if it detects an empty unbuckled passenger seat. The air curtain was designed to inflate between the side window area and occupant to further enhance the head protection

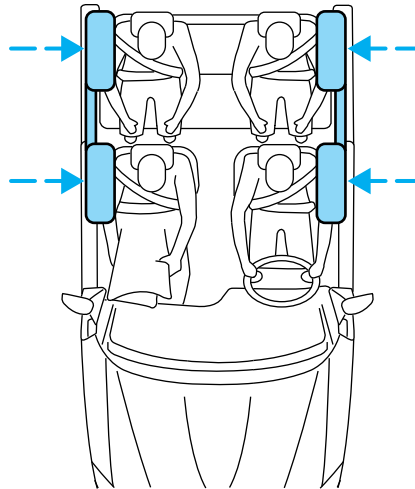

## Seating and Safety Restraints

provided to occupants in side impact collisions. The seat-mounted side airbag was designed to inflate between the door panel and occupant to further enhance the protection provided occupants in side impact collisions.

The side air curtain system SRS is designed to activate when the vehicle sustains lateral deceleration sufficient to cause the sensors to close an electrical circuit that initiates air curtain and seat-mounted side airbag inflation.

The fact that the side air curtain and seat-mounted side airbag did not inflate in a collision does not mean that something is wrong with the system. Rather, it means the forces were not of the type sufficient to cause activation. The side air curtain system is designed to inflate in side impact collisions, not roll-over, rear impact, frontal or near-frontal collisions, unless the collision causes sufficient lateral deceleration.



**WARNING:** Several air bag system components get hot after inflation. Do not touch them after inflation.



**WARNING:** If the side air curtain has deployed, **the air curtain will not function again. The side air curtain system (including the A, B and C pillar trim and headliner) must be inspected and serviced by an authorized dealer.** If the air curtain is not replaced, the unrepaired area will increase the risk of injury in a collision.

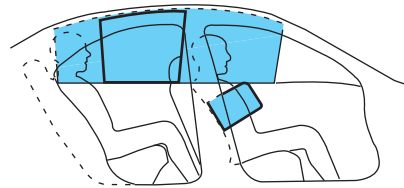

### ***Determining if the system is operational***

The SRS uses a readiness light in the instrument cluster or a tone to indicate the condition of the system. Refer to *Warning lights and chimes* in the *Instrument Cluster* chapter. Routine maintenance of the side airbag is not required.

A difficulty with the system is indicated by one or more of the following:

- The readiness light (same light as for front airbag system) will either flash or stay lit.

## Seating and Safety Restraints

- The readiness light will not illuminate immediately after ignition is turned on.
- A series of five beeps will be heard. The tone pattern will repeat periodically until the problem and/or light are repaired.

If any of these things happen, even intermittently, have the SRS serviced at your authorized dealer immediately. Unless serviced, the system may not function properly in the event of a collision.

### SOS Post-Crash Alert System™

The system flashes the turn signal lamps and sounds the horn (intermittently) in the event of a serious impact that deploys an airbag (front, side, side curtain or Safety Canopy®) or the safety belt pretensioners.

The horn and lamps will turn off when:

- the hazard control button is pressed, or
- the vehicle runs out of power.

### Disposal of airbags and airbag equipped vehicles (including pretensioners)

Contact your authorized dealer as soon as possible. Airbags MUST BE disposed of by qualified personnel.

### SAFETY RESTRAINTS FOR CHILDREN

See the following sections for directions on how to properly use safety restraints for children. Also see *Airbag supplemental restraint system (SRS)* in this chapter for special instructions about using airbags.

### Important child restraint precautions



**WARNING:** Always make sure your child is secured properly in a device that is appropriate for their height, age and weight. Child safety restraints must be purchased separately from the vehicle. Failure to follow these instructions and guidelines may result in an increased risk of serious injury or death to your child.

## Seating and Safety Restraints

 **WARNING:** All children are shaped differently. The Recommendations for Safety Restraints are based on probable child height, age and weight thresholds from NHTSA and other safety organizations or are the minimum requirements of law. Ford recommends checking with a NHTSA Certified Child Passenger Safety Technician (CPST) and consult your pediatrician to make sure your child seat is appropriate for your child, and is compatible with and properly installed in the vehicle. To locate a child seat fitting station and CPST contact the NHTSA toll free at 1-888-327-4236 or on the internet at <http://www.nhtsa.dot.gov>. In Canada, check with your local St. John Ambulance office for referral to a CPST or for further information, contact your provincial ministry of transportation, your local St. John Ambulance office at <http://www.sfa.ca>, or Transport Canada at 1-800-333-0371 (<http://www.tc.gc.ca>). Failure to properly restrain children in safety seats made especially for their height, age, and weight may result in an increased risk of serious injury or death to your child.

<b>Recommendations for Safety Restraints for Children</b>		
	<b>Child size, height, weight, or age</b>	<b>Recommended restraint type</b>
Infants or toddlers	Children weighing 40 lb (18 kg) or less (generally age four or younger)	Use a child safety seat (sometimes called an infant carrier, convertible seat, or toddler seat).
Small children	Children who have outgrown or no longer properly fit in a child safety seat (generally children who are less than 4 feet 9 inches (1.45 meters) tall, are greater than age four (4) and less than age twelve (12), and between 40 lb (18 kg) and 80 lb (36 kg) and upward to 100 lb (45 kg) if recommended by your child restraint manufacturer)	Use a belt-positioning booster seat.

## Seating and Safety Restraints

Recommendations for Safety Restraints for Children		
	Child size, height, weight, or age	Recommended restraint type
Larger children	Children who have outgrown or no longer properly fit in a belt-positioning booster seat (generally children who are at least 4 feet 9 inches (1.45 meters) tall or greater than 80 lb (36 kg) or 100 lb (45 kg) if recommended by child restraint manufacturer)	Use a vehicle safety belt having the lap belt snug and low across the hips, shoulder belt centered across the shoulder and chest, and seatback upright.

- You are required by law to properly use safety seats for infants and toddlers in the U.S. and Canada.
- Many states and provinces require that small children use approved booster seats until they reach age eight, a height of 4 ft 9 in. (1.45 meters) tall, or 80 lb (36 kg). Check your local and state or provincial laws for specific requirements regarding the safety of children in your vehicle.
- When possible, always properly restrain children twelve (12) years of age and under in a rear seating position of your vehicle. Accident statistics suggest that children are safer when properly restrained in the rear seating positions than in a front seating position.



## Seating and Safety Restraints

### **Recommendations for attaching child safety restraints for children**

Restraint Type	Child Weight	Use any attachment method as indicated below by "X"				
		LATCH (lower anchors and top tether anchor)	LATCH (lower anchors only)	Safety belt and top tether anchor	Safety belt and LATCH (lower anchors and top tether anchor)	Safety belt only
Rear facing child seat	Up to 48 lb (21 kg)		X			X
Forward facing child seat	Up to 48 lb (21 kg)	X		X	X	
Forward facing child seat	Over 48 lb (21 kg)			X	X	

 **WARNING:** Airbags can kill or injure a child in a child seat. NEVER place a rear-facing child seat in front of an active airbag. If you must use a forward-facing child seat in the front seat, move the vehicle seat all the way back. When possible, all children age 12 and under should be properly restrained in a rear seating position. If all children cannot be seated and restrained properly in a rear seating position, properly restrain the largest child in the front seat.

 **WARNING:** Always carefully follow the instructions and warnings provided by the manufacturer of any child restraint to determine if the restraint device is appropriate for your child's size, height, weight, or age. Follow the child restraint manufacturer's instructions and warnings provided for installation and use in conjunction with the instructions and warnings provided by the vehicle manufacturer. A safety seat that is improperly installed or utilized, is inappropriate for your child's height, age, or weight or does not properly fit the child may increase the risk of serious injury or death.

## Seating and Safety Restraints

 **WARNING:** Never let a passenger hold a child on his or her lap while the vehicle is moving. The passenger cannot protect the child from injury in a collision, which may result in serious injury or death.

 **WARNING:** Never use pillows, books, or towels to boost a child. They can slide around and increase the likelihood of injury or death in a collision.

 **WARNING:** Always restrain an unoccupied child seat or booster seat. These objects may become projectiles in a collision or sudden stop, which may increase the risk of serious injury.

 **WARNING:** Never place, or allow a child to place, the shoulder belt under a child's arm or behind the back because it reduces the protection for the upper part of the body and may increase the risk of injury or death in a collision.

 **WARNING:** Do not leave children, unreliable adults, or pets unattended in your vehicle.

### Transporting children

Always make sure your child is secured properly in a device that is appropriate for their age, height and weight. All children are shaped differently. The child height, age and weight thresholds provided are recommendations or the minimum requirements of law. The National Highway Traffic Safety Administration (NHTSA) provides education and training to ensure that all children ages 0 to 16 are properly restrained in the correct restraint system. Ford recommends checking with a NHTSA Certified Child Passenger Safety Technician (CPST) and your pediatrician to make sure your seat is appropriate for your child and properly installed in the vehicle. To locate a child seat fitting station and CPST contact the NHTSA toll free at **1-888-327-4236** or on the internet at <http://www.nhtsa.dot.gov>. In Canada, check with your local St. John Ambulance office for referral to a CPST or for further information, contact your provincial ministry of transportation, your local St. John Ambulance office at <http://www.sfa.ca>, or Transport Canada at 1-800-333-0371 (<http://www.tc.gc.ca>).

186

## Seating and Safety Restraints

Follow all the safety restraint and airbag precautions that apply to adult passengers in your vehicle.

If the child is the proper height, age, and weight (as specified by your child safety seat or booster manufacturer), fits the restraint and can be restrained properly, then restrain the child in the child safety seat or with the belt-positioning booster. Remember that child seats and belt-positioning boosters vary and may be designed to fit children of different heights, ages and weights. Children who are too large for child safety seats or belt-positioning boosters (as specified by your child safety seat manufacturer) should always properly wear safety belts.

### SAFETY SEATS FOR CHILDREN

#### Infant and/or toddler seats

Use a safety seat that is recommended for the size and weight of the child.

When installing a child safety seat:

- Review and follow the information presented in the *Airbag supplemental restraint system (SRS)* section in this chapter.
- Carefully follow all of the manufacturer's instructions included with the safety seat you put in your vehicle. If you do not install and use the safety seat properly, the child may be injured in a sudden stop or collision.

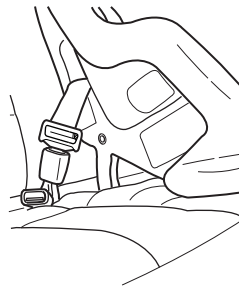

Airbags can kill or injure a child in a child seat. NEVER place a rear-facing child seat in front of an active airbag. If you must use a forward-facing child seat in the front seat, move the vehicle seat all the way back.

Children 12 and under should be properly restrained in a rear seating position whenever possible. If all children cannot be seated and restrained properly in a rear seating position, properly restrain the largest child in the front seat.

## Seating and Safety Restraints

### Installing child safety seats with combination lap and shoulder belts

Check to make sure the child seat is properly secured before each use. Children 12 and under should be properly restrained in a rear seating position whenever possible. If all children cannot be seated and restrained properly in a rear seating position, properly restrain the largest child in the front seat.

When installing a child safety seat with combination lap/shoulder belts:

- Use the correct safety belt buckle for that seating position.
- Insert the belt tongue into the proper buckle until you hear a snap and feel it latch. Make sure the tongue is securely fastened in the buckle.
- Keep the buckle release button pointing up and away from the safety seat, with the tongue between the child seat and the release button, to prevent accidental unbuckling.
- Place vehicle seat back in upright position.
- Put the safety belt in the automatic locking mode. Refer to Step 5 below. This vehicle does not require the use of a locking clip.



**WARNING:** Depending on where you secure a child restraint, and depending on the child restraint design, you may block access to certain safety belt buckle assemblies and/or LATCH lower anchors, rendering those features potentially unusable. To avoid risk of injury, occupants should only use seating positions where they are able to be properly restrained.

Perform the following steps when installing the child seat with combination lap/shoulder belts:

**Note:** Although the child seat illustrated is a forward facing child seat, the steps are the same for installing a rear facing child seat.

## Seating and Safety Restraints

1. Position the child safety seat in a seat with a combination lap and shoulder belt.

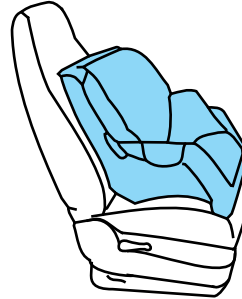

2. Pull down on the shoulder belt and then grasp the shoulder belt and lap belt together.

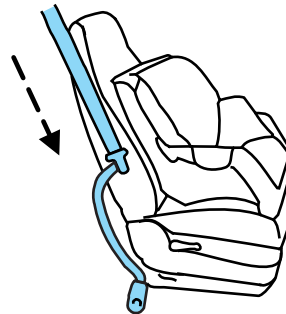

3. While holding the shoulder and lap belt portions together, route the tongue through the child seat according to the child seat manufacturer's instructions. Be sure the belt webbing is not twisted.

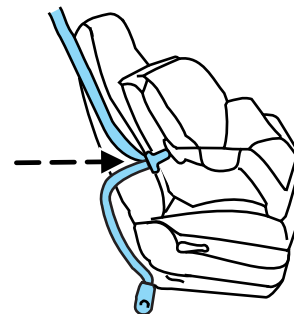

## Seating and Safety Restraints

4. Insert the belt tongue into the proper buckle (the buckle closest to the direction the tongue is coming from) for that seating position until you hear a snap and feel the latch engage. Make sure the tongue is latched securely by pulling on it.

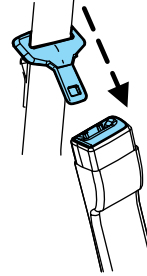

5. To put the retractor in the automatic locking mode, grasp the shoulder portion of the belt and pull downward until all of the belt is pulled out.

**Note:** The automatic locking mode is available on the front passenger and rear seats. This vehicle does not require the use of a locking clip.

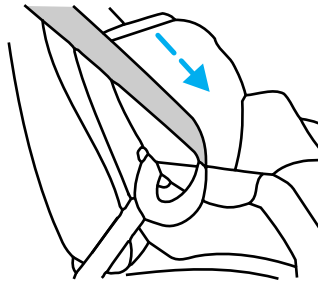

6. Allow the belt to retract to remove slack. The belt will click as it retracts to indicate it is in the automatic locking mode.

7. Try to pull the belt out of the retractor to make sure the retractor is in the automatic locking mode (you should not be able to pull more belt out). If the retractor is not locked, unbuckle the belt and repeat Steps 5 and 6.

8. Remove remaining slack from the belt. Force the seat down with extra weight, e.g., by pressing down or kneeling on the child restraint while pulling up on the shoulder belt in order to force slack from the belt. This is necessary to remove the remaining slack that will exist once the additional weight of the child is added to the child restraint. It also helps to achieve the proper snugness of the child seat to the vehicle. Sometimes, a slight lean towards the buckle will additionally help to remove remaining slack from the belt.

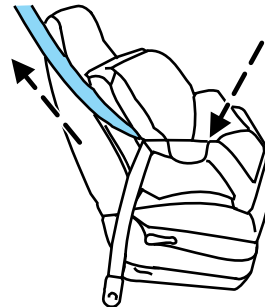

190

## Seating and Safety Restraints

9. Attach the tether strap (if the child seat is equipped). Refer to *Attaching child safety seats with tether straps* later in this chapter.

10. Before placing the child in the seat, forcibly move the seat forward and back to make sure the seat is securely held in place. To check this, grab the seat at the belt path and attempt to move it side to side and forward and back. There should be no more than 1 inch (2.5 cm) of movement for proper installation.

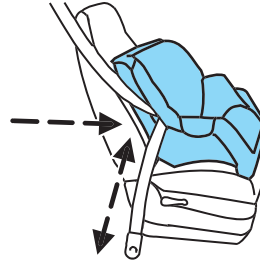

11. Ford recommends checking with a NHTSA Certified Child Passenger Safety Technician (CPST) to make certain the child restraint is properly installed. In Canada, check with your local St. John Ambulance office for referral to a CPST.

### **Attaching child safety seats with Lower Anchor and Tethers for Children (LATCH) attachments**

The LATCH system is composed of three vehicle anchor points: two (2) lower anchors located where the vehicle seat back and seat cushion meet (called the “seat bight”) and one (1) top tether anchor located behind that seating position.

LATCH compatible child safety seats have two rigid or webbing mounted attachments that connect to the two lower anchors at the LATCH equipped seating positions in your vehicle. This type of attachment method eliminates the need to use safety belts to attach the child seat, however the safety belt can still be used to attach the child seat. For forward-facing child seats, the top tether strap must also be attached to the proper top tether anchor, if a top tether strap has been provided with your child seat. Ford Motor Company recommends the use of a child safety seat having a top tether strap. See *Attaching child safety seats with tether straps* and *Recommendations for attaching safety restraints for children* in this chapter for more information.

## Seating and Safety Restraints

Your vehicle has LATCH lower anchors for child seat installation at the seating positions marked with the child seat symbol.

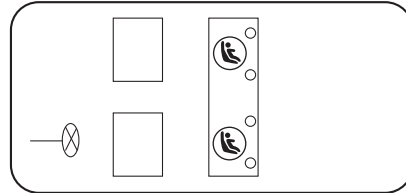

The LATCH anchors are located at the rear section of the rear seat between the cushion and seatback. Follow the child seat manufacturer's instructions to properly install a child seat with LATCH attachments.

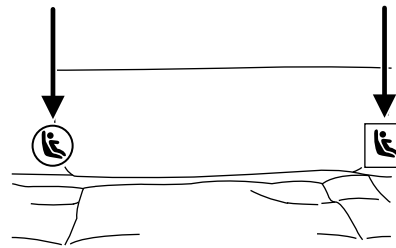

Follow the instructions on attaching child safety seats with tether straps. Refer to *Attaching child safety seats with tether straps* later in this chapter.

Attach LATCH lower attachments of the child seat only to the anchors shown.

**!** **WARNING:** Never attach two child safety seats to the same anchor. In a crash, one anchor may not be strong enough to hold two child safety seat attachments and may break, causing serious injury or death.

**!** **WARNING:** Depending on where you secure a child restraint, and depending on the child restraint design, you may block access to certain safety belt buckle assemblies and/or LATCH lower anchors, rendering those features potentially unusable. To avoid risk of injury, occupants should only use seating positions where they are able to be properly restrained.



## Seating and Safety Restraints

### ***Use of inboard lower anchors from the outboard seating positions (center seating use)***

The lower anchors at the center of the second row rear seat are spaced 390 mm (15 inches) apart. The standardized spacing for LATCH lower anchors is 280 mm (11 inches) center to center. A child seat with rigid LATCH attachments cannot be installed at the center seating position. LATCH compatible child seats (with attachments on belt webbing) can only be used at this seating position provided that the child seat manufacturer's instructions permit use with the anchor spacing stated. Do not attach a child seat to any lower anchor if an adjacent child seat is attached to that anchor.



**WARNING:** The standardized spacing for LATCH lower anchors is 280 mm (11 inches) center to center. Do not use LATCH lower anchors for the center seating position unless the child seat manufacturer's instructions permit and specify using anchors spaced at least as far apart as those in this vehicle.

Each time you use the safety seat, check that the seat is properly attached to the lower anchors and tether anchor, if applicable. Tug the child seat from side to side and forward and back where it is secured to the vehicle. The seat should move less than one inch when you do this for a proper installation.

If the safety seat is not anchored properly, the risk of a child being injured in a crash greatly increases.

### ***Combining safety belt and LATCH lower anchors for attaching child safety seats***

When used in combination, either the safety belt or the LATCH lower anchors may be attached first, provided a proper installation is achieved. Attach the tether strap afterward, if included with the child seat. Refer to *Recommendations for attaching child safety restraints for children* in this chapter.

### **Attaching child safety seats with tether straps**

Many forward-facing child safety seats include a tether strap which extends from the back of the child safety seat and hooks to an anchoring point called the top tether anchor. Tether straps are available as an accessory for many older safety seats. Contact the manufacturer of your child seat for information about ordering a tether strap, or to obtain a longer tether strap if the tether strap on your safety seat does not reach the appropriate top tether anchor in the vehicle.

193

## Seating and Safety Restraints

The rear seats of your vehicle are equipped with built-in tether strap anchors located behind the seats as described below.

**Four door:** The tether anchors in your vehicle are located under a cover marked with the tether anchor symbol (shown with title).

**Five door:** The tether anchors in your vehicle are located on the back panel of the rear seat, marked with the tether anchor symbol (shown with title).

The tether strap anchors in your vehicle are in the following positions (shown from top view):

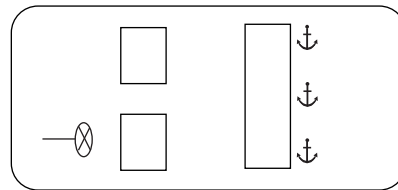

Attach the tether strap only to the appropriate tether anchor as shown. The tether strap may not work properly if attached somewhere other than the correct tether anchor.

Once the child safety seat has been installed using either the safety belt, the lower anchors of the LATCH system, or both, you can attach the top tether strap.

If you install a child seat with rigid LATCH attachments, do not tighten the tether strap enough to lift the child seat off the vehicle seat cushion when the child is seated in it. Keep the tether strap just snug without lifting the front of the child seat. Keeping the child seat just touching the vehicle seat gives the best protection in a severe crash.

Perform the following steps to install a child safety seat with tether anchors:

### **Four door**

1. Route the child safety seat tether strap over the back of the seat.

For outboard seating positions, route the tether strap under the head restraint and between the head restraint posts. For the center seating positions, route the tether strap over the top of the head restraint.

## Seating and Safety Restraints

2. Locate the correct anchor for the selected seating position.



3. Open the tether anchor cover.

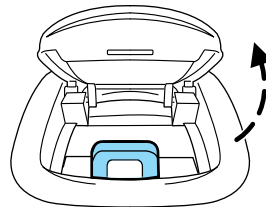

4. Clip the tether strap to the anchor as shown.

If the tether strap is clipped incorrectly, the child safety seat may not be retained properly in the event of a collision.

5. Tighten the child safety seat tether strap according to the manufacturer's instructions.

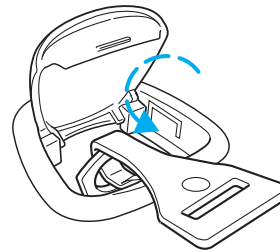

If the safety seat is not anchored properly, the risk of a child being injured in a collision greatly increases.

If your child restraint system is equipped with a tether strap, and the child restraint manufacturer recommends its use, Ford also recommends its use.

### **Five door**

1. Route the child safety seat tether strap over the back of the seat.

For outboard seating positions, route the tether strap under the head restraint and between the head restraint posts. For the center seating position, route the tether strap over the top of the head restraint.

## Seating and Safety Restraints

2. Locate the correct anchor for the selected seating position.

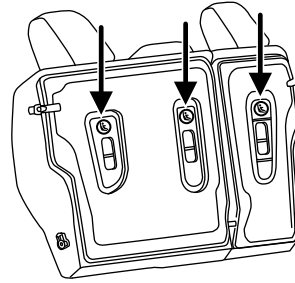

3. Clip the tether strap to the anchor as shown.

If the tether strap is clipped incorrectly, the child safety seat may not be retained properly in the event of a collision.

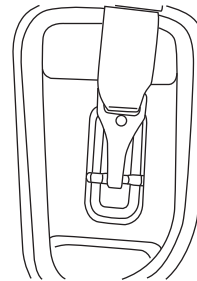

4. Tighten the child safety seat tether strap according to the manufacturer's instructions.

If the safety seat is not anchored properly, the risk of a child being injured in a collision greatly increases.

If your child restraint system is equipped with a tether strap, and the child restraint manufacturer recommends its use, Ford also recommends its use.

### Child booster seats

The belt-positioning booster (booster seat) is used to improve the fit of the vehicle safety belt. Children outgrow a typical child seat (e.g., convertible or toddler seat) when they weigh about 40 lb (18 kg) and are around four (4) years of age. Consult your child safety seat owner guide for the weight, height, and age limits specific to your child safety seat. Keep your child in the child safety seat if it properly fits the child, remains appropriate for their weight, height and age AND if properly secured to the vehicle.

## Seating and Safety Restraints

Although the lap/shoulder belt will provide some protection, children who have outgrown a typical child seat are still too small for lap/shoulder belts to fit properly, and wearing an improperly fitted vehicle safety belt could increase the risk of serious injury in a crash. To improve the fit of both the lap and shoulder belt on children who have outgrown child safety seats, Ford Motor Company recommends use of a belt-positioning booster.

Booster seats position a child so that vehicle lap/shoulder safety belts fit better. They lift the child up so that the lap belt rests low across the hips and the knees bend comfortably at the edge of the cushion, while minimizing slouching. Booster seats may also make the shoulder belt fit better and more comfortably. Try to keep the belt near the middle of the shoulder and across the center of the chest. Moving the child closer (a few centimeters or inches) to the center of the vehicle, but remaining in the same seating position, may help provide a good shoulder belt fit.

### **When children should use booster seats**

Children need to use booster seats from the time they outgrow the toddler seat until they are big enough for the vehicle seat and lap/shoulder belt to fit properly. Generally this is when they reach a height of at least 4 feet 9 inches (1.45 meters) tall (around age eight to age twelve and between 40 lb (18 kg) and 80 lb (36 kg) or upward to 100 lb (45 kg) if recommended by your child restraint manufacturer). Many state and provincial laws require that children use approved booster seats until they reach age eight, a height of 4 feet 9 inches (1.45 meters) tall, or 80 lb (36 kg).

Booster seats should be used until you can answer YES to ALL of these questions when seated without a booster seat:

- Can the child sit all the way back against the vehicle seat back with knees bent comfortably at the edge of the seat cushion?
- Can the child sit without slouching?

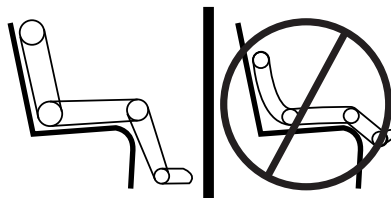

- Does the lap belt rest low across the hips?
- Is the shoulder belt centered on the shoulder and chest?
- Can the child stay seated like this for the whole trip?

197

## Seating and Safety Restraints

### **Types of booster seats**

There are generally two types of belt-positioning booster seats: backless and high back. Always use booster seats in conjunction with the vehicle lap/shoulder belt.

- **Backless booster seats**

If your backless booster seat has a removable shield, remove the shield. If a vehicle seating position has a low seat back or no head restraint, a backless booster seat may place your child's head (as measured at the tops of the ears) above the top of the seat. In this case, move the backless booster to another seating position with a higher seat back or head restraint and lap/shoulder belts, or consider using a high back booster seat.



- **High back booster seats**

If, with a backless booster seat, you cannot find a seating position that adequately supports your child's head, a high back booster seat would be a better choice.



## Seating and Safety Restraints

Children and booster seats vary in size and shape. Choose a booster that keeps the lap belt low and snug across the hips, never up across the stomach, and lets you adjust the shoulder belt to cross the chest and rest snugly near the center of the shoulder. The drawings below compare the ideal fit (center) to a shoulder belt uncomfortably close to the neck and a shoulder belt that could slip off the shoulder. The drawings below also show how the lap belt should be low and snug across the child's hips.

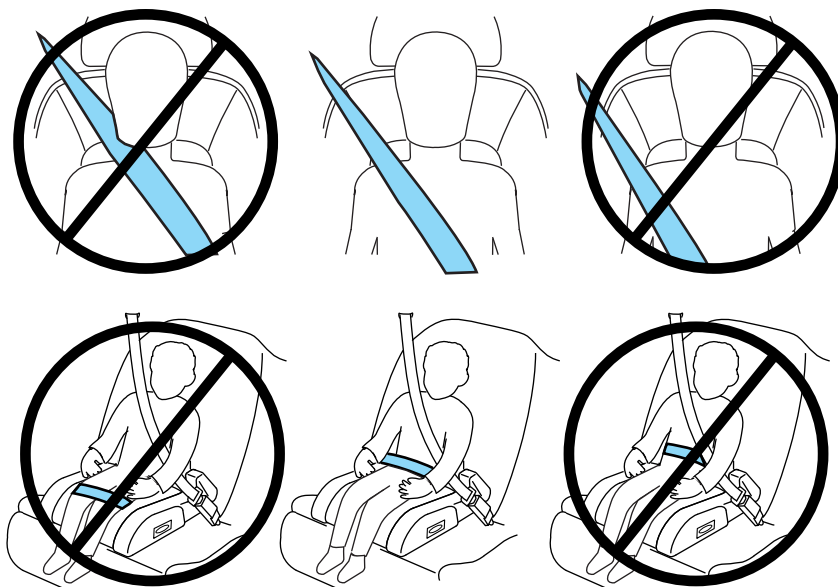

If the booster seat slides on the vehicle seat, placing a rubberized mesh sold as shelf or carpet liner under the booster seat may improve this condition. Do not introduce any item thicker than this under the booster seat. Check with the booster seat manufacturer's instructions.

### ***The importance of shoulder belts***

Using a booster without a shoulder belt increases the risk of a child's head hitting a hard surface in a collision. For this reason, you should never use a booster seat with a lap belt only. It is generally best to use a booster seat with lap/shoulder belts in the back seat.

Move a child to a different seating location if the shoulder belt does not stay positioned on the shoulder during use.

## Seating and Safety Restraints

Follow all instructions provided by the manufacturer of the booster seat.



**WARNING:** Never place, or allow a child to place, the shoulder belt under a child's arm or behind the back because it reduces the protection for the upper part of the body and may increase the risk of injury or death in a collision.

### Child restraint and safety belt maintenance

Inspect the vehicle safety belts and child safety seat systems periodically to make sure they work properly and are not damaged. Inspect the vehicle and child seat safety belts to make sure there are no nicks, tears or cuts. Replace if necessary. All vehicle safety belt assemblies, including retractors, buckles, front safety belt buckle assemblies, buckle support assemblies (slide bar-if equipped), shoulder belt height adjusters (if equipped), shoulder belt guide on seatback (if equipped), child safety seat LATCH and tether anchors, and attaching hardware, should be inspected after a collision. Refer to the child restraint manufacturer's instructions for additional inspection and maintenance information specific to the child restraint. Ford Motor Company recommends that all safety belt assemblies in use in vehicles involved in a collision be replaced. However, if the collision was minor and an authorized dealer finds that the belts do not show damage and continue to operate properly, they do not need to be replaced. Safety belt assemblies not in use during a collision should also be inspected and replaced if either damage or improper operation is noted.

For proper care of soiled safety belts, refer to *Interior* in the *Cleaning* chapter.



**WARNING:** Failure to inspect and if necessary replace the safety belt assembly or child restraint system under the above conditions could result in severe personal injuries in the event of a collision.



## Tires, Wheels and Loading

### INFORMATION ABOUT UNIFORM TIRE QUALITY GRADING

Tire Quality Grades apply to new pneumatic passenger car tires. The Quality grades can be found where applicable on the tire sidewall between tread shoulder and maximum section width. For example:

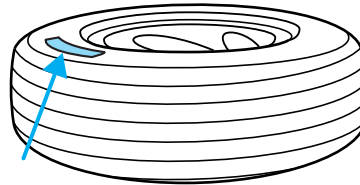

- **Treadwear 200 Traction AA Temperature A**

These Tire Quality Grades are determined by standards that the United States Department of Transportation has set.

Tire Quality Grades apply to new pneumatic passenger car tires. They do not apply to deep tread, winter-type snow tires, space-saver or temporary use spare tires, light truck or "LT" type tires, tires with nominal rim diameters of 10 to 12 inches or limited production tires as defined in Title 49 Code of Federal Regulations Part 575.104(c)(2).

**U.S. Department of Transportation-Tire quality grades:** The U.S. Department of Transportation requires Ford Motor Company to give you the following information about tire grades exactly as the government has written it.

#### **Treadwear**

The treadwear grade is a comparative rating based on the wear rate of the tire when tested under controlled conditions on a specified government test course. For example, a tire graded 150 would wear one and one-half (1½) times as well on the government course as a tire graded 100. The relative performance of tires depends upon the actual conditions of their use, however, and may depart significantly from the norm due to variations in driving habits, service practices, and differences in road characteristics and climate.

#### **Traction AA A B C**

The traction grades, from highest to lowest are AA, A, B, and C. The grades represent the tire's ability to stop on wet pavement as measured under controlled conditions on specified government test surfaces of asphalt and concrete. A tire marked C may have poor traction performance.

201

## Tires, Wheels and Loading



**WARNING:** The traction grade assigned to this tire is based on straight-ahead braking traction tests, and does not include acceleration, cornering, hydroplaning or peak traction characteristics.

### Temperature A B C

The temperature grades are A (the highest), B and C, representing the tire's resistance to the generation of heat and its ability to dissipate heat when tested under controlled conditions on a specified indoor laboratory test wheel. Sustained high temperature can cause the material of the tire to degenerate and reduce tire life, and excessive temperature can lead to sudden tire failure. The grade C corresponds to a level of performance which all passenger car tires must meet under the Federal Motor Vehicle Safety Standard No. 139. Grades B and A represent higher levels of performance on the laboratory test wheel than the minimum required by law.



**WARNING:** The temperature grade for this tire is established for a tire that is properly inflated and not overloaded. Excessive speed, underinflation, or excessive loading, either separately or in combination, can cause heat buildup and possible tire failure.

## TIRES

Tires are designed to give many thousands of miles of service, but they must be maintained in order to get the maximum benefit from them.

### Glossary of tire terminology

- **Tire label:** A label showing the OE (Original Equipment) tire sizes, recommended inflation pressure and the maximum weight the vehicle can carry.
- **Tire Identification Number (TIN):** A number on the sidewall of each tire providing information about the tire brand and manufacturing plant, tire size and date of manufacture. Also referred to as DOT code.
- **Inflation pressure:** A measure of the amount of air in a tire.
- **Standard load:** A class of P-metric or Metric tires designed to carry a maximum load at 35 psi [37 psi (2.5 bar) for Metric tires]. Increasing the inflation pressure beyond this pressure will not increase the tire's load carrying capability.
- **Extra load:** A class of P-metric or Metric tires designed to carry a heavier maximum load at 41 psi [43 psi (2.9 bar) for Metric tires].

202

## Tires, Wheels and Loading

Increasing the inflation pressure beyond this pressure will not increase the tire's load carrying capability.

- **kPa:** Kilopascal, a metric unit of air pressure.
- **PSI:** Pounds per square inch, a standard unit of air pressure.
- **Cold inflation pressure:** The tire pressure when the vehicle has been stationary and out of direct sunlight for an hour or more and prior to the vehicle being driven for 1 mile (1.6 km).
- **Recommended inflation pressure:** The cold inflation pressure found on the Safety Compliance Certification Label or Tire Label located on the B-Pillar or the edge of the driver's door.
- **B-pillar:** The structural member at the side of the vehicle behind the front door.
- **Bead area of the tire:** Area of the tire next to the rim.
- **Sidewall of the tire:** Area between the bead area and the tread.
- **Tread area of the tire:** Area of the perimeter of the tire that contacts the road when mounted on the vehicle.
- **Rim:** The metal support (wheel) for a tire or a tire and tube assembly upon which the tire beads are seated.

### INFLATING YOUR TIRES

Safe operation of your vehicle requires that your tires are properly inflated. Remember that a tire can lose up to half of its air pressure without appearing flat.

Every day before you drive, check your tires. If one looks lower than the others, use a tire gauge to check pressure of all tires and adjust if required.

At least once a month and before long trips, inspect each tire and check the tire pressure with a tire gauge (including spare, if equipped). Inflate all tires to the inflation pressure recommended by Ford Motor Company.

You are strongly urged to buy a reliable tire pressure gauge, as automatic service station gauges may be inaccurate. Ford recommends the use of a digital or dial-type tire pressure gauge rather than a stick-type tire pressure gauge.

Use the recommended cold inflation pressure for optimum tire performance and wear. Under-inflation or over-inflation may cause uneven treadwear patterns.

203

## Tires, Wheels and Loading



**WARNING:** Under-inflation is the most common cause of tire failures and may result in severe tire cracking, tread separation or “blowout”, with unexpected loss of vehicle control and increased risk of injury. Under-inflation increases sidewall flexing and rolling resistance, resulting in heat buildup and internal damage to the tire. It also may result in unnecessary tire stress, irregular wear, loss of vehicle control and accidents. A tire can lose up to half of its air pressure and not appear to be flat!

Always inflate your tires to the Ford recommended inflation pressure even if it is less than the maximum inflation pressure information found on the tire. The Ford recommended tire inflation pressure is found on the Safety Compliance Certification Label or Tire Label which is located on the B-Pillar or the edge of the driver's door. Failure to follow the tire pressure recommendations can cause uneven treadwear patterns and adversely affect the way your vehicle handles.

**Maximum Permissible Inflation Pressure** is the tire manufacturer's maximum permissible pressure and/or the pressure at which the maximum load can be carried by the tire. This pressure is normally higher than the manufacturer's recommended cold inflation pressure which can be found on the Safety Compliance Certification Label or Tire Label which is located on the B-Pillar or the edge of the driver's door. The cold inflation pressure should never be set lower than the recommended pressure on the Safety Compliance Certification Label or Tire Label.

When weather temperature changes occur, tire inflation pressures also change. A 10°F (6°C) temperature drop can cause a corresponding drop of 1 psi (7 kPa) in inflation pressure. Check your tire pressures frequently and adjust them to the proper pressure which can be found on the Safety Compliance Certification Label or Tire Label.

To check the pressure in your tire(s):

1. Make sure the tires are cool, meaning they are not hot from driving even a mile.

If you are checking tire pressure when the tire is hot, (i.e. driven more than 1 mile [1.6 km]), never “bleed” or reduce air pressure. The tires are hot from driving and it is normal for pressures to increase above recommended cold pressures. A hot tire at or below recommended cold inflation pressure could be significantly under-inflated.

## Tires, Wheels and Loading

**Note:** If you have to drive a distance to get air for your tire(s), check and record the tire pressure first and add the appropriate air pressure when you get to the pump. It is normal for tires to heat up and the air pressure inside to go up as you drive.

2. Remove the cap from the valve on one tire, then firmly press the tire gauge onto the valve and measure the pressure.

3. Add enough air to reach the recommended air pressure.

**Note:** If you overfill the tire, release air by pressing on the metal stem in the center of the valve. Then recheck the pressure with your tire gauge.

4. Replace the valve cap.

5. Repeat this procedure for each tire, including the spare.

**Note:** Some spare tires operate at a higher inflation pressure than the other tires. For T-type/mini-spare tires (see the *Dissimilar spare tire/wheel information* section for description): Store and maintain at 60 psi (4.15 bar). For full-size and dissimilar spare tires (see the *Dissimilar spare tire/wheel information* section for description): Store and maintain at the higher of the front and rear inflation pressure as shown on the Tire Label.

6. Visually inspect the tires to make sure there are no nails or other objects embedded that could poke a hole in the tire and cause an air leak.

7. Check the sidewalls to make sure there are no gouges, cuts or bulges.

### TIRE CARE

#### Inspecting your tires and wheel valve stems

Periodically inspect the tire treads for uneven or excessive wear and remove objects such as stones, nails or glass that may be wedged in the tread grooves. Check the tire and valve stems for holes, cracks, or cuts that may permit air leakage and repair or replace the tire and replace the valve stem. Inspect the tire sidewalls for cracking, cuts, bruises and other signs of damage or excessive wear. If internal damage to the tire is suspected, have the tire demounted and inspected in case it needs to be repaired or replaced. For your safety, tires that are damaged or show signs of excessive wear should not be used because they are more likely to blow out or fail.

## Tires, Wheels and Loading

Improper or inadequate vehicle maintenance can cause tires to wear abnormally. Inspect all your tires, including the spare, frequently, and replace them if one or more of the following conditions exist:

### Tire wear

When the tread is worn down to 1/16th of an inch (2 mm), tires must be replaced to help prevent your vehicle from skidding and hydroplaning. Built-in treadwear indicators, or “wear bars”, which look like narrow strips of smooth rubber across the tread will appear on the tire when the tread is worn down to 1/16th of an inch (2 mm).

When the tire tread wears down to the same height as these “wear bars”, the tire is worn out and must be replaced.

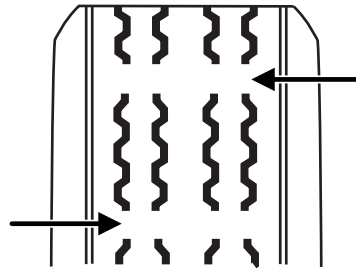

### Damage

Periodically inspect the tire treads and sidewalls for damage (such as bulges in the tread or sidewalls, cracks in the tread groove and separation in the tread or sidewall). If damage is observed or suspected have the tire inspected by a tire professional. Tires can be damaged during off-road use, so inspection after off-road use is also recommended.



### **WARNING: Age**

Tires degrade over time depending on many factors such as weather, storage conditions, and conditions of use (load, speed, inflation pressure, etc.) the tires experience throughout their lives. In general, tires should be replaced after six years regardless of tread wear. However, heat caused by hot climates or frequent high loading conditions can accelerate the aging process and may require tires to be replaced more frequently.

You should replace your spare tire when you replace the road tires or after six years due to aging even if it has not been used.

## Tires, Wheels and Loading

### U.S. DOT Tire Identification Number (TIN)

Both U.S. and Canada Federal regulations require tire manufacturers to place standardized information on the sidewall of all tires. This information identifies and describes the fundamental characteristics of the tire and also provides a U.S. DOT Tire Identification Number for safety standard certification and in case of a recall.

This begins with the letters “DOT” and indicates that the tire meets all federal standards. The next two numbers or letters are the plant code designating where it was manufactured, the next two are the tire size code and the last four numbers represent the week and year the tire was built. For example, the numbers 317 mean the 31st week of 1997. After 2000 the numbers go to four digits. For example, 2501 means the 25th week of 2001. The numbers in between are identification codes used for traceability. This information is used to contact customers if a tire defect requires a recall.

### Tire replacement requirements

Your vehicle is equipped with tires designed to provide a safe ride and handling capability.



**WARNING:** Only use replacement tires and wheels that are the same size, load index, speed rating and type (such as P-metric versus LT-metric or all-season versus all-terrain) as those originally provided by Ford. The recommended tire and wheel size may be found on either the Safety Compliance Certification Label or the Tire Label which is located on the B-Pillar or edge of the driver's door. If this information is not found on these labels then you should contact your authorized dealer as soon as possible. Use of any tire or wheel not recommended by Ford can affect the safety and performance of your vehicle, which could result in an increased risk of loss of vehicle control, vehicle rollover, personal injury and death. Additionally the use of non-recommended tires and wheels could cause steering, suspension, axle or transfer case/power transfer unit failure. If you have questions regarding tire replacement, contact your authorized dealer as soon as possible.

## Tires, Wheels and Loading



**WARNING:** When mounting replacement tires and wheels, you should not exceed the maximum pressure indicated on the sidewall of the tire to set the beads without additional precautions listed below. If the beads do not seat at the maximum pressure indicated, re-lubricate and try again.

When inflating the tire for mounting pressures up to 20 psi (1.38 bar) greater than the maximum pressure on the tire sidewall, the following precautions must be taken to protect the person mounting the tire:

1. Make sure that you have the correct tire and wheel size.
2. Lubricate the tire bead and wheel bead seat area again.
3. Stand at a minimum of 12 ft (3.66 m) away from the tire wheel assembly.
4. Use both eye and ear protection.

For a mounting pressure more than 20 psi (1.38 bar) greater than the maximum pressure, a Ford dealer or other tire service professional should do the mounting.

Always inflate steel carcass tires with a remote air fill with the person inflating standing at a minimum of 12 ft (3.66 m) away from the tire wheel assembly.

**Important:** Remember to replace the wheel valve stems when the road tires are replaced on your vehicle.

It is recommended that the two front tires or two rear tires generally be replaced as a pair.

The tire pressure sensors mounted in the wheels (originally installed on your vehicle) are not designed to be used in aftermarket wheels.

The use of wheels or tires not recommended by Ford Motor Company may affect the operation of your tire pressure monitoring system.

If the TPMS indicator is flashing, your TPMS is malfunctioning. Your replacement tire might be incompatible with your TPMS, or some component of the TPMS may be damaged.

### Safety practices

Driving habits have a great deal to do with your tire mileage and safety.

- Observe posted speed limits
- Avoid fast starts, stops and turns
- Avoid potholes and objects on the road

208



## Tires, Wheels and Loading

- Do not run over curbs or hit the tire against a curb when parking



**WARNING:** If your vehicle is stuck in snow, mud, sand, etc., **do not** rapidly spin the tires; spinning the tires can tear the tire and cause an explosion. A tire can explode in as little as three to five seconds.



**WARNING:** Do not spin the wheels at over 35 mph (56 km/h). The tires may fail and injure a passenger or bystander.

### Highway hazards

No matter how carefully you drive there's always the possibility that you may eventually have a flat tire on the highway. Drive slowly to the closest safe area out of traffic. This may further damage the flat tire, but your safety is more important.

If you feel a sudden vibration or ride disturbance while driving, or you suspect your tire or vehicle has been damaged, immediately reduce your speed. Drive with caution until you can safely pull off the road. Stop and inspect the tires for damage. If a tire is under-inflated or damaged, deflate it, remove wheel and replace it with your spare tire and wheel. If you cannot detect a cause, have the vehicle towed to the nearest repair facility or tire dealer to have the vehicle inspected.

### Tire and wheel alignment

A bad jolt from hitting a curb or pothole can cause the front end of your vehicle to become misaligned or cause damage to your tires. If your vehicle seems to pull to one side when you're driving, the wheels may be out of alignment. Have an authorized dealer check the wheel alignment periodically.

Wheel misalignment in the front or the rear can cause uneven and rapid treadwear of your tires and should be corrected by an authorized dealer. Front-wheel drive (FWD) vehicles and those with an independent rear suspension (if equipped) may require alignment of all four wheels.

The tires should also be balanced periodically. An unbalanced tire and wheel assembly may result in irregular tire wear.

### Tire rotation

Rotating your tires at the recommended interval (as indicated in the *Scheduled Maintenance Guide* chapter) will help your tires wear more evenly, providing better tire performance and longer tire life.

209

## Tires, Wheels and Loading

- Front-wheel drive (FWD) vehicles  
(front tires at top of diagram)

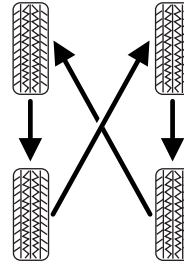

Sometimes irregular tire wear can be corrected by rotating the tires.

**Note:** If your tires show uneven wear ask an authorized dealer to check for and correct any wheel misalignment, tire imbalance or mechanical problem involved before tire rotation.

**Note:** Your vehicle may be equipped with a dissimilar spare tire/wheel. A dissimilar spare tire/wheel is defined as a spare tire and/or wheel that is different in brand, size or appearance from the road tires and wheels. If you have a dissimilar spare tire/wheel it is intended for temporary use only and should not be used in a tire rotation.

**Note:** After having your tires rotated, inflation pressure must be checked and adjusted to the vehicle requirements.

### INFORMATION CONTAINED ON THE TIRE SIDEWALL

Both U.S. and Canada Federal regulations require tire manufacturers to place standardized information on the sidewall of all tires. This information identifies and describes the fundamental characteristics of the tire and also provides a U.S. DOT Tire Identification Number for safety standard certification and in case of a recall.

## Tires, Wheels and Loading

### Information on “P” type tires

P215/65R15 95H is an example of a tire size, load index and speed rating. The definitions of these items are listed below. (Note that the tire size, load index and speed rating for your vehicle may be different from this example.)

1. **P:** Indicates a tire, designated by the Tire and Rim Association (T&RA), that may be used for service on cars, SUVs, minivans and light trucks.

**Note:** If your tire size does not begin with a letter this may mean it is designated by either ETRTO (European Tire and Rim Technical Organization) or JATMA (Japan Tire Manufacturing Association).

2. **215:** Indicates the nominal width of the tire in millimeters from sidewall edge to sidewall edge. In general, the larger the number, the wider the tire.

3. **65:** Indicates the aspect ratio which gives the tire's ratio of height to width.

4. **R:** Indicates a “radial” type tire.

5. **15:** Indicates the wheel or rim diameter in inches. If you change your wheel size, you will have to purchase new tires to match the new wheel diameter.

6. **95:** Indicates the tire's load index. It is an index that relates to how much weight a tire can carry. You may find this information in your owner's guide. If not, contact a local tire dealer.

**Note:** You may not find this information on all tires because it is not required by federal law.

7. **H:** Indicates the tire's speed rating. The speed rating denotes the speed at which a tire is designed to be driven for extended periods of time under a standard condition of load and inflation pressure. The tires on your vehicle may operate at different conditions for load and inflation pressure. These speed ratings may need to be adjusted for the difference in conditions. The ratings range from 81 mph (130 km/h) to 186 mph (299 km/h). These ratings are listed in the following chart.

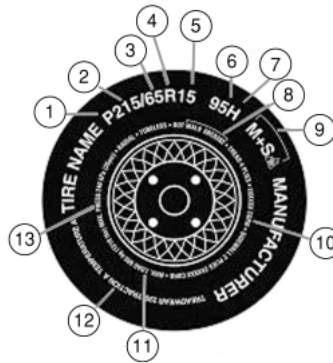

## Tires, Wheels and Loading

**Note:** You may not find this information on all tires because it is not required by federal law.

Letter rating	Speed rating - mph (km/h)
M	81 mph (130 km/h)
N	87 mph (140 km/h)
Q	99 mph (159 km/h)
R	106 mph (171 km/h)
S	112 mph (180 km/h)
T	118 mph (190 km/h)
U	124 mph (200 km/h)
H	130 mph (210 km/h)
V	149 mph (240 km/h)
W	168 mph (270 km/h)
Y	186 mph (299 km/h)

**Note:** For tires with a maximum speed capability over 149 mph (240 km/h), tire manufacturers sometimes use the letters ZR. For those with a maximum speed capability over 186 mph (299 km/h), tire manufacturers always use the letters ZR.

8. **U.S. DOT Tire Identification Number (TIN):** This begins with the letters "DOT" and indicates that the tire meets all federal standards. The next two numbers or letters are the plant code designating where it was manufactured, the next two are the tire size code and the last four numbers represent the week and year the tire was built. For example, the numbers 317 mean the 31st week of 1997. After 2000 the numbers go to four digits. For example, 2501 means the 25th week of 2001. The numbers in between are identification codes used for traceability. This information is used to contact customers if a tire defect requires a recall.

9. **M+S or M/S:** Mud and Snow, or

**AT:** All Terrain, or

**AS:** All Season.

10. **Tire Ply Composition and Material Used:** Indicates the number of plies or the number of layers of rubber-coated fabric in the tire tread and sidewall. Tire manufacturers also must indicate the ply materials in the tire and the sidewall, which include steel, nylon, polyester, and others.

11. **Maximum Load:** Indicates the maximum load in kilograms and pounds that can be carried by the tire. Refer to the Safety Compliance Certification Label, which is located on the B-Pillar or the edge of the driver's door, for the correct tire pressure for your vehicle.

212

## Tires, Wheels and Loading

### 12. Treadwear, Traction and Temperature Grades

- **Treadwear:** The treadwear grade is a comparative rating based on the wear rate of the tire when tested under controlled conditions on a specified government test course. For example, a tire graded 150 would wear one and one-half (1½) times as well on the government course as a tire graded 100.
- **Traction:** The traction grades, from highest to lowest are AA, A, B, and C. The grades represent the tire's ability to stop on wet pavement as measured under controlled conditions on specified government test surfaces of asphalt and concrete. A tire marked C may have poor traction performance.
- **Temperature:** The temperature grades are A (the highest), B and C, representing the tire's resistance to the generation of heat and its ability to dissipate heat when tested under controlled conditions on a specified indoor laboratory test wheel.

13. **Maximum Permissible Inflation Pressure:** Indicates the tire manufacturers' maximum permissible pressure and/or the pressure at which the maximum load can be carried by the tire. This pressure is normally higher than the manufacturer's recommended cold inflation pressure which can be found on the Safety Compliance Certification Label or Tire Label which is located on the B-Pillar or the edge of the driver's door. The cold inflation pressure should never be set lower than the recommended pressure on the vehicle label.

The tire suppliers may have additional markings, notes or warnings such as standard load, radial tubeless, etc.

## Tires, Wheels and Loading

### Additional information contained on the tire sidewall for “LT” type tires

“LT” type tires have some additional information beyond those of “P” type tires; these differences are described below.

**Note:** Tire Quality Grades do not apply to this type of tire.

1. **LT:** Indicates a tire, designated by the Tire and Rim Association (T&RA), that is intended for service on light trucks.

#### 2. Load Range/Load Inflation

**Limits:** Indicates the tire’s load-carrying capabilities and its inflation limits.

3. **Maximum Load Dual lb (kg) at psi (kPa) cold:** Indicates the maximum load and tire pressure when the tire is used as a dual; defined as four tires on the rear axle (a total of six or more tires on the vehicle).

4. **Maximum Load Single lb (kg) at psi (kPa) cold:** Indicates the maximum load and tire pressure when the tire is used as a single; defined as two tires (total) on the rear axle.

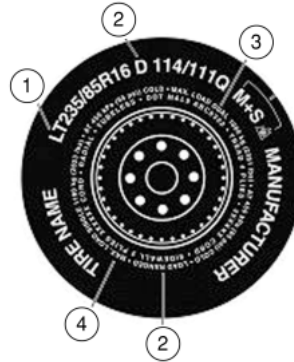

## Tires, Wheels and Loading

### Information on “T” type tires

“T” type tires have some additional information beyond those of “P” type tires; these differences are described below:

T145/80D16 is an example of a tire size.

**Note:** The temporary tire size for your vehicle may be different from this example. Tire Quality Grades do not apply to this type of tire.

1. **T:** Indicates a type of tire, designated by the Tire and Rim Association (T&RA), that is intended for temporary service on cars, SUVs, minivans and light trucks.

2. **145:** Indicates the nominal width of the tire in millimeters from sidewall edge to sidewall edge. In general, the larger the number, the wider the tire.

3. **80:** Indicates the aspect ratio which gives the tire’s ratio of height to width. Numbers of 70 or lower indicate a short sidewall.

4. **D:** Indicates a “diagonal” type tire.

**R:** Indicates a “radial” type tire.

5. **16:** Indicates the wheel or rim diameter in inches. If you change your wheel size, you will have to purchase new tires to match the new wheel diameter.

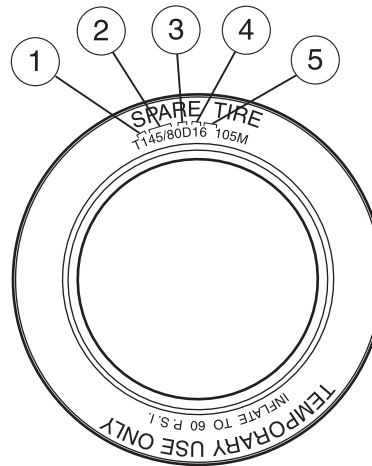

### Location of the tire label

You will find a Tire Label containing tire inflation pressure by tire size and other important information located on the B-Pillar or the edge of the driver’s door. Refer to the payload description and graphic in the *Vehicle loading* section.

## Tires, Wheels and Loading

### TIRE PRESSURE MONITORING SYSTEM (TPMS)

Each tire, including the spare (if provided), should be checked monthly when cold and inflated to the inflation pressure recommended by the vehicle manufacturer on the vehicle placard or tire inflation pressure label. (If your vehicle has tires of a different size than the size indicated on the vehicle placard or tire inflation pressure label, you should determine the proper tire inflation pressure for those tires.)

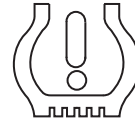

As an added safety feature, your vehicle has been equipped with a tire pressure monitoring system (TPMS) that illuminates a low tire pressure telltale when one or more of your tires is significantly under-inflated. Accordingly, when the low tire pressure telltale illuminates, you should stop and check your tires as soon as possible, and inflate them to the proper pressure. Driving on a significantly under-inflated tire causes the tire to overheat and can lead to tire failure. Under-inflation also reduces fuel efficiency and tire tread life, and may affect the vehicle's handling and stopping ability.

Please note that the TPMS is not a substitute for proper tire maintenance, and it is the driver's responsibility to maintain correct tire pressure, even if under-inflation has not reached the level to trigger illumination of the TPMS low tire pressure telltale.

Your vehicle has also been equipped with a TPMS malfunction indicator to indicate when the system is not operating properly. The TPMS malfunction indicator is combined with the low tire pressure telltale. When the system detects a malfunction, the telltale will flash for approximately one minute and then remain continuously illuminated. This sequence will continue upon subsequent vehicle start-ups as long as the malfunction exists.

When the malfunction indicator is illuminated, the system may not be able to detect or signal low tire pressure as intended. TPMS malfunctions may occur for a variety of reasons, including the installation of replacement or alternate tires or wheels on the vehicle that prevent the TPMS from functioning properly. Always check the TPMS malfunction telltale after replacing one or more tires or wheels on your vehicle to ensure that the replacement or alternate tires and wheels allow the TPMS to continue to function properly.



## Tires, Wheels and Loading

The tire pressure monitoring system complies with part 15 of the FCC rules and with RSS-210 of Industry Canada. Operation is subject to the following two conditions: (1) This device may not cause harmful interference, and (2) This device must accept any interference received, including interference that may cause undesired operation.



**WARNING:** The tire pressure monitoring system is NOT a substitute for manually checking tire pressure. The tire pressure should be checked periodically (at least monthly) using a tire gauge, see *Inflating your tires* in this chapter. Failure to properly maintain your tire pressure could increase the risk of tire failure, loss of control, vehicle rollover and personal injury.

### Changing tires with a TPMS

**Each road tire is equipped with a tire pressure sensor located inside the tire/wheel cavity. The pressure sensor is attached to the valve stem. The pressure sensor is covered by the tire and is not visible unless the tire is removed. Care must be taken when changing the tire to avoid damaging the sensor.** It is

recommended that you always have your tires serviced by an authorized dealer.

The tire pressure should be checked periodically (at least monthly) using an accurate tire gauge, refer to *Inflating your tires* in this chapter.

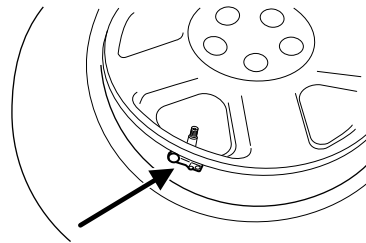

## Tires, Wheels and Loading

### **Understanding your tire pressure monitoring system (TPMS)**

The tire pressure monitoring system measures pressure in your four road tires and sends the tire pressure readings to your vehicle. The low tire pressure warning light will turn on if the tire pressure is significantly low. Once the light is illuminated, your tires are under-inflated and need to be inflated to the manufacturer's recommended tire pressure. Even if the light turns on and a short time later turns off, your tire pressure still needs to be checked. Visit [www.checkmytires.org](http://www.checkmytires.org) for additional information.

### ***When your temporary spare tire is installed***

When one of your road tires needs to be replaced with the temporary spare, the TPMS will continue to identify an issue to remind you that the damaged road wheel/tire needs to be repaired and put back on your vehicle.

To restore the full functionality of the tire pressure monitoring system, have the damaged road wheel/tire repaired and remounted on your vehicle. For additional information, refer to *Changing tires with a TPMS* in this section.

## Tires, Wheels and Loading

### ***When you believe your system is not operating properly***

The main function of the tire pressure monitoring system is to warn you when your tires need air. It can also warn you in the event the system is no longer capable of functioning as intended. Please refer to the following chart for information concerning your tire pressure monitoring system:

<b>Low tire pressure warning light</b>	<b>Possible cause</b>	<b>Customer action required</b>
Solid warning light	Tire(s) under-inflated	1. Check your tire pressure to ensure tires are properly inflated; refer to <i>Inflating your tires</i> in this chapter. 2. After inflating your tires to the manufacturer's recommended inflation pressure as shown on the Tire Label (located on the edge of driver's door or the B-Pillar), the vehicle must be driven for at least two minutes over 20 mph (32 km/h) before the light will turn off.
	Spare tire in use	Your temporary spare tire is in use. Repair the damaged road wheel/tire and reinstall it on the vehicle to restore system functionality. For a description on how the system functions, refer to <i>When your temporary spare tire is installed</i> in this section.
	TPMS malfunction	If your tires are properly inflated and your spare tire is not in use and the light remains on, contact your authorized dealer as soon as possible.
Flashing warning light	Spare tire in use	Your temporary spare tire is in use. Repair the damaged road wheel and re-mount it on the vehicle to restore system functionality. For a description of how the system functions under these conditions, refer to <i>When your temporary spare tire is installed</i> in this section.
	TPMS malfunction	If your tires are properly inflated and your spare tire is not in use and the TPMS warning light still flashes, contact your authorized dealer as soon as possible.

## Tires, Wheels and Loading

### ***When inflating your tires***

When putting air into your tires (such as at a gas station or in your garage), the tire pressure monitoring system may not respond immediately to the air added to your tires.

It may take up to two minutes of driving over 20 mph (32 km/h) for the light to turn off after you have filled your tires to the recommended inflation pressure.

### ***How temperature affects your tire pressure***

The tire pressure monitoring system (TPMS) monitors tire pressure in each pneumatic tire. While driving in a normal manner, a typical passenger tire inflation pressure may increase approximately 2 to 4 psi (14 to 28 kPa) from a cold start situation. If the vehicle is stationary overnight with the outside temperature significantly lower than the daytime temperature, the tire pressure may decrease approximately 3 psi (21 kPa) for a drop of 30°F (17°C) in ambient temperature. This lower pressure value may be detected by the TPMS as being significantly lower than the recommended inflation pressure and activate the TPMS warning light for low tire pressure. If the low tire pressure warning light is on, visually check each tire to verify that no tire is flat. (If one or more tires are flat, repair as necessary.) Check air pressure in the road tires. If any tire is under-inflated, carefully drive the vehicle to the nearest location where air can be added to the tires. Inflate all the tires to the recommended inflation pressure.

## SNOW TIRES AND CHAINS



**WARNING:** Snow tires must be the same size, load index, speed rating as those originally provided by Ford. Use of any tire or wheel not recommended by Ford can affect the safety and performance of your vehicle, which could result in an increased risk of loss of vehicle control, vehicle rollover, personal injury and death. Additionally, the use of non-recommended tires and wheels could cause steering, suspension, axle or transfer case/power transfer unit failure.

The original equipment tires on your vehicle have an all-weather tread design to provide traction, handling and braking performance in year-round driving. You may install snow tires for improved traction when driving in areas with sustained periods of snow or icy driving conditions.

220

## Tires, Wheels and Loading

If you choose to install snow tires on your vehicle, they must be the same size, construction, and load range as the original tires listed on the tire placard, and they must be installed on all four wheels. Mixing tires of different size or construction on your vehicle can adversely affect your vehicle's handling and braking, and may lead to loss of vehicle control.



**WARNING:** Do not use snow chains or cables on this vehicle as they may cause damage to your vehicle which may lead to loss of vehicle control.

### VEHICLE LOADING

This section will guide you in the proper loading of your vehicle to keep your loaded vehicle weight within its design rating capability. Properly loading your vehicle will provide maximum return of vehicle design performance. Before loading your vehicle, familiarize yourself with the following terms for determining your vehicle's weight ratings from the vehicle's Tire Label or Safety Compliance Certification Label:

**Base Curb Weight** – is the weight of the vehicle including a full tank of fuel and all standard equipment. It does not include passengers, cargo, or optional equipment.

**Vehicle Curb Weight** – is the weight of your new vehicle when you picked it up from your authorized dealer plus any aftermarket equipment.

## Tires, Wheels and Loading



**Payload** – is the combined weight of cargo and passengers that the vehicle is carrying. The maximum payload for your vehicle can be found on the Tire Label on the B-Pillar or the edge of the driver's door (vehicles exported outside the US and Canada may not have a Tire Label). Look for **“THE COMBINED WEIGHT OF OCCUPANTS AND CARGO SHOULD NEVER EXCEED XXX kg OR XXX lb.”** for maximum payload. The payload listed on the Tire Label is the maximum payload for the vehicle as built by the assembly plant. If any aftermarket or authorized-dealer installed equipment has been installed on the vehicle, the weight of the equipment must be subtracted from the payload listed on the Tire Label in order to determine the new payload.



**WARNING:** The appropriate loading capacity of your vehicle can be limited either by volume capacity (how much space is available) or by payload capacity (how much weight the vehicle should carry). Once you have reached the maximum payload of your vehicle, do not add more cargo, even if there is space available. Overloading or improperly loading your vehicle can contribute to loss of vehicle control and vehicle rollover.

## Tires, Wheels and Loading

Example only:

TIRE AND LOADING INFORMATION				
SEATING CAPACITY		TOTAL 5	FRONT 2	REAR 3
The combined weight of occupants and cargo should never exceed : <b>XXX kg or XXX lbs.</b>				
TIRE	SIZE	COLD TIRE PRESSURE		SEE OWNERS MANUAL FOR ADDITIONAL INFORMATION
FRONT	LT225/75R 16.5E	200 KPA, 29 PSI		
REAR	LT225/75R 16.5E	200 KPA, 29 PSI		
SPARE	T145/80D16 P225/60R17	420 KPA, 60 PSI 200 KPA, 29 PSI		

TIRE AND LOADING INFORMATION				
RENSEIGNEMENTS SUR LES PNEUS ET LE CHARGEMENT				
SEATING CAPACITY		TOTAL 5	FRONT 2	REAR 3
NOMBRE DE PLACES		TOTAL 5	AVANT 2	ARRIERE 3
The combined weight of occupants and cargo should never exceed 492 kg or 1085 lbs. Le poids total des occupants et du chargement ne doit jamais dépasser 492 kg ou 1085 lb.				
TIRE PNEU	SIZE DIMENSIONS	COLD TIRE PRESSURE PRESSION DES PNEUS A FROID		SEE OWNER'S MANUAL FOR ADDITIONAL INFORMATION  VOIR LE MANUEL DE L'USAGER POUR PLUS DE RENSEIGNEMENTS
FRONT AVANT	P235/70R16	240 KPA, 35 PSI		
REAR ARRIERE	P235/70R16	240 KPA, 35 PSI		
SPARE DE SECOURS	T145/90R17	415 KPA, 60 PSI		

**CARGO =**



**Cargo Weight** – includes all weight added to the Base Curb Weight, including cargo and optional equipment.

**GAW (Gross Axle Weight)** – is the total weight placed on each axle (front and rear) – including vehicle curb weight and all payload.

## Tires, Wheels and Loading

**GAWR (Gross Axle Weight Rating)** – is the maximum allowable weight that can be carried by a single axle (front or rear). **These numbers are shown on the Safety Compliance Certification Label located on the B-Pillar or the edge of the driver's door. The total load on each axle must never exceed its GAWR.**

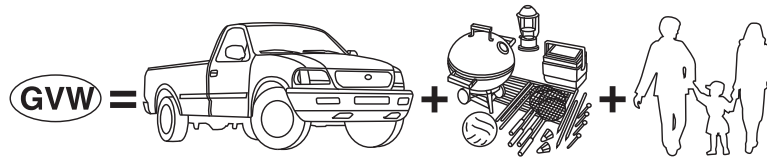

**GVW (Gross Vehicle Weight)** – is the Vehicle Curb Weight + cargo + passengers.

**GVWR (Gross Vehicle Weight Rating)** – is the maximum allowable weight of the fully loaded vehicle (including all options, equipment, passengers and cargo). **The GVWR is shown on the Safety Compliance Certification Label located on the B-Pillar or the edge of the driver's door. The GVW must never exceed the GVWR.**



## Tires, Wheels and Loading

- Example only:

**MFD. BY FORD MOTOR CO.**

DATE: XX/XX GVWR: XXXXXLB/ XXXXXKG  
 FRONT GAWR: XXXXL REAR GAWR: XXXXLB  
 XXXXKG WITH XXXXKG WITH  
 XXXX/XXXXXXXXX TIRES XXXX/XXXXXXXXX TIRES  
 XXXX.XX RIMS XXXX.XX RIMS  
 AT XXX kPa/XX PSI COLD AT XXX kPa/XX PSI COLD

THIS VEHICLE CONFORMS TO ALL APPLICABLE FEDERAL MOTOR VEHICLE SAFETY STANDARDS IN EFFECT ON THE DATE OF MANUFACTURE SHOWN ABOVE.

VIN: XXXXXXXXXXXXXXXXXXXX XXXXX  
 TYPE: XXX XXXXX

XXXXXXXXXXXXXXXX XXX XXXX-XXXXXX-XX

EXT PNT: XX RC: XX DSO:  
 WB INT TR TP/PS R AXLE TR SPR XXXXX  
 XXX XX X XX X XX XXX

XXXXXXXXXXXXXXXX XXX XXXX-XXXXXX-XX

**MFD. BY FORD MOTOR CO.**

DATE: XX/XX GVWR/PNBV: XXXX LB/XXXXKG  
 FRONT GAWR/PNBE AV REAR GAWR/PNBE AR  
 XXXX/XXXXB XXXXKG/XXXXLB  
 WITH/AVEC TIRES/PNEUS  
 XXXX/XXXXX RIMS/JANTES XXXXXX  
 XXXX/XXXXX  
 XXXX/XXXXX  
 XXXXXX

AT/A kPa/PSI/LPC XXX/XX COLD/A FROID XXX/XX  
 /JUMEELES

VIN: XXXXXXXXXXXXXXXXXXXX XXXXX  
 TYPE: XXX/XXXX COMPLIES: XXXX/XXX-XXX XXXXX  
 XXXXXX

XXXXXXXXXXXXXXXX XXX XXXX-XXXXXX-XX

EXT PNT: JJ RC: XX DSO:  
 WB INT TR TP/PS R AXLE TR SPR XXXXX  
 XXX XX X XX X XXXX XXX

XXXXXXXXXXXXXXXX XXX XXXX-XXXXXX-XX

**!** **WARNING:** Exceeding the Safety Compliance Certification Label vehicle weight rating limits could result in substandard vehicle handling or performance, engine, transmission and/or structural damage, serious damage to the vehicle, loss of control and personal injury.

**!** **WARNING:** Do not exceed the GVWR or the GAWR specified on the Safety Compliance Certification Label.

## Tires, Wheels and Loading



**WARNING:** Do not use replacement tires with lower load carrying capacities than the original tires because they may lower the vehicle's GVWR and GAWR limitations. Replacement tires with a higher limit than the original tires do not increase the GVWR and GAWR limitations.



**WARNING:** Exceeding any vehicle weight rating limitation could result in serious damage to the vehicle and/or personal injury.

### Steps for determining the correct load limit:

1. Locate the statement "The combined weight of occupants and cargo should never exceed XXX kg or XXX lbs." on your vehicle's placard.
2. Determine the combined weight of the driver and passengers that will be riding in your vehicle.
3. Subtract the combined weight of the driver and passengers from XXX kg or XXX lbs.
4. The resulting figure equals the available amount of cargo and luggage load capacity. For example, if the "XXX" amount equals 1,400 lbs. and there will be five 150 lb. passengers in your vehicle, the amount of available cargo and luggage load capacity is 650 lbs. ( $1400 - 750 (5 \times 150) = 650$  lb.). In metric units ( $635 - 340 (5 \times 68) = 295$  kg.)
5. Determine the combined weight of luggage and cargo being loaded on the vehicle. That weight may not safely exceed the available cargo and luggage load capacity calculated in Step 4.

The following gives you a few examples on how to calculate the available amount of cargo and luggage load capacity:

- Another example for your vehicle with 1400 lb. (635 kg) of cargo and luggage capacity. You decide to go golfing. Is there enough load capacity to carry you, 4 of your friends and all the golf bags? You and four friends average 220 lb. (99 kg) each and the golf bags weigh approximately 30 lb. (13.5 kg) each. The calculation would be:  $1400 - (5 \times 220) - (5 \times 30) = 1400 - 1100 - 150 = 150$  lb. Yes, you have enough load capacity in your vehicle to transport four friends and your golf bags. In metric units, the calculation would be:  $635 \text{ kg} - (5 \times 99 \text{ kg}) - (5 \times 13.5 \text{ kg}) = 635 - 495 - 67.5 = 72.5$  kg.

## Tires, Wheels and Loading

- A final example for your vehicle with 1400 lb. (635 kg) of cargo and luggage capacity. You and one of your friends decide to pick up cement from the local home improvement store to finish that patio you have been planning for the past 2 years. Measuring the inside of the vehicle with the rear seat folded down, you have room for 12-100 lb. (45 kg) bags of cement. Do you have enough load capacity to transport the cement to your home? If you and your friend each weigh 220 lb. (99 kg), the calculation would be:  $1400 - (2 \times 220) - (12 \times 100) = 1400 - 440 - 1200 = -240$  lb. No, you do not have enough cargo capacity to carry that much weight. In metric units, the calculation would be:  $635 \text{ kg} - (2 \times 99 \text{ kg}) - (12 \times 45 \text{ kg}) = 635 - 198 - 540 = -103$  kg. You will need to reduce the load weight by at least 240 lb. (104 kg). If you remove 3-100 lb. (45 kg) cement bags, then the load calculation would be:  
 $1400 - (2 \times 220) - (9 \times 100) = 1400 - 440 - 900 = 60$  lb. Now you have the load capacity to transport the cement and your friend home. In metric units, the calculation would be:  $635 \text{ kg} - (2 \times 99 \text{ kg}) - (9 \times 45 \text{ kg}) = 635 - 198 - 405 = 32$  kg.

The above calculations also assume that the loads are positioned in your vehicle in a manner that does not overload the Front or the Rear Gross Axle Weight Rating specified for your vehicle on the Safety Compliance Certification Label found on the edge of the driver's door.

### TRAILER TOWING



**WARNING:** Never tow a trailer with this vehicle. Your vehicle is not equipped to tow. No towing packages are available through an authorized dealer.

### RECREATIONAL TOWING

Follow these guidelines if you have a need for recreational (RV) towing. An example of recreational towing would be towing your vehicle behind a motor home.

**Note:** Put your climate control system in recirculated air mode to prevent exhaust fumes from entering the vehicle. Refer to the *Climate Controls* chapter for more information.

In case of a roadside emergency with a disabled vehicle, see *Wrecker towing* in the *Roadside Emergencies* chapter.

These guidelines are designed to ensure that your transmission is not damaged.

## Tires, Wheels and Loading

Before you tow your vehicle, follow these directions for your specific vehicle configuration after it is hooked-up to the RV or tow dolly:

### **Vehicles with a manual transmission:**

1. Release the parking brake.
2. Move the gearshift to the neutral position.
3. The maximum towing speed is 70 mph (113 km/h).
4. There is no limitation on towing distance.

**Note:** The vehicle must be towed in the forward position to ensure no damage is done to the internal transmission components. In addition, it is recommended that you follow the instructions provided by the aftermarket manufacturer of the towing equipment, if provided.

### **Vehicles with an automatic transmission but no push button start system:**

1. Release the parking brake.
2. Turn the ignition to the on (II) position.
3. Press the brake pedal, then move the gearshift to the N (Neutral) position. There **must** be battery power to properly move the transmission's internal components to N (Neutral). Also, moving the gearshift to the N (Neutral) without first turning the ignition to the on (II) position limits the towing capability to 35 mph (56 km/h) and 50 miles (80 km).
4. Turn the ignition key to the off (0) position.
5. Disconnect the negative (black) cable from the battery. (The anti-theft system is disabled until the battery cable is reconnected.) Refer to *Battery* in the *Maintenance and Specifications* chapter when disconnecting and reconnecting the battery cable.
6. The maximum towing speed is 70 mph (113 km/h).
7. There is no limitation on towing distance.
8. When done towing, start the engine within 15 minutes of reconnecting the battery cable. When reconnecting that cable, tighten it until it's snug against the terminal; be careful not to overtighten.

**Note:** The vehicle must be towed in the forward position to ensure no damage is done to the internal transmission components. In addition, it is recommended that you follow the instructions provided by the aftermarket manufacturer of the towing equipment, if provided.

## Tires, Wheels and Loading

### **Vehicles with an automatic transmission and push button start system:**

1. Release the parking brake.
2. Activate the ignition by pressing the START/STOP button, but **not** applying the brake pedal.
3. Press the brake pedal, then move the gearshift to the N (Neutral) position. There **must** be battery power to properly move the transmission's internal components to N (Neutral). Also, moving the gearshift to the N (Neutral) without first having the ignition on limits the towing capability to 35 mph (56 km/h) and 50 miles (80 km).
4. Deactivate the ignition by pressing the START/STOP button, but **not** applying the brake pedal.
5. Disconnect the negative (black) cable from the battery. (The door key [inside the Intelligent Access Key] is needed to lock/unlock doors when the battery cable is disconnected. Also, the anti-theft system is disabled until the battery cable is reconnected.) Refer to *Battery* in the *Maintenance and Specifications* chapter when disconnecting and reconnecting the battery cable.
6. The maximum towing speed is 70 mph (113 km/h).
7. There is no limitation on towing distance.
8. When done towing, start the engine within 15 minutes of reconnecting the battery cable. When reconnecting that cable, tighten it until it's snug against the terminal; be careful not to overtighten.

**Note:** The vehicle must be towed in the forward position to ensure no damage is done to the internal transmission components. In addition, it is recommended that you follow the instructions provided by the aftermarket manufacturer of the towing equipment, if provided.

## Driving

### STARTING

#### Positions of the ignition

If your vehicle is equipped with a push button start system, refer to *Push button start system* in this section for ignition modes.

1. 0 (off) — locks the steering wheel, automatic transmission gearshift lever and allows key removal. This position also shuts the engine and all electrical accessories off.

2. I (accessory) — allows the electrical accessories such as the radio to operate while the engine is not running.

3. II (on) — all electrical circuits operational. Warning lights illuminated. Key position when driving.

4. III (start) — cranks the engine. Release the key as soon as the engine starts.

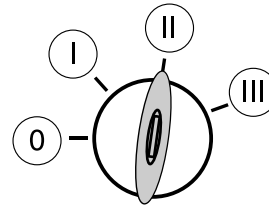

#### Preparing to start your vehicle

Engine starting is controlled by the powertrain control system.

This system meets all Canadian interference-causing equipment standard requirements regulating the impulse electrical field strength of radio noise.

When starting a fuel-injected engine, don't press the accelerator before or during starting. Only use the accelerator when you have difficulty starting the engine. For more information on starting the vehicle, refer to *Starting the engine* in this chapter.



**WARNING:** Extended idling at high engine speeds can produce very high temperatures in the engine and exhaust system, creating the risk of fire or other damage.

## Driving

 **WARNING:** Do not park, idle, or drive your vehicle in dry grass or other dry ground cover. The emission system heats up the engine compartment and exhaust system, which can start a fire.

 **WARNING:** Do not start your vehicle in a closed garage or in other enclosed areas. Exhaust fumes can be toxic. Always open the garage door before you start the engine. See *Guarding against exhaust fumes* in this chapter for more instructions.

 **WARNING:** If you smell exhaust fumes inside your vehicle, have your dealer inspect your vehicle immediately. Do not drive if you smell exhaust fumes.

### **Important safety precautions**

When the engine starts, the idle RPM runs faster to warm the engine. If the engine idle speed does not slow down automatically, have the vehicle checked.

Before starting the vehicle:

1. Make sure all occupants buckle their safety belts. For more information on safety belts and their proper usage, refer to the *Seating and Safety Restraints* chapter.
2. Make sure the headlamps and electrical accessories are off.

If starting a vehicle with an automatic transmission:

- Make sure the parking brake is set.

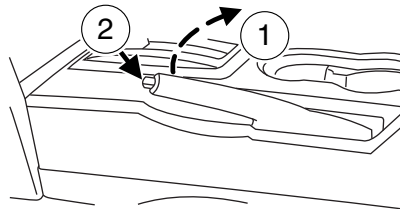

## Driving

- Make sure the gearshift is in P (Park).

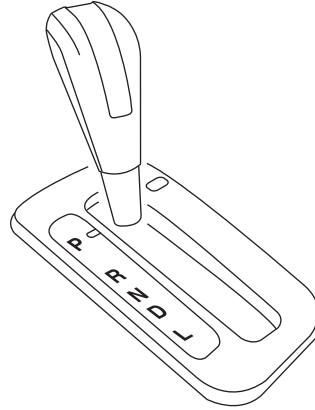

If starting a vehicle with a manual transmission:

- Make sure the parking brake is set.
- Press the clutch pedal to the floor.

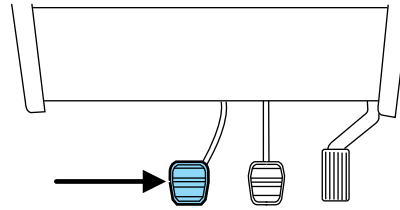

3. Turn the key to II (on) without turning the key to III (start).

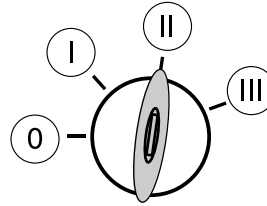

Some warning lights will briefly illuminate. See *Warning lights and chimes* in the *Instrument Cluster* chapter for more information regarding the warning lights.

### Starting the engine

**Note:** If your vehicle is equipped with a push button start system, refer to *Push button start system* in this section for starting.

232



## Driving

1. Turn the key to II (on) without turning the key to III (start).
2. Turn the key to III (start), then release the key as soon as the engine begins cranking. Your vehicle has a computer assisted cranking system that assists in starting the engine. After releasing the key from the III (start) position, the engine may continue cranking for up to 10 seconds or until the vehicle starts.

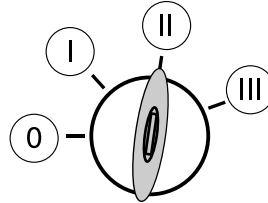

**Note:** Cranking may be stopped at any time by turning the key to the off position.

3. After idling for a few seconds, release the parking brake, apply the brake, shift into gear and drive.

**Note:** If the engine does not start on the first try, turn the vehicle to the off position, wait 10 seconds and try Step 2 again. If the engine still fails to start, press the accelerator to the floor and try Step 2 again, keeping the accelerator on the floor until the engine begins to accelerate above cranking speeds; this will allow the engine to crank with the fuel shut off in case the engine is flooded with fuel.

### Push button start system (if equipped)

If your vehicle is equipped with the push button start system, you can start your vehicle by pressing the start button in combination with the brake pedal (automatic transmission) or clutch pedal (manual transmission) rather than using a key. The start button is located on the instrument panel to the right of the steering wheel.

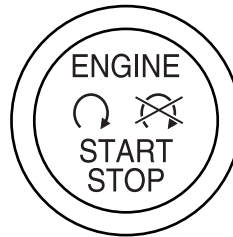

In order to operate the push button start system and start the vehicle, your intelligent access key (IA key) must be present inside the vehicle.

### Ignition modes

1. Off — press and release the START/STOP button without applying the brake pedal (automatic transmission) or clutch pedal (manual transmission) when your vehicle is in on mode or when the engine is running.

## Driving

2. On — press the START/STOP button without applying the brake pedal (automatic transmission) or clutch pedal (manual transmission). This will power your vehicle's electrical system and the warning lights in the instrument cluster will illuminate, but the engine will remain off.

3. Start — press the START/STOP button (for any length of time) while applying the brake pedal (automatic transmission) or clutch pedal (manual transmission). **Note:** The indicator light on the start button will illuminate when the vehicle is in on mode and when the engine is started.

There may be areas inside your vehicle where the IA key is not detected. If the message KEY NOT DETECTED appears on your multifunction display when you press the START/STOP button, it may be necessary to move your IA key to another area within the vehicle. The IA key may not be detected near the roof (between the driver or passenger sunvisor and the roof, or in the overhead console area) or in the extreme corners of the rear package tray, near your audio speakers. It is not recommended that you stow the IA key in these locations. If you move the IA key to a location where it has been detected before and you still see the KEY NOT DETECTED message, your IA key's battery may be low or you may be in an area with excessive radio frequency interference. If this occurs, you can use the backup method to start your vehicle (see below).

**Backup method of starting:** Your IA key uses a radio frequency signal to communicate with your vehicle and authorize your vehicle to start when you press the START/STOP button and apply the brake pedal or clutch pedal. If excessive radio frequency interference is present in the area, or if the battery in your IA key is low, it may be necessary to start your car by holding the IA key

to the backup location near the steering column. After holding the IA key to the backup location, use the START/STOP button and brake pedal (automatic transmission) or clutch pedal (manual transmission) to start your vehicle as usual. The vehicle should respond normally as long as the IA key is at the backup location on the steering column. Once the vehicle is started, the IA key can be moved from the backup location, if desired.

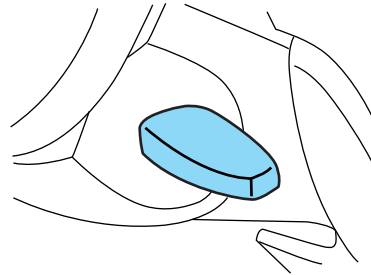

## Driving

**Fast restart feature:** The fast restart feature allows you to re-start your vehicle within 10 seconds of switching the vehicle off, if a valid IA key is not present when the vehicle is switched off. You can re-start the vehicle (by applying the brake/clutch pedal and pressing the START/STOP button) for up to 10 seconds, even though the IA key is not present. After 10 seconds have expired, you can no longer start your vehicle without the IA key present inside the vehicle. If the driver door is opened within this 10 seconds, the fast restart timer expires immediately.

**Switching the vehicle off when not in P (Park):** It is recommended that you shift into the P (Park) position before switching your vehicle off. If you switch your vehicle off with the shifter in any position other than P (Park), the message SHIFT TO PARK will be displayed in the multifunction display. If the vehicle is left in this state, your key in ignition chime will activate when the driver door is opened, and you may drain your vehicle's battery. In order to avoid draining your battery, it is recommended that you always shift to P (Park) before or immediately after switching your vehicle off.

**Absence of the intelligent access key:** Once the vehicle has started, the vehicle will remain running until being turned off by the START/STOP button, even if the IA key is no longer found in the vehicle. Whenever a door is opened and then closed while the vehicle is running, the system will search for an IA key inside the vehicle and the multifunction display will display KEY OUTSIDE CAR if the IA key is no longer present. This message is a reminder that someone else in the vehicle may have taken the IA key when exiting the vehicle. If the IA key is no longer present in the vehicle, you will not be able to re-start your vehicle outside of the Fast Restart time (see *Fast Restart Feature* above). It is important to be aware of where your IA key is located in the vehicle, to avoid becoming stranded without an IA key.

### Guarding against exhaust fumes

Carbon monoxide is present in exhaust fumes. Take precautions to avoid its dangerous effects.



**WARNING:** If you smell exhaust fumes inside your vehicle, have your dealer inspect your vehicle immediately. Do not drive if you smell exhaust fumes.

## Driving

### Important ventilating information

If the engine is idling while the vehicle is stopped for a long period of time, open the windows at least 1 inch (2.5 cm) or adjust the heating or air conditioning to bring in fresh air.

### ENGINE BLOCK HEATER (IF EQUIPPED)

An engine block heater warms the engine coolant which aids in starting and allows the heater/defroster system to respond quickly. If your vehicle is equipped with this system, your equipment includes a heater element which is installed in your engine block and a wire harness which allows the user to connect the system to a grounded 120 volt A/C electrical source. The block heater system is most effective when outdoor temperatures reach below 0°F (-18°C).



**WARNING:** Failure to follow engine block heater instructions could result in property damage or physical injury.



**WARNING:** To reduce the risk of electrical shock, do not use your heater with ungrounded electrical systems or two-pronged (cheater) adapters.

Prior to using the engine block heater, follow these recommendations for proper and safe operation:

- For your safety, use an outdoor extension cord that is product certified by Underwriter's Laboratory (UL) or Canadian Standards Association (CSA). Use only an extension cord that can be used outdoors, in cold temperatures, and is clearly marked "Suitable for Use with Outdoor Appliances." Never use an indoor extension cord outdoors; it could result in an electric shock or fire hazard.
- Use a 16-gauge outdoor extension cord, minimum.
- Use as short an extension cord as possible.
- Do not use multiple extension cords. Instead, use one extension cord which is long enough to reach from the engine block heater cord to the outlet without stretching.
- Make certain that the extension cord is in excellent condition (not patched or spliced). Store your extension cord indoors at temperatures above 32°F (0°C). Outdoor conditions can deteriorate extension cords over a period of time.

236

## Driving

- To reduce the risk of electrical shock, do not use your heater with ungrounded electrical systems or two pronged (cheater) adapters. Also ensure that the block heater, especially the cord, is in good condition before use.
- Make sure that when in operation, the extension cord plug/engine block heater cord plug connection is free and clear of water in order to prevent possible shock or fire.
- Be sure that areas where the vehicle is parked are clean and clear of all combustibles such as petroleum products, dust, rags, paper and similar items.
- Be sure that the engine block heater, heater cord and extension cord are solidly connected. A poor connection can cause the cord to become very hot and may result in an electrical shock or fire. Be sure to check for heat anywhere in the electrical hookup once the system has been operating for approximately a half hour.
- Finally, have the engine block heater system checked during your fall tune-up to be sure it's in good working order.

### **How to use the engine block heater**

Ensure the receptacle terminals are clean and dry prior to use. To clean them, use a dry cloth.

Depending on the type of factory installed equipment, your engine block heater will use .4 to 1.0 kilowatt-hours of energy per hour of use. Your factory installed block heater system does not have a thermostat; however, maximum temperature is attained after approximately three hours of operation. Block heater operation longer than three hours will not improve system performance and will unnecessarily use additional electricity.

Make sure system is unplugged and properly stowed before driving the vehicle. While not in use, make sure the protective cover seals the prongs of the engine block heater cord plug.

### **BRAKES**

Occasional brake noise is normal. If a metal-to-metal, continuous grinding or continuous squeal sound is present, the brake linings may be worn-out and should be inspected by an authorized dealer. If the vehicle has continuous vibration or shudder in the steering wheel while braking, the vehicle should be inspected by an authorized dealer.

237

## Driving

Refer to *Warning lights and chimes* in the *Instrument Cluster* chapter for information on the brake system warning light.

## BRAKE

Under normal operating conditions, brake dust may accumulate on the wheels. Some brake dust is inevitable as brakes wear and does not contribute to brake noise. The use of modern friction materials with emphasis on improved performance and environmental considerations can lead to more dust than in the past. Brake dust can be cleaned by weekly washing with soapy water and a soft sponge. Heavier deposits can be removed with Motorcraft® Wheel and Tire Cleaner (ZC-37-A).

### Four-wheel anti-lock brake system (ABS)

Your vehicle is equipped with an anti-lock braking system (ABS). This system helps you maintain steering control during emergency stops by keeping the brakes from locking. Noise from the ABS pump motor and brake pedal pulsation may be observed during ABS braking and the brake pedal may suddenly travel a little farther as soon as ABS braking is done and normal brake operation resumes. These are normal characteristics of the ABS and should be no reason for concern.

### Using ABS

When hard braking is required, apply continuous force on the brake pedal. Do not pump the brake pedal since this will reduce the effectiveness of the ABS and will increase your vehicle's stopping distance. The ABS will be activated immediately, allowing you to retain steering control during hard braking and on slippery surfaces. However, the ABS does not decrease stopping distance.

### ABS warning lamp

The ABS lamp in the instrument cluster momentarily illuminates when the ignition is turned on. If the light does not illuminate during start up, remains on or flashes, the ABS may be disabled and may need to be serviced.

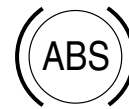

Even when the ABS is disabled, normal braking is still effective. (If your BRAKE warning lamp illuminates with the parking brake released, have your brake system serviced immediately.)

## BRAKE

238

## Driving

### Parking brake

To set the parking brake (1), pull the parking brake handle up as far as possible.

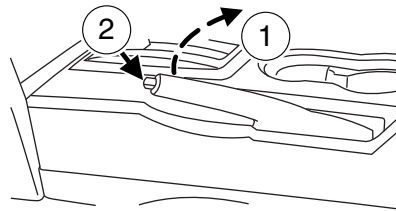

**BRAKE**

The BRAKE warning lamp will illuminate and will remain illuminated until the parking brake is released.

To release, press and hold the button (2), pull the handle up slightly, then push the handle down.



**WARNING:** Always set the parking brake fully and make sure that the gearshift is securely latched in P (Park) (automatic transmission) or in 1 (First) (manual transmission).



**WARNING:** If the parking brake is fully released, but the brake warning lamp remains illuminated, the brakes may not be working properly. See your authorized dealer as soon as possible.

### ADVANCETRAC® STABILITY ENHANCEMENT SYSTEM

Your vehicle is equipped with the AdvanceTrac® system. The AdvanceTrac® system provides the following stability enhancement features for certain driving situations:

- Traction control system (TCS), which functions to help avoid drive-wheel spin and loss of traction.

## Driving

- Electronic stability control (ESC), which functions to help avoid skids or lateral slides

 **WARNING:** Vehicle modifications involving braking system, aftermarket roof racks, suspension, steering system, tire construction and/or wheel/tire size may change the handling characteristics of the vehicle and may adversely affect the performance of the AdvanceTrac® system. In addition, installing any stereo loudspeakers may interfere with and adversely affect the AdvanceTrac® system. Install any aftermarket stereo loudspeaker as far as possible from the front center console, the tunnel, and the front seats in order to minimize the risk of interfering with the AdvanceTrac® sensors. Reducing the effectiveness of the AdvanceTrac® system could lead to an increased risk of loss of vehicle control, vehicle rollover, personal injury and death.

 **WARNING:** Remember that even advanced technology cannot defy the laws of physics. It's always possible to lose control of a vehicle due to inappropriate driver input for the conditions. Aggressive driving on any road condition can cause you to lose control of your vehicle increasing the risk of personal injury or property damage. Activation of the AdvanceTrac® system is an indication that at least some of the tires have exceeded their ability to grip the road; this could reduce the operator's ability to control the vehicle potentially resulting in a loss of vehicle control, vehicle rollover, personal injury and death. If your AdvanceTrac® system activates, SLOW DOWN.

 **WARNING:** If a failure has been detected within the AdvanceTrac® system, the stability control light will illuminate steadily. Have the system serviced by an authorized dealer immediately.

The AdvanceTrac® system automatically enables each time the engine is started. All features of the AdvanceTrac® system (TCS and ESC) are active and monitor the vehicle from start-up. However, the system will only intervene if the driving situation requires it.

The AdvanceTrac® system includes a stability control light and a stability control off light in the instrument cluster. Both the stability control light and the stability control off light in the instrument cluster will illuminate temporarily during start-up as part of a system self-check. The stability control light may illuminate during certain driving situations which may

240



## Driving

cause the AdvanceTrac® system to operate. If the stability control light illuminates steadily, have the system serviced by an authorized dealer immediately.

When AdvanceTrac® performs a normal system self-check, some drivers may notice a slight movement of the brake, and/or a rumble, grunting, or grinding noise after startup and when driving off.

When an event occurs that activates AdvanceTrac®, you may experience the following:

- A slight deceleration of the vehicle
- The stability control light will flash.
- A vibration in the pedal when your foot is on the brake pedal
- If the driving condition is severe and your foot is not on the brake, the brake pedal may move as the systems applies higher brake forces. You may also hear a whoosh of air from under the instrument panel during this severe condition.
- The brake pedal may feel stiffer than usual.

### **Traction control system (TCS)**

Traction control is a driver aid feature that helps your vehicle maintain traction of the wheels, typically when driving on slippery and/or hilly road surfaces, by detecting and controlling wheel spin.

Excessive wheel spin is controlled in two ways, which may work separately or in tandem, engine traction control and brake traction control. Engine traction control works to limit drive-wheel spin by momentarily reducing engine power. Brake traction control works to limit wheel spin by momentarily applying the brakes to the wheel that is slipping. Traction control is most active at low speeds.

During TCS events, the stability control light in the instrument cluster will flash.

If the TCS is activated excessively in a short period of time, the braking portion of the system may become temporarily disabled to allow the brakes to cool down. In this situation, TCS will use only engine power reduction or transfer to help control the wheels from over-spinning. When the brakes have cooled down, the system will regain all features. Anti-lock braking, and ESC are not affected by this condition and will continue to function during the cool-down period.

## Driving

### **Electronic stability control (ESC)**

Electronic stability control (ESC) may enhance your vehicle's directional stability during adverse maneuvers, for example when cornering severely or avoiding objects in the roadway. ESC operates by applying brakes to one or more of the wheels individually and, if necessary, reducing engine power if the system detects that the vehicle is about to skid or slide laterally.

During ESC events, the stability control light in the instrument cluster will flash.

Certain adverse driving maneuvers may activate the ESC system, which include but are not limited to:

- Taking a turn too fast
- Maneuvering quickly to avoid an accident, pedestrian or obstacle
- Driving over a patch of ice or other slippery surfaces
- Changing lanes on a snow-rutted road
- Entering a snow-free road from a snow-covered side street, or vice versa
- Entering a paved road from a gravel road, or vice versa

### **Switching off AdvanceTrac®**



If the vehicle is stuck in snow, mud or sand, and seems to lose engine power, switching off certain features of the AdvanceTrac® system may be beneficial because the wheels are allowed to spin. This will restore full engine power and will enhance momentum through the obstacle.

To switch off the AdvanceTrac® system, select traction control off through the vehicle setting menu in the multi-function display. Full features of the AdvanceTrac® system can be restored by selecting TCS again or by turning off and restarting the engine.

If you switch off the AdvanceTrac® system, the traction control system will be de-selected in the multi-function display and the stability control off light will illuminate steadily. Selecting the AdvanceTrac® system again will turn off the stability control off light.

## Driving

In R (Reverse), ABS and the engine and brake traction control features will continue to function; however, ESC is disabled.

AdvanceTrac® Features				
TCS switch in multi-function display	Stability control light 	Stability control off light 	ESC	TCS
Default at start-up	Illuminated during bulb check	Illuminated during bulb check	Enabled	Enabled
De-select TCS	Not illuminated	Illuminated solid	Enabled	Disabled
Select TCS again after deactivation	Not illuminated	Not illuminated	Enabled	Enabled

## STEERING

Your vehicle is equipped with an Electric Power Steering (EPS) system. There is no fluid reservoir to check or fill.

If your vehicle loses electrical power while you are driving (or if the ignition is turned off), you can steer the vehicle manually, but it takes more effort. Under extreme usage conditions, the steering effort may increase. This occurs to prevent overheating and permanent damage to your steering system. If this should occur, you will neither lose the ability to steer the vehicle manually nor will it cause permanent damage.

Typical steering and driving maneuvers will allow the system to cool and steering assist will return to normal.

The EPS system has diagnostic checks that continuously monitor the EPS system to ensure proper operation. When a system error is detected, the following message STEERING MALFUNCTION SERVICE NOW, STEERING MALFUNCTION STOP SAFELY, POWER STEERING MALFUNCTION SERVICE NOW may display in the multifunction display. Refer to the *Message center* in the *Instrument Cluster* chapter for more information.

## Driving



**WARNING:** The EPS has diagnostics checks that continuously monitor the EPS to ensure proper operation of the electronic system. When an electronic error is detected, the message POWER STEERING ASSIST FAULT will be displayed in the message center. If this happens, stop the vehicle in a safe place and turn off the engine. After at least 10 seconds, reset the system by restarting the engine, and watch the message center for POWER STEERING ASSIST FAULT. If the message returns, or returns while driving, take the vehicle to your dealer to have it checked. With the message displayed, the steering assist is turned off, making the vehicle harder to steer.

If the steering wanders or pulls, check for:

- an improperly inflated tire.
- uneven tire wear.
- loose or worn suspension components.
- loose or worn steering components.
- improper steering alignment.

A high crown in the road or high crosswinds may also make the steering seem to wander/pull.

### Speed sensitive steering

The steering in your vehicle is speed sensitive. At lower speeds the assist is increased to improve maneuverability.

If the amount of effort required to steer your vehicle changes while driving at a constant vehicle speed, have the power steering system checked by your authorized dealer.

### BRAKE-SHIFT INTERLOCK

This vehicle is equipped with a brake-shift interlock feature that prevents the gearshift lever from being moved from P (Park) when the ignition is in the on position unless the brake pedal is pressed.

If you cannot move the gearshift lever out of P (Park) with ignition in the on position and the brake pedal pressed, it is possible that a fuse has blown or the vehicle's brake lamps are not operating properly. Refer to *Fuses and relays* in the *Roadside Emergencies* chapter.

## Driving

If the fuse is not blown and the brake lamps are working properly, the following procedure will allow you to move the gearshift lever from P (Park):

1. Apply the parking brake, turn the ignition key to the off position and remove the key.

2. Using a screwdriver (or similar tool), carefully pry off and remove the passenger side console cover to expose the inside of the shifter assembly.

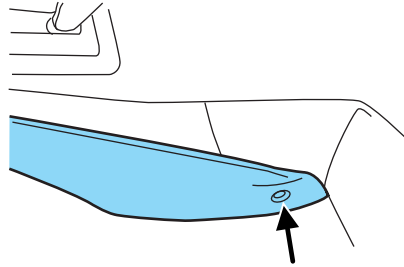

3. Locate the brake shift interlock lever on the passenger side of the shifter assembly.

4. Apply the brake pedal. Using a screwdriver (or similar tool), press and hold the brake shift interlock lever forward below the metal blade while pulling the gearshift lever out of the P (Park) position and into the N (Neutral) position.

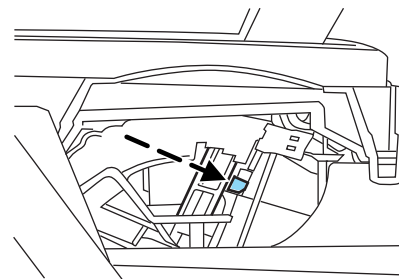

5. Install the console cover.

6. Apply the brake pedal, start the vehicle and release the parking brake.

**See your authorized dealer as soon as possible if this procedure is used.**



**WARNING:** Do not drive your vehicle until you verify that the brake lamps are working.



**WARNING:** Always set the parking brake fully and make sure the gearshift is latched in P (Park). Turn the ignition to the off position and remove the key whenever you leave your vehicle.



**WARNING:** If the parking brake is fully released, but the brake warning lamp remains illuminated, the brakes may not be working properly. See your authorized dealer.

## Driving

### AUTOMATIC TRANSMISSION OPERATION (IF EQUIPPED)

#### Understanding the gearshift positions of the 6-speed automatic transmission (if equipped)

##### P (Park)

This position locks the transmission and prevents the front wheels from turning.

To put your vehicle in gear:

- Press the brake pedal.
- Move the gearshift lever into the desired gear.

To put your vehicle in P (Park):

- Come to a complete stop.
- Move the gearshift lever and securely latch it in P (Park).

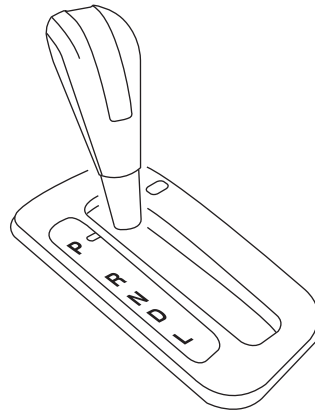

**WARNING:** Always set the parking brake fully and make sure the gearshift is latched in P (Park). Turn the ignition to the off position and remove the key whenever you leave your vehicle.

**Note:** The automatic transmission performs a series of automated checks when the ignition is turned to the off position. A slight clicking sound may be heard and is considered a normal part of operation.

**WARNING:** Do not apply the brake pedal and accelerator pedal simultaneously. Applying both pedals simultaneously for more than three seconds will limit engine rpm, which may result in difficulty maintaining speed in traffic and could lead to serious injury.

##### R (Reverse)

With the gearshift lever in R (Reverse), the vehicle will move backward. Always come to a complete stop before shifting into and out of R (Reverse).

##### N (Neutral)

With the gearshift lever in N (Neutral), the vehicle can be started and is free to roll. Hold the brake pedal down while in this position.

246

### D (Drive)

The normal driving position for the best fuel economy. Transmission operates in gears one through six.

### D (Drive) with Overdrive Cancel/Grade Assist

Pressing the transmission control switch on the side of the gearshift lever activates overdrive cancel and grade assist.

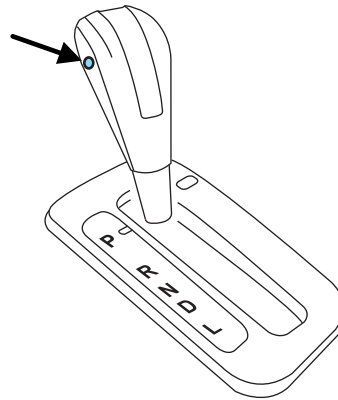

Overdrive cancel/grade assist

- Overdrive is deactivated.
- The transmission operates in gears one through five.
- The grade assist lamp in the instrument cluster is illuminated.



- Improves driving experience in hilly terrain or mountainous areas by providing additional grade (engine) braking and extends lower gear operation on uphill climbs.
- Provides additional engine braking through the automatic transmission shift strategy which reacts to vehicle inputs (vehicle acceleration, accelerator pedal, brake pedal and vehicle speed).
- Allows the transmission to select gears that will provide the desired engine braking based on the vehicle inputs mentioned above. This will increase engine RPM during engine braking.

Overdrive cancel with grade assist is designed to provide optimal gear selection in hilly terrain or mountainous areas. It is recommended that you return to D (Drive) on flat terrain to provide the best fuel economy and transmission function.

## Driving

To return to D (Drive), press the transmission control switch again.

- The grade assist lamp in the instrument cluster will not be illuminated.
- The transmission will operate in gears one through five.

### **L (Low)**

This position:

- Provides maximum engine braking.
- Will downshift to the lowest available gear for the current vehicle speed; allows for first gear when vehicle reaches slower speeds.
- Is not intended for use under extended or normal driving conditions and results in lower fuel economy.

### **Hill start assist (HSA) system (if equipped)**

The hill start assist (HSA) system makes it easier to pull away when the vehicle is on a slope without the need to use the parking brake. When HSA is active, the vehicle will remain stationary on the slope for two to three seconds after you release the brake pedal. During this time, you have time to move your foot from the brake to the accelerator pedal and pull away. The brakes are released automatically once the engine has developed sufficient drive to prevent the vehicle from rolling down the slope. This is an advantage when pulling away on a slope, (for example, from a car park ramp, traffic lights or while in reverse traveling uphill into a parking space).



**WARNING:** HSA does not replace the parking brake. When you leave the vehicle, always apply the parking brake and select P (Park).

### **Using HSA**

The HSA system is activated automatically when the vehicle is stopped on a slope greater than four degrees. HSA operates with the vehicle facing downhill if reverse gear is selected.



**WARNING:** You must remain in the vehicle once you have activated HSA.



**WARNING:** During all times you are responsible for controlling the vehicle, supervising the HSA system and intervening, if required.



### Activating HSA

1. Press the brake pedal to bring the vehicle to a complete standstill. Keep the brake pedal pressed.
2. If the sensors detect that the vehicle is on a slope, the HSA system will be activated automatically in D (Drive) uphill or R (Reverse) downhill.
3. When you remove your foot from the brake pedal, the vehicle will remain on the slope without rolling away for approximately two to three seconds. This hold time will automatically be extended if you are in the process of driving off.
4. Drive off in the normal manner. The brakes will be released automatically.

**Note:** If the engine is revved excessively, HSA will be deactivated.

### Deactivating hill start assist

To deactivate HSA, perform one of the following:

- Apply the parking brake.
- Drive off uphill without re-applying the brake.
- Wait for two to three seconds until the HSA system deactivates automatically.
- If hill start assist is active in D (Drive), select R (Reverse).
- If hill start assist is active in R (Reverse), select N (Neutral).

**Note:** The HSA warning lamp in the instrument cluster momentarily illuminates when the ignition is turned on. If a malfunction is



detected in the HSA system, HSA will be deactivated and this warning lamp will appear on the instrument cluster.

### If your vehicle gets stuck in mud or snow

If your vehicle gets stuck in mud or snow, it may be rocked out by shifting between forward and reverse gears, stopping between shifts in a steady pattern. Press lightly on the accelerator in each gear.

**Do not rock the vehicle if the engine is not at normal operating temperature or damage to the transmission may occur.**

**Do not rock the vehicle for more than a minute or damage to the transmission and tires may occur, or the engine may overheat.**

## Driving

### MANUAL TRANSMISSION OPERATION (IF EQUIPPED)

#### Using the clutch

Manual transmission vehicles have a starter interlock that prevents cranking the engine unless the clutch pedal is fully pressed.

To start the vehicle:

1. Make sure the parking brake is fully set.
2. Press the clutch pedal to the floor, then put the gearshift lever in the neutral position.
3. Start the engine.

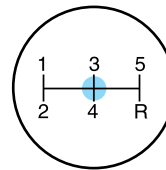

4. Press the brake pedal and move the gearshift lever to the desired gear; 1 (First) or R (Reverse).
5. Release the parking brake, then slowly release the clutch pedal while slowly pressing on the accelerator.

During each shift, the clutch pedal must be fully pressed to the floor. Make sure the floor mat is properly positioned so it doesn't interfere with the full extension of the clutch pedal.

**Failure to fully press the clutch pedal to the floor may cause increased shift efforts, prematurely wear transmission components or damage the transmission.**

**Do not drive with your foot resting on the clutch pedal or use the clutch pedal to hold your vehicle at a standstill while waiting on a hill. These actions will severely reduce the life of the clutch and could nullify a clutch warranty claim.**

## Driving

### Recommended shift speeds

**Do not downshift into 1 (First) when your vehicle is moving faster than 15 mph (24 km/h). This will damage the clutch.**

Upshift according to the following chart:

<b>Recommended upshifts (for best fuel economy) when accelerating</b>	
<b>5-speed manual transmission</b>	
Shift from:	
1 - 2	14 mph (23 km/h)
2 - 3	24 mph (39 km/h)
3 - 4	32 mph (51 km/h)
4 - 5	44 mph (71 km/h)

### Reverse

**Make sure that your vehicle is at a complete stop before you shift into R (Reverse). Failure to do so may damage the transmission.**

Hold the clutch pedal down and move the gearshift lever into the neutral position. Wait at least three seconds before shifting into R (Reverse).

**Note:** The gearshift lever can only be moved into R (Reverse) by moving it from left of 3 (Third) and 4 (Fourth) before shifting into R (Reverse). This is a lockout feature that protects the transmission from accidentally being shifted into R (Reverse) from 5 (Fifth).

If R (Reverse) is not fully engaged, press the clutch pedal down and return the gearshift to the neutral position. Release the clutch pedal for a moment, then press it down and shift to R (Reverse) again.

### Parking your vehicle

1. Apply the brake and shift into the neutral position.
2. Fully apply the parking brake, hold the clutch pedal down, then shift into 1 (First).
3. Turn the ignition off.



**WARNING:** Do not park your vehicle in Neutral, it may move unexpectedly and injure someone. Use 1 (First) gear and set the parking brake fully.

## Driving

### BLIND SPOT MIRRORS

Blind spot mirrors have an integrated convex spotter mirror built into the upper outboard corner of the outside mirrors. They are designed to assist the driver by increasing visibility along the side of the vehicle. For more information on your side view mirrors, refer to *Exterior mirrors* in the *Driver Controls* chapter.

#### Driving with blind spot mirrors

Before a lane change, check the main mirror first, then check the blind spot mirror. If no vehicles are present in the blind spot mirror and the traffic in the adjacent lane is at a safe distance, signal that you are going to change lanes. Glance over your shoulder to verify traffic is clear, and carefully change lanes.

When the approaching vehicle is at a distance, its image is small and near the inboard edge of the main mirror. As the vehicle approaches, the image becomes larger and begins to move outboard across the main mirror (1). As the vehicle approaches its image will transition from the main mirror and begin to appear in the blind spot mirror (2). As the vehicle leaves the blind spot mirror it will transition to the driver's peripheral field of view (3).

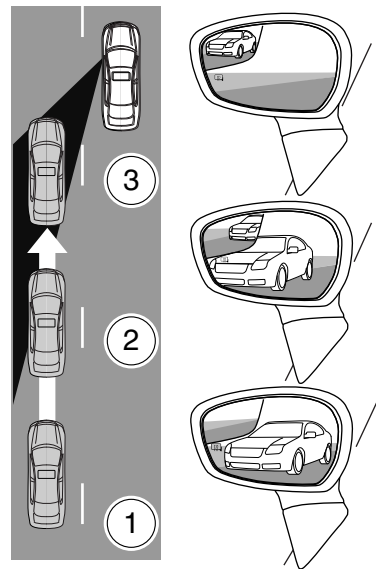

**WARNING:** Objects in the blind spot mirror are closer than they appear.

### DRIVING THROUGH WATER

If driving through deep or standing water is unavoidable, proceed very slowly especially when the depth is not known. Never drive through water that is higher than the bottom of the wheel rims (for cars) or the bottom of the hubs (for trucks).

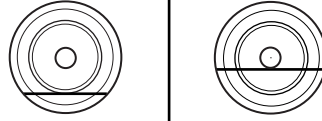

When driving through water, traction or brake capability may be limited. Also, water may enter your engine's air intake and severely damage your engine or your vehicle may stall. **Driving through deep water where the transmission vent tube is submerged may allow water into the transmission and cause internal transmission damage.**

**Once through the water, always dry the brakes by moving your vehicle slowly while applying light pressure on the brake pedal.** Wet brakes do not stop the vehicle as quickly as dry brakes.

## Roadside Emergencies

### ROADSIDE ASSISTANCE

#### Getting roadside assistance

To fully assist you should you have a vehicle concern, Ford Motor Company offers a complimentary roadside assistance program. This program is separate from the New Vehicle Limited Warranty. The service is available:

- 24-hours, seven days a week
- for the coverage period listed on the Roadside Assistance Card included in your Owner Guide portfolio.

Roadside assistance will cover:

- a flat tire change with a good spare (except vehicles that have been supplied with a tire inflation kit)
- battery jump start
- lock-out assistance (key replacement cost is the customer's responsibility)
- fuel delivery – Independent Service Contractors, if not prohibited by state, local or municipal law shall deliver up to 2.0 gallons (7.5L) of gasoline or 5.0 gallons (18.9L) of diesel fuel to a disabled vehicle. Fuel delivery service is limited to two no-charge occurrences within a 12-month period.
- winch out – available within 100 feet (30.5 meters) of a paved or county maintained road, no recoveries.
- towing – Ford and Lincoln eligible vehicles towed to an authorized dealer within 35 miles (56 km) of the disablement location or to the nearest authorized dealer. If a member requests to be towed to an authorized dealer more than 35 miles (56 km) from the disablement location, the member shall be responsible for any mileage costs in excess of 35 miles (56 km).

Trailers shall be covered up to \$200 if the disabled eligible vehicle requires service at the nearest authorized dealer. If the trailer is disabled, but the towing vehicle is operational, the trailer does not qualify for any roadside services.

## Roadside Emergencies

**Canadian customers refer to your Warranty Guide or visit our website at [www.ford.ca](http://www.ford.ca) for information on:**

### Using roadside assistance

Complete the roadside assistance identification card and place it in your wallet for quick reference. In the United States, this card is found in the Owner Guide portfolio in the glove compartment. In Canada, the card is found in the *Warranty Guide* in the glove compartment.

U.S. Ford and Lincoln vehicle customers who require Roadside Assistance, call 1-800-241-3673.

Canadian customers who require roadside assistance, call 1-800-665-2006.

If you need to arrange roadside assistance for yourself, Ford Motor Company will reimburse a reasonable amount for towing to the nearest dealership within 35 miles (56 km). To obtain reimbursement information, U.S. Ford and Lincoln vehicle customers call 1-800-241-3673. Customers will be asked to submit their original receipts.

Canadian customers who need to obtain reimbursement information, call 1-800-665-2006 or visit our website at [www.ford.ca](http://www.ford.ca).

### HAZARD FLASHER CONTROL

The hazard flasher control is located on the instrument panel by the radio. The hazard flashers will operate when the ignition is in any position or if the key is not in the ignition.



- Press the flasher control and all front and rear direction signals will flash.
- Press the flasher control again to turn them off.

Use it when your vehicle is disabled and is creating a safety hazard for other motorists.

**Note:** With extended use, the flasher may run down your battery.

### FUEL PUMP SHUT-OFF

In the event of a moderate to severe collision, this vehicle is equipped with a fuel pump shut-off feature that stops the flow of fuel to the engine. Not every impact will cause a shut-off.

255

## Roadside Emergencies

Should your vehicle shut off after a collision due to this feature, you may restart your vehicle by doing the following:

1. Turn the ignition switch to the off position.
2. Turn the ignition switch to the on position.

In some instances the vehicle may not restart the first time you try to restart and may take one additional attempt.



**WARNING:** Failure to inspect and if necessary repair fuel leaks after a collision may increase the risk of fire and serious injury. Ford Motor Company recommends that the fuel system be inspected by an authorized dealer after any collision.

## FUSES AND RELAYS

### Fuses

If electrical components in the vehicle are not working, a fuse may have blown. Blown fuses are identified by a broken wire within the fuse. Check the appropriate fuses before replacing any electrical components.

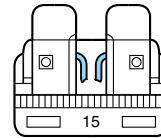

**Note:** Always replace a fuse with one that has the specified amperage rating. Using a fuse with a higher amperage rating can cause severe wire damage and could start a fire.

### Standard fuse amperage rating and color

COLOR					
Fuse rating	Mini fuses	Standard fuses	Maxi fuses	Cartridge maxi fuses	Fuse link cartridge
2A	Grey	Grey	—	—	—
3A	Violet	Violet	—	—	—
4A	Pink	Pink	—	—	—
5A	Tan	Tan	—	—	—
7.5A	Brown	Brown	—	—	—
10A	Red	Red	—	—	—
15A	Blue	Blue	—	—	—

256



## Roadside Emergencies

COLOR					
Fuse rating	Mini fuses	Standard fuses	Maxi fuses	Cartridge maxi fuses	Fuse link cartridge
20A	Yellow	Yellow	Yellow	Blue	Blue
25A	Natural	Natural	—	Natural	Natural
30A	Green	Green	Green	Pink	Pink
40A	—	—	Orange	Green	Green
50A	—	—	Red	Red	Red
60A	—	—	Blue	Yellow	Yellow
70A	—	—	Tan	—	Brown
80A	—	—	Natural	Black	Black

### Passenger compartment fuse panel

The fuse panel is located behind the glove box. Open the glove box, press the sides inward and swing the glove box down.

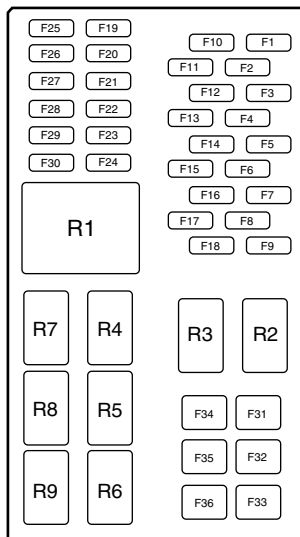

## Roadside Emergencies

The fuses are coded as follows:

Fuse/Relay Location	Fuse Amp Rating	Protected circuits
F1	15A	Ignition switch, Keyless entry ignition relay, Keyless entry accessory relay
F2	10A	Electronic mirror, A/C clutch, Engine compartment fuse panel
F3	7.5A	Instrument cluster
F4	7.5A	Passenger airbag deactivation indicator, Occupant classification system
F5	15A	Diagnostic connector
F6	10A	Backup lamp
F7	7.5A	Instrument panel display, Intelligent access (IA) antenna, Manual climate controls
F8	—	Not used
F9	20A	Keyless vehicle module
F10	15A	Radio, SYNC® module
F11	20A	Front wipers, Body control module (BCM)
F12	20A	Tire pressure monitoring system (TPMS)
F13	15A	Rear wiper, BCM
F14	20A	IA module
F15	15A	Washer pump
F16	15A	Global positioning system (GPS) module
F17	7.5A	Heated seat relay
F18	10A	Stop lamps, Turn signals
F19	7.5A	Radio, Instrument cluster
F20	10A	Airbag module

## Roadside Emergencies

Fuse/Relay Location	Fuse Amp Rating	Protected circuits
F21	10A	BCM, Climate control, Passive anti-theft system transceiver, Electronic power steering module, Instrument cluster, Engine compartment fuse panel
F22	7.5A	Accelerator pedal position sensor, Powertrain control module (PCM), Gear shifter, Anti-lock brake system (ABS) ignition feed
F23	10A	Transmission control unit ignition feed, TPMS ignition feed
F24	7.5A	Front dome lamp, Moon roof switch
F25	7.5A	Exterior mirrors
F26	7.5A	TPMS
F27	—	Not used
F28	—	Not used
F29	—	Not used
F30	—	Not used
F31	30A	Driver and rear power window switches
F32	20A	Passenger compartment fuse panel battery saver relay
F33	20A	Power points
F34	30A	Driver and passenger power window switches
F35	20A	Moon roof
F36	—	Not used
R1	—	Ignition relay
R2	—	Left rear stop/turn lamp relay
R3	—	Right rear stop/turn lamp relay
R4	—	Driver heated seat relay

## Roadside Emergencies

Fuse/Relay Location	Fuse Amp Rating	Protected circuits
R5	—	Passenger heated seat relay
R6	—	IA module – accessory relay
R7	—	IA module – ignition relay
R8	—	Battery saver relay
R9	—	Not used

### Power distribution box

The power distribution box is located in the engine compartment. The power distribution box contains high-current fuses that protect your vehicle's main electrical systems from overloads.



**WARNING:** Always disconnect the battery before servicing high current fuses.



**WARNING:** To reduce risk of electrical shock, always replace the cover to the power distribution box before reconnecting the battery or refilling fluid reservoirs.

If the battery has been disconnected and reconnected, refer to the *Battery* section of the *Maintenance and Specifications* chapter.

## Roadside Emergencies

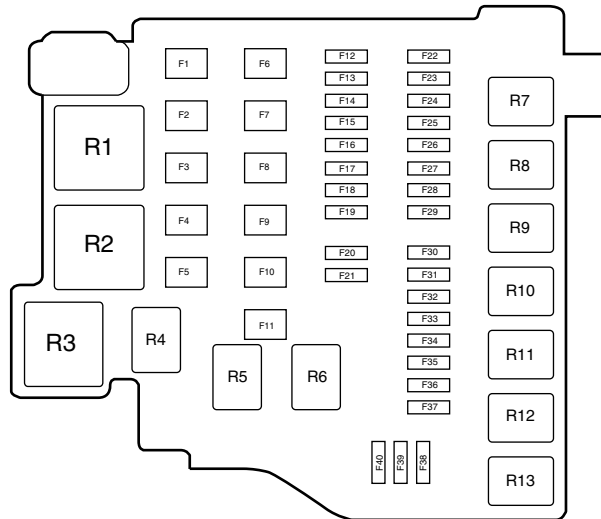

To remove a fuse, use the fuse puller tool provided on the inside of the passenger compartment fuse panel cover.

The high-current fuses are coded as follows:

Fuse/Relay Location	Fuse Amp Rating	Protected circuits
F1	40A*	Anti-lock brake system (ABS) pump
F2	50A*	Transmission control module (TCM)
F3	40A*	Engine cooling fan relay
F4	40A*	Heater blower relay, Climate controls
F5	60A*	Passenger compartment fuse panel
F6	30A*	Body control module (BCM) – door locks
F7	60A*	Passenger compartment fuse panel

## Roadside Emergencies

Fuse/Relay Location	Fuse Amp Rating	Protected circuits
F8	30A*	Fuel pump
F9	20A*	ABS module valve
F10	—	Not used
F11	30A*	Starter inhibit relay, Starter motor
F12	10A**	Left headlamp (high beam)
F13	10A**	Right headlamp (high beam)
F14	10A**	Left headlamp (low beam)
F15	10A**	Right headlamp (low beam)
F16	15A**	A/C clutch relay, Mass air flow (MAF) sensor, Powertrain control module (PCM), Fuel injectors, Vehicle speed sensor (VSS), Variable camshaft timing, Canister purge
F17	15A**	Heated exhaust gas oxygen sensor, Catalyst module sensor
F18	15A**	Ignition coil
F19	—	Not used
F20	—	Not used
F21	—	Not used
F22	15A**	BCM – exterior lighting
F23	7.5A**	Low beam relay
F24	15A**	BCM – turn signals
F25	15A**	Low beam relay, Daytime running lights
F26	7.5A**	Power mirror switch, Driver window switch
F27	7.5A**	TCM, PCM, Natural vacuum leak detection
F28	—	Not used
F29	10A**	A/C clutch solenoid and relay
F30	—	Not used

## Roadside Emergencies

Fuse/Relay Location	Fuse Amp Rating	Protected circuits
F31	20A**	Low beam relay
F32	20A**	BCM – battery saver, horn
F33	30A**	BCM – rear window defroster
F34	—	Not used
F35	—	Not used
F36	—	Not used
F37	—	Not used
F38	—	Not used
F39	—	Not used
F40	—	Not used
R1	—	Not used
R2	—	Not used
R3	—	Not used
R4	—	High beam relay
R5	—	PCM relay
R6	—	Daytime running lamp
R7	—	Engine cooling fan relay
R8	—	Starter inhibit relay
R9	—	A/C clutch relay
R10	—	Reverse light relay
R11	—	Coil pack relay
R12	—	Low beam relay
R13	—	Heater blower relay

\*Cartridge fuses \*\*Mini fuses

### CHANGING THE TIRES

If you get a flat tire while driving, do not apply the brake heavily. Instead, gradually decrease your speed. Hold the steering wheel firmly and slowly move to a safe place on the side of the road.

**Note:** The tire pressure monitoring system (TPMS) indicator light will illuminate when the spare tire is in use. To restore the full functionality of the monitoring system, all road wheels equipped with tire pressure monitoring sensors must be mounted on the vehicle.

263

## Roadside Emergencies

Have a flat serviced by an authorized dealer in order to prevent damage to the TPMS sensors, refer to *Tire pressure monitoring system (TPMS)* in the *Tires, Wheels and Loading* chapter. Replace the spare tire with a road tire as soon as possible. During repairing or replacing of the flat tire, have the authorized dealer inspect the TPMS sensor for damage.

 **WARNING:** The use of tire sealants may damage your tire pressure monitoring system (TPMS) and should not be used. However, if you must use a sealant, the TPMS sensor and valve stem on the wheel must be replaced by an authorized Ford dealer.

 **WARNING:** Refer to *Tire pressure monitoring system (TPMS)* in the *Tires, Wheels and Loading* chapter for important information. If the tire pressure monitor sensor becomes damaged, it will no longer function.

## Dissimilar spare tire/wheel information

 **WARNING:** Failure to follow these guidelines could result in an increased risk of loss of vehicle control, injury or death.

If you have a dissimilar spare tire/wheel, then it is intended for temporary use only. This means that if you need to use it, you should replace it as soon as possible with a road tire/wheel that is the same size and type as the road tires and wheels that were originally provided by Ford. If the dissimilar spare tire or wheel is damaged, it should be replaced rather than repaired.

A dissimilar spare tire/wheel is defined as a spare tire and/or wheel that is different in brand, size or appearance from the road tires and wheels and can be one of three types:

1. **T-type mini-spare:** This spare tire begins with the letter “T” for tire size and may have “Temporary Use Only” molded in the sidewall
2. **Full-size dissimilar spare with label on wheel:** This spare tire has a label on the wheel that states: “THIS TIRE AND WHEEL FOR TEMPORARY USE ONLY”

When driving with one of the dissimilar spare tires listed above, **do not:**

- Exceed 50 mph (80 km/h)
- Load the vehicle beyond maximum vehicle load rating listed on the Safety Compliance Label

264



## Roadside Emergencies

- Tow a trailer
- Use snow chains on the end of the vehicle with the dissimilar spare tire
- Use more than one dissimilar spare tire at a time
- Use commercial car washing equipment
- Try to repair the dissimilar spare tire

Use of one of the dissimilar spare tires listed above at any one wheel location can lead to impairment of the following:

- Handling, stability and braking performance
- Comfort and noise
- Ground clearance and parking at curbs
- Winter weather driving capability
- Wet weather driving capability
- All-wheel driving capability (if applicable)

### 3. Full-size dissimilar spare without label on wheel

When driving with the full-size dissimilar spare tire/wheel, **do not:**

- Exceed 70 mph (113 km/h)
- Use more than one dissimilar spare tire/wheel at a time
- Use commercial car washing equipment
- Use snow chains on the end of the vehicle with the dissimilar spare tire/wheel

The usage of a full-size dissimilar spare tire/wheel can lead to impairment of the following:

- Handling, stability and braking performance
- Comfort and noise
- Ground clearance and parking at curbs
- Winter weather driving capability
- Wet weather driving capability
- All-wheel driving capability (if applicable)
- Load leveling adjustment (if applicable)

When driving with the full-size dissimilar spare tire/wheel additional caution should be given to:

- Towing a trailer

## Roadside Emergencies

- Driving vehicles equipped with a camper body
- Driving vehicles with a load on the cargo rack

Drive cautiously when using a full-size dissimilar spare tire/wheel and seek service as soon as possible.

### Stopping and securing the vehicle

1. Park on a level surface, set the parking brake and activate the hazard flashers.

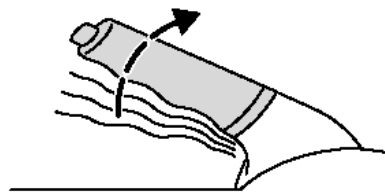



2. Place the gearshift lever in P (Park) (automatic transmission) or R (Reverse) (manual transmission) and turn the engine off.

### Tire change procedure

 **WARNING:** When one of the front wheels is off the ground, the transmission alone will not prevent the vehicle from moving or slipping off the jack, even if the vehicle is in P (Park) (automatic transmission) or R (Reverse) (manual transmission).

 **WARNING:** To help prevent the vehicle from moving when you change a tire, be sure the parking brake is set, then block (in both directions) the wheel that is diagonally opposite (other side and end of the vehicle) to the tire being changed.

 **WARNING:** If the vehicle slips off the jack, you or someone else could be seriously injured.

 **WARNING:** Do not attempt to change a tire on the side of the vehicle close to moving traffic. Pull far enough off the road to avoid the danger of being hit when operating the jack or changing the wheel.

## Roadside Emergencies

**Note:** Passengers should not remain in the vehicle when the vehicle is being jacked.

1. Remove the spare tire and jack by turning their tie-down bolts counterclockwise. The lug wrench is located in a bag next to, or on top of, the spare tire.

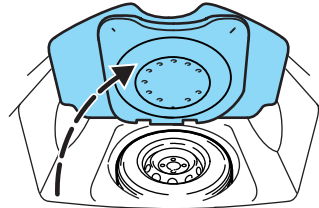

2. Block the diagonally opposite wheel.

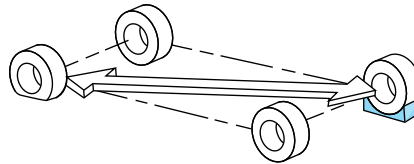

3. Loosen each wheel lug nut one-half turn counterclockwise but do not remove them until the wheel is raised off the ground.

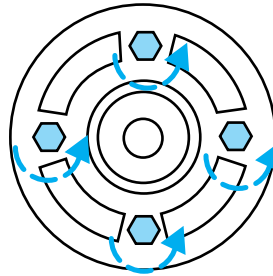

4. The vehicle jacking points are located inward of the wheels.

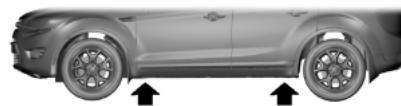

**WARNING:** To lessen the risk of personal injury, do not put any part of your body under the vehicle while changing a tire. Do not start the engine when your vehicle is on the jack. The jack is only meant for changing the tire.

## Roadside Emergencies

5. Position the jack in the indentions on the sill next to the tire you are changing. Turn the jack handle clockwise until the tire is off the ground.



6. Remove the lug nuts with the lug wrench.

7. Replace the flat tire with the spare tire, making sure the valve stem is facing outward. Reinstall the lug nuts until the wheel is snug against the hub. Do not fully tighten the lug nuts until the wheel has been lowered.

8. Lower the wheel by turning the jack handle counterclockwise.

9. Remove the jack and fully tighten the lug nuts in the order shown. Refer to *Wheel lug nut torque specifications* later in this chapter for the proper lug nut torque specification.

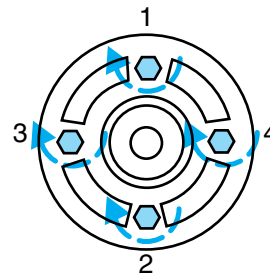

10. Put the flat tire, jack and lug wrench away. Make sure the jack is fastened so it does not rattle when you drive. Unblock the wheels.

### WHEEL LUG NUT TORQUE SPECIFICATIONS

Retighten the lug nuts to the specified torque at 500 miles (800 km) after any wheel disturbance (tire rotation, changing a flat tire, wheel removal, etc.).

Bolt size	Wheel lug nut torque*	
	ft-lb	N•m
M12 x 1.5	98	133

\* Torque specifications are for nut and bolt threads free of dirt and rust. Use only Ford recommended replacement fasteners.

## Roadside Emergencies

 **WARNING:** When a wheel is installed, always remove any corrosion, dirt or foreign materials present on the mounting surfaces of the wheel or the surface of the wheel hub, brake drum or brake disc that contacts the wheel. Ensure that any fasteners that attach the rotor to the hub are secured so they do not interfere with the mounting surfaces of the wheel. Installing wheels without correct metal-to-metal contact at the wheel mounting surfaces can cause the wheel nuts to loosen and the wheel to come off while the vehicle is in motion, resulting in loss of control.

**Note:** Inspect the wheel pilot hole prior to installation. If there is visible corrosion in wheel pilot hole, remove loose particles by wiping with clean rag and apply grease. Apply grease only to the wheel pilot hole surface by smearing a “dime” (1 square cm) sized glob of grease around the wheel pilot surface (1) with end of finger. **DO NOT** apply grease to lugnut/stud holes or wheel-to-brake surfaces.

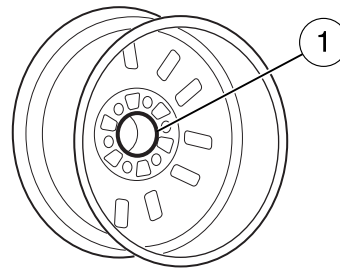

### RUNNING OUT OF FUEL

If you have run out of fuel and need to refill the vehicle with a portable fuel container, see *Running out of fuel* in the *Maintenance and Specifications* chapter for proper fuel filling method using a portable fuel container and the included fuel filler funnel. **Do not** insert the nozzle of portable fuel containers or any type of aftermarket funnels into the Easy Fuel™ “no cap” fuel system as it can be damaged. You must use the included funnel in such circumstances.

 **WARNING:** Do not insert the nozzle of portable fuel containers or aftermarket funnels into the Easy Fuel™ system. This could damage the fuel system and its seal, and may cause fuel to run onto the ground instead of filling the tank, all of which could result in serious personal injury.

## Roadside Emergencies

### JUMP STARTING



**WARNING:** The gases around the battery can explode if exposed to flames, sparks, or lit cigarettes. An explosion could result in injury or vehicle damage.



**WARNING:** Batteries contain sulfuric acid which can burn skin, eyes and clothing, if contacted.

**Do not attempt to push-start your automatic transmission vehicle. Automatic transmissions do not have push-start capability. Attempting to push-start a vehicle with an automatic transmission may cause transmission damage.**

### Preparing your vehicle

When the battery is disconnected or a new battery is installed, the automatic transmission must relearn its shift strategy. As a result, the transmission may have firm and/or soft shifts. This operation is considered normal and will not affect function or durability of the transmission. Over time, the adaptive learning process will fully update transmission operation.

1. **Use only a 12-volt supply to start your vehicle.**
2. Do not disconnect the battery of the disabled vehicle as this could damage the vehicle's electrical system.
3. Park the booster vehicle close to the hood of the disabled vehicle making sure the two vehicles **do not** touch. Set the parking brake on both vehicles and stay clear of the engine cooling fan and other moving parts.
4. Check all battery terminals and remove any excessive corrosion before you attach the battery cables. Ensure that vent caps are tight and level.
5. Turn the heater fan on in both vehicles to protect from any electrical surges. Turn all other accessories off.

### Connecting the jumper cables

**Note:** In the illustration, the vehicle on the bottom is used to designate the assisting (boosting) battery.

270

## Roadside Emergencies

1. Connect the positive (+) jumper cable to the positive (+) terminal of the discharged battery.
2. Connect the other end of the positive (+) cable to the positive (+) terminal of the assisting battery.
3. Connect the negative (-) cable to the negative (-) terminal of the assisting battery.
4. Make the final connection of the negative (-) cable to an exposed metal part of the stalled vehicle's engine, away from the battery and the carburetor/fuel injection system.

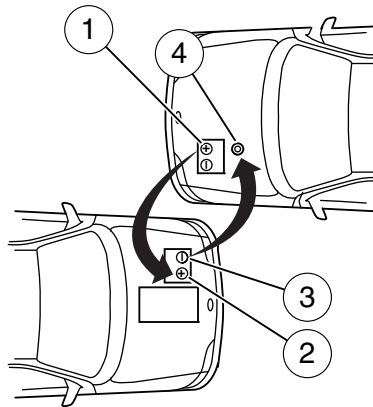

**Note:** Do not attach the negative (-) cable to fuel lines, engine rocker covers, the intake manifold or electrical components as grounding points.



**WARNING:** Do not connect the end of the second cable to the negative (-) terminal of the battery to be jumped. A spark may cause an explosion of the gases that surround the battery.

Ensure that the cables are clear of fan blades, belts, moving parts of both engines, or any fuel delivery system parts.

### Jump starting

1. Start the engine of the booster vehicle and run the engine at moderately increased speed.
2. Start the engine of the disabled vehicle.
3. Once the disabled vehicle has been started, run both engines for an additional three minutes before disconnecting the jumper cables.

## Roadside Emergencies

### Removing the jumper cables

Remove the jumper cables in the reverse order that they were connected.

**Note:** In the illustration, the vehicle on the bottom is used to designate the assisting (boosting) battery.

1. Remove the jumper cable from the ground metal surface.
2. Remove the jumper cable on the negative (-) terminal of the booster vehicle's battery.
3. Remove the jumper cable from the positive (+) terminal of the booster vehicle's battery.
4. Remove the jumper cable from the positive (+) terminal of the disabled vehicle's battery.

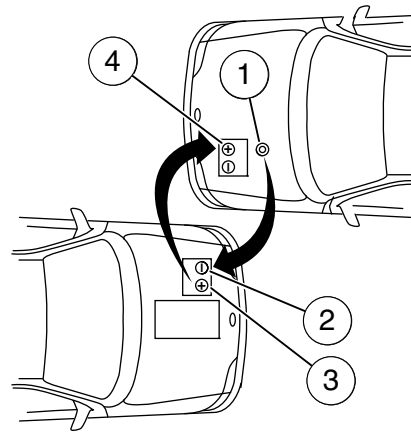

After the disabled vehicle has been started and the jumper cables removed, allow it to idle for several minutes so the engine computer can relearn its idle conditions.



## Roadside Emergencies

### WRECKER TOWING

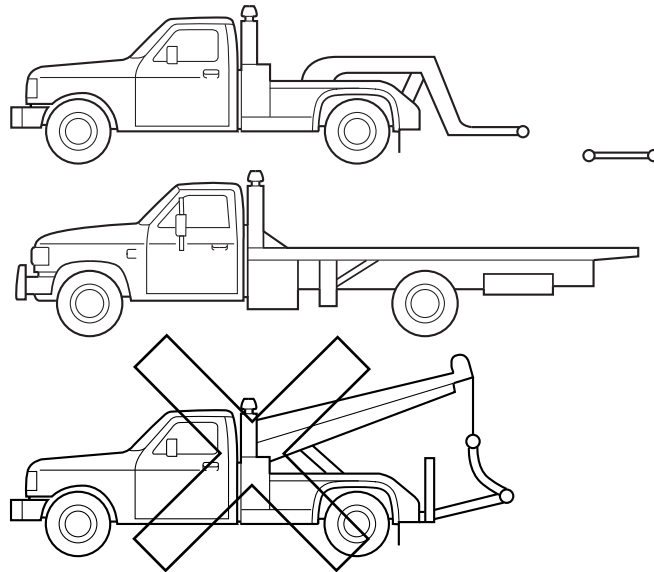

If you need to have your vehicle towed, contact a professional towing service or, if you are a member of a roadside assistance program, your roadside assistance service provider.

It is recommended that your vehicle be towed with a wheel lift and dollies or flatbed equipment. Do not tow with a slingbelt. Ford Motor Company has not approved a slingbelt towing procedure.

If your vehicle is to be towed from the rear using wheel lift equipment, it is recommended that the front wheels (drive wheels) be placed on a dolly to prevent damage to the transmission.

If your vehicle is to be towed from the front using wheel lift equipment, it is recommended that the rear wheels be placed on a dolly to prevent damage to the rear fascia.

## Roadside Emergencies

### **If the vehicle is towed by other means or incorrectly, vehicle damage may occur.**

Ford Motor Company produces a towing manual for all authorized tow truck operators. Have your tow truck operator refer to this manual for proper hook-up and towing procedures for your vehicle.

### **Emergency towing**

In case of a roadside emergency with a disabled vehicle (without access to wheel dollies, car hauling trailer, or flatbed transport vehicle) your vehicle (regardless of transmission powertrain configuration) can be flat towed (all wheels on the ground) under the following conditions:

- Vehicle is facing forward so that it is being towed in a forward direction.
- Place the transmission in N (Neutral). Refer to *Brake-shift interlock* in the *Driving* chapter for specific instructions if you cannot move the gear shift lever into N (Neutral).
- Maximum speed is not to exceed 35 mph (56 km/h).
- Maximum distance is 50 miles (80 km).

## Customer Assistance

### GETTING THE SERVICES YOU NEED

Warranty repairs to your vehicle must be performed by an authorized dealer. While any authorized dealer handling your vehicle line will provide warranty service, we recommend you return to your selling authorized dealer who wants to ensure your continued satisfaction.

Please note that certain warranty repairs require special training and/or equipment, so not all authorized dealers are authorized to perform all warranty repairs. This means that, depending on the warranty repair needed, you may have to take your vehicle to another authorized dealer.

A reasonable time must be allowed to perform a repair after taking your vehicle to the authorized dealer. Repairs will be made using Ford or Motorcraft® parts, or remanufactured or other parts that are authorized by Ford.

### Away from home

If you are away from home when your vehicle needs service, contact the Ford Customer Relationship Center or use the online resources listed below to find the nearest authorized dealer.

In the United States:

#### Mailing address

Ford Motor Company  
Customer Relationship Center  
P.O. Box 6248  
Dearborn, MI 48121

#### Telephone

1-800-392-3673 (FORD)  
(TDD for the hearing impaired: 1-800-232-5952)

#### Online

Additional information and resources are available online at [www.genuineservice.com](http://www.genuineservice.com).

- U.S. dealer locator by Dealer Name, City/State, or Zip Code
- Owner Guides
- Maintenance Schedules
- Recalls
- Ford Extended Service Plans
- Ford Genuine Accessories
- Service specials and promotions.

275

## Customer Assistance

In Canada:

**Mailing address (Ford vehicles)**

Customer Relationship Centre  
Ford Motor Company of Canada, Limited  
P.O. Box 2000  
Oakville, Ontario L6J 5E4

**Telephone**

1-800-565-3673 (FORD)

**Online**

[www.ford.ca](http://www.ford.ca)

**Mailing address (Lincoln vehicles)**

Lincoln Centre  
Ford Motor Company of Canada, Limited  
P.O. Box 2000  
Oakville, Ontario L6J 5E4

**Telephone**

1-800-387-9333

**Online**

[www.lincolncanada.com](http://www.lincolncanada.com)

**Additional assistance**

If you have questions or concerns, or are unsatisfied with the service you are receiving, follow these steps:

1. Contact your Sales Representative or Service Advisor at your selling/servicing authorized dealer.
2. If your inquiry or concern remains unresolved, contact the Sales Manager, Service Manager or Customer Relations Manager.
3. If you require assistance or clarification on Ford Motor Company policies, please contact the Ford Customer Relationship Center

In order to help you serve you better, please have the following information available when contacting a Customer Relationship Center:

- Vehicle Identification Number (VIN)
- Your telephone number (home and business)
- The name of the authorized dealer and city where located
- The vehicle's current odometer reading

In some states, you must directly notify Ford in writing before pursuing remedies under your state's warranty laws. Ford is also allowed a final repair attempt in some states.

276

## Customer Assistance

In the United States, a warranty dispute must be submitted to the BBB AUTO LINE before taking action under the Magnuson-Moss Warranty Act, or to the extent allowed by state law, before pursuing replacement or repurchase remedies provided by certain state laws. This dispute handling procedure is not required prior to enforcing state created rights or other rights which are independent of the Magnuson-Moss Warranty Act or state replacement or repurchase laws.

### IN CALIFORNIA (U.S. ONLY)

California Civil Code Section 1793.2(d) requires that, if a manufacturer or its representative is unable to repair a motor vehicle to conform to the vehicle's applicable express warranty after a reasonable number of attempts, the manufacturer shall be required to either replace the vehicle with one substantially identical or repurchase the vehicle and reimburse the buyer in an amount equal to the actual price paid or payable by the consumer (less a reasonable allowance for consumer use). The consumer has the right to choose whether to receive a refund or replacement vehicle.

California Civil Code Section 1793.22(b) presumes that the manufacturer has had a reasonable number of attempts to conform the vehicle to its applicable express warranties if, within the first 18 months of ownership of a new vehicle or the first 18,000 miles (29,000 km), whichever occurs first:

1. Two or more repair attempts are made on the same non-conformity likely to cause death or serious bodily injury OR
2. Four or more repair attempts are made on the same nonconformity (a defect or condition that substantially impairs the use, value or safety of the vehicle) OR
3. The vehicle is out of service for repair of nonconformities for a total of more than 30 calendar days (not necessarily all at one time)

In the case of 1 or 2 above, the consumer must also notify the manufacturer of the need for the repair of the nonconformity at the following address:

Ford Motor Company  
16800 Executive Plaza Drive  
Mail Drop 3NE-B  
Dearborn, MI 48126

## Customer Assistance

You are required to submit your warranty dispute to BBB AUTO LINE before asserting in court any rights or remedies conferred by California Civil Code Section 1793.22(b). You are also required to use BBB AUTO LINE before exercising rights or seeking remedies created by the Federal Magnuson-Moss Warranty Act, 15 U.S.C. sec. 2301 et seq. If you choose to seek redress by pursuing rights and remedies not created by California Civil Code Section 1793.22(b) or the Magnuson-Moss Warranty Act, resort to BBB AUTO LINE is not required by those statutes.

### **THE BETTER BUSINESS BUREAU (BBB) AUTO LINE PROGRAM (U.S. ONLY)**

Your satisfaction is important to Ford Motor Company and to your dealer. If a warranty concern has not been resolved using the three-step procedure outlined on the first page of the *Customer Assistance* section, you may be eligible to participate in the BBB AUTO LINE program.

The BBB AUTO LINE program consists of two parts – mediation and arbitration. During mediation, a representative of the BBB will contact both you and Ford Motor Company to explore options for settlement of the claim. If an agreement is not reached during mediation or you do not want to participate in mediation, and if your claim is eligible, you may participate in the arbitration process. An arbitration hearing will be scheduled so that you can present your case in an informal setting before an impartial person. The arbitrator will consider the testimony provided and make a decision after the hearing.

Disputes submitted to the BBB AUTO LINE program are usually decided within forty days after you file your claim with the BBB. You are not bound by the decision, and may reject the decision and proceed to court where all findings of the BBB Auto Line dispute, and decision, are admissible in the court action. Should you choose to accept the BBB AUTO LINE decision, Ford is then bound by the decision, and must comply with the decision within 30 days of receipt of your acceptance letter.

BBB AUTO LINE Application: Using the information provided below, please call or write to request a program application. You will be asked for your name and address, general information about your new vehicle, information about your warranty concerns, and any steps you have already taken to try to resolve them. A Customer Claim Form will be mailed that will need to be completed, signed and returned to the BBB along with proof of ownership. Upon receipt, the BBB will review the claim for eligibility under the Program Summary Guidelines.

278

## Customer Assistance

**You can get more information by calling BBB AUTO LINE at 1-800-955-5100, or writing to:**

**BBB AUTO LINE  
4200 Wilson Boulevard, Suite 800  
Arlington, Virginia 22203-1833**

BBB AUTO LINE applications can also be requested by calling the Ford Motor Company Customer Relationship Center at 1-800-392-3673.

**Note:** Ford Motor Company reserves the right to change eligibility limitations, modify procedures, or to discontinue this process at any time without notice and without obligation.

### **UTILIZING THE MEDIATION/ARBITRATION PROGRAM (CANADA ONLY)**

For vehicles delivered to authorized Canadian dealers. In those cases where you continue to feel that the efforts by Ford of Canada and the authorized dealer to resolve a factory-related vehicle service concern have been unsatisfactory, Ford of Canada participates in an impartial third party mediation/arbitration program administered by the Canadian Motor Vehicle Arbitration Plan (CAMVAP).

The CAMVAP program is a straight forward and relatively speedy alternative to resolve a disagreement when all other efforts to produce a settlement have failed. This procedure is without cost to you and is designed to eliminate the need for lengthy and expensive legal proceedings.

In the CAMVAP program, impartial third-party arbitrators conduct hearings at mutually convenient times and places in an informal environment. These impartial arbitrators review the positions of the parties, make decisions and, when appropriate, render awards to resolve disputes. CAMVAP decisions are fast, fair, and final as the arbitrator's award is binding on both you and Ford of Canada.

CAMVAP services are available in all Canadian territories and provinces. For more information, without charge or obligation, call your CAMVAP Provincial Administrator directly at 1-800-207-0685 or visit [www.camvap.ca](http://www.camvap.ca).

## Customer Assistance

### GETTING ASSISTANCE OUTSIDE THE U.S. AND CANADA

Before exporting your vehicle to a foreign country, contact the appropriate foreign embassy or consulate. These officials can inform you of local vehicle registration regulations and where to find unleaded fuel.

If you cannot find unleaded fuel or can only get fuel with an anti-knock index lower than is recommended for your vehicle, contact a regional office or owner relations/customer relationship office.

The use of leaded fuel in your vehicle without proper conversion may damage the effectiveness of your emission control system and may cause engine knocking or serious engine damage. Ford Motor Company/Ford of Canada is not responsible for any damage caused by use of improper fuel. Using leaded fuel may also result in difficulty importing your vehicle back into the U.S.

If your vehicle must be serviced while you are traveling or living in Asia-Pacific Region, Sub-Saharan Africa, U.S. Virgin Islands, Central America, the Caribbean, and Israel, contact the nearest authorized dealer. If the authorized dealer cannot help you, contact:

FORD MOTOR COMPANY  
FORD EXPORT OPERATIONS & GLOBAL INITIATIVES  
1555 Fairlane Drive  
Fairlane Business Park #3  
Allen Park, Michigan 48101  
U.S.A.

Telephone: (313) 594-4857

For customers in Guam, the Commonwealth of the Northern Mariana Islands (CNMI), America Samoa, and the U.S. Virgin Islands, please feel free to call our Toll-Free Number: (800) 841-FORD (3673).

FAX: (313) 390-0804

Email: [expcac@ford.com](mailto:expcac@ford.com)

If your vehicle must be serviced while you are traveling or living in Puerto Rico, contact the nearest authorized dealer. If the authorized dealer cannot help you, contact:

Ford International Business Development Inc.  
Customer Relationship Center  
P.O. Box 11957  
Caparra Heights Station  
San Juan, Puerto Rico 00922-1957  
Telephone: (800) 841-FORD (3673)  
FAX: (313) 390-0804  
Email: [prcac@ford.com](mailto:prcac@ford.com)  
[www.ford.com.pr](http://www.ford.com.pr)

280



## Customer Assistance

If your vehicle must be serviced while you are traveling or living in the Middle East, contact the nearest authorized dealer. If the authorized dealer cannot help you, contact:

Ford Middle East  
Customer Relationship Center  
P.O. Box 21470  
Dubai, United Arab Emirates  
Telephone: +971 4 3326084  
Toll-Free Number for the Kingdom of Saudi Arabia: 800 89717409  
Local Telephone Number for Kuwait: 24810575  
FAX: +971 4 3327299  
Email: [menacac@ford.com](mailto:menacac@ford.com)  
[www.me.ford.com](http://www.me.ford.com)

If you buy your vehicle in North America and then relocate to any of the above locations, register your vehicle identification number (VIN) and new address with Ford Motor Company Export Operations & Global Growth Initiatives by emailing [expcac@ford.com](mailto:expcac@ford.com).

If you are in another foreign country, contact the nearest authorized dealer. If the authorized dealer employees cannot help you, they can direct you to the nearest Ford affiliate office.

**Customers in the U.S. should call 1-800-392-3673.**

### ORDERING ADDITIONAL OWNER'S LITERATURE

To order the publications in this portfolio, contact Helm, Incorporated at:

HELM, INCORPORATED  
P.O. Box 07150  
Detroit, Michigan 48207

Or to order a free publication catalog, call toll free: 1-800-782-4356  
Monday-Friday 8:00 a.m. - 6:00 p.m. EST

Helm, Incorporated can also be reached by their website:  
[www.helminc.com](http://www.helminc.com).

*(Items in this catalog may be purchased by credit card, check or money order.)*

### Obtaining a French Owner's Guide

French Owner's Guides can be obtained from your authorized dealer or by contacting Helm, Incorporated using the contact information listed previously in this section.

281

## Customer Assistance

### REPORTING SAFETY DEFECTS (U.S. ONLY)

If you believe that your vehicle has a defect which could cause a crash or could cause injury or death, you should immediately inform the National Highway Traffic Safety Administration (NHTSA) in addition to notifying Ford Motor Company.



If NHTSA receives similar complaints, it may open an investigation, and if it finds that a safety defect exists in a group of vehicles, it may order a recall and remedy campaign. However, NHTSA cannot become involved in individual problems between you, your dealer, or Ford Motor Company.

To contact NHTSA, you may call the Vehicle Safety Hotline toll-free at 1-888-327-4236 (TTY: 1-800-424-9153); go to <http://www.safercar.gov>; or write to:

Administrator  
1200 New Jersey Avenue, Southeast  
Washington, D.C. 20590

You can also obtain other information about motor vehicle safety from <http://www.safercar.gov>.

### REPORTING SAFETY DEFECTS (CANADA ONLY)

If you believe that your vehicle has a defect which could cause a crash or could cause injury or death, you should immediately inform Transport Canada, using their toll-free number: 1-800-333-0510, or online at: <https://wwwapps.tc.gc.ca/Saf-Sec-Sur/7/PCDB-BDPP/Index.aspx>.

## Cleaning

### WASHING THE EXTERIOR

Wash your vehicle regularly with cool or lukewarm water and a neutral pH shampoo, such as Motorcraft® Detail Wash (ZC-3-A), which is available from your authorized dealer.

- Never use strong household detergents or soap, such as dish washing or laundry liquid. These products can discolor and spot painted surfaces.
- Never wash a vehicle that is “hot to the touch” or during exposure to strong, direct sunlight.
- Always use a clean sponge or car wash mitt with plenty of water for best results.
- Dry the vehicle with a chamois or soft terry cloth towel in order to eliminate water spotting.
- It is especially important to wash the vehicle regularly during the winter months, as dirt and road salt are difficult to remove and cause damage to the vehicle.
- Immediately remove items such as gasoline, diesel fuel, bird droppings and insect deposits because they can cause damage to the vehicle’s paintwork and trim over time. Use Motorcraft® Bug and Tar Remover (ZC-42) which is available from your authorized dealer.
- Remove any exterior accessories, such as antennas, before entering a car wash.
- **Suntan lotions and insect repellents can damage any painted surface; if these substances come in contact with your vehicle, wash off as soon as possible.**

### Exterior chrome

- Wash the vehicle first, using cool or lukewarm water and a neutral pH shampoo, such as Motorcraft® Detail Wash (ZC-3-A).
- Use Motorcraft® Custom Bright Metal Cleaner (ZC-15), available from your authorized dealer. Apply the product as you would a wax to clean bumpers and other chrome parts; allow the cleaner to dry for a few minutes, then wipe off the haze with a clean, dry rag.
- **Never use abrasive materials such as steel wool or plastic pads as they can scratch the chrome surface.**

### WAXING

- Wash the vehicle first.
- Use a quality wax that does not contain abrasives.

283

## Cleaning

- Do not allow paint sealant to come in contact with any non-body (low-gloss black) colored trim, such as grained door handles, roof racks, bumpers, side moldings, mirror housings or the windshield cowl area. The paint sealant will “gray” or stain the parts over time.

### PAINT CHIPS

Your authorized dealer has touch-up paint to match your vehicle’s color. Take your color code (printed on a sticker in the driver’s door jamb) to your authorized dealer to ensure you get the correct color.

- Remove particles such as bird droppings, tree sap, insect deposits, tar spots, road salt and industrial fallout before repairing paint chips.
- Always read the instructions before using the products.

### ALUMINUM WHEELS AND WHEEL COVERS

Aluminum wheels and wheel covers are coated with a clearcoat paint finish. In order to maintain their shine:

- Clean weekly with Motorcraft® Wheel and Tire Cleaner (ZC-37-A), which is available from your authorized dealer. Heavy dirt and brake dust accumulation may require agitation with a sponge. Rinse thoroughly with a strong stream of water.
- Never apply any cleaning chemical to hot or warm wheel rims or covers.
- Some automatic car washes may cause damage to the finish on your wheel rims or covers. Industrial-strength (heavy-duty) cleaners, or cleaning chemicals, in combination with brush agitation to remove brake dust and dirt, could wear away the clearcoat finish over time.
- Do not use hydrofluoric acid-based or high caustic-based wheel cleaners, steel wool, fuels or strong household detergent.
- To remove tar and grease, use Motorcraft® Bug and Tar Remover (ZC-42), available from your authorized dealer.

### ENGINE

Engines are more efficient when they are clean because grease and dirt buildup keep the engine warmer than normal.

When washing:

- Take care when using a power washer to clean the engine. The high-pressure fluid could penetrate the sealed parts and cause damage.

284

## Cleaning

- Do not spray a hot engine with cold water to avoid cracking the engine block or other engine components.
- Spray Motorcraft® Engine Shampoo and Degreaser (ZC-20) on all parts that require cleaning and pressure rinse clean. In Canada, use Motorcraft® Engine Shampoo (CXC-66-A).
- Never wash or rinse the engine while it is hot or running; water in the running engine may cause internal damage.
- Never wash or rinse any ignition coil, spark plug wire or spark plug well, or the area in and around these locations.
- Cover the highlighted areas to prevent water damage when cleaning the engine.

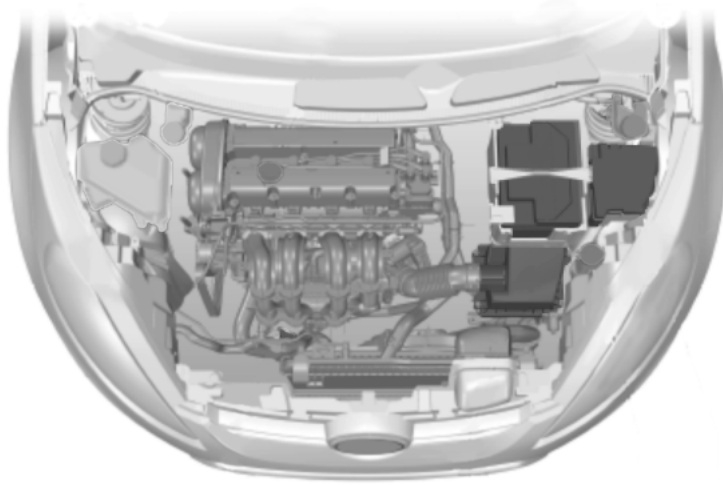

### PLASTIC (NON-PAINTED) EXTERIOR PARTS

Use only approved products to clean plastic parts. These products are available from your authorized dealer.

- For routine cleaning, use Motorcraft® Detail Wash (ZC-3-A).
- If tar or grease spots are present, use Motorcraft® Bug and Tar Remover (ZC-42).

## Cleaning

### WINDOWS AND WIPER BLADES

The windshield, rear and side windows and the wiper blades should be cleaned regularly. If the wipers do not wipe properly, substances on the vehicle's glass or the wiper blades may be the cause. These may include hot wax treatments used by commercial car washes, water repellent coatings, tree sap, or other organic contamination; these contaminants may cause squeaking or chatter noise from the blades, and streaking and smearing of the windshield. To clean these items, follow these tips:

- The windshield, rear windows and side windows may be cleaned with a non-abrasive cleaner such as Motorcraft® Ultra-Clear Spray Glass Cleaner (ZC-23), available from your authorized dealer.
- The wiper blades can be cleaned with isopropyl (rubbing) alcohol or Motorcraft® Premium Windshield Washer Concentrate (ZC-32-A) in the U.S., or Premium Quality Windshield Washer Fluid [CXC-37-(A, B, D, or F)] in Canada, available from your authorized dealer. This washer fluid contains special solution in addition to alcohol which helps to remove the hot wax deposited on the wiper blade and windshield from automated car wash facilities. Be sure to replace wiper blades when they appear worn or do not function properly.
- Do not use abrasives, as they may cause scratches.
- Do not use fuel, kerosene, or paint thinner to clean any parts.

If you cannot remove those streaks after cleaning with the glass cleaner or if the wipers chatter and move in a jerky motion, clean the outer surface of the windshield and the wiper blades using a sponge or soft cloth with a neutral detergent or mild-abrasive cleaning solution. After cleaning, rinse the windshield and wiper blades with clean water. The windshield is clean if beads do not form when you rinse the windshield with water.

**Do not use sharp objects, such as a razor blade, to clean the inside of the rear window or to remove decals, as it may cause damage to the rear window defroster's heated grid lines.**

### INSTRUMENT PANEL/INTERIOR TRIM AND CLUSTER LENS

Clean the instrument panel, interior trim areas and cluster lens with a clean, damp, white cotton cloth, then use a clean and dry white cotton cloth to dry these areas.

- Avoid cleaners or polishes that increase the gloss of the upper portion of the instrument panel. The dull finish in this area helps protect the driver from undesirable windshield reflection.

286

## Cleaning

- Be certain to wash or wipe your hands clean if you have been in contact with certain products such as insect repellent and suntan lotion in order to avoid possible damage to the interior painted surfaces.
- Do not use household or glass cleaners as these may damage the finish of the instrument panel, interior trim and cluster lens.
- Do not allow air fresheners and hand sanitizers to spill on interior surfaces. If a spill occurs, **wipe off immediately**. Damage may not be covered by your warranty.



**WARNING:** Do not use chemical solvents or strong detergents when cleaning the steering wheel or instrument panel to avoid contamination of the airbag system.

If a staining liquid like coffee/juice has been spilled on the instrument panel or on interior trim surfaces, clean as follows:

1. Wipe up spilled liquid using a clean, white, cotton cloth.
2. Wipe the surface with a damp, clean, white cotton cloth. For more thorough cleaning, use a mild soap and water solution. If the spot cannot be completely cleaned by this method, the area may be cleaned using a commercially available cleaning product designed for automotive interiors.
3. If necessary, apply more soap and water solution or cleaning product to a clean, white, cotton cloth and press the cloth onto the soiled area—allow this to set at room temperature for 30 minutes.
4. Remove the soaked cloth, and if it is not soiled badly, use this cloth to clean the area by using a rubbing motion for 60 seconds.
5. Following this, wipe area dry with a clean, white, cotton cloth.

### INTERIOR

For fabric, carpets, cloth seats, safety belts and seats equipped with side airbags:

- Remove dust and loose dirt with a vacuum cleaner.
- Remove light stains and soil with Motorcraft® Professional Strength Carpet & Upholstery Cleaner (ZC-54).
- If grease or tar is present on the material, spot-clean the area first with Motorcraft® Spot and Stain Remover (ZC-14). In Canada, use Motorcraft® Multi-Purpose Cleaner (CXC-101).

287

## Cleaning

- If a ring forms on the fabric after spot cleaning, clean the entire area immediately (but do not oversaturate) or the ring will set.
- Do not use household cleaning products or glass cleaners, which can stain and discolor the fabric and affect the flame retardant abilities of the seat materials.



**WARNING:** Do not use cleaning solvents, bleach or dye on the vehicle's safety belts, as these actions may weaken the belt webbing.



**WARNING:** On vehicles equipped with seat-mounted airbags, do not use chemical solvents or strong detergents. Such products could contaminate the side-airbag system and affect performance of the side airbag in a collision.

### LEATHER SEATS (IF EQUIPPED, EXCEPT FOR THE KING RANCH® EDITION)

**For King Ranch® leather seats, refer to a separate section in this chapter.**

- Clean spills and stains as quickly as possible.
- For routine cleaning, wipe the surface with a soft, damp cloth. For more thorough cleaning, wipe the surface with a mild soap and water solution. In Canada, use Motorcraft® Vinyl Cleaner (CXC-93). Dry the area with a soft cloth.
- If the leather cannot be completely cleaned using a mild soap and water solution, the leather may be cleaned using a commercially available leather cleaning product designed for automotive interiors.
- To check for compatibility, first test any cleaner or stain remover on an inconspicuous part of the leather.
- Do not use household cleaning products, alcohol solutions, solvents or cleaners intended for rubber, vinyl and plastics, or oil/petroleum-based leather conditioners. These products may cause premature wearing or damage to the leather.

### LEATHER SEATS FOR THE KING RANCH® EDITION ONLY (IF EQUIPPED)

Your vehicle is equipped with seating covered in premium, top-grain leather which is extremely durable, but still requires special care and maintenance in order to ensure longevity and comfort.

288



## Cleaning

Regular cleaning and conditioning will maintain the appearance of the leather.

### Cleaning

For dirt, use a vacuum cleaner then use a clean, damp cloth or soft brush.

For routine cleaning, wipe the surface with a soft, damp cloth. For more thorough cleaning, wipe the surface with a mild soap and water solution.

- Clean spills as quickly as possible.
- Test any cleaner or stain remover on an inconspicuous part of the leather as cleaners may darken the leather.
- Do not spill coffee, ketchup, mustard, orange juice or oil-based products on the leather as they may permanently stain the leather.
- Do not use household cleaning products, alcohol solutions, solvents or cleaners intended for rubber, vinyl or plastics.

### Scratches

Natural Markings - Because the leather in the seat comes from genuine steer hides, there will be evidence of naturally occurring markings, such as small scars. These markings give character to the seating covers and should be considered as proof of a genuine leather product.

In order to lessen the appearance of certain scratches and other wear marks, apply conditioner on the affected area following the same instructions as in the *Conditioning* section.

### Conditioning

Bottles of King Ranch® Leather Conditioner are available at the King Ranch® Saddle Shop. Visit the website at [www.krsaddleshop.com](http://www.krsaddleshop.com), or telephone (in the United States) 1-800-282-KING (5464). If you are unable to obtain King Ranch® Leather Conditioner, use another premium leather conditioner.

- Clean the surfaces using the steps outlined in the *Cleaning* section.
- Ensure the leather is dry then apply a nickel-sized amount of conditioner to a clean, dry cloth.
- Rub the conditioner into leather until it disappears. Allow the conditioner to dry and repeat the process for the entire interior. If a film appears, wipe off film with a dry, clean cloth.

### UNDERBODY

Flush the complete underside of your vehicle frequently. Keep body and door drain holes free from packed dirt.

289

## Cleaning

### FORD AND LINCOLN CAR CARE PRODUCTS

Your Ford or Lincoln authorized dealer has many quality products available to clean your vehicle and protect its finishes. These quality products have been specifically engineered to fulfill your automotive needs; they are custom designed to complement the style and appearance of your vehicle. Each product is made from high quality materials that meet or exceed rigid specifications. For best results, use the following products or products of equivalent quality:

- Motorcraft® Bug and Tar Remover (ZC-42)
- Motorcraft® Custom Bright Metal Cleaner (ZC-15)
- Motorcraft® Detail Wash (ZC-3-A)
- Motorcraft® Dusting Cloth (ZC-24)
- Motorcraft® Engine Shampoo and Degreaser (U.S. only) (ZC-20)
- Motorcraft® Engine Shampoo (Canada only) (CXC-66-A)
- Motorcraft® Multi-Purpose Cleaner (Canada only) (CXC-101)
- Motorcraft® Premium Glass Cleaner (Canada only) (CXC-100)
- Motorcraft® Premium Quality Windshield Washer Fluid (Canada only) [CXC-37-(A, B, D or F)]
- Motorcraft® Premium Windshield Washer Concentrate (U.S. only) (ZC-32-A)
- Motorcraft® Professional Strength Carpet & Upholstery Cleaner (ZC-54)
- Motorcraft® Spot and Stain Remover (U.S. only) (ZC-14)
- Motorcraft® Ultra-Clear Spray Glass Cleaner (ZC-23)
- Motorcraft® Vinyl Cleaner (Canada only) (CXC-93)
- Motorcraft® Wheel and Tire Cleaner (ZC-37-A)

## Maintenance and Specifications

### SERVICE RECOMMENDATIONS

To help you service your vehicle, we provide *scheduled maintenance information* which makes tracking routine service easy.

If your vehicle requires professional service, your authorized dealer can provide the necessary parts and service. Check your *Warranty Guide* to find out which parts and services are covered.

Use only recommended fuels, lubricants, fluids and service parts conforming to specifications. Motorcraft® parts are designed and built to provide the best performance in your vehicle.

### PRECAUTIONS WHEN SERVICING YOUR VEHICLE

Be especially careful when inspecting or servicing your vehicle.

- Do not work on a hot engine.
- When the engine is running, make sure that loose clothing, jewelry or long hair does not get caught in moving parts.
- Do not work on a vehicle with the engine running in an enclosed space, unless you are sure you have enough ventilation.
- Keep all open flames and other burning (cigarettes) material away from the battery and all fuel related parts.

If you disconnect the battery, the engine must “relearn” its idle condition before your vehicle will drive properly, as explained in *Battery* in this section.

#### Working with the engine off

1. For vehicles equipped with an automatic transmission, set the parking brake and shift to P (Park). For vehicles equipped with a manual transmission, set the parking brake, press and hold the clutch pedal, place the gearshift in 1 (First), and release the clutch pedal.
2. Turn off the engine and remove the key.
3. Block the wheels.

#### Working with the engine on

1. For vehicles equipped with an automatic transmission, set the parking brake and shift to P (Park). For vehicles equipped with a manual transmission, set the parking brake, press and hold the clutch pedal, place the gearshift in N (Neutral), and release the clutch pedal.
2. Block the wheels.

## Maintenance and Specifications

 **WARNING:** To reduce the risk of vehicle damage and/or personal burn injuries, do not start your engine with the air cleaner removed and do not remove it while the engine is running.

### OPENING THE HOOD

1. Inside the vehicle, pull the hood release handle located under the instrument panel.



2. Raise the hood slightly. Then push the hood latch release lever, located under the front center of the hood, to the left.

3. Lift the hood and support it with the prop rod.

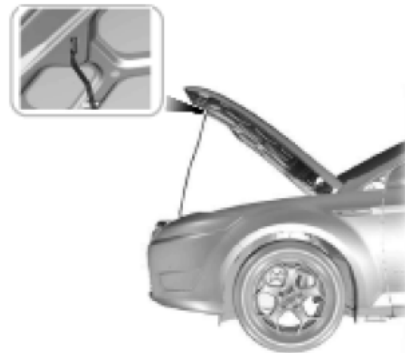

Lower the hood and allow it to drop for the last 8-11 inches (20-30 cm).

## Maintenance and Specifications

### IDENTIFYING COMPONENTS IN THE ENGINE COMPARTMENT

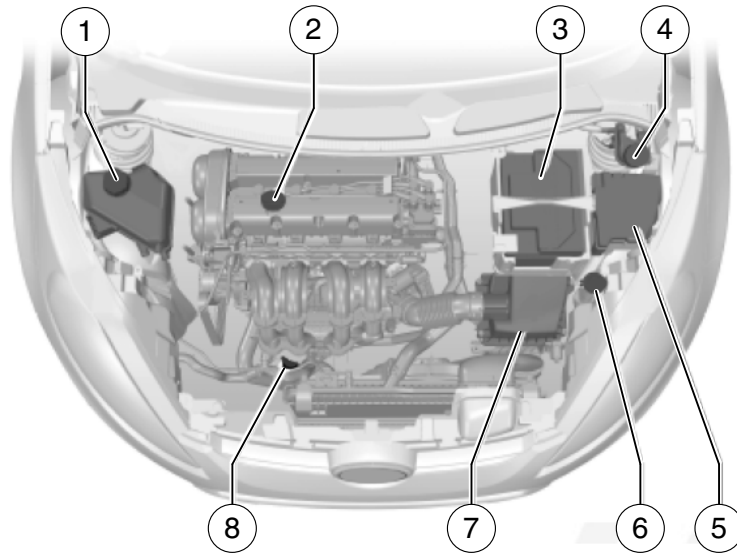

1. Engine coolant reservoir
2. Engine oil filler cap
3. Battery
4. Brake/Clutch fluid reservoir
5. Power distribution box
6. Windshield washer fluid reservoir
7. Air filter assembly
8. Engine oil dipstick

## Maintenance and Specifications

### WINDSHIELD WASHER FLUID

Add fluid to fill the reservoir if the level is low. In very cold weather, do not fill the reservoir completely.

Only use a washer fluid that meets Ford specifications. Do not use any special washer fluid such as windshield water repellent type fluid or bug wash. They may cause squeaking, chatter noise, streaking and smearing. Refer to *Maintenance product specifications and capacities* in this chapter.

State or local regulations on volatile organic compounds may restrict the use of methanol, a common windshield washer antifreeze additive. Washer fluids containing non-methanol antifreeze agents should be used only if they provide cold weather protection without damaging the vehicle's paint finish, wiper blades or washer system.



**WARNING:** If you operate your vehicle in temperatures below 40°F (5°C), use washer fluid with antifreeze protection. Failure to use washer fluid with antifreeze protection in cold weather could result in impaired windshield vision and increase the risk of injury or accident.

### CHANGING THE WIPER BLADES

Change your wiper blades at least once every year. Inspect them by running your finger along each blade to feel for irregularities.

Poor wiper quality can be improved by cleaning the wiper blades and windshield. Refer to *Windows and wiper blades* in the *Cleaning* chapter.

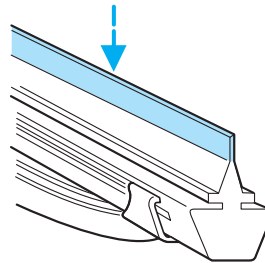

**WARNING:** Worn wiper bladed can reduce visibility in rainy weather and cause accidents.

## Maintenance and Specifications

To replace the wiper blades:

1. Pull the wiper arm away from the windshield.
2. Press the locking button (1).
3. Remove the wiper blade (2).

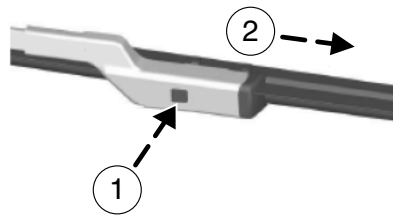

**Note:** Make sure the wiper blade locks into place.

### ENGINE OIL

#### Checking the engine oil

Refer to the *scheduled maintenance information* for the appropriate intervals for checking the engine oil.

1. Make sure the vehicle is at normal operating temperature and parked on level ground.
2. Turn the engine off and wait 15 minutes for the oil to drain into the oil pan.
3. Set the parking brake and ensure the gearshift is securely latched in 1st gear.
4. Open the hood, then locate and carefully remove the engine oil level dipstick.
5. Wipe the dipstick clean. Insert the dipstick fully, then remove it again.
  - If the oil level is **between the MIN and MAX marks**, the oil level is acceptable. **DO NOT ADD OIL.**
  - If the oil level is below the MIN mark, add enough engine oil to raise the level within the MIN and MAX range. Refer to *Adding engine oil* in this chapter.
  - **Oil levels above MAX mark may cause engine damage.** If the engine is overfilled, some oil must be removed from the engine by an authorized dealer.
6. Put the dipstick back in and ensure it is fully seated.

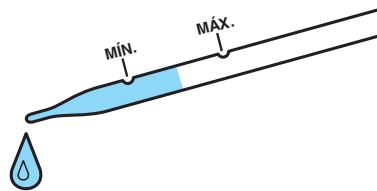

#### Adding engine oil

1. Check the engine oil. For instructions, refer to *Checking the engine oil* in this chapter.

295

## Maintenance and Specifications

2. If the engine oil level is not within the normal range, add only certified engine oil of the recommended viscosity. Remove the engine oil filler cap and use a funnel to pour the engine oil into the opening.
3. Recheck the engine oil level. Make sure the oil level is not above the MAX mark on the engine oil level dipstick.
4. Install the dipstick and ensure it is fully seated.
5. Fully install the engine oil filler cap by turning the filler cap clockwise tightly until it is snug.

**To avoid possible oil loss, DO NOT operate the vehicle with the engine oil level dipstick and/or the engine oil filler cap removed.**

### Engine oil and filter recommendations

Look for this certification trademark.

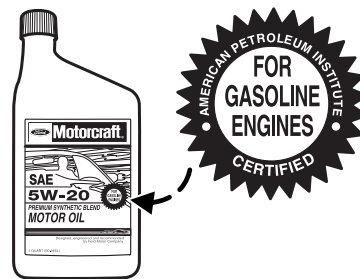

### Use SAE 5W-20 engine oil

Only use oils certified for gasoline engines by the American Petroleum Institute (API). An oil with this trademark symbol conforms to the current engine and emission system protection standards and fuel economy requirements of the International Lubricant Standardization and Approval Committee (ILSAC), comprised of U.S. and Japanese automobile manufacturers.

To protect your engine and engine's warranty, use Motorcraft® SAE 5W-20 or an equivalent SAE 5W-20 oil meeting Ford specification WSS-M2C930-A. **SAE 5W-20 oil provides optimum fuel economy and durability performance meeting all requirements for your vehicle's engine.** Refer to *Maintenance product specifications and capacities* later in this chapter for more information.

Do not use supplemental engine oil additives, cleaners or other engine treatments. They are unnecessary and could lead to engine damage that is not covered by Ford warranty.

296



## Maintenance and Specifications

Change your engine oil and filter according to the appropriate schedule listed in the *scheduled maintenance information*.

Ford production and Motorcraft® replacement oil filters are designed for added engine protection and long life. If a replacement oil filter is used that does not meet Ford material and design specifications, start-up engine noises or knock may be experienced.

It is recommended you use the appropriate Motorcraft® oil filter or another with equivalent performance for your engine application.

### BATTERY

Your vehicle is equipped with a Motorcraft® maintenance-free battery which normally does not require additional water during its life of service.

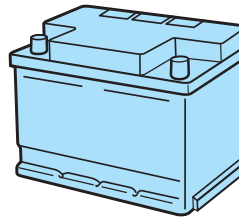

**If your battery has a cover/shield, make sure it is reinstalled after the battery has been cleaned or replaced.**

For longer, trouble-free operation, keep the top of the battery clean and dry. Also, make certain the battery cables are always tightly fastened to the battery terminals.

If you see any corrosion on the battery or terminals, remove the cables from the terminals and clean with a wire brush. You can neutralize the acid with a solution of baking soda and water.

It is recommended that the negative battery cable terminal be disconnected from the battery if you plan to store your vehicle for an extended period of time. This will minimize the discharge of your battery during storage.

**Note:** Electrical or electronic accessories or components added to the vehicle by the dealer or the owner may adversely affect battery performance and durability.



**WARNING:** Batteries normally produce explosive gases which can cause personal injury. Therefore, do not allow flames, sparks or lighted substances to come near the battery. When working near the battery, always shield your face and protect your eyes. Always provide proper ventilation.

## Maintenance and Specifications

 **WARNING:** When lifting a plastic-cased battery, excessive pressure on the end walls could cause acid to flow through the vent caps, resulting in personal injury and/or damage to the vehicle or battery. Lift the battery with a battery carrier or with your hands on opposite corners.

 **WARNING:** Keep batteries out of reach of children. Batteries contain sulfuric acid. Avoid contact with skin, eyes or clothing. Shield your eyes when working near the battery to protect against possible splashing of acid solution. In case of acid contact with skin or eyes, flush immediately with water for a minimum of 15 minutes and get prompt medical attention. If acid is swallowed, call a physician immediately.

 **WARNING:** Battery posts, terminals and related accessories contain lead and lead compounds. **Wash hands after handling.**

Because your vehicle's engine is electronically controlled by a computer, some control conditions are maintained by power from the battery. When the battery is disconnected or a new battery is installed, the engine must relearn its idle and fuel trim strategy for optimum driveability and performance. To begin this process:

1. With the vehicle at a complete stop, set the parking brake.
  2. Put the gearshift in P (Park) (automatic transmission) or the neutral position (manual transmission), turn off all accessories and start the engine.
  3. Run the engine until it reaches normal operating temperature.
  4. Allow the engine to idle for at least one minute.
  5. Turn the A/C on and allow the engine to idle for at least one minute.
  6. Drive the vehicle to complete the relearning process.
- The vehicle may need to be driven 10 miles (16 km) or more to relearn the idle and fuel trim strategy.
  - **If you do not allow the engine to relearn its idle trim, the idle quality of your vehicle may be adversely affected until the idle trim is eventually relearned.**

## Maintenance and Specifications

When the battery is disconnected or a new battery installed, the automatic transmission must relearn its adaptive strategy. As a result of this, the transmission may shift firmly when first driven. This operation is considered normal and will fully update transmission operation to its optimum shift feel.

If the battery has been disconnected or a new battery has been installed, the clock and the preset radio stations must be reset once the battery is reconnected.

- Always dispose of automotive batteries in a responsible manner. Follow your local authorized standards for disposal. Call your local authorized recycling center to find out more about recycling automotive batteries.

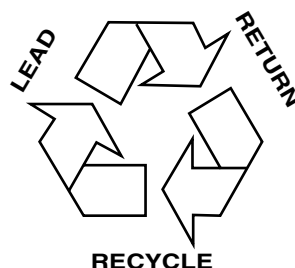

### ENGINE COOLANT

#### Checking engine coolant

The concentration and level of engine coolant should be checked at the intervals listed in *scheduled maintenance information*. The coolant concentration should be maintained at 50/50 coolant and distilled water. Coolant concentration testing is possible with a hydrometer or antifreeze tester. The level of coolant should be maintained at the FULL COLD level or within the COLD FILL RANGE in the coolant reservoir. If the level falls below, add coolant per the instructions in the *Adding engine coolant* section.

Your vehicle was factory-filled with a 50/50 engine coolant and water concentration. If the concentration of coolant falls below 40% or above 60%, the engine parts could become damaged or not work properly. **A 50/50 mixture of coolant and water provides the following:**

- **Improved freeze protection.**
- **Improved boiling protection .**
- **Protection against rust and other forms of corrosion.**
- **Proper function of calibrated gauges.**

299

## Maintenance and Specifications

When the engine is cold, check the level of the engine coolant in the reservoir.

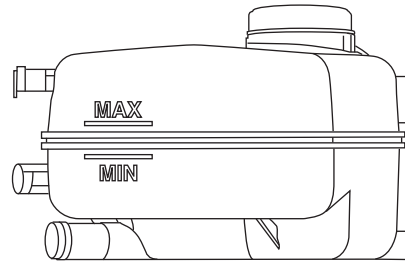

- The engine coolant should be at the FULL COLD level, or within the COLD FILL or MIN / MAX range as listed on the engine coolant reservoir (depending upon application).
- Refer to *scheduled maintenance information* for service interval schedules.

If the engine coolant has not been checked at the recommended interval, the engine coolant reservoir may become low or empty. If the reservoir is low or empty, add engine coolant to the reservoir. Refer to *Adding engine coolant* in this chapter.

**Note:** Automotive fluids are not interchangeable; do not use engine coolant/antifreeze or windshield washer fluid outside of its specified function and vehicle location.

### Adding engine coolant

When adding coolant, make sure it is a 50/50 mixture of engine coolant and distilled water. Add the mixture to the coolant reservoir, **when the engine is cool**, until the appropriate fill level is obtained. If coolant is filled to the COLD FILL RANGE or FULL COLD level when the engine is not cool, the system will remain underfilled.



**WARNING:** Do not add engine coolant when the engine is hot. Steam and scalding liquids released from a hot cooling system can burn you badly. Also, you can be burned if you spill coolant on hot engine parts.



**WARNING:** Do not put engine coolant in the windshield washer fluid container. If sprayed on the windshield, engine coolant could make it difficult to see through the windshield.

## Maintenance and Specifications

- **DO NOT MIX** different colors or types of coolant in your vehicle. Make sure the correct coolant is used. **DO NOT MIX** recycled coolant and new (unused) coolant together in the vehicle. Mixing of engine coolants may harm your engine's cooling system. The use of an improper coolant may harm engine and cooling system components and may void the warranty. Refer to *Maintenance product specifications and capacities* in this chapter.
- A large amount of water without engine coolant may be added, in case of emergency, to reach a vehicle service location. In this instance, the cooling system must be drained and refilled with a 50/50 mixture of engine coolant and distilled water as soon as possible. Water alone (without engine coolant) can cause engine damage from corrosion, overheating or freezing.
- **Do not use alcohol, methanol, brine or any engine coolants mixed with alcohol or methanol antifreeze (coolant).** Alcohol and other liquids can cause engine damage from overheating or freezing.
- **Do not add extra inhibitors or additives to the coolant.** These can be harmful and compromise the corrosion protection of the engine coolant.

For vehicles with overflow coolant systems with a non-pressurized cap on the coolant recovery system, add coolant to the coolant recovery reservoir when the engine is cool. Add the proper mixture of coolant and distilled water to the FULL COLD level. For all other vehicles which have a coolant degas system with a pressurized cap, or if it is necessary to remove the coolant pressure relief cap on the radiator of a vehicle with an overflow system, follow these steps to add engine coolant.



**WARNING:** To reduce the risk of personal injury, make sure the engine is cool before unscrewing the coolant pressure relief cap. The cooling system is under pressure; steam and hot liquid can come out forcefully when the cap is loosened slightly.

Add the proper mixture of coolant and water to the cooling system by following these steps:

1. Before you begin, turn the engine off and let it cool.
2. When the engine is cool, wrap a thick cloth around the coolant pressure relief cap on the coolant reservoir (a translucent plastic bottle). Slowly turn cap counterclockwise (left) until pressure begins to release.
3. Step back while the pressure releases.

301

## Maintenance and Specifications

4. When you are sure that all the pressure has been released, use the cloth to turn it counterclockwise and remove the cap.
5. Fill the coolant reservoir slowly with the proper coolant mixture, to within the COLD FILL RANGE or the FULL COLD level on the reservoir. If you removed the radiator cap in an overflow system, fill the radiator until the coolant is visible and radiator is almost full.
6. Replace the cap. Turn until tightly installed. Cap must be tightly installed to prevent coolant loss.

After any coolant has been added, check the coolant concentration (refer to *Checking engine coolant*). If the concentration is not 50/50, drain some coolant and adjust the concentration. It may take several drains and additions to obtain a 50/50 coolant concentration.

Whenever coolant has been added, the coolant level in the coolant reservoir should be checked the next few times you drive the vehicle. If necessary, add enough 50/50 concentration of engine coolant and distilled water to bring the liquid level to the proper level.

If you have to add more than 1.0 quart (1.0 liter) of engine coolant per month, have your authorized dealer check the engine cooling system. Your cooling system may have a leak. Operating an engine with a low level of coolant can result in engine overheating and possible engine damage.

### Recycled engine coolant

Ford Motor Company does NOT recommend the use of recycled engine coolant since a Ford-approved recycling process is not yet available.



Used engine coolant should be disposed of in an appropriate manner. Follow your community's regulations and standards for recycling and disposing of automotive fluids.

### Coolant refill capacity

To find out how much fluid your vehicle's cooling system can hold, refer to *Maintenance product specifications and capacities* in this chapter.

Fill your engine coolant reservoir as outlined in *Adding engine coolant* in this section.

## Maintenance and Specifications

### Severe climates

If you drive in extremely cold climates:

- **It may be necessary to increase the coolant concentration above 50%.**
- **NEVER increase the coolant concentration above 60%.**
- **A coolant concentration of 60% will provide improved freeze point protection. Increased engine coolant concentrations above 60% will decrease the overheat protection characteristics of the engine coolant and may cause engine damage.**
- **If available, refer to the chart on the coolant container to ensure the coolant concentration in your vehicle will provide adequate freeze protection at the temperatures in which you drive in the winter months.**



If you drive in extremely hot climates:

- **It is still necessary to maintain the coolant concentration above 40%.**
- **NEVER decrease the coolant concentration below 40%.**
- **Decreased engine coolant concentrations below 40% will decrease the corrosion/freeze protection characteristics of the engine coolant and may cause engine damage.**
- **If available, refer to the chart on the coolant container to ensure the coolant concentration in your vehicle will provide adequate protection at the temperatures in which you drive.**

Vehicles driven year-round in non-extreme climates should use a 50/50 mixture of engine coolant and distilled water for optimum cooling system and engine protection.

### Reduced engine power due to high temperature

If the engine begins to overheat:

- The engine malfunction  indicator will illuminate.
- The service engine soon  indicator will illuminate.

If either lamp illuminates when the engine is running, this indicates a fault. The engine will continue to run, but it may have limited power. If it flashes when you are driving, reduce the speed of your vehicle immediately. If it continues to flash, avoid heavy acceleration or deceleration. Have the system checked by a properly trained technician immediately.

303

## Maintenance and Specifications

If both lamps illuminate together, stop your vehicle as soon as it is safe to do so (continued use may cause reduced power and cause the engine to stop). Turn the ignition off and attempt to restart the engine. If the engine restarts, have the system checked by a properly trained technician immediately. If the engine does not restart, the vehicle must be checked before continuing to drive the vehicle.

### FUEL FILTER

Your vehicle is equipped with a lifetime fuel filter that is integrated with the fuel tank. Regular maintenance or replacement is not needed.

### WHAT YOU SHOULD KNOW ABOUT AUTOMOTIVE FUELS

#### Important safety precautions



**WARNING:** Do not overfill the fuel tank. The pressure in an overfilled tank may cause leakage and lead to fuel spray and fire.



**WARNING:** The fuel system may be under pressure. If you hear a hissing sound near the fuel filler door (Easy Fuel™ “no cap” fuel system), do not refuel until the sound stops. Otherwise, fuel may spray out, which could cause serious personal injury.



**WARNING:** Automotive fuels can cause serious injury or death if misused or mishandled.



**WARNING:** Gasoline may contain benzene, which is a cancer-causing agent.

Observe the following guidelines when handling automotive fuel:

- Extinguish all smoking materials and any open flames before refueling your vehicle.
- Always turn off the vehicle before refueling.
- Automotive fuels can be harmful or fatal if swallowed. Fuel such as gasoline is highly toxic and if swallowed can cause death or permanent injury. If fuel is swallowed, call a physician immediately, even if no symptoms are immediately apparent. The toxic effects of fuel may not be visible for hours.



304



## Maintenance and Specifications

- Avoid inhaling fuel vapors. Inhaling too much fuel vapor of any kind can lead to eye and respiratory tract irritation. In severe cases, excessive or prolonged breathing of fuel vapor can cause serious illness and permanent injury.
- Avoid getting fuel liquid in your eyes. If fuel is splashed in the eyes, remove contact lenses (if worn), flush with water for 15 minutes and seek medical attention. Failure to seek proper medical attention could lead to permanent injury.
- Fuels can also be harmful if absorbed through the skin. If fuel is splashed on the skin and/or clothing, promptly remove contaminated clothing and wash skin thoroughly with soap and water. Repeated or prolonged skin contact with fuel liquid or vapor causes skin irritation.
- Be particularly careful if you are taking “Antabuse” or other forms of disulfiram for the treatment of alcoholism. Breathing gasoline vapors, or skin contact could cause an adverse reaction. In sensitive individuals, serious personal injury or sickness may result. If fuel is splashed on the skin, promptly wash skin thoroughly with soap and water. Consult a physician immediately if you experience an adverse reaction.



**WARNING:** When refueling always shut the engine off and never allow sparks or open flames near the filler neck. Never smoke while refueling. Fuel vapor is extremely hazardous under certain conditions. Care should be taken to avoid inhaling excess fumes.



**WARNING:** The flow of fuel through a fuel pump nozzle can produce static electricity, which can cause a fire if fuel is pumped into an ungrounded fuel container.

## Maintenance and Specifications

### Refueling



**WARNING:** Fuel vapor burns violently and a fuel fire can cause severe injuries. To help avoid injuries to you and others:

- Read and follow all the instructions on the pump island;
- Turn off your engine when you are refueling;
- Do not smoke if you are near fuel or refueling your vehicle;
- Keep sparks, flames and smoking materials away from fuel;
- Stay outside your vehicle and do not leave the fuel pump unattended when refueling your vehicle — this is against the law in some places;
- Keep children away from the fuel pump; never let children pump fuel.
- Do not use personal electronic devices while refueling. It can ignite fuel vapors.

Use the following guidelines to avoid electrostatic charge build-up when filling an ungrounded fuel container:

- Place approved fuel container on the ground.
- DO NOT fill a fuel container while it is in the vehicle (including the cargo area).
- Keep the fuel pump nozzle in contact with the fuel container while filling.
- DO NOT use a device that would hold the fuel pump handle in the fill position.

### Easy Fuel™ “no cap” fuel system

Your fuel tank is equipped with an Easy Fuel™ “no cap” fuel filler system. This allows you to simply open the fuel filler door and insert the fuel filler nozzle into the fuel system. The Easy Fuel™ system is self-sealing and protected against dust, dirt, water and snow/ice.

When fueling your vehicle:

1. Turn the engine off.
2. Open the fuel filler door.
3. Slowly insert the fuel filler nozzle fully into the fuel system, and leave the nozzle fully inserted until you are done pumping. Pump fuel as normal.

306

## Maintenance and Specifications

4. After you are done pumping fuel, slowly remove the fuel filler nozzle—allow about five seconds after pumping fuel before removing the fuel filler nozzle. This allows residual fuel to drain back into the fuel tank and not spill onto the vehicle.

**Note:** A fuel spillage concern may occur if overfilling the fuel tank. Do not overfill the tank to the point that the fuel is able to bypass the fuel filler nozzle.

If the check fuel fill inlet lamp comes on, the fuel fill inlet may not have properly closed. The inlet may have stuck open or debris may be preventing the inlet from fully closing. At the next opportunity, safely pull off the road, turn off the engine, open the fuel filler door and remove any visible debris from the fuel fill opening. Insert either the fuel fill nozzle or the fuel fill funnel (see *Refilling with a portable fuel container* for funnel location) provided with the vehicle several times to dislodge any debris and/or allow the inlet to close properly. If this action corrects the problem, the check fuel fill inlet lamp may not reset immediately. It may take several driving cycles for the check fuel fill inlet lamp to turn off. A driving cycle consists of an engine start-up (after four or more hours with the engine off) followed by city/highway driving. Continuing to drive with the check fuel fill inlet lamp on may cause the service engine soon lamp to turn on as well.



**WARNING:** The fuel system may be under pressure. If you hear a hissing sound near the fuel filler door (Easy Fuel™ “no cap” fuel system), do not refuel until the sound stops. Otherwise, fuel may spray out, which could cause serious personal injury.

### Choosing the right fuel

Use only UNLEADED fuel or UNLEADED fuel blended with a maximum of 10% ethanol. Do not use fuel ethanol (E85), diesel, methanol, leaded fuel or any other fuel. The use of leaded fuel is prohibited by law and could damage your vehicle.

Your vehicle was not designed to use fuel or fuel additives with metallic compounds, including manganese-based additives.

**Note:** Use of any fuel other than those recommended may cause powertrain damage, a loss of vehicle performance, and repairs may not be covered under warranty.

307

## Maintenance and Specifications

### Octane recommendations

Your vehicle is designed to use “Regular” unleaded gasoline with a pump (R+M)/2 octane rating of 87. Some stations offer fuels posted as “Regular” with an octane rating below 87, particularly in high altitude areas. Fuels with octane levels below 87 are not recommended.

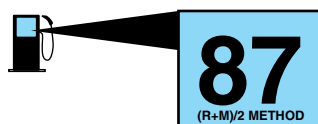

Do not be concerned if your engine sometimes knocks lightly. However, if it knocks heavily under most driving conditions while you are using fuel with the recommended octane rating, see your authorized dealer to prevent any engine damage.

### Fuel quality

If you are experiencing starting, rough idle or hesitation driveability problems during a cold start, try a different brand of “Regular” unleaded gasoline. Premium unleaded gasoline is not recommended for vehicles designed to use “Regular” unleaded gasoline because it may cause these problems to become more pronounced. If the problems persist, see your authorized dealer.

Do not add aftermarket fuel additive products to your fuel tank. It should not be necessary to add any aftermarket products to your fuel tank if you continue to use high quality fuel of the recommended octane rating. These products have not been approved for your engine and could cause damage to the fuel system. Repairs to correct the effects of using an aftermarket product in your fuel may not be covered by your warranty.

Many of the world’s automakers approved the World-Wide Fuel Charter that recommends gasoline specifications to provide improved performance and emission control system protection for your vehicle. Gasolines that meet the World-Wide Fuel Charter should be used when available. Ask your fuel supplier about gasolines that meet the World-Wide Fuel Charter.

### Cleaner air

Ford endorses the use of reformulated “cleaner-burning” gasolines to improve air quality, per the recommendations in the *Choosing the right fuel* section.

### Running out of fuel

Avoid running out of fuel because this situation may have an adverse effect on powertrain components.

308

## Maintenance and Specifications

If you have run out of fuel:

- You may need to cycle the ignition from off to on several times after refueling to allow the fuel system to pump the fuel from the tank to the engine. On restarting, cranking time will take a few seconds longer than normal.
- Normally, adding 1 gallon (3.8L) of fuel is enough to restart the engine. If the vehicle is out of fuel and on a steep grade, more than 1 gallon (3.8L) may be required.
- The service engine soon  indicator may come on. For more information on the service engine soon indicator, refer to *Warning lights and chimes* in the *Instrument Cluster* chapter.

### Refilling with a portable fuel container

With the Easy Fuel™ “no cap” fuel system, use the following directions when filling from a portable fuel container:

 **WARNING:** Do not insert the nozzle of portable fuel containers or aftermarket funnels into the Easy Fuel™ system. This could damage the fuel system and its seal, and may cause fuel to run onto the ground instead of filling the tank, which could result in serious personal injury.

 **WARNING:** Do not try to pry open or push open the Easy Fuel™ system with foreign objects. This could damage the fuel system and its seal and cause injury to you or others.

When filling the vehicle’s fuel tank from a portable fuel container, use the included funnel.

1. To locate the white plastic funnel, lift the carpeted floor panel covering the spare tire in the rear of the vehicle. The funnel is visible in the foam pod on the spare tire.

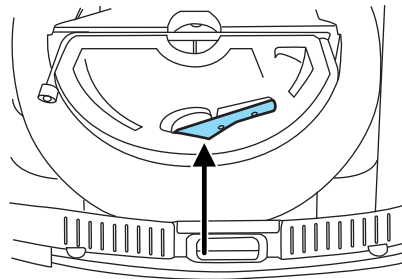

2. Slowly insert the funnel into the Easy Fuel™ system.
3. Fill the vehicle with fuel from the portable fuel container.

309

## Maintenance and Specifications

4. When done, clean the funnel or properly dispose of it. Extra funnels can be purchased from your authorized dealer if you choose to dispose of the funnel. **Do not** use aftermarket funnels; they will not work with the Easy Fuel™ system and can damage it. The included funnel has been specially designed to work safely with your vehicle.

### ESSENTIALS OF GOOD FUEL ECONOMY

#### Measuring techniques

Your best source of information about actual fuel economy is you, the driver. You must gather information as accurately and consistently as possible. Fuel expense, frequency of fill-ups or fuel gauge readings are NOT accurate as a measure of fuel economy. We do not recommend taking fuel economy measurements during the first 1,000 miles (1,600 km) of driving (engine break-in period). You will get a more accurate measurement after 2,000 miles–3,000 miles (3,000 km–5,000 km).

#### Filling the tank

The advertised fuel capacity of the fuel tank on your vehicle is equal to the rated refill capacity of the fuel tank as listed in the *Maintenance product specifications and capacities* section of this chapter.

The advertised capacity is the amount of the indicated capacity and the empty reserve combined. Indicated capacity is the difference in the amount of fuel in a full tank and a tank when the fuel gauge indicates empty. Empty reserve is the small amount of fuel remaining in the fuel tank after the fuel gauge indicates empty.

**The amount of usable fuel in the empty reserve varies and should not be relied upon to increase driving range. When refueling your vehicle after the fuel gauge indicates empty, you might not be able to refuel the full amount of the advertised capacity of the fuel tank due to the empty reserve still present in the tank.**

For consistent results when filling the fuel tank:

- Turn the engine/ignition switch to the off position prior to refueling, an error in the reading will result if the engine is left running.
- Use the same filling rate setting (low — medium — high) each time the tank is filled.
- Allow no more than two automatic click-offs when filling.
- Always use fuel with the recommended octane rating.
- Use a known quality gasoline, preferably a national brand.

310

## Maintenance and Specifications

- Have the vehicle loading and distribution the same every time. Your results will be most accurate if your filling method is consistent.

### Calculating fuel economy

1. Fill the fuel tank completely and record the initial odometer reading (in miles or kilometers).
2. Each time you fill the tank, record the amount of fuel added (in gallons or liters).
3. After at least three to five tank fill-ups, fill the fuel tank and record the current odometer reading.
4. Subtract your initial odometer reading from the current odometer reading.
5. Follow one of the simple calculations in order to determine fuel economy:

Calculation 1: **Divide total miles traveled by total gallons used.**

Calculation 2: **Multiply liters used by 100, then divide by total kilometers traveled.**

Keep a record for at least one month and record the type of driving (city or highway). This will provide an accurate estimate of the vehicle's fuel economy under current driving conditions. Additionally, keeping records during summer and winter will show how temperature impacts fuel economy. In general, lower temperatures give lower fuel economy.

### Driving style — good driving and fuel economy habits

Give consideration to the lists that follow and you may be able to change a number of variables and improve your fuel economy.

#### **Habits**

- Smooth, moderate operation can yield up to 10% savings in fuel.
- Steady speeds without stopping will usually give the best fuel economy.
- Idling for long periods of time (greater than one minute) may waste fuel.
- Anticipate stopping; slowing down may eliminate the need to stop.
- Sudden or hard accelerations may reduce fuel economy.
- Slow down gradually.
- Driving at reasonable speeds (traveling at 55 mph [88 km/h] uses 15% less fuel than traveling at 65 mph [105 km/h]).

311

## Maintenance and Specifications

- Revving the engine before turning it off may reduce fuel economy.
- Using the air conditioner or defroster may reduce fuel economy.
- You may want to turn off the speed control in hilly terrain if unnecessary shifting between the top gears occurs. Unnecessary shifting of this type could result in reduced fuel economy.
- Warming up a vehicle on cold mornings is not required and may reduce fuel economy.
- Resting your foot on the brake pedal while driving may reduce fuel economy.
- Combine errands and minimize stop-and-go driving.

### **Maintenance**

- Keep tires properly inflated and use only recommended size.
- Operating a vehicle with the wheels out of alignment will reduce fuel economy.
- Use recommended engine oil. Refer to *Maintenance product specifications and capacities* in this chapter.
- Perform all regularly scheduled maintenance items. Follow the recommended maintenance schedule and owner maintenance checks found in *scheduled maintenance information*.

### **Conditions**

- Heavily loading a vehicle or towing a trailer may reduce fuel economy at any speed.
- Carrying unnecessary weight may reduce fuel economy (approximately 1 mpg [0.4 km/L] is lost for every 400 lb [180 kg] of weight carried).
- Adding certain accessories to your vehicle (for example bug deflectors, rollbars/light bars, running boards, ski/luggage racks) may reduce fuel economy.
- Using fuel blended with alcohol may lower fuel economy.
- Fuel economy may decrease with lower temperatures during the first 8–10 miles (12–16 km) of driving.
- Driving on flat terrain offers improved fuel economy as compared to driving on hilly terrain.
- Transmissions give their best fuel economy when operated in the top cruise gear and with steady pressure on the gas pedal.
- Close windows for high speed driving.

312



## Maintenance and Specifications

### EMISSION CONTROL SYSTEM

Your vehicle is equipped with various emission control components and a catalytic converter which will enable your vehicle to comply with applicable exhaust emission standards. To make sure that the catalytic converter and other emission control components continue to work properly:

- Use only the specified fuel listed.
- Avoid running out of fuel.
- Do not turn off the ignition while your vehicle is moving, especially at high speeds.
- Have the items listed in *scheduled maintenance information* performed according to the specified schedule.

The scheduled maintenance items listed in *scheduled maintenance information* are essential to the life and performance of your vehicle and to its emissions system.

If other than Ford, Motorcraft® or Ford-authorized parts are used for maintenance replacements or for service of components affecting emission control, such non-Ford parts should be equivalent to genuine Ford Motor Company parts in performance and durability.



**WARNING:** Do not park, idle, or drive your vehicle in dry grass or other dry ground cover. The emission system heats up the engine compartment and exhaust system, which can start a fire.

Illumination of the service engine soon  indicator, charging system warning light or the temperature warning light, fluid leaks, strange odors, smoke or loss of engine power could indicate that the emission control system is not working properly.

An improperly operating or damaged exhaust system may allow exhaust to enter the vehicle. Have a damaged or improperly operating exhaust system inspected and repaired immediately.





**WARNING:** Exhaust leaks may result in entry of harmful and potentially lethal fumes into the passenger compartment.

## Maintenance and Specifications

Do not make any unauthorized changes to your vehicle or engine. By law, vehicle owners and anyone who manufactures, repairs, services, sells, leases, trades vehicles, or supervises a fleet of vehicles are not permitted to intentionally remove an emission control device or prevent it from working. Information about your vehicle's emission system is on the Vehicle Emission Control Information Decal located on or near the engine. This decal also lists engine displacement.



Please consult your *Warranty Guide* for complete emission warranty information.

### On-board diagnostics (OBD-II)

Your vehicle is equipped with a computer that monitors the engine's emission control system. This system is commonly known as the on-board diagnostics system (OBD-II). The OBD-II system protects the environment by ensuring that your vehicle continues to meet government emission standards. The OBD-II system also assists your authorized dealer in properly servicing your vehicle. When the service engine soon  indicator illuminates, the OBD-II system has detected a malfunction. Temporary malfunctions may cause the service engine soon  indicator to illuminate. Examples are:

1. The vehicle has run out of fuel—the engine may misfire or run poorly.
2. Poor fuel quality or water in the fuel—the engine may misfire or run poorly.
3. The fuel fill inlet may not have been properly closed. See *Easy Fuel™* “no cap” fuel system in this chapter.
4. Driving through deep water—the electrical system may be wet.

These temporary malfunctions can be corrected by filling the fuel tank with good quality fuel, properly closing the fuel fill inlet or letting the electrical system dry out. After three driving cycles without these or any other temporary malfunctions present, the service engine soon  indicator should stay off the next time the engine is started. A driving cycle consists of a cold engine startup followed by mixed city/highway driving. No additional vehicle service is required.

If the service engine soon  indicator remains on, have your vehicle serviced at the first available opportunity. Although some malfunctions detected by the OBD-II may not have symptoms that are apparent, continued driving with the service engine soon  indicator on can result in increased emissions, lower fuel economy, reduced engine and transmission smoothness, and lead to more costly repairs.



314

## Maintenance and Specifications

### Readiness for Inspection/Maintenance (I/M) testing

Some state/provincial and local governments may have Inspection/Maintenance (I/M) programs to inspect the emission control equipment on your vehicle. Failure to pass this inspection could prevent you from getting a vehicle registration. Your vehicle may not pass the I/M test if the service engine soon  indicator is on or not working properly (bulb is burned out), or if the OBD-II system has determined that some of the emission control systems have not been properly checked. In this case, the vehicle is considered not ready for I/M testing.

If the service engine soon  indicator is on or the bulb does not work, the vehicle may need to be serviced. Refer to *On-board diagnostics (OBD-II)* in this chapter.

If the vehicle's engine or transmission has just been serviced, or the battery has recently run down or been replaced, the OBD-II system may indicate that the vehicle is not ready for I/M testing. To determine if the vehicle is ready for I/M testing, turn the ignition key to the on position for 15 seconds without cranking the engine. If the service engine soon  indicator blinks eight times, it means that the vehicle is not ready for I/M testing; if the service engine soon  indicator stays on solid, it means that the vehicle is ready for I/M testing.

The OBD-II system is designed to check the emission control system during normal driving. A complete check may take several days. If the vehicle is not ready for I/M testing, the following driving cycle consisting of mixed city and highway driving may be performed:

15 minutes of steady driving on an expressway/highway followed by 20 minutes of stop-and-go driving with at least four 30-second idle periods.

Allow the vehicle to sit for at least eight hours without starting the engine. Then, start the engine and complete the above driving cycle. The engine must warm up to its normal operating temperature. Once started, do not turn off the engine until the above driving cycle is complete. If the vehicle is still not ready for I/M testing, the above driving cycle will have to be repeated.

### BRAKE/CLUTCH FLUID

Brake and clutch (if equipped) systems are supplied from the same reservoir.

315

## Maintenance and Specifications

The fluid level will drop slowly as the brakes wear, and will rise when the brake components are replaced. Fluid levels between the MIN and MAX lines are within the normal operating range; there is no need to add fluid. If the fluid levels are outside of the normal operating range, the performance of the system could be compromised; seek service from your authorized dealer immediately.



### TRANSMISSION FLUID

#### Checking 6-speed automatic transmission fluid

The automatic transmission does not have a transmission fluid dipstick. Refer to your *scheduled maintenance information* for scheduled intervals for fluid checks and changes. Your transmission does not consume fluid. However, the fluid level should be checked if the transmission is not working properly, (i.e., if the transmission slips or shifts slowly) or if you notice some sign of fluid leakage.

**Transmission fluid should be checked by an authorized dealer. If required, fluid should be added by an authorized dealer.**

Do not use supplemental transmission fluid additives, treatments or cleaning agents. The use of these materials may affect transmission operation and result in damage to internal transmission components.

#### Checking and adding manual transmission fluid (if equipped)

1. Clean the filler plug.
2. Remove the filler plug and inspect the fluid level.
3. Fluid level should be at the bottom of the opening.
4. Add enough fluid through the filler opening so that the fluid level is 5-10 mm below the bottom of the opening.
5. Install and tighten the fill plug securely.

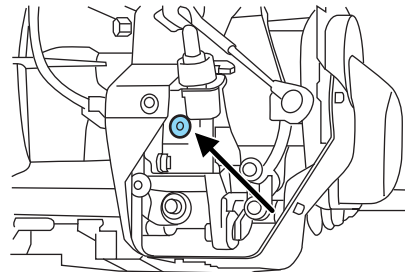

Use only fluid that meets Ford specifications. Refer to the *Maintenance product specifications and capacities* section in this chapter.

316

## Maintenance and Specifications

### AIR FILTER

Refer to *scheduled maintenance information* for the appropriate intervals for changing the air filter element.

When changing the air filter element, use only the air filter element listed. Refer to *Motorcraft® part numbers* in this chapter.



**WARNING:** To reduce the risk of vehicle damage and/or personal burn injuries do not start your engine with the air cleaner removed and do not remove it while the engine is running.

### Changing the air filter element

1. Remove the four screws that secure the air filter housing cover.
2. Carefully separate the two halves of the air filter housing.
3. Remove the air filter element from the air filter housing.
4. Wipe the air filter housing and cover clean to remove any dirt or debris and to ensure good sealing.
5. Install a new air filter element. Be careful not to crimp the filter element edges between the air filter housing and cover. This could cause filter damage and allow unfiltered air to enter the engine if not properly seated.
6. Replace the air filter housing cover and install the screws.

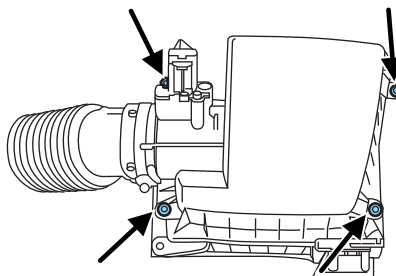

**Note:** Failure to use the correct air filter element may result in severe engine damage. The customer warranty may be void for any damage to the engine if the correct air filter element is not used.

### VEHICLE STORAGE

If you plan on storing your vehicle for an extended period of time (30 days or more), refer to the following maintenance recommendations to ensure your vehicle stays in good operating condition.

All motor vehicles and their components were engineered and tested for reliable, regular driving. Long term storage under various conditions may lead to component degradation or failure unless specific precautions are taken to preserve the components.

## Maintenance and Specifications

### *General*

- Store all vehicles in a dry, ventilated place.
- Protect from sunlight, if possible.
- If vehicles are stored outside, they require regular maintenance to protect against rust and damage.

### *Body*

- Wash vehicle thoroughly to remove dirt, grease, oil, tar or mud from exterior surfaces, rear-wheel housing and underside of front fenders. See the *Cleaning* chapter for more information.
- Periodically wash vehicles stored in exposed locations.
- Touch-up raw or primed metal to prevent rust.
- Cover chrome and stainless steel parts with a thick coat of auto wax to prevent discoloration. Re-wax as necessary when the vehicle is washed. See the *Cleaning* chapter for more information.
- Lubricate all hood, door and trunk lid hinges, and latches with a light grade oil. See the *Cleaning* chapter for more information.
- Cover interior trim to prevent fading.
- Keep all rubber parts free from oil and solvents.

### *Engine*

- The engine oil and filter should be changed prior to storage, as used engine oil contain contaminants that may cause engine damage.
- Start the engine every 15 days. Run at fast idle until it reaches normal operating temperature.
- With your foot on the brake, shift through all the gears while the engine is running.

### *Fuel system*

- Fill the fuel tank with high-quality fuel until the first automatic shutoff of the fuel pump nozzle.

**Note:** During extended periods of vehicle storage (30 days or more), fuel may deteriorate due to oxidation. Add Motorcraft® Gas Stabilizer or equivalent meeting Ford material specification ESE-M99C112-A to the vehicle fuel system whenever actual or expected storage periods exceed 30 days. Follow the instructions on the additive label. The vehicle should then be operated at idle speed to circulate the additive throughout the fuel system.

318

## Maintenance and Specifications

### *Cooling system*

- Protect against freezing temperatures.
- When removing vehicle from storage, check coolant fluid level. Confirm there are no cooling system leaks, and fluid is at the recommended level.

### *Battery*

- Check and recharge as necessary. Keep connections clean.
- If storing your vehicle for more than 30 days without recharging the battery, it may be advisable to disconnect the battery cables to ensure battery charge is maintained for quick starting.

**Note:** If battery cables are disconnected, it will be necessary to reset memory features.

### *Brakes*

- Make sure brakes and parking brake are fully released.

### *Tires*

- Maintain recommended air pressure.

### *Miscellaneous*

- Make sure all linkages, cables, levers and pins under vehicle are covered with grease to prevent rust.
- Move vehicles at least 25 feet (8 m) every 15 days to lubricate working parts and prevent corrosion.

### **Removing vehicle from storage**

When your vehicle is ready to come out of storage, do the following:

- Wash your vehicle to remove any dirt or grease film build-up on window surfaces.
- Check windshield wipers for any deterioration.
- Check under the hood for any foreign material that may have collected during storage (mice/squirrel nests).
- Check the exhaust for any foreign material that may have collected during storage.
- Check tire pressures and set tire inflation per the Tire Label.
- Check brake pedal operation. Drive the vehicle 15 ft (4.5 meters) back and forth to remove rust build-up.
- Check fluid levels (including coolant, oil and gas) to make sure there are no leaks, and fluids are at recommended levels.

319

## Maintenance and Specifications

- If the battery was removed, clean the battery cable ends and inspect. If you have any concerns or issues, contact your authorized dealer.

### MOTORCRAFT® PART NUMBERS

Component	1.6L engine
Air filter element	FA-1904
Oil filter	FL-910S <sup>1</sup>
Battery	BXT-96R-500
Spark plugs	<sup>2</sup>

<sup>1</sup>Only use the specified replacement oil filter. The use of a non-specified oil filter can result in engine damage.

<sup>2</sup>For spark plug replacement, see your authorized dealer. Refer to *scheduled maintenance information* for the appropriate intervals for changing the spark plugs.

**Replace the spark plugs with ones that meet Ford material and design specifications for your vehicle, such as Motorcraft® or equivalent replacement parts. The customer warranty may be void for any damage to the engine if such spark plugs are not used.**



## Maintenance and Specifications

### MAINTENANCE PRODUCT SPECIFICATIONS AND CAPACITIES

Item	Capacity	Ford Part Name or Equivalent	Ford Part Number / Ford Specification
Brake/Clutch fluid	Top-off to MAX line on reservoir	Motorcraft® High Performance DOT 3 Motor Vehicle Brake Fluid	PM-1-C / WSS-M6C62-A or WSS-M6C65-A1
Door latch, hood latch, auxiliary hood latch, trunk latch, seat tracks.	—	Multi-Purpose Grease (Lithium grease)	XG-4 or XL-5 or equivalent / ESB-M1C93-B
Lock cylinder	—	Motorcraft® Penetrating and Lock Lubricant	XL-1 / None
Manual transmission fluid	2.2 quarts (2.1L)	Motorcraft® Full Synthetic Manual Transmission Fluid	XT-M5-QS / WSD-M2C200-C
Automatic transmission fluid	1.8 quarts (1.7L)	Motorcraft® Dual Clutch Transmission Fluid	XT-11-QDC / WSS-M2C200-D2
Engine oil	4.2 quarts (4.0L) (with filter change)	<ul style="list-style-type: none"> <li>• Motorcraft® SAE 5W-20 Premium Synthetic Blend Motor Oil (US)</li> <li>• Motorcraft® SAE 5W-20 Full Synthetic Motor Oil (US)</li> <li>• Motorcraft® SAE 5W-20 Super Premium Motor Oil (Canada)</li> <li>• Motorcraft® SAE 5W-20 Synthetic Motor Oil (Canada)</li> </ul>	<ul style="list-style-type: none"> <li>• XO-5W20-QSP (US)</li> <li>• XO-5W20-QFS (US)</li> <li>• CXO-5W20-LSP12 (Canada)</li> <li>• CXO-5W20-LFS12 (Canada) / WSS-M2C930-A and API Certification Mark</li> </ul>

## Maintenance and Specifications

Item	Capacity	Ford Part Name or Equivalent	Ford Part Number / Ford Specification
Engine coolant	5.8 quarts (5.5L)	<ul style="list-style-type: none"> <li>Motorcraft® Specialty Orange Engine Coolant with Bittering Agent (US)</li> <li>Motorcraft® Specialty Orange Engine Coolant (Canada)</li> </ul>	<ul style="list-style-type: none"> <li>VC-3-B (US)</li> <li>CVC-3-B (Canada) / WSS-M97B44-D</li> </ul>
Windshield washer fluid	Fill as required	Motorcraft® Premium Windshield Washer Concentrate (US) Premium Quality Windshield Washer Fluid (Canada)	Motorcraft® Premium Windshield Washer Concentrate (US) Premium Quality Windshield Washer Fluid (Canada)
Fuel tank	12.4 gallons (47L)	—	—

322

## Maintenance and Specifications

### ENGINE DATA

Engine	1.6L engine
Cubic inches	97
Required fuel	Minimum 87 octane
Firing order	1-3-4-2
Ignition system	Distributorless Ignition System (D.I.S.)
Compression ratio	11:1
Spark plug gap	.027 -.031 inch (0.7 - 0.8mm)

# Maintenance and Specifications

## Engine drivebelt routing

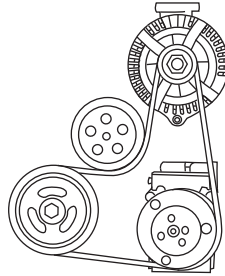

## IDENTIFYING YOUR VEHICLE

### Safety Compliance Certification Label

The National Highway Traffic Safety Administration Regulations require that a Safety Compliance Certification Label be affixed to a vehicle and prescribe where the Safety Compliance Certification Label may be located. The Safety Compliance Certification Label is located on the structure (B-Pillar) by the trailing edge of the driver's door or the edge of the driver's door.

MFD. BY FORD MOTOR CO.						
DATE: XX/XX	GVWR: XXXXXLB/ XXXXXKG					
FRONT GAWR: XXXXL	REAR GAWR: XXXXLB					
XXXXKG	WITH	XXXXKG	WITH			
XXXX/XX.XXXXX	TIRES	XXXX/XXXXXXX	TIRES			
XXXX.XX	RIMS	XXXX.XX	RIMS			
AT XXX kPa/XX	PSI COLD	AT XXX kPa/XX	PSI COLD			
THIS VEHICLE CONFORMS TO ALL APPLICABLE FEDERAL MOTOR VEHICLE SAFETY STANDARDS IN EFFECT ON THE DATE OF MANUFACTURE SHOWN ABOVE.						
VIN: XXXXXXXXXXXXXXXXX	XXXXX					
TYPE: XXX	XXXXX					
EXT PNT: XX	RC: XX	DSO:				
WB 1	INT TR	TP/PS	R	AXLE	TR SPR	XXXXX
XXX	XX	X	XX	X XX	XXX	
XXXXXXXXXXXXX XXX XXXX-XXXXXX-XX						

## Maintenance and Specifications

### Vehicle identification number (VIN)

The vehicle identification number is located on the driver side instrument panel.

Please note that in the graphic, XXXX is representative of your vehicle identification number.

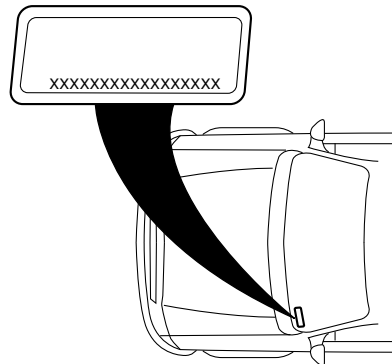

The Vehicle Identification Number (VIN) contains the following information:

1. World manufacturer identifier
2. Brake system / Gross Vehicle Weight Rating (GVWR) / Restraint Devices and their location
3. Make, vehicle line, series, body type
4. Engine type
5. Check digit
6. Model year
7. Assembly plant
8. Production sequence number

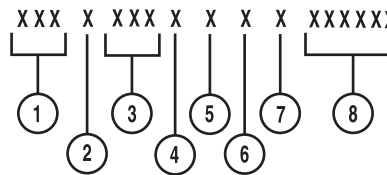

## Maintenance and Specifications

### TRANSMISSION CODE DESIGNATIONS

You can find a transmission code on the Safety Compliance Certification Label. The following table tells you which transmission each code represents.

**MFD. BY FORD MOTOR CO.**

DATE: XX/XX      GVWR: XXXXXLB/ XXXXXKG  
 FRONT GAWR: XXXXL      REAR GAWR: XXXXLB  
 XXXXKG      WITH      XXXXKG      WITH  
 XXXX/XXXXXXX      TIRES:      XXXX/XXXXXXX      TIRES  
 XXXX.XX      RIMS:      XXXX.XX      RIMS  
 AT XXX kPa/XX PSI COLD      AT XXX kPa/XX PSI COLD

THIS VEHICLE CONFORMS TO ALL APPLICABLE FEDERAL MOTOR VEHICLE SAFETY STANDARDS IN EFFECT ON THE DATE OF MANUFACTURE SHOWN ABOVE.

VIN: XXXXXXXXXXXXXXXX      XXXXX  
 TYPE: XXX      XXXXX



EXT PNT: XX      RC: XX      DSO:      XXXXX  
 WB<sup>1</sup> INT TR<sup>1</sup> TP/PS<sup>1</sup> TR<sup>1</sup> AXLE<sup>1</sup> TR<sup>1</sup> SPR<sup>1</sup>      XXXXX  
 XXX      XX      X      XX      X      XX      XXX

XXXXXXXXXXXX XX      XXXX-XXXXXX-XX

Description	Code
Five-speed manual transmission	C
Six-speed automatic transmission	A

## Accessories

### FORD CUSTOM ACCESSORIES FOR YOUR VEHICLE

A wide selection of Ford Custom Accessories are available for your vehicle through your local Ford or Ford of Canada dealer. These quality accessories have been specifically engineered to fulfill your automotive needs; they are custom designed to complement the style and aerodynamic appearance of your vehicle. In addition, each accessory is made from high quality materials and meets or exceeds Ford's rigorous engineering and safety specifications. Ford Motor Company will repair or replace any properly dealer-installed Ford Custom Accessories found to be defective in factory-supplied materials or workmanship during the warranty period, as well as any component damaged by the defective accessories. The accessories will be warranted for whichever provides you the greatest benefit:

- 12 months or 12,000 miles (20,000 km) (whichever occurs first), or
- the remainder of your new vehicle limited warranty.

Contact your dealer for details and a copy of the warranty.

The following is a list of several Ford Custom Accessories. Not all accessories are available for all models. For a complete listing of the accessories that are available for your vehicle, please contact your dealer or visit our online store at: [www.fordaccessories.com](http://www.fordaccessories.com) (U.S. only).

#### Exterior style

- Bug shields
- Spoilers
- Deflectors
- Wheels
- Graphics kit
- Body kit\*
- Splash guards

#### Interior style

- Ambient lighting kit
- Illuminated shift knob\*
- Floor mats
- Subwoofer\*
- Lighted sill plates

#### Lifestyle

- Ash cup / smoker's package
- Rear bumper protector\*
- Garmin navigation\*
- Cargo net\*
- Roof racks and carriers\*

327

## Accessories

### Peace of mind

- Keyless entry keypad
- Remote start
- Wheel locks
- Back-up camera\*
- Seat covers\*
- Windshield wiper shaker\*
- Vehicle tracking and recovery\*
- Bumper mounted parking sensors\*

\*Ford Licensed Accessories (FLA) are warranted by the accessory manufacturer's warranty. Ford Licensed Accessories are fully designed and developed by the accessory manufacturer and have not been designed or tested to Ford Motor Company engineering requirements. Contact your Ford dealer for details regarding the manufacturer's limited warranty and/or a copy of the FLA product limited warranty offered by the accessory manufacturer.

For maximum vehicle performance, keep the following information in mind when adding accessories or equipment to your vehicle:

- When adding accessories, equipment, passengers and luggage to your vehicle, do not exceed the total weight capacity of the vehicle or of the front or rear axle (GVWR or GAWR as indicated on the Safety Compliance Certification label). Consult your authorized dealer for specific weight information.
- The Federal Communications Commission (FCC) and Canadian Radio Telecommunications Commission (CRTC) regulate the use of mobile communications systems — such as two-way radios, telephones and theft alarms - that are equipped with radio transmitters. Any such equipment installed in your vehicle should comply with FCC or CRTC regulations and should be installed only by a qualified service technician.
- Mobile communications systems may harm the operation of your vehicle, particularly if they are not properly designed for automotive use.
- To avoid interference with other vehicle functions, such as anti-lock braking systems, amateur radio users who install radios and antennas onto their vehicle should not locate the Amateur Radio Antennas in the area of the driver's side hood.
- Electrical or electronic accessories or components that are added to the vehicle by the authorized dealer or the owner may adversely affect battery performance and durability and may also adversely affect the performance of other electrical systems in the vehicle.

328



## Ford Extended Service Plan

### FORD ESP EXTENDED SERVICE PLANS (U.S. ONLY)

More than 30 million Ford and Lincoln owners have discovered the powerful protection of Ford ESP. It is the only extended service plan backed by Ford Motor Company, and provides “peace of mind” protection beyond the New Vehicle Limited Warranty coverage.

#### ***Up to 500+ Covered Vehicle Components***

There are four, new-vehicle Extended Service Plans with different levels of coverage. Ask your dealer for details.

**PremiumCare** – Our most comprehensive coverage. With over 500 covered components, this plan is so complete that we generally only discuss what’s not covered!

**ExtraCare** – Covers 113 components, and includes many high-tech items.

**BaseCare** – Covers 84 components.

**PowertrainCare** – Covers 29 critical components.

**Ford ESP is honored by all Ford and Lincoln Dealers in the U.S. and Canada** It’s the only extended service plan authorized and backed by Ford Motor Company. That means you get:

- Reliable, quality service anywhere you go.
- **Factory-trained technicians.**
- **Genuine Ford and Motorcraft® Parts.**

#### ***Rental car reimbursement***

**If your vehicle is kept overnight for covered repairs**, you are eligible for rental car coverage, including Bumper-to-Bumper warranty repairs, or manufacturer’s recalls.

#### ***Transferable coverage***

If you sell your vehicle before your Ford ESP coverage expires, you can transfer any remaining coverage to the new owner. Whenever you’re ready to sell your car, prospective buyers may feel better about taking a risk on your used vehicle. Ford ESP may add resale value!

Plus, **exclusive 24/7 roadside assistance**, including:

- Towing, flat-tire change and battery jump starts.
- Out-of-fuel and lock-out assistance.
- Travel expense reimbursement for lodging, meals and rental car.
- Destination assistance for taxi, shuttle, rental car coverage and emergency transportation.

329

## Ford Extended Service Plan

### ***Ford ESP Can Quickly Pay for Itself***

One service bill – the cost of parts and labor – can easily exceed the price of your Ford ESP Service Contract. With Ford ESP, you minimize your risk for unexpected repair bills and rising repair costs.

### ***Avoid the rising cost of properly maintaining your vehicle!***

Ford ESP also offers a Premium Maintenance Plan that covers items that **routinely wear out**.

The coverage is prepaid, so you never have to worry about affording your vehicle maintenance. It covers regular checkups, routine inspections, preventive care and replacement of items that require periodic attention for **normal “wear”**:

- **Wiper blades**
- **Spark plugs (except California)**
- **Clutch disc**
- **Brake pads and linings**
- **Shock absorbers**
- **Belts and hoses**

Contact your selling Ford or Lincoln dealership today so they can customize a Ford Extended Service Plan that fits your driving lifestyle and budget.

### ***Interest free finance options available***

Take advantage of our installment payment plan, just a 10% down payment will provide you with an affordable no interest, no-fee payment opportunity.

Ford Extended Service Plan

***Get Genuine Peace of Mind with Ford ESP!***

To learn more, complete the information below and mail this to:

**Ford ESP  
P.O. Box 8072  
Royal Oak, MI 48068-9933**

NAME (PLEASE PRINT) \_\_\_\_\_

ADDRESS \_\_\_\_\_ APT.NO. \_\_\_\_\_

CITY \_\_\_\_\_ STATE \_\_\_\_\_ ZIP \_\_\_\_\_

E-MAIL: \_\_\_\_\_

## Ford Extended Service Plan

### FORD ESP EXTENDED SERVICE PLANS (CANADA ONLY)

You can get more protection for your vehicle by purchasing a Ford Extended Service Plan (ESP). Ford ESP is the only service contract backed by Ford Motor Company of Canada, Limited. Depending on the plan you purchase, Ford ESP provides benefits such as:

- Rental reimbursement
- Coverage for certain maintenance and wear items
- Protection against repair costs after your New Vehicle Limited Warranty Coverage expires
- Roadside Assistance benefits

There are several Ford ESP plans available in various time, distance and deductible combinations. Each plan is tailored to fit your own driving needs, including reimbursement for towing and rental.

When you purchase Ford ESP, you receive added peace-of-mind protection throughout Canada and the United States, provided by a network of participating Ford Motor Company dealers.

For more information, visit your local Ford of Canada dealer or [www.ford.ca](http://www.ford.ca) to find the Ford Extended Service Plan that is right for you.

**NOTE:** Repairs performed outside of Canada and the United States are not eligible for Ford ESP coverage. This information is subject to change.

## Scheduled Maintenance Guide

### GENERAL MAINTENANCE INFORMATION

#### Why maintain your vehicle?

This guide describes the scheduled maintenance required for your vehicle. Carefully following this schedule helps protect against major repair expenses resulting from neglect or inadequate maintenance and may also help to increase the value of your vehicle when you sell or trade it.

It is your responsibility to see that all scheduled maintenance is performed and that the materials used meet Ford engineering specifications. Failure to perform scheduled maintenance specific in this guide will invalidate warranty coverage on parts affected by the lack of maintenance. Be sure receipts for completed maintenance are kept with the vehicle and confirmation of the work performed is always recorded in this guide.

Your dealer has factory-trained technicians who can perform the required maintenance using genuine Ford parts. They are committed to meeting your service needs and to assuring your continuing satisfaction.

#### Protecting your investment

Maintenance is an investment that will pay dividends in the form of improved reliability, durability and resale value. To ensure the proper performance of your vehicle and its emission control systems, it is imperative that scheduled maintenance be completed at the designated intervals.

Your vehicle is very sophisticated and built with multiple complex performance systems. Every manufacturer develops these systems using different specifications and performance features. That's why it's important to rely upon your dealership to properly diagnose and repair your vehicle.

Ford Motor Company has recommended maintenance intervals for various parts and component systems based upon engineering testing. Ford Motor Company relies upon this testing to determine the most appropriate mileage for replacement of oils and fluids to protect your vehicle at the lowest overall cost to you and recommends against maintenance schedules that deviate from the scheduled maintenance information.

## Scheduled Maintenance Guide

Ford strongly recommends the use of genuine Ford replacement parts. Parts other than Ford, Motorcraft® or Ford-authorized remanufactured parts that are used for maintenance replacement or for the service of components affecting emission control must be equivalent to genuine Ford Motor Company parts in performance and durability. It is the owner's responsibility to determine the equivalency of such parts. Please consult your *Warranty Guide* for complete warranty information.

Chemicals or additives not approved by Ford are not required for factory recommended maintenance. In fact, Ford Motor Company recommends against the use of such additive products unless specifically recommended by Ford for a particular application.

### ***Oils, fluids and flushing***

In many cases, fluid discoloration is a normal operating characteristic and, by itself, does not necessarily indicate a concern or that the fluid needs to be changed. However, discolored fluids that also show signs of overheating and/or foreign material contamination should be inspected immediately by a qualified expert such as the factory-trained technicians at your dealership. Your vehicle's oils and fluids should be changed at the specified intervals or in conjunction with a repair. Flushing is a viable way to change fluid for many vehicle sub-systems during scheduled maintenance. It is critical that systems are flushed only with new fluid that is the same as that required to fill and operate the system, or using a Ford-approved flushing chemical.

### **Genuine Ford parts and service**

When planning your maintenance services, consider your dealership for all your vehicle's needs.

There are a lot of reasons why visiting your dealership for all your service needs is a great way to help keep your vehicle running great.

### ***Convenience***

Many dealerships have extended evening and Saturday hours to make your service visit more convenient. How's that for quality service?

### ***Factory-trained technicians***

Service technicians participate in extensive factory-sponsored certification training to help them become experts on the operation of your vehicle. Ask your dealership about the training and certification their technicians have received.

## Scheduled Maintenance Guide

### ***Genuine Ford and Motorcraft® replacement parts***

Dealerships stock Ford and Motorcraft® branded replacement parts. These parts meet or exceed Ford Motor Company's specifications, and we stand behind them. Parts installed at your dealership carry a nationwide, 12 month/12,000 mile (20,000 km) parts and labor limited warranty. Your dealer can give you details.

### ***Value shopping for your vehicle's maintenance needs***

Your dealership recognizes the competitive landscape of maintenance and light repair automotive services. With factory-trained technicians, and one-stop service from routine maintenance like oil changes and tire rotations to repairs like brake service, check out the value your dealers can offer.

### **Owner checks and services**

Certain basic maintenance checks and inspections should be performed by the owner or a service technician at the intervals indicated. Service information and supporting specifications are provided in this owner's guide.

Any adverse condition should be brought to the attention of your dealer or qualified service technician as soon as possible for the proper service advice. The owner maintenance service checks are generally not covered by warranties so you may be charged for labor, parts or fluids used.

<b>Engine oil/coolant change intervals</b>	
<b>Engine oil</b>	As indicated by the message center (can be up to one year or 10,000 miles [16,000 km])
<b>Engine coolant, initial change</b>	6 years or 100,000 miles (160,000 km) (whichever comes first)
<b>Engine coolant, after initial change</b>	Every 3 years or 50,000 miles (80,000 km)
<b>Check every month</b>	
Engine oil level	
Function of all interior and exterior lights	
Tires for wear and proper pressure, including spare	
Windshield washer fluid level	

## Scheduled Maintenance Guide

Check every six months
Battery connections; clean if necessary
Body and door drain holes for obstructions; clean if necessary
Cooling system fluid level and coolant strength
Door weatherstrips for wear; lubricate if necessary
Hinges/latches/outside locks for proper operation; lubricate if necessary
Parking brake for proper operation
Safety belts and seat latches for wear and function
Safety warning lamps (brake, ABS, airbag, safety belt) for operation
Washer spray/wiper operation; clean or replace blades as necessary

### Multi-point inspection

In order to keep your vehicle running right, it is important to have the systems on your vehicle checked regularly. This can help identify potential issues and prevent major problems. Ford Motor Company recommends the following multi-point inspection be performed at every scheduled maintenance interval to help ensure your vehicle keeps running great.

Multi-point inspection – Recommended each visit	
Accessory drive belt(s)	Half-shaft dust boots (if equipped)
Battery performance	Horn operation
Clutch operation (if equipped)	Radiator, cooler, heater and A/C hoses
Engine air filter	Suspension components for leaks and damage
Exhaust system	Steering and linkage
Exterior lamps and hazard warning system operation	Tires for wear and proper pressure, including spare
Fluid levels*; fill if necessary	Windshield for cracks, chips or pits
For oil and fluid leaks	Washer spray and wiper operation
*Brake, coolant recovery reservoir, manual and automatic transmission (with an underhood dipstick), power steering (if equipped) and window washer	

Be sure to ask your dealership service advisor or technician about the multi-point vehicle inspection. It's a comprehensive way to perform a thorough inspection of your vehicle. It's your checklist that gives you immediate feedback on the overall condition of your vehicle. You'll know

336





## Scheduled Maintenance Guide

### **NORMAL SCHEDULED MAINTENANCE AND LOG**

The following section contains the “Normal Schedule”. This schedule is presented at specific mileage (kilometer) intervals with exceptions noted. Reset your oil life monitoring system after each engine oil and filter change; refer to the *Instrument Cluster* chapter.

## Scheduled Maintenance Guide

	10	20	30	40	50	60	70	80	90	100	110	120	130	140	150
<b>Miles (x 1,000)</b>	10	20	30	40	50	60	70	80	90	100	110	120	130	140	150
<b>Kilometers (x 1,000)</b>	16	32	48	64	80	96	112	128	144	160	176	192	208	224	240
<b>Months</b>	12	24	36	48	60	72	84	96	108	120	132	144	156	168	180
Change engine oil and filter	•	•	•	•	•	•	•	•	•	•	•	•	•	•	•
Rotate tires, inspect tire wear and measure tread depth	•	•	•	•	•	•	•	•	•	•	•	•	•	•	•
Inspect wheels and related components for abnormal noise, wear, looseness or drag	•	•	•	•	•	•	•	•	•	•	•	•	•	•	•
Perform multi-point inspection (recommended)	•	•	•	•	•	•	•	•	•	•	•	•	•	•	•
Inspect automatic transmission fluid level (if equipped with dipstick); consult dealer for requirements	•	•	•	•	•	•	•	•	•	•	•	•	•	•	•
Inspect brake pads, shoes, rotors, drums, brake linings, hoses and parking brake	•	•	•	•	•	•	•	•	•	•	•	•	•	•	•
Inspect engine cooling system concentration and hoses	•	•	•	•	•	•	•	•	•	•	•	•	•	•	•
Inspect exhaust system and heat shields	•	•	•	•	•	•	•	•	•	•	•	•	•	•	•
Inspect half-shaft boots (if equipped)	•	•	•	•	•	•	•	•	•	•	•	•	•	•	•
Inspect steering linkage, ball joints, suspension, tie-rod ends, driveshaft and U-joints; lubricate if equipped with grease fittings	•	•	•	•	•	•	•	•	•	•	•	•	•	•	•
Inspect cabin air filter (if equipped)	•	•	•	•	•	•	•	•	•	•	•	•	•	•	•
Reset your oil life monitoring system after each engine oil and filter change; refer to the <i>Instrument Cluster</i> chapter	•	•	•	•	•	•	•	•	•	•	•	•	•	•	•

## Scheduled Maintenance Guide

Every 20,000 miles (32,000 km)	Replace cabin air filter (if equipped)
Every 30,000 miles (48,000 km)	Replace climate-controlled seat filter (if equipped)
	Replace engine air filter
Every 100,000 miles (160,000 km)	Change engine coolant <sup>1</sup>
	Replace spark plugs
	Inspect accessory drive belt(s) <sup>2</sup>
Every 150,000 miles (240,000 km)	Change automatic transmission fluid and filter (filter not required on 6F35, 6F50, DPS6 and AWF-21 transmissions); consult dealer for requirements
	Change manual transmission fluid
	Change rear axle fluid (RWD vehicles)
	Replace accessory drive belt(s) if not replaced within the last 100,000 miles (160,000 km)
	Replace timing belt (Fiesta); <b>failure to replace belt can cause internal engine damage</b>
<sup>1</sup> Initial replacement at 100,000 miles (160,000 km) or 72 months; every 50,000 miles (80,000 km) or 36 months thereafter	
<sup>2</sup> Perform a follow-up inspection at 120,000 miles (192,000 km)	

## Scheduled Maintenance Guide

**Maintenance schedule log**

<p style="text-align: center;">DEALER VALIDATION:</p> <p style="text-align: center;">P&amp;A CODE:</p> <p>RO#:                    HOURS:</p> <p>DATE:                  MILEAGE:</p>	<p style="text-align: center;">DEALER VALIDATION:</p> <p style="text-align: center;">P&amp;A CODE:</p> <p>RO#:                    HOURS:</p> <p>DATE:                  MILEAGE:</p>
<p style="text-align: center;">DEALER VALIDATION:</p> <p style="text-align: center;">P&amp;A CODE:</p> <p>RO#:                    HOURS:</p> <p>DATE:                  MILEAGE:</p>	<p style="text-align: center;">DEALER VALIDATION:</p> <p style="text-align: center;">P&amp;A CODE:</p> <p>RO#:                    HOURS:</p> <p>DATE:                  MILEAGE:</p>
<p style="text-align: center;">DEALER VALIDATION:</p> <p style="text-align: center;">P&amp;A CODE:</p> <p>RO#:                    HOURS:</p> <p>DATE:                  MILEAGE:</p>	<p style="text-align: center;">DEALER VALIDATION:</p> <p style="text-align: center;">P&amp;A CODE:</p> <p>RO#:                    HOURS:</p> <p>DATE:                  MILEAGE:</p>
<p style="text-align: center;">DEALER VALIDATION:</p> <p style="text-align: center;">P&amp;A CODE:</p> <p>RO#:                    HOURS:</p> <p>DATE:                  MILEAGE:</p>	<p style="text-align: center;">DEALER VALIDATION:</p> <p style="text-align: center;">P&amp;A CODE:</p> <p>RO#:                    HOURS:</p> <p>DATE:                  MILEAGE:</p>
<p style="text-align: center;">DEALER VALIDATION:</p> <p style="text-align: center;">P&amp;A CODE:</p> <p>RO#:                    HOURS:</p> <p>DATE:                  MILEAGE:</p>	<p style="text-align: center;">DEALER VALIDATION:</p> <p style="text-align: center;">P&amp;A CODE:</p> <p>RO#:                    HOURS:</p> <p>DATE:                  MILEAGE:</p>

## Scheduled Maintenance Guide

<p style="text-align: center;">DEALER VALIDATION:</p>  <p style="text-align: center;">P&amp;A CODE:</p> <p>RO#:            HOURS:</p> <p>DATE:           MILEAGE:</p>	<p style="text-align: center;">DEALER VALIDATION:</p>  <p style="text-align: center;">P&amp;A CODE:</p> <p>RO#:            HOURS:</p> <p>DATE:           MILEAGE:</p>
<p style="text-align: center;">DEALER VALIDATION:</p>  <p style="text-align: center;">P&amp;A CODE:</p> <p>RO#:            HOURS:</p> <p>DATE:           MILEAGE:</p>	<p style="text-align: center;">DEALER VALIDATION:</p>  <p style="text-align: center;">P&amp;A CODE:</p> <p>RO#:            HOURS:</p> <p>DATE:           MILEAGE:</p>
<p style="text-align: center;">DEALER VALIDATION:</p>  <p style="text-align: center;">P&amp;A CODE:</p> <p>RO#:            HOURS:</p> <p>DATE:           MILEAGE:</p>	<p style="text-align: center;">DEALER VALIDATION:</p>  <p style="text-align: center;">P&amp;A CODE:</p> <p>RO#:            HOURS:</p> <p>DATE:           MILEAGE:</p>
<p style="text-align: center;">DEALER VALIDATION:</p>  <p style="text-align: center;">P&amp;A CODE:</p> <p>RO#:            HOURS:</p> <p>DATE:           MILEAGE:</p>	<p style="text-align: center;">DEALER VALIDATION:</p>  <p style="text-align: center;">P&amp;A CODE:</p> <p>RO#:            HOURS:</p> <p>DATE:           MILEAGE:</p>
<p style="text-align: center;">DEALER VALIDATION:</p>  <p style="text-align: center;">P&amp;A CODE:</p> <p>RO#:            HOURS:</p> <p>DATE:           MILEAGE:</p>	<p style="text-align: center;">DEALER VALIDATION:</p>  <p style="text-align: center;">P&amp;A CODE:</p> <p>RO#:            HOURS:</p> <p>DATE:           MILEAGE:</p>

## Scheduled Maintenance Guide

<p style="text-align: center;">DEALER VALIDATION:</p>  <p style="text-align: center;">P&amp;A CODE:</p> <p>RO#:                    HOURS:</p> <p>DATE:                  MILEAGE:</p>	<p style="text-align: center;">DEALER VALIDATION:</p>  <p style="text-align: center;">P&amp;A CODE:</p> <p>RO#:                    HOURS:</p> <p>DATE:                  MILEAGE:</p>
<p style="text-align: center;">DEALER VALIDATION:</p>  <p style="text-align: center;">P&amp;A CODE:</p> <p>RO#:                    HOURS:</p> <p>DATE:                  MILEAGE:</p>	<p style="text-align: center;">DEALER VALIDATION:</p>  <p style="text-align: center;">P&amp;A CODE:</p> <p>RO#:                    HOURS:</p> <p>DATE:                  MILEAGE:</p>
<p style="text-align: center;">DEALER VALIDATION:</p>  <p style="text-align: center;">P&amp;A CODE:</p> <p>RO#:                    HOURS:</p> <p>DATE:                  MILEAGE:</p>	<p style="text-align: center;">DEALER VALIDATION:</p>  <p style="text-align: center;">P&amp;A CODE:</p> <p>RO#:                    HOURS:</p> <p>DATE:                  MILEAGE:</p>
<p style="text-align: center;">DEALER VALIDATION:</p>  <p style="text-align: center;">P&amp;A CODE:</p> <p>RO#:                    HOURS:</p> <p>DATE:                  MILEAGE:</p>	<p style="text-align: center;">DEALER VALIDATION:</p>  <p style="text-align: center;">P&amp;A CODE:</p> <p>RO#:                    HOURS:</p> <p>DATE:                  MILEAGE:</p>
<p style="text-align: center;">DEALER VALIDATION:</p>  <p style="text-align: center;">P&amp;A CODE:</p> <p>RO#:                    HOURS:</p> <p>DATE:                  MILEAGE:</p>	<p style="text-align: center;">DEALER VALIDATION:</p>  <p style="text-align: center;">P&amp;A CODE:</p> <p>RO#:                    HOURS:</p> <p>DATE:                  MILEAGE:</p>

## Scheduled Maintenance Guide

### SPECIAL OPERATING CONDITIONS

If you operate your vehicle **primarily** in one of the more demanding conditions listed below, you will need to have some items maintained more frequently. If you only **occasionally** operate your vehicle under these conditions, it is not necessary to perform the additional maintenance. For specific recommendations, see your dealership service advisor or technician.

#### Towing a trailer or using a camper or car-top carrier

- |  |   |
|--|---|
| <b>As required</b>                             | – Change engine oil and filter as indicated by message center and perform services listed in the Normal Scheduled Maintenance chart |
| <b>Inspect frequently, service as required</b> | – See axle maintenance items under <i>Exceptions</i>  |
| <b>Every 30,000 miles (48,000 km)</b>          | – Change automatic transmission fluid (except Fiesta and vehicles equipped with a 6R80 transmission)                                |
| <b>Every 60,000 miles (96,000 km)</b>          | – Change manual transmission fluid  |

#### Extensive idling and/or low-speed driving for long distances as in heavy commercial use such as delivery, taxi, patrol car or livery

- |  |   |
|--|---|
| <b>As required</b>                             | – Change engine oil and filter as indicated by message center and perform services listed in the Normal Scheduled Maintenance chart (except Fiesta) |
| <b>Inspect frequently, service as required</b> | – Replace cabin air filter (if equipped)<br>– Replace engine air filter   |
| <b>Every 300 hours of engine operation*</b>    | – Change engine oil and filter (Fiesta)   |
| <b>Every 30,000 miles (48,000 km)</b>          | – Change automatic transmission fluid (except Fiesta and vehicles equipped with a 6R80 transmission)  |
| <b>Every 60,000 miles (96,000 km)</b>          | – Replace spark plugs   |

\* Engine hour meter installation is recommended for these operating conditions.



## Scheduled Maintenance Guide

### Operating in dusty conditions such as unpaved or dusty roads

- |   |   |
|---|---|
| <b>Inspect frequently, service as required</b>  | – Replace cabin air filter (if equipped)<br>– Replace engine air filter   |
| <b>Every 5,000 miles (8,000 km)</b>             | – Inspect the wheels and related components for abnormal noise, wear, looseness or drag<br>– Rotate tires, inspect tires for wear and measure tread depth |
| <b>Every 5,000 miles (8,000 km) or 6 months</b> | – Change engine oil and filter  |
| <b>Every 30,000 miles (48,000 km)</b>           | – Change automatic transmission fluid (except Fiesta and vehicles equipped with a 6R80 transmission)  |
| <b>Every 50,000 miles (80,000 km)</b>           | – Change manual transmission fluid  |

Reset your oil life monitoring system after each engine oil and filter change; refer to the *Instrument Cluster* chapter.

### Exclusive use of E85 (Flex Fuel Vehicles only)

- |                                  |   |
|----------------------------------|---|
| <b>Every oil change interval</b> | – If ran exclusively on E85, fill the fuel tank full with regular unleaded fuel |
|----------------------------------|---|

# Scheduled Maintenance Guide

## Special operating condition log

<p style="text-align: center;">DEALER VALIDATION:</p>  <p style="text-align: center;">P&amp;A CODE:</p> <p>RO#:            HOURS:</p> <p>DATE:           MILEAGE:</p>	<p style="text-align: center;">DEALER VALIDATION:</p>  <p style="text-align: center;">P&amp;A CODE:</p> <p>RO#:            HOURS:</p> <p>DATE:           MILEAGE:</p>
<p style="text-align: center;">DEALER VALIDATION:</p>  <p style="text-align: center;">P&amp;A CODE:</p> <p>RO#:            HOURS:</p> <p>DATE:           MILEAGE:</p>	<p style="text-align: center;">DEALER VALIDATION:</p>  <p style="text-align: center;">P&amp;A CODE:</p> <p>RO#:            HOURS:</p> <p>DATE:           MILEAGE:</p>
<p style="text-align: center;">DEALER VALIDATION:</p>  <p style="text-align: center;">P&amp;A CODE:</p> <p>RO#:            HOURS:</p> <p>DATE:           MILEAGE:</p>	<p style="text-align: center;">DEALER VALIDATION:</p>  <p style="text-align: center;">P&amp;A CODE:</p> <p>RO#:            HOURS:</p> <p>DATE:           MILEAGE:</p>
<p style="text-align: center;">DEALER VALIDATION:</p>  <p style="text-align: center;">P&amp;A CODE:</p> <p>RO#:            HOURS:</p> <p>DATE:           MILEAGE:</p>	<p style="text-align: center;">DEALER VALIDATION:</p>  <p style="text-align: center;">P&amp;A CODE:</p> <p>RO#:            HOURS:</p> <p>DATE:           MILEAGE:</p>
<p style="text-align: center;">DEALER VALIDATION:</p>  <p style="text-align: center;">P&amp;A CODE:</p> <p>RO#:            HOURS:</p> <p>DATE:           MILEAGE:</p>	<p style="text-align: center;">DEALER VALIDATION:</p>  <p style="text-align: center;">P&amp;A CODE:</p> <p>RO#:            HOURS:</p> <p>DATE:           MILEAGE:</p>

## Scheduled Maintenance Guide

<p style="text-align: center;">DEALER VALIDATION:</p>  <p style="text-align: center;">P&amp;A CODE:</p> <p>RO#:                    HOURS:</p> <p>DATE:                  MILEAGE:</p>	<p style="text-align: center;">DEALER VALIDATION:</p>  <p style="text-align: center;">P&amp;A CODE:</p> <p>RO#:                    HOURS:</p> <p>DATE:                  MILEAGE:</p>
<p style="text-align: center;">DEALER VALIDATION:</p>  <p style="text-align: center;">P&amp;A CODE:</p> <p>RO#:                    HOURS:</p> <p>DATE:                  MILEAGE:</p>	<p style="text-align: center;">DEALER VALIDATION:</p>  <p style="text-align: center;">P&amp;A CODE:</p> <p>RO#:                    HOURS:</p> <p>DATE:                  MILEAGE:</p>
<p style="text-align: center;">DEALER VALIDATION:</p>  <p style="text-align: center;">P&amp;A CODE:</p> <p>RO#:                    HOURS:</p> <p>DATE:                  MILEAGE:</p>	<p style="text-align: center;">DEALER VALIDATION:</p>  <p style="text-align: center;">P&amp;A CODE:</p> <p>RO#:                    HOURS:</p> <p>DATE:                  MILEAGE:</p>
<p style="text-align: center;">DEALER VALIDATION:</p>  <p style="text-align: center;">P&amp;A CODE:</p> <p>RO#:                    HOURS:</p> <p>DATE:                  MILEAGE:</p>	<p style="text-align: center;">DEALER VALIDATION:</p>  <p style="text-align: center;">P&amp;A CODE:</p> <p>RO#:                    HOURS:</p> <p>DATE:                  MILEAGE:</p>
<p style="text-align: center;">DEALER VALIDATION:</p>  <p style="text-align: center;">P&amp;A CODE:</p> <p>RO#:                    HOURS:</p> <p>DATE:                  MILEAGE:</p>	<p style="text-align: center;">DEALER VALIDATION:</p>  <p style="text-align: center;">P&amp;A CODE:</p> <p>RO#:                    HOURS:</p> <p>DATE:                  MILEAGE:</p>

## Scheduled Maintenance Guide

### EXCEPTIONS

In addition, there are several exceptions to the Normal Schedule. They are listed below:

#### Normal vehicle axle maintenance

- Rear axles and power take-off (PTO) units containing synthetic fluid and light duty trucks equipped with Ford-design axles are lubricated for life. These fluids are not to be checked or changed unless a leak is suspected, service is required or the axle assembly has been submerged in water. The axle and PTO fluids should be changed anytime the axle and PTO have been submerged in water. During extended trailer tow operation above 70°F (21°C) ambient and wide open throttle for extended periods above 45 mph (72 km/h), non-synthetic rear axle fluids should be changed every 3,000 miles (4,800 km) or three months, whichever occurs first. The 3,000 mile (4,800 km) fluid change interval may be waived if the axle was filled with 75W140 synthetic gear fluid meeting Ford specification WSL-M2C192-A, part number FITZ-19580-B or equivalent. Add friction modifier XL-3 (EST-M2C118-A) or equivalent for complete refill of Traction-Lok rear axles (refer to *Maintenance product specifications and capacities* in the *Maintenance and Specifications* chapter for details). The axle fluid should be changed anytime an axle has been submerged in water.

#### Police/Taxi/Livery vehicle axle maintenance

- Change rear axle fluid every 100,000 miles (160,000 km). Rear axle fluid change may be waived if the axle was filled with 75W140 synthetic gear fluid meeting Ford specification WSL-M2C192-A, part number FITZ-19580-B or equivalent. Add four ounces (118 mL) of friction modifier XL-3 (EST-M2C118-A) or equivalent for complete refill of Traction-Lok rear axles. The axle fluid should be changed anytime the axle has been submerged in water.

#### California fuel filter replacement

- If the vehicle is registered in California, the California Air Resources Board has determined that the failure to perform this maintenance item will not nullify the emission warranty or limit recall liability prior to the completion of the vehicle's useful life. Ford Motor Company, however, urges you to have all recommended maintenance services performed at the specified intervals and to record all vehicle service.

#### Hot climate oil change intervals

- If operating conditions are normal and you drive your vehicle under typical, everyday conditions **and** you are using an API performance category oil of SL or later (for example SM, etc.) then you can follow the 7,500 mile (12,000 km) normal service oil change intervals schedule. Vehicles operating in the Middle East, North Africa, Sub-Saharan Africa or locations with similar climates must follow the oil change interval of 3,000 mile (4,800 km) if the owner is using oils defined by the American Petroleum Institute (API) performance category of API SK or earlier (for example SJ, etc.).

#### Engine air filter & cabin air filter replacement

- Engine air filter and cabin air filter life is dependent on exposure to dusty and dirty conditions. Vehicles operated in these conditions will require frequent inspection and replacement of the engine air filter and cabin air filter.

## Scheduled Maintenance Guide

### ENGINE COOLANT CHANGE RECORD

Initial change	6 years or 100,000 miles (160,000 km) (whichever comes first)
After initial change	Every 3 years or 50,000 miles (80,000 km)

### Engine coolant change log

<p style="text-align: center;">DEALER VALIDATION:</p>  <p><b>RO#:</b>                    <b>P&amp;A CODE:</b>  <b>HOURS:</b>  <b>DATE:</b>                <b>MILEAGE:</b></p>	<p style="text-align: center;">DEALER VALIDATION:</p>  <p><b>RO#:</b>                    <b>P&amp;A CODE:</b>  <b>HOURS:</b>  <b>DATE:</b>                <b>MILEAGE:</b></p>
<p style="text-align: center;">DEALER VALIDATION:</p>  <p><b>RO#:</b>                    <b>P&amp;A CODE:</b>  <b>HOURS:</b>  <b>DATE:</b>                <b>MILEAGE:</b></p>	<p style="text-align: center;">DEALER VALIDATION:</p>  <p><b>RO#:</b>                    <b>P&amp;A CODE:</b>  <b>HOURS:</b>  <b>DATE:</b>                <b>MILEAGE:</b></p>
<p style="text-align: center;">DEALER VALIDATION:</p>  <p><b>RO#:</b>                    <b>P&amp;A CODE:</b>  <b>HOURS:</b>  <b>DATE:</b>                <b>MILEAGE:</b></p>	<p style="text-align: center;">DEALER VALIDATION:</p>  <p><b>RO#:</b>                    <b>P&amp;A CODE:</b>  <b>HOURS:</b>  <b>DATE:</b>                <b>MILEAGE:</b></p>

## Index

- 911 Assist™ .....65
- A**
- Accessing and using your USB  
port .....79
- Accessing call history/phone  
book during active call .....54
- Accessing system settings .....83
- Accessing vehicle applications ..82
- Accessing your phone book .....55
- Accessing your playlists .....92
- Active call menu options .....52
- Adding a Bluetooth media  
device which is in discoverable  
mode .....84
- Adding a Bluetooth media  
device which is in discovery  
mode .....84
- Adding (pairing) a phone .....71
- AdvanceTrac .....239
- Airbag supplemental restraint  
system .....167, 176, 178  
and child safety seats .....169  
description .....167, 176, 178  
disposal .....182  
driver airbag .....169, 177, 180  
indicator light .....176, 181  
operation .....169, 177, 180  
passenger airbag .....169, 177, 180  
side airbag .....176
- Air cleaner filter .....317, 320
- Ambient mood/lighting .....110
- Answering an incoming call .....51
- Antifreeze  
(see Engine coolant) .....299
- 350
- Anti-lock brake system  
(see Brakes) .....238
- Anti-theft system .....144, 146  
arming the system .....145–146  
disarming a triggered  
system .....146  
triggering .....146
- Applications .....70
- AppLink™ .....82
- Audio system (see Radio) ...23, 27
- Automatically download your  
phone book .....61
- Automatic transmission .....246  
driving an automatic  
overdrive .....246  
fluid, adding .....316  
fluid, checking .....316
- Auxiliary input jack (Line in) ....31
- Auxiliary power point .....122
- B**
- Battery .....297  
acid, treating emergencies ....297  
jumping a disabled battery ....270  
maintenance-free .....297  
replacement, specifications ...320  
servicing .....297
- Belt-Minder® .....162
- Blind spot mirror .....252
- Booster seats .....197
- Brakes .....237–238  
anti-lock .....238  
anti-lock brake system (ABS)  
warning light .....238  
fluid, checking and adding ....315  
fluid, refill capacities .....321  
fluid, specifications .....321

## Index

- lubricant specifications .....321
- parking .....239
- shift interlock .....244
- Break-in period .....5
- Bulbs .....111
- C**
- Call history .....55
- Capacities for refilling fluids ....321
- Cell phone use .....8
- Changing a tire .....263
- Changing the SYNC® language  
setting .....74, 87
- Child safety seats .....187
  - attaching with tether straps ..193
  - in front seat .....188
  - in rear seat .....188
  - LATCH .....191
  - recommendations .....185
- Child safety seats - booster  
seats .....197
- Cleaning your vehicle
  - engine compartment .....284
  - instrument panel .....286
  - interior .....287
  - plastic parts .....285
  - washing .....283
  - waxing .....283
  - wheels .....284
  - wiper blades .....286
- Clock .....19, 23, 27–28
- Clutch
  - fluid .....315
  - operation while driving .....250
  - recommended shift speeds ....251
- Connecting a Bluetooth media  
device .....85
- Connecting a digital media  
player to SYNC® .....77
- Connecting a phone .....71
- Console .....122
- Controls
  - steering column .....129
- Coolant
  - checking and adding .....299
  - refill capacities .....302, 321
  - specifications .....321
- Cruise control  
(see Speed control) .....127
- Customer Assistance .....254
  - Ford Extended Service  
Plan .....329, 332
  - Getting assistance outside the  
U.S. and Canada .....280
  - Getting roadside assistance ...254
  - Getting the service you  
need .....275
  - Ordering additional owner's  
literature .....281
  - Utilizing the  
Mediation/Arbitration  
Program .....279
- D**
- Daytime running lamps  
(see Lamps) .....107
- Delete a device .....86
- Deleting all phones .....73
- Deleting all text messages .....58
- Deleting a phone .....73
- Dipstick
  - automatic transmission  
fluid .....316
  - engine oil .....295

351

## Index

Doors  
  central unlocking .....134

Downloading unread text  
messages .....58

Driving under special  
conditions .....249  
  through water .....253

**E**

Electronic message center .....18

Emergencies, roadside  
  jump-starting .....270  
  running out of fuel .....269, 308

Emission control system .....313

Ending a call .....51

End user license agreement .....96

Engine .....323–324  
  cleaning .....284  
  coolant .....299  
  idle speed control .....297  
  lubrication specifications .....321  
  refill capacities .....321  
  service points .....293–294

Engine block heater .....236

Engine fan .....293

Engine oil .....295  
  checking and adding .....295  
  dipstick .....295  
  filter, specifications .....296, 320  
  recommendations .....296  
  refill capacities .....321  
  specifications .....321

Event data recording .....6

Exhaust fumes .....235

Exiting phone mode .....51

Exploring the USB device .....93

352

**F**

Fan, Engine Cooling .....291, 293

Floor mats .....131–132

Fluid capacities .....321

Fuel .....304  
  calculating fuel economy .....310  
  cap .....306  
  capacity .....321  
  choosing the right fuel .....307  
  detergent in fuel .....308  
  filler funnel .....308  
  filling your vehicle with  
    fuel .....304, 306, 310  
  filter, specifications .....304, 320  
  fuel pump shut-off .....255  
  improving fuel economy .....310  
  octane rating .....308, 323–324  
  quality .....308  
  running out of fuel .....269, 308  
  safety information relating to  
    automotive fuels .....304

Fuses .....256–257

**G**

Gas cap (see Fuel cap) .....306

Gas mileage  
(see Fuel economy) .....310

Gauges .....17

**H**

Hazard flashers .....255

Headlamps .....106  
  aiming .....107  
  bulb specifications .....111  
  daytime running lights .....107  
  high beam .....106  
  replacing bulbs .....112



## Index

- turning on and off .....106
- Head restraints .....147
- Heating
  - heating and air conditioning system .....103
- Hill start assist .....248
- Hood .....292
- I**
- Ignition .....230, 323–324
- Incoming new text message .....51
- Infant seats
  - (see Safety seats) .....187
- Inspection/maintenance (I/M) testing .....315
- Installing new vehicle applications .....75, 88
- Instrument panel
  - cleaning .....286
  - cluster .....12
  - lighting up panel and interior .....107
- Intelligent Access Key .....132
- Intelligent Access with push button start .....139
- J**
- Jack .....263
  - positioning .....263
  - storage .....263
- Joining two calls
  - (multiparty/conference call) .....53
- Jump-starting your vehicle .....270
- K**
- Keyless entry system
  - autolock .....134–135
- Keys .....132, 145
  - positions of the ignition .....230
- L**
- Lamps
  - bulb replacement specifications chart .....111
  - daytime running light .....107
  - headlamps .....106
  - instrument panel, dimming ...107
  - interior lamps .....109–110, 112
  - replacing bulbs .....112
- LATCH anchors .....191
- Lights, warning and indicator ...12
  - anti-lock brakes (ABS) .....238
- Load limits .....221
- Locks
  - autolock .....134–135
  - childproof .....136
- Lubricant specifications .....321
- Lug nuts .....268
- M**
- Making a call .....50
- Manual transmission .....250
  - fluid capacities .....321
  - lubricant specifications .....321
  - reverse .....251
- Message center .....17–18
  - warning messages .....19
- Message notification .....60
- Mirrors .....125–126

353

## Index

- automatic dimming rearview mirror .....126
- heated .....127
- side view mirrors (power) .....126
- signal .....127
- Modifying your phone book .....60
- Moon roof .....130
- Motorcraft® parts .....290, 320
- O**
- Octane rating .....308
- Oil (see Engine oil) .....295
- P**
- Pairing media devices to SYNC® .....84
- Pairing your phone .....71
- Pairing your phone for the first time .....49
- Parking brake .....239
- Parts (see Motorcraft® parts) .....320
- Passenger Occupant Classification Sensor .....154
- Performing a master reset ...74, 88
- Phone dependent features .....41
- Phone redial .....55
- Phone settings .....58
- Phone status .....59
- Playing a specific track .....93
- Playing similar music .....94
- Play menu .....85
- Power distribution box (see Fuses) .....260
- 354
- Power door locks .....133
- Power mirrors .....126
- Power point .....122
- Power steering .....243–244
  - fluid, refill capacity .....321
  - fluid, specifications .....321
- Power Windows .....123
- Privacy information .....40
- Push button start system .....233
- Putting a call on/off hold .....53
- R**
- Radio .....23, 27
- Recommendations for attaching safety restraints for children .....185
- Relays .....256
- Remote entry system .....137, 139
  - illuminated entry .....144
  - locking/unlocking doors .....140
  - opening the trunk .....140
  - replacement/additional transmitters .....142–143
  - replacing the batteries .....140
- Returning to factory defaults .....74, 87
- Roadside assistance .....254
- S**
- Safety belts (see Safety restraints) .....153, 158–159, 161
- Safety Canopy .....176
- Safety defects, reporting .....282
- Safety information .....40

## Index

- Safety restraints .....153, 158–159, 161
    - Belt-Minder® .....162
    - extension assembly .....160
    - for adults .....158–159
    - for children .....182
    - Occupant Classification
    - Sensor .....154
    - warning light and chime .....161–162
  - Safety restraints - LATCH anchors .....191
  - Safety seats for children .....187
  - Safety Compliance Certification Label .....324
  - Satellite Radio Information .....36
  - Scheduled Maintenance Guide
    - Normal Scheduled Maintenance and Log .....338
  - Seats .....147
    - child safety seats .....187
    - cleaning .....288
    - heated .....150
  - SecuriLock passive anti-theft system .....144
  - Selecting and playing specific albums .....91
  - Selecting and playing specific artists .....90
  - Selecting different genres .....91
  - Selecting different media sources .....79
  - Sending new text messages .....57
  - Servicing your vehicle .....291
  - Setting a phone as primary .....72
  - Setting a ring tone .....59
  - Setting the clock .....19, 23, 28
  - Side air curtain .....178
  - SOS Post Crash Alert .....182
  - Spark plugs, specifications .....320, 323–324
  - Specification chart, lubricants .....321
  - Speed control .....127
  - Starting your vehicle .....230–232
    - jump starting .....270
    - push button start system .....233
  - Steering
    - speed sensitive .....244
  - Steering wheel
    - controls .....129
    - tilting .....122
  - Streaming music from your phone .....80
  - SYNC® AppLink™ .....82
  - SYNC® voice recognition feature .....42
  - System settings .....70
- T**
- Text messaging .....56
  - Tilt steering wheel .....122
  - Tire Pressure Monitoring System (TPMS)
    - Tires, Wheels and Loading ....216
  - Tires .....201–202, 263
    - alignment .....209
    - care .....205
    - changing .....263, 266
    - checking the pressure .....205
    - inflating .....203
    - label .....215
    - replacing .....207

## Index

- rotating .....209
- safety practices .....208
- sidewall information .....210
- snow tires and chains .....220
- spare tire .....264
- terminology .....202
- tire grades .....202
- treadwear .....201, 206
- Towing .....227
  - recreational towing .....227
  - trailer towing .....227
  - wrecker .....273
- Traffic, Directions and Information .....61
- Transmission
  - automatic operation .....246
  - brake-shift interlock (BSI) .....244
  - fluid, checking and adding (automatic) .....316
  - fluid, checking and adding (manual) .....316
  - fluid, refill capacities .....321
  - lubricant specifications .....321
  - manual operation .....250
- Trunk
  - remote release .....140
- Turning Bluetooth on/off .....72
- Turning prompts on/off .....73, 86
- Turn signal .....109
- U**
  - USB port .....33
  - Using privacy mode .....52
  - Using SYNC®'s play menu .....88
  - Using the Auxiliary input jack (Line in) .....81
  - Using the media settings .....81
  - Using the play all feature .....89
  - Using voice commands with SYNC® .....43
  - Using your media menu .....78
- V**
  - Vehicle health report .....68
  - Vehicle Identification Number (VIN) .....325
  - Vehicle loading .....221
  - Ventilating your vehicle .....236
  - Voice commands in media mode .....75
  - Voice commands in phone mode .....47
- W**
  - Warning lights (see Lights) .....12
  - Washer fluid .....294
  - Water, Driving through .....253
  - What is SYNC®? .....39
  - What's playing? .....78
  - Windows
    - power .....123
    - rear wiper/washer .....121
  - Windshield washer fluid and wipers
    - checking and adding fluid .....294
    - operation .....121
    - replacing wiper blades .....294
  - Wrecker towing .....273