

## Table of Contents 1

---

<b>Introduction</b>	<b>9</b>
<b>Child Safety</b>	<b>17</b>
Child seats . . . . .	.19
Child seat positioning . . . . .	.19
Booster seats . . . . .	.21
Installing child safety seats . . . . .	.24
Child safety locks . . . . .	.32
<b>Safety Belts</b>	<b>33</b>
Fastening the safety belts . . . . .	.35
Safety belt height adjustment . . . . .	.38
Safety belt warning light and indicator chime . . . . .	.39
Safety belt-minder . . . . .	.39
Child restraint and safety belt maintenance . . . . .	.42
<b>Personal Safety System</b>	<b>43</b>
<b>Supplementary Restraints System</b>	<b>44</b>
Driver and passenger airbags . . . . .	.46
Side airbags . . . . .	.52
Side curtain airbags . . . . .	.53
Crash sensors and airbag indicator . . . . .	.55
Airbag disposal . . . . .	.56
<b>Keys and Remote Control</b>	<b>57</b>
General information on radio frequencies . . . . .	.57
Remote control . . . . .	.58
Keys . . . . .	.58
Replacing a lost key or remote control . . . . .	.65



<b>MyKey</b>	<b>66</b>
Settings, MyKey . . . . .	.66
Creating . . . . .	.67
Clearing . . . . .	.68
System status . . . . .	.68
Remote start, MyKey . . . . .	.68
Troubleshooting, MyKey . . . . .	.70
<b>Locks</b>	<b>72</b>
Locking and unlocking . . . . .	.72
Trunk release . . . . .	.77
Interior luggage compartment release . . . . .	.78
<b>Security</b>	<b>79</b>
SecuriLock® passive anti-theft system . . . . .	.79
<b>Steering Wheel</b>	<b>82</b>
Adjusting the steering wheel . . . . .	.82
Steering wheel controls . . . . .	.83
<b>Wipers and Washers</b>	<b>86</b>
Windshield wipers . . . . .	.86
Windshield washers . . . . .	.87
Rear-window wiper and washer . . . . .	.87
<b>Lighting</b>	<b>89</b>
Lighting control . . . . .	.89
Autolamps . . . . .	.90
Instrument lighting dimmer . . . . .	.90
Headlamp exit delay . . . . .	.91
Daytime running lamps . . . . .	.91
Front fog lamps . . . . .	.92
Direction indicators . . . . .	.92
Interior lamps . . . . .	.92
Ambient lighting . . . . .	.94



## Table of Contents 3

---

<b>Windows and Mirrors</b>	<b>95</b>
Power windows . . . . .	.95
Exterior mirrors . . . . .	.97
Mirrors . . . . .	.97
Interior mirrors . . . . .	.99
Sun visors . . . . .	.99
Moonroof . . . . .	.99
<b>Instrument Cluster</b>	<b>102</b>
Gauges . . . . .	.102
Warning lamps and indicators . . . . .	.103
Audible warnings and indicators . . . . .	.107
<b>Information Displays</b>	<b>108</b>
Controls . . . . .	.108
Trip computer . . . . .	.110
Information messages . . . . .	.112
<b>Audio System</b>	<b>123</b>
AM/FM stereo . . . . .	.125
AM/FM/CD with SYNC . . . . .	.127
AM/FM/CD/SIRIUS Satellite Radio with SYNC . . . . .	.130
AM/FM stereo with single CD . . . . .	.132
Auxiliary input jack . . . . .	.136
USB port . . . . .	.137
Satellite radio information . . . . .	.138
<b>Climate Control</b>	<b>141</b>
Manual heating and air conditioning . . . . .	.141
Dual automatic temperature control . . . . .	.143
Rear window defroster . . . . .	.148
Cabin air filter . . . . .	.149



<b>Seats</b>	<b>151</b>
Sitting in the correct position . . . . .	151
Head restraints . . . . .	152
Manual seats . . . . .	155
Power seats . . . . .	157
Heated seats . . . . .	158
Rear seats . . . . .	159
<b>Auxiliary Power Points</b>	<b>161</b>
<b>Storage Compartments</b>	<b>162</b>
Overhead console . . . . .	162
<b>Starting and Stopping the Engine</b>	<b>163</b>
Ignition switch . . . . .	164
Keyless starting . . . . .	164
Engine block heater . . . . .	167
<b>Fuel and Refueling</b>	<b>169</b>
Fuel quality . . . . .	171
Running out of fuel . . . . .	172
Refueling . . . . .	173
Fuel consumption . . . . .	175
<b>Transmission</b>	<b>179</b>
Automatic transmission . . . . .	179
Manual transmission . . . . .	184
Hill start assist . . . . .	185
<b>Brakes</b>	<b>187</b>
Brakes . . . . .	187
Hints on driving with anti-lock brakes . . . . .	188
Parking brake . . . . .	188
<b>Traction Control</b>	<b>189</b>
Traction Control™ . . . . .	189



## Table of Contents

5

<b>Stability Control</b>	<b>190</b>
AdvanceTrac® . . . . .	191
<b>Parking Aids</b>	<b>192</b>
Sensing system . . . . .	192
Active park assist . . . . .	195
Rear-view camera system . . . . .	199
<b>Cruise Control</b>	<b>204</b>
<b>Driving Aids</b>	<b>206</b>
Eco Mode . . . . .	206
Steering . . . . .	207
<b>Load Carrying</b>	<b>209</b>
Vehicle loading . . . . .	209
<b>Towing</b>	<b>215</b>
Trailer towing . . . . .	215
Wrecker towing . . . . .	215
Recreational towing . . . . .	216
<b>Driving Hints</b>	<b>219</b>
Economical driving . . . . .	219
Floor mats . . . . .	221
<b>Roadside Emergencies</b>	<b>223</b>
Getting roadside assistance . . . . .	223
Hazard warning flashers . . . . .	224
Fuel cut-off switch . . . . .	224
Jump-starting the vehicle . . . . .	225
<b>Customer Assistance</b>	<b>228</b>
Reporting safety defects (U.S. only) . . . . .	235
Reporting safety defects (Canada only) . . . . .	235
<b>Fuses</b>	<b>236</b>
Changing a fuse . . . . .	236
Fuse specification chart . . . . .	237



<b>Maintenance</b>	<b>246</b>
General information . . . . .	.246
Opening and closing the hood . . . . .	.247
Under hood overview . . . . .	.248
Engine oil dipstick . . . . .	.249
Engine oil check . . . . .	.249
Engine coolant check . . . . .	.250
Automatic transmission fluid check . . . . .	.254
Brake fluid check . . . . .	.254
Power steering fluid check . . . . .	.254
Fuel filter . . . . .	.254
Washer fluid check . . . . .	.255
Changing the vehicle battery . . . . .	.255
Checking the wiper blades . . . . .	.257
Air filter(s) . . . . .	.258
Adjusting the headlamps . . . . .	.260
Removing a headlamp . . . . .	.261
Changing a bulb . . . . .	.262
Bulb specification chart . . . . .	.267
<b>Vehicle Care</b>	<b>268</b>
Cleaning products . . . . .	.268
Cleaning the exterior . . . . .	.268
Waxing . . . . .	.270
Repairing minor paint damage . . . . .	.270
Cleaning the engine . . . . .	.270
Cleaning the windows and wiper blades . . . . .	.271
Cleaning the interior . . . . .	.272
Cleaning the instrument panel and instrument cluster lens . . . . .	.272
Cleaning leather seats . . . . .	.273
Cleaning the alloy wheels . . . . .	.274
Vehicle storage . . . . .	.274



## Table of Contents

7

---

<b>Wheels and Tires</b>	<b>277</b>
Tire care . . . . .	.277
Tire Pressure Monitoring System (TPMS) . . . . .	.293
Changing a road wheel . . . . .	.297
Technical specifications . . . . .	.302
Wheel lug nut torque . . . . .	.302
<b>Capacities and Specifications</b>	<b>303</b>
Engine drivebelt . . . . .	.303
Maintenance product specifications and capacities . . . . .	.304
Part numbers . . . . .	.307
Vehicle identification number . . . . .	.308
Vehicle certification label . . . . .	.309
Transmission code designation . . . . .	.309
<b>Accessories</b>	<b>310</b>
Accessories . . . . .	.310
<b>Ford Extended Service Plan</b>	<b>312</b>
<b>Scheduled Maintenance</b>	<b>315</b>
Normal scheduled maintenance and log . . . . .	.320
<b>SYNC®</b>	<b>332</b>
Pairing your phone for the first time . . . . .	.337
911 Assist™ . . . . .	.351
Vehicle Health Report . . . . .	.354



<b>MyFord Touch® (If Equipped)</b>	<b>377</b>
Voice recognition . . . . .	.382
Listening to music . . . . .	.387
Phone features . . . . .	.408
Information Menu . . . . .	.414
Settings . . . . .	.426
Climate features . . . . .	.436
Navigation system. . . . .	.439
<b>Appendices</b>	<b>450</b>
<b>Index</b>	<b>468</b>

The information contained in this publication was correct at the time of going to print. In the interest of continuous development, we reserve the right to change specifications, design or equipment at any time without notice or obligation. No part of this publication may be reproduced, transmitted, stored in a retrieval system or translated into any language in any form by any means without our written permission. Errors and omissions excepted.

© Ford Motor Company 2012





**ABOUT THIS MANUAL**

Thank you for choosing Ford. We recommend that you take some time to get to know your vehicle by reading this manual. The more that you know about it, the greater the safety and pleasure you will get from driving it.



**WARNING:** Always drive with due care and attention when using and operating the controls and features on your vehicle.

**Note:** This manual describes a range of product features and options, sometimes before they are generally available. Therefore, you may find options in this manual that are not found on your vehicle.

**Note:** Some of the illustrations in this manual may be used for different models, so they may appear different than your vehicle. However, the essential information in the illustrations is always correct.

**Note:** Always use and operate your vehicle in line with all applicable laws and regulations.

**Note:** Pass on this manual when selling your vehicle. It is an integral part of the vehicle.

This manual may qualify the location of a component as right side or left side, which is determined by the side of the vehicle based on sitting in the seat.

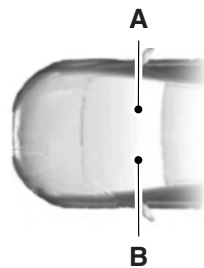

A. Right side

B. Left side

**Protecting the Environment**











You must play your part in protecting the environment. Correct vehicle usage and the authorized disposal of waste, cleaning and lubrication materials are significant steps toward this aim.























## SYMBOL GLOSSARY

 **WARNING:** You risk death or serious injury to yourself and others if you do not follow the instruction highlighted by the warning symbol.

These are some of the symbols you may see on your vehicle.

Symbol	Description	Symbol	Description	Symbol	Description
	Safety alert		See Owner's Manual		Anti-lock braking system
	Avoid smoking, flames, or sparks		Battery		Battery acid
	Brake fluid – non petroleum base		Brake system		Cabin air filter
	Check fuel cap		Child Safety Door Lock and Unlock		Child seat lower anchor
	Child seat tether anchor		Cruise control		Do not open when hot
	Engine air filter		Engine coolant		Engine coolant temperature
	Engine oil		Explosive gas		Fan warning
	Fasten safety belt		Front airbag		Front fog lamps



Symbol	Description	Symbol	Description	Symbol	Description
	Fuel pump reset		Fuse compartment		Hazard warning flasher
	Heated rear window		Interior luggage compartment release		Jack
	Lighting control		Low tire pressure warning		Maintain correct fluid level
	Panic alarm		Parking aid system		Parking brake system
	Power steering fluid		Power windows front and rear		Power window lockout
	Service engine soon		Side airbag		Stability control
	Windshield defrost and demist		Windshield washer and wiper		



**DATA RECORDING****Service Data Recording**

Service data recorders in your vehicle are capable of collecting and storing diagnostic information about your vehicle. This potentially includes information about the performance or status of various systems and modules in the vehicle, such as engine, throttle, steering or brake systems. In order to properly diagnose and service your vehicle, Ford Motor Company, Ford of Canada, and service and repair facilities may access or share among them vehicle diagnostic information received through a direct connection to your vehicle when diagnosing or servicing your vehicle. Additionally, when your vehicle is in for service or repair, Ford Motor Company, Ford of Canada, and service and repair facilities may access or share among them data for vehicle improvement purposes. For U.S. only (if equipped), if you choose to use the SYNC® Vehicle Health Report, you consent that certain diagnostic information may also be accessed electronically by Ford Motor Company and Ford authorized service facilities, and that the diagnostic information may be used for any purpose. See the SYNC® chapter for more information.

**Event Data Recording**

**This vehicle is equipped with an event data recorder (EDR). The main purpose of an EDR is to record, in certain crash or near crash-like situations, such as an airbag deployment or hitting a road obstacle; this data will assist in understanding how a vehicle's systems performed. The EDR is designed to record data related to vehicle dynamics and safety systems for a short period of time, typically 30 seconds or less. The EDR in this vehicle is designed to record such data as:**

- **How various systems in your vehicle were operating;**
- **Whether or not the driver and passenger safety belts were buckled/fastened;**
- **How far (if at all) the driver was depressing the accelerator and/or the brake pedal; and**
- **How fast the vehicle was travelling; and**
- **Where the driver was positioning the steering wheel.**

**This data can help provide a better understanding of the circumstances in which crashes and injuries occur.**

**Note: EDR data is recorded by your vehicle only if a non-trivial crash situation occurs; no data is recorded by the EDR under normal**



driving conditions and no personal data or information (e.g., name, gender, age, and crash location) is recorded (see limitations regarding 911 Assist and Traffic, directions and Information privacy below). However, parties, such as law enforcement, could combine the EDR data with the type of personally identifying data routinely acquired during a crash investigation.

To read data recorded by an EDR, special equipment is required, and access to the vehicle or the EDR is needed. In addition to the vehicle manufacturer, other parties, such as law enforcement, that have such special equipment, can read the information if they have access to the vehicle or the EDR. Ford Motor Company and Ford of Canada do not access event data recorder information without obtaining consent, unless pursuant to court order or where required by law enforcement, other government authorities or other third parties acting with lawful authority. Other parties may seek to access the information independently of Ford Motor Company and Ford of Canada.

**Note:** Including to the extent that any law pertaining to Event Data Recorders applies to SYNC® or its features, please note the following: Once 911 Assist (if equipped) is enabled (set ON), 911 Assist may, through any paired and connected cell phone, disclose to emergency services that the vehicle has been in a crash involving the deployment of an airbag or, in certain vehicles, the activation of the fuel pump shut-off. Certain versions or updates to 911 Assist may also be capable of being used to electronically or verbally provide to 911 operators the vehicle location (such as latitude and longitude), and/or other details about the vehicle or crash or personal information about the occupants to assist 911 operators to provide the most appropriate emergency services. If you do not want to disclose this information, do not activate the 911 Assist feature. See your SYNC® chapter for more information.

Additionally, when you connect to Traffic, Directions and Information (if equipped, U.S. only), the service uses GPS technology and advanced vehicle sensors to collect the vehicle's current location, travel direction, and speed ("vehicle travel information"), only to help provide you with the directions, traffic reports, or business searches that you request. If you do not want Ford or its vendors to receive this information, do not activate the service. Ford Motor Company and the vendors it uses to provide you with this information do not store your vehicle travel information. For more information, see Traffic, Directions and Information, Terms and Conditions. See your SYNC® supplement for more information.



**CALIFORNIA PROPOSITION 65**

**WARNING:** Some constituents of engine exhaust, certain vehicle components, certain fluids contained in vehicles and certain products of component wear contain or emit chemicals known to the State of California to cause cancer and birth defects or other reproductive harm.

**PERCHLORATE MATERIAL**

**Note:** Certain components in your vehicle such as airbag modules, safety belt pretensioners, and remote control batteries may contain perchlorate material. Special handling may apply for service or vehicle end of life disposal. See [www.dtsc.ca.gov/hazardouswaste/perchlorate](http://www.dtsc.ca.gov/hazardouswaste/perchlorate) for more information.

**FORD CREDIT (U.S. ONLY)**

Ford Credit offers a full range of financing and lease plans to help you acquire your vehicle. If you have financed or leased your vehicle through Ford Credit, thank you for your business.

For your convenience we offer a number of ways to contact us, as well as help manage your account.

Phone: 1-800-727-7000

For more information regarding Ford Credit, as well as access Account Manager, please go to [www.fordcredit.com](http://www.fordcredit.com).

**REPLACEMENT PARTS RECOMMENDATION**

Your vehicle has been built to the highest standards using quality parts. We recommend that you demand the use of genuine Ford and Motorcraft parts whenever your vehicle requires scheduled maintenance or repair. You can clearly identify genuine Ford and Motorcraft parts by looking for the Ford, FoMoCo or Motorcraft branding on the parts or their packaging.

**Scheduled Maintenance and Mechanical Repairs**

One of the best ways for you to make sure that your vehicle provides years of service is to have it maintained in line with our recommendations using parts that conform to the specifications detailed in this Owner's Manual. Genuine Ford and Motorcraft parts meet or exceed these specifications.



**Collision Repairs**

We hope that you never experience a collision but, accidents do happen. Genuine Ford replacement collision parts meet our stringent requirements for fit, finish, structural integrity, corrosion protection and dent resistance. During vehicle development we validate these parts deliver the intended level of protection as a whole system. A great way to know for sure you are getting this level of protection is to use genuine Ford replacement collision parts.

**Warranty on Replacement Parts**

Genuine Ford and Motorcraft replacement parts are the only replacement parts that benefit from a Ford Warranty. Damage caused to your vehicle as a result of the failure of non-Ford parts may not be covered by the Ford Warranty. For additional information, refer to the terms and conditions of the Ford Warranty.

**SPECIAL NOTICES****New Vehicle Limited Warranty**

For a detailed description of what is covered and what is not covered by your vehicle's New Vehicle Limited Warranty, refer to the warranty information that is provided to you along with your Owner's Manual.

**Special Instructions**

For your added safety, your vehicle is fitted with sophisticated electronic controls.



**WARNING:** Please read the *Supplementary Restraints System* chapter. Failure to follow the specific warnings and instructions could result in personal injury.



**WARNING:** Front seat mounted rear-facing child or infant seats should **NEVER** be placed in front of an active passenger airbag.

**Using your vehicle with a snowplow****Do not use this vehicle for snowplowing.**

Your vehicle is not equipped with a snowplowing package.

**Using your vehicle as an ambulance****Do not use this vehicle as an ambulance.**

Your vehicle is not equipped with the Ford Ambulance Preparation Package.



**MOBILE COMMUNICATIONS EQUIPMENT**

Using mobile communications equipment is becoming increasingly important in the conduct of business and personal affairs. However, you must not compromise your own or others' safety when using such equipment. Mobile communications can enhance personal safety and security when appropriately used, particularly in emergency situations. Safety must be paramount when using mobile communications equipment to avoid negating these benefits.

Mobile communication equipment includes, but is not limited to, cellular phones, pagers, portable email devices, text messaging devices and portable two-way radios.



**WARNING:** Driving while distracted can result in loss of vehicle control, accident and injury. Ford strongly recommends that you use extreme caution when using any device or feature that may take your focus off the road. Your primary responsibility is the safe operation of your vehicle. We recommend against the use of any handheld device while driving, encourage the use of voice operated systems when possible and that you become aware of applicable state and local laws that may affect use of electronic devices while driving.

**EXPORT UNIQUE (NON-UNITED STATES/CANADA) VEHICLE SPECIFIC INFORMATION**

For your particular global region, your vehicle may be equipped with features and options that are different from the features and options that are described in this Owner's Manual. A market unique supplement may be supplied that complements this book. By referring to the market unique supplement, if provided, you can properly identify those features, recommendations and specifications that are unique to your vehicle. This Owner's Manual is written primarily for the U.S. and Canadian Markets. Features or equipment listed as standard may be different on units built for Export. **Refer to this Owner's Manual for all other required information and warnings.**





**GENERAL INFORMATION**

See the following sections for directions on how to properly use safety restraints for children.



**WARNING:** Always make sure your child is secured properly in a device that is appropriate for their height, age and weight. Child safety restraints must be purchased separately from the vehicle. Failure to follow these instructions and guidelines may result in an increased risk of serious injury or death to your child.



**WARNING:** All children are shaped differently. The recommendations for safety restraints are based on probable child height, age and weight thresholds from NHTSA and other safety organizations, or are the minimum requirements of law. Ford recommends checking with a NHTSA Certified Child Passenger Safety Technician (CPST) and consulting your pediatrician to make sure your child seat is appropriate for your child, and is compatible with and properly installed in the vehicle. To locate a child seat fitting station and CPST, contact the NHTSA toll free at 1-888-327-4236 or on the internet at <http://www.nhtsa.dot.gov>. In Canada, check with your local St. John Ambulance office for referral to a CPST or for further information, contact your provincial ministry of transportation, your local St. John Ambulance office at <http://www.sfa.ca>, or Transport Canada at 1-800-333-0371 (<http://www.tc.gc.ca>). Failure to properly restrain children in safety seats made especially for their height, age, and weight may result in an increased risk of serious injury or death to your child.



<b>Recommendations for Safety Restraints for Children</b>		
	<b>Child size, height, weight, or age</b>	<b>Recommended restraint type</b>
Infants or toddlers	Children weighing 40 lb (18 kg) or less (generally age four or younger).	Use a child safety seat (sometimes called an infant carrier, convertible seat, or toddler seat).
Small children	Children who have outgrown or no longer properly fit in a child safety seat (generally children who are less than 4 ft. 9 in. (1.45 m) tall, are greater than age four (4) and less than age twelve (12), and between 40 lb (18 kg) and 80 lb (36 kg) and upward to 100 lb (45 kg) if recommended by your child restraint manufacturer).	Use a belt-positioning booster seat.
Larger children	Children who have outgrown or no longer properly fit in a belt-positioning booster seat (generally children who are at least 4 feet 9 inches (1.45 meters) tall or greater than 80 lb (36 kg) or 100 lb (45 kg) if recommended by child restraint manufacturer).	Use a vehicle safety belt having the lap belt snug and low across the hips, shoulder belt centered across the shoulder and chest, and seat back upright.

- You are required by law to properly use safety seats for infants and toddlers in the U.S. and Canada.
- Many states and provinces require that small children use approved booster seats until they reach age eight, a height of 4 feet 9 inches (1.45 meters) tall, or 80 pounds (36 kilograms). Check your local and state or provincial laws for specific requirements regarding the safety of children in your vehicle.
- When possible, always properly restrain children twelve (12) years of age and under in a rear seating position of your vehicle. Accident statistics suggest that children are safer when properly restrained in the rear seating positions than in a front seating position.



**CHILD SEATS**

Use a child safety seat (sometimes called an infant carrier, convertible seat, or toddler seat) for infants, toddlers or children weighing 40 pounds (18 kilograms) or less (generally age four or younger).

**CHILD SEAT POSITIONING**

**!** **WARNING:** Airbags can kill or injure a child in a child seat. NEVER place a rear-facing child seat in front of an active airbag. If you must use a forward-facing child seat in the front seat, move the vehicle seat all the way back. When possible, all children age 12 and under should be properly restrained in a rear seating position. If all children cannot be seated and restrained properly in a rear seating position, properly restrain the largest child in the front seat.

**!** **WARNING:** Always carefully follow the instructions and warnings provided by the manufacturer of any child restraint to determine if the restraint device is appropriate for your child's size, height, weight, or age. Follow the child restraint manufacturer's instructions and warnings provided for installation and use in conjunction with the instructions and warnings provided by the vehicle manufacturer. A safety seat that is improperly installed or utilized, is inappropriate for your child's height, age, or weight or does not properly fit the child may increase the risk of serious injury or death.

**!** **WARNING:** Never let a passenger hold a child on his or her lap while the vehicle is moving. The passenger cannot protect the child from injury in a collision, which may result in serious injury or death.



 **WARNING:** Never use pillows, books, or towels to boost a child. They can slide around and increase the likelihood of injury or death in a collision.

 **WARNING:** Always restrain an unoccupied child seat or booster seat. These objects may become projectiles in a collision or sudden stop, which may increase the risk of serious injury.

 **WARNING:** Never place, or allow a child to place, the shoulder belt under a child's arm or behind the back because it reduces the protection for the upper part of the body and may increase the risk of injury or death in a collision.

 **WARNING:** Do not leave children or pets unattended in your vehicle.

Restraint Type	Child Weight	Use any attachment method as indicated below by X				
		LATCH (lower anchors and top tether anchor)	LATCH (lower anchors only)	Safety belt and top tether anchor	Safety belt and LATCH (lower anchors and top tether anchor)	Safety belt only
Rear facing child seat	Up to 48 lb (21 kg)		X			X
Forward facing child seat	Up to 48 lb (21 kg)	X		X	X	
Forward facing child seat	Over 48 lb (21 kg)			X	X	



**Note:** The child seat must rest tightly against the vehicle seat. It may be necessary to lift or remove the head restraint. See the *Seats* chapter for information on head restraints.

**BOOSTER SEATS**



**WARNING:** Never place, or allow a child to place, the shoulder belt under a child’s arm or behind the back because it reduces the protection for the upper part of the body and may increase the risk of injury or death in a collision.

Use a belt-positioning booster seat for children who have outgrown or no longer properly fit in a child safety seat (generally children who are less than 4 feet 9 inches (1.45 meters) tall, are greater than age four (4) and less than age twelve (12), and between 40 lb (18 kg) and 80 lb (36 kg) and upward to 100 lb (45 kg) if recommended by your child restraint manufacturer). Many state and provincial laws require that children use approved booster seats until they reach age eight, a height of 4 feet 9 inches (1.45 meters) tall, or 80 lb (36 kg).

Booster seats should be used until you can answer YES to ALL of these questions when the child is seated without a booster seat:

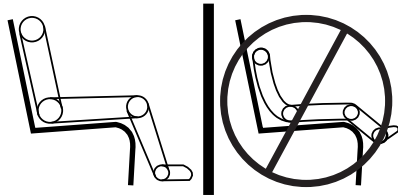

- Can the child sit all the way back against the vehicle seat back with knees bent comfortably at the edge of the seat cushion?
- Can the child sit without slouching?
- Does the lap belt rest low across the hips?
- Is the shoulder belt centered on the shoulder and chest?
- Can the child stay seated like this for the whole trip?

Always use booster seats in conjunction with the vehicle lap/shoulder belt.



**Types of Booster Seats**

- Backless booster seats

If your backless booster seat has a removable shield, remove the shield. If a vehicle seating position has a low seat back or no head restraint, a backless booster seat may place your child's head (as measured at the tops of the ears) above the top of the seat. In this case, move the backless booster to another seating position with a higher seat back or head restraint and lap/shoulder belts, or consider using a high back booster seat.



- High back booster seats

If, with a backless booster seat, you cannot find a seating position that adequately supports your child's head, a high back booster seat would be a better choice.



Children and booster seats vary in size and shape. Choose a booster that keeps the lap belt low and snug across the hips, never up across the stomach, and lets you adjust the shoulder belt to cross the chest and rest snugly near the center of the shoulder. The following drawings compare the ideal fit (center) to a shoulder belt uncomfortably close to the neck and a shoulder belt that could slip off the shoulder. The drawings also show how the lap belt should be low and snug across the child's hips.

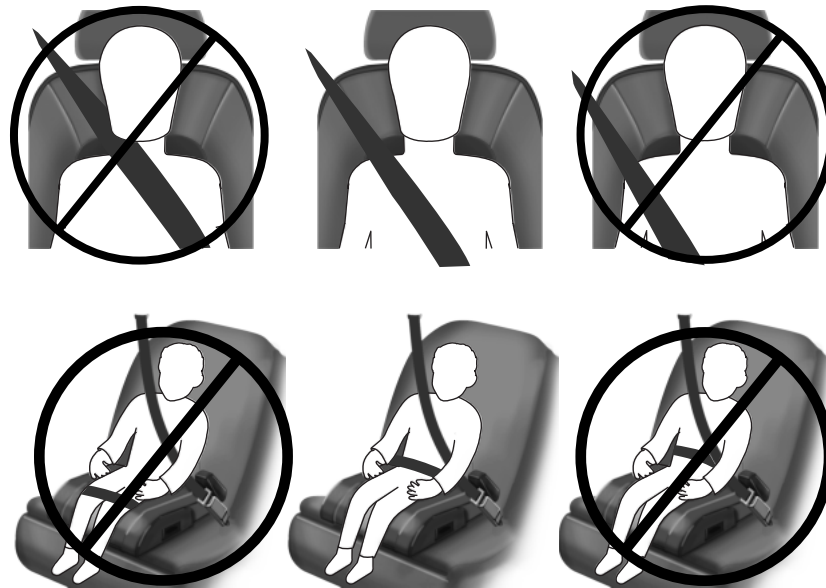

If the booster seat slides on the vehicle seat, placing a rubberized mesh sold as shelf or carpet liner under the booster seat may improve this condition. Do not introduce any item thicker than this under the booster seat. Check with the booster seat manufacturer's instructions.



**INSTALLING CHILD SEATS****Using Lap and Shoulder Belts**

**WARNING:** Airbags can kill or injure a child in a child seat. **NEVER** place a rear-facing child seat in front of an active airbag. If you must use a forward-facing child seat in the front seat, move the seat all the way back.



**WARNING:** Children 12 and under should be properly restrained in the rear seat whenever possible.



**WARNING:** Depending on where you secure a child restraint, and depending on the child restraint design, you may block access to certain safety belt buckle assemblies and/or LATCH lower anchors, rendering those features potentially unusable. To avoid risk of injury, occupants should only use seating positions where they are able to be properly restrained.

When installing a child safety seat with combination lap and shoulder belts:

- Use the correct safety belt buckle for that seating position.
- Insert the belt tongue into the proper buckle until you hear a snap and feel it latch. Make sure the tongue is securely fastened in the buckle.
- Keep the buckle release button pointing up and away from the safety seat, with the tongue between the child seat and the release button, to prevent accidental unbuckling.
- Place the vehicle seat back in the upright position.
- Put the safety belt in the automatic locking mode. See Step 5. This vehicle does not require the use of a locking clip.





Perform the following steps when installing the child seat with combination lap and shoulder belts:

**Note:** Although the child seat illustrated is a forward-facing child seat, the steps are the same for installing a rear-facing child seat.

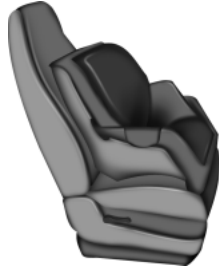

1. Position the child safety seat in a seat with a combination lap and shoulder belt.

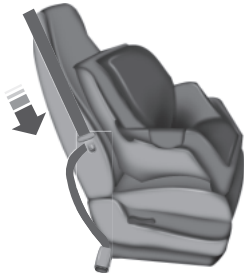

2. Pull down on the shoulder belt and then grasp the shoulder belt and lap belt together.

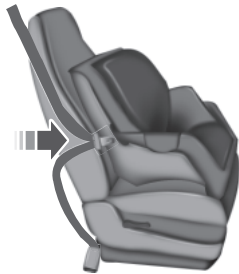

3. While holding the shoulder and lap belt portions together, route the tongue through the child seat according to the child seat manufacturer's instructions. Be sure the belt webbing is not twisted.



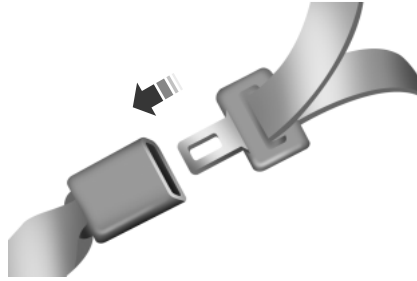

4. Insert the belt tongue into the proper buckle (the buckle closest to the direction the tongue is coming from) for that seating position until you hear a snap and feel the latch engage. Make sure the tongue is latched securely by pulling on it.



5. To put the retractor in the automatic locking mode, grasp the shoulder portion of the belt and pull downward until all of the belt is pulled out.

**Note:** The automatic locking mode is available on the front passenger and rear seats. This vehicle does not require the use of a locking clip.

6. Allow the belt to retract to remove slack. The belt will click as it retracts to indicate it is in the automatic locking mode.

7. Try to pull the belt out of the retractor to make sure the retractor is in the automatic locking mode. You should not be able to pull more belt out. If the retractor is not locked, unbuckle the belt and repeat Steps 5 and 6.

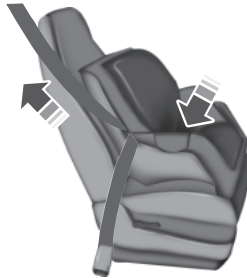

8. Remove remaining slack from the belt. Force the seat down with extra weight, e.g., by pressing down or kneeling on the child restraint while pulling up on the shoulder belt in order to force slack from the belt.



This is necessary to remove the remaining slack that will exist once the additional weight of the child is added to the child restraint. It also helps to achieve the proper snugness of the child seat to the vehicle. Sometimes, a slight lean towards the buckle will additionally help to remove remaining slack from the belt.

9. Attach the tether strap (if the child seat is equipped). See *Using Tether Straps* later in this chapter.

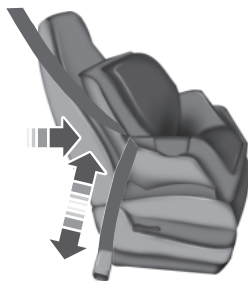

10. Before placing the child in the seat, forcibly move the seat forward and back to make sure the seat is securely held in place.

To check this, grab the seat at the belt path and attempt to move it side to side and forward and back. There should be no more than 1 inch (2.5 centimeters) of movement for proper installation.

Ford recommends checking with a NHTSA Certified Child Passenger Safety Technician (CPST) to make certain the child restraint is properly installed. In Canada, check with your local St. John Ambulance office for referral to a CPST.

**Using Lower Anchors and Tethers for Children (LATCH)**

**!** **WARNING:** Never attach two child safety seats to the same anchor. In a crash, one anchor may not be strong enough to hold two child safety seat attachments and may break, causing serious injury or death.

**!** **WARNING:** Depending on where you secure a child restraint, and depending on the child restraint design, you may block access to certain safety belt buckle assemblies and/or LATCH lower anchors, rendering those features potentially unusable. To avoid risk of injury, occupants should only use seating positions where they are able to be properly restrained.



The LATCH system is composed of three vehicle anchor points: two lower anchors located where the vehicle seat back and seat cushion meet (called the seat bight) and one top tether anchor located behind that seating position.

LATCH compatible child safety seats have two rigid or webbing mounted attachments that connect to the two lower anchors at the LATCH equipped seating positions in your vehicle. This type of attachment method eliminates the need to use safety belts to attach the child seat, however the safety belt can still be used to attach the child seat. For forward-facing child seats, the top tether strap must also be attached to the proper top tether anchor, if a top tether strap has been provided with your child seat.

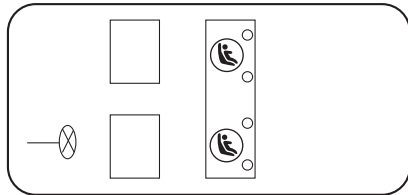

Your vehicle has LATCH lower anchors for child seat installation at the seating positions marked with the child seat symbol.



The LATCH anchors are located at the rear section of the rear seat between the cushion and seat back below the symbols as shown. Follow the child seat manufacturer's instructions to properly install a child seat with LATCH attachments.

Follow the instructions on attaching child safety seats with tether straps. Refer to *Using Tether Straps* later in this chapter.

Attach LATCH lower attachments of the child seat only to the anchors shown.



### Use of Inboard Lower Anchors from the Outboard Seating Positions (Center Seating Use)



**WARNING:** The standardized spacing for LATCH lower anchors is 11 in. (28 cm) center to center. Do not use LATCH lower anchors for the center seating position unless the child seat manufacturer's instructions permit and specify using anchors spaced at least as far apart as those in this vehicle.

The lower anchors at the center of the second row rear seat are spaced 18 in. (46 cm) apart. A child seat with rigid LATCH attachments cannot be installed at the center seating position. LATCH compatible child seats (with attachments on belt webbing) can only be used at this seating position provided that the child seat manufacturer's instructions permit use with the anchor spacing stated. Do not attach a child seat to any lower anchor if an adjacent child seat is attached to that anchor.

Each time you use the safety seat, check that the seat is properly attached to the lower anchors and tether anchor, if applicable. Tug the child seat from side to side and forward and back where it is secured to the vehicle. The seat should move less than one inch when you do this for a proper installation.

If the safety seat is not anchored properly, the risk of a child being injured in a crash greatly increases.

### Combining Safety Belt and LATCH Lower Anchors for Attaching Child Safety Seats

When used in combination, either the safety belt or the LATCH lower anchors may be attached first, provided a proper installation is achieved. Attach the tether strap afterward, if included with the child seat.

### Using Tether Straps



Many forward-facing child safety seats include a tether strap which extends from the back of the child safety seat and hooks to an anchoring point called the top tether anchor. Tether straps are available as an accessory for many older safety seats.

Contact the manufacturer of your child seat for information about ordering a tether strap, or to obtain a longer tether strap if the tether strap on your safety seat does not reach the appropriate top tether anchor in the vehicle.



The rear seats of your vehicle are equipped with built-in tether strap anchors located behind the seats as described below.

Four door: The tether anchors in your vehicle are located under a cover marked with the tether anchor symbol (shown with title).

Five door: The tether anchors in your vehicle are located on the back panel of the rear seat.

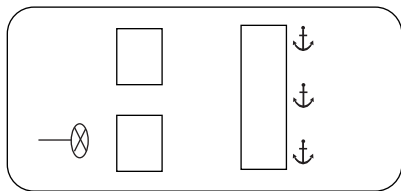

The tether strap anchors in your vehicle are in the following positions (shown from top view):

Perform the following steps to install a child safety seat with tether anchors:

**Note:** If you install a child seat with rigid LATCH attachments, do not tighten the tether strap enough to lift the child seat off the vehicle seat cushion when the child is seated in it. Keep the tether strap just snug without lifting the front of the child seat. Keeping the child seat just touching the vehicle seat gives the best protection in a severe crash.

#### Four door

1. Route the child safety seat tether strap over the back of the seat.

For outboard seating positions, route the tether strap under the head restraint and between the head restraint posts. For the center seating positions, route the tether strap over the top of the head restraint.



2. Locate the correct anchor for the selected seating position.





3. Open the tether anchor cover.



4. Clip the tether strap to the anchor as shown.

If the tether strap is clipped incorrectly, the child safety seat may not be retained properly in the event of a collision.

5. Tighten the child safety seat tether strap according to the manufacturer's instructions.

If the safety seat is not anchored properly, the risk of a child being injured in a collision greatly increases.

If your child restraint system is equipped with a tether strap, and the child restraint manufacturer recommends its use, Ford also recommends its use.

**Five door**

1. Route the child safety seat tether strap over the back of the seat.

For outboard seating positions, route the tether strap under the head restraint and between the head restraint posts. For the center seating position, route the tether strap over the top of the head restraint.

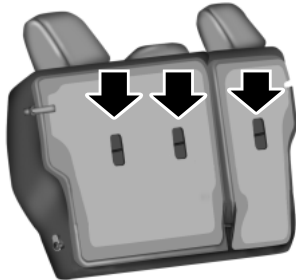

2. Locate the correct anchor for the selected seating position.





3. Clip the tether strap to the anchor as shown.

If the tether strap is clipped incorrectly, the child safety seat may not be retained properly in the event of a collision.

4. Tighten the child safety seat tether strap according to the manufacturer's instructions.

If the safety seat is not anchored properly, the risk of a child being injured in a collision greatly increases.

If your child restraint system is equipped with a tether strap, and the child restraint manufacturer recommends its use, Ford also recommends its use.

#### **CHILD SAFETY LOCKS**

When these locks are set, the rear doors cannot be opened from the inside.



The childproof locks are located on the rear edge of each rear door and must be set separately for each door.

- Driver side: turn counterclockwise to lock and clockwise to unlock.
- Passenger side: turn clockwise to lock and counterclockwise to unlock.





### PRINCIPLES OF OPERATION



**WARNING:** Always drive and ride with your seatback upright and the lap belt snug and low across the hips.



**WARNING:** To reduce the risk of injury, make sure children sit where they can be properly restrained.



**WARNING:** Never let a passenger hold a child on his or her lap while the vehicle is moving. The passenger cannot protect the child from injury in a collision.



**WARNING:** All occupants of the vehicle, including the driver, should always properly wear their safety belts, even when an airbag supplemental restraint system (SRS) is provided.



**WARNING:** It is extremely dangerous to ride in a cargo area, inside or outside of a vehicle. In a collision, people riding in these areas are more likely to be seriously injured or killed. Do not allow people to ride in any area of your vehicle that is not equipped with seats and safety belts. Be sure everyone in your vehicle is in a seat and using a safety belt properly.



**WARNING:** In a rollover crash, an unbelted person is significantly more likely to die than a person wearing a safety belt.



**WARNING:** Each seating position in your vehicle has a specific safety belt assembly which is made up of one buckle and one tongue that are designed to be used as a pair. 1) Use the shoulder belt on the outside shoulder only. Never wear the shoulder belt under the arm. 2) Never swing the safety belt around your neck over the inside shoulder. 3) Never use a single belt for more than one person.



**WARNING:** When possible, all children 12 years old and under should be properly restrained in a rear seating position.







**WARNING:** Safety belts and seats can become hot in a vehicle that has been closed up in sunny weather; they could burn a small child. Check seat covers and buckles before you place a child anywhere near them.



**WARNING:** Front and rear seat occupants, including pregnant women, should wear safety belts for optimum protection in an accident.

All seating positions in this vehicle have lap and shoulder safety belts. All occupants of the vehicle should always properly wear their safety belts, even when an airbag supplemental restraint system is provided.

The safety belt system consists of:

- Lap and shoulder safety belts.
- Shoulder safety belt with automatic locking mode, (except driver safety belt).
- Height adjuster at the front outboard seating positions
- Safety belt pretensioner at the front outboard seating positions.
- Belt tension sensor at the front outboard passenger seating position.
-  • Safety belt warning light and chime. See *Safety belt warning light and indicator chime* later in this chapter.
-  • Crash sensors and monitoring system with readiness indicator. See *Crash sensors and airbag indicator* in the *Supplemental Restraints System* chapter.

The safety belt pretensioners at the front seating positions are designed to tighten the safety belts when activated. In frontal and near-frontal collisions, the safety belt pretensioners may be activated alone or, if the collision is of sufficient severity, together with the front airbags. The pretensioners may also activate when a side curtain airbag is deployed.



### FASTENING THE SAFETY BELTS

The front outboard and rear safety restraints in the vehicle are combination lap and shoulder belts.

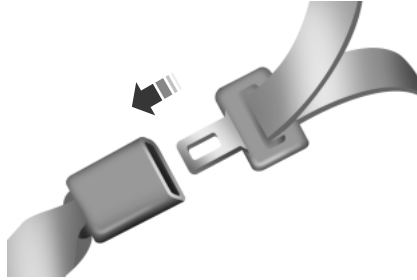

1. Insert the belt tongue into the proper buckle (the buckle closest to the direction the tongue is coming from) until you hear a snap and feel it latch. Make sure the tongue is securely fastened in the buckle.

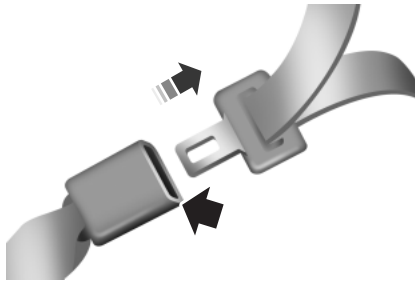

2. To unfasten, press the release button and remove the tongue from the buckle.

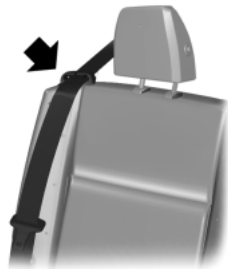

When in use, the rear safety belts should be placed in the belt guides on the outboard seatbacks.



**Restraint of Pregnant Women**

 **WARNING:** Always ride and drive with your seat back upright and the safety belt properly fastened. The lap portion of the safety belt should fit snug and be positioned low across the hips. The shoulder portion of the safety belt should be positioned across the chest. Pregnant women should also follow this practice. See the following figure.

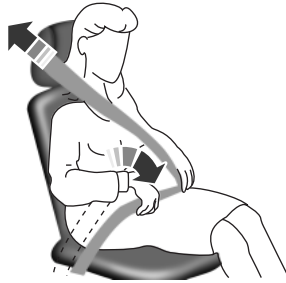

Pregnant women should always wear their safety belt. The lap belt portion of a combination lap and shoulder belt should be positioned low across the hips below the belly and worn as tight as comfort will allow. The shoulder belt should be positioned to cross the middle of the shoulder and the center of the chest.

**Safety Belt Locking Modes**

 **WARNING:** After any vehicle collision, the safety belt system at all passenger seating positions must be checked by an authorized dealer to verify that the automatic locking retractor feature for child seats is still functioning properly. In addition, all safety belts should be checked for proper function.

 **WARNING:** BELT AND RETRACTOR ASSEMBLY MUST BE REPLACED if the safety belt assembly automatic locking retractor feature or any other safety belt function is not operating properly when checked by an authorized dealer. Failure to replace the belt and retractor assembly could increase the risk of injury in collisions.



All safety restraints in the vehicle are combination lap and shoulder belts. The driver safety belt has the first type of locking mode, and the front outboard passenger and rear seat safety belts have both types of locking modes described as follows:

### **Vehicle Sensitive Mode**

This is the normal retractor mode, which allows free shoulder belt length adjustment to your movements and locking in response to vehicle movement. For example, if the driver brakes suddenly or turns a corner sharply, or the vehicle receives an impact of approximately 5 mph (8 km/h) or more, the combination safety belts will lock to help reduce forward movement of the driver and passengers.

In addition, the retractor is designed to lock if the webbing is pulled out too quickly. If this occurs, let the belt retract slightly and pull webbing out again in a slow and controlled manner.

### **Automatic Locking Mode**

In this mode, the shoulder belt is automatically pre-locked. The belt will still retract to remove any slack in the shoulder belt. The automatic locking mode is not available on the driver safety belt.

### **When to Use the Automatic Locking Mode**

This mode should be used any time a child safety seat, except a booster, is installed in passenger front or rear seating positions. Children 12 years old and under should be properly restrained in a rear seating position whenever possible. See the *Child Safety* chapter.

### **How to Use the Automatic Locking Mode**

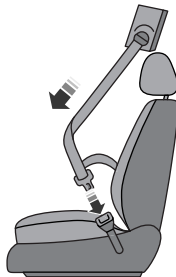

1. Buckle the combination lap and shoulder belt.
2. Grasp the shoulder portion and pull downward until the entire belt is pulled out.

Allow the belt to retract. As the belt retracts, you will hear a clicking sound. This indicates the safety belt is now in the automatic locking mode.



**How to Disengage the Automatic Locking Mode**

Disconnect the combination lap and shoulder belt and allow it to retract completely to disengage the automatic locking mode and activate the vehicle sensitive (emergency) locking mode.

**Safety Belt Extension Assembly**

**WARNING:** Do not use extensions to change the fit of the shoulder belt across the torso.

If the safety belt is too short when fully extended, a safety belt extension assembly can be obtained from an authorized dealer.

Use only extensions manufactured by the same supplier as the safety belt. Manufacturer identification is located at the end of the webbing on the label. Also, use the safety belt extension only if the safety belt is too short for you when fully extended.

**SAFETY BELT HEIGHT ADJUSTMENT**

**WARNING:** Position the safety belt height adjusters so that the belt rests across the middle of your shoulder. Failure to adjust the safety belt properly could reduce the effectiveness of the safety belt and increase the risk of injury in a collision.

Adjust the height of the shoulder belt so the belt rests across the middle of your shoulder.



To adjust the shoulder belt height, squeeze the button and slide the height adjuster up or down. Release the button and pull down on the height adjuster to make sure it is locked in place.



**SAFETY BELT WARNING LIGHT AND INDICATOR CHIME**



This lamp illuminates and an audible warning will sound if the driver's safety belt has not been fastened when the vehicle's ignition is turned on.

**Conditions of Operation**

<b>If...</b>	<b>Then...</b>
The driver's safety belt is not buckled before the ignition switch is turned to the on position...	The safety belt warning light illuminates 1-2 minutes and the warning chime sounds 4-8 seconds.
The driver's safety belt is buckled while the indicator light is illuminated and the warning chime is sounding...	The safety belt warning light and warning chime turn off.
The driver's safety belt is buckled before the ignition switch is turned to the on position...	The safety belt warning light and indicator chime remain off.

**SAFETY BELT-MINDER®**

This feature supplements the safety belt warning function by providing additional reminders by intermittently sounding a chime and illuminating the safety belt warning light when the driver's or front passenger's seat is occupied and the safety belt is unbuckled.

The system uses information from the front passenger sensing system to determine if a front seat passenger is present and therefore potentially in need of a warning. To avoid activating the Belt-Minder® feature for objects placed in the front passenger seat, warnings will only be given to large front seat occupants as determined by the front passenger sensing system.

If the Belt-Minder® warnings have expired (warnings for approximately five minutes) for one occupant (driver or front passenger), the other occupant can still activate the Belt-Minder® feature.



## Safety Belts

If...	Then...
The driver's and front passenger's safety belts are buckled before the ignition switch is turned to the on position or less than 1-2 minutes have elapsed since the ignition switch has been turned to on...	The Belt-Minder® feature will not activate.
The driver's or front passenger's safety belt is not buckled when the vehicle has reached at least 6 mph (9.7 km/h) and 1-2 minutes have elapsed since the ignition switch has been turned to on...	The Belt-Minder® feature is activated - the safety belt warning light illuminates and the warning chime sounds for six seconds every 30 seconds, repeating for approximately five minutes or until the safety belts are buckled.
The driver's or front passenger's safety belt becomes unbuckled for approximately one minute while the vehicle is traveling at least 6 mph (9.7 km/h) and more than 1-2 minutes have elapsed since the ignition switch has been turned to on...	The Belt-Minder® feature is activated - the safety belt warning light illuminates and the warning chime sounds for six seconds every 30 seconds, repeating for approximately five minutes or until the safety belts are buckled.





**Deactivating and Activating the Belt-Minder® Feature (If Equipped)**

**WARNING:** While the design allows you to deactivate your Belt-Minder®, this system is designed to improve your chances of being safely belted and surviving an accident. We recommend you leave the Belt-Minder® system activated for yourself and others who may use the vehicle. To reduce the risk of injury, do not deactivate/activate the Belt-Minder® feature while driving the vehicle.

**Note:** The driver and front passenger Belt-Minder® are deactivated and activated independently. When deactivating or activating one seating position, do not buckle the other position as this will terminate the process.

*Read Steps 1 - 4 thoroughly before proceeding with the deactivation or activation programming procedure.*

The driver and front passenger Belt-Minder® features can be deactivated or activated by performing the following procedure:

Before following the procedure, make sure that:

- The parking brake is set
  - The transmission selector lever is in position **P** (automatic transmission) or in neutral (manual transmission)
  - The ignition is off
  - The driver and front passenger safety belts are unbuckled
1. Turn the ignition on. **DO NOT START THE ENGINE.**
  2. Wait until the safety belt warning light turns off (approximately one minute).
    - Once the next step is started, the procedure must be completed within 60 seconds.
  3. For the seating position being disabled, buckle then unbuckle the safety belt four times at a moderate speed, ending in the unbuckled state.
    - After Step 3, the safety belt warning light will turn on.
  4. While the safety belt warning light is on, buckle and then unbuckle the safety belt.
    - After Step 4, the safety belt warning light will flash three times for confirmation.
    - This will disable the Belt-Minder feature for that seating position if it is currently enabled.
    - This will enable the Belt-Minder® feature for that seating position if it is currently disabled.



**CHILD RESTRAINT AND SAFETY BELT MAINTENANCE**

Inspect the vehicle safety belts and child safety seat systems periodically to make sure they work properly and are not damaged. Inspect the vehicle and child seat safety belts to make sure there are no nicks, tears or cuts. Replace if necessary. All vehicle safety belt assemblies, including retractors, buckles, front safety belt buckle assemblies, buckle support assemblies (slide bar-if equipped), shoulder belt height adjusters (if equipped), shoulder belt guide on seat back (if equipped), child safety seat LATCH and tether anchors, and attaching hardware, should be inspected after a collision. Read the child restraint manufacturer's instructions for additional inspection and maintenance information specific to the child restraint. Ford Motor Company recommends that all safety belt assemblies in use in vehicles involved in a collision be replaced. However, if the collision was minor and an authorized dealer finds that the belts do not show damage and continue to operate properly, they do not need to be replaced. Safety belt assemblies not in use during a collision should also be inspected and replaced if either damage or improper operation is noted.

For proper care of soiled safety belts, see *Cleaning the Interior* in the *Vehicle Care* chapter.



### PERSONAL SAFETY SYSTEM™

The Personal Safety System provides an improved overall level of frontal crash protection to front seat occupants and is designed to help further reduce the risk of airbag-related injuries. The system is able to analyze different occupant conditions and crash severity before activating the appropriate safety devices to help better protect a range of occupants in a variety of frontal crash situations.

Your vehicle's Personal Safety System consists of:

- Driver and passenger dual-stage airbag supplemental restraints.
- Front outboard safety belts with pretensioners, energy management retractors (first row only), and safety belt usage sensors.
- Driver's seat position sensor.
- Front passenger sensing system.
- Passenger airbag off/on indicator lamp.
- Front crash severity sensors.
- Restraints Control Module (RCM) with impact and safing sensors.
- Restraint system warning light and backup tone.
- The electrical wiring for the airbags, crash sensor(s), safety belt pretensioners, front safety belt usage sensors, driver seat position sensor, front passenger sensing system, and indicator lights.

### How does the Personal Safety System work?

The Personal Safety System can adapt the deployment strategy of your vehicle's safety devices according to crash severity and occupant conditions. A collection of crash and occupant sensors provides information to the restraints control module. During a crash, the restraints control module may activate the safety belt pretensioners and/or either one or both stages of the dual-stage airbag supplemental restraints based on crash severity and occupant conditions.





## 44      **Supplementary Restraints System**

---

### **PRINCIPLES OF OPERATION**

 **WARNING:** Airbags DO NOT inflate slowly or gently, and the risk of injury from a deploying airbag is the greatest close to the trim covering the airbag module.

 **WARNING:** All occupants of the vehicle, including the driver, should always properly wear their safety belts, even when an airbag supplemental restraint system is provided.

 **WARNING:** Always transport children 12 years old and under in the back seat and always properly use appropriate child restraints.

 **WARNING:** Never place your arm over the airbag module as a deploying airbag can result in serious arm fractures or other injuries.

 **WARNING:** Airbags can kill or injure a child in a child seat. NEVER place a rear-facing child seat in front of an active airbag. If you must use a forward-facing child seat in the front seat, move the seat all the way back.

 **WARNING:** Do not attempt to service, repair, or modify the airbag supplemental restraint systems or its fuses. Contact your authorized dealer as soon as possible.

 **WARNING:** Several airbag system components get hot after inflation. Do not touch them after inflation.

 **WARNING:** If the airbag has deployed, the airbag will not function again and must be replaced immediately. If the airbag is not replaced, the unrepaired area will increase the risk of injury in a collision.



The airbags are a supplemental restraint system and are designed to work with the safety belts to help protect the driver and right front passenger from certain upper body injuries. Airbags DO NOT inflate slowly; there is a risk of injury from a deploying airbag.

**Note:** You will hear a loud bang and see a cloud of harmless powdery residue if an airbag deploys. This is normal.

The airbags inflate and deflate rapidly upon activation. After airbag deployment, it is normal to notice a smoke-like, powdery residue or smell the burnt propellant. This may consist of cornstarch, talcum powder (to lubricate the bag) or sodium compounds (e.g., baking soda) that result from the combustion process that inflates the airbag. Small amounts of sodium hydroxide may be present which may irritate the skin and eyes, but none of the residue is toxic. While the system is designed to help reduce serious injuries, contact with a deploying airbag may also cause abrasions or swelling. Temporary hearing loss is also a possibility as a result of the noise associated with a deploying airbag. Because airbags must inflate rapidly and with considerable force, there is the risk of death or serious injuries, such as fractures, facial and eye injuries or internal injuries, particularly to occupants who are not properly restrained or are otherwise out of position at the time of airbag deployment. Thus, it is extremely important that occupants be properly restrained as far away from the airbag module as possible while maintaining vehicle control.

Routine maintenance of the airbags is not required.

### **SOS POST-CRASH ALERT SYSTEM™**

The system flashes the turn signal lamps and sounds the horn (intermittently) in the event of a serious impact that deploys an airbag equipped on your vehicle, such as front, side, side curtain or Safety Canopy®.

The horn and lamps will turn off when:

- the hazard control button is pressed
- the panic button (if equipped) is pressed on the remote entry transmitter, or
- the vehicle runs out of power.



**DRIVER AND PASSENGER AIRBAGS**

 **WARNING:** Never place your arm or any objects over an airbag module. Placing your arm over a deploying airbag can result in serious arm fractures or other injuries. Objects placed on or over the airbag inflation area may cause those objects to be propelled by the airbag into your face and torso causing serious injury.

 **WARNING:** Airbags can kill or injure a child in a child seat. Never place a rear-facing child seat in front of an active airbag. If you must use a forward-facing child seat in the front seat, move the seat all the way back.

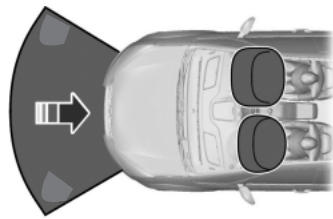

The driver and front passenger airbags will deploy during significant frontal and near-frontal collisions.

The driver and passenger front airbag system consists of the following:

- Driver and passenger airbag modules.
-  • Crash sensors and monitoring system with readiness indicator. See *Crash Sensors and Airbag Indicator* later in this chapter.
- Front passenger sensing system.



**Proper Driver and Front Passenger Seating Adjustment**

 **WARNING:** National Highway Traffic Safety Administration (NHTSA) recommends a minimum distance of at least 10 inches (25 centimeters) between an occupant's chest and the driver airbag module.

To properly position yourself away from the airbag:

- Move your seat to the rear as far as you can while still reaching the pedals comfortably.
- Recline the seat slightly (one or two degrees) from the upright position.

After all occupants have adjusted their seats and put on safety belts, it is very important that they continue to sit properly. A properly seated occupant sits upright, leaning against the seat back, and centered on the seat cushion, with their feet comfortably extended on the floor. Sitting improperly can increase the chance of injury in a crash event. For example, if an occupant slouches, lies down, turns sideways, sits forward, leans forward or sideways, or puts one or both feet up, the chance of injury during a crash is greatly increased.

**Children and Airbags**

 **WARNING:** Airbags can kill or injure a child in a child seat. NEVER place a rear-facing child seat in front of an active airbag. If you must use a forward-facing child seat in the front seat, move the seat all the way back.





Children must always be properly restrained. Accident statistics suggest that children are safer when properly restrained in the rear seating positions than in the front seating position. Failure to follow these instructions may increase the risk of injury in a collision.





## 48 Supplementary Restraints System

### FRONT PASSENGER SENSING SYSTEM

 **WARNING:** Even with Advanced Restraints Systems, children 12 and under should be properly restrained in a rear seating position.

 **WARNING:** Sitting improperly out of position or with the seat back reclined too far can take off weight from the seat cushion and affect the decision of the front passenger sensing system, resulting in serious injury or death in a crash.  
Always sit upright against your seatback, with your feet on the floor.

 **WARNING:** To reduce the risk of possible serious injury:  
Do not stow objects in seat back map pocket (if equipped) or hang objects off seat back if a child is in the front passenger seat. Do not place objects underneath the front passenger seat or between the seat and the center console (if equipped).  
Check the passenger airbag off or pass airbag off indicator lamp for proper airbag Status.  
Failure to follow these instructions may interfere with the passenger seat sensing system.

 **WARNING:** Any alteration/modification to the front passenger seat may affect the performance of the front passenger sensing system.

This system works with sensors that are part of the front passenger's seat and safety belt to detect the presence of a properly seated occupant and determine if the front passenger's frontal airbag should be enabled (may inflate) or not.



The front passenger sensing system uses a pass airbag off indicator which will illuminate and stay lit to remind you that the front passenger frontal airbag is disabled.





The indicator lamp is located under the climate controls. The indicator lamp will illuminate for a short period of time when the ignition is turned to the on position to confirm it is functional.

**Note:** When the passenger airbag off light is illuminated, the passenger (seat mounted) side airbag may be disabled to avoid the risk of airbag deployment injuries.

The front passenger sensing system is designed to disable (will not inflate) the front passenger's frontal airbag when the front passenger seat is unoccupied, or a rear facing infant seat, a forward-facing child restraint, or a booster seat is detected.

- When the front passenger sensing system disables (will not inflate) the front passenger frontal airbag, the passenger airbag status indicator will illuminate the OFF lamp and stay lit to remind you that the front passenger frontal airbag is disabled.
- If the child restraint has been installed and the indicator lamp is not lit, then turn the vehicle off, remove the child restraint from the vehicle and reinstall the restraint following the child restraint manufacturer's instructions.

The front passenger sensing system is designed to enable (may inflate) the front passenger's frontal airbag anytime the system senses that a person of adult size is sitting properly in the front passenger seat.

- When the front passenger sensing system enables the front passenger frontal airbag (may inflate), the indicator will be unlit and stay unlit.

If a person of adult size is sitting in the front passenger's seat, but the passenger airbag off indicator lamp is lit, it is possible that the person isn't sitting properly in the seat. If this happens:

- Turn the vehicle off and ask the person to place the seatback in the full upright position.
- Have the person sit upright in the seat, centered on the seat cushion, with the person's legs comfortably extended.
- Restart the vehicle and have the person remain in this position for about two minutes. This will allow the system to detect that person and enable the passenger's frontal airbag.
- If the indicator lamp remains lit even after this, the person should be advised to ride in the rear seat.



## 50 Supplementary Restraints System

Occupant	Pass Airbag Off Indicator Lamp	Passenger Airbag
Empty	Unlit	Disabled
Child	Lit	Disabled
Adult	Unlit	Enabled

After all occupants have adjusted their seats and put on safety belts, it's very important that they continue to sit properly. A properly seated occupant sits upright, leaning against the seat back, and centered on the seat cushion, with their feet comfortably extended on the floor. Sitting improperly can increase the chance of injury in a crash event. For example, if an occupant slouches, lies down, turns sideways, sits forward, leans forward or sideways, or puts one or both feet up, the chance of injury during a crash is greatly increased.

If you think that the status of the passenger airbag off indicator lamp is incorrect, check for the following:

- Objects lodged underneath the seat
- Objects between the seat cushion and the center console (if equipped)
- Objects hanging off the seat back
- Objects stowed in the seatback map pocket (if equipped)
- Objects placed on the occupant's lap
- Cargo interference with the seat
- Other passengers pushing or pulling on the seat
- Rear passenger feet and knees resting or pushing on the seat

The conditions listed above may cause the weight of a properly seated occupant to be incorrectly interpreted by the passenger sensing system. The person in the front passenger seat may appear heavier or lighter due to the conditions described in the list above.



To know if the front passenger sensing system is operating properly, refer to *Crash sensors and Airbag Indicator* later in this chapter.



**If the airbag readiness lamp is lit, do the following:**

The driver and/or adult passengers should check for any objects that may be lodged underneath the front passenger seat or cargo interfering with the seat.

If objects are lodged and/or cargo is interfering with the seat; please take the following steps to remove the obstruction:

- Pull the vehicle over.
- Turn the vehicle off.
- Driver and/or adult passengers should check for any objects lodged underneath the front passenger seat or cargo interfering with the seat.
- Remove the obstruction(s) (if found).
- Restart the vehicle.
- Wait at least two minutes and verify that the airbag readiness lamp is no longer illuminated
- If the airbag readiness lamp remains illuminated, this may or may/not be a problem due to the front passenger sensing system.

DO NOT attempt to repair or service the system; take your vehicle immediately to an authorized dealer.

If it is necessary to modify an advanced front airbag system to accommodate a person with disabilities, contact the Ford Customer Relationship Center at the phone number shown in the *Customer Assistance* section of this *Owner's Manual*.

**KNEE AIRBAG**

The knee airbag is located under the instrument panel. The system works along with the passenger's front airbag to help reduce injury to the legs. When the passenger's airbag activates in a collision, the knee airbag deploys from under the instrument panel. As with front and side airbags, it is important to be properly seated and restrained to reduce the risk of death or serious injury.



To know if the knee airbag is operating properly, refer to *Crash sensors and airbag indicator* later in this chapter.





## 52 Supplementary Restraints System

---

### SIDE AIRBAGS

 **WARNING:** Do not place objects or mount equipment on or near the airbag cover, on the side of the seat backs (of the front seats), or in front seat areas that may come into contact with a deploying airbag. Failure to follow these instructions may increase the risk of personal injury in the event of a collision.

 **WARNING:** Do not use accessory seat covers. The use of accessory seat covers may prevent the deployment of the side airbags and increase the risk of injury in an accident.

 **WARNING:** Do not lean your head on the door. The side airbag could injure you as it deploys from the side of the seat back.

 **WARNING:** Do not attempt to service, repair, or modify the airbag, its fuses or the seat cover on a seat containing an airbag. Contact your authorized dealer as soon as possible.

 **WARNING:** If the side airbag has deployed, **the airbag will not function again. The side airbag system (including the seat) must be inspected and serviced by an authorized dealer.** If the airbag is not replaced, the unrepaired area will increase the risk of injury in a collision.

The side airbags are located on the outboard side of the seat backs of the front seats. In certain lateral collisions, the airbag on the side affected by the collision will be inflated. The airbag was designed to inflate between the door panel and occupant to further enhance the protection provided occupants in side impact collisions.





The system consists of the following:

- a tag on the seat back indicating that side airbags are found on your vehicle
- side airbags located inside the seat back of the driver and front passenger seats.



- Crash sensors and monitoring system with readiness indicator. See *Crash Sensors and Airbag Indicator* later in this chapter.

- Front passenger sensing system.

**Note:** The passenger sensing system will deactivate the passenger seat-mounted side airbag if it detects an empty, unbuckled passenger seat.

The design and development of the side airbag system included recommended testing procedures that were developed by a group of automotive safety experts known as the Side Airbag Technical Working Group. These recommended testing procedures help reduce the risk of injuries related to the deployment of side airbags.

### SIDE CURTAIN AIRBAGS



**WARNING:** Do not place objects or mount equipment on or near the headliner at the siderail that may come into contact with a deploying side curtain airbag. Failure to follow these instructions may increase the risk of personal injury in the event of a collision.





**WARNING:** Do not lean your head on the door. The curtain airbag could injure you as it deploys from the headliner.



**WARNING:** Do not attempt to service, repair, or modify the side curtain airbags, its fuses, the A, B, or C pillar trim, or the headliner on a vehicle containing side curtain airbags. Contact your authorized dealer as soon as possible.



 **WARNING:** All occupants of the vehicle including the driver should always wear their safety belts even when an airbag SRS and side curtain airbag is provided.

 **WARNING:** To reduce risk of injury, do not obstruct or place objects in the deployment path of the side curtain airbag.

 **WARNING:** If the side curtain airbags have deployed, **the side curtain airbags will not function again. The side curtain airbags (including the A, B and C pillar trim and headliner) must be inspected and serviced by an authorized dealer.** If the side curtain airbag is not replaced, the unrepaired area will increase the risk of injury in a collision.

A side curtain airbag will deploy during significant side collisions. The side curtain airbags are mounted to the roof side-rail sheet metal, behind the headliner, above each row of seats. In certain lateral collisions, the side curtain airbag on the impacted side of the vehicle will be activated. The side curtain airbags are designed to inflate between the side window area and occupants to further enhance protection provided in side impact collisions.

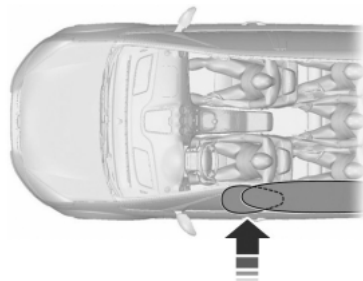

The system consists of the following:

- Side curtain airbags located above the trim panels over the front and rear side windows identified by a label or wording on the headliner or roof-pillar trim.
- A flexible headliner which opens above the side doors to allow side air curtain deployment.
-  Crash sensors and monitoring system with readiness indicator. Refer to *Crash sensors and Airbag Indicator* later in this chapter.



Children 12 years old and under should always be properly restrained in the back seats. The side curtain airbags will not interfere with children restrained using a properly installed child or booster seat because it is designed to inflate downward from the headliner above the doors along the side window opening.

The design and development of the side curtain airbags included recommended testing procedures that were developed by a group of automotive safety experts known as the Side Airbag Technical Working Group. These recommended testing procedures help reduce the risk of injuries related to the deployment of side curtain airbags.

### CRASH SENSORS AND AIRBAG INDICATOR



**WARNING:** Modifying or adding equipment to the front end of the vehicle (including frame, bumper, front end body structure and tow hooks) may affect the performance of the airbag system, increasing the risk of injury. Do not modify the front end of the vehicle.

The vehicle has a collection of crash and occupant sensors which provide information to the Restraints Control Module (RCM) which deploys (activates) the front safety belt pretensioners, driver airbag, passenger airbag, knee airbag, seat mounted side airbags, and the side curtain airbags. Based on the type of collision (frontal impact or side impact) the restraints control module will deploy the appropriate safety devices.

The restraints control module also monitors the readiness of the above safety devices plus the crash and occupant sensors. The readiness of the safety system is indicated by a warning indicator light in the instrument cluster or by a backup tone if the warning light is not working. See *Warning lamps and indicators* in the *Instrument Cluster* chapter. Routine maintenance of the airbag is not required.

A difficulty with the system is indicated by one or more of the following:



- The readiness light will either flash or stay lit.
- The readiness light will not illuminate immediately after the ignition is turned on.
- A series of five beeps will be heard. The tone pattern will repeat periodically until the problem and/or light are repaired.



## 56            **Supplementary Restraints System**

---

If any of these things happen, even intermittently, have the supplemental restraint system serviced at an authorized dealer immediately. Unless serviced, the system may not function properly in the event of a collision.

The safety belt pretensioners and the airbag supplemental restraint system are designed to activate when the vehicle sustains longitudinal deceleration sufficient to cause the restraints control module to deploy a safety device.

The fact that the safety belt pretensioners or front airbags did not activate for both front seat occupants in a collision does not mean that something is wrong with the system. Rather, it means the restraints control module determined the accident conditions (crash severity, belt usage, etc.) were not appropriate to activate these safety devices.

- Front airbags are designed to activate only in frontal and near-frontal collisions (not rollovers, side impacts or rear impacts) unless the collision causes sufficient longitudinal deceleration.
- The safety belt pretensioners are designed to activate in frontal and near-frontal collisions, and may also activate when a side curtain deploys.
- The knee airbag deploys from under the instrument panel when the passenger airbag activates in a collision.
- Side airbags and side curtain airbags are designed to inflate in side-impact collisions, not rollovers, rear impacts, frontal or near-frontal collisions, unless the collision causes sufficient lateral deceleration.

### **AIRBAG DISPOSAL**

Contact your authorized dealer as soon as possible. Airbags **MUST BE** disposed of by qualified personnel.





### PRINCIPLE OF OPERATION

The remote control allows you to:

- remotely lock or unlock the vehicle doors
- arm and disarm the anti-theft system
- remotely open the luggage compartment
- unlock the doors without actively using a key or remote control (intelligent access only).

### GENERAL INFORMATION ON RADIO FREQUENCIES

This device complies with part 15 of the FCC Rules and with Industry Canada license-exempt RSS standard(s). Operation is subject to the following two conditions: (1) This device may not cause harmful interference, and (2) This device must accept any interference received, including interference that may cause undesired operation.

**Note:** Changes or modifications not expressly approved by the party responsible for compliance could void the user's authority to operate the equipment. The term **IC** before the radio certification number only signifies that Industry Canada technical specifications were met.

The typical operating range for your transmitter is approximately 33 feet (10 meters). Vehicles with the remote start feature will have a greater range. A decrease in operating range could be caused by:

- weather conditions
- nearby radio towers
- structures around your vehicle
- other vehicles parked next to your vehicle.

The radio frequency used by your remote control can also be used by other short distance radio transmissions (e.g. amateur radios, medical equipment, wireless headphones, remote controls and alarm systems). If the frequencies are jammed, you will not be able to use your remote control. You can lock and unlock the doors with the key.

**Note:** Make sure your vehicle is locked before leaving it unattended.

**Note:** If you are in range, the remote control will operate if you press any button unintentionally.



### Intelligent Access (If Equipped)

The system uses a radio frequency signal to communicate with your vehicle and authorize your vehicle to authorize your vehicle to unlock when one of the following condition are met:

- You touch the inside of the front exterior door handle.
- You press the luggage compartment button.
- You press a button on the transmitter.

If excessive radio frequency interference is present in the area or if the transmitter battery is low, it may be necessary to mechanically unlock your door. You can use the mechanical key blade in your intelligent access key open the driver's door in this situation. Refer to *Remote Control* in this chapter for more information on the location and use of the mechanical key blade.

### REMOTE CONTROL

#### Integrated Keyhead Transmitters (IKTs) (If Equipped)

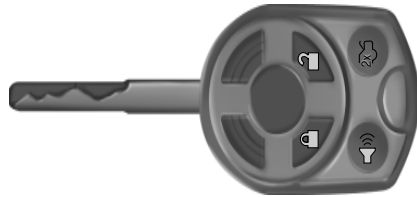

Your vehicle may be equipped with two integrated keyhead transmitters. The key blade is used to start the vehicle and unlock or lock the driver's door from outside the vehicle. The transmitter portion functions as the remote control.



**Note:** Your vehicle's keys were issued with a security label that provides important vehicle key cut information. Keep the label in a safe place for future reference.



**Intelligent Access Key (If Equipped)**

**Type 1**



**Type 2**



Your vehicle may be equipped with two intelligent access keys which operate the power locks and the remote start system. The key must be in the vehicle to activate the push button start system.

**Mechanical Key Blade**

The key also contains a removable mechanical key blade that can be used to unlock the driver door.

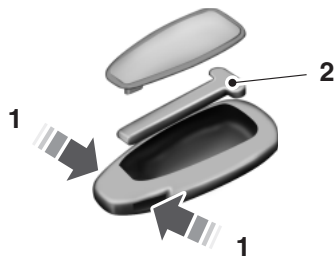

**Type 1**

To release the mechanical key blade:

1. Press and hold the push buttons on the edges of the transmitter to release the cover. Carefully remove the cover.
2. Remove the key blade.



**Type 2**

To release the key blade, slide the release on the back of the transmitter, then pull the blade out.



**Note:** Your vehicle's back-up keys were issued with a security tag that provides important vehicle key cut information. Keep the tag in a safe place for future reference.

**Replacing the Battery**

**Note:** Refer to local regulations when disposing of transmitter batteries.

**Note:** Do not wipe off any grease on the battery terminals or on the back surface of the circuit board.

**Note:** Replacing the battery will not delete the transmitter from the vehicle. The transmitter should operate normally.

The remote control uses one coin-type three-volt lithium battery CR2032 or equivalent.

**Integrated Keyhead Transmitter**

1. Twist a thin coin in the slot of the transmitter near the key ring to remove the battery cover.
2. Remove the old battery.



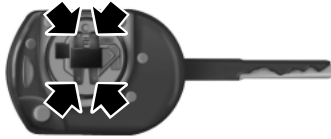

3. Insert the new battery. Refer to the instructions inside the transmitter for the correct orientation of the battery. Press the battery down to make sure it is fully in the housing.

4. Snap the battery cover back onto the transmitter.

**Intelligent Access Key (Type 1)**

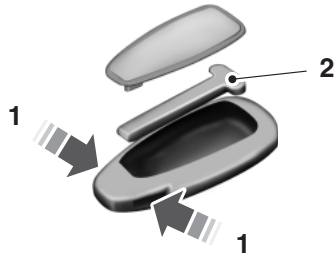

1. Press and hold the push buttons on the edges of the transmitter to release the cover. Carefully remove the cover.

2. Remove the key blade.



3. Twist a flat object in the position shown to separate the two halves of the transmitter.

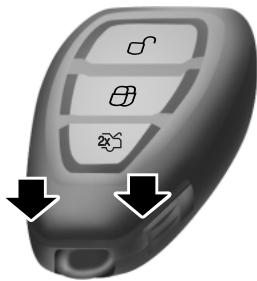

4. Carefully insert a flat object in the position show to open the transmitter.



5. Carefully pry out the battery with a flat object.
6. Install a new battery with the + facing downward.
7. Assemble the two halves of the transmitter back together.
8. Install the key blade.

**Intelligent Access Key (Type 2)**

1. Remove the backup key from the transmitter.

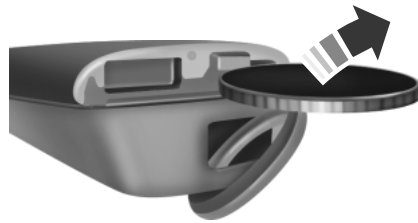

2. Twist a thin coin in the slot hidden behind the backup key slot to remove the battery cover.



3. Remove the old battery.

4. Insert a new battery with the + facing downward. Press the battery down to make sure it is fully in the housing.
5. Snap the battery cover back onto the transmitter and install the backup key.

**Car Finder**

Press the lock button on the key twice within three seconds. The horn will chirp and the turn signals will flash. It is recommended that this method be used to locate your vehicle, rather than using the panic alarm.



**Sounding a Panic Alarm (If Equipped)**

**Note:** The panic alarm will only operate when the ignition is off.



Press the button to activate the alarm. Press the button again or turn the ignition on to deactivate.

**Remote Start (If Equipped)**

**WARNING:** To avoid exhaust fumes, do not use remote start if your vehicle is parked indoors or areas that are not well ventilated.

**Note:** Do not use remote start if your vehicle is low on fuel.



Your vehicle has remote start if the transmitter has this button.

The remote start feature allows you to start the vehicle from outside the vehicle. The transmitter has an extended operating range.

Vehicles with automatic climate control can be configured to operate when the vehicle is remote started. Refer to the *Climate Control* chapter for more information.

Many states and provinces have restrictions for the use of remote start. Check your local and state or provincial laws for specific requirements regarding remote start systems.

The remote start system will not work if:

- the ignition is on
- the alarm system is triggered
- the feature has been disabled
- the hood is not closed
- two remote vehicle starts have already been attempted within the last hour
- the vehicle is not in **P**
- the vehicle battery voltage is too low
- the service engine soon indicator was on the last time the vehicle was driven.



**Remote Starting the Vehicle**

**Note:** Each button press must be done within three seconds of each other. The vehicle will not remote start if this sequence is not followed and the horn will not chirp.

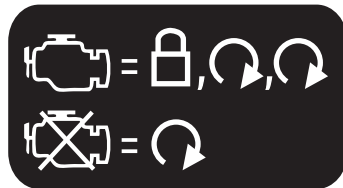

The label on your transmitter details the starting procedure. To remote start the vehicle:

1. Press the lock button to lock all the doors.
2. Press the remote start button twice. The exterior lamps will flash twice.

The horn will chirp if the system fails to start (unless quiet start is on). Quiet start will run the blower fan at a slower speed to reduce noise. It can be switched on or off. Refer to the *Information Displays* chapter.

**Note:** If the vehicle has been remote started and is equipped with an integrated keyhead transmitter, you must turn the ignition on before driving the vehicle. If equipped with an intelligent access transmitter, you must press the **START/STOP** button on the instrument panel once while applying the brake pedal before driving the vehicle.

The power windows will be inhibited during the remote start and the radio will not turn on automatically.

The parking lamps will remain on and the vehicle will run for 5, 10, or 15 minutes, depending on the setting. Refer to the *Information Displays* chapter to select the duration of the remote start system.

**Extending the Vehicle Run Time**

Repeat Steps 1 and 2 with the vehicle still running to extend the run time for another remote start duration. If you programmed the duration to last 10 minutes, the second 10 minutes will be added. For example, if the vehicle had been running from the first remote start for five minutes, the vehicle will continue to run now for a total of 20 minutes. You can only extend the remote start once.

Wait at least five seconds before remote starting after a vehicle shutdown. Only two remote starts are allowed.

The vehicle must be started without remote start then switched back off or allow one hour to pass before using remote start again if additional remote starts are desired.





### ***Turning the Vehicle Off After Remote Starting***



Press the button once. The parking lamps will turn off.

You may have to be closer to the vehicle than when starting due to ground reflection and the added noise of the running vehicle .

You can disable or enable the remote start system through the information display. Refer to the *Information Display* chapter.

### **REPLACING A LOST KEY OR REMOTE CONTROL**

Replacement or additional keys or remote controls can be purchased from your authorized dealer. Your dealer can program the transmitters to your vehicle or you may be able to program them yourself. See the *Security* chapter for information on programming your transmitters.



**PRINCIPLES OF OPERATION**

MyKey® allows you to program keys with restricted driving modes to promote good driving habits. All but one of the keys programmed to the vehicle can be activated with these restricted modes. Any keys that have not been programmed are referred to as an administrator key or admin key which can be used to:

- create a restricted key
- program optional MyKey settings
- clear all MyKey features altogether.

Once a key has been programmed, you can access the following information using the information display control:

- How many admin keys and MyKeys are programmed to the vehicle.
- The total distance the vehicle has been driven with a MyKey.

For vehicles equipped with Intelligent Access (push button start), when both a MyKey and an Admin Intelligent Access key (fob) are present, the admin fob will be recognized by the vehicle to start the engine.

**Standard Settings**

These settings cannot be changed.

- Belt-Minder. This cannot be disabled and the five-minute timer does not expire. The audio system is muted when MyKey Belt-Minder is activated.
- Early low fuel. Warnings are displayed in the information display control followed by an audible tone when the fuel tank is at one-eighth tank or less.
- Driver assist features, if equipped on your vehicle, are forced on: parking aid, blind spot information system (BLIS) with cross traffic alert and the collision warning system.

**Optional Settings**

These settings can be configured right after a MyKey is first created or changed afterward with an admin key.

- Vehicle speed limit of 80 mph (130 km/h). Visual warnings are displayed followed by an audible tone when vehicle speed has reached 80 mph (130 km/h).
- Vehicle speed warning of 45, 55 or 65 mph (75, 90, or 105 km/h). Visual warnings are displayed followed by an audible tone when the preselected vehicle speed is exceeded.



- Audio system maximum volume of 45%. A message in the audio system is displayed when attempting to exceed the limited volume.
- AdvanceTrac. The system cannot be turned off when Always-on has been set.

### CREATING A MYKEY

Use the information display control to create a MyKey.

1. Insert the key you want to program into the ignition or, if the vehicle is equipped with push button start, put the Intelligent Access key in the backup slot; see the *Starting and Stopping the Engine* chapter for the backup slot location.
2. Turn the ignition on.
3. Access the main menu from the information display controls and select Settings, then MyKey by pressing OK or the > button.
4. Press OK to select Create.
5. When prompted, hold the OK button until you see a message informing you to label this key as a MyKey. The key will be restricted at the next start.

The key is successfully programmed. Make sure you label it so you can distinguish it from the admin keys.

To program optional settings for the key(s), see the *Programming/Changing Optional Settings* chapter.

### Programming/Changing Optional Settings

**Note:** All programmed keys can be cleared within the same key cycle in which a key was programmed, otherwise an admin key is required to clear the keys. To clear all keys, see *Clearing all MyKeys*.

You can access the optional settings through the information display control.

1. Turn the ignition on using an admin key.
2. Access the main menu and select Settings, then MyKey.
3. Use the arrow buttons to get to an optional feature.
4. Press OK or > to scroll through settings.
5. Press OK or > to make a selection.



**CLEARING ALL MYKEYS**

**Note:** All programmed MyKeys can be cleared within the same key cycle in which a MyKey was created, otherwise an admin key is required to clear the keys.

To clear all MyKeys (which removes all restrictions and returns them to admin key status), use the information display controls to do the following:

1. Access the main menu and select Settings, then MyKey.
2. Scroll to Clear All and press the OK button.
3. Hold the OK button until ALL MYKEYS CLEARED is displayed.

**CHECKING MYKEY SYSTEM STATUS**

The information display controls provide information about keys programmed to the vehicle:

- **MYKEY MILES:** Tracks mileage when a MyKey is used. If mileage does not accumulate as expected, then the MyKey is not being used by the intended user. The only way to reset this to zero is by clearing MyKeys. If the mileage is lower than the last time you checked, then the key system has been recently reset.
- **# MYKEY(S):** Indicates how many MyKeys are programmed to the vehicle. Can also be used to detect deletion of a MyKey.
- **# ADMIN KEY(S):** Indicates how many admin keys are programmed to the vehicle. Can also be used to detect if an additional key has been programmed to the vehicle.

**USING MYKEY WITH REMOTE START SYSTEMS**

MyKey is NOT compatible with non-Ford-approved aftermarket remote start systems. If you choose to install a remote start system, please see your Ford authorized dealer for a Ford-approved remote start system.

The following information MAY help customers who choose to use a non-Ford-approved remote start system. The actions provided below do NOT make MyKey compatible with non-Ford-approved remote start system, but it MAY help you to retain some MyKey functions.

**Vehicles Equipped with Traditional Keys**

When using a non-Ford-approved remote start system, the default settings may recognize the remote start system as an additional admin key with its associated privileges. It is NOT compatible with MyKey. Restart the engine when you insert a key into the ignition cylinder; it may help you to retain some MyKey functions.



In addition to the key that has been programmed as a MyKey, owners of vehicles equipped with traditional keys have the option to program the non-Ford-approved remote start system as a MyKey if the remote start fob is used by the MyKey driver.

To program a non-Ford-approved remote start system as a MyKey, do the following:

1. Enter the vehicle and close all doors.
2. Remote start the vehicle using a non-Ford approved remote start fob.
3. Follow Steps 1-5 in the *Creating a MyKey* section.

### **Vehicles Equipped with Intelligent Access Key (Push Button Start)**

**Note:** It is not possible to program the remote start system as a MyKey on vehicles equipped with intelligent access key (push button start). Therefore, you should treat the remote start fob as you would any other admin key. When the vehicle is started using remote start, the system will stall the engine when you either enter the vehicle or shift the vehicle into gear. Prior to the engine stall, the vehicle will have administrative privileges. When you restart the engine, the vehicle will identify the user as an admin or MyKey driver depending on the settings of the actual key used to start the vehicle.

**Note:** For all vehicles, the number of MYKEY(S) PROGRAMMED or ADMIN KEYS PROGRAMMED that is displayed in the MyKey system status menu, may include the non-Ford-approved remote start system as an additional key in the total count. See the *Checking System Status* section.

For all vehicles with a non-Ford-approved remote start installed, it is possible to program all real keys as MyKeys, in which case, you will need to use your remote start system to clear all MyKeys (which removes all restrictions and returns them to admin key status) by doing the following:

1. Enter the vehicle and close all doors.
2. Remote start the vehicle using your non-Ford-approved remote start fob.
3. Follow Steps 1-3 in the *Clearing all MyKeys* section.



## MYKEY TROUBLESHOOTING

Condition	Potential Causes
I cannot program a key.	<ul style="list-style-type: none"> <li>• The key in the ignition does not have admin privileges.</li> <li>• The key in the ignition is the only admin key (there always has to be at least one admin key).</li> <li>• The intelligent access key is not in the backup slot (vehicles with push button start).</li> <li>• SecuriLock passive anti-theft system is disabled or in unlimited mode.</li> <li>• The vehicle has been started using a remote start system that is not programmed with admin privileges. See the <i>Using MyKey with Remote Start Systems</i> chapter.</li> </ul>
I cannot program the optional settings.	<ul style="list-style-type: none"> <li>• The key in the ignition does not have admin privileges.</li> <li>• No keys are programmed to the vehicle. See the <i>Creating a MyKey</i> chapter.</li> <li>• The vehicle has been started using a remote start system that is not programmed with admin privileges. See the <i>Using MyKey with Remote Start System</i> chapter.</li> </ul>
I cannot clear the restricted keys.	<ul style="list-style-type: none"> <li>• Key in the ignition does not have admin privileges.</li> <li>• No restricted keys are programmed to the vehicle. See the <i>Creating a MyKey</i> chapter.</li> <li>• The vehicle has been started using a remote start system that is not programmed with admin privileges. See the <i>Using MyKey with Remote Start System</i> chapter.</li> </ul>
I lost the only admin key.	<ul style="list-style-type: none"> <li>• Purchase a new key from your authorized dealer.</li> </ul>
I lost a key.	<ul style="list-style-type: none"> <li>• Program spare keys as outlined under <i>SecuriLock</i> in the <i>Security</i> chapter.</li> </ul>



Condition	Potential Causes
I accidentally programmed all keys as restricted keys.	<ul style="list-style-type: none"> <li>• The vehicle has a remote start system that is recognized as an admin key. See the <i>Using MyKey with Remote Start System</i> chapter to reset all restricted keys using remote start.</li> </ul>
No restricted key functions with intelligent access key (push button start).	<ul style="list-style-type: none"> <li>• An admin key is present at engine start-up.</li> <li>• No restricted keys are programmed to the vehicle. See the <i>Creating a MyKey</i> chapter.</li> </ul>
Restricted key programmed total includes one additional key.	<ul style="list-style-type: none"> <li>• An unknown key has been programmed to the vehicle as a restricted key.</li> <li>• The vehicle is equipped with a remote start system. See the <i>Using MyKey with Remote Start Systems</i> chapter.</li> </ul>
Admin keys programmed total includes one additional key.	<ul style="list-style-type: none"> <li>• An unknown key has been programmed to the vehicle as an admin key.</li> <li>• Vehicle is equipped with a remote start system. See the <i>Using MyKey with remote start systems</i> chapter.</li> </ul>
MyKey miles do not accumulate.	<ul style="list-style-type: none"> <li>• The restricted key is not being used by the intended user.</li> <li>• The key system has been reset.</li> </ul>



**LOCKING AND UNLOCKING**

You can use the power door lock control or the remote control to lock and unlock the vehicle.

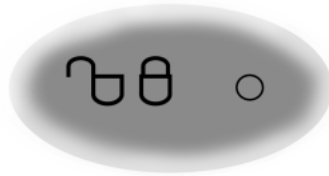
**Power Door Locks**

The power door lock control is located on the instrument panel near the radio.

Press the control to lock or unlock the doors. When the light on the button is on it indicates that all doors and the luggage compartment are locked. When the light is off it

indicates one or more doors are unlocked.

**Rear Door Unlocking and Opening**

Pull the interior door release handle twice to unlock and open the rear door. The first pull unlocks the door and the second pull will unlatch the door.

**Central Locking and Unlocking**

To centrally lock or unlock all doors (from the driver's side only) using the key from the outside when they are closed:

- Turn the key counterclockwise to lock all doors. The turn signal lamps will flash twice.
- Turn the key clockwise once to unlock the driver's door or twice to unlock all doors. The turn signal lamps will flash once.

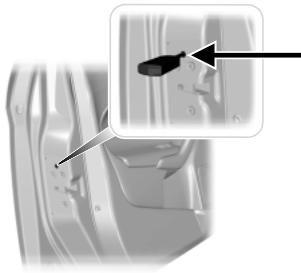

If the central locking function fails to operate, the doors can be individually locked using the key in the position shown.

On the driver's side, turn the key clockwise to lock. On the passenger's side, turn the key counterclockwise to lock.

**Remote Control**

The remote control can be used anytime the vehicle is not running.





**Unlocking the Doors (Two-Stage Unlock)****Type 1****Type 2**

Press the button to unlock the driver's door.

Press the button again within three seconds to unlock all doors. The turn signals will flash.

Press and hold both the lock and unlock buttons on the remote control for four seconds to disable or enable two-stage unlocking. Disabling two-stage unlocking allows all vehicle doors to unlock with one press of the button. The turn signals will flash twice to indicate the unlocking mode was changed. The unlocking mode will be applied to the remote control and intelligent access (if equipped).

Intelligent access at the driver's door will unlock all doors when two-stage unlocking is disabled.

**Locking the doors****Type 1****Type 2**

Press the button to lock all the doors. The turn signals will illuminate.

Press the button again within three seconds to confirm that all the doors are closed. The doors will lock again, the horn will chirp and the turn signals will illuminate if all the doors and the liftgate/trunk are closed.

**Note:** If any door or the liftgate/trunk is not closed, or if the hood is not closed on vehicles equipped with an anti-theft alarm or remote start, the horn will chirp twice and the lamps will not flash.

**Opening the luggage compartment**

Press twice to open the luggage compartment.

Ensure that the trunk is closed and latched before driving your vehicle. Failure to properly latch the trunk may cause objects to fall out or block the driver's rear view.



**Activating Intelligent Access (If Equipped)**

The intelligent access key must be within 3 feet (1 meter) of the vehicle.

**At the Front Doors**

Pull a front exterior door handle. The door will unlock and can be opened.

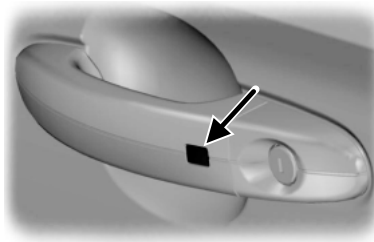

Press and hold the door handle lock sensor to lock the vehicle.

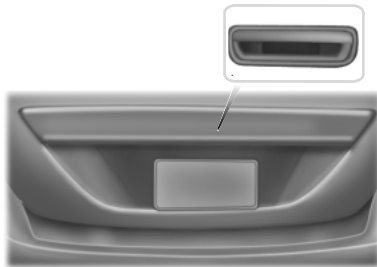
**At the Luggage Compartment**

Press the exterior release button above the license plate.

**Smart Unlocks for Integrated Keyhead Transmitter**

This feature helps to prevent you from locking yourself out of the vehicle if your key is still in the ignition.

When you open one of the front doors and lock the vehicle with the power door lock control, all the doors will lock then unlock if your key is still in the ignition.

The vehicle can still be locked by pressing the lock button on the transmitter even if the doors are not closed.

If both front doors are closed, the vehicle can be locked by any method, regardless of whether the key is in the ignition or not.



**Smart Unlocks for Intelligent Access Keys (If Equipped)**

This feature helps to prevent you from unintentionally locking your intelligent access key inside your vehicle's passenger compartment or rear cargo area.

When you lock your vehicle using the power door lock control (with the door open, vehicle in park and ignition off), after you close the door the vehicle will search for an intelligent access key in the passenger compartment. If an intelligent access key is found inside the vehicle, all of the doors will immediately unlock and the horn will chirp, indicating that the intelligent access key is inside.

In order to override the smart unlock feature and intentionally lock the intelligent access key inside the vehicle, you can lock your vehicle after all doors are closed by pressing the lock button on another intelligent access key or touching the locking area on the handle with another intelligent access key in your hand.

When you open one of the front doors and lock the vehicle using the power door lock control, all doors will lock then unlock if:

- the ignition is on, or
- the ignition is off and the vehicle is not in **P**.

**Autolock and Unlock (If Equipped)**

The autolock feature will lock all the doors when:

- all doors are closed,
- the ignition is on,
- you shift into any gear putting the vehicle in motion, and
- the vehicle attains a speed greater than 4 mph (7 km/h).

When autounlock is enabled, all doors will unlock when the driver door is opened.

**Enabling or Disabling Autolock and Autounlock**

**Note:** Your authorized dealer can perform this procedure, or you can do the procedure yourself.

To enable or disable these features, do the following:

**Note:** You will have 30 seconds to complete the procedure.

1. Switch the ignition on.
2. Press the power door lock button three times.
3. Switch the ignition off.



4. Press the power door lock button three times.
5. Switch the ignition on. The horn will chirp indicating the programming mode has been entered.

**Autolock:** Once in programming mode, each subsequent short press (less than 1 second) of the power door lock button will toggle autolock between on and off.

**Autounlock:** Each subsequent long press (more than 2 seconds) of the power door lock button will toggle autounlock between on and off.

**Note:** The autounlock feature can be enabled or disabled independently of the autolock feature.

### **Illuminated Entry**

The interior lamps and select exterior lamps illuminate when the remote entry system is used to unlock the door(s).

The illuminated entry system will turn off the lights if:

- the ignition is on,
- the remote transmitter lock control is pressed, or
- after 25 seconds of illumination.

The lights will not turn off if:

- they have been turned on with the dimmer control, or
- any door is open.

### **Illuminated Exit**

The interior lamps and select exterior lamps will illuminate when all doors are closed, the ignition is turned off and the key is removed from the ignition (integrated keyhead transmitter only).

The lamps will turn off if all the doors remain closed and:

- 25 seconds elapse
- the key is inserted in the ignition (integrated keyhead transmitter only)
- the **START/STOP** button is pressed (intelligent access key only).



**Battery Saver**

If the courtesy lamps, dome lamps or headlamps are left on, the battery saver will shut them off 10 minutes after the ignition has been turned off.

**Accessory Mode Battery Saver for Intelligent Access Keys (If Equipped)**

If you shut off the engine and leave the ignition in the on or accessory mode, the ignition will shut off after 30 minutes.

**TRUNK RELEASE**

Press the button located on the instrument panel to the left of the steering wheel.

To open the trunk with the outside release button:

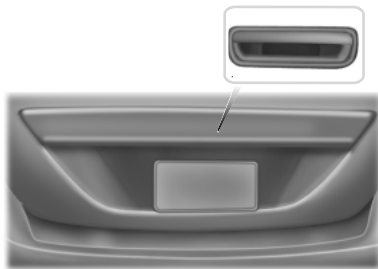



Press the release button located above the license plate if your vehicle is unlocked or if the intelligent access transmitter is within 3 feet (1 meter) of the trunk.

**Note:** If your vehicle is locked and you press the trunk button on the remote control once, you will have 20 seconds to press the outside release button.



**INTERIOR LUGGAGE COMPARTMENT RELEASE (4-DOOR ONLY)**

 **WARNING:** Keep vehicle doors and luggage compartment locked and keep keys and remote transmitters out of a child's reach. Unsupervised children could lock themselves in the trunk and risk injury. Children should be taught not to play in vehicles.

 **WARNING:** Do not leave children, unreliable adults, or animals unattended in the vehicle. On hot days, the temperature in the trunk or vehicle interior can rise very quickly. Exposure of people or animals to these high temperatures for even a short time can cause death or serious heat-related injuries, including brain damage. Small children are particularly at risk.

Your vehicle is equipped with a release handle that provides a means of escape for children and adults if they become locked inside the luggage compartment.

Adults should familiarize themselves with the operation and location of the release handle.

The handle is located inside the luggage compartment either on the luggage compartment door (lid) or near the tail lamps. It is composed of a material that will glow for hours in darkness following brief exposure to ambient light.

Pull the handle and push up on the luggage compartment door (lid) to open from within the luggage compartment.

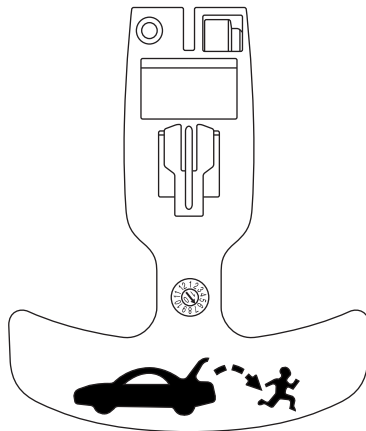

**SECURILOCK® PASSIVE ANTI-THEFT SYSTEM**

**Note:** The system is not compatible with non-Ford aftermarket remote start systems. Use of these systems may result in vehicle starting problems and a loss of security protection.

**Note:** Metallic objects, electronic devices or a second coded key on the same key chain may cause vehicle starting issues if they are too close to the key when starting the engine. Prevent these objects from touching the coded key while starting the engine. Switch the ignition off, move all objects on the key chain away from the coded key and restart the engine if a problem occurs.

**Note:** Do not leave a duplicate coded key in the vehicle. Always take your keys and lock all doors when leaving the vehicle.

The system is an engine immobilization system. It is designed to help prevent the engine from being started unless a coded key programmed to your vehicle is used. Using the wrong key may prevent the engine from starting. A message may appear in the information display.

If you are unable to start the engine with a correctly coded key, a malfunction has happened and a message may appear in the information display.

**Automatic Arming**

The vehicle is armed immediately after switching the ignition off.

**Automatic Disarming**

Switching the ignition on with a coded key disarms the vehicle.

**Replacement Keys**

**Note:** Your vehicle comes equipped with two integrated keyhead transmitters or two intelligent access keys.

The integrated keyhead transmitter functions as a programmed ignition key that operates all the locks and starts the vehicle, as well as a remote control.

The intelligent access key functions as a programmed key that operates the driver door lock and activates the intelligent access with push button start systems, as well as a remote control.

If your programmed transmitters or standard SecuriLock® coded keys (integrated keyhead transmitters only) are lost or stolen and you don't have an extra coded key, you will need to have your vehicle towed to an authorized dealer. The key codes need to be erased from your vehicle and new coded keys will need to be programmed.



Store an extra programmed key away from the vehicle in a safe place to help prevent any inconveniences. See your authorized dealer to purchase additional spare or replacement keys.

***Programming a Spare Integrated Keyhead Transmitter***

**Note:** A maximum of eight coded keys can be programmed to your vehicle; all eight can be integrated keyhead transmitters.

You can program your own integrated keyhead transmitter or standard SecuriLock® coded keys to your vehicle. This procedure will program both the engine immobilizer keycode and the remote entry portion of the remote control to your vehicle.

Only use integrated keyhead transmitters or standard SecuriLock® keys.

You must have two previously programmed coded keys and the new unprogrammed key readily accessible. See your authorized dealer to have the spare key programmed if two previously programmed coded keys are not available.

Read and understand the entire procedure before you begin.

1. Insert the first previously programmed coded key into the ignition.
2. Turn the ignition from off to on. Keep the ignition on for at least three seconds, but no more than 10 seconds.
3. Turn the ignition off and remove the first coded key from the ignition.
4. After three seconds but within 10 seconds of turning the ignition off, insert the second previously coded key into the ignition.
5. Turn the ignition from off to on. Keep the ignition on for at least three seconds, but no more than 10 seconds.
6. Turn the ignition off and remove the second previously programmed coded key from the ignition.
7. After three seconds but within 10 seconds of turning the ignition off and removing the previously programmed coded key, insert the new unprogrammed key into the ignition.
8. Turn the ignition from off to on. Keep the ignition on for at least six seconds.
9. Remove the newly programmed coded key from the ignition.

If the key has been successfully programmed it will start the engine and operate the remote entry system (if the new key is an integrated keyhead transmitter).





If it was not programmed successfully, wait 10 seconds and repeat Steps 1 through 8. If you are still unsuccessful, bring your vehicle to your authorized dealer.

Wait 20 seconds and then repeat this procedure from Step 1 to program an additional key.

***Programming a Spare Intelligent Access Key***

See your authorized dealer to have additional keys programmed to your vehicle.

**ANTI-THEFT ALARM (IF EQUIPPED)**

The system will warn you of an unauthorized entry to your vehicle. It will be triggered if any door, the luggage compartment or the hood is opened without using the key or the remote control.

The park and turn lamps will flash and the horn will sound if unauthorized entry is attempted while the alarm is armed.

Take all remote controls to an authorized dealer if there is any potential alarm problem with your vehicle.

**Arming the Alarm**

The alarm is ready to arm when there is not a key in the ignition. Lock the vehicle to arm the alarm.

**Disarming the alarm**

Disarm the alarm by any of the following actions:

- Unlock the doors or luggage compartment with the remote control.
- Turn the ignition on or start the vehicle.
- Use a key in the driver's door to unlock the vehicle, then turn the ignition on within 12 seconds.



**ADJUSTING THE STEERING WHEEL**

**WARNING:** Do not adjust the steering wheel when your vehicle is moving.

**Note:** Make sure that you are sitting in the correct position. See *Sitting in the Correct Position* in the *Seats* chapter.

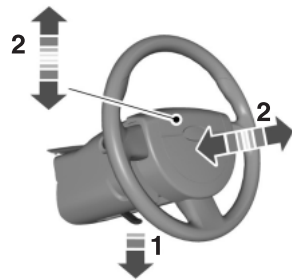

1. Unlock the steering column.
2. Adjust the steering wheel to the desired position.



3. Lock the steering column.



**AUDIO CONTROL (IF EQUIPPED)**

Select the required source on the audio unit.

The following functions can be operated with the control:

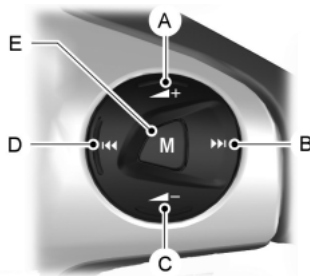
**Type 1**

- A. Volume up
- B. Seek up or next
- C. Volume down
- D. Seek down or previous
- E. Mode

Press **M** to select the audio source.

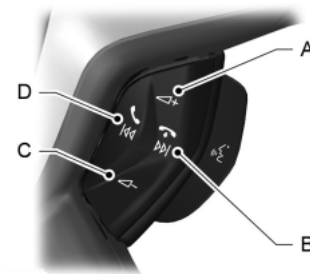
**Type 2**

- A. Volume up
- B. Seek up or next
- C. Volume down
- D. Seek down or previous

**Seek, Next or Previous**

Press the seek button to:

- tune the radio to the next or previous stored preset
- play the next or previous track.

Press and hold the seek button to:

- tune the radio to the next station up or down the frequency band
- seek through a track.



**VOICE CONTROL (IF EQUIPPED)**

Pull the control to select or deselect voice control. See the *SYNC* or *MyFord Touch* chapter.

**MyFord Touch Controls (If Equipped)**

Your steering wheel controls may also have these additional features.



Press to go to the home screen.



Press to go to the information screen.

**CRUISE CONTROL**

See the *Cruise Control* chapter.



### INFORMATION DISPLAY CONTROL



Use the arrows on the left side of the steering wheel to navigate the information display. See the *Information Displays* chapter for more information.

### Multimedia Controls (If Equipped)



Use the arrows on the right side of steering wheel to navigate through the available menus. Press **OK** to make a selection.



**WINDSHIELD WIPERS**

**Note:** Fully defrost the windshield before switching on the windshield wipers.

**Note:** Make sure the windshield wipers are switched off before entering car wash.

**Note:** Clean the windshield and wiper blades if they begin to leave streaks or smears. If that doesn't resolve the issue, install new wiper blades.

**Note:** Do not operate the wipers on a dry windshield. This may scratch the glass, damage the wiper blades or cause the wiper motor to burn out. Always use the windshield washer before wiping a dry windshield.

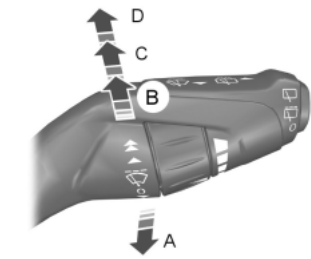

- A. Single wipe
- B. Intermittent wipe
- C. Normal wipe
- D. High-speed wipe

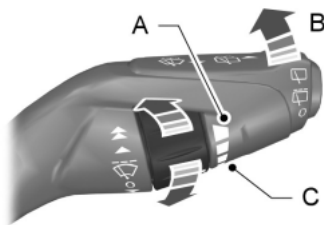
**Intermittent Wipe**

- A. Shortest wipe interval
  - B. Intermittent wipe
  - C. Longest wipe interval
- Use the rotary control to adjust the intermittent wipe interval.

**Speed Dependent Wipers**

When your vehicle speed increases, the interval between wipes will decrease when intermittent wipe is selected.



### WINDSHIELD WASHERS

**Note:** Do not operate the washers when the washer reservoir is empty. This may cause the washer pump to overheat.



The washer will spray for as long as the lever is pulled toward you. After you release the lever, the wipers will operate for a short time.

A wipe will occur a few seconds after washing to clear any remaining washer fluid.

### REAR WINDOW WIPER AND WASHERS (IF EQUIPPED)

#### Rear Window Wiper

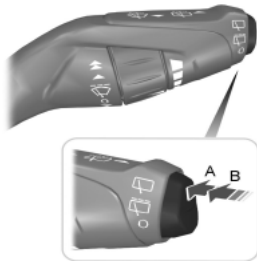

- A. Intermittent wipe
- B. Low-speed wipe

Press the button at the end of the lever to change between off, intermittent and low speed.

When you select reverse gear, the rear wiper will switch on to intermittent if the front wipers are activated.



**Rear Window Washers**

**Note:** Do not operate the washers when the washer reservoir is empty. This may cause the washer pump to overheat.

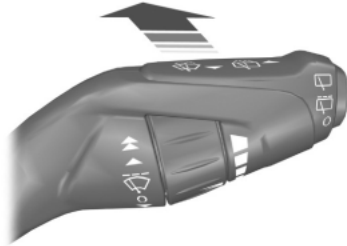

The washer will spray for as long as you push the lever away from you. When you release the lever, the wiper will operate for a short time.





## LIGHTING CONTROL

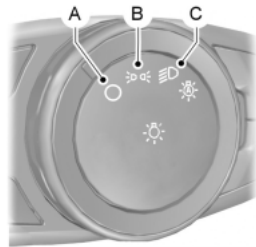

- A. Off
- B. Parking lamps, instrument panel lamps, license plate lamps and tail lamps
- C. Headlamps

## High Beams



Push the lever forward to switch the high beams on.  
Push the lever forward again or pull the lever toward you to switch the high beams off.

## Headlamp Flasher



Pull the lever toward you slightly and release it to flash the headlamps.



**AUTOLAMPS (IF EQUIPPED)**

**Note:** It may be necessary to switch your headlamps on manually in severe weather conditions.



The headlamps will switch on and off automatically in low light situations or during inclement weather.

The headlamps will remain on for a period of time after you switch the ignition off. You can adjust the time delay using the information display controls.

**Note:** If you switch autolamps on in conjunction with autowipers, low beam headlamps will illuminate automatically when the rain sensor activates the windshield wipers continuously.

**INSTRUMENT LIGHTING DIMMER**

**Note:** The illumination settings default to the maximum setting after the battery is disconnected then reconnected, or discharged then recharged.

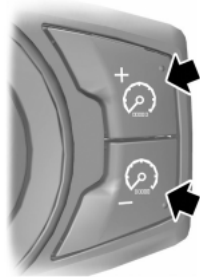
**Vehicles With Front Fog Lamps**

Press repeatedly or press and hold until the desired level is reached.

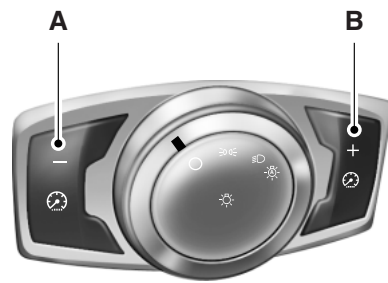

**Vehicles Without Front Fog Lamps**

A. Press repeatedly or press and hold to dim.

B. Press repeatedly or press and hold to brighten.

**HEADLAMP EXIT DELAY**

After you switch the ignition off, you can switch the headlamps on by pulling the direction indicator lever toward you. You will hear a short tone. The headlamps will switch off automatically after three minutes with any door open or 30 seconds after the last door has been closed.

You can cancel this feature by pulling the direction indicator toward you again or switching the ignition on.

**DAYTIME RUNNING LAMPS (IF EQUIPPED)**

**WARNING:** Always remember to switch your headlamps on in low light situations or during inclement weather. The system does not activate the tail lamps and may not provide adequate lighting during these conditions. Failure to activate your headlamps under these conditions may result in a collision.

The system switches the headlamps on in daylight conditions.

To switch the system on, switch the ignition on, and switch the lighting control to the off, autolamp, or parking lamp positions.



**FRONT FOG LAMPS**

Press the control to switch the fog lamps on or off.

You can switch the fog lamps on when the lighting control is in any position except off and the high beams are not on.

**DIRECTION INDICATORS**

Push the lever up or down to use the direction indicators.

**Note:** Tap the lever up or down to make the direction indicators flash three times to indicate a lane change.

**INTERIOR LAMPS**

The lamps will switch on when one of the following conditions have been met:

- You open any door.
- You press a remote control button.
- You press switch D on the front interior lamp.

**Note:** Press switch C on the front interior lamp to switch the courtesy and door illumination function off when you open any door. The indicator lamp will illuminate yellow when the door function is off. When the door function is off and you open a door, the courtesy and door lamps will stay off.



Press switch C again to switch them back on. The indicator lamp will illuminate blue when the door function is on. When the door function is on and you open a door, the courtesy and door lamps will switch on.

**Front Interior lamp (if equipped)**

**Note:** Some interior lamps are equipped with a single switch for the left and right map lamps.

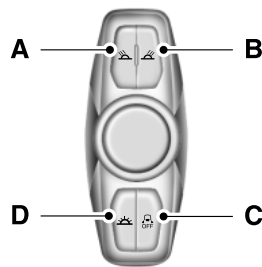

- A. Left map lamp switch, if equipped
- B. Right map lamp switch, if equipped
- C. Door function switch
- D. All lamps on and off switch

**Front/Rear Interior lamp (if equipped)**



Press switch A to switch individual map lamps on and off (if equipped).



**AMBIENT LIGHTING (IF EQUIPPED)**

The ambient lighting system illuminates the interior with a choice of several colors. The ambient lighting control is located in the overhead console.

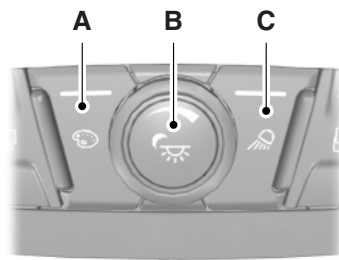

- A. Color palette
- B. Control knob
- C. Search mode

- Rotate B past the first detent to switch on and adjust to the desired brightness.
- Press A to cycle through the color choices.
- Press C to switch on all interior lamps and all ambient lighting. Press C again to switch off the interior lamps and return the ambient lighting to the previously selected color.

The ambient lighting will switch on when the following conditions have been met:

- you switch the ignition on
- you switch the headlamps on
- the outside ambient light level is low.

The ambient lighting will remain on until you switch the ignition off and one of the following conditions have been met:

- you lock your vehicle
- the accessory delay timer expires.



### POWER WINDOWS

 **WARNING:** Do not leave children unattended in the vehicle and do not let them play with the power windows. They may seriously injure themselves.

 **WARNING:** When closing the power windows, you should verify they are free of obstructions and make sure that children and pets are not in the proximity of the window openings.

**Note:** You may hear a rumbling noise when one or both of the rear windows are open. Lower a front window slightly to reduce this noise.

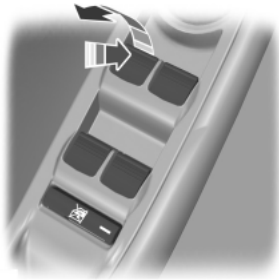

Press the switch to open the window.

Lift the switch to close the window.

#### **One-Touch Down (If Equipped)**

Press the switch fully and release it. Press or lift it again to stop the window.

#### **One-Touch Up (If Equipped)**

Lift the switch fully and release it. Press or lift it again to stop the window.



**Window Lock**

Press the control to lock or unlock the rear window controls. It will illuminate when the rear window controls are locked.

**Bounce-Back (If Equipped)**

The window will stop automatically while closing. It will reverse some distance if there is an obstacle in the way.

***Overriding the Bounce-Back Feature***

Proceed as follows to override this protection function when there is a resistance, e.g. in the winter:

1. Close the window twice until it reaches the resistance and let it reverse.
2. Close the window a third time to the resistance. The bounce-back function is disabled and you can close the window manually. The window will override the resistance and you can close it fully.

Contact your authorized dealer as soon as possible if the window does not close after the third attempt.

***Resetting the Bounce-Back Feature***

**WARNING:** The bounce-back function remains deactivated until you have reset the memory.

You must reset the bounce-back memory separately for each window after the battery has been disconnected.

1. Lift and hold the switch until the window is fully closed.
2. Release the switch.
3. Lift the switch again for one more second.
4. Press and hold the switch until the window is fully open.
5. Release the switch





6. Lift and hold the switch until the window is fully closed.
7. Open the window and then try to close it automatically.
8. Reset and repeat the procedure if the window does not close automatically.

### Accessory Delay (If Equipped)

You can use the window switches for several minutes after the you switch the ignition off, or until either front door is opened.

## EXTERIOR MIRRORS

### Power Exterior Mirrors



**WARNING:** Do not adjust the mirror while the vehicle is in motion.

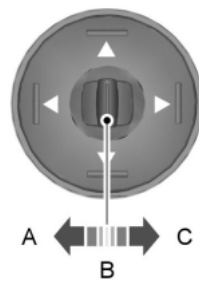

- A. Left-hand mirror
- B. Off
- C. Right-hand mirror

Press the arrows to adjust the mirror.

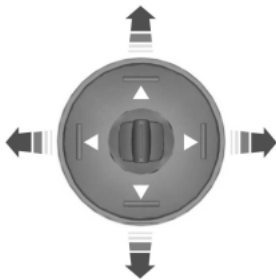

### Fold-Away Exterior Mirrors

Push the mirror toward the door window glass. Make sure that you fully engage the mirror in its support when returning it to its original position.



**Signal Indicator Mirrors (If Equipped)**

The outer portion of the appropriate mirror housing will blink when the turn signal is activated.

**Integrated Blind Spot Mirrors**

**WARNING:** Objects in the blind spot mirror are closer than they appear.

Blind spot mirrors have an integrated convex mirror built into the upper outboard corner of the exterior mirrors. They are designed to assist you by increasing visibility along the side of your vehicle.

Check the main mirror first before a lane change, then check the blind spot mirror. If no vehicles are present in the blind spot mirror and the traffic in the adjacent lane is at a safe distance, signal that you are going to change lanes. Glance over your shoulder to verify traffic is clear, and carefully change lanes.

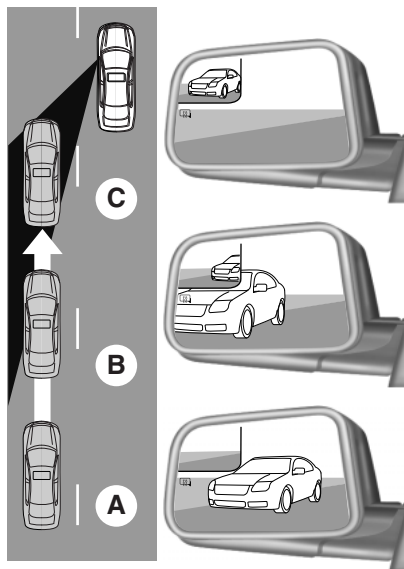

The image of the approaching vehicle is small and near the inboard edge of the main mirror when it is at a distance. The image becomes larger and begins to move outboard across the main mirror as the vehicle approaches (A). The image will transition from the main mirror and begin to appear in the blind spot mirror as the vehicle approaches (B). The vehicle will transition to your peripheral field of view as it leaves the blind spot mirror (C).



**INTERIOR MIRROR**

**WARNING:** Do not adjust the mirror when your vehicle is moving.

**Note:** Do not clean the housing or glass of any mirror with harsh abrasives, fuel or other petroleum or ammonia based cleaning products.

You can adjust the interior mirror to your preference. Some mirrors also have a second pivot point. This lets you move the mirror head up or down and from side to side.

Pull the tab below the mirror toward you to reduce glare at night.

**SUN VISORS****Illuminated Visor Vanity Mirror (If Equipped)**

Lift the cover to switch on the lamp.

**MOONROOF (IF EQUIPPED)**

**WARNING:** Do not let children play with the moonroof or leave them unattended in the vehicle. They may seriously hurt themselves.



**WARNING:** When closing the moonroof, you should verify that it is free of obstructions and ensure that children and/or pets are not in the proximity of the moon roof opening.

The sunscreen can be manually opened or closed when the glass panel is closed.

The moonroof has a one-touch open and close feature. To stop motion during one-touch operation, press the control a second time.





The moonroof control is located on the overhead console.

### Opening and Closing the Moonroof

Press and release the rear of the control to open the moonroof. If the sliding shade is closed, it will open along with the moonroof. The moonroof will stop short of the fully opened position.

**Note:** This position helps to reduce rumbling wind noise which may happen with the moonroof fully open. Press and release the control again to fully open the moonroof.

Press and release the front of the control to close the moonroof.

### Bounce-Back

The moonroof will stop automatically while closing and reverse some distance if there is an obstacle detected while closing.

Press and hold the front of the control within two seconds of a bounce-back event to override the function. While bounce-back is active, the closing force increases for each of the next three times the moonroof is closed.

### Venting the Moonroof

Press and release the front of the control while the moonroof is closed. Press and hold the rear of the control to close the moonroof.

### Relearning Function

In case the moonroof does not close properly, follow this procedure:

1. Tilt the moonroof into the vent position as far as possible. Release the switch.
2. Press and hold the same switch again for 30 seconds until you see the moonroof move.
3. Release the switch and immediately press and hold it again. The moonroof will close, open fully and then close again. Do not release the switch before the moonroof has reached the closed position for the second time.



### **Safety Mode**

The system enters a safety mode when it detects a malfunction. The moonroof will move about 0.5 seconds at a time and then stop again. Press the switch repeatedly until the moonroof is closed. Have the system checked by your authorized dealer immediately.



## GAUGES

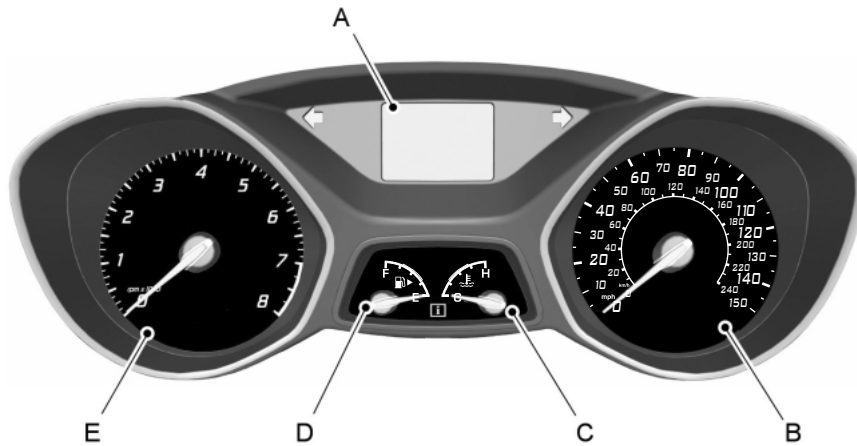

- A. Information display. See *Information Displays* for more information.
- B. Speedometer
- C. Engine coolant temperature gauge
- D. Fuel gauge
- E. Tachometer

**Engine coolant temperature gauge**

Shows the temperature of the engine coolant. At normal operating temperature, the needle will remain in the center section. If the needle enters the red section, the engine is overheating. Stop the engine, switch the ignition off and determine the cause once the engine has cooled down.

**Note:** Do not restart the engine until the cause of overheating has been resolved.



**WARNING:** Never remove the coolant reservoir cap while the engine is running or hot.



**Fuel gauge**

Switch the ignition on. The fuel gauge will indicate approximately how much fuel is left in the fuel tank. The fuel gauge may vary slightly when the vehicle is moving or on a gradient. The arrow adjacent to the fuel pump symbol indicates on which side of your vehicle the fuel filler door is located.

**WARNING LAMPS AND INDICATORS**

The following warning lamps and indicators will alert you to a vehicle condition that may become serious. Some lamps will illuminate when you start your vehicle to make sure they work. If any lamps remain on after starting your vehicle, refer to the respective system warning lamp for further information.

**Note:** Some warning indicators appear in the information display and function the same as a warning lamp but do not display when you start your vehicle.

**Airbag – Front**

If it fails to illuminate on startup, continues to flash or remains on, it indicates a malfunction. Have the system checked by your authorized dealer. A chime will sound when there is a malfunction in the indicator light.

**Anti-Lock Braking System**

If it illuminates when you are driving, this indicates a malfunction. You will continue to have the normal braking system (without ABS) unless the brake warning lamp is also illuminated. Have the system checked by your authorized dealer.

**Battery**

If it illuminates while driving, it indicates a malfunction. Switch off all unnecessary electrical equipment and have the system checked by your authorized dealer.

**Blind Spot Monitor (if equipped)**

It will illuminate when this feature is deactivated or in conjunction with a message.



**Brake System**

It will illuminate when the parking brake is engaged and the ignition is on.

If it illuminates when you are driving, check that the parking brake is not engaged. If the parking brake is not engaged, this indicates low brake fluid level or a brake system malfunction. Have the system checked immediately by your authorized dealer.



**WARNING:** Driving a vehicle with the brake system warning light on is dangerous. A significant decrease in braking performance may occur. It will take you longer to stop the vehicle. Have the vehicle checked by your authorized dealer as soon as possible. Driving extended distances with the parking brake engaged can cause brake failure and the risk of personal injury.

**Cruise Control (if equipped)**

It will illuminate when you switch this feature on.

**Direction Indicator**

Illuminates when the left or right turn signal or the hazard warning flasher is turned on. If the indicators flash faster, check for a burned out bulb.

**Engine Oil**

If it illuminates with the engine running or when you are driving, this indicates a malfunction. Stop your vehicle as soon as it is safe to do so and switch the engine off. Check the engine oil level.

**Note:** Do not resume your journey if it illuminates despite the level being correct. Have the system checked by your authorized dealer.

**Fasten Safety Belt**

It will illuminate and a chime will sound to remind you to fasten your safety belt.





**Fog Lamps – Front (if equipped)**

It will illuminate when you switch the front fog lamps on.

**High Beam**

It will illuminate when the headlamp high beam is switched on.  
It will flash when you use the headlamp flasher.

**Information**

It will illuminate when a new message is stored in the information display. It will be red or amber in color depending on the severity of the message and will remain on until the cause of the message has been rectified. .

**Low Fuel Level**

It will illuminate when the fuel level is low or near empty.  
Refuel as soon as possible.

**Low Tire Pressure Warning**

It illuminates when your tire pressure is low. If the lamp remains on with the engine running or when driving, check your tire pressure as soon as possible.

The lamp also illuminates momentarily when you switch the ignition on to confirm the lamp is functional. If it does not illuminate when you switch the ignition on, or begins to flash at any time, have the system checked by your authorized dealer.

**Overdrive Cancel and Grade Assist (if equipped)**

It will illuminate when you turn off the overdrive function of the transmission and switch on the grade assist function

**Parking Lamps**

It will illuminate when you switch the parking lamps on.



**Service Engine Soon**

If the service engine soon indicator light stays illuminated after the engine is started, it indicates that the On Board Diagnostics system (OBD) has detected a malfunction of the vehicle emissions control system. Refer to *On board diagnostics (OBD)* in the *Fuel and Refueling* chapter for more information about having your vehicle serviced.

If the light is blinking, engine misfire is occurring which could damage your catalytic converter. Drive in a moderate fashion (avoid heavy acceleration and deceleration) and have your vehicle serviced immediately.

**Note:** Under engine misfire conditions, excessive exhaust temperatures could damage the catalytic converter or other vehicle components.

The service engine soon indicator light illuminates when the ignition is first turned on prior to engine start to check the bulb and to indicate whether the vehicle is ready for Inspection/Maintenance (I/M) testing.

Normally, the service engine soon light will stay on until the engine is cranked, then turn itself off if no malfunctions are present. However, if after 15 seconds the service engine soon light blinks eight times, it means that the vehicle is not ready for I/M testing. See *Readiness for Inspection/Maintenance (I/M) testing* in the *Fuel and Refueling* chapter.

**Stability Control System**

It will flash when the system is active. It will illuminate when you switch the ignition on to confirm it is functional. If it remains illuminated or does not illuminate when you switch the ignition on, this indicates a malfunction. During a malfunction the system will switch off. Have the system checked by your authorized dealer.

**Stability Control System Off**

It will illuminate when you switch off the system. It will go out when you switch the system back on or when you switch the ignition off.



---

**AUDIBLE WARNINGS AND INDICATORS****Key In Ignition Warning Chime**

Sounds when the key is left in the ignition in the off or accessory position and the driver's door is opened.

**Keyless Warning Alert (If Equipped)**

Sounds when the keyless vehicle is in RUN and the driver's door is opened.

**Headlamps On Warning Chime**

Sounds when the headlamps or parking lamps are on, the ignition is off (the key is not in the ignition) and the driver's door is opened.

**Parking Brake On Warning Chime**

Sounds when you have left the parking brake on and drive your vehicle. If the warning chime remains on after you have released the parking brake, have the system checked by your authorized dealer immediately.



**GENERAL INFORMATION**

**WARNING:** Driving while distracted can result in loss of vehicle control, accident and injury. Ford strongly recommends that drivers use extreme caution when using any device or feature that may take their focus off the road. Your primary responsibility is the safe operation of the vehicle. We recommend against the use of any handheld device while driving and that you comply with all applicable laws.

Various systems on your vehicle can be controlled using the information display controls on the steering wheel. Corresponding information is displayed in the information display.

**Information Display Controls**

- Press the up and down arrow buttons to scroll through and highlight the options within a menu.
- Press the right arrow button to enter a sub-menu.
- Press the left arrow button to exit a menu.
- Press and hold the left arrow button at any time to return to the main menu display (escape button).
- Press the OK button to choose and confirm a setting/messages.

**Menu structure - information display (All vehicles)**

You can access the menu using the information display control.

**Note:** Some options may appear slightly different or not at all if the items are optional.

† Trip 1 / 2		
ToE / Distance to E		
Trip Odometer		
Trip Timer		
AVG / Average Fuel	Ford EcoMode	Gear Shifting
		Anticipation
		Speed
	OK = More Info	Provides additional EcoMode information
†See <i>Trip computer</i> later in this section for more information.		



Information				
MyKey (Distance driven if MyKey is programmed)				
MyKey Info (Number of MyKeys and Admin Keys programmed)				
Settings				
Driver Assist	Traction Ctrl	On or Off		
	Hill Start	On or Off		
	Rear Park Aid	On or Off		
Lighting	Rain Light			
	Dimming	Auto or Manual		
	Hdlamp Delay	Manual or xx Seconds		
Display	Navigation info	Always off, On guidance or Always on		
	Language	Choose your applicable setting		
	Distance	Choose your applicable setting		
	Temperature	Choose your applicable setting		
Chimes	Park Slot (park aid)			
Convenience	Compass (navigation systems)	Display		
	Compass (non-navigation systems)	Show	On or Off	
		Set	Zone (1-15)	
		Calibrate	Hold OK to Calibrate	
	Remote Start	Climate Control	Heater - A/C / Auto or Last Setting	
			Front Defrost / Auto or Off	
			Rear Defrost / Auto or Off	
		Duration	(5, 10 or 15 minutes)	
		Quiet Start	On/Off	
		Restore Default		
System	Enable or Disable			



Settings (cont'd)		
MyKey	Create MyKey	Hold OK to Create MyKey
	Traction Ctrl	Always On or User Selectable
	Max Speed	80 MPH (130 km/h) or Off
	Speed Warning	45 mph (75 km/h), 55 mph (90 km/h), 65 mph (105 km/h) or Off
	Volume Limiter	On or Off
	Clear MyKeys	Hold OK to Clear All MyKeys
System Reset	Hold OK to Reset System to Factory Default	
System Check		
All active warnings will display first if applicable. The system check menu may appear different based upon equipment options and current vehicle status. Use the up/down arrow buttons to scroll through the list.		

### Status Display

The following features will display in the information center.

### Compass

Displayed in the status line at the bottom of the display. Displays the vehicle's heading direction.

To calibrate the compass: Enter the compass menu and select Calibrate. Follow the prompts.

To set the compass zone: Enter the compass menu and select Set. Follow the prompts. See the diagram below to determine your magnetic zone.

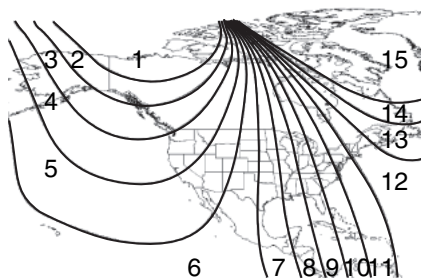

Determine which magnetic zone you are in for your geographic location by referring to the zone map.



### Odometer

Displayed in the status line at the bottom of the display. Registers the total mileage of the vehicle.

### Outside air temperature

Shows the outside air temperature.

### TRIP COMPUTER

#### Resetting the Trip Computer

Press and hold OK on the current screen to reset the respective trip, distance, time and average fuel information.

#### Trip Odometer



Registers the mileage of individual journeys.

#### Trip Timer



Registers the time of individual journeys.

#### Distance to E / ToE



Indicates the approximate distance the vehicle will travel on the fuel remaining in the tank. Changes in driving pattern may cause the value to vary.

#### Average Fuel



Indicates the average fuel consumption since the function was last reset.

Press the right arrow button to enter Ford EcoMode.



**INFORMATION MESSAGES**



**Note:** Depending on the vehicle options equipped with your vehicle, not all of the messages will display or be available. Certain messages may be abbreviated or shortened depending upon which cluster type you have.



Press the OK button to acknowledge and remove some messages from the information display. Other messages will be removed automatically after a short time. Certain messages need to be confirmed before you can access the menus.

** Message indicator (if equipped):** The message indicator illuminates to supplement some messages. It will be red or amber depending on the severity of the message and will remain on until the cause of the message has been rectified.

Some messages will be supplemented by a system specific symbol with a message indicator.



Airbag Message		Action / Description
Airbag malfunction Service now	Amber	Displays when the system requires service due to a malfunction. Contact your authorized dealer.
Alarm Message		Action / Description
Alarm triggered Check Vehicle	Amber	Displays when the alarm has been triggered due to unauthorized entry.
Alarm malfunction Service req'd	—	Displays when the system requires service due to a malfunction. Contact your authorized dealer.









## Information Displays

113



Battery and Charging System Message		Action / Description
Elec system overvoltage Stop safely	Red	Stop your vehicle as soon as it is safe to do so and switch off the ignition. Contact your authorized dealer.
Battery low Check handbook	Amber	Displays to warn of a low battery condition. Turn off all unneeded electrical accessories. Contact your authorized dealer.
Doors Message		Action / Description
X door open	Red	Displays when the door(s) listed is not completely closed and the vehicle is moving.
	—	Displays when the door(s) listed is not completely closed.
Luggage compartment lid open	Red	Displays when the luggage compartment is not completely closed and the vehicle is moving.
	—	Displays when the luggage compartment is not completely closed.
Hood open	Red	Displays when the hood is not completely closed and the vehicle is moving.
	—	Displays when the hood is not completely closed.





## Information Displays

Engine Message		Action / Description
Engine malfunction Service now	Amber	Engine service is required. Contact your authorized dealer.
High engine temperature Stop safely	Red	Displays when the engine temperature is too high. Stop the vehicle in a safe place and allow to engine to cool. If the problem persists, contact your authorized dealer.
Fuel Message		Action / Description
Fuel Level LOW	Amber	Displays when the fuel level is low.
Check Fuel Fill Inlet	Amber	Displayed when the fuel fill inlet may not be properly closed.
Hill Start Assist Message		Action / Description
Hill start assist not available	Amber	Displays when hill start assist is not available. Contact your authorized dealer.
Keyless Vehicle Message		Action / Description
Steering lock engaged. Turn steering wheel	—	Displays when you need to turn the steering wheel in order to disengage the steering lock.
Steering malfunction Service now	Amber	Contact your authorized dealer.
Steering malfunction Stop safely	Red	Stop the vehicle in a safe place. Contact your authorized dealer.





Keyless Vehicle Message		Action / Description
Ford KeyFree Key inside vehicle	Amber	Displays to remind you that the key is in the trunk. Refer to <i>Push button start system</i> in the <i>Driving</i> chapter for more information.
Ford KeyFree No key detected	—	Displayed if the key is not detected by the system. Refer to <i>Push button start system</i> in the <i>Driving</i> chapter for more information.
Switch ign. off Press ENGINE Start/Stop	Red	Refer to <i>Push button start system</i> in the <i>Driving</i> chapter for more information.
Ford KeyFree Key not inside car	Red	Refer to <i>Push button start system</i> in the <i>Driving</i> chapter for more information.
Key Battery low Replace soon	—	Displays when the key battery is low. Change the battery as soon as possible. Refer to the <i>Locks and Security</i> chapter for more information.
Lighting Message		Action / Description
Brake lamp Bulb fault	—	Displays when the brake lamp bulb has burned out. Contact your authorized dealer.
Dipped beam Bulb fault	—	Displays when the low beam headlamp bulb has burned out. Contact your authorized dealer.
Headlamp malfunction Service req'd	Amber	Displays when an electrical system problem occurs with the headlamp system. Contact your authorized dealer.





Maintenance Message		Action / Description
Engine oil change due	—	Displays when the engine oil life is depleted and requires a change. See <i>Engine oil</i> in the <i>Maintenance and specifications</i> chapter for more information.
Brake fluid level low Service now	Red	Indicates the brake fluid level is low and the brake system should be inspected immediately. Refer to <i>Brake fluid</i> in the <i>Maintenance and Specifications</i> chapter. Contact your authorized dealer.
Washer fluid level low	—	Displays when the washer fluid is low and needs to be refilled. Refer to <i>Windshield washer fluid</i> in the <i>Maintenance and Specifications</i> chapter.
MyKey® Message		Action / Description
MyKey active Drive Safely	—	Displays when MyKey® is active.
MyKey Speed Limited to XX MPH/km/h	—	Displays when starting the vehicle and MyKey® is in use and the MyKey speed limit is on.
MyKey Vehicle Near Top Speed	Amber	Displays when a MyKey® is in use and the MyKey speed limit is on and the vehicle speed is approaching 80 mph (130 km/h).



MyKey® Message		Action / Description
MyKey Buckle Up to Unmute Audio	—	Displays when a MyKey® is in use and Belt-Minder® is activated.
MyKey Park aid cannot be deactivated	—	Displays when a MyKey® is in use and park aid is activated.
Key is Already a MyKey	—	Displays when trying to create a MyKey® with a key already designated as a MyKey®.
MyKey Place key in key holder	—	Displays when programming a MyKey®.
MyKey ESC cannot be deactivated	—	Displays when a MyKey® is active and trying to disable ESC.
Park Aid Message		Action / Description
Parking aid malfunction Service req'd	Amber	Displays when the system has detected a condition that requires service. Contact your authorized dealer.
Park Brake Message		Action / Description
Park brake applied	Red	Displays when the parking brake is set, the engine is running and the vehicle is driven more than 3 mph (5 km/h). If the warning stays on after the parking brake is released.



Power Steering Message		Action / Description
Steering loss Stop safely	Red	The power steering system is not working. Stop the vehicle in a safe place. Contact your authorized dealer.
Steering assist fault Service req'd	Amber	The power steering system required service. Stop the vehicle in a safe place. Contact your authorized dealer.
Steering fault Service now	Amber	The power steering system has detected a condition within the power steering system or passive entry/passive start system that requires service. Contact your authorized dealer.
Starting System Message		Action / Description
Press brake to start	—	Displays when starting the vehicle as a reminder to apply the brake.
Cranking time exceeded	—	Displays when the vehicle fails to start.





Transmission Message		Action / Description
Transmission too hot Press brake	Amber	Displays when the transmission is overheating. Stop the vehicle in a safe spot and allow the transmission to cool and the message disappears before proceeding. If the condition persists, contact your authorized dealer for service.
	Red	Displays when the transmission is overheating. Stop the vehicle in a safe spot and allow the transmission to cool and the message disappears before proceeding. If the condition persists, contact your authorized dealer for service. If the vehicle is driven with this message active you may experience vehicle shudder as a further overheat warning.
Transmission overheating Stop safely	Red	Displays when the transmission is overheating. Stop the vehicle in a safe spot and allow the transmission to cool before proceeding. If the condition persists, contact your authorized dealer for service.
Transmission not in Park Select P	—	Displays as a reminder to shift into park.



Transmission Message		Action / Description
Transmission malfunction Service now	Red	Displays when the transmission requires service due to a malfunction. Contact your authorized dealer.
Use Brake Stop Safely	Red	Displays when the vehicle needs to be brought to a safe stop to allow the transmission to cool.
Transmission Hot / Stop or Speed Up	—	Displays when the transmission is overheating when idling with the brake applied for long periods such as in heavy stop-and-go traffic. Stop the vehicle in a safe spot and allow the transmission to cool before proceeding or drive an alternate route that allows less idling/slower speeds.
Transmission Hot Wait XX min	—	Displays when the transmission is overheating. Stop the vehicle in a safe spot and allow the transmission to cool for the displayed time before proceeding.
Transmission Hot Wait ...	—	Displays when the transmission is overheating. Stop the vehicle in a safe spot and allow the transmission to cool before proceeding.







Transmission Message		Action / Description
Transmission Ready	—	Displays after an transmission overheating event and the transmission has cooled enough to allow proper transmission function.
Transmission limited function Check handbook	Amber	Displays when certain transmission features are disabled.
Transmission warming up Please wait	—	Displays when the transmission needs a warming period before it will operate properly.
Tire pressure Monitoring System (TPMS) Message		Action / Description
Low Tire Pressure	Amber	Displays when one or more tires on your vehicle have low tire pressure. Refer to <i>Inflating Your Tires</i> in the <i>Tires, Wheels and Loading</i> chapter.
Tire Pressure Monitor Fault	Amber	Displays when the tire pressure monitoring system is malfunctioning. If the warning stays on or continues to come on, contact your authorized dealer.



## Information Displays

Tire pressure Monitoring System (TPMS) Message		Action / Description
Tire Pressure Sensor Fault	Amber	Displays when a tire pressure sensor is malfunctioning, or your spare tire is in use. For more information on how the system operates under these conditions, refer to <i>Understanding Your Tire Pressure Monitoring System (TPMS)</i> in the <i>Tires, Wheels and Loading</i> chapter. If the warning stays on or continues to come on, contact your authorized dealer.
Traction Control / AdvanceTrac® Message		Action / Description
Traction control off	—	Displays when the traction control system has been switched off.



## GENERAL AUDIO INFORMATION

### Radio Frequencies and Reception Factors

AM and FM frequencies are established by the Federal Communications Commission (FCC) and the Canadian Radio and Telecommunications Commission (CRTC). Those frequencies are:

AM: 530, 540–1700, 1710 kHz

FM: 87.9–107.7, 107.9 MHz

Radio reception factors	
<b>Distance/Strength</b>	The further you travel from an FM station, the weaker the signal and the weaker the reception.
<b>Terrain</b>	Hills, mountains, tall buildings, bridges, tunnels, freeway overpasses, parking garages, dense tree foliage and thunderstorms can interfere with your reception.
<b>Station Overload</b>	When you pass a ground-based broadcast repeating tower, a stronger signal may overtake a weaker one and result in the audio system muting.

### CD/CD Player Information

**Note:** CD units are designed to play commercially pressed 4.75 in (12 cm) audio compact discs only. Due to technical incompatibility, certain recordable and re-recordable compact discs may not function correctly when used in Ford CD players.

**Note:** CDs with homemade paper (adhesive) labels should not be inserted into the CD player as the label may peel and cause the CD to become jammed. It is recommended that homemade CDs be identified with permanent felt tip marker rather than adhesive labels. Ballpoint pens may damage CDs. Please contact your authorized dealer for further information.

**Note:** Do not use any irregularly shaped discs or discs with a scratch protection film attached.



Always handle discs by their edges only. Clean the disc with an approved CD cleaner only, wiping from the center of the disc toward the edge. Do not clean in a circular motion.

Do not expose discs to direct sunlight or heat sources for extended periods of time.

### MP3 Track and Folder Structure

Audio systems capable of recognizing and playing MP3 individual tracks and folder structures work as follows:

- There are two different modes for MP3 disc playback: MP3 track mode (system default) and MP3 folder mode.
- MP3 track mode ignores any folder structure on the MP3 disc. The player numbers each MP3 track on the disc (noted by the .mp3 file extension) from T001 to a maximum of T255. **Note:** The maximum number of playable MP3 files may be less depending on the structure of the CD and exact model of radio present.
- MP3 folder mode represents a folder structure consisting of one level of folders. The CD player numbers all MP3 tracks on the disc (noted by the .mp3 file extension) and all folders containing MP3 files, from F001 (folder) T001 (track) to F253 T255.
- Creating discs with only one level of folders helps with navigation through the disc files.

If you are burning your own MP3 discs, it is important to understand how the system reads the structures you create. While various files may be present, (files with extensions other than mp3), only files with the .mp3 extension are played; other files are ignored by the system. This enables you to use the same MP3 disc for a variety of tasks on your work computer, home computer and your in-vehicle system.

In track mode, the system displays and plays the structure as if it were only one level deep (all .mp3 files are played, regardless of being in a specific folder). In folder mode, the system only plays the .mp3 files in the current folder.



### AM/FM STEREO or AM/FM STEREO CD

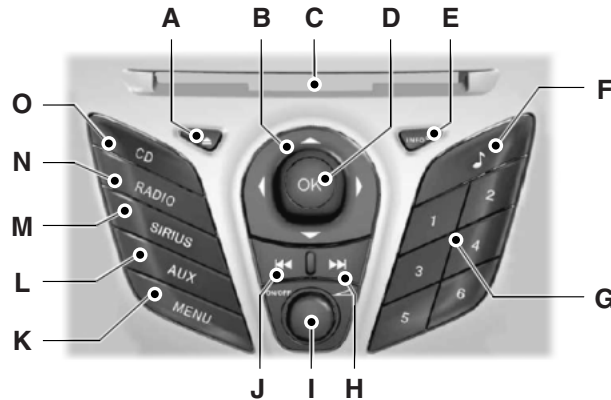

**WARNING:** Driving while distracted can result in loss of vehicle control, accident and injury. Ford strongly recommends that you use extreme caution when using any device or feature that may take your focus off the road. Your primary responsibility is the safe operation of the vehicle. We recommend against the use of any handheld device while driving, encourage the use of voice-operated systems when possible and that you become aware of applicable state and local laws that may affect use of electronic devices while driving.

**Note:** Your audio system can operate for up to one hour after the ignition is turned off. Press the ON/OFF control to operate the system with the ignition turned off. The system automatically turns off after one hour.

- A. **Eject:** Ejects a CD.
- B. **Cursor arrows:** Scroll through on-screen audio system choices.
- C. **CD slot:** Insert a CD.
- D. **OK:** Confirm on-screen selections after pressing MENU.
- E. **INFO:** Press to access any available radio or CD information.



**F. SOUND:**

- Press to access Treble, Bass, Middle, Fade (if equipped) and Balance menu options.
- Use the up and down arrow buttons to see the various options. When you make your selection, press the left and right arrow buttons to increase or decrease the levels. Press OK to set or press MENU to exit.
- Sound settings can be set for each audio source independently.

**G. Memory presets:** Store your favorite stations for later access. When tuned to any station, press and hold a preset button until sound returns.

**H. SEEK:**

- Press and release to go to the next track or preset radio station.
- Press and hold to fast forward through the current track or to the next strong radio station (manually advances between station presets or through radio stations).

**I. ON/OFF:**

- Press the power control to turn the system on and off.
- Turn to adjust the volume.

**J. SEEK:**

- Press and release to go to the previous track or preset radio station.
- Press and hold to reverse through the current track or to the previous strong radio station (manually reverses between station presets or through radio stations).

**K. MENU:** Access different audio system features. See *Menu structure* information later in this section.

**L. AUX:** Press to access LINE IN (auxiliary input jack) mode.

**M. SIRIUS:** Press repeatedly to access SAT1, SAT2 and SAT3 satellite radio modes (if equipped).

**N. RADIO:** Access different radio features. See *Menu structure* information later in this section.

**O. CD:** Access different CD features. See *Menu structure* information later in this section.



AM/FM/CD WITH SYNC®

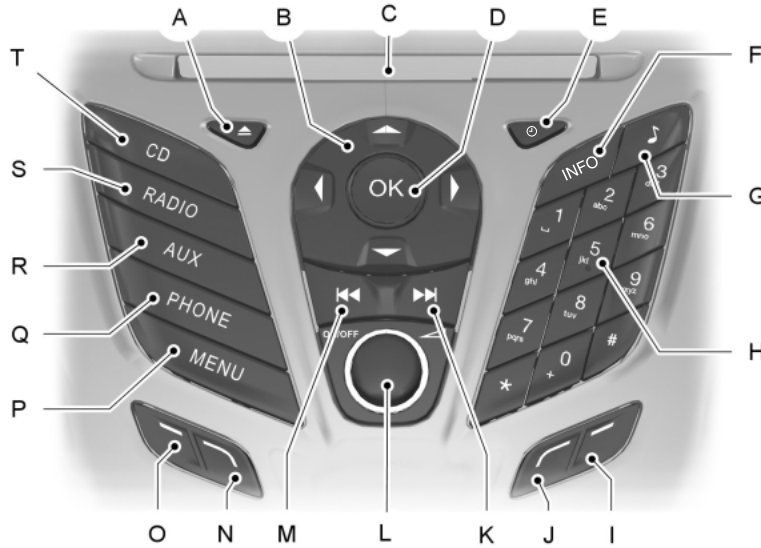

**!** **WARNING:** Driving while distracted can result in loss of vehicle control, accident and injury. Ford strongly recommends that you use extreme caution when using any device or feature that may take your focus off the road. Your primary responsibility is the safe operation of the vehicle. We recommend against the use of any handheld device while driving, encourage the use of voice-operated systems when possible and that you become aware of applicable state and local laws that may affect use of electronic devices while driving.

**Note:** Your audio system can operate for up to one hour after the ignition is turned off. Press the ON/OFF control to operate the system with the ignition turned off. The system automatically turns off after one hour.



- A. **Eject:** Eject the CD.
- B. **Cursor arrows:** Scroll through on-screen choices.
- C. **CD slot:** Insert a CD.
- D. **OK:** Confirm on-screen selections after pressing MENU.
- E. **Clock:** Set the time:
1. Press the H or M buttons on the outside of the display.
  2. Press the H or M buttons repeatedly until the desired time appears.
  3. Press OK to confirm the time.
    - The clock can also be set by pressing the MENU button and scrolling to the clock settings menu.
- F. **INFO:** Access any available radio or CD information.
- G. **SOUND:** Adjust the sound settings for Bass, Treble, Balance and Fade.
- H. **Number block:**
- In radio mode, store your favorite stations for later access. When tuned to any station, press and hold a preset button until sound returns.
  - In CD mode, select a track.
  - In phone mode, enter a phone number.
- I. **Function Button 4:** Select different functions of the audio system depending on which mode (i.e., radio or CD) you are in.
- J. **Function Button 3:** Select different functions of the audio system depending on which mode (i.e., radio or CD) you are in.
- K. **SEEK:**
- In radio mode, select a frequency band and press the SEEK button. The system stops at the first next station it finds up the band.
  - In CD mode, press to select the next track or press and hold to advance within the same track.
- L. **ON/OFF:**
- Press the power control to turn the system on and off.
  - Turn to adjust the volume.





M. **SEEK:**

- In radio mode, select a frequency band and press the SEEK button. The system stops at the first next station it finds down the band.
- In CD mode, select the previous track or press and hold to rewind within the same track.

N. **Function Button 2:** Select different functions of the audio system depending on which mode (i.e., radio or CD) you are in.

O. **Function Button 1:** Select different functions of the audio system depending on which mode (i.e., radio or CD) you are in.

P. **MENU:** Access different audio system features. See *Menu structure* later in this section.

Q. **PHONE:** Access the phone features of the SYNC® system. See the SYNC® chapter for more information.

R. **AUX:** Access the media features of the SYNC® system. See the SYNC® chapter for more information.

S. **RADIO:** Access different radio features. See *Menu structure* later in this section.

T. **CD:** Access different CD features. See *Menu structure* later in this section.



## AM/FM/CD/SIRIUS SATELLITE RADIO WITH SYNC®

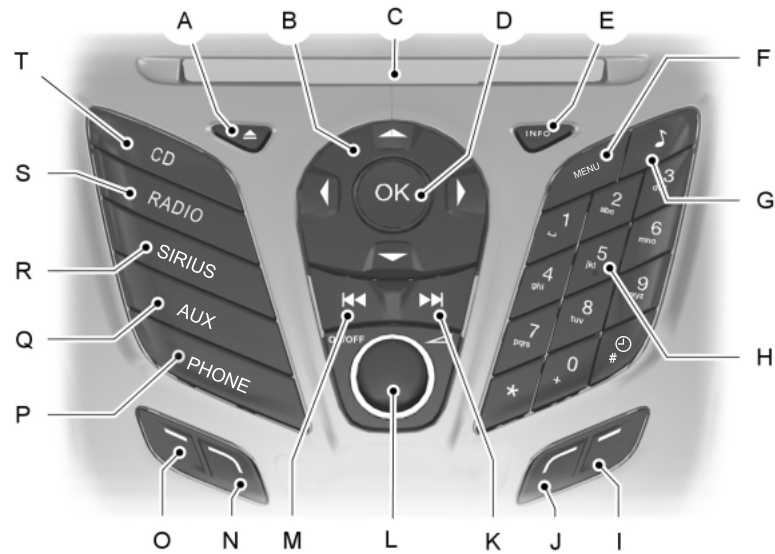

**WARNING:** Driving while distracted can result in loss of vehicle control, accident and injury. Ford strongly recommends that you use extreme caution when using any device or feature that may take your focus off the road. Your primary responsibility is the safe operation of the vehicle. We recommend against the use of any handheld device while driving, encourage the use of voice-operated systems when possible and that you become aware of applicable state and local laws that may affect use of electronic devices while driving.

**Note:** Your audio system can operate for up to one hour after the ignition is turned off. Press the ON/OFF control to operate the system with the ignition turned off. The system automatically turns off after one hour.

**Note:** Some features, such as SIRIUS satellite radio, may not be available in your location. Check with your authorized dealer.

A. **Eject:** Eject the CD.

B. **Cursor arrows:** Scroll through on-screen choices.



- C. **CD slot:** Insert a CD.
- D. **OK:** Confirm on-screen selections after pressing MENU.
- E. **INFO:** Access any available radio or CD information.
- F. **MENU:** Access different audio system features. See *Menu structure* information later in this section.
- G. **Sound:** Adjust the sound settings for Bass, Treble, Balance and Fade.
- H. **Number block:**
- In radio mode, store your favorite stations for later access. When tuned to any station, press and hold a preset button until sound returns.
  - In CD mode, select a track.
  - In phone mode, enter a phone number.
  - The clock function does not work with this button. Press the MENU button and scroll to the clock settings menu.
- I. **Function Button 4:** Select different functions of the audio system depending on which mode (i.e., radio or CD) you are in.
- J. **Function Button 3:** Select different functions of the audio system depending on which mode (i.e., radio or CD) you are in.
- K. **SEEK:**
- Press and release to go to the next track or preset radio station.
  - Press and hold to fast forward through the current track or to the next strong radio station (manually advances between station presets or through radio stations).
- L. **ON/OFF:**
- Press the power control to turn the system on and off.
  - Turn to adjust the volume.
- M. **SEEK:**
- Press and release to go to the previous track or preset radio station.
  - Press and hold to reverse through the current track or to the previous strong radio station (manually reverse between station presets or through radio stations).
- N. **Function Button 2:** Select different functions of the audio system depending on which mode (i.e., radio or CD) you are in.
- O. **Function Button 1:** Select different functions of the audio system depending on which mode (i.e., radio or CD) you are in.
- P. **PHONE:** Access the phone features of the SYNC® system. See the SYNC® chapter for more information.
- Q. **AUX:** Access the media features of the SYNC® system. See the SYNC® chapter for more information.



R. **SIRIUS:** Access different SIRIUS satellite radio features by pressing SIRIUS, then MENU. See *Menu structure* later in this section.

S. **RADIO:** Access different radio features by pressing RADIO, then MENU. See *Menu structure* later in this section.

T. **CD:** Access different CD features by pressing CD, then MENU. See *Menu structure* later in this section.

#### AM/FM/SINGLE CD SONY® AUDIO SYSTEM

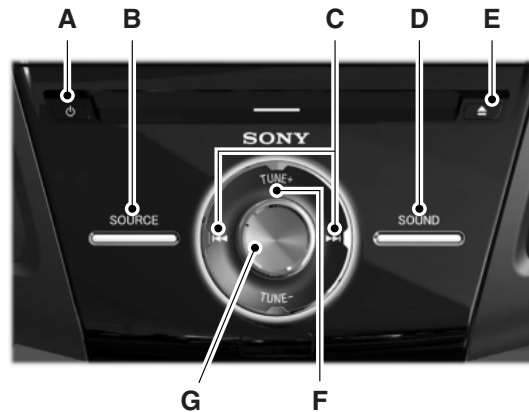

**WARNING:** Driving while distracted can result in loss of vehicle control, accident and injury. Ford strongly recommends that you use extreme caution when using any device or feature that may take your focus off the road. Your primary responsibility is the safe operation of the vehicle. We recommend against the use of any handheld device while driving, encourage the use of voice-operated systems when possible and that you become aware of applicable state and local laws that may affect use of electronic devices while driving.

**Note:** Most of the audio features are controlled through the MyFord Touch® system. See the *MyFord Touch®* chapter more information.

A. **Power:** Press the power control to turn the system on and off.

B. **SOURCE:** Access different audio modes such as AM, FM and A/V Input.



**C. Seek/Reverse/Fast Forward:**

- In radio mode, select a frequency band and press one of the seek buttons. The system stops at the first station it finds in that direction.
- In SIRIUS mode, select the previous or next channel. If a specific category is selected, (Jazz, Rock, News, etc.), use the seek buttons find to the previous or next channel in the selected category.
- In CD mode, select the previous or next track.

D. **SOUND:** Allows you to adjust the sound settings (Treble, Bass, Midrange, Fade and Balance).

E. **Eject:** Press the eject control to eject the CD.

**F. TUNE +/TUNE - :**

- In radio mode, you can search the frequency band in individual increments.
- In SIRIUS mode, you can find the next or previous available SIRIUS satellite station.

G. **Volume:** Turn to adjust the volume.

**MENU STRUCTURE**

**Note:** Depending on your system, some options may appear slightly different, not at all or on-screen and able to be selected using the function buttons.

Press MENU.

Press the up and down arrow buttons to scroll through the options (if active).

Press the right arrow to enter a menu. Press the left arrow to exit a menu.

Radio Settings	
<b>Manual tune</b>	Use the left and right arrows to go up or down the frequency band
<b>Scan</b>	Select for a brief sampling of all available channels.
<b>Autostore</b>	Select to store the six strongest local stations on the AM and FM frequency bands.
<b>PTY/Set Category</b>	Select to have the system search by certain music categories (rock, pop, country, etc.).
<b>RBDS/RDS Text</b>	Select to view additional broadcast data, if available. This feature defaults to off. RBDS must be on for you to set a category.



<b>SIRIUS</b>	
<b>Scan</b>	Select for a brief sampling of all available channels.
<b>Show ESN</b>	Select to view your satellite radio electronic serial number (ESN). You will need this number when communicating with SIRIUS® to activate, modify or track your account.
<b>Channel Guide</b>	Select to view available satellite radio channels. Press OK to select Tune Channel, Skip Channel or Lock Channel. Once a channel is skipped or locked, you can only access it by pressing Direct and entering the channel number. Locking or unlocking a channel requires your PIN.
<b>Set Category</b>	Select to view channel categories (pop, rock, news, etc.). If you select a category, seek and scan functions will only stop on channels in that category.
<b>Alerts</b>	Select to enable/disable an alert for a song, artist or team. The system alerts you when the selection is playing on another channel. Save up to 20 alerts.
<b>Unlock All Stations</b>	Use your PIN to unlock previously locked stations.
<b>Skip No Stations</b>	Use to unskip any channels you previously skipped.
<b>Parental Lock (PIN)</b>	Select to create a PIN which allows you to lock or unlock channels. Your initial PIN is 1234.





<b>Audio Settings</b>	
<b>Spd. Comp. Vol.</b>	Automatically adjusts the volume to compensate for speed and wind noise. You can set the system between 0 and +7.
<b>Sound</b>	Allows you to adjust sound settings such as treble, middle, bass, fade and balance.
<b>Occupancy Mode</b>	Optimizes sound quality for the chosen seating position.
<b>RBDS/RDS Text</b>	Select to view additional broadcast data, if available. This feature defaults to off. RBDS must be on for you to set a category.
<b>DSP</b>	Allows you to choose between STEREO SURROUND mode and STEREO mode.
<b>CD Settings</b>	
<b>Scan All</b>	Select to scan all disc selections.
<b>Scan Folder</b>	Select to scan all music in the current MP3 folder.
<b>CD Compression</b>	Select to bring soft and loud passages together for a more consistent listening level.
<b>Clock Settings</b>	
<b>Set Time</b>	Select to set the time.
<b>Set Date</b>	Select to set the calendar date.
<b>24h Mode</b>	Select to view clock time in a 12-hour mode or 24-hour mode.
<b>Display Settings</b>	
<b>Dimming</b>	Select to change display brightness.
<b>Language</b>	Select to display the language in English, French or Spanish.
<b>Temp. Setting</b>	Select to display the outside temperature in Fahrenheit or Celsius



**AUXILIARY INPUT JACK**

 **WARNING:** Driving while distracted can result in loss of vehicle control, accident and injury. Ford strongly recommends that you use extreme caution when using any device or feature that may take your focus off the road. Your primary responsibility is the safe operation of the vehicle. We recommend against the use of any handheld device while driving, encourage the use of voice-operated systems when possible and that you become aware of applicable state and local laws that may affect use of electronic devices while driving.

 **WARNING:** For safety reasons, do not connect or adjust the settings on your portable music player while the vehicle is moving.

 **WARNING:** Store the portable music player in a secure location, such as the center console or the glove box, when the vehicle is in motion. Hard objects may become projectiles in a collision or sudden stop, which may increase the risk of serious injury. The audio extension cable must be long enough to allow the portable music player to be safely stored while the vehicle is in motion.



The auxiliary input jack (AIJ) may be located in the center console (as shown) or inside the glovebox. It allows you to connect and play music from your portable music player through the vehicle speakers. You can use any portable music player designed for use with headphones. Your audio extension cable must have male 1/8-inch. (3.5 millimeter) connectors at each end.

1. Make sure the vehicle, radio and portable music player are turned off and the transmission is in position **P**.
2. Plug the extension cable from the portable music player into the AIJ.





3. Turn on the radio. Select either a tuned FM station or a CD.
4. Adjust the volume as desired.
5. Turn on your portable music player and adjust its volume to  $\frac{1}{2}$  the maximum.
6. Press AUX until LINE or LINE IN appears in the display. You should hear music from your device even if it is low.
7. Adjust the volume on your portable music player until it reaches the volume level of the FM station or CD. Do this by switching back and forth between the AUX and FM or CD controls.

**USB PORT (IF EQUIPPED)**

**WARNING:** Driving while distracted can result in loss of vehicle control, accident and injury. Ford strongly recommends that you use extreme caution when using any device or feature that may take your focus off the road. Your primary responsibility is the safe operation of the vehicle. We recommend against the use of any handheld device while driving, encourage the use of voice-operated systems when possible and that you become aware of applicable state and local laws that may affect use of electronic devices while driving.



The USB port allows you to plug in media playing devices, memory sticks and charge devices (if supported). See the *SYNC* chapter for more information.



**MEDIA HUB (IF EQUIPPED)**

The media hub is located in the center console and has the following features:

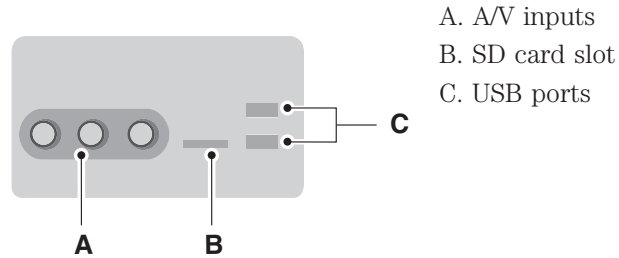

For more information, see the *MyFord Touch* chapter.

**SATELLITE RADIO INFORMATION (IF EQUIPPED)****Satellite Radio Channels**

SIRIUS® broadcasts a variety of music, news, sports, weather, traffic and entertainment satellite radio channels. For more information and a complete list of SIRIUS® satellite radio channels, visit [www.siriusxm.com](http://www.siriusxm.com) in the United States, [www.sirius.ca](http://www.sirius.ca) in Canada, or call SIRIUS® at 1-888-539-7474.

**Satellite Radio Reception Factors**

<b>Potential Satellite Radio Reception Issues</b>	
<b>Antenna obstructions</b>	For optimal reception performance, keep the antenna clear of snow and ice build-up and keep luggage and other material as far away from the antenna as possible.
<b>Terrain</b>	Hills, mountains, tall buildings, bridges, tunnels, freeway overpasses, parking garages, dense tree foliage and thunderstorms can interfere with your reception.
<b>Station overload</b>	When you pass a ground-based broadcast repeating tower, a stronger signal may overtake a weaker one and the audio system may mute.
<b>Satellite radio signal interference</b>	Your display may show ACQUIRING . . . to indicate the interference and the audio system may mute.



**SIRIUS® Satellite Radio Service**

**Note:** SIRIUS® reserves the unrestricted right to change, rearrange, add or delete programming including canceling, moving or adding particular channels, and its prices, at any time, with or without notice to you. Ford Motor Company shall not be responsible for any such programming changes.



SIRIUS® satellite radio is a subscription-based satellite radio service that broadcasts a variety of music, sports, news, weather, traffic and entertainment programming. Your factory-installed SIRIUS® satellite radio system includes

hardware and a limited subscription term which begins on the date of sale or lease of the vehicle. See your authorized dealer for availability.

For more information on extended subscription terms (a service fee is required), the online media player and a complete list of SIRIUS® satellite radio channels, and other features, please visit [www.siriusxm.com](http://www.siriusxm.com) in the United States, [www.sirius.ca](http://www.sirius.ca) in Canada, or call SIRIUS® at 1-888-539-7474.

**Satellite Radio Electronic Serial Number (ESN)**

You need your ESN to activate, modify or track your satellite radio account. When in satellite radio mode, you can view this number by pressing SIRIUS and memory preset 1 at the same time.

**Troubleshooting**

SIRIUS® Troubleshooting Tips		
Radio Display	Condition	Possible Action
Acquiring	Radio requires more than two seconds to produce audio for the selected channel.	No action required. This message should disappear shortly.
Sat Fault/SIRIUS® system failure	Internal module or system failure present.	If this message does not clear shortly, or with an ignition key cycle, your receiver may have a fault. See your authorized dealer for service.



<b>SIRIUS® Troubleshooting Tips</b>		
<b>Radio Display</b>	<b>Condition</b>	<b>Possible Action</b>
Invalid Channel	Channel no longer available.	Tune to another channel or choose another preset.
Unsubscribed Channel	Subscription not available for this channel.	Contact SIRIUS® at 1-888-539-7474 to subscribe to the channel, or tune to another channel.
No Signal	Loss of signal from the SIRIUS® satellite or SIRIUS® tower to the vehicle antenna.	The signal is currently being blocked. When you move into an open area, the signal should return.
Updating	Update of channel programming in progress.	No action required. The process may take up to three minutes.
Call SIRIUS® 1-888-539-7474	Satellite service has been deactivated by SIRIUS® Satellite Radio.	Call SIRIUS® at 1-888-539-7474 to reactivate or resolve subscription issues.
No Channels Available	All the channels in the selected category are skipped or locked.	Using the channel guide, unlock or unskip the channels.
Subscription Updated	SIRIUS® has updated the channels available for your vehicle.	No action required.



## MANUAL CLIMATE CONTROL

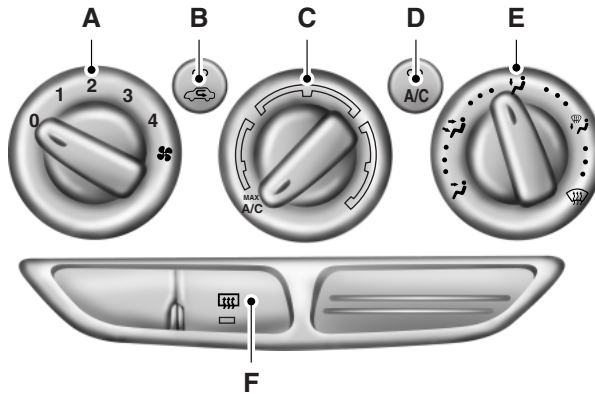

**A. Fan speed control:** Controls the volume of air circulated in your vehicle. Adjust to select the desired fan speed or switch off. If you switch the fan off, the windshield may fog up.

**B. Recirculated air:** Press to switch between outside air and recirculated air. When you select recirculated air, the button illuminates and the air currently in the passenger compartment recirculates. This can reduce the time needed to cool the interior and reduce unwanted odors from entering your vehicle.

**C. Temperature control:** Controls the temperature of the air circulated in your vehicle. Adjust to select the desired temperature. If you select MAX A/C, the system distributes recirculated air through the instrument panel air vents. This mode is more economical and efficient than normal air conditioning.

**Note:** When the temperature control is in the MAX A/C position, neither the air conditioning or recirculated air can be turned off.

**D. Air conditioning:** Press to switch the air conditioning on or off. Air conditioning cools your vehicle using outside air. To improve air conditioning when starting your vehicle, drive with the windows slightly open for two to three minutes.



E. **Air distribution control:** Adjust to select the desired air distribution.



Select to distribute air through the instrument panel air vents.



Select to distribute air through the instrument panel and footwell air vents.



Select to distribute air through the footwell air vents.



Select to distribute air through the windshield and footwell air vents.



Select to distribute air through the windshield air vents. You can also use this setting to defog and clear the windshield of a thin covering of ice. You can also increase the temperature and fan speed to improve clearing.

F. **Rear defrost:** Turns the heated windows and mirrors on and off. See *Heated windows and mirrors* later in this chapter for more information.



## AUTOMATIC CLIMATE CONTROL

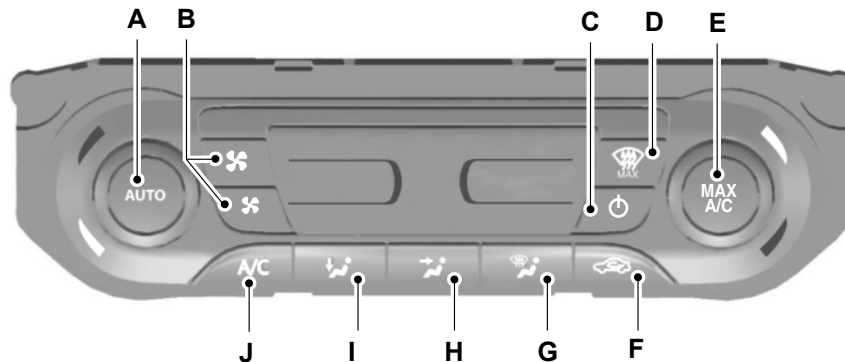

A. **AUTO:** Press to select automatic operation. The system automatically controls the temperature, amount and distribution of the airflow to reach and maintain your previously selected temperature.

B. **Fan speed:** Controls the volume of air circulated in your vehicle. Press to select the desired fan speed. The setting is shown in the display.

C. **On and off button:** Press to switch the system on and off.

D. **MAX Defrost:** Press to distribute outside air through the windshield air vents. Air conditioning is automatically selected. The fan is set to the highest speed and the temperature to HI. When the air distribution is set in this position, you are unable to select recirculated air or manually adjust the fan speed and temperature control. Press the AUTO button to return to auto mode.

E. **MAX A/C:** Press to distribute maximum air conditioning through the instrument panel air vents. This mode is more economical and efficient than normal air conditioning.

F. **Recirculated air:** Press to switch between outside air and recirculated air. The air currently in the passenger compartment recirculates. This can reduce the time needed to cool the interior and reduce unwanted odors from entering your vehicle.

G. **Defrost:** Press to distribute air through the windshield air vents. You can also use this setting to defog and clear the windshield of a thin covering of ice.

H. **Instrument panel:** Press to distribute air through the instrument panel air vents.

I. **Footwell:** Press to distribute air through the footwell air vents.



**J. Air conditioning:** Press to switch the air conditioning on or off. Air conditioning cools your vehicle using outside air. To improve air conditioning when starting your vehicle, drive with the windows slightly open for two to three minutes.

### Temperature Control

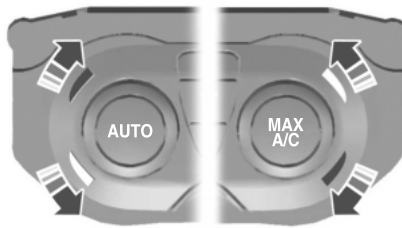

You can set the temperature between 60°F (15.5°C) and 85°F (29.5°C) in 1°F (0.5°C) increments. In position LO, 59°F (15°C), the system switches to permanent cooling. In position HI, 86°F (30°C), the system switches to permanent heating.

**Note:** If you select either position LO or HI, the system does not regulate a stable temperature.

### Mono Mode

In this mode, the temperature settings for both the driver's side and passenger's side are linked. If you adjust the setting using the rotary control on the driver's side, the system adjusts the temperature on the passenger side.

### Switching Mono Mode Off

Select a temperature for the passenger's side using the rotary control on the passenger's side. Mono mode automatically switches off. The temperature on the driver's side remains unchanged. You can now adjust the driver's side and passenger's side temperatures independently of each other. The temperature settings for each are shown in the display.

### Switching Mono Mode Back On

Press and hold the AUTO button. The passenger's side temperature is adjusted to the driver's side temperature setting.





---

**HINTS ON CONTROLLING THE INTERIOR CLIMATE****General Hints**

**Note:** Prolonged use of recirculated air may cause the windows to fog up.

**Note:** A small amount of air may be felt from the footwell air vents regardless of the air distribution setting.

**Note:** To reduce humidity build-up inside your vehicle, do not drive with the system switched off or with recirculated air always switched on.

**Note:** Do not place objects under the front seats as this may interfere with the airflow to the rear seats.

**Note:** Remove any snow, ice or leaves from the air intake area at the base of the windshield.

**Manual Climate Control**

**Note:** To reduce fogging of the windshield during humid weather, adjust the air distribution control to the windshield air vents position. Increase the temperature and fan speed to improve clearing if required.

**Automatic Climate Control**

**Note:** Do not adjust the settings when your vehicle interior is extremely hot or cold. The system automatically adjusts to the previously stored settings. For the system to function efficiently, the instrument panel and side air vents should be fully open.

**Note:** At low ambient temperatures with AUTO selected, the air stream is directed toward the windshield and side windows for as long as the engine remains cold.

**Note:** When the system is switched off, outside air is prevented from entering your vehicle.

**Note:** When the system is in AUTO mode, and the interior and exterior temperatures are high, the system automatically selects recirculated air to maximize cooling of the interior. When the selected air temperature is reached, the system automatically selects outside air.

**Note:** When you select windshield defrosting and defogging, the instrument panel and footwell level functions automatically switch off and air conditioning switches on. Outside air flows into your vehicle.



**Heating the Interior Quickly**

	<b>Vehicles with Manual Climate Control</b>	<b>Vehicles with Automatic Climate Control</b>
1	Adjust the fan speed to the highest speed setting.	Press the high fan speed button control.
2	Adjust the temperature control to the highest setting.	Adjust the temperature control to the highest setting.
3	Adjust the air distribution control to the footwell air vents position.	Press the footwell button to distribute air to the footwell air vents.

**Recommended Settings for Heating**

	<b>Vehicles with Manual Climate Control</b>	<b>Vehicles with Automatic Climate Control</b>
1	Adjust the fan speed to the second speed setting.	Press the slow fan speed button.
2	Adjust the temperature control to the midway point of the hot settings.	Adjust the temperature control to the midway point of the hot settings.
3	Adjust the air distribution control to the footwell and windshield air vents position.	Press the footwell and windshield air distribution buttons.
4		Close the instrument panel air vents. Open the side air vents and direct them toward the side windows.



**Cooling the Interior Quickly**

	<b>Vehicles with Manual Climate Control</b>	<b>Vehicles with Automatic Climate Control</b>
1	Adjust the fan speed to the highest speed setting.	Press the AUTO button.
2	Adjust the temperature control to the MAX A/C position.	Adjust the temperature control to the desired setting.
3	Adjust the air distribution control to the instrument panel air vents position.	

**Recommended Settings for Cooling**

	<b>Vehicles with Manual Climate Control</b>	<b>Vehicles with Automatic Climate Control</b>
1	Adjust the fan speed to the second speed setting.	Press the slow fan speed button.
2	Adjust the temperature control to the midway point of the cold settings.	Adjust the temperature control to the midway point of the cold settings.
3	Adjust the air distribution control to the instrument panel air vents position.	Press the instrument panel vent button to distribute air to the instrument panel air vents.

**Vehicle Stationary for Extended Periods During Extreme High Ambient Temperatures**

	<b>Vehicles with Manual Climate Control</b>	<b>Vehicles with Automatic Climate Control</b>
1	Apply the parking brake.	Apply the parking brake.
2	Move the transmission selector lever to position <b>P</b> .	Move the transmission selector lever to position <b>P</b> .
3	Adjust the temperature control to the MAX A/C position.	Press the MAX A/C button.
4	Adjust the fan speed to the lowest speed setting.	



**Side Window Defogging in Cold Weather**

	<b>Vehicles with Manual Climate Control</b>	<b>Vehicles with Automatic Climate Control</b>
1	Adjust the air distribution control to the instrument panel and footwell air vents positions.	Press the windshield defrosting and defogging button.
2	Press the A/C button.	Adjust the temperature control to the desired setting.
3	Adjust the temperature control to the desired setting.	
4	Adjust the fan speed to the highest setting.	
5	Direct the instrument panel side air vents toward the side windows.	
6	Close the instrument panel vents.	

**Maximum Cooling Performance in Instrument Panel or Instrument Panel and Footwell Positions**

	<b>Both Manual and Automatic Climate Control</b>
1	Adjust the temperature control to the lowest setting.
2	Press the A/C and recirculated air buttons.
3	Adjust the fan speed to the highest setting initially and then adjust it to suit the desired comfort level.

**HEATED WINDOWS AND MIRRORS (IF EQUIPPED)****Heated Rear Window**

**Note:** The ignition must be switched on to use this feature.

Press the button to clear the rear window of thin ice and fog. Press the button again within 10 minutes to switch it off. It switches off automatically after 10 minutes, or when you switch the ignition off.

**Do not use razor blades or other sharp objects to clean the inside of the rear window or to remove decals from the inside of the rear window. This may cause damage to the heated grid lines and will not be covered by your warranty.**



**Heated Exterior Mirror (If Equipped)**

**Note:** Do not remove ice from the mirrors with a scraper or attempt to readjust the mirror glass if it is frozen in place. These actions could cause damage to the glass and mirrors.

**Note:** Do not clean the housing or glass of any mirror with harsh abrasives, fuel or other petroleum-based cleaning products.

Both mirrors are heated to remove ice, mist and fog when the rear window defroster is activated.

**CABIN AIR FILTER**

**Note:** A cabin air filter must be installed at all times to prevent foreign objects from entering the system. Running the system without a filter in place could result in degradation or damage to the system.

Your vehicle is equipped with a cabin air filter; it is located in the passenger footwell area.

The particulate air filtration system is designed to reduce the concentration of airborne particles, such as dust, spores and pollen, in the air being supplied to the interior of the vehicle. The particulate filtration system gives the following benefits to customers:

- Improves the customer's driving comfort by reducing particle concentration.
- Improves the interior compartment cleanliness.
- Protects the climate control components from particle deposits.

The filter should be replaced at regular intervals. See the *Scheduled Maintenance* chapter.

For additional information, or to replace the filter, see an authorized dealer.



**REMOTE START CLIMATE OPERATION**

The climate control system adjusts the cabin temperature during remote start.

You cannot adjust the system during remote start operation. Turn the ignition on to return the system to its previous settings. You can now make adjustments. You will need to turn certain vehicle-dependent features back on, such as:

- heated seats
- heated mirrors
- heated rear window.

You can adjust the settings using the information display controls. See the *Information Displays* chapter.

**Automatic Climate Systems*****Automatic Settings***

You can set the climate control to operate in AUTO mode through the information display setting: Remote Start > Climate Control > Heater – A/C > Auto. The climate control system automatically sets the interior temperature to 72°F (22°C).

In hot weather, the system is set to 72°F (22°C).

In moderate weather, the system either heats or cools (based on previous settings). The rear defroster and heated mirrors are not automatically turned on.

In cold weather, the system is set to 72°F (22°C). The rear defroster and heated mirrors are automatically turned on.

***Last Settings***

You can set the climate control to operate using the last climate control settings through the information display setting: Remote Start > Climate Control > Heater – A/C > Last Settings. The climate control system automatically uses the settings last selected before the vehicle was turned off.

***Heated and Cooled Devices***

The climate control system controls other heated and cooled devices inside the vehicle. These devices (if available, and selected to AUTO in the information displays) may also be switched on during remote start. Heated devices are typically switched on during cold weather, and cooled devices during hot weather.



**SITTING IN THE CORRECT POSITION**

 **WARNING:** Sitting improperly out of position or with the seat back reclined too far can take off weight from the seat cushion and affect the decision of the passenger sensing system, resulting in serious injury or death in a crash. Always sit upright against your seat back, with your feet on the floor.

 **WARNING:** Do not recline the seat back as this can cause the occupant to slide under the seat's safety belt, resulting in severe personal injury in the event of a collision.

 **WARNING:** Do not place objects higher than the seat backs to reduce the risk of injury in a collision or during heavy braking or when stopping suddenly.

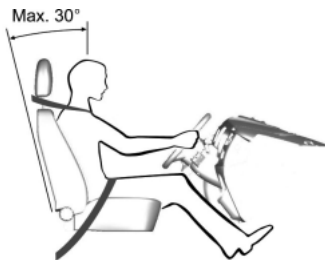

When you use them properly, the seat, head restraint, safety belt and airbags will provide optimum protection in the event of a collision. We recommend that you follow these guidelines:

- Do not recline the seat back more than 30 degrees from vertical.
- Sit in an upright position with the base of your spine as far back as possible.
- Adjust the head restraint so that the top of it is level with the top of your head and as far forward as possible, remaining comfortable.
- Keep sufficient distance between yourself and the steering wheel. We recommend a minimum of 10 inches (250 millimeters) between your breastbone and the airbag cover.



- Hold the steering wheel with your arms slightly bent.
- Bend your legs slightly so that you can press the pedals fully.
- Position the shoulder strap of the safety belt over the center of your shoulder and position the lap strap tightly across your hips.

Make sure that your driving position is comfortable and that you can maintain full control of your vehicle.

### HEAD RESTRAINTS



**WARNING:** To minimize the risk of neck injury in the event of a crash, the driver and passenger occupants should not sit in and/or operate the vehicle, until the head restraint is placed in its proper position. The driver should never adjust the head restraint while the vehicle is in motion.



**WARNING:** The adjustable head restraint is a safety device. Whenever possible, it should be installed and properly adjusted when the seat is occupied.



**WARNING:** Install the head restraint properly to minimize the risk of neck injury in the event of a crash.

**Note:** Adjust the seatback to an upright driving position before adjusting any head restraint. Adjust the head restraint so that the top of it is level with the top of your head and as far forward as possible, remaining comfortable. For occupants of extremely tall stature, adjust the head restraint to its highest position.





**Front Seat Head Restraints**

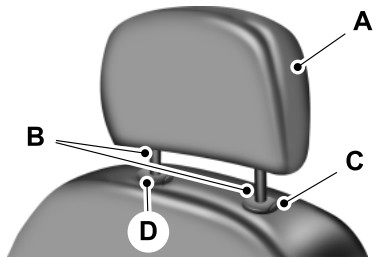

**Rear Seat Outboard Head Restraints**

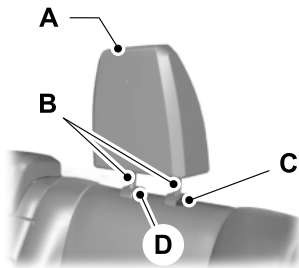

**Rear Seat Center Head Restraints**

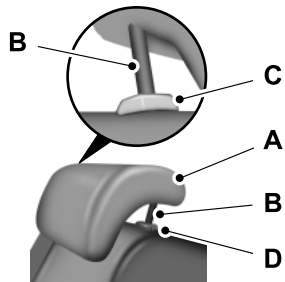

The head restraints consist of:

- A. An energy absorbing head restraint
- B. Two steel stems
- C. Guide sleeve adjust and release button
- D. Guide sleeve unlock and remove button



**Adjusting the Head Restraint****Raise**

Pull up the head restraint.

**Lower**

1. Press and hold button C.
2. Push the head restraint down.

**Remove**

1. Pull up the head restraint until it reaches the highest adjustment position.
2. Press and hold buttons C and D.
3. Pull the head restraint up.

**Install**

Align the steel stems into the guide sleeves and push the head restraint down until it locks. Make sure the front of the head restraint faces the front of the vehicle.

**Tilting Head Restraints (If Equipped)**

The front head restraints may have a tilting feature for extra comfort. To tilt the head restraint, do the following:



1. Adjust the seat back to an upright driving/riding position.
2. Tilt the head restraint forward by gently pulling the top of the head restraint.

Once it is in its forward-most position, tilting it forward once more will release it to the upright position.

**Note:** Do not attempt to force the head restraint backward after it is tilted. Instead, continue tilting it forward until the head restraint releases to the upright position.



**MANUAL SEATS**

 **WARNING:** Never adjust the driver's seat or seatback when the vehicle is moving.

 **WARNING:** Rock the seat backward and forward after releasing the lever to make sure that it is fully engaged.

**Moving the Seat Backward and Forward**

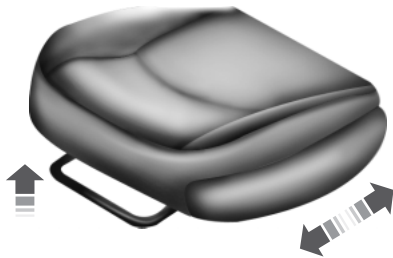

**Adjust the Height of the Driver's Seat**

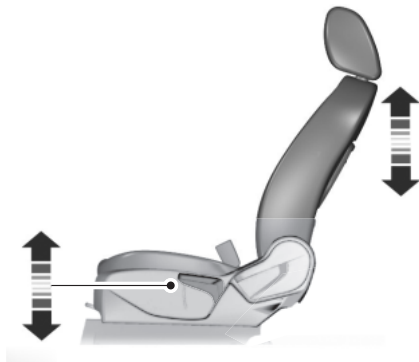

---

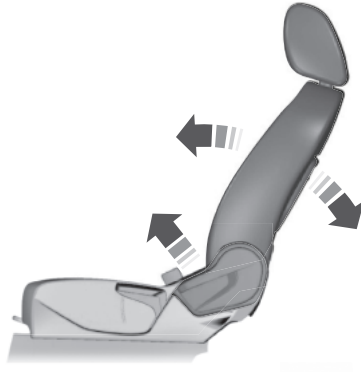
**Recline Adjustment**

 **WARNING:** Reclining the seatback can cause an occupant to slide under the seat's safety belt, resulting in severe personal injuries in the event of a collision.



**POWER SEATS (IF EQUIPPED)**

 **WARNING:** Never adjust the driver's seat or seat back when the vehicle is moving.

 **WARNING:** Reclining the seat back can cause an occupant to slide under the seat's safety belt, resulting in severe personal injuries in the event of a collision.

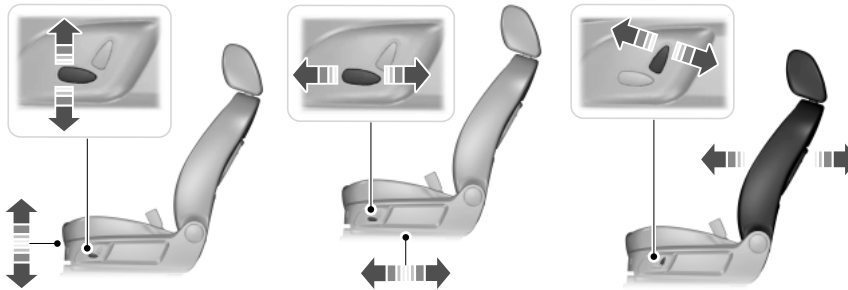

**Lumbar Adjustment (If Equipped)**

Use the lever located on the side of the seat back to adjust the lumbar.



**HEATED SEATS (IF EQUIPPED)**

 **WARNING:** Persons who are unable to feel pain to the skin because of advanced age, chronic illness, diabetes, spinal cord injury, medication, alcohol use, exhaustion, or other physical conditions, must exercise care when using the seat heater. The seat heater may cause burns even at low temperatures, especially if used for long periods of time. Do not place anything on the seat that insulates against heat, such as a blanket or cushion, because this may cause the seat heater to overheat. Do not puncture the seat with pins, needles, or other pointed objects because this may damage the heating element which may cause the seat heater to overheat. An overheated seat may cause serious personal injury.

**Note:** Do not do the following:

- Place heavy objects on the seat
- Operate the seat heater if water or any other liquid is spilled on the seat. Allow the seat to dry thoroughly.
- Operate the heated seats unless the engine is running. Doing so could drain the vehicle's battery.

Adjust the control to the desired heat setting.



**Folding the Rear Seats**

**Note:** Before lowering the seat back(s), remove the outboard head restraints.

To lower the seat back(s) from inside the vehicle, do the following:

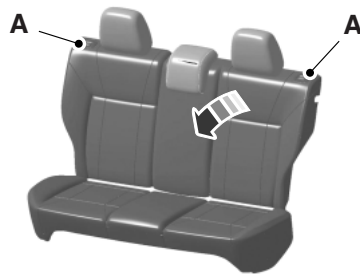

1. Press the unlock buttons (A) down.
2. Push the seat back forward.

**Note:** Your vehicle may have split seat backs that must be folded individually.



3. Stow the safety belt in the belt stowage clip. This will prevent the safety belt from getting caught in the seat latch.

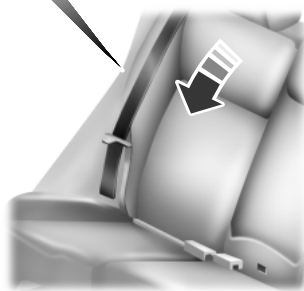

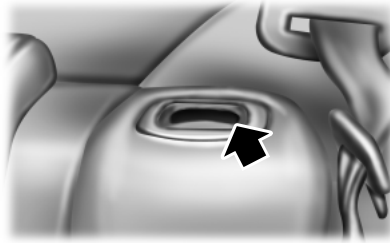

When raising the seatback(s), make sure you hear the seat latch into place and that no red portion is visible on the release button on both sides.

### Flip Up Seat Cushions (If Equipped)

 **WARNING:** Before returning the seat back to its original position, make sure that cargo or any objects are not trapped behind the seat back. Make sure that the safety belt is not laying on the seat latch. After returning the seat back to its original position, pull on the seat back to ensure that it has fully latched. An unlatched seat may become dangerous in the event of a sudden stop or collision.

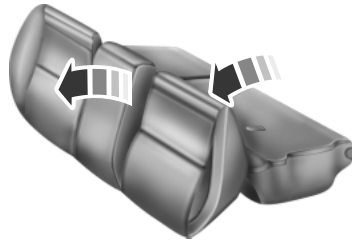

For additional cargo space, flip the seat cushions up before folding the seat back. This feature is only available on vehicles with a split folding seat back.





### AUXILIARY POWER POINTS



**WARNING:** Do not plug optional electrical accessories into the cigarette lighter socket (if equipped). Improper use of the lighter can cause damage not covered by your warranty, and can result in fire or serious injury.

**Note:** If used when the engine is not running, the battery will discharge. There may be insufficient power to restart your engine.

**Note:** Do not insert objects other than an accessory plug into the power point. This will damage the outlet and blow the fuse.

**Note:** Do not hang any type of accessory or accessory bracket from the plug.

**Note:** Do not use the power point over the vehicle capacity of 12 volts DC 180 watts or a fuse may blow.

**Note:** Do not use the power point for operating a cigarette lighter element.

**Note:** Improper use of the power point can cause damage not covered by your warranty.

**Note:** Always keep the power point caps closed when not in use.

Run the engine for full capacity use of the power point. To prevent the battery from being discharged:

- Do not use the power point longer than necessary when the engine is not running.
- Do not leave devices plugged in overnight or when the vehicle is parked for extended periods.

#### Locations

Power points may be found:

- on the center console
- on the rear of the center console.



**CENTER CONSOLE**

**WARNING:** Use only soft cups in the cupholder. Hard objects can injure you in a collision.

Your vehicle has a variety of console features. These may include:

- Cupholders
- Utility compartment
- Auxiliary AV connections, USB port, SD slot

**OVERHEAD CONSOLE (IF EQUIPPED)**

The appearance of the overhead console will vary according to your option package.

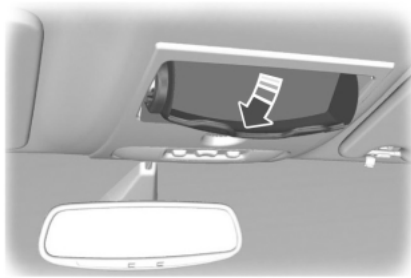



Press near the rear edge of the door to open it.



### GENERAL INFORMATION

 **WARNING:** Extended idling at high engine speeds can produce very high temperatures in the engine and exhaust system, creating the risk of fire or other damage.

 **WARNING:** Do not park, idle, or drive your vehicle on dry grass or other dry ground cover. The emission system heats up the engine compartment and exhaust system, which can start a fire.

 **WARNING:** Do not start your vehicle in a closed garage or in other enclosed areas. Exhaust fumes can be toxic. Always open the garage door before you start the engine.

 **WARNING:** If you smell exhaust fumes inside your vehicle, have your vehicle checked by an authorized dealer immediately. Do not drive if you smell exhaust fumes.

If you disconnect the battery, your vehicle may exhibit some unusual driving characteristics for approximately 5 miles (8 kilometers) after you connect it. This is because the engine management system must realign itself with the engine. You may disregard any unusual driving characteristics during this period.

The powertrain control system meets all Canadian interference-causing equipment standard requirements regulating the impulse electrical field strength of radio noise.

When starting your vehicle, avoid pressing the accelerator pedal before and during operation. Only use the accelerator pedal when you have difficulty starting the engine.



## 164 Starting and Stopping the Engine

### IGNITION SWITCH (IF EQUIPPED)

**Note:** When you switch the ignition off and leave your vehicle, do not leave your key in the ignition. This could discharge your vehicle battery.

**Note:** To switch the engine off when your vehicle is moving, move the transmission selector lever to position **N**. Use the brakes to bring your vehicle to a safe stop. After your vehicle has stopped, switch the engine off and move the transmission selector lever to position **P**. Turn the key to position 0 or 1.



**0 (Off):** The ignition is off.

**I (Accessory):** Allows the electrical accessories, such as the radio, to operate.

**II (On):** All electrical circuits are operational. Warning lamps and indicators illuminate. This is the key position when driving.

**III (Start):** Cranks the engine. Release the key as soon as the engine starts.

### KEYLESS STARTING (IF EQUIPPED)



**WARNING:** The keyless starting system may not function if the key is close to metal objects or electronic devices such as mobile phones.

**Note:** A valid key must be located inside the vehicle to switch the ignition on and start the engine.

The start button is located on the instrument panel near the steering wheel.

### Ignition On Mode

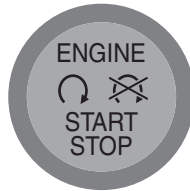

To switch the ignition on, press the start button. All electrical circuits and accessories are operational, and warning lamps and indicators illuminate.



**Starting Your Vehicle**

Carry out the following steps to start your vehicle:

1. Move the transmission selector lever to position **P**.
2. Fully press the brake pedal (automatic transmission) or clutch pedal (manual transmission).
3. Press the start button.

The system does not function if:

- the key frequencies are jammed
- the key battery has no charge.

If you are unable to start your vehicle, do the following:

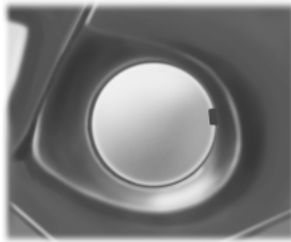
**3-button remote**

1. Hold the key at the backup location on the steering column.
2. With the key in this position, you can use the start button to switch the ignition on and start your vehicle.

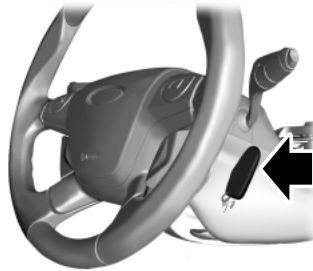
**5-button remote**

1. Hold the key next to the symbol on the steering column.
2. With the key in this position, you can use the start button to switch the ignition on and start your vehicle.

**Stopping the Engine When Your Vehicle is Stationary**

To stop the engine with the vehicle stationary, do the following:

1. Move the transmission selector lever to position **P**.
2. Press the start button.

**Note:** The ignition, all electrical circuits, warning lamps and indicators are switched off.



## 166 Starting and Stopping the Engine

---

### Stopping the Engine When Your Vehicle is Moving



**WARNING:** Switching off the engine when the vehicle is still moving will result in a loss of brake and steering assistance. The steering will not be locked, but higher effort will be required. When the ignition is switched off, some electrical circuits, warning lamps and indicators may also be off.

1. Press the start button for one second, or press it three times within two seconds.
2. Move the transmission selector lever to position **N** and use the brakes to bring your vehicle to a safe stop.
3. When your vehicle has stopped, move the transmission selector lever to position **P**.

### Fast Restart

If a valid key is not present, the fast restart feature allows you to restart your vehicle within 10 seconds of switching it off. Press the brake pedal and press the start button within 10 seconds. After 10 seconds have expired, you can no longer start your vehicle without the key present inside the vehicle.

Once your vehicle has started, it remains running until you press the start button, even if a valid key has not been detected. If you open and close a door while your vehicle is running, the system searches for a valid key. You cannot start your vehicle if a valid key is not detected within 10 seconds.

### STARTING A GASOLINE ENGINE

When you start your engine, the idle speed increases to warm the engine up. If the engine idle speed does not slow down automatically, have your vehicle checked by an authorized dealer.

Before starting your vehicle, check the following:

- Make sure all occupants have fastened their safety belts.
- Make sure the headlamps and electrical accessories are off.
- Make sure the parking brake is on.
- Move the transmission selector lever to position **P**.
- Switch the ignition on.

**Note:** Do not touch the accelerator pedal.

1. Fully press the brake pedal.
2. Move the transmission selector lever to position **P** or **N**.



3. Start the engine. The engine may continue cranking for up to 15 seconds or until it starts.

**Note:** If you cannot start your engine on the first try, wait for a short period of time and try again.

If you have difficulty starting the engine when the temperature is below -13°F (-25°C), press the accelerator pedal slightly and try again.

If you cannot start your engine after three attempts, wait 10 seconds, then follow this procedure:

1. Fully press the brake pedal.
2. Fully press the accelerator pedal and hold it there.
3. Move the transmission selector lever to position **P** or **N**.
4. Start the engine.

### Guarding Against Exhaust Fumes



**WARNING:** If you smell exhaust fumes inside your vehicle, have this checked immediately. Do not drive your vehicle if you smell exhaust fumes. Carbon monoxide is present in exhaust fumes. Take precautions to avoid its dangerous effects.

### Important Ventilating Information

If you stop your vehicle and leave the engine idling for long periods of time, we recommend that you do one of the following:

- Open the windows at least 1 inch (2.5 centimeters).
- Set your climate control to outside air.

### ENGINE BLOCK HEATER (IF EQUIPPED)



**WARNING:** Failure to follow engine block heater instructions could result in property damage or physical injury.



**WARNING:** Do not use your heater with ungrounded electrical systems or two-pronged (cheater) adapters. There is a risk of electrical shock.

**Note:** The heater is most effective when outdoor temperatures are below 0°F (-18°C).



## 168 Starting and Stopping the Engine

---

The heater acts as a starting aid by warming the engine coolant. This allows the climate control system to respond quickly. The equipment includes a heater element (installed in the engine block) and a wire harness. You can connect the system to a grounded 120 volt A/C electrical source.

We recommend that you do the following for safe and correct operation:

- Use a 16-gauge outdoor extension cord that is product certified by Underwriter's Laboratory or Canadian Standards Association. This extension cord must be able to be used outdoors, in cold temperatures, and be clearly marked *Suitable for Use with Outdoor Appliances*. Never use an indoor extension cord outdoors; it could result in an electric shock or become a fire hazard.
- Use as short an extension cord as possible.
- Do not use multiple extension cords.
- Make sure that when in operation, the extension cord plug and the heater cord plug connections are free and clear of water. This could cause an electric shock or fire.
- Make sure your vehicle is parked in a clean area, clear of combustibles.
- Make sure the heater, heater cord and extension cord are firmly connected.
- Check for heat anywhere in the electrical hookup once the system has been operating for approximately 30 minutes.
- Make sure the system is unplugged and properly stowed before driving your vehicle. Make sure the protective cover seals the prongs of the block heater cord plug when not in use.
- Make sure the heater system is checked for proper operation before winter.

### Using the Engine Block Heater

Make sure the receptacle terminals are clean and dry prior to use. Clean them with a dry cloth, if necessary.

The heater uses 0.4 to 1.0 kilowatt-hours of energy per hour of use. The system does not have a thermostat. It achieves maximum temperature after approximately three hours of operation. Using the heater longer than three hours does not improve system performance and unnecessarily uses electricity.





### SAFETY PRECAUTIONS



**WARNING:** Do not overfill the fuel tank. The pressure in an overfilled tank may cause leakage and lead to fuel spray and fire.



**WARNING:** The fuel system may be under pressure. If you hear a hissing sound near the fuel filler door (Easy Fuel® “no cap” fuel system), do not refuel until the sound stops. Otherwise, fuel may spray out, which could cause serious personal injury.



**WARNING:** Automotive fuels can cause serious injury or death if misused or mishandled.



**WARNING:** The flow of fuel through a fuel pump nozzle can produce static electricity, which can cause a fire if fuel is pumped into an ungrounded fuel container.



**WARNING:** Fuel ethanol and gasoline may contain benzene, which is a cancer-causing agent.



**WARNING:** When refueling always shut the engine off and never allow sparks or open flames near the filler neck. Never smoke while refueling. Fuel vapor is extremely hazardous under certain conditions. Care should be taken to avoid inhaling excess fumes.



**WARNING:** Flexible fuel components and standard unleaded gasoline fuel components are not interchangeable. If your vehicle is not serviced in accordance with flexible fuel vehicles procedures, damage may occur and your warranty may be invalidated.

Observe the following guidelines when handling automotive fuel:

- Extinguish all smoking materials and any open flames before refueling your vehicle.
- Always turn off the vehicle before refueling.
- Automotive fuels can be harmful or fatal if swallowed. Fuel such as gasoline is highly toxic and if swallowed can cause death or permanent injury. If fuel is swallowed, call a physician immediately, even if no symptoms are immediately apparent. The toxic effects of fuel may not be visible for hours.



- Avoid inhaling fuel vapors. Inhaling too much fuel vapor of any kind can lead to eye and respiratory tract irritation. In severe cases, excessive or prolonged breathing of fuel vapor can cause serious illness and permanent injury.
- Avoid getting fuel liquid in your eyes. If fuel is splashed in the eyes, remove contact lenses (if worn), flush with water for 15 minutes and seek medical attention. Failure to seek proper medical attention could lead to permanent injury.
- Fuels can also be harmful if absorbed through the skin. If fuel is splashed on the skin and/or clothing, promptly remove contaminated clothing and wash skin thoroughly with soap and water. Repeated or prolonged skin contact with fuel liquid or vapor causes skin irritation.
- Be particularly careful if you are taking “Antabuse” or other forms of disulfiram for the treatment of alcoholism. Breathing gasoline vapors, or skin contact could cause an adverse reaction. In sensitive individuals, serious personal injury or sickness may result. If fuel is splashed on the skin, promptly wash skin thoroughly with soap and water. Consult a physician immediately if you experience an adverse reaction.
- Flex fuel vehicle fuel tanks may contain zero to 85% ethanol. Any fuel blends containing gasoline and ethanol should be treated the same as “Fuel Ethanol.” Flex fuel vehicles have a yellow bezel placed over the fuel fill inlet.

Pure ethanol is the alcohol which is the intoxicating agent in liquor, beer and wine. It is distilled from the fermentation of plants such as field corn and sugar cane. When ethanol is produced for use in motor fuels, a small amount of gasoline is added to make it unfit for beverage use. The resulting ethanol blend is called denatured fuel ethanol meaning that it is denatured with 2% to 5% gasoline and is suitable for automotive use.

During the summer season, fuel ethanol may contain a maximum of 85% denatured ethanol (Ed85) and 15% unleaded gasoline. The fuel ethanol has a higher octane rating than unleaded regular or premium gasoline and this allows the design of engines with greater efficiency and power.

Winter blends may contain up to 75% denatured ethanol (Ed75) and up to 25% unleaded gasoline to enhance cold engine starts. Severely cold weather may require additional measures for reliable starting.

Ethanol is more chemically active than gasoline. It corrodes some metals and causes some plastic and rubber components to swell, break down or become brittle and crack, especially when mixed with gasoline. Special materials and procedures have been developed for flexible fuel vehicles and the dispensers used by ethanol fuel providers.



**FUEL QUALITY**

**Note:** Use of any fuel other than those recommended may cause powertrain damage, a loss of vehicle performance, and repairs may not be covered under warranty.

**Choosing the Right Fuel**

Use only UNLEADED fuel or UNLEADED fuel blended with a maximum of 15% ethanol. Do not use fuel ethanol (E85), diesel fuel, fuel-methanol, leaded fuel or any other fuel because it could damage or impair the emission control system. The use of leaded fuel is prohibited by law.

**Choosing the Right Fuel With a Flex Fuel Vehicle (If Equipped)**

**Note:** If your vehicle is flex fuel capable, it will have a yellow bezel placed over the fuel fill inlet.

Flex fuel vehicles are designed to use only FUEL ETHANOL (Ed75-Ed85) fuel blends which contains 51 to 83% ethanol and UNLEADED FUEL “Regular” unleaded gasoline or any mixture of the two fuels.

It is best not to alternate repeatedly between gasoline and E85. If you do switch fuels, it is recommended that you add as much fuel as possible—at least half a tank. Do not add less than five gallons (18.9L) when refueling. You should drive the vehicle immediately after refueling for at least 5 miles (8 km) to allow the vehicle to adapt to the change in ethanol concentration. If you exclusively use E85 fuel, it is recommended to fill the fuel tank with regular unleaded gasoline at each scheduled oil change.

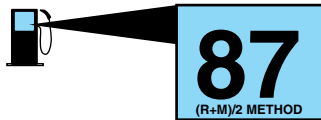
**Octane Recommendations**

“Regular” unleaded gasoline with a pump (R+M)/2 octane rating of 87 is recommended. Some stations offer fuels posted as “Regular” with an octane rating below 87,

particularly in high altitude areas. Fuels with octane levels below 87 are not recommended.

Do not be concerned if your engine sometimes knocks lightly. However, if it knocks heavily under most driving conditions while you are using fuel with the recommended octane rating, see your authorized dealer to prevent any engine damage.



**RUNNING OUT OF FUEL**

Avoid running out of fuel because this situation may have an adverse effect on powertrain components.

If you have run out of fuel:

- You may need to cycle the ignition from off to on several times after refueling to allow the fuel system to pump the fuel from the tank to the engine. On restarting, cranking time will take a few seconds longer than normal. With keyless ignition, just start the engine. Crank time will be longer than usual.
- Normally, adding 1 gallon (3.8L) of fuel is enough to restart the engine. If the vehicle is out of fuel and on a steep grade, more than 1 gallon (3.8L) may be required.
- The service engine soon indicator may come on. For more information on the service engine soon indicator, refer to *Warning lamps and indicators* in the *Instrument Cluster* chapter.

**Refilling with a Portable Fuel Container**

 **WARNING:** Do not insert the nozzle of portable fuel containers or aftermarket funnels into the capless fuel system. This could damage the fuel system and its seal, and may cause fuel to run onto the ground instead of filling the tank, which could result in serious personal injury.

 **WARNING:** Do not try to pry open or push open the capless fuel system with foreign objects. This could damage the fuel system and its seal and cause injury to you or others.

**Note:** Do not use aftermarket funnels; they will not work with the capless fuel system and can damage it. The included funnel has been specially designed to work safely with your vehicle.

When filling the vehicle's fuel tank from a portable fuel container, use the funnel included with the vehicle.



1. Locate the white plastic funnel in the spare tire compartment.
2. Slowly insert the funnel into the capless fuel system.
3. Fill the vehicle with fuel from the portable fuel container.



4. When done, clean the funnel or properly dispose of it. Extra funnels can be purchased from your authorized dealer if you choose to dispose of the funnel.

## REFUELING



**WARNING:** Fuel vapor burns violently and a fuel fire can cause severe injuries. To help avoid injuries to you and others:

- Read and follow all the instructions on the pump island;
- Turn off your engine when you are refueling;
- Do not smoke if you are near fuel or refueling your vehicle;
- Keep sparks, flames and smoking materials away from fuel;
- Stay outside your vehicle and do not leave the fuel pump unattended when refueling your vehicle — this is against the law in some places;
- Keep children away from the fuel pump; never let children pump fuel.
- Do not use personal electronic devices while refueling.

Use the following guidelines to avoid electrostatic charge build-up when filling an ungrounded fuel container:

- Place approved fuel container on the ground.
- DO NOT fill a fuel container while it is in the vehicle (including the cargo area).
- Keep the fuel pump nozzle in contact with the fuel container while filling.
- DO NOT use a device that would hold the fuel pump handle in the fill position.

## Easy Fuel® Capless Fuel System



**WARNING:** The fuel system may be under pressure. If you hear a hissing sound near the fuel filler door, do not refuel until the sound stops. Otherwise, fuel may spray out, which could cause serious personal injury.

When fueling your vehicle:

1. Turn the engine off.
2. Open the fuel filler door.



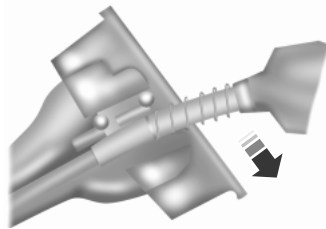

3. Slowly insert the fuel filler nozzle fully into the fuel system, and leave the nozzle fully inserted to open both doors until you are done pumping. Hold handle higher during insertion for easier access.

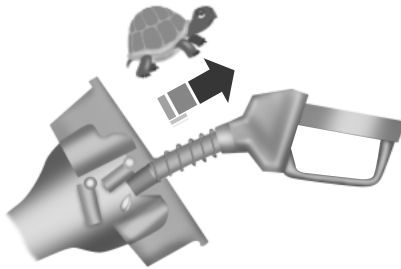

4. After you are done pumping fuel, slowly remove the fuel filler nozzle—allow about five to ten seconds after pumping fuel before removing the fuel filler nozzle. This allows residual fuel to drain back into the fuel tank and not spill onto the vehicle.

**Note:** A fuel spillage concern may occur if overfilling the fuel tank. Do not overfill the tank to the point that

the fuel is able to bypass the fuel filler nozzle. The overfilled fuel may run down the drain located below and in front of the fuel filler door.

If the fuel fill inlet was not properly closed, a Check Fuel Fill Inlet message may appear on the instrument cluster. At the next opportunity, do the following:

1. Safely pull off the road.
2. Turn off the engine.
3. Open the fuel filler door and remove any visible debris from the fuel fill opening.
4. Insert either the fuel fill nozzle or the fuel fill funnel provided with the vehicle several times to dislodge any debris and/or allow the inlet to close properly.

If this action corrects the problem, the message may not reset immediately. It may take several driving cycles for the message to turn off. A driving cycle consists of an engine start-up (after four or more hours with the engine off) followed by city/highway driving. Continuing to drive with the message on may cause the service engine soon lamp to turn on as well.



**FUEL CONSUMPTION****Filling the tank**

The advertised capacity is the indicated capacity and the empty reserve combined. Indicated capacity is the difference in the amount of fuel in a full tank and a tank when the fuel gauge indicates empty. Empty reserve is the amount of fuel in the tank after the fuel gauge indicates empty.

**Note:** The amount of usable fuel in the empty reserve varies and should not be relied upon to increase driving range. When refueling your vehicle after the fuel gauge indicates empty, you might not be able to refuel the full amount of the advertised capacity of the fuel tank due to the empty reserve still present in the tank.

For consistent results when filling the fuel tank:

- Turn the ignition off before fueling; an inaccurate reading results if the engine is left running.
- Use the same fill rate (low–medium–high) each time the tank is filled.
- Allow no more than two automatic click–offs when filling.

Results are most accurate when the filling method is consistent.

**Calculating fuel economy**

Do not measure fuel economy during the first 1,000 miles (1,600 km) of driving (this is your engine's break-in period); a more accurate measurement is obtained after 2,000 miles–3,000 miles (3,200 km–4,800 km). Also, fuel expense, frequency of fill-ups or fuel gauge readings are not accurate ways to measure fuel economy.

1. Fill the fuel tank completely and record the initial odometer reading.
2. Each time you fill the tank, record the amount of fuel added.
3. After at least three to five tank fill-ups, fill the fuel tank and record the current odometer reading.
4. Subtract your initial odometer reading from the current odometer reading.
5. Calculate fuel economy as follows:

Standard: Divide miles traveled by gallons used.

Metric: Multiply liters used by 100, then divide by kilometers traveled.

Keep a record for at least one month and record the type of driving (city or highway). This provides an accurate estimate of the vehicle's fuel economy under current driving conditions. Additionally, keeping records during summer and winter show how temperature impacts fuel economy. In general, lower temperatures mean lower fuel economy.



**EMISSION CONTROL SYSTEM**

**WARNING:** Do not park, idle, or drive your vehicle in dry grass or other dry ground cover. The emission system heats up the engine compartment and exhaust system, which can start a fire.



**WARNING:** Exhaust leaks may result in entry of harmful and potentially lethal fumes into the passenger compartment. If you smell exhaust fumes inside your vehicle, have your dealer inspect your vehicle immediately. Do not drive if you smell exhaust fumes.

Your vehicle is equipped with various emission control components and a catalytic converter which will enable your vehicle to comply with applicable exhaust emission standards. To make sure that the catalytic converter and other emission control components continue to work properly:

- Use only the specified fuel listed.
- Avoid running out of fuel.
- Do not turn off the ignition while your vehicle is moving, especially at high speeds.
- Have the items listed in *scheduled maintenance information* performed according to the specified schedule.

The scheduled maintenance items listed in *scheduled maintenance information* are essential to the life and performance of your vehicle and to its emissions system.

If other than Ford, Motorcraft® or Ford-authorized parts are used for maintenance replacements or for service of components affecting emission control, such non-Ford parts should be equivalent to genuine Ford Motor Company parts in performance and durability.

Illumination of the service engine soon indicator, charging system warning light or the temperature warning light, fluid leaks, strange odors, smoke or loss of engine power could indicate that the emission control system is not working properly.

An improperly operating or damaged exhaust system may allow exhaust to enter the vehicle. Have a damaged or improperly operating exhaust system inspected and repaired immediately.





Do not make any unauthorized changes to your vehicle or engine. By law, vehicle owners and anyone who manufactures, repairs, services, sells, leases, trades vehicles, or supervises a fleet of vehicles are not permitted to intentionally remove an emission control device or prevent it from working. Information about your vehicle's emission system is on the Vehicle Emission Control Information Decal located on or near the engine. This decal also lists engine displacement.

Please consult your warranty information for complete emission warranty information.

### On-board Diagnostics (OBD-II)

Your vehicle is equipped with a computer that monitors the engine's emission control system. This system is commonly known as the on-board diagnostics system (OBD-II). The OBD-II system protects the environment by ensuring that your vehicle continues to meet government emission standards. The OBD-II system also assists your authorized dealer in properly servicing your vehicle.



When the service engine soon indicator illuminates, the OBD-II system has detected a malfunction. Temporary malfunctions may cause the service engine soon indicator to illuminate.

Examples are:

1. The vehicle has run out of fuel—the engine may misfire or run poorly.
2. Poor fuel quality or water in the fuel—the engine may misfire or run poorly.
3. The fuel fill inlet may not have been properly closed. See *Easy Fuel*® “no cap” fuel system in this chapter.
4. Driving through deep water—the electrical system may be wet.

These temporary malfunctions can be corrected by filling the fuel tank with good quality fuel, properly closing the fuel fill inlet or letting the electrical system dry out. After three driving cycles without these or any other temporary malfunctions present, the service engine soon indicator should stay off the next time the engine is started. A driving cycle consists of a cold engine startup followed by mixed city/highway driving. No additional vehicle service is required.

If the service engine soon indicator remains on, have your vehicle serviced at the first available opportunity. Although some malfunctions detected by the OBD-II may not have symptoms that are apparent, continued driving with the service engine soon indicator on can result in increased emissions, lower fuel economy, reduced engine and transmission smoothness, and lead to more costly repairs.



**Readiness for Inspection/Maintenance (I/M) Testing**

Some state/provincial and local governments may have Inspection/Maintenance (I/M) programs to inspect the emission control equipment on your vehicle. Failure to pass this inspection could prevent you from getting a vehicle registration.



If the service engine soon indicator is on or the bulb does not work, the vehicle may need to be serviced. Refer to *On-board diagnostics (OBD-II)* in this chapter.

Your vehicle may not pass the I/M test if the service engine soon indicator is on or not working properly (bulb is burned out), or if the OBD-II system has determined that some of the emission control systems have not been properly checked. In this case, the vehicle is considered not ready for I/M testing.

If the vehicle's engine or transmission has just been serviced, or the battery has recently run down or been replaced, the OBD-II system may indicate that the vehicle is not ready for I/M testing. To determine if the vehicle is ready for I/M testing, turn the ignition key to the on position for 15 seconds without cranking the engine. If the service engine soon indicator blinks eight times, it means that the vehicle is not ready for I/M testing; if the service engine soon indicator stays on solid, it means that the vehicle is ready for I/M testing.

The OBD-II system is designed to check the emission control system during normal driving. A complete check may take several days. If the vehicle is not ready for I/M testing, the following driving cycle consisting of mixed city and highway driving may be performed:

15 minutes of steady driving on an expressway/highway followed by 20 minutes of stop-and-go driving with at least four 30-second idle periods.

Allow the vehicle to sit for at least eight hours without starting the engine. Then, start the engine and complete the above driving cycle. The engine must warm up to its normal operating temperature. Once started, do not turn off the engine until the above driving cycle is complete. If the vehicle is still not ready for I/M testing, the above driving cycle will have to be repeated.



**AUTOMATIC TRANSMISSION**

**!** **WARNING:** Always set the parking brake fully and make sure the gearshift is latched in P (Park). Turn the ignition to the off position and remove the key whenever you leave your vehicle.

**!** **WARNING:** Do not apply the brake pedal and accelerator pedal simultaneously. Applying both pedals simultaneously for more than three seconds will limit engine rpm, which may result in difficulty maintaining speed in traffic and could lead to serious injury.

**PowerShift Fuel Efficient Transmission**

Your vehicle has been designed to improve fuel economy by reducing fuel usage while coasting or decelerating. When you take your foot off the accelerator pedal and the vehicle begins to slow down, the torque converter clutch locks up and aggressively shuts off fuel flow to the engine while decelerating. This fuel economy benefit may be perceived as a light to medium braking sensation when removing your foot from the accelerator pedal.

**P (Park)**

This position locks the transmission and prevents the front wheels from turning.

To put your vehicle in gear:

- Press the brake pedal
- Move the gearshift lever into the desired gear

To put your vehicle in P (Park):

- Come to a complete stop
- Move the gearshift lever and securely latch it in P (Park)

**R (Reverse)**

With the gearshift lever in R (Reverse), the vehicle will move backward. Always come to a complete stop before shifting into and out of R (Reverse).

**N (Neutral)**

With the gearshift lever in N (Neutral), the vehicle can be started and is free to roll. Hold the brake pedal down while in this position.



**D (Drive)**

The normal driving position for the best fuel economy. Transmission operates in gears one through six.

**D (Drive) with Overdrive Cancel/Grade Assist**

Pressing the transmission control switch on the side of the gearshift lever activates overdrive cancel and grade assist.

Overdrive cancel/grade assist



- Overdrive is deactivated.
- The transmission operates in gears one through five.
- The grade assist lamp in the instrument cluster is illuminated.
- Improves driving experience in hilly terrain or mountainous areas by providing additional grade (engine) braking and extends lower gear operation on uphill climbs.
- Provides additional engine braking through the automatic transmission shift strategy which reacts to vehicle inputs (vehicle acceleration, accelerator pedal, brake pedal and vehicle speed).
- Allows the transmission to select gears that will provide the desired engine braking based on the vehicle inputs mentioned above. This will increase engine RPM during engine braking.

Overdrive cancel with grade assist is designed to provide optimal gear selection in hilly terrain or mountainous areas. It is recommended that you return to D (Drive) on flat terrain to provide the best fuel economy and transmission function.

To return to D (Drive), press the transmission control switch again.

- The grade assist lamp in the instrument cluster will not be illuminated.
- The transmission will operate in gears one through six.



**L (Low)**

This position:

- Provides maximum engine braking.
- Will downshift to the lowest available gear for the current vehicle speed; allows for first gear when vehicle reaches slower speeds.
- Is not intended for use under extended or normal driving conditions and results in lower fuel economy.

**S (Sport) (If Equipped)**

Moving the gearshift lever to S (Sport):

- Provides additional grade (engine) braking and extends lower gear operation to enhance performance for uphill climbs, hilly terrain or mountainous areas. This will increase engine RPM during engine braking.
- Provides additional lower gear operation through the automatic transmission shift strategy which reacts to vehicle inputs (vehicle acceleration, accelerator pedal, brake pedal and vehicle speed).
- Gears are selected more quickly and at higher engine speeds.

**Understanding Your SelectShift Automatic® Transmission (If Equipped)**

**Note:** Your transmission must be in S (Sport) for SelectShift to operate properly.

Your SelectShift automatic transmission gives you the ability to manually change gears if you'd like. To use SelectShift, move the gearshift lever into S (Sport). Now you can use the thumb toggle on the side of your gearshift lever to select gears.



When using the toggle for manual shifting:

- Press (+) on the toggle to upshift.
- Press (-) on the toggle to downshift.

Upshift to the recommended shift speeds according to the following chart.



<b>Upshifts when accelerating (recommended for best fuel economy)</b>	
Shift from:	
1 - 2	15 mph (24 km/h)
2 - 3	25 mph (40 km/h)
3 - 4	40 mph (64 km/h)
4 - 5	45 mph (72 km/h)
5 - 6	50 mph (80 km/h)

The instrument cluster will show the current selected gear you are in.

SelectShift will automatically make some downshifts for you if it has determined that you have not downshifted in time. Although SelectShift will make some downshifts for you, it will still allow you to downshift at any time as long as SelectShift determines that the engine will not be damaged from over-revving.

**Note:** If manual control is no longer desired, return the gear shift lever from S (Sport) to D (Drive).

**Note:** Engine damage may occur if excessive engine revving is held without shifting.

#### Brake-Shift Interlock



**WARNING:** Do not drive your vehicle until you verify that the brake lamps are working.



**WARNING:** When doing this procedure, you will be taking the vehicle out of park which means the vehicle can roll freely. To avoid unwanted vehicle movement, always fully set the parking brake prior to doing this procedure. Use wheel chocks if appropriate.



**WARNING:** If the parking brake is fully released, but the brake warning lamp remains illuminated, the brakes may not be working properly. See your authorized dealer.

This vehicle is equipped with a brake-shift interlock feature that prevents the gearshift lever from being moved from P (Park) when the ignition is in the on position unless the brake pedal is pressed.

If you cannot move the gearshift lever out of P (Park) with ignition in the on position and the brake pedal pressed, it is possible that a fuse has blown or the vehicle's brake lamps are not operating properly. Refer to *Fuses and relays* in the *Roadside Emergencies* chapter.



If the fuse is not blown and the brake lamps are working properly, the following procedure will allow you to move the gearshift lever from P (Park):

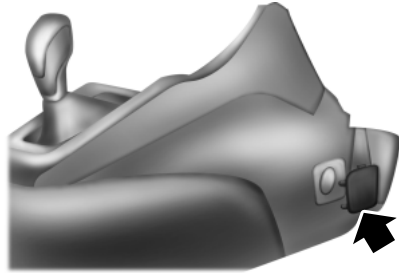

1. Apply the parking brake, turn the ignition key to the off position and remove the key.
2. Using a screwdriver (or similar tool), carefully pry off and remove the passenger side access cover. Remove the fastener, then remove the console side panel to expose the inside of the shifter assembly.

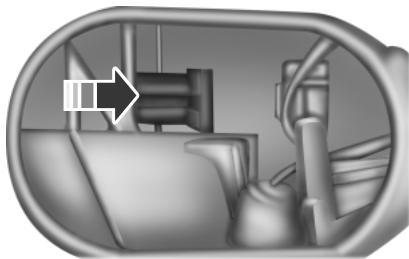

3. Locate the brake shift interlock lever on the passenger side of the shifter assembly.
4. Apply the brake pedal. Using a screwdriver (or similar tool), press and hold the white brake shift interlock lever forward while pulling the gearshift lever out of the P (Park) position and into the N (Neutral) position.
5. Reinstall the console side panel and attach the fastener.
6. Reinstall the access cover.
7. Apply the brake pedal, start the vehicle and release the parking brake. See your authorized dealer as soon as possible if this procedure is used.

#### If Your Vehicle Gets Stuck in Mud or Snow

**Note:** Do not rock the vehicle if the engine is not at normal operating temperature or damage to the transmission may occur.

**Note:** Do not rock the vehicle for more than a minute or damage to the transmission and tires may occur, or the engine may overheat.

If your vehicle gets stuck in mud or snow, it may be rocked out by shifting between forward and reverse gears, stopping between shifts in a steady pattern. Press lightly on the accelerator in each gear.



**MANUAL TRANSMISSION (IF EQUIPPED)****Using the Clutch**

Manual transmission vehicles have a starter interlock that prevents cranking the engine unless the clutch pedal is fully pressed.

To start the vehicle:

1. Make sure the parking brake is fully set.
2. Press the clutch pedal to the floor, then put the gearshift lever in the neutral position.
3. Start the engine.
4. Press the brake pedal and move the gearshift lever to the desired gear; 1 (First) or R (Reverse).
5. Release the parking brake, then slowly release the clutch pedal while slowly pressing on the accelerator.

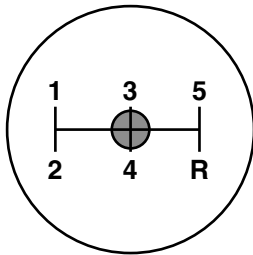

During each shift, the clutch pedal must be fully pressed to the floor. Make sure the floor mat is properly positioned so it doesn't interfere with the full extension of the clutch pedal.

**Note:** Failure to fully press the clutch pedal to the floor may cause increased shift efforts, prematurely wear transmission components or damage the transmission.

**Note:** Do not drive with your foot resting on the clutch pedal or use the clutch pedal to hold your vehicle at a standstill while waiting on a hill. These actions will reduce the life of the clutch.

**Recommended Shift Speeds**

The engine is designed to operate at a minimum of 1250 RPM for optimal power, fuel economy, and durability. When driving a vehicle equipped with a manual transmission, do not operate the engine below 1250 RPM while driving with the transmission in any gear (also known as "lugging"). This does not apply while starting or idling the engine while the transmission is in neutral and/or the clutch pedal is pressed. Lugging the engine below 1250 RPM may result in damage to the vehicle powertrain, poor fuel economy, poor acceleration, and undesirable noise, vibration, and harshness. Choose the next lowest gear until a proper engine RPM is reached.

**Note:** Do not downshift into 1 (First) when your vehicle is moving faster than 15 mph (24 km/h). This will damage the clutch.





Upshift according to the following chart:

<b>Recommended upshifts (for best fuel economy) when accelerating</b>	
<b>5-speed manual transmission</b>	
Shift from:	
1 - 2	14 mph (23 km/h)
2 - 3	24 mph (39 km/h)
3 - 4	32 mph (51 km/h)
4 - 5	44 mph (71 km/h)

### Reverse

**Note:** Make sure that your vehicle is at a complete stop before you shift into R (Reverse). Failure to do so may damage the transmission.

**Note:** The gearshift lever can only be moved into R (Reverse) by moving it from left of 3 (Third) and 4 (Fourth) before shifting into R (Reverse). This is a lockout feature that protects the transmission from accidentally being shifted into R (Reverse) from 5 (Fifth).

Hold the clutch pedal down and move the gearshift lever into the neutral position. Shift into R (Reverse).

If R (Reverse) is not fully engaged, press the clutch pedal down and return the gearshift to the neutral position. Release the clutch pedal for a moment, then press it down and shift to R (Reverse) again.

### Parking Your Vehicle



**WARNING:** Do not park your vehicle in Neutral, it may move unexpectedly and injure someone. Use 1 (First) gear and set the parking brake fully.

To park your vehicle:

1. Apply the brake and shift into the neutral position.
2. Fully apply the parking brake, hold the clutch pedal down, then shift into 1 (First).
3. Turn the ignition off.

### HILL START ASSIST (IF EQUIPPED)



**WARNING:** The hill start assist feature does not replace the parking brake. When you leave the vehicle, always apply the parking brake and shift the transmission into P (Park) for automatic transmission or 1st gear for manual transmissions.





**WARNING:** You must remain in the vehicle once you have activated the hill start assist feature.



**WARNING:** During all times, you are responsible for controlling the vehicle, supervising the hill start assist system and intervening, if required.



**WARNING:** If the engine is revved excessively, or if a malfunction is detected when the hill start assist feature is active, the hill start assist feature will be deactivated.

This feature makes it easier to pull away when the vehicle is on a slope without the need to use the parking brake. When this feature is active, the vehicle will remain stationary on the slope for two to three seconds after you release the brake pedal. This allows you time to move your foot from the brake to the accelerator pedal. The brakes are released automatically once the engine has developed sufficient drive to prevent the vehicle from rolling down the slope. This is an advantage when pulling away on a slope, (for example from a car park ramp, traffic lights or when reversing uphill into a parking space).

This feature is activated automatically on any slope that can result in significant vehicle rollback. This feature will not operate if the parking brake is activated.

### Using Hill Start Assist

**Note:** If the engine is revved excessively, hill start assist will be deactivated.

1. Press the brake pedal to bring the vehicle to a complete standstill. Keep the brake pedal pressed.
2. If the sensors detect that the vehicle is on a slope, the hill start assist feature will be activated automatically.
3. When you remove your foot from the brake pedal, the vehicle will remain on the slope without rolling away for approximately two or three seconds. This hold time will automatically be extended if you are in the process of driving off.
4. Drive off in the normal manner. The brakes will be released automatically.



**GENERAL INFORMATION**

**Note:** Occasional brake noise is normal. If a metal-to-metal, continuous grinding or continuous squeal sound is present, the brake linings may be worn-out and should be inspected by an authorized dealer. If the vehicle has continuous vibration or shudder in the steering wheel while braking, the vehicle should be inspected by an authorized dealer.

**Note:** Brake dust may accumulate on the wheels, even under normal driving conditions. Some dust is inevitable as the brakes wear and does not contribute to brake noise. See the *Vehicle Care* chapter for wheel cleaning instructions.



See the *Instrument Cluster* chapter for information on the brake system warning light.

Wet brakes result in reduced braking efficiency. Gently press the brake pedal a few times when driving from a car wash or standing water to dry the brakes.

**Brake Over Accelerator**

In the event the accelerator pedal becomes stuck or entrapped, apply steady and firm pressure to the brake pedal to slow the vehicle and reduce engine power. If you experience this condition, apply the brakes and bring your vehicle to a safe stop. Turn the engine off, shift to position **P** and apply the parking brake, then inspect the accelerator pedal for any interferences. If none are found and the condition persists, have your vehicle towed to the nearest authorized dealer.

**Brake Assist**

Brake assist detects when you brake heavily by measuring the rate at which you press the brake pedal. It provides maximum braking efficiency as long as you press the pedal. Brake assist can reduce stopping distances in critical situations.

**Anti-Lock Brake System (ABS)**

This system helps you maintain steering control during emergency stops by keeping the brakes from locking.



The ABS lamp momentarily illuminates when the ignition is turned on. If the light does not illuminate during start-up, remains on or flashes, the ABS may be disabled and may need to be serviced.





If the ABS is disabled, normal braking is still effective. If the brake warning lamp illuminates with the parking brake released, have your brake system serviced immediately.

### HINTS ON DRIVING WITH ANTI-LOCK BRAKES

When the system is operating, the brake pedal will pulse and may travel further. Maintain pressure on the brake pedal. You may also hear a noise from the system. This is normal.

The ABS will not eliminate the dangers inherent when:

- you drive too closely to the vehicle in front of you.
- your vehicle is hydroplaning.
- you take corners too fast.
- the road surface is poor.

### PARKING BRAKE



**WARNING:** If the parking brake is fully released, but the brake warning lamp remains illuminated, the brakes may not be working properly. See your authorized dealer as soon as possible.



**WARNING:** Always set the parking brake fully and make sure that the transmission selector lever is securely latched in position **P** (automatic transmission) or in position **1** (manual transmission).

To set the parking brake, pull the parking brake handle up as far as possible.

To release the parking brake, press and hold the button located at the end of the parking brake handle. Pull the handle up slightly, then push the handle down.



**PRINCIPLES OF OPERATION**

The traction control system helps avoid drive wheel spin and loss of traction.

If your vehicle begins to slide, the system applies the brakes to individual wheels and, when needed, reduces engine power at the same time. If the wheels spin when accelerating on slippery or loose surfaces, the system reduces engine power in order to increase traction.

**USING TRACTION CONTROL**

In certain situations (e.g. stuck in snow or mud), turning the traction control off may be beneficial as this allows the wheels to spin with full engine power. Turn off the traction control system through the information display. This option may not be available for all models. See the *Information Displays* chapter.

**System Indicator Lights and Messages**

**WARNING:** If a failure has been detected within the Traction Control System, the stability control light will illuminate steadily. Verify that the Traction Control System was not manually disabled through the information display. If the stability control light still illuminates steadily, have the system serviced by an authorized dealer immediately. Operating your vehicle with Traction Control disabled could lead to an increased risk of loss of vehicle control, vehicle rollover, personal injury and death.



The stability control light temporarily illuminates on engine start-up and flashes when a driving condition activates the stability system.





The stability control off light temporarily illuminates on engine start-up and stays on when the traction control system is turned off.

When the traction control system is turned off or on, a message appears in the information display showing system status.



**PRINCIPLES OF OPERATION**

 **WARNING:** Vehicle modifications involving braking system, aftermarket roof racks, suspension, steering system, tire construction and/or wheel/tire size may change the handling characteristics of the vehicle and may adversely affect the performance of the AdvanceTrac® system. In addition, installing any stereo loudspeakers may interfere with and adversely affect the AdvanceTrac® system. Install any aftermarket stereo loudspeaker as far as possible from the front center console, the tunnel, and the front seats in order to minimize the risk of interfering with the AdvanceTrac® sensors. Reducing the effectiveness of the AdvanceTrac® system could lead to an increased risk of loss of vehicle control, vehicle rollover, personal injury and death.

 **WARNING:** Remember that even advanced technology cannot defy the laws of physics. It is always possible to lose control of a vehicle due to inappropriate driver input for the conditions. Aggressive driving on any road condition can cause you to lose control of your vehicle increasing the risk of personal injury or property damage. Activation of the AdvanceTrac® system is an indication that at least some of the tires have exceeded their ability to grip the road; this could reduce the operator's ability to control the vehicle potentially resulting in a loss of vehicle control, vehicle rollover, personal injury and death. If your AdvanceTrac® system activates, SLOW DOWN.

The AdvanceTrac® system helps you keep control of your vehicle when on a slippery surface. The electronic stability control (ESC) portion of the system helps avoid skids and lateral slides and the traction control system (TCS) helps avoid drive wheel spin and loss of traction. (For details on TCS operation, see the *Traction Control* chapter.)



**A** Vehicle without AdvanceTrac® skidding off its intended route.

**B** Vehicle with AdvanceTrac® maintaining control on a slippery surface.

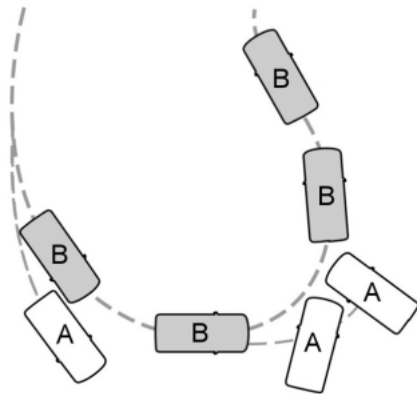



**USING ADVANCETRAC®**

The system automatically activates when you start your engine. The AdvanceTrac® system cannot be completely turned off, but the ESC portion of the system is disabled when the transmission is in R (Reverse). The traction control portion of the system can be turned off independently. See the *Traction Control* chapter.



**SENSING SYSTEM (IF EQUIPPED)**

 **WARNING:** To help avoid personal injury, please read and understand the limitations of the system as contained in this section. Sensing is only an aid for some (generally large and fixed) objects when moving in reverse on a flat surface at parking speeds. Traffic control systems, inclement weather, air brakes, and external motors and fans may also affect the function of the sensing system; this may include reduced performance or a false activation.

 **WARNING:** To help avoid personal injury, always use caution when in R (Reverse) and when using the sensing system.

 **WARNING:** This system is not designed to prevent contact with small or moving objects. The system is designed to provide a warning to assist the driver in detecting large stationary objects to avoid damaging the vehicle. The system may not detect smaller objects, particularly those close to the ground.

 **WARNING:** Certain add-on devices such as large trailer hitches, bike or surfboard racks and any device that may block the normal detection zone of the system, may create false beeps.

**Note:** Keep the sensors (located on the bumper/fascia) free from snow, ice and large accumulations of dirt. If the sensors are covered, the system's accuracy can be affected. Do not clean the sensors with sharp objects.

**Note:** If your vehicle sustains damage to the bumper/fascia, leaving it misaligned or bent, the sensing zone may be altered causing inaccurate measurement of obstacles or false alarms.

**Note:** If your vehicle is equipped with MyKey®, it is possible to prevent turning the sensing system off. Refer to the *MyKey®* chapter.

The sensing system warns the driver of obstacles within a certain range of the bumper area. The system turns on automatically whenever the ignition is switched on.

When receiving a detection warning, the radio volume is reduced to a predetermined level. After the warning goes away, the radio volume returns to the previous level.





**Using the Front and Rear Sensing System**

**Rear Sensing System**

The rear sensors are only active when the transmission is in R (Reverse). As the vehicle moves closer to the obstacle, the rate of the audible warning increases. When the obstacle is fewer than 12 inches (30 centimeters) away, the warning sounds continuously. If a stationary or receding object is detected farther than 12 inches (30 centimeters) from the side of the vehicle, the tone sounds for only three seconds. Once the system detects an object approaching, the warning sounds again.

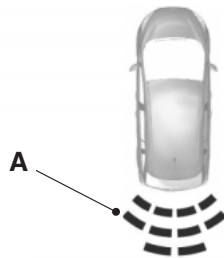

A. Coverage area of up to 6 feet (2 meters) from the rear bumper (with a decreased coverage area at the outer corners of the bumper).

The system detects certain objects while the transmission is in R (Reverse):

- and moving toward a stationary object at a speed of 3 mph (5 km/h) or less but not moving,
- and a moving object is approaching the rear of the vehicle at a speed of 3 mph (5 km/h) or less
- and moving at a speed of less than 3 mph (5 km/h) and a moving object is approaching the rear of the vehicle at a speed of less than 3 mph (5 km/h).

The system can be turned off using the information display control. Refer to the *Information Display* chapter. If a fault is present in the system, a warning message appears in the information display and does not allow the driver to switch the faulted system on.



**Front Sensing System**

The front sensors are active when the gearshift is in any position other than P (Park) or N (Neutral) and the vehicle speed is below 7 mph (12 km/h).

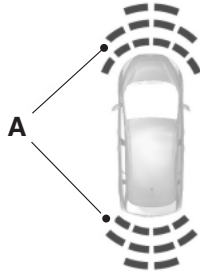

A. Coverage area of up to 27 inches (70 centimeters) from the front of the vehicle and about 6–14 inches (15–35 centimeters) to the side of the front end of the vehicle. Refer to the reverse sensing section for details on coverage area.

The system sounds an audible warning when obstacles are near either bumper in the following manner:

- Objects detected by the front sensors are indicated by a high-pitched tone from the front radio speakers.
- Objects detected by the rear sensors are indicated by a lower pitched tone from the rear radio speakers.
- The sensing system reports the obstacle which is closest to the front or rear of the vehicle. For example, if an obstacle is 24 inches (60 centimeters) from the front of the vehicle and, at the same time, an obstacle is only 16 inches (40 centimeters) from the rear of the vehicle, the lower pitched tone sounds.
- An alternating warning sounds from the front and rear if there are objects at both bumpers that are closer than 10 inches (25 centimeters).

For specific information on the reverse sensing portion of the system, refer to that section.

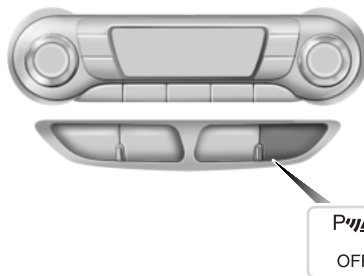

Press the button to switch the system off. It will remain off for the entire ignition cycle.



### ACTIVE PARK ASSIST (IF EQUIPPED)



**WARNING:** This system is designed to be a supplementary park aid. It may not work in all conditions and is not intended to replace the driver's attention and judgment. The driver is responsible for avoiding hazards and maintaining a safe distance and speed, even when the system is in use.

**Note:** The driver is always responsible for controlling the vehicle, supervising the system and intervening if required.

The system detects an available parallel parking space and automatically steers the vehicle into the space (hands-free) while you control the accelerator, gearshift and brakes. The system visually and/or audibly instructs the driver to park the vehicle.

The system may not function correctly if something passes between the front bumper and the parking space (i.e. a pedestrian or cyclist) or if the edge of the neighboring parked vehicle is high from the ground (i.e. a bus, tow truck or flatbed truck).

**Note:** The sensors may not detect objects in heavy rain or other conditions that cause disruptive reflections.

**Note:** The sensors may not detect objects with surfaces that absorb ultrasonic waves.

The system should not be used if:

- a foreign object (i.e. bike rack or trailer) is attached to the front or rear of the vehicle or at another location close to the sensors.
- an overhanging object (i.e. surfboard) is attached to the roof.
- the front bumper or side sensors are damaged (i.e. in a collision) or obstructed by a foreign object (i.e. front bumper cover).
- a mini-spare tire is in use.

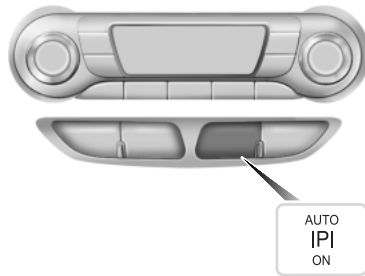

**Using Active Park Assist**

Press the button; the touch screen displays a message and a corresponding graphic to indicate it's searching for a parking space. Use the turn signal to indicate which side of the vehicle you want the system to search on.

**Note:** If the turn signal is not on, the system automatically searches on the vehicle's passenger side.

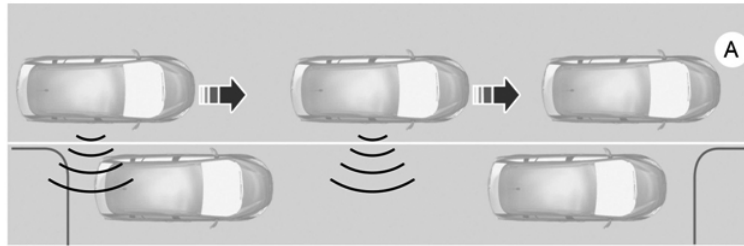

When a suitable space is found, the touch screen displays a message and a chime sounds. Slow down and stop at approximately position (A), then follow the instructions on the touch screen.

**Note:** You must observe that the selected space remains clear of obstructions at all times in the maneuver.

**Note:** Vehicles with overhanging loads (e.g. a bus or a truck), street furniture and other items may not be detected by active park assist. You must ensure the selected space is suitable for parking.

**Note:** The vehicle should be driven as parallel to other vehicles as possible while passing a parking space.

**Note:** The system always offers the last detected parking space (i.e. if the vehicle detects multiple spaces while you are driving, it offers the last one).

**Note:** If driven above approximately 20 mph (35 km/h), the touch screen shows a message to alert the driver to reduce vehicle speed.



**Automatic Steering into Parking Space**

**Note:** If vehicle speed exceeds 7 mph (12 km/h), the system turns off and you need to take full control of the vehicle.

**Note:** If a maneuver is interrupted before completion, the system turns off. The steering wheel position will not indicate the actual position of the steering and you have to full take control of the vehicle.

With hands off the wheel (and nothing obstructing its movement) and the transmission in R (Reverse), the vehicle steers itself as instructions to safely move the vehicle back and forward in the space are displayed in the touch screen. While reversing, the touch screen displays a message instructing the driver to check their surroundings (for safety reasons) and to back-up slowly, accompanied by a corresponding graphic.



When you think the vehicle has enough space in front and behind it, or you hear a solid tone from the parking aid, bring the vehicle to a complete stop.

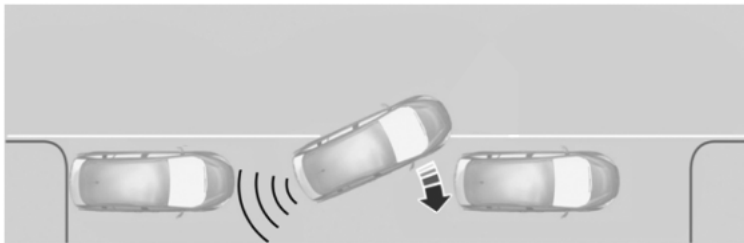

When automatic steering is finished, the touch screen displays a message indicating that the active park assist process is done. The driver is responsible for checking the parking job and making any necessary corrections before putting the transmission in P (Park).



**Deactivating the Park Assist Feature**

The system can be deactivated manually by:

- pressing the active park assist button
- grabbing the steering wheel
- driving above approximately 20 mph (35 km/h) for 30 seconds during an active park search
- driving above 7 mph (12 km/h) during automatic steering
- turning off the traction control system.

Certain vehicle conditions can also deactivate the system:

- Traction control has activated on a slippery or loose surface.
- Anti-lock brake system activation or failure.
- Any door (except the driver's) opens.
- Something touches the steering wheel.

If a problem occurs with the system, a warning message is displayed, followed by a chime. Occasional active park assist messages may occur in normal operation. For recurring or frequent active park assist faults, contact an authorized dealer to have your vehicle serviced.

**Troubleshooting the System**

<b>The system does not look for a space</b>
The traction control system may be off
Any door (except the driver's) may not be completely closed
<b>The system does not offer a particular space</b>
Something may be contacting the front bumper or side sensors
There is not enough room on both sides of the vehicle in order to park
There is not enough space for the parking maneuver on the opposite side of the parking space
The vehicle is farther than 5 ft (1.5 m) from the parking space
The vehicle is closer than 16 in. (40 cm) from neighboring parked vehicles
The transmission is in R (Reverse); the vehicle must be moving forward to detect a parking space



<b>The system does not position the vehicle where I want in the space</b>
The vehicle is rolling in the opposite direction of the transmission (i.e. rolling forward when R [Reverse] is selected)
The transmission is in R (Reverse); the vehicle must be moving forward to detect a parking space
An irregular curb along the parking space prevents the system from aligning the vehicle properly
Vehicles or objects bordering the space may not be positioned correctly
The vehicle was pulled too far past the parking space. The system performs best when you drive the same distance past the parking space
The tires may not be installed or maintained correctly (i.e. not inflated correctly, improper size, or of different sizes)
A repair or alteration has changed detection capabilities
A parked vehicle has a high attachment (i.e. salt sprayer, snowplow, moving truck bed, etc.)
The parking space length or position of parked objects changed after your vehicle passed
The temperature around your vehicle changes quickly (i.e. driving from a heated garage into the cold, or after leaving a car wash)

**REAR VIEW CAMERA SYSTEM (IF EQUIPPED)**

 **WARNING:** The rear view camera system is a reverse aid supplement device that still requires the driver to use it in conjunction with the interior and exterior mirrors for maximum coverage.

 **WARNING:** Objects that are close to either corner of the bumper or under the bumper, might not be seen on the screen due to the limited coverage of the camera system.

 **WARNING:** Back up as slow as possible since higher speeds might limit your reaction time to stop the vehicle.



 **WARNING:** Use caution when using the rear video camera and the liftgate is ajar. If the liftgate is ajar, the camera will be out of position and the video image may be incorrect. All guidelines (if enabled) have been removed when the liftgate is ajar.

 **WARNING:** Use caution when turning camera features on or off while in R (Reverse). Make sure the vehicle is not moving.

The rear view camera system provides a video image of the area behind the vehicle. The image will be displayed in either in the rear view mirror or the display in the center of the instrument panel.

During operation, lines appear in the display which represent your vehicle's path and proximity to objects behind the vehicle.

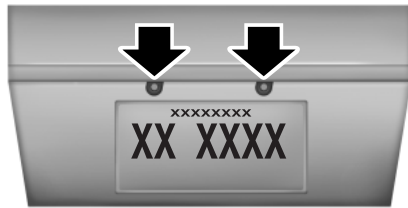

The camera is located in the rear of the vehicle near the license plate. It can be found in either location depending on the vehicle model.

### Using the Rear View Camera System

The rear view camera system displays what is behind your vehicle when you place the transmission in R (Reverse). The system uses three types of guides to help you see what is behind your vehicle:

1. Active guidelines: Show the intended path of the vehicle when reversing.
2. Fixed guidelines: Show the actual path the vehicle is moving in while reversing in a straight line, which can be helpful when backing into a parking space or aligning the vehicle with another object behind the vehicle.
3. Centerline: Helps align the center of the vehicle with an object (i.e. a trailer).

**Note:** If the transmission is in R (Reverse) and the trunk/liftgate is ajar, no rear view camera features are displayed.





**Note:** If the image comes on while the transmission is not in R (Reverse), have the system inspected by your authorized dealer.

**Note:** When towing, the camera only sees what is being towed behind the vehicle. This might not provide adequate coverage as it usually provides in normal operation and some objects might not be seen. In some vehicles, the guidelines may disappear once the trailer tow connector is engaged.

**Note:** The camera may not operate correctly under the following conditions:

- Nighttime or dark areas if one or both reverse lamps are not operating. Do not use the rear view camera display when lighting is low until both reverse lamps are functional.
- The camera's view is obstructed by mud, water or debris. Clean the lens with a soft, lint-free cloth and non-abrasive cleaner.
- The rear of the vehicle is hit or damaged, causing the camera to become misaligned. Check with your authorized dealer to have the rear view camera system checked for proper coverage and operation.

***Adjusting the Rear View Camera Settings (If Equipped)***

To access any of the rear view camera system settings, make the following selections in the touch screen when the transmission is not in R (Reverse):

1. Menu
2. Vehicle
3. Rear View Camera

After changing a system setting, the touch screen shows a preview of the feature(s) selected.



### Guidelines and the Centerline

**Note:** Active guidelines and fixed guidelines are only available when the transmission is in R (Reverse).

**Note:** The centerline is only available if Active or Fixed guidelines are on.

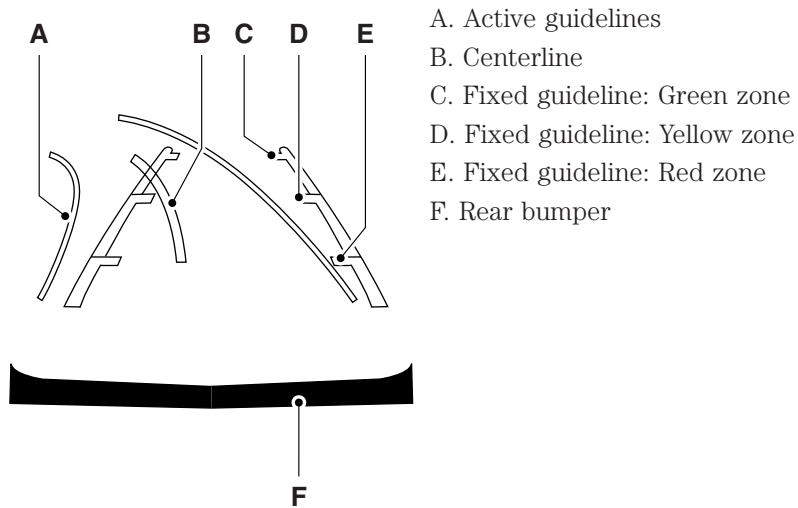

Active guidelines are only shown with fixed guidelines. To use active guidelines, turn the steering wheel to point the guidelines toward an intended path. If the steering wheel position is changed while reversing, the vehicle might deviate from the original intended path.

The fixed and active guidelines fade in and out depending on the steering wheel position. When the steering wheel position is straight, the active guidelines are not shown.

Always use caution while reversing. Objects in the red zone are closest to your vehicle and objects in the green zone are further away. Objects are getting closer to your vehicle as they move from the green zone to the yellow or red zones. Use the side view mirrors and rear view mirror to get better coverage on both sides and rear of the vehicle.

Selectable settings for this feature are ACTIVE + FIXED, FIXED and OFF.



**Visual Park Aid Alert**

**Note:** Visual park alert is only available when the transmission is in R (Reverse).

**Note:** The reverse sensing system is not effective at speeds above 3 mph (5 km/h) and may not detect certain angular or moving objects.

The visual park aid alert allows the driver to view the area that is being detected by the reverse sensing system. The system uses red, yellow and green highlights which appear on top of the video image when an object is detected by the reverse sensing system. The alert highlights the closest object detected. The reverse sensing alert can be disabled and if visual park aid alert is enabled, highlighted areas are still displayed.

Refer to *Adjusting the Rear View Camera Settings* above on how to enable or disable the visual park alert feature.

**Manual Zoom**

**WARNING:** When manual zoom is on, the full area behind the vehicle is not shown. Be aware of your surroundings when using the manual zoom feature.

**Note:** Manual zoom is only available when the transmission is in R (Reverse).

**Note:** When manual zoom is enabled, only the centerline is shown.

Allows the driver to get a closer view of an object behind the vehicle. The zoomed image keeps the bumper in the image to provide a reference. The zoom is only active while the transmission is in R (Reverse). When the transmission is shifted out of R (Reverse), the feature automatically turns off and must be reset when it is used again.

Selectable settings for this feature are OFF, Level 1, Level 2 or Level 3. Press the up and down arrows to change the view. The selection level appears between the buttons (i.e. Level 1). The default setting for the manual zoom is OFF.

**Rear Camera Delay**

When shifting the transmission out of R (Reverse) and into any gear other than P (Park), the camera image remains in the display until the vehicle speed reaches 6 mph (10 km/h). This occurs when the rear camera delay feature is on, or until a radio button is selected.

Selectable settings for this feature are ON and OFF. The default setting for the rear camera delay is OFF.



**PRINCIPLES OF OPERATION**

Cruise control lets you maintain a set speed without keeping your foot on the accelerator pedal.

**USING CRUISE CONTROL (IF EQUIPPED)**

**WARNING:** Do not use cruise control in heavy traffic or on roads that are winding, slippery or unpaved.

**Note:** Vehicle speed may vary momentarily when driving up or down a steep hill. Apply the brakes if the vehicle speed increases above the set speed while driving downhill.

**Note:** Cruise control will disengage if the vehicle speed decreases more than 10 mph (16 km/h) below your set speed while driving uphill.

The cruise controls are located on the steering wheel.

**Switching Cruise Control On**

Press and release **ON**.

**Setting a Speed**

Press and release **SET+**.



The indicator will appear in the instrument cluster.



### Changing the Set Speed

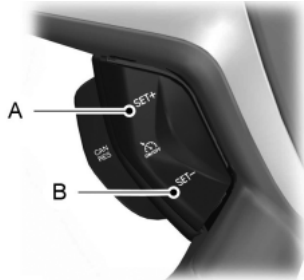

- A. Accelerate
- B. Decelerate

- Press and hold **SET+** or **SET-**. Release the control when you reach the desired speed.
- Press and release **SET+** or **SET-**. The set speed will change in approximately 1 mph (2 km/h) increments.
- Press the accelerator or brake pedal until you reach the desired speed. Press and release **SET+**.

### Canceling the Set Speed

Pull **CAN** toward you and release, tap the brake pedal or press the clutch pedal. You will not erase the set speed.

**Note:** When you use the clutch pedal to cancel a set speed, the engine speed may briefly increase.

### Resuming the Set Speed

Pull **RES** toward you and release.

### Switching Cruise Control Off

**Note:** You will erase the set speed if you switch the system off.

Press and release **OFF** or switch the ignition off.



**ECO MODE**

This system assists the driver in driving more efficiently by constantly monitoring characteristics of gear changing, anticipation of traffic conditions and speeds while driving.

The value of these characteristics is represented by petals shown in the display, with five petals being the most efficient. The more efficiently you drive, the better the rating, and the better your overall fuel economy.

**Note:** These efficiency values do not result in a defined fuel consumption figure. It might vary as it is not only related to these driving habits, but also influenced by many other factors such as short trips and cold starts.

**Note:** Frequent short trips, where the engine does not fully warm up, will also increase fuel consumption.

The system is accessed using the information display control. Refer to the trip computer table in the *Information Displays* chapter.

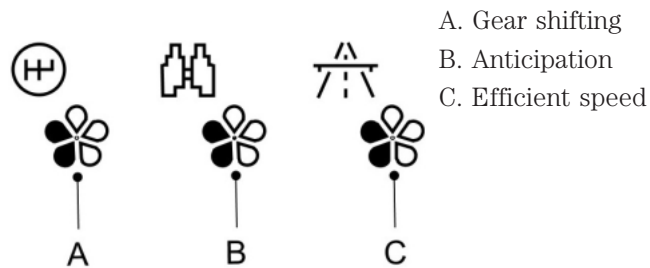
**Type 1*****Gear shifting***

To improve fuel economy, use the highest gear appropriate for the road conditions.

***Anticipation***

Adjust your vehicle speed and the distance to other vehicles to avoid the need for heavy braking or acceleration to improve fuel economy.

***Efficient speed***

Reduce your cruising speed on open roads to improve economy. Higher speeds use more fuel.



**Type 2 and 3**

The relevant information is shown in the display.

**Resetting Eco Mode**

Reset the average fuel consumption by using the information display control.

**Note:** New values may take a short time to calculate.

**STEERING****Electric Power Steering**

**WARNING:** The electric power steering system has diagnostic checks that continuously monitor the system to ensure proper operation. When a system error is detected a steering message will appear in the information display.



**WARNING:** The electric power steering system has diagnostic checks that continuously monitor the system to ensure proper operation of the electronic system. When an electronic error is detected, a message will be displayed in the information display. If this happens, stop the vehicle in a safe place, and turn off the engine. After at least 10 seconds, reset the system by restarting the engine, and watch the information display for a steering message. If a steering message returns, or returns while driving, take the vehicle to your dealer to have it checked.



**WARNING:** Obtain immediate service if a system error is detected. You may not notice any difference in the feel of your steering, but a serious condition may exist. Failure to do so may result in loss of steering control.

Your vehicle is equipped with an electric power-assisted steering system. There is no fluid reservoir to check or fill.



If your vehicle loses electrical power while you are driving (or if the ignition is turned off), you can steer the vehicle manually, but it takes more effort. Extreme continuous steering may increase the effort it takes for you to steer. This occurs to prevent internal overheating and permanent damage to your steering system. If this should occur, you will neither lose the ability to steer the vehicle manually nor will it cause permanent damage. Typical steering and driving maneuvers will allow the system to cool and steering assist will return to normal.

When a steering system error is detected, steering messages may appear in the information display.

### ***Steering Tips***

If the steering wanders or pulls, check for:

- an improperly inflated tire
- uneven tire wear
- loose or worn suspension components
- loose or worn steering components
- improper vehicle alignment

A high crown in the road or high crosswinds may also make the steering seem to wander/pull.





**LOAD LIMIT****Vehicle loading**

This section will guide you in the proper loading of your vehicle to keep your loaded vehicle weight within its design rating capability. Properly loading your vehicle will provide maximum return of vehicle design performance. Before loading your vehicle, familiarize yourself with the following terms for determining your vehicle's weight ratings from the vehicle's Tire Label or Safety Compliance Certification Label:

**Base Curb Weight** – is the weight of the vehicle including a full tank of fuel and all standard equipment. It does not include passengers, cargo, or optional equipment.

**Vehicle Curb Weight** – is the weight of your new vehicle when you picked it up from your authorized dealer plus any aftermarket equipment.



**Payload** – is the combined weight of cargo and passengers that the vehicle is carrying. The maximum payload for your vehicle can be found on the Tire Label on the B-Pillar or the edge of the driver's door (vehicles exported outside the US and Canada may not have a Tire Label). Look for **“THE COMBINED WEIGHT OF OCCUPANTS AND CARGO SHOULD NEVER EXCEED XXX kg OR XXX lb.”** for maximum payload. The payload listed on the Tire Label is the maximum payload for the vehicle as built by the assembly plant. If any aftermarket or authorized-dealer installed equipment has been installed on the vehicle, the weight of the equipment must be subtracted from the payload listed on the Tire Label in order to determine the new payload.



**WARNING:** The appropriate loading capacity of your vehicle can be limited either by volume capacity (how much space is available) or by payload capacity (how much weight the vehicle should carry). Once you have reached the maximum payload of your vehicle, do not add more cargo, even if there is space available. Overloading or improperly loading your vehicle can contribute to loss of vehicle control and vehicle rollover.

Example only:

**TIRE AND LOADING INFORMATION**

SEATING CAPACITY TOTAL 5 FRONT 2 REAR 3

The combined weight of occupants and cargo should never exceed : XXX kg or XXX lbs.

TIRE	SIZE	COLD TIRE PRESSURE	SEE OWNERS MANUAL FOR ADDITIONAL INFORMATION
FRONT	LT225/75R 16.5E	200 KPA, 29 PSI	
REAR	LT225/75R 16.5E	200 KPA, 29 PSI	
SPARE	T145/80D16 P225/60R17	420 KPA, 60 PSI 200 KPA, 29 PSI	

**TIRE AND LOADING INFORMATION**  
**RENSEIGNEMENTS SUR LES PNEUS ET LE CHARGEMENT**

SEATING CAPACITY TOTAL 5 FRONT 2 REAR 3  
NOMBRE DE PLACES TOTAL 5 AVANT 2 ARRIERE 3

The combined weight of occupants and cargo should never exceed 492 kg or 1085 lbs.  
Le poids total des occupants et du chargement ne doit jamais dépasser 492 kg ou 1085 lb.

TIRE PNEU	SIZE DIMENSIONS	COLD TIRE PRESSURE PRESSION DES PNEUS A FROID	SEE OWNER'S MANUAL FOR ADDITIONAL INFORMATION  VOIR LE MANUEL DE L'USAGER POUR PLUS DE RENSEIGNEMENTS
FRONT AVANT	P235/70R16	240 KPA, 35 PSI	
REAR ARRIERE	P235/70R16	240 KPA, 35 PSI	
SPARE DE SECOURS	T145/90R17	415 KPA, 60 PSI	



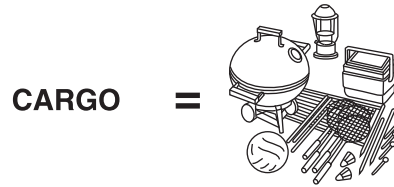

**Cargo Weight** – includes all weight added to the Base Curb Weight, including cargo and optional equipment.

**GAW (Gross Axle Weight)** – is the total weight placed on each axle (front and rear) – including vehicle curb weight and all payload.

**GAWR (Gross Axle Weight Rating)** – is the maximum allowable weight that can be carried by a single axle (front or rear). **These numbers are shown on the Safety Compliance Certification Label. The label shall be affixed to either the door hinge pillar, door-latch post, or the door edge that meets the door-latch post, next to the driver's seating position. The total load on each axle must never exceed its GAWR.**

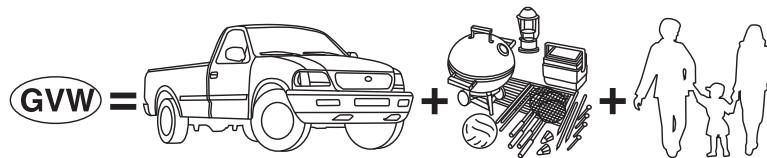

**GVW (Gross Vehicle Weight)** – is the Vehicle Curb Weight + cargo + passengers.

**GVWR (Gross Vehicle Weight Rating)** – is the maximum allowable weight of the fully loaded vehicle (including all options, equipment, passengers and cargo). **The GVWR is shown on the Safety Compliance Certification Label. The label shall be affixed to either the door hinge pillar, door-latch post, or the door edge that meets the door-latch post, next to the driver's seating position. The GVW must never exceed the GVWR.**



- Example only:

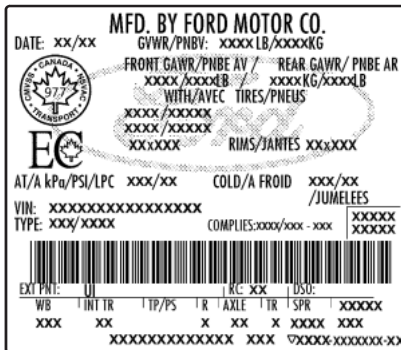
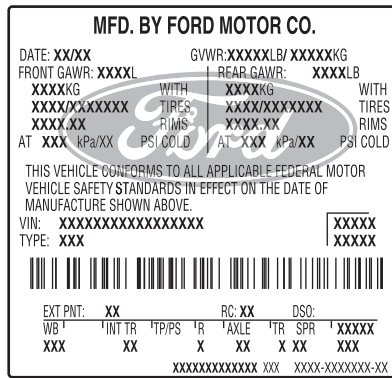

**WARNING:** Exceeding the Safety Compliance Certification Label vehicle weight rating limits could result in substandard vehicle handling or performance, engine, transmission and/or structural damage, serious damage to the vehicle, loss of control and personal injury.

**WARNING:** Do not exceed the GVWR or the GAWR specified on the Safety Compliance Certification Label.





**WARNING:** Do not use replacement tires with lower load carrying capacities than the original tires because they may lower the vehicle's GVWR and GAWR limitations. Replacement tires with a higher limit than the original tires do not increase the GVWR and GAWR limitations.



**WARNING:** Exceeding any vehicle weight rating limitation could result in serious damage to the vehicle and/or personal injury.

**Steps for determining the correct load limit:**

1. Locate the statement "The combined weight of occupants and cargo should never exceed XXX kg or XXX lbs." on your vehicle's placard.
2. Determine the combined weight of the driver and passengers that will be riding in your vehicle.
3. Subtract the combined weight of the driver and passengers from XXX kg or XXX lbs.
4. The resulting figure equals the available amount of cargo and luggage load capacity. For example, if the "XXX" amount equals 1,400 lbs. and there will be five 150 lb. passengers in your vehicle, the amount of available cargo and luggage load capacity is 650 lbs. ( $1400 - 5 \times 150 = 650$  lbs.). In metric units ( $635 - 5 \times 68 = 295$  kg.)
5. Determine the combined weight of luggage and cargo being loaded on the vehicle. That weight may not safely exceed the available cargo and luggage load capacity calculated in Step 4.

The following gives you a few examples on how to calculate the available amount of cargo and luggage load capacity:

- Another example for your vehicle with 1400 lb. (635 kg) of cargo and luggage capacity. You decide to go golfing. Is there enough load capacity to carry you, 4 of your friends and all the golf bags? You and four friends average 220 lb. (99 kg) each and the golf bags weigh approximately 30 lb. (13.5 kg) each. The calculation would be:  $1400 - (5 \times 220) - (5 \times 30) = 1400 - 1100 - 150 = 150$  lb. Yes, you have enough load capacity in your vehicle to transport four friends and your golf bags. In metric units, the calculation would be:  $635 \text{ kg} - (5 \times 99 \text{ kg}) - (5 \times 13.5 \text{ kg}) = 635 - 495 - 67.5 = 72.5$  kg.



- A final example for your vehicle with 1400 lb. (635 kg) of cargo and luggage capacity. You and one of your friends decide to pick up cement from the local home improvement store to finish that patio you have been planning for the past 2 years. Measuring the inside of the vehicle with the rear seat folded down, you have room for 12-100 lb. (45 kg) bags of cement. Do you have enough load capacity to transport the cement to your home? If you and your friend each weigh 220 lb. (99 kg), the calculation would be:  $1400 - (2 \times 220) - (12 \times 100) = 1400 - 440 - 1200 = -240$  lb. No, you do not have enough cargo capacity to carry that much weight. In metric units, the calculation would be:  $635 \text{ kg} - (2 \times 99 \text{ kg}) - (12 \times 45 \text{ kg}) = 635 - 198 - 540 = -103$  kg. You will need to reduce the load weight by at least 240 lb. (104 kg). If you remove 3-100 lb. (45 kg) cement bags, then the load calculation would be:

$1400 - (2 \times 220) - (9 \times 100) = 1400 - 440 - 900 = 60$  lb. Now you have the load capacity to transport the cement and your friend home. In metric units, the calculation would be:  $635 \text{ kg} - (2 \times 99 \text{ kg}) - (9 \times 45 \text{ kg}) = 635 - 198 - 405 = 32$  kg.

The above calculations also assume that the loads are positioned in your vehicle in a manner that does not overload the Front or the Rear Gross Axle Weight Rating specified for your vehicle on the Safety Compliance Certification Label. The label shall be affixed to either the door hinge pillar, door-latch post, or the door edge that meets the door-latch post, next to the driver's seating position.



**TOWING A TRAILER**

**WARNING:** Never tow a trailer with this vehicle. Your vehicle is not equipped to tow. No towing packages are available through an authorized dealer.

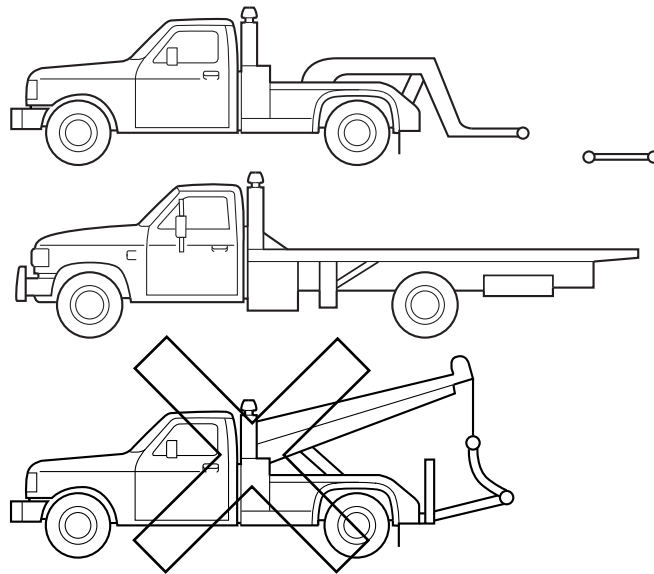
**WRECKER TOWING**

If you need to have your vehicle towed, contact a professional towing service or, if you are a member of a roadside assistance program, your roadside assistance service provider.

It is recommended that your vehicle be towed with a wheel lift and dollies or flatbed equipment. Do not tow with a slingbelt. Ford Motor Company has not approved a slingbelt towing procedure. If the vehicle is towed incorrectly, or by any other means, vehicle damage may occur.

Ford Motor Company produces a towing manual for all authorized tow truck operators. Have your tow truck operator refer to this manual for proper hook-up and towing procedures for your vehicle.



If your vehicle is towed from the rear with wheel lift equipment, the front wheels must be placed on a dolly to prevent damage to the transmission.

If your vehicle is towed from the front with wheel lift equipment, it is recommended that the rear wheels be placed on a dolly to prevent damage to the rear fascia.

### TOWING THE VEHICLE ON FOUR WHEELS

#### Emergency Towing

In the event your vehicle becomes disabled (without access to wheel dollies, car-hauling trailer, or flatbed transport vehicle), it can be flat-towed (all wheels on the ground, regardless of the powertrain/transmission configuration) under the following conditions:

- The vehicle is facing forward so that it is towed in a forward direction.
- The transmission is placed in position **N**. See *Automatic transmission* in the *Transmission* chapter if you cannot move the transmission into **N**.
- Maximum speed is 35 mph (56 km/h).
- Maximum distance is 50 miles (80 kilometers).

#### Recreational Towing

**Note:** Put your climate control system in recirculated air mode to prevent exhaust fumes from entering the vehicle. Refer to the *Climate Controls* chapter for more information.

**Note:** The vehicle must be towed in the forward position to ensure no damage is done to the internal transmission components. In addition, it is recommended that you follow the instructions provided by the aftermarket manufacturer of the towing equipment, if provided.

Follow these guidelines if you have a need for recreational (RV) towing. An example of recreational towing would be towing your vehicle behind a motor home. These guidelines are designed to ensure that your transmission is not damaged.

Before you tow your vehicle, follow these directions for your specific vehicle configuration **after** it is hooked-up to the RV or tow dolly:





**Vehicles with a Manual Transmission**

1. Release the parking brake.
2. Move the gearshift to the neutral position.
  - The maximum towing speed is 70 mph (113 km/h).
  - There is no limitation on towing distance.

**Vehicles with an Automatic Transmission but No Push Button Start System**

**Note:** There **must** be battery power to properly move the transmission's internal components to N (Neutral) in Step 3. Also, moving the gearshift to the N (Neutral) position without first turning the ignition to the on (II) position limits the towing capability to 35 mph (56 km/h) and 50 miles (80 kilometers).

1. Release the parking brake.
2. Turn the ignition to the on (II) position.
3. Press the brake pedal, then move the gearshift to the N (Neutral) position.
4. Wait for TRANSMISSION READY to appear in the multi-function display, then turn the ignition to the off (0) position and release the brake pedal.
5. Disconnect the negative (black) cable from the battery. (The anti-theft system is disabled until the battery cable is reconnected.) Refer to *Battery* in the *Maintenance* chapter when disconnecting and reconnecting the battery cable.
  - The maximum towing speed is 70 mph (113 km/h).
  - There is no limitation on towing distance.

When done towing, start the engine within 15 minutes of reconnecting the battery cable. When reconnecting that cable, tighten it until it's snug against the terminal; be careful not to overtighten.

**Vehicles with an Automatic Transmission and Push Button Start System**

**Note:** There **must** be battery power to properly move the transmission's internal components to N (Neutral) in Step 3. Also, moving the gearshift to the N (Neutral) position without first turning the ignition to the on (II) position limits the towing capability to 35 mph (56 km/h) and 50 miles (80 kilometers).

1. Release the parking brake.
2. Activate the ignition by pressing the START/STOP button, but **not** applying the brake pedal.



3. Press the brake pedal, then move the gearshift to the N (Neutral) position. Release the brake pedal.
4. Wait for TRANSMISSION READY to appear in the multi-function display, then deactivate the ignition by pressing the START/STOP button.
5. Disconnect the negative (black) cable from the battery. (The door key [inside the Intelligent Access Key] is needed to lock/unlock doors when the battery cable is disconnected. Also, the anti-theft system is disabled until the battery cable is reconnected.) Refer to *Battery* in the *Maintenance and Specifications* chapter when disconnecting and reconnecting the battery cable.
  - The maximum towing speed is 70 mph (113 km/h).
  - There is no limitation on towing distance.

When done towing, start the engine within 15 minutes of reconnecting the battery cable. When reconnecting that cable, tighten it until it's snug against the terminal; be careful not to overtighten.



**BREAKING-IN**

You need to break in new tires for approximately 300 miles (480 kilometers). During this time, your vehicle may exhibit some unique driving characteristics. Avoid driving too fast during the first 1000 miles (1600 kilometers). Vary your speed frequently and change up through the gears early. Do not labor the engine. Do not tow during the first 1000 miles (1600 kilometers).

**ECONOMICAL DRIVING**

Fuel economy is affected by several things such as how you drive, the conditions you drive under and how you maintain your vehicle.

There are some things to keep in mind that may improve your fuel economy:

- Accelerate and slow down in a smooth, moderate fashion.
- Drive at steady speeds without stopping.
- Anticipate stops; slowing down may eliminate the need to stop.
- Combine errands and minimize stop-and-go driving.
- Close the windows for high-speed driving.
- Drive at reasonable speeds (traveling at 55 mph [88 km/h] uses 15% less fuel than traveling at 65 mph [105 km/h]).
- Keep the tires properly inflated and use only the recommended size.
- Use the recommended engine oil.
- Perform all regularly scheduled maintenance.

There are also some things you may not want to do because they may reduce your fuel economy:

- Sudden or hard accelerations.
- Rev the engine before turning it off.
- Idle for periods longer than one minute.
- Warm up your vehicle on cold mornings.
- Use the air conditioner or front defroster.
- Use the speed control in hilly terrain.
- Rest your foot on the brake pedal while driving.
- Drive a heavily loaded vehicle or tow a trailer.

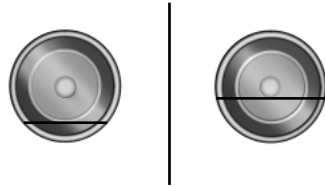

- Carry unnecessary weight (approximately 1 mpg [0.4 km/L] is lost for every 400 lb [180 kg] of weight carried).
- Add particular accessories to your vehicle (e.g. bug deflectors, rollbars/light bars, running boards, ski racks).
- Drive with the wheels out of alignment.

**DRIVING THROUGH WATER**

If driving through deep or standing water is unavoidable, proceed very slowly. Never drive through water that is higher than the bottom of the wheel rims (for cars) or the bottom of the hubs (for trucks).

When driving through water, traction or brake capability may be limited. Also, water may enter your engine's air intake and severely damage your engine or your vehicle may stall.

**Note:** Driving through deep water where the transmission vent tube is submerged may allow water into the transmission and cause internal transmission damage.

**Note:** Once through the water, always dry the brakes by moving your vehicle slowly while applying light pressure on the brake pedal. Wet brakes do not stop the vehicle as quickly as dry brakes.

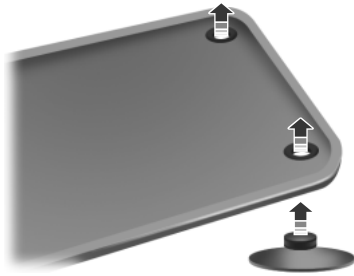

**FLOOR MATS**

**WARNING:** Always use floor mats that are designed to fit the foot well of your vehicle. Only use floor mats that leave the pedal area unobstructed. Only use floor mats that are firmly secured to retention posts so that they cannot slip out of position and interfere with the pedals or impair safe operation of your vehicle in other ways.

- Pedals that cannot move freely can cause loss of vehicle control and increase the risk of serious personal injury.
- Always make sure that the floor mats are properly attached to the retention posts in the carpet that are supplied with your vehicle. Floor mats must be properly secured to both retention posts to ensure mats do not shift out of position.
- Never place floor mats or any other covering in the vehicle foot well that cannot be properly secured to prevent them from moving and interfering with the pedals or the ability to control the vehicle.
- Never place floor mats or any other covering on top of already installed floor mats. Floor mats should always rest on top of vehicle carpeting surface and not another floor mat or other covering. Additional floor mats or any other covering will reduce the pedal clearance and potentially interfere with pedal operation.
- Check attachment of floor mats on a regular basis. Always properly reinstall and secure floor mats that have been removed for cleaning or replacement.
- Always make sure that objects cannot fall into the driver foot well while the vehicle is moving. Objects that are loose can become trapped under the pedals causing a loss of vehicle control.



**WARNING** *(Continued)*

- Failure to properly follow floor mat installation or attachment instructions can potentially cause interference with pedal operation causing loss of control of vehicle.
- To install floor mats, position the floor mat so that the eyelet is over the retention post and press down to lock in.
- To remove the floor mat, reverse the installation procedure.



**ROADSIDE ASSISTANCE****Vehicles Sold in the U.S. : Getting Roadside Assistance**

To fully assist you should you have a vehicle concern, Ford Motor Company offers a complimentary roadside assistance program. This program is separate from the New Vehicle Limited Warranty. The service is available:

- 24-hours a day, seven days a week
- for the coverage period listed on the Roadside Assistance Card included in your owner's manual portfolio.

Roadside assistance will cover:

- a flat tire change with a good spare (except vehicles that have been supplied with a tire inflation kit).
- battery jump start.
- lock-out assistance (key replacement cost is the customer's responsibility).
- fuel delivery – Independent Service Contractors, if not prohibited by state, local or municipal law shall deliver up to 2.0 gallons (7.5 liters) of gasoline or 5.0 gallons (18.9 liters) of diesel fuel to a disabled vehicle. Fuel delivery service is limited to two no-charge occurrences within a 12-month period.
- winch out – available within 100 feet (30.5 meters) of a paved or county maintained road, no recoveries.
- towing – Ford and Lincoln eligible vehicles towed to an authorized dealer within 35 miles (56 kilometers) of the disablement location or to the nearest authorized dealer. If a member requests to be towed to an authorized dealer more than 35 miles (56 kilometers) from the disablement location, the member shall be responsible for any mileage costs in excess of 35 miles (56 kilometers).

Trailers shall be covered up to \$200 if the disabled eligible vehicle requires service at the nearest authorized dealer. If the trailer is disabled, but the towing vehicle is operational, the trailer does not qualify for any roadside services.

**Vehicles Sold in the U.S. : Using Roadside Assistance**

Complete the roadside assistance identification card and place it in your wallet for quick reference. This card is found in the owner's manual portfolio in the glove compartment.

U.S. Ford vehicle customers who require Roadside Assistance, call 1-800-241-3673.



If you need to arrange roadside assistance for yourself, Ford Motor Company will reimburse a reasonable amount for towing to the nearest dealership within 35 miles (56 kilometers). To obtain reimbursement information, U.S. Ford vehicle customers call 1-800-241-3673. Customers will be asked to submit their original receipts.

#### **Vehicles Sold in Canada : Getting Roadside Assistance**

Canadian customers who require roadside assistance, call 1-800-665-2006.

#### **Vehicles Sold in Canada : Using Roadside Assistance**

Complete the roadside assistance identification card and place it in your wallet for quick reference. In Canada, the card is found in the warranty information in the glove box.

Canadian Roadside coverage and benefits may differ from the U.S. coverage. Please see your warranty information or visit our website at [www.ford.ca](http://www.ford.ca) for information on Canadian services and benefits.

Canadian customers who need to obtain roadside information, call 1-800-665-2006 or visit our website at [www.ford.ca](http://www.ford.ca).

#### **HAZARD WARNING FLASHERS**



The hazard flasher control is located on the instrument panel by the radio. Use it when your vehicle is disabled and is creating a safety hazard for other motorists.

- Press the flasher control and all front and rear direction signals will flash.
- Press the flasher control again to turn them off.

**Note:** With extended use, the flashers may run down your 12 volt battery.

#### **FUEL CUT-OFF SWITCH**



**WARNING:** Failure to inspect and if necessary repair fuel leaks after a collision may increase the risk of fire and serious injury. Ford Motor Company recommends that the fuel system be inspected by an authorized dealer after any collision.

In the event of a moderate to severe collision, this vehicle is equipped with a fuel pump shut-off feature that stops the flow of fuel to the engine. Not every impact will cause a shut-off.





Should your vehicle shut off after a collision, you may restart your vehicle by doing the following:

1. Turn the ignition off.
2. Turn the ignition on.
3. Repeat steps 1 and 2 to re-enable fuel pump.

**Note:** If your vehicle has the push button start system, press the stop/start button twice to reactivate the fuel system.

### JUMP-STARTING THE VEHICLE



**WARNING:** The gases around the battery can explode if exposed to flames, sparks, or lit cigarettes. An explosion could result in injury or vehicle damage.



**WARNING:** Batteries contain sulfuric acid which can burn skin, eyes and clothing, if contacted.

Do not attempt to push-start your automatic transmission vehicle. Automatic transmissions do not have push-start capability. Attempting to push-start a vehicle with an automatic transmission may cause transmission damage.

When the battery is disconnected or a new battery is installed, the automatic transmission must relearn its shift strategy. As a result, the transmission may exhibit a combination of firm and soft shifts. This operation is considered normal and will not affect function or durability of the transmission. Over time, the adaptive learning process will fully update transmission operation.

### Preparing Your Vehicle

**Note:** Use only a 12 volt supply to start your vehicle.

**Note:** Do not disconnect the battery of the disabled vehicle as this could damage the vehicle's electrical system.

1. Park the booster vehicle close to the hood of the disabled vehicle making sure the two vehicles do not touch. Set the parking brake on both vehicles and stay clear of the engine cooling fan and other moving parts.
2. Check all battery terminals and remove any excessive corrosion before you attach the battery cables. Ensure that vent caps are tight and level.
3. Turn the heater fan on in both vehicles to protect from any electrical surges. Turn all other accessories off.



### Connecting the Jumper Cables



**WARNING:** Do not connect the end of the second cable to the negative (-) terminal of the battery to be jumped. A spark may cause an explosion of the gases that surround the battery.

**Note:** Do not attach the negative (-) cable to fuel lines, engine rocker covers, the intake manifold or electrical components as grounding points.

**Note:** In the illustration, the vehicle on the bottom is used to designate the assisting (boosting) battery.

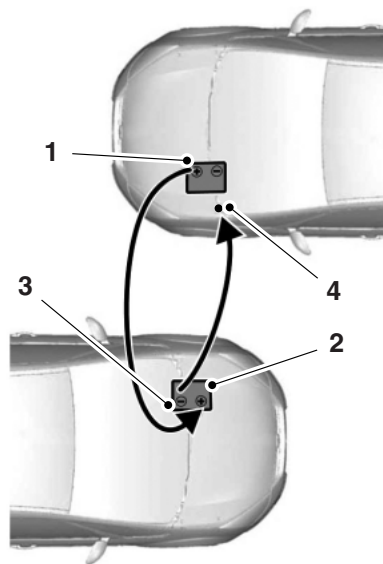

1. Connect the positive (+) jumper cable to the positive (+) terminal of the discharged battery.

2. Connect the other end of the positive (+) cable to the positive (+) terminal of the assisting battery.

3. Connect the negative (-) cable to the negative (-) terminal of the assisting battery.

4. Make the final connection of the negative (-) cable to an exposed metal part of the stalled vehicle's engine, away from the battery and the carburetor or fuel injection system.

Ensure that the cables are clear of fan blades, belts, moving parts of both engines, or any fuel delivery system parts.



### Jump Starting

1. Start the engine of the booster vehicle and run the engine at a moderately increased speed.
2. Start the engine of the disabled vehicle.
3. Once the disabled vehicle has been started, run both engines for an additional three minutes before disconnecting the jumper cables.

### Removing the Jumper Cables

**Note:** In the illustration, the vehicle on the bottom is used to designate the assisting (boosting) battery.

Remove the jumper cables in the reverse order that they were connected.

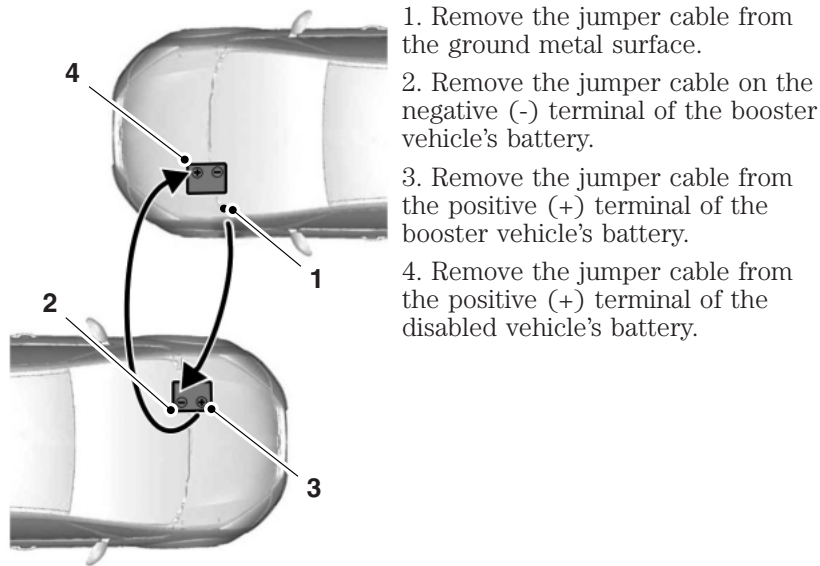

After the disabled vehicle has been started and the jumper cables removed, allow it to idle for several minutes so the engine computer can relearn its idle conditions.



**GETTING THE SERVICES YOU NEED**

Warranty repairs to your vehicle must be performed by an authorized dealer. While any authorized dealer handling your vehicle line will provide warranty service, we recommend you return to your selling authorized dealer who wants to ensure your continued satisfaction.

Please note that certain warranty repairs require special training, equipment or both, so not all authorized dealers are authorized to perform all warranty repairs. This means that, depending on the warranty repair needed, you may have to take your vehicle to another authorized dealer.

A reasonable time must be allowed to perform a repair after taking your vehicle to the authorized dealer. Repairs will be made using Ford or Motorcraft parts, or remanufactured or other parts that are authorized by Ford.

**Away from home**

If you are away from home when your vehicle needs service, contact the Ford Customer Relationship Center or use the online resources listed below to find the nearest authorized dealer.

In the United States:

**Mailing address**

Ford Motor Company  
Customer Relationship Center  
P.O. Box 6248  
Dearborn, MI 48121

**Telephone**

1-800-392-3673 (FORD)  
(TDD for the hearing impaired: 1-800-232-5952)

**Online**

Additional information and resources are available online at [www.fordowner.com](http://www.fordowner.com)

These are some of the items that can be found online:

- U.S. dealer locator by Dealer Name, City/State, or Zip Code
- Owner Manuals
- Maintenance Schedules
- Recalls
- Ford Extended Service Plans



- Ford Genuine Accessories
- Service specials and promotions.

In Canada:

**Mailing address**

Customer Relationship Centre  
Ford Motor Company of Canada, Limited  
P.O. Box 2000  
Oakville, Ontario L6J 5E4

**Telephone**

1-800-565-3673 (FORD)

**Online**

[www.ford.ca](http://www.ford.ca)

**Additional assistance**

If you have questions or concerns, or are unsatisfied with the service you are receiving, follow these steps:

1. Contact your Sales Representative or Service Advisor at your selling/servicing authorized dealer.
2. If your inquiry or concern remains unresolved, contact the Sales Manager, Service Manager or Customer Relations Manager.
3. If you require assistance or clarification on Ford Motor Company policies, please contact the Ford Customer Relationship Center

In order to help you serve you better, please have the following information available when contacting a Customer Relationship Center:

- Vehicle Identification Number (VIN)
- Your telephone number (home and business)
- The name of the authorized dealer and city where located
- The vehicle's current odometer reading

In some states, you must directly notify Ford in writing before pursuing remedies under your state's warranty laws. Ford is also allowed a final repair attempt in some states.

In the United States, a warranty dispute must be submitted to the BBB AUTO LINE before taking action under the Magnuson-Moss Warranty Act, or to the extent allowed by state law, before pursuing replacement or repurchase remedies provided by certain state laws. This dispute handling procedure is not required prior to enforcing state created rights or other rights which are independent of the Magnuson-Moss Warranty Act or state replacement or repurchase laws.



**IN CALIFORNIA (U.S. ONLY)**

California Civil Code Section 1793.2(d) requires that, if a manufacturer or its representative is unable to repair a motor vehicle to conform to the vehicle's applicable express warranty after a reasonable number of attempts, the manufacturer shall be required to either replace the vehicle with one substantially identical or repurchase the vehicle and reimburse the buyer in an amount equal to the actual price paid or payable by the consumer (less a reasonable allowance for consumer use). The consumer has the right to choose whether to receive a refund or replacement vehicle.

California Civil Code Section 1793.22(b) presumes that the manufacturer has had a reasonable number of attempts to conform the vehicle to its applicable express warranties if, within the first 18 months of ownership of a new vehicle or the first 18000 miles (29 000 km), whichever occurs first:

1. Two or more repair attempts are made on the same non-conformity likely to cause death or serious bodily injury OR
2. Four or more repair attempts are made on the same nonconformity (a defect or condition that substantially impairs the use, value or safety of the vehicle) OR
3. The vehicle is out of service for repair of nonconformities for a total of more than 30 calendar days (not necessarily all at one time)

In the case of 1 or 2 above, the consumer must also notify the manufacturer of the need for the repair of the nonconformity at the following address:

Ford Motor Company  
16800 Executive Plaza Drive  
Mail Drop 3NE-B  
Dearborn, MI 48126

You are required to submit your warranty dispute to BBB AUTO LINE before asserting in court any rights or remedies conferred by California Civil Code Section 1793.22(b). You are also required to use BBB AUTO LINE before exercising rights or seeking remedies created by the Federal Magnuson-Moss Warranty Act, 15 U.S.C. sec. 2301 et seq. If you choose to seek redress by pursuing rights and remedies not created by California Civil Code Section 1793.22(b) or the Magnuson-Moss Warranty Act, resort to BBB AUTO LINE is not required by those statutes.

**THE BETTER BUSINESS BUREAU (BBB) AUTO LINE PROGRAM (U.S. ONLY)**

Your satisfaction is important to Ford Motor Company and to your dealer. If a warranty concern has not been resolved using the three-step



procedure outlined earlier in this chapter in the *Getting the services you need* section, you may be eligible to participate in the BBB AUTO LINE program.

The BBB AUTO LINE program consists of two parts – mediation and arbitration. During mediation, a representative of the BBB will contact both you and Ford Motor Company to explore options for settlement of the claim. If an agreement is not reached during mediation or you do not want to participate in mediation, and if your claim is eligible, you may participate in the arbitration process. An arbitration hearing will be scheduled so that you can present your case in an informal setting before an impartial person. The arbitrator will consider the testimony provided and make a decision after the hearing.

Disputes submitted to the BBB AUTO LINE program are usually decided within forty days after you file your claim with the BBB. You are not bound by the decision, and may reject the decision and proceed to court where all findings of the BBB Auto Line dispute, and decision, are admissible in the court action. Should you choose to accept the BBB AUTO LINE decision, Ford is then bound by the decision, and must comply with the decision within 30 days of receipt of your acceptance letter.

BBB AUTO LINE Application: Using the information provided below, please call or write to request a program application. You will be asked for your name and address, general information about your new vehicle, information about your warranty concerns, and any steps you have already taken to try to resolve them. A Customer Claim Form will be mailed that will need to be completed, signed and returned to the BBB along with proof of ownership. Upon receipt, the BBB will review the claim for eligibility under the Program Summary Guidelines.

**You can get more information by calling BBB AUTO LINE at 1-800-955-5100, or writing to:**

**BBB AUTO LINE  
3033 Wilson Boulevard, Suite 600  
Arlington, Virginia 22201**

BBB AUTO LINE applications can also be requested by calling the Ford Motor Company Customer Relationship Center at 1-800-392-3673.

**Note:** Ford Motor Company reserves the right to change eligibility limitations, modify procedures, or to discontinue this process at any time without notice and without obligation.



**UTILIZING THE MEDIATION/ARBITRATION PROGRAM  
(CANADA ONLY)**

For vehicles delivered to authorized Canadian dealers. In those cases where you continue to feel that the efforts by Ford of Canada and the authorized dealer to resolve a factory-related vehicle service concern have been unsatisfactory, Ford of Canada participates in an impartial third party mediation/arbitration program administered by the Canadian Motor Vehicle Arbitration Plan (CAMVAP).

The CAMVAP program is a straight forward and relatively speedy alternative to resolve a disagreement when all other efforts to produce a settlement have failed. This procedure is without cost to you and is designed to eliminate the need for lengthy and expensive legal proceedings.

In the CAMVAP program, impartial third-party arbitrators conduct hearings at mutually convenient times and places in an informal environment. These impartial arbitrators review the positions of the parties, make decisions and, when appropriate, render awards to resolve disputes. CAMVAP decisions are fast, fair, and final as the arbitrator's award is binding on both you and Ford of Canada.

CAMVAP services are available in all Canadian territories and provinces. For more information, without charge or obligation, call your CAMVAP Provincial Administrator directly at 1-800-207-0685 or visit [www.camvap.ca](http://www.camvap.ca).

**GETTING ASSISTANCE OUTSIDE THE U.S. AND CANADA**

Before exporting your vehicle to a foreign country, contact the appropriate foreign embassy or consulate. These officials can inform you of local vehicle registration regulations and where to find unleaded fuel.

If you cannot find unleaded fuel or can only get fuel with an anti-knock index lower than is recommended for your vehicle, contact a regional office or owner relations/customer relationship office.

The use of leaded fuel in your vehicle without proper conversion may damage the effectiveness of your emission control system and may cause engine knocking or serious engine damage. Ford Motor Company/Ford of Canada is not responsible for any damage caused by use of improper fuel. Using leaded fuel may also result in difficulty importing your vehicle back into the U.S.





If your vehicle must be serviced while you are traveling or living in Asia-Pacific Region, Sub-Saharan Africa, U.S. Virgin Islands, Central America, the Caribbean, and Israel, contact the nearest authorized dealer. If the authorized dealer cannot help you, contact:

FORD MOTOR COMPANY  
FORD EXPORT OPERATIONS & GLOBAL INITIATIVES  
1555 Fairlane Drive  
Fairlane Business Park #3  
Allen Park, Michigan 48101  
U.S.A.

Telephone: (313) 594-4857

For customers in Guam, the Commonwealth of the Northern Mariana Islands (CNMI), America Samoa, and the U.S. Virgin Islands, please feel free to call our Toll-Free Number: (800) 841-FORD (3673).

FAX: (313) 390-0804

Email: [expcac@ford.com](mailto:expcac@ford.com)

If your vehicle must be serviced while you are traveling or living in Puerto Rico, contact the nearest authorized dealer. If the authorized dealer cannot help you, contact:

Ford International Business Development Inc.  
Customer Relationship Center  
P.O. Box 11957  
Caparra Heights Station  
San Juan, Puerto Rico 00922-1957  
Telephone: (800) 841-FORD (3673)  
FAX: (313) 390-0804  
Email: [prcac@ford.com](mailto:prcac@ford.com)  
[www.ford.com.pr](http://www.ford.com.pr)

If your vehicle must be serviced while you are traveling or living in the Middle East, contact the nearest authorized dealer. If the authorized dealer cannot help you, contact:

Ford Middle East  
Customer Relationship Center  
P.O. Box 21470  
Dubai, United Arab Emirates  
Telephone: +971 4 3326084  
Toll-Free Number for the Kingdom of Saudi Arabia: 800 8971409  
Local Telephone Number for Kuwait: 24810575  
FAX: +971 4 3327299  
Email: [menacac@ford.com](mailto:menacac@ford.com)  
[www.me.ford.com](http://www.me.ford.com)



If you buy your vehicle in North America and then relocate to any of the above locations, register your vehicle identification number (VIN) and new address with Ford Motor Company Export Operations & Global Growth Initiatives by emailing [expcac@ford.com](mailto:expcac@ford.com).

If you are in another foreign country, contact the nearest authorized dealer. If the authorized dealer employees cannot help you, they can direct you to the nearest Ford affiliate office.

**Customers in the U.S. should call 1-800-392-3673.**

#### **ORDERING ADDITIONAL OWNER'S LITERATURE**

To order the publications in this portfolio, contact Helm, Incorporated at:

HELM, INCORPORATED  
47911 Halyard Drive  
Plymouth, Michigan 48170  
Attention: Customer Service

Or to order a free publication catalog, call toll free: 1-800-782-4356

Monday-Friday 8:00 a.m. - 6:00 p.m. EST

Helm, Incorporated can also be reached by their website:  
[www.helminc.com](http://www.helminc.com).

*(Items in this catalog may be purchased by credit card, check or money order.)*

#### **Obtaining a French Owner's Manual**

French Owner's Manual can be obtained from your authorized dealer or by contacting Helm, Incorporated using the contact information listed previously in this section.



**REPORTING SAFETY DEFECTS (U.S. ONLY)**

If you believe that your vehicle has a defect which could cause a crash or could cause injury or death, you should immediately inform the National Highway Traffic Safety

Administration (NHTSA) in addition to notifying Ford Motor Company.

If NHTSA receives similar complaints, it may open an investigation, and if it finds that a safety defect exists in a group of vehicles, it may order a recall and remedy campaign. However, NHTSA cannot become involved in individual problems between you, your dealer, or Ford Motor Company.

To contact NHTSA, you may call the Vehicle Safety Hotline toll-free at 1-888-327-4236 (TTY: 1-800-424-9153); go to <http://www.safercar.gov>; or write to:

Administrator  
1200 New Jersey Avenue, Southeast  
Washington, D.C. 20590

You can also obtain other information about motor vehicle safety from <http://www.safercar.gov>.

**REPORTING SAFETY DEFECTS (CANADA ONLY)**

If you believe that your vehicle has a defect which could cause a crash or could cause injury or death, you should immediately inform Transport Canada, using their toll-free number: 1-800-333-0510, or online at: <https://www.wapps.tc.gc.ca/Saf-Sec-Sur/7/PCDB-BDPP/Index.aspx>.

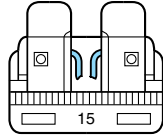

**CHANGING A FUSE****Fuses**

If electrical components in the vehicle are not working, a fuse may have blown. Blown fuses are identified by a broken wire within the fuse. Check the appropriate fuses before replacing any electrical components.

**Note:** Always replace a fuse with one that has the specified amperage rating. Using a fuse with a higher amperage rating can cause severe wire damage and could start a fire.

**Standard Fuse Amperage Rating and Color**

COLOR					
Fuse rating	Mini fuses	Standard fuses	Maxi fuses	Cartridge maxi fuses	Fuse link cartridge
2A	Grey	Grey	—	—	—
3A	Violet	Violet	—	—	—
4A	Pink	Pink	—	—	—
5A	Tan	Tan	—	—	—
7.5A	Brown	Brown	—	—	—
10A	Red	Red	—	—	—
15A	Blue	Blue	—	—	—
20A	Yellow	Yellow	Yellow	Blue	Blue
25A	Natural	Natural	—	Natural	Natural
30A	Green	Green	Green	Pink	Pink
40A	—	—	Orange	Green	Green
50A	—	—	Red	Red	Red
60A	—	—	Blue	Yellow	Yellow
70A	—	—	Tan	—	Brown
80A	—	—	Natural	Black	Black



**FUSE SPECIFICATION CHART**

**Power Distribution Box**

 **WARNING:** Always disconnect the battery before servicing high current fuses.

 **WARNING:** To reduce risk of electrical shock, always replace the cover to the power distribution box before reconnecting the battery or refilling fluid reservoirs.

The power distribution box is located in the engine compartment. It has high-current fuses that protect your vehicle's main electrical systems from overloads.

If the battery has been disconnected and reconnected, refer to *Changing the vehicle battery* in the *Maintenance* chapter.

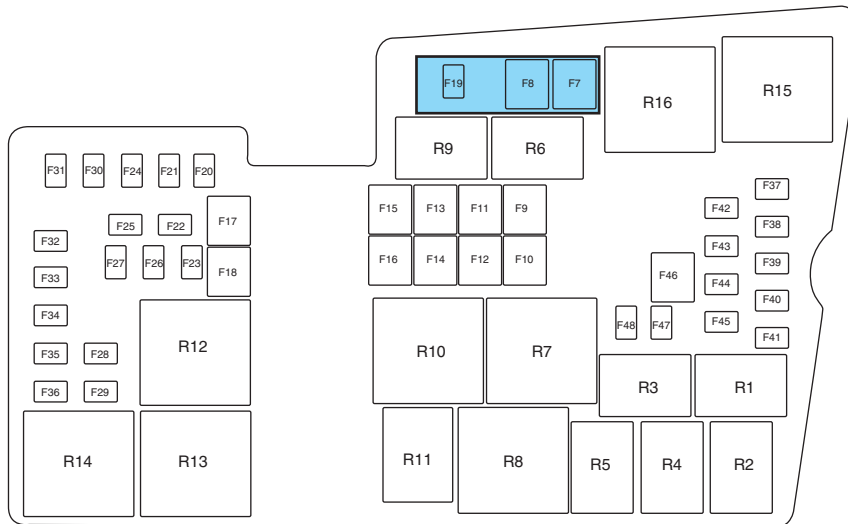

The high-current fuses are coded as follows:

Fuse/Relay Number	Fuse Amp Rating	Protected Components
F1	—	Not used
F2	—	Not used



Fuse/Relay Number	Fuse Amp Rating	Protected Components
F3	—	Not used
F4	—	Not used
F5	—	Not used
F6	—	Not used
F7	40A**	Anti-lock brake system/Electronic stability program pump
F8	30A**	Electronic stability program valve
F9	30A**	Heated rear window
F10	40A**	Heater blower motor
F11	—	Not used
F12	30A**	Engine control relay Fuse
F13	30A**	Starter relay
F14	25A**	Rear power window (without door control unit)
F15	25A**	Automatic transmission
F16	—	Not used
F17	—	Not used
F18	20A**	Front wiper motor
F19	5A*	Anti-lock brake system/Electronic stability program 15 feed
F20	15A*	Horn
F21	5A*	Stop light switch
F22	15A*	Battery monitor system
F23	5A*	Relay coils, Light switch module
F24	—	Not used
F25	10A*	Power exterior mirror (without door control unit)
F26	15A*	Transmission control module 30 feed automatic transmission
F27	15A*	Air conditioning clutch
F28	5A*	Mass air flow fuel relay feed
F29	20A*	Not used (spare)



Fuse/Relay Number	Fuse Amp Rating	Protected Components
F30	—	Not used
F31	—	Not used
F32	10A*	Exhaust gas recovery valve, Swirl control valves, Heated oxygen sensors
F33	15A*	Ignition coils
F34	10A*	Injectors
F35	5A*	Active grill shutter
F36	10A*	Engine control module
F37	—	Not used
F38	15A*	Engine control module/Transmission control module 15 feed
F39	5A*	Headlamp control module (Focus ST)
F40	5A*	Electronic power assist steering 15 feed
F41	20A*	Body control module 15 feed
F42	15A*	Rear Wiper
F43	15A*	HID headlamp leveling (Focus ST)
F44	—	Not used
F45	—	Not used
F46	25A*	Power windows front (without door control unit)
F47	7.5A*	Heated mirror (without door control unit)
F48	5A*	Power exterior mirror (without door control unit)
R1	—	Not used
R2	Micro relay	Horn
R3	—	Not used
R4	—	Not used
R5	Micro relay	Rear wiper
R6	—	Not used
R7	—	Not used



Fuse/Relay Number	Fuse Amp Rating	Protected Components
R8	—	Not used
R9	—	Not used
R10	Mini relay	Starter relay
R11	Micro relay	Air conditioning clutch
R12	Power relay	Cooling fan
R13	Mini relay	Heater blower
R14	Mini relay	Engine control relay
R15	Power relay	Heated rear window
R16	Power relay	Ignition 15
*Mini Fuses **Cartridge Fuses		

### Passenger Compartment Fuse Panel

The fuse panel is located on the right side below the glove box.

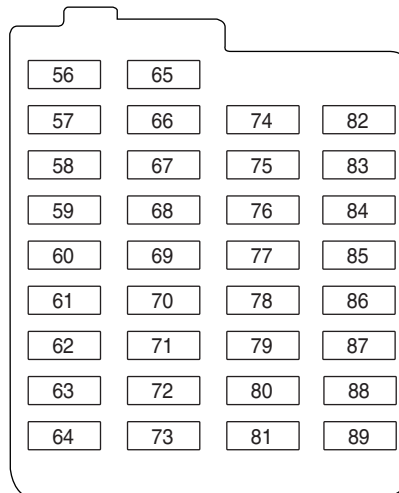



The fuses are coded as follows:

Fuse/Relay Number	Fuse Amp Rating	Protected Components
56	20A	Fuel pump supply, Mass air flow sensor
57	—	Not used
58	—	Not used
59	5A	Passive anti-theft transceiver
60	10A	Interior light, Driver door switch pack, Glove box illumination, Overhead console switch bank
61	20A	Cigar lighter, Power point
62	5A	Rain sensor module, Humidity sensor, Auto-dimming rear view mirror
63	—	Not used
64	—	Not used
65	10A	Luggage compartment release
66	20A	Driver door unlock supply, double lock
67	7.5A	SYNC®, Multifunction display, Global positioning system module, Compass
68	—	Not used
69	5A	Instrument cluster
70	20A	Central lock and unlock supply
71	10A	Heating control head (manual air conditioning), Duel electronic automatic temperature control
72	7.5A	Steering wheel module
73	5A	Data link connector
74	15A	Low beam headlamp supply
75	15A	Fog lamp supply
76	10A	Reversing lamp supply
77	20A	Windshield washer supply
78	5A	Ignition switch, Start button



Fuse/Relay Number	Fuse Amp Rating	Protected Components
79	15A	Radio, Navigation DVD player, Touch screen, Hazard light switch, Door lock switch
80	20A	Moonroof supply
81	5A	Radio frequency receiver
82	20A	Windshield washer relay
83	20A	Central locking
84	20A	Driver door unlock supply, double lock
85	7.5A	Passenger air bag deactivation indicator, Front seat heater switch, Heating module (manual air conditioning), Air quality sensor, Radio, In-car temperature and humidity sensor
86	10A	Air bag module, Occupant classification system, Passenger air bag deactivation indicator
87	—	Not used
88	—	Not used
89	—	Not used



**Luggage Compartment Fuse Panel**

The fuse panel is located in the luggage compartment behind the left side wheel well. Remove the fuse panel cover to gain access to the fuses.

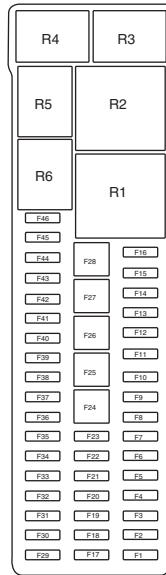

The fuses are coded as follows.

Fuse/Relay Number	Fuse Amp Rating	Protected Components
F1	—	Not used
F2	10A	Keyless vehicle module
F3	5A	Keyless vehicle door handles
F4	25A	Door control unit front left
F5	25A	Door control unit front right
F6	25A	Door control unit rear left
F7	25A	Door control unit rear right
F8	—	Not used
F9	25A	Driver seat motor
F10	—	Not used



Fuse/Relay Number	Fuse Amp Rating	Protected Components
F11	—	Not used
F12	—	Not used
F13	—	Not used
F14	—	Not used
F15	—	Not used
F16	—	Not used
F17	—	Not used
F18	—	Not used
F19	—	Not used
F20	—	Not used
F21	—	Not used
F22	—	Not used
F23	25A	Audio amplifier
F24	—	Not used
F25	—	Not used
F26	—	Not used
F27	—	Not used
F28	—	Not used
F29	5A	Park assist camera
F30	5A	Parking aid module
F31	—	Not used
F32	—	Not used
F33	—	Not used
F34	15A	Driver seat heater
F35	15A	Passenger seat heater
F36	—	Not used
F37	5A	Moonroof
F38	—	Not used
F39	—	Not used
F40	—	Not used
F41	—	Not used



## Fuses

245

Fuse/Relay Number	Fuse Amp Rating	Protected Components
F42	—	Not used
F43	—	Not used
F44	—	Not used
F45	—	Not used
F46	—	Not used
R1	Power relay	Rear 15 relay (2/88)
R2	—	Not used
R3	—	Not used
R4	—	Not used
R5	—	Not used
R6	—	Not used



**GENERAL INFORMATION**

Have your vehicle serviced regularly to help maintain its roadworthiness and resale value. There is a large network of Ford authorized dealers that are there to help you with their professional servicing expertise. We believe that their specially trained technicians are best qualified to service your vehicle properly and expertly. They are supported by a wide range of highly specialized tools developed specifically for servicing your vehicle.

To help you service your vehicle, we provide *scheduled maintenance information* which makes tracking routine service easy.

If your vehicle requires professional service, your authorized dealer can provide the necessary parts and service. Check your warranty information to find out which parts and services are covered.

Use only recommended fuels, lubricants, fluids and service parts conforming to specifications. Motorcraft® parts are designed and built to provide the best performance in your vehicle.

**Precautions**

- Do not work on a hot engine.
- Make sure that nothing gets caught in moving parts.
- Do not work on a vehicle with the engine running in an enclosed space, unless you are sure you have enough ventilation.
- Keep all open flames and other burning material (such as cigarettes) away from the battery and all fuel related parts.

**Working with the Engine Off**

1. For vehicles equipped with an automatic transmission, set the parking brake and shift to P (Park). For vehicles equipped with a manual transmission, set the parking brake, press and hold the clutch pedal, shift to 1 (First), and release the clutch pedal.
2. Turn off the engine and remove the key.
3. Block the wheels.



**Working with the Engine On**

 **WARNING:** To reduce the risk of vehicle damage and/or personal burn injuries, do not start your engine with the air cleaner removed and do not remove it while the engine is running.

1. For vehicles equipped with an automatic transmission, set the parking brake and shift to P (Park). For vehicles equipped with a manual transmission, set the parking brake, press and hold the clutch pedal, shift in N (Neutral), and release the clutch pedal.

2. Block the wheels.

**OPENING AND CLOSING THE HOOD**

1. Inside the vehicle, pull the hood release handle located under the instrument panel.

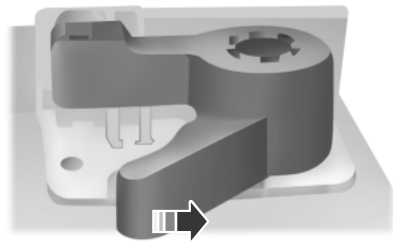

2. Go to the front of the vehicle and locate the auxiliary latch located under the front of the hood (left of center) and then release it by pushing the auxiliary latch to the right.

3. Open the hood and support it with the prop rod.

To close the hood, lower the hood and allow it to drop from under its

own weight for the last 8-11 inches (20-30 centimeters).

**Note:** Make sure that the hood is closed properly.

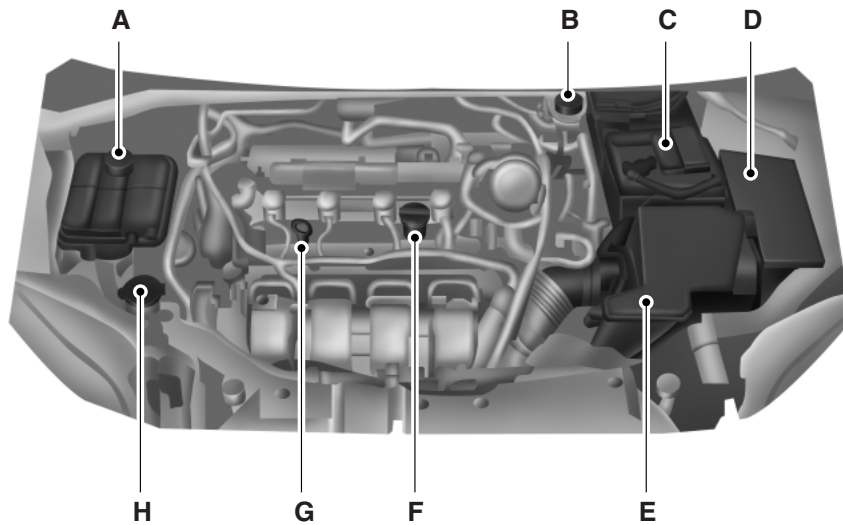

---

**UNDER HOOD OVERVIEW****2.0L Engine**

(Shown without engine cover, if equipped)

- A. Engine coolant reservoir
- B. Brake/clutch fluid reservoir
- C. Battery
- D. Power distribution box
- E. Air filter assembly
- F. Engine oil filler cap
- G. Engine oil dipstick
- H. Windshield washer fluid reservoir





**ENGINE OIL DIPSTICK**

- A. – MIN
- B. – MAX

**ENGINE OIL CHECK**

**Note:** Check the level before starting the engine.

**Note:** Make sure that the level is between the MIN and MAX marks.

1. Make sure that your vehicle is on level ground.
2. Turn the engine off and wait 10 minutes for the oil to drain into the oil pan.
3. Remove the dipstick and wipe it with a clean, lint-free cloth. Replace the dipstick and remove it again to check the oil level.

If the level is at the MIN mark, add oil immediately.

**Adding Engine Oil**

**Note:** Do not remove the filler cap when the engine is running.

**Note:** Do not add engine oil further than the MAX mark. Oil levels above the MAX mark may cause engine damage.



Only use oils certified for gasoline engines by the American Petroleum Institute (API). An oil with this trademark symbol conforms to the current engine and emission system protection standards and fuel economy requirements of the International Lubricants Specification Advisory Council (ILSAC), comprised of U.S. and Japanese automobile manufacturers.

1. Remove the filler cap.
2. Add engine oil that meets Ford specifications. See *Capacities and Specifications* for more information.
3. Replace the filler cap. Turn it until you feel a strong resistance.



**Resetting the Oil Life Monitoring System**

**Note:** Reset the oil life monitoring only after an oil change.

1. Turn the ignition key to the on position. Do not start the engine. For vehicles with push-button start, press and hold the start button for two seconds without pressing the brake pedal. Do not attempt to start the engine.
2. Press both the accelerator and brake pedals at the same time.
3. Keep both pedals fully pressed.
4. After three seconds, the **Service: Oil reset in prog.** message will be displayed.
5. After 25 seconds, the **Service: Oil reset complete** message will be displayed.
6. Release both the accelerator and brake pedals.
7. The **Service: Oil reset complete** message will no longer be displayed.
8. Rotate the key to the off position. For vehicles with push-button start, press the start button to turn the vehicle off completely.

**ENGINE COOLANT CHECK****Checking the Engine Coolant**

**Note:** If your vehicle is equipped with a diesel engine, refer to *Maintenance and Specifications* section of your *Diesel Supplement*

The concentration and level of engine coolant should be checked at the intervals listed in *scheduled maintenance information*.

**Note:** Make sure that the level is between the MIN and MAX marks on the coolant reservoir.

The coolant concentration should be maintained within 48% to 50%, which equates to a freeze point between -30 degrees Fahrenheit (-34 degrees Centigrade) and -34 degrees Fahrenheit (-37 degrees Centigrade).

**Note:** For best results, coolant concentration should be tested with a refractometer such as Rotunda tool 300-ROB75240 available from your dealer. Ford does not recommend the use of hydrometers or coolant test strips for measuring coolant concentrations.

**Note:** Coolant expands when it is hot. The level may extend beyond the MAX mark.

If the level is at the MIN mark, add coolant immediately.



**Note:** Automotive fluids are not interchangeable; do not use engine coolant/antifreeze or windshield washer fluid outside of its specified function and vehicle location.

### Adding Engine Coolant



**WARNING:** Do not add engine coolant when the engine is hot. Steam and scalding liquids released from a hot cooling system can burn you badly. Also, you can be burned if you spill coolant on hot engine parts.



**WARNING:** Do not put engine coolant in the windshield washer fluid container. If sprayed on the windshield, engine coolant could make it difficult to see through the windshield.



**WARNING:** To reduce the risk of personal injury, make sure the engine is cool before unscrewing the coolant pressure relief cap. The cooling system is under pressure; steam and hot liquid can come out forcefully when the cap is loosened slightly.



**WARNING:** Do not add coolant further than the MAX mark.

**Note:** Do not use stop leak pellets or cooling system sealants/additives as they can cause damage to the engine cooling and/or heating systems. This damage would not be covered under your vehicle's warranty.

**Note:** During normal vehicle operation, the engine coolant may change color from orange to pink or light red. As long as the engine coolant is clear and uncontaminated, this color change does not indicate the engine coolant has degraded nor does it require the engine coolant to be drained, the system to be flushed, or the engine coolant to be replaced.

- DO NOT MIX different colors or types of coolant in your vehicle. Make sure the correct coolant is used. Mixing of engine coolants may harm your engine's cooling system. The use of an improper coolant may harm engine and cooling system components and may void the warranty.



- In case of emergency, a large amount of water without engine coolant may be added in order to reach a vehicle service location. In this instance, the cooling system must be drained, chemically cleaned with Motorcraft® Premium Cooling System Flush, and refilled with prediluted engine coolant as soon as possible. Water alone (without engine coolant) can cause engine damage from corrosion, overheating or freezing.
- Do not use alcohol, methanol, brine or any engine coolants mixed with alcohol or methanol antifreeze (coolant). Alcohol and other liquids can cause engine damage from overheating or freezing.
- Do not add extra inhibitors or additives to the coolant. These can be harmful and compromise the corrosion protection of the engine coolant.

Unscrew the cap slowly. Any pressure will escape as you unscrew the cap.

Add prediluted engine coolant meeting the Ford specification. See *Capacities and Specifications* for more information.

Whenever coolant has been added, the coolant level in the coolant reservoir should be checked the next few times you drive the vehicle. If necessary, add enough prediluted engine coolant to bring the coolant level to the proper level.

### Recycled Engine Coolant

Ford Motor Company does not recommend the use of recycled engine coolant since a Ford-approved recycling process is not yet available.



Always dispose of used automotive fluids in a responsible manner. Follow your community's regulations and standards for recycling and disposing of automotive fluids.

### Severe Climates

If you drive in extremely cold climates:

- It may be necessary to have a Ford authorized dealer increase the coolant concentration above 50%.
- A coolant concentration of 60% will provide improved freeze point protection. Increased engine coolant concentrations above 60% will decrease the overheat protection characteristics of the engine coolant and may cause engine damage.



If you drive in extremely hot climates:

- It may be necessary to have a Ford authorized dealer decrease the coolant concentration to 40%.
- A coolant concentration of 40% will provide improved overheat protection. Decreased engine coolant concentrations below 40% will decrease the corrosion/freeze protection characteristics of the engine coolant and may cause engine damage.

Vehicles driven year-round in non-extreme climates should use prediluted engine coolant for optimum cooling system and engine protection.

### Powertrain Limiting and Protection

**Note:** Driving the vehicle without repairing the engine problem increases the chance of engine damage. Take your vehicle to an authorized dealer as soon as possible.

The engine control module (ECU) is equipped with a feature called powertrain limiting and protection (PTLP). PTLP will help protect the engine from damage in case the engine is overheating (coolant and/or oil temperature too hot). PTLP will automatically intervene during normal engine operation should it determine the engine coolant and/or oil temperatures are too hot. It does this by gradually reducing the maximum allowable engine rpm until the engine has cooled sufficiently. PTLP will automatically reinstate normal engine operation if it determines the engine temperatures have cooled sufficiently.

During an engine overheating condition, the instrument cluster will display a message and a chime will sound. The engine may also have temporarily reduced power and reduced rpm limit during an overheating condition.

Operating the engine with high engine coolant temperature (coolant gauge indicator is red) may cause powertrain damage. Stop the vehicle as soon as safely possible, and let the engine cool off while idling.



**TRANSMISSION FLUID CHECK****Checking Automatic Transmission Fluid**

**Note:** Transmission fluid should be checked and, if required, added by an authorized dealer.

The automatic transmission does not have a transmission fluid dipstick.

Refer to your *scheduled maintenance information* for scheduled intervals for fluid checks and changes. Your transmission does not consume fluid. However, the fluid level should be checked if the transmission is not working properly, (i.e., if the transmission slips or shifts slowly) or if you notice some sign of fluid leakage.

Do not use supplemental transmission fluid additives, treatments or cleaning agents. The use of these materials may affect transmission operation and result in damage to internal transmission components.

**Checking and Adding Manual Transmission Fluid (If Equipped)**

1. Clean the filler plug.
2. Remove the filler plug and inspect the fluid level.
3. Fluid level should be at the bottom of the opening.
4. Add enough fluid through the filler opening so that the fluid level is at the bottom of the opening.
5. Install and tighten the fill plug securely.

Use only fluid that meets Ford specifications. Refer to the *Technical Specifications* section in the *Capacities and Specifications* chapter.

**BRAKE FLUID CHECK**

Fluid levels between the MIN and MAX lines are within the normal operating range; there is no need to add fluid. If the fluid levels are outside of the normal operating range, the performance of the system could be compromised; seek service from your authorized dealer immediately.

**POWER STEERING FLUID CHECK**

Your vehicle is equipped with an electric power steering (EPS) system. There is no fluid reservoir to check or fill.

**FUEL FILTER**

Your vehicle is equipped with a lifetime fuel filter that is integrated with the fuel tank. Regular maintenance or replacement is not needed.



**WASHER FLUID CHECK**

 **WARNING:** If you operate your vehicle in temperatures below 40°F (5°C), use washer fluid with antifreeze protection. Failure to use washer fluid with antifreeze protection in cold weather could result in impaired windshield vision and increase the risk of injury or accident.

Add fluid to fill the reservoir if the level is low. Only use a washer fluid that meets Ford specifications. See the technical specifications chart in the *Capacities and Specifications* chapter.

**Note:** The front and rear washer systems are supplied from the same reservoir.

State or local regulations on volatile organic compounds may restrict the use of methanol, a common windshield washer antifreeze additive. Washer fluids containing non-methanol antifreeze agents should be used only if they provide cold weather protection without damaging the vehicle's paint finish, wiper blades or washer system.

**CHANGING THE VEHICLE BATTERY**

 **WARNING:** Batteries normally produce explosive gases which can cause personal injury. Therefore, do not allow flames, sparks or lighted substances to come near the battery. When working near the battery, always shield your face and protect your eyes. Always provide proper ventilation.

 **WARNING:** When lifting a plastic-cased battery, excessive pressure on the end walls could cause acid to flow through the vent caps, resulting in personal injury and/or damage to the vehicle or battery. Lift the battery with a battery carrier or with your hands on opposite corners.

 **WARNING:** Keep batteries out of reach of children. Batteries contain sulfuric acid. Avoid contact with skin, eyes or clothing. Shield your eyes when working near the battery to protect against possible splashing of acid solution. In case of acid contact with skin or eyes, flush immediately with water for a minimum of 15 minutes and get prompt medical attention. If acid is swallowed, call a physician immediately.





**WARNING:** Battery posts, terminals and related accessories contain lead and lead compounds. Wash hands after handling.

Your vehicle is equipped with a Motorcraft® maintenance-free battery which normally does not require additional water during its life of service.

**Note:** If your battery has a cover/shield, make sure it is reinstalled after the battery has been cleaned or replaced.

For longer, trouble-free operation, keep the top of the battery clean and dry. Also, make certain the battery cables are always tightly fastened to the battery terminals.

If you see any corrosion on the battery or terminals, remove the cables from the terminals and clean with a wire brush. You can neutralize the acid with a solution of baking soda and water.

It is recommended that the negative battery cable terminal be disconnected from the battery if you plan to store your vehicle for an extended period of time.

To ensure proper operation of the battery management system (BMS), any electrical devices that are added to the vehicle should not have their ground connection made directly at the negative battery post. A connection at the negative battery post can cause inaccurate measurements of the battery condition and potential incorrect system operation.

**Note:** Electrical or electronic accessories or components added to the vehicle by the dealer or the owner may adversely affect battery performance and durability and may also affect the performance of other electrical systems in the vehicle.

When a battery replacement is required, the battery should only be replaced with a Ford recommended replacement battery that matches the electrical requirements of the vehicle.

When the battery is disconnected or a new battery installed, the automatic transmission must relearn its adaptive strategy. As a result of this, the transmission may shift firmly when first driven. This operation is considered normal and will fully update transmission operation to its optimum shift feel.

If the battery has been disconnected or a new battery has been installed, the clock and the preset radio stations must be reset once the battery is reconnected.

**Note:** Always dispose of automotive batteries in a responsible manner. Follow your local authorized standards for disposal. Call your local authorized recycling center to find out more about recycling automotive batteries.



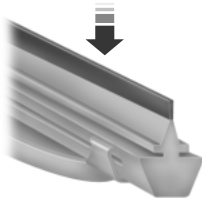

**CHECKING THE WIPER BLADES**

Run the tip of your fingers over the edge of the blade to check for roughness.

Clean the wiper blades with washer fluid or water applied with a soft sponge or cloth.

**CHANGING THE WIPER BLADES**

The wiper arms can be manually moved when the ignition is off. This allows for ease of blade replacement and cleaning under the blades.

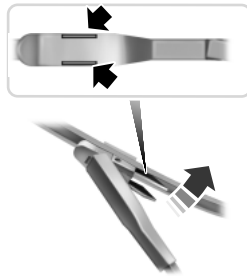

1. Turn the ignition off before removing the wiper blade.

2. Pull the wiper blade and arm away from the glass.

3. Squeeze the locking tabs to release the blade from the arm and pull the blade away from the arm to remove it.

4. Attach the new blade to the arm and snap it into place. Lower the wiper arm and blade back to the windshield. The wiper arms will automatically return to their normal position when the ignition is turned on.

Replace wiper blades at least once per year for optimum performance.

Poor wiper quality can be improved by cleaning the wiper blades and the windshield. Refer to the *Vehicle Care* chapter.

To prolong the life of the wiper blades, it is highly recommended to scrape off the ice on the windshield before turning on the wipers. The layer of ice has many sharp edges and can damage the micro edge of the wiper rubber element.



### Changing the Rear Window Wiper Blade (If Equipped)

To replace the rear wiper blade:

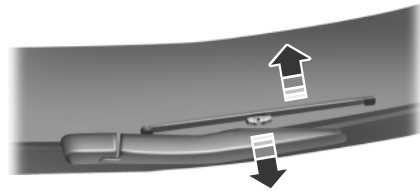

1. Press the wiper blade against the glass with one hand and hold it.
2. Pull the wiper arm away from the wiper blade to separate.

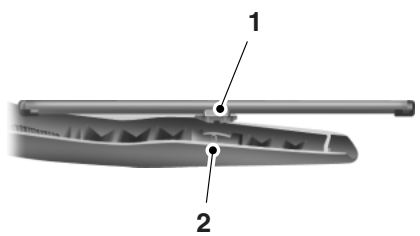

3. To attach the new wiper to the wiper arm, align the slot (1) and cross pin (2) and firmly press the wiper arm into the wiper blade until a click is heard.

If you find this procedure too difficult, please see your dealer.

### AIR FILTER CHECK



**WARNING:** To reduce the risk of vehicle damage and/or personal burn injuries do not start your engine with the air cleaner removed and do not remove it while the engine is running.

When changing the air filter element, use only the air filter element listed. Refer to *Motorcraft® Part Numbers* in the Capacities and Specifications chapter.

For EcoBoost equipped vehicles: When servicing the air cleaner, it is important that no foreign material enter the air induction system. The engine and turbocharger are susceptible to damage from even small particles.

Refer to *Scheduled Maintenance* for the appropriate intervals for changing the air filter element.

**Note:** Failure to use the correct air filter element may result in severe engine damage. The customer warranty may be void for any damage to the engine if the correct air filter element is not used.



**Changing the Air Filter Element**

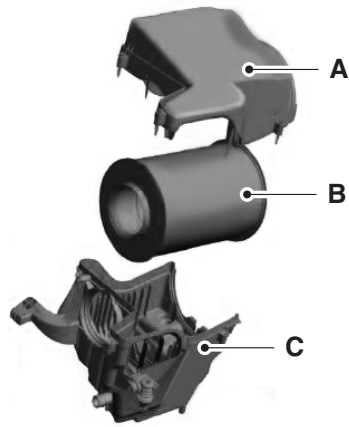

1. Loosen the screws that secure the air filter housing cover (A).
2. Carefully lift the air filter housing cover.
3. Remove the air filter element (B) from the air filter housing (C).
4. Wipe the air filter housing and cover clean to remove any dirt or debris and to ensure good sealing.
5. Install a new air filter element. Slide the open end of the air filter element in first, below the tab.

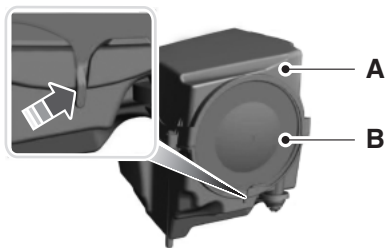

6. Align the tab on the closed end of the air filter element (B) with the slot in the air filter housing.
7. Install the air filter housing cover (A).
8. Tighten the screws that secure the air filter housing cover to the air filter housing.



**ADJUSTING THE HEADLAMPS**

The headlamps on your vehicle are properly aimed at the assembly plant. If your vehicle has been in an accident, the alignment of your headlamps should be checked by your authorized dealer.

**Vertical Aim Adjustment**

1. Park the vehicle directly in front of a wall or screen on a level surface, approximately 25 feet (7.6 meters) away.

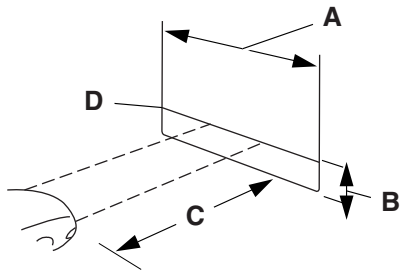

- (A) 8 feet (2.4 meters)
- (B) Center height of lamp to ground
- (C) 25 feet (7.6 meters)
- (D) Horizontal reference line

2. Measure the height of the headlamp bulb center from the ground and mark an 8 foot (2.4 meter) horizontal reference line on the vertical wall or screen at this height.

3. Turn on the low beam headlamps to illuminate the wall or screen and open the hood.

To see a clearer light pattern for adjusting, you may want to block the light from one headlamp while adjusting the other.

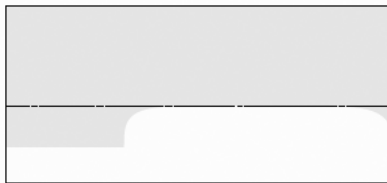
**For Vehicles with Halogen Headlamps:**

On the wall or screen you will observe a flat zone of high intensity light located at the top of the right hand portion of the beam pattern. If the top edge of the high intensity light zone is not at the horizontal reference line, the headlamp will need to be adjusted.



**For Vehicles with HID Headlamps:**

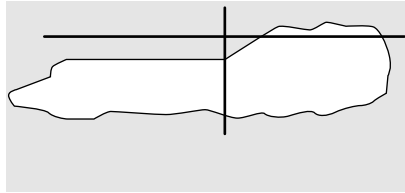

There is a distinct cut-off (change from light to dark) in the left portion of the beam pattern. The top edge of this cut-off should be positioned two inches (5 centimeters) below the horizontal reference line.

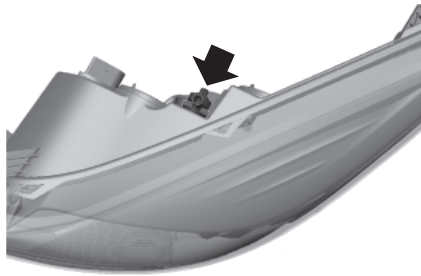

4. Locate the vertical adjuster on each headlamp. Using a Phillips #2 screwdriver, turn the adjuster either clockwise or counterclockwise in order to aim the headlamp. The horizontal edge of the brighter light should touch the horizontal reference line.

5. Close the hood and turn off the lamps.

**HORIZONTAL AIM IS NOT REQUIRED FOR THIS VEHICLE AND IS NOT ADJUSTABLE.**

**REMOVING A HEADLAMP**



1. Make sure the headlamp control is in the off position and open the hood.
2. Remove the two screws from the headlamp assembly.
3. Carefully pull the headlamp assembly as far as possible towards the front of the vehicle to disengage it from the lower fixing point.

4. Carefully lift the outer side of the headlamp and remove it.
5. Disconnect the electrical connector.



**CHANGING A BULB****Lamp Assembly Condensation**

Exterior lamps are vented to accommodate normal changes in pressure. Condensation can be a natural by-product of this design. When moist air enters the lamp assembly through the vents, there is a possibility that condensation can occur when the temperature is cold. When normal condensation occurs, a thin film of mist can form on the interior of the lens. The thin mist eventually clears and exits through the vents during normal operation. Clearing time may take as long as 48 hours under dry weather conditions.

These are examples of acceptable condensation:

- Presence of thin mist (no streaks, drip marks or droplets).
- Fine mist covers less than 50% of the lens.

These are examples of unacceptable moisture (usually caused by a lamp water leak):

- Water puddle inside the lamp.
- Large water droplets, drip marks or streaks present on the interior of the lens.

Take your vehicle to a dealer for service if any of the above conditions of unacceptable moisture are present.

**Replacing Headlamp Bulbs**

**WARNING:** Handle a halogen headlamp bulb carefully and keep out of children's reach. Grasp the bulb by only its plastic base and do not touch the glass. The oil from your hand could cause the bulb to break the next time the headlamps are operated.

**Note:** If the bulb is accidentally touched, it should be cleaned with rubbing alcohol before being used.

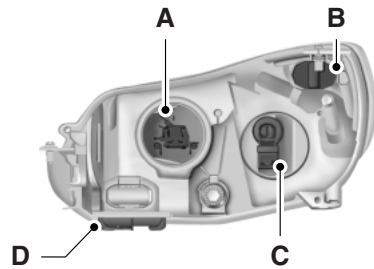

**Headlamp assembly:**

- A. High beam headlamp bulb
- B. Side marker bulb
- C. Low beam headlamp bulb
- D. Front parking lamp and turn signal bulb

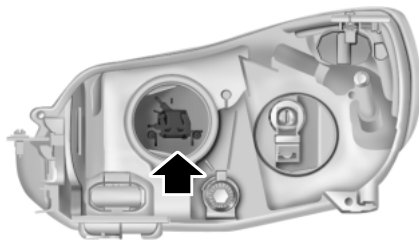
**High beam headlamp bulb:**

1. Remove the headlamp assembly.
2. Remove the service cap.
3. Disconnect the electrical connector.
4. Remove the bulb from the headlamp assembly by turning it counterclockwise, then pull it straight out.

Install the new bulb in reverse order.

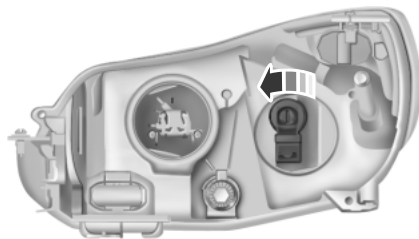
**Low beam headlamp bulb:**

1. Remove the headlamp assembly.
2. Remove the service cap.
3. Disconnect the electrical connector.
4. Remove the bulb from the headlamp assembly by turning it counterclockwise, then pull it straight out.

Install the new bulb in reverse order.

**Note:** Be sure that the spring clip is not damaged or detached from the headlamp assembly during the replacement procedure.

**Replacing HID Headlamp Bulbs (If Equipped)**

The low beam headlamps on your vehicle use a “high intensity discharge” source. These lamps operate at a high voltage. When the bulb is burned out, the bulb and starter capsule assembly must be replaced by your authorized dealer.

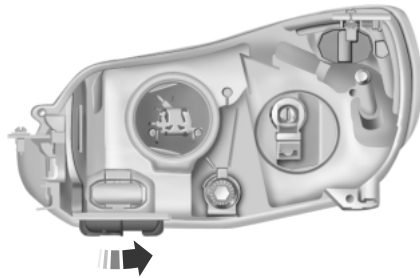

**Replacing Front Parking Lamp and Turn Signal Bulbs**

1. Remove the service cap by turning it counterclockwise.
  2. Remove the bulb socket from the headlamp assembly by turning it counterclockwise.
  3. Remove the bulb by gently pulling the bulb straight out of the socket
- Install the new bulb in reverse order.

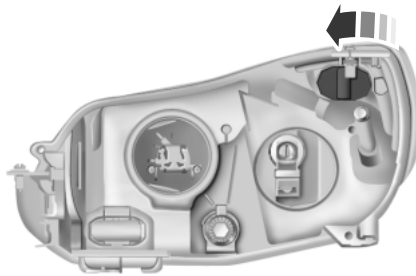
**Replacing Side Marker Bulbs**

1. Remove the service cap.
  2. Remove the bulb socket from the headlamp assembly by turning it counterclockwise.
  3. Remove the bulb by gently pulling the bulb straight out of the socket
- Install the new bulb in reverse order.

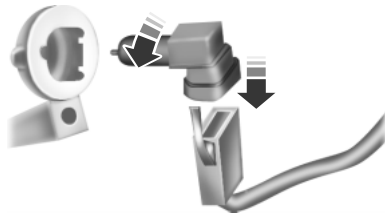
**Replacing Fog Lamp Bulbs (If Equipped)**

1. Make sure the lighting control switch is in the off position.
2. Reach under the front fender and remove the aero shield.
3. Remove the harness/bulb assembly from the fog lamp by turning it counterclockwise.
4. Disconnect the harness from the bulb by pulling it straight out.

Install the new bulb in reverse order.





### Replacing Rear Lamps - 4 Door

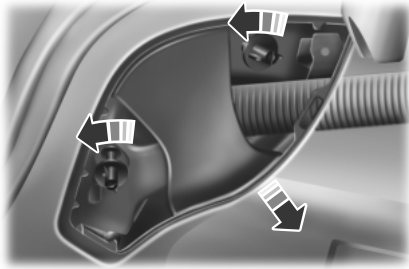

1. Make sure the headlamp control is in the off position and open the trunk.
2. Remove the trim panel from inside the luggage compartment.
3. Remove the two nuts from the lamp assembly

4. Gently pull the lamp assembly away from the vehicle
5. Remove the bulb by turning the bulb socket counterclockwise. Gently pull the bulb straight out of the socket.

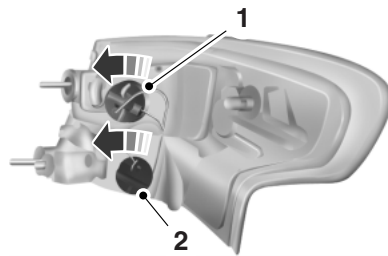

- Turn signal bulb (1)
- Stop and tail lamp bulb (2)

Install the new bulb in reverse order.

**Note:** The reverse lamp bulb is located in the luggage compartment lid. If replacement is required, it is recommended that you see your authorized dealer.

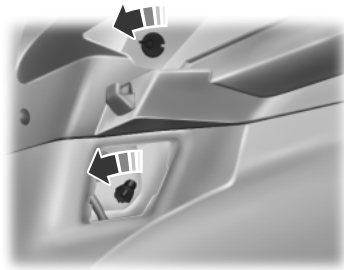

**Replacing Rear Lamps - 5 Door**

1. Make sure the headlamp control is in the off position and open the trunk.
2. Remove the trim panel from inside the luggage compartment.
3. Remove the two nuts from the lamp assembly

4. Gently pull the lamp assembly away from the vehicle
5. Remove the bulb by turning the bulb socket counterclockwise. Gently pull the bulb straight out of the socket.

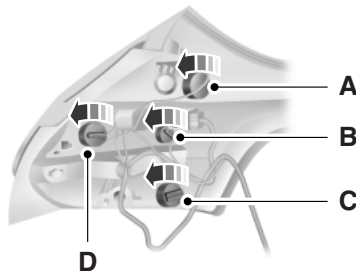

- A. Brake lamp bulb
- B. Reverse lamp bulb
- C. Tail lamp and side marker lamp bulb
- D. Turn signal bulb

Install the new bulb in reverse order.

**Replacing License Plate Lamp Assembly**

Your vehicle is equipped with an LED license plate lamp assembly. It is designed to last the life of the vehicle. If replacement is required, it is recommended that you see your authorized dealer.

**Replacing High-Mount Brake Lamp Assembly**

Your vehicle is equipped with an LED center high-mount stop lamp. It is designed to last the life of the vehicle. If replacement is required, it is recommended that you see your authorized dealer.



**BULB SPECIFICATION CHART**

Replacement bulbs are specified in the chart below. Headlamp bulbs must be marked with an authorized “D.O.T.” for North America to ensure lamp performance, light brightness and pattern and safe visibility. The correct bulbs will not damage the lamp assembly or void the lamp assembly warranty and will provide quality bulb burn time.

Function	Trade number
Headlamp high beam	H1LL
Headlamp low beam (halogen)	H11LL
Headlamp low beam (HID)	D8S
Turn lamp (front)	W21W
Park/Side marker lamp (front)	168NA
Fog lamps (if equipped)	H11LL
Stop/tail lamp	3157K
Turn lamp	3757AK
Backup lamp	921
Dome lamp	H5W
* License plate lamp	LED
* High-mount brake lamp	LED
* To replace these lamps - see your authorized dealer.	
To replace all instrument panel lights - see your authorized dealer	



**GENERAL INFORMATION**

Your Ford or Lincoln authorized dealer has many quality products available to clean your vehicle and protect its finishes.

**CLEANING PRODUCTS**

For best results, use the following products or products of equivalent quality:

- Motorcraft® Bug and Tar Remover (ZC-42)
- Motorcraft® Custom Bright Metal Cleaner (ZC-15)
- Motorcraft® Detail Wash (ZC-3-A)
- Motorcraft® Dusting Cloth (ZC-24)
- Motorcraft® Engine Shampoo and Degreaser (U.S. only) (ZC-20)
- Motorcraft® Engine Shampoo (Canada only) (CXC-66-A)
- Motorcraft® Multi-Purpose Cleaner (Canada only) (CXC-101)
- Motorcraft® Premium Glass Cleaner (Canada only) (CXC-100)
- Motorcraft® Premium Quality Windshield Washer Fluid (Canada only) [CXC-37-(A, B, D or F)]
- Motorcraft® Premium Windshield Washer Concentrate (U.S. only) (ZC-32-A)
- Motorcraft® Professional Strength Carpet & Upholstery Cleaner (ZC-54)
- Motorcraft® Spot and Stain Remover (U.S. only) (ZC-14)
- Motorcraft® Ultra-Clear Spray Glass Cleaner (ZC-23)
- Motorcraft® Vinyl Cleaner (Canada only) (CXC-93)
- Motorcraft® Wheel and Tire Cleaner (ZC-37-A)

**CLEANING THE EXTERIOR**

Wash your vehicle regularly with cool or lukewarm water and a neutral pH shampoo, such as Motorcraft® Detail Wash.

- Never use strong household detergents or soap, such as dish washing or laundry liquid. These products can discolor and spot painted surfaces.
- Never wash a vehicle that is “hot to the touch” or during exposure to strong, direct sunlight.
- Dry the vehicle with a chamois or soft terry cloth towel in order to eliminate water spotting.



- Immediately remove items such as gasoline, diesel fuel, bird droppings and insect deposits because they can cause damage to the vehicle's paintwork and trim over time. Use Motorcraft® Bug and Tar Remover.
- Remove any exterior accessories, such as antennas, before entering a car wash.
- **Note:** Suntan lotions and insect repellents can damage any painted surface; if these substances come in contact with your vehicle, wash off as soon as possible.

### Exterior Chrome

**Note:** Never use abrasive materials such as steel wool or plastic pads as they can scratch the chrome surface.

**Note:** Do not use chrome cleaner, metal cleaner or polish on wheels and wheel covers.

- Wash the vehicle first, using cool or lukewarm water and a neutral pH shampoo, such as Motorcraft® Detail Wash.
- Use Motorcraft® Custom Bright Metal Cleaner. Apply the product as you would a wax to clean bumpers and other chrome parts; allow the cleaner to dry for a few minutes, then wipe off the haze with a clean, dry rag.
- Do not apply cleaning product to hot surfaces and do not leave cleaning product on chrome surfaces for a period of time exceeding that which is recommended.
- **Note:** Using other non-recommended cleaners can result in severe and permanent cosmetic damage.

### Underbody

Flush the complete underside of your vehicle frequently. Keep body and door drain holes free from packed dirt.

### Cleaning Plastic Exterior Parts

Use only approved products to clean plastic parts.

- For routine cleaning, use Motorcraft® Detail Wash.
- If tar or grease spots are present, use Motorcraft® Bug and Tar Remover.



**WAXING**

- Wash the vehicle first.
- Use a quality wax that does not contain abrasives.
- Do not allow paint sealant to come in contact with any non-body (low-gloss black) colored trim, such as grained door handles, roof racks, bumpers, side moldings, mirror housings or the windshield cowl area. The paint sealant will “gray” or stain the parts over time.

**REPAIRING MINOR PAINT DAMAGE**

Your authorized dealer has touch-up paint to match your vehicle's color. Take your color code (printed on a sticker in the driver's door jamb) to your authorized dealer to ensure you get the correct color.

- Remove particles such as bird droppings, tree sap, insect deposits, tar spots, road salt and industrial fallout before repairing paint chips.
- Always read the instructions before using the products.

**CLEANING THE ENGINE**

Engines are more efficient when they are clean because grease and dirt buildup keep the engine warmer than normal.

When washing:

- Take care when using a power washer to clean the engine. The high-pressure fluid could penetrate the sealed parts and cause damage.
- Do not spray a hot engine with cold water to avoid cracking the engine block or other engine components.
- Spray Motorcraft® Engine Shampoo and Degreaser on all parts that require cleaning and pressure rinse clean. In Canada, use Motorcraft® Engine Shampoo.
- Never wash or rinse the engine while it is hot or running; water in the running engine may cause internal damage.
- Never wash or rinse any ignition coil, spark plug wire or spark plug well, or the area in and around these locations.
- Cover the battery, power distribution box, and air filter assembly to prevent water damage when cleaning the engine.



**CLEANING THE WINDOWS AND WIPER BLADES**

The windows and wiper blades should be cleaned regularly. If the wipers do not wipe properly, substances on the vehicle's glass or the wiper blades may cause squeaking or chatter noise from the blades, and streaking and smearing of the windshield. To clean these items, follow these tips:

- The windows may be cleaned with a non-abrasive cleaner such as Motorcraft® Ultra-Clear Spray Glass Cleaner.
- The wiper blades can be cleaned with isopropyl (rubbing) alcohol or Motorcraft® Premium Windshield Washer Concentrate in the U.S., or Premium Quality Windshield Washer Fluid in Canada. Be sure to replace wiper blades when they appear worn or do not function properly.
- Do not use abrasives, as they may cause scratches.
- Do not use fuel, kerosene, or paint thinner to clean any parts.

If you cannot remove those streaks after cleaning with the glass cleaner or if the wipers chatter and move in a jerky motion, clean the outer surface of the windshield and the wiper blades using a sponge or soft cloth with a neutral detergent or mild-abrasive cleaning solution. After cleaning, rinse the windshield and wiper blades with clean water. The windshield is clean if beads do not form when you rinse the windshield with water.

**Note:** Do not use sharp objects, such as a razor blade, to clean the inside of the rear window or to remove decals, as it may cause damage to the rear window defroster's heated grid lines.



**CLEANING THE INTERIOR**

**WARNING:** Do not use cleaning solvents, bleach or dye on the vehicle's safety belts, as these actions may weaken the belt webbing.



**WARNING:** On vehicles equipped with seat-mounted airbags, do not use chemical solvents or strong detergents. Such products could contaminate the side airbag system and affect performance of the side airbag in a collision.

For fabric, carpets, cloth seats, safety belts and seats equipped with side airbags:

- Remove dust and loose dirt with a vacuum cleaner.
- Remove light stains and soil with Motorcraft® Professional Strength Carpet & Upholstery Cleaner.
- If grease or tar is present on the material, spot-clean the area first with Motorcraft® Spot and Stain Remover. In Canada, use Motorcraft® Multi-Purpose Cleaner.
- If a ring forms on the fabric after spot cleaning, clean the entire area immediately (but do not oversaturate) or the ring will set.
- Do not use household cleaning products or glass cleaners, which can stain and discolor the fabric and affect the flame retardant abilities of the seat materials.

**CLEANING THE INSTRUMENT PANEL AND INSTRUMENT CLUSTER LENS**

**WARNING:** Do not use chemical solvents or strong detergents when cleaning the steering wheel or instrument panel to avoid contamination of the airbag system.

Clean the instrument panel and cluster lens with a clean, damp, white cotton cloth, then use a clean and dry white cotton cloth to dry these areas.

- Avoid cleaners or polishes that increase the gloss of the upper portion of the instrument panel. The dull finish in this area helps protect the driver from undesirable windshield reflection.
- Be certain to wash or wipe your hands clean if you have been in contact with certain products such as insect repellent and suntan lotion in order to avoid possible damage to the interior painted surfaces.





- Do not use household or glass cleaners as these may damage the finish of the instrument panel, interior trim and cluster lens.
- Do not allow air fresheners and hand sanitizers to spill on interior surfaces. If a spill occurs, wipe off immediately. Damage may not be covered by your warranty.

If a staining liquid like coffee/juice has been spilled on the instrument panel or on interior trim surfaces, clean as follows:

1. Wipe up spilled liquid using a clean, white, cotton cloth.
2. Wipe the surface with a damp, clean, white cotton cloth. For more thorough cleaning, use a mild soap and water solution. If the spot cannot be completely cleaned by this method, the area may be cleaned using a commercially available cleaning product designed for automotive interiors.
3. If necessary, apply more soap and water solution or cleaning product to a clean, white, cotton cloth and press the cloth onto the soiled area—allow this to set at room temperature for 30 minutes.
4. Remove the soaked cloth, and if it is not soiled badly, use this cloth to clean the area by using a rubbing motion for 60 seconds.
5. Following this, wipe area dry with a clean, white, cotton cloth.

#### **CLEANING LEATHER SEATS (IF EQUIPPED)**

- Remove dust and loose dirt with a vacuum cleaner.
- Clean spills and stains as quickly as possible.
- For routine cleaning, wipe the surface with a soft, damp cloth. For more thorough cleaning, wipe the surface with a mild soap and water solution. In Canada, use Motorcraft® Vinyl Cleaner . Dry the area with a soft cloth.
- If the leather cannot be completely cleaned using a mild soap and water solution, the leather may be cleaned using a commercially available leather cleaning product designed for automotive interiors.
- To check for compatibility, first test any cleaner or stain remover on an inconspicuous part of the leather.
- Do not use household cleaning products, alcohol solutions, solvents or cleaners intended for rubber, vinyl and plastics, or oil/petroleum-based leather conditioners. These products may cause premature wearing or damage to the leather.



**CLEANING THE ALLOY WHEELS**

**Note:** Do not use chrome cleaner, metal cleaner or polish on wheels and wheel covers.

Aluminum wheels and wheel covers are coated with a clear coat paint finish. In order to maintain their shine:

- Clean weekly with Motorcraft® Wheel and Tire Cleaner. Heavy dirt and brake dust accumulation may require agitation with a sponge. Rinse thoroughly with a strong stream of water.
- Never apply any cleaning chemical to hot or warm wheel rims or covers.
- Some automatic car washes may cause damage to the finish on your wheel rims or covers. Industrial-strength (heavy-duty) cleaners, or cleaning chemicals, in combination with brush agitation to remove brake dust and dirt, could wear away the clear coat finish over time.
- Do not use hydrofluoric acid-based or high caustic-based wheel cleaners, steel wool, fuels or strong household detergent.
- To remove tar and grease, use Motorcraft® Bug and Tar Remover.

**VEHICLE STORAGE**

If you plan on storing your vehicle for an extended period of time (30 days or more), read the following maintenance recommendations to make sure your vehicle stays in good operating condition.

All motor vehicles and their components were engineered and tested for reliable, regular driving. Long term storage under various conditions may lead to component degradation or failure unless specific precautions are taken to preserve the components.

*General*

- Store all vehicles in a dry, ventilated place.
- Protect from sunlight, if possible.
- If vehicles are stored outside, they require regular maintenance to protect against rust and damage.

*Body*

- Wash vehicle thoroughly to remove dirt, grease, oil, tar or mud from exterior surfaces, rear-wheel housing and underside of front fenders.
- Periodically wash vehicles stored in exposed locations.
- Touch-up raw or primed metal to prevent rust.



- Cover chrome and stainless steel parts with a thick coat of auto wax to prevent discoloration. Re-wax as necessary when the vehicle is washed.
- Lubricate all hood, door and trunk lid hinges, and latches with a light grade oil.
- Cover interior trim to prevent fading.
- Keep all rubber parts free from oil and solvents.

#### *Engine*

- The engine oil and filter should be changed prior to storage, as used engine oil contain contaminants that may cause engine damage.
- Start the engine every 15 days. Run at fast idle until it reaches normal operating temperature.
- With your foot on the brake, shift through all the gears while the engine is running.

#### *Fuel system*

- Fill the fuel tank with high-quality fuel until the first automatic shutoff of the fuel pump nozzle.

**Note:** During extended periods of vehicle storage (30 days or more), fuel may deteriorate due to oxidation. Add a quality gas stabilizer product to the vehicle fuel system whenever actual or expected storage periods exceed 30 days. Follow the instructions on the additive label. The vehicle should then be operated at idle speed to circulate the additive throughout the fuel system.

#### *Cooling system*

- Protect against freezing temperatures.
- When removing vehicle from storage, check coolant fluid level. Confirm there are no cooling system leaks, and fluid is at the recommended level.

#### *Battery*

- Check and recharge as necessary. Keep connections clean.
- If storing your vehicle for more than 30 days without recharging the battery, it may be advisable to disconnect the battery cables to ensure battery charge is maintained for quick starting.

**Note:** If battery cables are disconnected, it will be necessary to reset memory features.



*Brakes*

- Make sure brakes and parking brake are fully released.

*Tires*

- Maintain recommended air pressure.

*Miscellaneous*

- Make sure all linkages, cables, levers and pins under vehicle are covered with grease to prevent rust.
- Move vehicles at least 25 feet (8 meters) every 15 days to lubricate working parts and prevent corrosion.

**Removing Vehicle from Storage**

When your vehicle is ready to come out of storage, do the following:

- Wash your vehicle to remove any dirt or grease film build-up on window surfaces.
- Check windshield wipers for any deterioration.
- Check under the hood for any foreign material that may have collected during storage (mice/squirrel nests).
- Check the exhaust for any foreign material that may have collected during storage.
- Check tire pressures and set tire inflation per the Tire Label.
- Check brake pedal operation. Drive the vehicle 15 feet (4.5 meters) back and forth to remove rust build-up.
- Check fluid levels (including coolant, oil and gas) to make sure there are no leaks and fluids are at recommended levels.
- If the battery was removed, clean the battery cable ends and inspect.

Contact your authorized dealer if you have any concerns or issues.



**TIRE CARE****IMPORTANT INFORMATION FOR 235/40R18 LOW-PROFILE TIRES AND WHEELS**

If your vehicle is equipped with 235/40R18 tires, they are low-profile tires. These tires and wheels are designed to give your vehicle a sport appearance. With low-profile tires, you may notice an increase in road noise and faster tire wear, depending on road conditions and driving styles. Due to their design, low-profile tires and wheels are more prone to road damage from potholes, rough or unpaved roads, car wash rails and curb contact than standard tires and wheels.

**Note:** Your vehicle's warranty does not cover these types of damage. Tires should always be kept at the correct inflation pressures and extra caution should be taken when operating on rough roads to avoid impacts that could cause wheel and tire damage.

**Information About Uniform Tire Quality Grading**

Tire Quality Grades apply to new pneumatic passenger car tires. The Quality grades can be found where applicable on the tire sidewall between tread shoulder and maximum section width. For example:

- **Treadwear 200 Traction AA Temperature A**

These Tire Quality Grades are determined by standards that the United States Department of Transportation has set.

Tire Quality Grades apply to new pneumatic passenger car tires. They do not apply to deep tread, winter-type snow tires, space-saver or temporary use spare tires, light truck or LT type tires, tires with nominal rim diameters of 10 to 12 inches or limited production tires as defined in Title 49 Code of Federal Regulations Part 575.104(c)(2).

**U.S. Department of Transportation-Tire quality grades:** The U.S. Department of Transportation requires Ford Motor Company to give you the following information about tire grades exactly as the government has written it.



**Treadwear**

The treadwear grade is a comparative rating based on the wear rate of the tire when tested under controlled conditions on a specified government test course. For example, a tire graded 150 would wear one and one-half (1½) times as well on the government course as a tire graded 100. The relative performance of tires depends upon the actual conditions of their use, however, and may depart significantly from the norm due to variations in driving habits, service practices, and differences in road characteristics and climate.

**Traction AA A B C**

**WARNING:** The traction grade assigned to this tire is based on straight-ahead braking traction tests, and does not include acceleration, cornering, hydroplaning or peak traction characteristics.

The traction grades, from highest to lowest are AA, A, B, and C. The grades represent the tire's ability to stop on wet pavement as measured under controlled conditions on specified government test surfaces of asphalt and concrete. A tire marked C may have poor traction performance.

**Temperature A B C**

**WARNING:** The temperature grade for this tire is established for a tire that is properly inflated and not overloaded. Excessive speed, underinflation, or excessive loading, either separately or in combination, can cause heat buildup and possible tire failure.

The temperature grades are A (the highest), B and C, representing the tire's resistance to the generation of heat and its ability to dissipate heat when tested under controlled conditions on a specified indoor laboratory test wheel. Sustained high temperature can cause the material of the tire to degenerate and reduce tire life, and excessive temperature can lead to sudden tire failure. The grade C corresponds to a level of performance which all passenger car tires must meet under the Federal Motor Vehicle Safety Standard No. 139. Grades B and A represent higher levels of performance on the laboratory test wheel than the minimum required by law.



**Glossary of Tire Terminology**

- **Tire label:** A label showing the OE (Original Equipment) tire sizes, recommended inflation pressure and the maximum weight the vehicle can carry.
- **Tire Identification Number (TIN):** A number on the sidewall of each tire providing information about the tire brand and manufacturing plant, tire size and date of manufacture. Also referred to as DOT code.
- **Inflation pressure:** A measure of the amount of air in a tire.
- **Standard load:** A class of P-metric or Metric tires designed to carry a maximum load at 35 psi [37 psi (2.5 bar) for Metric tires]. Increasing the inflation pressure beyond this pressure will not increase the tire's load carrying capability.
- **Extra load:** A class of P-metric or Metric tires designed to carry a heavier maximum load at 41 psi [43 psi (2.9 bar) for Metric tires]. Increasing the inflation pressure beyond this pressure will not increase the tire's load carrying capability.
- **kPa:** Kilopascal, a metric unit of air pressure.
- **PSI:** Pounds per square inch, a standard unit of air pressure.
- **Cold inflation pressure:** The tire pressure when the vehicle has been stationary and out of direct sunlight for an hour or more and prior to the vehicle being driven for 1 mile (1.6 kilometers).
- **Recommended inflation pressure:** The cold inflation pressure found on the Safety Compliance Certification Label (affixed to either the door hinge pillar, door-latch post, or the door edge that meets the door-latch post, next to the driver's seating position), or Tire Label located on the B-Pillar or the edge of the driver's door.
- **B-pillar:** The structural member at the side of the vehicle behind the front door.
- **Bead area of the tire:** Area of the tire next to the rim.
- **Sidewall of the tire:** Area between the bead area and the tread.
- **Tread area of the tire:** Area of the perimeter of the tire that contacts the road when mounted on the vehicle.
- **Rim:** The metal support (wheel) for a tire or a tire and tube assembly upon which the tire beads are seated.



**INFORMATION CONTAINED ON THE TIRE SIDEWALL**

Both U.S. and Canada Federal regulations require tire manufacturers to place standardized information on the sidewall of all tires. This information identifies and describes the fundamental characteristics of the tire and also provides a U.S. DOT Tire Identification Number for safety standard certification and in case of a recall.

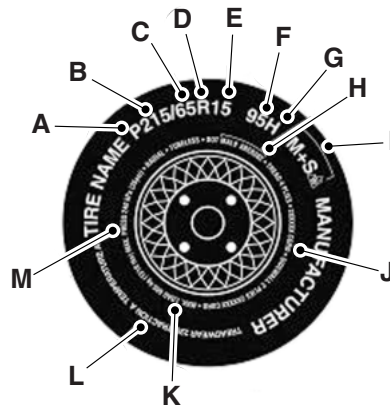
**Information on P Type Tires**

P215/65R15 95H is an example of a tire size, load index and speed rating. The definitions of these items are listed below. (Note that the tire size, load index and speed rating for your vehicle may be different from this example.)

A. **P:** Indicates a tire, designated by the Tire and Rim Association (T&RA), that may be used for service on cars, SUVs, minivans and light trucks.

**Note:** If your tire size does not begin with a letter, this may mean it is designated by either ETRTO (European Tire and Rim Technical Organization) or JATMA (Japan Tire Manufacturing Association).

B. **215:** Indicates the nominal width of the tire in millimeters from sidewall edge to sidewall edge. In general, the larger the number, the wider the tire.

C. **65:** Indicates the aspect ratio which gives the tire's ratio of height to width.

D. **R:** Indicates a radial type tire.





E. **15:** Indicates the wheel or rim diameter in inches. If you change your wheel size, you will have to purchase new tires to match the new wheel diameter.

F. **95:** Indicates the tire's load index. It is an index that relates to how much weight a tire can carry. You may find this information in your owner's manual. If not, contact a local tire dealer.

**Note:** You may not find this information on all tires because it is not required by federal law.

G. **H:** Indicates the tire's speed rating. The speed rating denotes the speed at which a tire is designed to be driven for extended periods of time under a standard condition of load and inflation pressure. The tires on your vehicle may operate at different conditions for load and inflation pressure. These speed ratings may need to be adjusted for the difference in conditions. The ratings range from 81 mph (130 km/h) to 186 mph (299 km/h). These ratings are listed in the following chart.

**Note:** You may not find this information on all tires because it is not required by federal law.

Letter rating	Speed rating - mph (km/h)
M	81 mph (130 km/h)
N	87 mph (140 km/h)
Q	99 mph (159 km/h)
R	106 mph (171 km/h)
S	112 mph (180 km/h)
T	118 mph (190 km/h)
U	124 mph (200 km/h)
H	130 mph (210 km/h)
V	149 mph (240 km/h)
W	168 mph (270 km/h)
Y	186 mph (299 km/h)

**Note:** For tires with a maximum speed capability over 149 mph (240 km/h), tire manufacturers sometimes use the letters ZR. For those with a maximum speed capability over 186 mph (299 km/h), tire manufacturers always use the letters ZR.



**H. U.S. DOT Tire Identification Number (TIN):** This begins with the letters DOT and indicates that the tire meets all federal standards. The next two numbers or letters are the plant code designating where it was manufactured, the next two are the tire size code and the last four numbers represent the week and year the tire was built. For example, the numbers 317 mean the 31st week of 1997. After 2000 the numbers go to four digits. For example, 2501 means the 25th week of 2001. The numbers in between are identification codes used for traceability. This information is used to contact customers if a tire defect requires a recall.

**I. M+S or M/S:** Mud and Snow, or

**AT:** All Terrain, or

**AS:** All Season.

**J. Tire Ply Composition and Material Used:** Indicates the number of plies or the number of layers of rubber-coated fabric in the tire tread and sidewall. Tire manufacturers also must indicate the ply materials in the tire and the sidewall, which include steel, nylon, polyester, and others.

**K. Maximum Load:** Indicates the maximum load in kilograms and pounds that can be carried by the tire. See the Safety Compliance Certification Label (affixed to either the door hinge pillar, door-latch post, or the door edge that meets the door-latch post, next to the driver's seating position), for the correct tire pressure for your vehicle.

**L. Treadwear, Traction and Temperature Grades**

- **Treadwear:** The treadwear grade is a comparative rating based on the wear rate of the tire when tested under controlled conditions on a specified government test course. For example, a tire graded 150 would wear one and one-half (1½) times as well on the government course as a tire graded 100.
- **Traction:** The traction grades, from highest to lowest are AA, A, B, and C. The grades represent the tire's ability to stop on wet pavement as measured under controlled conditions on specified government test surfaces of asphalt and concrete. A tire marked C may have poor traction performance.
- **Temperature:** The temperature grades are A (the highest), B and C, representing the tire's resistance to the generation of heat and its ability to dissipate heat when tested under controlled conditions on a specified indoor laboratory test wheel.



**M. Maximum Permissible Inflation Pressure:** Indicates the tire manufacturers' maximum permissible pressure and/or the pressure at which the maximum load can be carried by the tire. This pressure is normally higher than the manufacturer's recommended cold inflation pressure which can be found on the Safety Compliance Certification Label (affixed to either the door hinge pillar, door-latch post, or the door edge that meets the door-latch post, next to the driver's seating position), or Tire Label which is located on the B-Pillar or the edge of the driver's door. The cold inflation pressure should never be set lower than the recommended pressure on the vehicle label.

The tire suppliers may have additional markings, notes or warnings, such as standard load, radial tubeless, etc.

**Additional Information Contained on the Tire Sidewall for LT Type Tires**

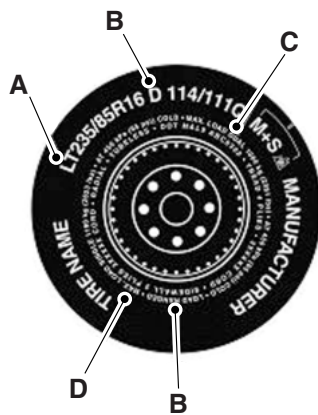

LT type tires have some additional information beyond those of P type tires; these differences are described below.

**Note:** Tire Quality Grades do not apply to this type of tire.

**A. LT:** Indicates a tire, designated by the Tire and Rim Association (T&RA), that is intended for service on light trucks.

**B. Load Range/Load Inflation Limits:** Indicates the tire's load-carrying capabilities and its inflation limits.

**C. Maximum Load Dual lb (kg) at psi (kPa) cold:** Indicates the maximum load and tire pressure when the tire is used as a dual; defined as four tires on the rear axle (a total of six or more tires on the vehicle).

**D. Maximum Load Single lb (kg) at psi (kPa) cold:** Indicates the maximum load and tire pressure when the tire is used as a single; defined as two tires (total) on the rear axle.

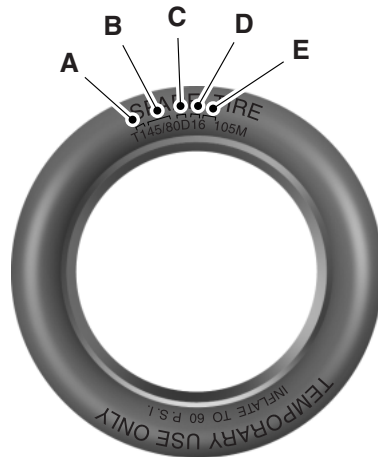

**Information on T Type Tires**

T type tires have some additional information beyond those of P type tires; these differences are described below.

T145/80D16 is an example of a tire size.

**Note:** The temporary tire size for your vehicle may be different from this example. Tire Quality Grades do not apply to this type of tire.

A. **T:** Indicates a type of tire, designated by the Tire and Rim Association (T&RA), that is intended for temporary service on cars, SUVs, minivans and light trucks.

B. **145:** Indicates the nominal width of the tire in millimeters from sidewall edge to sidewall edge. In general, the larger the number, the wider the tire.

C. **80:** Indicates the aspect ratio which gives the tire's ratio of height to width. Numbers of 70 or lower indicate a short sidewall.

D. **D:** Indicates a diagonal type tire.

**R:** Indicates a radial type tire.

E. **16:** Indicates the wheel or rim diameter in inches. If you change your wheel size, you will have to purchase new tires to match the new wheel diameter.

**Location of the Tire Label**

You will find a Tire Label containing tire inflation pressure by tire size and other important information located on the B-Pillar or the edge of the driver's door. See the payload description and graphic in the *Load Carrying* chapter.



**INFLATING YOUR TIRES**

Safe operation of your vehicle requires that your tires are properly inflated. Remember that a tire can lose up to half of its air pressure without appearing flat.

Every day before you drive, check your tires. If one looks lower than the others, use a tire gauge to check pressure of all tires and adjust if required.

At least once a month and before long trips, inspect each tire and check the tire pressure with a tire gauge (including spare, if equipped). Inflate all tires to the inflation pressure recommended by Ford Motor Company.



**WARNING:** Under-inflation is the most common cause of tire failures and may result in severe tire cracking, tread separation or blowout, with unexpected loss of vehicle control and increased risk of injury. Under-inflation increases sidewall flexing and rolling resistance, resulting in heat build-up and internal damage to the tire. It also may result in unnecessary tire stress, irregular wear, loss of vehicle control and accidents. A tire can lose up to half of its air pressure and not appear to be flat!

You are strongly urged to buy a reliable tire pressure gauge, as automatic service station gauges may be inaccurate. Ford recommends the use of a digital or dial-type tire pressure gauge rather than a stick-type tire pressure gauge.

Use the recommended cold inflation pressure for optimum tire performance and wear. Under-inflation or over-inflation may cause uneven treadwear patterns.

Always inflate your tires to the Ford recommended inflation pressure even if it is less than the maximum inflation pressure information found on the tire. The Ford recommended tire inflation pressure is found on the Safety Compliance Certification Label (affixed to either the door hinge pillar, door-latch post, or the door edge that meets the door-latch post, next to the driver's seating position), or Tire Label which is located on the B-Pillar or the edge of the driver's door. Failure to follow the tire pressure recommendations can cause uneven treadwear patterns and adversely affect the way your vehicle handles.

**Maximum Permissible Inflation Pressure** is the tire manufacturer's maximum permissible pressure or the pressure at which the maximum load can be carried by the tire. This pressure is normally higher than the manufacturer's recommended cold inflation pressure which can be found on the Safety Compliance Certification Label (affixed to either the door



hinge pillar, door-latch post, or the door edge that meets the door-latch post, next to the driver's seating position), or Tire Label which is located on the B-Pillar or the edge of the driver's door. The cold inflation pressure should never be set lower than the recommended pressure on the Safety Compliance Certification Label or Tire Label.

When weather temperature changes occur, tire inflation pressures also change. A 10°F (6°C) temperature drop can cause a corresponding drop of 1 psi (7 kPa) in inflation pressure. Check your tire pressures frequently and adjust them to the proper pressure which can be found on the Safety Compliance Certification Label or Tire Label.

To check the pressure in your tire(s):

1. Make sure the tires are cool, meaning they are not hot from driving even a mile.

If you are checking tire pressure when the tire is hot, (i.e. driven more than 1 mile [1.6 kilometers]), never bleed or reduce air pressure. The tires are hot from driving and it is normal for pressures to increase above recommended cold pressures. A hot tire at or below recommended cold inflation pressure could be significantly under-inflated.

**Note:** If you have to drive a distance to get air for your tire(s), check and record the tire pressure first and add the appropriate air pressure when you get to the pump. It is normal for tires to heat up and the air pressure inside to go up as you drive.

2. Remove the cap from the valve on one tire, then firmly press the tire gauge onto the valve and measure the pressure.
3. Add enough air to reach the recommended air pressure.

**Note:** If you overfill the tire, release air by pressing on the metal stem in the center of the valve. Then recheck the pressure with your tire gauge.

4. Replace the valve cap.
5. Repeat this procedure for each tire, including the spare.

**Note:** Some spare tires operate at a higher inflation pressure than the other tires. For T-type mini-spare tires (see the *Dissimilar Spare Tire and Wheel Assembly Information* section for description): Store and maintain at 60 psi (4.15 bar). For full-size and dissimilar spare tires (see the *Dissimilar Spare Tire and Wheel Assembly Information* section for description): Store and maintain at the higher of the front and rear inflation pressure as shown on the Tire Label.

6. Visually inspect the tires to make sure there are no nails or other objects embedded that could poke a hole in the tire and cause an air leak.
7. Check the sidewalls to make sure there are no gouges, cuts or bulges.



**Inspecting Your Tires and Wheel Valve Stems**

Periodically inspect the tire treads for uneven or excessive wear and remove objects such as stones, nails or glass that may be wedged in the tread grooves. Check the tire and valve stems for holes, cracks, or cuts that may permit air leakage and repair or replace the tire and replace the valve stem. Inspect the tire sidewalls for cracking, cuts, bruises and other signs of damage or excessive wear. If internal damage to the tire is suspected, have the tire demounted and inspected in case it needs to be repaired or replaced. For your safety, tires that are damaged or show signs of excessive wear should not be used because they are more likely to blow out or fail.

Improper or inadequate vehicle maintenance can cause tires to wear abnormally. Inspect all your tires, including the spare, frequently, and replace them if one or more of the following conditions exist:

**Tire Wear**

When the tread is worn down to 1/16th of an inch (2 millimeters), tires must be replaced to help prevent your vehicle from skidding and hydroplaning. Built-in treadwear indicators, or wear bars, which look like narrow strips of smooth rubber across the tread will appear on the tire when the tread is worn down to 1/16th of an inch (2 millimeters).

When the tire tread wears down to the same height as these wear bars, the tire is worn out and must be replaced.



**Damage**

Periodically inspect the tire treads and sidewalls for damage (such as bulges in the tread or sidewalls, cracks in the tread groove and separation in the tread or sidewall). If damage is observed or suspected, have the tire inspected by a tire professional. Tires can be damaged during off-road use, so inspection after off-road use is also recommended.

**WARNING: Age**

Tires degrade over time depending on many factors such as weather, storage conditions, and conditions of use (load, speed, inflation pressure, etc.) the tires experience throughout their lives. In general, tires should be replaced after six years regardless of tread wear. However, heat caused by hot climates or frequent high loading conditions can accelerate the aging process and may require tires to be replaced more frequently. You should replace your spare tire when you replace the road tires or after six years due to aging even if it has not been used.

**U.S. DOT Tire Identification Number (TIN)**

Both U.S. and Canada Federal regulations require tire manufacturers to place standardized information on the sidewall of all tires. This information identifies and describes the fundamental characteristics of the tire and also provides a U.S. DOT Tire Identification Number for safety standard certification and in case of a recall.

This begins with the letters DOT and indicates that the tire meets all federal standards. The next two numbers or letters are the plant code designating where it was manufactured, the next two are the tire size code and the last four numbers represent the week and year the tire was built. For example, the numbers 317 mean the 31st week of 1997. After 2000 the numbers go to four digits. For example, 2501 means the 25th week of 2001. The numbers in between are identification codes used for traceability. This information is used to contact customers if a tire defect requires a recall.





**Tire Replacement Requirements**

**WARNING:** Only use replacement tires and wheels that are the same size, load index, speed rating and type (such as P-metric versus LT-metric or all-season versus all-terrain) as those originally provided by Ford. The recommended tire and wheel size may be found on either the Safety Compliance Certification Label (affixed to either the door hinge pillar, door-latch post, or the door edge that meets the door-latch post, next to the driver's seating position), or the Tire Label which is located on the B-Pillar or edge of the driver's door. If this information is not found on these labels, then you should contact your authorized dealer as soon as possible. Use of any tire or wheel not recommended by Ford can affect the safety and performance of your vehicle, which could result in an increased risk of loss of vehicle control, vehicle rollover, personal injury and death. Additionally the use of non-recommended tires and wheels could cause steering, suspension, axle, transfer case or power transfer unit failure. If you have questions regarding tire replacement, contact your authorized dealer as soon as possible.



**WARNING:** When mounting replacement tires and wheels, you should not exceed the maximum pressure indicated on the sidewall of the tire to set the beads without additional precautions listed below. If the beads do not seat at the maximum pressure indicated, re-lubricate and try again.

When inflating the tire for mounting pressures up to 20 psi (1.38 bar) greater than the maximum pressure on the tire sidewall, the following precautions must be taken to protect the person mounting the tire:

1. Make sure that you have the correct tire and wheel size.
2. Lubricate the tire bead and wheel bead seat area again.
3. Stand at a minimum of 12 ft (3.66 m) away from the tire wheel assembly.
4. Use both eye and ear protection.

For a mounting pressure more than 20 psi (1.38 bar) greater than the maximum pressure, a Ford dealer or other tire service professional should do the mounting.

Always inflate steel carcass tires with a remote air fill with the person inflating standing at a minimum of 12 ft (3.66 m) away from the tire wheel assembly.

Your vehicle is equipped with tires designed to provide a safe ride and handling capability.



**Important:** Remember to replace the wheel valve stems when the road tires are replaced on your vehicle.

It is recommended that the two front tires or two rear tires generally be replaced as a pair.

The tire pressure sensors mounted in the wheels (originally installed on your vehicle) are not designed to be used in aftermarket wheels.

The use of wheels or tires not recommended by Ford Motor Company may affect the operation of your tire pressure monitoring system.

If the TPMS indicator is flashing, your TPMS is malfunctioning. Your replacement tire might be incompatible with your TPMS, or some component of the TPMS may be damaged.

### Safety Practices



**WARNING:** If your vehicle is stuck in snow, mud, sand, etc., do not rapidly spin the tires; spinning the tires can tear the tire and cause an explosion. A tire can explode in as little as three to five seconds.



**WARNING:** Do not spin the wheels at over 35 mph (56 km/h). The tires may fail and injure a passenger or bystander.

Driving habits have a great deal to do with your tire mileage and safety.

- Observe posted speed limits.
- Avoid fast starts, stops and turns.
- Avoid potholes and objects on the road.
- Do not run over curbs or hit the tire against a curb when parking.

### Highway Hazards

No matter how carefully you drive, there is always the possibility that you may eventually have a flat tire on the highway. Drive slowly to the closest safe area out of traffic. This may further damage the flat tire, but your safety is more important.

If you feel a sudden vibration or ride disturbance while driving, or you suspect your tire or vehicle has been damaged, immediately reduce your speed. Drive with caution until you can safely pull off the road. Stop and inspect the tires for damage. If a tire is under-inflated or damaged, deflate it, remove the wheel and replace it with your spare tire and wheel. If you cannot detect a cause, have the vehicle towed to the nearest repair facility or tire dealer to have the vehicle inspected.



### Tire and Wheel Alignment

A bad jolt from hitting a curb or pothole can cause the front end of your vehicle to become misaligned or cause damage to your tires. If your vehicle seems to pull to one side when you are driving, the wheels may be out of alignment. Have an authorized dealer check the wheel alignment periodically.

Wheel misalignment in the front or the rear can cause uneven and rapid treadwear of your tires and should be corrected by an authorized dealer. Front-wheel drive vehicles and those with an independent rear suspension (if equipped) may require alignment of all four wheels.

The tires should also be balanced periodically. An unbalanced tire and wheel assembly may result in irregular tire wear.

### Tire Rotation

**Note:** If your tires show uneven wear ask an authorized dealer to check for and correct any wheel misalignment, tire imbalance or mechanical problem involved before tire rotation.

**Note:** Your vehicle may be equipped with a dissimilar spare tire and wheel assembly. A dissimilar spare tire and wheel assembly is defined as a spare tire and wheel that is different in brand, size or appearance from the road tires and wheels. If you have a dissimilar spare tire and wheel assembly, it is intended for temporary use only and should not be used in a tire rotation.

**Note:** After having your tires rotated, inflation pressure must be checked and adjusted to the vehicle requirements.

Rotating your tires at the recommended interval (as indicated in the *Scheduled Maintenance* chapter) will help your tires wear more evenly, providing better tire performance and longer tire life.

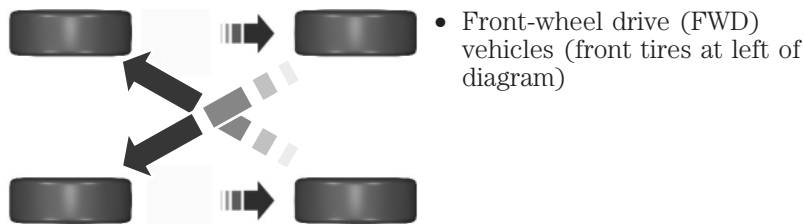

Sometimes irregular tire wear can be corrected by rotating the tires.



**USING SNOW CHAINS**

**WARNING:** Snow tires must be the same size, load index, speed rating as those originally provided by Ford. Use of any tire or wheel not recommended by Ford can affect the safety and performance of your vehicle, which could result in an increased risk of loss of vehicle control, vehicle rollover, personal injury and death. Additionally, the use of non-recommended tires and wheels could cause steering, suspension, axle or transfer case/power transfer unit failure.

**Note:** The suspension insulation and bumpers will help prevent vehicle damage. Do not remove these components from your vehicle when using snow tires and chains.

The tires on your vehicle may have all-weather treads to provide traction in rain and snow. However, in some climates, you may need to use snow tires and chains. Use chains on the tires only in an emergency or if the law requires them.

Follow these guidelines when using snow tires and chains:

- If possible, avoid fully loading your vehicle.
- Chains may damage aluminum wheels.
- Use SAE Class S chains with 195/65R15 or 215/55R16 tires only; do not use tire chains with any other size tires.
- Install chains securely, verifying that the chains do not touch any wiring, brake lines or fuel lines.
- Drive cautiously. If you hear the chains rub or bang against your vehicle, stop and retighten the chains. If this does not work, remove the chains to prevent damage to your vehicle.
- Remove the tire chains when they are no longer needed. Do not use tire chains on dry roads.



**TIRE PRESSURE MONITORING SYSTEM**

**WARNING:** The tire pressure monitoring system is NOT a substitute for manually checking tire pressure. The tire pressure should be checked periodically (at least monthly) using a tire gauge. See *Inflating Your Tires* in this chapter. Failure to properly maintain your tire pressure could increase the risk of tire failure, loss of control, vehicle rollover and personal injury.



Each tire, including the spare (if provided), should be checked monthly when cold and inflated to the inflation pressure recommended by the vehicle manufacturer on the vehicle placard or tire inflation pressure label. (If your vehicle has tires of a different size than the size indicated on the vehicle placard or tire inflation pressure label, you should determine the proper tire inflation pressure for those tires.)

As an added safety feature, your vehicle has been equipped with a tire pressure monitoring system (TPMS) that illuminates a low tire pressure telltale when one or more of your tires is significantly under-inflated. Accordingly, when the low tire pressure telltale illuminates, you should stop and check your tires as soon as possible, and inflate them to the proper pressure. Driving on a significantly under-inflated tire causes the tire to overheat and can lead to tire failure. Under-inflation also reduces fuel efficiency and tire tread life, and may affect the vehicle's handling and stopping ability.

The TPMS is not a substitute for proper tire maintenance, and it is the driver's responsibility to maintain correct tire pressure, even if under-inflation has not reached the level to trigger illumination of the TPMS low tire pressure telltale.

Your vehicle has also been equipped with a TPMS malfunction indicator to indicate when the system is not operating properly. The TPMS malfunction indicator is combined with the low tire pressure telltale. When the system detects a malfunction, the telltale will flash for approximately one minute and then remain continuously illuminated. This sequence will continue upon subsequent vehicle start-ups as long as the malfunction exists.

When the malfunction indicator is illuminated, the system may not be able to detect or signal low tire pressure as intended. TPMS malfunctions may occur for a variety of reasons, including the installation of replacement or alternate tires or wheels on the vehicle that prevent the TPMS from functioning properly. Always check the TPMS malfunction



telltale after replacing one or more tires or wheels on your vehicle to ensure that the replacement or alternate tires and wheels allow the TPMS to continue to function properly.

The tire pressure monitoring system complies with part 15 of the FCC rules and with RSS-210 of Industry Canada. Operation is subject to the following two conditions: (1) This device may not cause harmful interference, and (2) This device must accept any interference received, including interference that may cause undesired operation.

### Changing Tires with a TPMS

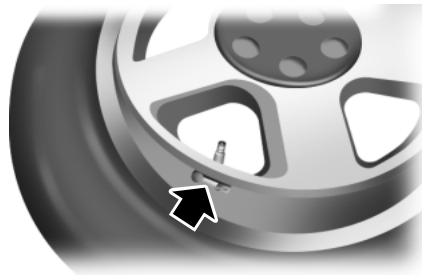

**Note:** Each road tire is equipped with a tire pressure sensor located inside the tire and wheel assembly cavity. The pressure sensor is attached to the valve stem. The pressure sensor is covered by the tire and is not visible unless the tire is removed. Care must be taken when changing the tire to avoid damaging the sensor.

It is recommended that you always have your tires serviced by an authorized dealer.

The tire pressure should be checked periodically (at least monthly) using an accurate tire gauge. See *Inflating Your Tires* in this chapter.

### Understanding Your Tire Pressure Monitoring System

The tire pressure monitoring system measures pressure in your four road tires and sends the tire pressure readings to your vehicle. The low tire pressure warning light will turn on if the tire pressure is significantly low. Once the light is illuminated, your tires are under-inflated and need to be inflated to the manufacturer's recommended tire pressure. Even if the light turns on and a short time later turns off, your tire pressure still needs to be checked.

### When Your Temporary Spare Tire Is Installed

When one of your road tires needs to be replaced with the temporary spare, the TPMS will continue to identify an issue to remind you that the damaged road wheel and tire assembly needs to be repaired and put back on your vehicle.



To restore the full functionality of the tire pressure monitoring system, have the damaged road wheel and tire assembly repaired and remounted on your vehicle. For additional information, see *Changing Tires with a TPMS* in this section.

**When You Believe Your System Is Not Operating Properly**

The main function of the tire pressure monitoring system is to warn you when your tires need air. It can also warn you in the event the system is no longer capable of functioning as intended. Please refer to the following chart for information concerning your tire pressure monitoring system:

Low tire pressure warning light	Possible cause	Customer action required
Solid warning light	Tire(s) under-inflated	1. Make sure tires are at the proper pressure. See <i>Inflating Your Tires</i> in this chapter. 2. After inflating your tires to the manufacturer's recommended pressure as shown on the Tire Label (located on the edge of driver's door or the B-Pillar), the vehicle must be driven for at least two minutes over 20 mph (32 km/h) before the light turns off.
	Spare tire in use	Repair the damaged road wheel and tire and reinstall it on the vehicle to restore system functionality. For a description on how the system functions, see <i>When Your Temporary Spare Tire is Installed</i> in this section.
	TPMS malfunction	If the tires are properly inflated and the spare tire is not in use but the light remains on, contact your authorized dealer as soon as possible.



Low tire pressure warning light	Possible cause	Customer action required
Flashing warning light	Spare tire in use	Repair the damaged road wheel/tire and reinstall it on the vehicle to restore system functionality. For a description on how the system functions, see <i>When Your Temporary Spare Tire is Installed</i> in this section.
	TPMS malfunction	If the tires are properly inflated and the spare tire is not in use but the light remains on, contact your authorized dealer as soon as possible.

#### **When Inflating Your Tires**

When putting air into your tires (such as at a gas station or in your garage), the tire pressure monitoring system may not respond immediately to the air added to your tires.

It may take up to two minutes of driving over 20 mph (32 km/h) for the light to turn off after you have filled your tires to the recommended inflation pressure.

#### **How Temperature Affects Your Tire Pressure**

The tire pressure monitoring system monitors tire pressure in each pneumatic tire. While driving in a normal manner, a typical passenger tire inflation pressure may increase approximately 2 to 4 psi (14 to 28 kPa) from a cold start situation. If the vehicle is stationary overnight with the outside temperature significantly lower than the daytime temperature, the tire pressure may decrease approximately 3 psi (21 kPa) for a drop of 30°F (17°C) in ambient temperature. This lower pressure value may be detected by the TPMS as being significantly lower than the recommended inflation pressure and activate the TPMS warning light for low tire pressure. If the low tire pressure warning light is on, visually check each tire to verify that no tire is flat. (If one or more tires are flat, repair as necessary.) Check air pressure in the road tires. If any tire is under-inflated, carefully drive the vehicle to the nearest location where air can be added to the tires. Inflate all the tires to the recommended inflation pressure.





**CHANGING A ROAD WHEEL**

**WARNING:** The use of tire sealants may damage your tire pressure monitoring system (TPMS) and should not be used. However, if you must use a sealant, the TPMS sensor and valve stem on the wheel must be replaced by an authorized Ford dealer.



**WARNING:** See *Tire Pressure Monitoring System* in this chapter for important information. If the tire pressure monitor sensor becomes damaged, it will no longer function.

**Note:** The tire pressure monitoring system indicator light will illuminate when the spare tire is in use. To restore the full functionality of the monitoring system, all road wheels equipped with tire pressure monitoring sensors must be mounted on the vehicle.

If you get a flat tire while driving, do not apply the brake heavily. Instead, gradually decrease your speed. Hold the steering wheel firmly and slowly move to a safe place on the side of the road.

Have a flat serviced by an authorized dealer in order to prevent damage to the TPMS sensors. See *Tire Pressure Monitoring System* earlier in the chapter. Replace the spare tire with a road tire as soon as possible. During repairing or replacing of the flat tire, have the authorized dealer inspect the TPMS sensor for damage.

**Dissimilar Spare Tire and Wheel Assembly Information**

**WARNING:** Failure to follow these guidelines could result in an increased risk of loss of vehicle control, injury or death.

If you have a dissimilar spare tire and wheel assembly, then it is intended for temporary use only. This means that if you need to use it, you should replace it as soon as possible with a road tire and wheel assembly that is the same size and type as the road tires and wheels that were originally provided by Ford. If the dissimilar spare tire or wheel is damaged, it should be replaced rather than repaired.



A dissimilar spare tire and wheel assembly is defined as a spare tire or wheel that is different in brand, size or appearance from the road tires and wheels and can be one of three types:

1. **T-type mini-spares:** This spare tire begins with the letter T for tire size and may have Temporary Use Only molded in the sidewall.
2. **Full-size dissimilar spare with label on wheel:** This spare tire has a label on the wheel that states: THIS TIRE AND WHEEL FOR TEMPORARY USE ONLY

When driving with one of the dissimilar spare tires listed above, do not:

- exceed 50 mph (80 km/h).
- load the vehicle beyond maximum vehicle load rating listed on the Safety Compliance Label.
- tow a trailer.
- use snow chains on the end of the vehicle with the dissimilar spare tire.
- use more than one dissimilar spare tire at a time.
- use commercial car washing equipment.
- try to repair the dissimilar spare tire.

Use of one of the dissimilar spare tires listed above at any one wheel location can lead to impairment of the following:

- Handling, stability and braking performance
- Comfort and noise
- Ground clearance and parking at curbs
- Winter weather driving capability
- Wet weather driving capability
- All-wheel driving capability (if applicable)

### 3. **Full-size dissimilar spare without label on wheel**

When driving with the full-size dissimilar spare tire and wheel assembly, do not:

- exceed 70 mph (113 km/h).
- use more than one dissimilar spare tire and wheel at a time.
- use commercial car washing equipment.
- use snow chains on the end of the vehicle with the dissimilar spare tire and wheel.



The usage of a full-size dissimilar spare tire and wheel assembly can lead to impairment of the following:

- Handling, stability and braking performance
- Comfort and noise
- Ground clearance and parking at curbs
- Winter weather driving capability
- Wet weather driving capability
- All-wheel driving capability (if applicable)
- Load leveling adjustment (if applicable)

When driving with the full-size dissimilar spare tire and wheel assembly, additional caution should be given to:

- towing a trailer.
- driving vehicles equipped with a camper body.
- driving vehicles with a load on the cargo rack.

Drive cautiously when using a full-size dissimilar spare tire and wheel, and seek service as soon as possible.

### Tire Change Procedure



**WARNING:** When one of the front wheels is off the ground, the transmission alone will not prevent the vehicle from moving or slipping off the jack, even if the transmission selector lever is in position **P** or **N**.





**WARNING:** To help prevent the vehicle from moving when you change a tire, be sure to place the transmission selector lever in position **P** or **N**, set the parking brake and block (in both directions) the wheel that is diagonally opposite (other side and end of the vehicle) to the tire being changed.



**WARNING:** Never get underneath a vehicle that is supported only by a jack. If the vehicle slips off the jack, you or someone else could be seriously injured.



 **WARNING:** Do not attempt to change a tire on the side of the vehicle close to moving traffic. Pull far enough off the road to avoid the danger of being hit when operating the jack or changing the wheel.

 **WARNING:** Always use the jack provided as original equipment with your vehicle. If using a jack other than the one provided as original equipment with your vehicle, make sure the jack capacity is adequate for the vehicle weight, including any vehicle cargo or modifications.

**Note:** Passengers should not remain in the vehicle when the vehicle is being jacked.

1. Park on a level surface, set the parking brake and activate the hazard flashers.
2. Place the transmission selector lever in position **P** or **N** and turn the engine off.

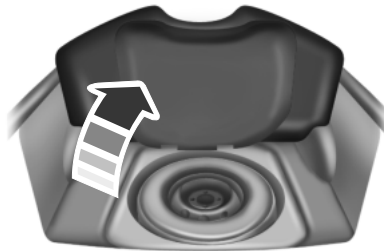

3. Remove the carpeted wheel cover.
4. Remove the wing nut/bolt assembly that secures the spare tire and jack by turning it counterclockwise.

5. Remove the lug wrench and jack from the foam holder.

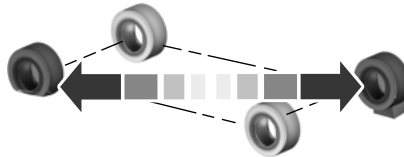

6. Block the diagonally opposite wheel.



7. Loosen each wheel lug nut one-half turn counterclockwise but do not remove them until the wheel is raised off the ground.

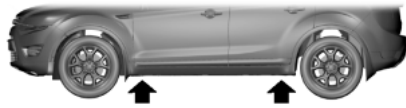

8. The vehicle jacking points are shown here, and are depicted on the yellow warning label on the jack.

**Jack at the specified locations to avoid damage to the vehicle.**

9. Remove the lug nuts with the lug wrench.

10. Replace the flat tire with the spare tire, making sure the valve stem is facing outward. Reinstall the lug nuts until the wheel is snug against the hub. Do not fully tighten the lug nuts until the wheel has been lowered.

11. Lower the wheel by turning the jack handle counterclockwise.

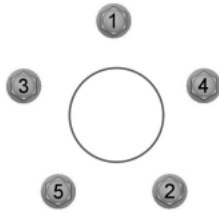

12. Remove the jack and fully tighten the lug nuts in the order shown. Refer to *Wheel lug nut torque specifications* later in this chapter for the proper lug nut torque specification.

13. Put the flat tire, jack and lug wrench away. Make sure the jack is fastened so it does not rattle when you drive. Unblock the wheels.



**TECHNICAL SPECIFICATIONS****Wheel Lug Nut Torque Specifications**

 **WARNING:** When a wheel is installed, always remove any corrosion, dirt or foreign materials present on the mounting surfaces of the wheel or the surface of the wheel hub, brake drum or brake disc that contacts the wheel. Ensure that any fasteners that attach the rotor to the hub are secured so they do not interfere with the mounting surfaces of the wheel. Installing wheels without correct metal-to-metal contact at the wheel mounting surfaces can cause the wheel nuts to loosen and the wheel to come off while the vehicle is in motion, resulting in loss of control.

Retighten the lug nuts to the specified torque within 100 miles (160 kilometers) after any wheel disturbance (tire rotation, changing a flat tire, wheel removal, etc.).

Bolt size	Wheel lug nut torque*	
	ft-lb	N•m
M12 x 1.5	100	135

\* Torque specifications are for nut and bolt threads free of dirt and rust. Use only Ford recommended replacement fasteners.



**Note:** Inspect the wheel pilot bore and mounting surface prior to installation. Remove any visible corrosion or loose particles.



**ENGINE SPECIFICATIONS**

<b>Engine</b>	<b>2.0L GDI engine</b>
Cubic inches	121
Required fuel	Minimum 87 octane or E85
Firing order	1-3-4-2
Ignition system	Coil On Plug
Compression ratio	12.0:1
Spark plug gap	.035 +/- .001 in. (0.9 +/- .05 mm)

**Engine Drivebelt Routing**

2.0L GDI

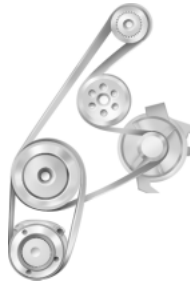

## TECHNICAL SPECIFICATIONS

Item	Capacity	Ford Part Name or Equivalent	Ford Part Number / Ford Specification
Brake fluid (and clutch fluid—if equipped) <sup>1</sup>	Between MIN and MAX on reservoir	Motorcraft® High Performance DOT 4 Motor Vehicle Brake Fluid	PM-1-C / WSS-M6C65-A2
Door latch, hood latch, auxiliary hood latch, trunk latch, seat tracks.	—	Multi-Purpose Grease (Lithium grease)	XG-4 or XL-5 or equivalent / ESB-M1C93-B
Lock cylinder	—	Motorcraft® Penetrating and Lock Lubricant	XL-1 / None
Automatic transmission fluid <sup>2,3</sup>	1.9 quarts (1.8L)	Motorcraft® Dual Clutch Transmission Fluid	XT-11-QDC
Manual transmission fluid <sup>2</sup>	1.9 quarts (1.8L)	Motorcraft® Full Synthetic Manual Transmission Fluid	BOT350-M3 / WSS-M2C200-D2





Item	Capacity	Ford Part Name or Equivalent	Ford Part Number / Ford Specification
Engine oil <sup>4,5</sup>	2.0L engine 4.5 quarts (4.3L)	<ul style="list-style-type: none"> <li>• Motorcraft® SAE 5W-20 Premium Synthetic Blend Motor Oil (US)</li> <li>• Motorcraft® SAE 5W-20 Full Synthetic Motor Oil (US)</li> <li>• Motorcraft® SAE 5W-20 Super Premium Motor Oil (Canada)</li> <li>• Motorcraft® SAE 5W-20 Synthetic Motor Oil (Canada)</li> </ul>	<ul style="list-style-type: none"> <li>• XO-5W20-QSP (US)</li> <li>• XO-5W20-QFS (US)</li> <li>• CXO-5W20-LSP12 (Canada)</li> <li>• CXO-5W20-LFS12 (Canada) / WSS-M2C945-A and API Certification Mark</li> </ul>
Engine coolant <sup>6</sup>	2.0L engine 5.3 quarts (5.0L)	Motorcraft® Orange Antifreeze/Coolant Prediluted	VC-3DIL-B (US) CVC-3DIL-B (Canada) / WSS-M97B44-D2



Item	Capacity	Ford Part Name or Equivalent	Ford Part Number / Ford Specification
Windshield washer fluid	Fill as required	Motorcraft® Premium Windshield Washer Concentrate (US) Premium Quality Windshield Washer Fluid (Canada)	ZC-32-A (US) CXC-37-(A, B, D, and F) (Canada) / WSB-M8B16-A2/- -
Fuel tank	12.4 gallons (46.9L)	—	—
<sup>1</sup> Use only Motorcraft® DOT 4 LV High Performance Brake Fluid or equivalent meeting WSS-M6C65-A2 and ISO 4925 Class 6. Use of any fluid other than the recommended fluid may cause brake system damage.			
<sup>2</sup> Approximate dry fill capacity. Actual amount may vary during fluid changes.			
<sup>3</sup> Automatic transmissions that require Motorcraft® Dual Clutch Transmission Fluid should only use Motorcraft® Dual Clutch Transmission Fluid. Refer to <i>scheduled maintenance</i> to determine the correct service interval. Use of any fluid other than the recommended fluid may cause transmission damage.			
<sup>4</sup> Use of synthetic or synthetic blend motor oil is not mandatory. Engine oil need only meet the requirements of Ford specification WSS-M2C945-A, SAE 5W-20 and display the API Certification Mark.			
<sup>5</sup> Your engine has been designed to be used with Ford engine oil, which gives a fuel economy benefit while maintaining the durability of your engine. Using oils other than the one specified can result in longer engine cranking periods, reduced engine performance, reduced fuel economy and increased emission levels.			
<sup>6</sup> Add the coolant type originally equipped in your vehicle.			



**MOTORCRAFT PART NUMBERS**

Component	2.0L GDI engine / 2.0L GTDI EcoBoost engine
Air filter element	FA-1908 <sup>1</sup>
Oil filter	FL-910- S <sup>2</sup>
Battery	BXT-96R-500/BXT-96R-590
Spark plugs	<sup>3</sup>
Cabin air filter	FP70
Windshield wiper blade	WW-2802 (driver side) / WW-2803 (passenger side)

<sup>1</sup> Failure to use the correct air filter element may result in severe engine damage. The customer warranty may be void for any damage to the engine if the correct air filter element is not used.

<sup>2</sup> Only use the specified replacement oil filter. The use of a non-specified oil filter can result in engine damage.

<sup>3</sup> For spark plug replacement, see your authorized dealer. Refer to your scheduled maintenance information for the appropriate intervals for changing the spark plugs.

**Note:** Replace the spark plugs with ones that meet Ford material and design specifications for your vehicle, such as Motorcraft® or equivalent replacement parts. The customer warranty may be void for any damage to the engine if such spark plugs are not used.



**VEHICLE IDENTIFICATION NUMBER**

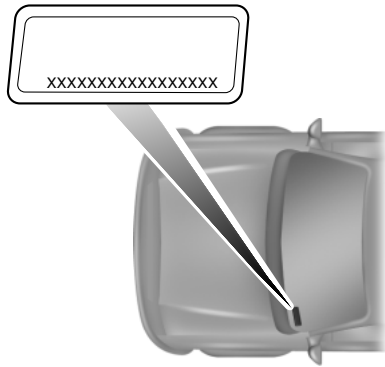

The vehicle identification number is located on the driver side instrument panel.

Please note that in the graphic, XXXX is representative of your vehicle identification number.

The Vehicle Identification Number (VIN) contains the following information:

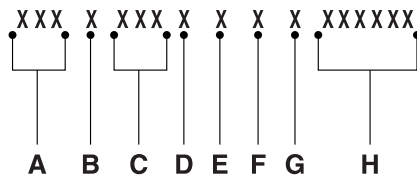

- A. World manufacturer identifier
- B. Brake system / Gross Vehicle Weight Rating (GVWR) / Restraint Devices and their location
- C. Make, vehicle line, series, body type
- D. Engine type
- E. Check digit
- F. Model year

- G. Assembly plant
- H. Production sequence number



**VEHICLE CERTIFICATION LABEL**

**MFD. BY FORD MOTOR CO.**

DATE: XX/XX GVWR: XXXXXLB/ XXXXXKG  
 FRONT GAWR: XXXXL REAR GAWR: XXXXLB  
 XXXXKG WITH XXXXKG WITH  
 XXXX/XXXXXXX TIRES XXXX/XXXXXXX TIRES  
 XXXX.XX RIMS XXXX.XX RIMS  
 AT XXX kPa/XX PSI COLD AT XXX kPa/XX PSI COLD

THIS VEHICLE CONFORMS TO ALL APPLICABLE FEDERAL MOTOR VEHICLE SAFETY STANDARDS IN EFFECT ON THE DATE OF MANUFACTURE SHOWN ABOVE.

VIN: XXXXXXXXXXXXXXXXXX XXXXX  
 TYPE: XXX XXXXX



EXT PNT: XX RC: XX DSO:  
 WB<sup>1</sup> INT TR TP/PS<sup>2</sup> R AXLE TR SPR<sup>3</sup> XXXXX  
 XXX XX X XX X XX XXX

XXXXXXXXXXXXX XX XXXX-XXXXXX-XX

The National Highway Traffic Safety Administration Regulations require that a Safety Compliance Certification Label be affixed to a vehicle and prescribe where the Safety Compliance Certification Label may be located. The Safety Compliance Certification Label shall be affixed to either the door hinge pillar, the door latch post, or the edge of the door near the door latch, next to the driver's seating position.

**TRANSMISSION CODE DESIGNATION**

**MFD. BY FORD MOTOR CO.**

DATE: XX/XX GVWR: XXXXXLB/ XXXXXKG  
 FRONT GAWR: XXXXL REAR GAWR: XXXXLB  
 XXXXKG WITH XXXXKG WITH  
 XXXX/XXXXXXX TIRES XXXX/XXXXXXX TIRES  
 XXXX.XX RIMS XXXX.XX RIMS  
 AT XXX kPa/XX PSI COLD AT XXX kPa/XX PSI COLD

THIS VEHICLE CONFORMS TO ALL APPLICABLE FEDERAL MOTOR VEHICLE SAFETY STANDARDS IN EFFECT ON THE DATE OF MANUFACTURE SHOWN ABOVE.

VIN: XXXXXXXXXXXXXXXXXX XXXXX  
 TYPE: XXX XXXXX



EXT PNT: XX RC: XX DSO:  
 WB<sup>1</sup> INT TR TP/PS<sup>2</sup> R AXLE TR SPR<sup>3</sup> XXXXX  
 XXX XX X XX X XX XXX

XXXXXXXXXXXXX XX XXXX-XXXXXX-XX

You can find a transmission code on the Safety Compliance Certification Label. The following table tells you which transmission each code represents.

Description	Code
Six-speed automatic (DPS6)	W
Five-speed manual (MTX75)	Z



**ACCESSORIES**

For a complete listing of the accessories that are available for your vehicle, please contact your dealer or visit our online store at:

**Accessories.Ford.com** (U.S. only).

Ford Custom Accessories are available for your vehicle through your local Ford or Ford of Canada dealer. Ford Motor Company will repair or replace any properly dealer-installed Ford Custom Accessories found to be defective in factory-supplied materials or workmanship during the warranty period, as well as any component damaged by the defective accessories. The accessories will be warranted for whichever provides you the greatest benefit:

- 12 months or 12,000 miles (20,000 km) (whichever occurs first), or
- the remainder of your new vehicle limited warranty.

Contact your dealer for details and a copy of the warranty.

**Exterior Style**

- Hood deflectors
- Body styling kit
- Side window deflectors
- Graphics kit
- Rear bumper protector
- Spoilers
- Wheels
- Splash guards
- Custom graphics\*

**Interior Style**

- Floor mats
- Stainless steel door sill plates
- Auto dimming rearview mirror with compass and temperature
- Illuminated gear knob

**Lifestyle**

- Ash cup / smoker's package
- Cargo net\*
- Cargo area protector
- Cargo area protector
- Car covers\*
- Roof racks and carriers\*
- Soft cargo organizers
- Premium carpeted trunk mat
- Premium carpeted trunk mat



**Peace of mind**

- Keyless entry keypad
- Remote start
- Vehicle security systems
- Wheel locks
- Bumper mounted parking assist system\*
- Car cover

\*Ford Licensed Accessories (FLA) are warranted by the accessory manufacturer's warranty. Ford Licensed Accessories are fully designed and developed by the accessory manufacturer and have not been designed or tested to Ford Motor Company engineering requirements. Contact your Ford dealer for details regarding the manufacturer's limited warranty and/or a copy of the FLA product limited warranty offered by the accessory manufacturer.

For maximum vehicle performance, keep the following information in mind when adding accessories or equipment to your vehicle:

- When adding accessories, equipment, passengers and luggage to your vehicle, do not exceed the total weight capacity of the vehicle or of the front or rear axle (GVWR or GAWR as indicated on the Safety Compliance Certification label). Consult your authorized dealer for specific weight information.
- The Federal Communications Commission (FCC) and Canadian Radio Telecommunications Commission (CRTC) regulate the use of mobile communications systems — such as two-way radios, telephones and theft alarms - that are equipped with radio transmitters. Any such equipment installed in your vehicle should comply with FCC or CRTC regulations and should be installed only by a qualified service technician.
- Mobile communications systems may harm the operation of your vehicle, particularly if they are not properly designed for automotive use.
- To avoid interference with other vehicle functions, such as anti-lock braking systems, amateur radio users who install radios and antennas onto their vehicle should not locate the amateur radio antennas in the area of the driver's side hood.
- Any non-Ford custom electrical or electronic accessories or components that are added to the vehicle by the authorized dealer or the owner, may adversely affect battery performance and durability, and may also adversely affect the performance of other electrical systems in the vehicle.



**FORD ESP EXTENDED SERVICE PLANS (U.S. ONLY)**

More than 32 million Ford and Lincoln owners have discovered the powerful protection of Ford ESP. It is the only extended service plan backed by Ford Motor Company, and provides “peace of mind” protection beyond the New Vehicle Limited Warranty coverage.

***Up to 500+ Covered Vehicle Components***

There are four, new-vehicle Extended Service Plans with different levels of coverage. Ask your dealer for details.

**PremiumCare** – Our most comprehensive coverage. With over 500 covered components, this plan is so complete that we generally only discuss what’s not covered!

**ExtraCare** – Covers 113 components, and includes many high-tech items.

**BaseCare** – Covers 84 components.

**PowertrainCare** – Covers 29 critical components.

**Ford ESP is honored by all Ford and Lincoln Dealers in the U.S. and Canada** It’s the only extended service plan authorized and backed by Ford Motor Company. That means you get:

- Reliable, quality service anywhere you go.
- **Factory-trained technicians.**
- **Ford Authorized Parts used with every covered repair.**

***Rental car reimbursement***

**If your vehicle is kept overnight for covered repairs**, you are eligible for rental car coverage, including Bumper-to-Bumper warranty repairs, or manufacturer’s recalls.

***Transferable coverage***

If you sell your vehicle before your Ford ESP coverage expires, you can transfer any remaining coverage to the new owner. Whenever you’re ready to sell your car, prospective buyers may feel better about taking a risk on your used vehicle. Ford ESP may add resale value!

Plus, **exclusive 24/7 roadside assistance**, including:

- Towing, flat-tire change and battery jump starts.
- Out-of-fuel and lock-out assistance.
- Travel expense reimbursement for lodging, meals and rental car.
- Destination assistance for taxi, shuttle, rental car coverage and emergency transportation.





***Ford ESP Can Quickly Pay for Itself***

One service bill – the cost of parts and labor – can easily exceed the price of your Ford ESP Service Contract. With Ford ESP, you minimize your risk for unexpected repair bills and rising repair costs.

***Avoid the rising cost of properly maintaining your vehicle!***

Ford ESP also offers a Premium Maintenance Plan that covers items that **routinely wear out**.

The coverage is prepaid, so you never have to worry about affording your vehicle maintenance. It covers regular checkups, routine inspections, preventive care and replacement of items that require periodic attention for **normal “wear”**:

- **Wiper blades**
- **Spark plugs (except California)**
- **Clutch disc**
- **Brake pads and linings**
- **Shock absorbers**
- **Belts and hoses**

Contact your selling Ford or Lincoln dealership today so they can customize a Ford Extended Service Plan that fits your driving lifestyle and budget.

***Interest free finance options available***

Take advantage of our installment payment plan, just a 10% down payment will provide you with an affordable no interest, no-fee payment opportunity.

**Protect Yourself From the Rising Cost of Vehicle Repairs With a Ford Extended Service Plan**

To learn more, call our Ford ESP specialists at 800-367-3377, and don't forget to ask about our interest free payment program, allowing you all the security and benefits Ford ESP has to offer while paying over time. You're pre-approved with no credit checks, no hassles!

Or, mail your name, address, city, state and zip code to:

Ford ESP  
P.O. Box 8072  
Royal Oak, MI 48068-9933



**FORD ESP EXTENDED SERVICE PLANS (CANADA ONLY)**

You can get more protection for your vehicle by purchasing a Ford Extended Service Plan (ESP). Ford ESP is the only service contract backed by Ford Motor Company of Canada, Limited. Depending on the plan you purchase, Ford ESP provides benefits such as:

- Rental reimbursement
- Coverage for certain maintenance and wear items
- Protection against repair costs after your New Vehicle Limited Warranty Coverage expires
- Roadside Assistance benefits

There are several Ford ESP plans available in various time, distance and deductible combinations. Each plan is tailored to fit your own driving needs, including reimbursement for towing and rental.

When you purchase Ford ESP, you receive added peace-of-mind protection throughout Canada and the United States, provided by a network of participating Ford Motor Company dealers. The Lincoln Maintenance Protection Plan is honored at authorized Lincoln dealers.

**Note:** Repairs performed outside of Canada and the United States are not eligible for Ford ESP coverage.

This information is subject to change.

For more information, visit your local Ford of Canada dealer or [www.ford.ca](http://www.ford.ca) to find the Ford Extended Service Plan that is right for you.



---

**GENERAL MAINTENANCE INFORMATION****Why Maintain Your Vehicle?**

Carefully following the maintenance schedule helps protect against major repair expenses resulting from neglect or inadequate maintenance and may also help to increase the value of your vehicle when you sell or trade it. Keep all receipts for completed maintenance with the vehicle.

Regular maintenance intervals for your vehicle have been established based upon rigorous testing. It is important that you have your vehicle serviced at the proper times. These intervals serve two purposes; one is to maintain the reliability of your vehicle and the second is to keep your cost of owning the vehicle down.

It is your responsibility to see that all scheduled maintenance is performed and that the materials used meet the specifications identified in the *Capacities and Specifications* chapter. Failure to perform scheduled maintenance invalidates warranty coverage on parts affected by the lack of maintenance.

**Why Maintain Your Vehicle at Your Dealership?*****Factory-Trained Technicians***

Service technicians participate in extensive factory-sponsored certification training to help them become experts on the operation of your vehicle. Ask your dealership about the training and certification their technicians have received.

***Genuine Ford and Motorcraft® Replacement Parts***

Dealerships stock Ford, Motorcraft® and Ford-authorized branded remanufactured replacement parts. These parts meet or exceed Ford Motor Company's specifications. Parts installed at your dealership carry a nationwide, 12 month/12000 mile (20000 kilometer) parts and labor limited warranty. If you do not use Ford authorized parts, they may not meet Ford specifications and, depending on the part, it could affect emissions compliance.

***Convenience***

Many dealerships have extended evening and Saturday hours to make your service visit more convenient and they offer one stop shopping. They can perform any services that are required on your vehicle, from general maintenance to collision repairs.

**Note:** Not all dealers have extended hours or bodyshops. Please contact your dealer for details.



**Protecting Your Investment**

Maintenance is an investment that pays dividends in the form of improved reliability, durability and resale value. To maintain the proper performance of your vehicle and its emission control systems, it is imperative that scheduled maintenance be completed at the designated intervals.

Your vehicle is equipped with the Intelligent Oil-Life Monitor® (IOLM) system which shows a message in the information display at the proper oil change service interval; this interval may be up to two years or 10000 miles (16000 kilometers). When ENGINE OIL CHANGE DUE or OIL CHANGE REQUIRED appears in the information display, it's time for an oil change; the oil change must be done within two weeks or 500 miles (800 kilometers) of the ENGINE OIL CHANGE DUE or OIL CHANGE REQUIRED message appearing. The Intelligent Oil-Life Monitor® must be reset after each oil change. See *Engine oil check* in the *Maintenance* chapter.

If your information display is prematurely reset or becomes inoperative, you should perform the oil change interval at six months or 5000 miles (8000 kilometers) from your last oil change. Never exceed one year or 10000 miles (16000 kilometers) between oil change intervals.

Your vehicle is very sophisticated and built with multiple complex performance systems. Every manufacturer develops these systems using different specifications and performance features. That is why it is important to rely upon your dealership to properly diagnose and repair your vehicle.

Ford Motor Company has recommended maintenance intervals for various parts and component systems based upon engineering testing. Ford Motor Company relies upon this testing to determine the most appropriate mileage for replacement of oils and fluids to protect your vehicle at the lowest overall cost to you and recommends against maintenance schedules that deviate from the scheduled maintenance information.

Ford strongly recommends using only genuine Ford, Motorcraft® or Ford-authorized remanufactured replacement parts because they are engineered for your vehicle.

**Additives and Chemicals**

Ford Motor Company recommended additives and chemicals are listed in this book and in the *Workshop Manual*. Additional chemicals or additives not approved by Ford Motor Company are not recommended as part of normal maintenance. Please consult your warranty information.



**Oils, Fluids and Flushing**

In many cases, fluid discoloration is a normal operating characteristic and, by itself, does not necessarily indicate a concern or that the fluid needs to be changed. However, discolored fluids that also show signs of overheating and/or foreign material contamination should be inspected immediately by a qualified expert such as the factory-trained technicians at your dealership. Your vehicle's oils and fluids should be changed at the specified intervals or in conjunction with a repair. Flushing is a viable way to change fluid for many vehicle sub-systems during scheduled maintenance. It is critical that systems are flushed only with new fluid that is the same as that required to fill and operate the system, or using a Ford-approved flushing chemical.

**Owner Checks and Services**

Certain basic maintenance checks and inspections should be performed every month or at six month intervals.

<b>Check Every Month</b>
Engine oil level.
Function of all interior and exterior lights.
Tires (including spare) for wear and proper pressure.
Windshield washer fluid level.
<b>Check Every Six Months</b>
Battery connections. Clean if necessary.
Body and door drain holes for obstructions. Clean if necessary.
Cooling system fluid level and coolant strength.
Door weatherstrips for wear. Lubricate if necessary.
Hinges, latches and outside locks for proper operation. Lubricate if necessary.
Parking brake for proper operation.
Safety belts and seat latches for wear and function.
Safety warning lamps (brake, ABS, airbag, safety belt) for operation.
Washer spray and wiper operation. Clean or replace blades as necessary.



**Multi-point Inspection**

In order to keep your vehicle running right, it is important to have the systems on your vehicle checked regularly. This can help identify potential issues and prevent major problems. Ford Motor Company recommends the following multi-point inspection be performed at every scheduled maintenance interval to help make sure your vehicle keeps running great.

<b>Multi-point Inspection</b>	
Accessory drive belt(s)	Half-shaft dust boots
Battery performance	Horn operation
Clutch operation (if equipped)	Radiator, cooler, heater and A/C hoses
Engine air filter	Suspension components for leaks or damage
Exhaust system	Steering and linkage
Exterior lamps and hazard warning system operation	Tires (including spare) for wear and proper pressure
Fluid levels <sup>*</sup> ; fill if necessary	Windshield for cracks, chips or pits
For oil and fluid leaks	Washer spray and wiper operation

<sup>\*</sup>Brake, coolant recovery reservoir, manual transmission, automatic transmission and window washer.

Be sure to ask your dealership service advisor or technician about the multi-point vehicle inspection. It is a comprehensive way to perform a thorough inspection of your vehicle. It is your checklist that gives you immediate feedback on the overall condition of your vehicle. You will know what has been checked, what is okay, as well as those things that may require future or immediate attention. The multi-point vehicle inspection is one more way to keep your vehicle running great!





LINK & PIN

**GENUINE**  
PARTS & SERVICE

**Owner Advantage**  
Member's Member #:  
Member's Serial # Balance

**Multi-Point Inspection Report Card as Recommended by Ford Motor Company**

Name: \_\_\_\_\_ Today's Date: \_\_\_\_\_ Mileage: \_\_\_\_\_ State Inspection Month: \_\_\_\_\_

E-Mail Address: \_\_\_\_\_

SCHEDULED MAINTENANCE / INSPECTION CHECKS FOR SERVICE ON THIS MODEL			
<input type="checkbox"/> Engine Air Filter	<input type="checkbox"/> Oil Filter	<input type="checkbox"/> Spark Plugs	<input type="checkbox"/> Tire Rotation
<input type="checkbox"/> Engine Coolant	<input type="checkbox"/> Transmission Fluid	<input type="checkbox"/> Brake Pads	<input type="checkbox"/> Transmission Filter
<input type="checkbox"/> Fuel Filter	<input type="checkbox"/> Transmission Fluid	<input type="checkbox"/> Brake Lines	<input type="checkbox"/> Transmission Filter
<input type="checkbox"/> Oil Change	<input type="checkbox"/> Transmission Fluid	<input type="checkbox"/> Brake Lines	<input type="checkbox"/> Transmission Filter

\*This is only a partial list of vehicle maintenance items and is NOT all-inclusive. Please consult your Owner's Manual or visit [www.ford.com/ownermanual](http://www.ford.com/ownermanual) for vehicle specific maintenance requirements.

CHECK FLUID LEVELS AND FILL			
<input type="checkbox"/> Oil and/or Oil Leaks	<input type="checkbox"/> Power Steering	<input type="checkbox"/> Windshield Washer	<input type="checkbox"/> Coolant
<input type="checkbox"/> Coolant	<input type="checkbox"/> Brake Fluid	<input type="checkbox"/> Windshield Washer	<input type="checkbox"/> Coolant
<input type="checkbox"/> Brake Fluid	<input type="checkbox"/> Windshield Washer	<input type="checkbox"/> Windshield Washer	<input type="checkbox"/> Coolant

BATTERY	
State of Health	Condition of Cell
<input type="checkbox"/> Factory spec cold cranking amps	<input type="checkbox"/> Anticorrosion treatment

EXTERIOR BODY	
<input type="checkbox"/> Note any existing exterior body damage or defects	<input type="checkbox"/> Wheel well liner
<input type="checkbox"/> Wheel well liner	<input type="checkbox"/> Wheel well liner

TIRE & BRAKE INSPECTION	
<input type="checkbox"/> Brake Lining	<input type="checkbox"/> Brake Lining
<input type="checkbox"/> Brake Lining	<input type="checkbox"/> Brake Lining

TIRE TREAD			
<input type="checkbox"/> Front Left	<input type="checkbox"/> Front Right	<input type="checkbox"/> Rear Left	<input type="checkbox"/> Rear Right
<input type="checkbox"/> Tread Depth	<input type="checkbox"/> Tread Depth	<input type="checkbox"/> Tread Depth	<input type="checkbox"/> Tread Depth
<input type="checkbox"/> Tread Pattern/Usage	<input type="checkbox"/> Tread Pattern/Usage	<input type="checkbox"/> Tread Pattern/Usage	<input type="checkbox"/> Tread Pattern/Usage
<input type="checkbox"/> Tire Pressure - set to factory recommended PSI	<input type="checkbox"/> Tire Pressure - set to factory recommended PSI	<input type="checkbox"/> Tire Pressure - set to factory recommended PSI	<input type="checkbox"/> Tire Pressure - set to factory recommended PSI
<input type="checkbox"/> Brake Lining	<input type="checkbox"/> Brake Lining	<input type="checkbox"/> Brake Lining	<input type="checkbox"/> Brake Lining

Comments: \_\_\_\_\_

Service Advisor: \_\_\_\_\_ Customer's Signature: \_\_\_\_\_

Technician: \_\_\_\_\_

12-XXXXXXXX

© 2012 Ford Motor Company. Ford Motor Company is a registered trademark.



**NORMAL SCHEDULED MAINTENANCE AND LOG****Intelligent Oil-Life Monitor®**

Your vehicle is equipped with an Intelligent Oil-Life Monitor® that determines when the engine oil needs to be changed based on how your vehicle is used. By using several important factors in its calculations, the monitor helps reduce the cost of owning your vehicle and reduce environmental waste at the same time. This means you won't have to remember to change the oil on a mileage-based schedule; the vehicle lets you know when an oil change is due by displaying ENGINE OIL CHANGE DUE or OIL CHANGE REQUIRED in the information display. The following table is intended to provide examples of vehicle use and its impact on engine oil change intervals; it is provided as a guideline only. Actual engine oil change intervals depend on several factors and generally decrease with severity of use.

<b>When to expect the OIL CHANGE REQUIRED message</b>	
<b>Miles (km)</b>	<b>Vehicle use and examples</b>
7500-10000 (12000-16000)	<b>Normal</b>
	<ul style="list-style-type: none"> <li>- Normal commuting with highway driving</li> <li>- No, or moderate, load or towing</li> <li>- Flat to moderately hilly roads</li> <li>- No extended idling</li> </ul>
5000-7499 (8000-11999)	<b>Severe</b>
	<ul style="list-style-type: none"> <li>- Moderate to heavy load or towing</li> <li>- Mountainous or off-road conditions</li> <li>- Extended idling</li> <li>- Extended hot or cold operation</li> </ul>
3000-4999 (4000-7999)	<b>Extreme</b>
	<ul style="list-style-type: none"> <li>- Maximum load or towing</li> <li>- Extreme hot or cold operation</li> </ul>





Normal Scheduled Maintenance*	
At every oil change interval as indicated by the information display	Change engine oil and filter.**
	Rotate tires, inspect tire wear and measure tread depth.
	Perform multi-point inspection (recommended).
	Inspect automatic transmission fluid level (if equipped with dipstick). Consult dealer for requirements.
	Inspect brake pads, shoes, rotors, drums, brake linings, hoses and parking brake.
	Inspect cabin air filter (if equipped).
	Inspect engine cooling system strength and hoses.
	Inspect exhaust system and heat shields.
	Inspect half-shaft boots.
	Inspect steering linkage, ball joints, suspension and tie-rod ends. Lubricate if equipped with grease fittings.
	Inspect wheels and related components for abnormal noise, wear, looseness or drag.

\*Do not exceed one year or 10000 miles (16000 kilometers) between service intervals.

\*\*Reset your Intelligent Oil-Life Monitor after each engine oil and filter change. See *Engine oil check* in the *Maintenance* chapter.



Additional Maintenance Items <sup>1</sup>	
Every 20000 miles (32000 km)	Replace cabin air filter (if equipped).
Every 30000 miles (48000 km)	Replace engine air filter.
At 100000 miles (160000 km)	Change engine coolant. <sup>2</sup>
Every 100000 miles (160000 km)	Replace spark plugs.
	Inspect accessory drive belt(s). <sup>3</sup>
Every 150000 miles (240000 km)	Change automatic transmission fluid and filter.
	Change manual transmission fluid.
	Replace accessory drive belt(s) if not replaced within the last 100000 miles (160000 km).

<sup>1</sup>Additional maintenance items can be performed within 3000 miles (4800 kilometers) of the last oil change. Do not exceed the designated distance for the interval.

<sup>2</sup>Initial replacement at six years or 100000 miles (160000 kilometers), then every three years or 50000 miles (80000 kilometers).

<sup>3</sup>After initial inspection, inspect every other oil change until replaced.



**Maintenance Schedule Log**

<p>DEALER VALIDATION:</p> <p>RO#: P&amp;A CODE:                  HOURS:                  DATE: MILEAGE:</p>	<p>DEALER VALIDATION:</p> <p>RO#: P&amp;A CODE:                  HOURS:                  DATE: MILEAGE:</p>
<p>DEALER VALIDATION:</p> <p>RO#: P&amp;A CODE:                  HOURS:                  DATE: MILEAGE:</p>	<p>DEALER VALIDATION:</p> <p>RO#: P&amp;A CODE:                  HOURS:                  DATE: MILEAGE:</p>
<p>DEALER VALIDATION:</p> <p>RO#: P&amp;A CODE:                  HOURS:                  DATE: MILEAGE:</p>	<p>DEALER VALIDATION:</p> <p>RO#: P&amp;A CODE:                  HOURS:                  DATE: MILEAGE:</p>
<p>DEALER VALIDATION:</p> <p>RO#: P&amp;A CODE:                  HOURS:                  DATE: MILEAGE:</p>	<p>DEALER VALIDATION:</p> <p>RO#: P&amp;A CODE:                  HOURS:                  DATE: MILEAGE:</p>
<p>DEALER VALIDATION:</p> <p>RO#: P&amp;A CODE:                  HOURS:                  DATE: MILEAGE:</p>	<p>DEALER VALIDATION:</p> <p>RO#: P&amp;A CODE:                  HOURS:                  DATE: MILEAGE:</p>



**Scheduled Maintenance**

<p style="text-align: center;">DEALER VALIDATION:</p>  <p style="text-align: center;">P&amp;A CODE:</p> <p>RO#:            HOURS:</p> <p>DATE:           MILEAGE:</p>	<p style="text-align: center;">DEALER VALIDATION:</p>  <p style="text-align: center;">P&amp;A CODE:</p> <p>RO#:            HOURS:</p> <p>DATE:           MILEAGE:</p>
<p style="text-align: center;">DEALER VALIDATION:</p>  <p style="text-align: center;">P&amp;A CODE:</p> <p>RO#:            HOURS:</p> <p>DATE:           MILEAGE:</p>	<p style="text-align: center;">DEALER VALIDATION:</p>  <p style="text-align: center;">P&amp;A CODE:</p> <p>RO#:            HOURS:</p> <p>DATE:           MILEAGE:</p>
<p style="text-align: center;">DEALER VALIDATION:</p>  <p style="text-align: center;">P&amp;A CODE:</p> <p>RO#:            HOURS:</p> <p>DATE:           MILEAGE:</p>	<p style="text-align: center;">DEALER VALIDATION:</p>  <p style="text-align: center;">P&amp;A CODE:</p> <p>RO#:            HOURS:</p> <p>DATE:           MILEAGE:</p>
<p style="text-align: center;">DEALER VALIDATION:</p>  <p style="text-align: center;">P&amp;A CODE:</p> <p>RO#:            HOURS:</p> <p>DATE:           MILEAGE:</p>	<p style="text-align: center;">DEALER VALIDATION:</p>  <p style="text-align: center;">P&amp;A CODE:</p> <p>RO#:            HOURS:</p> <p>DATE:           MILEAGE:</p>
<p style="text-align: center;">DEALER VALIDATION:</p>  <p style="text-align: center;">P&amp;A CODE:</p> <p>RO#:            HOURS:</p> <p>DATE:           MILEAGE:</p>	<p style="text-align: center;">DEALER VALIDATION:</p>  <p style="text-align: center;">P&amp;A CODE:</p> <p>RO#:            HOURS:</p> <p>DATE:           MILEAGE:</p>



## Scheduled Maintenance

325

<p style="text-align: center;">DEALER VALIDATION:</p>  <p style="text-align: center;">P&amp;A CODE:</p> <p>RO#:                    HOURS:</p> <p>DATE:                   MILEAGE:</p>	<p style="text-align: center;">DEALER VALIDATION:</p>  <p style="text-align: center;">P&amp;A CODE:</p> <p>RO#:                    HOURS:</p> <p>DATE:                   MILEAGE:</p>
<p style="text-align: center;">DEALER VALIDATION:</p>  <p style="text-align: center;">P&amp;A CODE:</p> <p>RO#:                    HOURS:</p> <p>DATE:                   MILEAGE:</p>	<p style="text-align: center;">DEALER VALIDATION:</p>  <p style="text-align: center;">P&amp;A CODE:</p> <p>RO#:                    HOURS:</p> <p>DATE:                   MILEAGE:</p>
<p style="text-align: center;">DEALER VALIDATION:</p>  <p style="text-align: center;">P&amp;A CODE:</p> <p>RO#:                    HOURS:</p> <p>DATE:                   MILEAGE:</p>	<p style="text-align: center;">DEALER VALIDATION:</p>  <p style="text-align: center;">P&amp;A CODE:</p> <p>RO#:                    HOURS:</p> <p>DATE:                   MILEAGE:</p>
<p style="text-align: center;">DEALER VALIDATION:</p>  <p style="text-align: center;">P&amp;A CODE:</p> <p>RO#:                    HOURS:</p> <p>DATE:                   MILEAGE:</p>	<p style="text-align: center;">DEALER VALIDATION:</p>  <p style="text-align: center;">P&amp;A CODE:</p> <p>RO#:                    HOURS:</p> <p>DATE:                   MILEAGE:</p>
<p style="text-align: center;">DEALER VALIDATION:</p>  <p style="text-align: center;">P&amp;A CODE:</p> <p>RO#:                    HOURS:</p> <p>DATE:                   MILEAGE:</p>	<p style="text-align: center;">DEALER VALIDATION:</p>  <p style="text-align: center;">P&amp;A CODE:</p> <p>RO#:                    HOURS:</p> <p>DATE:                   MILEAGE:</p>



**SPECIAL OPERATING CONDITIONS**

If you operate your vehicle **primarily** in any of the following conditions, you need to perform additional maintenance as indicated. If you **occasionally** operate your vehicle under any of these conditions, it is not necessary to perform the additional maintenance. For specific recommendations, see your dealership service advisor or technician.

Perform the services shown in the following tables when specified or within 3000 miles (4800 kilometers) of the OIL CHANGE REQUIRED message appearing in the information display.

**Example #1:** The OIL CHANGE REQUIRED message comes on at 28751 miles (46270 kilometers); perform the 30000 mile (48000 kilometer) automatic transmission fluid replacement.

**Example #2:** The OIL CHANGE REQUIRED message has **not** come on, but the odometer reads 30000 miles (48000 kilometers); perform the engine air filter replacement. (i.e., Intelligent Oil-Life Monitor® was reset at 25000 miles [40000 kilometers].)

<b>Using a Car-top Carrier</b>	
As required	Change engine oil and filter as indicated by the information display and perform services listed in the Normal Scheduled Maintenance chart.
Every 60000 miles (96000 km)	Change manual transmission fluid.
<b>Extensive Idling or Low-speed Driving for Long Distances as in Heavy Commercial Use (i.e., Delivery, Taxi, Patrol Car or Livery)</b>	
As required	Change engine oil and filter as indicated by the information display and perform services listed in the Normal Scheduled Maintenance chart.
Inspect frequently, service as required	Replace cabin air filter (if equipped).
	Replace engine air filter.
Every 60000 miles (96000 km)	Replace spark plugs.



<b>Operating in Dusty or Sandy Conditions Such as Unpaved or Dusty Roads</b>	
Inspect frequently, service as required	Replace cabin air filter (if equipped).
	Replace engine air filter.
Every 5000 miles (8000 km)	Inspect the wheels and related components for abnormal noise, wear, looseness or drag.
	Rotate tires, inspect tires for wear and measure tread depth.
Every 5000 miles (8000 km) or six months	Change engine oil and filter.*
	Perform multi-point inspection.
Every 50000 miles (80000 km)	Change manual transmission fluid.

\*Reset your Intelligent Oil-Life Monitor® after each engine oil and filter change. See the *Instrument Cluster* chapter.

<b>Exclusive Use of E85 (Flex Fuel Vehicles only)</b>	
Every oil change	If ran exclusively on E85, fill the fuel tank full with regular unleaded fuel.



Special Operating Condition Log

<p>DEALER VALIDATION:</p> <p>RO#: P&amp;A CODE:            HOURS:            DATE: MILEAGE:</p>	<p>DEALER VALIDATION:</p> <p>RO#: P&amp;A CODE:            HOURS:            DATE: MILEAGE:</p>
<p>DEALER VALIDATION:</p> <p>RO#: P&amp;A CODE:            HOURS:            DATE: MILEAGE:</p>	<p>DEALER VALIDATION:</p> <p>RO#: P&amp;A CODE:            HOURS:            DATE: MILEAGE:</p>
<p>DEALER VALIDATION:</p> <p>RO#: P&amp;A CODE:            HOURS:            DATE: MILEAGE:</p>	<p>DEALER VALIDATION:</p> <p>RO#: P&amp;A CODE:            HOURS:            DATE: MILEAGE:</p>
<p>DEALER VALIDATION:</p> <p>RO#: P&amp;A CODE:            HOURS:            DATE: MILEAGE:</p>	<p>DEALER VALIDATION:</p> <p>RO#: P&amp;A CODE:            HOURS:            DATE: MILEAGE:</p>
<p>DEALER VALIDATION:</p> <p>RO#: P&amp;A CODE:            HOURS:            DATE: MILEAGE:</p>	<p>DEALER VALIDATION:</p> <p>RO#: P&amp;A CODE:            HOURS:            DATE: MILEAGE:</p>





## Scheduled Maintenance

329

<p style="text-align: center;">DEALER VALIDATION:</p>  <p style="text-align: center;">P&amp;A CODE:</p> <p>RO#:                    HOURS:</p> <p>DATE:                  MILEAGE:</p>	<p style="text-align: center;">DEALER VALIDATION:</p>  <p style="text-align: center;">P&amp;A CODE:</p> <p>RO#:                    HOURS:</p> <p>DATE:                  MILEAGE:</p>
<p style="text-align: center;">DEALER VALIDATION:</p>  <p style="text-align: center;">P&amp;A CODE:</p> <p>RO#:                    HOURS:</p> <p>DATE:                  MILEAGE:</p>	<p style="text-align: center;">DEALER VALIDATION:</p>  <p style="text-align: center;">P&amp;A CODE:</p> <p>RO#:                    HOURS:</p> <p>DATE:                  MILEAGE:</p>
<p style="text-align: center;">DEALER VALIDATION:</p>  <p style="text-align: center;">P&amp;A CODE:</p> <p>RO#:                    HOURS:</p> <p>DATE:                  MILEAGE:</p>	<p style="text-align: center;">DEALER VALIDATION:</p>  <p style="text-align: center;">P&amp;A CODE:</p> <p>RO#:                    HOURS:</p> <p>DATE:                  MILEAGE:</p>
<p style="text-align: center;">DEALER VALIDATION:</p>  <p style="text-align: center;">P&amp;A CODE:</p> <p>RO#:                    HOURS:</p> <p>DATE:                  MILEAGE:</p>	<p style="text-align: center;">DEALER VALIDATION:</p>  <p style="text-align: center;">P&amp;A CODE:</p> <p>RO#:                    HOURS:</p> <p>DATE:                  MILEAGE:</p>
<p style="text-align: center;">DEALER VALIDATION:</p>  <p style="text-align: center;">P&amp;A CODE:</p> <p>RO#:                    HOURS:</p> <p>DATE:                  MILEAGE:</p>	<p style="text-align: center;">DEALER VALIDATION:</p>  <p style="text-align: center;">P&amp;A CODE:</p> <p>RO#:                    HOURS:</p> <p>DATE:                  MILEAGE:</p>



**SPECIAL OPERATING CONDITIONS**

If you operate your vehicle **primarily** in any of the following conditions, you need to perform additional maintenance as indicated. If you **occasionally** operate your vehicle under any of these conditions, it is not necessary to perform the additional maintenance. For specific recommendations, see your dealership service advisor or technician.

Perform the services shown in the following tables when specified or within 3000 miles (4800 kilometers) of the OIL CHANGE REQUIRED message appearing in the information display.

**Example #1:** The OIL CHANGE REQUIRED message comes on at 28751 miles (46270 kilometers); perform the 30000 mile (48000 kilometer) automatic transmission fluid replacement.

**Example #2:** The OIL CHANGE REQUIRED message has **not** come on, but the odometer reads 30000 miles (48000 kilometers); perform the engine air filter replacement. (i.e., Intelligent Oil-Life Monitor® was reset at 25000 miles [40000 kilometers].)

<b>Extensive Idling or Low-speed Driving for Long Distances as in Heavy Commercial Use (i.e., Delivery, Taxi, Patrol Car or Livery)</b>	
As required	Change engine oil and filter as indicated by the information display and perform services listed in the Normal Scheduled Maintenance chart.
Inspect frequently, service as required	Replace cabin air filter.
	Replace engine air filter.
Every 60000 miles (96000 km)	Replace spark plugs.
<b>Operating in Dusty or Sandy Conditions such as Unpaved or Dusty Roads</b>	
Inspect frequently, service as required	Replace cabin air filter.
	Replace engine air filter.
Every 5000 miles (8000 km)	Inspect the wheels and related components for abnormal noise, wear, looseness or drag.
	Rotate tires, inspect tires for wear and measure tread depth.



**Operating in Dusty or Sandy Conditions such as Unpaved or Dusty Roads**

Every 5000 miles (8000 km) or six months	Change engine oil and filter.*
	Perform multi-point inspection.

\* **C-MAX Energi only:** Reset your Intelligent Oil-Life Monitor® after each engine oil and filter change. See *Engine oil check* in the *Maintenance* chapter.

**ENGINE COOLANT CHANGE RECORD**

Initial change	Six years or 100000 miles (160000 km) (whichever comes first)
After initial change	Every three years or 50000 miles (80000 km)

**Engine Coolant Change Log**

<p>DEALER VALIDATION:</p>  <p>RO#: P&amp;A CODE: HOURS: DATE: MILEAGE:</p>	<p>DEALER VALIDATION:</p>  <p>RO#: P&amp;A CODE: HOURS: DATE: MILEAGE:</p>
<p>DEALER VALIDATION:</p>  <p>RO#: P&amp;A CODE: HOURS: DATE: MILEAGE:</p>	<p>DEALER VALIDATION:</p>  <p>RO#: P&amp;A CODE: HOURS: DATE: MILEAGE:</p>
<p>DEALER VALIDATION:</p>  <p>RO#: P&amp;A CODE: HOURS: DATE: MILEAGE:</p>	<p>DEALER VALIDATION:</p>  <p>RO#: P&amp;A CODE: HOURS: DATE: MILEAGE:</p>



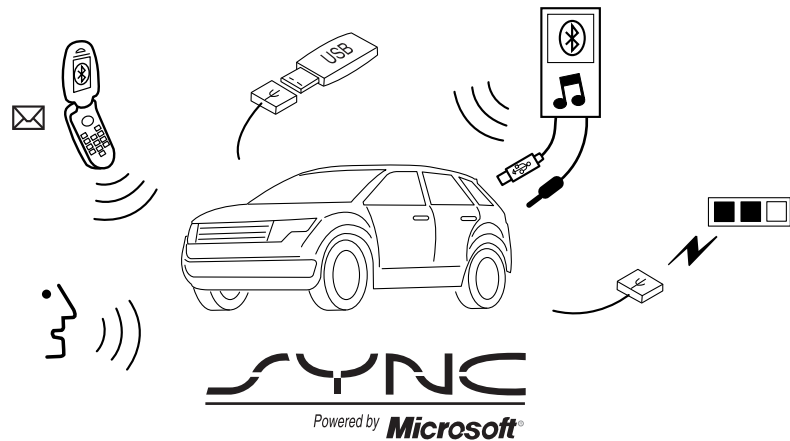

SYNC is an in-vehicle communications system that works with your Bluetooth-enabled cellular phone and portable media player. This allows you to:

- Make and receive calls.
- Access and play music from your portable music player.
- Use 911 Assist®, Vehicle Health Report and SYNC Services (Traffic, Directions & Information) (if equipped).
- Use applications, such as Pandora and Stitcher, via SYNC AppLink™ (if applicable).
- Access phonebook contacts and music via voice commands.
- Stream music from your connected phone.
- Text message.
- Use the advanced voice recognition system.
- USB device charging (if your device supports this).



**GENERAL INFORMATION**

Ensure that you review your device's user guide before using it with SYNC.

**Support**

The SYNC support team is available to help you with any questions you cannot answer on your own.

Monday-Saturday, 8:30am-8:00pm EST

In the United States, call: 1-888-270-1055

In Canada, call: 1-800-565-3673

Times are subject to change due to holidays.

**SYNC Owner Account**

Why do I need a SYNC owner account?

- Required to activate Vehicle Health Report and to view the reports online.
- Required to activate the subscription-based SYNC Services and to personalize your Saved Points and Favorites.
- Essential for keeping up with the latest software downloads available for SYNC.
- Access to customer support for any questions you may have.

**Driving Restrictions**

For your safety, certain features are speed-dependent and restricted when your vehicle is traveling over 3 mph (5 km/h).

**Safety Information**

**WARNING:** Driving while distracted can result in loss of vehicle control, accident and injury. Ford strongly recommends that drivers use extreme caution when using any device that may take their focus off the road. Your primary responsibility is the safe operation of the vehicle. We recommend against the use of any handheld device while driving, encourage the use of voice-operated systems when possible and that you become aware of applicable state and local laws that may affect use of electronic devices while driving.

When using SYNC, do not:

- Operate playing devices if the power cords or cables are broken, split or damaged. Carefully place cords and cables where they cannot be stepped on or interfere with the operation of pedals, seats, compartments or safe driving abilities.



- Leave playing devices in the vehicle during extreme conditions as it could cause them damage. See your device's user guide for further information.
- Attempt to service or repair the system. See your authorized dealer.

### Privacy Information

When a cellular phone is connected to SYNC, the system creates a profile within your vehicle that is linked to that cellular phone. This profile is created in order to offer you more cellular features and to operate more efficiently. Among other things, this profile may contain data about your cellular phone book, text messages (read and unread), and call history, including history of calls when your cell phone was not connected to the system. In addition, if you connect a media device, the system creates and retains an index of supported media content. The system also records a short development log of approximately 10 minutes of all recent system activity. The log profile and other system data may be used to improve the system and help diagnose any problems that may occur.

The cellular profile, media device index, and development log remain in the vehicle unless you delete them and are generally accessible only in the vehicle when the cellular phone or media player is connected. If you no longer plan to use the system or the vehicle, we recommend you perform a Master Reset to erase all stored information.

System data cannot be accessed without special equipment and access to the vehicle's SYNC module. Ford Motor Company and Ford of Canada do not access the system data for any purpose other than as described absent consent, a court order, or where required by law enforcement, other government authorities, or other third parties acting with lawful authority. Other parties may seek to access the information independently of Ford Motor Company and Ford of Canada. For further privacy information, see the sections on 911 Assist® (if equipped), Vehicle Health Report (if equipped), and Traffic, Directions and Information (if equipped).



**USING VOICE RECOGNITION**

This system helps you control many features using voice commands. This allows you to keep your hands on the wheel and focus on what is in front of you.

**Initiating a Voice Session**



Push the voice icon; a tone sounds and Listening appears in the display. Say any of the following:

Say:	If you want to:
“Phone”	Make calls.
“USB”	Access the device connected to your USB port.
“Bluetooth Audio”	Stream audio from your phone.
“Line in”	Access the device connected to the auxiliary input jack.
“Cancel”	Cancel the requested action.
“SYNC”	Return to the main menu.
“Voice settings”	Adjust the level of voice interaction and feedback.
“Vehicle Health Report”	Run a vehicle health report.*
“Services”	Access the SYNC Services portal.*
“Mobile apps”	Access mobile applications.*
“Help”	Hear a list of voice commands available in the current mode.

\*If equipped, U.S. only.

**System Interaction and Feedback**

The system provides feedback through audible tones, prompts, questions and spoken confirmations depending on the situation and the chosen level of interaction (voice settings). You can customize the voice recognition system to provide more or less instruction and feedback.

The default setting is to a higher level of interaction in order to help you learn to use the system. You can change these settings at any time.



**Adjusting the Interaction Level**

Push the voice icon; when prompted, say “Voice settings”, then any of the following:

When you say:	The system:
“Interaction mode standard”	Provides more detailed interaction and guidance.
“Interaction mode advanced”	Provides less audible interaction and more tone prompts.

The system defaults to the standard interaction mode.

Confirmation prompts are short questions the system asks when it is not sure of your request or when there are multiple possible responses to your request. (For example, the system may ask “Phone, is that correct?”) If turned off, the system simply makes a best guess as to what you requested and you may still occasionally be asked to confirm settings.

“Confirmation prompts on”
“Confirmation prompts off”

The system creates candidate lists when it has the same confidence level of several options based on your voice command. When turned on, you may be prompted with as many as four possibilities for clarification.

For example, “Say 1 after the tone to call John Doe at home. Say 2 after the tone to call Johnny Doe on mobile. Say 3 after the tone to call Jane Doe at home.” Or, “Say 1 after the tone to play John Doe, Say 2 after the tone to play Johnny Doe.”

“Phone candidate lists on”
“Phone candidate lists off”
“Media candidate lists on”
“Media candidate lists off”

**Helpful Hints**

- Make sure the interior of the vehicle is as quiet as possible. Wind noise from open windows and road vibrations may prevent the system from correctly recognizing spoken commands.
- After pressing the voice icon, wait until after the tone sounds and Listening appears before saying a command. Any command spoken prior to this does not register with the system.





- Speak naturally, without long pauses between words.
- At any time you can interrupt the system while it is speaking by pressing the voice icon.

### USING SYNC WITH YOUR PHONE

Hands-free calling is one of the main features of SYNC. While the system supports a variety of features, many are dependent on your cellular phone's functionality. At a minimum, most cellular phones with Bluetooth wireless technology support the following functions:

- Answering an incoming call.
- Ending a call.
- Using privacy mode.
- Dialing a number.
- Redialing.
- Call waiting notification.
- Caller ID.

Other features, such as text messaging using Bluetooth and automatic phonebook download, are phone-dependent features. To check your phone's compatibility, see your phone's user manual and visit [www.SYNCMYRide.com](http://www.SYNCMYRide.com), [www.SYNCMYRide.ca](http://www.SYNCMYRide.ca) or [www.syncmaroute.ca](http://www.syncmaroute.ca).

### Pairing a Phone for the First Time

**Note:** SYNC can support downloading up to approximately 2000 entries per Bluetooth-enabled cellular phone.

**Note:** Make sure the vehicle ignition and radio are turned on and the transmission is in position **P**.

**Note:** To scroll through the menus, press the up and down arrows on your audio system.

Wirelessly pairing your phone with SYNC allows you to make and receive hands-free calls.

1. Press the phone button; when the display indicates no phone is paired, press OK.
2. When Add Bluetooth Device appears, press OK.
3. When Find SYNC appears in the display, press OK.
4. Put your phone into Bluetooth discovery mode. See your phone's user guide if necessary.
5. When prompted on your phone's display, enter the six-digit PIN provided by SYNC in the radio display.



6. The display indicates when the pairing is successful.
7. Depending on your phone's capability and your market, the system may prompt you with questions such as setting the current phone as the primary phone (the phone SYNC automatically tries to connect with first upon vehicle start-up), downloading your phone book, etc.

### Pairing Subsequent Phones

**Note:** To scroll through the menus, press the up and down arrows on your audio system.

**Note:** Make sure the vehicle ignition and radio are turned on and that the transmission is in position **P**.

1. Press the phone button and scroll until System Settings is selected.
2. Press OK and scroll until Bluetooth Devices is selected and press OK.
3. Scroll until Add Bluetooth Device is selected and press OK.
4. When Find SYNC appears in the display, press OK.
5. Put your phone into Bluetooth discovery mode. See your phone's user guide if necessary.
6. When prompted on your phone's display, enter the six-digit PIN provided by SYNC in the radio display. The display indicates when the pairing is successful.
7. The system then prompts with questions such as if you would like to set the current phone as the primary phone (the phone SYNC automatically tries to connect with first upon vehicle start-up), download your phone book, etc.

### Phone Voice Commands



Press the voice icon and say "Phone". Say any of the following:

<b>"PHONE"</b>
"Call <name>" <sup>1</sup>
"Call <name> on mobile OR cell" <sup>1</sup>
"Call <name> on other" <sup>1</sup>
"Phone book <name> at home" <sup>2</sup>
"Phone book <name> on mobile OR cell" <sup>2</sup>
"Call history outgoing" <sup>2</sup>
"Phone book <name> on Other" <sup>2</sup>
"Call history missed" <sup>2</sup>
"Menu" <sup>2,3</sup>



<b>“PHONE”</b>
“Join”
“Call <name> at home” <sup>1</sup>
“Call <name> at work” OR “Call <name> in office” <sup>1</sup>
“Dial” <sup>1,4</sup>
“Phone book <name>” <sup>2</sup>
“Phone book <name> at work” OR “Phone book <name> at office” <sup>2</sup>
“Call history incoming” <sup>2</sup>
“Connections” <sup>2</sup>
“Go to privacy”
“Hold”

<sup>1</sup>These commands do not require you to say “Phone” first.

<sup>2</sup>These commands are not available until phone information is completely downloaded using Bluetooth.

<sup>3</sup>See “MENU” table below.

<sup>4</sup>See “DIAL” table below.

<b>“MENU”</b>
“(Phone) connections” <sup>*</sup>
“(Phone) settings (message) notification off” <sup>*</sup>
“(Phone) settings (message) notification on” <sup>*</sup>
“(Phone) settings (set) phone ringer” <sup>*</sup>
“(Phone) settings (set) ringer 1” <sup>*</sup>
“(Phone) settings (set) ringer 2” <sup>*</sup>
“(Phone) settings (set) ringer 3” <sup>*</sup>
“(Phone) settings (set) ringer off” <sup>*</sup>
“Battery”
“Phone name”
“Signal”
“Text message inbox”

<sup>\*</sup>Words in ( ) are optional and do not have to be spoken for the system to understand the command.



**Phone book commands:** When you ask SYNC® to access a phone book name, number, etc., the requested information appears in the display to view. Press the phone button and say “Call” to call the contact.

<b>“DIAL”</b>
“411” (four-one-one), “911” (nine-one-one), etc.
“700 (seven hundred)” (seven hundred)
“800 (eight hundred)” (eight hundred)
“900 (nine hundred)” (nine hundred)
“#” “/” (pound, slash)
“<number> 0–9”
“Asterisk” (*)
“Clear” (deletes all entered digits)
“Delete” (deletes one digit)
“Plus”
“Star”

**Note:** To exit dial mode, press and hold the phone button or press MENU to go to the PHONE menu.

### Making Calls

Press the voice icon and when prompted say:

1. Say “Call <name>” or “Dial”, then the desired number.
2. When the system confirms the number, say “Dial” again to initiate the call.

To erase the last spoken digit, say “Delete” or press the left arrow button. To erase all spoken digits, say “Clear” or press and hold the left arrow button.

To end the call, press and hold the phone button.

### Receiving Calls

When receiving a call, you can:



Answer the call by pressing this button on your steering wheel controls.



Reject the call by pressing this button on your steering wheel controls.

Ignore the call by doing nothing.



**Phone Options during an Active Call**

During an active call, you have additional menu features which become available such as putting a call on hold, joining calls, etc. Use the arrow buttons to scroll through the menu options.

To access:

1. Press MENU during an active call.
2. When Active Call Menu is selected, press OK.
3. Scroll to cycle through the following options:

When you select:	You can:
<b>Mute Call?</b>	Mute the call.
<b>Privacy</b>	Switch a call from an active hands-free environment to your cellular phone for a more private conversation. Press OK when Privacy on/off appears. (The display indicates In Privacy and the system transfers your call.)
<b>Call Hold</b>	Put an active call on hold. Press OK when Place Call on Hold? appears. To answer another call at this time, press the phone button.
<b>Join Calls</b>	Join two separate calls. 1. Press the phone button. 2. Access the desired contact through SYNC or use voice commands to place the second call. Once actively in the second call, press MENU. 3. Scroll until Join Calls appears and press OK. Press OK again when Join Calls? appears. <b>Note:</b> SYNC supports a maximum of three callers on a multiparty/conference call.
<b>Enter Tones</b>	Enter “tones” such as numbers for passwords. Scroll until the desired number appears in the display, then press OK; a tone sounds as confirmation. Repeat as necessary.
<b>Phonebook</b>	Access your phonebook contacts. 1. Press OK to select, then scroll through your phonebook contacts. 2. Press OK again when the desired selection appears in the display. 3. Press the phone button.



When you select:	You can:
<b>Call History</b>	Access your call history log. 1. Press OK to select, then scroll through your call history options (incoming, outgoing or missed). 2. Press OK when the desired selection appears in the display. 3. Press the phone button to call the selection.
<b>Return</b>	Exit the current menu.

### Accessing Features through the Phone Menu

SYNC's phone menu allows you to redial a number, access your call history and phone book and send text messages as well as access phone and system settings. You can also access advanced features, such as 911 Assist®, Vehicle Health Report and SYNC Services.

1. Press the phone button to enter the Phone Menu.
2. Scroll to cycle through:

When you select:	You can:
<b>Phone Redial</b>	Redial the last number called (if available). Press OK to select, then press OK again to confirm.
<b>Call History<sup>1</sup></b>	Allows you to access any previously dialed, received or missed calls while your phone has been connected to the system. 1. Press OK to select. 2. Scroll to select from Call History Incoming, Call History Outgoing or Call History Missed. Press OK make your selection. 3. Press OK or the phone button to call the desired selection. <b>Note:</b> The system attempts to automatically re-download your phone book and call history each time your phone connects to SYNC (if the auto download feature is on and your Bluetooth-enabled cellular phone supports this feature).



When you select:	You can:
<b>Phonebook</b> <sup>1,2</sup>	Allows you to access your downloaded phonebook. 1. Press OK to confirm and enter. If your phonebook has fewer than 255 listings, they appear alphabetically in flat file mode. If there are more, they are organized into alphabetical categories. 2. Scroll until the desired contact appears, then press OK. 3. Press OK or the phone button.
<b>Text Message</b> <sup>1</sup>	Enables you to send, download and delete text messages.
<b>Phone Settings</b> <sup>1</sup>	Allows you to view your phone's status, set ring tones, select your message notification, change phone book entries and automatically download your cellular phone among other features.
<b>SYNC Services</b> <sup>3</sup>	Access the SYNC services portal where you can request various types of information, traffic reports and directions.
<b>911 Assist</b> <sup>4</sup>	Place an emergency call to a 911 operator for you after an accident (if the feature is used properly).
<b>Vehicle Health Report</b> <sup>3</sup>	Create and receive a diagnostic report card on your vehicle.
<b>Mobile Apps</b> <sup>3</sup>	Interact with SYNC®-capable mobile applications on your smartphone.
<b>System Settings</b>	Access Bluetooth Devices menu listings (add, connect, set as primary, on/off, delete) as well as Advanced menu listings (prompts, languages, defaults, master reset, install application and system information).
<b>Exit Phone Menu</b>	Exit the phone menu by pressing OK.

<sup>1</sup>This is a phone-dependent feature.

<sup>2</sup>This is a phone-dependent and speed-dependent feature.

<sup>3</sup>If equipped, U.S. only.

<sup>4</sup>If equipped, U.S. and Canada only.



**Text Messaging**

**Note:** This is a phone-dependent feature.

SYNC allows you to receive, send, download and delete text messages. The system can also read incoming text messages to you so that you do not have to take your eyes off the road.

**Receiving a Text Message**

**Note:** This is a phone-dependent feature. Your phone must support downloading text messages using Bluetooth to receive incoming text messages.

**Note:** Forwarding a text message is a speed-dependent feature and can only be done when the vehicle is traveling at 3 mph (5 km/h) or less.

**Note:** Only one recipient is allowed per text message.

When a new message arrives, an audible tone sounds and the display indicates you have a new message. You have these options:

1. Press the voice button, wait for the prompt and say "Read Message" to have SYNC read the message to you.
2. Press OK to receive and open the text message or do nothing and the message goes into your text message inbox. Press OK again and SYNC reads your message aloud as you are not able to view the message. You can then also choose whether you'd like to reply or forward the message.
3. Press OK and scroll to choose between:
  - Reply to Text Message: Press OK to access and then scroll through the list of pre-defined messages to send.
  - Forward Text Message: Press OK to forward the message to anyone in your Phonebook or Call History. You can also choose Enter Number.

**Sending, Downloading and Deleting Your Text Messages**

Text messaging is a phone-dependent feature. If your phone is compatible, SYNC allows you to receive, send, download and delete text messages.

1. Press the phone button.
2. Scroll until Text Message appears and press OK.
3. Scroll to select from the following options:

**Send Text Message?** enables you to send a new text message based on a pre-defined set of 15 messages.

**Download Unread Msgs** allows you to download your unread messages (only) to SYNC. To download the messages, press OK to select. The display indicates your messages are being downloaded. When complete, SYNC takes you to your inbox.





**Delete All Messages?** allows you to delete current text messages from SYNC (not your phone). To delete the messages, press OK to select. The display indicates when all your text messages have been deleted and SYNC returns you to the text message menu.

**Note:** SYNC does not automatically download all of your unread text messages at every ignition cycle (as it does with call history and phonebook if automatic download is set to on).

**Return** exits the current menu when you press OK.

If you select **Send Text Message?**:

1. Press OK to select. If the system detects your phone does not support this feature, Unsupported appears in the display and SYNC returns to the main menu.
2. Scroll to cycle through the message options in the following chart.
3. Press OK when the desired selection is in the display. The system now needs to know who to send the message to.
4. Scroll to cycle through Phonebook or Call History entries. You can also select Enter Number to audibly enter a desired number.
5. Press OK to enter the desired menu and scroll to select the specific contact.
6. Press OK when the contact appears and press OK again to confirm when the system asks if you would like to send the message. Each text message is sent with the following signature: "This message was sent from my <Ford or Lincoln>".

Pre-defined text message options
Can't talk right now
Call me
Call you later
Be there in 10 minutes
Be there in 20 minutes
Yes
No
Why?
Thanks
Where R you?
I need more directions
I love you



Pre-defined text message options
Too funny
Can't wait to see you
I'm stuck in traffic

### Accessing Your Phone Settings

These are phone-dependent features. Your phone settings allow you to access and adjust features such as your ring tone, text message notification, modify your phone book and also set up automatic download.

1. Press the phone button.
2. Scroll until Phone Settings appears, then press OK.
3. Scroll to select from the following options:

When you select:	You can:
<b>Phone Status</b>	See the provider, name, signal power, battery power and roaming status of your connected phone. Press OK to select and scroll to view the information. When done, press OK again to return to the phone status menu.
<b>Set Ringer</b>	Select which ring tone sounds during an incoming call (one of the system's or your phone's). 1. Press OK to select and scroll to hear Ringer 1, Ringer 2, Ringer 3 and Phone Ringer. 2. Press OK to select. <b>Note:</b> If your phone supports in-band ringing, your phone's ringer sounds when Phone Ringer is chosen.
<b>Message Notification</b>	Have the option of hearing an audible tone to notify you when a text message arrives. 1. Press OK to select and scroll between Message Notification On or Message Notification Off. 2. Press OK to select.



When you select:	You can:
<b>Modify Phonebook</b>	<p>Modify the contents of your phone book (i.e., add, delete, download). Press OK to select and scroll between:</p> <p>Add Contacts: Press OK to add more contacts from your phone book. Push the desired contact(s) on your phone. See your phone's user guide on how to push contacts.</p> <p>Delete Phonebook: Press OK to delete the current phone book and call history. When Delete Phonebook appears, press OK to confirm. SYNC takes you back to the Phone Settings menu.</p> <p>Download Phonebook: Press OK to select and press OK again when Confirm Download? appears.</p>
<b>Auto Download</b>	<p>Automatically download your phone book each time your phone connects to SYNC. Press OK to select. When Auto Download On? appears, press OK to have your phonebook automatically downloaded each time.</p> <p>Select Off to NOT download your phonebook every time your phone connects to SYNC. Your phonebook, call history and text messages can only be accessed when your specific phone is connected to SYNC.</p> <p><b>Note:</b> Downloading times are phone- and quantity-dependent.</p> <p><b>Note:</b> When auto download is on, any changes, additions or deletions saved since your last download are deleted.</p>
<b>Return</b>	Exit the current menu.



### System Settings

System Settings provide access to your Bluetooth Devices and Advanced menu features. Use the arrow buttons to scroll through the menu options.

The Bluetooth Devices menu allows you to add, connect, delete and set a phone as primary as well as turn your Bluetooth feature on and off.

The Advanced menu allows you to access and set prompts, languages, defaults, perform a master reset, install an application and view system information.

#### **Bluetooth Devices Menu Options**

This menu allows you to add, connect, delete, set a phone as primary, and turn Bluetooth on or off.

1. Press the phone button to enter the Phone Menu.
2. Scroll until System Settings appears and press OK.
3. Scroll until Bluetooth Devices appears and select OK.
4. Scroll to select from the following options:

If you select:	You can:
<b>Add Bluetooth Device*</b>	See <i>Using SYNC with your phone</i> earlier in this chapter for pairing instructions.
<b>Connect Bluetooth Device</b>	Connect a previously paired Bluetooth-enabled phone. <ol style="list-style-type: none"> <li>1. Press OK to select and view a list of previously paired phones.</li> <li>2. Scroll until the desired device is chosen, then press OK to connect the phone.</li> </ol> <b>Note:</b> Only one device can be connected at a time. When another phone is connected, the previous one is disconnected.
<b>Set Primary Phone</b>	Set a previously paired phone as your primary phone. Press OK to select and scroll to select the desired phone. Press OK to confirm. <b>Note:</b> SYNC attempts to connect with the primary phone at every ignition cycle. When a phone is selected as primary, it appears first in the list and is marked with an *.



If you select:	You can:
<b>Set Bluetooth On/Off</b>	Turn the Bluetooth feature on and off. Press OK and scroll to toggle between On and Off. When the desired selection is chosen, press OK. <b>Note:</b> Turning Bluetooth off disconnects all Bluetooth devices and deactivates all Bluetooth features.
<b>Delete Device</b>	Delete a paired phone. Press OK and scroll to select the device. Press OK to confirm.
<b>Delete All Devices</b>	Delete all previously paired phones (and all information originally saved with those phones). Press OK to select.
<b>Return</b>	Exit the current menu.

\*This is a speed-dependent feature.

**Advanced Menu Options**

This menu allows you to access settings such as prompts, languages, defaults, perform a master reset, install an application and view system information.

1. Press the phone button to enter the Phone Menu.
2. Scroll until System Settings appears and press OK.
3. Scroll until Advanced appears and select OK.
4. Scroll to select from the following options:

If you select:	You can:
<b>Prompts</b>	Get help from SYNC by using questions, helpful hints or asking you for a specific action. To turn these prompts on or off: 1. Press OK to select and scroll to select between on or off. 2. Press OK when the desired selection appears in the display. SYNC takes you back to the Advanced menu.



<b>If you select:</b>	<b>You can:</b>
<b>Languages</b>	Choose between English, Espanol and Francais. Once selected, all of SYNC's radio displays and prompts are in the selected language. 1. Press OK to select and then scroll through the languages. 2. Press OK when the desired selection appears in the display. If you change the language setting, the display indicates that the system is updating. When complete, SYNC takes you back to the Advanced menu.
<b>Factory Defaults</b>	Return to the factory default settings. This selection does not erase your indexed information (phonebook, call history, text messages and paired devices). 1. Press OK to select and then press OK again when Restore Defaults? appears in the display. 2. Press OK to confirm.
<b>Master Reset</b>	Completely erase all information stored on SYNC (phonebook, call history, text messages and paired devices) and return to the factory default settings. Press OK to select. The display indicates when complete and SYNC takes you back to the Advanced menu.
<b>Install Application</b>	Install applications you have downloaded. Press OK and scroll to select. Press OK to confirm.
<b>System Info</b>	Access the Auto Version number as well as the FPN number. Press OK to select.
<b>MAP Profile</b>	This is a Bluetooth component which can further help your phone with the exchange of text messages.
<b>Return</b>	Exit the current menu.



**SYNC APPLICATIONS AND SERVICES (IF EQUIPPED)**

**Note:** In order for the following features to work, your cellular phone must be compatible with SYNC. To check your phone's compatibility, visit [www.SYNCMYride.com](http://www.SYNCMYride.com), [www.SYNCMYride.ca](http://www.SYNCMYride.ca) or [www.syncmaroute.ca](http://www.syncmaroute.ca).

- SYNC Services (if equipped, U.S. only): Provides access to traffic, directions and information such as travel, horoscopes, stock prices and more.
- 911 Assist®: Can alert 911 in the event of an emergency.
- Vehicle Health Report (if equipped, U.S. only): Provides a diagnostic and maintenance report card of your vehicle.
- SYNC AppLink™: Allows you to connect to and use certain applications such as Pandora and Stitcher (if your phone is compatible).

**911 Assist®**

**WARNING:** Unless the 911 Assist setting is set on prior to a crash, the system will not dial for help which could delay response time, potentially increasing the risk of serious injury or death after a crash.



**WARNING:** Do not wait for 911 Assist to make an emergency call if you can do it yourself. Dial emergency services immediately to avoid delayed response time which could increase the risk of serious injury or death after a crash. If you do not hear 911 Assist within five seconds of the crash, the system or phone may be damaged or non-functional.



**WARNING:** Always place your phone in a secure location in the vehicle so it does not become a projectile or get damaged in a collision. Failure to do so may cause serious injury to someone or damage the phone which could prevent 911 Assist from working properly.

**Note:** SYNC 911 Assist feature must be set on prior to the incident.

**Note:** Before setting this feature on, ensure that you read the 911 Assist privacy notice later in this section for important information.

**Note:** If 911 Assist is turned on or off by any user, that setting applies for all paired phones. If 911 Assist is turned off, a voice message plays and/or a display message/icon comes on when the vehicle is started after a previously paired phone connects.



**Note:** Every phone operates differently. While SYNC 911 Assist works with most cellular phones, some may have trouble using this feature.

If a crash deploys an airbag or activates the fuel pump shut-off, your SYNC equipped vehicle may be able to contact emergency services by dialing 911 through a paired and connected Bluetooth-enabled phone. For more information about 911 Assist, visit [www.SYNCMYRide.com](http://www.SYNCMYRide.com), [www.SYNCMYRide.ca](http://www.SYNCMYRide.ca) or [www.syncmaroute.ca](http://www.syncmaroute.ca).

- For information on airbag deployment, see the *Supplementary Restraints System* chapter.
- For information on the fuel pump shut-off, see the *Roadside Emergencies* chapter.

### **Setting 911 Assist On**

Perform the following:

1. Press the phone button to enter the Phone Menu.
2. Scroll until 911 Assist is selected.
3. Press OK to confirm and enter the 911 Assist menu.
4. Scroll to select between On and Off selections.
5. Press OK when the desired option appears in the radio display. Set On or Set Off appears in the display as confirmation.

Off selections include: Off with reminder and Off without reminder. Off with reminder provides a display and voice reminder at phone connection at vehicle start. Off without reminder provides a display reminder only without a voice reminder at phone connection.

To make sure that 911 Assist works properly:

- SYNC must be powered and working properly at the time of the incident and throughout feature activation and use.
- SYNC 911 Assist feature must be set on prior to the incident.
- A Bluetooth-enabled and compatible phone has to be paired and connected to SYNC.
- A connected Bluetooth-enabled phone must have the ability to make and maintain an outgoing call at the time of the incident.
- A connected Bluetooth-enabled phone must have adequate network coverage, battery power and signal strength.
- The vehicle must have battery power and be located in the U.S., Canada or in a territory in which 911 is the emergency number.





***In the Event of a Crash***

Not all crashes deploy an airbag or activate the fuel pump shut-off (which would activate 911 Assist); however, if 911 Assist is triggered, SYNC tries to contact emergency services. If a connected phone is damaged or loses connection to SYNC, SYNC searches for, and tries to connect to, any available previously paired phone and tries to make the call to 911.

Before making the call:

- SYNC provides a short window of time (about 10 seconds) to cancel the call. Failure to cancel the call results in SYNC attempting to dial 911.
- SYNC says the following, or a similar message: “SYNC will attempt to call 911, to cancel the call, press Cancel on your screen or press and hold the phone button on your steering wheel.”

If the call is not cancelled and a successful call is made, a pre-recorded message is played for the 911 operator, then the occupant(s) in the vehicle is able to talk with the operator. Be prepared to provide your name, phone number and location immediately, because not all 911 systems are capable of receiving this information electronically.

***911 Assist May Not Work If***

- Your cellular phone or 911 Assist hardware was damaged in a crash.
- The vehicle's battery or SYNC system has no power.
- The phone(s) paired and connected to the system was thrown from the vehicle.

***911 Assist Privacy Notice***

Once 911 Assist is set on, it may disclose to emergency services that the vehicle has been in a crash involving the deployment of an airbag or activation of the fuel pump shut-off. Certain versions or updates to 911 Assist may also be capable of electronically or verbally disclosing to 911 operators the vehicle location, and/or other details about the vehicle or crash to assist 911 operators to provide the most appropriate emergency services. If you do not want to disclose this information, do not turn the feature on.



### Vehicle Health Report



**WARNING:** Always follow scheduled maintenance instructions, regularly inspect your vehicle, and seek repair for any damage or problem you suspect. Vehicle Health Report supplements, but cannot replace normal maintenance and vehicle inspection. Vehicle Health Report only monitors certain systems that are electronically monitored by the vehicle and will not monitor or report the status of any other system, (i.e., brake lining wear). Failure to perform scheduled maintenance and regularly inspect your vehicle may result in vehicle damage and serious injury.

**Note:** Your Vehicle Health Report feature requires activation prior to use. Visit [www.SYNCMYRide.com](http://www.SYNCMYRide.com) to register. There is no fee or subscription associated with Vehicle Health Report, but you must register to use this feature.

**Note:** This feature may not function properly if you have enabled caller ID blocking on your mobile phone. Before running a report, review the *Vehicle Health Report privacy notice*.

**Note:** In order to allow a break-in period for your vehicle, you may not be able to create a Vehicle Health Report until your vehicle odometer has reached 200 miles.

Register for Vehicle Health Report and set your report preferences at [www.SYNCMYRide.com](http://www.SYNCMYRide.com). After registering, you can request a Vehicle Health Report (inside your vehicle). Return to your account at [www.SYNCMYRide.com](http://www.SYNCMYRide.com) to view your report. You can also choose for SYNC to automatically remind you to run reports at specific mileage intervals. Cellular phone airtime usage may apply when reporting.

The system allows you to check your vehicle's overall health in the form of a diagnostic report card. The vehicle health report contains valuable information such as:

- Vehicle Diagnostic Information
- Scheduled maintenance
- Open Recalls and Field Service Actions
- Unserviced items from vehicle inspections by your authorized dealer.

You can run a report (after the vehicle has been running a minimum of 60 seconds) by pressing the voice button and saying "Vehicle health report", or pressing the phone button.



To run a report using the phone button:

1. Press the phone button to enter Phone Menu.
2. Scroll until Vehicle Health is selected and press OK.
3. Scroll to select from the following options:

<b>Vehicle Health Report Options</b>	
<b>User Preferences:</b> <b>Press OK to select and enter the menu.</b> <b>Scroll to select from:</b>	<p><b>Automatic Reports:</b> Press OK and select on or off. Select On to have SYNC automatically prompt you to run a health report at certain mileage intervals. <b>Note:</b> You must first turn this feature on before you can select the mileage intervals at which you would like to be prompted.</p> <p><b>Mileage Intervals:</b> Press OK. Scroll to select between 5000, 7500 or 10000 mile intervals and press OK to make your selection.</p> <p><b>Return:</b> Press OK to exit the menu.</p>
<b>Run Report?</b>	Press OK for SYNC to run a health report of your vehicle's diagnostic systems and send the results to Ford where it is combined with scheduled maintenance information, open recalls and other field service actions and unserviced vehicle inspection items from your authorized dealer.

**Vehicle Health Report Privacy Notice**

When you run a Vehicle Health Report, Ford Motor Company may collect your cellular phone number (to process your report request) and diagnostic information about your vehicle. Certain versions or updates to Vehicle Health Report may also collect additional vehicle information. Ford may use the vehicle information it collects for any purpose. If you do not want to disclose your cellular phone number or vehicle information, do not run the feature or set up your Vehicle Health Report profile at [www.SYNCMYride.com](http://www.SYNCMYride.com). See [www.SYNCMYride.com](http://www.SYNCMYride.com) - Vehicle Health Report Terms and Conditions, and Privacy Statement - for more information.



**SYNC Services: Traffic, Directions & Information (TDI)**

**Note:** SYNC Services requires activation prior to use. Visit [www.SYNCMYRIDE.com](http://www.SYNCMYRIDE.com) to register and check your eligibility for complimentary services. Standard phone and message rates may apply. Subscription may be required. You must also have the active SYNC Services Bluetooth-enabled cellular phone paired and connected to the system in order to connect to, and use, SYNC Services. See *Using SYNC with your phone* for pairing instructions.

**Note:** This feature does not function properly if you have enabled caller ID blocking on your mobile phone. Make sure your mobile phone is not blocking caller ID before using SYNC Services.

**Note:** The driver is ultimately responsible for the safe operation of the vehicle, and therefore, must evaluate whether it is safe to follow the suggested directions. Any navigation features are provided only as an aid. Make your driving decisions based on your observations of local conditions and existing traffic regulations. Do not follow the route suggestions if doing so would result in an unsafe or illegal maneuver, if you would be placed in an unsafe situation, or if you would be directed into an area that you consider unsafe. Maps used by this system may be inaccurate because of errors, changes in roads, traffic conditions or driving conditions.

**Note:** When you connect, the service uses GPS technology and advanced vehicle sensors to collect the vehicle's current location, travel direction and speed to help provide you with the directions, traffic reports, or business searches you request. Further, to provide the services you request and for continuous improvement, the service may collect and record call details and voice communications. For more information, see SYNC Services Terms and Conditions at [www.SYNCMYRIDE.com](http://www.SYNCMYRIDE.com). If you do not want Ford or its service providers to collect the vehicle travel information or other information identified in the Terms and Conditions, do not activate or use the service.

SYNC Services uses advanced vehicle sensors, integrated GPS technology and comprehensive map and traffic data, to give you personalized traffic reports, precise turn-by-turn directions, business search, news, sports, weather and more. For a complete list of services, or to learn more, please visit [www.SYNCMYRIDE.com](http://www.SYNCMYRIDE.com).

**Connecting to SYNC Services Using Voice Commands**

1. Press the voice button.
2. When prompted, say "Services". This initiates an outgoing call to SYNC Services using your paired and connected Bluetooth-enabled cellular phone.



3. Once you are connected to the service, follow the voice prompts to request the desired service, such as “Traffic” or “Directions”. You can also say “What are my choices?” to receive a complete list of available services from which to choose.
4. Say “Services” to return to the services main menu or for help, say “Help”.

#### **Connecting to SYNC Services Using the Phone Menu**

1. Press the phone button to enter the Phone Menu.
2. Scroll until *Services* appears in the display.
3. Press OK to confirm and enter the Services menu. The display indicates the system is connecting.
4. Press OK. SYNC initiates the call to the Services portal.
5. Once connected, follow the voice prompts to request your desired Service, such as Traffic or Directions. You can also say “What are my choices?” to receive a complete list of available services from which to choose.
6. To return to the Services menu, say “Services” or for help, say “Help”.

#### **Receiving Turn-by-Turn Directions**

1. When connected to SYNC Services, say “Directions” or “Business search”. To find the closest business or type of business to your current location, just say “Business search” and then “Search near me”. If you need further assistance in finding a location you can say “Operator” at any time within a Directions or Business search to speak with a live operator. You may also be prompted to speak with an operator when the automatic system has difficulty matching your voice request. The live operator can assist you by searching for businesses by name or by category, residential addresses by street address or by name or specific street intersections. Operator Assist is a feature of your SYNC Services subscription. For more information on Operator Assist visit [www.SYNCMYRide.com/support](http://www.SYNCMYRide.com/support).
2. Follow the voice prompts to select your destination. Once your destination is selected, your current vehicle location is uploaded and a route based on current traffic conditions is calculated and sent back to your vehicle. After the route download is complete, the phone call is automatically ended. You then receive audible and visual driving instructions as you travel toward your destination.
3. While on an active route, you can select or say “Route summary” or “Route status” to view the Route Summary turn list or the Route Status ETA. You can also turn voice guidance on or off, cancel the route or update the route.

If you miss a turn, SYNC automatically asks if you want the route updated. Just say, “Yes” when prompted and a new route will be delivered to your vehicle.



**Disconnecting from SYNC Services**

1. Press and hold the phone button on the steering wheel.
2. Say “Good-bye” from the SYNC Services main menu.

<b>SYNC Services Quick Tips</b>	
<b>Personalizing</b>	You can personalize your Services feature to provide quicker access to your most used or favorite information. You can save address points such as work or home. You can also save favorite information like sports teams or a news category. To learn more, log onto <a href="http://www.SYNCMyRide.com">www.SYNCMyRide.com</a> .
<b>Push to interrupt</b>	Press the voice button at any time (while you are connected to SYNC TDI Services) to interrupt a voice prompt or an audio clip (such as a sports report), wait for the listening tone, and say your voice command.
<b>Portable</b>	Your subscription is associated with your Bluetooth-enabled cellular phone number, not your VIN (Vehicle Identification Number). You can pair and connect your phone to any vehicle equipped with Traffic, Directions and Information and continue enjoying your personalized services. You can even access your account outside the vehicle. Just use the number on your phone's call history. Traffic and Directions features do not function properly but information services and the 411 connect and text message features are available.

**SYNC AppLink™**

**Note:** Your smartphone must be paired and connected to SYNC to access AppLink.

**Note:** iPhone® users need to connect the phone to the USB port in order to start the application. It is recommended to lock your iPhone® after starting an application.

**Note:** The AppLink feature is not available if your vehicle is equipped with the MyFord Touch® or MyLincoln Touch™ system.



Depending on your display type, you can access AppLink from the media menu, the phone menu, or by using voice commands. Once an app is running through AppLink, you can control main features of the app through voice commands and steering wheel controls.

**To Access Using the Phone Menu**

1. Press the phone button to access the SYNC phone menu on-screen.
2. Scroll to Mobile Apps and press OK to access a list of available applications.
3. Scroll through the list of available applications and press OK to select a particular app.
4. Once an app is running through SYNC, you can access an app's menu by pressing the MENU button to first access the SYNC menu.
5. Select "SYNC-Media" by pressing OK.
6. Scroll until "<App name> Menu" is displayed (i.e., Pandora Menu), then press OK. From here, you can access an application's features, such as Thumbs up, Thumbs down, etc. For more information, please visit [www.SYNCMYRIDE.com](http://www.SYNCMYRIDE.com).

**To Access Using the Media Menu**

1. Press AUX button on the center console.
2. Press MENU to access the SYNC menu.
3. Select "SYNC-Media" by pressing OK.
4. Then scroll to Mobile Apps and press OK to access a list of available applications.
5. Scroll through the list of available applications and press OK to select a particular app.
6. Once an app is running through SYNC, you can access an app's menu by pressing the MENU button to first access the SYNC menu.
7. Select "SYNC-Media" by pressing OK.
8. Scroll until "<App name> Menu" is displayed (i.e., Pandora Menu), then press OK. From here, you can access an application's features, such as Thumbs up, Thumbs down, etc. For more information, please visit [www.SYNCMYRIDE.com](http://www.SYNCMYRIDE.com).

**To Access Using Voice Commands**

1. Press the voice icon.
2. When prompted, say "Mobile Apps".
3. Say the name of the application after the tone.
4. The app should start. While an app is running through SYNC, you can press the voice button and speak commands specific to the app, such as "Play Station Quickmix". Say "Help" to discover available voice commands.



---

**USING SYNC WITH YOUR MEDIA PLAYER**

You can access and play music from your digital music player over the vehicle's speaker system using the system's media menu or voice commands. You can also sort and play your music by specific categories, such as artists, albums, etc.

SYNC is capable of hosting nearly any digital media player including: iPod®, Zune™, Plays from device players, and most USB drives. SYNC also supports audio formats such as MP3, WMA, WAV and ACC.

**Connecting Your Digital Media Player via the USB Port**

**Note:** If your digital media player has a power switch, ensure that the device is turned on.

To connect using voice commands:

1. Plug the device into the vehicle's USB port.
2. Press the voice icon and when prompted, say "USB".
3. You can now play music by saying any of the appropriate voice commands. See the media voice commands.

To connect using the system menu:

1. Plug the device into the vehicle's USB port.
2. Press AUX and then MENU to enter the Media Menu.
3. Scroll until Select Source appears and press OK.
4. Scroll to select USB and press OK.
5. Depending on how many digital media files are on your connected device, Indexing may appear in the radio display. When indexing is complete, the screen returns to the Play Menu.
6. Press OK and scroll through selections of:
  - Play All
  - Artists
  - Albums
  - Genres
  - Playlists
  - Tracks
  - Explore USB
  - Similar Music
  - Return

When the desired selection appears in the display, press OK to build your desired music selection.





**What's Playing?**



At any time when a track is playing, you can press the voice icon and ask the system, "What's playing?". The system reads the metadata tags (if populated) of the playing track to you.

**Media Voice Commands**



Press the voice icon and, when prompted, say "USB" then any of the following:

"USB"
"Autoplay off"
"Autoplay on"
"(Phone) (Media) (Bluetooth) Connections"
"Pause"
"Play"
"Play album <name>" <sup>1,3</sup>
"Play all"
"Play artist <name>" <sup>1,3</sup>
"Play genre <name>" <sup>1,3</sup>
"Play next folder" <sup>2</sup>
"Play next track"
"Play playlist <name>" <sup>1,3</sup>
"Play previous folder" <sup>2</sup>
"Play previous track"
"Play song <name>" <sup>1</sup>
"Play track <name>" <sup>1,3</sup>
"Refine album <name>" <sup>1,3</sup>
"Refine artist <name>" <sup>1,3</sup>
"Refine song <name>" <sup>1</sup>
"Refine track <name>" <sup>1,3</sup>
"Repeat off"
"Repeat on"
"Search album <name>" <sup>1,3</sup>



<b>“USB”</b>
“Search artist <name>” <sup>1,3</sup>
“Search genre <name>” <sup>1,3</sup>
“Search song <name>” <sup>1</sup>
“Search track <name>” <sup>1,3</sup>
“Shuffle off”
“Shuffle on”
“Similar music”
“What’s playing?”

<sup>1</sup>“<name>” is a dynamic listing, meaning that it could be the name of any desired group, artist, etc.

<sup>2</sup>Voice commands which are only available in folder mode.

<sup>3</sup>Voice commands which are not available until indexing is complete.

<b>Voice Command Guide</b>	
<b>“Autoplay”</b>	<p>Turn on to listen to music which has already been randomly indexed during the indexing process.</p> <p>Turn off and the system does not begin to play any of your music until all media has all been indexed. Indexing times can vary from device to device and also with regard to the number of songs being indexed.</p>
<b>“Search/Play Genre”</b>	<p>The system searches all the data from your indexed music and, if available, begins to play the chosen type of music. You can only play genres of music which are present in the GENRE metadata tags that you have on your digital media player.</p>



<b>Voice Command Guide</b>	
<b>“Similar Music”</b>	The system compiles a playlist and then plays similar music to what is currently playing from the USB port using indexed metadata information.
<b>“Search/Play Artist/Track/Album”</b>	The system searches for a specific artist/track/album from the music indexed through the USB port.
<b>“Refine”</b>	This allows you to make your previous command more specific. For example, if you asked to search and play all music by a certain artist, you could then say “refine album” and choose a specific album from the list to view. If you then select Play, the system only plays music from that specific album.

Press the voice icon and when prompted say “Bluetooth Audio” and then any of the following:

<b>“BLUETOOTH AUDIO”</b>
“(Phone) (Media) (Bluetooth) Connections”
“Pause”
“Play”
“Play next track ”
“Play previous track ”



### Media Menu Features

The media menu allows you to select your media source, how to play your music (by artist, genre, shuffle, repeat, etc.), and also to add, connect or delete devices.

1. Press AUX and then MENU to enter the Media Menu.
2. Scroll to cycle through:

When you select:	You can:
<b>Play Menu</b>	Play your music by artist, album, genre, playlists, tracks, similar music or to simply, play all. You can also choose to Explore USB to view the supported digital music files on your playing device. See Play Menu later in this section for more information.
<b>Select Source</b>	<p><b>SYNC USB:</b> Press OK to access music plugged into your USB port. You can also plug in devices to charge them (if supported by your device). Once connected, the system indexes any readable media files. (The time required to complete this depends on the size of the media content being indexed.) If Autoplay is on, you can access media files randomly as they are indexed. If turned off, indexed media is not available until the indexing process is complete. SYNC is capable of indexing thousands of average size media and notifies you if the maximum indexing file size is reached.</p> <p><b>Bluetooth Audio:</b> This is a phone-dependent feature which allows you to stream music playing on your Bluetooth-enabled phone. If supported by your device, you can press SEEK to play the previous or next track.</p> <p><b>SYNC Line In:</b> Press OK to select and play music from your portable music player over the vehicle's speakers.</p> <p><b>Note:</b> If you have already connected a device to the USB port, you cannot access the line in feature. Some digital media players require both USB and line in ports to stream data and music separately.</p>



When you select:	You can:
<b>Media Settings</b>	<p>Choose to shuffle or repeat your music and select your Autoplay settings. Once these selections are turned on, they remain on until turned off. Press SEEK to play the previous or next track.</p> <p><b>Note:</b> Some digital media players require both USB and line in ports to stream data and music separately. Press OK to select and then scroll to choose from:</p> <p><b>Shuffle:</b> Press OK to shuffle available media files in the current playlist. <b>Note:</b> To shuffle all media tracks, you must select Play All in the Play Menu and then select Shuffle.</p> <p><b>Repeat:</b> Press OK to repeat any song.</p> <p><b>Autoplay:</b> Press OK to listen to music which has already been randomly indexed during the indexing process.</p>
<b>Mobile Apps</b>	<p>Interact with SYNC®-capable mobile applications on your smart phone. See SYNC® <i>AppLink</i>™ earlier in this chapter for more information.</p>
<b>System Settings</b>	<p>Access Bluetooth Device menu listings (add, connect, set as primary, on/off, delete) as well as Advanced menu listings (prompts, languages, defaults, master reset, install application and system information).</p> <p><b>Note:</b> See System Settings for more information.</p>
<b>Exit Media Menu</b>	<p>Press OK to exit the media menu.</p>



### Accessing Your Play Menu

This menu allows you to select and play your media by artist, album, genre, playlist, track, similar music or even to explore what is on your USB device.

1. Make sure that your device is plugged into the USB port and is turned on.
2. Press AUX and then MENU to enter the Media Menu.
3. Scroll to select the Play Menu and press OK.

If there are no media files to access, the display indicates there is no media. If there are media files, you have the following options to scroll through and select from:

When you select:	You can:
<b>Play All</b>	Play all indexed media (tracks) from your playing device in flat file mode, one at a time in numerical order. Press OK to select. The first track title appears in the display.
Artists	Sort all indexed media by artist. Once selected, the system lists and then play all artists and tracks alphabetically. If there are less than 255 indexed artist, they are listed alphabetically in flat file mode. If there are more, they are categorized in alphabetical categories. 1. Press OK to select. You can select to play All Artists or any indexed artist. 2. Scroll until the desired artist is chosen and press OK.



When you select:	You can:
<b>Albums</b>	<p>Sort all indexed media by albums. If there are less than 255 indexed albums, they are listed alphabetically in flat file mode. If there are more, they are organized into alphabetical categories.</p> <ol style="list-style-type: none"> <li>1. Press OK to enter the album menu and select from playing all albums or from any individual indexed album.</li> <li>2. Scroll until the desired album is chosen and press OK.</li> </ol>
<b>Genres</b>	<p>Sort indexed music by genre (category) type. SYNC lists the genres alphabetically in flat file mode. If there are more than 255, SYNC automatically organizes them into alphabetical categories.</p> <p>Press OK to select and then scroll to select the desired genre and press OK.</p>
<b>Playlists</b>	<p>Access your playlists (from formats such as ASX, .M3U, .WPL, .MTP.). The system lists your playlists alphabetically in flat file mode. If there are more than 255, they are organized into alphabetical categories.</p> <p>Press OK to select. Then scroll to select the desired playlist and press OK.</p>
<b>Tracks</b>	<p>Search for and play a specific track which has been indexed. SYNC lists your tracks alphabetically in flat file mode. If there are more than 255, SYNC automatically organizes them into alphabetical categories.</p> <p>Press OK to select. Then scroll to select the desired track and press OK.</p>



When you select:	You can:
<b>Explore USB</b>	Explore all supported digital media on your media device connected to the USB port. You can only view media content which is compatible with SYNC; other files saved are not visible. Press OK to select. Then scroll to explore indexed media on your flash drive.
<b>Similar Music</b>	Play music similar to what is currently playing from the USB port. The system uses the metadata information of each song to compile a playlist for you. Press OK to select. The system creates a new list of similar songs and begins playing. The metadata tags must be populated for this feature to include each track. <b>Note:</b> With certain playing devices, if your metadata tags are not populated, the tracks won't be available in voice recognition, play menu or similar music. However, if you place these tracks onto your playing device in "Mass Storage Device Mode", they are available in voice recognition, play menu browsing and similar music. Unknowns are placed into any unpopulated metadata tag.
<b>Return</b>	Exit the current menu.

### System Settings

System settings provide access to your Bluetooth Devices and Advanced menu features.

The Bluetooth Devices menu allows you to add, connect and delete a device as turn the Bluetooth feature on and off.

Your Advanced menu allows you to access and set prompts, languages, defaults and perform a master reset.





**Bluetooth Devices Menu Options**

This menu allows you to add, connect and delete devices as well as turn Bluetooth on and off.

1. Press AUX and then MENU to enter the Media Menu.
2. Scroll until System Settings appears and select OK.
3. Scroll until Bluetooth Devices appears.
4. Press OK and then scroll to select from:

<b>When you select:</b>	<b>You can:</b>
<b>Add Bluetooth Device*</b>	Allows you to pair additional devices to the system. 1. Press OK to select and press OK again when Find SYNC appears in the display. 2. Follow the directions in your phone's user guide to put your phone into discovery mode. A six-digit PIN appears in the display. 3. When prompted on your phone's six-digit display, enter the PIN.
<b>Connect Bluetooth Device</b>	Connect a previously paired Bluetooth-enabled phone. 1. Press OK to select and view a list of devices. 2. Scroll until the desired device is chosen and press OK to connect the device.
<b>Set Bluetooth On/Off</b>	Turn the Bluetooth feature on and off. Press OK and scroll to toggle between On and Off. When the desired selection is chosen, press OK. Turning Bluetooth off disconnects all Bluetooth devices and deactivates Bluetooth features.
<b>Delete Device</b>	Delete a paired media device. Press OK and scroll to select the device. Press OK to confirm.
<b>Delete All Devices</b>	Delete all previously paired devices. Press OK to select.
<b>Return</b>	Exit the current menu.

\*This is a speed-dependent feature



**Advanced Menu Options**

This menu allows you to access settings such as prompts, language, performing a master reset as well as returning to factory defaults.

1. Press AUX and then MENU to access the Media Menu.
2. Scroll until System Settings appears and select OK.
3. Scroll until Advanced appears.
4. Press OK and then scroll to select from the following:

<b>When you select:</b>	<b>You can:</b>
<b>Prompts</b>	Have SYNC guide you via questions, helpful hints or ask you for a specific action. <ol style="list-style-type: none"> <li>1. Press OK to select and scroll to select between on or off.</li> <li>2. Press OK when the desired selection appears in the display. SYNC takes you back to the Advanced menu.</li> </ol>
<b>Languages</b>	Choose from English, Francais and Espanol. The displays and prompts are in the selected language. <ol style="list-style-type: none"> <li>1. Press OK to select and then scroll through the languages.</li> <li>2. Press OK when the desired selection appears in the display.</li> <li>3. If you change the language setting, the display indicates that the system is updating. When complete, SYNC takes you back to the Advanced menu.</li> </ol>
<b>Factory Defaults</b>	Return to the factory default settings. This selection does not erase your indexed information (phonebook, call history, text messages and paired devices). <ol style="list-style-type: none"> <li>1. Press OK to select and then press OK again when Restore Defaults? appears in the display.</li> <li>2. Press OK to confirm.</li> </ol>
<b>Master Reset</b>	Completely erase all information stored on SYNC (all phonebook, call history, text messages and all paired devices) and return to the factory default settings.



When you select:	You can:
<b>Application</b>	Download new software applications (if available) and then load the desired applications through your USB port. See the web site for more information.
<b>Return</b>	Exit the current menu.

**TROUBLESHOOTING**

Your SYNC system is easy to use. However, should questions arise, see the tables below.

Use the website at any time to check your phone’s compatibility, register your account and set preferences as well as access a customer representative via an online chat (during certain hours). Visit [www.SYNCMYride.com](http://www.SYNCMYride.com), [www.SYNCMYride.ca](http://www.SYNCMYride.ca) or [www.syncmaroute.ca](http://www.syncmaroute.ca) for more information.

Phone Issues		
Issue	Possible Cause(s)	Possible Solution(s)
Excessive background noise during a phone call.	The audio control settings on your phone may be affecting SYNC performance.	Review your phone’s user guide regarding audio adjustments.
During a call, I can hear the other person but they cannot hear me.	Possible phone malfunction.	Try turning off the device, resetting the device, removing the device’s battery, then trying again.
SYNC is not able to download my phonebook.	<ul style="list-style-type: none"> <li>• This is a phone-dependent feature, OR</li> <li>• Possible phone malfunction.</li> </ul>	<ul style="list-style-type: none"> <li>• Go to the website to review your phone’s compatibility.</li> <li>• Try turning off the device, resetting the device or removing the device’s battery, then trying again.</li> <li>• Try pushing your phonebook contacts to SYNC by using the Add Contacts feature.</li> <li>• Use the SYNCmyphone feature available on the website.</li> </ul>



Phone Issues		
Issue	Possible Cause(s)	Possible Solution(s)
The system says Phonebook Downloaded but my phonebook in SYNC is empty or is missing contacts.	Limitations on your phone's capability.	<ul style="list-style-type: none"> <li>• Try pushing your phonebook contacts to SYNC by using the Add Contacts feature.</li> <li>• If the missing contacts are stored on your SIM card, try moving them to the device memory.</li> <li>• Remove any pictures or special ring tones associated with the missing contact.</li> </ul>
I am having trouble connecting my phone to SYNC.	<ul style="list-style-type: none"> <li>• This is a phone-dependent feature, OR</li> <li>• Possible phone malfunction.</li> </ul>	<ul style="list-style-type: none"> <li>• Go to the website to review your phone's compatibility.</li> <li>• Try turning off the device, resetting the device or removing the device's battery, then trying again.</li> <li>• Try deleting your device from SYNC, deleting SYNC from your device and trying again.</li> <li>• Check the security and auto accept/prompt always settings relative to the SYNC Bluetooth connection on your phone.</li> <li>• Update your device's software firmware.</li> <li>• Turn off the Auto phonebook download setting.</li> </ul>
Text messaging is not working on SYNC.	<ul style="list-style-type: none"> <li>• This is a phone-dependent feature, OR</li> <li>• Possible phone malfunction.</li> </ul>	<ul style="list-style-type: none"> <li>• Go to the website to review your phone's compatibility.</li> <li>• Try turning off the device, resetting the device or removing the device's battery, then trying again.</li> </ul>



USB/Media Issues		
Issue	Possible Cause(s)	Possible Solution(s)
I am having trouble connecting my device.	Possible device malfunction.	<ul style="list-style-type: none"> <li>• Try turning off the device, resetting the device or removing the device's battery, then trying again.</li> <li>• Make sure you are using the manufacturer's cable.</li> <li>• Make sure the USB cable is properly inserted into the device and the vehicle's USB port.</li> <li>• Make sure that the device does not have an auto-install program or active security settings.</li> </ul>
SYNC does not recognize my device when I turn on the car.	This is a device limitation.	Make sure you are not leaving the device in your vehicle during very hot or cold temperatures.
Bluetooth audio does not stream.	<ul style="list-style-type: none"> <li>• This is a phone-dependent feature, OR</li> <li>• The device is not connected.</li> </ul>	Make sure the device is connected to SYNC and that you have pressed play on your device.
SYNC does not recognize music that is on my device.	<ul style="list-style-type: none"> <li>• Your music files may not contain the proper artist, song title, album or genre information, OR</li> <li>• The file may be corrupted, OR</li> <li>• The song may have copyright protection which does not allow it to play.</li> </ul>	<ul style="list-style-type: none"> <li>• Make sure that all song details are populated.</li> <li>• Some devices require you to change the USB settings from mass storage to MTP class.</li> </ul>



<b>Vehicle Health Report/Services (Traffic, Directions and Information) Issues</b>		
<b>Issue</b>	<b>Possible Cause(s)</b>	<b>Possible Solution(s)</b>
I received a text that the Vehicle Health Report is not activated.	<ul style="list-style-type: none"> <li>Your account may not be activated on the website, OR</li> <li>You may have the wrong VIN (vehicle identification number) listed.</li> </ul>	<ul style="list-style-type: none"> <li>This is a free feature, but you must first register online to use it.</li> <li>Make sure that your VIN is correctly listed in your account.</li> </ul>
I am unable to retrieve the report on the website, or I receive a system error.	The preferred dealer information did not load correctly.	When you register your account, you must list a preferred dealer. If one is already listed, try selecting another dealer and logging out. Log back in and change it back to your preferred dealer and retrieve the report.
I am unable to submit a report.	<ul style="list-style-type: none"> <li>This could be due to your phone's compatibility, OR</li> <li>Bad signal strength, OR</li> <li>Your phone may not be activated on the website.</li> </ul>	<ul style="list-style-type: none"> <li>Update your mobile number in your account on the website.</li> <li>Make sure you have full signal strength and that your <i>Bluetooth</i> volume level has been turned up.</li> <li>Try deleting your phone and performing a clean pairing.</li> </ul>
I heard a commercial when I tried to use Traffic, Directions and Information.	<ul style="list-style-type: none"> <li>The phone in use is not activated, OR</li> <li>Your phone has ID blocker active.</li> </ul>	<ul style="list-style-type: none"> <li>This is a free feature, but you must first register online to use it.</li> <li>Turn off ID blocker on your phone as the system recognizes you by your phone number.</li> <li>Make sure the currently connected phone is the same one that is registered on your SyncMyRide account.</li> </ul>



Voice Command Issues		
Issue	Possible Cause(s)	Possible Solution(s)
SYNC does not understand what I am saying.	<ul style="list-style-type: none"> <li>You may be using the wrong voice commands, OR</li> <li>You may be speaking too soon or at the wrong time.</li> </ul>	<ul style="list-style-type: none"> <li>Review the Phone voice commands and the Media voice commands at the beginning of their respective sections.</li> <li>Be aware that SYNC's microphone is either in your rear view mirror or in the headliner just above the windshield.</li> </ul>
SYNC does not understand the name of a song or artist.	<ul style="list-style-type: none"> <li>You may be using the wrong voice commands, OR</li> <li>You may not be saying the name exactly as it is saved, OR</li> <li>The system may not be reading the name the same way you are saying it.</li> </ul>	<ul style="list-style-type: none"> <li>Review the media voice commands at the beginning of the media section.</li> <li>Say the song or artist exactly as listed. If you say, "Play Artist Prince", the system does not play music by Prince and the Revolution or Prince and the New Power Generation.</li> <li>Make sure you are saying the complete title, such as "California remix featuring Jennifer Nettles".</li> <li>If the songs are saved in all CAPS, you have to spell them. LOLA requires you to say, "Play L-O-L-A".</li> <li>Do not use special characters in the title as the system does not recognize them.</li> </ul>



Voice Command Issues		
Issue	Possible Cause(s)	Possible Solution(s)
SYNC does not understand or is calling the wrong contact when I want to make a call.	<ul style="list-style-type: none"> <li>• You may be using the wrong voice commands, OR</li> <li>• You may not be saying the name exactly as it is saved, OR</li> <li>• Contacts in your phonebook may be very short and similar, or they may contain special characters, OR</li> <li>• Your phonebook contacts may be saved in CAPS.</li> </ul>	<ul style="list-style-type: none"> <li>• Review the phone voice commands at the beginning of the phone section.</li> <li>• Make sure you are saying the contacts exactly as listed. For example, if a contact is saved as Joe Wilson, say “Call Joe Wilson”.</li> <li>• The system works better if you list full names, such as “Joe Wilson” rather than “Joe”.</li> <li>• Do not use special characters such as 123 or ICE, as the system does not recognize them.</li> <li>• If contacts are saved in CAPS, you have to spell them. JAKE requires you to say, “Call J-A-K-E”.</li> </ul>





**INTRODUCTION**

**WARNING:** Driving while distracted can result in loss of vehicle control, accident and injury. Ford strongly recommends that drivers use extreme caution when using any device or feature that may take their focus off the road. Your primary responsibility is the safe operation of the vehicle. We recommend against the use of any handheld device while driving, encourage the use of voice-operated systems when possible and that you become aware of applicable state and local laws that may affect use of electronic devices while driving.

**Note:** Some features are not available while the vehicle is moving.

**Note:** Your system is equipped with a feature that allows you to access and control audio features for 30 minutes after the ignition has been turned off (as long as no doors are opened).

This system uses a four-corner strategy to provide quick access to vehicle features and settings. The comprehensive touchscreen provides easy interaction with your cellular phone, multimedia, climate control and navigation system. The corners display any active modes within those menus, such as your phone being connected or the climate temperature.

**SETTINGS**

Press to select any of the following:

- Clock
- Display
- Sound
- Vehicle
- Settings
- Help

**INFORMATION**

Press to select any of the following:

- SYNC® Services
- SIRIUS® Travel Link™
- Alerts
- Calendar
- SYNC Apps

If the icon is yellow, see *Alerts* in the *Information* section of this chapter.



**PHONE**

Press to select any of the following:

- Making and Receiving Calls
- Quick Dial
- Phonebook
- Call History
- Text Messaging
- Settings

**NAVIGATION**

Press to select any of the following:

- My Home
- Favorites
- Previous Destinations
- Point of Interest
- Emergency
- Street Address
- Intersection
- City Center
- Map
- Previous Starting Point
- Latitude/Longitude
- Freeway Entrance/Exit

**ENTERTAINMENT**

Press to select any of the following:

- AM
- FM
- SIRIUS
- CD
- USB
- BT Stereo
- SD Card
- A/V In

**CLIMATE**

Press to select any of the following:

- Driver Settings
- Recirculated Air
- Auto
- Dual
- Passenger Settings
- A/C
- Defrost



**HOME**

Press to access your home screen. Depending on your vehicle's option package and software, your screens may vary in appearance from the screens shown in this section. Your features may also be limited depending on your market. Check with your authorized dealer for availability.

**Using the Touch-sensitive Controls on Your System**

To turn a feature on and off, just touch the graphic with your finger. To get the best performance from the touch-sensitive controls:

- Do not press hard on the controls. They are sensitive to light touch.
- Use your bare finger to touch the center of a touch-control graphic. Touching off-center of the graphic may cause a nearby control to turn on or off.
- Make sure your hands are clean and dry.
- Since the touchscreen operates based on the touch of a finger, you may have trouble using it if you are wearing gloves.
- Metal and other conductive material should be kept away from the surface of the touchscreen as this may cause electronic interference (i.e., control activation).

Depending on your vehicle and option package, you may also have these controls on your bezel:

- Power: Turn the media (or climate features) on or off.
- VOL: Increase or decrease the volume.
- Fan: Increase or decrease the fan speed.
- Seek and Tune buttons: Use as you normally would in media modes.
- Eject: Eject a CD.
- SOURCE: Touch the word repeatedly to see all available media modes. The screen does not change, but you see the media change in the lower left status bar.
- SOUND: Touch the word to access the Sound menu where you can make adjustments to settings, such as: Bass, Midrange, Treble, Balance and Fade, THX Deep Note Demo (if equipped), DSP (if equipped), Occupancy Mode (if equipped), and Speed Compensated Volume settings.
- Hazard flasher: Press the button to turn the hazard flashers on or off.

**Cleaning the Touchscreen Display**

Clean the display with a clean, soft cloth, such as one used for cleaning glasses. If dirt or finger prints are still visible, apply a small amount of alcohol to the cloth. Do not pour or spray alcohol onto the display. Do not use detergent or any type of solvent to clean the display.



**Support**

The SYNC support team is available to help you with any questions you cannot answer on your own.

Monday-Saturday, 8:30am-8:00pm EST

In the United States, call: 1-888-270-1055

In Canada, call: 1-800-565-3673

Times are subject to change due to holidays.

**Safety Information**

**WARNING:** Driving while distracted can result in loss of vehicle control, accident and injury. Ford strongly recommends that drivers use extreme caution when using any device that may take their focus off the road. Your primary responsibility is the safe operation of the vehicle. We recommend against the use of any handheld device while driving, encourage the use of voice-operated systems when possible and that you become aware of applicable state and local laws that may affect use of electronic devices while driving.

When using SYNC, do not:

- Operate playing devices if the power cords or cables are broken, split or damaged. Carefully place cords and cables where they cannot be stepped on or interfere with the operation of pedals, seats, compartments or safe driving abilities.
- Leave playing devices in the vehicle during extreme conditions as it could cause them damage. See your device's user guide for further information.
- Attempt to service or repair the system. See your authorized dealer.

**Speed-restricted Features**

Some features of this system may be too difficult to use while the vehicle is in motion so they are restricted from being modified unless the vehicle is not moving. Some examples of these are listed below:

- Screens that are too crowded with information, such as Point of Interest (POI) reviews and ratings, SIRIUS® Travel Link™ sports scores, movie times, ski conditions, etc.
- Any action that requires using a keyboard, such as entering a navigation destination or editing information.
- All lists are limited so the user can view fewer entries (e.g., phone contacts, recent phone call entries).



Listed below are more specific features that can only be modified while the vehicle is not moving:

<b>Restricted Features</b>	
Cellular Phone	Pairing a Bluetooth phone
	Adding phonebook contacts or uploading phonebook contacts (from a USB)
	List entries are limited for phone contacts and recent phone call entries
System Functionality	Editing the keypad code
	Enabling Valet Mode
	Editing settings while the rear view camera or Active Park Assist are active
Wi-Fi and Wireless	Editing wireless settings
	Editing the list of wireless networks
Videos, Photos and Graphics	Playing video
	Editing the screen's wallpaper or adding new wallpaper
Text Messages	Composing text messages
	Viewing received text messages
	Editing preset text messages
Navigation	Using the keyboard to enter a destination
	Demo navigation route
	Adding or Editing Address Book entries or Avoid Areas

**Privacy Information**

When a cellular phone is connected to SYNC, the system creates a profile within your vehicle that is linked to that cellular phone. This profile is created in order to offer you more cellular features and to operate more efficiently. Among other things, this profile may contain data about your cellular phone book, text messages (read and unread), and call history, including history of calls when your cell phone was not connected to the system. In addition, if you connect a media device, the system creates and retains an index of supported media content. The system also records a short development log of approximately 10 minutes of all recent system activity. The log profile and other system data may be used to improve the system and help diagnose any problems that may occur.



The cellular profile, media device index, and development log remain in the vehicle unless you delete them and are generally accessible only in the vehicle when the cellular phone or media player is connected. If you no longer plan to use the system or the vehicle, we recommend you perform a Master Reset to erase all stored information.

System data cannot be accessed without special equipment and access to the vehicle's SYNC module. Ford Motor Company and Ford of Canada do not access the system data for any purpose other than as described absent consent, a court order, or where required by law enforcement, other government authorities, or other third parties acting with lawful authority. Other parties may seek to access the information independently of Ford Motor Company and Ford of Canada. For further privacy information, see the sections on 911 Assist® (if equipped), Vehicle Health Report (if equipped), and Traffic, Directions and Information (if equipped).

### **USING VOICE RECOGNITION**

This system helps you control many features using voice commands. This allows you to keep your hands on the wheel and focus on what is in front of you. The system provides feedback through audible tones, prompts, questions and spoken confirmations depending on the situation and the chosen level of interaction (voice settings).

The system also asks short questions (confirmation prompts) when it is not sure of your request or when there are multiple possible responses to your request.

When using voice commands, words and icons may also appear in the lower left status bar indicating the status of the voice session (i.e., listening, success, failed, paused or try again).

### **How to Use Voice Commands with Your System**



Press the voice icon; after the tone, speak your command clearly.

<b>These commands can be said at any time.</b>
“Cancel”
“Exit”
“Go back”
“List of commands”
“Main menu”
“Next page”



These commands can be said at any time.
“Previous page”
“What can I say?”
“Help”

**What Can I Say**

To access the available voice commands for the current session, do one of the following:

- During a voice session, press the help icon (?) in the lower left status bar of the screen.
- Say “What can I say?” for an on-screen listing of the possible voice commands associated with your current voice session.
- Press the voice icon. After the tone, say “Help” for an audible list of possible voice commands.

**To Access a List of Available Commands**

- Press the Settings icon > Help > Voice Command List, OR
- Press the voice icon; after the tone, speak your command clearly:

Voice Command List
“Audio list of commands”
“Bluetooth audio list of commands”
“Browse list of commands”
“CD list of commands”
“Climate control list of commands”
“List of commands”
“Navigation list of commands” *
“Phone list of commands”
“Radio list of commands”
“SD card list of commands”
“Sirius satellite list of commands” *
“Travel link list of commands” *
“USB list of commands”
“Voice instructions list of commands”
“Voice settings list of commands”
“Help”

\* If equipped.



**Helpful Hints**

- Make sure the interior of the vehicle is as quiet as possible. Wind noise from open windows and road vibrations may prevent the system from correctly recognizing spoken commands.
- After pressing the voice icon, wait until after the tone sounds and Listening appears before saying a command. Any command spoken prior to this does not register with the system.
- Speak naturally, without long pauses between words.
- At any time you can interrupt the system while it is speaking by pressing the voice icon.

**Voice Settings**

Voice settings allow you to customize the level of system interaction, help and feedback. The system defaults to standard interaction which uses candidate lists and confirmation prompts as these provide the highest level of guidance and feedback.

**Interaction Mode:** Novice mode provides more detailed interaction and guidance while the advanced mode has less audible interaction and more tone prompts.

**Confirmation Prompts:** Confirmation prompts are short questions the system asks when it is not sure of your request or when there are multiple possible responses to your request. If turned off, the system simply makes a best guess as to what you requested and you may still occasionally be asked to confirm settings.

**Phone/Media Candidate Lists:** Candidate lists are lists of possible results from your voice commands. The system creates these lists when it has the same confidence level of several options based on your voice command.

To access these settings using the touchscreen:

1. Press the Settings icon > Settings > Voice Control.
2. Select from:
  - Interaction Mode
  - Confirmation Prompts
  - Media Candidate Lists
  - Phone Candidate Lists
  - Voice Control Volume.





To access these settings using voice commands:



Press the voice icon; after the tone sounds, the system says “Please say a command”. Another tone sounds to let you know the system is listening.

**Using Voice Commands with the Touchscreen Options**

Your voice system has a dual mode feature which allows you to switch between using voice commands and making on-screen selections. This is most often available when using navigation.

On-screen buttons are outlined in blue to indicate the selections that are part of the dual mode feature. For example, if while you are in a voice session rather than saying the command “Enter Street Name” to change the field, you can press Street and the voice session does not end. Instead, the voice system changes to the Street field and asks you to say the street name. The buttons not outlined in blue cannot be used as voice commands; if they are touched during a voice session, the voice session is canceled. For example:

From the Navigation home screen, you can choose from the following:

- My Home
- Favorites
- Previous Destinations
- Point of Interest (POI)
- Emergency
- Street Address
- Intersection
- Cancel Route.

Some of the voice commands that are available while viewing this screen are:

<b>“DESTINATION”</b>
“Destination my home”
“Destination street address”
“Destination favorites”
“Destination previous destinations”
“Destination POI”
“Destination intersection”
“Destination emergency”



If you choose Street Address from the navigation screen, you can choose from the following:

- Number
- City
- Street Name
- State/Prov.

Some of the voice commands that are available while viewing this screen are:

<b>“STREET ADDRESS”</b>
“Enter house number”
“Change house number”
“Enter street name”
“Change street name”
“Enter city”
“Change city”
“Enter state”
“Change state”

If you choose Points of Interest from the navigation screen, you can choose from the following:

- Search Area
- Search By Name
- Fuel Station
- ATM
- All Restaurants
- Accommodations
- Parking.

Some of the voice commands that are available while viewing this screen are:

<b>“POINTS OF INTEREST” or “POI”</b>
“Destination <POI category name>”
“Search by name”
“Search by category”
“Change search area”

**Note:** These are just a sample of the voice commands available within the Points of Interest section; the categories themselves are also technically voice commands.



If you choose Intersection from the navigation screen, you can choose from the following:

- 1st Street
- 2nd Street
- City
- State/Prov.

Some of the voice commands that are available while viewing this screen are:

<b>“INTERSECTION”</b>
“Enter first street name”
“Change first street name”
“Enter second street name”
“Change second street name”
“Enter city”
“Change city”
“Enter state”
“Change state”

The dual mode feature is also available when the voice system displays a list of items to pick from during a voice session, where you would be able to touch the line item or say “Line 2”. If a command is not understood or there are multiple options, the system returns a list for you to choose from.

## ENTERTAINMENT

Your system offers many media options. You can access these options using the touchscreen or voice commands.

### Browsing Device Content

When listening to any type of audio, you can browse through other devices without having to change sources. For example, if you are currently listening to the radio, you can browse all the artists that are stored on your USB device.



Press the voice icon on the steering wheel. When prompted, you can say:

<b>“BROWSE” within Devices</b>
“Browse” <sup>**</sup>
“Browse <league> games” <sup>**</sup>
“Browse <Sirius category> channels” <sup>**</sup>
“Browse CD track list”



<b>“BROWSE” within Devices</b>
“Browse Sirius channel guide”**
“Browse SD card”
“Browse USB”
“Help”

\*If you have said “Browse”, you can then say any commands in the following chart.

\*\*If equipped with SIRIUS® satellite radio.

<b>“BROWSE”</b>
“<League> games”*
”<Sirius category> channels”*
“CD track list”
“SD card”
“Sirius channel guide”*
“USB”
“Help”

\*If equipped with SIRIUS® satellite radio.

For a complete list of “Browse” voice commands, see *USB and SD card voice commands* and *Bluetooth audio voice commands* in the following sections.

### AM/FM Radio



Press the lower left corner of the touchscreen and then select the AM or FM tab.

To change between AM and FM presets, just touch the AM or FM tab.

<b>When you select:</b>	<b>You can:</b>
<b>Presets</b>	Save a station by pressing and holding one of the memory preset areas. There is a brief mute while the station is being saved, then sound returns when it is done.
<b>HD Radio</b>	Turn the feature on. This enables you to receive radio broadcasts digitally (where available), providing free, crystal-clear sound. See <i>HD Radio information</i> later in this chapter.



When you select:	You can:
<b>Scan</b>	Go to the next strong AM or FM radio station.
<b>Options</b>	<b>Sound Settings</b> allows you to adjust Bass, Midrange, Treble, Balance and Fade, THX Deep Note Demo (if equipped), DSP (if equipped), Occupancy Mode (if equipped), and Speed Compensated Volume settings.
	<b>Set PTY for Seek/Scan</b> allows you to select a category of music you would like to search for and then choose to either seek or scan for the stations.
	<b>RDS Text Display</b> allows you to always view the information broadcast by FM stations by selecting On.
	<b>Auto Presets (AST)</b> allows you to have the system automatically store the six strongest stations in your current location.
	<b>TAG Button</b> (if available) allows you to tag a song to download later. When you select On, TAG appears on-screen when HD Radio is active. You can press TAG to save the information of the song that is playing. When you plug in your portable music player, the information is transferred (if supported by your device). When you are connected to iTunes®, the tags appear to remind you of the songs you would like to download. See <i>HD Radio information</i> later in this chapter.
<b>Direct Tune</b>	Enter the desired station number when prompted. Press Enter.



**Radio Voice Commands**

If you are listening to the radio, press the voice button on the steering wheel control. When prompted, say any of the commands in the following chart.

If you are not listening to the radio, press the voice button and, after the tone, say “Radio”, then any of the commands in the following chart.

<b>“RADIO”</b>	
“<87.9–107.9>”	“FM autotset preset <#>”
“<87.9–107.9> HD” <sup>1</sup>	“FM preset <#>”
“<530–1710>”	“FM1”
“AM”	“FM 1 preset <#>”
“AM <530–1710>”	“FM2”
“AM autotset”	“FM 2 preset <#>”
“AM autotset preset <#>”	“HD <#>” <sup>1</sup>
“AM preset <#>”	“Preset <#>”
“Browse” <sup>2</sup>	“Radio off”
“FM”	“Radio on”
“FM <87.9–107.9>”	“Set PTY”
“FM <87.9–107.9> HD <#>” <sup>1</sup>	“Tune” <sup>3</sup>
“FM autotset”	“Help”

<sup>1</sup>If available.

<sup>2</sup>If you have said, “Browse”, see *Browsing device content* earlier in this section.

<sup>3</sup>If you have said, “Tune”, see the following “Tune” chart.

<b>“TUNE”</b>	
“<87.9–107.9>”	“FM autotset”
“<87.9–107.9> HD <#>” <sup>*</sup>	“FM autotset preset <#>”
“<530–1710>”	“FM preset <#>”
“AM”	“FM1”
“AM <530–1710>”	“FM 1 preset <#>”
“AM autotset”	“FM2”
“AM autotset preset <#>”	“FM 2 preset <#>”



“TUNE”	
“AM preset <#>”	“HD <#>”*
“FM”	“Preset <#>”
“FM <87.9-107.9>”	“Help”
“FM <87.9-107.9> HD <#>”*	

\*If available.

### **HD Radio™ Information (If Available)**

**Note:** HD Radio broadcasts are not available in all markets.

HD Radio technology is the digital evolution of analog AM/FM radio. Your system has a special receiver which allows it to receive digital broadcasts (where available) in addition to the analog broadcasts it already receives. Digital broadcasts provide a better sound quality than analog broadcasts with free, crystal-clear audio and no static or distortion. For more information, and a guide to available stations and programming, please visit [www.hdradio.com](http://www.hdradio.com).

When this feature is enabled and you are tuned to a station broadcasting HD Radio technology, you may notice the following indicators on your screen:

 **HD) logo** blinks when a digital station is being acquired and is solid when digital audio is playing. When this logo is available, you may also see Title and Artist fields on-screen.

**Multicast indicator** appears in FM mode (only) if the current station is broadcasting multiple digital broadcasts. The numbers that are highlighted signify available digital channels where new or different content is available. HD1 signifies the main programming status and is available in analog and digital broadcasts. Any additional multicast stations (HD2 through HD7) are only broadcast digitally.

**TAG** allows you to save a song to download later. When you are on an acquired HD Radio station, the TAG button is available (provided the feature has been turned on). To use the tag feature:

1. Press AM or FM > Options > TAG Button > On.
2. When you hear a song you like, touch TAG.



3. The system automatically saves the song's information and, if supported, transfers it to your portable music player when it is connected to the system. If your music player is connected at the time, the system automatically transfers the tag to your player and a pop-up confirms the transfer.
4. When you access iTunes® with your portable music player, the tags appear to you as a reminder. The system allows you to tag up to approximately 100 songs. For a list of devices that support tagging, see [www.SYNCMYRide.com](http://www.SYNCMYRide.com), [www.SYNCMYRide.ca](http://www.SYNCMYRide.ca) or [www.syncmaroute.ca](http://www.syncmaroute.ca).

When HD Radio broadcasts are active, you can access the following functions:

<b>When you select:</b>	<b>You can:</b>
<b>Scan</b>	Hear a brief sampling of all available stations. This feature still works when HD Radio reception is activated, although it does not scan for HD2 through HD7 channels. You may see the HD logo appear if the station has a digital broadcast.
<b>To save a multicast station as a preset</b>	When the channel is active on-screen, press and hold a memory preset slot until the sound returns. There is a brief mute, then the sound returns signifying it was saved. When recalling an HD2 or HD3 memory preset, there is a mute before the digital audio is played as the system must once again acquire the digital signal. As with any saved radio station, you cannot access the saved station if your vehicle is outside the station's reception area.





**HD Radio Reception and Station Troubleshooting**

<b>Potential Reception Issues</b>	
<b>Reception area</b>	<p>If you are listening to a multicast station and you are on the fringe of the reception area, the station may mute due to weak signal strength.</p> <p>If you are listening to HD1, the system switches back to the analog broadcast until the digital broadcast is available again.</p> <p>However, if you are listening to any of the possible HD2 through HD7 multicast channels, the station mutes and stays muted unless it is able to connect to the digital signal again.</p>
<b>Station blending</b>	<p>When a station is first received (aside from HD2 through HD7 multicast stations), the system first plays the station in the analog version and then, if the receiver verifies the station is an HD Radio station, it shifts to the digital version. Depending on the station quality, you may hear a slight sound change when the station changes from analog to digital. This shift from analog to digital sound or digital back to analog, is known as blending.</p>

In order to provide the best possible experience, a contact form has been developed to report any station issues found while listening to a station broadcasting with HD Radio technology. Every station is independently owned and operated. These stations are responsible for ensuring all audio streams and data fields are accurate. See the following chart for potential station issues.



Potential Station Issues		
Issue	Cause	Action
Echo, stutter, skip or repeat in audio. Increase or decrease in audio volume.	Poor time alignment by the radio broadcaster.	None. This is a broadcast issue.
Sound fading or blending in and out.	The radio is shifting between analog and digital audio.	None. This is a reception issue that may clear up as you continue to drive.
Audio mute delay when selecting HD2 or HD3, multicast preset or direct tune.	The digital multicast is not available until the HD Radio broadcast is decoded. Once decoded, the audio is available.	None. This is normal behavior. Wait until the audio is available.
Cannot access HD2 or HD3 multicast channel when recalling a preset or from a direct tune.	The previously stored multicast preset or direct tune is not available in your current reception area.	None. The station is not available in your current location.
Text information does not match currently playing audio.	Data service issue by the radio broadcaster.	Fill out the station issue form at website listed below.*
No text information shown for currently selected frequency.	Data service issue by the radio broadcaster.	Fill out the station issue form at website listed below.*
HD2 through HD7 stations not found when Scan is pressed.	Pressing Scan disables HD2 through HD7 channel search.	None. This is normal behavior.

\*[http://www.ibiquity.com/automotive/report\\_radio\\_station\\_experiences](http://www.ibiquity.com/automotive/report_radio_station_experiences)

HD Radio™ Technology manufactured under license from iBiquity Digital Corp. U.S. and foreign patents. HD Radio™ and the HD and HD Radio logos are proprietary trademarks of iBiquity Digital Corp. Ford Motor Company and iBiquity Digital Corp. are not responsible for the content sent using HD Radio technology. Content may be changed, added or deleted at any time at the station owner's discretion.



**SIRIUS® Satellite Radio (If Activated)**



Press the lower left corner of the touchscreen, then select the SIRIUS tab.

When you select:	You can:
<b>Presets</b>	Save a station by pressing and holding one of the memory preset areas. There is a brief mute while the station is being saved, then sound returns when it is done.
<b>ALERT</b>	Save the current song, artist, or team as a favorite. The system alerts you when it plays again on any SIRIUS channel.
<b>Replay</b>	<p>Replay audio on the current channel. You can replay approximately 45 minutes of audio as long as you have remained tuned to the current station. If you change stations, the previous audio is erased.</p> <p>While in replay mode:</p> <ol style="list-style-type: none"> <li>1. Press and release the seek buttons to hear the previous or next song.</li> <li>2. Press and hold the seek buttons to reverse or fast forward in the current track.</li> <li>3. Press play or pause to play or pause the audio.</li> <li>4. Press Replay again to return to live audio if you have been using the replay feature to replay audio.</li> </ol>
<b>Scan</b>	Hear a brief sampling of channels.



When you select:	You can:
<b>Options</b>	<b>Sound Settings</b> allows you to adjust Bass, Midrange, Treble, Balance and Fade, THX Deep Note Demo (if equipped), DSP (if equipped), Occupancy Mode (if equipped), and Speed Compensated Volume.
	<b>Set Category for Seek/Scan</b> allows you to select the desired category (Rock, Country, etc.) and then use Seek or Scan to initiate a search for those channels.
	<b>Parental Lockout</b> allows you to lock and unlock channels, change or reset your PIN or unlock all channels. To use this feature, you need your initial PIN which is 1234.
	<b>Artist/Title/Team Alerts</b> allows you to select Artists, Titles and Teams that you would like the system to alert you to when they are playing on other channels. Press Edit Alerts to delete or turn off alerts. You can also set all alerts to on or off. When an alert appears on the screen, you can choose to Tune to the channel, to Cancel the alert or to Disable Alerts. If you are listening to a sporting event, you can save your favorite teams so that the system can alert you when they are playing on a satellite radio channel. <b>Note:</b> SIRIUS does not support the Alert feature on all channels. Ford Motor Company shall not be responsible for Alert feature variation.
	<b>Electronic Serial Number (ESN)</b> is required when communicating with SIRIUS about your account.
<b>Direct Tune</b>	Enter the desired satellite channel number using the on-screen keypad.
<b>Browse</b>	View a list of all available stations. Scroll and select the desired station. You can also lock or skip unwanted channels or view the song and artist on other stations.



**Satellite Radio Voice Commands**



If you are listening to SIRIUS satellite radio, press the voice button on the steering wheel control. When prompted, say any of the commands in the following chart.

If you are not listening to SIRIUS satellite radio, press the voice button and, after the tone, say “Sirius”, then any of the commands in the following chart.

“SIRIUS”	
“<0-233>”	“SAT 3”
“<Channel name>”	“SAT 3 preset <#>”
“Preset <#>”	“SAT preset <#>”
“SAT”	“Sirius off”
“SAT 1”	“Sirius on”
“SAT 1 preset <#>”	“Sports game”*
“SAT 2”	“Tune”**
“SAT 2 preset <#>”	“Help”

\*If you have said, “Sports game”, see the following “Sports game” chart.

\*\*If you have said, “Tune”, see the following “Tune” chart.

“SPORTS GAME”
“Tune to the <college name> game”
“Tune to the <team city> game”
“Tune to the <team city> <team name> game”
“Tune to the <team name> game”
“Help”

“TUNE”
“<0-233>”
“<Channel name>”
“Preset <#>”
“SAT”
“SAT 1”
“SAT 1 preset <#>”
“SAT 2”
“SAT 2 preset <#>”



<b>“TUNE”</b>
“SAT 3”
“SAT 3 preset <#>”
“Help”

### **SIRIUS Satellite Radio Information**

**Note:** SIRIUS reserves the unrestricted right to change, rearrange, add or delete programming including canceling, moving or adding particular channels, and its prices, at any time, with or without notice to you. Ford Motor Company shall not be responsible for any such programming changes.



SIRIUS satellite radio is a subscription-based satellite radio service that broadcasts a variety of music, sports, news, weather, traffic and entertainment programming.

Your factory-installed SIRIUS satellite radio system includes

hardware and a limited subscription term which begins on the date of sale or lease of the vehicle. See your authorized dealer for availability.

For more information on extended subscription terms (a service fee is required), the online media player and a complete list of SIRIUS satellite radio channels, and other features, please visit [www.siriusxm.com](http://www.siriusxm.com) in the United States, [www.sirius.ca](http://www.sirius.ca) in Canada, or call SIRIUS at 1-888-539-7474.

**Satellite radio electronic serial number (ESN):** You need your ESN to activate, modify or track your satellite radio account. The ESN is found on the System Information Screen (SR ESN:XXXXXXXXXXXX). To access your ESN, press the bottom left corner of the touchscreen, then SIRIUS > Options.

<b>Potential Satellite Radio Reception Issues</b>	
<b>Antenna obstructions</b>	For optimal reception performance, keep the antenna clear of snow and ice build-up and keep luggage and other materials as far away from the antenna as possible.
<b>Terrain</b>	Hills, mountains, tall buildings, bridges, tunnels, freeway overpasses, parking garages, dense tree foliage and thunderstorms can interfere with your reception.



<b>Potential Satellite Radio Reception Issues</b>	
<b>Station overload</b>	When you pass a ground-based broadcast repeating tower, a stronger signal may overtake a weaker one and the audio system may mute.
<b>Satellite radio signal interference</b>	Your display may show ACQUIRING . . . to indicate the interference and the audio system may mute.

<b>SIRIUS Troubleshooting Tips</b>		
<b>Radio Display</b>	<b>Condition</b>	<b>Possible Action</b>
Acquiring...	Radio requires more than two seconds to produce audio for the selected channel.	None. This message should disappear shortly.
Sat Fault/SIRIUS system failure.	Internal module or system failure present.	If this message does not clear shortly, or with an ignition key cycle, your receiver may have a fault. See your authorized dealer for service.
Invalid Channel.	Channel no longer available.	Tune to another channel or choose another preset.
Unsubscribed Channel.	Subscription not available for this channel.	Contact SIRIUS at 1-888-539-7474 to subscribe to the channel, or tune to another channel.
No Signal.	Loss of signal from the SIRIUS satellite or SIRIUS tower to the vehicle antenna.	The signal is currently being blocked. When you move into an open area, the signal should return.
Updating.	Update of channel programming in progress.	None. The process may take up to three minutes.



SIRIUS Troubleshooting Tips		
Radio Display	Condition	Possible Action
Call SIRIUS 1-888-539-7474.	Satellite service has been deactivated by SIRIUS Satellite Radio.	Call SIRIUS at 1-888-539-7474 to reactivate or resolve subscription issues.
No Channels Available.	All the channels in the selected category are locked or skipped.	Unlock or unskip the channels using the channel guide.
Subscription Updated.	SIRIUS has updated the channels available for your vehicle.	None.

**CD**

Press the lower left corner of the touchscreen, then select the CD tab.

When you select:	You can:
<b>Repeat</b>	Choose to repeat the currently playing track, all tracks on the disc or turn the feature off if already on.
<b>Shuffle</b>	Play the tracks or entire albums in random order, or turn the feature off if already on.
<b>Scan</b>	Hear a brief sampling of all available tracks.
<b>More Info</b>	See disc information.
<b>Options</b>	<b>Sound:</b> Adjust Bass, Treble, Midrange, Balance and Fade, THX Deep Note Demo (if equipped), DSP (if equipped), Occupancy Mode (if equipped), and Speed Compensated Volume settings.
	<b>Compression:</b> Turn the compression feature on and off.
<b>Browse</b>	Look through all available audio sources.

You can also advance and reverse the current track or current folder (if applicable).





**CD Voice Commands**



If you are listening to a CD, press the voice button on the steering wheel control. When prompted, say any of the commands in the following chart.

If you are not listening to a CD, press the voice button and, after the tone, say “CD”, then any of the commands in the following chart.

“CD”	
“Pause”	“Repeat off”
“Play”	“Repeat track”
“Play next track”	“Shuffle”
“Play previous track”	“Shuffle CD”*
“Play track <1-512>”	“Shuffle folder”*
“Repeat”	“Shuffle off”
“Repeat folder”*	“Help”

\*WMA or MP3 only.

**SD Card Slot and USB Port**

**SD Card Slot**

**Note:** Your SD card slot is spring-loaded. To remove the SD card, press the card in and the system ejects it. Do not attempt to pull the card to remove it as this could cause damage.

The card slot can be used for your navigation card (if equipped). See *Navigation system* later in this chapter for more information.

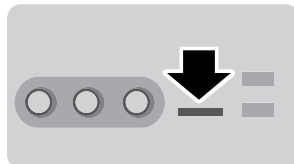

The slot is located either in the center console or behind a small access door in the instrument panel. To access and play music from your SD card slot, press the lower left corner of the touchscreen.



SD logo is a trademark of SD-3C, LLC.

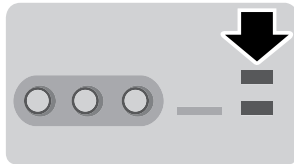

**USB Port**

The ports are located either in the center console or behind a small access door in the instrument panel. To access and play music from your device, press the lower left corner of the touchscreen.

This feature allows you to plug in media playing devices, memory sticks, flash drives, thumb drives, and also charge devices if they support this feature.

In order to playback video from your iPod® or iPhone® (if compatible), you MUST have a special combination USB/RCA composite video cable (available for purchase from Apple®). When the cable is connected to your iPod® or iPhone®, plug the other end into both the RCA jacks and the USB port.

**Playing Music from Your Device**

Insert your device and select the USB or SD Card tab once the system recognizes it. You can then select from the following options:

<b>When you select:</b>	<b>You can:</b>
<b>Repeat</b>	Repeat the currently playing song or album.
<b>Shuffle</b>	Play music on the selected album or folder in random order.
<b>Similar Music</b>	Choose music similar to that which is currently playing.
<b>More Info</b>	Displays information, such as current track, artist name, album and genre.



When you select:	You can:
<b>Options</b>	<b>Sound Settings</b> allows you to adjust Bass, Midrange, Treble, Balance and Fade, THX Deep Note Demo (if equipped), DSP (if equipped), Occupancy Mode (if equipped), and Speed Compensated Volume.
	<b>Media Player Settings</b> allows you to select more settings, which can be found under <i>Settings</i> later in this chapter.
	<b>Device Information</b> displays software and firmware information about the currently connected media device.
	<b>Update Media Index</b> indexes the device each time it is connected to make sure you have the latest voice commands available for all media on the device.
<b>Browse</b>	Browse the contents of the device. It also allows you to search by genre, artist, album, etc.

To view song information, such as Title, Artist, File, Folder, Album, and Genre, touch the on-screen album art.

You can also press *What's Playing?* to hear how the system pronounces the current band and song. This can be helpful when using voice commands to make sure the system correctly plays your request.

**SD Card and USB Voice Commands**



If you are listening to a USB device or an SD card, press the voice button on the steering wheel control. When prompted, say any of the commands in the following chart.

If you are not listening to a USB device or an SD card, press the voice button and, after the tone, say “USB” or “SD card”, then any of the commands in the following chart.

“USB” or “SD CARD”	
“Browse”*	“Play podcast episode <name>”
“Next”	“Play similar music”
“Pause”	“Play song <name>”
“Play”	“Play TV show <name>”**
“Play album <name>”	“Play TV show episode <name>”**



“USB” or “SD CARD”	
“Play all”	“Play video <name>” <sup>**</sup>
“Play artist <name>”	“Play video podcast episode <name>” <sup>**</sup>
“Play audiobook <name>”	“Play video playlist <name>” <sup>**</sup>
“Play author <name>”	“Previous”
“Play composer <name>”	“Repeat all”
“Play folder <name>”	“Repeat off”
“Play genre <name>”	“Repeat one”
“Play movie <name>” <sup>**</sup>	“Shuffle”
“Play music video <name>” <sup>**</sup>	“Shuffle off”
“Play playlist <name>”	“What’s this?”
“Play podcast <name>”	“Help”

<sup>\*</sup>If you have said you would like to browse your USB or SD card, the system prompts you to specify what you would like to browse. When prompted, see the following “Browse” chart.

<sup>\*\*</sup>These commands are only available in USB mode and are device-dependent.

“BROWSE”	
“Album <name>”	“All video podcasts” <sup>*</sup>
“All albums”	“All videos” <sup>*</sup>
“All artists”	“Artist <name>”
“All audiobooks”	“Audiobook <name>”
“All authors”	“Author <name>”
“All composers”	“Composer <name>”
“All folders”	“Folder <name>”
“All genres”	“Genre <name>”
“All movies” <sup>*</sup>	“Playlist <name>”
“All music videos” <sup>*</sup>	“Podcast <name>”
“All playlists”	“TV show <name>” <sup>*</sup>
“All podcasts”	“Video <name>” <sup>*</sup>
“All songs”	“Video playlist <name>” <sup>*</sup>
“All TV shows” <sup>*</sup>	“Video podcast <name>” <sup>*</sup>
“All video playlists” <sup>*</sup>	“Help”

<sup>\*</sup>These commands are only available in USB mode and are device-dependent.



**Bluetooth Audio**

Your system allows you to stream audio over your vehicle’s speakers from your connected, Bluetooth-enabled cellular phone.



To access, press the lower left corner on the touchscreen, then select the BT Stereo tab.

**Bluetooth Audio Voice Commands**



If you are listening to a Bluetooth audio device, press the voice button on the steering wheel control. When prompted, say any of the commands in the following chart.

If you are not listening to a Bluetooth audio device, press the voice button and, after the tone, say “Bluetooth Audio”, then any of the commands in the following chart.

**Note:** If your Bluetooth device supports streaming metadata, all the commands below are available. If your device does not, only “Next song”, “Pause”, “Play” and “Previous song” are available.

Bluetooth Voice Commands		
“Browse album <name>”	“Browse composer <name>”	“Play genre <name>”
“Browse all albums”	“Browse folder <name>”	“Play playlist <name>”
“Browse all artists”	“Browse genre <name>”	“Play podcast episode <name>”
“Browse all audiobooks”	”Browse playlist <name>”	“Play similar music”
“Browse all authors”	”Browse podcast <name>”	“Play song <name>”
“Browse all composers”	“Next”	“Previous”
“Browse all folders”	“Pause”	“Repeat all”
“Browse all genres”	“Play”	“Repeat off”
“Browse all playlists”	“Play album <name>”	“Repeat one”
“Browse all podcasts”	“Play artist <name>”	“Shuffle”
“Browse all songs”	“Play audiobook <name>”	”Shuffle album”



Bluetooth Voice Commands		
“Browse artist <name>”	“Play author <name>”	“Shuffle off”
“Browse audiobook <name>”	“Play composer <name>”	“What’s this?”
“Browse author <name>”	“Play folder <name>”	“Help”

### A/V Inputs

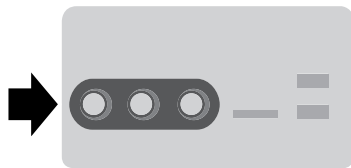

Your A/V inputs allow you to connect an auxiliary audio/video source (e.g., game systems and personal camcorders) by connecting RCA cords (not included) to these input jacks. The jacks are yellow, red and white and are located either behind a small access door on the

instrument panel or in your center console.

You can also use the A/V inputs as an auxiliary input jack (AIJ) to play music from your portable music player over your vehicle’s speakers. Plug in your one-eighth inch (three and one-half millimeter) RCA adapter into the two left A/V input jacks (red and white).

Press the lower left corner of the touchscreen, then select A/V In.

To use the auxiliary input jack feature, make sure that your portable music player is designed to be used with headphones and that it is fully charged. You also need an audio extension cable with stereo male one-eighth inch (three and one-half millimeter) connectors at one end and a RCA jack at the other.

1. Begin with the vehicle parked and the radio and portable device turned off.
2. Attach one end of the audio extension cable to the headphone output of your player and the other end into the adapter in one of the two left A/V input jacks (white or red) inside the center console.
3. Press the lower left corner on the touchscreen. Select either a tuned station from the FM tab or the CD tab (if there is a CD already loaded into the system). Adjust the volume to a comfortable listening level.



4. Turn the portable music player on and adjust the volume to one-half the maximum.
5. Press the lower left corner on the touchscreen. Select the A/V In tab. (You should hear audio from your portable music player although it may be low.)
6. Adjust the sound on your portable music player until it reaches the level of the FM station or CD by switching back and forth between the controls.

In order to playback video from your iPod® or iPhone® (if compatible), you must have a special combination USB/RCA composite video cable (available for purchase from Apple®). When the cable is connected to your iPod® or iPhone®, plug the other end into both the RCA jacks and the USB port.

**Note:** For safety reasons, connecting or adjusting the settings on your portable music player should not be attempted while the vehicle is moving. Also, the portable music player should be stored in a secure location, such as the center console or the glove box, when the vehicle is in motion. The audio extension cable must be long enough to allow the portable music player to be safely stored while the vehicle is in motion.

### **Troubleshooting**

- Do not connect the audio input jack to a line level output. The AIJ only works correctly with devices that have a headphone output with a volume control.
- Do not set the portable music player's volume level higher than is necessary to match the volume of the CD or FM radio as this causes distortion and reduces sound quality.
- If the music sounds distorted at lower listening levels, turn the portable music player volume down. If the problems persists, replace or recharge the batteries in the portable music player.
- The portable music player must be controlled in the same manner when it is used with headphones as the AIJ does not provide control (play, pause, etc.) over the attached portable music player.



**PHONE**

Hands-free calling is one of the main features of SYNC®. Once your phone is paired, you can access many options using the touchscreen or voice commands. While the system supports a variety of features, many are dependent on your cellular phone's functionality. At a minimum, most cellular phones with Bluetooth wireless technology support the following functions:

- Answering an incoming call
- Ending a call
- Using privacy mode
- Dialing a number
- Redialing
- Call waiting notification
- Caller ID.

Other features, such as text messaging using Bluetooth and automatic phonebook download, are phone-dependent features. To check your phone's compatibility, see your phone's user manual and visit [www.SYNCMyRide.com](http://www.SYNCMyRide.com), [www.SYNCMyRide.ca](http://www.SYNCMyRide.ca) or [www.syncmaroute.ca](http://www.syncmaroute.ca).

**Pairing Your Phone for the First Time**

**WARNING:** Driving while distracted can result in loss of vehicle control, accident and injury. Ford strongly recommends that drivers use extreme caution when using any device that may take their focus off the road. Your primary responsibility is the safe operation of the vehicle. We recommend against the use of any handheld device while driving, encourage the use of voice-operated systems when possible and that you become aware of applicable state and local laws that may affect use of electronic devices while driving.

The first thing you must do to use the phone features of SYNC is to pair your Bluetooth-enabled cellular phone with SYNC. This allows you to use your phone in a hands-free manner.

1. Touch Add Phone in the upper left corner of the touchscreen.
2. Make sure that Bluetooth is set to ON and that your cellular phone is in the proper mode. See your phone's user guide if necessary.





3. When prompted on your phone's display, enter the six-digit PIN provided by SYNC in the radio display. The display indicates when the pairing is successful.
4. The system asks you if you want to download your phone book.

Depending on your phone's capability, you may be prompted with additional options. For more information on your phone's capability, see your phone's user guide and visit the website.

### Pairing Subsequent Phones

**Note:** Make sure the vehicle ignition and radio are turned on and that the transmission is in position **P**.

1. Press the phone corner of the touchscreen > Settings > Phone > BT Devices > Add Device.
2. Make sure that Bluetooth is set to ON and that your cellular phone is in the proper mode. See your phone's user guide if necessary.
3. When prompted on your phone's display, enter the six-digit PIN provided by SYNC on the screen. The display indicates when the pairing is successful.
4. The system asks you if you want to download your phone book.

Depending on your phone's capability, you may be prompted with additional options. For more information on your phone's capability, see your phone's user guide and visit the website.

### Making Calls



Press the voice button. When prompted, say "Call <name>" or say "Dial", then the desired number.



To end the call or exit phone mode, press and hold the phone button.

### Receiving Calls

During an incoming call, an audible tone sounds. Call information appears in the display if it is available.



Accept the call by pressing Accept on the touchscreen or by pressing this button on your steering wheel control.



Reject the call by pressing Reject on the touchscreen or by pressing this button on your steering wheel control.

Ignore the call by doing nothing. SYNC logs it as a missed call.



**Phone Menu Options**

Press the top left corner on your touchscreen to select from the following options:

<b>When you select:</b>	<b>You can:</b>
<b>Phone</b>	Access the on-screen numerical pad to enter a number and place a call. During an active call, you can also choose to mute the call, put it on hold, activate privacy (returns the call to your cellular phone), join two calls or end the call.
<b>Quick Dial</b>	Select and call contacts stored in your phonebook contacts and call history folder.
<b>Phonebook</b>	Access and call any contacts in your previously downloaded phone book. The system places the entries in alphabetical categories summarized at the top of the screen. To turn on contact picture settings (if your device supports this feature), press Phone > Settings > Manage Phonebook > Download photos from Phonebook > On. Certain smart phones <i>may</i> support transferring street addresses when listed with phone book contact information. If this feature is supported, you can select and use these addresses as destinations and also save them as favorites.
<b>History</b>	Access any previously dialed, received or missed calls while your Bluetooth-enabled phone was connected to SYNC. You can also choose to save these to your Favorites or Quick Dial. This is a phone-dependent feature. If your phone does not support downloading call history using Bluetooth, SYNC keeps track of calls made with the SYNC system.
<b>Messaging</b>	Send text messages using your touchscreen. See <i>Text messaging</i> later in this section.
<b>Settings</b>	Access various phone settings, such as turning Bluetooth on and off, managing your phonebook and more. See <i>Phone settings</i> later in this section.



**Text Messaging**

**Note:** Downloading and sending text messages using Bluetooth are phone-dependent features.

**Note:** Certain features in text messaging are speed-dependent and cannot be completed when the vehicle is traveling at speeds over 5 mph (8 km/h).

**Note:** SYNC does not download read text messages from your phone.

You can send and receive text messages using Bluetooth, read them aloud and translate text messaging acronyms, such as LOL.

1. Touch the top left corner of the display to access the Phone menu.
2. Select Messaging.
3. Choose from the following:
  - Listen (speaker icon)
  - Dial
  - Send Text
  - View
  - Delete.

**Composing a Text Message**

**Note:** This is a speed-dependent feature and cannot be completed when the vehicle is traveling at speeds over 5 mph (8 km/h).

**Note:** Downloading and sending text messages using Bluetooth are phone-dependent features.

1. Touch the top left corner of the display to access the Phone menu.
2. Press Messaging > Send Text.
3. Enter a phone number or choose from your phone book.
4. You can select from the following options:
  - **Send** sends the message as it is.
  - **Edit Text** allows you to customize the pre-defined message or create a message on your own.



You can then preview the message and verify the recipient as well as update the message list and send it to a connected device (i.e., USB drive).

<b>Pre-defined Text Message Options</b>
I'll call you back in a few minutes.
I just left, I'll be there soon.
Can you give me a call?
I'm on my way.
I'm running a few minutes late.
I'm ahead of schedule, so I'll be there early.
I'm outside.
I'll call you when I get there.
OK
Yes
No
Thanks
Stuck in traffic.
Call me later.
LOL

### ***Receiving a Text Message***

**Note:** If you select View and your vehicle is traveling over 5 mph (8 km/h), the system offers to read the message to you instead of allowing you to view it while driving.

When a new message arrives, an audible tone sounds and the screen displays a pop-up with the caller name and ID, if supported by your phone. You can press:

- **View** to view the text message.
- **Listen** for SYNC to read the message to you.
- **Dial** to call the contact.
- **Ignore** to exit the screen.



**Phone Settings**

Press Phone > Settings, then select from the following settings:

<b>If you select:</b>	<b>You can:</b>
<b>Bluetooth Devices</b>	Connect, disconnect, add or delete a device, as well as save it as a favorite.
<b>Bluetooth</b>	Turn Bluetooth on or off.
<b>Do Not Disturb</b>	Have all calls go directly to your voice mail and not ring in the vehicle. With this feature turned on, text message notifications are also suppressed and do not ring inside the vehicle.
<b>911 Assist</b>	Turn 911 Assist® on or off. See <i>911 Assist®</i> in the <i>SYNC Services and Applications</i> section.
<b>Phone Ringer</b>	Select what ring tone you would like to hear when you receive a call. Choose from possible system ring tones, your currently paired phone's ring tone, a beep, text-to-speech or if you would like the notification to be silent.
<b>Text Message Notification</b>	Select how you would like to be notified when you receive a text message, if supported by your phone. Choose from possible system alert tones, text-to-speech or silent.
<b>Internet Data Connection*</b>	Use this screen to make adjustments to your internet data connection. Select to make your connection profile with the PAN (personal area network) or to turn off your connection. You can also choose to make adjustments to your settings or have the system always connect, never connect when roaming or query on connect. Press ? for additional information.
<b>Manage Phonebook</b>	Access features, such as automatic phonebook download, re-download your phonebook, add contacts from your phone as well as delete or upload your phonebook.
<b>Roaming Warning</b>	Be alerted to when your phone is in roaming mode.

\*If compatible.



**Phone Voice Commands**

Press the voice button on the steering wheel control. After the tone, say any of the following commands:

<b>“PHONE”</b>	
“Bluetooth off”	“Hold call off”*
“Bluetooth on”	“Hold on”*
“Call”	“Join calls”*
“Call <name>”	“Listen to text message <#>”
“Call <name> at home”	“Listen to text messages”
“Call <name> at work”	“Messages”,**
“Call <name> on cell”	“Mute call”*
“Call <name> on other”	“Pair phone”
“Call voicemail”	“Privacy on”*
“Dial”	“Reply to text messages”
“Do not disturb off”	“Turn ringer off”
“Do not disturb on”	“Turn ringer on”
“Forward text messages”	“Unmute call”*
“Go to hands free”*	“Help”

\*These commands are only available during an active call.

\*\*If you have said “Messages”, see the following “Messages” chart.

<b>“MESSAGES”</b>
“Call”
“Forward text messages”
“Listen to text message <#>”
“Listen to text messages”
“Reply to text messages”
“Help”

**INFORMATION**

Under the Information menu, you can access features, such as:

- SYNC® Services
- SIRIUS® Travel Link™
- Alerts
- Calendar
- SYNC Applications.



If your vehicle is equipped with Navigation, press the *i* (Information) button to access these features. If your vehicle is not equipped with Navigation, press the corner of the touchscreen with the green tab.

### **SYNC Services (If Equipped, U.S. Only)**

**Note:** SYNC Services requires activation prior to use. Visit [www.SYNCMyRide.com](http://www.SYNCMyRide.com) to register and check your eligibility for complimentary services. Standard phone and message rates may apply. Subscription may be required. You must also have the active SYNC Services Bluetooth-enabled cellular phone paired and connected to the system in order to connect to, and use, SYNC Services. (See *Phone* earlier in this chapter for pairing instructions.)

**Note:** This feature does not function properly if you have enabled caller ID blocking on your mobile phone. Make sure your mobile phone is not blocking caller ID before using SYNC Services.

**Note:** The driver is ultimately responsible for the safe operation of the vehicle, and therefore, must evaluate whether it is safe to follow the suggested directions. Any navigation features are provided only as an aid. Make your driving decisions based on your observations of local conditions and existing traffic regulations. Do not follow the route suggestions if doing so would result in an unsafe or illegal maneuver, if you would be placed in an unsafe situation, or if you would be directed into an area that you consider unsafe. Maps used by this system may be inaccurate because of errors, changes in roads, traffic conditions or driving conditions.

**Note:** When you connect, the service uses GPS technology and advanced vehicle sensors to collect the vehicle's current location, travel direction and speed to help provide you with the directions, traffic reports, or business searches you request. Further, to provide the services you request and for continuous improvement, the service may collect and record call details and voice communications. For more information, see SYNC Services Terms and Conditions at [www.SYNCMyRide.com](http://www.SYNCMyRide.com). If you do not want Ford or its service providers to collect the vehicle travel information or other information identified in the Terms and Conditions, do not activate or use the service.

SYNC Services uses advanced vehicle sensors, integrated GPS technology and comprehensive map and traffic data, to give you personalized traffic reports, precise turn-by-turn directions, business search, news, sports, weather and more. For a complete list of services, or to learn more, please visit [www.SYNCMyRide.com](http://www.SYNCMyRide.com).



**Connecting to SYNC Services Using Voice Commands**

1. Press the voice button.
2. When prompted, say “Services”. This initiates an outgoing call to SYNC Services using your paired and connected Bluetooth-enabled cellular phone.
3. Once you are connected to the service, follow the voice prompts to request the desired service, such as “Traffic” or “Directions”. You can also say “What are my choices?” to receive a complete list of available services from which to choose.
4. Say “Services” to return to the Services main menu or for help, say “Help”.

**Connecting to SYNC Services Using the Touchscreen**

If your vehicle is equipped with the Navigation, press the Information button.

If your vehicle is not equipped with Navigation, press the green tab on your touchscreen.

1. Select Connect to Services to initiate an outgoing call to SYNC Services using your phone.
2. Once connected, follow the voice prompts to request your desired Service, such as “Traffic” or “Directions”. You can also say “What are my choices?” to receive a complete list of available services from which to choose.
3. To return to the Services menu, say “Services” or for help, say “Help”.

**Receiving Turn-by-Turn Directions**

1. When connected to SYNC Services, say “Directions” or “Business Search”. To find the closest business or type of business to your current location, just say “Business Search” and then “Search Near Me”. If you need further assistance in finding a location, you can say “Operator” at any time within a Directions or Business search to speak with a live operator. You may also be prompted to speak with an operator when the automatic system has difficulty matching your voice request. The live operator can assist you by searching for businesses by name or by category, residential addresses by street address or by name or specific street intersections. Operator Assist is a feature of your SYNC Services subscription. For more information on Operator Assist, visit [www.SYNCMyRide.com/support](http://www.SYNCMyRide.com/support).
2. Follow the voice prompts to select your Destination. After the route download is complete, the phone call is automatically ended.





If your vehicle is not equipped with Navigation:

- Turn-by-turn directions appear in the right vehicle information display, in the status bar of your touchscreen system and also on the SYNC Services screen. You also receive driving instructions from audible prompts.
- When on an active route, you can select Route Summary or Route Status using the touchscreen controls or voice commands to view the Route summary turn list or the Route Status ETA. You can also turn voice guidance on or off, cancel the route or update the route.

If you miss a turn, SYNC automatically asks if you want the route updated. Just say, “Yes” when prompted and a new route is delivered to your vehicle.

If your vehicle is equipped with Navigation, SYNC Services downloads your requested destination to the navigation system. The navigation system then calculates the route and provides driving instructions. See the *Navigation system* section for more information.

**Disconnecting from SYNC Services**

1. Press and hold the hang-up phone button on the steering wheel.
2. Say “Goodbye” from the SYNC Services main menu.

<b>SYNC Services Quick Tips</b>	
<b>Personalizing</b>	You can personalize your Services feature to provide quicker access to your most used or favorite information. You can save address points, such as work or home. You can also save favorite information like sports teams, such as Detroit Lions, or a news category. To learn more, log onto <a href="http://www.SYNCMyRide.com">www.SYNCMyRide.com</a> .
<b>Push to interrupt</b>	Press the voice button at any time (while you are connected to SYNC TDI Services) to interrupt a voice prompt or an audio clip (such as a sports report) and say your voice command.
<b>Portable</b>	Your subscription is associated with your Bluetooth-enabled cellular phone number, not your VIN (Vehicle Identification Number). You can pair and connect your phone to any vehicle equipped with Traffic, Directions and Information and continue enjoying your personalized services.



**SYNC Services Voice Commands**

When a route has been downloaded (non-navigation systems), press the voice button on the steering wheel control. When prompted, say any of the following commands:

<b>“SERVICES”</b>
“Cancel route”
“Navigation voice off”
“Navigation voice on”
“Next turn”
“Route status”
“Route summary”
“Services”
“Update route”
“Help”

**SIRIUS Travel Link (If Equipped and If Activated)**

**WARNING:** Driving while distracted can result in loss of vehicle control, accident and injury. Ford strongly recommends that drivers use extreme caution when using any device or feature that may take their focus off the road. Your primary responsibility is the safe operation of the vehicle. We recommend against the use of any handheld device while driving, encourage the use of voice-operated systems when possible and that you become aware of applicable state and local laws that may affect use of electronic devices while driving.

**Note:** In order to use SIRIUS Travel Link, your vehicle must be equipped with navigation and your navigation SD card must be in the SD card slot.

**Note:** A paid subscription is required to access and use these features. Go to [www.siriusxm.com/travellink](http://www.siriusxm.com/travellink) for more information.

**Note:** Visit [www.siriusxm.com/traffic#](http://www.siriusxm.com/traffic#) and click on Coverage map and details for a complete listing of all traffic areas covered by SIRIUS Travel Link.

**Note:** Neither SIRIUS nor Ford is responsible for any errors or inaccuracies in the SIRIUS Travel Link services or its use in vehicles.



SIRIUS Travel Link (if activated) can help you locate the best gas prices, find movie listings, get current traffic alerts, access the current weather map, get accurate ski conditions and scores to current sports games.



Press the Information button and then select Travel Link, then choose from any of the following services:

<b>When you select:</b>	<b>You can:</b>
<b>Traffic On Route</b>	Identify traffic incidents on your route, nearby your vehicle's current location or near any of your favorite places (if programmed).
<b>Traffic Nearby</b>	
<b>Fuel Prices</b>	View fuel prices at stations close to your vehicle's location or on an active navigation route.
<b>Movie Listings</b>	View nearby movie theaters and their show times (if available).
<b>Weather</b>	View the nearby weather, current weather, or the five day forecast for the chosen area. Select Map to see the weather map which can show storms, radar information, charts and winds. Select Area to select from a listing of weather locations.
<b>Sports Info</b>	View scores and schedules from a variety of sports. You can also save up to 10 favorite teams for easier access. The score automatically refreshes when a game is in progress.
<b>Ski Conditions</b>	View ski conditions for a specific area.



**SIRIUS Travel Link Voice Commands**

**Note:** In order to use SIRIUS Travel Link, your vehicle must be equipped with navigation and your navigation SD card must be in the SD card slot.



Press the voice button and when prompted, say any of the following:

Travel Link Voice Commands	
"5-day weather forecast"	"Sports scores"***
"Fuel prices"	"Traffic"
"Movie listings"	"Travel Link"
"Sports headlines"	"Weather"
"Sports schedule"*	"Weather map"

\*If you have said, "Sports headlines", "Sports schedule" or "Sports scores", you may say any of the commands in the "Sports headlines, Sports schedules and Sports scores" commands chart:

\*If you have said, "Travel Link", you may say any of the commands in the "Travel Link" chart:

Sports Headlines, Sports Schedules and Sports Scores Voice Commands	
"Baseball"	"My teams"
"College basketball"	"NBA"
"College football"	"NFL"
"Golf"	"NHL"
"MLS"	"WNBA"
"Motor sports"	

"TRAVEL LINK"		
"5-day weather forecast"	"Golf schedule"	"NBA scores"
"Baseball headlines"	"MLS headlines"	"NFL headlines"
"Baseball schedule"	"MLS schedule"	"NFL schedule"
"Baseball scores"	"MLS scores"	"NFL scores"
"College basketball headlines"	"Motor sports"	"NHL headlines"



"TRAVEL LINK"		
"College basketball schedule"	"Motor sports order"	"NHL schedule"
"College basketball scores"	"Motor sports schedule"	"NHL scores"
"College football headlines"	"Movie listings"	"Traffic"
"College football schedule"	"My team headlines"	"Weather"
"College football scores"	"My teams schedule"	"Weather map"
"Fuel prices"	"My teams scores"	"WNBA headlines"
"Golf headlines"	"NBA headlines"	"WNBA schedule"
"Golf leaderboard"	"NBA schedule"	"WNBA scores"

**Alerts**



Press the Information button, then select Alerts. You can select a message and choose to:

- **View** the complete message.
- **Delete** the message.
- **Delete All** messages.

This screen displays any system messages, such as an SD card fault, etc.

**Note:** The system alerts you to any messages by turning the information icon yellow. When the messages are read or deleted, the icon returns to white.

**Calendar**



Press the Information button, then select Calendar. You can view the current calendar by day, week or month.



## 911 Assist® (If Equipped)



**WARNING:** Unless the 911 Assist setting is set on prior to a crash, the system will not dial for help which could delay response time, potentially increasing the risk of serious injury or death after a crash.



**WARNING:** Do not wait for 911 Assist to make an emergency call if you can do it yourself. Dial emergency services immediately to avoid delayed response time which could increase the risk of serious injury or death after a crash. If you do not hear 911 Assist within five seconds of the crash, the system or phone may be damaged or non-functional.



**WARNING:** Always place your phone in a secure location in the vehicle so it does not become a projectile or get damaged in a collision. Failure to do so may cause serious injury to someone or damage the phone which could prevent 911 Assist from working properly.

**Note:** The SYNC 911 Assist feature must be set on prior to the incident.

**Note:** Before setting this feature on, make sure that you read the 911 Assist privacy notice later in this section for important information.

**Note:** If 911 Assist is turned on or off by any user, that setting applies for all paired phones. If 911 Assist is turned off, either a voice message plays or a display message/icon comes on (or both) when the vehicle is started after a previously paired phone connects.

**Note:** Every phone operates differently. While SYNC 911 Assist works with most cellular phones, some may have trouble using this feature.

If a crash deploys an airbag or activates the fuel pump shut-off, your SYNC-equipped vehicle may be able to contact emergency services by dialing 911 through a paired and connected Bluetooth-enabled phone. For more information about 911 Assist, visit [www.SYNCMYride.com](http://www.SYNCMYride.com), [www.SYNCMYride.ca](http://www.SYNCMYride.ca) or [www.syncmaroute.ca](http://www.syncmaroute.ca).

- For information on airbag deployment, see the *Supplementary Restraints System* chapter.
- For information on the fuel pump shut-off, see the *Roadside Emergencies* chapter.



**Setting 911 Assist On**

Press the Information button > Apps > 911 Assist, then select On.

You can also access 911 Assist by:

- Pressing the Settings icon > Settings > Phone > 911 Assist, or
- Pressing the Settings icon > Help > 911 Assist.

**To Make Sure that 911 Assist Works Properly**

- SYNC must be powered and working properly at the time of the incident and throughout feature activation and use.
- SYNC 911 Assist feature must be set on prior to the incident.
- A Bluetooth-enabled and compatible phone has to be paired and connected to SYNC.
- A connected Bluetooth-enabled phone must have the ability to make and maintain an outgoing call at the time of the incident.
- A connected Bluetooth-enabled phone must have adequate network coverage, battery power and signal strength.
- The vehicle must have battery power and be located in the U.S., Canada or in a territory in which 911 is the emergency number.

**In the Event of a Crash**

Not all crashes deploy an airbag or activate the fuel pump shut-off (which would activate 911 Assist); however, if 911 Assist is triggered, SYNC tries to contact emergency services. If a connected phone is damaged or loses connection to SYNC, SYNC searches for, and tries to connect to, any available previously paired phone and tries to make the call to 911.

Before making the call:

- SYNC provides a short window of time (about 10 seconds) to cancel the call. Failure to cancel the call results in SYNC attempting to dial 911.
- SYNC says the following, or a similar message: “SYNC will attempt to call 911, to cancel the call, press Cancel on your screen or press and hold the phone button on your steering wheel.”

If the call is not cancelled and a successful call is made, a prerecorded message is played for the 911 operator, then the occupant(s) in the vehicle is able to talk with the operator. Be prepared to provide your name, phone number and location immediately, because not all 911 systems are capable of receiving this information electronically.



**911 Assist May Not Work If**

- Your cellular phone or 911 Assist hardware was damaged in a crash.
- The vehicle's battery or SYNC system has no power.
- The phone(s) paired and connected to the system was thrown from the vehicle.

**911 Assist Privacy Notice**

Once 911 Assist is set on, it may disclose to emergency services that the vehicle has been in a crash involving the deployment of an airbag or activation of the fuel pump shut-off. Certain versions or updates to 911 Assist may also be capable of electronically or verbally disclosing to 911 operators the vehicle location, or other details about the vehicle or crash to assist 911 operators to provide the most appropriate emergency services. If you do not want to disclose this information, do not turn the feature on.

**Vehicle Health Report (If Equipped, U.S. Only)**

**WARNING:** Always follow scheduled maintenance instructions, regularly inspect your vehicle, and seek repair for any damage or problem you suspect. Vehicle Health Report supplements, but cannot replace, normal maintenance and vehicle inspection. Vehicle Health Report only monitors certain systems that are electronically monitored by the vehicle and will not monitor or report the status of any other system, (i.e., brake lining wear). Failure to perform scheduled maintenance and regularly inspect your vehicle may result in vehicle damage and serious injury.

**Note:** Your Vehicle Health Report feature requires activation prior to use. Visit [www.SYNCMYride.com](http://www.SYNCMYride.com) to register. There is no fee or subscription associated with Vehicle Health Report, but you must register to use this feature.

**Note:** This feature may not function properly if you have enabled caller ID blocking on your mobile phone. Before running a report, review the *Vehicle Health Report Privacy Notice*.

**Note:** In order to allow a break-in period for your vehicle, you may not be able to create a Vehicle Health Report until your vehicle odometer has reached 200 miles.

**Note:** Cellular phone and SMS charges may apply when making a report.





Register for Vehicle Health Report and set your report preferences at [www.SYNCMYRide.com](http://www.SYNCMYRide.com). After registering, you can request a Vehicle Health Report (inside your vehicle). Return to your account at [www.SYNCMYRide.com](http://www.SYNCMYRide.com) to view your report. You can also choose for SYNC to automatically remind you to run reports at specific mileage intervals. Cellular phone airtime usage may apply when reporting.

The system allows you to check your vehicle's overall health in the form of a diagnostic report card. The Vehicle Health Report contains valuable information, such as:

- Vehicle Diagnostic Information
- Scheduled maintenance
- Open Recalls and Field Service Actions
- Unserviced items from vehicle inspections by your authorized dealer.

#### **Making a Report**



To run a report by touchscreen, touch the Information button > Apps > Vehicle Health Report.



To run a report by voice command, press the voice button on the steering wheel and, when prompted, say "Vehicle health report".

#### **Vehicle Health Report Privacy Notice**

When you run a Vehicle Health Report, Ford Motor Company may collect your cellular phone number (to process your report request) and diagnostic information about your vehicle. Certain versions or updates to Vehicle Health Report may also collect additional vehicle information. Ford may use the vehicle information it collects for any purpose. If you do not want to disclose your cellular phone number or vehicle information, do not run the feature or set up your Vehicle Health Report profile at [www.SYNCMYRide.com](http://www.SYNCMYRide.com). See [www.SYNCMYRide.com](http://www.SYNCMYRide.com) - Vehicle Health Report Terms and Conditions, and Privacy Statement - for more information.



**SETTINGS**

Under this menu, you can set your clock, access and make adjustments to the display, sound and vehicle settings as well as access settings for specific modes or the help feature.

**Clock**

**Note:** The date is set by your vehicle's GPS; you cannot manually set the date.

**Note:** If the battery has been disconnected, the vehicle needs to acquire a GPS signal to update the clock. Once your vehicle acquires the signal, it may take a few minutes for the update to display the correct time.

1. Press the Settings icon > Clock.
2. Press + and - to adjust the time.

From this screen, you can also make other adjustments, such as 12- or 24-hour mode, activate GPS time synchronization and have the system automatically update for daylight savings time and new time zones.

You can also turn the outside air temperature display on and off. When the outside air temperature is displayed, it appears at the top center of the touchscreen next to the time and date.

Once you update any settings, they are automatically saved.

**Display**

You can make adjustments to the touchscreen display through the touchscreen or by pressing the voice button on your steering wheel controls and when prompted, say "Display settings".

Press the Settings icon > Display, then select from the following:

**Brightness** allows you to make the screen display brighter or dimmer.

**Mode** allows you to set the screen to a certain brightness or have the system automatically change based on the outside light level.

- If you select AUTO or NIGHT, you have the options of turning the display's Auto Dim feature on or off and changing the Auto Dim Manual Offset feature.

**Edit Wallpaper**

- You can have your touchscreen display the default photo or upload your own.

**Uploading Photos for Your Home Screen Wallpaper**

**Note:** You cannot load photos directly from your camera. You must access the photos from either your USB mass storage device or from an SD card.



**Note:** Photographs with extremely large dimensions (i.e., 2048 x 1536) may not be compatible and appear as a blank (black) image on the display.

Your system allows you to upload and view up to 32 photos.

To access, press the Settings icon > Display > Edit Wallpaper, then follow the system prompts to upload your photographs. Only the photograph(s) which meets the following conditions display:

- Compatible file formats are as follows: .jpg, .gif, .png, .bmp.
- Each file must be 1.5 MB or less.
- Recommended dimensions: 800 x 384.

**Sound**

Press the Settings icon > Sound, then select from the following:

<b>Sound Settings</b>	
Bass	THX Deep Note Demo*
Midrange	DSP*
Treble	Occupancy Mode*
Set Balance and Fade	Speed Compensated Volume

\*If equipped.

**Vehicle**

Press the Settings icon > Vehicle, then select from the following:

- Active Park Assist
- Vehicle Health Report
- Door Keypad Code
- Rear View Camera
- Enable Valet Mode.

**Active Park Assist (If Equipped)**

When activated, your system displays directions for you regarding the active park assist process.

For complete information on this system, see *Active park assist* in the *Driving Aids* chapter.

**Vehicle Health Report (If Equipped)**

Turn Automatic Reminders on and off and set the mileage interval at which you would like to receive the reports. Press the ? for more information on these selections.

When done making your selections, press Run Vehicle Health Report Now if you want your report.



**Door Keypad Code (If Equipped)**

To change the keypad code for your keyless entry keypad system:

1. Press the Settings icon > Vehicle > Door Keypad Code.
2. Enter your current factory code, then, when prompted, enter your new code.

**Rear View Camera (If Equipped)**

This menu allows you to access settings for your rear view camera.

Press the Settings icon > Vehicle > Rear View Camera, then select from the following settings:

- Rear Camera Delay
- Visual Park Aid Alert
- Guidelines.

**Enable Valet Mode**

**Note:** If you are locked out and need to reset the PIN, you can enter 3681 and the system unlocks.

Valet mode allows you to lock the system so that none of your information on the system can be accessed until it is unlocked with the correct PIN.

1. Press the Settings icon > Vehicle > Enable Valet Mode.
2. When prompted, enter a four-digit PIN.

After you press Continue, the system is locked until the correct PIN is entered again.

**Settings**

Access and adjust system settings, voice features, as well as phone, navigation and wireless settings. Some of these settings can also be accessed with regard to their specific modes (i.e., phone and media).

**System**

Press the Settings icon > Settings > System, then select from the following:

<b>System</b>	
<b>Language</b>	Select to have the touchscreen display in English, Spanish or French.
<b>Distance</b>	Select to display units in kilometers or miles.
<b>Temperature</b>	Select to display units in Celsius or Fahrenheit.
<b>System Prompt Volume</b>	Adjust the volume of voice prompts from the system.



System	
<b>Touch Screen Button Beep</b>	Select to have the system beep to confirm choices made through the touchscreen.
<b>Touch Panel Button Beep</b>	Select to have the system beep to confirm button choices made through the climate or audio system.
<b>Keyboard Layout</b>	Have the touchscreen keyboard display in QWERTY or ABC format.
<b>Install Applications</b>	Install any downloaded applications or view the current software licenses.
<b>Master Reset</b>	Select to restore factory defaults. This erases all personal settings and personal data.

**Voice Control**

Press the Settings icon > Settings > Voice Control, then select from the following:

Voice Control	
<b>Interaction Mode</b>	Standard interaction mode provides more detailed interaction and guidance. Advanced mode has less audible interaction and more tone prompts.
<b>Confirmation Prompts</b>	Have the system ask you short questions if it has not clearly heard or understood your request. <b>Note:</b> Even with confirmation prompts turned off, you may be asked to confirm settings occasionally.
<b>Media Candidate Lists</b>	Candidate lists are possible results from your voice commands. If these are turned off, the system simply makes a best guess at your request.
<b>Phone Candidate Lists</b>	Candidate lists are possible results from your voice commands. If these are turned off, the system simply makes a best guess at your request.
<b>Voice Control Volume</b>	Allows you to adjust the voice volume level.



**Media Player**

Press the Settings icon > Settings > Media Player, then select from the following:

<b>Media Player</b>	
<b>Autoplay</b>	With this feature on, the system automatically switches to the media source upon initial connection and you can listen to music which has already been randomly indexed during the indexing process. With this feature off, the system does not automatically switch to the inserted media source.
<b>Bluetooth Devices</b>	Select to connect, disconnect, add or delete a device. You can also set a device as your favorite so that the system automatically attempts to connect to that device at every ignition cycle.
<b>Gracenote® Database Info</b>	Allows you to view the version level of the Gracenote Database.
<b>Gracenote® Mgmt</b>	With this feature on, metadata information is pulled from the Gracenote Database for your music files. This overrides information from your device. This feature defaults to off.
<b>Cover Art Priority</b>	With this feature on, cover art is pulled from the Gracenote Database for your music files. This overrides any art from your device. This feature defaults to Media Player.



**Navigation**

Press the Settings icon > Settings > Navigation, then select from the following:

<b>Navigation</b>	
<b>Map Preferences</b>	Turn breadcrumbs on and off.
	Have the system display your turn list top to bottom or bottom to top.
	Turn the Parking POI notification on and off.
<b>Route Preferences</b>	Have the system display the shortest route, fastest route or most ecological route.
	Have the system avoid freeways.
	Have the system avoid tollroads.
	Have the system avoid ferries or car trains.
	Have the system use HOV (high-occupancy vehicle) lanes.
<b>Navigation Preferences</b>	Have the system use guidance prompts.
	Have the system automatically fill-in State/Province information.
<b>Traffic Preferences</b>	Have the system display areas where road work occurs.
	Have the system display incident map icons on the map.
	Have the system display areas where difficult driving conditions may occur.
	Have the system display areas where snow and ice on the road may occur.
	Have the system display any smog alerts.
	Have the system display weather warnings.
	Have the system display where there may be reduced visibility.
	Have the system turn on your radio for traffic announcements.
<b>Avoid Areas</b>	Enter specific areas that you would like to avoid on planned navigation routes.



**Phone Settings**

Press the Settings icon > Settings > Phone, then select from the following:

<b>Phone</b>	
<b>Bluetooth Devices</b>	Connect, disconnect, add or delete a device, as well as save it as a favorite.
<b>Bluetooth</b>	Turn Bluetooth on and off.
<b>Do Not Disturb</b>	Have all calls go directly to your voice mail and not ring inside the vehicle. With this feature turned on, text message notifications are also suppressed and do not ring inside the vehicle.
<b>911 Assist</b>	Turn 911 Assist on and off. See <i>911 Assist</i> in the <i>SYNC applications and services</i> section.
<b>Phone Ringer</b>	Select the type of notification for phone calls - ring tone, beep, text to speech, or have it be silent.
<b>Text Message Notification</b>	Select the type of notification for text messages - alert tone, beep, text to speech, or have it be silent.
<b>Internet Data Connection</b>	If compatible with your phone, you can make adjustments to your internet data connection. Select to make your connection profile with the PAN (personal area network) or to turn off your connection. You can also choose to make adjustments to your settings or have the system always connect, never connect when roaming or query on connect. Press ? for additional information.
<b>Manage Phonebook</b>	Access features, such as automatic phonebook download, re-download your phonebook, add contacts from your phone as well as delete or upload your phonebook.
<b>Roaming Warning</b>	Have the system alert you when in Roaming mode.





**Wireless & Internet**

Your system has a Wi-Fi feature which creates a wireless network within your vehicle, thereby allowing other devices (i.e., personal computers or phones) in your vehicle to speak to each other, share files, play games, etc. Using this Wi-Fi feature, everyone in your vehicle can also access the internet if you have a USB mobile broadband connection inside the vehicle, your phone supports PAN (personal area networking) and if you are parked outside of a wireless hotspot.

Press the Settings icon > Settings > Wireless & Internet, then select from the following:

<b>Wireless &amp; Internet</b>	
<b>Wi-Fi Settings</b>	<b>Wi-Fi Network (Client) Mode</b> Turn the Wi-Fi feature on and off in your vehicle. Make sure it is turned on for connectivity purposes.
	<b>Choose a Wireless Network</b> Use a previously stored wireless network. You can categorize by alphabetical listing, priority and signal strength. You can also choose to search for a network, connect to a network, disconnect from a network, receive more information, prioritize a network or delete a network.
	<b>Gateway (Access Point) Mode</b> Make SYNC an access point for a phone or a computer by turning this feature on. This forms the local area network within the vehicle for things, such as game playing, file transfer, internet browsing, etc. Press ? for more information.
	<b>Gateway (Access Point) Settings</b> View and change settings for using SYNC as the internet gateway.
	<b>Gateway (Access Point) Device List</b> View who has connected to your Wi-Fi connection recently.



<b>Wireless &amp; Internet</b>	
<b>USB Mobile Broadband</b>	Instead of using Wi-Fi, your system can also use a USB mobile broadband connection to access the internet. (You must activate your mobile broadband device on your PC prior to connecting it to the system.) This screen allows you to set up what is your typical area for your USB mobile broadband connection. (USB mobile broadband settings may not be displayed if the device is already activated.) You can select the following: Country, Carrier, Phone Number, User Name and Password.
<b>Bluetooth Settings</b>	Shows you what device is currently paired with the system as well as giving you your typical Bluetooth options to connect, disconnect, set as favorite, delete and add device. Bluetooth is a registered trademark of the Bluetooth SIG.
<b>Prioritize Connection Methods</b>	Choose your connection methods and change them as needed. You can select to Change Order and have the system either always attempt to connect using a USB mobile broadband or using Wi-Fi.

The Wi-Fi CERTIFIED Logo is a certification mark of the Wi-Fi Alliance.



**Help**

Press the Settings icon > Help, then select from the following:

<b>Help</b>	
<b>Where Am I?</b>	View the vehicle's current location, if your vehicle is equipped with navigation. If your vehicle is not equipped with navigation, nothing is displayed.
<b>System Information</b>	View the following information: Touchscreen system serial number, vehicle identification number (VIN), touchscreen system software version, navigation system version (if applicable), map database version (if equipped with navigation), Sirius satellite radio ESN (if activated) and Gracenote® Database Information and Library version.
<b>Software Licenses</b>	View the licenses for any software and applications installed on your system.
<b>Driving Restrictions</b>	Certain features are disabled when your vehicle is moving.
<b>911 Assist</b>	Turn 911 Assist on and off. See <i>911 Assist</i> in the <i>SYNC applications and services</i> section.
<b>Voice Command List</b>	View categorized lists of voice commands.

To access Help using the voice commands, press the voice button, then, after the tone, say "Help". The system provides voice commands that can be used in the current mode.



## CLIMATE CONTROLS



Depending on your vehicle line and option package, your climate screen may look different than what is shown here.

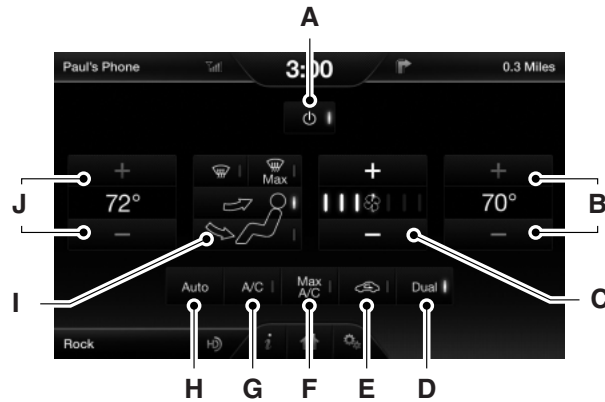

A. **Power:** Touch to turn the system on and off. Outside air cannot enter the vehicle when the system is off.

B. **Passenger settings:** Touch + or – to adjust the temperature.

C. **Fan speed:** Touch + or – to adjust fan speed.

D. **DUAL:** Touch to turn on the passenger side temperature control.

E. **Recirculated air:** Touch to turn the recirculated air on or off which:

- May reduce the amount of time needed to cool down the interior.
- May help reduce odors from reaching the interior.
- Engages automatically when MAX A/C or MAX defrost is selected.
- May be engaged manually in any airflow mode except defrost.
- May turn off in all airflow modes except MAX A/C and MAX defrost to reduce fog potential.

F. **MAX A/C:** Touch to cool the vehicle with recirculated air. Touch again for normal A/C operation. MAX A/C:

- Distributes air through instrument panel vents.
- Is more economical and efficient than normal A/C mode.
- May help reduce odors from entering the vehicle.

G. **A/C:** Touch to turn the air conditioning on or off.

- Use with recirculated air to improve cooling performance and efficiency.
- Engages automatically in MAX A/C, defrost and floor/defrost.



H. **AUTO:** Touch to engage automatic operation, then set the temperature using the temperature control. The system automatically controls:

- Fan speed
- Airflow distribution
- A/C on or off
- Outside or recirculated air.

I. **Manual controls:** Select any of the following airflow distribution modes:

- Floor/Defrost: Distributes air through the windshield defroster vents, demister vents, floor vents and rear seat floor vents, and provides outside air to reduce window fogging.
- Panel: Distributes air through the instrument panel vents.
- Panel/Floor: Distributes air through the instrument panel vents, demister vents, floor vents and rear seat floor vents.
- Floor: Distributes air through the demister vents, floor vents and rear seat floor vents.
- MAX Defrost: Touch to distribute outside air through the windshield air vents. Air conditioning is automatically selected. The fan is set to the highest speed and the temperature to HI. When the air distribution is set in this position, you are unable to select recirculated air or manually adjust the fan speed and temperature control.
- Defrost: Touch to clear the windshield of fog and thin ice. Touch again to return to the previous airflow selection. When on, defrost provides outside air to reduce window fogging and distributes air through the windshield defroster vents and demister vents.

J. **Driver settings:** Touch + or – to adjust the temperature.

### Climate Control Voice Commands



The following voice commands are available at the main menu level of a voice session. For example, press the voice button and after the prompt, “Say a command”; say any of the following commands:

Climate Control Voice Commands
“Climate automatic”
“Climate off”
“Climate on”
“Climate temperature <15.5–29.5> degrees”
“Climate temperature <60–85> degrees”
“Help”



There are additional climate control commands but in order to access them, you have to say “Climate” first, then when the system is ready to listen, you may say any of the following commands:

<b>Additional Climate Control Voice Commands</b>	
“Automatic”	“Panel floor on”
“A/C off”	“Panel off”
“A/C on”	“Panel on”
“Defrost off”	“Rear defrost off”
“Defrost on”	“Rear defrost on”
“Dual off”	“Recirc off”
“Fan decrease”	“Recirc on”
“Fan increase”	“Temperature”*
“Floor off”	“Temperature <15.5–29.5> degrees”
“Floor on”	“Temperature <60–85> degrees”
“Max A/C off”	“Temperature decrease”
“Max A/C on”	“Temperature high on”
“Maximum fan”	“Temperature increase”
“Maximum windshield off”	“Temperature low on”
“Maximum windshield on”	“Windshield floor on”
“Minimum fan”	“Windshield panel floor on”
“Off”	“Windshield panel on”
“On”	“Help”

\*If you have said “Temperature”, you can say any of the commands in the following “Temperature” chart.

<b>“TEMPERATURE”</b>
“<15.5–29.5> degrees”
“<60–85> degrees”
“High”
“Low”
“Help”



**NAVIGATION SYSTEM (IF EQUIPPED)**

**Note:** The navigation SD card must be in the SD card slot to operate the navigation system. If you need a replacement SD card, see your authorized dealer.

**Note:** The SD card slot is spring-loaded. To remove the SD card, just push the card in and release it. Do not attempt to pull the card out to remove it; this could cause damage.

Your navigation system is comprised of two main features, destination mode and map mode.

To set a destination, press the green corner of your touchscreen, then the Dest button when it appears. See *Setting a destination* later in this chapter.

To view the navigation map and the vehicle's current location, touch the green bar in the upper right hand corner of the touchscreen, or press Dest > Map. See *Map mode* later in this chapter.

**Setting a Destination**

Press the green corner of your touchscreen, then the Dest button when it appears. Choose any of the following:

Destination Selections	
My Home	Street Address
Favorites	Intersection
Previous Destinations	City Center
Point of Interest	Map
Emergency	Edit Route Cancel Route
Previous Starting Point	Freeway Entrance/Exit
Latitude/Longitude	

1. Enter the necessary information into the highlighted text fields (in any order). For address destination entry, the Go! button appears once all the necessary information has been entered. Pressing the Go! button makes the address location appear on the map. If you choose Previous Destination, the last 20 destinations you have selected appear.
2. Select Set as Dest to make this your destination. You can also choose to set this as a waypoint (have the system route to this point on the way to your current destination) or save it as a favorite. Any Avoid Areas selections are also considered in route calculation.



3. Choose from up to three different types of routes, then select Start Route.
- Fastest: Uses the fastest moving roads possible.
  - Shortest: Uses the shortest distance possible.
  - Eco (EcoRoute): Uses the most fuel efficient route.

You can cancel the route or have the system demo the route for you. Select Route Prefs to set route preferences like avoiding freeways, toll roads, ferries and car trains as well as to use or not use HOV lanes. (HOV lanes are High Occupancy Vehicle lanes also known as carpool or diamond lanes. These lanes are reserved for people who ride in buses, vanpools or carpools.)

**Note:** If Start Route button is not pressed and the vehicle is driven on a recognized road, the system defaults to the fastest route option and begins guidance.

During route guidance, the talking bubble icon that appears in the upper right navigation corner (green bar) can be pressed if the user wants the system to repeat a route guidance instruction. Instructions decrease with each press.

### POI Categories

Your system offers a variety of POI (Points of Interest) categories.

Main Categories	
Food/Drink & Dining	Automotive
Travel & Transportation	Shopping
Financial	Entertainment & Arts
Emergency	Recreation & Sports
Community	Government
Health & Medicine	Domestic Services

Within these main categories, there are subcategories which contain more listings:

Subcategories
Restaurant
Golf
Parking
Home & Garden
Personal Care Services





Subcategories
Automobile Dealership
Govt. Office
Public Transit
Education

To expand these listings, press the + in front of the POI listing.

The system also allows you to sort the POIs alphabetically, by distance or by cityseekr listings (if available).

#### cityseekr (If Available)

**Note:** cityseekr point of interest (POI) information is limited to approximately 154 cities (132 in the U.S., 13 in Canada and 9 in Mexico).



cityseekr is a service which provides additional information about certain POIs, such as restaurants, hotels and attractions.

When you have selected a POI, the location and information appear, such as address and phone number. If the POI is listed with cityseekr, you also see information, such as a brief description,

check-in and check-out times, when the restaurant is open, etc.

Press More Information for a longer review, a list of services and facilities, the average room or meal price as well as the website link.

This screen displays the POI icon, such as:



Hotel



Coffeehouse



Food & Drink





Nightlife



Attraction



This icon appears when your selection exists in multiple categories within the system.

When you are viewing additional information for hotels, cityseekr also tells you if the hotel has certain services and facilities using icons:

<b>Hotel Services and Facilities</b>	
 Restaurant	 24 Hr Room Service
 Business Center	 Fitness Center
 Handicap Facilities	 Internet Access
 Laundry	 Pool
 Refrigerator	 Wi-Fi

For restaurants, cityseekr can provide information, such as star rating, average cost, review, handicap access, hours of operation, and website address.



For hotels, cityseekr can provide information, such as star rating, price category, review, check-in and check-out times, hotel service icons and website address.

**Setting Your Navigation Preferences**

Select settings for the system to take into account when planning your route.



Press the Settings icon > Settings > Navigation.

When you select:	You can:
<p><b>Map Preferences</b></p>	Turn breadcrumbs on and off.
	Have the system display your turn list top to bottom or bottom to top.
	Set the automatic parking POI notification. When parking POI notification is on, parking POI icons display on the map when you get close to your destination. (This may not be very useful in dense areas, and may clutter the map if other POIs are also set for display.)
<p><b>Route Preferences</b></p>	Choose to have the system display the shortest route, fastest route or most ecological route.
	Avoid freeways, toll roads, ferries and car trains when planning your route.
	Use high-occupancy vehicle (HOV) lanes (if available).
<p><b>Navigation Preferences</b></p>	Choose prompts to be either voice or tone only.
	Have the system automatically fill in the state and province based on the information already entered into the system.



When you select:	You can:
<b>Traffic Preferences</b>	<p>Choose how you want the system to handle traffic problems along your route.</p> <p>Automatic: Have the system reroute you to avoid traffic incidents that develop and impact the current route (no notification is provided).</p> <p>Manual: Have the system always provide a traffic alert notification for traffic incidents along the planned route. You have a choice to accept or ignore the notification before the route deviation is made.</p> <hr/> <p>Turn on certain, or all, traffic icons on the map (road work, incidents, accidents, closed roads, etc.).</p>
<b>Avoid Areas</b>	<p>Choose areas which you want the system to avoid when calculating a route for you. Press Add to select a category.</p> <p>Once you make a selection, the system tries to avoid the area(s) if possible for all routes.</p> <p>To delete a selection, choose the listing on the screen; when the screen changes to Avoid Areas Edit, press Delete at the bottom right of the screen.</p>

### Map Mode

Press the green bar in the upper right area of the touchscreen to view map mode. Map mode shows advanced viewing comprised of both 2D city maps as well as 3D landmarks (when available).

**2D city maps** show detailed outlines of buildings, visible land use and land elements and detailed railway infrastructure for the most essential cities around the globe. These maps also contain features, such as town blocks, building footprints, and railways.

**3D landmarks** appear as clear, visible objects which are typically recognizable and have a certain tourist value. The 3D landmarks appear in 3D map mode only. Coverage varies, and improves with updated map releases.





Change the appearance of the map display by repeatedly pressing the arrow button in the upper left corner of the screen. It toggles between three different map modes; Heading up, North up, and 3D.



**Heading up (2D map)** always shows the direction of forward travel to be upward on the screen. This view is available for map scales up to 2.5 miles (4 kilometers). For larger map scales, this setting is remembered, but the map is shown in North up only. If the scale returns below this level, then Heading up is restored.



**North up (2D map)** always shows the northern direction to be upward on the screen.



**3D map mode** provides an elevated perspective of the map. This viewing angle can be adjusted and the map can be rotated 180 degrees by dragging your finger along the shaded bar with arrows at the bottom of the map.



**Re-centering the map** can be done by pressing this icon whenever you scroll the map away from your vehicle's current location.

### Auto Zoom

Press the green bar to access map mode, then select the + or - zoom button to bring up the zoom level and Auto buttons on the touchscreen. When the Auto button is pressed, Auto Zoom is turned on and Auto is displayed in the bottom left corner of the screen. The map zoom level then synchronizes with vehicle speed. The slower the vehicle is traveling, the farther in the map is zoomed in; the faster the vehicle is traveling, the farther the map is zoomed out. To turn the feature off, just press the + or - button again.



**Map Icons**

**Vehicle mark** shows the current location of the vehicle. It stays in the center of the map display, except when in scroll mode.



**Scroll cursor** allows you to scroll the map; the icon is fixed in the center of the screen. The map position closest to the cursor is in a window on the top center part of the screen.



**Address book entry default icon(s)** indicates the location on the map of an address book entry. This is the default symbol shown after the entry has been stored to the Address Book by any method other than the map. A different icon can be selected from the 22 icons available; each icon can be used more than once.



**Home** indicates the location on the map currently stored as the home position. Only one entry from the Address Book can be saved as Home. This icon cannot be changed.



**POI (Point Of Interest) icons** can be displayed on the map and can be turned on or off. There are about 56 subcategories of POIs that can be selected to be displayed on the map one at a time.



**Starting point** indicates the starting point of a planned route.



**Waypoints** indicates the location of a waypoint on the map. The number inside the circle is different for each waypoint and represents the position of the waypoint in the route list.



**Destination symbol** indicates the ending point of a planned route.



**Next maneuver point** indicates the location of the next turn on the planned route.



**No GPS symbol** indicates that insufficient GPS satellite signals are available for accurate map positioning. This icon may be intermittently displayed under normal operation in an area with poor GPS access.



**Quick-touch Buttons**

When in map mode, touch anywhere on the map display to access the following options:

When you select:	You can:
<b>Set as Dest</b>	Select a scrolled location on the map as your destination. (You may scroll the map by pressing your index finger on the map display. When you reach the desired location, simply let go and then press Set as Dest.)
<b>Set as Waypoint</b>	Set the current location as a waypoint.
<b>Save to Favorites</b>	Save the current location to your favorites.
<b>POI Icons On/Off</b>	Select POI icons to be displayed on the map. Up to three icons can be selected for display on the map at the same time.
<b>Cancel Route</b>	Cancel the active route.
<b>View/Edit Route</b>	Access these features when a route is active: <ul style="list-style-type: none"> <li>• View route</li> <li>• Edit destination/waypoints</li> <li>• Edit turn list</li> <li>• Detour</li> <li>• Edit route preferences</li> <li>• Edit traffic preferences</li> <li>• Cancel route.</li> </ul>



Rotate the map view by swiping your finger across the shaded bar with the arrows.

Navteq is the digital map provider for the navigation application. If you find map data errors, you may report them directly to Navteq by going to <http://mapreporter.navteq.com>. Navteq evaluates all reported map errors and responds with the result of their investigation by e-mail.



### Navigation Map Updates

Annual navigation map updates are available for purchase through your dealership, by calling 1-800-NAVMAPS (in Mexico, call 01-800-557-5539) or going to [www.navigation.com/ford](http://www.navigation.com/ford). You need to specify the make and model of your vehicle to determine if there is an update available.

### Navigation Voice Commands



When in navigation mode, press the voice button on the steering wheel control. After the tone, say any of the following commands:

Navigation System Voice Commands	
“Cancel next waypoint” <sup>1</sup>	“Navigation” <sup>3</sup>
“Cancel route” <sup>1</sup>	“Repeat instruction” <sup>1</sup>
“Destination” <sup>2</sup>	“Show 3D”
“Destination <nametag>”	“Show heading up”
“Destination <POI category>”	“Show map”
“Destination favorites”	“Show north up”
“Destination home”	“Show route” <sup>1</sup>
“Destination intersection”	“Show turn list” <sup>1</sup>
“Destination nearest <POI category>”	“Voice off”
“Destination nearest POI”	“Voice on”
“Destination play nametags”	“Voice volume decrease”
“Destination POI”	“Voice volume increase”
“Destination POI category”	“Where am I?”
“Destination previous destination”	“Zoom in”
“Destination street address”	“Zoom out”
“Detour” <sup>1</sup>	“Help”

<sup>1</sup>These commands are only available when a navigation route is active.

<sup>2</sup>If you have said the command, “Destination”, you may say any of the above commands or commands in the following Destination chart.

<sup>3</sup>If you have said the command, “Navigation”, you may say any of the above commands or commands in the following Navigation chart.





<b>“DESTINATION”</b>
“<nametag>”
“<POI category>”
“Favorites”
“Home”
“Intersection”
“Nearest <POI category>”
“Nearest POI”
“Play nametags”
“POI category”
“Previous destination”
“Street address”
“Help”
<b>“NAVIGATION”</b>
“Destination”*
“Zoom city”
“Zoom country”
“Zoom in minimum”
“Zoom out maximum”
“Zoom province”
“Zoom state”
“Zoom street”
“Zoom to <distance>”
“Help”

\*If you have said, “Destination”, you may say any of the commands in the Destination chart.

#### **One-shot Destination Street Address**

If your vehicle is equipped with the SD card navigation feature, you have the ability to enter in a street address using a feature called one-shot destination street address. When you say either “Navigation destination street address” or “Destination street address”, the system asks you to say the full address. The system displays an example on-screen. You can then speak the address naturally, such as “One two three four Main Street, Anytown”.



**GENERAL INFORMATION****SYNC® End User License Agreement (EULA)**

- You have acquired a device (“DEVICE”) that includes software licensed by FORD MOTOR COMPANY from an affiliate of Microsoft Corporation (“MS”). Those installed software products of MS origin, as well as associated media, printed materials, and “online” or electronic documentation (“MS SOFTWARE”) are protected by international intellectual property laws and treaties. The MS SOFTWARE is licensed, not sold. All rights reserved.
- The MS SOFTWARE may interface with and/or communicate with, or may be later upgraded to interface with and/or communicate with additional software and/or systems provided by FORD MOTOR COMPANY. The additional software and systems of FORD MOTOR COMPANY origin, as well as associated media, printed materials, and “online” or electronic documentation (“FORD SOFTWARE”) are protected by international intellectual property laws and treaties. The FORD SOFTWARE is licensed, not sold. All rights reserved.
- The MS SOFTWARE and/or FORD SOFTWARE may interface with and/or communicate with, or may be later upgraded to interface with and/or communicate with additional software and/or systems provided by third party software and service suppliers. The additional software and services of third party origin, as well as associated media, printed materials, and “online” or electronic documentation (“THIRD PARTY SOFTWARE”) are protected by international intellectual property laws and treaties. The THIRD PARTY SOFTWARE is licensed, not sold. All rights reserved.
- The MS SOFTWARE, FORD SOFTWARE and THIRD PARTY SOFTWARE hereinafter collectively and individually will be referred to as “SOFTWARE.”

**IF YOU DO NOT AGREE TO THIS END USER LICENSE AGREEMENT (“EULA”), DO NOT USE THE DEVICE OR COPY THE SOFTWARE. ANY USE OF THE SOFTWARE, INCLUDING BUT NOT LIMITED TO USE ON THE DEVICE, WILL CONSTITUTE YOUR AGREEMENT TO THIS EULA (OR RATIFICATION OF ANY PREVIOUS CONSENT).**

**GRANT OF SOFTWARE LICENSE:** This EULA grants you the following license:

- You may use the SOFTWARE as installed on the DEVICE and as otherwise interfacing with systems and/or services provide by or through FORD MOTOR COMPANY or its third party software and service providers.



**DESCRIPTION OF OTHER RIGHTS AND LIMITATIONS:**

- **Speech Recognition:** If the SOFTWARE includes speech recognition component(s), you should understand that speech recognition is an inherently statistical process and that recognition errors are inherent in the process. Neither FORD MOTOR COMPANY nor its suppliers shall be liable for any damages arising out of errors in the speech recognition process.
- **Limitations on Reverse Engineering, Decompilation and Disassembly:** You may not reverse engineer, decompile, or disassemble nor permit others to reverse engineer, decompile or disassemble the SOFTWARE, except and only to the extent that such activity is expressly permitted by applicable law notwithstanding this limitation.
- **Limitations on Distributing, Copying, Modifying and Creating Derivative Works:** You may not distribute, copy, make modifications to or create derivative works based on the SOFTWARE, except and only to the extent that such activity is expressly permitted by applicable law notwithstanding this limitation.
- **Single EULA:** The end user documentation for the DEVICE and related systems and services may contain multiple EULAs, such as multiple translations and/or multiple media versions (e.g., in the user documentation and in the software). Even if you receive multiple EULAs, you are licensed to use only one (1) copy of the SOFTWARE.
- **SOFTWARE Transfer:** You may permanently transfer your rights under this EULA only as part of a sale or transfer of the DEVICE, provided you retain no copies, you transfer all of the SOFTWARE (including all component parts, the media and printed materials, any upgrades, and, if applicable, the Certificate(s) of Authenticity), and the recipient agrees to the terms of this EULA. If the SOFTWARE is an upgrade, any transfer must include all prior versions of the SOFTWARE.
- **Termination:** Without prejudice to any other rights, FORD MOTOR COMPANY or MS may terminate this EULA if you fail to comply with the terms and conditions of this EULA.
- **Security Updates/Digital Rights Management:** Content owners use the WMDRM technology included in your DEVICE to protect their intellectual property, included copyrighted content. Portions of the SOFTWARE on your DEVICE use WMDRM software to access WMDRM-protected content. If the WMDRM software fails to protect the content, content owners may ask Microsoft to revoke the



SOFTWARE's ability to use WMDRM to play or copy protected content. This action does not affect unprotected content. When your DEVICE downloads licenses for protected content, you agree that Microsoft may include a revocation list with the licenses. Content owners may require you to upgrade the SOFTWARE on your DEVICE to access their content. If you decline an upgrade, you will not be able to access content that requires the upgrade.

- **Consent to Use of Data:** You agree that MS, Microsoft Corporation, FORD MOTOR COMPANY, third party software and systems suppliers, their affiliates and/or their designated agent may collect and use technical information gathered in any manner as part of product support services related to the SOFTWARE or related services. MS, Microsoft Corporation, FORD MOTOR COMPANY, third party software and services suppliers, their affiliates and/or their designated agent may use this information solely to improve their products or to provide customized services or technologies to you. MS, Microsoft Corporation, FORD MOTOR COMPANY, third party software and systems suppliers, their affiliates and/or their designated agent may disclose this information to others, but not in a form that personally identifies you.
- **Internet-Based Services Components:** The SOFTWARE may contain components that enable and facilitate the use of certain Internet-based services. You acknowledge and agree that MS, Microsoft Corporation, FORD MOTOR COMPANY, third party software and service suppliers, their affiliates and/or their designated agent may automatically check the version of the SOFTWARE and/or its components that you are utilizing and may provide upgrades or supplements to the SOFTWARE that may be automatically downloaded to your DEVICE.
- **Additional Software/Services:** The SOFTWARE may permit FORD MOTOR COMPANY, third party software and service suppliers, MS, Microsoft Corporation, their affiliates and/or their designated agent to provide or make available to you SOFTWARE updates, supplements, add-on components, or Internet-based services components of the SOFTWARE after the date you obtain your initial copy of the SOFTWARE ("Supplemental Components").

If FORD MOTOR COMPANY or third party software and services suppliers provide or make available to you Supplemental Components and no other EULA terms are provided along with the Supplemental Components, then the terms of this EULA shall apply.

If MS, Microsoft Corporation, their affiliates and/or their designated agent make available Supplemental Components, and no other EULA terms are



provided, then the terms of this EULA shall apply, except that the MS, Microsoft Corporation or affiliate entity providing the Supplemental Component(s) shall be the licensor of the Supplemental Component(s).

FORD MOTOR COMPANY, MS, Microsoft Corporation, their affiliates and/or their designated agent reserve the right to discontinue without liability any Internet-based services provided to you or made available to you through the use of the SOFTWARE.

- **Links to Third Party Sites:** The MS SOFTWARE may provide you with the ability to link to third party sites through the use of the SOFTWARE. The third party sites are not under the control of MS, Microsoft Corporation, their affiliates and/or their designated agent. Neither MS nor Microsoft Corporation nor their affiliates nor their designated agent are responsible for (i) the contents of any third party sites, any links contained in third party sites, or any changes or updates to third party sites, or (ii) webcasting or any other form of transmission received from any third party sites. If the SOFTWARE provides links to third party sites, those links are provided to you only as a convenience, and the inclusion of any link does not imply an endorsement of the third party site by MS, Microsoft Corporation, their affiliates and/or their designated agent.
- **Obligation to Drive Responsibly:** You recognize your obligation to drive responsibly and keep attention on the road. You will read and abide with the DEVICE operating instructions particularly as they pertain to safety and assumes any risk associated with the use of the DEVICE.

**UPGRADES AND RECOVERY MEDIA:** If the SOFTWARE is provided by FORD MOTOR COMPANY separate from the DEVICE on media such as a ROM chip, CD ROM disk(s) or via web download or other means, and is labeled “For Upgrade Purposes Only” or “For Recovery Purposes Only” you may install one (1) copy of such SOFTWARE onto the DEVICE as a replacement copy for the existing SOFTWARE, and use it in accordance with this EULA, including any additional EULA terms accompanying the upgrade SOFTWARE.

**INTELLECTUAL PROPERTY RIGHTS:** All title and intellectual property rights in and to the SOFTWARE (including but not limited to any images, photographs, animations, video, audio, music, text and “applets,” incorporated into the SOFTWARE), the accompanying printed materials, and any copies of the SOFTWARE, are owned by MS, Microsoft Corporation, FORD MOTOR COMPANY, or their affiliates or suppliers. The SOFTWARE is licensed, not sold. You may not copy the printed materials accompanying the SOFTWARE. All title and intellectual



property rights in and to the content which may be accessed through use of the SOFTWARE is the property of the respective content owner and may be protected by applicable copyright or other intellectual property laws and treaties. This EULA grants you no rights to use such content. All rights not specifically granted under this EULA are reserved by MS, Microsoft Corporation, FORD MOTOR COMPANY, third party software and service providers, their affiliates and suppliers. Use of any on-line services which may be accessed through the SOFTWARE may be governed by the respective terms of use relating to such services. If this SOFTWARE contains documentation that is provided only in electronic form, you may print one copy of such electronic documentation.

**EXPORT RESTRICTIONS:** You acknowledge that the SOFTWARE is subject to U.S. and European Union export jurisdiction. You agree to comply with all applicable international and national laws that apply to the SOFTWARE, including the U.S. Export Administration Regulations, as well as end-user, end-use and destination restrictions issued by U.S. and other governments. For additional information, see <http://www.microsoft.com/exporting/>.

**TRADEMARKS:** This EULA does not grant you any rights in connection with any trademarks or service marks of FORD MOTOR COMPANY, MS, Microsoft Corporation, third party software or service providers, their affiliates or suppliers.

**PRODUCT SUPPORT:** Product support for the SOFTWARE is not provided by MS, its parent corporation Microsoft Corporation, or their affiliates or subsidiaries. For product support, please refer to FORD MOTOR COMPANY instructions provided in the documentation for the DEVICE. Should you have any questions concerning this EULA, or if you desire to contact FORD MOTOR COMPANY for any other reason, please refer to the address provided in the documentation for the DEVICE.

**No Liability for Certain Damages:** EXCEPT AS PROHIBITED BY LAW, FORD MOTOR COMPANY, ANY THIRD PARTY SOFTWARE OR SERVICES SUPPLIERS, MS, MICROSOFT CORPORATION AND THEIR AFFILIATES SHALL HAVE NO LIABILITY FOR ANY INDIRECT, SPECIAL, CONSEQUENTIAL OR INCIDENTAL DAMAGES ARISING FROM OR IN CONNECTION WITH THE USE OR PERFORMANCE OF THE SOFTWARE. THIS LIMITATION SHALL APPLY EVEN IF ANY REMEDY FAILS OF ITS ESSENTIAL PURPOSE. IN NO EVENT SHALL MS, MICROSOFT CORPORATION AND/OR THEIR AFFILIATES BE LIABLE FOR ANY AMOUNT IN EXCESS OF U.S. TWO HUNDRED FIFTY DOLLARS (U.S.\$250.00).

- THERE ARE NO WARRANTIES OTHER THAN THOSE THAT MAY EXPRESSLY BE PROVIDED FOR YOUR NEW VEHICLE.



**End user notice**

**Microsoft® Windows® Mobile for Automotive Important Safety Information**

This system Ford SYNC™ contains software that is licensed to Manufacturer FORD MOTOR COMPANY by an affiliate of Microsoft Corporation pursuant to a license agreement. Any removal, reproduction, reverse engineering or other unauthorized use of the software from this system in violation of the license agreement is strictly prohibited and may subject you to legal action.

**Read and follow instructions**

Before using your Windows Automotive-based system, read and follow all instructions and safety information provided in this end user manual (“User’s Guide”). Not following precautions found in this User’s Guide can lead to an accident or other serious consequences.

**Keep User’s Guide in Vehicle**

When kept in the vehicle, the User’s Guide will be a ready reference for you and other users unfamiliar with the Windows Automotive-based system. Please make certain that before using the system for the first time, all persons have access to the User’s Guide and read its instructions and safety information carefully.



**WARNING:** Operating certain parts of this system while driving can distract your attention away from the road, and possibly cause an accident or other serious consequences. Do not change system settings or enter data non-verbally (using your hands) while driving. Stop the vehicle in a safe and legal manner before attempting these operations. This is important since while setting up or changing some functions you might be required to distract your attention away from the road and remove your hands from the wheel.

**General operation**

**Voice Command Control**

Functions within the Windows Automotive-based system may be accomplished using only voice commands. Using voice commands while driving allows you to operate the system without removing your hands from the wheel.

**Prolonged Views of Screen**

Do not access any function requiring a prolonged view of the screen while you are driving. Pull over in a safe and legal manner before



attempting to access a function of the system requiring prolonged attention. Even occasional short scans to the screen may be hazardous if your attention has been diverted away from your driving task at a critical time.

**Volume Setting**

Do not raise the volume excessively. Keep the volume at a level where you can still hear outside traffic and emergency signals while driving. Driving while unable to hear these sounds could cause an accident.

**Use of Speech Recognition Functions**

Speech recognition software is inherently a statistical process which is subject to errors. It is your responsibility to monitor any speech recognition functions included in the system and address any errors.

**Navigation Features**

Any navigation features included in the system are intended to provide turn by turn instructions to get you to a desired destination. Please make certain all persons using this system carefully read and follow instructions and safety information fully.

**Distraction Hazard**

Any navigation features may require manual (non-verbal) setup. Attempting to perform such set-up or insert data while driving can seriously distract your attention and could cause an accident or other serious consequences. Stop the vehicle in a safe and legal manner before attempting these operations.

**Let Your Judgment Prevail**

Any navigation features are provided only as an aid. Make your driving decisions based on your observations of local conditions and existing traffic regulations. Any such feature is not a substitute for your personal judgment. Any route suggestions made by this system should never replace any local traffic regulations or your personal judgment or knowledge of safe driving practices.

**Route Safety**

Do not follow the route suggestions if doing so would result in an unsafe or illegal maneuver, if you would be placed in an unsafe situation, or if you would be directed into an area that you consider unsafe. The driver is ultimately responsible for the safe operation of the vehicle and therefore, must evaluate whether it is safe to follow the suggested directions.





**Potential Map Inaccuracy**

Maps used by this system may be inaccurate because of changes in roads, traffic controls or driving conditions. Always use good judgment and common sense when following the suggested routes.

**Emergency Services**

Do not rely on any navigation features included in the system to route you to emergency services. Ask local authorities or an emergency services operator for these locations. Not all emergency services such as police, fire stations, hospitals and clinics are likely to be contained in the map database for such navigation features.

**TeleNav Software End User License Agreement**

*Please read these terms and conditions carefully before you use the TeleNav Software. Your use of the TeleNav Software indicates that you accept these terms and conditions. If you do not accept these terms and conditions, do not break the seal of the package, launch, or otherwise use the TeleNav Software.*

TeleNav may revise this Agreement and the privacy policy at any time, with or without notice to you. You agree to visit <http://www.telenav.com> from time to time to review the then current version of this Agreement and of the privacy policy.

**1. Safe and Lawful Use**

You acknowledge that devoting attention to the TeleNav Software may pose a risk of injury or death to you and others in situations that otherwise require your undivided attention, and you therefore agree to comply with the following when using the TeleNav Software: (a) observe all traffic laws and otherwise drive safely; (b) use your own personal judgment while driving. If you feel that a route suggested by the TeleNav Software instructs you to perform an unsafe or illegal maneuver, places you in an unsafe situation, or directs you into an area that you consider to be unsafe, do not follow such instructions; (c) do not input destinations, or otherwise manipulate the TeleNav Software, unless your vehicle is stationary and parked; (d) do not use the TeleNav Software for any illegal, unauthorized, unintended, unsafe, hazardous, or unlawful purposes, or in any manner inconsistent with this Agreement; (e) arrange all GPS and wireless devices and cables necessary for use of the TeleNav Software in a secure manner in your vehicle so that they will not interfere with your driving and will not prevent the operation of any safety device (such as an airbag).



You agree to indemnify and hold TeleNav harmless against all claims resulting from any dangerous or otherwise inappropriate use of the TeleNav Software in any moving vehicle, including as a result of your failure to comply with the directions above.

### **2. Account Information**

You agree: (a) when registering the TeleNav Software, to provide TeleNav with true, accurate, current, and complete information about yourself, and (b) to inform TeleNav promptly of any changes to such information, and to keep it true, accurate, current and complete.

### **3. Software License**

Subject to your compliance with the terms of this Agreement, TeleNav hereby grants to you a personal, non-exclusive, non-transferable license (except as expressly permitted below in connection with your permanent transfer of the TeleNav Software license), without the right to sublicense, to use the TeleNav Software (in object code form only) in order to access and use the TeleNav Software. This license shall terminate upon any termination or expiration of this Agreement. You agree that you will use the TeleNav Software only for your personal business or leisure purposes, and not to provide commercial navigation services to other parties.

#### **3.1 License limitations**

You agree not to do any of the following: (a) reverse engineer, decompile, disassemble, translate, modify, alter or otherwise change the TeleNav Software or any part thereof; (b) attempt to derive the source code, audio library or structure of the TeleNav Software without the prior express written consent of TeleNav; (c) remove from the TeleNav Software, or alter, any of TeleNav's or its suppliers' trademarks, trade names, logos, patent or copyright notices, or other notices or markings; (d) distribute, sublicense or otherwise transfer the TeleNav Software to others, except as part of your permanent transfer of the TeleNav Software; or (e) use the TeleNav Software in any manner that (i) infringes the intellectual property or proprietary rights, rights of publicity or privacy or other rights of any party, (ii) violates any law, statute, ordinance or regulation, including but not limited to laws and regulations related to spamming, privacy, consumer and child protection, obscenity or defamation, or (iii) is harmful, threatening, abusive, harassing, tortuous, defamatory, vulgar, obscene, libelous, or otherwise objectionable; and (f) lease, rent out, or otherwise permit unauthorized access by third parties to the TeleNav Software without advanced written permission of TeleNav.

### **4. Disclaimers**

To the fullest extent permissible pursuant to applicable law, in no event will TeleNav, its licensors and suppliers, or agents or employees of any of



the foregoing, be liable for any decision made or action taken by you or anyone else in reliance on the information provided by the TeleNav Software. TeleNav also does not warrant the accuracy of the map or other data used for the TeleNav Software. Such data may not always reflect reality due to, among other things, road closures, construction, weather, new roads and other changing conditions. You are responsible for the entire risk arising out of your use of the TeleNav Software. For example but without limitation, you agree not to rely on the TeleNav Software for critical navigation in areas where the well-being or survival of you or others is dependent on the accuracy of navigation, as the maps or functionality of the TeleNav Software are not intended to support such high risk applications, especially in more remote geographical areas. TELENV EXPRESSLY DISCLAIMS AND EXCLUDES ALL WARRANTIES IN CONNECTION WITH THE TELENV SOFTWARE, WHETHER STATUTORY, EXPRESS OR IMPLIED, INCLUDING ALL WARRANTIES WHICH MAY ARISE FROM COURSE OF DEALING, CUSTOM OR TRADE AND INCLUDING, BUT NOT LIMITED TO, THE IMPLIED WARRANTIES OF MERCHANTABILITY, FITNESS FOR A PARTICULAR PURPOSE AND NON-INFRINGEMENT OF THIRD PARTY RIGHTS WITH RESPECT TO THE TELENV SOFTWARE. Certain jurisdictions do not permit the disclaimer of certain warranties, so this limitation may not apply to you.

**5. Limitation of Liability**

TO THE EXTENT PERMITTED UNDER APPLICABLE LAW, UNDER NO CIRCUMSTANCES SHALL TELENV OR ITS LICENSORS AND SUPPLIERS BE LIABLE TO YOU OR TO ANY THIRD PARTY FOR ANY INDIRECT, INCIDENTAL, CONSEQUENTIAL, SPECIAL OR EXEMPLARY DAMAGES (INCLUDING IN EACH CASE, BUT NOT LIMITED TO, DAMAGES FOR THE INABILITY TO USE THE EQUIPMENT OR ACCESS DATA, LOSS OF DATA, LOSS OF BUSINESS, LOSS OF PROFITS, BUSINESS INTERRUPTION OR THE LIKE) ARISING OUT OF THE USE OF OR INABILITY TO USE THE TELENV SOFTWARE, EVEN IF TELENV HAS BEEN ADVISED OF THE POSSIBILITY OF SUCH DAMAGES.

NOTWITHSTANDING ANY DAMAGES THAT YOU MIGHT INCUR FOR ANY REASON WHATSOEVER (INCLUDING, WITHOUT LIMITATION, ALL DAMAGES REFERENCED HEREIN AND ALL DIRECT OR 09/22/09 - 10 of 19 - Confidential GENERAL DAMAGES IN CONTRACT, TORT (INCLUDING NEGLIGENCE) OR OTHERWISE), THE ENTIRE LIABILITY OF TELENV AND OF ALL OF TELENV'S SUPPLIERS SHALL BE LIMITED TO THE AMOUNT ACTUALLY PAID BY YOU FOR THE TELENV SOFTWARE. SOME STATES AND/OR JURISDICTIONS DO NOT ALLOW THE EXCLUSION OR LIMITATION OF INCIDENTAL



OR CONSEQUENTIAL DAMAGES, SO THE ABOVE LIMITATIONS OR EXCLUSIONS MAY NOT APPLY TO YOU.

#### **6. Arbitration and Governing Law**

You agree that any dispute, claim or controversy arising out of or relating to this Agreement or the TeleNav Software shall be settled by independent arbitration involving a neutral arbitrator and administered by the American Arbitration Association in the County of Santa Clara, California. The arbitrator shall apply the Commercial Arbitration Rules of the American Arbitration Association, and the judgment upon the award rendered by the arbitrator may be entered by any court having jurisdiction. Note that there is no judge or jury in an arbitration proceeding and the decision of the arbitrator shall be binding upon both parties. You expressly agree to waive your right to a jury trial.

This Agreement and performance hereunder will be governed by and construed in accordance with the laws of the State of California, without giving effect to its conflict of laws provisions. To the extent judicial action is necessary in connection with the binding arbitration, both TeleNav and you agree to submit to the exclusive jurisdiction of the courts of the County of Santa Clara, California. The United Nations Convention on Contracts for the International Sale of Goods shall not apply.

#### **7. Assignment**

You may not resell, assign, or transfer this Agreement or any of your rights or obligations, except in totality, in connection with your permanent transfer of the TeleNav Software, and expressly conditioned upon the new user of the TeleNav Software agreeing to be bound by the terms and conditions of this Agreement. Any such sale, assignment or transfer that is not expressly permitted under this paragraph will result in immediate termination of this Agreement, without liability to TeleNav, in which case you and all other parties shall immediately cease all use of the TeleNav Software. Notwithstanding the foregoing, TeleNav may assign this Agreement to any other party at any time without notice, provided the assignee remains bound by this Agreement.

#### **8. Miscellaneous**

8.1 This Agreement constitutes the entire agreement between TeleNav and you with respect to the subject matter hereof.

8.2 Except for the limited licenses expressly granted in this Agreement, TeleNav retains all right, title and interest in and to the TeleNav Software, including without limitation all related intellectual property rights. No licenses or other rights which are not expressly granted in this Agreement are intended to, or shall be, granted or conferred by



implication, statute, inducement, estoppel or otherwise, and TeleNav and its suppliers and licensors hereby reserve all of their respective rights other than the licenses explicitly granted in this Agreement.

8.3 By using the TeleNav Software, you consent to receive from TeleNav all communications, including notices, agreements, legally required disclosures or other information in connection with the TeleNav Software (collectively, “Notices”) electronically. TeleNav may provide such Notices by posting them on TeleNav’s Website or by downloading such Notices to your wireless device. If you desire to withdraw your consent to receive Notices electronically, you must discontinue your use of the TeleNav Software.

8.4 TeleNav’s or your failure to require performance of any provision shall not affect that party’s right to require performance at any time thereafter, nor shall a waiver of any breach or default of this Agreement constitute a waiver of any subsequent breach or default or a waiver of the provision itself.

8.5 If any provision herein is held unenforceable, then such provision will be modified to reflect the intention of the parties, and the remaining provisions of this Agreement will remain in full force and effect.

8.6 The headings in this Agreement are for convenience of reference only, will not be deemed to be a part of this Agreement, and will not be referred to in connection with the construction or interpretation of this Agreement. As used in this Agreement, the words “include” and “including,” and variations thereof, will not be deemed to be terms of limitation, but rather will be deemed to be followed by the words “without limitation.”

**9. Other Vendors Terms and Conditions**

*The TeleNav Software utilizes map and other data licensed to TeleNav by third party vendors for the benefit of you and other end users. This Agreement includes end-user terms applicable to these companies (included at the end of this Agreement), and thus your use of the TeleNav Software is also subject to such terms. You agree to comply with the following additional terms and conditions, which are applicable to TeleNav’s third party vendor licensors:*

**NavTeq End User License Agreement**

**END USER TERMS**

The content provided (“Data”) is licensed, not sold. By opening this package, or installing, copying, or otherwise using the Data, you agree to be bound by the terms of this agreement. If you do not agree to the terms of this agreement, you are not permitted to install, copy, use, resell or transfer the Data. If you wish to reject the terms of this



agreement, and have not installed, copied, or used the Data, you must contact your retailer or NAVTEQ North America, LLC (“NT”) within thirty (30) days of purchase for a refund of your purchase price. To contact NT, please visit [www.navteq.com](http://www.navteq.com).

The Data is provided for your personal, internal use only and may not be resold. It is protected by copyright, and is subject to the following terms (this “End User License Agreement”) and conditions which are agreed to by you, on the one hand, and NAVTEQ North America, LLC (“NT”) and its licensors (including their licensors and suppliers) on the other hand.

The Data for areas of Canada includes information taken with permission from Canadian authorities, including: © Her Majesty the Queen in Right of Canada, © Queen’s Printer for Ontario, © Canada Post Corporation, GeoBase ®.

NT holds a nonexclusive license from the United States Postal Service ® to publish and sell ZIP+4 ® information.

© United States Postal Service ® 2009. Prices are not established, controlled or approved by the United States Postal Service ®. The following trademarks and registrations are owned by the USPS: United States Postal Service, USPS, and ZIP+4.

The Data for Mexico includes certain Data from Instituto Nacional de Estadística y Geografía.

#### TERMS AND CONDITIONS

**License Limitations on Use:** You agree that your license to use this Data is limited to and conditioned on use for solely personal, noncommercial purposes, and not for service bureau, timesharing or other similar purposes. Except as otherwise set forth herein, you agree not to otherwise reproduce, copy, modify, decompile, disassemble or reverse engineer any portion of this Data, and may not transfer or distribute it in any form, for any purpose, except to the extent permitted by mandatory laws.

**License Limitations on Transfer:** Your limited license does not allow transfer or resale of the Data, except on the condition that you may transfer the Data and all accompanying materials on a permanent basis if: (a) you retain no copies of the Data; (b) the recipient agrees to the terms of this End User License Agreement; and (c) you transfer the Data in the exact same form as you purchased it by physically transferring the original media (e.g., the CD-ROM or DVD you purchased), all original packaging, all Manuals and other documentation. Specifically, Multi-disc sets may only be transferred or sold as a complete set as provided to you and not as a subset thereof.



**Additional License Limitations:** Except where you have been specifically licensed to do so by NT in a separate written agreement, and without limiting the preceding paragraph, your license is conditioned on use of the Data as prescribed in this agreement, and you may not (a) use this Data with any products, systems, or applications installed or otherwise connected to or in communication with vehicles capable of vehicle navigation, positioning, dispatch, real time route guidance, fleet management or similar applications; or (b) with, or in communication with, including without limitation, cellular phones, palmtop and handheld computers, pagers, and personal digital assistants or PDAs.



**WARNING:** This Data may contain inaccurate or incomplete information due to the passage of time, changing circumstances, sources used and the nature of collecting comprehensive geographic Data, any of which may lead to incorrect results.

**No Warranty:** This Data is provided to you “as is”, and you agree to use it at your own risk. NT and its licensors (and their licensors and suppliers) make no guarantees, representations or warranties of any kind, express or implied, arising by law or otherwise, including but not limited to, content, quality, accuracy, completeness, effectiveness, reliability, fitness for a particular purpose, usefulness, use or results to be obtained from this Data, or that the Data or server will be uninterrupted or error free.

**Disclaimer of Warranty:** NT AND ITS LICENSORS (INCLUDING THEIR LICENSORS AND SUPPLIERS) DISCLAIM ANY WARRANTIES, EXPRESS OR IMPLIED, OF QUALITY, PERFORMANCE, MERCHANTABILITY, FITNESS FOR A PARTICULAR PURPOSE OR NON-INFRINGEMENT. Some States, Territories and Countries do not allow certain warranty exclusions, so to that extent the above exclusion may not apply to you.

**Disclaimer of Liability:** NT AND ITS LICENSORS (INCLUDING THEIR LICENSORS AND SUPPLIERS) SHALL NOT BE LIABLE TO YOU IN RESPECT OF ANY CLAIM, DEMAND OR ACTION, IRRESPECTIVE OF THE NATURE OF THE CAUSE OF THE CLAIM, DEMAND OR ACTION ALLEGING ANY LOSS, INJURY OR DAMAGES, DIRECT OR INDIRECT, WHICH MAY RESULT FROM THE USE OR POSSESSION OF THIS DATA; OR FOR ANY LOSS OF PROFIT, REVENUE, CONTRACTS OR



SAVINGS, OR ANY OTHER DIRECT, INDIRECT, INCIDENTAL, SPECIAL OR CONSEQUENTIAL DAMAGES ARISING OUT OF YOUR USE OF OR INABILITY TO USE THIS DATA, ANY DEFECT IN THIS DATA, OR THE BREACH OF THESE TERMS OR CONDITIONS, WHETHER IN AN ACTION IN CONTRACT OR TORT OR BASED ON A WARRANTY, EVEN IF NT OR ITS LICENSORS HAVE BEEN ADVISED OF THE POSSIBILITY OF SUCH DAMAGES. Some States, Territories and Countries do not allow certain liability exclusions or damages limitations, so to that extent the above may not apply to you.

**Export Control:** You agree not to export from anywhere any part of the Data or any direct product thereof except in compliance with, and with all licenses and approvals required under, applicable export laws, rules and regulations, including but not limited to the laws, rules and regulations administered by the Office of Foreign Assets Control of the U.S. Department of Commerce and the Bureau of Industry and Security of the U.S. Department of Commerce. To the extent that any such export laws, rules or regulations prohibit NT from complying with any of its obligations hereunder to deliver or distribute Data, such failure shall be excused and shall not constitute a breach of this Agreement.

**Entire Agreement:** These terms and conditions constitute the entire agreement between NT (and its licensors, including their licensors and suppliers) and you pertaining to the subject matter hereof, and supersedes in their entirety any and all written or oral agreements previously existing between us with respect to such subject matter.

**Severability:** You and NT agree that if any portion of this agreement is found illegal or unenforceable, that portion shall be severed and the remainder of the Agreement shall be given full force and effect.

**Governing Law:** The above terms and conditions shall be governed by the laws of the State of Illinois, without giving effect to (i) its conflict of laws provisions, or (ii) the United Nations Convention for Contracts for the International Sale of Goods, which is explicitly excluded. You agree to submit to the personal jurisdiction of the State of Illinois for any and all disputes, claims and actions arising from or in connection with the Data provided to you hereunder.

**Government End Users:** If the Data is being acquired by or on behalf of the United States government or any other entity seeking or applying rights similar to those customarily claimed by the United States government, this Data is a "commercial item" as that term is defined at 48 C.F.R. ("FAR") 2.101, is licensed in accordance with this End User





License Agreement, and each copy of Data delivered or otherwise furnished shall be marked and embedded as appropriate with the following “Notice of Use”, and be treated in accordance with such Notice:

**NOTICE OF USE**

CONTRACTOR (MANUFACTURER/ SUPPLIER)

NAME:

**NAVTEQ**

CONTRACTOR (MANUFACTURER/SUPPLIER)

ADDRESS:

**425 West Randolph Street, Chicago, IL 60606.**

This Data is a commercial item as defined in FAR 2.101 and is subject to the EndUser License Agreement under which this Data was provided.

© 2011 NAVTEQ. All rights reserved.

If the Contracting Officer, federal government agency, or any federal official refuses to use the legend provided herein, the Contracting Officer, federal government agency, or any federal official must notify NAVTEQ prior to seeking additional or alternative rights in the Data.

Wi-Fi hotspot data provided by JiWire ©2013 JiWire.

**Gracenote® Copyright**

CD and music — related data from Gracenote, Inc., copyright © 2000–2007 Gracenote. Gracenote Software, copyright © 2000–2007 Gracenote. This product and service may practice one or more of the following U.S. Patents #5,987,525; #6,061,680; #6,154,773, #6,161,132, #6,230,192, #6,230,207, #6,240,459, #6,330,593, and other patents issued or pending. Some services supplied under license from Open Globe, Inc. for U.S. Patent: #6,304,523.

Gracenote and CDDB are registered trademarks of Gracenote. The Gracenote logo and logotype, and the “Powered by Gracenote™” logo are trademarks of Gracenote.

**Gracenote® End User License Agreement (EULA)**

This device contains software from Gracenote, Inc. of 2000 Powell Street Emeryville, California 94608 (“Gracenote”).

The software from Gracenote (the “Gracenote Software”) enables this device to do disc and music file identification and obtain music-related information, including name, artist, track, and title information



(“Gracenote Data”) from online servers (“Gracenote Servers”), and to perform other functions. You may use Gracenote Data only by means of the intended End User functions of this device

This device may contain content belonging to Gracenote’s providers. If so, all of the restrictions set forth herein with respect to Gracenote Data shall also apply to such content and such content providers shall be entitled to all of the benefits and protections set forth herein that are available to Gracenote.

You agree that you will use the content from Gracenote (“Gracenote Content”), Gracenote Data, the Gracenote Software, and Gracenote Servers for your own personal, non-commercial use only. You agree not to assign, copy, transfer or transmit the Gracenote Content, Gracenote Software or any Gracenote Data (except in a Tag associated with a music file) to any third party. **YOU AGREE NOT TO USE OR EXPLOIT GRACENOTE CONTENT, GRACENOTE DATA, THE GRACENOTE SOFTWARE, OR GRACENOTE SERVERS, EXCEPT AS EXPRESSLY PERMITTED HEREIN.**

You agree that your non-exclusive licenses to use the Gracenote Content, Gracenote Data, the Gracenote Software, and Gracenote Servers will terminate if you violate these restrictions. If your licenses terminate, you agree to cease any and all use of the Gracenote Content, Gracenote Data, the Gracenote Software, and Gracenote Servers. Gracenote, respectively, reserve all rights in Gracenote Data, the Gracenote Software, and the Gracenote Servers and Gracenote Content, including all ownership rights. Under no circumstances will either Gracenote become liable for any payment to you for any information that you provide, including any copyrighted material or music file information. You agree that Gracenote may enforce its respective rights, collectively or separately, under this agreement against you, directly in each company’s own name.

Gracenote uses a unique identifier to track queries for statistical purposes. The purpose of a randomly assigned numeric identifier is to allow Gracenote to count queries without knowing anything about who you are. For more information, see the web page at [www.gracenote.com](http://www.gracenote.com) for the Gracenote Privacy Policy

**THE GRACENOTE SOFTWARE, EACH ITEM OF GRACENOTE DATA AND THE GRACENOTE CONTENT ARE LICENSED TO YOU “AS IS.” NEITHER GRACENOTE MAKES ANY REPRESENTATIONS OR WARRANTIES, EXPRESS OR IMPLIED, REGARDING THE ACCURACY OF ANY GRACENOTE DATA FROM THE GRACENOTE SERVERS OR GRACENOTE CONTENT. GRACENOTE COLLECTIVELY AND**



SEPARATELY RESERVE THE RIGHT TO DELETE DATA AND/OR CONTENT FROM THE COMPANIES' RESPECTIVE SERVERS OR, IN THE CASE OF GRACENOTE, CHANGE DATA CATEGORIES FOR ANY CAUSE THAT GRACENOTE DEEMS SUFFICIENT. NO WARRANTY IS MADE THAT EITHER GRACENOTE CONTENT OR THE GRACENOTE SOFTWARE OR GRACENOTE SERVERS ARE ERROR-FREE OR THAT THE FUNCTIONING OF THE GRACENOTE SOFTWARE OR GRACENOTE SERVERS WILL BE UNINTERRUPTED. GRACENOTE IS NOT OBLIGATED TO PROVIDE YOU WITH ANY ENHANCED OR ADDITIONAL DATA TYPES THAT GRACENOTE MAY CHOOSE TO PROVIDE IN THE FUTURE AND IS FREE TO DISCONTINUE ITS ONLINE SERVICES AT ANY TIME. GRACENOTE DISCLAIM ALL WARRANTIES EXPRESS OR IMPLIED, INCLUDING, BUT NOT LIMITED TO, IMPLIED WARRANTIES OF MERCHANTABILITY, FITNESS FOR A PARTICULAR PURPOSE, TITLE, AND NON-INFRINGEMENT. NEITHER GRACENOTE WARRANTS THE RESULTS THAT WILL BE OBTAINED BY YOUR USE OF THE GRACENOTE SOFTWARE OR ANY GRACENOTE SERVER. IN NO CASE WILL GRACENOTE BE LIABLE FOR ANY CONSEQUENTIAL OR INCIDENTAL DAMAGES OR FOR ANY LOST PROFITS OR LOST REVENUES FOR ANY REASON WHATSOEVER.

© Gracenote 2007

FCC ID: KMHSYNG2 IC: 1422A-SYNG2

This device complies with Part 15 of the FCC Rules and with RSS-210 of Industry Canada. Operation is subject to the following two conditions: (1) This device may not cause harmful interference, and (2) this device must accept any interference received, including interference that may cause undesired operation.

 **WARNING:** Changes or modifications not expressly approved by the party responsible for compliance could void the user's authority to operate the equipment. The term "IC:" before the radio certification number only signifies that Industry Canada technical specifications were met.

The antenna used for this transmitter must not be co-located or operating in conjunction with any other antenna or transmitter.



- 911 Assist™ .....351, 422
- A**
- ABS (see Brakes) .....187
- Accessing and using your USB  
port .....401
- Accessing call history/phone  
book during active call .....341
- Accessing your calendar .....421
- Accessing your media menu  
features .....364
- Accessing your phone menu  
features .....342
- Accessory delay .....97
- Active call menu options .....341
- Active Park Assist .....195
- Adding (pairing) a phone .....409
- Advanced menu options ...349, 370
- Advanced menu options  
(prompts, languages, defaults,  
master reset, installing  
applications) .....349
- Airbag supplemental restraint  
system .....46  
and child safety seats .....47  
description .....46  
disposal .....56  
driver airbag .....46  
passenger airbag .....46  
side airbag .....46, 52
- Air cleaner filter .....258–259, 307
- Air conditioning .....141  
manual heating and air  
conditioning system .....141
- Air filter .....259
- Air filter, cabin .....149
- Ambient mood/lighting .....94, 427
- Ambulance packages .....15
- AM/FM .....388
- Antifreeze  
(see Engine coolant) .....250
- Anti-lock brake system  
(see Brakes) .....187
- Anti-theft system .....79  
arming the system .....79, 81  
disarming a triggered system ..81
- AppLink™ .....358
- Audio system  
Single CD .....125, 127, 130, 132
- Audio system  
(see Radio) .....125, 127, 130, 132
- Automatic transmission  
fluid, adding .....254  
fluid, checking .....254  
fluid, refill capacities .....304  
fluid, specification .....304  
Selectshift (SST) .....181
- Auxiliary Input Jack .....398
- Auxiliary input jack (Line in) ..136
- Auxiliary powerpoint .....161
- A/V inputs .....138, 406
- Axle  
refill capacities .....304
- B**
- Battery .....255  
acid, treating emergencies ....255  
jumping a disabled battery ...225  
maintenance-free .....255  
replacement, specifications ...307  
servicing .....255
- Booster seats .....22



- 
- Brakes .....187  
 anti-lock .....187  
 anti-lock brake system (ABS)  
 warning light .....187  
 brake warning light .....187  
 fluid, checking and adding ....254  
 fluid, refill capacities .....304  
 fluid, specifications .....304  
 lubricant specifications .....304  
 parking .....188  
 shift interlock .....182
- C**
- Capacities for refilling fluids ....304  
 CD .....125, 127, 130, 132  
 CD player .....123, 400  
 CD voice commands .....401  
 Cell phone use .....16  
 Changing a tire .....297  
 Changing the air filter .....259  
 Child safety restraints .....27  
 Child safety seats  
 attaching with tether straps ....29  
 automatic locking mode  
 (retractor) .....36  
 LATCH .....27  
 Child safety seats -  
 booster seats .....22  
 Cleaning the touchscreen .....379  
 Cleaning your vehicle .....268  
 engine compartment .....270  
 instrument panel .....272  
 interior .....272  
 plastic parts .....269  
 washing .....268  
 waxing .....270  
 wheels .....274
- wiper blades .....271  
 Climate control (see Air  
 conditioning or Heating) .....141  
 Climate voice commands .....437  
 Clock .....125, 127, 130, 426  
 Clutch  
 operation while driving .....184  
 recommended shift speeds ....184  
 Console .....162  
 overhead .....162  
 Coolant .....250  
 checking and adding .....250  
 refill capacities .....304  
 specifications .....304  
 Customer Assistance .....223  
 Ford Extended Service  
 Plan .....312, 314  
 Getting assistance outside  
 the U.S. and Canada .....232  
 Getting roadside assistance ...223  
 Getting the service you  
 need .....228  
 Ordering additional owner's  
 literature .....234  
 Utilizing the  
 Mediation/Arbitration  
 Program .....232
- D**
- Defrost .....141, 143  
 rear window .....148  
 Dipstick  
 automatic transmission  
 fluid .....254  
 engine oil .....249  
 Display settings .....426  
 Doors  
 central unlocking .....72



- Driving under special conditions .....183  
 through water .....220
- Dual automatic temperature control (DATC) .....143
- E**
- Eco Mode .....206
- Electronic message center .....108
- Electronic stability control .....191
- Emergencies, roadside  
 jump-starting .....225  
 running out of fuel .....172
- Emission control system .....176
- End user license agreement ....450
- Engine .....303  
 cleaning .....270  
 coolant .....250  
 idle speed control .....255  
 lubrication specifications .....304  
 refill capacities .....304  
 service points .....248
- Engine block heater .....167
- Engine fan .....248
- Engine oil  
 checking and adding .....249  
 dipstick .....249  
 filter, specifications .....307  
 refill capacities .....304  
 specifications .....304
- Event data recording .....12
- Exhaust fumes .....167
- F**
- Fan, Engine Cooling .....248
- Fleet MyKey programming .....66
- Flexible Fuel Vehicle (FFV) ....169
- Floor mats .....221
- Fluid capacities .....304
- Fog lamps .....92
- Forward and reverse sensing system .....193
- Fuel  
 cap .....174  
 capacity .....304  
 choosing the right fuel .....171  
 filler funnel .....172  
 filling your vehicle with fuel ..174  
 filter, specifications .....254, 307  
 fuel pump shut-off .....224  
 octane rating .....171  
 quality .....171  
 running out of fuel .....172  
 safety information relating to automotive fuels .....169
- Fuel and distance  
 computer .....110–111  
 outside temperature indicator .....110–111  
 to empty indicator .....110–111  
 trip distance .....110–111  
 trip/reset button .....110–111
- Fuel - flex fuel vehicle (FFV) .....169, 171
- Fuses .....236–237, 243
- G**
- Gas cap (see Fuel cap) .....174
- Gauges .....102  
 odometer .....110–111  
 trip odometer .....110–111
- H**
- Hazard flashers .....224



HD Radio™ .....	391	<b>K</b>	
Headlamps		Keyless entry system	
aiming .....	260	autolock .....	75
bulb specifications .....	267	Keys .....	58, 79
flash to pass .....	89	positions of the ignition .....	164
high beam .....	89	<b>L</b>	
replacing bulbs .....	261–262	Lamps	
Head restraints .....	152	bulb replacement	
Heated steering wheel .....	436	specifications chart .....	267
Heating .....	141, 143	fog lamps .....	92
Help .....	435	headlamps, flash to pass .....	89
Hill start assist .....	185	interior lamps .....	92
Hood .....	247	replacing bulbs .....	261–262
How to use voice commands ...	382	LATCH anchors .....	27
<b>I</b>		Lights, warning and indicator ..	103
Ignition .....	164	Listening to music .....	387
Illuminated visor mirror .....	99	Load limits .....	209
Information displays .....	108	Locks	
Inspection/maintenance (I/M)		autolock .....	75
testing .....	178	childproof .....	32
Instrument panel		doors .....	72
cleaning .....	272	Lubricant specifications .....	304
cluster .....	103	Lug nuts .....	302
Intelligent Access Key .....	59	<b>M</b>	
<b>J</b>		Making and receiving calls .....	409
Jack .....	297	Manual transmission .....	184
positioning .....	297	fluid capacities .....	304
storage .....	297	lubricant specifications .....	304
Joining two calls		reverse .....	185
(multiparty/conference call) ...	341	MAP DVD - Loading and	
Jump-starting your vehicle .....	225	Unloading .....	409
		Map icons .....	446
		Map mode .....	444



- 
- Map preferences .....443
- Map updates .....448
- Media Bluetooth menu options  
(adding, connecting, deleting,  
turning on/off) .....369
- Message center .....108  
warning messages .....112
- Mirrors .....97, 99  
fold away .....97  
side view mirrors (power) .....97
- Moon roof .....99
- Motorcraft® parts .....268, 307
- MyFord Touch™ system .....377
- MyKey .....66
- N**
- Navigation features .....439
- Navigation voice commands ....448
- Notifications .....421
- O**
- Octane rating .....171
- P**
- Pairing other phones .....338, 409
- Pairing your phone .....408
- Pairing your phone for the  
first time .....337, 408
- Parental MyKey programming ...66
- Park Assist .....195
- Parking brake .....188
- Parts  
(see Motorcraft® parts) .....307
- Phone Bluetooth menu options  
(adding, connecting, deleting,  
turning on/off) .....348
- Phone redial .....342
- Phone settings .....413, 432
- Phone voice commands .....414
- Playing music (by artist,  
album, genre, playlist,  
tracks, similar) .....366
- POI categories .....440
- Point of Interest (POI) .....440
- Power distribution box  
(see Fuses) .....237
- Power door locks .....72
- Power mirrors .....97
- Powerpoint .....161
- Power steering .....207  
fluid, refill capacity .....304  
fluid, specifications .....304
- Power Windows .....95
- Privacy information .....334, 381
- Push button start system .....164
- Putting a call on/off hold .....341
- Q**
- Quick touch buttons .....447
- R**
- Radio .....125, 127, 130, 132  
AM/FM .....388  
Single CD .....125, 127, 130, 132
- Radio reception .....123
- Radio voice commands .....390





- Rear view camera display .....199, 428
- Rear window defroster .....141, 143
- Receiving a text message .....344, 412
- Recommendations for attaching safety restraints for children .....24
- Relays .....236–237
- Remote entry system  
illuminated entry .....76  
locking/unlocking doors .....73  
opening the trunk .....73  
replacing the batteries .....60
- Roadside assistance .....223
- Route preferences .....443
- S**
- Safety Belt Maintenance .....42
- Safety belts  
(see Safety restraints) .....35, 38
- Safety defects, reporting .....235
- Safety information .....333, 380
- Safety restraints .....35–36, 38  
Belt-Minder® .....39  
extension assembly .....38  
for adults .....35–36  
for children .....19, 24  
safety belt maintenance .....42  
seat belt maintenance .....42  
warning light and chime .....39
- Safety restraints -  
LATCH anchors .....27
- Safety seats for children .....19, 24
- Safety Compliance  
Certification Label .....309
- Satellite Radio .....130, 395
- Scheduled Maintenance Guide  
Normal Scheduled  
Maintenance and Log .....320
- SD card .....138, 401, 439
- Seat belts  
(see Safety restraints) .....35
- Seats  
child safety seats .....19, 24  
heated .....158
- SecuriLock passive anti-theft  
system .....79
- Selecting your media source  
(USB, Line in, BT audio) .....364
- Sending new text messages .....411
- Setting a destination .....439
- Setting a destination  
by voice .....439
- Settings .....426
- Setting the clock .....125,  
127, 130, 426
- Side air curtain .....53
- Side-curtain airbags system .....53
- SIRIUS® satellite radio .....130, 395
- SIRIUS satellite radio  
voice commands .....397
- SIRIUS Travel Link .....418
- SIRIUS Travel Link voice  
commands .....420
- Snowplowing .....15
- SOS Post Crash Alert .....45
- Spark plugs, specifications .....307
- Special notice  
ambulance conversions .....15



- Specification chart,  
lubricants .....304
- Stability system .....191
- Starting your vehicle .....166  
  jump starting .....225  
  push button start system .....164
- Steering wheel .....82  
  controls .....83  
  tilting .....82
- Supplemental Restraint System  
(SRS) (see airbags) .....46
- Supported media file types .....405
- Supported player, media  
formats and metadata  
information .....405
- SYNC® AppLink™ .....358
- SYNC® customer  
support .....333, 380
- SYNC® Services .....356, 415
- System settings .....428
- T**
- Temperature control (see  
Climate control) .....141, 143, 436
- Text messaging .....344, 411
- Text messaging (sending,  
downloading, deleting) .....344, 346
- Tilt steering wheel .....82
- Tires .....277–278, 297  
  alignment .....291  
  care .....277  
  changing .....297, 299  
  checking the pressure .....287  
  inflating .....285
- label .....284  
  replacing .....289  
  rotating .....291  
  safety practices .....290  
  sidewall information .....280  
  snow tires and chains .....292  
  spare tire .....297  
  terminology .....279  
  tire grades .....278  
  treadwear .....278, 287
- Touchscreen features  
(climate) .....436
- Towing .....215  
  recreational towing .....216  
  trailer towing .....215  
  wrecker .....215
- Traction control .....189
- Traffic, Directions and  
Information .....356
- Traffic preferences .....443
- Transmission  
  brake-shift interlock  
  (BSI) .....182  
  fluid, checking and adding  
  (automatic) .....254  
  fluid, checking and adding  
  (manual) .....254  
  fluid, refill capacities .....304  
  lubricant specifications .....304
- Trunk .....77–78  
  remote release .....73
- Turn signal .....92
- U**
- USB port .....137–138, 401
- Using privacy mode .....341



**V**

Vehicle health report .....354, 424  
 Vehicle Identification Number  
 (VIN) .....308  
 Vehicle loading .....209  
 Ventilating your vehicle .....167  
 Voice commands in media  
 mode .....361  
 Voice commands in phone  
 mode .....338  
 Voice recognition .....382

**W**

Warning lights (see Lights) .....103  
 Washer fluid .....255  
 Water, Driving through .....220  
 Windows  
     power .....95  
     rear wiper/washer .....87  
 Windshield washer fluid and  
 wipers  
     checking and adding fluid .....255  
     replacing wiper blades ...257–258  
 Wrecker towing .....215

