

CHRYSLER



2016

200

---

OWNER'S MANUAL



## VEHICLES SOLD IN CANADA

With respect to any Vehicles Sold in Canada, the name FCA US LLC shall be deemed to be deleted and the name FCA Canada Inc. used in substitution therefore.

## DRIVING AND ALCOHOL

Drunken driving is one of the most frequent causes of accidents.

Your driving ability can be seriously impaired with blood alcohol levels far below the legal minimum. If you are drinking, don't drive. Ride with a designated non-drinking driver, call a cab, a friend, or use public transportation.

### WARNING!

**Driving after drinking can lead to an accident. Your perceptions are less sharp, your reflexes are slower, and your judgment is impaired when you have been drinking. Never drink and then drive.**

This manual illustrates and describes the operation of features and equipment that are either standard or optional on this vehicle. This manual may also include a description of features and equipment that are no longer available or were not ordered on this vehicle. Please disregard any features and equipment described in this manual that are not on this vehicle.

FCA US LLC reserves the right to make changes in design and specifications, and/or make additions to or improvements to its products without imposing any obligation upon itself to install them on products previously manufactured.

Copyright © 2015 FCA US LLC



# TABLE OF CONTENTS

SECTION		PAGE
1	INTRODUCTION .....	3
2	THINGS TO KNOW BEFORE STARTING YOUR VEHICLE .....	9
3	UNDERSTANDING THE FEATURES OF YOUR VEHICLE .....	115
4	UNDERSTANDING YOUR INSTRUMENT PANEL .....	313
5	STARTING AND OPERATING .....	447
6	WHAT TO DO IN EMERGENCIES .....	545
7	MAINTAINING YOUR VEHICLE .....	589
8	MAINTENANCE SCHEDULES .....	663
9	IF YOU NEED CONSUMER ASSISTANCE .....	669
10	INDEX .....	681



# INTRODUCTION

## CONTENTS

---

■ INTRODUCTION . . . . .	.4	■ VEHICLE IDENTIFICATION NUMBER . . . . .	.6
■ HOW TO USE THIS MANUAL . . . . .	.4	■ VEHICLE MODIFICATIONS/ALTERATIONS . . . . .	.7
■ WARNINGS AND CAUTIONS . . . . .	.6		

### INTRODUCTION

Congratulations on selecting your new FCA US LLC vehicle. Be assured that it represents precision workmanship, distinctive styling, and high quality - all essentials that are traditional to our vehicles.

This Owner's Manual has been prepared with the assistance of service and engineering specialists to acquaint you with the operation and maintenance of your vehicle. It is supplemented by Warranty Information, and various customer-oriented documents. Please take the time to read these publications carefully. Following the instructions and recommendations in this manual will help assure safe and enjoyable operation of your vehicle.

**NOTE: After reviewing the owner information, it should be stored in the vehicle for convenient referencing and remain with the vehicle when sold.**

When it comes to service, remember that your authorized dealer knows your vehicle best, has factory-trained technicians and genuine MOPAR® parts, and cares about your satisfaction.











### HOW TO USE THIS MANUAL

Consult the Table of Contents to determine which section contains the information you desire.

Since the specification of your vehicle depends on the items of equipment ordered, certain descriptions and illustrations may differ from your vehicle's equipment.

The detailed index at the back of this Owner's Manual contains a complete listing of all subjects.

Consult the following table for a description of the symbols that may be used on your vehicle or throughout this Owner's Manual:

 WATER IN FUEL	 REAR WINDOW WIPER	 WINDSHIELD WIPER INTERMITTENT	 EXTERIOR BULB FAILURE	 HIGH BEAM	 TURN SIGNALS	 UPPER AIR OUTLET	 HEATED SEAT LOW	 DOOR LOCK	 ADJUSTABLE PEDALS	 ELECTRONIC SPEED CONTROL	 ESP BAS ELECTRONIC STABILITY PROGRAM / BRAKE ASSIST SYSTEM
 FUEL	 REAR WINDOW INTERMITTENT WIPER	 WINDSHIELD WASHER	 MASTER LIGHTING SWITCH	 LOW BEAM	 KEY ACTIVATE (POWER OUTLET)	 UPPER AND LOWER AIR OUTLET	 HEATED SEAT HIGH	 WINDOW LIFT	 TIRE PRESSURE MONITOR	 HILL DESCENT CONTROL	 BRAKE SYSTEM WARNING PARKING BRAKE
 FUEL FILL SIDE	 REAR WINDOW WASHER	 WINDSHIELD WASHER FLUID LEVEL	 DOME LIGHT	 FRONT FOG LIGHT	 HOOD RELEASE	 LOWER AIR OUTLET	 REIRCULATION	 CONVERTIBLE 4 WINDOW DOWN	 ELECTRONIC STABILITY CONTROL	 AWD!	 FAILURE OF ANTI-LOCK BRAKING SYSTEM
 ENGINE OIL	 REAR WINDOW DEFROST	 WINDSHIELD, ELECTRICALLY HEATED	 PARK LIGHTS	 REAR FOG LAMP	 LIFTGATE RELEASE AND LIFTGATE OPEN	 DEFROST AND LOWER AIR OUTLET	 VENTILATING FAN	 WINDOW LOCK	 ELECTRONIC THROTTLE CONTROL	 4WD!	 BRAKE SYSTEM WARNING PARKING BRAKE
 BATTERY CHARGING	 HEATED MIRROR	 WINDSHIELD DEFROST	 INSTRUMENT PANEL ILLUMINATION	 SEAT BELT	 SLIDING DOOR	 TRUNK / DECK RELEASE	 AIR CONDITIONING	 CHILD SEAT TETHER ANCHOR	 VOICE RECOGNITION BUTTON	 WARNING	 TOW / HAUL
 GLOW PLUG	 POWER STEERING FLUID	 WINDSHIELD WIPER AND WASHER	 SIDE AIRBAG	 AIRBAG	 SLIDING DOOR	 EMERGENCY RELEASE HANDLE	 LIGHTER	 LOWER ANCHORS AND TETHER FOR CHILDREN (LATCH)	 iCONNECT™ BUTTON	 HAZARD	 4 LOW
 MALFUNCTION INDICATOR LIGHT	 TRANS OIL TEMP	 ENGINE COOLANT TEMPERATURE	 SRS AIRBAG SUPPLEMENTAL RESTRAINT SYSTEM	 PASSENGER AIRBAG OFF	 DOOR AJAR	 CONVERTIBLE TOP DOWN	 CONVERTIBLE TOP UP	 HORN	 SEE OWNER'S MANUAL ISO	 A/C PUSH	 ELECTRONIC STABILITY CONTROL OFF

010533317

## WARNINGS AND CAUTIONS

This Owner's Manual contains **WARNINGS** against operating procedures that could result in a collision or bodily injury. It also contains **CAUTIONS** against procedures that could result in damage to your vehicle. If you do not read this entire Owner's Manual, you may miss important information. Observe all Warnings and Cautions.

## VEHICLE IDENTIFICATION NUMBER

The Vehicle Identification Number (VIN) is on the left front corner of the instrument panel and is visible from outside of the vehicle through the windshield. This number also appears stamped under the right front seat and printed on the Automobile Information Disclosure Label affixed to a window on your vehicle, the vehicle registration and title.

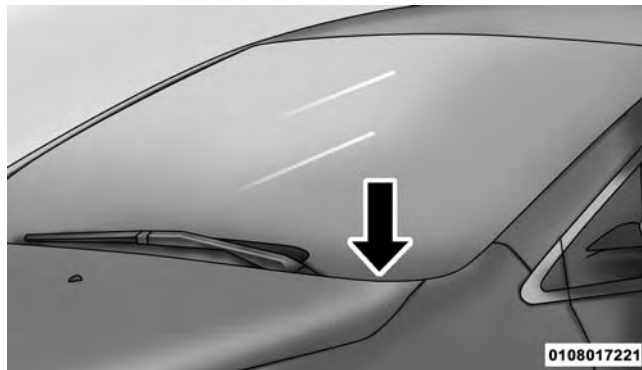

Vehicle Identification Number



## VEHICLE MODIFICATIONS/ALTERATIONS

1

**WARNING!**

Any modifications or alterations to this vehicle could seriously affect its roadworthiness and safety and may lead to a collision resulting in serious injury or death.

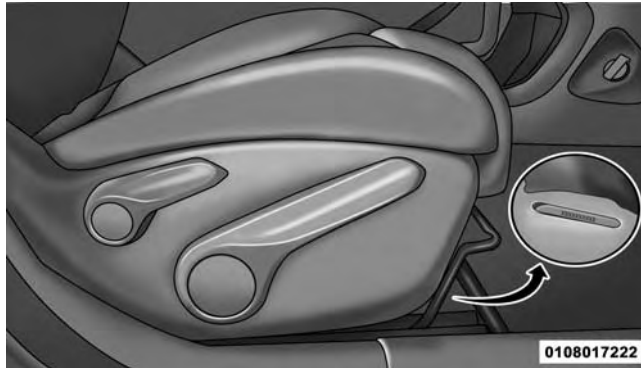
**Stamped VIN Location**

**NOTE:** It is illegal to remove or alter the VIN.



# THINGS TO KNOW BEFORE STARTING YOUR VEHICLE

## CONTENTS

■ A WORD ABOUT YOUR KEYS . . . . .	.12	■ VEHICLE SECURITY ALARM — IF EQUIPPED . . . . .	.19
□ Keyless Push Button Ignition . . . . .	.12	□ Rearming Of The System . . . . .	.19
□ Key Fob . . . . .	.13	□ To Arm The System . . . . .	.19
□ Ignition Or Accessory On Message . . . . .	.15	□ To Disarm The System . . . . .	.20
□ General Information . . . . .	.16	□ Tamper Alert . . . . .	.21
■ SENTRY KEY . . . . .	.16	□ Security System Manual Override . . . . .	.21
□ Replacement Keys . . . . .	.18	■ ILLUMINATED ENTRY . . . . .	.22
□ Customer Key Programming . . . . .	.18	■ REMOTE KEYLESS ENTRY (RKE) . . . . .	.22
□ General Information . . . . .	.18	□ To Unlock The Doors . . . . .	.23

## 10 THINGS TO KNOW BEFORE STARTING YOUR VEHICLE

□ To Lock The Doors . . . . .	.24	■ KEYLESS ENTER-N-GO . . . . .	.36
□ To Unlatch The Trunk . . . . .	.24	□ General Information . . . . .	.41
□ Using The Panic Alarm . . . . .	.24	■ WINDOWS . . . . .	.41
□ Programming Additional Transmitters . . . . .	.25	□ Power Windows . . . . .	.41
□ Transmitter Battery Replacement . . . . .	.25	□ Wind Buffeting . . . . .	.45
□ General Information . . . . .	.27	■ TRUNK LOCK AND RELEASE . . . . .	.45
■ REMOTE STARTING SYSTEM — IF EQUIPPED . . . . .	.27	■ TRUNK SAFETY WARNING. . . . .	.46
□ How To Use Remote Start . . . . .	.28	□ Trunk Emergency Release . . . . .	.47
■ DOOR LOCKS . . . . .	.31	■ OCCUPANT RESTRAINT SYSTEMS . . . . .	.47
□ Manual Door Locks . . . . .	.31	□ Important Safety Precautions . . . . .	.47
□ Power Door Locks . . . . .	.33	□ Seat Belt Systems . . . . .	.49
□ Child-Protection Door Lock System — Rear Doors . . . . .	.34	□ Supplemental Restraint System (SRS) . . . . .	.61
		□ Child Restraints . . . . .	.86



- Transporting Pets . . . . .108
- ENGINE BREAK-IN RECOMMENDATIONS . . .108
- SAFETY TIPS . . . . .109
  - Transporting Passengers . . . . .109
  - Exhaust Gas . . . . .110

**THINGS TO KNOW BEFORE STARTING YOUR VEHICLE 11**

- Safety Checks You Should Make Inside The Vehicle . . . . .111
- Periodic Safety Checks You Should Make Outside The Vehicle . . . . .113

### A WORD ABOUT YOUR KEYS

Your vehicle uses a keyless ignition system. This system consists of a Key Fob with Remote Keyless Entry (RKE) transmitter and a Keyless Push Button Ignition.

#### Keyless Enter-N-Go Feature

This vehicle is equipped with the Keyless Enter-N-Go feature, (refer to "Keyless Enter-N-Go" in "Things To Know Before Starting Your Vehicle" for further information).

#### Keyless Push Button Ignition

This feature allows the driver to operate the ignition with the push of a button as long as the Remote Keyless Entry (RKE) transmitter is in the passenger compartment.

The Keyless Push Button Ignition has four operating positions, three of which are labeled and will illuminate when in position. The three positions are: OFF, ACC, and ON/RUN. The fourth position is START. During start, ON/RUN will illuminate.

**NOTE:** In case the ignition does not change with the push of a button, the RKE transmitter (Key Fob) may have a low or dead battery. In this situation, a back up method can be used to operate the ignition switch. Put the nose side (side opposite of the emergency key) of the Key Fob against the engine START/STOP button and push to operate the ignition.

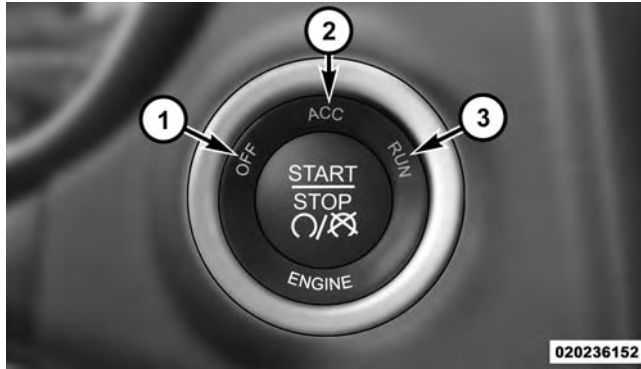

**Keyless Push Button Ignition**

- 1 — OFF
- 2 — ACC (ACCESSORY)
- 3 — ON/RUN

## Key Fob

The Key Fob also contains the Remote Keyless Entry (RKE) transmitter and an emergency key, which stores in the rear of the Key Fob.

The emergency key allows for entry into the vehicle should the battery in the vehicle or the Key Fob go dead. The emergency key is also for locking/unlocking the glove compartment. You can keep the emergency key with you when valet parking.

To remove the emergency key, slide the mechanical latch on the back of the Key Fob sideways with your thumb and then pull the key out with your other hand.



0202072526

Mechanical Latch On The Back Of The Key Fob



0202008030

Emergency Key Removal

**NOTE:** You can insert the double-sided emergency key into the lock cylinders with either side up.



## Ignition Or Accessory On Message

When opening the driver's door when the ignition is in ACC or ON (engine not running), a chime will sound to remind you to cycle the ignition to OFF. In addition to the chime, the ignition or accessory on message will display in the cluster.

**NOTE:** With the Uconnect system, the power window switches, radio, power sunroof (if equipped), and power outlets will remain active for up to 10 minutes after the ignition is placed in the OFF position. Opening either front door will cancel this feature. The time for this feature is programmable. Refer to "Uconnect Settings" in "Understanding Your Instrument Panel" for further information.

### WARNING!

- When leaving the vehicle, always make sure the keyless ignition node is in the "OFF" mode, remove the Key Fob from the vehicle and lock the vehicle.
- Never leave children alone in a vehicle, or with access to an unlocked vehicle.
- Allowing children to be in a vehicle unattended is dangerous for a number of reasons. A child or others could be seriously or fatally injured. Children should be warned not to touch the parking brake, brake pedal or the gear selector.
- Do not leave the Key Fob in or near the vehicle, or in a location accessible to children, and do not leave the ignition of a vehicle equipped with Keyless Enter-N-Go in the ACC or ON/RUN mode.

2

*(Continued)*

**WARNING! (Continued)**

A child could operate power windows, other controls, or move the vehicle.

- Do not leave children or animals inside parked vehicles in hot weather. Interior heat build-up may cause serious injury or death.

**CAUTION!**

An unlocked car is an invitation to thieves. Always remove the Key Fob from vehicle, place the ignition in the OFF position and lock all doors when leaving the vehicle unattended.

**General Information**

The following regulatory statement applies to all radio frequency (RF) devices equipped in this vehicle:

This device complies with Part 15 of the FCC Rules and with Industry Canada licence-exempt RSS standard(s). Operation is subject to the following two conditions:

1. This device may not cause harmful interference, and
2. This device must accept any interference received, including interference that may cause undesired operation.

**NOTE:** Changes or modifications not expressly approved by the party responsible for compliance could void the user's authority to operate the equipment.

**SENTRY KEY**

The Sentry Key Immobilizer system prevents unauthorized vehicle operation by disabling the engine. The system does not need to be armed or activated. Operation is automatic, regardless of whether the vehicle is locked or unlocked.

The system uses a Key Fob with a factory-mated Remote Keyless Entry (RKE) transmitter, a Keyless Push Button Ignition, and a RF receiver to prevent unauthorized vehicle operation. Therefore, only Key Fobs that are programmed to the vehicle can be used to start and operate the vehicle. The system will not allow the engine to crank if an invalid Key Fob is used to start and operate the vehicle. The system will shut the engine off in two seconds if the engine controller does not receive the proper authorization codes from the body control module.

After placing the ignition to the ON/RUN position, the Vehicle Security Light will turn on for three seconds for a bulb check. If the light remains on after the bulb check, it indicates that there is a problem with the electronics. In addition, if the light begins to flash after the bulb check, it indicates that someone used an invalid Key Fob to start the engine. Either of these conditions will result in the engine being shut off after two seconds.

If the Vehicle Security Light turns on during normal vehicle operation (vehicle running for longer than 10 seconds), it indicates that there is a fault in the electronics. Should this occur, have the vehicle serviced as soon as possible by an authorized dealer.

### CAUTION!

- **Do not make modifications or alterations to the immobilizer system. Modifications or alterations to the immobilization system may result in a loss of security protection.**
- **The Sentry Key Immobilizer system is not compatible with some aftermarket remote starting systems. Use of these systems may result in vehicle starting problems and loss of security protection.**

All of the Key Fobs provided with your new vehicle have been programmed to the vehicle electronics.

## Replacement Keys

**NOTE:** Only Key Fobs that are programmed to the vehicle electronics can be used to start and operate the vehicle. Once a Key Fob is programmed to a vehicle, it cannot be programmed to any other vehicle.

### CAUTION!

- Always remove the Key Fobs from the vehicle and lock all doors when leaving the vehicle unattended.
- For vehicles equipped with Keyless Enter-N-Go, always remember to place the ignition in the OFF position.

Duplication of Key Fobs may be performed at an authorized dealer. This procedure consists of programming a blank Key Fob to the vehicle electronics. A blank Key Fob is one that has never been programmed.

**NOTE:** When having the Sentry Key Immobilizer System serviced, bring all vehicle keys with you to an authorized dealer.

## Customer Key Programming

Programming Key Fobs or RKE transmitters may be performed at an authorized dealer.

## General Information

The following regulatory statement applies to all radio frequency (RF) devices equipped in this vehicle:

This device complies with Part 15 of the FCC Rules and with Industry Canada licence-exempt RSS standard(s). Operation is subject to the following two conditions:

1. This device may not cause harmful interference, and
2. This device must accept any interference received, including interference that may cause undesired operation.

**NOTE:** Changes or modifications not expressly approved by the party responsible for compliance could void the user's authority to operate the equipment.

## VEHICLE SECURITY ALARM — IF EQUIPPED

The Vehicle Security Alarm monitors the vehicle doors for unauthorized entry and the ignition switch for unauthorized operation. If something triggers the alarm, the Vehicle Security Alarm will provide the following audible and visible signals: the horn will pulse, the headlights, park lamps and/or turn signals will flash, and the Vehicle Security Light in the instrument cluster will flash.

### Rearming Of The System

If something triggers the alarm, and no action is taken to disarm it, the Vehicle Security Alarm will turn the horn off after three minutes, turn all of the visual signals off after 15 minutes, and then the Vehicle Security Alarm will rearm itself.

## To Arm The System

Follow these steps to arm the Vehicle Security Alarm:

1. Make sure the vehicle ignition is cycled to the "OFF" position (refer to "Starting Procedures" in "Starting And Operating" for further information).
2. Perform one of the following methods to lock the vehicle:
  - Push the LOCK button on the interior power door lock switch panel with the driver and/or passenger door open.
  - Push the LOCK button on the exterior Passive Entry Door Handle with a valid Key Fob (RKE) available in the same exterior zone (refer to "Keyless Enter-N-Go" in "Things To Know Before Starting Your Vehicle" for further information).
  - Push the LOCK button on the Remote Keyless Entry (RKE) transmitter.
3. If any doors are open, close them.

### To Disarm The System

The Vehicle Security Alarm can be disarmed using any of the following methods:

- Push the UNLOCK button on the Remote Keyless Entry (RKE) transmitter.
- Grasp the Passive Entry Unlock Door Handle (if equipped, refer to “Keyless Enter-N-Go” in “Things To Know Before Starting Your Vehicle” for further information).
- Cycle the vehicle ignition system out of the OFF position.

#### NOTE:

- The driver’s door key cylinder and the Trunk button on the RKE transmitter cannot arm or disarm the Vehicle Security Alarm.

- The Vehicle Security Alarm remains armed during power trunk entry. Pushing the trunk button will not disarm the Vehicle Security Alarm. If someone enters the vehicle through the trunk and opens any door the alarm will sound.
- When the Vehicle Security Alarm is armed, the interior power door lock switches will not unlock the doors.

The Vehicle Security Alarm is designed to protect your vehicle. However, you can create conditions where the system will give you a false alarm. If one of the previously described arming sequences has occurred, the Vehicle Security Alarm will arm regardless of whether you are in the vehicle or not. If you remain in the vehicle and open a door, the alarm will sound. If this occurs, disarm the Vehicle Security Alarm.

If the Vehicle Security Alarm is armed and the battery becomes disconnected, the Vehicle Security Alarm will remain armed when the battery is reconnected; the exterior lights will flash, and the horn will sound. If this occurs, disarm the Vehicle Security Alarm.

### Tamper Alert

If something has triggered the Vehicle Security Alarm in your absence, the horn will sound three times, and the exterior lights blink three times when you unlock the doors. Check the vehicle for tampering.

### Security System Manual Override

The Vehicle Security Alarm will not arm if you lock the doors using the manual door lock.

2

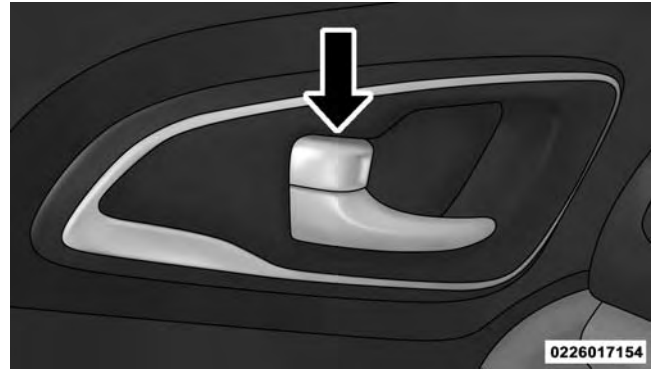

Manual Door Lock Switch

### ILLUMINATED ENTRY

The courtesy lights will turn on when you use the Remote Keyless Entry (RKE) transmitter to unlock the doors or open any door.

This feature also turns on the approach lighting in the outside mirrors (if equipped). Refer to “Mirrors” in “Understanding The Features Of Your Vehicle” for further information.

The lights will fade to off after approximately 30 seconds, or they will immediately fade to off once the ignition is cycled to the ON/RUN position from the OFF position.

#### NOTE:

- The front courtesy overhead console and door courtesy lights will turn on if the dimmer control is in the “Dome ON” position (extreme top position).

- The Illuminated Entry system will not operate if the dimmer control is in the “Dome defeat” position (extreme bottom position).

### REMOTE KEYLESS ENTRY (RKE)

The RKE system allows you to lock or unlock the doors, open the trunk, or activate the Panic Alarm from distances up to approximately 66 ft (20 m) using a hand-held Key Fob with RKE transmitter. The RKE transmitter does not need to be pointed at the vehicle to activate the system.

**NOTE:** Driving at speeds 5 mph (8 km/h) and above disables the system from responding to all RKE transmitter buttons for all RKE transmitters.



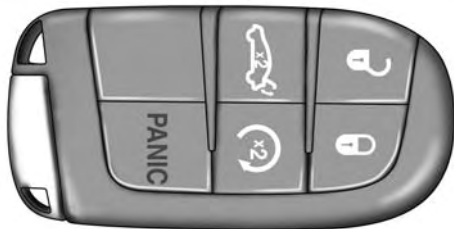

0202008029

### Key Fob With RKE Transmitter To Unlock The Doors

Push and release the UNLOCK button on the RKE transmitter once to unlock the driver's door or twice within five seconds to unlock all doors. The turn signal lights will flash to acknowledge the unlock signal. The illuminated entry system will also turn on.

If the vehicle is equipped with Passive Entry, refer to "Keyless Enter-N-Go" under "Things To Know Before Starting Your Vehicle" for further information.

### 1st Press Of Key Fob Unlocks

This feature lets you program the system to unlock either the driver's door or all doors on the first push of the UNLOCK button on the RKE transmitter. To change the current setting, refer to "Uconnect Settings" in "Understanding Your Instrument Panel" for further information.

### Flash Lights With Lock

This feature will cause the turn signal lights to flash when the doors are locked with the RKE transmitter. This feature can be turned on or turned off. To change the current setting, refer to "Uconnect Settings" in "Understanding Your Instrument Panel" for further information.

### Headlight Illumination On Approach

This feature activates the headlights for up to 90 seconds when the doors are unlocked with the RKE transmitter. The time for this feature is programmable on vehicles equipped through Uconnect. To change the current setting, refer to “Uconnect Settings” in “Understanding Your Instrument Panel” for further information.

### To Lock The Doors

Push and release the LOCK button on the RKE transmitter to lock all doors. The turn signal lights will flash, and the horn will chirp to acknowledge the signal.

If the vehicle is equipped with Passive Entry, refer to “Keyless Enter-N-Go” under “Things To Know Before Starting Your Vehicle” for further information.

### Sound Horn With Lock

This feature will cause the horn to chirp when the doors are locked with the RKE transmitter. This feature can be

turned on or turned off. To change the current setting, refer to “Uconnect Settings” in “Understanding Your Instrument Panel” for further information.

### To Unlatch The Trunk

Push the TRUNK button on the RKE transmitter two times within five seconds to unlatch the trunk.

If the vehicle is equipped with Passive Entry, refer to “Keyless Enter-N-Go” under “Things To Know Before Starting Your Vehicle” for further information.

### Using The Panic Alarm

To turn the Panic Alarm feature on or off, push and hold the PANIC button on the RKE transmitter for at least one second and release. When the Panic Alarm is activated, the turn signals will flash, the horn will pulse on and off, and the interior lights will turn on.

The Panic Alarm will stay on for three minutes unless you turn it off by either pushing the PANIC button a second time or drive the vehicle at a speed of 15 MPH (24 km/h) or greater.

**NOTE:**

- The interior lights will turn off if you place the ignition in the ACC or ON/RUN position while the Panic Alarm is activated. However, the exterior lights and horn will remain on.
- You may need to be less than 35 ft (11 m) from the vehicle when using the RKE transmitter to turn off the Panic Alarm due to the radio frequency noises emitted by the system.

**Programming Additional Transmitters**

Programming Key Fobs or RKE transmitters may be performed at an authorized dealer.

**Transmitter Battery Replacement**

The recommended replacement battery is one CR2032 battery.

**NOTE:**

- Perchlorate Material — special handling may apply. See [www.dtsc.ca.gov/hazardouswaste/perchlorate](http://www.dtsc.ca.gov/hazardouswaste/perchlorate)
  - Do not touch the battery terminals that are on the back housing or the printed circuit board.
1. Remove the emergency key by sliding the mechanical latch on the back of the RKE transmitter sideways with your thumb and then pull the key out with your other hand.

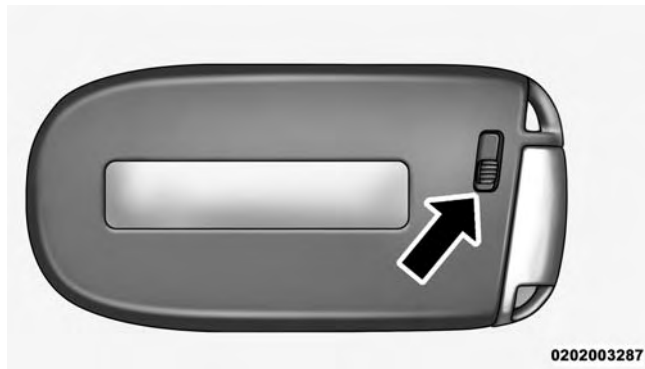

### Emergency Key Removal

2. Insert the tip of the emergency key or a #2 flat blade screwdriver into the slot and gently pry the two halves of the RKE transmitter apart. Make sure not to damage the seal during removal.



### Separating The RKE Transmitter Case

3. Remove the battery by turning the back cover over (battery facing downward) and tapping it lightly on a solid surface such as a table or similar, then replace the battery. When replacing the battery, match the + sign on the battery to the + sign on the inside of the battery clip, located on the back cover. Avoid touching the

new battery with your fingers. Skin oils may cause battery deterioration. If you touch a battery, clean it with rubbing alcohol.

4. To assemble the RKE transmitter case, snap the two halves together.

### General Information

The following regulatory statement applies to all radio frequency (RF) devices equipped in this vehicle:

This device complies with Part 15 of the FCC Rules and with Industry Canada licence-exempt RSS standard(s). Operation is subject to the following two conditions:

1. This device may not cause harmful interference, and
2. This device must accept any interference received, including interference that may cause undesired operation.

**NOTE:** Changes or modifications not expressly approved by the party responsible for compliance could void the user's authority to operate the equipment.

### REMOTE STARTING SYSTEM — IF EQUIPPED

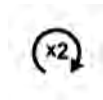

This system uses the Key Fob with Remote Keyless Entry (RKE) transmitter to start the engine conveniently from outside the vehicle while still maintaining security. The system has a range of approximately 300 ft (91 m).

#### NOTE:

- The vehicle must be equipped with an automatic transmission to be equipped with Remote Start.
- Low fuel indicator must not be illuminated.
- Obstructions between the vehicle and the Key Fob may reduce this range.

## How To Use Remote Start

All of the following conditions must be met before the engine will remote start:

- Vehicle in PARK
- Doors closed
- Hood closed
- Trunk closed
- Hazard switch off
- Brake switch inactive (brake pedal not pushed)
- Battery at an acceptable charge level
- RKE panic button not pushed
- System not disabled from previous remote start event
- Vehicle Security Alarm not active
- Ignition in OFF position

### WARNING!

- **Do not start or run an engine in a closed garage or confined area. Exhaust gas contains Carbon Monoxide (CO) which is odorless and colorless. Carbon Monoxide is poisonous and can cause serious injury or death when inhaled.**
- **Keep Remote Keyless Entry (RKE) transmitters away from children. Operation of the Remote Start System, windows, door locks or other controls could cause serious injury or death.**

### Remote Start Abort Messages on Your Instrument Cluster Display

The following messages will display in the instrument cluster if the vehicle fails to remote start or exits remote start prematurely:

- Remote Start Aborted — Door Open

- Remote Start Aborted — Hood Open
- Remote Start Aborted — Trunk Open
- Remote Start Aborted — Fuel Low
- Remote Start Disabled — Start To Reset
- Remote Start Aborted — Too Cold
- Remote Start Aborted — Time Expired

The instrument cluster message stays active until the ignition is cycled to the ON/RUN position.

**To Enter Remote Start Mode**

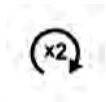

Push and release the REMOTE START button on the RKE transmitter twice within five seconds. The vehicle doors will lock, parking lights will flash, and the horn will chirp twice

(if programmed). Then, the engine will start and the vehicle will remain in the Remote Start mode for a 15-minute cycle.

**NOTE:**

- If an engine fault is present or fuel level is low, the vehicle will start and then shut down in 10 seconds.
- The park lamps will turn on and remain on during Remote Start mode.
- For security, power window and power sunroof operation (if equipped) are disabled when the vehicle is in the Remote Start mode.
- The engine can be started two consecutive times (two 15-minute cycles) with the RKE transmitter. However, the ignition must be cycled to the RUN position before you can repeat the start sequence for a third cycle.

### To Exit Remote Start Mode Without Driving The Vehicle

Push and release the REMOTE START button one time or allow the engine to run for the entire 15-minute cycle.

**NOTE:** To avoid unintentional shutdowns, the system will disable the one time push of the REMOTE START button for two seconds after receiving a valid Remote Start request.

### To Exit Remote Start Mode And Drive The Vehicle

Before the end of 15-minute cycle, push and release the UNLOCK button on the RKE transmitter to unlock the doors and disarm the Vehicle Security Alarm (if equipped). Then, prior to the end of the 15-minute cycle, push and release the START/STOP button (vehicles equipped with Keyless Enter-N-Go).

**NOTE:** The message "Remote Start Active Push Start Button" (vehicles equipped with Keyless Enter-N-Go) will display in the instrument cluster until you push the START button.

### General Information

The following regulatory statement applies to all radio frequency (RF) devices equipped in this vehicle:

This device complies with Part 15 of the FCC Rules and with Industry Canada licence-exempt RSS standard(s). Operation is subject to the following two conditions:

1. This device may not cause harmful interference, and
2. This device must accept any interference received, including interference that may cause undesired operation.

**NOTE:** Changes or modifications not expressly approved by the party responsible for compliance could void the user's authority to operate the equipment.



## DOOR LOCKS

### Manual Door Locks

To lock each door, rotate the door lock knob on each door trim panel forward. To unlock the front doors, pull the inside door handle to the first detent or rotate the door lock button until the red indicator is visible. To unlock the rear doors, rotate the door lock button until the red indicator is visible.

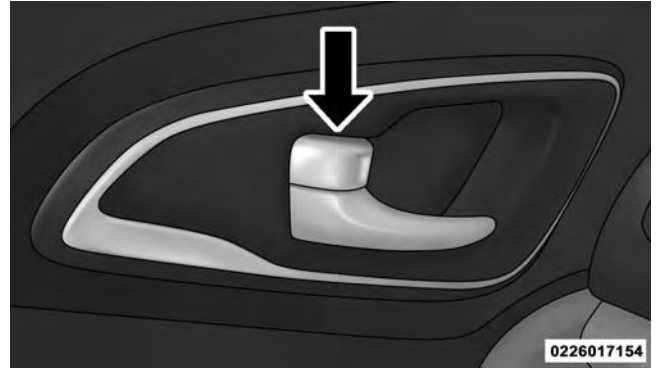

### Manual Door Lock Switch

If the door lock button is locked (no red indicator visible) when you shut the door, the door will lock. Therefore, make sure the Key Fob is not inside the vehicle before closing the door.

**NOTE:** The manual door locks will not lock or unlock the trunk.

**WARNING!**

- For personal security and safety in the event of a collision, lock the vehicle doors before you drive as well as when you park and leave the vehicle.
- Never use the PARK position as a substitute for the parking brake. Always apply the parking brake fully when parked to guard against vehicle movement and possible injury or damage.
- When leaving the vehicle, always make sure the keyless ignition node is in the "OFF" mode, remove the Key Fob from the vehicle and lock the vehicle.

*(Continued)*

**WARNING! (Continued)**

- Never leave children alone in a vehicle, or with access to an unlocked vehicle. Allowing children to be in a vehicle unattended is dangerous for a number of reasons. A child or others could be seriously or fatally injured. Children should be warned not to touch the parking brake, brake pedal or the gear selector.
- Do not leave the Key Fob in or near the vehicle, or in a location accessible to children, and do not leave the ignition of a vehicle equipped with Keyless Enter-N-Go in the ACC or ON/RUN mode. A child could operate power windows, other controls, or move the vehicle.

## Power Door Locks

A power door lock switch is located on each of the front door trim panels. Use this switch to lock or unlock the doors and trunk.

The doors can also be locked and unlocked with the Keyless Enter-N-Go (Passive Entry) system. Refer to “Keyless Enter-N-Go” in “Things To Know Before Starting Your Vehicle” for further information.



2

### Power Door Lock Switches

If you push the power door lock switch while the ignition is in the ACC or ON/RUN position, and any front door is open, the power locks will not operate. This prevents you from accidentally locking the Key Fob in the vehicle. Placing the ignition in the OFF position or closing the door will allow the locks to operate. If a door is open, and

the ignition is in the ACC or ON/RUN position, a chime will sound as a reminder to remove the Key Fob.

### **Automatic Door Locks — If Equipped**

The auto door lock feature default condition is enabled. When enabled, the door locks will lock automatically when the vehicle's speed exceeds 15 mph (24 km/h). The auto door lock feature can be enabled or disabled by your authorized dealer per written request of the customer. Please see your authorized dealer for service.

### **Automatic Unlock Doors On Exit**

The doors will unlock automatically on vehicles with power door locks if:

1. The Automatic Unlock Doors On Exit feature is enabled.
2. The vehicle was in motion, then speed returned to 0 mph (0 km/h) and the transmission is placed in PARK.

3. The driver door is opened.
4. The doors were not previously unlocked.

### **Automatic Unlock Doors On Exit Programming**

To change the current setting, refer to "Uconnect Settings" in "Understanding Your Instrument Panel" for further information.

**NOTE:** Use the Automatic Unlock Doors On Exit feature in accordance with local laws.

### **Child-Protection Door Lock System — Rear Doors**

To provide a safer environment for children riding in the rear seat, the rear doors of your vehicle have a Child-Protection Door Lock system.

The Child-Protection Door Locks are located inside the rear edge of the door.

1. Open the rear door.

2. Insert the tip of the emergency key or similar flat-bladed object into the lock and rotate clockwise approximately one-quarter turn to the lock position or counter clockwise to the unlock position (as indicated by the stamped icons).
3. Repeat steps 1 and 2 for the opposite rear door.



Lock Child Protection Door Lock



Unlock Child Protection Door Lock

**WARNING!**

Avoid trapping anyone in a vehicle in a collision. Remember that the rear doors can only be opened from the outside when the Child-Protection locks are engaged.

**NOTE:** For emergency exit with the system engaged, pull the toggle lock by the door handle (UNLOCKED position), roll down the window, and open the door with the outside door handle.

### KEYLESS ENTER-N-GO

The Passive Entry system is an enhancement to the vehicle's Remote Keyless Entry (RKE) system and a feature of Keyless Enter-N-Go. This feature allows you to lock and unlock the vehicle's door(s) without having to push the RKE transmitter lock or unlock buttons.

#### NOTE:

- Passive Entry may be programmed ON/OFF. Refer to "Uconnect Settings" in "Understanding Your Instrument Panel" for further information.

- If wearing gloves on your hands, or if it has been raining on the Passive Entry door handle, the unlock sensitivity can be affected, resulting in a slower response time.
- If the vehicle is unlocked by Passive Entry and no door is opened within 60 seconds, the vehicle will re-lock and if equipped will arm the security alarm.

### To Unlock From The Driver's Side

With a valid Passive Entry RKE transmitter within 5 ft (1.5 m) of the driver's door handle, grab the front driver door handle to unlock the driver's door automatically. The interior door panel lock knob will toggle when the door is unlocked.

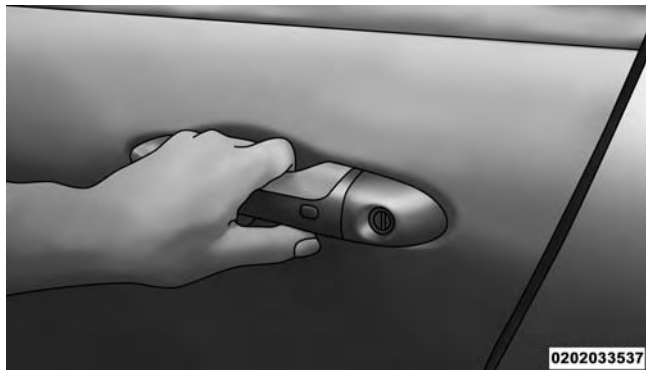

Grab The Door Handle To Unlock

**NOTE:** If “1st Press of Key Fob Unlocks All Doors” is programmed, all doors will unlock when you grab hold of the drivers door handle. To select between “1st Press of Key Fob Unlocks All Doors” and “1st Press of Key Fob Unlocks Driver Door,” refer to “Uconnect Settings” in “Understanding Your Instrument Panel” for further information.

### To Unlock From The Passenger Side — If Equipped

With a valid Passive Entry RKE transmitter within 5 ft (1.5 m) of the passenger door handle, grab the front passenger door handle to unlock all four doors automatically. The interior door panel lock knob will toggle when the door is unlocked.

**NOTE:** All doors will unlock when the front passenger door handle is grabbed regardless of the driver’s door unlock preference setting (“1st Press of Key Fob Unlocks All Doors” or “1st Press of Key Fob Unlocks Driver Door”).

### Preventing Inadvertent Locking Of Passive Entry RKE Transmitter In Vehicle

To minimize the possibility of unintentionally locking a Passive Entry RKE transmitter inside your vehicle, the Passive Entry system is equipped with an automatic door unlock feature which will function if the ignition switch is in the OFF position.

FOBIK-Safe only executes in vehicles with passive entry. There are three situations that trigger a FOBIK-Safe search in any passive entry vehicle.

- A lock request is made by a valid Passive Entry RKE transmitter while a door is open.
- A lock request is made by the Passive Entry door handle while a door is open.
- A lock request is made by the door panel switch while the door is open.

When any of these situations occur, after all open doors are shut, the FOBIK-Safe search will be executed. If it finds a Passive Entry RKE transmitter inside the car and it does not find any Passive Entry RKE transmitters outside the car, then the car will unlock and alert the customer.

**NOTE:** The vehicle will only unlock the doors a valid Passive Entry RKE transmitter is detected inside the vehicle, and no valid Passive Entry RKE transmitter is detected outside the vehicle. The vehicle will not unlock the doors when any of the following conditions are true:

- The doors are manually locked using the door lock knobs.
- There is a valid Passive Entry RKE transmitter outside the vehicle and within 5 ft (1.5 m) of either Passive Entry door handle.
- Three attempts are made to lock the doors using the door panel switch and then close the doors.



## To Enter The Trunk

With a valid Passive Entry RKE transmitter within 3 ft (1.0 m) of the decklid, push the button located on the light bar between the license plate lamps.

**NOTE:** If you inadvertently leave your vehicle's Passive Entry RKE transmitter in the trunk and try to close the decklid, the decklid will automatically unlatch, unless another one of the vehicle's Passive Entry RKE transmitters is outside the vehicle and within 3 ft (1.0 m) of the decklid.

## To Lock The Vehicle's Doors

With one of the vehicle's Passive Entry RKE transmitters within 5 ft (1.5 m) of the driver or passenger front door handles, push the door handle LOCK button to lock all four doors.

Do NOT grab the door handle, when pushing the door handle lock button. This could unlock the door(s).

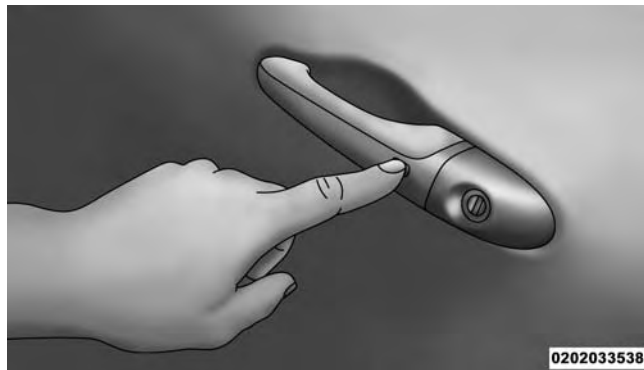

Push The Door Handle Button To Lock

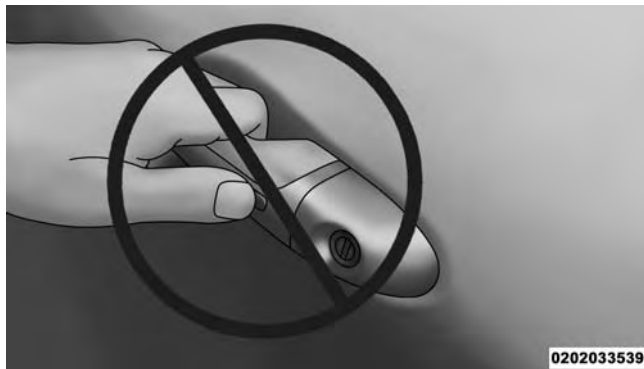

**Do NOT Grab The Handle When Locking**

**NOTE:**

- After pushing the door handle LOCK button, you must wait two seconds before you can lock or unlock the doors, using either Passive Entry door handle. This is done to allow you to check if the vehicle is locked by pulling the door handle without the vehicle reacting and unlocking.
- The Passive Entry system will not operate if the RKE transmitter battery is dead.

The vehicle doors can also be locked by using the RKE transmitter lock button or the lock button located on the vehicle's interior door panel.

## General Information

The following regulatory statement applies to all radio frequency (RF) devices equipped in this vehicle:

This device complies with Part 15 of the FCC Rules and with Industry Canada licence-exempt RSS standard(s). Operation is subject to the following two conditions:

1. This device may not cause harmful interference, and
2. This device must accept any interference received, including interference that may cause undesired operation.

**NOTE:** Changes or modifications not expressly approved by the party responsible for compliance could void the user's authority to operate the equipment.

## WINDOWS

### Power Windows

The window controls on the driver's door control all the door windows.



### Power Window Controls

- 1 — Window Lockout Switch
- 2 — Rear Passenger Window Controls
- 3 — Driver/Passenger Window Controls

There are single window controls on each passenger door trim panel, which operate the passenger door windows. The window controls will operate only when the ignition is in the ACC or ON/RUN position.

**NOTE:** For vehicles equipped with the Uconnect, the power window switches will remain active for up to 10 minutes after the ignition is cycled to the OFF position. Opening either front door will cancel this feature. The time is programmable. Refer to “Uconnect Settings” in “Understanding Your Instrument Panel” for further information.

### WARNING!

**Never leave children unattended in a vehicle, and do not let children play with power windows. Do not leave the Key Fob in or near the vehicle, or in a**

*(Continued)*

**WARNING! (Continued)**

location accessible to children. Occupants, particularly unattended children, can become entrapped by the windows while operating the power window switches. Such entrapment may result in serious injury or death.

**Driver One Touch Down**

The driver door power window switch has an auto down feature. Push the window switch to the second detent and release, and the window will go down automatically.

To open the window part way, push the window switch to the first detent and release it when you want the window to stop.

To stop the window from going all the way down during the Auto Down operation, pull up on the switch briefly.

**Front Windows Express Up And Down — If Equipped****Express Down**

Push the switch to the second detent and release. The window will go down automatically.

**Manual Down**

Push and hold the switch to the first detent and release when you want the window to stop.

**Express Up**

Lift the switch to the second detent and release. The window will go up automatically.

**Manual Up**

Lift the switch to the first detent and release when you want the window to stop.

#### NOTE:

- If the window runs into any obstacle during auto-closure, it will reverse direction and then go back down. Remove the obstacle and use the window switch again to close the window.
- Any impact due to rough road conditions may trigger the auto-reverse function unexpectedly during auto-closure. If this happens, pull the switch lightly to the first detent and hold to close the window manually.

#### **WARNING!**

**There is no anti-pinch protection when the window is almost closed. Be sure to clear all objects from the window before closing.**

#### **Reset Auto-Up**

Should the Auto Up feature stop working, the window may need to be reset. To reset Auto Up:

1. Make sure the door is fully closed.
2. Pull the window switch up to close the window completely and continue to hold the switch up for an additional two seconds after the window is closed.
3. Push the window switch down firmly to the second detent to open the window completely and continue to hold the switch down for an additional two seconds after the window is fully open.

#### **Window Lockout Switch**

The window lockout switch on the driver's door trim panel allows you to disable the window controls on the rear passenger doors. To disable the window controls, push and release the window lockout button (setting it in

the DOWN position). To enable the window controls, push and release the window lockout button again (setting it in the UP position).

### Wind Buffeting

Wind buffeting can be described as the perception of pressure on the ears or a helicopter-type sound in the ears. Your vehicle may exhibit wind buffeting with the windows down, or the sunroof (if equipped) in certain open or partially open positions. This is a normal occurrence and can be minimized. If the buffeting occurs with the rear windows open, then open the front and rear windows together to minimize the buffeting. If the buffeting occurs with the sunroof open, adjust the sunroof opening to minimize the buffeting.

### TRUNK LOCK AND RELEASE

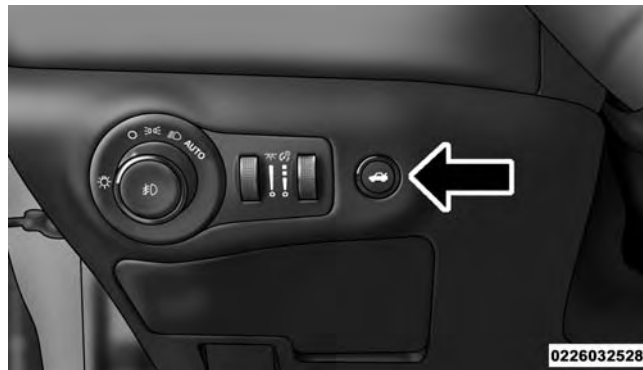

2

#### Trunk Release Button

The trunk lid can be released from inside the vehicle by pushing the TRUNK RELEASE button located on the instrument panel to the left of the steering wheel.

**NOTE:** The transmission must be in PARK before the button will operate.

The trunk lid can be released from outside the vehicle by pushing the TRUNK button on the Remote Keyless Entry (RKE) transmitter twice within five seconds or by using the external release switch located on the underside of the decklid overhang. The release feature will function only when the vehicle is in the unlock condition.

With the ignition in the ON/RUN position, the Trunk Open symbol will display in the instrument cluster indicating that the trunk is open. The EVIC/DID display will reappear once the trunk is closed.

With the ignition in the OFF position, the Trunk Open symbol will display until the trunk is closed.

Refer to “Keyless Enter-N-Go” in this section for more information on trunk operation with the Passive Entry feature.

## TRUNK SAFETY WARNING

### WARNING!

**Do not allow children to have access to the trunk, either by climbing into the trunk from outside, or through the inside of the vehicle. Always close the trunk lid when your vehicle is unattended. Once in the trunk, young children may not be able to escape, even if they entered through the rear seat. If trapped in the trunk, children can die from suffocation or heat stroke.**



## Trunk Emergency Release

As a security measure, a trunk internal emergency release lever is built into the trunk latching mechanism. In the event of an individual being locked inside the trunk, the trunk can be opened by actuating the glow-in-the-dark handle attached to the trunk latching mechanism.

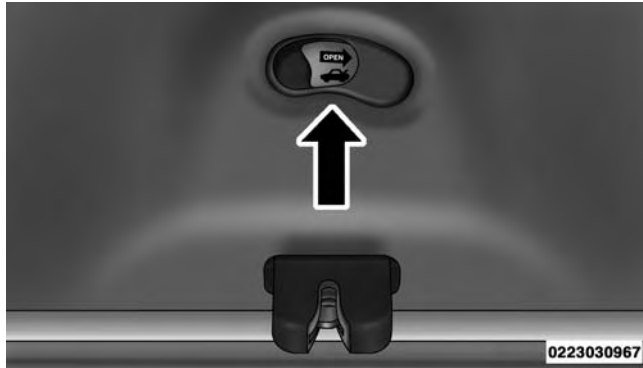

Trunk Emergency Release

## OCCUPANT RESTRAINT SYSTEMS

Some of the most important safety features in your vehicle are the restraint systems:

- Seat Belt Systems
- Supplemental Restraint Systems (SRS) Air Bags
- Child Restraints

### Important Safety Precautions

Please pay close attention to the information in this section. It tells you how to use your restraint system properly, to keep you and your passengers as safe as possible.

Here are some simple steps you can take to minimize the risk of harm from a deploying air bag:

1. Children 12 years old and under should always ride buckled up in a vehicle with a rear seat.

## 48 THINGS TO KNOW BEFORE STARTING YOUR VEHICLE

2. If a child from 2 to 12 years old (not in a rear-facing child restraint) must ride in the front passenger seat, move the seat as far back as possible and use the proper child restraint. (Refer to "Child Restraints")
3. Children that are not big enough to wear the vehicle seat belt properly (Refer to "Child Restraints") should be secured in a vehicle with a rear seat in child restraints or belt-positioning booster seats. Older children who do not use child restraints or belt-positioning booster seats should ride properly buckled up in a vehicle with a rear seat.
4. Never allow children to slide the shoulder belt behind them or under their arm.
5. You should read the instructions provided with your child restraint to make sure that you are using it properly.
6. All occupants should always wear their lap and shoulder belts properly.
7. The driver and front passenger seats should be moved back as far as practical to allow the Advanced Front Air Bags room to inflate.
8. Do not lean against the door or window. If your vehicle has side air bags, and deployment occurs, the side air bags will inflate forcefully into the space between occupants and the door and occupants could be injured.
9. If the air bag system in this vehicle needs to be modified to accommodate a disabled person, contact the Customer Center. Phone numbers are provided under "If You Need Assistance."

**WARNING!**

- **Never place a rear-facing child restraint in front of an air bag. A deploying passenger Advanced Front Air Bag can cause death or serious injury to a child 12 years or younger, including a child in a rear-facing child restraint.**
- **Only use a rear-facing child restraint in a vehicle with a rear seat.**

**Seat Belt Systems**

Buckle up even though you are an excellent driver, even on short trips. Someone on the road may be a poor driver and could cause a collision that includes you. This can happen far away from home or on your own street.

Research has shown that seat belts save lives, and they can reduce the seriousness of injuries in a collision. Some of the worst injuries happen when people are thrown from the vehicle. Seat belts reduce the possibility of

ejection and the risk of injury caused by striking the inside of the vehicle. Everyone in a motor vehicle should be belted at all times.

**Driver And Passenger BeltAlert (If Equipped)**

 BeltAlert is a feature intended to remind the driver and outboard front seat passenger (if equipped with outboard front passenger seat BeltAlert) to buckle their seat belts. The Belt Alert feature is active whenever the ignition switch is in the START or ON/RUN position.

**Initial Indication**

If the driver is unbuckled when the ignition switch is first turned to the START or ON/RUN position, an intermittent chime will signal for a few seconds. If the driver or outboard front seat passenger (if equipped with outboard front passenger seat BeltAlert) is unbuckled when the ignition switch is first turned to the START or ON/RUN

position the Seat Belt Reminder Light will turn on and remain on until both outboard front seat belts are buckled. The outboard front passenger seat BeltAlert is not active when an outboard front passenger seat is unoccupied.

### **BeltAlert Warning Sequence**

The BeltAlert warning sequence is activated when the vehicle is moving above a specified vehicle speed range and the driver or outboard front seat passenger is unbuckled (if equipped with outboard front passenger seat BeltAlert). The BeltAlert warning sequence starts by blinking the Seat Belt Reminder Light and sounding an intermittent chime. Once the BeltAlert warning sequence has completed, the Seat Belt Reminder Light will remain on until the seat belts are buckled. The BeltAlert warning sequence may repeat based on vehicle speed until the driver and occupied outboard front seat passenger seat belts are buckled. The driver should instruct all occupants to buckle their seat belts.

### **Change Of Status**

If the driver or outboard front seat passenger (if equipped with outboard front passenger seat BeltAlert) unbuckles their seat belt while the vehicle is traveling, the BeltAlert warning sequence will begin until the seat belts are buckled again.

The outboard front passenger seat BeltAlert is not active when the outboard front passenger seat is unoccupied. BeltAlert may be triggered when an animal or heavy object is on the outboard front passenger seat or when the seat is folded flat (if equipped). It is recommended that pets be restrained in the rear seat (if equipped) in pet harnesses or pet carriers that are secured by seat belts, and cargo is properly stowed.

BeltAlert can be activated or deactivated by your authorized dealer. FCA US LLC does not recommend deactivating BeltAlert.

**NOTE:** If BeltAlert has been deactivated and the driver or outboard front seat passenger (if equipped with outboard front passenger seat BeltAlert) is unbuckled the Seat Belt Reminder Light will turn on and remain on until the driver and outboard front seat passenger seat belts are buckled.

### Lap/Shoulder Belts

All seating positions in your vehicle are equipped with lap/shoulder belts.

The seat belt webbing retractor will lock only during very sudden stops or collisions. This feature allows the shoulder part of the seat belt to move freely with you under normal conditions. However, in a collision the seat belt will lock and reduce your risk of striking the inside of the vehicle or being thrown out of the vehicle.

### WARNING!

- Relying on the air bags alone could lead to more severe injuries in a collision. The air bags work with your seat belt to restrain you properly. In some collisions, the air bags won't deploy at all. Always wear your seat belt even though you have air bags.
- In a collision, you and your passengers can suffer much greater injuries if you are not properly buckled up. You can strike the interior of your vehicle or other passengers, or you can be thrown out of the vehicle. Always be sure you and others in your vehicle are buckled up properly.
- It is dangerous to ride in a cargo area, inside or outside of a vehicle. In a collision, people riding in these areas are more likely to be seriously injured or killed.

*(Continued)*

**WARNING! (Continued)**

- Do not allow people to ride in any area of your vehicle that is not equipped with seats and seat belts.
- Be sure everyone in your vehicle is in a seat and using a seat belt properly.
- Wearing your seat belt incorrectly could make your injuries in a collision much worse. You might suffer internal injuries, or you could even slide out of the seat belt. Follow these instructions to wear your seat belt safely and to keep your passengers safe, too.
- Two people should never be belted into a single seat belt. People belted together can crash into one another in a collision, hurting one another badly. Never use a lap/shoulder belt or a lap belt for more than one person, no matter what their size.

*(Continued)*

**WARNING! (Continued)**

- A lap belt worn too high can increase the risk of injury in a collision. The seat belt forces won't be at the strong hip and pelvic bones, but across your abdomen. Always wear the lap part of your seat belt as low as possible and keep it snug.
- A twisted seat belt may not protect you properly. In a collision, it could even cut into you. Be sure the seat belt is flat against your body, without twists. If you can't straighten a seat belt in your vehicle, take it to your authorized dealer immediately and have it fixed.
- A seat belt that is buckled into the wrong buckle will not protect you properly. The lap portion could ride too high on your body, possibly causing internal injuries. Always buckle your seat belt into the buckle nearest you.

*(Continued)*

**WARNING! (Continued)**

- A seat belt that is too loose will not protect you properly. In a sudden stop, you could move too far forward, increasing the possibility of injury. Wear your seat belt snugly.
- A seat belt that is worn under your arm is dangerous. Your body could strike the inside surfaces of the vehicle in a collision, increasing head and neck injury. A seat belt worn under the arm can cause internal injuries. Ribs aren't as strong as shoulder bones. Wear the seat belt over your shoulder so that your strongest bones will take the force in a collision.
- A shoulder belt placed behind you will not protect you from injury during a collision. You are more likely to hit your head in a collision if you do not wear your shoulder belt. The lap and shoulder belt are meant to be used together.

(Continued)



Information Provided by:  
**DEALER**  
E-PROCESS

**WARNING! (Continued)**

- A frayed or torn seat belt could rip apart in a collision and leave you with no protection. Inspect the seat belt system periodically, checking for cuts, frays, or loose parts. Damaged parts must be replaced immediately. Do not disassemble or modify the seat belt system. Seat belt assemblies must be replaced after a collision.

**Lap/Shoulder Belt Operating Instructions**

1. Enter the vehicle and close the door. Sit back and adjust the seat.
2. The seat belt latch plate is above the back of the front seat, and next to your arm in the rear seat (for vehicles equipped with a rear seat). Grasp the latch plate and pull out the seat belt. Slide the latch plate up the webbing as far as necessary to allow the seat belt to go around your lap.



**Pulling Out The Latch Plate**

3. When the seat belt is long enough to fit, insert the latch plate into the buckle until you hear a “click.”

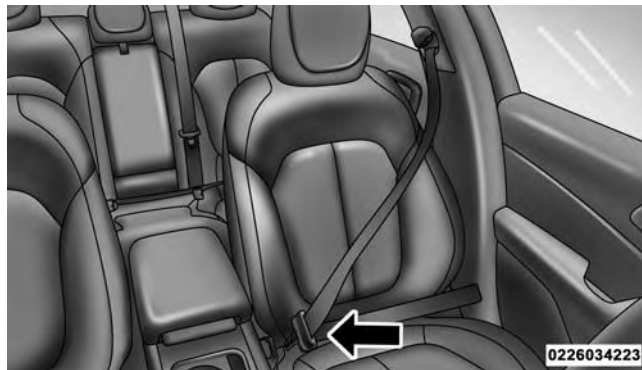

**Inserting Latch Plate Into Buckle**

4. Position the lap belt so that it is snug and lies low across your hips, below your abdomen. To remove slack in the lap belt portion, pull up on the shoulder belt. To loosen the lap belt if it is too tight, tilt the latch plate and pull on the lap belt. A snug seat belt reduces the risk of sliding under the seat belt in a collision.



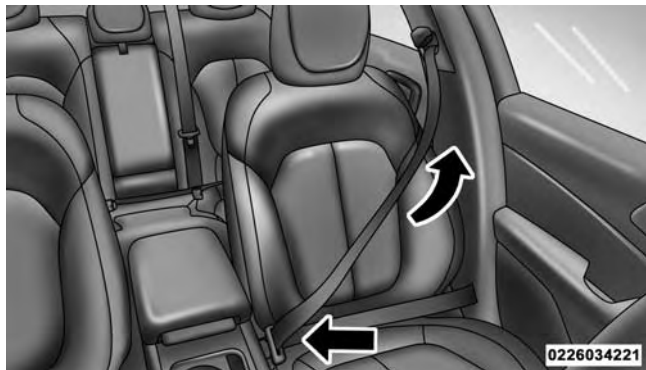

### Positioning The Lap Belt

5. Position the shoulder belt across the shoulder and chest with minimal, if any slack so that it is comfortable and not resting on your neck. The retractor will withdraw any slack in the shoulder belt.
6. To release the belt, push the red button on the buckle. The seat belt will automatically retract to its stowed

position. If necessary, slide the latch plate down the webbing to allow the seat belt to retract fully.

### Lap/Shoulder Belt Untwisting Procedure

2

Use the following procedure to untwist a twisted lap/shoulder belt.

1. Position the latch plate as close as possible to the anchor point.
2. At about 6 to 12 in (15 to 30 cm) above the latch plate, grasp and twist the seat belt webbing 180 degrees to create a fold that begins immediately above the latch plate.
3. Slide the latch plate upward over the folded webbing. The folded webbing must enter the slot at the top of the latch plate.
4. Continue to slide the latch plate up until it clears the folded webbing and the seat belt is no longer twisted.

## Adjustable Upper Shoulder Belt Anchorage

In the driver and front passenger seats, the top of the shoulder belt can be adjusted upward or downward to position the seat belt away from your neck. Push or squeeze the anchorage button to release the anchorage, and move it up or down to the position that serves you best.

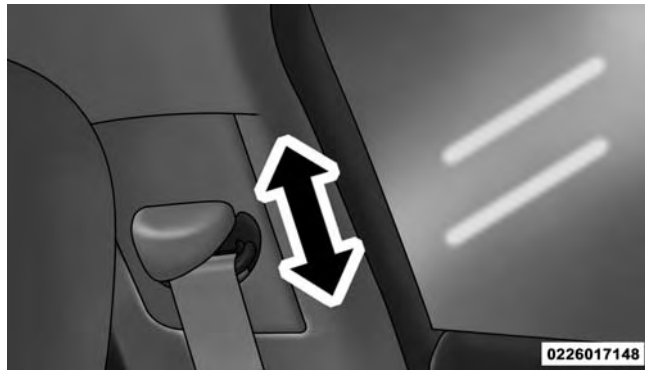

Adjustable Anchorage

As a guide, if you are shorter than average, you will prefer the shoulder belt anchorage in a lower position, and if you are taller than average, you will prefer the shoulder belt anchorage in a higher position. After you release the anchorage button, try to move it up or down to make sure that it is locked in position.

**NOTE:** The adjustable upper shoulder belt anchorage is equipped with an Easy Up feature. This feature allows the shoulder belt anchorage to be adjusted in the upward position without pushing or squeezing the release button. To verify the shoulder belt anchorage is latched, pull downward on the shoulder belt anchorage until it is locked into position.

## Seat Belt Extender

If a seat belt is not long enough to fit properly, even when the webbing is fully extended and the adjustable upper shoulder belt anchorage (if equipped) is in its lowest position, your authorized dealer can provide you with a

Seat Belt Extender. The Seat Belt Extender should be used only if the existing seat belt is not long enough. When the Seat Belt Extender is not required for a different occupant, it must be removed.

### WARNING!

- **ONLY** use a Seat Belt Extender if it is physically required in order to properly fit the original seat belt system. **DO NOT USE** the Seat Belt Extender if, when worn, the distance between the front edge of the Seat Belt Extender buckle and the center of the occupant's body is **LESS** than 6 inches.
- Using a Seat Belt Extender when not needed can increase the risk of serious injury or death in a collision. Only use the Seat Belt Extender when the lap belt is not long enough and only use in the recommended seating positions. Remove and store the Seat Belt Extender when not needed.

## Seat Belts And Pregnant Women

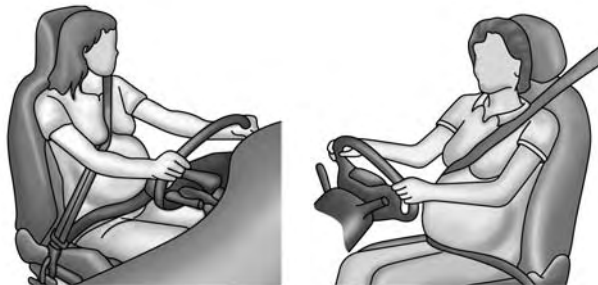

0226075266

### Pregnant Women And Seat Belts

Seat belts must be worn by all occupants including pregnant women: the risk of injury in the event of an accident is reduced for the mother and the unborn child if they are wearing a seat belt.

Position the lap belt snug and low below the abdomen and across the strong bones of the hips. Place the shoulder belt across the chest and away from the neck. Never place the shoulder belt behind the back or under the arm .

### Seat Belt Pretensioner

The front seat belt system is equipped with pretensioning devices that are designed to remove slack from the seat belt in the event of a collision. These devices may improve the performance of the seat belt by removing slack from the seat belt early in a collision. Pretensioners work for all size occupants, including those in child restraints.

**NOTE:** These devices are not a substitute for proper seat belt placement by the occupant. The seat belt still must be worn snugly and positioned properly.

The pretensioners are triggered by the Occupant Restraint Controller (ORC). Like the air bags, the pretensioners are single use items. A deployed pretensioner or a deployed air bag must be replaced immediately.

### Energy Management Feature

This vehicle has a seat belt system with an Energy Management feature in the front seating positions that may help further reduce the risk of injury in the event of a collision. This seat belt system has a retractor assembly that is designed to release webbing in a controlled manner.

### Switchable Automatic Locking Retractors (ALR)

The seat belts in the passenger seating positions are equipped with a Switchable Automatic Locking Retractor (ALR) which is used to secure a child restraint system. For additional information, refer to “Installing Child Restraints Using The Vehicle Seat Belt” under the “Child

Restraints” section of this manual. The table below defines the type of feature for each seating position.

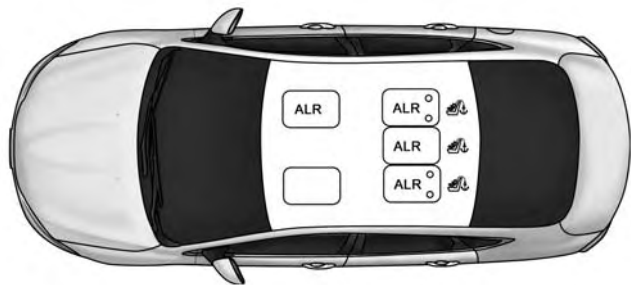

0226017160

**ALR — Automatic Locking Retractor**

If the passenger seating position is equipped with an ALR and is being used for normal usage, only pull the seat belt webbing out far enough to comfortably wrap around the occupant’s mid-section so as to not activate the ALR. If the ALR is activated, you will hear a clicking sound as the seat belt retracts. Allow the webbing to retract completely in this case and then carefully pull out only the amount of webbing necessary to comfortably wrap around the occupant’s mid-section. Slide the latch plate into the buckle until you hear a “click.”

In Automatic Locking Mode, the shoulder belt is automatically pre-locked. The seat belt will still retract to remove any slack in the shoulder belt. Use the Automatic Locking Mode anytime a child restraint is installed in a seating position that has a seat belt with this feature. Children 12 years old and under should always be properly restrained in a vehicle with a rear seat.

**WARNING!**

- **Never place a rear-facing child restraint in front of an air bag. A deploying Passenger Advanced Front Air Bag can cause death or serious injury to a child 12 years or younger, including a child in a rear-facing child restraint.**
- **Only use a rear-facing child restraint in a vehicle with a rear seat.**

**How To Engage The Automatic Locking Mode**

1. Buckle the combination lap and shoulder belt.
2. Grasp the shoulder portion and pull downward until the entire seat belt is extracted.
3. Allow the seat belt to retract. As the seat belt retracts, you will hear a clicking sound. This indicates the seat belt is now in the Automatic Locking Mode.

**How To Disengage The Automatic Locking Mode**

Unbuckle the combination lap/shoulder belt and allow it to retract completely to disengage the Automatic Locking Mode and activate the vehicle sensitive (emergency) locking mode.

**WARNING!**

- **The seat belt assembly must be replaced if the switchable Automatic Locking Retractor (ALR) feature or any other seat belt function is not working properly when checked according to the procedures in the Service Manual.**
- **Failure to replace the seat belt assembly could increase the risk of injury in collisions.**

*(Continued)*

**WARNING! (Continued)**

- Do not use the Automatic Locking Mode to restrain occupants who are wearing the seat belt or children who are using booster seats. The locked mode is only used to install rear-facing or forward-facing child restraints that have a harness for restraining the child.

**Supplemental Restraint System (SRS)****Air Bag System Components**

Your vehicle may be equipped with the following air bag system components:

- Occupant Restraint Controller (ORC)
- Air Bag Warning Light 

- Steering Wheel and Column
- Instrument Panel
- Knee Impact Bolsters
- Advanced Front Air Bags
- Supplemental Side Air Bags
- Supplemental Knee Air Bags
- Front and Side Impact Sensors
- Seat Belt Pretensioners
- Seat Belt Buckle Switch
- Seat Track Position Sensors
- Occupant Classification System

## Advanced Front Air Bags

This vehicle has Advanced Front Air Bags for both the driver and front passenger as a supplement to the seat belt restraint systems. The driver's Advanced Front Air Bag is mounted in the center of the steering wheel. The passenger's Advanced Front Air Bag is mounted in the instrument panel, above the glove compartment. The words "SRS AIRBAG" or "AIRBAG" are embossed on the air bag covers.



0220032530

### Advanced Front Air Bag And Knee Impact Bolster Locations

- 1 — Driver And Passenger Advanced Front Air Bags
- 2 — Passenger Knee Impact Bolster / Supplemental Passenger Knee Air Bag
- 3 — Driver Knee Impact Bolster / Supplemental Driver Knee Air Bag



**WARNING!**

- **Being too close to the steering wheel or instrument panel during Advanced Front Air Bag deployment could cause serious injury, including death. Air bags need room to inflate. Sit back, comfortably extending your arms to reach the steering wheel or instrument panel.**
- **Never place a rear-facing child restraint in front of an air bag. A deploying Passenger Advanced Front Air Bag can cause death or serious injury to a child 12 years or younger, including a child in a rear-facing child restraint.**
- **Only use a rear-facing child restraint in a vehicle with a rear seat.**

### Advanced Front Air Bag Features

The Advanced Front Air Bag system has multistage driver and front passenger air bags. This system provides

output appropriate to the severity and type of collision as determined by the Occupant Restraint Controller (ORC), which may receive information from the front impact sensors or other system components.

The first stage inflator is triggered immediately during an impact that requires air bag deployment. A low energy output is used in less severe collisions. A higher energy output is used for more severe collisions.

This vehicle may be equipped with driver and/or front passenger seat track position sensors that may adjust the inflation rate of the Advanced Front Air Bags based upon seat position.

This vehicle may be equipped with a driver and/or front passenger seat belt buckle switch that detects whether the driver or front passenger seat belt is buckled. The seat belt buckle switch may adjust the inflation rate of the Advanced Front Air Bags.

## Advanced Air Bag Features

This vehicle is equipped with a right front passenger Occupant Classification System (“OCS”) that is designed to provide Passenger Advanced Front Air Bag output appropriate to the occupant’s seated weight input, as determined by the OCS.

### WARNING!

- No objects should be placed over or near the air bag on the instrument panel or steering wheel, because any such objects could cause harm if the vehicle is in a collision severe enough to cause the air bags to inflate.
- Do not put anything on or around the air bag covers or attempt to open them manually. You may damage the air bags and you could be injured because the air bags may no longer be functional.

### WARNING! (Continued)

The protective covers for the air bag cushions are designed to open only when the air bags are inflating.

- Relying on the air bags alone could lead to more severe injuries in a collision. The air bags work with your seat belt to restrain you properly. In some collisions, air bags won’t deploy at all. Always wear your seat belts even though you have air bags.

## Advanced Front Air Bag Operation

Advanced Front Air Bags are designed to provide additional protection by supplementing the seat belts. Advanced Front Air Bags are not expected to reduce the risk of injury in rear, side, or rollover collisions. The Advanced Front Air Bags will not deploy in all frontal collisions, including some that may produce substantial

(Continued)



vehicle damage — for example, some pole collisions, truck underrides, and angle offset collisions.

On the other hand, depending on the type and location of impact, Advanced Front Air Bags may deploy in crashes with little vehicle front-end damage but that produce a severe initial deceleration.

Because air bag sensors measure vehicle deceleration over time, vehicle speed and damage by themselves are not good indicators of whether or not an air bag should have deployed.

Seat belts are necessary for your protection in all collisions, and also are needed to help keep you in position, away from an inflating air bag.

When the ORC detects a collision requiring the Advanced Front Air Bags, it signals the inflator units. A large quantity of non-toxic gas is generated to inflate the Advanced Front Air Bags.

The steering wheel hub trim cover and the upper right side of the instrument panel separate and fold out of the way as the air bags inflate to their full size. The Advanced Front Air Bags fully inflate in less time than it takes to blink your eyes. The air bags then quickly deflate while helping to restrain the driver and front passenger.

### **Occupant Classification System (OCS) — Front Passenger Seat**

The OCS is part of a Federally regulated safety system for this vehicle. It is designed to provide Passenger Advanced Front Air Bag output appropriate to the occupant's seated weight, as determined by the OCS.

The Occupant Classification System (OCS) consists of the following:

- Occupant Restraint Controller (ORC)
- Occupant Classification Module (OCM) and Sensor located in the front passenger seat
- Air Bag Warning Light 

### Occupant Classification Module (OCM) and Sensor

The Occupant Classification Module (OCM) is located underneath the front passenger seat. The Sensor is located beneath the passenger seat cushion foam. Any weight on the seat will be sensed by the Sensor. The OCM uses input from the Sensor to determine the front passenger's most probable classification. The OCM communicates this information to the ORC. The ORC may reduce the inflation rate of the Passenger Advanced Front Air Bag deployment based on occupant classification. In order for the OCS to operate as designed, it is important for the front passenger to be seated properly and properly wearing the seat belt.

The OCS will NOT prevent deployment of the Passenger Advanced Front Air Bag. The OCS may reduce the inflation rate of the Passenger Advanced Front Air Bag if the OCS estimates that:

- The front passenger seat is unoccupied or has very light objects on it; or
- The front passenger seat is occupied by a small passenger, including a child; or
- The front passenger seat is occupied by a rear-facing child restraint; or
- The front passenger is not properly seated or his or her weight is taken off of the seat for a period of time.

Front Passenger Seat Occupant Status	Front Passenger Air Bag Output
Rear-facing child restraint	Reduced-power deployment
Child, including a child in a forward-facing child restraint or booster seat*	Reduced-power deployment OR Full-power deployment
Properly seated adult	Full-power deployment OR reduced-power deployment
Unoccupied seat	Reduced-power deployment

\* It is possible for a child to be classified as an adult, allowing a full-power Passenger Advanced Front Air Bag deployment. Never allow children to ride in the front passenger seat and never install a child restraint system, including a rear-facing child restraint, in the front passenger seat.

### WARNING!

- Never place a rear-facing child restraint in front of an air bag. A deploying Passenger Advanced Front Air Bag can cause death or serious injury to a child 12 years or younger, including a child in a rear-facing child restraint.
- Only use a rear-facing child restraint in a vehicle with a rear seat.
- Children 12 years or younger should always ride buckled up in a rear seat.

The OCS determines the front passenger's most probable classification. The OCS estimates the seated weight on the front passenger seat and where that weight is located. The OCS communicates the classification status to the ORC. The ORC uses the classification to determine whether the Passenger Advanced Front Air Bag inflation rate should be adjusted.

## 68 THINGS TO KNOW BEFORE STARTING YOUR VEHICLE

In order for the OCS to operate as designed, it is important for the front passenger to be seated properly and properly wearing the seat belt. Properly seated passengers are:

- Sitting upright
- Facing forward
- Sitting in the center of the seat with their feet comfortably on or near the floor
- Sitting with their back against the seatback and the seatback in an upright position



### Seated Properly

### Lighter Weight Passengers (Including Small Adults)

When a lighter weight passenger, including a small adult, occupies the front passenger seat, the OCS may reduce the inflation rate of the Passenger Advanced Front Air Bag. This does not mean that the OCS is working improperly.

### Do not decrease OR increase the front passenger's seated weight on the front passenger seat

The front passenger's seated weight must be properly positioned on the front passenger seat. Failure to do so may result in serious injury or death. The OCS determines the most probable classification of the occupant that it detects.

The OCS will detect the front passenger's decreased or increased seated weight, which may result in an adjusted inflation rate of the Passenger Advanced Front Air Bag in a collision. This does not mean that the OCS is working improperly.

Decreasing the front passenger's seated weight on the front passenger seat may result in a reduced-power deployment of the Passenger Advanced Front Air Bag. Increasing the front passenger's seated weight on the front passenger seat may result in a full-power deployment of the Passenger Advanced Front Air Bag.

Examples of improper front passenger seating include:

- The front passenger's weight is transferred to another part of the vehicle (like the door, arm rest or instrument panel).
- The front passenger leans forward, sideways, or turns to face the rear of the vehicle.
- The front passenger's seatback is not in the full upright position.
- The front passenger carries or holds an object while seated (e.g., backpack, box, etc.).
- Objects are lodged under the front passenger seat.
- Objects are lodged between the front passenger seat and center console.
- Accessories that may change the seated weight on the front passenger seat are attached to the front passenger seat.

## 70 THINGS TO KNOW BEFORE STARTING YOUR VEHICLE

- Anything that may decrease or increase the front passenger's seated weight.

The OCS determines the front passenger's most probable classification. If an occupant in the front passenger seat is seated improperly, the occupant may provide an output signal to the OCS that is different from the occupant's properly seated weight input, for example:

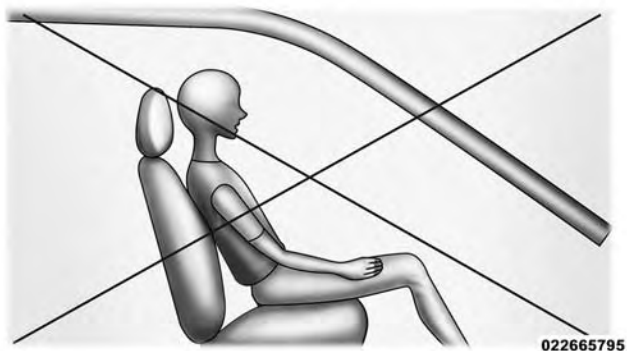

**Not Seated Properly**



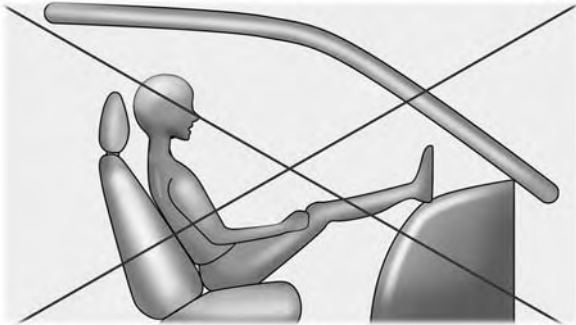

022665796

Not Seated Properly

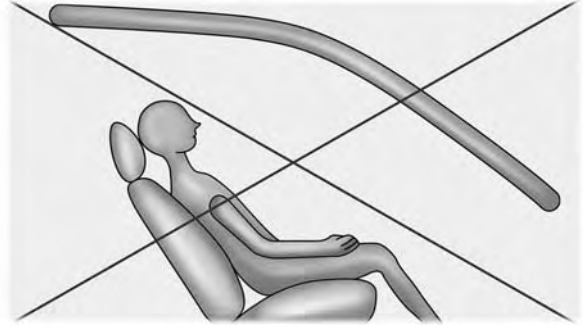

022665798

Not Seated Properly

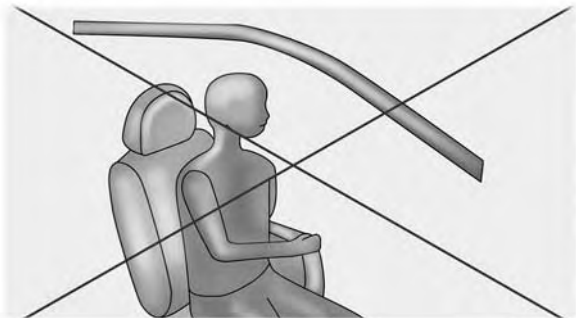

022665799

Not Seated Properly

**WARNING!**

- If an occupant in the front passenger seat is seated improperly, the occupant may provide an output signal to the OCS that is different from the occupant's properly seated weight input. This may result in serious injury or death in a collision.
- Always wear your seat belt and sit properly, with the seatback in an upright position, your back against the seatback, sitting upright, facing forward, in the center of the seat, with your feet comfortably on or near the floor.
- Do not carry or hold any objects (e.g., backpacks, boxes, etc.) while seated in the front passenger seat. Holding an object may provide an output signal to the OCS that is different than the occupant's properly seated weight input, which may result in serious injury or death in a collision.

*(Continued)*

**WARNING! (Continued)**

- **Placing an object on the floor under the front passenger seat may prevent the OCS from working properly, which may result in serious injury or death in a collision. Do not place any objects on the floor under the front passenger seat.**

The Air Bag Warning Light  in the instrument panel will turn on whenever the OCS is unable to classify the front passenger seat status. A malfunction in the OCS may affect the operation of the air bag system.

If the Air Bag Warning Light  does not come on, or stays on after you start the vehicle, or it comes on as you drive, take the vehicle to an authorized dealer for service immediately.

The passenger seat assembly contains critical OCS components that may affect the Passenger Advanced Front Air Bag inflation. In order for the OCS to properly

classify the seated weight of a front seat passenger, the OCS components must function as designed.

Do not make any modifications to the front passenger seat components, assembly, or to the seat cover. If the seat, trim cover, or cushion needs service for any reason, take the vehicle to your authorized dealer. Only FCA LLC approved seat accessories may be used.

The following requirements must be strictly followed:

- Do not modify the front passenger seat assembly or components in any way.
- Do not use prior or future model year seat covers or cushions not designated by FCA US LLC for the specific model being repaired. Always use the correct seat cover and cushion specified for the vehicle.
- Do not replace the seat cover or cushion with an aftermarket seat cover or cushion.

## 74 THINGS TO KNOW BEFORE STARTING YOUR VEHICLE

- Do not add a secondary seat cover or mat.
- At no time should any Supplemental Restraint System (SRS) component or SRS related component or fastener be modified or replaced with any part except those which are approved by FCA US LLC.

### **WARNING!**

Unapproved modifications or service procedures to the passenger seat assembly, its related components, seat cover or cushion may inadvertently change the air bag deployment in case of a frontal collision. This could result in death or serious injury to the front passenger if the vehicle is involved in a collision. A modified vehicle may not comply with required Federal Motor Vehicle Safety Standards (FMVSS) and/or Canadian Motor Vehicle Safety Standards (CMVSS).

### **Knee Impact Bolsters**

The Knee Impact Bolsters help protect the knees of the driver and front passenger, and position the front occupants for improved interaction with the Advanced Front Air Bags.

### **WARNING!**

- Do not drill, cut, or tamper with the knee impact bolsters in any way.
- Do not mount any accessories to the knee impact bolsters such as alarm lights, stereos, citizen band radios, etc.

## Supplemental Driver And Front Passenger Knee Air Bags

This vehicle is equipped with a Supplemental Driver Knee Air Bag mounted in the instrument panel below the steering column and a Supplemental Passenger Knee Air Bag mounted in the instrument panel below the glove compartment. The Supplemental Knee Air Bags provide enhanced protection during a frontal impact by working together with the seat belts, pretensioners, and Advanced Front Air Bags.

## Supplemental Side Air Bags

Your vehicle is equipped with two types of side air bags:

1. **Supplemental Seat-Mounted Side Air Bags (SABs):** Located in the outboard side of the front seats. The SABs are marked with a "SRS AIRBAG" or "AIR-BAG" label sewn into the outboard side of the seats.

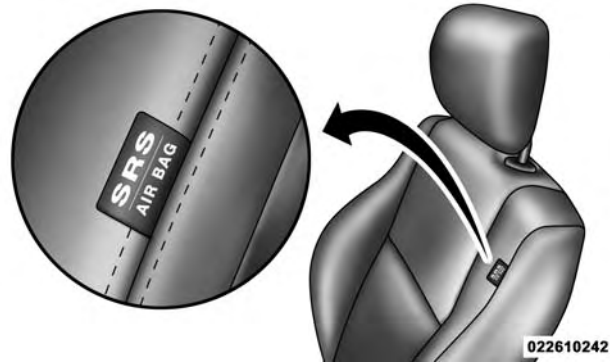

### Front Supplemental Seat-Mounted Side Air Bag Label

The SABs may help to reduce the risk of occupant injury during certain side impacts and/or vehicle rollover events, in addition to the injury reduction potential provided by the seat belts and body structure.

When the SAB deploys, it opens the seam on the outboard side of the seatback's trim cover. The inflating SAB

## 76 THINGS TO KNOW BEFORE STARTING YOUR VEHICLE

deploys through the seat seam into the space between the occupant and the door. The SAB moves at a very high speed and with such a high force that it could injure occupants if they are not seated properly, or if items are positioned in the area where the SAB inflates. Children are at an even greater risk of injury from a deploying air bag.

### WARNING!

Do not use accessory seat covers or place objects between you and the Side Air Bags; the performance could be adversely affected and/or objects could be pushed into you, causing serious injury.

2. Supplemental Side Air Bag Inflatable Curtains (SABICs): Located above the side windows. The trim covering the SABICs is labeled "SRS AIRBAG" or "AIRBAG."



Supplemental Side Air Bag Inflatable Curtain (SABIC)  
Label Location

SABICs may help reduce the risk of head or other injuries to front and rear seat outboard occupants in certain side impacts and/or vehicle rollover events, in addition to the injury reduction potential provided by the seat belts and body structure.

The SABICs deploy downward, covering the side windows. An inflating SABIC pushes the outside edge of the trim out of the way and covers the window. The SABICs inflate with enough force to injure occupants if they are not belted and seated properly, or if items are positioned in the area where the SABICs inflate. Children are at an even greater risk of injury from a deploying air bag.

The SABICs may help reduce the risk of partial or complete ejection of vehicle occupants through side windows in certain rollover or side impact events.

### WARNING!

- **Your vehicle is equipped with left and right Supplemental Side Air Bag Inflatable Curtains (SABICs). Do not stack luggage or other cargo up high enough to block the deployment of the SABICs. The trim covering above the side windows where the SABIC and its deployment path are located should remain free from any obstructions.**
- **Your vehicle is equipped with SABICs. In order for the SABICs to work as intended, do not install any accessory items in your vehicle which could alter the roof. Do not add an aftermarket sunroof to your vehicle. Do not add roof racks that require permanent attachments (bolts or screws) for installation on the vehicle roof. Do not drill into the roof of the vehicle for any reason.**

## 78 THINGS TO KNOW BEFORE STARTING YOUR VEHICLE

The SABICs and SABs (“Side Air Bags”) are designed to activate in certain side impacts and certain rollover events. The Occupant Restraint Controller (“ORC”) determines whether the deployment of the Side Air Bags in a particular side impact or rollover event is appropriate, based on the severity and type of collision. Vehicle damage by itself is not a good indicator of whether or not Side Air Bags should have deployed.

Side Air Bags are a supplement to the seat belt restraint system. Side Air Bags deploy in less time than it takes to blink your eyes. Occupants, including children, who are up against or very close to Side Air Bags can be seriously injured or killed. Occupants, including children, should never lean on or sleep against the door, side windows, or area where the Side Air Bags inflate, even if they are in an infant or child restraint.

Seat belts (and child restraints where appropriate) are necessary for your protection in all collisions. They also help keep you in position, away from inflating Side Air Bags. To get the best protection from the Side Air Bags, occupants must wear their seat belts properly and sit upright with their backs against the seats. Children must be properly restrained in a child restraint or booster seat that is appropriate for the size of the child.

### WARNING!

- **Side Air Bags need room to inflate. Do not lean against the door or window. Sit upright in the center of the seat.**
- **Being too close to the Side Air Bags during deployment could cause you to be severely injured or killed.**

*(Continued)*



**WARNING! (Continued)**

- Relying on the Side Air Bags alone could lead to more severe injuries in a collision. The Side Air Bags work with your seat belt to restrain you properly. In some collisions, Side Air Bags won't deploy at all. Always wear your seat belt even though you have Side Air Bags.

**NOTE:** Air bag covers may not be obvious in the interior trim, but they will open during air bag deployment.

**Side Impacts**

In side impacts, the side impact sensors aid the ORC in determining the appropriate response to impact events. The system is calibrated to deploy the Side Air Bags on the impact side of the vehicle during impacts that require Side Air Bag occupant protection. In side impacts, the Side Air Bags deploy independently; a left side impact

deploys the left Side Air Bags only and a right side impact deploys the right Side Air Bags only.

The Side Air Bags will not deploy in all side collisions, including some collisions at certain angles, or some side collisions that do not impact the area of the passenger compartment. The Side Air Bags may deploy during angled or offset frontal collisions where the Advanced Front Air Bags deploy.

**Rollover Events**

Side Air Bags are designed to activate in certain rollover events. The ORC determines whether the deployment of the Side Air Bags in a particular rollover event is appropriate, based on the severity and type of collision. Vehicle damage by itself is not a good indicator of whether or not Side Air Bags should have deployed.

The Side Air Bags will not deploy in all rollover events. The rollover sensing-system determines if a rollover event may be in progress and whether deployment is appropriate. A slower-developing event may deploy the seat belt pretensioners on both sides of the vehicle. A faster-developing event may deploy the seat belt pretensioners as well as the Side Air Bags on both sides of the vehicle. The rollover sensing-system may also deploy the seat belt pretensioners, with or without the Side Air Bags, on both sides of the vehicle if the vehicle experiences a near rollover event.

### **If A Deployment Occurs**

The Advanced Front Air Bags are designed to deflate immediately after deployment.

**NOTE:** Front and/or side air bags will not deploy in all collisions. This does not mean something is wrong with the air bag system.

If you do have a collision which deploys the air bags, any or all of the following may occur:

- The air bag material may sometimes cause abrasions and/or skin reddening to the occupants as the air bags deploy and unfold. The abrasions are similar to friction rope burns or those you might get sliding along a carpet or gymnasium floor. They are not caused by contact with chemicals. They are not permanent and normally heal quickly. However, if you haven't healed significantly within a few days, or if you have any blistering, see your doctor immediately.
- As the air bags deflate, you may see some smoke-like particles. The particles are a normal by-product of the process that generates the non-toxic gas used for air bag inflation. These airborne particles may irritate the skin, eyes, nose, or throat. If you have skin or eye irritation, rinse the area with cool water. For nose or throat irritation, move to fresh air. If the irritation

continues, see your doctor. If these particles settle on your clothing, follow the garment manufacturer's instructions for cleaning.

Do not drive your vehicle after the air bags have deployed. If you are involved in another collision, the air bags will not be in place to protect you.

### WARNING!

**Deployed air bags and seat belt pretensioners cannot protect you in another collision. Have the air bags, seat belt pretensioners, and the seat belt retractor assemblies replaced by an authorized dealer immediately. Also, have the Occupant Restraint Controller System serviced as well.**

#### NOTE:

- Air bag covers may not be obvious in the interior trim, but they will open during air bag deployment.

- After any collision, the vehicle should be taken to an authorized dealer immediately.

### Enhanced Accident Response System

In the event of an impact, if the communication network remains intact, and the power remains intact, depending on the nature of the event, the ORC will determine whether to have the Enhanced Accident Response System perform the following functions:

- Cut off fuel to the engine.
- Flash hazard lights as long as the battery has power or until the hazard light button is pressed. The hazard lights can be deactivated by pressing the hazard light button.
- Turn on the interior lights, which remain on as long as the battery has power.
- Unlock the power door locks.

## Enhanced Accident Response System Reset Procedure

In order to reset the Enhanced Accident Response System functions after an event, the ignition switch must be changed from ignition START or ON/RUN to ignition OFF. Carefully check the vehicle for fuel leaks in the engine compartment and on the ground near the engine compartment and fuel tank before resetting the system and starting the engine.

### Air Bag Warning Light

The air bags must be ready to inflate for your protection in a collision. The Occupant Restraint Controller (ORC) monitors the internal circuits and interconnecting wiring associated with air bag system electrical components.



The ORC monitors the readiness of the electronic parts of the air bag system whenever the ignition switch is in the START or ON/RUN position. If the ignition switch is in

the OFF position or in the ACC position, the air bag system is not on and the air bags will not inflate.

The ORC contains a backup power supply system that may deploy the air bags even if the battery loses power or it becomes disconnected prior to deployment.

The ORC turns on the Air Bag Warning Light in the instrument panel for approximately four to eight seconds for a self-check when the ignition switch is first turned to the ON/RUN position. After the self-check, the Air Bag Warning Light will turn off. If the ORC detects a malfunction in any part of the system, it turns on the Air Bag Warning Light, either momentarily or continuously. A single chime will sound to alert you if the light comes on again after initial startup.

The ORC also includes diagnostics that will illuminate the instrument panel Air Bag Warning Light if a malfunction is detected that could affect the air bag system. The diagnostics also record the nature of the malfunction.

While the air bag system is designed to be maintenance free, if any of the following occurs, have an authorized dealer service the air bag system immediately.

- The Air Bag Warning Light does not come on during the four to eight seconds when the ignition switch is first turned to the ON/RUN position.
- The Air Bag Warning Light remains on after the four to eight-second interval.
- The Air Bag Warning Light comes on intermittently or remains on while driving.

**NOTE:** If the speedometer, tachometer, or any engine related gauges are not working, the Occupant Restraint Controller (ORC) may also be disabled. In this condition the air bags may not be ready to inflate for your protection. Have an authorized dealer service the air bag system immediately.

## WARNING!

**Ignoring the Air Bag Warning Light in your instrument panel could mean you won't have the air bags to protect you in a collision. If the light does not come on as a bulb check when the ignition is first placed in the on position, and stays on after you start the vehicle, or if it comes on as you drive, have an authorized dealer service the air bag system immediately.**

2

### Redundant Air Bag Warning Light

If a fault with the Air Bag Warning Light is detected, which could affect the Supplemental Restraint System ("SRS"), the Redundant Air Bag Warning Light will illuminate on the instrument panel. The Redundant Air Bag Warning Light will stay on until the fault is cleared. In addition, a single chime will sound to alert you that the Redundant Air Bag



Warning Light has come on and a fault has been detected. If the Redundant Air Bag Warning Light comes on intermittently or remains on while driving have an authorized dealer service the vehicle immediately. For additional information regarding the Redundant Air Bag Warning Light refer to the “Instrument Panel” section of this manual.

### Maintaining Your Air Bag System

#### **WARNING!**

- Modifications to any part of the air bag system could cause it to fail when you need it. You could be injured if the air bag system is not there to protect you. Do not modify the components or wiring, including adding any kind of badges or stickers to the steering wheel hub trim cover or the upper right side of the instrument panel. Do not

#### **WARNING! (Continued)**

- modify the front bumper, vehicle body structure, or add aftermarket side steps or running boards.
- It is dangerous to try to repair any part of the air bag system yourself. Be sure to tell anyone who works on your vehicle that it has an air bag system.
- Do not attempt to modify any part of your air bag system. The air bag may inflate accidentally or may not function properly if modifications are made. Take your vehicle to an authorized dealer for any air bag system service. If your seat, including your trim cover and cushion, needs to be serviced in any way (including removal or loosening/tightening of seat attachment bolts), take the vehicle to your authorized dealer. Only manufacturer approved seat accessories may be used. If it is necessary to modify the air bag system for persons with disabilities, contact your authorized dealer.

(Continued) tion Provided by:



## Event Data Recorder (EDR)

This vehicle is equipped with an event data recorder (EDR). The main purpose of an EDR is to record, in certain crash or near crash-like situations, such as an air bag deployment or hitting a road obstacle, data that will assist in understanding how a vehicle's systems performed. The EDR is designed to record data related to vehicle dynamics and safety systems for a short period of time, typically 30 seconds or less. The EDR in this vehicle is designed to record such data as:

- How various systems in your vehicle were operating;
- Whether or not the driver and passenger safety belts were buckled/fastened;
- How far (if at all) the driver was depressing the accelerator and/or brake pedal; and,
- How fast the vehicle was traveling.

These data can help provide a better understanding of the circumstances in which crashes and injuries occur.

**NOTE:** EDR data are recorded by your vehicle only if a non-trivial crash situation occurs; no data are recorded by the EDR under normal driving conditions and no personal data (e.g., name, gender, age, and crash location) are recorded. However, other parties, such as law enforcement, could combine the EDR data with the type of personally identifying data routinely acquired during a crash investigation.

To read data recorded by an EDR, special equipment is required, and access to the vehicle or the EDR is needed. In addition to the vehicle manufacturer, other parties, such as law enforcement, that have the special equipment, can read the information if they have access to the vehicle or the EDR.

## Child Restraints

Everyone in your vehicle needs to be buckled up at all times, including babies and children.

Every state in the United States, and every Canadian province, requires that small children ride in proper restraint systems. This is the law, and you can be prosecuted for ignoring it.

Children 12 years or younger should ride properly buckled up in a rear seat, if available. According to crash statistics, children are safer when properly restrained in the rear seats rather than in the front.

### WARNING!

**In a collision, an unrestrained child can become a projectile inside the vehicle. The force required to hold even an infant on your lap could become so**

### WARNING! (Continued)

**great that you could not hold the child, no matter how strong you are. The child and others could be badly injured. Any child riding in your vehicle should be in a proper restraint for the child's size.**

There are different sizes and types of restraints for children from newborn size to the child almost large enough for an adult safety belt. Always check the child seat Owner's Manual to make sure you have the correct seat for your child. Carefully read and follow all the instructions and warnings in the child restraint Owner's Manual and on all the labels attached to the child restraint.

Before buying any restraint system, make sure that it has a label certifying that it meets all applicable Safety Standards. You should also make sure that you can install it in the vehicle where you will use it.

(Continued)



**NOTE:**

- For additional information, refer to [www.seatcheck.org](http://www.seatcheck.org) or call 1-866-732-8243.

- Canadian residents should refer to Transport Canada's website for additional information: [www.tc.gc.ca/eng/motorvehiclesafety/safedrivers-childsafety-index-53.htm](http://www.tc.gc.ca/eng/motorvehiclesafety/safedrivers-childsafety-index-53.htm)

**Summary Of Recommendations For Restraining Children In Vehicles**

	<b>Child Size, Height, Weight Or Age</b>	<b>Recommended Type Of Child Restraint</b>
Infants and Toddlers	Children who are two years old or younger and who have not reached the height or weight limits of their child restraint	Either an Infant Carrier or a Convertible Child Restraint, facing rearward in the rear seat of the vehicle
Small Children	Children who are at least two years old or who have out-grown the height or weight limit of their rear-facing child restraint	Forward-Facing Child Restraint with a five-point Harness, facing forward in the rear seat of the vehicle

	<b>Child Size, Height, Weight Or Age</b>	<b>Recommended Type Of Child Restraint</b>
Larger Children	Children who have out-grown their forward-facing child restraint, but are too small to properly fit the vehicle's seat belt	Belt Positioning Booster Seat and the vehicle seat belt, seated in the rear seat of the vehicle
Children Too Large for Child Restraints	Children 12 years old or younger, who have out-grown the height or weight limit of their booster seat	Vehicle Seat Belt, seated in the rear seat of the vehicle

### **Infants And Child Restraints**

Safety experts recommend that children ride rear-facing in the vehicle until they are two years old or until they reach either the height or weight limit of their rear-facing child restraint. Two types of child restraints can be used rear-facing: infant carriers and convertible child seats.

The infant carrier is only used rear-facing in the vehicle. It is recommended for children from birth until they

reach the weight or height limit of the infant carrier. Convertible child seats can be used either rear-facing or forward-facing in the vehicle. Convertible child seats often have a higher weight limit in the rear-facing direction than infant carriers do, so they can be used rear-facing by children who have outgrown their infant carrier but are still less than at least two years old. Children should remain rear-facing until they reach the highest weight or height allowed by their convertible child seat.

**WARNING!**

- **Never place a rear-facing child restraint in front of an air bag. A deploying passenger Advanced Front Air Bag can cause death or serious injury to a child 12 years or younger, including a child in a rear-facing child restraint.**
- **Only use a rear-facing child restraint in a vehicle with a rear seat.**

**Older Children And Child Restraints**

Children who are two years old or who have outgrown their rear-facing convertible child seat can ride forward-facing in the vehicle. Forward-facing child seats and convertible child seats used in the forward-facing direction are for children who are over two years old or who have outgrown the rear-facing weight or height limit of their rear-facing convertible child seat. Children should

remain in a forward-facing child seat with a harness for as long as possible, up to the highest weight or height allowed by the child seat.

All children whose weight or height is above the forward-facing limit for the child seat should use a belt-positioning booster seat until the vehicle's seat belts fit properly. If the child cannot sit with knees bent over the vehicle's seat cushion while the child's back is against the seatback, they should use a belt-positioning booster seat. The child and belt-positioning booster seat are held in the vehicle by the seat belt.

**WARNING!**

- **Improper installation can lead to failure of an infant or child restraint. It could come loose in a collision. The child could be badly injured or killed. Follow the child restraint manufacturer's**

*(Continued)*

**WARNING! (Continued)**

directions exactly when installing an infant or child restraint.

- After a child restraint is installed in the vehicle, do not move the vehicle seat forward or rearward because it can loosen the child restraint attachments. Remove the child restraint before adjusting the vehicle seat position. When the vehicle seat has been adjusted, reinstall the child restraint.
- When your child restraint is not in use, secure it in the vehicle with the seat belt or LATCH anchorages, or remove it from the vehicle. Do not leave it loose in the vehicle. In a sudden stop or accident, it could strike the occupants or seatbacks and cause serious personal injury.

**Children Too Large For Booster Seats**

Children who are large enough to wear the shoulder belt comfortably, and whose legs are long enough to bend over the front of the seat when their back is against the seatback, should use the seat belt in a rear seat. Use this simple 5-step test to decide whether the child can use the vehicle's seat belt alone:

1. Can the child sit all the way back against the back of the vehicle seat?
2. Do the child's knees bend comfortably over the front of the vehicle seat – while they are still sitting all the way back?
3. Does the shoulder belt cross the child's shoulder between their neck and arm?
4. Is the lap part of the belt as low as possible, touching the child's thighs and not their stomach?

5. Can the child stay seated like this for the whole trip?

If the answer to any of these questions was “no,” then the child still needs to use a booster seat in this vehicle. If the child is using the lap/shoulder belt, check seat belt fit periodically and make sure the seat belt buckle is latched. A child’s squirming or slouching can move the belt out of position. If the shoulder belt contacts the face or neck, move the child closer to the center of the vehicle, or use a booster seat to position the seat belt on the child correctly.

### WARNING!

**Never allow a child to put the shoulder belt under an arm or behind their back. In a crash, the shoulder belt will not protect a child properly, which may result in serious injury or death. A child must always wear both the lap and shoulder portions of the seat belt correctly.**

2

## Recommendations For Attaching Child Restraints

Restraint Type	Combined Weight of the Child + Child Restraint	Use any attachment method shown with an "X" Below			
		LATCH – Lower Anchors Only	Seat Belt Only	LATCH – Lower Anchors + Top Tether Anchor	Seat Belt + Top Tether Anchor
Rear-Facing Child Restraint	Up to 65 lbs (29.5 kg)	X	X		
Rear-Facing Child Restraint	More than 65 lbs (29.5 kg)		X		
Forward-Facing Child Restraint	Up to 65 lbs (29.5 kg)			X	X
Forward-Facing Child Restraint	More than 65 lbs (29.5 kg)				X

## Lower Anchors And Tethers For CHildren (LATCH) Restraint System





022668173

Your vehicle is equipped with the child restraint anchorage system called LATCH, which stands for Lower Anchors and Tethers for CHildren. The LATCH system has three vehicle anchor points for installing LATCH-equipped child seats. There are two lower anchorages located at the back of the seat cushion where it meets the seatback and one top tether anchorage located behind the seating position. These anchorages are used to install LATCH-equipped child seats without using the vehicle's seat belts. Some seating positions may have a top tether anchorage but no lower anchorages. In these seating positions, the seat belt must be used with the top tether anchorage to install the child restraint. Please see the following table for more information.

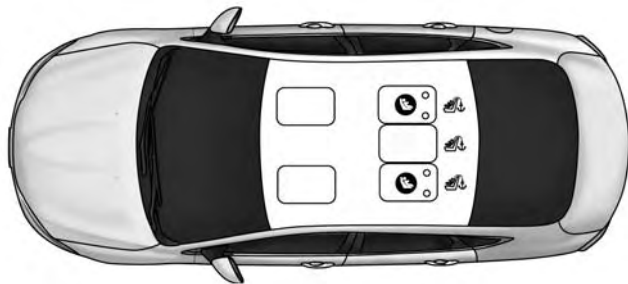
## LATCH Positions For Installing Child Restraints In This Vehicle



0226017157

-  Lower Anchorage Symbol : 2 anchorages per seating position
-  Top Tether Anchorage Symbol



Frequently Asked Questions About Installing Child Restraints With LATCH		
What is the weight limit (child's weight + weight of the child restraint) for using the LATCH anchorage system to attach the child restraint?	65 lbs (29.5 kg)	Use the LATCH anchorage system until the combined weight of the child and the child restraint is 65 lbs (29.5 kg). Use the seat belt and tether anchor instead of the LATCH anchorage system once the combined weight is more than 65 lbs (29.5 kg).
Can the LATCH anchorages and the seat belt be used together to attach a rear-facing or forward-facing child restraint?	No	Do not use the seat belt when you use the LATCH anchorage system to attach a rear-facing or forward-facing child restraint.

Frequently Asked Questions About Installing Child Restraints With LATCH		
Can a child seat be installed in the center position using the inner LATCH lower anchorages?	Yes	You can install child restraints with flexible lower anchors in the center position. The inner anchorages are 17.7 inches (450 mm) apart. Do not install child restraints with rigid lower anchors in the center position.
Can two child restraints be attached using a common lower LATCH anchorage?	No	Never “share” a LATCH anchorage with two or more child restraints. If the center position does not have dedicated LATCH lower anchorages, use the seat belt to install a child seat in the center position next to a child seat using the LATCH anchorages in an outboard position.

Frequently Asked Questions About Installing Child Restraints With LATCH		
Can the rear-facing child restraint touch the back of the front passenger seat?	Yes	The child seat may touch the back of the front passenger seat if the child restraint manufacturer also allows contact. See your child restraint owner's manual for more information.
Can the head restraints be removed?	Yes	All head restraints may be removed

## Locating LATCH Anchorages



The lower anchorages are round bars that are found at the rear of the seat cushion where it meets the seatback, below the anchorage symbols on the seatback. They are just visible when you lean into the rear seat to install the child restraint. You will easily feel them if you run your finger along the gap between the seatback and seat cushion.

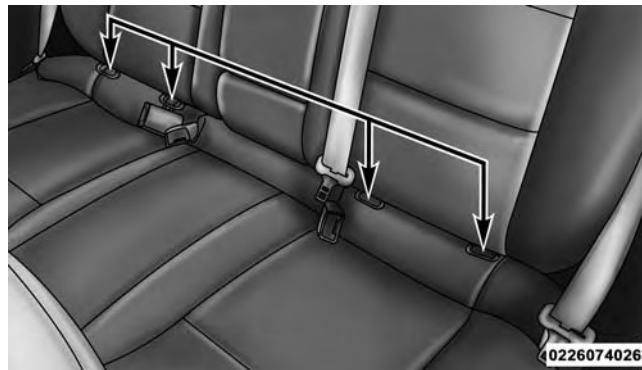

Rear Seat LATCH Anchorages

## Locating Tether Anchorages



There are tether strap anchorages behind each rear seating position located in the panel between the rear seatback and the rear window. They are found under a plastic cover with the tether anchorage symbol on it.

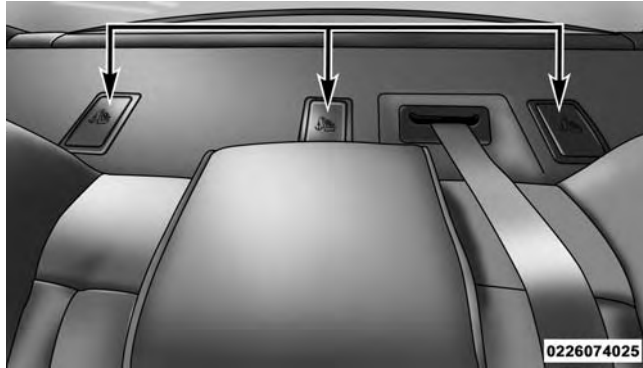

Tether Strap Anchorages

LATCH-compatible child restraint systems will be equipped with a rigid bar or a flexible strap on each side. Each will have a hook or connector to attach to the lower anchorage and a way to tighten the connection to the anchorage. Forward-facing child restraints and some rear-facing child restraints will also be equipped with a tether strap. The tether strap will have a hook at the end to attach to the top tether anchorage and a way to tighten the strap after it is attached to the anchorage.

## Center Seat LATCH

Do not install child restraints with rigid lower attachments in the center seating position. Only install this type of child restraint in the outboard seating positions. Child restraints with flexible, webbing mounted lower attachments can be installed in any rear seating position.

**WARNING!**

Never use the same lower anchorage to attach more than one child restraint. If you are installing LATCH-compatible child restraints next to each other, you must use the seat belt for the center position. You can then use either the LATCH anchors or the vehicle's seat belt for installing child seats in the outboard positions. Please refer to "Installing The LATCH-Compatible Child Restraint System" for typical installation instructions.

Always follow the directions of the child restraint manufacturer when installing your child restraint. Not all child restraint systems will be installed as described here.

**To Install A LATCH-Compatible Child Restraint**

If the selected seating position has a Switchable Automatic Locking Retractor (ALR) seat belt, stow the seat

belt, following the instructions below. See the section "Installing Child Restraints Using the Vehicle Seat Belt" to check what type of seat belt each seating position has.

1. Loosen the adjusters on the lower straps and on the tether strap of the child seat so that you can more easily attach the hooks or connectors to the vehicle anchorages.
2. Place the child seat between the lower anchorages for that seating position. For some second row seats, you may need to recline the seat and / or raise the head restraint to get a better fit. If the rear seat can be moved forward and rearward in the vehicle, you may wish to move it to its rear-most position to make room for the child seat. You may also move the front seat forward to allow more room for the child seat.
3. Attach the lower hooks or connectors of the child restraint to the lower anchorages in the selected seating position.

4. If the child restraint has a tether strap, connect it to the top tether anchorage. See the section “Installing Child Restraints Using the Top Tether Anchorage” for directions to attach a tether anchor.
5. Tighten all of the straps as you push the child restraint rearward and downward into the seat. Remove slack in the straps according to the child restraint manufacturer’s instructions.
6. Test that the child restraint is installed tightly by pulling back and forth on the child seat at the belt path. It should not move more than 1 inch (25.4 mm) in any direction.

### How To Stow An Unused ALR Seat Belt:

When using the LATCH attaching system to install a child restraint, stow all ALR seat belts that are not being used by other occupants or being used to secure child restraints. An unused belt could injure a child if they play with it and accidentally lock the seat belt retractor. Before installing a child restraint using the LATCH system, buckle the seat belt behind the child restraint and out of the child’s reach. If the buckled seat belt interferes with the child restraint installation, instead of buckling it behind the child restraint, route the seat belt through the child restraint belt path and then buckle it. Do not lock the seat belt. Remind all children in the vehicle that the seat belts are not toys and that they should not play with them.

**WARNING!**

- **Improper installation of a child restraint to the LATCH anchorages can lead to failure of the restraint. The child could be badly injured or killed. Follow the child restraint manufacturer's directions exactly when installing an infant or child restraint.**
- **Child restraint anchorages are designed to withstand only those loads imposed by correctly-fitted child restraints. Under no circumstances are they to be used for adult seat belts, harnesses, or for attaching other items or equipment to the vehicle.**

**Installing Child Restraints Using The Vehicle Seat Belt**

The seat belts in the passenger seating positions are equipped with a Switchable Automatic Locking Retractor (ALR) that is designed to keep the lap portion of the seat belt tight around the child restraint so that it is not necessary to use a locking clip. The ALR retractor can be "switched" into a locked mode by pulling all of the webbing out of the retractor and then letting the webbing retract back into the retractor. If it is locked, the ALR will make a clicking noise while the webbing is pulled back into the retractor. Refer to the "Automatic Locking Mode" description under "Occupant Restraints" for additional information on ALR.



## Lap/Shoulder Belt Systems For Installing Child Restraints In This Vehicle

2

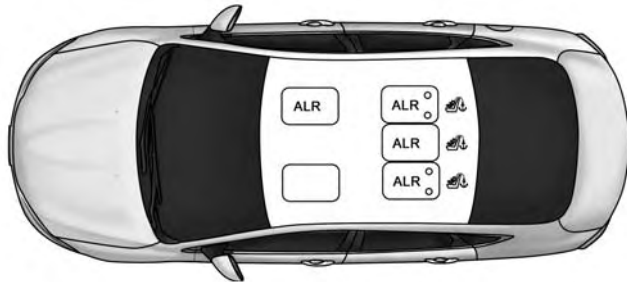

0226017160

- ALR = Switchable Automatic Locking Retractor
-  Top Tether Anchorage Symbol

Frequently Asked Questions About Installing Child Restraints With Seat Belts		
What is the weight limit (child's weight + weight of the child restraint) for using the Tether Anchor with the seat belt to attach a forward facing child restraint?	Weight limit of the Child Restraint	Always use the tether anchor when using the seat belt to install a forward facing child restraint, up to the recommended weight limit of the child restraint.
Can the rear-facing child restraint touch the back of the front passenger seat?	Yes	Contact between the front passenger seat and the child restraint is allowed, if the child restraint manufacturer also allows contact.
Can the head restraints be removed?	Yes	All head restraints may be removed.
Can the buckle stalk be twisted to tighten the seat belt against the seat belt path of the child restraint?	No	Do not twist the buckle stalk in a seating position with an ALR retractor.

### Installing A Child Restraint With A Switchable Automatic Locking Retractor (ALR)

1. Place the child seat in the center of the seating position. For some second row seats, you may need to recline the seat and/or raise the head restraint to get a better fit. If the rear seat can be moved forward and rearward in the vehicle, you may wish to move it to its rear-most position to make room for the child seat. You may also move the front seat forward to allow more room for the child seat.
2. Pull enough of the seat belt webbing from the retractor to pass it through the belt path of the child restraint. Do not twist the belt webbing in the belt path.
3. Slide the latch plate into the buckle until you hear a "click."
4. Pull on the webbing to make the lap portion tight against the child seat.
5. To lock the seat belt, pull down on the shoulder part of the belt until you have pulled all the seat belt webbing out of the retractor. Then, allow the webbing to retract back into the retractor. As the webbing retracts, you will hear a clicking sound. This means the seat belt is now in the Automatic Locking mode.
6. Try to pull the webbing out of the retractor. If it is locked, you should not be able to pull out any webbing. If the retractor is not locked, repeat step 5.
7. Finally, pull up on any excess webbing to tighten the lap portion around the child restraint while you push the child restraint rearward and downward into the vehicle seat.
8. If the child restraint has a top tether strap and the seating position has a top tether anchorage, connect the tether strap to the anchorage and tighten the tether strap. See the section "Installing Child Restraints Using the Top Tether Anchorage" for directions to attach a tether anchor.

9. Test that the child restraint is installed tightly by pulling back and forth on the child seat at the belt path. It should not move more than 1 inch (25.4 mm) in any direction.

Any seat belt system will loosen with time, so check the belt occasionally, and pull it tight if necessary.

### Installing Child Restraints Using The Top Tether Anchorage

#### WARNING!

Do not attach a tether strap for a rear-facing car seat to any location in front of the car seat, including the seat frame or a tether anchorage. Only attach the tether strap of a rear-facing car seat to the tether anchorage that is approved for that seating position, located behind the top of the vehicle seat. See the section “Lower Anchors and Tethers for Children

#### WARNING! (Continued)

“(LATCH) Restraint System” for the location of approved tether anchorages in your vehicle.



0226047162



1. Look behind the seating position where you plan to install the child restraint to find the tether anchorage. You may need to move the seat forward to provide better access to the tether anchorage. If there is no top tether anchorage for that seating position, move the child restraint to another position in the vehicle if one is available.

(Continued)

2. Rotate or lift the cover to access the anchor directly behind the seat where you are placing the child restraint.
3. Route the tether strap to provide the most direct path for the strap between the anchor and the child seat. If your vehicle is equipped with adjustable rear head restraints, raise the head restraint, and where possible, route the tether strap under the head restraint and between the two posts. If not possible, lower the head restraint and pass the tether strap around the outboard side of the head restraint.

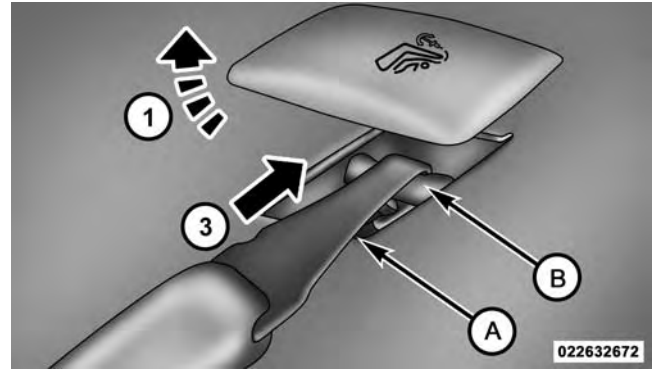

2

### Tether Strap Mounting

- |                     |                       |
|---------------------|-----------------------|
| 1 — Cover           | A — Tether Strap Hook |
| 3 — Attaching Strap | B — Tether Anchor     |

4. Attach the tether strap hook of the child restraint to the top tether anchorage as shown in the diagram.

5. Remove slack in the tether strap according to the child restraint manufacturer's instructions.

### **WARNING!**

- An incorrectly anchored tether strap could lead to increased head motion and possible injury to the child. Use only the anchorage position directly behind the child seat to secure a child restraint top tether strap.
- If your vehicle is equipped with a split rear seat, make sure the tether strap does not slip into the opening between the seatbacks as you remove slack in the strap.

### **Transporting Pets**

Air Bags deploying in the front seat could harm your pet. An unrestrained pet will be thrown about and possibly injured, or injure a passenger during panic braking or in a collision.

Pets should be restrained in the rear seat in pet harnesses or pet carriers that are secured by seat belts.

### **ENGINE BREAK-IN RECOMMENDATIONS**

A long break-in period is not required for the engine and drivetrain (transmission and axle) in your vehicle.

Drive moderately during the first 300 miles (500 km). After the initial 60 miles (100 km), speeds up to 50 or 55 mph (80 or 90 km/h) are desirable.

While cruising, brief full-throttle acceleration within the limits of local traffic laws contributes to a good break-in. Wide-open throttle acceleration in low gear can be detrimental and should be avoided.

The engine oil installed in the engine at the factory is a high-quality energy conserving type lubricant. Oil changes should be consistent with anticipated climate conditions under which vehicle operations will occur. For the recommended viscosity and quality grades, refer to “Maintenance Procedures” in “Maintaining Your Vehicle.”

### CAUTION!

**Never use Non-Detergent Oil or Straight Mineral Oil in the engine or damage may result.**

**NOTE:** A new engine may consume some oil during its first few thousand miles (kilometers) of operation. This should be considered a normal part of the break-in and not interpreted as a problem.

## SAFETY TIPS

### Transporting Passengers

NEVER TRANSPORT PASSENGERS IN THE CARGO AREA.

2

### WARNING!

- Do not leave children or animals inside parked vehicles in hot weather. Interior heat build-up may cause serious injury or death.
- It is extremely dangerous to ride in a cargo area, inside or outside of a vehicle. In a collision, people riding in these areas are more likely to be seriously injured or killed.
- Do not allow people to ride in any area of your vehicle that is not equipped with seats and seat belts.
- Be sure everyone in your vehicle is in a seat and using a seat belt properly.

## Exhaust Gas

### WARNING!

Exhaust gases can injure or kill. They contain carbon monoxide (CO), which is colorless and odorless. Breathing it can make you unconscious and can eventually poison you. To avoid breathing (CO), follow these safety tips:

- Do not run the engine in a closed garage or in confined areas any longer than needed to move your vehicle in or out of the area.
- If you are required to drive with the trunk/liftgate/rear doors open, make sure that all windows are closed and the climate control BLOWER switch is set at high speed. DO NOT use the recirculation mode.
- If it is necessary to sit in a parked vehicle with the engine running, adjust your heating or cooling controls to force outside air into the vehicle. Set the blower at high speed.

The best protection against carbon monoxide entry into the vehicle body is a properly maintained engine exhaust system.

Whenever a change is noticed in the sound of the exhaust system, when exhaust fumes can be detected inside the vehicle, or when the underside or rear of the vehicle is damaged, have a competent mechanic inspect the complete exhaust system and adjacent body areas for broken, damaged, deteriorated, or mispositioned parts. Open seams or loose connections could permit exhaust fumes to seep into the passenger compartment. In addition, inspect the exhaust system each time the vehicle is raised for lubrication or oil change. Replace as required.



## Safety Checks You Should Make Inside The Vehicle

### Seat Belts

Inspect the seat belt system periodically, checking for cuts, frays, and loose parts. Damaged parts must be replaced immediately. Do not disassemble or modify the system.

Front seat belt assemblies must be replaced after a collision. Rear seat belt assemblies must be replaced after a collision if they have been damaged (i.e., bent retractor, torn webbing, etc.). If there is any question regarding seat belt or retractor condition, replace the seat belt.

### Air Bag Warning Light

The Air Bag warning light  will turn on for four to eight seconds as a bulb check when the ignition switch is first turned to ON/RUN. If the light is either not on during starting, stays on, or turns on while driving,

have the system inspected at an authorized dealer as soon as possible. This light will illuminate with a single chime when a fault with the Air Bag Warning Light has been detected, it will stay on until the fault is cleared. If the light comes on intermittently or remains on while driving, have an authorized dealer service the vehicle immediately. Refer to “Occupant Restraints” in “Things To Know Before Starting Your Vehicle” for further information.

### Defroster

Check operation by selecting the defrost mode and place the blower control on high speed. You should be able to feel the air directed against the windshield. See your authorized dealer for service if your defroster is inoperable.

### Floor Mat Safety Information

Always use floor mats designed to fit the footwell of your vehicle. Use only floor mats that leave the pedal area

unobstructed and that are firmly secured so that they cannot slip out of position and interfere with the pedals or impair safe operation of your vehicle in other ways.

**WARNING!**

Pedals that cannot move freely can cause loss of vehicle control and increase the risk of serious personal injury.

- Always make sure that floor mats are properly attached to the floor mat fasteners.
- Never place or install floor mats or other floor coverings in the vehicle that cannot be properly secured to prevent them from moving and interfering with the pedals or the ability to control the vehicle.
- Never put floor mats or other floor coverings on top of already installed floor mats. Additional floor mats and other coverings will reduce the size of the pedal area and interfere with the pedals.

**WARNING! (Continued)**

- Check mounting of mats on a regular basis. Always properly reinstall and secure floor mats that have been removed for cleaning.
- Always make sure that objects cannot fall into the driver footwell while the vehicle is moving. Objects can become trapped under the brake pedal and accelerator pedal causing a loss of vehicle control.
- If required, mounting posts must be properly installed, if not equipped from the factory.

Failure to properly follow floor mat installation or mounting can cause interference with the brake pedal and accelerator pedal operation causing loss of control of the vehicle.

(Continued)



Information Provided by:  
**DEALER**  
E-PROCESS

## Periodic Safety Checks You Should Make Outside The Vehicle

### Tires

Examine tires for excessive tread wear and uneven wear patterns. Check for stones, nails, glass, or other objects lodged in the tread or sidewall. Inspect the tread for cuts and cracks. Inspect sidewalls for cuts, cracks, and bulges. Check the wheel nuts for tightness. Check the tires (including spare) for proper cold inflation pressure.

### Lights

Have someone observe the operation of brake lights and exterior lights while you work the controls. Check turn signal and high beam indicator lights on the instrument panel.

### Door Latches

Check for proper closing, latching, and locking.

### Fluid Leaks

Check area under vehicle after overnight parking for fuel, engine coolant, oil, or other fluid leaks. Also, if gasoline fumes are detected or if fuel, power steering fluid (if equipped), or brake fluid leaks are suspected. The cause should be located and corrected immediately.



# UNDERSTANDING THE FEATURES OF YOUR VEHICLE

## CONTENTS

■ MIRRORS . . . . .	122	□ Heated Mirrors — If Equipped . . . . .	132
□ Inside Day/Night Mirror — If Equipped . . .	122	□ Illuminated Vanity Mirrors — If Equipped . .	133
□ Automatic Dimming Mirror — If Equipped . .	123	■ BLIND SPOT MONITORING (BSM) — IF EQUIPPED . . . . .	134
□ Outside Mirrors . . . . .	130	□ Rear Cross Path. . . . .	139
□ Outside Mirrors Folding Feature . . . . .	130	□ Modes Of Operation . . . . .	141
□ Outside Mirrors With Turn Signal And Approach Lighting — If Equipped . . . . .	130	□ General Information. . . . .	142
□ Tilt Mirrors In Reverse (Available With Memory Seat Only) — If Equipped . . . . .	131	■ SEATS . . . . .	142
□ Power Mirrors . . . . .	132	□ Power Seats — If Equipped . . . . .	143
		□ Manual Seats — If Equipped . . . . .	146

## 116 UNDERSTANDING THE FEATURES OF YOUR VEHICLE

- Front Heated Seats — If Equipped . . . . .148
- Front Ventilated Seats — If Equipped . . . . .149
- Head Restraints . . . . .150
- Folding Rear Seat . . . . .154
- DRIVER MEMORY SEAT — IF EQUIPPED . . . . .155
  - Programming The Memory Feature . . . . .156
  - Linking And Unlinking The Remote Keyless Entry Transmitter To Memory . . . . .157
  - Memory Position Recall . . . . .158
  - Easy Entry/Exit Seat . . . . .158
- TO OPEN AND CLOSE THE HOOD . . . . .159
- LIGHTS . . . . .161
  - Headlight Switch . . . . .161
  - Automatic Headlights — If Equipped . . . . .162
  - Headlights On With Wipers (Available With Automatic Headlights Only) . .162
  - Headlight Time Delay . . . . .163
  - Automatic High Beam Headlamp Control — If Equipped . . . . .164
  - Daytime Running Lights — If Equipped . . . . .165
  - Lights-On Reminder . . . . .165
  - Fog Lights — If Equipped . . . . .166
  - Multifunction Lever . . . . .167
  - Turn Signals . . . . .167
  - Lane Change Assist . . . . .168
  - High/Low Beam Switch . . . . .168
  - Flash-To-Pass . . . . .168

<ul style="list-style-type: none"> <li>□ Front Map/Reading Lights . . . . .168</li> <li>□ Interior Lights . . . . .170</li> <li>□ Battery Saver Feature . . . . .172</li> </ul>	<b>UNDERSTANDING THE FEATURES OF YOUR VEHICLE 117</b> <ul style="list-style-type: none"> <li>□ To Activate . . . . .181</li> <li>□ To Set A Desired Speed . . . . .181</li> <li>□ To Deactivate . . . . .182</li> <li>□ To Resume Speed . . . . .182</li> <li>□ To Vary The Speed Setting . . . . .182</li> <li>□ To Accelerate For Passing . . . . .183</li> </ul>
<b>■ WINDSHIELD WIPERS AND WASHERS . . . . .172</b> <ul style="list-style-type: none"> <li>□ Windshield Wiper Operation . . . . .173</li> <li>□ Intermittent Wiper System . . . . .174</li> <li>□ Windshield Washer Operation. . . . .175</li> <li>□ Mist . . . . .175</li> <li>□ Rain Sensing Wipers — If Equipped . . . . .176</li> </ul>	<b>■ ADAPTIVE CRUISE CONTROL (ACC) — IF EQUIPPED . . . . .184</b> <ul style="list-style-type: none"> <li>□ Adaptive Cruise Control (ACC) Operation. . . . .186</li> <li>□ Activating Adaptive Cruise Control (ACC). . . . .187</li> <li>□ To Activate/Deactivate. . . . .188</li> <li>□ To Set A Desired ACC Speed . . . . .189</li> <li>□ To Cancel . . . . .190</li> </ul>
<b>■ TILT/TELESCOPING STEERING COLUMN . . .178</b>	
<b>■ HEATED STEERING WHEEL — IF EQUIPPED . . . . .179</b>	
<b>■ ELECTRONIC SPEED CONTROL — IF EQUIPPED . . . . .180</b>	

## 118 UNDERSTANDING THE FEATURES OF YOUR VEHICLE

- To Turn Off . . . . .190
- To Resume . . . . .191
- To Vary The Speed Setting . . . . .191
- Setting The Following Distance In ACC . . . . .194
- Overtake Aid . . . . .198
- ACC Operation At Stop . . . . .198
- Adaptive Cruise Control (ACC) Menu . . . . .199
- Display Warnings And Maintenance . . . . .200
- Precautions While Driving With ACC . . . . .203
- General Information. . . . .207
- Normal (Fixed Speed) Electronic Speed Control Mode . . . . .207
- FORWARD COLLISION WARNING (FCW) WITH MITIGATION — IF EQUIPPED . . . . .211
  - Forward Collision Warning (FCW) With Mitigation Operation . . . . .211
  - Turning FCW ON Or OFF . . . . .213
  - Changing FCW And Active Braking Status. . . . .214
  - FCW Limited Warning . . . . .215
  - Service FCW Warning . . . . .215
- LANESENSE — IF EQUIPPED . . . . .216
  - LaneSense Operation . . . . .216
  - Turning LaneSense ON Or OFF. . . . .217
  - LaneSense Warning Message. . . . .218
  - Changing LaneSense Status . . . . .222
- PARKSENSE REAR PARK ASSIST — IF EQUIPPED . . . . .222
  - ParkSense Sensors . . . . .223



- ParkSense Warning Display . . . . . 223
- ParkSense Display . . . . . 224
- Enabling And Disabling ParkSense . . . . . 229
- Service The ParkSense Rear Park Assist System . . . . . 229
- Cleaning The ParkSense System . . . . . 230
- ParkSense System Usage Precautions. . . . . 230
- **PARKSENSE FRONT AND REAR PARK ASSIST — IF EQUIPPED** . . . . . 232
  - ParkSense Sensors . . . . . 234
  - ParkSense Warning Display . . . . . 234
  - ParkSense Display . . . . . 235
  - Enabling And Disabling ParkSense . . . . . 244
  - Service The ParkSense Park Assist System . . . . . 245

## UNDERSTANDING THE FEATURES OF YOUR VEHICLE 119

- Cleaning The ParkSense System . . . . . 246
- ParkSense System Usage Precautions. . . . . 246
- **PARKSENSE ACTIVE PARK ASSIST SYSTEM — IF EQUIPPED** . . . . . 248
  - Enabling And Disabling The ParkSense Active Park Assist System. . . . . 250
  - Parallel Parking Space Assistance Operation/Display. . . . . 252
  - Perpendicular Parking Space Assistance Operation/Display. . . . . 261
- **PARKVIEW REAR BACK UP CAMERA — IF EQUIPPED** . . . . . 271
- **OVERHEAD CONSOLE** . . . . . 274
  - Front Map/Reading Lights . . . . . 275
  - Sunglass Bin Door . . . . . 276

## 120 UNDERSTANDING THE FEATURES OF YOUR VEHICLE

- GARAGE DOOR OPENER — IF EQUIPPED . . .277
  - Before You Begin Programming HomeLink . . .279
  - Programming A Rolling Code . . . . .280
  - Programming A Non-Rolling Code . . . . .282
  - Canadian/Gate Operator Programming . . . . .283
  - Using HomeLink . . . . .285
  - Security . . . . .285
  - Troubleshooting Tips . . . . .285
  - General Information. . . . .286
- POWER SUNROOF — IF EQUIPPED . . . . .287
  - Opening Sunroof — Express . . . . .288
  - Opening Sunroof — Manual Mode . . . . .288
  - Closing Sunroof — Express. . . . .289
    - Closing Sunroof — Manual Mode . . . . .289
    - Pinch Protect Feature . . . . .289
    - Venting Sunroof — Express . . . . .289
    - Sunshade Operation. . . . .290
    - Wind Buffeting . . . . .290
    - Sunroof Maintenance . . . . .290
    - Ignition Off Operation . . . . .290
- POWER SUNROOF WITH POWER SHADE — IF EQUIPPED . . . . .291
  - Opening Sunroof — Express . . . . .292
  - Opening Sunroof — Manual Mode . . . . .292
  - Closing Sunroof — Express. . . . .293
  - Closing Sunroof — Manual Mode . . . . .293

<input type="checkbox"/> Venting Sunroof — Express . . . . .	.293	<b>UNDERSTANDING THE FEATURES OF YOUR VEHICLE</b> . . . . .	121
<input type="checkbox"/> Opening Power Shade — Express . . . . .	.293	<input type="checkbox"/> Rear Seat Cupholders . . . . .	.301
<input type="checkbox"/> Opening Power Shade — Manual Mode . . . . .	.294	<b>STORAGE</b> . . . . .	.301
<input type="checkbox"/> Closing Power Shade — Express . . . . .	.294	<input type="checkbox"/> Glove Compartment . . . . .	.301
<input type="checkbox"/> Closing Power Shade — Manual Mode . . . . .	.294	<input type="checkbox"/> Console Features . . . . .	.302
<input type="checkbox"/> Pinch Protect Feature . . . . .	.294	<input type="checkbox"/> Door Storage . . . . .	.306
<input type="checkbox"/> Wind Buffeting . . . . .	.295	<input type="checkbox"/> Rear Seat Armrest Storage — If Equipped . . . . .	.306
<input type="checkbox"/> Sunroof Maintenance . . . . .	.295	<b>CARGO AREA FEATURES</b> . . . . .	.307
<input type="checkbox"/> Ignition Off Operation . . . . .	.295	<input type="checkbox"/> Cargo Area — 60/40 Split-Folding Rear Seat — If Equipped . . . . .	.307
<b>POWER OUTLETS — IF EQUIPPED</b> . . . . .	.295	<input type="checkbox"/> Grocery Bag Hooks . . . . .	.309
<b>POWER INVERTER — IF EQUIPPED</b> . . . . .	.299	<input type="checkbox"/> Ski Pass-Through . . . . .	.310
<b>CUPHOLDERS</b> . . . . .	.300	<b>REAR WINDOW FEATURES</b> . . . . .	.311
<input type="checkbox"/> Front Seat Cupholders . . . . .	.300	<input type="checkbox"/> Rear Window Defroster . . . . .	.311

## MIRRORS

### Inside Day/Night Mirror — If Equipped

The mirror head can be adjusted up, down, left, and right for various drivers. The mirror should be adjusted to center on the view through the rear window.

Headlight glare from vehicles behind you can be reduced by moving the small control under the mirror to the night position (toward the rear of the vehicle). The mirror should be adjusted while set in the day position (toward the windshield).

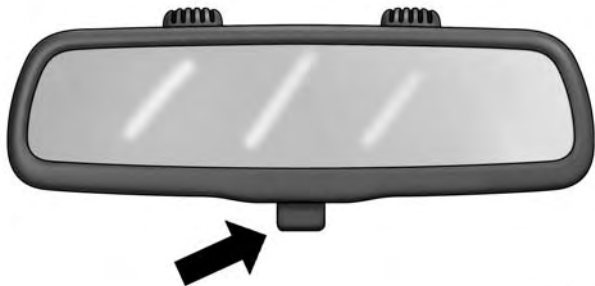

0304049206

Adjusting Rearview Mirror

## Automatic Dimming Mirror — If Equipped

The mirror head can be adjusted up, down, left, and right for various drivers. The mirror should be adjusted to center on the view through the rear window.

This mirror automatically adjusts for headlight glare from vehicles behind you.

**NOTE:** The Automatic Dimming Mirror feature is disabled when the vehicle is in reverse gear to improve rear view viewing.

The Automatic Dimming Mirror feature can be turned On or Off through the touchscreen.

- Push the Mirror Dimmer button once to turn the feature On.
- Push the Mirror Dimmer button a second time to turn the feature Off.



3

0304049205

### Automatic Dimming Mirror

If equipped, the rearview mirror contains an ASSIST and a 9-1-1 button.

**WARNING!**

**ALWAYS** obey traffic laws and pay attention to the road. Some Uconnect Access services, including 9-1-1 and Assist, will NOT work without an operable 1X (voice/data) or 3G (data) network connection.

**NOTE:**

- Your vehicle may be transmitting data as authorized by the subscriber.
- The 9-1-1 and ASSIST buttons will only function if you are connected to an operable 1X(voice/data) or 3G(data) network. Other Uconnect services will only be operable if your Uconnect Access service is active and you are connected to an operable 1X(voice/data) or 3G(data) network.

**ASSIST Call**

The ASSIST Button is used to automatically connect you to any one of the following support centers:

- Roadside Assistance – If you get a flat tire, or need a tow, just push the ASSIST button and you'll be connected to someone who can help. Roadside Assistance will know what vehicle you're driving and its location. Additional fees may apply for roadside Assistance.
- Uconnect Access Customer Care – In-vehicle support for Uconnect Access and Uconnect Access Via Mobile features.
- Vehicle Customer Care – Total support for all other vehicle issues.

## 9-1-1 Call

1. Push the 9-1-1 Call button on the Rearview Mirror.

**NOTE:** In case the 9-1-1 Call button is pushed in error, there will be a 10 second delay before the 9-1-1 Call system initiates a call to a 9-1-1 operator. To cancel the 9-1-1 Call connection, push the 9-1-1 Call button on the Rearview Mirror or press the cancellation button on the Device Screen. Termination of the 9-1-1 Call will turn off the green LED light on the Rearview Mirror.

2. The LED light located between the ASSIST and 9-1-1 buttons on the Rearview Mirror will turn green once a connection to a 9-1-1 operator has been made.

3. Once a connection between the vehicle and a 9-1-1 operator is made, the 9-1-1 Call system may transmit the following important vehicle information to a 9-1-1 operator:

- Indication that the occupant placed a 9-1-1 Call.

- The vehicle brand.

- The last known GPS coordinates of the vehicle.

4. You should be able to speak with the 9-1-1 operator through the vehicle audio system to determine if additional help is needed.

### WARNING!

**ALWAYS obey traffic laws and pay attention to the road. Some Uconnect Access services, including 9-1-1 and Assist, will NOT work without an operable 1X (voice/data) or 3G (data) network connection.**

**NOTE:**

- Your vehicle may be transmitting data as authorized by the subscriber.
  - Once a connection is made between the vehicle's 9-1-1 Call system and the 9-1-1 operator, the 9-1-1 operator may be able to open a voice connection with the vehicle to determine if additional help is needed. Once the 9-1-1 operator opens a voice connection with the vehicle's 9-1-1 Call system, the operator should be able to speak with you or other vehicle occupants and hear sounds occurring in the vehicle. The vehicle's 9-1-1 Call system will attempt to remain connected with the 9-1-1 operator until the 9-1-1 operator terminates the connection.
5. The 9-1-1 operator may attempt to contact appropriate emergency responders and provide them with important vehicle information and GPS coordinates.

**WARNING!**

- **If anyone in the vehicle could be in danger (e.g., fire or smoke is visible, dangerous road conditions or location), do not wait for voice contact from a 9-1-1 operator. All occupants should exit the vehicle immediately and move to a safe location.**
- **Never place anything on or near the vehicle's operable 1X (voice/data) or 3G(data) network and GPS antennas. You could prevent operable 1X (voice/data) or 3G(data) network and GPS signal reception, which can prevent your vehicle from placing an emergency call. An operable 1X (voice/data) or 3G(data) network and GPS signal reception is required for the 9-1-1 Call system to function properly.**

*(Continued)*



**WARNING! (Continued)**

- The 9-1-1 Call system is embedded into the vehicle's electrical system. Do not add aftermarket electrical equipment to the vehicle's electrical system. This may prevent your vehicle from sending a signal to initiate an emergency call. To avoid interference that can cause the 9-1-1 Call system to fail, never add aftermarket equipment (e.g., two-way mobile radio, CB radio, data recorder, etc.) to your vehicle's electrical system or modify the antennas on your vehicle. **IF YOUR VEHICLE LOSES BATTERY POWER FOR ANY REASON (INCLUDING DURING OR AFTER AN ACCIDENT), THE UCONNECT FEATURES, APPS AND SERVICES, AMONG OTHERS, WILL NOT OPERATE.**
- Modifications to any part of the 9-1-1 Call system could cause the air bag system to fail when you need it. You could be injured if the air bag system is not there to help protect you.

**9-1-1 Call System Limitations**

Vehicles sold in Canada and Mexico **DO NOT** have 9-1-1 Call system capabilities.

9-1-1 or other emergency line operators in Canada and Mexico may not answer or respond to 9-1-1 system calls.

If the 9-1-1 Call system detects a malfunction, any of the following may occur at the time the malfunction is detected, and at the beginning of each ignition cycle:

- The Rearview Mirror light located between the ASSIST and 9-1-1 buttons will continuously be illuminated red.
- The Device Screen will display the following message "Vehicle device requires service. Please contact your dealer."
- An In-Vehicle Audio message will state "Vehicle device requires service. Please contact your dealer."

**WARNING!**

- Ignoring the Rearview Mirror light could mean you will not have 9-1-1 Call services. If the Rearview Mirror light is illuminated, have an authorized dealer service the 9-1-1 Call system immediately.
- The Occupant Restraint Control module turns on the air bag Warning Light on the instrument panel if a malfunction in any part of the system is detected. If the Air Bag Warning Light is illuminated, have an authorized dealer service the Occupant Restraint Control system immediately.

Even if the 9-1-1 Call system is fully functional, factors beyond FCA US LLC's control may prevent or stop the 9-1-1 Call system operation. These include, but are not limited to, the following factors:

- Delayed accessories mode is active.
- The ignition is in the OFF position.

- The vehicle's electrical systems are not intact.
- The 9-1-1 Call system software and/or hardware are damaged during a crash.
- The vehicle battery loses power or becomes disconnected during a vehicle crash.
- 1X(voice/data) or 3G(data) network and/or Global Positioning Satellite signals are unavailable or obstructed.
- Equipment malfunction at the 9-1-1 operator facility.
- Operator error by the 9-1-1 operator.
- 1X (voice/data) or 3G (data) network congestion.
- Weather.
- Buildings, structures, geographic terrain, or tunnels.

**WARNING!**

**ALWAYS obey traffic laws and pay attention to the road. Some Uconnect Access services, including 9-1-1 and Assist, will NOT work without an operable 1X (voice/data) or 3G (data) network connection.**

**NOTE:**

- Your vehicle may be transmitting data as authorized by the subscriber.
- Never place anything on or near the vehicle's 1X (voice/data) or 3G (data) and GPS antennas. You could prevent 1X (voice/data) or 3G (data) and GPS signal reception, which can prevent your vehicle from placing an emergency call. An operable 1X (voice/data) or 3G (data) network connection and a GPS signal is required for the 9-1-1 Call system to function properly.

**General Information**

This device complies with Part 15 of the FCC Rules. Operation is subject to the following two conditions: (1) This device may not cause harmful interference, and (2) this device must accept any interference received, including interference that may cause undesired operation.

**NOTE:** Changes or modifications not expressly approved by the party responsible for compliance could void the user's authority to operate the equipment.

**CAUTION!**

**To avoid damage to the mirror during cleaning, never spray any cleaning solution directly onto the mirror. Apply the solution onto a clean cloth and wipe the mirror clean.**

## Outside Mirrors

To receive maximum benefit, adjust the outside mirror(s) to center on the adjacent lane of traffic and a slight overlap of the view obtained from the inside mirror.

**NOTE:** The passenger side convex outside mirror will give a much wider view to the rear, and especially of the lane next to your vehicle.

### **WARNING!**

**Vehicles and other objects seen in the passenger side convex mirror will look smaller and farther away than they really are. Relying too much on your passenger side convex mirror could cause you to collide with another vehicle or other object. Use your inside mirror when judging the size or distance of a vehicle seen in the passenger side convex mirror.**

## Outside Mirrors Folding Feature

All outside mirrors are hinged and may be moved either forward or rearward to resist damage. The hinges have three detent positions:

- Full forward position
- Full rearward position
- Normal position

## Outside Mirrors With Turn Signal And Approach Lighting — If Equipped

Driver and passenger outside mirrors with turn signal and puddle lamp contain three LEDs.

Two of the LED's are used as turn signal indicators, which flash with the corresponding turn signal lights in the front and rear of the vehicle. Turning on the Hazard Warning flashers will also activate these LEDs.

The third LED supplies illuminated entry lighting, which turns on in both mirrors when you use the Remote Keyless Entry (RKE) transmitter or open any door. This LED shines downward to illuminate the ground adjacent to the Front and Rear Doors.

The Illuminated Entry lighting fades to off after about 30 seconds or it will fade to off immediately once the ignition is placed into the RUN position.

**NOTE:** The approach lighting will not function when the shift lever is moved out of the PARK position.

### **Tilt Mirrors In Reverse (Available With Memory Seat Only) — If Equipped**

Tilt Mirrors in Reverse provides automatic outside mirror positioning which will aid the driver's view of the ground rearward of the front doors. Outside mirrors will move slightly downward from the present position when the vehicle is shifted into REVERSE. Outside mirrors will then return to the original position when the vehicle is shifted out of REVERSE position. Each stored memory setting will have an associated Tilt Mirrors in Reverse position.

**NOTE:** The Tilt Mirrors in Reverse feature is not turned on when delivered from the factory. The Tilt Mirrors in Reverse feature can be turned on and off using the Uconnect System. Refer to "Uconnect Settings/Customer Programmable Features" in "Understanding Your Instrument Panel" for further information.

## Power Mirrors

The power mirror controls are located on the driver's door trim panel.



Power Mirror Control

The power mirror controls consist of mirror select buttons and a four-way mirror control switch. To adjust a mirror, push either the L (left) or R (right) button to select the mirror that you want to adjust.

Using the mirror control switch, push on any of the four arrows for the direction that you want the mirror to move.

## Heated Mirrors — If Equipped



These mirrors are heated to melt frost or ice. This feature can be activated whenever you turn on the rear window defroster (if equipped). Refer to “Rear Window Features” in “Understanding The Features Of Your Vehicle” for further information.

### Illuminated Vanity Mirrors — If Equipped

An illuminated vanity mirror is on each sun visor. To use the mirror, rotate the sun visor downward and swing the mirror cover upward. The light will turn on automatically. Closing the mirror cover will turn off the light.



Illuminated Vanity Mirror

### Sun Visor “Slide-On Rod” Feature — If Equipped

This feature allows for additional flexibility in positioning the visor to block out the sun.

1. Fold down the sun visor.
2. Unclip the visor from the center clip.
3. Pull the sun visor toward the inside rearview mirror to extend it.

## BLIND SPOT MONITORING (BSM) — IF EQUIPPED

The Blind Spot Monitoring (BSM) system uses two radar-based sensors, located inside the rear bumper fascia, to detect highway licensable vehicles (automobiles, trucks, motorcycles, etc.) that enter the blind spot zones from the rear/front/side of the vehicle.

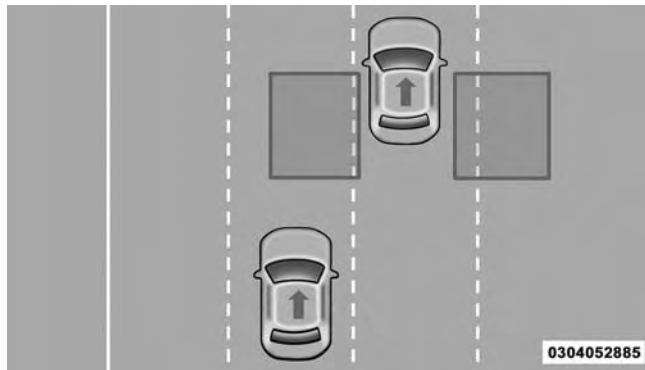

Rear Detection Zones

When the vehicle is started, the BSM warning light will momentarily illuminate in both outside rear view mirrors to let the driver know that the system is operational.

The BSM system sensors operate when the vehicle is in any forward gear or REVERSE and enters stand-by mode when the vehicle is in PARK.

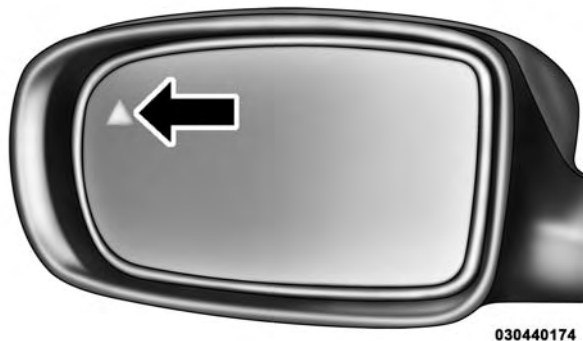

BSM Warning Light



The BSM detection zone covers approximately one lane width on both sides of the vehicle (12 ft or 3.8 m). The zone length starts at the outside rear view mirror and extends approximately 10 ft (3 m) beyond the rear bumper of the vehicle. The BSM system monitors the detection zones on both sides of the vehicle when the vehicle speed reaches approximately 6 mph (10 km/h) or higher and will alert the driver of vehicles in these areas.

**NOTE:** The BSM system does NOT alert the driver about rapidly approaching vehicles that are outside the detection zones.

The area on the rear fascia where the radar sensors are located must remain free of snow, ice, and dirt/road contamination so that the BSM system can function properly. Do not block the area of the rear fascia where the radar sensors are located with foreign objects (bumper stickers, bicycle racks, etc.).

The BSM system notifies the driver of objects in the detection zones by illuminating the BSM warning light located in the outside mirrors in addition to sounding an audible (chime) alert and reducing the radio volume. Refer to “Modes Of Operation” for further information.

The BSM system monitors the detection zone from three different entry points (side, rear, front) while driving to see if an alert is necessary. The BSM system will issue an alert during these types of zone entries.

### Entering From The Side

Vehicles that move into your adjacent lanes from either side of the vehicle.

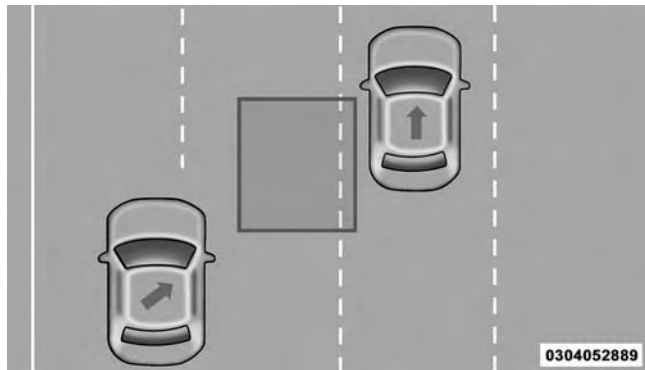

Side Monitoring

### Entering From The Rear

Vehicles that come up from behind your vehicle on either side and enter the rear detection zone with a relative speed of less than 30 mph (48 km/h).

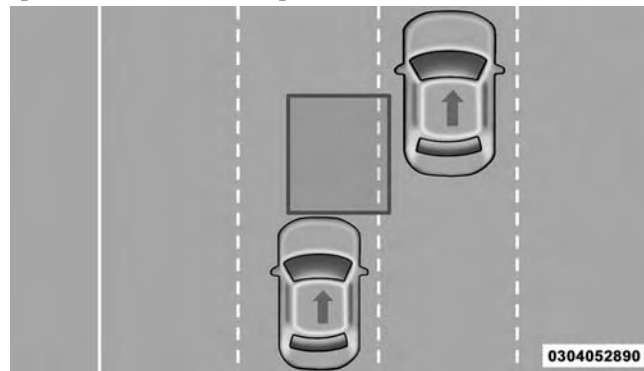

Rear Monitoring

## Overtaking Traffic

If you pass another vehicle slowly (with a relative speed of less than 15 mph (24 km/h) and the vehicle remains in the blind spot for approximately 1.5 seconds, the warning light will be illuminated. If the difference in speed between the two vehicles is greater than 15 mph (24 km/h), the warning light will not illuminate.

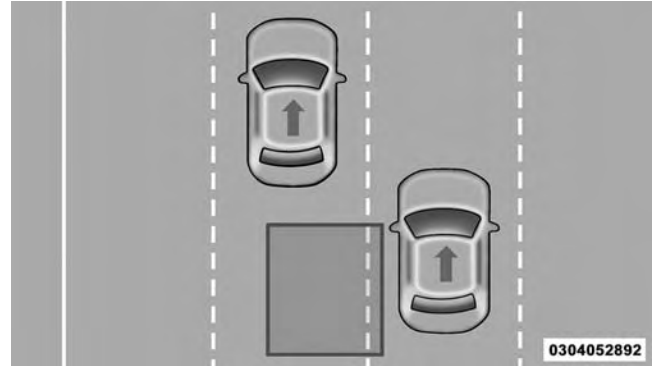

## 138 UNDERSTANDING THE FEATURES OF YOUR VEHICLE

The BSM system is designed not to issue an alert on stationary objects such as guardrails, posts, walls, foliage, berms, etc. However, occasionally the system may alert on such objects. This is normal operation and your vehicle does not require service.

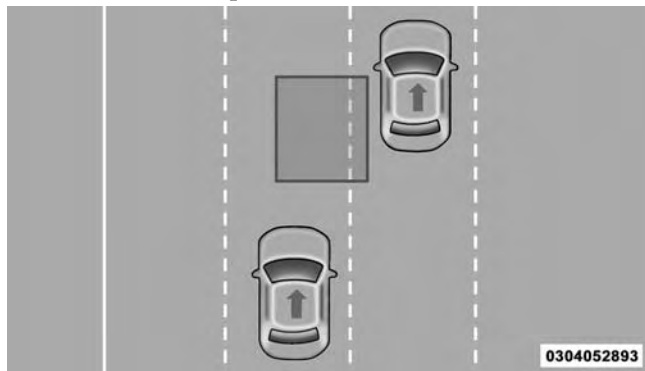

Overtaking/Passing

The BSM system will not alert you of objects that are traveling in the opposite direction of the vehicle in adjacent lanes.

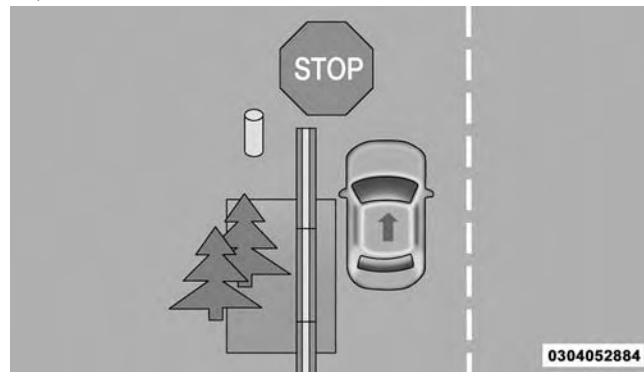

Stationary Objects

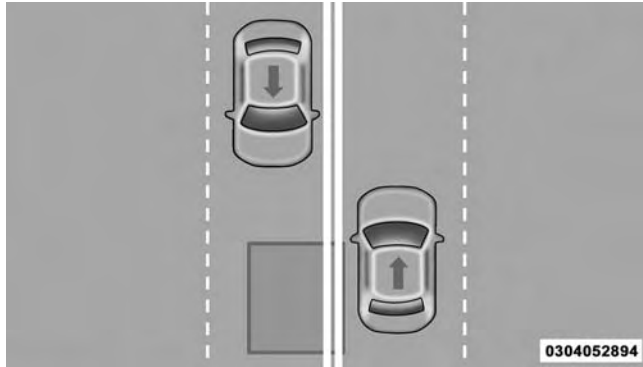

Opposing Traffic

**WARNING!**

The Blind Spot Monitoring system is only an aid to help detect objects in the blind spot zones. The BSM

*(Continued)*

**WARNING! (Continued)**

system is not designed to detect pedestrians, bicyclists, or animals. Even if your vehicle is equipped with the BSM system, always check your vehicle's mirrors, glance over your shoulder, and use your turn signal before changing lanes. Failure to do so can result in serious injury or death.

**Rear Cross Path**

The Rear Cross Path (RCP) feature is intended to aid the driver when backing out of parking spaces where the vision of oncoming vehicles may be blocked. Proceed slowly and cautiously out of the parking space until the rear end of the vehicle is exposed. The RCP system will then have a clear view of the cross traffic and if an oncoming vehicle is detected, will alert the driver.

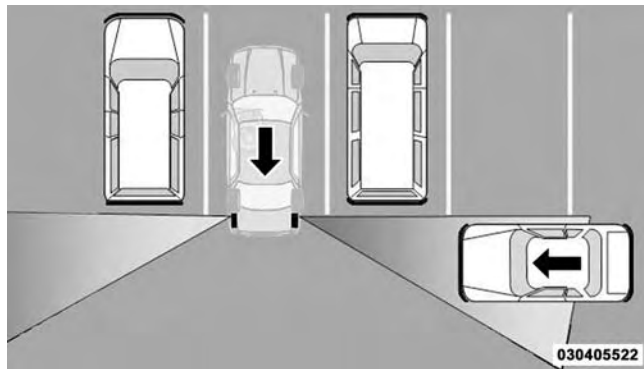

### RCP Detection Zones

RCP monitors the rear detection zones on both sides of the vehicle, for objects that are moving toward the side of the vehicle with a minimum speed of approximately 3 mph (5 km/h), to objects moving a maximum of approximately 20 mph (32 km/h), such as in parking lot situations.

**NOTE:** In a parking lot situation, oncoming vehicles can be obscured by vehicles parked on either side. If the sensors are blocked by other structures or vehicles, the system will not be able to alert the driver.

When RCP is on and the vehicle is in REVERSE, the driver is alerted using both the visual and audible alarms, including reducing the radio volume.

### WARNING!

**Rear Cross Path (RCP) is not a Back Up Aid system. It is intended to be used to help a driver detect an oncoming vehicle in a parking lot situation. Drivers must be careful when backing up, even when using RCP. Always check carefully behind your vehicle, look behind you, and be sure to check for pedestrians, animals, other vehicles, obstructions, and blind spots before backing up. Failure to do so can result in serious injury or death.**

## Modes Of Operation

Three selectable modes of operation are available in the Uconnect System. Refer to “Uconnect Settings/Customer Programmable Features” in “Understanding Your Instrument Panel” for further information.

### Blind Spot Alert Lights Only

When operating in Blind Spot Alert mode, the BSM system will provide a visual alert in the appropriate side view mirror based on a detected object. However, when the system is operating in Rear Cross Path (RCP) mode, the system will respond with both visual and audible alerts when a detected object is present. Whenever an audible alert is requested, the radio is muted.

### Blind Spot Alert Lights/Chime

When operating in Blind Spot Alert Lights/Chime mode, the BSM system will provide a visual alert in the appropriate side view mirror based on a detected object. If the

turn signal is then activated, and it corresponds to an alert present on that side of the vehicle, an audible chime will also be sounded. Whenever a turn signal and detected object are present on the same side at the same time, both the visual and audible alerts will be issued. In addition to the audible alert the radio (if on) will also be muted.

**NOTE:** Whenever an audible alert is requested by the BSM system, the radio is also muted.

When the system is in RCP, the system shall respond with both visual and audible alerts when a detected object is present. Whenever an audible alert is requested, the radio is also muted. Turn/hazard signal status is ignored; the RCP state always requests the chime.

### Blind Spot Alert Off

When the BSM system is turned off there will be no visual or audible alerts from either the BSM or RCP systems.

**NOTE:** The BSM system will store the current operating mode when the vehicle is shut off. Each time the vehicle is started the previously stored mode will be recalled and used.

### General Information

This vehicle has systems that operate on radio frequency that comply with Part 15 of the Federal Communications Commission (FCC) rules and with Industry Canada Standards RSS- GEN/210/220/310.

Operation is subject to the following two conditions:

1. The device may not cause harmful interference.
2. The device must accept any interference received, including interference that may cause undesired operation of the device.

Changes or modifications to any of these systems by other than an authorized service facility could void authorization to use this equipment.

### SEATS

Seats are a part of the Occupant Restraint System of the vehicle.

#### WARNING!

- It is dangerous to ride in a cargo area, inside or outside of a vehicle. In a collision, people riding in these areas are more likely to be seriously injured or killed.
- Do not allow people to ride in any area of your vehicle that is not equipped with seats and seat belts. In a collision, people riding in these areas are more likely to be seriously injured or killed.
- Be sure everyone in your vehicle is in a seat and using a seat belt properly.



## Power Seats — If Equipped

Some models may be equipped with a power driver's seat. The power seat switch is located on the outboard side of the seat near the floor. Use the switch to move the seat up, down, forward or rearward.

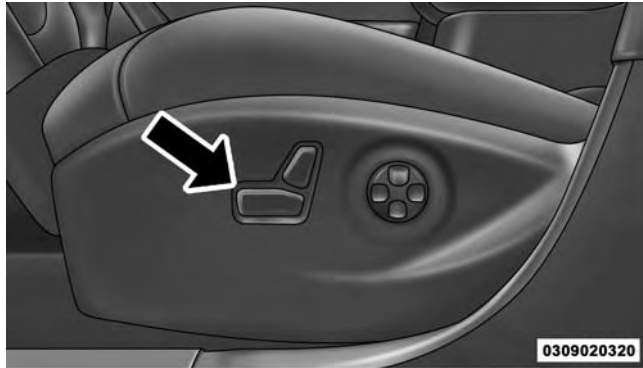

Power Seat Switch

## Adjusting The Seat Forward Or Rearward

The seat can be adjusted both forward and rearward. Push the seat switch forward or rearward. The seat will move in the direction of the switch. Release the switch when the desired position has been reached.

## Adjusting The Seat Up Or Down

The height of the seats can be adjusted up or down. Pull upward or push downward on the seat switch. The seat will move in the direction of the switch. Release the switch when the desired position is reached.

## Tilting The Seat Up Or Down

The angle of the seat cushion can be adjusted up or down. Pull upward or push downward on the front of the seat switch. The front of the seat cushion will move in the direction of the switch. Release the switch when the desired position has been reached.

## Reclining The Seatback Forward Or Rearward

The seatback can be reclined both forward and rearward. Push the seat recliner switch forward or rearward. The seatback will move in the direction of the switch. Release the switch when the desired position has been reached.

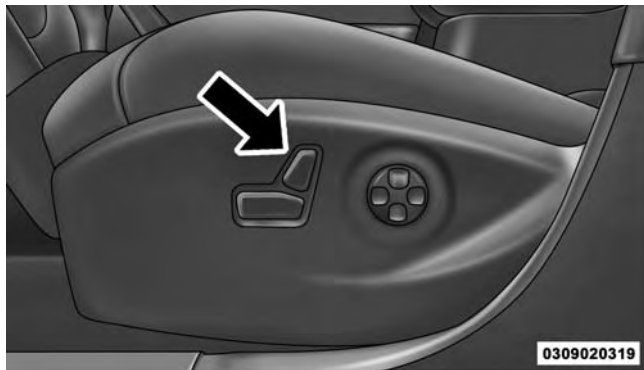

Power Seat Recliner Switch

### WARNING!

**Do not ride with the seatback reclined so that the shoulder belt is no longer resting against your chest. In a collision you could slide under the seat belt, which could result in serious injury or death.**

### Power Lumbar — If Equipped

Vehicles equipped with power driver's seat may be equipped with power lumbar. The power lumbar switch is located on the outboard side of the power seat. Push the switch forward or rearward to increase or decrease the lumbar support. Push the switch upward or downward to raise or lower the lumbar support.



3

Power Lumbar Switch

## Manual Seats — If Equipped

### Manual Front Seat Forward/Rearward Adjustment

On models equipped with manual seats, the adjusting bar is located at the front of the seats, near the floor.



Front Seat Adjustment

While sitting in the seat, lift up on the bar and move the seat forward or rearward. Release the bar once you have reached the desired position. Then, using body pressure, move forward and rearward on the seat to be sure that the seat adjusters have latched.

### WARNING!

- Adjusting a seat while driving may be dangerous. Moving a seat while driving could result in loss of control which could cause a collision and serious injury or death.
- Seats should be adjusted before fastening the seat belts and while the vehicle is parked. Serious injury or death could result from a poorly adjusted seat belt.

## Manual Front Seat Recline Adjustment

To adjust the seatback, lift the lever located on the outboard side of the seat, lean back to the desired position and release the lever. To return the seatback, lift the lever, lean forward and release the lever.



Recline Lever

### WARNING!

**Do not ride with the seatback reclined so that the shoulder belt is no longer resting against your chest. In a collision you could slide under the seat belt, which could result in serious injury or death.**

### Manual Seat Height Adjustment — If Equipped

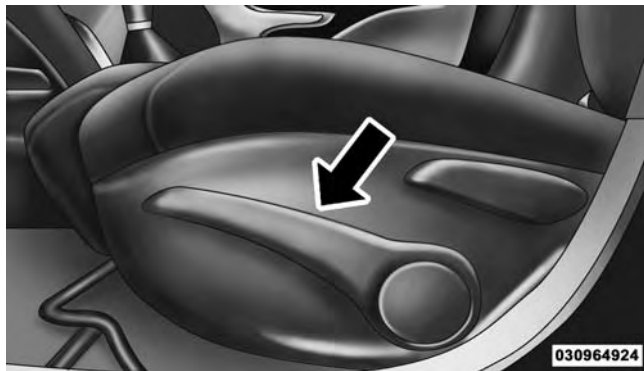

The driver's seat height can be raised or lowered by using a lever, located on the outboard side of the seat. Pull upward on the lever to raise the seat height or push downward on the lever to lower the seat height.



Seat Height Adjustment

### Front Heated Seats — If Equipped

The front heated seats control buttons are located within the Uconnect system. You can gain access to the control buttons through the climate screen or the controls screen.

- Press the heated seat button  once to turn the HI setting ON.
- Press the heated seat button  a second time to turn the LO setting ON.
- Press the heated seat button  a third time to turn the heating elements OFF.

If the HI-level setting is selected, the system will automatically switch to LO-level after approximately 60 minutes of continuous operation. At that time, the display will change from HI to LO, indicating the change. The LO-level setting will turn OFF automatically after approximately 45 minutes.

**NOTE:** The engine must be running for the heated seats to operate.

### Vehicles Equipped With Remote Start

On models that are equipped with remote start, the heated seats can be programmed to come on during a remote start.

This feature can be programmed through the Uconnect system. Refer to “Uconnect Settings” in “Understanding Your Instrument Panel” for further information.

#### **WARNING!**

- **Persons who are unable to feel pain to the skin because of advanced age, chronic illness, diabetes, spinal cord injury, medication, alcohol use, exhaustion or other physical condition must exercise care when using the seat heater. It may cause burns**

#### **WARNING! (Continued)**

even at low temperatures, especially if used for long periods of time.

- **Do not place anything on the seat or seatback that insulates against heat, such as a blanket or cushion. This may cause the seat heater to overheat. Sitting in a seat that has been overheated could cause serious burns due to the increased surface temperature of the seat.**



3

### Front Ventilated Seats — If Equipped

Located in the seat cushion and seat back are fans that draw the air from the passenger compartment and move air through fine perforations in the seat cover to help keep the driver and front passenger cooler in higher ambient temperatures. The fans operate at two speeds, HI and LO.

*(Continued)*

The front ventilated seats control buttons are located within the Uconnect system. You can gain access to the control buttons through the climate screen or the controls screen.

- Press the ventilated seat button  once to choose HI.
- Press the ventilated seat button  a second time to choose LO.
- Press the ventilated seat button  a third time to turn the ventilated seat OFF.

**NOTE:** The engine must be running for the ventilated seats to operate.

### Vehicles Equipped With Remote Start

On models that are equipped with remote start, the ventilated seats can be programmed to come on during a remote start.

This feature can be programmed through the Uconnect system. Refer to “Uconnect Settings” in “Understanding Your Instrument Panel” for further information.

### Head Restraints

Head restraints are designed to reduce the risk of injury by restricting head movement in the event of a rear impact. Head restraints should be adjusted so that the top of the head restraint is located above the top of your ear.

#### **WARNING!**

**The head restraints for all occupants must be properly adjusted prior to operating the vehicle or occupying a seat. Head restraints should never be adjusted while the vehicle is in motion. Driving a vehicle with the head restraints improperly adjusted or removed could cause serious injury or death in the event of a collision.**

**NOTE:** Do not reverse the head restraints (making the rear of the head restraint face forward) in an attempt to gain additional clearance to the back of your head.



## Reactive Head Restraints — Front Seats

The front driver and passenger seats are equipped with Reactive Head Restraints (RHR). In the event of a rear impact the RHRs will automatically extend forward minimizing the gap between the back of the occupant's head and the RHR.

The RHRs will automatically return to their normal position following a rear impact. If the RHRs do not return to their normal position see your authorized dealer immediately.

To raise the head restraint, pull upward on the head restraint. To lower the head restraint, push the adjustment button, located at the base of the head restraint, and push downward on the head restraint.

**NOTE:** To remove the head restraint, raise it as far as it can go then push the release button and the adjustment button at the base of each post while pulling the head restraint up. Seatback angle may need to be adjusted to fully remove the head restraint. To reinstall the head restraint, put the head restraint posts into the holes and push downward. Then adjust the head restraint to the appropriate height.

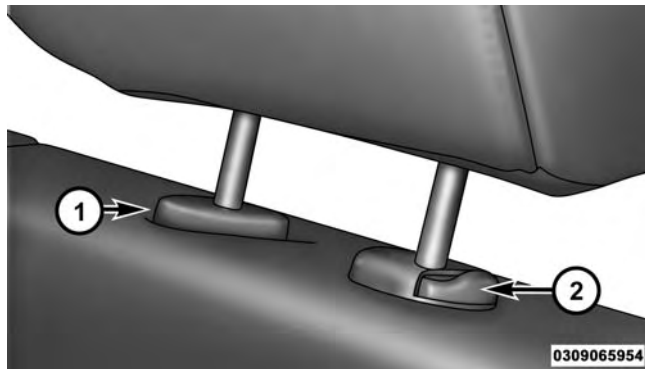

Front Head Restraint

- 1 — Release Button  
2 — Adjustment Button

**WARNING!**

- A loose head restraint thrown forward in a collision or hard stop could cause serious injury or death to occupants of the vehicle. Always securely stow removed head restraints in a location outside the occupant compartment.
- ALL the head restraints MUST be reinstalled in the vehicle to properly protect the occupants. Follow the re-installation instructions above prior to operating the vehicle or occupying a seat.
- Do not place items over the top of the Reactive Head Restraint, such as coats, seat covers or portable DVD players. These items may interfere with the operation of the Reactive Head Restraint in the event of a collision and could result in serious injury or death.

## Rear Head Restraints

The rear outboard head restraints have three positions Up, Mid and Down. The center head restraint has only two positions, Up and Down. When the center seat is being occupied the head restraint should be in the raised position. When there is no occupant in the center seat, the head restraint can be lowered for maximum visibility for the driver.

To raise the head restraint, pull upward on the head restraint. To lower the head restraint, push the adjustment button, located at the base of the head restraint, and push downward on the head restraint.

**NOTE:** To remove the head restraint, raise it as far as it can go then push the release button and the adjustment button at the base of each post while pulling the head restraint up. To reinstall the head restraint, put the head restraint posts into the holes and push downward. Then adjust the head restraint to the appropriate height.

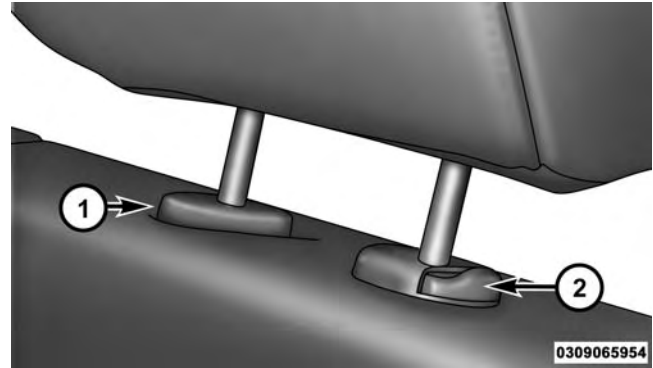

Head Restraint

- 1 — Release Button
- 2 — Adjustment Button

**WARNING!**

ALL the head restraints MUST be reinstalled in the vehicle to properly protect the occupants. Follow the re-installation instructions above prior to operating the vehicle or occupying a seat.

**Folding Rear Seat**

To provide additional storage area, the rear seatback can be folded forward. Pull on the loops to fold down either or both seatbacks.

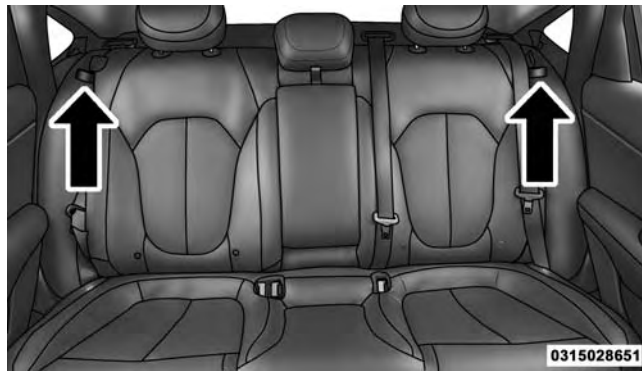
**Rear Seat Release Loops**

When returning the rear seatback to the upright position, be sure the seatback is latched.

**WARNING!**

- **Be certain that the seatback is securely locked into position. If the seatback is not securely locked into position the seat will not provide the proper stability for child seats and/or passengers. An improperly latched seat could cause serious injury.**
- **The rear cargo area of the vehicle (with the rear seatbacks in the locked-up or folded down position) should not be used as a play area by children. They could be seriously injured in a collision. Children should be seated and using the proper restraint system.**

**DRIVER MEMORY SEAT — IF EQUIPPED**

This feature allows the driver to store up to two different memory profiles, for easy recall through a memory switch. Each memory profile contains desired position settings for the driver seat and side mirrors and a set of desired radio station presets.

The memory switch is located on the driver's side door panel. The switch contains 3 buttons, a S (SET) button to activate the memory save function, the number (1) memory button and the number (2) memory button. The memory switch allows the driver to recall either of the two pre-programmed memory profiles by pushing the appropriate number button on the switch.



### Driver Memory Switch

### Programming The Memory Feature

To create a new memory profile, perform the following:

**NOTE:** Saving a new memory profile will erase an existing profile from memory.

1. Cycle the vehicle's ignition to the ON position.

2. Adjust all memory profile settings to desired preferences (i.e., seat, side mirror and radio station presets).
3. Push and release the SET button on the memory switch, then push the number (1) button within five seconds. The Electronic Vehicle Information Center (EVIC) or Driver Information Display (DID), will display which memory position is being set.

If desired, a second memory profile can be stored into memory as follows:

1. Cycle the vehicle's ignition to the ON position.
2. Adjust all memory profile settings to desired preferences (i.e., seat, side mirror and radio station presets).
3. Push and release the SET button on the memory switch, then push the number (2) button within five seconds. The EVIC/DID will display which memory position is being set.

**NOTE:**

- Memory profiles can be set without the vehicle in PARK, but the vehicle must be in PARK to recall a memory profile.
- To set a memory profile to your RKE transmitter, refer to “Linking And Unlinking The Remote Keyless Entry Transmitter To Memory” in this section.

**Linking And Unlinking The Remote Keyless Entry Transmitter To Memory**

Your Remote Keyless Entry (RKE) transmitters can be programmed to recall one of two pre-programmed memory profiles with a push of the UNLOCK button on the RKE transmitter.

**NOTE:** Before programming your RKE transmitters you must select the “Memory To FOB” feature through the Uconnect system screen. Refer to “Uconnect Settings” in “Understanding Your Instrument Panel” for further information.

To program your RKE transmitters, perform the following:

1. Cycle the vehicle’s ignition to the OFF position.
2. Select the desired memory profile 1 or 2.

**NOTE:** If a memory profile has not already been set, refer to “Programming The Memory Feature” in this section for instructions on how to set a memory profile.

3. Push and release the SET button on the memory switch, then within five seconds push and release the button labeled 1 or 2 accordingly. “Memory Profile Set” (1 or 2) will display in the EVIC/DID.

4. Push and release the LOCK button on the RKE transmitter within 10 seconds.

**NOTE:** Your RKE transmitters can be unlinked to your memory settings by pushing the SET (S) button, followed by pushing the UNLOCK button on the RKE transmitter within 10 seconds.

### Memory Position Recall

**NOTE:** The vehicle must be in PARK to recall memory positions. If a recall is attempted when the vehicle is not in PARK, a message will display in the EVIC/DID.

To recall the memory settings for driver one, push MEMORY button number 1 or the UNLOCK button on the RKE transmitter linked to memory position 1.

To recall the memory settings for driver two, push MEMORY button number 2 or the UNLOCK button on the RKE transmitter linked to memory position 2.

A recall can be cancelled by pushing any of the MEMORY buttons (S, 1, or 2) during a recall. When a recall is cancelled, the driver seat will stop moving. A delay of one second will occur before another recall can be selected.

### Easy Entry/Exit Seat

This feature provides automatic driver seat positioning to enhance driver mobility when entering and exiting the vehicle.

The distance the driver seat moves depends on where you have the driver seat positioned when you cycle the vehicle's ignition to the OFF position.

- When you cycle the vehicle's ignition to the OFF position, the driver seat will move about 2.4 in (60 mm) rearward if the driver seat position is greater than or equal to 2.7 in (67.7 mm) forward of the rear stop.



The seat will return to its previously set position when you cycle the vehicle's ignition to the ACC or RUN position.

- The Easy Entry/Easy Exit feature is disabled when the driver seat position is less than 0.9 in (22.7 mm) forward of the rear stop. At this position, there is no benefit to the driver by moving the seat for Easy Exit or Easy Entry.

Each stored memory setting will have an associated Easy Entry and Easy Exit position.

**NOTE:** The Easy Entry/Exit feature is not enabled when the vehicle is delivered from the factory. The Easy Entry/Exit feature is enabled (or later disabled) through the programmable features in the Uconnect system. Refer to "Uconnect Settings/Customer Programmable Features" in "Understanding Your Instrument Panel" for further information.

## TO OPEN AND CLOSE THE HOOD

To open the hood, two levers must be released.

1. Pull the release lever located below the instrument panel and in front of the driver's door.

3

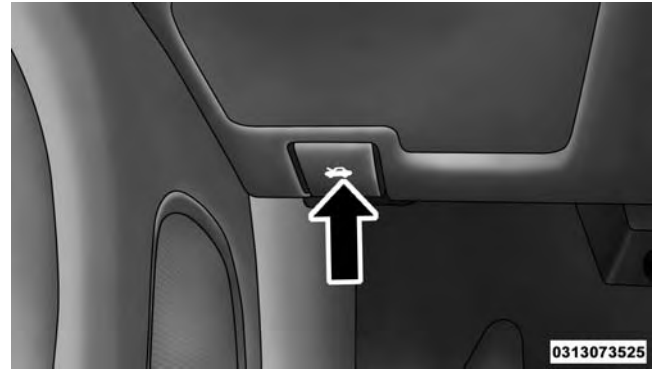

Hood Release Lever

160 UNDERSTANDING THE FEATURES OF YOUR VEHICLE

2. Move to the front of the vehicle.



0313020508

Safety Latch Lever Location

3. Reach under the center front edge of the hood and push and hold the safety latch lever to the right.

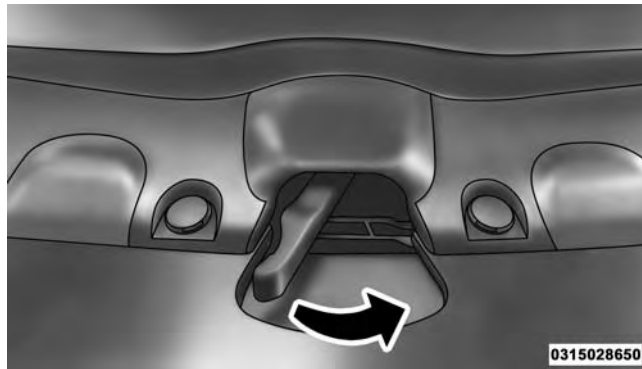

0315028650

Safety Latch Lever

4. Lift the hood upward to the open position.

**CAUTION!**

To prevent possible damage, do not slam the hood to close it. Use a firm downward push at the front center of the hood to ensure that both latches engage.

**WARNING!**

Be sure the hood is fully latched before driving your vehicle. If the hood is not fully latched, it could open when the vehicle is in motion and block your vision. Failure to follow this warning could result in serious injury or death.

**LIGHTS****Headlight Switch**

The headlight switch is located on the left side of the instrument panel. This switch controls the operation of the headlights, parking lights, automatic headlights — if equipped, instrument panel lights, instrument panel light dimming, interior lights and fog lights — if equipped.

**3**

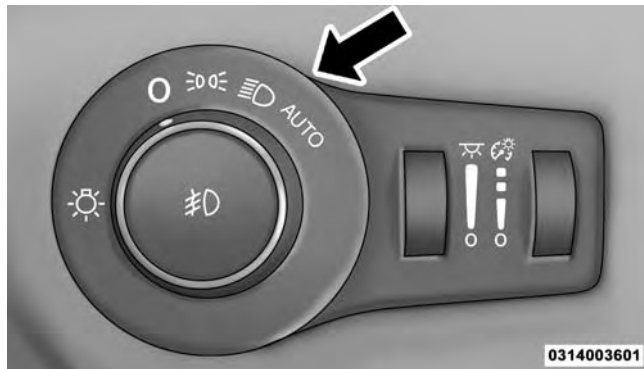

### Headlight Switch

Rotate the headlight switch clockwise to the first detent for parking light and instrument panel light operation. Rotate the headlight switch to the second detent for headlight, parking light and instrument panel light operation.

### Automatic Headlights — If Equipped

This system automatically turns the headlights on or off according to ambient light levels. To turn the system on, rotate the headlight switch clockwise to the last detent for automatic headlight operation. When the system is on, the headlight time delay feature is also on. This means the headlights will stay on for up to 90 seconds after you place the ignition into the OFF position. To turn the automatic system off, move the headlight switch out of the AUTO position.

**NOTE:** The engine must be running before the headlights will come on in the automatic mode.

### Headlights On With Wipers (Available With Automatic Headlights Only)

When this feature is active, the headlights will turn on after the wipers are turned on if the headlight switch is placed in the AUTO position and programmable feature

is set to ON. In addition, the headlights will turn off when the wipers are turned off if they were turned on by this feature.

**NOTE:** The Headlights On with Wipers feature can be turned on or off using the Uconnect System. Refer to “Uconnect Settings/Customer Programmable Features” in “Understanding Your Instrument Panel” for further information.

### Headlight Time Delay

This feature provides the safety of headlight illumination for up to 90 seconds (programmable) when leaving your vehicle in an unlit area.

To activate the delay feature, place the ignition in the OFF position while the headlights are still on. Then, turn off the headlights within 45 seconds. The delay interval begins when the headlight switch is turned off.

If you turn the headlights or parking lights on, or place the ignition in ACC or RUN, the system will cancel the delay.

If you turn the headlights off before the ignition, they will turn off in the normal manner.

### NOTE:

- The lights must be turned off within 45 seconds of placing the ignition in the OFF position to activate this feature.
- The headlight delay time is programmable using the Uconnect System, refer to “Uconnect Settings” in “Understanding Your Instrument Panel” for further information.

## Automatic High Beam Headlamp Control — If Equipped

The Automatic High Beam Headlamp Control system provides increased forward lighting at night by automating high beam control through the use of a digital camera mounted on the inside rearview mirror. This camera detects vehicle specific light and automatically switches from high beams to low beams until the approaching vehicle is out of view.

### NOTE:

- The Automatic High Beam Headlamp Control can be turned on or off using the Uconnect System. Refer to “Uconnect Settings” in “Understanding Your Instrument Panel” for further information.
- Broken, muddy, or obstructed headlights and taillights of vehicles in the field of view will cause headlights to remain on longer (closer to the vehicle). Also, dirt, film,

and other obstructions on the windshield or camera lens will cause the system to function improperly.

- To opt out of the Advanced Auto High-Beam Sensitivity Control (default) and enter Reduced High-Beam Sensitivity Control (not recommended), toggle high-beam lever 6 full on/off cycles within 10 seconds of ignition ON. System will return to default setting upon ignition off.

If the windshield or Automatic High Beam Headlamp Control mirror is replaced, the mirror must be re-aimed to ensure proper performance. See your local authorized dealer.

### To Activate

1. Turn the headlight switch to the AUTO headlight position.
2. Push the multifunction lever away from you (toward front of vehicle) to engage the high beam mode.

**NOTE:** This system will not activate until the vehicle is at or above 15 mph (24 km/h).

### To Deactivate

1. Pull the multifunction lever toward you (or rearward in vehicle) to manually deactivate the system (normal operation of low beams).
2. Push back on the multifunction lever to reactivate the system.

### Daytime Running Lights — If Equipped

The Daytime Running Lights come on whenever the engine is running, and the transmission is not in the PARK position. The lights will remain on until the ignition is switched to the OFF or ACC position or the parking brake is engaged. The headlight switch must be used for normal nighttime driving.

**NOTE:** If allowed by law in the country in which the vehicle was purchased the Daytime Running Lights can be turned on and off using the Uconnect System, refer to “Uconnect Settings” in “Understanding Your Instrument Panel” for further information.

### Lights-On Reminder

If the headlights or parking lights are on after the ignition is placed in the OFF position, a chime will sound to alert the driver when the driver’s door is opened.

## Fog Lights — If Equipped

The front fog light switch is built into the headlight switch.



Fog Light Switch

 To activate the front fog lights, turn on the parking lights or the low beam headlights and push the headlight switch. To turn off the front fog lights, either push the headlight switch a second time or turn off the headlight switch.

An indicator light in the instrument cluster illuminates when the fog lights are turned on.

**NOTE:** The fog lights will operate with the low beam headlights or parking lights on. However, selecting the high beam headlights will turn off the fog lights.



## Multifunction Lever

The multifunction lever controls the operation of the turn signals, headlight beam selection and passing lights. The multifunction lever is located on the left side of the steering column.



Multifunction Lever

## Turn Signals

Move the multifunction lever up or down and the arrows on each side of the instrument cluster flash to show proper operation of the front and rear turn signal lights.

### NOTE:

- If either light remains on and does not flash, or there is a very fast flash rate, check for a defective outside light bulb. If an indicator fails to light when the lever is moved, it would suggest that the indicator bulb is defective.
- A “Turn Signal On” message will appear in the EVIC/DID and a continuous chime will sound if the vehicle is driven more than 1 mile (1.6 km) with either turn signal on.

- When the Daytime Running Lights are on and a turn signal is activated, the Daytime Running Lamp will turn off on the side of the vehicle in which the turn signal is flashing. The Daytime Running Lamp will turn back on when the turn signal is turned off.

### **Lane Change Assist**

Tap the lever up or down once, without moving beyond the detent, and the turn signal (right or left) will flash three times then automatically turn off.

### **High/Low Beam Switch**

Push the multifunction lever away from you to switch the headlights to high beam. Pull the multifunction lever toward you to switch the headlights back to low beam.

### **Flash-To-Pass**

You can signal another vehicle with your headlights by lightly pulling the multifunction lever toward you. This will turn on the high beams headlights until the lever is released.

### **Front Map/Reading Lights**

The front map/reading lights are mounted in the overhead console.

### Front Map/Reading Lights — With Center Buttons

There are two map/reading light buttons located in the center of the overhead console that allow the lights to operate independently.

Push the button once to turn the light on.

To turn the light off, push the button a second time.



0333031567

Front Map/Reading Lights Center Buttons

### Front Map/Reading Lights — With Push Lenses

The two map/reading lights can be operated independently by pushing the lenses.

Push the lens once to turn the light on.

To turn the light off, push the lens a second time.



0333031215

Front Map/Reading Lights Push Lenses

**NOTE:** The lights also turn on when a door is opened. The lights will also turn on when the UNLOCK button on the RKE is pushed.

### Interior Lights

The interior lights come on when a door is opened.

To protect the battery, the interior lights will turn off automatically 10 minutes after the ignition is moved to the LOCK position. This will occur if the interior lights were switched on manually or are on because a door is open. This includes the glove box light and the trunk light. To restore interior light operation, either place the ignition in the ON/RUN position or cycle the light switch.

### Instrument Panel Dimmer Control

The instrument panel dimmer control is part of the headlight switch and is located on the drivers side of the instrument panel.

With the parking lights or headlights on, rotating the instrument panel dimmer control upward will increase the brightness of the instrument panel lights.



Instrument Panel Dimmer

## Ambient Light Control — If Equipped

Rotate the ambient dimmer control upward or downward to increase or decrease the brightness of the ambient light located in the overhead console, door handle lights, under I/P lights, door map pocket lights, and cubby bin lights.

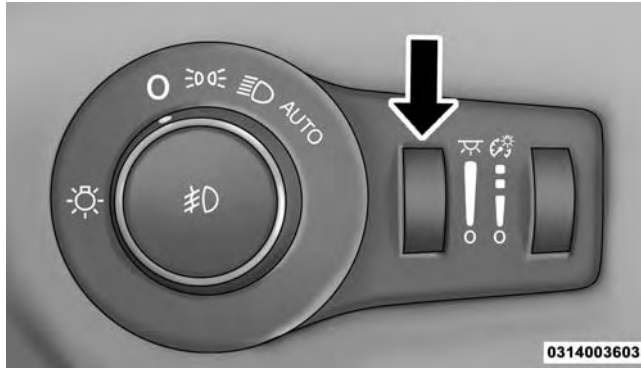

Ambient Light/Door Handle Light Dimmer

## Dome Light Position

Rotate the instrument panel dimmer control completely upward to the second detent to turn on the interior lights. The interior lights will remain on when the instrument panel dimmer control is in this position.

3

## Interior Light Defeat (OFF)

Rotate the instrument panel dimmer control to the extreme bottom OFF position. The interior lights will remain off when the doors are open.

## Parade Mode (Daytime Brightness Feature)

Rotate the instrument panel dimmer control upward to the first detent. This feature brightens all text displays such as the odometer, EVIC/DID, and radio when the position lights or headlights are on.

## Battery Saver Feature

To protect the battery, the interior lights will turn off automatically 10 minutes after the ignition switch is moved to the LOCK position. This will occur if the interior lights were switched on manually or are on because a door is open.

## WINDSHIELD WIPERS AND WASHERS

The windshield wiper/washer controls are located on the windshield wiper/washer lever on the right side of the steering column. The front wipers are operated by rotating a switch, located on the end of the lever.



Windshield Wiper/Washer Lever

## Windshield Wiper Operation

Rotate the end of the lever to one of the first four detent positions for intermittent settings, the fifth detent for low wiper operation and the sixth detent for high wiper operation.



Windshield Wiper Operation

**NOTE:** If snow packing occurs that obstructs the normal operation of the windshield wipers the following message will appear in the Electronic Vehicle Information Center (EVIC) or the Driver Information Display (DID): "Front Wipers Blocked Cycle Switch or Clean the Windshield". It is important to remove the snow accumulation to allow the wipers to function normally and to maintain good visibility of the road.

### CAUTION!

Always remove any buildup of snow that prevents the windshield wiper blades from returning to the "park" position. If the windshield wiper switch is turned off, and the blades cannot return to the "park" position, damage to the wiper motor may occur.

## Intermittent Wiper System

Use one of the four intermittent wiper settings when weather conditions make a single wiping cycle, with a variable delay between cycles, desirable. At driving speeds above 10 mph (16 km/h), the delay can be regulated from a maximum of approximately 18 seconds between cycles (first detent), to a cycle every one second (fourth detent).



### Intermittent Wiper Operation

**NOTE:** If the vehicle is moving less than 10 mph (16 km/h), delay times will be doubled.



## Windshield Washer Operation

To use the washer, pull the lever rearward toward you and hold while spray is desired. If the lever is pulled while in the intermittent setting, the wipers will turn on and operate for several wipe cycles after the lever is released, and then resume the intermittent interval previously selected.



Windshield Washer Operation

If the lever is pulled while the wipers are in the off position, the wipers will operate for several wipe cycles, then turn off.

### WARNING!

Sudden loss of visibility through the windshield could lead to a collision. You might not see other vehicles or other obstacles. To avoid sudden icing of the windshield during freezing weather, warm the windshield with the defroster before and during windshield washer use.

### Mist

Use the Mist feature when weather conditions make occasional usage of the wipers necessary. Push the lever upward to the Mist position and release for a single wiping cycle.

**NOTE:** The mist feature does not activate the washer pump; therefore, no washer fluid will be sprayed on the windshield. The wash function must be used in order to spray the windshield with washer fluid.

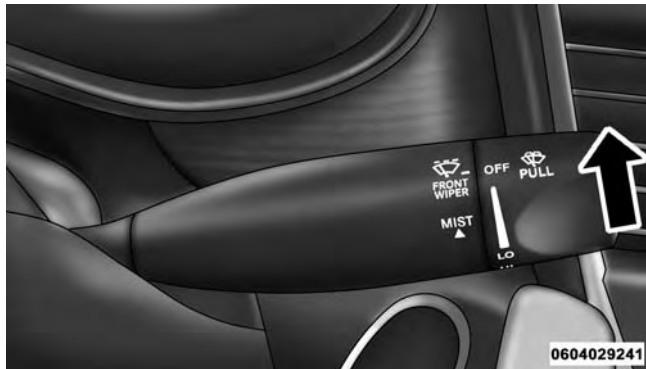

**Mist Control**

### **Rain Sensing Wipers — If Equipped**

This feature senses moisture on the windshield and automatically activates the wipers for the driver. The feature is especially useful for road splash or overspray from the windshield washers of the vehicle ahead. Rotate the end of the multifunction lever to one of four settings to activate this feature.

The sensitivity of the system can be adjusted with the multifunction lever. Wiper delay position one is the least sensitive, and wiper delay position four is the most sensitive. Setting three should be used for normal rain conditions. Settings one and two can be used if the driver desires less wiper sensitivity. Setting four can be used if the driver desires more sensitivity. Place the wiper switch in the OFF position when not using the system.

**NOTE:**

- The Rain Sensing feature will not operate when the wiper switch is in the low or high-speed position.
- The Rain Sensing feature may not function properly when ice, or dried salt water is present on the windshield.
- Use of Rain-X or products containing wax or silicone may reduce Rain Sensing performance.
- The Rain Sensing feature can be turned on and off using the Uconnect System, refer to “Uconnect Settings” in “Understanding Your Instrument Panel” for further information.

The Rain Sensing system has protection features for the wiper blades and arms, and will not operate under the following conditions:

- **Low Ambient Temperature** — When the ignition is first turned ON, the Rain Sensing system will not operate until the wiper switch is moved, vehicle speed is greater than 0 mph (0 km/h), or the outside temperature is greater than 32°F (0°C).
- **Transmission In NEUTRAL Position** — When the ignition is ON, and the automatic transmission is in the NEUTRAL position, the Rain Sensing system will not operate until the wiper switch is moved, vehicle speed is greater than 3 mph (5 km/h), or the shift lever/gear selector is moved out of the NEUTRAL position.

**Remote Start Mode Inhibit** — On vehicles equipped with Remote Starting system, Rain Sensing wipers are not operational when the vehicle is in the remote start mode. Once the operator is in the vehicle and has placed the ignition switch in the RUN position, rain sensing wiper operation can resume, if it has been selected, and no other inhibit conditions (mentioned previously) exist.

## TILT/TELESCOPING STEERING COLUMN

This feature allows you to tilt the steering column upward or downward. It also allows you to lengthen or shorten the steering column. The tilt/telescoping control handle is located below the steering wheel at the end of the steering column.

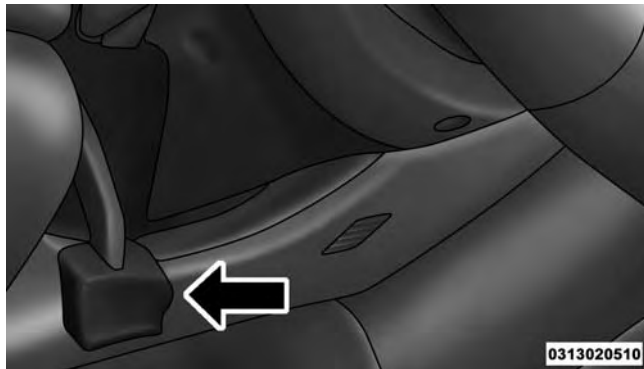

Tilt/Telescoping Steering Control Handle

To unlock the steering column, pull the control handle down. To tilt the steering column, move the steering wheel upward or downward as desired. To lengthen or shorten the steering column, pull the steering wheel outward or push it inward as desired. To lock the steering column in position, push the control handle up until fully engaged.



### WARNING!

**Do not adjust the steering column while driving. Adjusting the steering column while driving or driving with the steering column unlocked, could cause the driver to lose control of the vehicle. Failure to follow this warning may result in serious injury or death.**

## HEATED STEERING WHEEL — IF EQUIPPED

The steering wheel contains a heating element that helps warm your hands in cold weather. The heated steering wheel has only one temperature setting. Once the heated steering wheel has been turned on it can operate for up to 120 minutes before automatically shutting off. The heated steering wheel can shut off early or may not turn on when the steering wheel is already warm.

The heated steering wheel control button is located within the Uconnect system. You can gain access to the control button through the climate screen or the controls screen.

- Press the heated steering wheel button  once to turn the heating element ON.
- Press the heated steering wheel button  a second time to turn the heating element OFF.

**NOTE:** The engine must be running for the heated steering wheel to operate.

## Vehicles Equipped With Remote Start

On models that are equipped with remote start, the heated steering wheel can be programmed to come on during a remote start through the Uconnect system. Refer to “Uconnect Settings” in “Understanding Your Instrument Panel” for further information.

3

### WARNING!

- **Persons who are unable to feel pain to the skin because of advanced age, chronic illness, diabetes, spinal cord injury, medication, alcohol use, exhaustion, or other physical conditions must exercise care when using the steering wheel heater. It may cause burns even at low temperatures, especially if used for long periods.**

*(Continued)*

**WARNING! (Continued)**

- Do not place anything on the steering wheel that insulates against heat, such as a blanket or steering wheel covers of any type and material. This may cause the steering wheel heater to overheat.

**ELECTRONIC SPEED CONTROL — IF EQUIPPED**

When engaged, the Electronic Speed Control takes over accelerator operations at speeds greater than 25 mph (40 km/h).

The Electronic Speed Control buttons are located on the right side of the steering wheel.

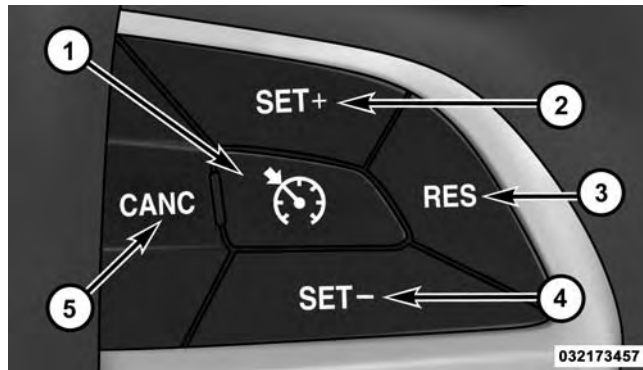

**Electronic Speed Control Buttons**

- |                |                 |
|----------------|-----------------|
| 1 — ON/OFF     | 4 — SET-/DECCEL |
| 2 — SET+/ACCEL | 5 — CANCEL      |
| 3 — RESUME     |                 |

**NOTE:** In order to ensure proper operation, the Electronic Speed Control System has been designed to shut down if multiple Speed Control functions are operated at the same time. If this occurs, the Electronic Speed Control System can be reactivated by pushing the Electronic Speed Control ON/OFF button and resetting the desired vehicle set speed.

### To Activate

Push the ON/OFF button to activate the electronic speed control. The Cruise Indicator Light in the Electronic Vehicle Information Center (EVIC) or Driver Information Display (DID) will illuminate. To turn the system off, push the ON/OFF button a second time. The Cruise Indicator Light will turn off. The system should be turned off when not in use.

### WARNING!

**Leaving the Electronic Speed Control system on when not in use is dangerous. You could accidentally set the system or cause it to go faster than you want. You could lose control and have an accident. Always leave the system OFF when you are not using it.**

3

### To Set A Desired Speed

Turn the Electronic Speed Control ON.

**NOTE:** The vehicle should be traveling at a steady speed and on level ground before pushing the SET (+) or SET (-) button.

When the vehicle has reached the desired speed, push the SET (+) or SET (-) button and release. Release the accelerator and the vehicle will operate at the selected speed.

### To Deactivate

A soft tap on the brake pedal, pushing the CANCEL button, or normal brake pressure while slowing the vehicle will deactivate the Electronic Speed Control without erasing the set speed from memory.

Pushing the ON/OFF button or turning the ignition switch OFF erases the set speed from memory.

### To Resume Speed

To resume a previously set speed, push the RES button and release. Resume can be used at any speed above 20 mph (32 km/h).

### To Vary The Speed Setting

#### To Increase Speed

When the Electronic Speed Control is set, you can increase speed by pushing the SET + button.

The drivers preferred units can be selected through the instrument panel settings if equipped. Refer to “Understanding Your Instrument Panel” for more information. The speed increment shown is dependant on the chosen speed unit of U.S. (mph) or Metric (km/h):

#### *U.S. Speed (mph)*

- Pushing the SET + button once will result in a 1 mph increase in set speed. Each subsequent tap of the button results in an increase of 1 mph.
- If the button is continually pushed, the set speed will continue to increase until the button is released, then the new set speed will be established.

#### *Metric Speed (km/h)*

- Pushing the SET + button once will result in a 1 km/h increase in set speed. Each subsequent tap of the button results in an increase of 1 km/h.



- If the button is continually pushed, the set speed will continue to increase until the button is released, then the new set speed will be established.

### To Decrease Speed

When the Electronic Speed Control is set, you can decrease speed by pushing the SET - button.

The drivers preferred units can be selected through the instrument panel settings if equipped. Refer to “Understanding Your Instrument Panel” for more information. The speed decrement shown is dependant on the chosen speed unit of U.S. (mph) or Metric (km/h):

#### *U.S. Speed (mph)*

- Pushing the SET - button once will result in a 1 mph decrease in set speed. Each subsequent tap of the button results in a decrease of 1 mph.

- If the button is continually pushed, the set speed will continue to decrease until the button is released, then the new set speed will be established.

#### *Metric Speed (km/h)*

- Pushing the SET - button once will result in a 1 km/h decrease in set speed. Each subsequent tap of the button results in a decrease of 1 km/h.
- If the button is continually pushed, the set speed will continue to decrease until the button is released, then the new set speed will be established.

### To Accelerate For Passing

Press the accelerator as you would normally. When the pedal is released, the vehicle will return to the set speed.

### Using Electronic Speed Control On Hills

The transmission may downshift on hills to maintain the vehicle set speed.

**NOTE:** The Electronic Speed Control system maintains speed up and down hills. A slight speed change on moderate hills is normal.

On steep hills, a greater speed loss or gain may occur so it may be preferable to drive without Electronic Speed Control.

### **WARNING!**

**Electronic Speed Control can be dangerous where the system cannot maintain a constant speed. Your vehicle could go too fast for the conditions, and you could lose control and have an accident. Do not use Electronic Speed Control in heavy traffic or on roads that are winding, icy, snow-covered or slippery.**

### **ADAPTIVE CRUISE CONTROL (ACC) — IF EQUIPPED**

Adaptive Cruise Control (ACC) increases the driving convenience provided by cruise control while traveling on highways and major roadways. However, it is not a safety system and not designed to prevent collisions. **Electronic Speed Control function performs differently. Please refer to the proper section within this chapter.**

ACC will allow you to keep cruise control engaged in light to moderate traffic conditions without the constant need to reset your cruise control. ACC utilizes a radar sensor and a forward facing camera designed to detect a vehicle directly ahead of you.

#### **NOTE:**

- If the sensor does not detect a vehicle ahead of you, ACC will maintain a fixed set speed.

- If the ACC sensor detects a vehicle ahead, ACC will apply limited braking or acceleration (not to exceed the original set speed) automatically to maintain a preset following distance, while matching the speed of the vehicle ahead.

The Cruise Control system has two control modes:

- Adaptive Cruise Control mode for maintaining an appropriate distance between vehicles.
- Normal (fixed speed) electronic speed control mode for cruising at a constant preset speed. For additional information, refer to “Normal (Fixed Speed) Cruise Control Mode” in this section.

**NOTE:** Normal (fixed speed) electronic speed control will not react to preceding vehicles. Always be aware of the mode selected.

You can change the mode by using the Cruise Control buttons. The two control modes function differently. Always confirm which mode is selected.

### WARNING!

- **Adaptive Cruise Control (ACC) is a convenience system. It is not a substitute for active driving involvement. It is always the driver's responsibility to be attentive of road, traffic, and weather conditions, vehicle speed, distance to the vehicle ahead; and, most importantly, brake operation to ensure safe operation of the vehicle under all road conditions. Your complete attention is always required while driving to maintain safe control of your vehicle. Failure to follow these warnings can result in a collision and death or serious personal injury.**

*(Continued)*

**WARNING! (Continued)**

- The ACC system:
  - Does not react to pedestrians, oncoming vehicles, and stationary objects (e.g., a stopped vehicle in a traffic jam or a disabled vehicle).
  - Cannot take street, traffic, and weather conditions into account, and may be limited upon adverse sight distance conditions.
  - Does not always fully recognize complex driving conditions, which can result in wrong or missing distance warnings.
  - Will bring the vehicle to a complete stop while following a target vehicle and hold the vehicle for approximately 3 minutes in the stop position. If the target vehicle does not start moving within 3 minutes the parking brake will be activated, and the ACC system will be cancelled.

**WARNING! (Continued)**

You should switch off the ACC system:

- When driving in fog, heavy rain, heavy snow, sleet, heavy traffic, and complex driving situations (i.e., in highway construction zones).
- When entering a turn lane or highway off ramp; when driving on roads that are winding, icy, snow-covered, slippery, or have steep uphill or downhill slopes.
- When towing a trailer up or down steep slopes.
- When circumstances do not allow safe driving at a constant speed.

**Adaptive Cruise Control (ACC) Operation**

The speed control buttons (located on the right side of the steering wheel) operates the ACC system.

(Continued)

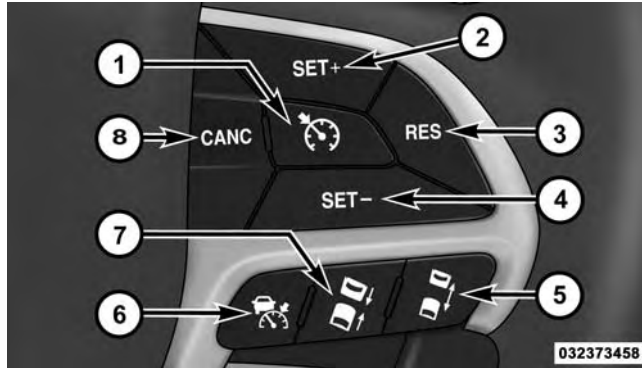

### Adaptive Cruise Control Buttons

- 1 — NORMAL (FIXED SPEED) CRUISE CONTROL ON/OFF
- 2 — SET+/ACCEL
- 3 — RESUME
- 4 — SET-/DECEL
- 5 — DISTANCE SETTING — INCREASE
- 6 — ADAPTIVE CRUISE CONTROL (ACC) ON/OFF
- 7 — DISTANCE SETTING — DECREASE
- 8 — CANCEL

**NOTE:** Any chassis/suspension or tire size modifications to the vehicle will effect the performance of the Adaptive Cruise Control and Forward Collision Warning System.

### Activating Adaptive Cruise Control (ACC)

You can only engage ACC if the vehicle speed is above 0 mph (0 km/h).

The minimum Set Speed for the ACC system is 20 mph (32 km/h).

When the system is turned on and in the READY state, the Electronic Vehicle Information Center (EVIC) or Driver Information Display (DID) displays “ACC Ready.”

When the system is OFF, the EVIC/DID displays “Adaptive Cruise Control (ACC) Off.”

**NOTE:** You cannot engage ACC under the following conditions:

- When you apply the brakes.
- When the parking brake is set.
- When the automatic transmission is in PARK, REVERSE or NEUTRAL.
- When the Vehicle speed is outside of the speed range.
- When the brakes are overheated.
- When the driver door is open.
- When the driver seat belt is unbuckled.

### To Activate/Deactivate

Push and release the Adaptive Cruise Control (ACC) ON/OFF button. The ACC menu in the EVIC/DID displays “ACC Ready.”

# ACC Ready

0323001278

Adaptive Cruise Control Ready

To turn the system OFF, push and release the Adaptive Cruise Control (ACC) ON/OFF button again. At this time, the system will turn off and the EVIC/DID will display “Adaptive Cruise Control (ACC) Off.”

# Adaptive Cruise Control (ACC) Off

Adaptive Cruise Control Off

0323001263

## WARNING!

Leaving the Adaptive Cruise Control (ACC) system on when not in use is dangerous. You could accidentally set the system or cause it to go faster than you want. You could lose control and have a collision. Always leave the system off when you are not using it.

### To Set A Desired ACC Speed

When the vehicle reaches the speed desired, push the SET + button or the SET - button and release. The EVIC/DID will display the set speed.

If the system is Set when the vehicle speed is below 20 mph (32 km/h), the Set Speed shall be defaulted to 20 mph (32 km/h). If the system is Set when the vehicle speed is above 20 mph (32 km/h), the Set Speed shall be the current speed of the vehicle.

**NOTE:** ACC cannot be set if there is a stationary vehicle in front of your vehicle in close proximity.

Remove your foot from the accelerator pedal. If you do not, the vehicle may continue to accelerate beyond the set speed. If this occurs:

- The message “DRIVER OVERRIDE” will display in the EVIC/DID.
- The system will not be controlling the distance between your vehicle and the vehicle ahead. The vehicle speed will only be determined by the position of the accelerator pedal.

### To Cancel

The following conditions cancel the system:

- The brake pedal is applied.
- The CANCEL button is pushed.
- An Anti-Lock Brake System (ABS) event occurs.

- The shift lever/gear selector is removed from the Drive position.
- The Electronic Stability Control/Traction Control System (ESC/TCS) activates.
- The vehicle parking brake is applied.
- Driver seatbelt is unbuckled at low speeds.
- Driver door is opened at low speeds.

### To Turn Off

The system will turn off and clear the set speed in memory if:

- The Adaptive Cruise Control (ACC) ON/OFF button is pushed.
- The Normal (Fixed Speed) Electronic Speed Control ON/OFF button is pushed.
- The ignition is turned OFF.



## To Resume

If there is a set speed in memory push the RES (resume) button and then remove your foot from the accelerator pedal. The EVIC/DID will display the last set speed.

### NOTE:

- If your vehicle stays at standstill for longer than two seconds, then the driver will either have to push the RES (resume) button, or apply the accelerator pedal to reengage the ACC to the existing Set Speed.
- ACC cannot be resumed if there is a stationary vehicle in-front of your vehicle in close proximity.

## WARNING!

**The Resume function should only be used if traffic and road conditions permit. Resuming a set speed that is too high or too low for prevailing traffic and road conditions could cause the vehicle to accelerate or decelerate too sharply for safe operation. Failure to follow these warnings can result in a collision and death or serious personal injury.**

## To Vary The Speed Setting

### To Increase Speed

While ACC is set, you can increase the set speed by pushing the SET + button.

The drivers preferred units can be selected through the instrument panel settings if equipped. Refer to “Understanding Your Instrument Panel” for more information.

The speed increment shown is dependant on the chosen speed unit of U.S. (mph) or Metric (km/h):

### *U.S. Speed (mph)*

- Pushing the SET + button once will result in a 1 mph increase in set speed. Each subsequent tap of the button results in an increase of 1 mph.
- If the button is continually pushed, the set speed will continue to increase in 5 mph increments until the button is released. The increase in set speed is reflected in the EVIC/DID.

### *Metric Speed (km/h)*

- Pushing the SET + button once will result in a 1 km/h increase in set speed. Each subsequent tap of the button results in an increase of 1 km/h.

- If the button is continually pushed, the set speed will continue to increase in 10 km/h increments until the button is released. The increase in set speed is reflected in the EVIC/DID.

### **To Decrease Speed**

While ACC is set, the set speed can be decreased by pushing the SET - button.

The drivers preferred units can be selected through the instrument panel settings if equipped. Refer to “Understanding Your Instrument Panel” for more information. The speed decrement shown is dependant on the chosen speed unit of U.S. (mph) or Metric (km/h):

### *U.S. Speed (mph)*

- Pushing the SET - button once will result in a 1 mph decrease in set speed. Each subsequent tap of the button results in a decrease of 1 mph.

- If the button is continually pushed, the set speed will continue to decrease in 5 mph decrements until the button is released. The decrease in set speed is reflected in the EVIC/DID.

### *Metric Speed (km/h)*

- Pushing the SET - button once will result in a 1 km/h decrease in set speed. Each subsequent tap of the button results in a decrease of 1 km/h.
- If the button is continually pushed, the set speed will continue to decrease in 10 km/h decrements until the button is released. The decrease in set speed is reflected in the EVIC/DID.

### **NOTE:**

- When you override and push the SET + button or SET - buttons, the new Set Speed will be the current speed of the vehicle.

- When you use the SET - button to decelerate, if the engine's braking power does not slow the vehicle sufficiently to reach the set speed, the brake system will automatically slow the vehicle.
- The ACC system decelerates the vehicle to a full stop when following a target vehicle. If an ACC host vehicle follows a target vehicle to a standstill, after two seconds the driver will either have to push the RES (resume) button, or apply the accelerator pedal to reengage the ACC to the existing Set Speed.
- The ACC system maintains set speed when driving up hill and down hill. However, a slight speed change on moderate hills is normal. In addition, downshifting may occur while climbing uphill or descending downhill. This is normal operation and necessary to maintain set speed. When driving up hill and down hill, the ACC system will cancel if the braking temperature exceeds normal range (overheated).

## Setting The Following Distance In ACC

The specified following distance for ACC can be set by varying the distance setting between four bars (longest), three bars (long), two bars (medium) and one bar (short). Using this distance setting and the vehicle speed, ACC calculates and sets the distance to the vehicle ahead. This distance setting displays in the EVIC/DID.

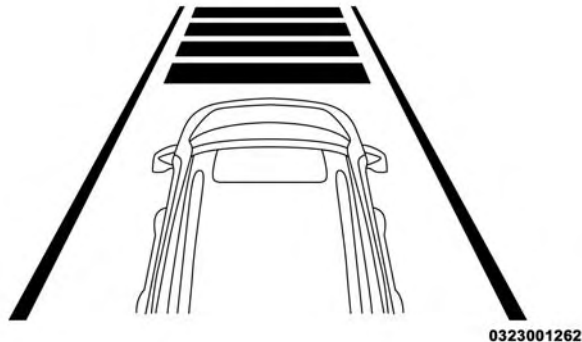

Distance Setting 4 Bars (Longest)



0323001261

Distance Setting 3 Bars (Long)

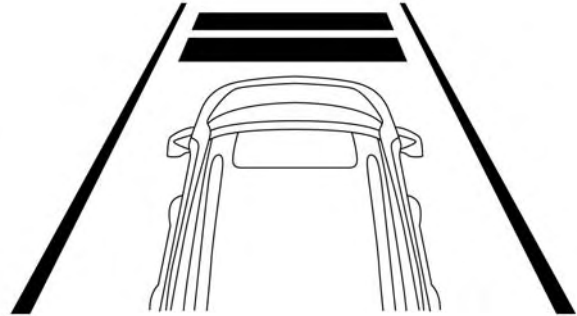

0323001260

Distance Setting 2 Bars (Medium)

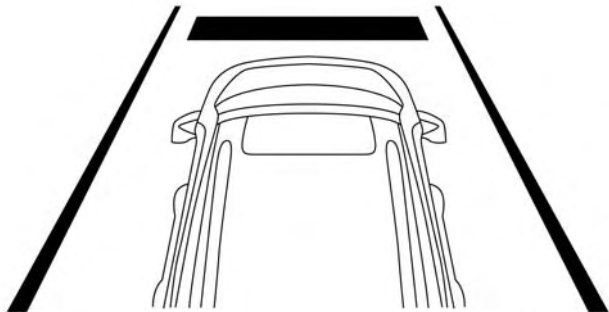

0323001259

### Distance Setting 1 Bar (Short)

To increase the distance setting, push the Distance Setting — Increase button and release. Each time the button is pushed, the distance setting increases by one bar (longer).

To decrease the distance setting, push the Distance Setting — Decrease button and release. Each time the button is pushed, the distance setting decreases by one bar (shorter).

If there is no vehicle ahead, the vehicle will maintain the set speed. If a slower moving vehicle is detected in the same lane, the EVIC/DID displays the “Sensed Vehicle Indicator” icon, and the system adjusts vehicle speed automatically to maintain the distance setting, regardless of the set speed.

The vehicle will then maintain the set distance until:

- The vehicle ahead accelerates to a speed above the set speed.
- The vehicle ahead moves out of your lane or view of the sensor.
- The distance setting is changed.

- The system disengages. (Refer to the information on ACC Activation).

The maximum braking applied by ACC is limited; however, the driver can always apply the brakes manually, if necessary.

**NOTE:** The brake lights will illuminate whenever the ACC system applies the brakes.

A Proximity Warning will alert the driver if ACC predicts that its maximum braking level is not sufficient to maintain the set distance. If this occurs, a visual alert “BRAKE” will flash in the EVIC/DID and a chime will sound while ACC continues to apply its maximum braking capacity.



**Brake Alert**

**NOTE:** The “Brake!” Screen in the EVIC/DID is a warning for the driver to take action and does not necessarily mean that the Forward Collision Warning system is applying the brakes autonomously.

## Overtake Aid

When driving with ACC engaged and following a vehicle, the system will provide an additional acceleration up to the ACC set speed to assist in passing the vehicle. This additional acceleration is triggered when the driver utilizes the left turn signal and will only be active when passing on the left hand side.

## ACC Operation At Stop

In the event that the ACC system brings your vehicle to a standstill while following a target vehicle, if the target vehicle starts moving within two seconds of your vehicle coming to a standstill, your vehicle will resume motion without the need for any driver action.

If the target vehicle does not start moving within two seconds of your vehicle coming to a standstill, the driver will either have to push the RES (resume) button, or apply the accelerator pedal to reengage the ACC to the existing Set Speed.

**NOTE:** After the ACC system holds your vehicle at a standstill for approximately 3 consecutive minutes, the parking brake will be activated, and the ACC system will be cancelled.

While ACC is holding your vehicle at a standstill, if the driver seatbelt is unbuckled or the driver door is opened, the parking brake will be activated, and the ACC system will be cancelled.

### WARNING!

**When the ACC system is resumed, the driver must ensure that there are no pedestrians, vehicles or objects in the path of the vehicle. Failure to follow these warnings can result in a collision and death or serious personal injury.**



## Adaptive Cruise Control (ACC) Menu

The EVIC/DID displays the current ACC system settings. The EVIC/DID is located in the center of the instrument cluster. The information it displays depends on ACC system status.

Push the ADAPTIVE CRUISE CONTROL (ACC) ON/OFF button (located on the steering wheel) until one of the following displays in the EVIC/DID:

### *Adaptive Cruise Control Off*

When ACC is deactivated, the display will read “Adaptive Cruise Control Off.”

### *Adaptive Cruise Control Ready*

When ACC is activated but the vehicle speed setting has not been selected, the display will read “Adaptive Cruise Control Ready.”

Push the SET + or the SET- button (located on the steering wheel) and the following will display in the EVIC/DID:

### *ACC SET*

When ACC is set, the set speed will display in the instrument cluster.

The ACC screen may display once again if any ACC activity occurs, which may include any of the following:

- System Cancel
- Driver Override
- System Off
- ACC Proximity Warning
- ACC Unavailable Warning
- The EVIC/DID will return to the last display selected after five seconds of no ACC display activity

## Display Warnings And Maintenance

### “Wipe Front Radar Sensor In Front Of Vehicle” Warning

The “ACC/FCW Unavailable Wipe Front Radar Sensor” warning will display and also a chime will indicate when conditions temporarily limit system performance.

This most often occurs at times of poor visibility, such as in snow or heavy rain. The ACC system may also become temporarily blinded due to obstructions, such as mud, dirt or ice. In these cases, the EVIC/DID will display “ACC/FCW Unavailable Wipe Front Radar Sensor” and the system will deactivate.

The “ACC/FCW Unavailable Wipe Front Radar Sensor” message can sometimes be displayed while driving in highly reflective areas (i.e. tunnels with reflective tiles, or ice and snow). The ACC system will recover after the

vehicle has left these areas. Under rare conditions, when the radar is not tracking any vehicles or objects in its path this warning may temporarily occur.

**NOTE:** If the “ACC/FCW Unavailable Wipe Front Radar Sensor” warning is active Normal (Fixed Speed) Cruise Control is still available. For additional information refer to “Normal (Fixed Speed) Cruise Control Mode” in this section.

If weather conditions are not a factor, the driver should examine the sensor. It may require cleaning or removal of an obstruction. The sensor is located in the center of the vehicle behind the lower grille.

To keep the ACC System operating properly, it is important to note the following maintenance items:

- Always keep the sensor clean. Carefully wipe the sensor lens with a soft cloth. Be cautious not to damage the sensor lens.

- Do not remove any screws from the sensor. Doing so could cause an ACC system malfunction or failure and require a sensor realignment.
- If the sensor or front end of the vehicle is damaged due to a collision, see your authorized dealer for service.
- Do not attach or install any accessories near the sensor, including transparent material or aftermarket grilles. Doing so could cause an ACC system failure or malfunction.

When the condition that deactivated the system is no longer present, the system will return to the “Adaptive Cruise Control Off” state and will resume function by simply reactivating it.

**NOTE:**

- If the “ACC/FCW Unavailable Wipe Front Radar Sensor” message occurs frequently (e.g. more than once on every trip) without any snow, rain, mud, or other obstruction, have the radar sensor realigned at your authorized dealer.
- Installing a snow plow, front-end protector, an aftermarket grille or modifying the grille is not recommended. Doing so may block the sensor and inhibit ACC/FCW operation.

**“Clean Front Windshield” Warning**

The “ACC/FCW Limited Functionality Clean Front Windshield” warning will display and also a chime will indicate when conditions temporarily limit system performance. This most often occurs at times of poor visibility, such as in snow or heavy rain and fog. The ACC system may also become temporarily blinded due to

obstructions, such as mud, dirt, or ice on windshield and fog on the inside of glass. In these cases, the EVIC/DID will display “ACC/FCW Limited Functionality Clean Front Windshield” and the system will have degraded performance.

The “ACC/FCW Limited Functionality Clean Front Windshield” message can sometimes be displayed while driving in adverse weather conditions. The ACC/FCW system will recover after the vehicle has left these areas. Under rare conditions, when the camera is not tracking any vehicles or objects in its path this warning may temporarily occur.

If weather conditions are not a factor, the driver should examine the windshield and the camera located on the back side of the inside rear view mirror. They may require cleaning or removal of an obstruction.

When the condition that created limited functionality is no longer present, the system will return to full functionality.

**NOTE:** If the “ACC/FCW Limited Functionality Clean Front Windshield” message occurs frequently (e.g. more than once on every trip) without any snow, rain, mud, or other obstruction, have the windshield and forward facing camera inspected at your authorized dealer.

### **Service ACC/FCW Warning**

If the system turns off, and the EVIC/DID displays “ACC/FCW Unavailable Service Required” or “Cruise/FCW Unavailable Service Required”, there may be an internal system fault or a temporary malfunction that limits ACC functionality. Although the vehicle is still drivable under normal conditions, ACC will be temporarily unavailable. If this occurs, try activating ACC again later, following an ignition cycle. If the problem persists, see your authorized dealer.

## Precautions While Driving With ACC

In certain driving situations, ACC may have detection issues. In these cases, ACC may brake late or unexpectedly. The driver needs to stay alert and may need to intervene.

### Offset Driving

ACC may not detect a vehicle in the same lane that is offset from your direct line of travel, or a vehicle merging in from a side lane. There may not be sufficient distance to the vehicle ahead. The offset vehicle may move in and out of the line of travel, which can cause your vehicle to brake or accelerate unexpectedly.

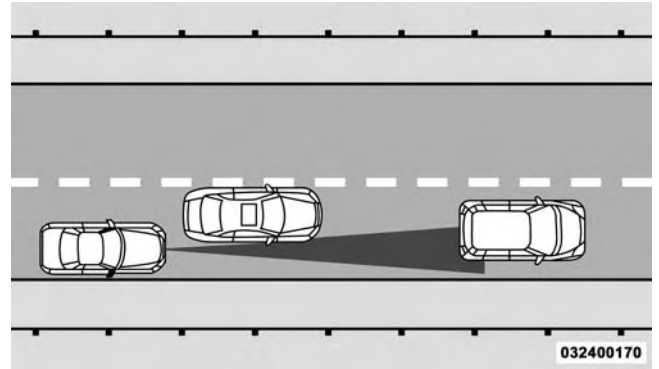

Offset Driving Condition Example

### Turns And Bends

When driving on a curve with ACC engaged, the system may decrease the vehicle speed and acceleration for stability reasons, with no target vehicle detected. Once

## 204 UNDERSTANDING THE FEATURES OF YOUR VEHICLE

the vehicle is out of the curve the system will resume your original Set Speed. This is a part of normal ACC system functionality.

**NOTE:** On tight turns ACC performance may be limited.

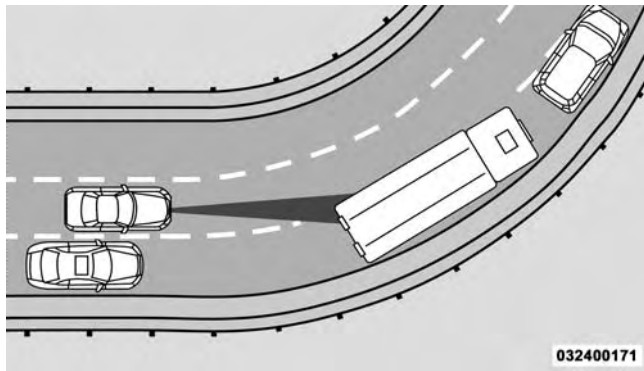

Turn Or Bend Example

## Using ACC On Hills

When driving on hills, ACC may not detect a vehicle in your lane. Depending on the speed, vehicle load, traffic conditions, and the steepness of the hills, ACC performance may be limited.

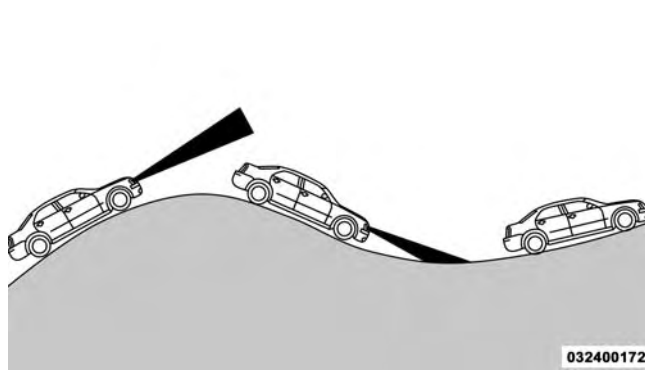

ACC Hill Example

## Lane Changing

ACC may not detect a vehicle until it is completely in the lane in which you are traveling. In the illustration shown, ACC has not yet detected the vehicle changing lanes and it may not detect the vehicle until it's too late for the ACC system to take action. ACC may not detect a vehicle until it is completely in the lane. There may not be sufficient distance to the lane-changing vehicle. Always be attentive and ready to apply the brakes if necessary.

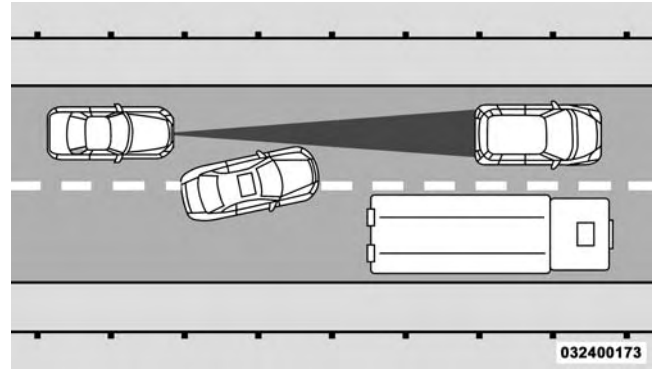

Lane Changing Example

## Narrow Vehicles

Some narrow vehicles traveling near the outer edges of the lane or edging into the lane are not detected until they have moved fully into the lane. There may not be sufficient distance to the vehicle ahead.

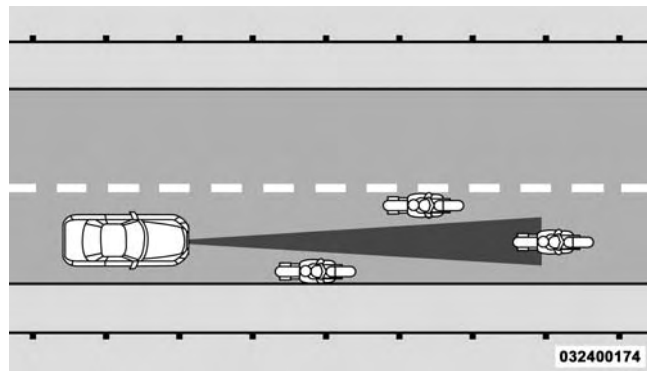

Narrow Vehicle Example

## Stationary Objects And Vehicles

ACC does not react to stationary objects and stationary vehicles. For example, ACC will not react in situations where the vehicle you are following exits your lane and the vehicle ahead is stopped in your lane. Always be attentive and ready to apply the brakes if necessary.

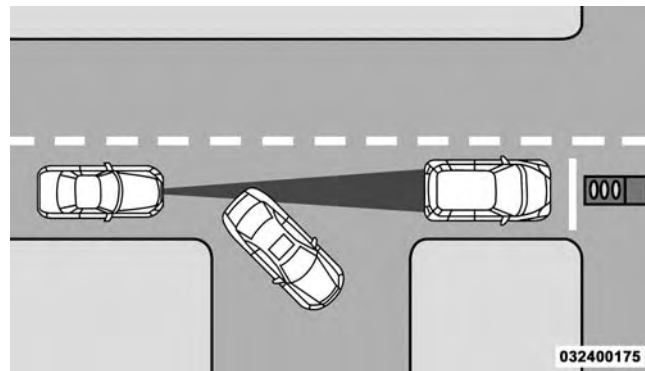

Stationary Object And Stationary Vehicle Example



## General Information

This vehicle has systems that operate on radio frequency that comply with Part 15 of the Federal Communications Commission (FCC) rules and with Industry Canada Standards RSS- GEN/210/220/310.

Operation is subject to the following two conditions:

1. The device may not cause harmful interference.
2. The device must accept any interference received, including interference that may cause undesired operation of the device.

Changes or modifications to any of these systems by other than an authorized service facility could void authorization to use this equipment.

## Normal (Fixed Speed) Electronic Speed Control Mode

In addition to Adaptive Cruise Control mode, a Normal (Fixed Speed) Electronic Speed Control mode is available for cruising at fixed speeds. The Normal (Fixed Speed) Electronic Speed Control mode is designed to maintain a set cruising speed without requiring the driver to operate the accelerator. Electronic Speed Control can only be operated if the vehicle speed is above 20 mph (32 km/h).

To change between the different control modes, push the ADAPTIVE CRUISE CONTROL (ACC) ON/OFF button which turns the ACC and the NORMAL (Fixed Speed) ELECTRONIC SPEED CONTROL OFF. Pushing of the NORMAL (Fixed Speed) ELECTRONIC SPEED CONTROL ON/OFF button will result in turning ON (changing to) the Normal (Fixed Speed) Electronic Speed Control mode.

**WARNING!**

In the normal Cruise Control mode, the system will not react to vehicles ahead. In addition, the proximity warning does not activate and no alarm will sound even if you are too close to the vehicle ahead since neither the presence of the vehicle ahead nor the vehicle-to vehicle distance is detected. Be sure to maintain a safe distance between your vehicle and the vehicle ahead. Always be aware which mode is selected.

**To Set A Desired Speed**

Turn the Normal (Fixed Speed) Electronic Speed Control ON. When the vehicle has reached the desired speed, push the SET (+) or SET (-) button and release. Release the accelerator and the vehicle will operate at the selected speed.

Once a speed has been set a message (CRUISE CONTROL SET TO MPH/KM) will appear indicating what speed was set. This light will turn on when the electronic speed control is SET.

**To Vary The Speed Setting****To Increase Speed**

When the Normal (Fixed Speed) Electronic Speed Control is set, you can increase speed by pushing the SET + button.

The drivers preferred units can be selected through the instrument panel settings if equipped. Refer to “Understanding Your Instrument Panel” for more information. The speed increment shown is dependant on the speed of U.S. (mph) or Metric (km/h) units:

***U.S. Speed (mph)***

- Pushing the SET + button once will result in a 1 mph increase in set speed. Each subsequent tap of the button results in an increase of 1 mph.

- If the button is continually pushed, the set speed will continue to increase in 5 mph increments until the button is released. The increase in set speed is reflected in the EVIC/DID display.

### *Metric Speed (km/h)*

- Pushing the SET + button once will result in a 1 km/h increase in set speed. Each subsequent tap of the button results in an increase of 1 km/h.
- If the button is continually pushed, the set speed will continue to increase in 10 km/h increments until the button is released. The increase in set speed is reflected in the EVIC/DID display.

### **To Decrease Speed**

When the Normal (Fixed Speed) Cruise Control is set, you can decrease speed by pushing the SET - button.

The drivers preferred units can be selected through the instrument panel settings if equipped. Refer to “Understanding Your Instrument Panel” for more information. The speed decrement shown is dependant on the speed of U.S. (mph) or Metric (km/h) units:

### *U.S. Speed (mph)*

- Pushing the SET - button once will result in a 1 mph decrease in set speed. Each subsequent tap of the button results in a decrease of 1 mph.
- If the button is continually pushed, the set speed will continue to decrease in 5 mph decrements until the button is released. The decrease in set speed is reflected in the EVIC/DID display.

### *Metric Speed (km/h)*

- Pushing the SET - button once will result in a 1 km/h decrease in set speed. Each subsequent tap of the button results in a decrease of 1 km/h.

## 210 UNDERSTANDING THE FEATURES OF YOUR VEHICLE

- If the button is continually pushed, the set speed will continue to decrease in 10 km/h decrements until the button is released. The decrease in set speed is reflected in the EVIC/DID display.

### To Cancel

The following conditions will cancel the Normal (Fixed Speed) Electronic Speed Control without clearing the memory:

- The brake pedal is applied.
- The CANCEL button is pushed.
- The Electronic Stability Control/Traction Control System (ESC/TCS) activates.
- The vehicle parking brake is applied.
- The braking temperature exceeds normal range (overheated).

- The shift lever/gear selector is removed from the Drive position.

### To Resume Speed

To resume a previously set speed, push the RES button and release. Resume can be used at any speed above 20 mph (32 km/h).

### To Turn Off

The system will turn off and erase the set speed in memory if:

- The Normal (Fixed Speed) Electronic Speed Control ON/OFF button is pushed.
- The ignition is turned off.
- The Adaptive Cruise Control (ACC) On/Off button is pushed.

## FORWARD COLLISION WARNING (FCW) WITH MITIGATION — IF EQUIPPED

### Forward Collision Warning (FCW) With Mitigation Operation

The Forward Collision Warning (FCW) system with mitigation provides the driver with audible warnings, visual warnings (within the EVIC/DID), and may apply a brake jerk to warn the driver when it detects a potential frontal collision. The warnings and limited braking are intended to provide the driver with enough time to react, avoid or mitigate the potential collision.

**NOTE:** FCW monitors the information from the forward looking sensors as well as the Electronic Brake Controller (EBC), to calculate the probability of a forward collision. When the system determines that a forward collision is probable, the driver will be provided with audible and visual warnings and may provide a brake jerk warning.

If the driver does not take action based upon these progressive warnings, then the system will provide a limited level of active braking to help slow the vehicle and mitigate the potential forward collision. If the driver reacts to the warnings by braking and the system determines that the driver intends to avoid the collision by braking but has not applied sufficient brake force, the system will compensate and provide additional brake force as required.

If a Forward Collision Warning with Mitigation event begins at a speed below 20 mph (32 km/h), the system may provide the maximum braking possible to mitigate the potential forward collision. If the Forward Collision Warning with Mitigation event stops the vehicle completely, the system will hold the vehicle at standstill for two seconds and then release the brakes.



FCW Message

When the system determines a collision with the vehicle in front of you is no longer probable, the warning message will be deactivated.

#### NOTE:

- The minimum speed for FCW activation is 1 mph (2 km/h).
- The FCW alerts may be triggered on objects other than vehicles such as guard rails or sign posts based on the course prediction. This is expected and is a part of normal FCW activation and functionality.
- It is unsafe to test the FCW system. To prevent such misuse of the system, after four Active Braking events within a key cycle, the Active Braking portion of FCW will be deactivated until the next key cycle.
- The FCW system is intended for on-road use only. If the vehicle is taken off-road, the FCW system should be deactivated to prevent unnecessary warnings to the surroundings.

**WARNING!**

Forward Collision Warning (FCW) is not intended to avoid a collision on its own, nor can FCW detect every type of potential collision. The driver has the responsibility to avoid a collision by controlling the vehicle via braking and steering. Failure to follow this warning could lead to serious injury or death.

**Turning FCW ON Or OFF**

**NOTE:** The default status of FCW is “On”, this allows the system to warn you of a possible collision with the vehicle in front of you.

The forward collision button is located on the switch panel below the Uconnect display.

**Forward Collision Button**

To turn the FCW system OFF, push the forward collision button once to turn the system OFF (LED turns on).

To turn the FCW system back ON, push the forward collision button again to turn the system ON (LED turns off).

- Changing the FCW status to “Off” prevents the system from warning you of a possible collision with the vehicle in front of you.
- Changing the FCW sensitivity - Near vs. Far. Far warns the driver of a possible collision earlier and Near warns the driver later.
- Changing the Active Braking status to “Off” prevents the system from providing limited active braking, or additional brake support if the driver is not braking adequately in the event of a potential frontal collision, but maintains the audible and visual warnings.

**NOTE:** The FCW system state is kept in memory from one key cycle to the next. If the system is turned OFF, it will remain off when the vehicle is restarted.

### Changing FCW And Active Braking Status

The FCW Sensitivity And Active Braking Settings are programmable through the Uconnect System. Refer to “Uconnect Settings” in “Understanding Your Instrument Panel” for further information.

The default status of FCW is the “Far” setting and the Active Braking is the “On” setting, this allows the system to warn you of a possible collision with the vehicle in front of you when you are farther away and it applies limited braking. This gives you the most reaction time to avoid a possible collision.

Changing the FCW status to the “Near” setting, allows the system to warn you of a possible collision with the vehicle in front of you when you are much closer. This setting provides less reaction time than the “Far” setting, which allows for a more dynamic driving experience.



**NOTE:**

- The system will retain the last setting selected by the driver after ignition shut down.
- FCW may not react to irrelevant objects such as overhead objects, ground reflections, objects not in the path of the vehicle, stationary objects that are far away, oncoming traffic, or leading vehicles with the same or higher rate of speed.
- FCW will be disabled like ACC, with the unavailable screens.

**FCW Limited Warning**

If the EVIC/DID displays “ACC/FCW Limited Functionality” or “ACC/FCW Limited Functionality Clean Front Windshield” momentarily, there may be a condition that

limits FCW functionality. Although the vehicle is still drivable under normal conditions, the active braking may not be fully available. Once the condition that limited the system performance is no longer present, the system will return to its full performance state. If the problem persists, see your authorized dealer.

**Service FCW Warning**

If the system turns off, and the EVIC/DID displays:

- ACC/FCW Unavailable Service Required
- Cruise/FCW Unavailable Service Required

This indicates there is an internal system fault. Although the vehicle is still drivable under normal conditions, have the system checked by an authorized dealer.

## LANESENSE — IF EQUIPPED

### LaneSense Operation

The LaneSense system is operational at speeds above 37 mph (60 km/h) and below 112 mph (180 km/h). The LaneSense system uses a forward looking camera to detect lane markings and measure vehicle position within the lane boundaries.

When both lane markings are detected and the driver unintentionally drifts out of the lane (no turn signal applied), the LaneSense system provides a haptic warning in the form of torque applied to the steering wheel to prompt the driver to remain within the lane boundaries. If the driver continues to unintentionally drift out of the lane, the LaneSense system provides a visual warning through the Electronic Vehicle Information Center (EVIC) or Driver Information Display (DID) to prompt the driver to remain within the lane boundaries.

The driver may manually override the haptic warning by applying torque into the steering wheel at any time.

When only a single lane marking is detected and the driver unintentionally drifts across the lane marking (no turn signal applied), the LaneSense system provides a visual warning through the EVIC/DID to prompt the driver to remain within the lane. When only a single lane marking is detected, a haptic (torque) warning will not be provided.

**NOTE:** When operating conditions have been met, the LaneSense system will monitor if the driver's hands are on the steering wheel and provides an audible warning to the driver when the driver's hands are not detected on the steering wheel. The system will cancel if the driver does not return their hands to the wheel.

## Turning LaneSense ON Or OFF

The default status of LaneSense is “OFF”.

The LaneSense button is located on the switch panel below the Uconnect display.



LaneSense Warning Button

0327021019

To turn the LaneSense system ON, push the LaneSense button (LED turns off). A “Lane Sense On” message is shown in the Driver Information Display (DID).

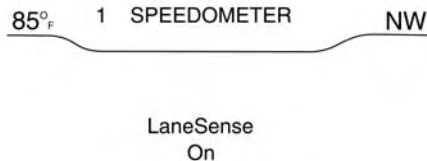

0323033354

### Lane Sense On Message

To turn the LaneSense system OFF, push the LaneSense button once to turn the system OFF (LED turns on).

**NOTE:** The LaneSense system will retain the last system state ON or OFF from the last ignition cycle when the ignition is changed to the ON/RUN position.

### LaneSense Warning Message

The LaneSense system will indicate the current lane drift condition through the Driver Information Display (DID).

#### 7.0 Driver Information Display (DID) Screen — If Equipped

When the LaneSense system is ON; the lane lines are gray when both of the lane boundaries have not been detected and the LaneSense indicator is solid white.

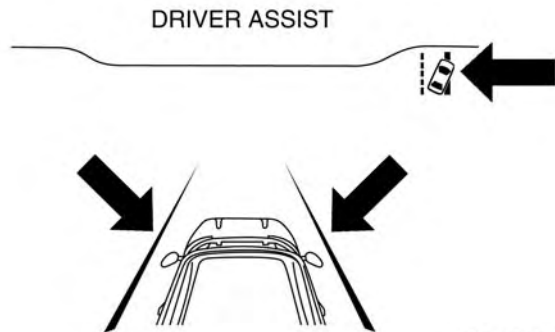

0324033151

**System ON (Gray Lines/White Indicator)**

#### Left Lane Departure — Only Left Lane Detected

- When the LaneSense system is ON, the LaneSense indicator is solid white when only the left lane marking has been detected and the system is ready to provide visual warnings in the DID if an unintentional lane departure occurs.

- When the LaneSense system senses the lane has been approached and is in a lane departure situation, the left thick lane line flashes yellow (on/off), the left thin line remains solid yellow and the LaneSense indicator changes from solid white to flashing yellow.

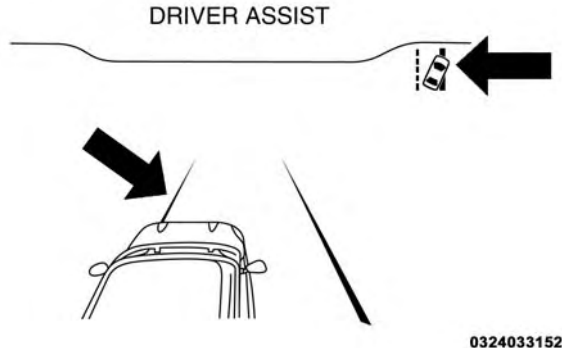

**Lane Approached (Flashing Yellow Thick Line, Solid Yellow Thin Line/Flashing Yellow Indicator)**

**NOTE:** The LaneSense system operates with the similar behavior for a right lane departure when only the right lane marking has been detected.

### Left Lane Departure — Both Lanes Detected

- When the LaneSense system is ON, the lane lines turn from gray to white to indicate that both of the lane markings have been detected. The LaneSense indicator is solid green when both lane markings have been detected and the system is “armed” to provide visual warnings in the DID and a torque warning in the steering wheel if an unintentional lane departure occurs.

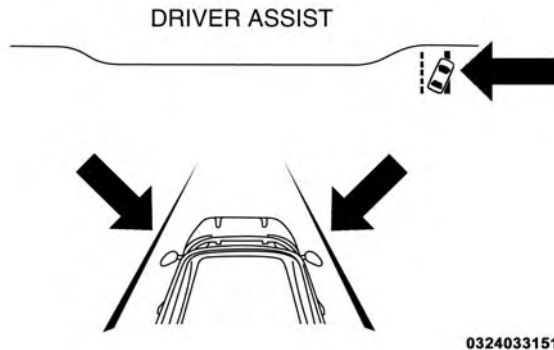

**Lanes Sensed (White Lines/Green Indicator)**

- When the LaneSense system senses a lane drift situation, the left thick lane line and left thin line turn solid yellow. The LaneSense indicator changes from solid green to solid yellow. At this time torque is applied to the steering wheel in the opposite direction of the lane boundary.

- For example: If approaching the left side of the lane the steering wheel will turn to the right.

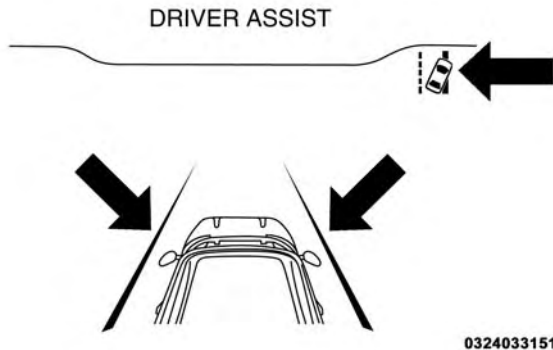

**Lane Sensed (Solid Yellow Thick Line, Solid Yellow Thin Line/Solid Yellow Indicator)**

- When the LaneSense system senses the lane has been approached and is in a lane departure situation, the left thick lane line flashes yellow (on/off) and the left thin line remains solid yellow. The LaneSense indicator changes from solid yellow to flashing yellow. At this time torque is applied to the steering wheel in the opposite direction of the lane boundary.
- For example: If approaching the left side of the lane the steering wheel will turn to the right.

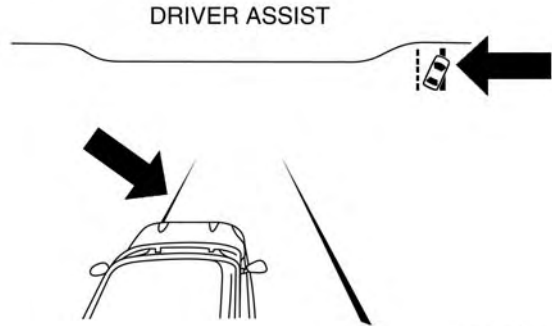

0324033152

**Lane Approached (Flashing Yellow Thick Line, Solid Yellow Thin Line/Flashing Yellow Indicator)**

**NOTE:** The LaneSense system operates with the similar behavior for a right lane departure.

## Changing LaneSense Status

The LaneSense system settings can be configured through the Uconnect system screen.

Follow these steps to change the LaneSense settings:

1. Push the “Controls” button on touchscreen located on the bottom of the Uconnect display.
2. Push the “Settings” button.
3. Push the “Safety & Driving Assistance” button.

When in the Safety & Driving Assistance screen, you can configure the intensity of the torque warning and the warning zone sensitivity (early/late) through the personalization settings.

### NOTE:

- When enabled the system operates above 37 mph (60 km/h) and below 112 mph (180 km/h).

- Use of the turn signal suppresses the warnings.
- The system will not apply torque to the steering wheel whenever a safety system engages. (anti-lock brakes, traction control system, electronic stability control, forward collision warning, etc.)

## PARKSENSE REAR PARK ASSIST — IF EQUIPPED

The ParkSense Rear Park Assist system provides visual and audible indications of the distance between the rear fascia and a detected obstacle when backing up, e.g. during a parking maneuver. Refer to ParkSense System Usage Precautions for limitations of this system and recommendations.

ParkSense will retain the last system state (enabled or disabled) from the last ignition cycle when the ignition is changed to the ON/RUN position.



ParkSense can be active only when the shift lever/gear selector is in REVERSE. If ParkSense is enabled at this shift lever/gear selector position, the system will remain active until the vehicle speed is increased to approximately 7 mph (11 km/h) or above. When in REVERSE and above the system's operating speed, a warning will appear within the Electronic Vehicle Information Center (EVIC) or Driver Information Display (DID) indicating the vehicle speed is too fast. The system will become active again if the vehicle speed is decreased to speeds less than approximately 6 mph (9 km/h).

### **ParkSense Sensors**

The four ParkSense sensors, located in the rear fascia/bumper, monitor the area behind the vehicle that is within the sensors' field of view. The sensors can detect obstacles from approximately 12 in (30 cm) up to 79 in

(200 cm) from the rear fascia/bumper in the horizontal direction, depending on the location, type and orientation of the obstacle.

### **ParkSense Warning Display**

The ParkSense Warning screen will only be displayed if Sound and Display is selected from the Customer - Programmable Features section of the Uconnect System. Refer to "Uconnect Settings" in "Understanding Your Instrument Panel" for further information.

The ParkSense Warning screen is located within the EVIC/DID. It provides visual warnings to indicate the distance between the rear fascia/bumper and the detected obstacle. Refer to "Electronic Vehicle Information Center (EVIC) or Driver Information Display (DID)" for further information.

## ParkSense Display

When the vehicle is in REVERSE, the EVIC/DID will display the park assist ready system status.

The system will indicate a detected obstacle by showing a single arc in one or more regions based on the obstacle's distance and location relative to the vehicle.

If an obstacle is detected in the center rear region, the display will show a single solid arc in the center rear region and will produce a one-half second tone. As the vehicle moves closer to the obstacle, the display will show the single arc moving closer to the vehicle and the sound tone will change from slow, to fast, to continuous.

If an obstacle is detected in the left and/or right rear region, the display will show a single flashing arc in the left and/or right rear region and will produce a fast sound tone. As the vehicle moves closer to the obstacle, the display will show the single arc moving closer to the vehicle and the tone will change from fast to continuous.

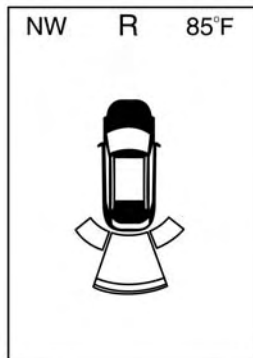

0329002014

Single 1/2 Second Tone/Solid Arc

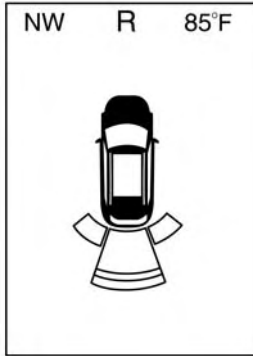

Slow Tone/Solid Arc

0329002016

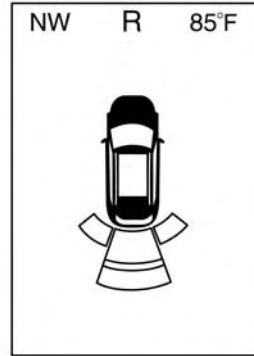

Slow Tone/Solid Arc

0329002018

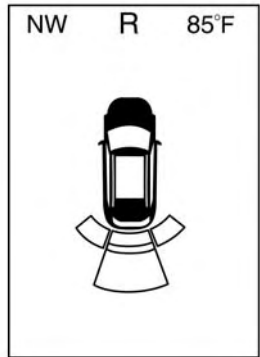

Fast Tone/Flashing Arc

0329002020

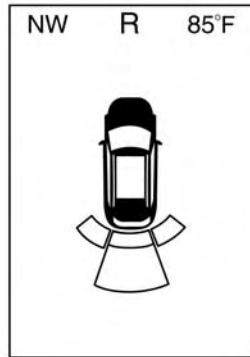

Continuous Tone/Flashing Arc

0329002022

The vehicle is close to the obstacle when the warning display shows one flashing arc and sounds a continuous tone. The following chart shows the warning alert operation when the system is detecting an obstacle:

WARNING ALERTS							
Rear Distance (in/cm)	Greater than 79 in (200 cm)	79-59 in (200-150 cm)	59-47 in (150-120 cm)	47-39 in (120-100 cm)	39-25 in (100-65 cm)	25-12 in (65-30 cm)	Less than 12 in (30 cm)
Arcs — Left	None	None	None	None	None	2nd Flashing	1st Flashing
Arcs — Center	None	6th Solid	5th Solid	4th Solid	3rd Flashing	2nd Flashing	1st Flashing
Arcs — Right	None	None	None	None	None	2nd Flashing	1st Flashing

## 228 UNDERSTANDING THE FEATURES OF YOUR VEHICLE

Audible Alert Chime	None	Single 1/2-Second Tone (for rear center only)	Slow (for rear center only)	Slow (for rear center only)	Fast (for rear center only)	Fast	Continuous
Radio Volume Reduced	No	Yes	Yes	Yes	Yes	Yes	Yes

**NOTE:** ParkSense will reduce the volume of the radio, if on, when the system is sounding an audio tone.

## Enabling And Disabling ParkSense

ParkSense can be enabled and disabled with the ParkSense switch, located on the switch panel below the Uconnect display.



**ParkSense Switch**

When the ParkSense switch is pushed to disable the system, the instrument cluster will display the

“PARKSENSE OFF” message for approximately five seconds. Refer to “Electronic Vehicle Information Center (EVIC) or 7” Driver Information Display (DID)” for further information. When the shift lever is moved to REVERSE and the system is disabled, the EVIC/DID will display the “PARKSENSE OFF” message for as long as the vehicle is in REVERSE.

The ParkSense switch LED will be ON when ParkSense is disabled or requires service. The ParkSense switch LED will be OFF when the system is enabled. If the ParkSense switch is pushed, and requires service, the ParkSense switch LED will blink momentarily, and then the LED will be ON.

## Service The ParkSense Rear Park Assist System

During vehicle start up, when the ParkSense Rear Park Assist System has detected a faulted condition, the instrument cluster will actuate a single chime, once per ignition cycle, and it will display the “PARKSENSE

UNAVAILABLE WIPE REAR SENSORS” or the “PARKSENSE UNAVAILABLE SERVICE REQUIRED” message. Refer to “Electronic Vehicle Information Center (EVIC) or Driver Information Display (DID)” for further information. When the shift lever/gear selector is moved to REVERSE and the system has detected a faulted condition, the EVIC/DID will display the “PARKSENSE UNAVAILABLE WIPE REAR SENSORS” or “PARKSENSE UNAVAILABLE SERVICE REQUIRED” message for as long as the vehicle is in REVERSE. Under this condition, ParkSense will not operate.

If “PARKSENSE UNAVAILABLE WIPE REAR SENSORS” appears in the Electronic Vehicle Information Center (EVIC) or Driver Information Display (DID) make sure the outer surface and the underside of the rear fascia/bumper is clean and clear of snow, ice, mud, dirt or other obstruction and then cycle the ignition. If the message continues to appear, see an authorized dealer.

If “PARKSENSE UNAVAILABLE SERVICE REQUIRED” appears in the EVIC/DID, see an authorized dealer.

### **Cleaning The ParkSense System**

Clean the ParkSense sensors with water, car wash soap and a soft cloth. Do not use rough or hard cloths. Do not scratch or poke the sensors. Otherwise, you could damage the sensors.

### **ParkSense System Usage Precautions**

#### **NOTE:**

- Ensure that the rear bumper is free of snow, ice, mud, dirt and debris to keep the ParkSense system operating properly.
- Jackhammers, large trucks, and other vibrations could affect the performance of ParkSense.



- When you turn ParkSense OFF, the instrument cluster will display “PARKSENSE OFF” Furthermore, once you turn ParkSense off, it remains off until you turn it on again, even if you cycle the ignition.
- When you move the shift lever to the REVERSE position and ParkSense is turned OFF, the EVIC/DID will display “PARKSENSE OFF” message for as long as the vehicle is in REVERSE.
- ParkSense, when on, will reduce the volume of the radio when it is sounding a tone.
- Clean the ParkSense sensors regularly, taking care not to scratch or damage them. The sensors must not be covered with ice, snow, slush, mud, dirt or debris. Failure to do so can result in the system not working properly. The ParkSense system might not detect an obstacle behind the fascia/bumper, or it could provide a false indication that an obstacle is behind the fascia/bumper.
- Use the ParkSense switch to turn the ParkSense system OFF if objects such as bicycle carriers, trailer hitches, etc. are placed within 12 in (30 cm) from the rear fascia/bumper. Failure to do so can result in the system misinterpreting a close object as a sensor problem, causing the “PARKSENSE UNAVAILABLE SERVICE REQUIRED” message to be displayed in the EVIC/DID.

**CAUTION!**

- **ParkSense is only a parking aid and it is unable to recognize every obstacle, including small obstacles. Parking curbs might be temporarily detected or not detected at all. Obstacles located above or below the sensors will not be detected when they are in close proximity.**

*(Continued)*

**CAUTION!** *(Continued)*

- The vehicle must be driven slowly when using ParkSense in order to be able to stop in time when an obstacle is detected. It is recommended that the driver looks over his/her shoulder when using ParkSense.

**WARNING!**

Drivers must be careful when backing up even when using ParkSense. Always check carefully behind your vehicle, look behind you, and be sure to check for pedestrians, animals, other vehicles, obstructions, and blind spots before backing up. You are responsible for safety and must continue to pay attention to your surroundings. Failure to do so can result in serious injury or death.

**PARKSENSE FRONT AND REAR PARK ASSIST — IF EQUIPPED**

The ParkSense Park Assist system provides visual and audible indications of the distance between the rear and/or front fascia and a detected obstacle when backing up or moving forward, e.g. during a parking maneuver. If your vehicle is equipped with an Automatic Transmission, the vehicle brakes may be automatically applied and released when performing a reverse parking maneuver if the system detects a possible collision with an obstacle.

**NOTE:**

- The driver can override the automatic braking function by pushing the gas pedal, turning ParkSense off via ParkSense switch, or changing the gear while the automatic brakes are being applied.

- Automatic brakes will not be available if ESC is not available.
- Automatic brakes will not be available if there is a faulted condition detected with the ParkSense Park Assist system or the Braking System Module.
- The automatic braking function may only be applied if the vehicle deceleration is not enough to avoid colliding with a detected obstacle.
- The automatic braking function may not be applied fast enough for obstacles that move toward the rear of the vehicle from the left and/or right sides.
- The automatic braking function can be enabled/disabled from the Customer-Programmable Features section of the Uconnect System.
- ParkSense will retain its last known configuration state for the automatic braking function through ignition cycles.

The automatic braking function is intended to assist the driver in avoiding possible collisions with detected obstacles when backing up in REVERSE gear.

**NOTE:**

- The driver is always responsible for controlling the vehicle.
- The system is provided to assist the driver and not to substitute the driver.
- The driver must stay in full control of the vehicle's acceleration and braking and is responsible for the vehicle's movements.

Refer to ParkSense System Usage Precautions for limitations of this system and recommendations.

ParkSense will retain the last system state (enabled or disabled) from the last ignition cycle when the ignition is changed to the ON/RUN position.

ParkSense can be active only when the shift lever is in REVERSE or DRIVE. If ParkSense is enabled at one of these shift lever positions, the system will remain active until the vehicle speed is increased to approximately 7 mph (11 km/h) or above. When in REVERSE and above the system's operating speed, a warning will appear in the EVIC/DID indicating the vehicle speed is too fast. The system will become active again if the vehicle speed is decreased to speeds less than approximately 6 mph (9 km/h).

### **ParkSense Sensors**

The four ParkSense sensors, located in the rear fascia/bumper, monitor the area behind the vehicle that is within the sensors' field of view. The sensors can detect obstacles from approximately 12 in (30 cm) up to 79 in (200 cm) from the rear fascia/bumper in the horizontal direction, depending on the location, type and orientation of the obstacle.

**NOTE:** If your vehicle is equipped with the ParkSense Active Park Assist system, six sensors will be located in the rear fascia/bumper. Refer to the "ParkSense Active Park Assist System" section for further information.

The six ParkSense sensors, located in the front fascia/bumper, monitor the area in front of the vehicle that is within the sensors' field of view. The sensors can detect obstacles from approximately 12 in (30 cm) up to 47 in (120 cm) from the front fascia/bumper in the horizontal direction, depending on the location, type and orientation of the obstacle.

### **ParkSense Warning Display**

The ParkSense Warning screen will only be displayed if Sound and Display is selected from the Customer - Programmable Features section of the Uconnect System. Refer to "Uconnect Settings" in "Understanding Your Instrument Panel" for further information.

The ParkSense Warning screen is located within the Electronic Vehicle Information Center (EVIC) or Driver Information Display (DID). It provides visual warnings to indicate the distance between the rear fascia/bumper and/or front fascia/bumper and the detected obstacle. Refer to “Electronic Vehicle Information Center (EVIC) or 7” Driver Information Display (DID)” for further information.

## **ParkSense Display**

### **Rear Park Assist**

When the vehicle is in REVERSE, the EVIC/DID will display the park assist ready system status.

The system will indicate a detected obstacle by showing a single arc in one or more regions based on the obstacle’s distance and location relative to the vehicle.

If an obstacle is detected in the center rear region, the display will show a single solid arc in the center rear region and will produce a one-half second tone. As the vehicle moves closer to the obstacle, the display will show the single arc moving closer to the vehicle and the sound tone will change from slow, to fast, to continuous.

If an obstacle is detected in the left and/or right rear region, the display will show a single flashing arc in the left and/or right rear region and will produce a fast sound tone. As the vehicle moves closer to the obstacle, the display will show the single arc moving closer to the vehicle and the tone will change from fast to continuous.

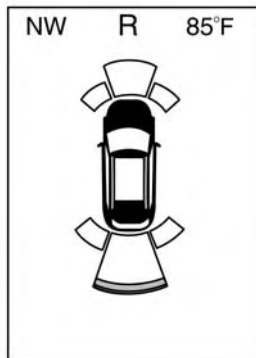

0329002063

Single 1/2 Second Tone/Solid Arc

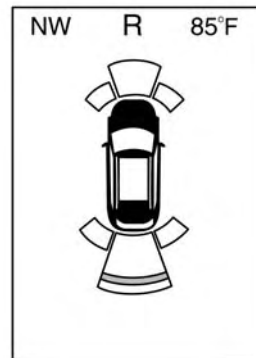

0329002064

Slow Tone/Solid Arc

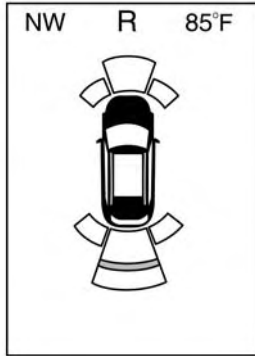

Slow Tone/Solid Arc

0329002065

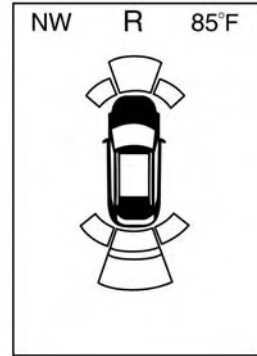

Fast Tone/Flashing Arc

0329002066

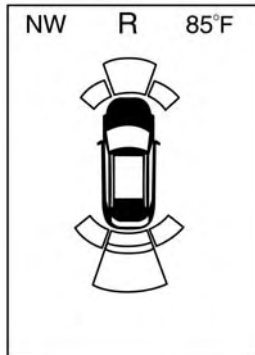

Fast Tone/Flashing Arc

0329002019

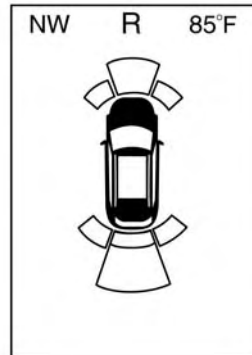

Continuous Tone/Flashing Arc

0329002021



The vehicle is close to the obstacle when the warning display shows one flashing arc and sounds a continuous tone. The following chart shows the warning alert operation when the system is detecting an obstacle:

WARNING ALERTS							
Rear Distance (in/cm)	Greater than 79 in (200 cm)	79-59 in (200-150 cm)	59-47 in (150-120 cm)	47-39 in (120-100 cm)	39-25 in (100-65 cm)	25-12 in (65-30 cm)	Less than 12 in (30 cm)
Arcs — Left	None	None	None	None	None	2nd Flashing	1st Flashing
Arcs — Center	None	6th Solid	5th Solid	4th Solid	3rd Flashing	2nd Flashing	1st Flashing
Arcs — Right	None	None	None	None	None	2nd Flashing	1st Flashing
Audible Alert	None	Single 1/2-Second	Slow (for rear	Slow (for rear	Fast (for rear	Fast	Continuous

Chime		Tone (for rear center only)	center only)	center only)	center only)		
Radio Volume Reduced	No	Yes	Yes	Yes	Yes	Yes	Yes

**NOTE:** ParkSense will reduce the volume of the radio, if on, when the system is sounding an audio tone.

### Front Park Assist

When the vehicle is in DRIVE the ParkSense Warning screen will be displayed when an obstacle is detected.

The system will indicate a detected obstacle by showing a single arc in one or more regions based on the obstacle's distance and location relative to the vehicle.

If an obstacle is detected in the center front region, the display will show a single arc in the center front region.

As the vehicle moves closer to the obstacle, the display will show the single arc moving closer to the vehicle. A fast sound tone will be produced when reaching the 2nd flashing arc and will change to a continuous sound tone when the 1st flashing arc appears.

If an obstacle is detected in the left and/or right front region, the display will show a single flashing arc in the left and/or right front region and will produce a fast sound tone. As the vehicle moves closer to the obstacle, the display will show the single arc moving closer to the vehicle and the tone will change from fast to continuous.

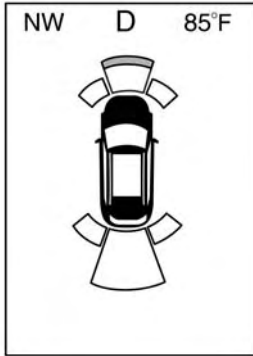

No Tone/Solid Arc

0329002059

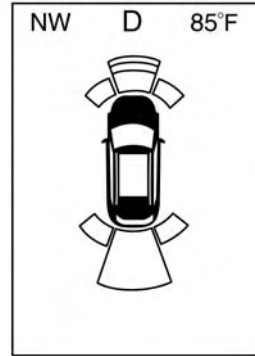

No Tone/Flashing Arc

0329002060



Fast Tone/Flashing Arc

0329002061

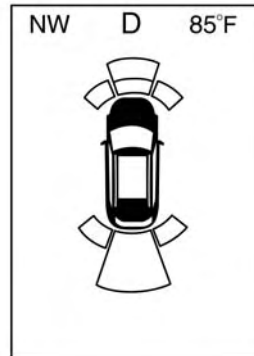

Continuous Tone/Flashing Arc

0329002062

The vehicle is close to the obstacle when the warning display shows one flashing arc and sounds a continuous tone. The following chart shows the warning alert operation when the system is detecting an obstacle:

WARNING ALERTS					
Front Distance (in/cm)	Greater than 47 in (120 cm)	47-39 in (120-100 cm)	39-25 in (100-65 cm)	25-12 in (65-30 cm)	Less than 12 in (30 cm)
Arcs — Left	None	None	None	2nd Flashing	1st Flashing
Arcs — Center	None	4th Solid	3rd Flashing	2nd Flashing	1st Flashing
Arcs — Right	None	None	None	2nd Flashing	1st Flashing
Audible Alert Chime	None	None	None	Fast	Continuous
Radio Volume Reduced	No	No	No	Yes	Yes

**NOTE:** ParkSense will reduce the volume of the radio, if on, when the system is sounding an audio tone.

### Front Park Assist Audible Alerts

ParkSense will turn off the Front Park Assist audible alert (chime) after approximately three seconds when an obstacle has been detected, the vehicle is stationary, and brake pedal is applied.

### Adjustable Chime Volume Settings

Front and Rear chime volume settings can be selected from the Customer-Programmable Features section of the Uconnect System, refer to “Uconnect Settings” in “Understanding Your Instrument Panel” for further information.

If the Uconnect System is equipped, chime volume settings will not be accessible from the EVIC/DID.

The chime volume settings include LOW, MEDIUM, and HIGH. The factory default volume setting is MEDIUM.

ParkSense will retain its last known configuration state through ignition cycles.

### Enabling And Disabling ParkSense

ParkSense can be enabled and disabled with the ParkSense switch, located on the switch panel below the Uconnect display.



**ParkSense Switch**

When the ParkSense switch is pushed to disable the system, the instrument cluster will display the

“PARKSENSE OFF” message for approximately five seconds. Refer to “Electronic Vehicle Information Center (EVIC) or 7” Driver Information Display (DID)” for further information. When the shift lever is moved to REVERSE and the system is disabled, the EVIC/DID will display the “PARKSENSE OFF” message for as long as the vehicle is in REVERSE.

The ParkSense switch LED will be ON when ParkSense is disabled or requires service. The ParkSense switch LED will be OFF when the system is enabled. If the ParkSense switch is pushed, and requires service, the ParkSense switch LED will blink momentarily, and then the LED will be ON.

### **Service The ParkSense Park Assist System**

During vehicle start up, when the ParkSense System has detected a faulted condition, the instrument cluster will actuate a single chime, once per ignition cycle, and it will display the “PARKSENSE UNAVAILABLE WIPE REAR

SENSORS”, “PARKSENSE UNAVAILABLE WIPE FRONT SENSORS”, or the “PARKSENSE UNAVAILABLE SERVICE REQUIRED” message for five seconds. When the shift lever/gear selector is moved to Reverse and the system has detected a faulted condition, the Electronic Vehicle Information Center (EVIC) or Driver Information Display (DID) will display a “PARKSENSE UNAVAILABLE WIPE REAR SENSORS”, “PARKSENSE UNAVAILABLE WIPE FRONT SENSORS” or “PARKSENSE UNAVAILABLE SERVICE REQUIRED” pop up message for five seconds. After five seconds, a car graphic will be displayed with “UNAVAILABLE” at either the front or rear sensor location depending on where the fault is detected. The system will continue to provide arc alerts for the side that is functioning properly. These arc alerts will interrupt the “PARKSENSE UNAVAILABLE WIPE REAR SENSORS”, “PARKSENSE UNAVAILABLE WIPE FRONT SENSORS”, or “PARKSENSE UNAVAILABLE SERVICE REQUIRED” messages if an object

is detected within the five second pop-up duration. The car graphic will remain displayed for as long as the vehicle is in REVERSE. Refer to “Electronic Vehicle Information Center (EVIC) or “Driver Information Display (DID)” for further information.

If “PARKSENSE UNAVAILABLE WIPE REAR SENSORS” or “PARKSENSE UNAVAILABLE WIPE FRONT SENSORS” appears in the Electronic Vehicle Information Center (EVIC) or Driver Information Display (DID) make sure the outer surface and the underside of the rear fascia/bumper and/or front fascia/bumper is clean and clear of snow, ice, mud, dirt or other obstruction and then cycle the ignition. If the message continues to appear see an authorized dealer.

If the “PARKSENSE UNAVAILABLE SERVICE REQUIRED” message appears in the EVIC/DID, see an authorized dealer.

## Cleaning The ParkSense System

Clean the ParkSense sensors with water, car wash soap and a soft cloth. Do not use rough or hard cloths. Do not scratch or poke the sensors. Otherwise, you could damage the sensors.

## ParkSense System Usage Precautions

### NOTE:

- Ensure that the front and rear bumper are free of snow, ice, mud, dirt and debris to keep the ParkSense system operating properly.
- Construction equipment, large trucks, and other vibrations could affect the performance of ParkSense.
- When you turn ParkSense off, the instrument cluster will display “PARKSENSE OFF.” Furthermore, once you turn ParkSense off, it remains off until you turn it on again, even if you cycle the ignition key.



- When you move the shift lever to the REVERSE position and ParkSense is turned off, the instrument cluster will display “PARKSENSE OFF” for as long as the vehicle is in REVERSE.
- ParkSense, when on, will reduce the volume of the radio when it is sounding a tone.
- Clean the ParkSense sensors regularly, taking care not to scratch or damage them. The sensors must not be covered with ice, snow, slush, mud, dirt or debris. Failure to do so can result in the system not working properly. The ParkSense system might not detect an obstacle behind or in front of the fascia/bumper, or it could provide a false indication that an obstacle is behind or in front of the fascia/bumper.
- Use the ParkSense switch to turn the ParkSense system off if objects such as bicycle carriers, trailer hitches, etc. are placed within 12 in (30 cm) from the rear fascia/bumper. Failure to do so can result in the system misinterpreting a close object as a sensor problem, causing the “PARKSENSE UNAVAILABLE SERVICE REQUIRED” message to be displayed in the instrument cluster.
- There may be a delay in the object detection rate if the object is moving. This will cause the automatic braking application to be delayed.

**CAUTION!**

- **ParkSense is only a parking aid and it is unable to recognize every obstacle, including small obstacles. Parking curbs might be temporarily detected or not detected at all. Obstacles located above or below the sensors will not be detected when they are in close proximity.**

*(Continued)*

**CAUTION!** *(Continued)*

- The vehicle must be driven slowly when using ParkSense in order to be able to stop in time when an obstacle is detected. It is recommended that the driver looks over his/her shoulder when using ParkSense.

**WARNING!**

Drivers must be careful when backing up even when using ParkSense. Always check carefully behind your vehicle, look behind you, and be sure to check for pedestrians, animals, other vehicles, obstructions, and blind spots before backing up. You are responsible for safety and must continue to pay attention to your surroundings. Failure to do so can result in serious injury or death.

**PARKSENSE ACTIVE PARK ASSIST SYSTEM — IF EQUIPPED**

The ParkSense Active Park Assist system is intended to assist the driver during parallel and perpendicular parking maneuvers by identifying a proper parking space, providing audible/visual instructions, and controlling the steering wheel. The ParkSense Active Park Assist system is defined as “semi-automatic” since the driver maintains control of the accelerator, shift lever and brakes. Depending on the driver’s parking maneuver selection, the ParkSense Active Park Assist system is capable of maneuvering a vehicle into a parallel or a perpendicular parking space on either side (i.e., driver side or passenger side).

**NOTE:**

- The driver is always responsible for controlling the vehicle, responsible for any surrounding objects, and must intervene as required.
  - The system is provided to assist the driver and not to substitute the driver.
  - During a semi-automatic maneuver, if the driver touches the steering wheel after being instructed to remove their hands from the steering wheel, the system will cancel, and the driver will be required to manually complete the parking maneuver.
- The system may not work in all conditions (e.g. environmental conditions such as heavy rain, snow, etc., or if searching for a parking space that has surfaces that will absorb the ultrasonic sensor waves).
  - New vehicles from the dealership must have at least 30 miles accumulated before the ParkSense Active Park Assist system is fully calibrated and performs accurately. This is due to the system's dynamic vehicle calibration to improve the performance of the feature. The system will also continuously perform the dynamic vehicle calibration to account for differences such as over or under inflated tires and new tires.

## Enabling And Disabling The ParkSense Active Park Assist System

The ParkSense Active Park Assist system can be enabled and disabled with the ParkSense Active Park Assist switch, located on the switch panel below the Uconnect display.



**ParkSense Active Park Assist Switch**

To enable the ParkSense Active Park Assist system, push the ParkSense Active Park Assist switch once (LED turns on).

To disable the ParkSense Active Park Assist system, push the ParkSense Active Park Assist switch again (LED turns off).

The ParkSense Active Park Assist system will turn off automatically for any of the following conditions:

- The parking maneuver is completed.
- Vehicle speed greater than 18 mph (30 km/h) when searching for a parking space.
- Vehicle speed greater than 5 mph (7 km/h) during active steering guidance into the parking space.
- Touching the steering wheel during active steering guidance into the parking space.

- pushing the ParkSense Front and Rear Park Assist switch.
- The Driver's door is opened.
- The trunk is opened.
- Electronic Stability Control/Anti-lock Braking System intervention.
- The ParkSense Active Park Assist system will allow a maximum of six shifts between DRIVE and REVERSE. If the maneuver cannot be completed within six shifts, the system will cancel and the EVIC/DID will instruct the driver to complete the maneuver manually.
- The ParkSense Active Park Assist switch is activated.
- The Driver's door is closed.
- The trunk is closed.
- Vehicle speed is less than 15 mph (25 km/h).

**NOTE:** If the vehicle is driven above approximately 15 mph (25 km/h), the EVIC/DID will instruct the driver to slow down. If the vehicle is driven above approximately 18 mph (30 km/h), the system will cancel. The driver must then reactivate the system by pushing the ParkSense Active Park Assist switch.

The ParkSense Active Park Assist system will only operate and search for a parking space when the following conditions are present:

- The gear position is in DRIVE.
- The ignition is in the RUN position.
- The outer surface and the underside of the front and rear fascias/bumpers are clean and clear of snow, ice, mud, dirt or other obstruction.

When pushed, the LED on the ParkSense Active Park Assist switch will blink momentarily, and then the LED will turn OFF if any of the above conditions are not present.

## Parallel Parking Space Assistance Operation/ Display

When the ParkSense Active Park Assist system is enabled the “Active ParkSense Searching - Press OK for Perpendicular Park” message will appear in the Driver Information Display (DID). You may switch to perpendicular parking if you desire. Push the OK button on the left side steering wheel switch to change your parking space setting.

### NOTE:

- When searching for a parking space, use the turn signal indicator to select which side of the vehicle you want to perform the parking maneuver. The ParkSense Active Park Assist system will automatically search for a parking space on the passenger’s side of the vehicle if the turn signal is not activated.

- The driver needs to make sure that the selected parking space for the maneuver remains free and clear of any obstructions (e.g. pedestrians, bicycles, etc.).
- The driver is responsible to ensure that the selected parking space is suitable for the maneuver and free/clear of anything that may be overhanging or protruding into the parking space (e.g., ladders, tailgates, etc. from surrounding objects/vehicles).
- When seeking for a parking space, the driver should drive as parallel or perpendicular (depending on the type of maneuver) to other vehicles as possible.

- The feature will only indicate the last detected parking space (example: if passing multiple available parking spaces, the system will only indicate the last detected parking space for the maneuver).

When an available parking space has been found, and the vehicle is not in position, you will be instructed to move forward to position the vehicle for a parallel parking sequence.

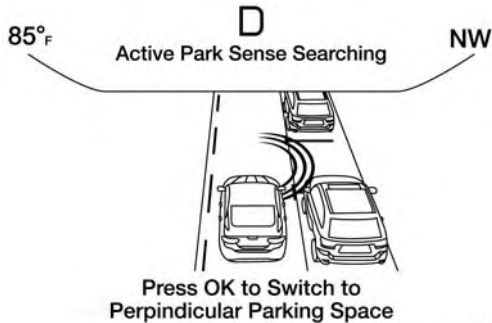

0327033426

Active ParkSense Searching

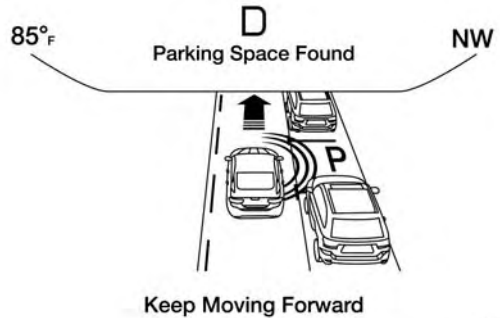

0327033427

Parking Space Found — Keep Moving Forward

## 254 UNDERSTANDING THE FEATURES OF YOUR VEHICLE

Once the vehicle is in position, you will be instructed to stop the vehicle's movement and remove your hands from the steering wheel.

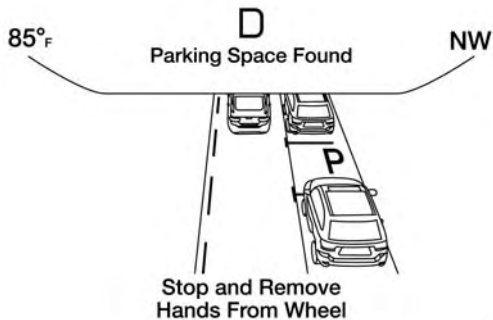

0327033428

Parking Space Found — Stop And Remove Hands From Wheel

Once the vehicle is at a standstill with your hands removed from the steering wheel, you will be instructed to place the shift lever into the REVERSE position.

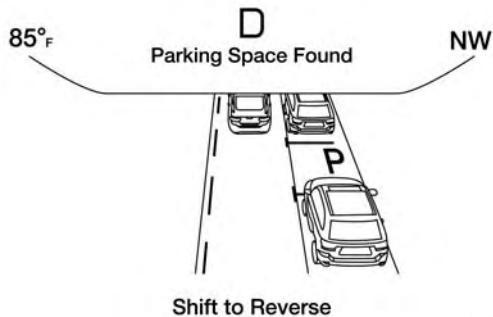

0327033429

Parking Space Found — Shift To Reverse



When the driver places the shift lever into the REVERSE position, the system may instruct the driver to wait for steering to complete.

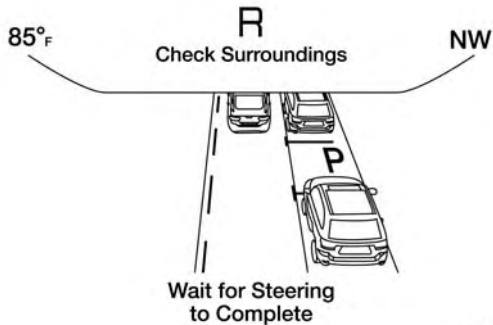

0327033430

**Check Surroundings — Wait For Steering To Complete**  
 The system will then instruct the driver to check their surroundings and move backward.

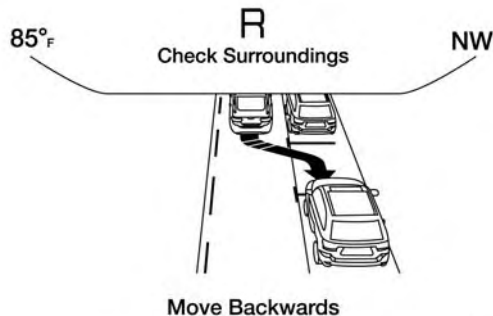

0327033431

**Check Surroundings — Move Backward**

**NOTE:**

- It is the drivers responsibility to use the brake and accelerator during the semi-automatic parking maneuver.

## 256 UNDERSTANDING THE FEATURES OF YOUR VEHICLE

- When the system instructs the driver to remove their hands from the steering wheel, the driver should check their surroundings and begin to back up slowly.
- The ParkSense Active Park Assist system will allow a maximum of six shifts between DRIVE or REVERSE. If the maneuver cannot be completed within six shifts, the system will cancel and the DID will instruct the driver to complete the maneuver manually.
- The system will cancel the maneuver if the vehicle speed exceeds 5 mph (7 km/h) during active steering guidance into the parking space. The system will provide a warning to the driver at 3 mph (5 km/h) that tells them to slow down. The driver is then responsible for completing the maneuver if the system is canceled.
- If the system is canceled during the maneuver for any reason, the driver must take control of the vehicle.

When the vehicle has reached the end of its backward movement, the system will instruct the driver to check their surroundings and stop the vehicle's movement.

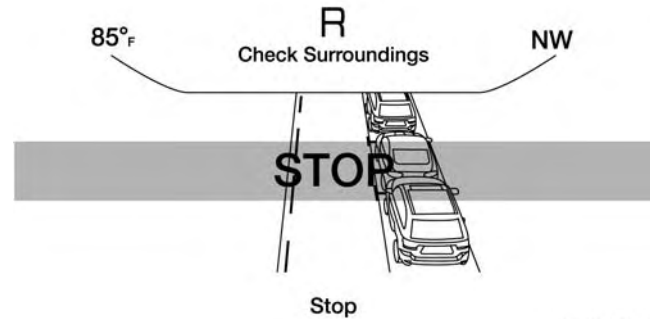

0327033432

**Check Surroundings — STOP**

**NOTE:** It is the drivers responsibility to use the brake and stop the vehicle. The driver should check their surroundings and be prepared to stop the vehicle either when instructed to, or when driver intervention is required.

Once the vehicle is in a standstill condition, the driver will be instructed to place the shift lever into the DRIVE position.

When the driver places the shift lever into the DRIVE position, the system may instruct the driver to wait for steering to complete.

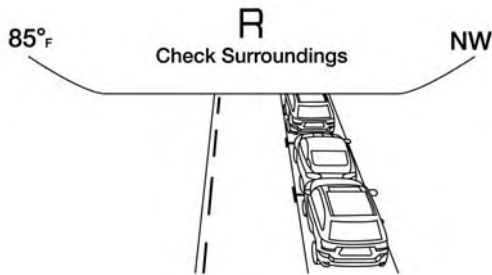

Shift to Drive

0327033433

Check Surroundings — Shift To Drive

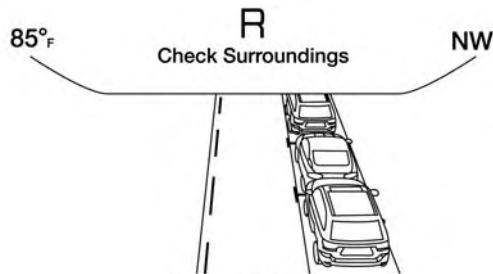

Wait for Steering to Complete

0327033434

**Check Surroundings — Wait For Steering To Complete**  
The system will then instruct the driver to check their surroundings and move forward.

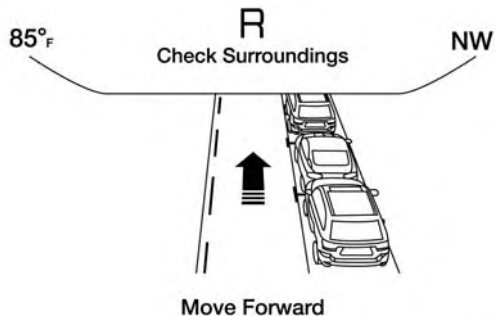

0327033435

### Check Surroundings — Move Forward

When the vehicle has reached the end of its forward movement, the system will instruct the driver to check their surroundings and stop the vehicle's movement.

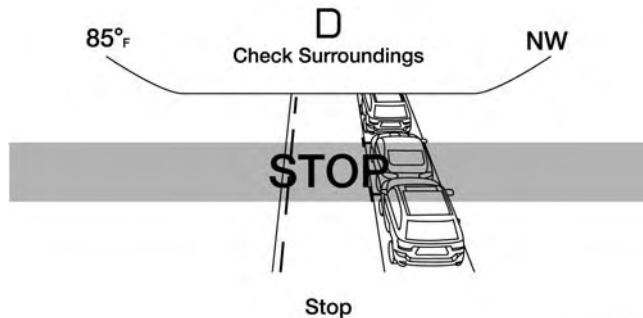

0327033436

### Check Surroundings — STOP

**NOTE:** It is the drivers responsibility to use the brake and stop the vehicle. The driver should check their surroundings and be prepared to stop the vehicle either when instructed to, or when driver intervention is required.

Once the vehicle is in a standstill condition, the driver will be instructed to place the shift lever into the REVERSE position.

When the driver places the shift lever into the REVERSE position, the system may instruct the driver to wait for steering to complete.

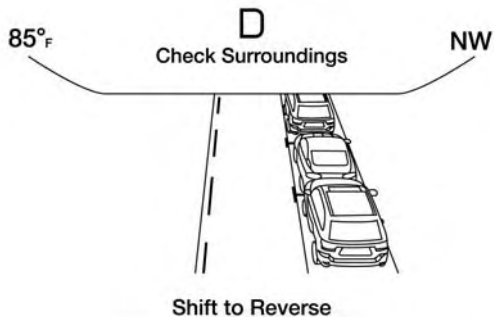

0327033437

Check Surroundings — Shift To Reverse

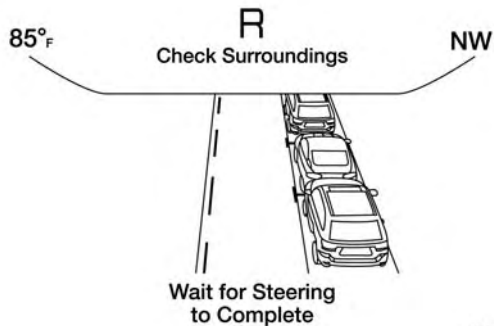

0327033438

Check Surroundings — Wait For Steering To Complete

## 260 UNDERSTANDING THE FEATURES OF YOUR VEHICLE

The system will then instruct the driver to check their surroundings and move backward.

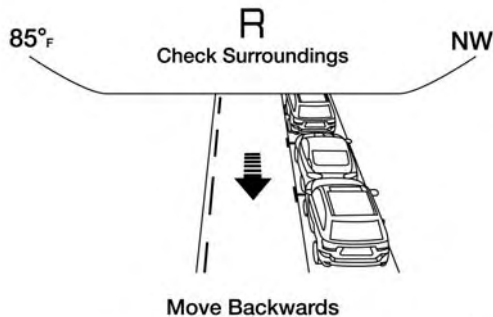

0327033439

Check Surroundings — Move Backward

Your vehicle is now in the parallel park position. When the maneuver is complete, the driver will be instructed to check the vehicle's parking position. If the driver is satisfied with the vehicle position, they should shift to PARK. The "Active ParkSense Complete - Check Parking Position" message will be momentarily displayed.



0327033440

Active ParkSense Complete — Check Parking Position

## Perpendicular Parking Space Assistance Operation/Display

When the ParkSense Active Park Assist system is enabled, the “Active ParkSense Searching - Press OK for Perpendicular Park” message will show in the DID display. Push the OK button on the left side steering wheel switch to change your parking space setting to a perpendicular maneuver. You may switch back to parallel parking if you desire.

Once the driver pushes OK for a perpendicular parking maneuver, the “Active ParkSense Searching - Press OK for Parallel Park” message will appear in the DID display.

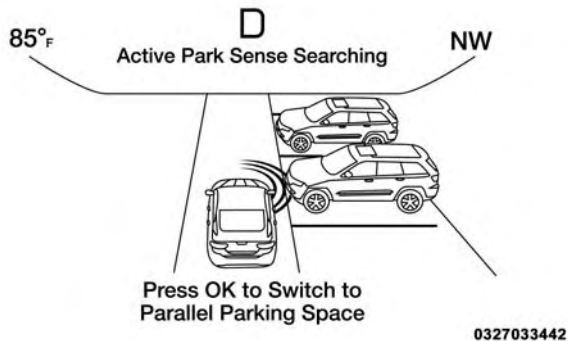

Active ParkSense Searching Display

### NOTE:

- When searching for a parking space, use the turn signal indicator to select which side of the vehicle you want to perform the parking maneuver. The ParkSense Active Park Assist system will automatically search for a parking space on the passenger's side of the vehicle if the turn signal is not activated.
- The driver needs to make sure that the selected parking space for the maneuver remains free and clear of any obstructions (e.g. pedestrians, bicycles, etc.).
- The driver is responsible to ensure that the selected parking space is suitable for the maneuver and free/clear of anything that may be overhanging or protruding into the parking space (e.g., ladders, tailgates, etc. from surrounding objects/vehicles).
- When seeking for a parking space, the driver should drive as parallel or perpendicular (depending on the type of maneuver) to other vehicles as possible.
- The feature will only indicate the last detected parking space (example: if passing multiple available parking spaces, the system will only indicate the last detected parking space for the maneuver).



When an available parking space has been found, and the vehicle is not in position, you will be instructed to move forward to position the vehicle for a perpendicular parking sequence.

Once the vehicle is in position, you will be instructed to stop the vehicle's movement and remove your hands from the steering wheel.

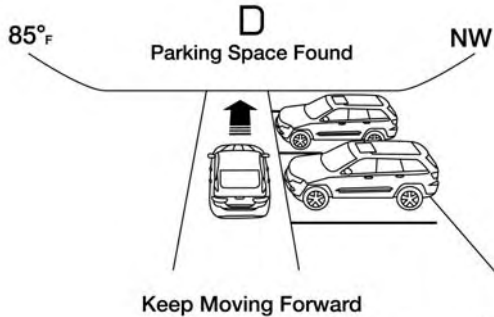

0327033444

Parking Space Found — Keep Moving Forward



0327033446

Parking Space Found — Stop And Remove Hands From Wheel

## 264 UNDERSTANDING THE FEATURES OF YOUR VEHICLE

Once the vehicle is at a standstill with your hands removed from the steering wheel, you will be instructed to place the shift lever into the REVERSE position.

When the driver places the shift lever into the REVERSE position, the system may instruct the driver to wait for steering to complete.

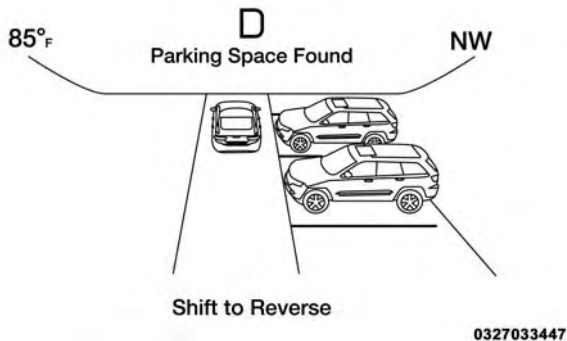

Parking Space Found — Shift To Reverse

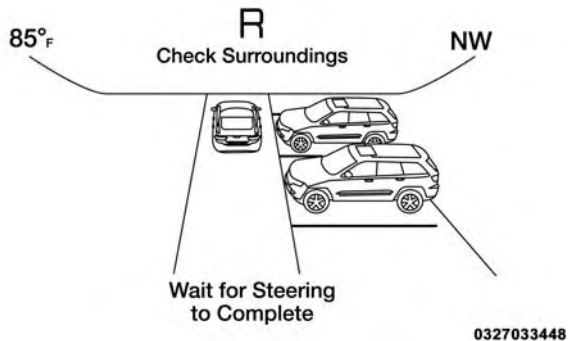

Check Surroundings — Wait For Steering To Complete

The system will then instruct the driver to check their surroundings and move backward.

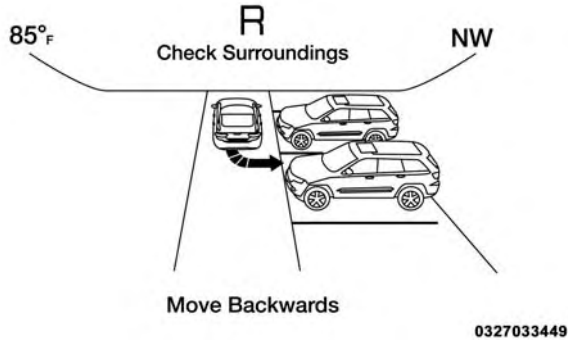

**Check Surroundings — Move Backwards**

**NOTE:**

- It is the drivers responsibility to use the brake and accelerator during the semi-automatic parking maneuver.

- When the system instructs the driver to remove their hands from the steering wheel, the driver should check their surroundings and begin to back up slowly.
- The ParkSense Active Park Assist system will allow a maximum of six shifts between DRIVE or REVERSE. If the maneuver cannot be completed within six shifts, the system will cancel and the DID will instruct the driver to complete the maneuver manually.
- The system will cancel the maneuver if the vehicle speed exceeds 5 mph (7 km/h) during active steering guidance into the parking space. The system will provide a warning to the driver at 3 mph (5 km/h) that tells them to slow down. The driver is then responsible for completing the maneuver if the system is canceled.
- If the system is canceled during the maneuver for any reason, the driver must take control of the vehicle.

## 266 UNDERSTANDING THE FEATURES OF YOUR VEHICLE

When the vehicle has reached the end of its backward movement, the system will instruct the driver to check their surroundings and stop the vehicle's movement.

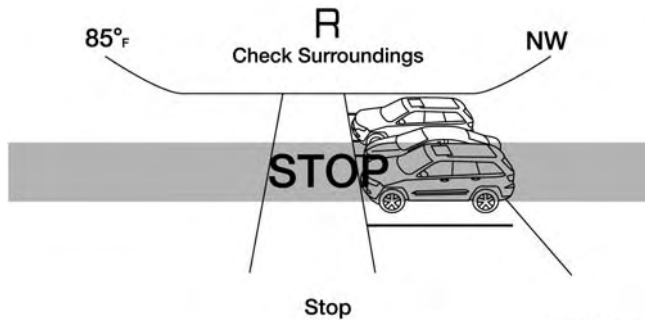

0327033450

Check Surroundings — STOP

**NOTE:** It is the driver's responsibility to use the brake and stop the vehicle. The driver should check their surroundings and be prepared to stop the vehicle either when instructed to, or when driver intervention is required.

Once the vehicle is in a standstill condition, the driver will be instructed to place the shift lever into the DRIVE position.

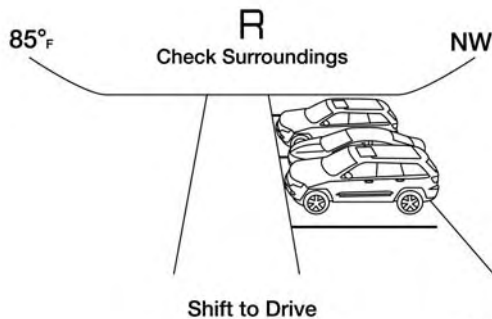

0327033451

Check Surroundings — Shift To Drive

When the driver places the shift lever into the DRIVE position, the system may instruct the driver to wait for steering to complete.

The system will then instruct the driver to check their surroundings and move forward.

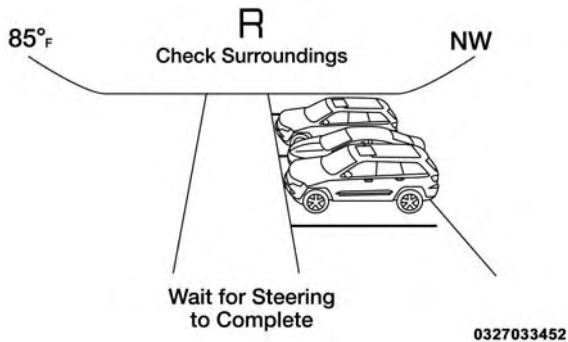

Check Surroundings — Wait For Steering To Complete

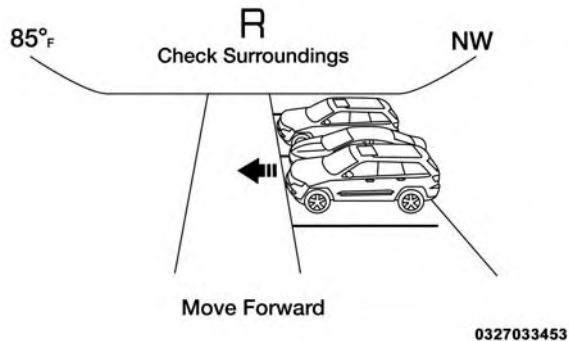

Check Surroundings — Move Forward

## 268 UNDERSTANDING THE FEATURES OF YOUR VEHICLE

When the vehicle has reached the end of its forward movement, the system will instruct the driver to check their surroundings and stop the vehicle's movement.

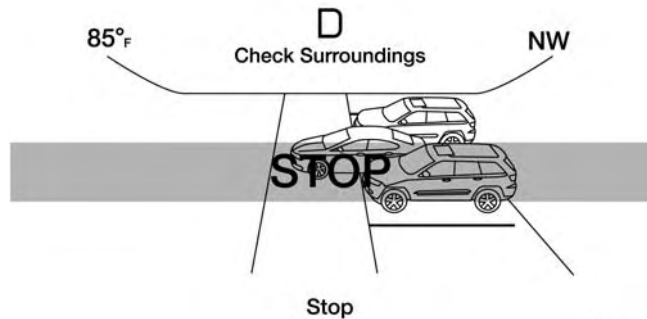

Check Surroundings — STOP

0327033454

**NOTE:** It is the driver's responsibility to use the brake and stop the vehicle. The driver should check their surroundings and be prepared to stop the vehicle either when instructed to, or when driver intervention is required.

Once the vehicle is in a standstill condition, the driver will be instructed to place the shift lever into the REVERSE position.

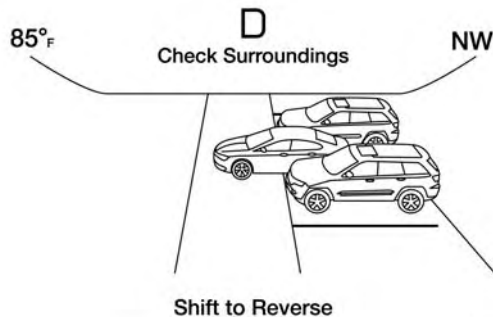

Check Surroundings — Shift To Reverse

0327033455

When the driver places the shift lever into the REVERSE position, the system may instruct the driver to wait for steering to complete.

The system will then instruct the driver to check their surroundings and move backward.

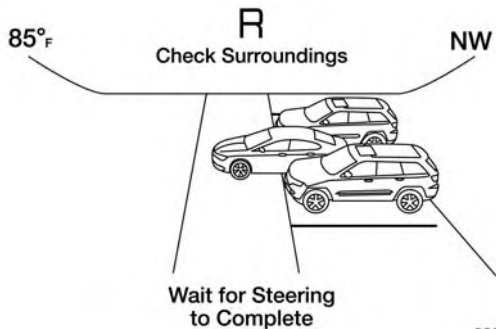

0327033456

**Check Surroundings — Wait For Steering To Complete**

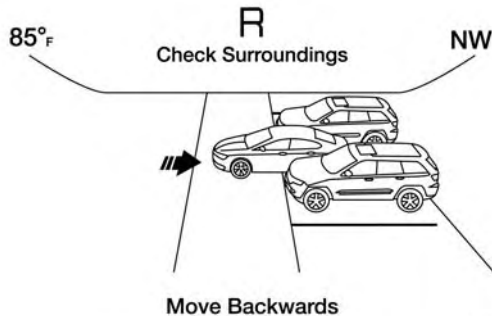

0327033457

**Check Surroundings — Move Backwards**

Your vehicle is now in the perpendicular park position. When the maneuver is complete, the driver will be instructed to check the vehicle's parking position. If the driver is satisfied with the vehicle position, they should

## 270 UNDERSTANDING THE FEATURES OF YOUR VEHICLE

shift to PARK. The "Active ParkSense Complete - Check Parking Position" message will be momentarily displayed.



0327033440

Active ParkSense Complete — Check Parking Position

### CAUTION!

- The ParkSense Active Park Assist system is only a parking aid and it is unable to recognize every obstacle, including small obstacles. Parking curbs might be temporarily detected or not detected at all. Obstacles located above or below the sensors will not be detected when they are in close proximity.
- The vehicle must be driven slowly when using the ParkSense Active Park Assist system in order to be able to stop in time when an obstacle is detected. It is recommended that the driver looks over his/her shoulder when using the ParkSense Active Park Assist system.



**WARNING!**

Drivers must be careful when performing parallel or perpendicular parking maneuvers even when using the ParkSense Active Park Assist system. Always check carefully behind and in front of your vehicle, look behind and in front of you, and be sure to check for pedestrians, animals, other vehicles, obstructions, and blind spots before backing up and moving forward. You are responsible for safety and must continue to pay attention to your surroundings. Failure to do so can result in serious injury or death.

**PARKVIEW REAR BACK UP CAMERA — IF EQUIPPED**

Your vehicle may be equipped with the ParkView Rear Back Up Camera that allows you to see an on-screen image of the rear surroundings of your vehicle whenever the shift lever is put into REVERSE. The image will be displayed on the touchscreen display along with a caution note to “check entire surroundings” across the top of the screen. After five seconds this note will disappear. The ParkView camera is located on the rear of the vehicle above the rear license plate.

**NOTE:** The ParkView Rear Back Up Camera has programmable modes of operation that may be selected through the Uconnect System. Refer to “Uconnect Settings” in “Understanding Your Instrument Panel” for further information.

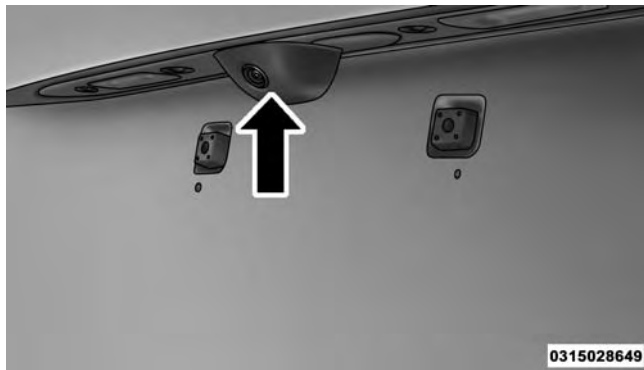

### ParkView Camera Location

When the vehicle is shifted out of REVERSE (with camera delay turned OFF), the rear camera mode is exited and the navigation or audio screen appears again.

When the vehicle is shifted out of REVERSE (with camera delay turned ON), the camera image will continue to be displayed for up to 10 seconds after shifting out of REVERSE unless the vehicle speed exceeds 8 mph (13 km/h), the vehicle is shifted into PARK or the ignition is switched to the OFF position.

A touch screen button to disable display of the camera image is made available when the vehicle is not in REVERSE gear. Display of the camera image after shifting out of REVERSE can be disabled via a touch screen button personalization entry in the camera settings menu.

When enabled, active guide lines are overlaid on the image to illustrate the width of the vehicle and its projected backup path based on the steering wheel position.

When enabled, fixed guide lines are overlaid on the image to illustrate the width of the vehicle.

Different colored zones indicate the distance to the rear of the vehicle.

The following table shows the approximate distances for each zone:

Zone	Distance to the rear of the vehicle
Red	0 - 1 ft (0 - 30 cm)
Yellow	1 ft - 6.5 ft (30 cm - 2 m)
Green	6.5 ft or greater (2 m or greater)

**NOTE:** If snow, ice, mud, or any foreign substance builds up on the camera lens, clean the lens, rinse with water, and dry with a soft cloth. Do not cover the lens.

<b>CAUTION!</b>
<ul style="list-style-type: none"> <li>• <b>To avoid vehicle damage, ParkView should only be used as a parking aid. The ParkView camera is unable to view every obstacle or object in your drive path.</b></li> </ul>

*(Continued)*

**CAUTION!** *(Continued)*

- To avoid vehicle damage, the vehicle must be driven slowly when using ParkView to be able to stop in time when an obstacle is seen. It is recommended that the driver look frequently over his/her shoulder when using ParkView.

**WARNING!**

Drivers must be careful when backing up even when using the ParkView Rear Back Up Camera. Always check carefully behind your vehicle, and be sure to check for pedestrians, animals, other vehicles, obstructions, or blind spots before backing up. You are responsible for the safety of your surroundings and must continue to pay attention while backing up. Failure to do so can result in serious injury or death.

**OVERHEAD CONSOLE**

The overhead console contains courtesy/reading lights and storage for sunglasses. Power sunroof and power sunshade switches may also be included, if equipped.



Overhead Console — Power Sunroof/Sunshade



0333031216

**Overhead Console — Power Sunroof  
Front Map/Reading Lights**

The front map/reading lights are mounted in the overhead console.

**Front Map/Reading Lights — With Center Buttons**

There are two map/reading light buttons located in the center of the overhead console that allow the lights to operate independently.

Push the button once to turn the light on.

To turn the light off, push the button a second time.

3



0333031567

**Front Map/Reading Lights Center Buttons**

### Front Map/Reading Lights — With Push Lenses

The two map/reading lights can be operated independently by pushing the lenses.

Push the lens once to turn the light on.

To turn the light off, push the lens a second time.



0333031215

Front Map/Reading Lights Push Lenses

**NOTE:** The lights also turn on when a door is opened. The lights will also turn on when the UNLOCK button on the RKE is pushed.

### Sunglass Bin Door

The overhead console has a compartment which provides storage for a pair of sunglasses.

Your vehicle may be equipped with a rear mounted or front mounted sunglass bin door.

The storage compartment access is a “push/push” design. Push the chrome pad on the sunglass bin door to open. Push the chrome pad on the sunglass bin door to close.



Sunglass Bin Door — Rear Mounted



Sunglass Bin Door — Front Mounted  
**GARAGE DOOR OPENER — IF EQUIPPED**

HomeLink replaces up to three remote controls (hand-held transmitters) that operate devices such as garage door openers, motorized gates, lighting or home security systems. The HomeLink unit operates off your vehicle's battery.

The HomeLink buttons that are located in the sun visor designate the three different HomeLink channels.

The HomeLink indicator is located above the center button.

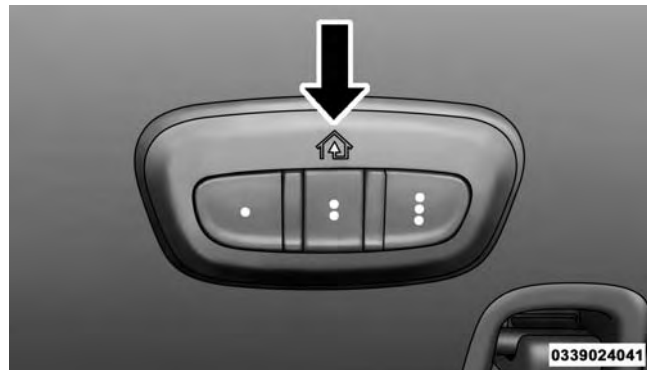

HomeLink Indicator And Buttons

**NOTE:** HomeLink is disabled when the Vehicle Security Alarm is active.

**WARNING!**

- Your motorized door or gate will open and close while you are training the universal transceiver. Do not train the transceiver if people, pets or other objects are in the path of the door or gate. Only use this transceiver with a garage door opener that has a “stop and reverse” feature as required by Federal safety standards. This includes most garage door opener models manufactured after 1982. Do not use a garage door opener without these safety features. Call toll-free 1-800-355-3515 or, on the Internet at [www.HomeLink.com](http://www.HomeLink.com) for safety information or assistance.

*(Continued)*



**WARNING! (Continued)**

- **Vehicle exhaust contains carbon monoxide, a dangerous gas. Do not run your vehicle in the garage while training the transceiver. Exhaust gas can cause serious injury or death.**

**NOTE:** Only use this transceiver with a garage door opener that has a “stop and reverse” feature as required by federal safety standards. This includes most garage door opener models manufactured after 1982. Do not use a garage door opener without these safety features. Call toll-free 1-800-355-3515 or, on the Internet at HomeLink.com for safety information or assistance.

**Before You Begin Programming HomeLink**

Be sure that your vehicle is parked outside of the garage before you begin programming.

For more efficient programming and accurate transmission of the radio-frequency signal it is recommended that a new battery be placed in the hand-held transmitter of the device that is being programmed to the HomeLink system.

To erase the channels place the ignition in the ON/RUN position and push and hold the two outside HomeLink buttons (I and III) for up 20 seconds or until the red indicator flashes.

**NOTE:**

- Erasing all channels should only be performed when programming HomeLink for the first time. Do not erase channels when programming additional buttons.
- If you have any problems, or require assistance, please call toll-free 1-800-355-3515 or, on the Internet at HomeLink.com for information or assistance.

**Programming A Rolling Code**

For programming garage door openers that were manufactured after 1995. These garage door openers can be identified by the "LEARN" or "TRAIN" button located where the hanging antenna is attached to the garage door opener. It is NOT the button that is normally used to open and close the door. The name and color of the button may vary by manufacturer.

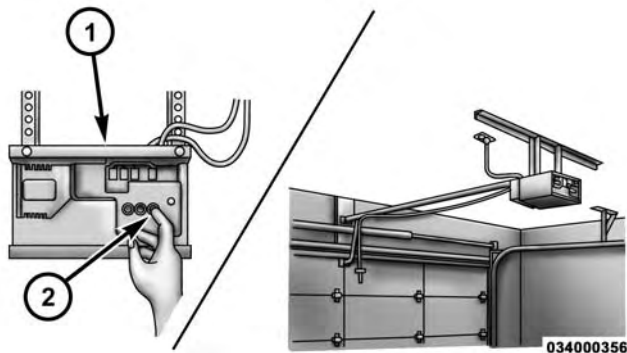

**Training The Garage Door Opener**

- 1 — Door Opener  
2 — Training Button

1. Place the ignition in the ON/RUN position.

2. Place the hand-held transmitter 1 to 3 inches (3 to 8 cm) away from the HomeLink button you wish to program while keeping the HomeLink indicator light in view.
3. Push and hold the HomeLink button you want to program while you push and hold the hand-held transmitter button.
4. Continue to hold both buttons and observe the indicator light. The HomeLink indicator will flash slowly and then rapidly after HomeLink has received the frequency signal from the hand-held transmitter. Release both buttons after the indicator light changes from slow to rapid.
5. At the garage door opener motor (in the garage), locate the “LEARN” or “TRAINING” button. This can usually be found where the hanging antenna wire is attached to the garage door opener/device motor.

Firmly push and release the “LEARN” or “TRAINING” button. On some garage door openers/devices there may be a light that blinks when the garage door opener/device is in the LEARN/TRAIN mode.

**NOTE:** You have 30 seconds in which to initiate the next step after the LEARN button has been pushed.

6. Return to the vehicle and push the programmed HomeLink button twice (holding the button for two seconds each time). If the garage door opener/device activates, programming is complete.

**NOTE:** If the garage door opener/device does not activate, push the button a third time (for two seconds) to complete the training.

To program the remaining two HomeLink buttons, repeat each step for each remaining button. DO NOT erase the channels.

### Reprogramming A Single HomeLink Button (Rolling Code)

To reprogram a channel that has been previously trained, follow these steps:

1. Cycle the ignition to the ON/RUN position.
2. Push and hold the desired HomeLink button until the indicator light begins to flash after 20 seconds. **Do not release the button.**
3. **Without releasing the button** proceed with “Programming A Rolling Code” step 2 and follow all remaining steps.

### Programming A Non-Rolling Code

For programming Garage Door Openers manufactured before 1995.

1. Place the ignition in the ON/RUN position.
2. Place the hand-held transmitter 1 to 3 inches (3 to 8 cm) away from the HomeLink button you wish to program while keeping the HomeLink indicator light in view.
3. Push and hold the Homelink button you want to program while you push and hold the hand-held transmitter button.
4. Continue to hold both buttons and observe the indicator light. The Homelink indicator will flash slowly and then rapidly after HomeLink has received the frequency signal from the hand-held transmitter. Release both buttons after the indicator light changes from slow to rapid.



5. Push and hold the programmed HomeLink button and observe the indicator light.
  - If the indicator light stays on constantly, programming is complete and the garage door/device should activate when the HomeLink button is pushed.
  - To program the two remaining HomeLink buttons, repeat each step for each remaining button. **DO NOT** erase the channels.

### Reprogramming A Single HomeLink Button (Non-Rolling Code)

To reprogram a channel that has been previously trained, follow these steps:

1. Cycle the ignition to the ON/RUN position.
2. Push and hold the desired HomeLink button until the indicator light begins to flash after 20 seconds. **Do not release the button.**

3. **Without releasing the button** proceed with “Programming A Non-Rolling Code” step 2 and follow all remaining steps.

### Canadian/Gate Operator Programming

For programming transmitters in Canada/United States that require the transmitter signals to “time-out” after several seconds of transmission.

Canadian radio frequency laws require transmitter signals to time-out (or quit) after several seconds of transmission – which may not be long enough for HomeLink to pick up the signal during programming. Similar to this Canadian law, some U.S. gate operators are designed to time-out in the same manner.

It may be helpful to unplug the device during the cycling process to prevent possible overheating of the garage door or gate motor.

1. Cycle the ignition to the ON/RUN position.

2. Place the hand-held transmitter 1 to 3 inches (3 to 8 cm) away from the HomeLink button you wish to program while keeping the HomeLink indicator light in view.
3. Continue to push and hold the HomeLink button, while you push and release (“cycle”) your hand-held transmitter every two seconds until HomeLink has successfully accepted the frequency signal. The indicator light will flash slowly and then rapidly when fully trained.
4. Watch for the HomeLink indicator to change flash rates. When it changes, it is programmed. It may take up to 30 seconds or longer in rare cases. The garage door may open and close while you are programming.
5. Push and hold the programmed HomeLink button and observe the indicator light.

**NOTE:**

- If the indicator light stays on constantly, programming is complete and the garage door/device should activate when the HomeLink button is pushed.
- To program the two remaining HomeLink buttons, repeat each step for each remaining button. **DO NOT** erase the channels.

If you unplugged the garage door opener/device for programming, plug it back in at this time.

**Reprogramming A Single HomeLink Button  
(Canadian/Gate Operator)**

To reprogram a channel that has been previously trained, follow these steps:

1. Cycle the ignition to the ON/RUN position.

2. Push and hold the desired HomeLink button until the indicator light begins to flash after 20 seconds. **Do not release the button.**
3. **Without releasing the button** proceed with “Canadian/Gate Operator Programming” step 2 and follow all remaining steps.

### Using HomeLink

To operate, push and release the programmed HomeLink button. Activation will now occur for the programmed device (i.e. garage door opener, gate operator, security system, entry door lock, home/office lighting, etc.). The hand-held transmitter of the device may also be used at any time.

### Security

It is advised to erase all channels before you sell or turn in your vehicle.

To do this, push and hold the two outside buttons for 20 seconds until the red indicator flashes. Note that all channels will be erased. Individual channels cannot be erased.

The HomeLink Universal Transceiver is disabled when the Vehicle Security Alarm is active.

### Troubleshooting Tips

If you are having trouble programming HomeLink, here are some of the most common solutions:

- Replace the battery in the Garage Door Opener hand-held transmitter.
- Push the LEARN button on the Garage Door Opener to complete the training for a Rolling Code.
- Did you unplug the device for programming and remember to plug it back in?

If you have any problems, or require assistance, please call toll-free 1-800-355-3515 or, on the Internet at HomeLink.com for information or assistance.

**WARNING!**

- Vehicle exhaust contains carbon monoxide, a dangerous gas. Do not run your vehicle in the garage while programming the transceiver. Exhaust gas can cause serious injury or death.
- Your motorized door or gate will open and close while you are programming the universal transceiver. Do not program the transceiver if people, pets or other objects are in the path of the door or gate. Only use this transceiver with a garage door opener that has a "stop and reverse" feature as required by Federal safety standards. This includes most garage door opener models manufactured

**WARNING! (Continued)**

after 1982. Do not use a garage door opener without these safety features. Call toll-free 1-800-355-3515 or, on the Internet at HomeLink.com for safety information or assistance.

**General Information**

This device complies with FCC rules Part 15 and Industry Canada RSS-210. Operation is subject to the following two conditions:

1. This device may not cause harmful interference.
2. This device must accept any interference that may be received including interference that may cause undesired operation.

*(Continued)*



**NOTE:**

- The transmitter has been tested and it complies with FCC and IC rules. Changes or modifications not expressly approved by the party responsible for compliance could void the user's authority to operate the device.
- The term IC before the certification/registration number only signifies that Industry Canada technical specifications were met.

**POWER SUNROOF — IF EQUIPPED**

The power sunroof switch is located between the sun visors on the overhead console.



0333031218

**Sunroof Switch**

- 1 — Opening Sunroof
- 2 — Venting Sunroof
- 3 — Closing Sunroof



**WARNING!**

- Never leave children unattended in a vehicle, or with access to an unlocked vehicle. Never leave the Key Fob in or near the vehicle, or in a location accessible to children. Do not leave the ignition of a vehicle equipped with Keyless Enter-N-Go in the ACC or ON/RUN mode. Occupants, particularly unattended children, can become entrapped by the power sunroof while operating the power sunroof switch. Such entrapment may result in serious injury or death.
- In a collision, there is a greater risk of being thrown from a vehicle with an open sunroof. You could also be seriously injured or killed. Always fasten your seat belt properly and make sure all passengers are also properly secured.

**WARNING! (Continued)**

- Do not allow small children to operate the sunroof. Never allow your fingers, other body parts, or any object, to project through the sunroof opening. Injury may result.

**Opening Sunroof — Express**

Push the switch rearward and release it within one-half second. The sunroof and sunshade will open automatically from any position. The sunroof and sunshade will open fully and stop automatically. This is called “Express Open.” During Express Open operation, any other actuation of the sunroof switch will stop the sunroof.

**Opening Sunroof — Manual Mode**

To open the sunroof, push and hold the switch rearward to full open. Any release of the switch will stop the

*(Continued)*

movement. The sunroof and sunshade will remain in a partially opened condition until the sunroof switch is pushed again.

### **Closing Sunroof — Express**

Push the switch forward and release it within one-half second and the sunroof will close automatically from any position. The sunroof will close fully and stop automatically. This is called “Express Close.” During Express Close operation, any other actuation of the switch will stop the sunroof.

### **Closing Sunroof — Manual Mode**

To close the sunroof, push and hold the switch in the forward position. Any release of the switch will stop the movement and the sunroof will remain in a partially closed condition until the sunroof switch is pushed again.

### **Pinch Protect Feature**

This feature will detect an obstruction in the opening of the sunroof during Express Close operation. If an obstruction in the path of the sunroof is detected, the sunroof will automatically retract. Remove the obstruction if this occurs.

**NOTE:** If three consecutive sunroof close attempts result in Pinch Protect reversals, Pinch Protect will disable and the sunroof must be closed in Manual Mode.

### **Venting Sunroof — Express**

Push and release the Vent button within one half second and the sunroof will open to the vent position. This is called “Express Vent”, and it will occur regardless of sunroof position. During Express Vent operation, any other actuation of the switch will stop the sunroof.

## Sunshade Operation

The sunshade can be opened manually. However, the sunshade will open automatically as the sunroof opens.

**NOTE:** The sunshade cannot be closed if the sunroof is open.

## Wind Buffeting

Wind buffeting can be described as the perception of pressure on the ears or a helicopter-type sound in the ears. Your vehicle may exhibit wind buffeting with the windows down, or the sunroof (if equipped) in certain open or partially open positions. This is a normal occurrence and can be minimized. If the buffeting occurs with the rear windows open, open the front and rear windows together to minimize the buffeting. If the buffeting occurs with the sunroof open, adjust the sunroof opening to minimize the buffeting or open any window.

## Sunroof Maintenance

Use only a non-abrasive cleaner and a soft cloth to clean the glass panel.

## Ignition Off Operation

The power sunroof switch will remain active for up to approximately ten minutes after the ignition switch is turned to the LOCK position. Opening either front door will cancel this feature.

**NOTE:** Ignition Off time is programmable through the Uconnect System. Refer to “Uconnect Settings/Customer Programmable Features” in “Understanding Your Instrument Panel” for further information.

**POWER SUNROOF WITH POWER SHADE — IF EQUIPPED**

The power sunroof switches are located to the left between the sun visors on the overhead console.



**Power Sunroof Switches**

The power shade switches are located to the right between the sun visors on the overhead console.



**Power Shade Switches**

3

<b>WARNING!</b>
<ul style="list-style-type: none"> <li>• Never leave children unattended in a vehicle, or with access to an unlocked vehicle. Never leave the Key Fob in or near the vehicle, or in a location</li> </ul>

*(Continued)*

**WARNING! (Continued)**

accessible to children. Do not leave the ignition of a vehicle equipped with Keyless Enter-N-Go in the ACC or ON/RUN mode. Occupants, particularly unattended children, can become entrapped by the power sunroof while operating the power sunroof switch. Such entrapment may result in serious injury or death.

- In a collision, there is a greater risk of being thrown from a vehicle with an open sunroof. You could also be seriously injured or killed. Always fasten your seat belt properly and make sure all passengers are also properly secured.
- Do not allow small children to operate the sunroof. Never allow your fingers, other body parts, or any object, to project through the sunroof opening. Injury may result.

**Opening Sunroof — Express**

Push the sunroof switch rearward and release it within one-half second. The sunroof will open automatically to the full open position and automatically stop. (If the sunshade is in the closed position when the operation is initiated the sunshade will automatically open to the half open position prior to the sunroof opening). This is called “Express Open”. During Express Open operation, any movement of the sunroof switch will stop the sunroof.

**Opening Sunroof — Manual Mode**

To open the sunroof, push and hold the switch rearward. The sunroof will (if the sunshade is in the closed position when the operation is initiated the sunshade will automatically open to the half open position prior to the sunroof opening) open to the full open position and automatically stop. Any release of the switch will stop the

movement. The sunroof and sunshade will remain in a partially opened condition until the switch is pushed and held again.

### **Closing Sunroof — Express**

Push the switch forward and release it within one-half second and the sunroof will close automatically from any position. The sunroof will close fully and stop automatically. This is called “Express Close.” During Express Close operation, any other actuation of the switch will stop the sunroof.

### **Closing Sunroof — Manual Mode**

To close the sunroof, push and hold the switch in the forward position. Any release of the switch will stop the movement and the sunroof will remain in a partially closed condition until the sunroof switch is pushed again.

### **Venting Sunroof — Express**

Push and release the “Vent” button within one-half second and the sunroof will open to the vent position. This is called “Express Vent”, and it will occur regardless of sunroof position. During Express Vent operation, any movement of the switch will stop the sunroof.

**NOTE:** If the sunshade is in the closed position when the vent switch is pushed, the sunshade will automatically cycle to the halfway open position prior to the sunroof opening to the Vent position.

### **Opening Power Shade — Express**

Push the shade switch rearward and release it within one-half second and the shade will automatically open to the halfway position and stop automatically. Push the switch a second time from the halfway position and the shade will automatically open to the full open position

and stop automatically. This is called “Express Open”. During Express Open operation, any movement of the shade switch will stop the shade.

### **Opening Power Shade — Manual Mode**

To open the shade, push and hold the switch rearward. The shade will open and stop automatically at the half-open position. Push and hold the shade switch rearward again and the shade will open automatically to the full-open position. Any release of the switch will stop the movement and the shade will remain in a partially opened condition until the switch is pushed again.

### **Closing Power Shade — Express**

Push the switch forward and release it within one-half second and the shade will close automatically from any position. If the sunroof is completely closed the shade will close fully and stop automatically. This is called “Express Close”. During Express Close operation, any movement of the switch will stop the shade.

**NOTE:** If the sunroof is open, the shade will close to the half-open position. Pushing the shade close button again will automatically close both the sunroof and shade completely.

### **Closing Power Shade — Manual Mode**

To close the shade, push and hold the switch in the forward position. Any release of the switch will stop the movement and the shade will remain in a partially closed condition until the switch is pushed again.

### **Pinch Protect Feature**

This feature will detect an obstruction in the opening of the sunroof during Express Close operation. If an obstruction in the path of the sunroof is detected, the sunroof will automatically retract. Remove the obstruction if this occurs. Next, push the switch forward and release to Express Close.



**NOTE:** If three consecutive sunroof close attempts result in Pinch Protect reversals, the fourth close attempt will be a Manual Close movement with Pinch Protect disabled.

### Wind Buffeting

Wind buffeting can be described as the perception of pressure on the ears or a helicopter-type sound in the ears. Your vehicle may exhibit wind buffeting with the windows down, or the sunroof (if equipped) in certain open or partially open positions. This is a normal occurrence and can be minimized. If the buffeting occurs with the rear windows open, then open the front and rear windows together to minimize the buffeting. If the buffeting occurs with the sunroof open, adjust the sunroof opening to minimize the buffeting or open any window.

### Sunroof Maintenance

Use only a non-abrasive cleaner and a soft cloth to clean the glass panel.

### Ignition Off Operation

The power sunroof switch will remain active for up to approximately ten minutes after the ignition switch is turned to the LOCK position. Opening either front door will cancel this feature.

**NOTE:** Ignition Off time is programmable through the Uconnect System. Refer to “Uconnect Settings/Customer Programmable Features” in “Understanding Your Instrument Panel” for further information.

### POWER OUTLETS — IF EQUIPPED

Your vehicle is equipped with 12 Volt (13 Amp) power outlets that can be used to power cellular phones, small electronics and other low powered electrical accessories. The power outlets are labeled with either a “key” or a “battery” symbol to indicate how the outlet is powered. Power outlets labeled with a “key” are powered when

## 296 UNDERSTANDING THE FEATURES OF YOUR VEHICLE

the ignition switch is in the ON or ACC position, while the outlets labeled with a “battery” are connected directly to the battery and powered at all times.

**NOTE:** All accessories connected to the “battery” powered outlets should be removed or turned off when the vehicle is not in use to protect the battery against discharge.

The front power outlet is located next to the storage area on the center stack of the instrument panel.

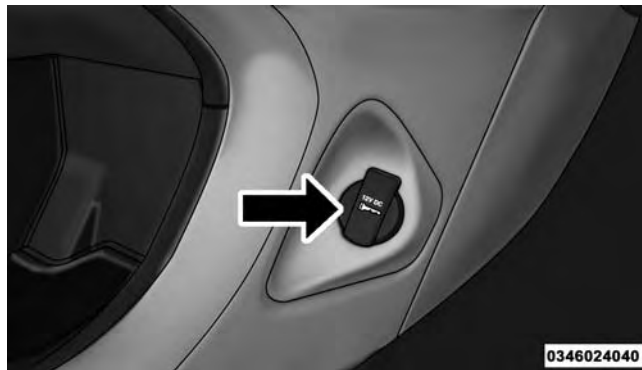

**Front Power Outlet**

In addition to the front power outlet, there is also a power outlet located in the storage area of the center console.

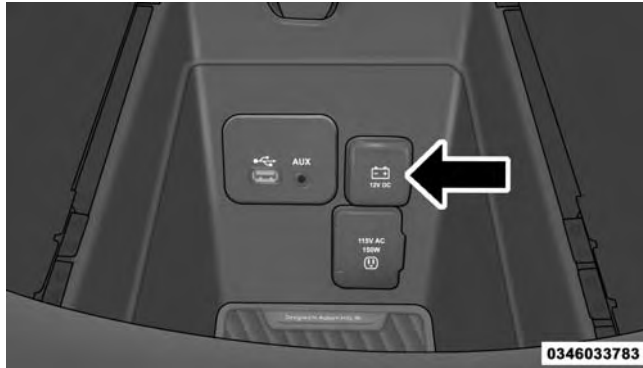

Front Center Console Outlet

**NOTE:** To ensure proper operation a MOPAR cigar knob and element must be used.

### CAUTION!

- Do not exceed the maximum power of 160 Watts (13 Amps) at 12 Volts. If the 160 Watt (13 Amp) power rating is exceeded the fuse protecting the system will need to be replaced.
- Power outlets are designed for accessory plugs only. Do not insert any other object in the power outlets as this will damage the outlet and blow the fuse. Improper use of the power outlet can cause damage not covered by your New Vehicle Limited Warranty.

3

### WARNING!

To avoid serious injury or death:

- Only devices designed for use in this type of outlet should be inserted into any 12 Volt outlet.

*(Continued)*

**WARNING! (Continued)**

- Do not touch with wet hands.
- Close the lid when not in use and while driving the vehicle.
- If this outlet is mishandled, it may cause an electric shock and failure.

**CAUTION!**

- Many accessories that can be plugged in draw power from the vehicle's battery, even when not in use (i.e., cellular phones, etc.). Eventually, if plugged in long enough, the vehicle's battery will discharge sufficiently to degrade battery life and/or prevent the engine from starting.

*(Continued)*

**CAUTION! (Continued)**

- Accessories that draw higher power (i.e., coolers, vacuum cleaners, lights, etc.), will degrade the battery even more quickly. Only use these intermittently and with greater caution.
- After the use of high power draw accessories, or long periods of the vehicle not being started (with accessories still plugged in), the vehicle must be driven a sufficient length of time to allow the alternator to recharge the vehicle's battery.
- Power outlets are designed for accessory plugs only. Do not hang any type of accessory or accessory bracket from the plug. Improper use of the power outlet can cause damage.

## POWER INVERTER — IF EQUIPPED

A 115 Volt (150 Watts Maximum) outlet is located on the forward wall of the center console storage bin, below the media center. This outlet can power cellular phones, electronics and other low power devices requiring power up to 150 Watts. Certain high-end video game consoles will exceed this power limit, as will most power tools.

The power inverter is designed with built-in overload protection. If the power rating of 150 Watts is exceeded, the power inverter will automatically shut down. Once the electrical device has been removed from the outlet the inverter should automatically reset.



3

### Power Inverter Outlet

To turn on the power outlet, simply plug in the device. The outlet automatically turns off when the device is unplugged.

**NOTE:** Due to built-in overload protection, the power inverter will shut down if the power rating is exceeded.

**WARNING!**

To avoid serious injury or death:

- Do not insert any objects into the receptacles.
- Do not touch with wet hands.
- Close the lid when not in use.
- If this outlet is mishandled, it may cause an electric shock and failure.

## CUPHOLDERS

### Front Seat Cupholders

The cupholders are located in the center console forward of the armrest between the front seats.

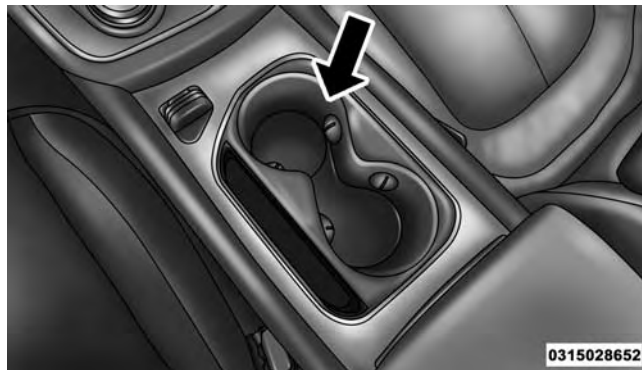

Front Seat Cupholders

## Rear Seat Cupholders

The rear seat cupholders are located in the center armrest between the rear seats. The cupholders are positioned forward in the armrest and side-by-side to provide convenient access to beverage cans or bottles while maintaining a resting place for the rear occupant's elbows.



Rear Seat Cupholders

## STORAGE

### Glove Compartment

The glove compartment is located on the passenger side of the instrument panel. Pull on the release handle to open the glove compartment.

3

**NOTE:** The glove compartment handle is equipped with a lock. To lock the glove compartment, remove the emergency key from the key fob, insert emergency key into glove compartment handle lock cylinder and turn the key to the lock position and remove the key. Use the reverse sequence to unlock the glove compartment.



Glove Compartment Release Handle

### Console Features

There is a storage compartment located under the center console armrest.

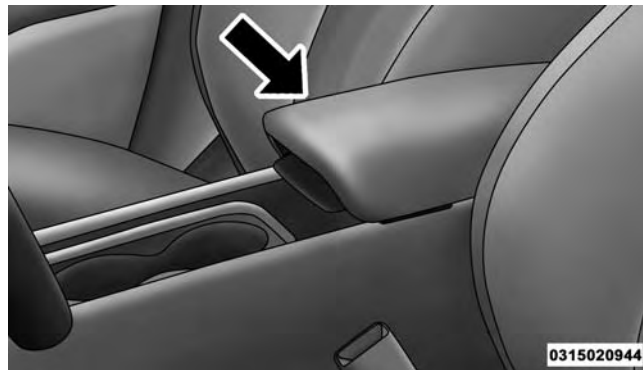

Center Console Armrest Storage

Pull upward on the release handle, located on the front of the armrest, to open the storage compartment.

The armrest can be slid forward/rearward to allow driver/passenger comfort position.



**WARNING!**

Do not operate this vehicle with a console compartment lid in the open position. Driving with the console compartment lid open may result in injury in a collision.

There is a front center console storage area located under the center console cupholder.

- To access the front center console storage area push the release button and pull rearward.

**NOTE:** The center console cupholder can be placed in any position to maintain access to the storage area.

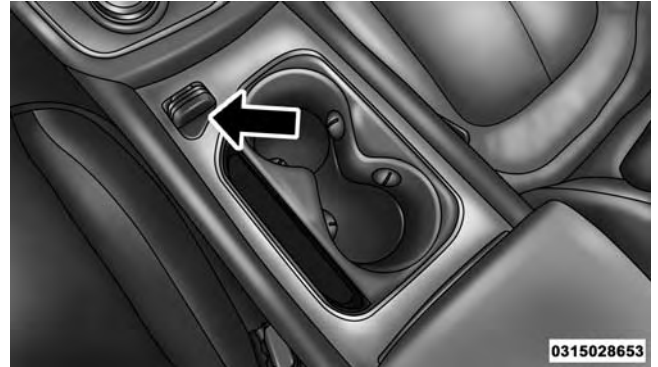

3

Center Console Cupholder Release

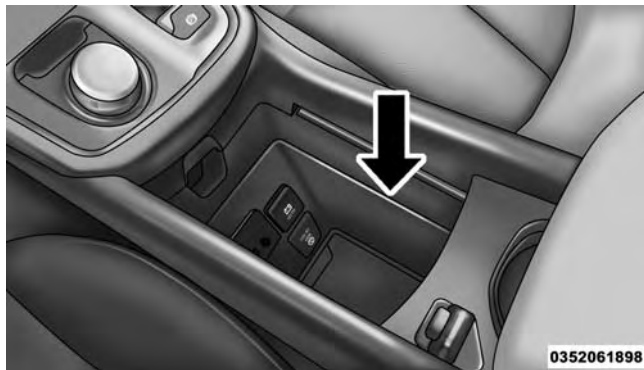

### Front Center Console Storage

Located inside the center console storage compartment is a line that indicates how much storage is allowed.

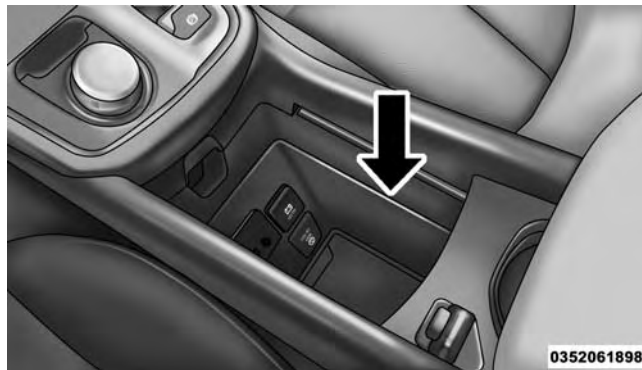

### Storage Compartment Fill Line

**NOTE:** Filling the console storage area above this line may impede the sliding of the cupholder.

Located inside the front of the console storage area power cords can be routed from the storage area to the center console pass-through.



Center Console Storage Passage



Front Center Console Pass-Through

## Door Storage

The door panels contain storage areas with a bottle holder.

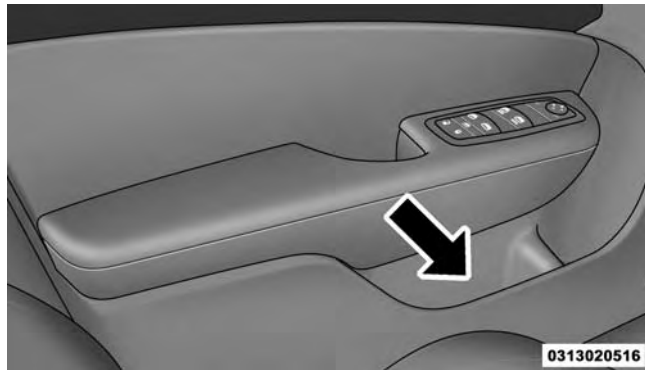

Front Door Storage

## Rear Seat Armrest Storage — If Equipped

For rear passengers there is a storage bin located in the armrest. Lift upward on the latch to open the storage compartment.

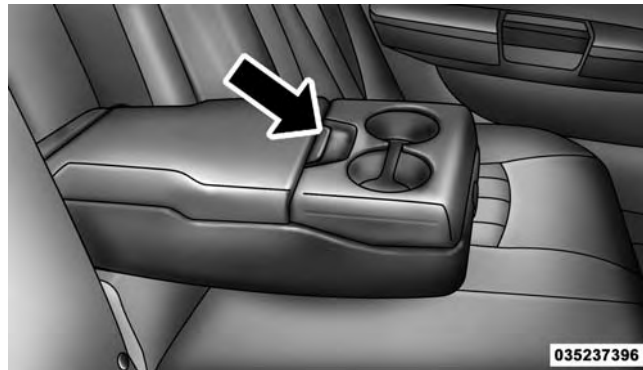

Rear Armrest Storage

## CARGO AREA FEATURES

### Cargo Area — 60/40 Split-Folding Rear Seat — If Equipped

The 60/40 split-folding rear seat provides cargo-carrying versatility. The seatbacks fold down easily by pulling the seatback loops between the seatbacks and the bolsters. When the seats are folded down, they provide a continuous, nearly-flat extension of the load floor.

**NOTE:** The rear seatback loops can be tucked away when not in use.

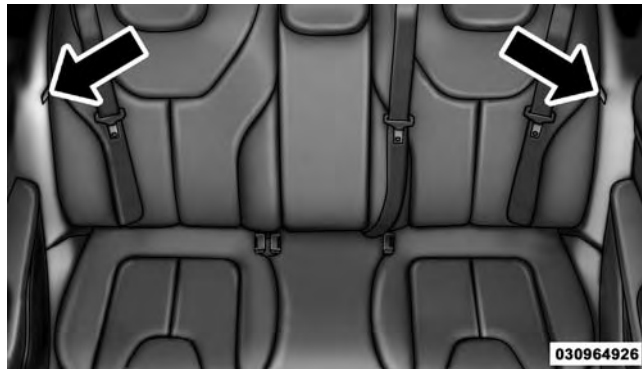

3

#### Rear Seatback Loops

After releasing the seatback, it can be folded forward.



030964927

### Folded Rear Seatback

When the seatback is folded to the upright position, make sure it is latched by strongly pulling on the top of the seatback above the seat strap.

### WARNING!

- Be certain that the seatback is securely locked into position. If the seatback is not securely locked into position, the seat will not provide the proper stability for child seats and/or passengers. An improperly latched seat could cause serious injury.
- The cargo area in the rear of the vehicle (with the rear seatbacks in the locked-up or folded down position) should not be used as a play area by children when the vehicle is in motion. They could be seriously injured in a collision. Children should be seated and using the proper restraint system.
- To help protect against personal injury, passengers should not be seated in the rear cargo area. The rear cargo space is intended for load carrying purposes only, not for passengers, who should sit in seats and use seat belts.



Information Provided by:

**DEALER**  
PROCESS

**WARNING!**

The weight and position of cargo and passengers can change the vehicle center of gravity and vehicle handling. To avoid loss of control resulting in personal injury, follow these guidelines for loading your vehicle:

- Always place cargo evenly on the cargo floor. Put heavier objects as low and as far forward as possible.
- Place as much cargo as possible in front of the rear axle. Too much weight or improperly placed weight over or behind the rear axle can cause the rear of the vehicle to sway.
- Do not pile luggage or cargo higher than the top of the seatback. This could impair visibility or become a dangerous projectile in a sudden stop or collision.

**Grocery Bag Hooks**

The rear cargo area is equipped with grocery bag hooks, located on either side of the rear cargo area.

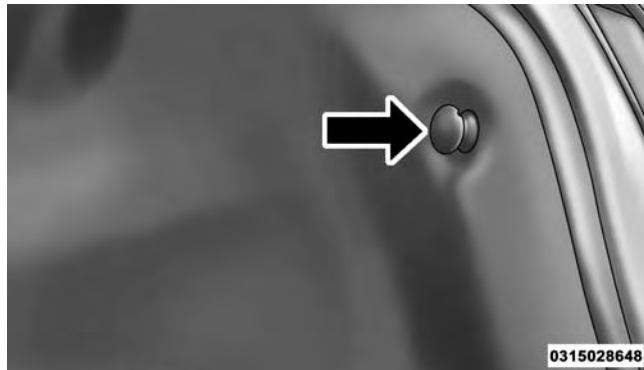

Grocery Bag Hooks

**CAUTION!**

Do not exceed the maximum weight limit 35 lbs (16 kg) of the grocery bag hook. Damage may occur to hook and mounting surface.

**Ski Pass-Through**

There is a ski pass-through door located behind the rear seat armrest that allows longer items, such as snow skis, to be stored in the rear cargo area. Lower the armrest and pull downward on the latch to open the ski pass-through door.

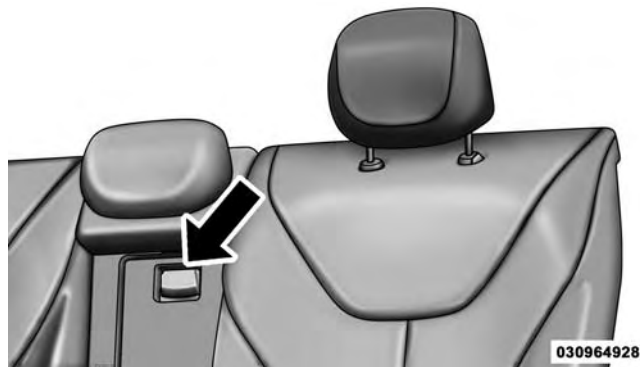

Ski Pass-Through



## REAR WINDOW FEATURES

### Rear Window Defroster



The rear window defroster button is located on the climate control. Push this button to turn on the rear window defroster and the heated outside mirrors (if equipped). An indicator in the button will illuminate when the rear window defroster is on. The rear window defroster automatically turns off after approximately 15 minutes. For an additional 5 minutes of operation, push the button a second time.

### CAUTION!

Failure to follow these cautions can cause damage to the heating elements:

- Use care when washing the inside of the rear window. Do not use abrasive window cleaners on the interior surface of the window. Use a soft cloth and a mild washing solution, wiping parallel to the heating elements. Labels can be peeled off after soaking with warm water.
- Do not use scrapers, sharp instruments, or abrasive window cleaners on the interior surface of the window.
- Keep all objects a safe distance from the window.





# UNDERSTANDING YOUR INSTRUMENT PANEL

## CONTENTS

■ INSTRUMENT PANEL FEATURES . . . . .	.316	■ ELECTRONIC VEHICLE INFORMATION CENTER (EVIC) . . . . .	.354
■ INSTRUMENT CLUSTER — BASE . . . . .	.317	□ Oil Change Reset . . . . .	.356
■ INSTRUMENT CLUSTER — PREMIUM . . . . .	.320	□ Instrument Cluster Messages For (EVIC) And (DID) . . . . .	.357
■ WARNING AND INDICATOR LIGHTS . . . . .	.322	□ EVIC Selectable Menu Items . . . . .	.359
□ Red Telltale Indicator Lights . . . . .	.323	□ Screen Setup Driver Selectable Items . . . . .	.365
□ Yellow Telltale Indicator Lights . . . . .	.335	■ DRIVER INFORMATION DISPLAY (DID) . . . . .	.367
□ Green Telltale Indicator Lights . . . . .	.348	□ Oil Change Reset . . . . .	.369
□ White Telltale Indicator Light . . . . .	.350	□ Instrument Cluster Messages For (EVIC) And (DID) . . . . .	.370
□ Blue Telltale Indicator Light . . . . .	.353		

## 314 UNDERSTANDING YOUR INSTRUMENT PANEL

- DID Selectable Menu Items . . . . . 372
- Screen Setup Driver Selectable Items . . . . . 376
- CYBERSECURITY. . . . . 378
- UCONNECT SETTINGS . . . . . 380
  - Buttons On The Faceplate. . . . . 381
  - Buttons On The Touchscreen. . . . . 382
  - Customer Programmable Features/Personal Settings — Uconnect 5.0/8.4A/8.4AN Settings. . . . . 382
- UCONNECT RADIOS — IF EQUIPPED . . . . . 398
- USB PORT AND AUX JACK — IF EQUIPPED . 398
- STEERING WHEEL AUDIO CONTROLS — IF EQUIPPED . . . . . 399
  - Radio Operation . . . . . 400
  - Media Mode . . . . . 400
- RADIO OPERATION AND MOBILE DEVICES . 400
  - Regulatory And Safety Information . . . . . 400
- CLIMATE CONTROLS . . . . . 402
  - Manual Climate Controls . . . . . 402
  - Manual Climate Controls With Touchscreen — If Equipped . . . . . 407
  - Automatic Climate Controls With Touchscreen — If Equipped. . . . . 412
  - Climate Control Functions . . . . . 419
  - Automatic Temperature Control (ATC) . . . . . 421
  - Operating Tips . . . . . 422
- PERSONALIZED MENU BAR . . . . . 425

- **UCONNECT VOICE RECOGNITION QUICK TIPS** . . . . . 426
- Introducing Uconnect. . . . . 426
- Get Started . . . . . 427
- Basic Voice Commands. . . . . 428
- Radio . . . . . 429
- Media. . . . . 431
- Phone. . . . . 432
- Voice Text Reply . . . . . 434
- Climate (8.4A/8.4AN) . . . . . 435
- Navigation (8.4A/8.4AN) . . . . . 436
- Uconnect Access (8.4A/8.4AN) . . . . . 437

- Vehicle Health Alert . . . . . 438
- Register (8.4A/8.4AN) . . . . . 439
- Mobile App (8.4A/8.4AN) . . . . . 440
- Voice Texting (8.4A/8.4AN) . . . . . 441
- Yelp (8.4A/8.4AN). . . . . 442
- SiriusXM Travel Link (8.4A/8.4AN). . . . . 443
- Siri Eyes Free — If Equipped . . . . . 444
- Do Not Disturb . . . . . 444
- General Information . . . . . 445
- Additional Information . . . . . 446

## INSTRUMENT PANEL FEATURES

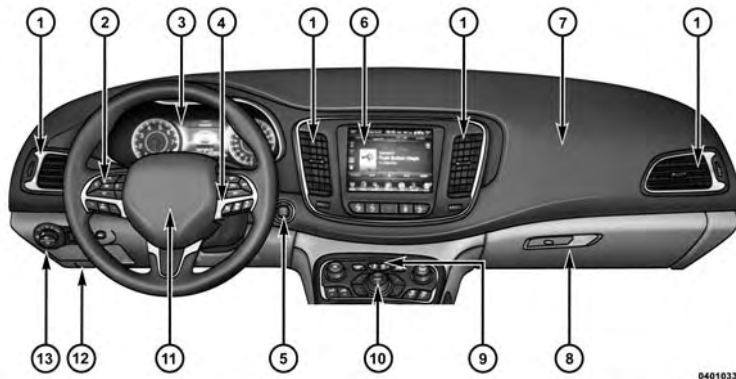

0401033142

- 1 — Air Outlet
- 2 — EVIC/DID Controls
- 3 — Instrument Cluster
- 4 — Cruise Controls
- 5 — Ignition Switch

- 6 — Radio Screen
- 7 — Passenger Air Bag
- 8 — Glove Compartment
- 9 — Radio Controls
- 10 — Climate Controls

- 11 — Steering Wheel
- 12 — Hood Release
- 13 — Headlight Switch

**INSTRUMENT CLUSTER — BASE**

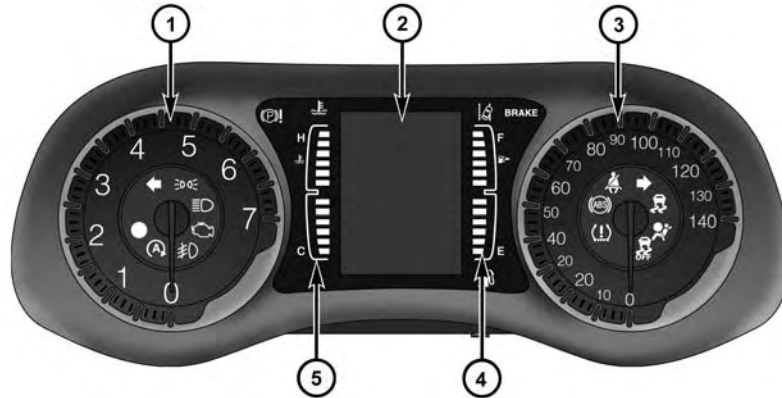

4

0403076751

**Base Electronic Vehicle Information Center (EVIC) Instrument Cluster**



## 1. Tachometer

- Indicates the engine speed in revolutions per minute (RPM x 1000).

## 2. Electronic Vehicle Information Center (EVIC) Display

- When the appropriate conditions exist, this display shows the Electronic Vehicle Information Center (EVIC) messages. Refer to “Electronic Vehicle Information Center” in “Understanding Your Instrument Panel” for further information.

## 3. Speedometer

- Indicates vehicle speed.

## 4. Fuel Gauge

- The pointer shows the level of fuel in the fuel tank when the ignition switch is in the ON/RUN position.

The fuel pump symbol points  to the side of the vehicle where the fuel door is located.

## 5. Temperature Gauge

- The temperature gauge shows engine coolant temperature. Any reading within the normal range indicates that the engine cooling system is operating satisfactorily.
- The gauge pointer will likely indicate a higher temperature when driving in hot weather or up mountain grades. It should not be allowed to exceed the upper limits of the normal operating range.

**CAUTION!**

**Driving with a hot engine cooling system could damage your vehicle. If the temperature gauge reads “H” pull over and stop the vehicle. Idle the vehicle with the air conditioner turned off until the pointer drops back into the normal range. If the pointer remains on the “H”, turn the engine off immediately and call an authorized dealer for service.**



**WARNING!**

A hot engine cooling system is dangerous. You or others could be badly burned by steam or boiling coolant. You may want to call an authorized dealer for service if your vehicle overheats. If you decide to look under the hood yourself, see "Maintaining Your Vehicle". Follow the warnings under the Cooling System Pressure Cap paragraph.

## INSTRUMENT CLUSTER — PREMIUM



0403076752

Premium Driver Information Display (DID) Instrument Cluster



### 1. Tachometer

- Indicates the engine speed in revolutions per minute (RPM x 1000).

### 2. Driver Information Display (DID)

- When the appropriate conditions exist, this display shows the Driver Information Display (DID) messages. Refer to “Driver Information Display” in “Understanding Your Instrument Panel” for further information.

### 3. Speedometer

- Indicates vehicle speed.

### 4. Fuel Gauge

- The pointer shows the level of fuel in the fuel tank when the ignition switch is in the ON/RUN position.

The fuel pump symbol points  to the side of the vehicle where the fuel door is located.

### 5. Temperature Gauge

- The temperature gauge shows engine coolant temperature. Any reading within the normal range indicates that the engine cooling system is operating satisfactorily.
- The gauge pointer will likely indicate a higher temperature when driving in hot weather or up mountain grades. It should not be allowed to exceed the upper limits of the normal operating range.

#### CAUTION!

**Driving with a hot engine cooling system could damage your vehicle. If the temperature gauge reads “H” pull over and stop the vehicle. Idle the vehicle with the air conditioner turned off until the pointer drops back into the normal range. If the pointer remains on the “H”, turn the engine off immediately and call an authorized dealer for service.**

**WARNING!**

A hot engine cooling system is dangerous. You or others could be badly burned by steam or boiling coolant. You may want to call an authorized dealer for service if your vehicle overheats. If you decide to look under the hood yourself, see “Maintaining Your Vehicle”. Follow the warnings under the Cooling System Pressure Cap paragraph.

**WARNING AND INDICATOR LIGHTS**

**IMPORTANT:** The warning / indicator light switches on in the instrument panel together with a dedicated message and/or acoustic signal when applicable. These indications are indicative and precautionary and as such must not be considered as exhaustive and/or alternative to the information contained in the Owner Manual, which you are advised to read carefully in all cases. Always refer to the information in this chapter in the event of a failure indication.

All active telltales will display first if applicable. The system check menu may appear different based upon equipment options and current vehicle status. Some telltales are optional and may not appear.

## Red Telltale Indicator Lights



### Seat Belt Reminder Warning Light

Red Telltale Light	What It Means
	<p><b>Seat Belt Reminder Warning Light</b></p> <p>When the ignition switch is first turned to ON/RUN, this light will turn on for four to eight seconds as a bulb check. During the bulb check, if the driver's seat belt is unbuckled, a chime will sound. After the bulb check or when driving, if the driver seat belt remains unbuckled, the Seat Belt Reminder Light will flash or remain on continuously and a chime will sound. Refer to "Occupant Restraints" in "Things To Know Before Starting Your Vehicle" for further information.</p>

## Air Bag Warning Light

Red Telltale Light	What It Means
	<p><b>Air Bag Warning Light</b> This light will turn on for four to eight seconds as a bulb check when the ignition switch is first turned to ON/RUN. If the light is either not on during starting, stays on, or turns on while driving, have the system inspected at an authorized dealer as soon as possible. This light will illuminate with a single chime when a fault with the Air Bag Warning Light has been detected, it will stay on until the fault is cleared. If the light comes on intermittently or remains on while driving, have an authorized dealer service the vehicle immediately. Refer to “Occupant Restraints” in “Things To Know Before Starting Your Vehicle” for further information.</p>

## Brake Warning Light

Red Telltale Light	What It Means
<p></p> <p>United States</p> <p></p> <p>Canada</p>	<p><b>Brake Warning Light</b></p> <p>This light monitors various brake functions, including brake fluid level and parking brake application. If the brake light turns on it may indicate that the parking brake is applied, that the brake fluid level is low, or that there is a problem with the anti-lock brake system reservoir.</p> <p>If the light remains on when the parking brake has been disengaged, and the fluid level is at the full mark on the master cylinder reservoir, it indicates a possible brake hydraulic system malfunction or that a problem with the Brake Booster has been detected by the Anti-Lock Brake System (ABS) / Electronic Stability Control (ESC) system. In this case, the light will remain on until the condition has been corrected. If the problem is related to the brake booster, the ABS pump will run when applying the brake, and a brake pedal pulsation may be felt during each stop.</p>

The dual brake system provides a reserve braking capacity in the event of a failure to a portion of the hydraulic system. A leak in either half of the dual brake system is

indicated by the Brake Warning Light, which will turn on when the brake fluid level in the master cylinder has dropped below a specified level.

The light will remain on until the cause is corrected.

**NOTE:** The light may flash momentarily during sharp cornering maneuvers, which change fluid level conditions. The vehicle should have service performed, and the brake fluid level checked.

If brake failure is indicated, immediate repair is necessary.

### WARNING!

**Driving a vehicle with the red brake light on is dangerous. Part of the brake system may have failed. It will take longer to stop the vehicle. You could have a collision. Have the vehicle checked immediately.**

Vehicles equipped with the Anti-Lock Brake System (ABS) are also equipped with Electronic Brake Force Distribution (EBD). In the event of an EBD failure, the

Brake Warning Light will turn on along with the ABS Light. Immediate repair to the ABS system is required.

Operation of the Brake Warning Light can be checked by turning the ignition switch from the OFF position to the ON/RUN position. The light should illuminate for approximately two seconds. The light should then turn off unless the parking brake is applied or a brake fault is detected. If the light does not illuminate, have the light inspected by an authorized dealer.

The light also will turn on when the parking brake is applied with the ignition switch in the ON/RUN position.

**NOTE:** This light shows only that the parking brake is applied. It does not show the degree of brake application.



## Vehicle Security Warning Light — If Equipped

Red Telltale Light	What It Means
	<p><b>Vehicle Security Warning Light</b> This light will flash at a fast rate for approximately 15 seconds when the vehicle security alarm is arming, and then will flash slowly until the vehicle is disarmed.</p>

## Engine Temperature Warning Light

Red Telltale Light	What It Means
	<p><b>Engine Temperature Warning Light</b></p> <p>This light warns of an overheated engine condition. If the engine coolant temperature is too high, this indicator will illuminate and a single chime will sound.</p> <p>If the light turns on while driving, safely pull over and stop the vehicle. If the A/C system is on, turn it off. Also, shift the transmission into NEUTRAL and idle the vehicle. If the temperature reading does not return to normal, turn the engine off immediately and call for service. Refer to “If Your Engine Overheats” in “What To Do In Emergencies” for further information.</p> <p>For vehicles equipped with a premium cluster, this indicator will display in the DID. Refer to “Driver Information Display (DID) — If Equipped” for further information.</p>

## Charging System Warning Light

Red Telltale Light	What It Means
	<p><b>Charging System Warning Light</b>            This light shows the status of the electrical charging system. If the light stays on or comes on while driving, turn off some of the vehicle's nonessential electrical devices or increase engine speed (if at idle). If the charging system light remains on, it means that the vehicle is experiencing a problem with the charging system. Obtain <b>SERVICE IMMEDIATELY</b>. See an authorized dealer.</p> <p>If jump starting is required, refer to "Jump Starting Procedures" in "What To Do In Emergencies."</p>

## Oil Pressure Warning Light

Red Telltale Light	What It Means
 The icon depicts a black oil can with a red flame-like shape above it, indicating a warning.	<p><b>Oil Pressure Warning Light</b></p> <p>This light indicates low engine oil pressure. If the light turns on while driving, stop the vehicle and shut off the engine as soon as possible. A chime will sound when this light turns on.</p> <p>Do not operate the vehicle until the cause is corrected. This light does not indicate how much oil is in the engine. The engine oil level must be checked under the hood.</p>

## Electronic Throttle Control (ETC) Warning Light

Red Telltale Light	What It Means
	<p><b>Electronic Throttle Control (ETC) Warning Light</b></p> <p>This light informs you of a problem with the Electronic Throttle Control (ETC) system. If a problem is detected while the engine is running, the light will either stay on or flash depending on the nature of the problem. Cycle the ignition key when the vehicle is safely and completely stopped and the shift lever is placed in the PARK position. The light should turn off. If the light remains on with the engine running, your vehicle will usually be drivable; however, see an authorized dealer for service as soon as possible.</p> <p>If the light continues to flash when the engine is running, immediate service is required and you may experience reduced performance, an elevated/rough idle, or engine stall and your vehicle may require towing. The light will come on when the ignition is first turned to ON/RUN and remain on briefly as a bulb check. If the light does not come on during starting, have the system checked by an authorized dealer.</p>

## Transmission Temperature Warning Light

Red Telltale Light	What It Means
	<p><b>Transmission Temperature Warning Light</b>            This light indicates that the transmission fluid temperature is running hot. This may occur with severe usage. If this light turns on, safely pull over and stop the vehicle. Then, shift the transmission into NEUTRAL and run the engine at idle or faster until the light turns off.</p>

### CAUTION!

Continuous driving with the Transmission Temperature Warning Light illuminated will eventually cause severe transmission damage or transmission failure.

### WARNING!

If you continue operating the vehicle when the Transmission Temperature Warning Light is illuminated you could cause the fluid to boil over, come in contact with hot engine or exhaust components and cause a fire.

### Electric Power Steering Fail Warning — If Equipped

Red Telltale Light	What It Means
	<p><b>Electric Power Steering Fail Warning</b>                      This light is used to manage the electrical warning of the EPS (Power Steering System). Refer to “Power Steering” in “Starting and Operating” for further information.</p>

### Oil Temperature Warning Light

Red Telltale Light	What It Means
	<p><b>Oil Temperature Warning Light</b>                      This telltale indicates engine oil temperature is high. If the light turns on while driving, stop the vehicle and shut off the engine as soon as possible.</p>

## Door Open Warning Light

Red Telltale Light	What It Means
	<b>Door Open Warning Light</b> This indicator will illuminate when a door is ajar/open and not fully closed. If the vehicle is moving there will also be a single chime.

## Trunk Open Warning Light

Red Telltale Light	What It Means
	<b>Trunk Open Warning Light</b> This indicator will illuminate when the trunk is open and not fully closed.



## Yellow Telltale Indicator Lights

### Engine Check/Malfunction Indicator Light (MIL)

Yellow Telltale Light	What It Means
	<p><b>Engine Check/Malfunction Indicator Light (MIL)</b></p> <p>The Engine Check/Malfunction Indicator Light (MIL) is a part of an Onboard Diagnostic System called OBD II that monitors engine and automatic transmission control systems. The light will illuminate when the ignition is in the ON position before engine start. If the bulb does not come on when turning the key from OFF to ON/RUN, have the condition checked promptly.</p> <p>Certain conditions, such as a loose or missing gas cap, poor quality fuel, etc., may illuminate the light after engine start. The vehicle should be serviced if the light stays on through several typical driving styles. In most situations, the vehicle will drive normally and will not require towing.</p> <p>When the engine is running, the MIL may flash to alert serious conditions that could lead to immediate loss of power or severe catalytic converter damage. The vehicle should be serviced as soon as possible if this occurs.</p>

**CAUTION!**

Prolonged driving with the Malfunction Indicator Light (MIL) on could cause damage to the engine control system. It also could affect fuel economy and driveability. If the MIL is flashing, severe catalytic converter damage and power loss will soon occur. Immediate service is required.

**WARNING!**

A malfunctioning catalytic converter, as referenced above, can reach higher temperatures than in normal operating conditions. This can cause a fire if you drive slowly or park over flammable substances such as dry plants, wood, cardboard, etc. This could result in death or serious injury to the driver, occupants or others.

## Electronic Stability Control (ESC) Indicator Light — If Equipped

Yellow Telltale Light	What It Means
	<p><b>Electronic Stability Control (ESC) Indicator Light</b></p> <p>The “ESC Indicator Light” in the instrument cluster will come on when the ignition switch is turned to the ON/RUN position. It should go out with the engine running. If the “ESC Indicator Light” comes on continuously with the engine running, a malfunction has been detected in the ESC system. If this light remains on after several ignition cycles, and the vehicle has been driven several miles (kilometers) at speeds greater than 30 mph (48 km/h), see your authorized dealer as soon as possible to have the problem diagnosed and corrected.</p> <ul style="list-style-type: none"> <li>• The “ESC Off Indicator Light” and the “ESC Indicator Light” come on momentarily each time the ignition switch is turned to ON/RUN.</li> <li>• Each time the ignition is turned to ON/RUN, the ESC system will be ON, even if it was turned off previously.</li> <li>• The ESC system will make buzzing or clicking sounds when it is active. This is normal; the sounds will stop when ESC becomes inactive following the maneuver that caused the ESC activation.</li> </ul>

**Electronic Stability Control (ESC) OFF Indicator Light — If Equipped**

Yellow Telltale Light	What It Means
 The icon shows a car with a wavy line underneath it, representing instability, and the word "OFF" below it.	<b>Electronic Stability Control (ESC) OFF Indicator Light</b> This light indicates the Electronic Stability Control (ESC) is off.

**Low Washer Fluid Indicator Light — If Equipped**

Yellow Telltale Light	What It Means
 The icon shows a windshield washer reservoir with a wiper blade and a low fluid level indicator.	<b>Low Washer Fluid Indicator Light</b> This indicator will illuminate when the windshield washer fluid is low.

## Tire Pressure Monitoring Indicator Light

Yellow Telltale Light	What It Means
	<p><b>Tire Pressure Monitoring Indicator Light</b>                      The warning light switches on and a message is displayed to indicate that the tire pressure is lower than the recommended value and/or that slow pressure loss is occurring. In these cases, optimal tire duration and fuel consumption may not be guaranteed. Should one or more tires be in the condition mentioned above, the display will show the indications corresponding to each tire in sequence.</p>

**IMPORTANT:** Do not continue driving with one or more flat tires as handling may be compromised. Stop the vehicle, avoiding sharp braking and steering. Repair immediately using the dedicated tire repair kit and contact your authorized dealership as soon as possible.

Each tire, including the spare (if provided), should be checked monthly when cold and inflated to the inflation pressure recommended by the vehicle manufacturer on

the vehicle placard or tire inflation pressure label. If your vehicle has tires of a different size than the size indicated on the vehicle placard or tire inflation pressure label, you should determine the proper tire inflation pressure for those tires.

As an added safety feature, your vehicle has been equipped with a Tire Pressure Monitoring System (TPMS) that illuminates a low tire pressure telltale when

one or more of your tires is significantly under-inflated. Accordingly, when the low tire pressure telltale illuminates, you should stop and check your tires as soon as possible and inflate them to the proper pressure. Driving on a significantly under-inflated tire causes the tire to overheat and can lead to tire failure. Under-inflation also reduces fuel efficiency and tire tread life, and may affect the vehicle's handling and stopping ability.

Please note that the TPMS is not a substitute for proper tire maintenance, and it is the driver's responsibility to maintain correct tire pressure, even if under-inflation has not reached the level to trigger illumination of the TPMS low tire pressure telltale.

Your vehicle has also been equipped with a TPMS malfunction indicator to indicate when the system is not operating properly. The TPMS malfunction indicator is combined with the low tire pressure telltale. When the system detects a malfunction, the telltale will flash for

approximately one minute and then remain continuously illuminated. This sequence will continue upon subsequent vehicle start-ups as long as the malfunction exists. When the malfunction indicator is illuminated, the system may not be able to detect or signal low tire pressure as intended. TPMS malfunctions may occur for a variety of reasons, including the installation of replacement or alternate tires or wheels on the vehicle that prevent the TPMS from functioning properly. Always check the TPMS malfunction telltale after replacing one or more tires or wheels on your vehicle, to ensure that the replacement or alternate tires and wheels allow the TPMS to continue to function properly.

**CAUTION!**

The TPMS has been optimized for the original equipment tires and wheels. TPMS pressures and warning have been established for the tire size equipped on your vehicle. Undesirable system operation or sensor damage may result when using replacement equipment that is not of the same size, type, and/or style. Aftermarket wheels can cause sensor damage. Using aftermarket tire sealants may cause the Tire Pressure Monitoring System (TPMS) sensor to become inoperable. After using an aftermarket tire sealant it is recommended that you take your vehicle to an authorized dealership to have your sensor function checked.

## Electronic Park Brake Fail Light

Yellow Telltale Light	What It Means
	<p><b>Electronic Park Brake Fail Warning Light</b> This telltale will turn on to indicate the Electronic Park Brake is not functioning properly and that service is required. Contact your authorized dealership.</p>

## Low Fuel Indicator Light

Yellow Telltale Light	What It Means
	<p><b>Low Fuel Indicator Light</b> When the fuel level reaches approximately 3.0 gal (11.0 L) this light will turn on, and remain on until fuel is added.</p>



## Anti-Lock Brake (ABS) Indicator Light

Yellow Telltale Light	What It Means
	<p><b>Anti-Lock Brake (ABS) Indicator Light</b></p> <p>This light monitors the Anti-Lock Brake System (ABS). The light will turn on when the ignition switch is placed in the ON/RUN position and may stay on for as long as four seconds. If the ABS light remains on or turns on while driving, then the Anti-Lock portion of the brake system is not functioning and service is required. However, the conventional brake system will continue to operate normally if the brake warning light is not on. If the ABS light is on, the brake system should be serviced as soon as possible to restore the benefits of Anti-Lock Brakes. If the ABS light does not turn on when the ignition switch is placed in the ON/RUN position, have the light inspected by an authorized dealer.</p>

## Service Forward Collision Warning Indicator Light — If Equipped

Yellow Telltale Light	What It Means
	<p><b>Service Forward Collision Warning Indicator Light</b></p> <p>This light warns the driver of a potential collision with the vehicle in front and prompts the driver to take action in order to avoid the collision. Refer to “Adaptive Cruise Control (ACC)” in “Understanding The Features Of Your Vehicle” for further information.</p>

## LaneSense Indicator Light — If Equipped

Yellow Telltale Light	What It Means
	<p><b>LaneSense Indicator Light — If Equipped</b></p> <p>The LaneSense system provides the driver with visual and steering torque warnings when the vehicle starts to drift out of its lane unintentionally without the use of a turn signal.</p> <ul style="list-style-type: none"> <li>• When the LaneSense system senses a lane drift situation, the LaneSense indicator changes from solid green to solid yellow.</li> <li>• When the LaneSense system senses the lane has been approached and is in a lane departure situation, the LaneSense indicator changes from solid white/green to flashing yellow.</li> </ul> <p>Refer to “LaneSense - If Equipped” in “Understanding The Features Of Your Vehicle” for further information.</p>

### LaneSense Failure Indicator Light — If Equipped

Yellow Telltale Light	What It Means
	<p><b>LaneSense Failure Indicator Light</b> This light will turn on when the LaneSense system is not operating and needs service. Please see your authorized dealer.</p>

### Service AWD Indicator Light — If Equipped

Yellow Telltale Light	What It Means
	<p><b>Service AWD Indicator Light</b> This telltale will turn on to indicate the All Wheel Drive (AWD) system is not functioning properly and that service is required. Contact your authorized dealership.</p>

## Loose Fuel Filler Cap Indicator Light — If Equipped

Yellow Telltale Light	What It Means
	<p><b>Loose Fuel Filler Cap Indicator Light</b>            This light will illuminate when fuel filler cap is loose. Properly close the filler cap to disengage the light. If the light does not turn off, please see your authorized dealer.</p>

## Service Adaptive Cruise Control Light

Yellow Telltale Light	What It Means
	<p><b>Service Adaptive Cruise Control Light</b>            This light will turn on when a ACC is not operating and needs service. For further information, refer to “Adaptive Cruise Control (ACC)” in “Understanding The Features Of Your Vehicle.”</p>

## Green Telltale Indicator Lights

### Park/Headlight ON Indicator Light

Green Telltale Light	What It Means
	<p><b>Park/Headlight ON Indicator Light</b> This indicator will illuminate when the park lights or headlights are turned on.</p>

### Front Fog Indicator Light — If Equipped

Green Telltale Light	What It Means
	<p><b>Front Fog Indicator Light</b> This indicator will illuminate when the front fog lights are on.</p>

## Turn Signal Indicator Lights

Green Tell-tale Light	What It Means
	<p><b>Turn Signal Indicator Lights</b>                      The instrument cluster arrow will flash independently for the LEFT or RIGHT turn signal as selected, as well as the exterior turn signal lamp(s) (front and rear) as selected when the multi-function lever is moved down (LEFT) or up (RIGHT).</p> <p><b>NOTE:</b></p> <ul style="list-style-type: none"> <li>• A continuous chime will sound if the vehicle is driven more than 1 mile (1.6 km) with either turn signal on.</li> <li>• Check for an inoperative outside light bulb if either indicator flashes at a rapid rate.</li> </ul>

## Electronic Speed Control SET Indicator Light

Green Telltale Light	What It Means
	<p><b>Electronic Speed Control SET Indicator Light</b> This light will turn on when the electronic speed control is SET. Refer to “Electronic Speed Control” in “Understanding The Features Of Your Vehicle” for further information.</p>

## White Telltale Indicator Light

### Electronic Speed Control ON Indicator Light

White Telltale Light	What It Means
	<p><b>Electronic Speed Control ON Indicator Light</b> This light will turn on when the electronic speed control is ON.</p>



### Cruise Control Cancelled Light

White Telltale Light	What It Means
	<p><b>Cruise Control Cancelled Light</b>                      This light will turn on when the cruise control has been cancelled by the driver. Refer to “Electronic Speed Control” in “Understanding The Features Of Your Vehicle” for further information.</p>

### Adaptive Cruise Control (ACC) Ready Light — If Equipped

White Telltale Light	What It Means
	<p><b>Adaptive Cruise Control (ACC) Ready Light — If Equipped</b>                      This light will turn on when the vehicle equipped with Adaptive Cruise Control (ACC) has been turned on and in the READY state. Refer to “Electronic Speed Control” in “Understanding The Features Of Your Vehicle” for further information.</p>

### Adaptive Cruise Control (ACC) Set Light — If Equipped

White Telltale Light	What It Means
	<p><b>Adaptive Cruise Control (ACC) Set Light — If Equipped</b>            This light will turn on when the vehicle equipped with Adaptive Cruise Control (ACC) has reached the speed desired and the set button has been selected. For further information, refer to “Electronic Speed Control” in “Understanding The Features Of Your Vehicle.”</p>

### Adaptive Cruise Control (ACC) Distance Setting Display Light — If Equipped

White Telltale Light	What It Means
	<p><b>Adaptive Cruise Control (ACC) Distance Setting Display Light</b>            This will display the distance setting for the ACC system. Refer to “Adaptive Cruise Control (ACC)” in “Understanding The Features Of Your Vehicle” for further information.</p>

## Blue Telltale Indicator Light

### High Beam Indicator Light

Blue Telltale Light	What It Means
	<p><b>High Beam Indicator Light</b> This indicator shows that the high beam headlights are on. Push the multifunction control lever away from you to switch the headlights to high beam. Pull the lever toward you to switch the headlights back to low beam.</p>

## ELECTRONIC VEHICLE INFORMATION CENTER (EVIC)

The 3.5" Electronic Vehicle Information Center (EVIC) display is located in the instrument cluster.

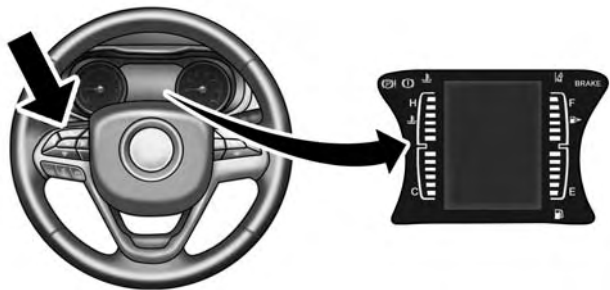

0409035239

Electronic Vehicle Information Center (EVIC) Display

The EVIC Main Menu items consists of the following:

- Speedometer
- Vehicle Info
- Fuel Economy Info
- Trip (Trip A/Trip B)
- Audio Info
- Messages
- Screen Setup
- Settings

The system allows the driver to select information by pushing the following buttons mounted on the steering wheel:



EVIC Controls

- **UP Arrow Button**



Push and release the UP arrow button to scroll upward through the Main Menu items (Speedometer, Vehicle Info, Fuel Economy, Trip A, Trip B, Audio, Messages, Screen Set Up, Settings).

- **DOWN Arrow Button**



Push and release the DOWN arrow button to scroll downward through the Main Menu items (Speedometer, Vehicle Info, Fuel Economy, Trip A, Trip B, Audio, Messages, Screen Set Up, Settings).

- **RIGHT Arrow Button**



Push and release the RIGHT arrow button to access the information screens or submenu screens of a main menu item.

- **BACK/LEFT Arrow Button**



Push and release the LEFT arrow button to access the information screens or submenu screens of a main menu item.

- **OK Button**

Push the OK button to access/select the information screens or submenu screens of a Main Menu item. Push and hold the OK arrow button for one second to reset displayed/selected features that can be reset.

## **Oil Change Reset**

### **Oil Change Due**

Your vehicle is equipped with an engine oil change indicator system. The “Oil Change Due” message will display in the EVIC for five seconds after a single chime has sounded to indicate the next scheduled oil change interval. The engine oil change indicator system is duty

cycle based, which means the engine oil change interval may fluctuate, dependent upon your personal driving style.

Unless reset, this message will continue to display each time the ignition is cycled to the ON/RUN position. To turn off the message temporarily, push and release the **OK** button. To reset the oil change indicator system (after performing the scheduled maintenance), refer to the following procedure.

1. Without pushing the brake pedal, push the ENGINE START/STOP button and cycle the ignition to the ON/RUN position (do not start the engine).
2. Fully push the accelerator pedal, slowly, three times within 10 seconds.
3. Without pushing the brake pedal, push the ENGINE START/STOP button once to return the ignition to the OFF/LOCK position.

## Secondary Method Of Navigating To The Oil Life Screen In The DID And Holding OK

1. Without pushing the brake pedal, push the ENGINE START/STOP button and cycle the ignition to the ON/RUN position (do not start the engine).
2. Push and release the **DOWN** arrow button to scroll downward through the main menu to “Vehicle Info.”
3. Push and release the **RIGHT** arrow button to access the “Oil Life” screen.
4. Push and hold the **OK** button to reset of the Oil Life.
5. Push and release the **UP** arrow button to exit the screen.

**NOTE:** If the indicator message illuminates when you start the vehicle, the oil change indicator system did not reset. If necessary, repeat this procedure.

## Instrument Cluster Messages For (EVIC) And (DID)

- Front Seatbelts Unbuckled
- Driver Seatbelt Unbuckled
- Passenger Seatbelt Unbuckled
- Service Airbag System
- Traction Control Off
- Washer Fluid Low
- Oil Pressure Low
- Oil Change Due
- Fuel Low
- Service Antilock Brake System
- Service Electronic Throttle Control

## 358 UNDERSTANDING YOUR INSTRUMENT PANEL

- Service Power Steering
- Cruise Off
- Cruise Ready
- Cruise Set To XXX MPH
- Cruise Set To XXX KM/H
- Tire Pressure Screen With Low Tire(s) "Inflate Tire to XX"
- Service Tire Pressure System
- Parking Brake Engaged
- Brake Fluid Low
- Service Electronic Braking System
- Engine Temperature Hot
- Battery Voltage Low
- Service Electronic Throttle Control
- Lights On
- Right Turn Signal Light Out
- Left Turn Signal Light Out
- Turn Signal On
- Vehicle Not in Park
- Key in Ignition
- Key in Ignition Lights On
- Remote Start Active Key to Run
- Remote Start Active Push Start Button
- Remote Start Aborted Fuel Low
- Remote Start Aborted Too Cold
- Remote Start Aborted Door Open





- Remote Start Aborted Hood Open
- Remote Start Aborted Trunk Open
- Remote Start Aborted Time Expired
- Remote Start Disabled Start to Reset
- Service Airbag System
- Service Airbag Warning Light
- Door Open
- Doors Open
- Gear Not Available
- Shift Not Allowed
- Shift to Neutral then Drive or Reverse
- Transmission Getting Hot Push Brake
- Trans. Hot Stop Safely Shift to Park Wait to Cool

- Service Transmission
- Service Shifter
- Engage Park Brake to Prevent Rolling
- Washer Fluid Low

The Reconfigurable Telltales section is divided into the white telltales area on the right, amber telltales in the middle, and red telltales on the left.

### **EVIC Selectable Menu Items**

Push and release the **UP** or **DOWN** arrow buttons until the desired Selectable Menu icon is highlighted in the EVIC.

### **Speedometer**

Push and release the **UP** or **DOWN** arrow button until the Speedometer Menu displays in the EVIC/DID. Push

and release the **RIGHT** arrow button to toggle between km/h and MPH and push the **OK** button to select your speedometer display.

### Vehicle Info

Push and release the **UP** or **DOWN** arrow button until the Vehicle Info icon is highlighted in the EVIC/DID. Push and release the **RIGHT** arrow button and Coolant Temp will be displayed. Push the **LEFT** or **RIGHT** arrow button to scroll through the information sub-menus and push the **OK** button to select or reset the following resettable sub-menus:

### Tire Pressure

Push and release the **UP** or **DOWN** arrow button until "Tire Pressure" is highlighted in the EVIC/DID. Push and release the **RIGHT** arrow button and one of the following will be displayed:

If tire pressure is **OK** for all tires, a vehicle **ICON** is displayed with tire pressure values in each corner of the **ICON**.

If one or more tires have low pressure, "Inflate Tire To XX" is displayed with the vehicle **ICON**, and the tire pressure values in each corner of the **ICON** with the pressure value of the low tire displayed in a different color than the other tire pressure value.

If the Tire Pressure system requires service, "Service Tire Pressure System" is displayed.

Tire PSI is an information only function and cannot be reset. Push and release the **LEFT** arrow button to return to the main menu.

Refer to "Tire Pressure Monitoring System (TPMS)" under "Starting and Operating" for further information.

**Coolant Temperature**

**Transmission Temperature – Automatic Transmission Only**

**Oil Temperature**

**Oil Life**

**Battery Voltage**

**Fuel Economy**

Push and release the **UP** or **DOWN** arrow button until the Fuel Economy Menu item is highlighted in the DID.

- Two sub menu pages one with Current value displayed and one without the Current Value displayed:
  - Current Fuel Economy (MPG, L/100 km, or km/l)
  - Range To Empty (miles or km)
  - Average Fuel Economy (MPG, L/100 km, or km/l)

– The Max and Min values will correspond to the particular engine requirements

- Lower end of gauge will be displayed in an amber color and turn green as Fuel Economy improves.
- Hold **OK** to reset average fuel economy information.

**Trip Info**

Push and release the **UP** or **DOWN** arrow button until the Trip Menu item is highlighted in the EVIC (Toggle left or right to select Trip A or Trip B). The Trip information will display the following:

- Distance
- Average Fuel Economy
- Elapsed Time

Hold the **OK** button to reset feature information.

## Audio

Push and release the **UP** or **DOWN** arrow button until the Audio Menu displays in the EVIC/DID.

## Stored Messages

Push and release the **UP** or **DOWN** arrow button until the Messages Menu displays in the EVIC/DID. This feature shows the number of stored warning messages. Pushing the **RIGHT** arrow button will allow you to see what the stored messages are.

## Screen Setup

Push and release the **UP** or **DOWN** arrow button until the Screen Setup Menu displays in the EVIC/DID. Push and release the **OK** button to enter the sub-menus. The Screen Setup feature allows you to change what information is displayed in the instrument cluster as well as the location that information is displayed.

## Vehicle Settings (EVIC) — If Equipped

	Settings	Translation Message	Submenu
1	Language Select	Language	English, Spanish, French
2	Units Select	Units	U.S., Metric
3	FCW Sensitivity	FCW Sensitivity	Near, Far
4	ParkSense	ParkSense	Off, Sound Only, Sound & Display
5	Blind Spot Alert	Blind Spot Alert	Off, Lights Only, Lights & Chime
6	Hill Start Assist	Hill Start Asst	On, Off
7	Auto Lock Doors	Auto Lock Doors	On, Off

	Settings	Translation Message	Submenu
8	Auto Unlock Doors	Auto Unlock Doors	On, Off
9	Passive Entry	Passive Entry	On, Off
10	Remote Unlock Sequence	Remote Unlock	Driver Door, All Doors
11	Key Fob Linked to Memory	Key in Memory	On, Off
12	Remote Start Comfort System	Rmt Start Comfort	Off, Remote Starts Only, All Starts

	Settings	Translation Message	Submenu
13	Sound Horn with Remote Start	Horn w/ Rmt Start	On, Off
14	Sound Horn with Remote Lock	Horn w/ Rmt Lock	Off, 1st Press, 2nd Press
15	Flash Lights with Lock	Lights w/ Lock	On, Off
16	Daytime Running Lights	Daytime Lights	On, Off
17	Automatic Highbeams	Auto Highbeams	On, Off

	Settings	Translation Message	Submenu
18	Headlights On with Wipers	Lights w/ Wipers	On, Off
19	Rain Sensing Wipers	Auto Wipers	On, Off
20	Headlights Off Delay	Lights Off Delay	0 seconds, 30 seconds, 60 seconds, 90 seconds
21	Key-Off Power Delay	Power Off Delay	Off, 45 seconds, 5 minutes, 10 minutes

	Settings	Translation Message	Submenu
22	Illuminated Approach	Lights w/ Unlock	0 seconds, 30 seconds, 60 seconds, 90 seconds
23	Easy Exit Seat	Easy Exit Seat	On, Off
24	Tilt Mirror in Reverse	Tilt Mirror in R	On, Off
25	Compass variance	Compass Var	See Owner's Manual, X Increment
26	Calibrate Compass	Compass Cal	Push > to calibrate the compass

	Settings	Translation Message	Submenu
27	Brake Service	Brake Service	Follow the VF specifically for this one
28	Auto Park Brake	Auto Park Brake	On, Off

### Screen Setup Driver Selectable Items

#### 1. Upper Left

- None
- Compass (default)
- Outside Temp
- Time
- Range To Empty (RTE)
- Average Economy L/100km (or MPG)

- Current Economy L/100km (or MPG)

#### 2. Upper Right

- None
- Compass
- Outside Temp (default)
- Time
- Range To Empty (RTE)
- Average Economy L/100km (or MPG)
- Current Economy L/100km (or MPG)

**NOTE:** Defaults will change to Average Economy L/100km (or MPG) UR, Range UL if the proxies for Compass and Outside Temp are not available

### 3. Center

- None
- Compass
- Outside Temp
- Time
- Range To Empty
- Average Economy
- Current Economy
- Trip A
- Trip B
- Audio Information
- Menu Title (default)
- Digital Speedo

### 4. Current Gear

- On
- Off (default)

### 5. Defaults (defaults: Compass UR, Outside Temp UL, Center Menu Title, Gear Display Off)

- Restore
- Cancel



## DRIVER INFORMATION DISPLAY (DID)

The Driver Information Display (DID) features a driver-interactive display that is located in the instrument cluster.

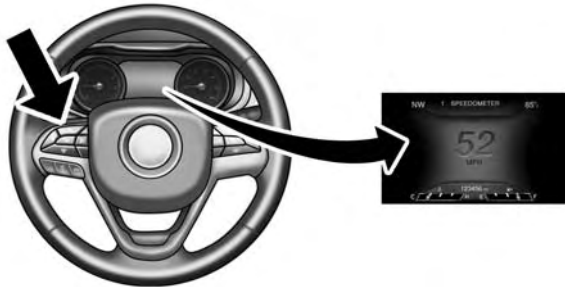

0409004648

Driver Information Display (DID)

The DID Main Menu items consists of the following:

- Speedometer
- Vehicle Info
- Driver Assist
- Fuel Economy Info
- Trip (Trip A/Trip B)
- Audio Info
- Messages
- Screen Setup

The system allows the driver to select information by pushing the following buttons mounted on the steering wheel:

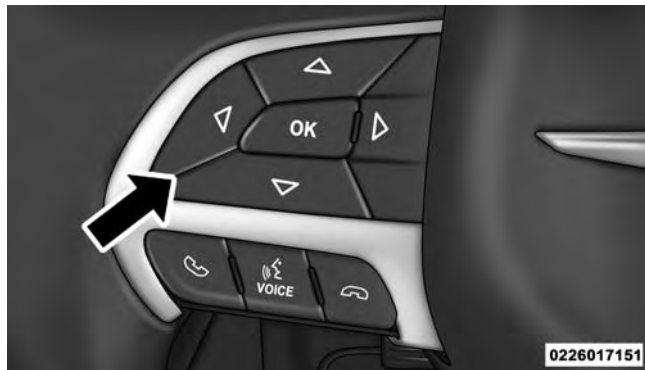

DID Controls

- ***UP Arrow Button***



Push and release the UP arrow button to scroll upward through the main menu and sub-menus (Speedometer, Vehicle Info, Driver Assist, Fuel Economy, Trip Info, Audio, Messages, Screen Setup).

- ***DOWN Arrow Button***



Push and release the DOWN arrow button to scroll downward through the main menu and sub-menus (Speedometer, Vehicle Info, Driver Assist, Fuel Economy, Trip Info, Audio, Messages, Screen Setup).

- ***RIGHT Arrow Button***



Push and release the RIGHT arrow button to access the information screens or sub-menu screens of a main menu item.

- **LEFT Arrow Button**



Push and release the LEFT arrow button to access the information screens or sub-menu screens of a main menu item.

- **OK Button**

Push the OK button to access/select the information screens or sub-menu screens of a main menu item. Push and hold the OK arrow button for one second to reset displayed/selected features that can be reset.

## Oil Change Reset

### Oil Change Due

Your vehicle is equipped with an engine oil change indicator system. The “Oil Change Due” message will display in the EVIC for five seconds after a single chime has sounded to indicate the next scheduled oil change interval. The engine oil change indicator system is duty

cycle based, which means the engine oil change interval may fluctuate, dependent upon your personal driving style.

Unless reset, this message will continue to display each time the ignition is cycled to the ON/RUN position. To turn off the message temporarily, push and release the **OK** button. To reset the oil change indicator system (after performing the scheduled maintenance), refer to the following procedure.

1. Without pushing the brake pedal, push the ENGINE START/STOP button and cycle the ignition to the ON/RUN position (do not start the engine).
2. Fully push the accelerator pedal, slowly, three times within 10 seconds.
3. Without pushing the brake pedal, push the ENGINE START/STOP button once to return the ignition to the OFF/LOCK position.

### Secondary Method Of Navigating To The Oil Life Screen In The DID And Holding OK

1. Without pushing the brake pedal, push the ENGINE START/STOP button and cycle the ignition to the ON/RUN position (do not start the engine).
2. Push and release the **DOWN** arrow button to scroll downward through the main menu to “Vehicle Info.”
3. Push and release the **RIGHT** arrow button to access the “Oil Life” screen.
4. Push and hold the **OK** button to reset of the Oil Life.
5. Push and release the **UP** arrow button to exit the screen.

**NOTE:** If the indicator message illuminates when you start the vehicle, the oil change indicator system did not reset. If necessary, repeat this procedure.

### Instrument Cluster Messages For (EVIC) And (DID)

- Front Seatbelts Unbuckled
- Driver Seatbelt Unbuckled
- Passenger Seatbelt Unbuckled
- Service Airbag System
- Traction Control Off
- Washer Fluid Low
- Oil Pressure Low
- Oil Change Due
- Fuel Low
- Service Antilock Brake System
- Service Electronic Throttle Control

- Service Power Steering
- Cruise Off
- Cruise Ready
- Cruise Set To XXX MPH
- Cruise Set To XXX KM/H
- Tire Pressure Screen With Low Tire(s) “Inflate Tire to XX”
- Service Tire Pressure System
- Parking Brake Engaged
- Brake Fluid Low
- Service Electronic Braking System
- Engine Temperature Hot
- Battery Voltage Low
- Service Electronic Throttle Control
- Lights On
- Right Turn Signal Light Out
- Left Turn Signal Light Out
- Turn Signal On
- Vehicle Not in Park
- Key in Ignition
- Key in Ignition Lights On
- Remote Start Active Key to Run
- Remote Start Active Push Start Button
- Remote Start Aborted Fuel Low
- Remote Start Aborted Too Cold
- Remote Start Aborted Door Open

- Remote Start Aborted Hood Open
- Remote Start Aborted Trunk Open
- Remote Start Aborted Time Expired
- Remote Start Disabled Start to Reset
- Service Airbag System
- Service Airbag Warning Light
- Door Open
- Doors Open
- Gear Not Available
- Shift Not Allowed
- Shift to Neutral then Drive or Reverse
- Transmission Getting Hot Push Brake
- Trans. Hot Stop Safely Shift to Park Wait to Cool

- Service Transmission
- Service Shifter
- Engage Park Brake to Prevent Rolling
- Washer Fluid Low

The Reconfigurable Telltales section is divided into the white telltales area on the right, amber telltales in the middle, and red telltales on the left.

### **DID Selectable Menu Items**

Push and release the **UP** or **DOWN** arrow buttons until the desired Selectable Menu icon/title is highlighted in the DID.

### **Speedometer**

Push and release the **UP** or **DOWN** arrow button until the Speedometer Menu displays in the EVIC/DID. Push

and release the **RIGHT** arrow button to toggle between km/h and MPH and push the **OK** button to select your speedometer display.

### Vehicle Info

Push and release the **UP** or **DOWN** arrow button until the Vehicle Info icon is highlighted in the EVIC/DID. Push and release the **RIGHT** arrow button and Coolant Temp will be displayed. Push the **LEFT** or **RIGHT** arrow button to scroll through the information sub-menus and push the **OK** button to select or reset the following resettable sub-menus:

### Tire Pressure

Push and release the **UP** or **DOWN** arrow button until "Tire Pressure" is highlighted in the EVIC/DID. Push and release the **RIGHT** arrow button and one of the following will be displayed:

If tire pressure is **OK** for all tires, a vehicle **ICON** is displayed with tire pressure values in each corner of the **ICON**.

If one or more tires have low pressure, "Inflate Tire To XX" is displayed with the vehicle **ICON**, and the tire pressure values in each corner of the **ICON** with the pressure value of the low tire displayed in a different color than the other tire pressure value.

If the Tire Pressure system requires service, "Service Tire Pressure System" is displayed.

Tire PSI is an information only function and cannot be reset. Push and release the **LEFT** arrow button to return to the main menu.

Refer to "Tire Pressure Monitoring System (TPMS)" under "Starting and Operating" for further information.

## Coolant Temperature

## Transmission Temperature – Automatic Transmission Only

## Oil Temperature

## Oil Life

## Battery Voltage

## Adaptive Cruise Control (ACC) Menu — If Equipped

The DID displays the current ACC system settings. The information displayed depends on ACC system status.

Push the ADAPTIVE CRUISE CONTROL (ACC) ON/OFF button (located on the steering wheel) until one of the following displays in the DID:

### Adaptive Cruise Control Off

When ACC is deactivated, the display will read “Adaptive Cruise Control Off.”

## Adaptive Cruise Control Ready

When ACC is activated but the vehicle speed setting has not been selected, the display will read “Adaptive Cruise Control Ready.”

Push the SET + or the SET- button (located on the steering wheel) and the following will display in the DID:

### ACC SET

When ACC is set, the set speed will display in the instrument cluster.

The ACC screen may display once again if any ACC activity occurs, which may include any of the following:

- Distance Setting Change
- System Cancel
- Driver Override
- System Off



- ACC Proximity Warning
- ACC Unavailable Warning
- The DID will return to the last display selected after five seconds of no ACC display activity.

For further information, refer to “Adaptive Cruise Control (ACC) — If Equipped” in “Understanding The Features Of Your Vehicle.”

### LaneSense Menu — If Equipped

The DID displays the current LaneSense system settings. The information displayed depends on LaneSense system status and the conditions that need to be met. For further information, refer to “LaneSense — If Equipped” in “Understanding The Features Of Your Vehicle.”

### Fuel Economy

Push and release the **UP** or **DOWN** arrow button until the Fuel Economy Menu item is highlighted in the DID.

- Two sub menu pages one with Current value displayed and one without the Current Value displayed:
  - Current Fuel Economy (MPG, L/100 km, or km/l)
  - Range To Empty (miles or km)
  - Average Fuel Economy (MPG, L/100 km, or km/l)
  - The Max and Min values will correspond to the particular engine requirements
- Lower end of gauge will be displayed in an amber color and turn green as Fuel Economy improves.
- Hold **OK** to reset average fuel economy information.

### Trip Info

Push and release the **UP** or **DOWN** arrow button until the Trip Menu item is highlighted in the EVIC (Toggle left or right to select Trip A or Trip B). The Trip information will display the following:

- Distance

- Average Fuel Economy
- Elapsed Time

Hold the **OK** button to reset feature information.

### Audio

Push and release the **UP** or **DOWN** arrow button until the Audio Menu displays in the EVIC/DID.

### Stored Messages

Push and release the **UP** or **DOWN** arrow button until the Messages Menu displays in the EVIC/DID. This feature shows the number of stored warning messages. Pushing the **RIGHT** arrow button will allow you to see what the stored messages are.

### Screen Setup

Push and release the **UP** or **DOWN** arrow button until the Screen Setup Menu displays in the EVIC/DID. Push and release the **OK** button to enter the sub-menus. The

Screen Setup feature allows you to change what information is displayed in the instrument cluster as well as the location that information is displayed.

### Screen Setup Driver Selectable Items

#### 1. Upper Left

- None
- Compass
- Outside Temp. (Default)
- Time
- Range
- Average Economy L/100km (or MPG)
- Current Economy L/100km (or MPG)

## 2. Upper Right

- None
- Compass
- Outside Temp (Default)
- Time
- Range
- Average Economy L/100km (or MPG)
- Current Economy L/100km (or MPG)

**NOTE:** Defaults will change to Average Economy L/100km (or MPG) UR, Range UL if the proxies for Compass and Outside Temp are not available

## 3. Center

- None
- Compass

- Outside Temp
  - Time
  - Range
  - Average L/100km (or MPG)
  - Current L/100km (or MPG)
  - Trip A Distance
  - Trip B Distance
  - Audio Information
  - Menu Title (Default )
  - Digital Speedo
- ## 4. Current Gear
- On
  - Off (default)

## 5. Odometer

- On (Default)
- Off

## 6. Fuel Gauge

- Standard (Default)
- Range

## 7. Defaults

- Restore
- Cancel

## CYBERSECURITY

Your vehicle may be a connected vehicle and may be equipped with both wired and wireless networks. These networks allow your vehicle to send and receive information. This information allows systems and features in your vehicle to function properly.

Your vehicle may be equipped with certain security features to reduce the risk of unauthorized and unlawful access to vehicle systems and wireless communications. Vehicle software technology continues to evolve over time and FCA US LLC, working with its suppliers, evaluates and takes appropriate steps as needed. Similar to a computer or other devices, your vehicle may require software updates to improve the usability and performance of your systems or to reduce the potential risk of unauthorized and unlawful access to your vehicle systems.

The risk of unauthorized and unlawful access to your vehicle systems may still exist, even if the most recent version of vehicle software (such as Uconnect software) is installed.

### WARNING!

- It is not possible to know or to predict all of the possible outcomes if your vehicle's systems are breached. It may be possible that vehicle systems, including safety related systems, could be impaired or a loss of vehicle control could occur that may result in an accident involving serious injury or death.
- **ONLY** insert media (e.g., USB, SD card, or CD) into your vehicle if it came from a trusted source. Media of unknown origin could possibly contain malicious software, and if installed in your vehicle, it

*(Continued)*



### WARNING! *(Continued)*

- **may increase the possibility for vehicle systems to be breached.**
- **As always, if you experience unusual vehicle behavior, take your vehicle to your nearest authorized dealer immediately.**

### NOTE:

- FCA or your dealer may contact you directly regarding software updates.
- To help further improve vehicle security and minimize the potential risk of a security breach, vehicle owners should:
  - Routinely check [www.driveuconnect.com/software-update](http://www.driveuconnect.com/software-update) to learn about available Uconnect software updates.
  - Only connect and use trusted media devices (e.g. personal mobile phones, USBs, CDs).

Privacy of any wireless and wired communications cannot be assured. Third parties may unlawfully intercept information and private communications without your consent. For further information, refer to “Privacy Practices” in “All About Uconnect Access” in your Owner’s Manual Radio Supplement and “Onboard Diagnostic System (OBD II) Cybersecurity” in “Maintaining Your Vehicle” in your Owner’s Manual on the DVD.

### UCONNECT SETTINGS

The Uconnect system uses a combination of buttons on the touchscreen and buttons on the faceplate located on the center of the instrument panel that allows you to access and change the customer programmable features.

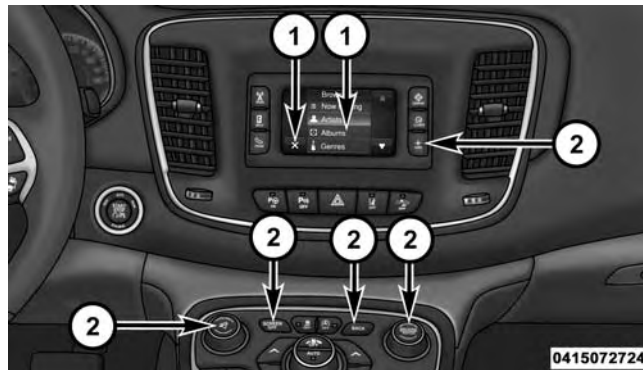

**Uconnect 5.0 Buttons On Touchscreen And Buttons On Faceplate**

- 1 — Uconnect Buttons On The Touchscreen
- 2 — Uconnect Buttons On The Faceplate

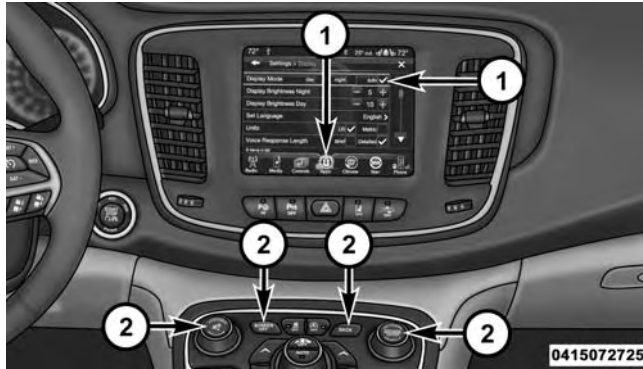

### Uconnect 8.4 Buttons On Touchscreen And Buttons On Faceplate

- 1 — Uconnect Buttons On The Touchscreen  
 2 — Uconnect Buttons On The Faceplate

### Buttons On The Faceplate

Buttons are located below the Uconnect system in the center of the instrument panel. In addition, there is a Scroll/Enter control knob located on the right side of the Climate Controls in the center of the instrument panel. Turn the control knob to scroll through menus and change settings (i.e. 30, 60, 90) push the center of the control knob one or more times to select or change a setting (i.e. ON, OFF).

Your Uconnect system may also have a Screen Off and Back buttons located below the system.

Push the Screen Off button to turn off the Uconnect screen. Push the Screen Off button a second time to turn the screen on.

Push the Back button to exit out of a Menu or certain option on the Uconnect system.

## Buttons On The Touchscreen

Buttons on the touchscreen are accessible on the Uconnect display.

### Customer Programmable Features/Personal Settings — Uconnect 5.0/8.4A/8.4AN Settings

Uconnect 5.0 — If a SETTINGS button on the faceplate exists, push this button. If not, push the MORE button on the faceplate and press the "Settings" button on the touchscreen. The remaining settings are defined for the Uconnect 8.4A/8.4AN — Press the "Apps" button on the touchscreen, then press the "Settings" button on the touchscreen to display the menu setting screen. In this mode the Uconnect system allows you to access programmable features that may be equipped such as Display, Voice, Clock, Safety & Driving Assistance (if equipped), Lights, Doors & Locks, Auto-On Comfort (if

equipped), Engine Off Options, Audio, Phone/Bluetooth, SiriusXM Setup, Restore Settings, Clear Personal Data (if equipped).

**NOTE:** Only one category may be selected at a time.

To adjust the setting of a programmable feature, press the desired setting option. Once in the desired setting option, press and release the preferred setting until a check-mark appears next to the setting, showing that the setting has been selected. Once the setting is complete, either press the back arrow button on the touchscreen or the Back button on the faceplate to return to the previous menu or press the "X" button on the touchscreen to close out of the settings screen. Pressing the Up or Down Arrow buttons on the right side of the screen will allow you to toggle up or down through the list of available settings.



## Display

After pressing the “Display” button on the touchscreen the following settings will be available:

- *Display Mode*

This feature allows you to select one of the auto display settings. To change Mode status, press and release the Auto or Manual button on the touchscreen.

- *Display Brightness With Headlights On*

This feature allows you to select the display brightness when the headlights are on. Adjust the brightness with the + and – setting buttons on the touchscreen.

- *Display Brightness With the Headlights Off*

This feature allows you to select the display brightness when the headlights are off. Adjust the brightness with the + and – setting buttons on the touchscreen.

- *Set Language*

This feature allows you to select one of the languages for all display nomenclature, including the trip functions and the navigation system (if equipped). Press the “Set Language” button on the touchscreen and then press the desired language button on the touchscreen until a check-mark appears next to the language, showing that setting has been selected.

- *Units*

This feature allows you to select US or Metric units of measure in the EVIC/DID, odometer, and navigation system (if equipped). Press “US” or “Metric” until a check-mark appears next to the setting, showing that setting has been selected.

- *Touchscreen Beep*

This feature allows you to turn on or shut off the sound heard when a touchscreen button is pressed. Press the

“Touchscreen Beep” button on the touchscreen until a check-mark appears next to the setting, showing that setting has been selected.

- *Navigation Turn-By-Turn In Cluster — If Equipped*

When this feature is selected, the turn-by-turn directions will appear in the driver screen/EVIC/DID/Cluster display as the vehicle approaches a designated turn within a programmed route. To turn on or enable, press the “Navigation Turn-By-Turn In Cluster” button on the touchscreen, until a check-mark appears next to the setting, showing that setting has been selected.

- *Voice*

This feature allows you to change the Voice Response Length settings. To change the Voice Response Length, press the “Brief” (Brief is a shortened response for advanced users) or “Detailed” (Detailed provides more comprehensive responses for new users) button on the

touchscreen until a check-mark appears next to the setting, showing that setting has been selected.

### **Clock**

After pressing the “Clock” button on the touchscreen the following settings will be available:

- *Sync Time With GPS*

This feature allows you to automatically have the radio set the time. To change the Sync Time setting, press the “Sync with GPS Time” button on the touchscreen until a check-mark appears next to the setting, showing that setting has been selected.

- *Set Time Hours*

This feature allows you to adjust the hours. The “Sync with GPS Time” button on the touchscreen must be unchecked. To make your selection, press the “+” or “-” buttons on the touchscreen to adjust the hours up or down.

- *Set Time Minutes*

This feature allows you to adjust the minutes. The “Sync with GPS Time” button on the touchscreen must be unchecked. To make your selection, press the “+” or “-” buttons on the touchscreen to adjust the minutes up or down.

- *Time Format*

This feature allows you to select the time format display setting. Press the “Time Format” button on the touchscreen until a check-mark appears next to the 12hrs or 24hrs setting, showing that setting has been selected.

- *Show Time In Status Bar — If Equipped*

This feature allows you to choose to show the time in the Status bar. To change the Time in Status Bar setting, press the “Show Time in Status Bar” button on the touchscreen until a check-mark appears next to the setting, showing that setting has been selected.

## Safety & Driving Assistance

After pressing the “Safety & Driving Assistance” button on the touchscreen the following settings will be available:

- *Forward Collision Warning (FCW) Sensitivity — If Equipped*

The Forward Collision Warning (FCW) feature can be set to Far, or set to Near. The default status of FCW is the Far setting. This means the system will warn you of a possible collision with the vehicle in front of you when you are farther away. This gives you the most reaction time. To change the setting for a more dynamic driving experience, select the Near setting. This warns you of a possible collision when you are much closer to the vehicle in front of you. To change the FCW status, press and release the “Near” or “Far” button.

For further information, refer to “Adaptive Cruise Control (ACC)” in “Understanding The Features Of Your Vehicle”.

• ***Forward Collision Warning (FCW) Active Braking — If Equipped***

The FCW system includes Advanced Brake Assist (ABA). When this feature is selected, it will apply the brakes to slow your vehicle in case of potential forward collision. The ABA applies additional brake pressure when the driver requests insufficient brake pressure to avoid a potential frontal collision. The ABA system becomes active at 5 mph (8 km/h) and is only enabled when FCW is on.

For further information, refer to “Forward Collision Warning (FCW) With Mitigation” in “Understanding The Features Of Your Vehicle”.

• ***LaneSense Warning — If Equipped***

When this feature is selected, it sets the distance at which the steering wheel will provide feedback for potential lane departures. The LaneSense Warning can be set to provide either an “early”, “medium” or “late” warning zone start point.

For further information, refer to “Lane Departure Warning (LDW)” in “Understanding The Features Of Your Vehicle”.

• ***LaneSense Strength — If Equipped***

When this feature is selected, it sets the strength of the steering wheel feedback for potential lane departures. The amount of directional torque the steering system can apply to the steering wheel to correct for vehicle lane departure can be set at “Low,” “Medium” or “High.”

For further information, refer to “Lane Departure Warning (LDW)” in “Understanding The Features Of Your Vehicle”.

- ***ParkSense — If Equipped***

The ParkSense system will scan for objects behind the vehicle when the transmission shift lever is in REVERSE and the vehicle speed is less than 11 mph (18 km/h). The system can be enabled with Sound Only, or Sound and Display. To change the ParkSense status, press and release the checkbox for “Sound” or “Sound and Display.”

Refer to “ParkSense” in “Understanding The Features Of Your Vehicle” for system function and operating information.

- ***Front ParkSense Volume — If Equipped***

Front ParkSense volume settings can be selected from the EVIC/DID or Uconnect System (if equipped). The chime

volume settings include “LOW,” “MEDIUM,” and “HIGH.” The factory default volume setting is MEDIUM.

- ***Rear ParkSense Volume — If Equipped***

Rear ParkSense volume settings can be selected from the EVIC/DID or Uconnect System (if equipped). The chime volume settings include “LOW,” “MEDIUM,” and “HIGH.” The factory default volume setting is MEDIUM.

- ***Rear ParkSense Braking Assist — If Equipped***

When this feature is selected, the ParkSense system will detect objects located behind the vehicle and utilize autonomous braking to help stop the vehicle (only enabled when ParkSense is also on).

Refer to “ParkSense Rear Braking Assist” in “Understanding The Features Of Your Vehicle” for system function and operating information.

- *Tilt Mirrors In Reverse — If Equipped*

When this feature is selected, the outside sideview mirrors will tilt downward when the ignition is in the RUN position and the transmission shift lever is in the REVERSE position. The mirrors will move back to their previous position when the transmission is shifted out of REVERSE. To enable or turn on, press the “Tilt Mirrors In Reverse” button on the touchscreen, until a check-mark appears next to setting, showing that setting has been selected.

- *Blind Spot Alert — If Equipped*

When this feature is selected, the Blind Spot Alert feature can be set to Off, Lights Only or Lights and Chime. The Blind Spot Alert feature can be activated in Lights category. When this category is selected, the Blind Spot Monitor (BSM) system is activated and will only show a visual alert in the outside mirrors. When Lights & Chime category is activated, the Blind Spot Monitor (BSM) will

show a visual alert in the outside mirrors as well as an audible alert when the turn signal is on. When Off is selected, the Blind Spot Monitor (BSM) system is deactivated. To change the Blind Spot Alert status, press the “Off,” “Lights” or “Lights & Chime” button on the touchscreen.

**NOTE:** If your vehicle has experienced any damage in the area where the sensor is located, even if the fascia is not damaged, the sensor may have become misaligned. Take your vehicle to an authorized dealer to verify sensor alignment. Having a sensor that is misaligned will result in the BSM not operating to specification.

- *ParkView Backup Camera Active Guidelines — If Equipped*

When this feature is enabled, active (dynamic) grid lines are overlaid on the Rear Backup Camera image to illustrate the width of the vehicle and its projected back up path based on the steering wheel position. A dashed

center line overlay indicates the center of the vehicle to assist with parking or aligning to a hitch/receiver.

- *ParkView Backup Camera Fixed Guidelines — If Equipped*

When this feature is enabled, fixed (static) grid lines are overlaid on the Rear Backup Camera image to illustrate the width of the vehicle.

- *ParkView Backup Camera Delay*

When this feature is enabled, it will allow the ParkView Backup Camera display to remain on while in drive for up to 10 seconds, or 8 mph (13 km/h).

- *Rain Sensing Auto Wipers*

When this feature is selected, the system will automatically activate the windshield wipers if it senses moisture on the windshield and the wipers are set to an intermittent position. To make your selection, press the “Rain

Sensing” button on the touchscreen, until a check-mark appears next to the setting, showing that setting has been selected.

- *Electric Park Brake Service Mode — If Equipped*

This feature provides a means for a technician or vehicle owner to utilize a vehicle integrated, menu driven system, to command the electric park brake retraction, to service the rear foundation brakes (brake pads, calipers, rotors, etc.).

For further information, refer to “Electric Parking Brake (EPD)” in “Starting and Operating.”

- *Auto Park Brake*

Auto Park Brake will set the park brake once the vehicle is set in park (or at key off for a manual transmission)

- *Hill Start Assist*

This setting will hold the brake if the driver is on a hill and takes their foot off the brake to accelerate.

## Lights

After pressing the “Lights” button on the touchscreen the following settings will be available.

- *Headlights Off Delay*

When this feature is selected, it allows the adjustment of the amount of time the headlights remain on after the engine is shut off. To change the Headlights Off Delay setting, press the “Headlights Off Delay” button on the touchscreen, and choose either 0 sec, 30 sec, 60 sec or 90 seconds. A check-mark appears next to setting indicating that the setting has been selected.

- *Headlight Illumination On Approach*

When this feature is selected, the headlights will activate and remain on for 0, 30, 60, or 90 seconds when the doors are unlocked with the Remote Keyless Entry (RKE) transmitter. To change the Illuminated Approach status, press the + or - button on the touchscreen to select your desired time interval.

- *Headlights With Wipers — If Equipped*

When this feature is selected, and the headlight switch is in the AUTO position, the headlights will turn on approximately 10 seconds after the wipers are turned on. The headlights will also turn off when the wipers are turned off if they were turned on by this feature. To make your selection, press the “Headlights With Wipers” button on the touchscreen, until a check-mark appears next to setting, indicating that the setting has been selected.



- *Auto Dim High Beams — If Equipped*

When this feature is selected, the high beam headlights will activate/deactivate automatically under certain conditions. To make your selection, press the “Auto High Beams” button on the touchscreen, until a check-mark appears next to setting, indicating that the setting has been selected. Refer to “Lights — If Equipped” in “Understanding The Features Of Your Vehicle” for further information.

- *Daytime Running Lights — If Equipped*

When this feature is selected, the headlights will turn on whenever the engine is running. To make your selection, press the Daytime Running Lights button on the touchscreen, until a check-mark appears next to setting, indicating that the setting has been selected.

- *Flash Lights With Lock*

When this feature is selected, the hazard lights will flash when the doors are locked or unlocked with the Remote Keyless Entry (RKE) transmitter, or when using the passive entry feature. This feature may be selected with or without the sound horn on lock feature selected. To make your selection, press the “Flash Lights with Lock” button on the touchscreen, until a check-mark appears next to setting, indicating that the setting has been selected.

## Doors & Locks

After pressing the “Doors & Locks” button on the touchscreen the following settings will be available:

- *Auto Door Locks*

The Auto Door Lock feature can be enabled, or disabled, by your authorized dealer. Please visit your local authorized dealer for further information.

- *Auto Unlock On Exit*

When this feature is selected, all doors will unlock when the vehicle is stopped and the transmission is in the PARK or NEUTRAL position and the driver's door is opened. To make your selection, press the "Auto Unlock On Exit" button on the touchscreen, until a check-mark appears next to setting, showing that setting has been selected.

- *Flash Lights With Lock*

When this feature is selected, the exterior lights will flash when the doors are locked or unlocked with the Remote Keyless Entry (RKE) transmitter, or when using the passive entry feature. This feature may be selected with or without the sound horn on lock feature selected. To make your selection, press the "Flash Lights with Lock" button on the touchscreen, until a check-mark appears next to setting, indicating that the setting has been selected.

- *Sound Horn With Remote*

When this feature is selected, the horn will sound when the door locks are activated via the key fob. To make your selection, press either the "Off," "1st Press," or "2nd Press" button on the touchscreen, until a check-mark appears next to setting, showing that setting has been selected.

- *Sound Horn With Remote Start*

When this feature is selected, the horn will sound when the remote start is activated. To make your selection, press the "Sound Horn With Remote Start" button on the touchscreen, until a check-mark appears next to setting, showing that setting has been selected. Select one of three options to sound the horn, Off, 1st Press, or 2nd Press.

- *1st Press Of Key Fob Unlocks*

When "Driver Door" is selected with 1st Press Of Key Fob Unlocks, only the driver's door will unlock with the first

press of the Remote Keyless Entry (RKE) transmitter UNLOCK button. You must press the RKE transmitter UNLOCK button twice to unlock the passenger's doors. When "All Doors" is selected for 1st Press Of Key Fob Unlocks, all doors will unlock on the first press of the RKE transmitter UNLOCK button.

**NOTE:** If the vehicle is programmed 1st Press Of Key Fob Unlocks "All Doors," all doors will unlock no matter which Passive Entry equipped door handle is grasped. If 1st Press Of Key Fob Unlocks "Driver Door" is programmed, only the driver's door will unlock when the driver's door is grasped. With Passive Entry, if 1st Press Of Key Fob Unlocks "Driver Door" is programmed, touching the handle more than once will only result in the driver's door opening. If "Driver Door" is selected, once the driver door is opened, the interior door lock/unlock switch can be used to unlock all doors (or use RKE transmitter).

- *Passive Entry — If Equipped*

This feature allows you to lock and unlock the vehicles door(s) without having to press the Remote Keyless Entry (RKE) transmitter lock or unlock buttons. To make your selection, press the "Passive Entry" button on the touchscreen, until a check-mark appears next to setting, showing that setting has been selected. Refer to "Keyless Enter-N-Go" in "Things To Know Before Starting Your Vehicle".

- *Personal Settings Linked to Key Fob On/Off — If Equipped*

This feature provides automatic driver seat positioning to enhance driver mobility when entering and exiting the vehicle. To make your selection, press the "Memory Linked To FOB" button on the touchscreen, until a check-mark appears next to setting, showing that setting has been selected.

**NOTE:** The seat will return to the memorized seat location (if Recall Memory with Remote Key Unlock is set to ON) when the Remote Keyless Entry (RKE) transmitter is used to unlock the door. Refer to “Driver Memory Seat” in “Understanding The Features Of Your Vehicle” for further information.

### Auto-On Comfort — If Equipped

After pressing the “Auto-On Comfort” button on the touchscreen, one of the following settings will be available:

- *Auto-On Driver Heated Seat OR Auto-On Driver Heated Seat & Steering wheel OR Auto-On Driver Heated/Vented Seat OR Auto-On Driver Heated/Vented Seat & Steering Wheel*

When this feature is selected the driver’s heated/vented seat and heated steering wheel will automatically turn on when temperatures are below 40° F (4.4° C). When

temperatures are above 80° F (26.7° C) the driver vented seat will turn on. To make your selection, press “Off,” “Remote Start Only,” OR “All Starts” checkbox until a check-mark appears next to the setting option. Select “Off,” “Remote Start Only” OR “All Starts” to determine when the feature is activated.

### Engine Off Options

After pressing the “Engine Off Options” button on the touchscreen the following settings will be available:

- *Easy Exit Seat*

This feature provides automatic driver seat positioning to enhance driver mobility when entering and exiting the vehicle. To make your selection, press the “Easy Exit Seats” button on the touchscreen, until a check-mark appears next to setting, showing that setting has been selected.

- *Engine Off Power Delay*

When this feature is selected, the power window switches, radio, Uconnect Phone system (if equipped), DVD video system (if equipped), power sunroof (if equipped), and power outlets will remain active for up to 10 minutes after the ignition is cycled to OFF. Opening either front door will cancel this feature. To change the Engine Off Power Delay status, press the “0 seconds,” “45 seconds,” “5 minutes” or “10 minutes” button on the touchscreen.

- *Headlight Off Delay*

When this feature is selected, it allows the adjustment of the amount of time the headlights remain on after the engine is shut off. To change the Headlights Off Delay setting, press the “Headlights Off Delay” button on the touchscreen, and choose either 0 sec, 30 sec, 60 sec or 90 seconds. A check-mark appears next to setting indicating that the setting has been selected.

## Audio

After pressing the “Audio” button on the touchscreen the following settings will be available.

- *Balance/Fade*

This feature allows you to adjust the Balance and Fade settings. Press and drag the ‘C’ icon, use the arrows to adjust, or tap the ‘C’ icon to readjust to the center.

- *Equalizer*

This feature allows you to adjust the Bass, Mid and Treble settings. Adjust the settings with the + and – setting buttons on the touchscreen or by selecting any point on the scale between the “+” and “–” buttons on the touchscreen.

**NOTE:** Bass/Mid/Treble allow you to simply slide your finger up or down to change the setting as well as press directly on the desired setting.

- *Speed Adjusted Volume*

This feature increases or decreases volume relative to vehicle speed. To change the Speed Adjusted Volume press the “Off,” “1,” “2” or “3” button on the touchscreen.

- *Surround Sound — If Equipped*

This feature provides simulated surround sound mode. To make your selection, press the “Surround Sound” button on the touchscreen, select “On” or “Off”.

- *AUX Volume Match*

This feature provides the ability to tune the audio level for portable devices connected through the AUX input. To make your selection, press the AUX Volume Match button on the touchscreen, choose a level from -3 to +3.

### **Phone/Bluetooth**

After pressing the “Phone/Bluetooth” button on the touchscreen the following settings will be available:

- *Paired Phones*

This feature shows which phones are paired to the Phone/Bluetooth system. For further information, refer to the Uconnect Supplement Manual.

- *Paired Audio Sources*

This feature shows which audio devices are paired to the Phone/Bluetooth system. For further information, refer to the Uconnect Supplement Manual.

### **SiriusXM Setup**

After pressing the SIRIUS Setup button on the touchscreen the following settings will be available.

- *Channel Skip*

SiriusXM can be programmed to designate a group of channels that are the most desirable to listen to, or to exclude undesirable channels while scanning. To make

your selection, press the Channel Skip button on the touchscreen, select the channels you would like to skip.

- *Subscription Information*

New vehicle purchasers or lessees will receive a free limited time subscription to SiriusXM Satellite Radio with your radio. Following the expiration of the free services, it will be necessary to access the information on the Subscription Information screen in order to re-subscribe.

Press the Subscription Info button on the touchscreen to access the Subscription Information screen.

Write down the SIRIUS ID numbers for your receiver. To reactivate your service, either call the number listed on the screen or visit the provider online.

**NOTE:** SiriusXM Travel Link is a separate subscription and is available for U.S. residents only.

## Restore Settings

After pressing the “Restore Settings” button on the touchscreen the following settings will be available:

- *Restore Settings*

When this feature is selected it will reset the Display, Clock, Audio, and Radio Settings to their default settings. To restore the settings to their default setting, press the Restore Settings button. A pop-up will appear asking “Are you sure you want to reset your settings to default?” select Yes to restore, or Cancel to exit. Once the settings are restored, a pop up appears stating “settings reset to default.” Press the okay button on the touchscreen to exit.

## Clear Personal Data

After pressing the “Clear Personal Data Settings” button on the touchscreen the following settings will be available:

- *Clear Personal Data*

When this feature is selected it will remove personal data including Bluetooth devices and presets. To Clear Personal Data press the “Yes” or “No” button on the touchscreen. A check mark will appear in the box when selected.

## UCONNECT RADIOS — IF EQUIPPED

For detailed information about your Uconnect radio, refer to your Uconnect Supplement Manual.

## USB PORT AND AUX JACK — IF EQUIPPED

Located in the front storage area of the center console, this feature allows an external device, to be connected to the audio system.

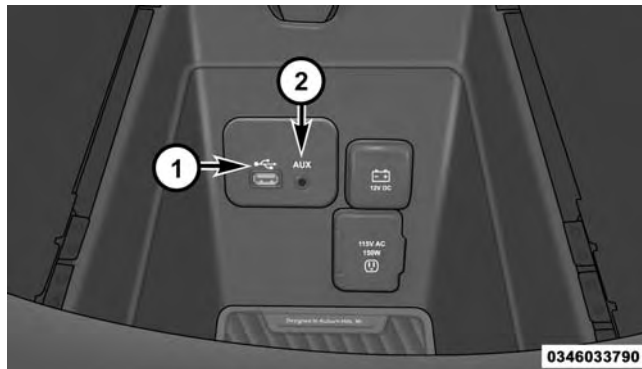

**USB Port and AUX Jack**

- 1 — USB Port  
2 — AUX Jack

For further information, refer to the Uconnect User’s Manual.



## STEERING WHEEL AUDIO CONTROLS — IF EQUIPPED

The remote sound system controls are located on the rear surface of the steering wheel. Reach behind the wheel to access the switches.



0456001002

Remote Sound System Controls (Back View Of Steering Wheel)

The right-hand control is a rocker-type switch with a pushbutton in the center and controls the volume and mode of the sound system. Pushing the top of the rocker switch will increase the volume, and pushing the bottom of the rocker switch will decrease the volume.

Pushing the center button will make the radio switch between the various audio modes available (AM/FM/SXM/AUX, etc.).

The left-hand control is a rocker-type switch with a pushbutton in the center. The function of the left-hand control is different depending on which audio mode you are in.

The following describes the left-hand control operation while in mode.

## Radio Operation

Pushing the top of the switch will “Seek” up for the next listenable station and pushing the bottom of the switch will “Seek” down for the next listenable station.

The button located in the center of the left-hand control will tune to the next preset station that you have programmed in the radio preset button.

## Media Mode

Pushing the top of the switch once will go to the next track on the selected media (Disc, AUX, Bluetooth). Pushing the bottom of the switch once will go to the beginning of the current track, or to the beginning of the previous track if it is within eight seconds after the current track begins to play.

If you push the switch up or down twice, it plays the second track; three times, it will play the third, etc.

## RADIO OPERATION AND MOBILE DEVICES

Under certain conditions, the mobile device being on in your vehicle can cause erratic or noisy performance from your radio. This condition may be lessened or eliminated by relocating the mobile device antenna. This condition is not harmful to the radio. If your radio performance does not satisfactorily “clear” by the repositioning of the antenna, it is recommended that the radio volume be turned down or off during mobile device operation when not using Uconnect (if equipped).

## Regulatory And Safety Information

### USA/CANADA

#### Exposure to Radio Frequency Radiation

The radiated output power of the internal wireless radio is far below the FCC radio frequency exposure limits.

Nevertheless, the wireless radio will be used in such a manner that the radio is 20 cm or further from the human body.

The internal wireless radio operates within guidelines found in radio frequency safety standards and recommendations, which reflect the consensus of the scientific community.

The radio manufacturer believes the internal wireless radio is safe for use by consumers. The level of energy emitted is far less than the electromagnetic energy emitted by wireless devices such as mobile phones. However, the use of wireless radios may be restricted in some situations or environments, such as aboard airplanes. If you are unsure of restrictions, you are encouraged to ask for authorization before turning on the wireless radio.

This device complies with Part 15 of the FCC Rules and with Industry Canada license-exempt RSS standard(s). Operation is subject to the following two conditions:

1. This device may not cause harmful interference.
2. This device must accept any interference received, including interference that may cause undesired operation.

**NOTE:**

- This equipment has been tested and found to comply with the limits for a Class B digital device, pursuant to Part 15 of the FCC Rules. These limits are designed to provide reasonable protection against harmful interference in a residential installation. This equipment generates, uses and can radiate radio frequency energy and, if not installed and used in accordance with the instructions, may cause harmful interference to radio communications. However, there is no guarantee that interference will not occur in a particular installation.
- If this equipment does cause harmful interference to radio or television reception, which can be determined by turning the equipment off and on, the user is encouraged to try to correct the interference by one or more of the following measures:
- Increase the separation between the equipment and receiver.

- Consult the dealer or an experienced radio technician for help.

**CLIMATE CONTROLS**

The air conditioning and heating system is designed to make you comfortable in all types of weather. This system can be operated through either the controls on the instrument panel or through the Uconnect system display.

When the Uconnect system is in different modes (Radio, Player, Settings, More, etc.) the driver and passenger temperature settings will be indicated at the top of the display.

**Manual Climate Controls**

The controls for the manual heating and air conditioning system in this vehicle consist of a series of outer rotary dials and inner push knobs. These comfort controls can be set to obtain desired interior conditions.

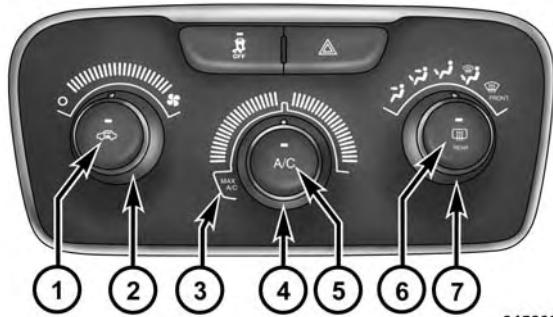

0456028368

### Manual Climate Controls

- |                                |                            |
|--------------------------------|----------------------------|
| 1 — RECIRCULATION Control      | 5 — Air Conditioning (A/C) |
| 2 — Front Blower Control       | 6 — REAR DEFROST Mode      |
| 3 — MAX Air Conditioning (A/C) | 7 — MODE Control           |
| 4 — Temperature Control        |                            |

### Front Blower Control



There are seven blower speeds. Use this control to regulate the amount of air forced through the system in any mode you select. The blower speed increases as you move the control clockwise from the OFF position.

4

### Temperature Control



Use this control to regulate the temperature of the air inside the passenger compartment. Rotating the knob counterclockwise, from top center into the blue area of the scale, indicates cooler temperatures. Rotating the knob clockwise, into the red area, indicates warmer temperatures.

## Air Conditioning Operation

Push the A/C button to engage the Air Conditioning (A/C). An LED will illuminate when the A/C system is operating.

### MAX A/C

For maximum cooling, when MAX A/C is selected the A/C is turned on automatically and the air is recirculated. A/C cannot be deselected when in MAX A/C position. The LED will blink three times if the A/C button is pushed.

**NOTE:** If your air conditioning performance seems lower than expected, check the front of the A/C condenser (located in front of the radiator), for an accumulation of dirt or insects. Clean with a gentle water spray from behind the radiator and through the condenser. Fabric front fascia protectors may reduce airflow to the condenser, reducing air conditioning performance.

## Mode Control (Air Direction)



Mode control allows you to choose from several patterns of air distribution. You can select either a primary mode, as identified by the symbols, or a blend of two of these modes. The closer the control is to a particular mode, the more air distribution you

receive from that mode.

### Panel Mode



Air is directed through the outlets in the instrument panel. These outlets can be adjusted to direct airflow.

**NOTE:** For maximum airflow to the rear, the center instrument panel outlets can be directed toward the rear seat passengers.

## Bi-Level Mode

 Air is directed through the panel and floor outlets.

**NOTE:** There is a difference in temperature (in any conditions other than full cold or full hot), between the upper and lower outlets for added comfort. The warmer air goes to the floor outlets. This feature gives improved comfort during sunny but cool conditions.

## Floor Mode

 Air is directed through the floor outlets with a small amount through the defrost and side window demist outlets.

## Mix Mode

 Air is directed through the floor, defrost and side window demist outlets. This setting works best in cold or snowy conditions that require extra heat at the windshield. This setting is good for maintaining comfort, while reducing moisture on the windshield.

## Defrost Mode

 Air is directed through the windshield and side window demist outlets. Use the DEFROST mode with maximum blower and warm temperature settings for best windshield and side window defrosting.

**NOTE:** The air conditioning compressor operates in MIX and DEFROST, or a blend of these modes even if the A/C button is not pushed. This dehumidifies the air to help dry the windshield. To improve fuel economy, use these modes only when necessary.

## Recirculation Control

Push this button to choose between outside air intake or recirculation of the air inside the vehicle. A LED will illuminate when you are in Recirculation mode. Only use the Recirculation mode to temporarily block out any outside odors, smoke, or dust, and to cool the interior rapidly upon initial start-up in very hot or humid weather.

### NOTE:

- If the RECIRCULATION  button is pushed when the system is in Defrost mode the Recirculation LED indicator will flash three times and then turn off to indicate Recirculation mode is not allowed.
- Continuous use of the Recirculation mode may make the inside air stuffy and window fogging may occur. Extended use of this mode is not recommended.

- In cold or damp weather, the use of the Recirculation mode will cause windows to fog on the inside because of moisture buildup inside the vehicle. For maximum defogging, select the outside air position.
- The A/C can be deselected manually without disturbing the mode control selection by pushing the A/C button.

## Economy Mode

If ECONOMY mode is desired, push the A/C button to turn off the LED indicator and the A/C compressor. Rotate the temperature control knob to the desired temperature. Also, make sure to select only Panel, Bi-Level or Floor modes.



## Manual Climate Controls With Touchscreen — If Equipped

### Buttons On Your Faceplate

The buttons on the faceplate are located below the Uconnect touchscreen.

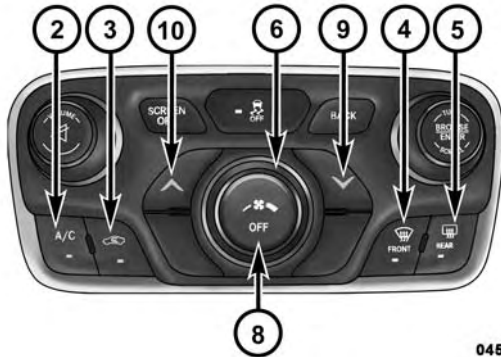

0456027554

Manual Climate Controls — Buttons On The Faceplate

### Buttons On Your Uconnect Touchscreen

Buttons on the touchscreen are accessible on the Uconnect system screen.

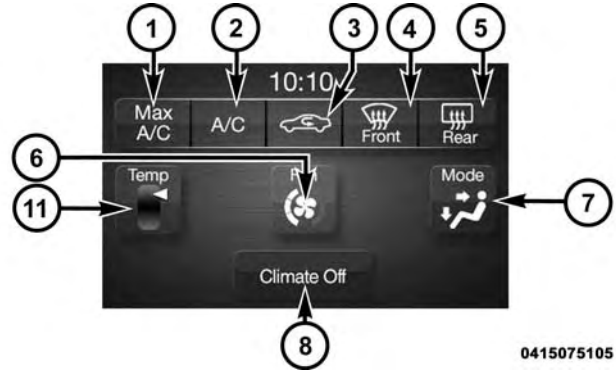

0415075105

Uconnect 5.0 Manual Temperature Controls — Buttons On The Touchscreen

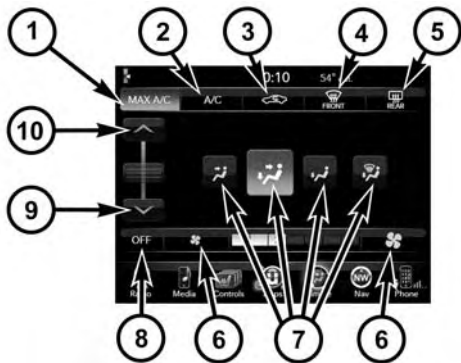

0415075114

### Uconnect 8.4A/8.4AN Manual Temperature Controls — Buttons On The Touchscreen

#### Button Descriptions (Applies To Both The Buttons On Your Faceplate And The Buttons On Your Touchscreen)

##### 1. MAX A/C Button

Press to change the current setting, the indicator illuminates when MAX A/C is ON. Performing this function

again will cause the MAX A/C operation to switch into manual mode and the MAX A/C indicator will turn off.

##### 2. A/C Button

Press to change the current setting, the indicator illuminates when A/C is ON. Performing this function again will cause the A/C operation to switch into manual mode and the A/C indicator will turn off.

##### 3. Recirculation Button

Press to change the current setting, the indicator illuminates when ON.

##### 4. Front Defrost Button

Press to change the current airflow setting to Defrost mode. The indicator illuminates when this feature is ON. Air comes from the windshield and side window demist outlets. When the defrost button is selected, the blower level will increase. Use Defrost mode with maximum

temperature settings for best windshield and side window defrosting and defogging. If the front defrost mode is turned off the climate system will return the previous setting.

### 5. *Rear Defrost Button*

Press this button to turn on the rear window defroster and the heated outside mirrors (if equipped). An indicator will illuminate when the rear window defroster is on. The rear window defroster automatically turns off after 10 minutes. For each additional press of this button, five additional minutes will be added to the timer function.

### CAUTION!

**Failure to follow these cautions can cause damage to the heating elements:**

- Use care when washing the inside of the rear window. Do not use abrasive window cleaners on the interior surface of the window. Use a soft cloth and a mild washing solution, wiping parallel to the heating elements. Labels can be peeled off after soaking with warm water.
- Do not use scrapers, sharp instruments, or abrasive window cleaners on the interior surface of the window.
- Keep all objects a safe distance from the window.

## 6. Blower Control

Blower control is used to regulate the amount of air forced through the climate system. There are seven blower speeds available. Adjusting the blower will cause automatic mode to switch to manual operation. The speeds can be selected using either the blower control knob on the faceplate or buttons on the touchscreens as follows:

### Blower Control Knob On The Faceplate

The blower speed increases as you turn the control clockwise from the lowest blower setting. The blower speed decreases as you turn the blower control knob counterclockwise.

### Buttons On The Touchscreen

Use the small blower icon to reduce the blower setting and the large blower icon to increase the blower setting. Blower can also be selected by pressing the blower bar area between the icons.

## 7. Modes

The airflow distribution mode can be adjusted so air comes from the instrument panel outlets, floor outlets, demist outlets and defrost outlets. The Mode settings are as follows:

- **Panel Mode**



Air comes from the outlets in the instrument panel. Each of these outlets can be individually adjusted to direct the flow of air. The air vanes of the center outlets and outboard outlets can be moved up and down or side to side to regulate airflow direction. There is a shut off wheel located adjacent to the air vanes to shut off or adjust the amount of airflow from these outlets.

- **Bi-Level Mode**



Air comes from the instrument panel outlets and floor outlets. A slight amount of air is directed through the defrost and side window demister outlets.

**NOTE:** BI-LEVEL mode is designed under comfort conditions to provide cooler air out of the panel outlets and warmer air from the floor outlets.

- **Floor Mode**



Air comes from the floor outlets. A slight amount of air is directed through the defrost and side window demister outlets.

- **Mix Mode**



Air comes from the floor, defrost and side window demist outlets. This mode works best in cold or snowy conditions.

**NOTE:** The air conditioning compressor operates in MIX and DEFROST modes even if the A/C button is not pressed. This dehumidifies the air to help dry the windshield. To improve fuel economy, use these modes only when necessary.

### 8. *Climate Control OFF Button*

Press this button to turn the Climate Control ON/OFF.

### 9. *Temperature Control Down Button (Uconnect 8.4)*

Provides temperature control. Press the button on the faceplate for cooler temperature settings or on the touchscreen, press and slide the button on the touchscreen temperature bar towards the blue arrow button on the touchscreen for cooler temperature settings.

### 10. Temperature Control Up Button (Uconnect 8.4)

Provides temperature control. Press the button on the faceplate for warmer temperature settings or on the touchscreen, press and slide the button on the touchscreen temperature bar towards the red arrow button on the touchscreen for warmer temperature settings.

### 11. Temperature Control (Uconnect 5.0)

Press the temperature button on the touchscreen to regulate the temperature of the air inside the passenger compartment. Moving the temperature bar into the red area, indicates warmer temperatures. Moving the temperature bar into the blue area indicates cooler temperatures.

## Automatic Climate Controls With Touchscreen — If Equipped

### Buttons On Your Faceplate

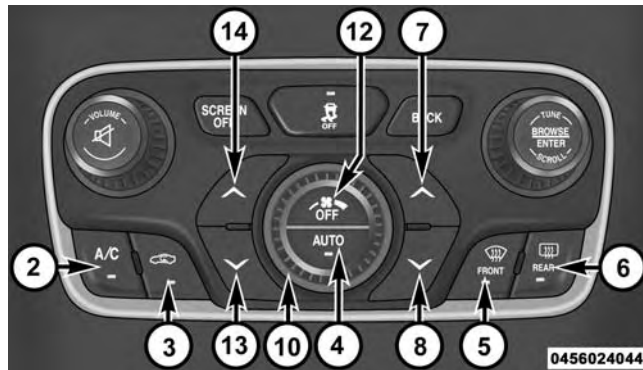

### Automatic Climate Controls — Buttons On The Faceplate

### Buttons On Your Uconnect Touchscreen

The buttons on your faceplate are also accessible on the Uconnect system touchscreen.

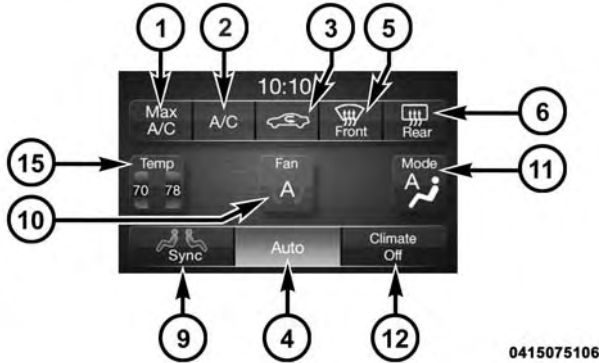

Uconnect 5.0 Automatic Temperature Controls — Buttons On The Touchscreen

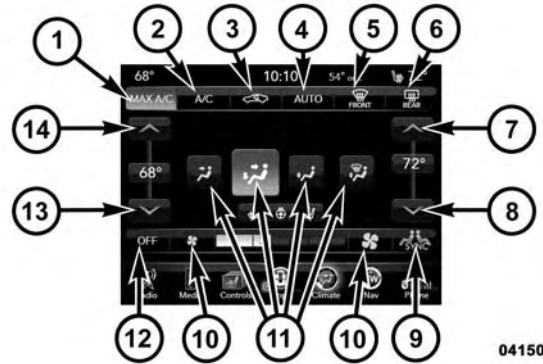

Uconnect 8.4 Automatic Temperature Controls — Buttons On The Touchscreen

## Button Descriptions (Applies To Both The Buttons On Your Faceplate And The Buttons On Your Touchscreen)

### 1. *MAX A/C Button*

Press to change the current setting, the indicator illuminates when MAX A/C is ON. Performing this function again will cause the MAX A/C operation to switch into manual mode and the MAX A/C indicator will turn off.

### 2. *A/C Button*

Press to change the current setting, the indicator illuminates when A/C is ON. Performing this function again will cause the A/C operation to switch into manual mode and the A/C indicator will turn off.

### 3. *Recirculation Button*

Press to change the current setting, the indicator illuminates when ON.

### 4. *AUTO Operation Button*

Automatically controls the interior cabin temperature by adjusting airflow distribution and amount. Performing this function will cause the ATC to switch between manual mode and automatic modes. Refer to “Automatic Operation” for more information.

### 5. *Front Defrost Button*

Press to change the current airflow setting to Defrost mode. The indicator illuminates when this feature is ON. Air comes from the windshield and side window demist outlets. When the defrost button is selected, the blower level will increase. Use Defrost mode with maximum temperature settings for best windshield and side window defrosting and defogging. Performing this function will cause the ATC to switch into manual mode. If the front defrost mode is turned off the climate system will return the previous setting.



## 6. Rear Defrost Button

Press this button to turn on the rear window defroster (if equipped) and the heated outside mirrors (if equipped). An indicator will illuminate when the rear window defroster is on. The rear window defroster automatically turns off after 10 minutes.

### CAUTION!

Failure to follow these cautions can cause damage to the heating elements:

- Use care when washing the inside of the rear window. Do not use abrasive window cleaners on the interior surface of the window. Use a soft cloth and a mild washing solution, wiping parallel to the heating elements. Labels can be peeled off after soaking with warm water.

*(Continued)*

### CAUTION! *(Continued)*

- Do not use scrapers, sharp instruments, or abrasive window cleaners on the interior surface of the window.
- Keep all objects a safe distance from the window.

## 7. Passenger Temperature Control Up Button (Uconnect 8.4)

Provides the passenger with independent temperature control. Press the button on the faceplate for warmer temperature settings or on the touchscreen, press and slide the button on the touchscreen temperature bar towards the red arrow button on the touchscreen for warmer temperature settings.

**NOTE:** Pressing this button while in Sync mode will automatically exit Sync.

### 8. *Passenger Temperature Control Down Button (Uconnect 8.4)*

Provides the passenger with independent temperature control. Press the button on the faceplate for cooler temperature settings or on the touchscreen, press and slide the button on the touchscreen temperature bar towards the blue arrow button on the touchscreen for cooler temperature settings.

**NOTE:** Pressing this button while in Sync mode will automatically exit Sync.

### 9. *SYNC*

Press the Sync button on the touchscreen to toggle the Sync feature On/Off. The Sync indicator is illuminated when this feature is enabled. Sync is used to synchronize the passenger temperature setting with the driver temperature setting. Changing the passenger temperature setting while in Sync will automatically exit this feature.

### 10. *Blower Control*

Blower control is used to regulate the amount of air forced through the climate system. There are seven blower speeds available. Adjusting the blower will cause automatic mode to switch to manual operation. The speeds can be selected using either the blower control knob on your faceplate or the buttons on your touchscreen as follows:

#### **Blower Control Knob On Your Faceplate**

The blower speed increases as you turn the knob clockwise from the lowest blower setting. The blower speed decreases as you turn the blower control knob counterclockwise.

## Buttons On Your Touchscreen

Use the small blower icon to reduce the blower setting and the large blower icon to increase the blower setting. Blower can also be selected by pressing the blower bar area between the icons.

### 11. Modes

The airflow distribution mode can be adjusted so air comes from the instrument panel outlets, floor outlets, demist outlets and defrost outlets. The Mode settings are as follows:

- **Panel Mode**



Air comes from the outlets in the instrument panel. Each of these outlets can be individually adjusted to direct the flow of air. The air vanes of the center outlets and outboard outlets can be moved up and down or side to side to regulate airflow direction. There

is a shut off wheel located adjacent to the air vanes to shut off or adjust the amount of airflow from these outlets.

- **Bi-Level Mode**



Air comes from the instrument panel outlets and floor outlets. A slight amount of air is directed through the defrost and side window demister outlets.

**NOTE:** BI-LEVEL mode is designed under comfort conditions to provide cooler air out of the panel outlets and warmer air from the floor outlets.

- **Floor Mode**



Air comes from the floor outlets. A slight amount of air is directed through the defrost and side window demister outlets.

- Mix Mode



Air comes from the floor, defrost and side window demist outlets. This mode works best in cold or snowy conditions.

### 12. Climate Control OFF Button

Press this button to turn the Climate Control ON/OFF.

### 13. Driver Temperature Control Down Button (Uconnect 8.4)

Provides the driver with independent temperature control. Press the button on the faceplate for cooler temperature settings or on the touchscreen, press and slide the button on the touchscreen temperature bar towards the blue arrow button on the touchscreen for cooler temperature settings.

**NOTE:** In Sync mode, this button will also automatically adjust the passenger temperature setting at the same time.

### 14. Driver Temperature Control Up Button (Uconnect 8.4)

Provides the driver with independent temperature control. Press the button on the faceplate for warmer temperature settings or on the touchscreen, press and slide the button on the touchscreen temperature bar towards the red arrow button on the touchscreen for warmer temperature settings.

**NOTE:** In Sync mode, this button will also automatically adjust the passenger temperature setting at the same time.

### 15. Temperature Control (Uconnect 5.0)

Press the temperature button on the touchscreen to regulate the temperature of the air inside the passenger compartment. Moving the temperature bar into the red area, indicates warmer temperatures. Moving the temperature bar into the blue area indicates cooler temperatures.

## Climate Control Functions

### A/C (Air Conditioning)

The Air Conditioning (A/C) button allows the operator to manually activate or deactivate the air conditioning system. When the air conditioning system is turned on, cool dehumidified air will flow through the outlets into the cabin. For improved fuel economy, push the A/C button to turn off the air conditioning and manually adjust the blower and airflow mode settings. Also, make sure to select only Panel, Bi-Level or Floor modes.

#### NOTE:

- If fog or mist appears on the windshield or side glass, select Defrost mode and adjust blower speed if needed.

- If your air conditioning performance seems lower than expected, check the front of the A/C condenser (located in front of the radiator), for an accumulation of dirt or insects. Clean with a gentle water spray from behind the radiator and through the condenser. Fabric front fascia protectors may reduce airflow to the condenser, reducing air conditioning performance.

### MAX A/C

MAX A/C sets the control for maximum cooling performance.

Press to toggle between MAX A/C and the prior settings. The button on the touchscreen illuminates when MAX A/C is ON.

In MAX A/C, the blower level and mode position can be adjusted to desired user settings. Pushing other settings will cause the MAX A/C operation to switch to the selected setting and cause MAX A/C to exit.

## Recirculation Control



When outside air contains smoke, odors, or high humidity, or if rapid cooling is desired, you may wish to recirculate interior air by pressing the RECIRCULATION control button.

Recirculation mode should only be used temporarily. The recirculation LED will illuminate the button on your touchscreen and the button on your faceplate when either button is selected. Push either button on your touchscreen or button on your faceplate a second time to turn off the Recirculation mode LED and allow outside air into the vehicle.

**NOTE:** In cold weather, use of Recirculation mode may lead to excessive window fogging. The recirculation feature may be unavailable (recirculation button on touchscreen greyed out) if conditions exist that could create fogging on the inside of the windshield. On systems with Manual Climate Controls, the Recirculation mode is not allowed in Defrost mode to improve window clearing operation. Recirculation will be disabled automatically if this mode is selected. Attempting to use Recirculation while in this mode will cause the LED in the control button to blink and then turn off.

## Automatic Temperature Control (ATC)

### Automatic Operation

1. Push the AUTO button on your faceplate or the button on your touchscreen on the Automatic Temperature Control (ATC) Panel.
2. Next, adjust the temperature you would like the system to maintain by adjusting the driver and passenger temperature hard or soft control buttons. Once the desired temperature is displayed, the system will achieve and automatically maintain that comfort level.
3. When the system is set up for your comfort level, it is not necessary to change the settings. You will experience the greatest efficiency by simply allowing the system to function automatically.

### NOTE:

- It is not necessary to move the temperature settings for cold or hot vehicles. The system automatically adjusts the temperature, mode, and blower speed to provide comfort as quickly as possible.
- The temperature can be displayed in U.S. or Metric units by selecting the US/M customer-programmable feature. Refer to the “Uconnect System Settings” in this section of the manual.

To provide you with maximum comfort in the Automatic mode, during cold start-ups the blower fan will remain on low until the engine warms up. The blower will increase in speed and transition into Auto mode.

### Manual Operation Override

The system allows for manual selection of blower speed, air distribution mode, A/C status and recirculation control.

The blower fan speed can be set to any fixed speed by adjusting the blower control. The fan will now operate at a fixed speed until additional speeds are selected. This allows the front occupants to control the volume of air circulated in the vehicle and cancel the Auto mode.

The operator can also select the direction of the airflow by selecting one of the available mode settings. A/C operation and Recirculation control can also be manually selected in Manual operation.

**NOTE:** Each of these features operates independently from each other. If any feature is controlled manually, temperature control will continue to operate automatically.

### Operating Tips

**NOTE:** Refer to the chart at the end of this section for suggested control settings for various weather conditions.

### Summer Operation

The engine cooling system must be protected with a high-quality antifreeze coolant to provide proper corrosion protection and to protect against engine overheating. OAT coolant (conforming to MS.90032) is recommended. Refer to “Maintenance Procedures” in “Maintaining Your Vehicle” for proper coolant selection.

### Winter Operation

To ensure the best possible heater and defroster performance, make sure the engine cooling system is functioning properly and the proper amount, type, and concentration of coolant is used. Refer to “Maintenance Procedures” in “Maintaining Your Vehicle” for proper coolant selection. Use of the air Recirculation mode during Winter months is not recommended because it may cause window fogging.



## Vacation/Storage

Any time you store your vehicle or keep it out of service (i.e., vacation) for two weeks or more, run the air conditioning system at idle for about five minutes in fresh air with the blower setting in high. This will ensure adequate system lubrication to minimize the possibility of compressor damage when the system is started again.

## Window Fogging

Vehicle windows tend to fog on the inside of the glass in mild, rainy and/or humid weather. Windows may frost on the inside of the glass in very cold weather. To clear the windows, select Defrost or Mix mode and increase the front blower speed. Do not use the Recirculation mode without A/C for long periods, as fogging may occur.

**NOTE:** Automatic Temperature Controls (ATC) will automatically adjust the climate control settings to reduce or eliminate window fogging on the front windshield. When this occurs, recirculation will be unavailable.









## Outside Air Intake

Make sure the air intake, located directly in front of the windshield, is free of obstructions such as leaves. Leaves collected in the air intake may reduce airflow, can cause odor, and if they enter the plenum they could plug the water drains. In Winter months make sure the air intake is clear of ice, slush and snow.

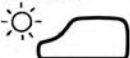
## A/C Air Filter

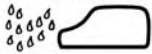
The climate control system filters outside air containing dust, pollen and some odors. Strong odors cannot be totally filtered out. Refer to “Maintenance Procedures” in “Maintaining Your Vehicle” for filter replacement instructions.

## Control Setting Suggestions For Various Weather Conditions

WEATHER	CONTROL SETTINGS
Hot weather and vehicle interior is very hot 	Set the mode control to  . A/C on, and blower on high. Roll down the windows for a minute to flush out the hot air. Once comfort is achieved adjust controls for comfort.
Warm Weather 	Turn A/C on and set the mode control to the  position.
Cool Sunny	Operate in  position.
Cool & Humid conditions 	Set the mode control to  and turn on A/C to keep windows clear.
Cold Weather	Set the mode control to the  position. If windshield fogging starts to occur, move the control towards the  position.

0456052237

## PERSONALIZED MENU BAR

The Uconnect features and services in the main menu bar are easily changed for your convenience. Simply follow these steps:



Uconnect 8.4A/8.4AN Main Menu

1. Press the “Apps  ” button to open the App screen.
2. Press and hold, then drag the selected App to replace an existing shortcut in the main menu bar.

The replaced shortcut will now be an active App/shortcut on the main menu bar.

## UCONNECT VOICE RECOGNITION QUICK TIPS

### Introducing Uconnect

Start using Uconnect Voice Recognition with these helpful quick tips. It provides the key Voice Commands and tips you need to know to control your Uconnect 5.0 or 8.4A/8.4AN system.



Uconnect 5.0

Key Features:

- 5" touchscreen
- Three buttons on either side of the display



Uconnect 8.4AN

If you see the  icon on your touchscreen, you have the Uconnect 8.4AN system. If not, you have a Uconnect 8.4A system.

## Get Started

All you need to control your Uconnect system with your voice are the buttons on your steering wheel.

1. Visit **UconnectPhone.com** to check mobile device and feature compatibility and to find phone pairing instructions.
2. Reduce background noise. Wind and passenger conversations are examples of noise that may impact recognition.
3. Speak clearly at a normal pace and volume while facing straight ahead. The microphone is positioned on the rearview mirror and aimed at the driver.
4. Each time you give a Voice Command, you must first push either the VR or Phone button, wait until **after** the beep, then say your Voice Command.
5. You can interrupt the help message or system prompts by pushing the VR or Phone button and saying a Voice Command from current category.

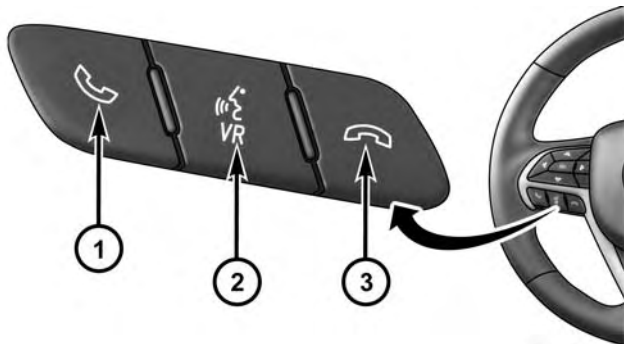

0415083920

Uconnect Voice Command Buttons

- 1 — Push To Initiate Or To Answer A Phone Call, Send Or Receive A Text
- 2 — For All Radios: Push To Begin Radio Or Media functions. For 8.4A/8.4AN Only: Push To Begin Navigation, Apps And Climate Functions.
- 3 — Push To End Call

## Basic Voice Commands

The basic Voice Commands below can be given at any point while using your Uconnect system.

Push the VR button . After the beep, say...

- **Cancel** to stop a current voice session
- **Help** to hear a list of suggested Voice Commands
- **Repeat** to listen to the system prompts again

Notice the visual cues that inform you of your voice recognition system's status. Cues appear on the touchscreen.

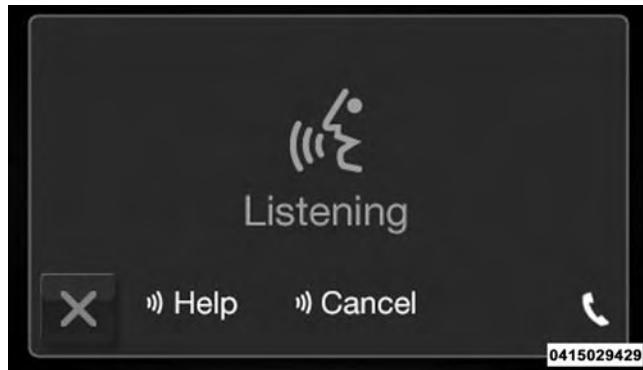

Uconnect 5.0



Uconnect 8.4A/8.4AN

## Radio

Use your voice to quickly get to the AM, FM or SiriusXM Satellite Radio stations you would like to hear. (Subscription or included SiriusXM Satellite Radio trial required.)

Push the VR button . After the beep, say...

- Tune to ninety-five-point-five FM
- Tune to Satellite Channel Hits 1

#### 430 UNDERSTANDING YOUR INSTRUMENT PANEL

**TIP:** At any time, if you are not sure of what to say or want to learn a Voice Command, push the VR button  and say **“Help.”** The system will provide you with a list of commands.



Uconnect 5.0 Radio



Uconnect 8.4A/8.4AN Radio



## Media

Uconnect offers connections via USB, SD, Bluetooth and auxiliary ports (If Equipped). Voice operation is only available for connected USB and AUX devices. (Remote CD player optional and not available on all vehicles.)

Push the VR button . After the beep, say one of the following commands and follow the prompts to switch your media source or choose an artist.

- **Change source** to Bluetooth
- **Change source** to AUX
- **Change source** to USB
- **Play artist** Beethoven; **Play album** Greatest Hits; **Play song** Moonlight Sonata; **Play genre** Classical

**TIP:** Press the Browse button on the touchscreen to see all of the music on your AUX or USB device. Your Voice Command must match **exactly** how the artist, album, song and genre information is displayed.

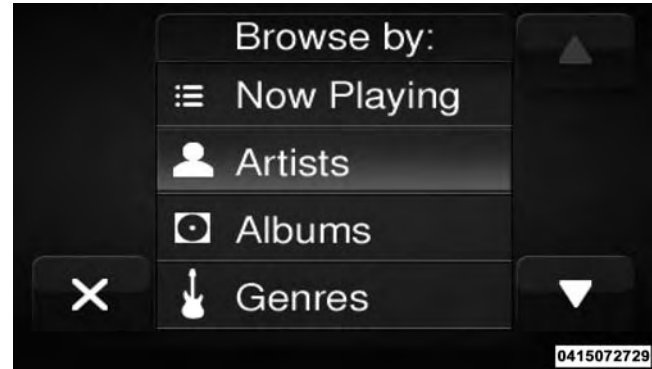

Uconnect 5.0 Media



Uconnect 8.4A/8.4AN Media

## Phone

Making and answering hands-free phone calls is easy with Uconnect. When the Phonebook button is illuminated on your touchscreen, your system is ready. Check [UconnectPhone.com](http://UconnectPhone.com) for mobile phone compatibility and pairing instructions.

Push the Phone button . After the beep, say one of the following commands...

- Call John Smith
- Dial 123-456-7890 and follow the system prompts
- Redial (call previous outgoing phone number)
- Call back (call previous incoming phone number)

**TIP:** When providing a Voice Command, push the Phone button  and say **“Call,”** then pronounce the name **exactly** as it appears in your phone book. When a contact has multiple phone numbers, you can say **“Call John Smith work.”**





Uconnect 5.0 Phone



Uconnect 8.4A/8.4AN Phone

## Voice Text Reply

Uconnect will announce **incoming** text messages. Push the Phone button  and say **Listen**. (Must have compatible mobile phone paired to Uconnect system.)

1. Once an incoming text message is read to you, push the Phone button . After the beep, say: **“Reply.”**
2. Listen to the Uconnect prompts. After the beep, repeat one of the pre-defined messages and follow the system prompts.

PRE-DEFINED VOICE TEXT REPLY RESPONSES		
Yes.	Stuck in traffic.	See you later.
No.	Start without me.	I'll be late.
Okay.	Where are you?	I will be <number> minutes late.
Call me.	Are you there yet?	
I'll call you later.	I need directions.	See you in <number> of minutes.
I'm on my way.	Can't talk right now.	
I'm lost.		Thanks.

**TIP:** Your mobile phone must have the full implementation of the **Message Access Profile (MAP)** to take advantage of this feature. For details about MAP, visit [UconnectPhone.com](http://UconnectPhone.com).

Apple iPhone iOS 6 or later supports reading **incoming** text messages only. To enable this feature on your Apple iPhone, follow these 4 simple steps:



### iPhone Notification Settings

- 1 — Select “Settings”
- 2 — Select “Bluetooth”
- 3 — Select the (i) for the paired vehicle
- 4 — Turn on “Show Notifications”

**TIP:** Voice Text Reply is not compatible with iPhone, but if your vehicle is equipped with Siri Eyes Free, you can use your voice to send a text message.

### Climate (8.4A/8.4AN)

Too hot? Too cold? Adjust vehicle temperatures hands-free and keep everyone comfortable while you keep moving ahead. (If vehicle is equipped with climate control.)

Push the VR button . After the beep, say one of the following commands:

- Set driver temperature to 70 degrees
- Set passenger temperature to 70 degrees

**TIP:** Voice Command for Climate may only be used to adjust the interior temperature of your vehicle. Voice Command will not work to adjust the heated seats or steering wheel if equipped.



Uconnect 8.4A/8.4AN Climate

## Navigation (8.4A/8.4AN)

The Uconnect navigation feature helps you save time and become more productive when you know exactly how to get to where you want to go. (Navigation is optional on the Uconnect 8.4A system. See your dealer to activate navigation at any time.)

- To enter a destination, push the VR button . After the beep, say:
  - For the 8.4A Uconnect System, say: **“Enter state.”**
  - For the 8.4AN Uconnect System, say: **“Find address 800 Chrysler Drive Auburn Hills, Michigan.”**
- Then follow the system prompts.

**TIP:** To start a POI search, push the VR button . After the beep, say: “ **Find nearest coffee shop.**”



Uconnect 8.4A/8.4AN Navigation

## Uconnect Access (8.4A/8.4AN)

### WARNING!

**ALWAYS** obey traffic laws and pay attention to the road. Some Uconnect Access services, including 9-1-1 and Assist, will **NOT** work without an operable 1X (voice/data) or 3G (data) network connection.

**NOTE:** Your vehicle may be transmitting data as authorized by the subscriber.

An included trial and/or subscription is required to take advantage of the Uconnect Access services in the next section of this guide. To register with Uconnect Access, press the Apps button on the 8.4-inch touchscreen to get started. Detailed registration instructions can be found on the next page.

**NOTE:** Uconnect Access is available only on equipped vehicles purchased within the continental United States, Alaska and Hawaii. Services can only be used where coverage is available; see coverage map for details.

 9-1-1 Call

 Security Alarm Notification

 Remote Door Lock/Unlock

 Stolen Vehicle Assistance

 Remote Vehicle Start\*\*

 Remote Horn and Lights

 Yelp Search

 Voice Texting

 Roadside Assistance Call

 WiFi Hotspot\*\*\*

\*\*If vehicle is equipped.

\*\*\*Extra charges apply.

### Vehicle Health Alert

Your vehicle will send you an email alert if it senses a problem under the hood with one of your vehicles key systems. For further information go to the Mopar Owner Connect website [moparownerconnect.com](http://moparownerconnect.com).



## Register (8.4A/8.4AN)

To unlock the full potential of Uconnect Access in your vehicle, you first need to register with Uconnect Access.

1. Push the ASSIST button on your rearview mirror.



0401020352

2. Press the “Uconnect Care” button on the touchscreen.
3. A helpful Uconnect Care Agent will register your vehicle and handle all of the details.

**Signing up is easy!** Simply follow the steps above. Or, press the “Apps ” button on the touchscreen to “Register By Web” to complete the process using your smartphone or computer.

For further information please visit [DriveUconnect.com](http://DriveUconnect.com).

## Mobile App (8.4A/8.4AN)

You're only a few steps away from using remote commands and playing your favorite music in your vehicle.



Mobile App

0415083930

To link your internet radio accounts:

1. Download the Uconnect Access App to your mobile device.

2. Press the Via Mobile icon on the navigation bar at the bottom of the app.
3. Press the app you'd like to connect to your vehicle.
4. Enter your login information for the selected app and press Link.
5. Next time you're in your vehicle, enable Bluetooth, pair your phone and select the Via Mobile app you want to play from the Uconnect touchscreen to stream your personalized music.

### NOTE:

- You can also complete this process on the web. Simply visit [moparownerconnect.com](http://moparownerconnect.com) log in and click Set Up Via Mobile Profile (under Quick Links).
- Once you download the app to your compatible mobile device, you will also be able to start your vehicle and lock/unlock its doors from virtually anywhere.

## Voice Texting (8.4A/8.4AN)

1. To send a message, push the Phone button . After the beep, say the following command: **“Send message to John Smith.”**
2. Listen to the prompt. After the beep, dictate the message you would like to send. Wait for Uconnect to process your message.
3. The Uconnect system will repeat your message and provide a variety of options to add to, delete, send or hear the message again. After the beep, tell Uconnect what you’d like to do. For instance, if you’re happy with your message, after the beep, say: **“Send.”**

You must be registered with Uconnect Access and have a compatible MAP – enabled smartphone to use your voice to send a personalized text message. For details about MAP, visit [UconnectPhone.com](http://UconnectPhone.com).

Apple iPhone iOS6 or later supports reading **incoming** text messages only. To enable this feature on your Apple iPhone, follow these 4 simple steps:



4

### iPhone Notification Settings

- 1 — Select “Settings”
- 2 — Select “Bluetooth”
- 3 — Select the (i) for the paired vehicle
- 4 — Turn on “Show Notifications”

**TIP:**

- Voice Texting is not compatible with iPhone, but if your vehicle is equipped with Siri Eyes Free, you can use your voice to send a text message.
- Messages are limited to 140 characters.
- The Messaging button on the touchscreen must be illuminated to use the feature.

**Yelp (8.4A/8.4AN)**

Once registered with Uconnect Access, you can use your voice to search for the most popular places or things around you.

1. Press the “Apps ” button on the touchscreen.

2. Press the “Yelp” button on the touchscreen.
3. Once the YELP home screen appears on the touchscreen, push the VR button , then say: “**YELP search.**”
4. Listen to the system prompts and after the beep, tell Uconnect the place or business that you’d like Uconnect to find.

**TIP:** Once you perform a search, you can reorganize the results by selecting either the Best Match, Rating or Distance tab on the top of the touchscreen display.



Yelp

### SiriusXM Travel Link (8.4A/8.4AN)

Need to find a gas station, view local movie listings, check a sports score or the 5 - day weather forecast? SiriusXM Travel Link is a suite of services that brings a wealth of information right to your Uconnect 8.4AN system. (Not available for 8.4A system.)

Push the VR button . After the beep, say one of the following commands:

- Show fuel prices
- Show 5 - day weather forecast
- Show extended weather

**TIP:** Traffic alerts are not accessible with Voice Command.



SiriusXM Travel Link

## Siri Eyes Free — If Equipped

If your vehicle is equipped with Siri Eyes Free, you can use your voice to send text messages, schedule meetings, set reminders, and more. For further information go to the Mopar Owner Connect website [moparownerconnect.com](http://moparownerconnect.com).

## Do Not Disturb

With Do Not Disturb, you can disable notifications from incoming calls and texts, allowing you to keep your eyes on the road and hands on the wheel. For your convenience there is a counter display to keep track of your missed calls and text messages while you were using Do Not Disturb.

Do Not Disturb can automatically reply with a text message, a call or both, when declining an incoming call and send it to voicemail.

Automatic reply messages can be:

- “I am driving right now, I will get back to you shortly.”
- Create a custom auto reply message up to 160 characters.

**NOTE:** Only the first 25 characters can be seen on the touchscreen while typing a custom message.

While in Do Not Disturb, Conference Call can be selected so you can still place a second call without being interrupted by incoming calls.

**NOTE:**

- Reply with text message is not compatible with iPhones.
- Auto reply with text message is only available on phones that supporting Bluetooth MAP.

## General Information

This device complies with FCC rules Part 15 and Industry Canada RSS-210. Operation is subject to the following two conditions:

1. This device may not cause harmful interference.
2. This device must accept any interference that may be received including interference that may cause undesired operation.

**NOTE:**

- The transmitter has been tested and it complies with FCC and IC rules. Changes or modifications not expressly approved by the party responsible for compliance could void the user’s authority to operate the device.
- The term IC before the certification/registration number only signifies that Industry Canada technical specifications were met.

### Additional Information

© 2015 FCA US LLC. All rights reserved. Mopar and Uconnect are registered trademarks and Mopar Owner Connect is a trademark of FCA US LLC. Android is a trademark of Google Inc. SiriusXM and all related marks and logos are trademarks of SiriusXM Radio Inc. Yelp, Yelp logo, Yelp burst and related marks are registered trademarks of Yelp.

Uconnect System Support:

- U.S. residents call 1-877-855-8400 (24 hours a day 7 days a week) or visit [DriveUconnect.com](http://DriveUconnect.com)
- Canadian residents call 1-800-465-2001 (English) or 1-800-387-9983 (French) or visit [DriveUconnect.ca](http://DriveUconnect.ca)

Mon. – Fri., 8:00 am – 8:00 pm, ET

Sat., 9:00 am – 5:00 pm, ET

Sun., Closed

Uconnect Access Services Support 1-855-792-4241 Please have your Uconnect Security PIN ready when you call.



# STARTING AND OPERATING

## CONTENTS

■ STARTING PROCEDURES . . . . .	.451	□ Brake/Transmission Shift Interlock System . . .	.457
□ Normal Starting. . . . .	.451	□ Nine-Speed Automatic Transmission . . . . .	.457
□ Extreme Cold Weather (Below -22°F Or -30°C) . . . . .	.452	□ Gear Ranges . . . . .	.459
□ Extended Park Starting. . . . .	.452	■ PADDLE SHIFT MODE — IF EQUIPPED . . . . .	.465
□ If Engine Fails To Start . . . . .	.453	□ Operation . . . . .	.465
□ After Starting . . . . .	.454	■ ALL WHEEL DRIVE (AWD) — IF EQUIPPED . . .	.467
■ ENGINE BLOCK HEATER — IF EQUIPPED . . .	.454	■ DRIVING ON SLIPPERY SURFACES . . . . .	.468
■ AUTOMATIC TRANSMISSION . . . . .	.455	□ Acceleration . . . . .	.468
□ Key Ignition Park Interlock. . . . .	.457	□ Traction . . . . .	.468

■ DRIVING THROUGH WATER . . . . .	469	□ Anti-Lock Brake Warning Light. . . . .	481
□ Flowing/Rising Water . . . . .	469	□ Brake Assist System (BAS) . . . . .	481
□ Shallow Standing Water . . . . .	469	□ Hill Start Assist (HSA) . . . . .	482
■ POWER STEERING . . . . .	470	□ Traction Control System (TCS) . . . . .	485
■ ELECTRIC PARK BRAKE (EPB) . . . . .	471	□ Electronic Stability Control (ESC) . . . . .	485
□ Auto Park Brake . . . . .	476	□ Electronic Roll Mitigation (ERM). . . . .	489
□ SafeHold. . . . .	476	□ Ready Alert Braking (RAB). . . . .	490
□ Brake Service Mode . . . . .	476	□ Rainy Brake Support (RBS). . . . .	490
■ BRAKE SYSTEM . . . . .	478	□ Dynamic Steering Torque (DST) . . . . .	490
■ ELECTRONIC BRAKE CONTROL SYSTEM . . .	478	■ TIRE SAFETY INFORMATION . . . . .	491
□ Electronic Brake Force Distribution (EBD) . . .	478	□ Tire Markings . . . . .	491
□ Brake System Warning Light. . . . .	479	□ Tire Identification Number (TIN). . . . .	495
□ Anti-Lock Brake System (ABS) . . . . .	479	□ Tire Terminology And Definitions . . . . .	497

□ Tire Loading And Tire Pressure . . . . .	.498	■ TIRE CHAINS (TRACTION DEVICES) . . . . .	.515
■ TIRES — GENERAL INFORMATION . . . . .	.503	■ TIRE ROTATION RECOMMENDATIONS . . . . .	.516
□ Tire Pressure . . . . .	.503	■ TIRE PRESSURE MONITOR SYSTEM (TPMS) . . . . .	.518
□ Tire Inflation Pressures . . . . .	.504	□ Base System . . . . .	.521
□ Tire Pressures For High Speed Operation . . . . .	.506	□ Premium System — If Equipped . . . . .	.523
□ Radial Ply Tires . . . . .	.506	□ General Information. . . . .	.527
□ Tire Types . . . . .	.507	■ FUEL REQUIREMENTS . . . . .	.528
□ Run Flat Tires — If Equipped . . . . .	.508	□ Reformulated Gasoline . . . . .	.528
□ Spare Tires — If Equipped . . . . .	.509	□ Gasoline/Oxygenate Blends . . . . .	.529
□ Tire Spinning . . . . .	.511	□ E-85 Usage In Non-Flex Fuel Vehicles . . . . .	.529
□ Tread Wear Indicators . . . . .	.512	□ MMT In Gasoline . . . . .	.530
□ Life Of Tire . . . . .	.513	□ Materials Added To Fuel . . . . .	.530
□ Replacement Tires . . . . .	.513	□ Fuel System Cautions. . . . .	.531

## 450 STARTING AND OPERATING

- Carbon Monoxide Warnings . . . . .532
- FLEXIBLE FUEL — IF EQUIPPED . . . . .532
  - E-85 General Information . . . . .532
  - Ethanol Fuel (E-85) . . . . .533
  - Fuel Requirements . . . . .533
  - Selection Of Engine Oil For Flexible Fuel Vehicles (E-85) And Gasoline Vehicles . . . . .534
  - Starting . . . . .534
  - Cruising Range . . . . .535
  - Replacement Parts . . . . .535
  - Maintenance . . . . .535
- ADDING FUEL . . . . .536
  - Loose Fuel Filler Cap Message . . . . .539
- VEHICLE LOADING . . . . .539
  - Certification Label . . . . .539
- TRAILER TOWING . . . . .541
- RECREATIONAL TOWING (BEHIND MOTORHOME, ETC.) . . . . .542
  - Towing This Vehicle Behind Another Vehicle . . . . .542
  - Recreational Towing — Front-Wheel Drive (FWD) Models . . . . .543
  - Recreational Towing — All-Wheel Drive (AWD) Models . . . . .544

## STARTING PROCEDURES

Before starting your vehicle, adjust your seat, adjust both inside and outside mirrors, and fasten your seat belts.

### WARNING!

- When leaving the vehicle, always remove the Key Fob from the ignition and lock your vehicle.
- Never leave children alone in a vehicle, or with access to an unlocked vehicle.
- Allowing children to be in a vehicle unattended is dangerous for a number of reasons. A child or others could be seriously or fatally injured. Children should be warned not to touch the parking brake, brake pedal or the gear selector/shift lever.
- Do not leave the Key Fob in or near the vehicle, or in a location accessible to children, and do not leave the ignition of a vehicle equipped with

### WARNING! (Continued)

**Keyless Enter-N-Go in the ACC or ON/RUN mode. A child could operate power windows, other controls, or move the vehicle.**

Start the engine with the shift lever in the NEUTRAL or PARK position. Apply the brake before shifting to any driving range.

### Normal Starting

**NOTE:** Normal starting of either a cold or a warm engine is obtained without pumping or pressing the accelerator pedal.

Cycle the ignition switch to the START position and release when the engine starts. If the engine fails to start within 10 seconds, cycle the ignition switch to the LOCK/OFF position, wait 10 to 15 seconds, then repeat the "Normal Starting" procedure.

(Continued)



### Tip Start Feature

Cycle the ignition switch to START position and release it as soon as the starter engages. The starter motor will continue to run, but will automatically disengage itself when the engine is running. If the engine fails to start, the starter will disengage automatically in 10 seconds. If this occurs, cycle the ignition switch to the OFF position, wait 10 to 15 seconds, then repeat the “Normal Starting” procedure.

### Extreme Cold Weather (Below $-22^{\circ}\text{F}$ Or $-30^{\circ}\text{C}$ )

To ensure reliable starting at these temperatures, use of an externally powered electric engine block heater (available from your authorized dealer) is recommended.

### Extended Park Starting

**NOTE:** Extended Park condition occurs when the vehicle has not been started or driven for at least 30 days.

1. Install a battery charger or jumper cables to the battery to ensure a full battery charge during the crank cycle.
2. Cycle the ignition in the START position and release it when the engine starts.
3. If the engine fails to start within ten seconds, cycle the ignition to the STOP (OFF/LOCK) position, wait five seconds to allow the starter to cool, then repeat the Extended Park Starting procedure.
4. If the engine fails to start after eight attempts, allow the starter to cool for at least 10 minutes, then repeat the procedure.

### CAUTION!

**To prevent damage to the starter, do not crank continuously for more than 10 seconds at a time. Wait 10 to 15 seconds before trying again.**

## If Engine Fails To Start

### WARNING!

- Never pour fuel or other flammable liquid into the throttle body air inlet opening in an attempt to start the vehicle. This could result in flash fire causing serious personal injury.
- Do not attempt to push or tow your vehicle to get it started. Vehicles equipped with an automatic transmission cannot be started this way. Unburned fuel could enter the catalytic converter and once the engine has started, ignite and damage the converter and vehicle.
- If the vehicle has a discharged battery, booster cables may be used to obtain a start from a booster battery or the battery in another vehicle. This type of start can be dangerous if done improperly. Refer

### WARNING! (Continued)

to "Jump-Starting" in "What To Do In Emergencies" for further information.

### With Tip Start

If the engine fails to start after you have followed the "Normal Starting", "Extreme Cold Weather" and "Extended Park Starting" procedures, it may be flooded. To clear any excess fuel;

1. Press the accelerator pedal all the way to the floor and hold it
2. Cycle the ignition to the START position and release it as soon as the starter engages. The starter motor will disengage automatically in 10 seconds.
3. Once this occurs, release the accelerator pedal.

4. Cycle the ignition to the LOCK position, wait 10 to 15 seconds, then repeat the “Normal Starting” procedure.

**CAUTION!**

To prevent damage to the starter, wait 10 to 15 seconds before trying again.

**After Starting**

The idle speed is controlled automatically and it will decrease as the engine warms up.

**ENGINE BLOCK HEATER — IF EQUIPPED**

The engine block heater warms the engine and permits quicker starts in cold weather.

Connect the cord to a 110-115 Volt AC electrical outlet with a grounded, three-wire extension cord.

For ambient temperatures below 0°F (-18°C), the engine block heater is recommended. For ambient temperatures below -20°F (-29°C), the engine block heater is required.

The engine block heater cord is routed under the hood, behind to the driver’s side headlamp. Follow the steps below to properly use the engine block heater:

1. Locate the engine block heater cord (behind the driver’s side headlamp).
2. Undo the Velcro strap that secures the heater cord in place.
3. Pull the cord to the front of the vehicle and plug it into a grounded, three-wire extension cord.
4. After the vehicle is running, reattach the cord to the Velcro strap and properly stow away behind the driver’s side headlamp.



**NOTE:**

- The engine block heater cord is a factory installed option. If your vehicle is not equipped, heater cords are available from your authorized MOPAR dealer.
- The engine block heater will require 110 Volts AC and 6.5 Amps to activate the heater element.
- The engine block heater must be plugged in at least one hour to have an adequate warming effect on the engine.

**WARNING!**

Remember to disconnect the engine block heater cord before driving. Damage to the 110-115 Volt electrical cord could cause electrocution.

**AUTOMATIC TRANSMISSION****CAUTION!**

Damage to the transmission may occur if the following precautions are not observed:

- Shift into or out of PARK or REVERSE only after the vehicle has come to a complete stop.
- Do not shift between PARK, REVERSE, NEUTRAL, or DRIVE when the engine is above idle speed.
- Before shifting into any gear, make sure your foot is firmly pressing the brake pedal.

**WARNING!**

- It is dangerous to shift out of PARK or NEUTRAL if the engine speed is higher than idle speed. If your foot is not firmly pressing the brake pedal, the vehicle could accelerate quickly forward or in reverse. You could lose control of the vehicle and hit someone or something. Only shift into gear when the engine is idling normally and your foot is firmly pressing the brake pedal.
- Unintended movement of a vehicle could injure those in or near the vehicle. As with all vehicles, you should never exit a vehicle while the engine is running. Before exiting a vehicle, always apply the parking brake, shift the transmission into PARK, turn the engine OFF, and remove the Key Fob. When the ignition is in the OFF mode, the transmission is locked in PARK, securing the vehicle against unwanted movement.

**WARNING! (Continued)**

- When leaving the vehicle, always make sure the ignition is in the OFF mode, remove the Key Fob from the vehicle, and lock the vehicle.
- Never leave children alone in a vehicle, or with access to an unlocked vehicle. Allowing children to be in a vehicle unattended is dangerous for a number of reasons. A child or others could be seriously or fatally injured. Children should be warned not to touch the parking brake, brake pedal or the transmission gear selector.
- Do not leave the Key Fob in or near the vehicle (or in a location accessible to children), and do not leave the ignition in the ACC or ON/RUN position. A child could operate power windows, other controls, or move the vehicle.

(Continued)

**NOTE:** You must press and hold the brake pedal while shifting out of PARK.

### **Key Ignition Park Interlock**

This vehicle is equipped with a Key Ignition Park Interlock which requires the transmission to be in PARK before the engine can be turned off. This helps the driver avoid inadvertently leaving the vehicle without placing the transmission in PARK. This system also locks the transmission in PARK whenever the ignition switch is in the OFF position.

### **Brake/Transmission Shift Interlock System**

This vehicle is equipped with a Brake Transmission Shift Interlock system (BTSI) that holds the transmission gear selector in PARK unless the brakes are applied. To shift the transmission out of PARK, the engine must be running and the brake pedal must be pressed. The brake pedal must also be pressed to shift from NEUTRAL into DRIVE or REVERSE when the vehicle is stopped or moving at low speeds.

### **Nine-Speed Automatic Transmission**

The transmission is controlled using a rotary electronic gear selector located on the center console. The transmission gear range (PRNDL/S) is displayed both above the gear selector and in the Electronic Vehicle Information Center (EVIC) or the Driver Information Display (DID). To select a gear range, simply rotate the gear selector. Push down on the gear selector and then rotate it, to access the L or S position. You must also press the brake pedal to shift the transmission out of PARK, or to shift from NEUTRAL into DRIVE or REVERSE when the vehicle is stopped or moving at low speeds (refer to "Brake/Transmission Shift Interlock System" in this section). To shift past multiple gear ranges at once (such as PARK to DRIVE), simply rotate the gear selector to the appropriate detent. Select the DRIVE range for normal driving.

The electronically-controlled transmission provides a precise shift schedule. The transmission electronics are self-calibrating; therefore, the first few shifts on a new

vehicle may be somewhat abrupt. This is a normal condition, and precision shifts will develop within a few hundred miles (kilometers).

The nine-speed transmission has been developed to meet the needs of FCA US's current and future lineup of FWD/AWD vehicles. Software and calibration is refined to optimize the customer's driving experience and fuel economy. By design, some vehicle and driveline combinations utilize 9th gear only in very specific driving situations and conditions.

Only shift from DRIVE to PARK or REVERSE when the accelerator pedal is released and the vehicle is stopped. Be sure to keep your foot on the brake pedal when shifting between these gears.

### **Standard Shifter**

The standard transmission gear selector has PARK, REVERSE, NEUTRAL, DRIVE, and LOW shift positions.

Using the LOW position manually downshifts the transmission to a lower gear based on vehicle speed.

### **Premium Shifter with Shift Paddles**

The premium transmission gear selector (with manual shift paddles mounted on the steering wheel) provides PARK, REVERSE, NEUTRAL, DRIVE, and SPORT shift positions. Manual shifts can be made using the shift paddles (refer to "Paddle Shift Mode" in this section). Pressing the shift paddles (-/+ ) while in the DRIVE or SPORT position will manually select the transmission gear, and will display the current gear in the instrument cluster as 1, 2, 3, etc.

**NOTE:** In the event of a mismatch between the gear selector position and the actual transmission gear (for example, driver selects PARK while driving), the position indicator will blink continuously until the selector is returned to the proper position, or the requested shift can be completed.



Transmission Gear Selector

0512074804

## Gear Ranges

DO NOT race the engine when shifting from PARK or NEUTRAL into another gear range.

**NOTE:** After selecting any gear range, wait a moment to allow the selected gear to engage before accelerating. This is especially important when the engine is cold.

## PARK (P)

This range supplements the parking brake by locking the transmission. The engine can be started in this range. Never attempt to use PARK while the vehicle is in motion. Apply the parking brake when leaving the vehicle in this range.

When parking on a level surface, you may shift the transmission into PARK first, and then apply the parking brake.

When parking on a hill, apply the parking brake before shifting the transmission to PARK. As an added precaution, turn the front wheels toward the curb on a downhill grade and away from the curb on an uphill grade.

**WARNING!**

- Never use the PARK position as a substitute for the parking brake. Always apply the parking brake fully when parked to guard against vehicle movement and possible injury or damage.
- Your vehicle could move and injure you and others if it is not in PARK. Make sure the transmission is in PARK before leaving the vehicle.
- It is dangerous to shift out of PARK or NEUTRAL if the engine speed is higher than idle speed. If your foot is not firmly pressing the brake pedal, the vehicle could accelerate quickly forward or in reverse. You could lose control of the vehicle and hit someone or something. Only shift into gear when the engine is idling normally and your foot is firmly pressing the brake pedal.

*(Continued)*

**WARNING! (Continued)**

- Unintended movement of a vehicle could injure those in or near the vehicle. As with all vehicles, you should never exit a vehicle while the engine is running. Before exiting a vehicle, always apply the parking brake, shift the transmission into PARK, turn the engine OFF, and remove the Key Fob. When the ignition is in the OFF position, the transmission is locked in PARK, securing the vehicle against unwanted movement.
- When leaving the vehicle, always make sure the ignition is in the OFF position, remove the Key Fob from the vehicle, and lock the vehicle.
- Never leave children alone in a vehicle, or with access to an unlocked vehicle. Allowing children to be in a vehicle unattended is dangerous for a number of reasons. A child or others could be

*(Continued)*

**WARNING! (Continued)**

seriously or fatally injured. Children should be warned not to touch the parking brake, brake pedal or the transmission gear selector.

- Do not leave the Key Fob in or near the vehicle (or in a location accessible to children), and do not leave the ignition in the ACC or ON/RUN position. A child could operate power windows, other controls, or move the vehicle.

**CAUTION!**

- Before moving the transmission gear selector out of PARK, you must start the engine and also press the brake pedal. Otherwise, damage to the gear selector could result.

**CAUTION! (Continued)**

- DO NOT race the engine when shifting from PARK or NEUTRAL into another gear range, as this can damage the drivetrain.

The following indicator should be used to ensure that you have engaged the transmission into the PARK position:

- With brake pedal released, look at the transmission gear position display and verify that it indicates the PARK position (P).

**REVERSE (R)**

This range is for moving the vehicle backward. Shift into REVERSE only after the vehicle has come to a complete stop.

**NEUTRAL (N)**

Use this range when the vehicle is standing for prolonged periods with the engine running. The engine may be started in this range. Apply the parking brake and shift the transmission into PARK if you must leave the vehicle.

**WARNING!**

**Do not coast in NEUTRAL and never turn off the ignition to coast down a hill. These are unsafe practices that limit your response to changing traffic or road conditions. You might lose control of the vehicle and have a collision.**

**CAUTION!**

**Towing the vehicle, coasting, or driving for any other reason with the transmission in NEUTRAL can cause**

**CAUTION! (Continued)**

**severe transmission damage. Refer to "Recreational Towing" in "Starting And Operating" and "Towing A Disabled Vehicle" in "What To Do In Emergencies" for further information.**

**DRIVE (D)**

This range should be used for most city and highway driving. It provides the smoothest upshifts and downshifts, and the best fuel economy. The transmission automatically upshifts through all forward gears. The DRIVE position provides optimum driving characteristics under all normal operating conditions.

When frequent transmission shifting occurs (such as when operating the vehicle under heavy loading conditions, in hilly terrain, or traveling into strong head winds), use the shift paddles (if equipped, refer to "Paddle Shift Mode" in this section for further information) to select a lower gear.

*(Continued)*

Information Provided by:  
**DEALER**  
 SERVICE PROCESS



Under these conditions, using a lower gear will improve performance and extend transmission life by reducing excessive shifting and heat buildup.

If the transmission temperature exceeds normal operating limits, the transmission controller may modify the transmission shift schedule, reduce engine torque, and/or expand the range of torque converter clutch engagement. This is done to prevent transmission damage due to overheating.

If the transmission becomes extremely hot, the "Transmission Temperature Warning Light" will illuminate, a warning message will appear in the EVIC/DID and the transmission may operate differently until the transmission cools down.

During cold temperatures, transmission operation may be modified depending on engine and transmission temperature as well as vehicle speed. This feature improves warm up time of the engine and transmission to

achieve maximum efficiency. Engagement of the torque converter clutch, and shifts into 8th or 9th gear, are inhibited until the transmission fluid is warm (refer to the "Note" under "Torque Converter Clutch" in this section). Normal operation will resume once the transmission temperature has risen to a suitable level.

### **SPORT (S) — If Equipped**

This mode alters the transmission's automatic shift schedule for sportier driving. Upshift speeds are increased to make full use of available engine power. To access SPORT mode, push down on the gear selector and rotate it fully clockwise.

### **LOW (L) — If Equipped**

Use this range for engine braking when descending very steep grades. In this range, the transmission will downshift for increased engine braking. To access the LOW position, push down on the gear selector and rotate it fully clockwise.

### Transmission Limp Home Mode

Transmission function is monitored electronically for abnormal conditions. If a condition is detected that could result in transmission damage, Transmission Limp Home Mode is activated. In this mode, the transmission may operate only in a fixed gear, or may remain in NEUTRAL. The Malfunction Indicator Light (MIL) may be illuminated. Limp Home Mode may allow the vehicle to be driven to an authorized dealer for service without damaging the transmission.

In the event of a momentary problem, the transmission can be reset to regain all forward gears by performing the following steps:

1. Stop the vehicle.
2. Shift the transmission into PARK, if possible. If not, shift the transmission to NEUTRAL.

3. Push and hold the ignition switch until the engine turns OFF.
4. Wait approximately 30 seconds.
5. Restart the engine.
6. Shift into the desired gear range. If the problem is no longer detected, the transmission will return to normal operation.

**NOTE:** Even if the transmission can be reset, we recommend that you visit your authorized dealer at your earliest possible convenience. Your authorized dealer has diagnostic equipment to determine if the problem could recur. If the transmission cannot be reset, authorized dealer service is required.

### Torque Converter Clutch

A feature designed to improve fuel economy has been included in the automatic transmission on your vehicle.

A clutch within the torque converter engages automatically at calibrated speeds. This may result in a slightly different feeling or response during normal operation in the upper gears. When the vehicle speed drops or during some accelerations, the clutch automatically disengages.

**NOTE:** The torque converter clutch will not engage until the transmission fluid is warm (usually after 1 to 3 miles [2 to 5 km] of driving). Because the engine speed is higher when the torque converter clutch is not engaged, it may seem as if the transmission is not shifting properly when cold. This is normal. The torque converter clutch will function normally once the transmission is sufficiently warm.

### **PADDLE SHIFT MODE — IF EQUIPPED**

Paddle Shift mode is a driver-interactive transmission feature providing manual shift control, giving you more control of the vehicle. Paddle Shift allows you to maximize engine braking, eliminate undesirable upshifts and

downshifts, and improve overall vehicle performance. This system can also provide you with more control during passing, city driving, cold slippery conditions, mountain driving and many other situations.

### **Operation**

When the transmission is in DRIVE or SPORT mode, it will operate automatically, shifting between the nine available gears. To activate Paddle Shift mode, simply tap one of the steering wheel-mounted shift paddles (+/-) while in DRIVE or SPORT mode. In DRIVE mode, this will activate a temporary Paddle Shift mode. The transmission will revert back to normal operation after a period of time, depending on accelerator pedal activity. When the transmission gear selector is in the SPORT position, tapping either shift paddle will activate "permanent" Paddle Shift mode. The transmission will remain in Paddle Shift mode until the driver deliberately disables Paddle Shift (as described below). Tapping (-) to enter

Paddle Shift mode will downshift the transmission to the next lower gear, while using (+) to enter Paddle Shift mode will retain the current gear. When Paddle Shift is active, the current transmission gear is displayed in the instrument cluster.

In Paddle Shift mode, the transmission will shift up or down when (+/-) is manually selected by the driver, unless an engine lugging or overspeed condition would result. It will remain in the selected gear until another upshift or downshift is chosen, except as described below.

- If Paddle Shift is engaged while in DRIVE mode, the transmission will automatically shift up when maximum engine speed is reached. Lack of accelerator pedal activity will cause the transmission to revert to automatic operation.
- If Paddle Shift is engaged while in SPORT mode, the transmission will remain in the selected gear even when maximum engine speed is reached (except the transmission will upshift automatically from 1st to 2nd gear at wide open throttle, if necessary). Otherwise, the transmission will upshift only when commanded by the driver.
- In either DRIVE or SPORT mode, the transmission will automatically downshift as the vehicle slows to a stop (to prevent engine lugging) and will display the current gear. Tapping the (+) paddle (at a stop) will allow starting in second gear. After a stop, the driver should manually upshift (+) the transmission as the vehicle accelerates.
- If a requested downshift would cause the engine to over-speed, that shift will not occur.
- The system will ignore attempts to upshift at too low of a vehicle speed.
- Holding the (-) paddle depressed will downshift the transmission to the lowest gear possible at the current speed.

- Transmission shifting will be more noticeable when Paddle Shift mode is enabled.
- The system may revert to automatic shift mode if a fault or overheat condition is detected.

To disengage Paddle Shift mode, press and hold the (+) shift paddle until “D” or “S” is once again indicated in the instrument cluster. You can shift in or out of Paddle Shift mode at any time without taking your foot off the accelerator pedal.

### **WARNING!**

**Do not downshift for additional engine braking on a slippery surface. The drive wheels could lose their grip and the vehicle could skid, causing a collision or personal injury.**

### **ALL WHEEL DRIVE (AWD) — IF EQUIPPED**

This feature provides on-demand All-Wheel Drive (AWD). The system is automatic with no driver inputs or additional driving skills required. Under normal driving conditions, the front wheels provide most of the traction. If the front wheels begin to lose traction, power is shifted automatically to the rear wheels. The greater the front wheel traction loss, the greater the power transfer to the rear wheels.

Additionally, on dry pavement under heavy throttle input (where one may have no wheel spin), torque will be sent to the rear in a pre-emptive effort to improve vehicle launch and performance characteristics.

### **CAUTION!**

**All wheels must have the same size and type tires. Unequal tire sizes must not be used. Unequal tire size may cause failure of the power transfer unit.**

## DRIVING ON SLIPPERY SURFACES

### Acceleration

Rapid acceleration on snow covered, wet, or other slippery surfaces may cause the driving wheels to pull erratically to the right or left. This phenomenon occurs when there is a difference in the surface traction under the front (driving) wheels.

#### WARNING!

**Rapid acceleration on slippery surfaces is dangerous. Unequal traction can cause sudden pulling of the front wheels. You could lose control of the vehicle and possibly have a collision. Accelerate slowly and carefully whenever there is likely to be poor traction (ice, snow, wet, mud, loose sand, etc.).**

### Traction

When driving on wet or slushy roads, it is possible for a wedge of water to build up between the tire and road surface. This is hydroplaning and may cause partial or complete loss of vehicle control and stopping ability. To reduce this possibility, the following precautions should be observed:

1. Slow down during rainstorms or when the roads are slushy.
2. Slow down if the road has standing water or puddles.
3. Replace the tires when tread wear indicators first become visible.
4. Keep tires properly inflated.
5. Maintain sufficient distance between your vehicle and the vehicle in front of you to avoid a collision in a sudden stop.

## DRIVING THROUGH WATER

Driving through water more than a few inches/centimeters deep will require extra caution to ensure safety and prevent damage to your vehicle.

### Flowing/Rising Water

#### WARNING!

Do not drive on or across a road or path where water is flowing and/or rising (as in storm run-off). Flowing water can wear away the road or path's surface and cause your vehicle to sink into deeper water. Furthermore, flowing and/or rising water can carry your vehicle away swiftly. Failure to follow this warning may result in injuries that are serious or fatal to you, your passengers, and others around you.

### Shallow Standing Water

Although your vehicle is capable of driving through shallow standing water, consider the following Cautions and Warnings before doing so.

#### WARNING!

- Driving through standing water limits your vehicle's traction capabilities. Do not exceed 5 mph (8 km/h) when driving through standing water.
- Driving through standing water limits your vehicle's braking capabilities, which increases stopping distances. Therefore, after driving through standing water, drive slowly and lightly press on the brake pedal several times to dry the brakes.
- Failure to follow these warnings may result in injuries that are serious or fatal to you, your passengers, and others around you.

**CAUTION!**

- Always check the depth of the standing water before driving through it. Never drive through standing water that is deeper than the bottom of the tire rims mounted on the vehicle.
- Determine the condition of the road or the path that is under water and if there are any obstacles in the way before driving through the standing water.
- Do not exceed 5 mph (8 km/h) when driving through standing water. This will minimize wave effects.
- Driving through standing water may cause damage to your vehicle's drivetrain components. Always inspect your vehicle's fluids (i.e., engine oil, transmission, axle, etc.) for signs of contamination (i.e., fluid that is milky or foamy in appearance) after driving through standing water. Do not continue to

*(Continued)*

**CAUTION! (Continued)**

- operate the vehicle if any fluid appears contaminated, as this may result in further damage. Such damage is not covered by the New Vehicle Limited Warranty.
- Getting water inside your vehicle's engine can cause it to lock up and stall out, and cause serious internal damage to the engine. Such damage is not covered by the New Vehicle Limited Warranty.

**POWER STEERING**

The electric power steering system will give you good vehicle response and increased ease of maneuverability in tight spaces. The system will vary its assist to provide light efforts while parking and good feel while driving. If the electric steering system experiences a fault that reduces assist or prevents the vehicle from providing assist, you will still have the ability to steer the vehicle manually.



**WARNING!**

**Continued operation with reduced assist could pose a safety risk to yourself and others. Service should be obtained as soon as possible.**



If the “SERVICE POWER STEERING” OR “POWER STEERING ASSIST OFF - SERVICE SYSTEM” message and a steering wheel icon are displayed on the EVIC/DID screen, it indicates that the vehicle needs to be taken to the dealer for service. It is likely the vehicle has lost power steering assistance. Refer to “Electronic Vehicle Information (EVIC) or “Driver Information Display (DID)” in “Understanding Your Instrument Panel” for further information.

**NOTE:**

- Even if the power steering assistance is no longer operational, it is still possible to steer the vehicle. Under these conditions there will be a substantial increase in steering effort, especially at low speeds and during parking maneuvers.
- If the condition persists, see your authorized dealer for service.

**ELECTRIC PARK BRAKE (EPB)**

Your vehicle is equipped with an Electric Park Brake System (EPB) that offers simple operation, and some additional features that make the park brake more convenient and useful.

## 472 STARTING AND OPERATING

The park brake is primarily intended to prevent the vehicle from rolling while parked. Before leaving the vehicle, make sure that the park brake is applied. Also, be certain to leave the transmission in PARK.

You can engage the park brake in two ways;

- Manually, by applying the park brake switch.
- Automatically, by enabling the Auto Park Brake feature in the customer programmable features section of the Uconnect Settings.

The park brake switch is located in the center console.



**Electric Park Brake Switch**

To apply the park brake manually, pull up on the switch momentarily. You may hear a slight whirring sound from the back of the vehicle while the park brake engages. Once the park brake is fully engaged, the BRAKE warning lamp in the instrument cluster and an indicator on the switch will illuminate. If your foot is on the brake

pedal while you apply the park brake, you may notice a small amount of brake pedal movement. The park brake can be applied even when the ignition switch is OFF, however, it can only be released when the ignition switch is in the RUN position.

**NOTE:** The EPB fault lamp will illuminate if the EPB switch is held for longer than 20 seconds in the applied position or 90 seconds in the released position. The light will extinguish upon releasing the switch.

If the Auto Park Brake feature is enabled, the parking brake will automatically engage whenever the transmission is placed into PARK. Once the park brake is engaged, the BRAKE warning lamp in the instrument cluster and the LED indicator on the switch will illuminate. If your foot is on the brake pedal, you may notice a small amount of brake pedal movement while the parking brake is engaging.

The park brake will release automatically when the ignition is cycled to the RUN position, the transmission is in DRIVE or REVERSE, the driver seat belt is buckled, and an attempt is made to drive away by pressing the accelerator pedal.

To release the parking brake manually, the ignition switch must be in the RUN position. Press on the brake pedal, then push the park brake switch down momentarily. You may hear a slight whirring sound from the back of the vehicle while the parking brake disengages. You may also notice a small amount of movement in the brake pedal. Once the park brake is fully disengaged, the BRAKE warning lamp in the instrument cluster and the LED indicator on the switch will extinguish.

**NOTE:** When parking on a hill, it is important to turn the front wheels toward the curb on a downhill grade and away from the curb on an uphill grade. Apply the park brake before placing the shift lever in PARK, otherwise the load on the transmission locking mechanism may make it difficult to move the shift lever out of PARK. The park brake should always be applied whenever the driver is not in the vehicle.

**WARNING!**

- Never use the PARK position as a substitute for the parking brake. Always apply the parking brake fully when parked to guard against vehicle movement and possible injury or damage.
- When leaving the vehicle, always make sure the ignition is in the OFF mode, remove the Key Fob from the vehicle, and lock your vehicle.

**WARNING! (Continued)**

- Never leave children alone in a vehicle, or with access to an unlocked vehicle. Allowing children to be in a vehicle unattended is dangerous for a number of reasons. A child or others could be seriously or fatally injured. Children should be warned not to touch the parking brake, brake pedal or the transmission gear selector.
- Do not leave the Key Fob in or near the vehicle, (or in a location accessible to children), and do not leave the ignition in the ACC or ON/RUN mode. A child could operate power windows, other controls, or move the vehicle.
- Be sure the parking brake is fully disengaged before driving; failure to do so can lead to brake failure and a collision.

*(Continued)*

*(Continued)*

**WARNING! (Continued)**

- Always fully apply the parking brake when leaving your vehicle, or it may roll and cause damage or injury. Also be certain to leave the transmission in PARK. Failure to do so may allow the vehicle to roll and cause damage or injury.
- Driving the vehicle with the parking brake engaged, or repeated use of the parking brake to slow the vehicle may cause serious damage to the brake system.

**CAUTION!**

If the Brake System Warning Light remains on with the parking brake released, a brake system malfunction is indicated. Have the brake system serviced by an authorized dealer immediately.

If exceptional circumstances should make it necessary to engage the park brake while the vehicle is in motion, maintain upward pressure on the electric park brake switch for as long as engagement is desired. The BRAKE warning lamp will illuminate, and a continuous chime will sound. The rear stop lamps will also be illuminated automatically while the vehicle remains in motion.

To disengage the park brake while the vehicle is in motion, release the switch. If the vehicle is brought to a complete stop using the park brake, when the vehicle reaches approximately 3 mph (4.8 km/h), the park brake will remain engaged.

In the unlikely event of a malfunction of the Electric Park Brake system, a yellow EPB fault lamp will illuminate. This may be accompanied by the BRAKE warning lamp flashing. In this case, urgent service of the electric park brake system is required. Do not rely on the park brake to hold the vehicle stationary.

## Auto Park Brake

The Electric Park Brake can be programmed to be applied automatically whenever the vehicle is at a standstill and the automatic transmission is placed in PARK. Auto Park Brake is enabled and disabled by customer selection through the customer programmable features section of the Uconnect Settings.

Any single Auto Park Brake application can be bypassed by holding the EPB switch in the release position while the transmission is being placed into PARK. This bypass can be reset by cycling the ignition off and back on again, or by driving the vehicle up to at least 12 mph (20 km/h), or by going to the personal setting menu and turning the Auto Park Brake function OFF and then back ON again.

## SafeHold

SafeHold is a safety feature of the Electric Park Brake System that will engage the park brake automatically if

the vehicle is left unsecured. If the automatic transmission is not in PARK, the seat belt is unbuckled, the driver door is open, the vehicle is at a standstill, and there is no attempt to depress the brake pedal or accelerator pedal, the park brake will automatically engage to prevent the vehicle from rolling.

SafeHold can be temporarily bypassed by pressing the Electric Park Brake Switch to the release position while the driver door is open. Once manually bypassed, SafeHold will be enabled again once the vehicle reaches 12 mph (20 km/h) or the ignition is cycled to the OFF position and back to ON again.

## Brake Service Mode

We recommend having your brakes serviced by your authorized dealer. You should only make repairs for which you have the knowledge and the right equipment. You should only enter Brake Service Mode during brake service.

When servicing your rear brakes, it may be necessary for you or your technician push the rear piston into the rear caliper bore. With the Electric Park Brake system, this can only be done after retracting the Electric Park Brake actuator. Fortunately, actuator retraction can be done easily by entering the Brake Service Mode through EVIC (Electronic Vehicle Information Center), Driver Information Display (DID) or the Uconnect Settings in your vehicle. This menu based system will guide you through the steps necessary to retract the EPB actuator in order to perform rear brake service.

Service Mode has requirements that must be met in order to be activated:

- The vehicle must be at a standstill.
- The park brake must be unapplied.
- The transmission must be in PARK or NEUTRAL.

While in service mode, the Electric Park Brake fault lamp will flash continuously while the ignition switch is ON.

When brake service work is complete, the following steps must be followed to reset the parking brake system to normal operation:

- Ensure the vehicle is at a standstill.
- Press the brake pedal with moderate force.
- Apply the Electric Park Brake Switch.

### WARNING!

**You can be badly injured working on or around a motor vehicle. Do only that service work for which you have the knowledge and the right equipment. If you have any doubt about your ability to perform a service job, take your vehicle to a competent mechanic.**

## BRAKE SYSTEM

Your vehicle is equipped with dual hydraulic brake systems. If either of the two hydraulic systems loses normal capability, the remaining system will still function. However, there will be some loss of overall braking effectiveness. You may notice increased pedal travel during application, greater pedal force required to slow or stop, and potential activation of the “Brake System Warning Light”.

In the event power assist is lost for any reason (i.e., repeated brake applications with the engine off) the brakes will still function. However, the effort required to brake the vehicle will be much greater than that required with the power system operating.

## ELECTRONIC BRAKE CONTROL SYSTEM

Your vehicle is equipped with an advanced Electronic Brake Control system (EBC). This system includes Electronic Brake Force Distribution (EBD), Anti-Lock Brake System (ABS), Brake Assist System (BAS), Hill Start Assist (HSA), Traction Control System (TCS), Electronic Stability Control (ESC), and Electronic Roll Mitigation (ERM). These systems work together to enhance both vehicle stability and control in various driving conditions.

Your vehicle may also be equipped with Ready Alert Braking (RAB), Rain Brake Support (RBS), and Dynamic Steering Torque (DST).

### Electronic Brake Force Distribution (EBD)

This function manages the distribution of the braking torque between the front and rear axles by limiting braking pressure to the rear axle. This is done to prevent overslip of the rear wheels to avoid vehicle instability, and to prevent the rear axle from entering ABS before the front axle.



## Brake System Warning Light

The red “Brake System Warning Light” will turn on when the ignition switch is turned to the ON position and may stay on for as long as four seconds.

If the “Brake System Warning Light” remains on or comes on while driving, it indicates that the brake system is not functioning properly and that immediate service is required. If the “Brake System Warning Light” does not come on when the ignition switch is turned to the ON position, have the light repaired as soon as possible.

## Anti-Lock Brake System (ABS)

The Anti-Lock Brake System (ABS) provides increased vehicle stability and brake performance under most braking conditions. The system automatically prevents wheel lock, and enhances vehicle control during braking.

The ABS performs a self-check cycle to ensure that the ABS is working properly each time the vehicle is started

and driven. During this self-check you may hear a slight clicking sound as well as some related motor noises.

ABS is activated during braking when the system detects one or more wheels begins to lock. Road conditions such as ice, snow, gravel, bumps, railroad tracks, loose debris, or panic stops may increase the likelihood of ABS activation(s).

You also may experience the following when ABS activates:

- The ABS motor noise (it may continue to run for a short time after the stop).
- The clicking sound of solenoid valves.
- Brake pedal pulsations.
- A slight drop of the brake pedal at the end of the stop.

These are all normal characteristics of ABS.

**WARNING!**

- The ABS contains sophisticated electronic equipment that may be susceptible to interference caused by improperly installed or high output radio transmitting equipment. This interference can cause possible loss of anti-lock braking capability. Installation of such equipment should be performed by qualified professionals.
- Pumping of the Anti-Lock Brakes will diminish their effectiveness and may lead to a collision. Pumping makes the stopping distance longer. Just press firmly on your brake pedal when you need to slow down or stop.

*(Continued)*

**WARNING! (Continued)**

- The ABS cannot prevent the natural laws of physics from acting on the vehicle, nor can it increase braking or steering efficiency beyond that afforded by the condition of the vehicle brakes and tires or the traction afforded.
- The ABS cannot prevent collisions, including those resulting from excessive speed in turns, following another vehicle too closely, or hydroplaning.
- The capabilities of an ABS equipped vehicle must never be exploited in a reckless or dangerous manner that could jeopardize the user's safety or the safety of others.

ABS is designed to function with the OEM tires. Modification may result in degraded ABS performance.

## Anti-Lock Brake Warning Light

The amber “Anti-Lock Brake Warning Light” will turn on when the ignition switch is turned to the ON position and may stay on for as long as four seconds.

If the “Anti-Lock Brake Warning Light” remains on or comes on while driving, it indicates that the anti-lock portion of the brake system is not functioning and that service is required. However, the conventional brake system will continue to operate normally if the “Brake System Warning Light” is not on.

If the “Anti-Lock Brake Warning Light” is on, the brake system should be serviced as soon as possible to restore the benefits of anti-lock brakes. If the “Anti-Lock Brake Warning Light” does not come on when the ignition switch is turned to the ON position, have the light repaired as soon as possible.

## Brake Assist System (BAS)

The BAS is designed to optimize the vehicle’s braking capability during emergency braking maneuvers. The system detects an emergency braking situation by sensing the rate and amount of brake application and then applies optimum pressure to the brakes. This can help reduce braking distances. The BAS complements the anti-lock brake system (ABS). Applying the brakes very quickly results in the best BAS assistance. To receive the benefit of the system, you must apply continuous braking pressure during the stopping sequence, (do not “pump” the brakes). Do not reduce brake pedal pressure unless braking is no longer desired. Once the brake pedal is released, the BAS is deactivated.

**WARNING!**

The Brake Assist System (BAS) cannot prevent the natural laws of physics from acting on the vehicle, nor can it increase the traction afforded by prevailing road conditions. BAS cannot prevent collisions, including those resulting from excessive speed in turns, driving on very slippery surfaces, or hydroplaning. The capabilities of a BAS-equipped vehicle must never be exploited in a reckless or dangerous manner, which could jeopardize the user's safety or the safety of others.

**Hill Start Assist (HSA)**

The HSA system is designed to mitigate roll back from a complete stop while on an incline. If the driver releases the brake while stopped on an incline, HSA will continue to hold the brake pressure for a short period. If the driver

does not apply the throttle before this time expires, the system will release brake pressure and the vehicle will roll down the hill as normal.

The following conditions must be met in order for HSA to activate:

- The feature must be enabled.
- The vehicle must be stopped.
- Park brake must be off.
- Driver door must be closed.
- The vehicle must be on a sufficient grade.
- The gear selection must match vehicle uphill direction (i.e., vehicle facing uphill is in forward gear; vehicle backing uphill is in REVERSE gear).
- HSA will work in REVERSE gear and all forward gears. The system will not activate if the transmission

is in PARK or NEUTRAL. For vehicles equipped with a manual transmission if the clutch is pressed HSA will remain active.

### WARNING!

There may be situations where the Hill Start Assist (HSA) will not activate and slight rolling may occur, such as on minor hills or with a loaded vehicle, or while pulling a trailer. HSA is not a substitute for active driving involvement. It is always the driver's responsibility to be attentive to distance to other vehicles, people, and objects, and most importantly brake operation to ensure safe operation of the vehicle under all road conditions. Your complete attention is always required while driving to maintain safe control of your vehicle. Failure to follow these warnings can result in a collision or serious personal injury.

### Towing With HSA

HSA will also provide assistance to mitigate roll back while towing a trailer.

### WARNING!

- If you use a trailer brake controller with your trailer, the trailer brakes may be activated and deactivated with the brake switch. If so, there may not be enough brake pressure to hold both the vehicle and the trailer on a hill when the brake pedal is released. In order to avoid rolling down an incline while resuming acceleration, manually activate the trailer brake or apply more vehicle brake pressure prior to releasing the brake pedal.
- HSA is not a parking brake. Always apply the parking brake fully when leaving your vehicle. Also, be certain to leave the transmission in PARK.

*(Continued)*

**WARNING! (Continued)**

- Failure to follow these warnings can result in a collision or serious personal injury.

**Disabling And Enabling HSA**

This feature can be turned on or turned off. To change the current setting, proceed as follows:

- For vehicles equipped with the Electronic Vehicle Information Center (EVIC) or Driver Information Display (DID), refer to “Electronic Vehicle Information Center (EVIC)” or “Driver Information Display (DID)” in “Understanding Your Instrument Panel” for further information.
- If disabling HSA using Uconnect Settings, refer to “Uconnect Settings” in “Understanding Your Instrument Panel” for further information.

For vehicles not equipped with the EVIC/DID, perform the following steps:

1. Center the steering wheel (front wheels pointing straight forward).
2. Shift the transmission into PARK.
3. Apply the parking brake.
4. Start the engine.
5. Rotate the steering wheel slightly more than one-half turn to the left.
6. Push the “ESC Off” button located in the lower switch bank below the climate control four times within twenty seconds. The “ESC Off Indicator Light” should turn on and turn off two times.
7. Rotate the steering wheel back to center and then an additional slightly more than one-half turn to the right.

8. Turn the ignition switch to the OFF position and then back to the ON position. If the sequence was completed properly, the “ESC Off Indicator Light” will blink several times to confirm HSA is disabled.
9. Repeat these steps if you want to return this feature to its previous setting.

### Traction Control System (TCS)

This system monitors the amount of wheel spin of each of the driven wheels. If wheel spin is detected, the TCS may apply brake pressure to the spinning wheel(s) and/or reduce engine power to provide enhanced acceleration and stability. A feature of the TCS, Brake Limited Differential (BLD), functions similar to a limited slip differential and controls the wheel spin across a driven axle. If one wheel on a driven axle is spinning faster than the other, the system will apply the brake of the spinning wheel. This will allow more engine torque to be applied to the wheel that is not spinning. BLD may remain enabled even if TCS and ESC are in a reduced mode.

### Electronic Stability Control (ESC)

This system enhances directional control and stability of the vehicle under various driving conditions. ESC corrects for oversteering or understeering of the vehicle by applying the brake of the appropriate wheel(s) to assist in counteracting the oversteer or understeer condition. Engine power may also be reduced to help the vehicle maintain the desired path.

ESC uses sensors in the vehicle to determine the vehicle path intended by the driver and compares it to the actual path of the vehicle. When the actual path does not match the intended path, ESC applies the brake of the appropriate wheel to assist in counteracting the oversteer or understeer condition.

- Oversteer - when the vehicle is turning more than appropriate for the steering wheel position.
- Understeer - when the vehicle is turning less than appropriate for the steering wheel position.

The “ESC Activation/Malfunction Indicator Light” located in the instrument cluster will start to flash as soon as the ESC system becomes active. The “ESC Activation/Malfunction Indicator Light” also flashes when the TCS is active. If the “ESC Activation/Malfunction Indicator Light” begins to flash during acceleration, ease up on the accelerator and apply as little throttle as possible. Be sure to adapt your speed and driving to the prevailing road conditions.

**WARNING!**

- Electronic Stability Control (ESC) cannot prevent the natural laws of physics from acting on the vehicle, nor can it increase the traction afforded by prevailing road conditions. ESC cannot prevent accidents, including those resulting from excessive speed in turns, driving on very slippery surfaces, or

*(Continued)*



Information Provided by:  
**DEALER**  
E-PROCESS

**WARNING! (Continued)**

hydroplaning. ESC also cannot prevent accidents resulting from loss of vehicle control due to inappropriate driver input for the conditions. Only a safe, attentive, and skillful driver can prevent accidents. The capabilities of an ESC equipped vehicle must never be exploited in a reckless or dangerous manner which could jeopardize the user’s safety or the safety of others.

- Vehicle modifications, or failure to properly maintain your vehicle, may change the handling characteristics of your vehicle, and may negatively affect the performance of the ESC system. Changes to the steering system, suspension, braking system, tire type and size or wheel size may adversely affect

*(Continued)*



**WARNING! (Continued)**

ESC performance. Improperly inflated and unevenly worn tires may also degrade ESC performance. Any vehicle modification or poor vehicle maintenance that reduces the effectiveness of the ESC system can increase the risk of loss of vehicle control, vehicle rollover, personal injury and death.

**ESC Operating Modes**

**NOTE:** Depending upon model and mode of operation, the ESC system may have multiple operating modes.

**ESC On**

This is the normal operating mode for the ESC. Whenever the vehicle is started, the ESC system will be in this mode. This mode should be used for most driving conditions. Alternate ESC modes should only be used for specific reasons as noted in the following paragraphs.

**Partial Off**

The “Partial Off” mode is intended for times when a more spirited driving experience is desired. This mode may modify TCS and ESC thresholds for activation, which allows for more wheel spin than normally allowed. This mode may be useful if the vehicle becomes stuck.

To enter the “Partial Off” mode, momentarily push the “ESC Off” switch and the “ESC Off Indicator Light” will illuminate. To turn the ESC on again, momentarily push the “ESC Off” switch and the “ESC Off Indicator Light” will turn off.

**NOTE:** When driving with snow chains, or when starting off in deep snow, sand, or gravel, it may be desirable to allow more wheel spin when starting off in snow, mud, sand, gravel, or when using tire chains. This can be accomplished by momentarily pushing the “ESC off” button to enter partial mode “Partial Off” mode. Once the situation requiring “Partial Off” mode is overcome, turn ESC back on by momentarily pushing the “ESC Off” button. This may be done while the vehicle is in motion.

**NOTE:**

- When in “Partial Off” mode, the TCS functionality of ESC, (except for the limited slip feature described in the TCS section), has been disabled and the “ESC Off Indicator Light” will be illuminated. When in “Partial Off” mode, the engine power reduction feature of TCS is disabled, and the enhanced vehicle stability offered by the ESC system is reduced.
- Trailer Sway control (TSC) is disabled when the ESC system is in the “Partial Off” mode.

**ESC Activation/Malfunction Indicator Light and ESC OFF Indicator Light**

The “ESC Activation/Malfunction Indicator Light” in the instrument cluster will come on when the ignition switch is turned to the ON position. It should go out with the engine

running. If the “ESC Activation/Malfunction Indicator Light” comes on continuously with the engine running, a malfunction has been detected in the ESC system. If this light remains on after several ignition cycles, and the vehicle has been driven several miles (kilometers) at speeds greater than 30 mph (48 km/h), see your authorized dealer as soon as possible to have the problem diagnosed and corrected.

The “ESC Activation/Malfunction Indicator Light” (located in the instrument cluster) starts to flash as soon as the tires lose traction and the ESC system becomes active. The “ESC Activation/Malfunction Indicator Light” also flashes when TCS is active. If the “ESC Activation/Malfunction Indicator Light” begins to flash during acceleration, ease up on the accelerator and apply as little throttle as possible. Be sure to adapt your speed and driving to the prevailing road conditions.

**NOTE:**

- The “ESC Activation/Malfunction Indicator Light” and the “ESC OFF Indicator Light” come on momentarily each time the ignition switch is turned ON.
- Each time the ignition is turned ON, the ESC system will be ON even if it was turned off previously.
- The ESC system will make buzzing or clicking sounds when it is active. This is normal; the sounds will stop when ESC becomes inactive following the maneuver that caused the ESC activation.



The “ESC OFF Indicator Light” indicates the customer has elected to have the Electronic Stability Control (ESC) in a reduced mode.

**Electronic Roll Mitigation (ERM)**

This system anticipates the potential for wheel lift by monitoring the driver’s steering wheel input and the speed of the vehicle. When ERM determines that the rate of change of the steering wheel angle and vehicle’s speed are sufficient to potentially cause wheel lift, it then applies the appropriate brake and may also reduce engine power to lessen the chance that wheel lift will occur. ERM can only reduce the chance of wheel lift occurring during severe or evasive driving maneuvers; it cannot prevent wheel lift due to other factors, such as road conditions, leaving the roadway, or striking objects or other vehicles.

**WARNING!**

Many factors, such as vehicle loading, road conditions and driving conditions, influence the chance that wheel lift or rollover may occur. ERM cannot prevent all wheel lift or roll overs, especially those that involve leaving the roadway or striking objects or other vehicles. The capabilities of an ERM-equipped vehicle must never be exploited in a reckless or dangerous manner which could jeopardize the user's safety or the safety of others.

**Ready Alert Braking (RAB)**

Ready Alert Braking may reduce the time required to reach full braking during emergency braking situations. It anticipates when an emergency braking situation may occur by monitoring how fast the throttle is released by the driver. The EBC will prepare the brake system for a panic stop.

**Rainy Brake Support (RBS)**

Rainy Brake Support may improve braking performance in wet conditions. It will periodically apply a small amount of brake pressure to remove any water buildup on the front brake rotors. It functions when the windshield wipers are in LO or HI speed. When Rainy Brake Support is active, there is no notification to the driver and no driver interaction is required.

**Dynamic Steering Torque (DST)**

Dynamic Steering Torque is a feature of the ESC and EPS modules that provides torque at the steering wheel for certain driving conditions in which the ESC module is detecting vehicle instability. The torque that the steering wheel receives is only meant to help the driver realize optimal steering behavior in order to reach/maintain vehicle stability. The only notification the driver receives that the feature is active is the torque applied to the steering wheel.

**NOTE:** The DST feature is only meant to help the driver realize the correct course of action through small torques on the steering wheel, which means the effectiveness of the DST feature is highly dependent on the drivers sensitivity and overall reaction to the applied torque. It is very important to realize that this feature will not steer the vehicle, meaning the driver is still responsible for steering the vehicle.

## TIRE SAFETY INFORMATION

### Tire Markings

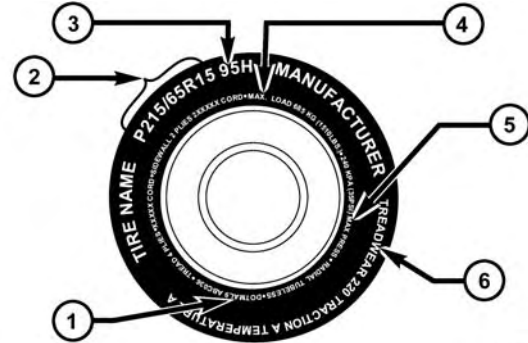

054903773

- |  |  |
|--|--|
| 1 — U.S. DOT Safety Standards Code (TIN) | 4 — Maximum Load                               |
| 2 — Size Designation                     | 5 — Maximum Pressure                           |
| 3 — Service Description                  | 6 — Treadwear, Traction and Temperature Grades |

**NOTE:**

- P (Passenger) — Metric tire sizing is based on U.S. design standards. P-Metric tires have the letter “P” molded into the sidewall preceding the size designation. Example: P215/65R15 95H.
- European — Metric tire sizing is based on European design standards. Tires designed to this standard have the tire size molded into the sidewall beginning with the section width. The letter “P” is absent from this tire size designation. Example: 215/65R15 96H.
- LT (Light Truck) — Metric tire sizing is based on U.S. design standards. The size designation for LT-Metric tires is the same as for P-Metric tires except for the letters “LT” that are molded into the sidewall preceding the size designation. Example: LT235/85R16.
- Temporary spare tires are designed for temporary emergency use only. Temporary high pressure compact spare tires have the letter “T” or “S” molded into the sidewall preceding the size designation. Example: T145/80D18 103M.
- High flotation tire sizing is based on U.S. design standards and it begins with the tire diameter molded into the sidewall. Example: 31x10.5 R15 LT.

## Tire Sizing Chart

### EXAMPLE:

---

**Example Size Designation: P215/65R15XL 95H, 215/65R15 96H, LT235/85R16C, T145/80D18 103M, 31x10.5 R15 LT**

---

**P** = Passenger car tire size based on U.S. design standards, or

**"...blank..."** = Passenger car tire based on European design standards, or

**LT** = Light truck tire based on U.S. design standards, or

**T or S** = Temporary spare tire or

**31** = Overall diameter in inches (in)

---

**215, 235, 145** = Section width in millimeters (mm)

---

**65, 85, 80** = Aspect ratio in percent (%)

– Ratio of section height to section width of tire, or

**10.5** = Section width in inches (in)

---

**R** = Construction code

– "R" means radial construction, or

– "D" means diagonal or bias construction

---

**15, 16, 18** = Rim diameter in inches (in)

---

**EXAMPLE:**

---

**Service Description:**

---

95 = Load Index

- A numerical code associated with the maximum load a tire can carry

---

H = Speed Symbol

- A symbol indicating the range of speeds at which a tire can carry a load corresponding to its load index under certain operating conditions
- The maximum speed corresponding to the speed symbol should only be achieved under specified operating conditions (i.e., tire pressure, vehicle loading, road conditions, and posted speed limits)

---

**Load Identification:**

Absence of the following load identification symbols on the sidewall of the tire indicates a Standard Load (SL) tire:

- **XL** = Extra load (or reinforced) tire, or
- **LL** = Light load tire or
- **C, D, E, F, G** = Load range associated with the maximum load a tire can carry at a specified pressure

---

**Maximum Load** – Maximum load indicates the maximum load this tire is designed to carry

---

**Maximum Pressure** – Maximum pressure indicates the maximum permissible cold tire inflation pressure for this tire

---



## Tire Identification Number (TIN)

The TIN may be found on one or both sides of the tire, however, the date code may only be on one side. Tires with white sidewalls will have the full TIN, including the date code, located on the white sidewall side of the tire.

Look for the TIN on the outboard side of black sidewall tires as mounted on the vehicle. If the TIN is not found on the outboard side, then you will find it on the inboard side of the tire.

### EXAMPLE:

**DOT MA L9 ABCD 0301**

**DOT** = Department of Transportation

– This symbol certifies that the tire is in compliance with the U.S. Department of Transportation tire safety standards and is approved for highway use

**MA** = Code representing the tire manufacturing location (two digits)

**L9** = Code representing the tire size (two digits)

**ABCD** = Code used by the tire manufacturer (one to four digits)

**03** = Number representing the week in which the tire was manufactured (two digits)

– 03 means the 3rd week

**EXAMPLE:****DOT MA L9 ABCD 0301**

**01** = Number representing the year in which the tire was manufactured (two digits)

– 01 means the year 2001

– Prior to July 2000, tire manufacturers were only required to have one number to represent the year in which the tire was manufactured. Example: 031 could represent the 3rd week of 1981 or 1991

## Tire Terminology And Definitions

Term	Definition
<b>B-Pillar</b>	The vehicle B-Pillar is the structural member of the body located behind the front door.
<b>Cold Tire Inflation Pressure</b>	Cold tire inflation pressure is defined as the tire pressure after the vehicle has not been driven for at least three hours, or driven less than 1 mile (1.6 km) after sitting for a minimum of three hours. Inflation pressure is measured in units of PSI (pounds per square inch) or kPa (kilopascals).
<b>Maximum Inflation Pressure</b>	The maximum inflation pressure is the maximum permissible cold tire inflation pressure for this tire. The maximum inflation pressure is molded into the sidewall.
<b>Recommended Cold Tire Inflation Pressure</b>	Vehicle manufacturer's recommended cold tire inflation pressure as shown on the tire placard.
<b>Tire Placard</b>	A label permanently attached to the vehicle describing the vehicle's loading capacity, the original equipment tire sizes and the recommended cold tire inflation pressures.

## Tire Loading And Tire Pressure

### Tire And Loading Information Placard Location

**NOTE:** The proper cold tire inflation pressure is listed on the driver's side B-Pillar or the rear edge of the driver's side door.

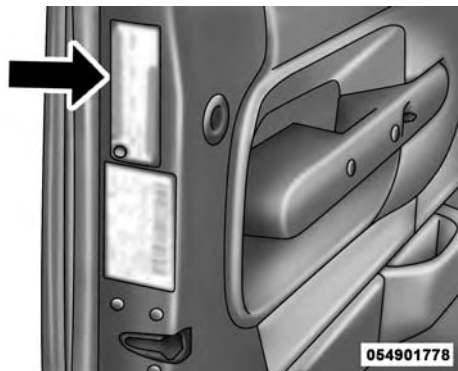

Example Tire Placard Location (Door)

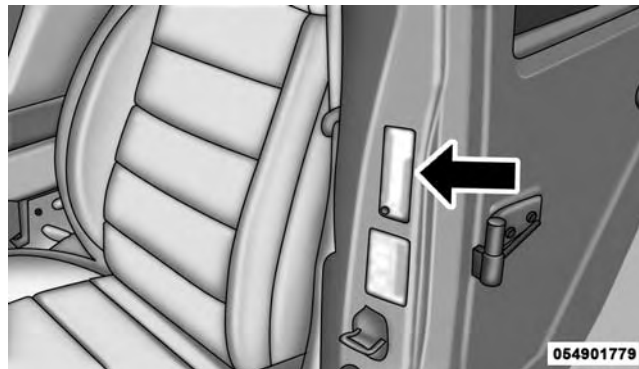

Example Tire Placard Location (B-Pillar)

## Tire And Loading Information Placard

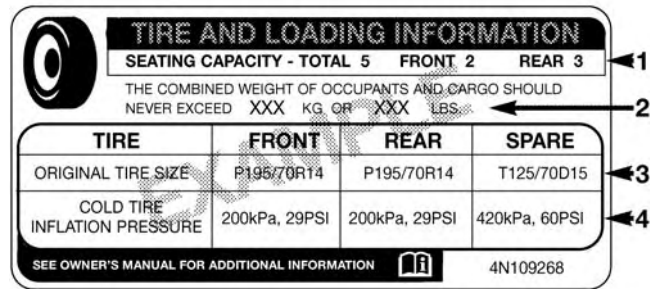

**TIRE AND LOADING INFORMATION**

SEATING CAPACITY - TOTAL 5 FRONT 2 REAR 3

THE COMBINED WEIGHT OF OCCUPANTS AND CARGO SHOULD NEVER EXCEED XXX KG OR XXX LBS.

TIRE	FRONT	REAR	SPARE
ORIGINAL TIRE SIZE	P195/70R14	P195/70R14	T125/70D15
COLD TIRE INFLATION PRESSURE	200kPa, 29PSI	200kPa, 29PSI	420kPa, 60PSI

SEE OWNER'S MANUAL FOR ADDITIONAL INFORMATION  4N109268

Callouts: 1 points to SEATING CAPACITY; 2 points to THE COMBINED WEIGHT OF OCCUPANTS AND CARGO SHOULD NEVER EXCEED; 3 points to ORIGINAL TIRE SIZE; 4 points to COLD TIRE INFLATION PRESSURE.

811b5a9a

### Tire And Loading Information Placard

This placard tells you important information about the:

1. Number of people that can be carried in the vehicle.
2. Total weight your vehicle can carry.

3. Tire size designed for your vehicle.
4. Cold tire inflation pressures for the front, rear, and spare tires.

### Loading

The vehicle maximum load on the tire must not exceed the load carrying capacity of the tire on your vehicle. You will not exceed the tire's load carrying capacity if you adhere to the loading conditions, tire size, and cold tire inflation pressures specified on the Tire and Loading Information placard in "Vehicle Loading" in the "Starting And Operating" section of this manual.

**NOTE:** Under a maximum loaded vehicle condition, gross axle weight ratings (GAWRs) for the front and rear axles must not be exceeded. For further information on GAWRs, vehicle loading, and trailer towing, refer to "Vehicle Loading" in the "Starting And Operating" section of this manual.

To determine the maximum loading conditions of your vehicle, locate the statement “The combined weight of occupants and cargo should never exceed XXX lbs or XXX kg” on the Tire and Loading Information placard. The combined weight of occupants, cargo/luggage and trailer tongue weight (if applicable) should never exceed the weight referenced here.

### Steps For Determining Correct Load Limit

1. Locate the statement “The combined weight of occupants and cargo should never exceed XXX lbs or XXX kg” on your vehicle’s placard.
2. Determine the combined weight of the driver and passengers that will be riding in your vehicle.
3. Subtract the combined weight of the driver and passengers from XXX lbs or XXX kg.
4. The resulting figure equals the available amount of cargo and luggage load capacity. For example, if “XXX” amount equals 1,400 lbs (635 kg) and there will be five 150 lb (68 kg) passengers in your vehicle, the amount of available cargo and luggage load capacity is 650 lbs (295 kg) (since  $5 \times 150 \text{ lbs (68 kg)} = 750 \text{ lbs (340 kg)}$ , and  $1400 \text{ lbs (635 kg)} - 750 \text{ lbs (340 kg)} = 650 \text{ lbs [295 kg]}$ ).
5. Determine the combined weight of luggage and cargo being loaded on the vehicle. That weight may not safely exceed the available cargo and luggage load capacity calculated in step 4.

**NOTE:**

- If your vehicle will be towing a trailer, load from your trailer will be transferred to your vehicle. The following table shows examples on how to calculate total load, cargo/luggage, and towing capacities of your vehicle with varying seating configurations and number and size of occupants. This table is for illustration purposes only and may not be accurate for the seating and load carry capacity of your vehicle.
- For the following example, the combined weight of occupants and cargo should never exceed 865 lbs (392 kg).

Occupants			Combined weight of occupants and cargo from Tire Placard	MINUS	Combined Occupant's weight	=	AVAILABLE Cargo/Luggage and Trailer Tongue Weight
TOTAL	FRONT	REAR					
<b>EXAMPLE 1</b>							
5	2	3	↓ 865 lbs	minus	Occupant 1: 200 lbs Occupant 2: 130 lbs Occupant 3: 160 lbs Occupant 4: 100 lbs Occupant 5: 80 lbs TOTAL WEIGHT: 670 lbs 670 lbs	=	↓ 195 lbs
<b>EXAMPLE 2</b>							
3	2	1	865 lbs	minus	Occupant 1: 210 lbs Occupant 2: 180 lbs Occupant 3: 150 lbs TOTAL WEIGHT: 540 lbs 540 lbs	=	325 lbs
<b>EXAMPLE 3</b>							
2	2	0	865 lbs	minus	Occupant 1: 200 lbs Occupant 2: 200 lbs TOTAL WEIGHT: 400 lbs 400 lbs	=	465 lbs

811a4d11



**WARNING!**

Overloading of your tires is dangerous. Overloading can cause tire failure, affect vehicle handling, and increase your stopping distance. Use tires of the recommended load capacity for your vehicle. Never overload them.

**TIRES — GENERAL INFORMATION****Tire Pressure**

Proper tire inflation pressure is essential to the safe and satisfactory operation of your vehicle. Four primary areas are affected by improper tire pressure:

- Safety and Vehicle Stability
- Economy
- Tread Wear
- Ride Comfort

**Safety****WARNING!**

- Improperly inflated tires are dangerous and can cause collisions.
- Underinflation increases tire flexing and can result in overheating and tire failure.
- Overinflation reduces a tire's ability to cushion shock. Objects on the road and chuckholes can cause damage that result in tire failure.
- Overinflated or underinflated tires can affect vehicle handling and can fail suddenly, resulting in loss of vehicle control.
- Unequal tire pressures can cause steering problems. You could lose control of your vehicle.

*(Continued)*

**WARNING! (Continued)**

- Unequal tire pressures from one side of the vehicle to the other can cause the vehicle to drift to the right or left.
- Always drive with each tire inflated to the recommended cold tire inflation pressure.

Both under-inflation and over-inflation affect the stability of the vehicle and can produce a feeling of sluggish response or over responsiveness in the steering.

**NOTE:**

- Unequal tire pressures from side to side may cause erratic and unpredictable steering response.
- Unequal tire pressure from side to side may cause the vehicle to drift left or right.

**Fuel Economy**

Underinflated tires will increase tire rolling resistance resulting in higher fuel consumption.

**Tread Wear**

Improper cold tire inflation pressures can cause abnormal wear patterns and reduced tread life, resulting in the need for earlier tire replacement.

**Ride Comfort And Vehicle Stability**

Proper tire inflation contributes to a comfortable ride. Over-inflation produces a jarring and uncomfortable ride.

**Tire Inflation Pressures**

The proper cold tire inflation pressure is listed on the driver's side B-Pillar or rear edge of the driver's side door.

At least once a month:

- Check and adjust tire pressure with a good quality pocket-type pressure gauge. Do not make a visual judgement when determining proper inflation. Tires may look properly inflated even when they are under-inflated.
- Inspect tires for signs of tire wear or visible damage.

### CAUTION!

**After inspecting or adjusting the tire pressure, always reinstall the valve stem cap. This will prevent moisture and dirt from entering the valve stem, which could damage the valve stem.**

Inflation pressures specified on the placard are always “cold tire inflation pressure”. Cold tire inflation pressure is defined as the tire pressure after the vehicle has not been driven for at least three hours, or driven less than 1 mile (1.6 km) after sitting for a minimum of three hours.

The cold tire inflation pressure must not exceed the maximum inflation pressure molded into the tire sidewall.

Check tire pressures more often if subject to a wide range of outdoor temperatures, as tire pressures vary with temperature changes.

Tire pressures change by approximately 1 psi (7 kPa) per 12°F (7°C) of air temperature change. Keep this in mind when checking tire pressure inside a garage, especially in the Winter.

Example: If garage temperature = 68°F (20°C) and the outside temperature = 32°F (0°C) then the cold tire inflation pressure should be increased by 3 psi (21 kPa), which equals 1 psi (7 kPa) for every 12°F (7°C) for this outside temperature condition.

Tire pressure may increase from 2 to 6 psi (13 to 40 kPa) during operation. DO NOT reduce this normal pressure build up or your tire pressure will be too low.

## Tire Pressures For High Speed Operation

The manufacturer advocates driving at safe speeds and within posted speed limits. Where speed limits or conditions are such that the vehicle can be driven at high speeds, maintaining correct tire inflation pressure is very important. Increased tire pressure and reduced vehicle loading may be required for high-speed vehicle operation. Refer to your authorized tire dealer or original equipment vehicle dealer for recommended safe operating speeds, loading and cold tire inflation pressures.

### WARNING!

**High speed driving with your vehicle under maximum load is dangerous. The added strain on your tires could cause them to fail. You could have a serious collision. Do not drive a vehicle loaded to the maximum capacity at continuous speeds above 75 mph (120 km/h).**

## Radial Ply Tires

### WARNING!

**Combining radial ply tires with other types of tires on your vehicle will cause your vehicle to handle poorly. The instability could cause a collision. Always use radial ply tires in sets of four. Never combine them with other types of tires.**

## Tire Repair

If your tire becomes damaged, it may be repaired if it meets the following criteria:

- The tire has not been driven on when flat.
- The damage is only on the tread section of your tire (sidewall damage is not repairable).
- The puncture is no greater than a ¼ of an inch (6 mm).

Consult an authorized tire dealer for tire repairs and additional information.

Damaged Run Flat tires, or Run Flat tires that have experienced a loss of pressure should be replaced immediately with another Run Flat tire of identical size and service description (Load Index and Speed Symbol).

## Tire Types

### All Season Tires — If Equipped

All Season tires provide traction for all seasons (Spring, Summer, Fall and Winter). Traction levels may vary between different all season tires. All season tires can be identified by the M+S, M&S, M/S or MS designation on the tire sidewall. Use all season tires only in sets of four; failure to do so may adversely affect the safety and handling of your vehicle.

### Summer Or Three Season Tires — If Equipped

Summer tires provide traction in both wet and dry conditions, and are not intended to be driven in snow or on ice. If your vehicle is equipped with Summer tires, be aware these tires are not designed for Winter or cold driving conditions. Install Winter tires on your vehicle when ambient temperatures are less than 40°F (5°C) or if roads are covered with ice or snow. For more information, contact an authorized dealer.

Summer tires do not contain the all season designation or mountain/snowflake symbol on the tire sidewall. Use Summer tires only in sets of four; failure to do so may adversely affect the safety and handling of your vehicle.

**WARNING!**

**Do not use Summer tires in snow/ice conditions. You could lose vehicle control, resulting in severe injury or death. Driving too fast for conditions also creates the possibility of loss of vehicle control.**

**Snow Tires**

Some areas of the country require the use of snow tires during the Winter. Snow tires can be identified by a “mountain/snowflake” symbol on the tire sidewall.



If you need snow tires, select tires equivalent in size and type to the original equipment tires. Use snow tires only in sets of four; failure to do so may adversely affect the safety and handling of your vehicle.

Snow tires generally have lower speed ratings than what was originally equipped with your vehicle and should not be operated at sustained speeds over 75 mph (120 km/h). For speeds above 75 mph (120 km/h) refer to original equipment or an authorized tire dealer for recommended safe operating speeds, loading and cold tire inflation pressures.

While studded tires improve performance on ice, skid and traction capability on wet or dry surfaces may be poorer than that of non-studded tires. Some states prohibit studded tires; therefore, local laws should be checked before using these tire types.

**Run Flat Tires — If Equipped**

Run Flat tires allow you the capability to drive 50 miles (80 km) at 50 mph (80 km/h) after a rapid loss of inflation pressure. This rapid loss of inflation is referred to as the Run Flat mode. A Run Flat mode occurs when the tire inflation pressure is of/or below 14 psi (96 kPa). Once a

Run Flat tire reaches the run flat mode it has limited driving capabilities and needs to be replaced immediately. A Run Flat tire is not repairable.

It is not recommended driving a vehicle loaded at full capacity or to tow a trailer while a tire is in the run flat mode.

See the tire pressure monitoring section for more information.

### **Spare Tires — If Equipped**

**NOTE:** For vehicles equipped with Tire Service Kit instead of a spare tire, please refer to “Tire Service Kit” in “What To Do In Emergencies” for further information.

### **CAUTION!**

**Because of the reduced ground clearance, do not take your vehicle through an automatic car wash with a compact or limited-use temporary spare installed. Damage to the vehicle may result.**

### **Spare Tire Matching Original Equipped Tire And Wheel — If Equipped**

Your vehicle may be equipped with a spare tire and wheel equivalent in look and function to the original equipment tire and wheel found on the front or rear axle of your vehicle. This spare tire may be used in the tire rotation for your vehicle. If your vehicle has this option, refer to an authorized tire dealer for the recommended tire rotation pattern.

### Compact Spare Tire — If Equipped

The compact spare is for temporary emergency use only. You can identify if your vehicle is equipped with a compact spare by looking at the spare tire description on the Tire and Loading Information Placard located on the driver's side door opening or on the sidewall of the tire. Compact spare tire descriptions begin with the letter "T" or "S" preceding the size designation. Example: T145/80D18 103M.

T, S = Temporary Spare Tire

Since this tire has limited tread life, the original equipment tire should be repaired (or replaced) and reinstalled on your vehicle at the first opportunity.

Do not install a wheel cover or attempt to mount a conventional tire on the compact spare wheel, since the wheel is designed specifically for the compact spare tire.

Do not install more than one compact spare tire and wheel on the vehicle at any given time.

#### **WARNING!**

**Compact spares are for temporary emergency use only. With these spares, do not drive more than 50 mph (80 km/h). Temporary use spares have limited tread life. When the tread is worn to the tread wear indicators, the temporary use spare tire needs to be replaced. Be sure to follow the warnings, which apply to your spare. Failure to do so could result in spare tire failure and loss of vehicle control.**

### Full Size Spare — If Equipped

The full size spare is for temporary emergency use only. This tire may look like the originally equipped tire on the front or rear axle of your vehicle, but it is not. This spare tire may have limited tread life. When the tread is worn to the tread wear indicators, the temporary use full size



spare tire needs to be replaced. Since it is not the same as your original equipment tire, replace (or repair) the original equipment tire and reinstall on the vehicle at the first opportunity.

### Limited-Use Spare — If Equipped

The limited-use spare tire is for temporary emergency use only. This tire is identified by a label located on the limited-use spare wheel. This label contains the driving limitations for this spare. This tire may look like the original equipped tire on the front or rear axle of your vehicle, but it is not. Installation of this limited-use spare tire affects vehicle handling. Since it is not the same as your original equipment tire, replace (or repair) the original equipment tire and reinstall on the vehicle at the first opportunity.

### WARNING!

**Limited-use spares are for emergency use only. Installation of this limited-use spare tire affects vehicle handling. With this tire, do not drive more than the speed listed on the limit-use spare wheel. Keep inflated to the cold tire inflation pressures listed on your Tire and Loading Information Placard located on the driver's side B-Pillar or the rear edge of the driver's side door. Replace (or repair) the original equipment tire at the first opportunity and reinstall it on your vehicle. Failure to do so could result in loss of vehicle control.**

5

### Tire Spinning

When stuck in mud, sand, snow, or ice conditions, do not spin your vehicle's wheels above 30 mph (48 km/h) or for longer than 30 seconds continuously without stopping.

Refer to “Freeing A Stuck Vehicle” in “What To Do In Emergencies” for further information.

### WARNING!

Fast spinning tires can be dangerous. Forces generated by excessive wheel speeds may cause tire damage or failure. A tire could explode and injure someone. Do not spin your vehicle’s wheels faster than 30 mph (48 km/h) for more than 30 seconds continuously when you are stuck, and do not let anyone near a spinning wheel, no matter what the speed.

### Tread Wear Indicators

Tread wear indicators are in the original equipment tires to help you in determining when your tires should be replaced.

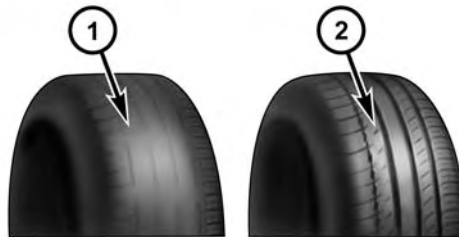

055007576

Tire Tread

- 1 — Worn Tire
- 2 — New Tire

These indicators are molded into the bottom of the tread grooves. They will appear as bands when the tread depth becomes a 1/16 of an inch (1.6 mm). When the tread is

worn to the tread wear indicators, the tire should be replaced. Refer to “Replacement Tires” in this section for further information.

### Life Of Tire

The service life of a tire is dependent upon varying factors including, but not limited to:

- Driving style.
- Tire pressure - Improper cold tire inflation pressures can cause uneven wear patterns to develop across the tire tread. These abnormal wear patterns will reduce tread life, resulting in the need for earlier tire replacement.
- Distance driven.
- Performance tires, tires with a speed rating of V or higher, and Summer tires typically have a reduced

tread life. Rotation of these tires per the vehicle maintenance schedule is highly recommended.

### WARNING!

**Tires and the spare tire should be replaced after six years, regardless of the remaining tread. Failure to follow this warning can result in sudden tire failure. You could lose control and have a collision resulting in serious injury or death.**

Keep dismounted tires in a cool, dry place with as little exposure to light as possible. Protect tires from contact with oil, grease, and gasoline.

### Replacement Tires

The tires on your new vehicle provide a balance of many characteristics. They should be inspected regularly for

wear and correct cold tire inflation pressures. The manufacturer strongly recommends that you use tires equivalent to the originals in size, quality and performance when replacement is needed. Refer to the paragraph on "Tread Wear Indicator". Refer to the Tire and Loading Information placard or the Vehicle Certification Label for the size designation of your tire. The Load Index and Speed Symbol for your tire will be found on the original equipment tire sidewall. See the Tire Sizing Chart example found in the "Tire Safety Information" section of this manual for more information relating to the Load Index and Speed Symbol of a tire.

It is recommended to replace the two front tires or two rear tires as a pair. Replacing just one tire can seriously affect your vehicle's handling. If you ever replace a wheel, make sure that the wheel's specifications match those of the original wheels.

It is recommended you contact your authorized tire dealer or original equipment dealer with any questions

you may have on tire specifications or capability. Failure to use equivalent replacement tires may adversely affect the safety, handling, and ride of your vehicle.

### WARNING!

- **Do not use a tire, wheel size or rating other than that specified for your vehicle. Some combinations of unapproved tires and wheels may change suspension dimensions and performance characteristics, resulting in changes to steering, handling, and braking of your vehicle. This can cause unpredictable handling and stress to steering and suspension components. You could lose control and have a collision resulting in serious injury or death. Use only the tire and wheel sizes with load ratings approved for your vehicle.**

*(Continued)*

**WARNING! (Continued)**

- Never use a tire with a smaller load index or capacity, other than what was originally equipped on your vehicle. Using a tire with a smaller load index could result in tire overloading and failure. You could lose control and have a collision.
- Failure to equip your vehicle with tires having adequate speed capability can result in sudden tire failure and loss of vehicle control.

**CAUTION!**

Replacing original tires with tires of a different size may result in false speedometer and odometer readings.

**TIRE CHAINS (TRACTION DEVICES)**

Use of traction devices require sufficient tire-to-body clearance. Follow these recommendations to guard against damage:

- Traction device must be of proper size for the tire, as recommended by the traction device manufacturer.
- Install on front tires only.
- For a 215/55R17 tire on a 17 x 7.0J x 41mm wheel, use of a snow traction device with a maximum projection of 9 mm beyond the tire profile is recommended.

**WARNING!**

Using tires of different size and type (M+S, Snow) between front and rear axles can cause unpredictable handling. You could lose control and have a collision.

**CAUTION!**

To avoid damage to your vehicle or tires, observe the following precautions:

- Because of restricted traction device clearance between tires and other suspension components, it is important that only traction devices in good condition are used. Broken devices can cause serious damage. Stop the vehicle immediately if noise occurs that could indicate device breakage. Remove the damaged parts of the device before further use.
- Install device as tightly as possible and then re-tighten after driving about ½ mile (0.8 km).
- Do not exceed 30 mph (48 km/h).
- Drive cautiously and avoid severe turns and large bumps, especially with a loaded vehicle.
- Do not drive for a prolonged period on dry pavement.

**CAUTION! (Continued)**

- Observe the traction device manufacturer's instructions on the method of installation, operating speed, and conditions for use. Always use the suggested operating speed of the device manufacturer's if it is less than 30 mph (48 km/h).
- Do not use traction devices on a compact spare tire.

**TIRE ROTATION RECOMMENDATIONS**

The tires on the front and rear of your vehicle operate at different loads and perform different steering, driving, and braking functions. For these reasons, they wear at unequal rates.

These effects can be reduced by timely rotation of tires. The benefits of rotation are especially worthwhile with aggressive tread designs such as those on all season type

(Continued)



Information Provided by:  
**DEALER**  
E-PROCESS

tires. Rotation will increase tread life, help to maintain mud, snow and wet traction levels, and contribute to a smooth, quiet ride.

Refer to the “Maintenance Schedule” for the proper maintenance intervals. The reasons for any rapid or unusual wear should be corrected prior to rotation being performed.

The suggested rotation method is the “forward cross” shown in the following diagram. This rotation pattern does not apply to some directional tires that must not be reversed.

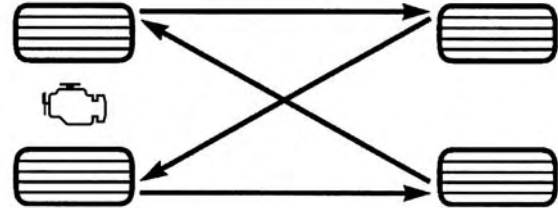

Tire Rotation

055707139

## TIRE PRESSURE MONITOR SYSTEM (TPMS)

The Tire Pressure Monitor System (TPMS) will warn the driver of a low tire pressure based on the vehicle recommended cold placard pressure.

The tire pressure will vary with temperature by approximately 1 psi (7 kPa) for every 12°F (6.5°C). This means that when the outside temperature decreases, the tire pressure will decrease. Tire pressure should always be set based on cold inflation tire pressure. This is defined as the tire pressure after the vehicle has not been driven for at least three hours, or driven less than 1 mile (1.6 km) after a three hour period. The cold tire inflation pressure must not exceed the maximum inflation pressure molded into the tire sidewall. Refer to “Tires – General Information” in “Starting And Operating” for information on how to properly inflate the vehicle’s tires. The tire

pressure will also increase as the vehicle is driven. This is normal and there should be no adjustment for this increased pressure.

The TPMS will warn the driver of a low tire pressure if the tire pressure falls below the low-pressure warning limit for any reason, including low temperature effects and natural pressure loss through the tire.

The TPMS will continue to warn the driver of low tire pressure as long as the condition exists, and will not turn off until the tire pressure is at or above the recommended cold placard pressure. Once the low tire pressure warning (Tire Pressure Monitoring Telltale Light) illuminates, you must increase the tire pressure to the recommended cold placard pressure in order for the “Tire Pressure Monitoring Telltale Light” to turn off.



**NOTE:** When filling warm tires, the tire pressure may need to be increased up to an additional 4 psi (30 kPa) above the recommended cold placard pressure in order to turn the Tire Pressure Monitoring Telltale Light off.

The system will automatically update and the “Tire Pressure Monitoring Telltale Light” will turn off once the system receives the updated tire pressures. The vehicle may need to be driven for up to 20 minutes above 15 mph (24 km/h) in order for the TPMS to receive this information.

For example, your vehicle may have a recommended cold (parked for more than three hours) placard pressure of 33 psi (227 kPa). If the ambient temperature is 68°F (20°C) and the measured tire pressure is 28 psi (193 kPa), a temperature drop to 20°F (-7°C) will decrease the tire pressure to approximately 24 psi (165 kPa). This tire pressure is low enough to turn ON the “Tire Pressure Monitoring Telltale Light.” Driving the vehicle may cause

the tire pressure to rise to approximately 28 psi (193 kPa), but the “Tire Pressure Monitoring Telltale Light” will still be on. In this situation, the “Tire Pressure Monitoring Telltale Light” will turn off only after the tires are inflated to the vehicle’s recommended cold placard pressure value.

**NOTE:** When filling warm tires, the tire pressure may need to be increased up to an additional 4 psi (30 kPa) above the recommended cold placard pressure in order to turn the Tire Pressure Monitoring Telltale Light off.

### CAUTION!

- **The TPMS has been optimized for the original equipment tires and wheels. TPMS pressures and warning have been established for the tire size equipped on your vehicle. Undesirable system operation or sensor damage may result when using**

*(Continued)*

**CAUTION!** *(Continued)*

replacement equipment that is not of the same size, type, and/or style. Aftermarket wheels can cause sensor damage.

- Using aftermarket tire sealants may cause the Tire Pressure Monitoring System (TPMS) sensor to become inoperable. After using an aftermarket tire sealant it is recommended that you take your vehicle to an authorized dealership to have your sensor function checked.
- After inspecting or adjusting the tire pressure always reinstall the valve stem cap. This will prevent moisture and dirt from entering the valve stem, which could damage the TPMS sensor.

**NOTE:**

- The TPMS is not intended to replace normal tire care and maintenance, or to provide warning of a tire failure or condition.
- The TPMS should not be used as a tire pressure gauge while adjusting your tire pressure.
- Driving on a significantly underinflated tire causes the tire to overheat and can lead to tire failure. Underinflation also reduces fuel efficiency and tire tread life, and may affect the vehicle's handling and stopping ability.
- The TPMS is not a substitute for proper tire maintenance, and it is the driver's responsibility to maintain correct tire pressure using an accurate tire pressure gauge, even if underinflation has not reached the level to trigger illumination of the "Tire Pressure Monitoring Telltale Light".

- Seasonal temperature changes will affect tire pressure, and the TPMS will monitor the actual tire pressure in the tire.

### Base System

The Tire Pressure Monitor System (TPMS) uses wireless technology with wheel rim mounted electronic sensors to monitor tire pressure levels. Sensors, mounted to each wheel as part of the valve stem, transmit tire pressure readings to the receiver module.

**NOTE:** It is particularly important for you to check the tire pressure in all of the tires on your vehicle monthly and to maintain the proper pressure.

The TPMS consists of the following components:

- Receiver Module
- Four Tire Pressure Monitoring Sensors
- Tire Pressure Monitoring Telltale Light

### Tire Pressure Monitoring Low Pressure Warnings



The “Tire Pressure Monitoring Telltale Light” will illuminate in the instrument cluster, a “LOW TIRE PRESSURE” message will display in the instrument cluster, an “Inflate to XX” message will be displayed and a chime will sound when tire pressure is low in one or more of the four active road tires. Should this occur, you should stop as soon as possible, check the inflation pressure of each tire on your vehicle, and inflate each tire to the vehicle’s recommended cold placard pressure value as shown in the “Inflate to XX” message. Once the system receives the updated tire pressures, the system will automatically update and the “Tire Pressure Monitoring Telltale Light” will turn off.

**NOTE:** When filling warm tires, the tire pressure may need to be increased up to an additional 4 psi (30 kPa) above the recommended cold placard pressure in order to turn the Tire Pressure Monitoring Telltale Light off. The vehicle may need to be driven for up to 20 minutes above 15 mph (24 km/h) in order for the TPMS to receive this information.

### **Service TPMS Warning**

When a system fault is detected, the “Tire Pressure Monitoring Telltale Light” will flash on and off for 75 seconds and then remain on solid. The system fault will also sound a chime. If the ignition is cycled, this sequence will repeat, providing the system fault still exists. The “Tire Pressure Monitoring Telltale Light” will turn off when the fault condition no longer exists. A system fault can occur due to any of the following:

1. Jamming due to electronic devices or driving next to facilities emitting the same radio frequencies as the TPMS sensors.
2. Installing some form of aftermarket window tinting that affects radio wave signals.
3. Lots of snow or ice around the wheels or wheel housings.
4. Using tire chains on the vehicle.
5. Using wheels/tires not equipped with TPMS sensors.

### **Vehicles With Compact Spare or non-Matching Full Size Spare**

1. The compact spare tire or non-matching full size spare tire does not have a tire pressure monitoring sensor. Therefore, the TPMS will not monitor the pressure in the spare tire.

2. If you install the compact or non-matching full size spare tire in place of a road tire that has a pressure below the low-pressure warning limit, a chime will sound and the “TPMS Telltale Light” and “LOW TIRE PRESSURE” and “Inflate to XX” messages will turn on upon the next ignition cycle.
3. After driving the vehicle for up to 20 minutes above 15 mph (24 km/h), the “TPMS Telltale Light” will flash on and off for 75 seconds and then remain on solid.
4. For each subsequent ignition cycle, a chime will sound and the “TPMS Telltale Light” will flash on and off for 75 seconds and then remain on solid.
5. Once you repair or replace the original road tire and reinstall it on the vehicle in place of the compact spare or non-matching full size spare, the TPMS will update automatically and the “TPMS Telltale Light” will turn

off, as long as no tire pressure is below the low-pressure warning limit in any of the four active road tires. The vehicle may need to be driven for up to 20 minutes above 15 mph (24 km/h) in order for the TPMS to receive this information.

### Premium System — If Equipped

The Tire Pressure Monitor System (TPMS) uses wireless technology with wheel rim mounted electronic sensors to monitor tire pressure levels. Sensors, mounted to each wheel as part of the valve stem, transmit tire pressure readings to the receiver module.

**NOTE:** It is particularly important for you to check the tire pressure in all of the tires on your vehicle monthly and to maintain the proper pressure.

The TPMS consists of the following components:

- Receiver Module
- Four Tire Pressure Monitoring Sensors

- Various Tire Pressure Monitoring System messages, which display in the Electronic Vehicle Information Center (EVIC) or Driver Information Display (DID).
- Tire Pressure Monitoring Telltale Light

### Tire Pressure Monitoring Low Pressure Warnings

 The "Tire Pressure Monitoring Telltale Light" will illuminate in the instrument cluster and a chime will sound when tire pressure is low in one or more of the four active road tires. In addition, the Driver Information Display (DID) will display an "Inflate to XX" message and a graphic showing the pressure values of each tire with the low tire pressure values in a different color.

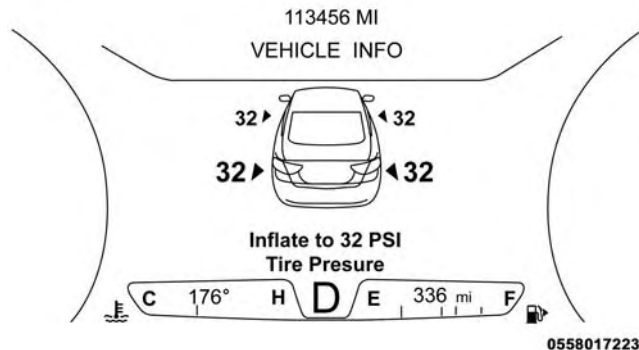

### Tire Pressure Monitoring Low Pressure Warning

Should this occur, you should stop as soon as possible and inflate the tires with low pressure (those in a different color in the DID graphic) to the vehicle's recommended cold placard pressure value as shown in the "Inflate to XX" message. Once the system receives the updated tire pressures, the system will automatically

update, the pressure values in the graphic display in the DID will return to their original color, and the “Tire Pressure Monitoring Telltale Light” will turn off. The vehicle may need to be driven for up to 20 minutes above 15 mph (24 km/h) in order for the TPMS to receive this information.

### SERVICE TPMS Warning

When a system fault is detected, the “Tire Pressure Monitoring Telltale Light” will flash on and off for 75 seconds and then remain on solid. The system fault will also sound a chime. In addition, the DID will display a “SERVICE SYSTEM” message for a minimum of five seconds and then display dashes (- -) in place of the pressure value to indicate which sensor is not being received.

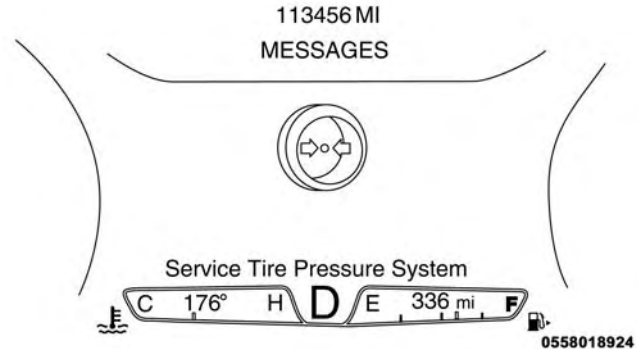

Tire Pressure Monitoring Service Warning

If the ignition is cycled, this sequence will repeat, providing the system fault still exists. If the system fault no longer exists, the “Tire Pressure Monitoring Telltale Light” will no longer flash, and the “SERVICE SYSTEM message will no longer display, and a pressure value will display in place of the dashes. A system fault can occur due to any of the following:

1. Jamming due to electronic devices or driving next to facilities emitting the same radio frequencies as the TPMS sensors.
2. Installing some form of aftermarket window tinting that affects radio wave signals.
3. Lots of snow or ice around the wheels or wheel housings.
4. Using tire chains on the vehicle.
5. Using wheels/tires not equipped with TPMS sensors.

### Vehicles With Compact Spare

1. The compact spare tire does not have a tire pressure monitoring sensor. Therefore, the TPMS will not monitor the pressure in the compact spare tire.
2. If you install the compact spare tire in place of a road tire that has a pressure below the low-pressure warning limit, upon the next ignition cycle, the “TPMS Telltale Light” will remain on and a chime will sound. In addition, the graphic in the DID will still display a different color pressure value and an “Inflate to XX” message.
3. After driving the vehicle for up to 20 minutes above 15 mph (24 km/h), the “TPMS Telltale Light” will flash on and off for 75 seconds and then remain on solid. In addition, the DID will display a “SERVICE SYSTEM” message for five seconds and then display dashes (- -) in place of the pressure value.



4. For each subsequent ignition cycle, a chime will sound, the “TPMS Telltale Light” will flash on and off for 75 seconds and then remain on solid, and the DID will display a “SERVICE SYSTEM” message for five seconds and then display dashes (- -) in place of the pressure value.
5. Once you repair or replace the original road tire and reinstall it on the vehicle in place of the compact spare, the TPMS will update automatically. In addition, the “TPMS Telltale Light” will turn off and the graphic in the DID will display a new pressure value instead of dashes (- -), as long as no tire pressure is below the low-pressure warning limit in any of the four active road tires. The vehicle may need to be driven for up to 20 minutes above 15 mph (24 km/h) in order for the TPMS to receive this information.

## General Information

This device complies with Part 15 of the FCC rules and RSS-210 of Industry Canada. Operation is subject to the following two conditions:

- (1) This device may not cause harmful interference.
- (2) This device must accept any interference received, including interference that may cause undesired operation.

**NOTE:** Changes or modifications not expressly approved by the party responsible for compliance could void the user’s authority to operate the equipment.

## FUEL REQUIREMENTS



These engines are designed to meet all emissions regulations and provide optimum fuel economy and performance when using high quality unleaded “Regular” gasoline having a posted octane number of 87 as specified by the (R+M)/2 method. The use of higher octane “Premium” gasoline is not required, as it will not provide any benefit over “Regular” gasoline in these engines.

While operating on gasoline with an octane number of 87, hearing a light knocking sound from the engine is not a cause for concern. However, if the engine is heard making a heavy knocking sound, see your dealer immediately. Use of gasoline with an octane number lower than 87 can cause engine failure and may void or not be covered by the New Vehicle Limited Warranty.

Poor quality gasoline can cause problems such as hard starting, stalling, and hesitations. If you experience these symptoms, try another brand of gasoline before considering service for the vehicle.

### Reformulated Gasoline

Many areas of the country require the use of cleaner burning gasoline referred to as “Reformulated Gasoline”. Reformulated gasoline contains oxygenates and are specifically blended to reduce vehicle emissions and improve air quality.

The use of reformulated gasoline is recommended. Properly blended reformulated gasoline will provide improved performance and durability of engine and fuel system components.

## Gasoline/Oxygenate Blends

Some fuel suppliers blend unleaded gasoline with oxygenates such as ethanol.

### CAUTION!

**DO NOT use gasoline containing methanol or gasoline containing more than 15% ethanol (E-15). Use of these blends may result in starting and drivability problems, damage critical fuel system components, cause emissions to exceed the applicable standard, and/or cause the "Malfunction Indicator Light" to illuminate. Please observe pump labels as they should clearly communicate if a fuel contains greater than 15% ethanol (E-15).**

Problems that result from using gasoline containing more than 15% ethanol (E-15) or gasoline containing methanol

are not the responsibility of the manufacturer and may void or not be covered under New Vehicle Limited Warranty.

## E-85 Usage In Non-Flex Fuel Vehicles

Non-Flex Fuel Vehicles (FFV) are compatible with gasoline containing up to 15% ethanol (E-15). Gasoline with higher ethanol content may void the New Vehicle Limited Warranty.

If a Non-FFV vehicle is inadvertently fueled with E-85 fuel, the engine will have some or all of these symptoms:

- Operate in a lean mode.
- OBD II "Malfunction Indicator Light" on.
- Poor engine performance.
- Poor cold start and cold drivability.
- Increased risk for fuel system component corrosion.

## MMT In Gasoline

Methylcyclopentadienyl Manganese Tricarbonyl (MMT) is a manganese-containing metallic additive that is blended into some gasoline to increase octane. Gasoline blended with MMT provides no performance advantage beyond gasoline of the same octane number without MMT. Gasoline blended with MMT reduces spark plug life and reduces emissions system performance in some vehicles. The manufacturer recommends that gasoline without MMT be used in your vehicle. The MMT content of gasoline may not be indicated on the gasoline pump, therefore, you should ask your gasoline retailer whether the gasoline contains MMT. MMT is prohibited in Federal and California reformulated gasoline.

## Materials Added To Fuel

Besides using unleaded gasoline with the proper octane rating, gasolines that contain detergents, corrosion and stability additives are recommended. Using gasolines that have these additives will help improve fuel economy, reduce emissions, and maintain vehicle performance. Designated TOP TIER Detergent Gasoline contains a higher level of detergents to further aid in minimizing engine and fuel system deposits. When available the usage of Top Tier Detergent gasoline is recommended. Visit [www.toptiergas.com](http://www.toptiergas.com) for a list of TOP TIER Detergent Gasoline Retailers.

Indiscriminate use of fuel system cleaning agents should be avoided. Many of these materials intended for gum and varnish removal may contain active solvents or similar ingredients. These can harm fuel system gasket and diaphragm materials.

## Fuel System Cautions

### CAUTION!

Follow these guidelines to maintain your vehicle's performance:

- The use of leaded gasoline is prohibited by Federal law. Using leaded gasoline can impair engine performance and damage the emissions control system.
- An out-of-tune engine or certain fuel or ignition malfunctions can cause the catalytic converter to overheat. If you notice a pungent burning odor or some light smoke, your engine may be out of tune or malfunctioning and may require immediate service. Contact your authorized dealer for service assistance.

*(Continued)*

### CAUTION! *(Continued)*

- The use of fuel additives, which are now being sold as octane enhancers, is not recommended. Most of these products contain high concentrations of methanol. Fuel system damage or vehicle performance problems resulting from the use of such fuels or additives is not the responsibility of the manufacturer and may void or not be covered under the New Vehicle Limited Warranty.

**NOTE:** Intentional tampering with the emissions control system can result in civil penalties being assessed against you.

## Carbon Monoxide Warnings

### WARNING!

Carbon monoxide (CO) in exhaust gases is deadly. Follow the precautions below to prevent carbon monoxide poisoning:

- Do not inhale exhaust gases. They contain carbon monoxide, a colorless and odorless gas, which can kill. Never run the engine in a closed area, such as a garage, and never sit in a parked vehicle with the engine running for an extended period. If the vehicle is stopped in an open area with the engine running for more than a short period, adjust the ventilation system to force fresh, outside air into the vehicle.

*(Continued)*

### WARNING! *(Continued)*

- Guard against carbon monoxide with proper maintenance. Have the exhaust system inspected every time the vehicle is raised. Have any abnormal conditions repaired promptly. Until repaired, drive with all side windows fully open.

## FLEXIBLE FUEL — IF EQUIPPED

### E-85 General Information

The information in this section is unique for Flexible Fuel vehicles only. These vehicles can be identified by a unique fuel filler door label that states **Ethanol (E-85) or Unleaded Gasoline Only** and a yellow fuel cap. Please refer to the other sections of this manual for information on features that are common between Flexible Fuel and non-Flexible Fuel powered vehicles.

**CAUTION!**

Only vehicles with the E-85 fuel filler door label or a yellow gas cap can operate on E-85.

**Ethanol Fuel (E-85)**

E-85 is a mixture of approximately 85% ethanol and 15% unleaded gasoline.

**WARNING!**

Ethanol vapors are extremely flammable and could cause serious personal injury. Never have any smoking materials lit or products that can cause spark in or near the vehicle when removing the fuel filler tube cap (gas cap) or filling the tank. Do not use E-85 as a cleaning agent and never use it near an open flame.

**Fuel Requirements**

If your vehicle is E-85 compatible, it will operate on unleaded gasoline with any octane rating, or solely E-85 fuel, or any mixture of these fuels.

**For best results, avoid fueling patterns alternating between E-85 and unleaded gasoline.**

When switching fuel types:

- Add 5 gallons (19 liters) or more when refueling.
- Drive the vehicle immediately after refueling for at least 5 miles (8 km).

Observing these precautions will avoid possible hard starting and/or driveability problems during warm up.

**NOTE:**

- Use seasonally adjusted E-85 fuel (ASTM D5798). With non-seasonally adjusted E-85 fuel, hard starting and rough idle following start up may be experienced even if the above recommendations are followed, especially when the ambient temperature is below 32°F (0°C).
- Some additives used in regular gasoline are not fully compatible with E-85 and may form deposits in your engine. To eliminate driveability issues that may be caused by these deposits, a supplemental gasoline additive, such as MOPAR Injector Cleanup or Techron may be used.

**Selection Of Engine Oil For Flexible Fuel Vehicles (E-85) And Gasoline Vehicles**

FFV vehicles operated on E-85 require specially formulated engine oils. These special requirements are included in MOPAR engine oils, and in equivalent oils meeting

FCA US Material Standard MS-6395. It is recommended that engine oils that are API Certified and meet the requirements of Material Standard MS-6395 be used. MS-6395 contains additional requirements, developed during extensive fleet testing, to provide additional protection to FCA US LLC engines.

**Starting**

The characteristics of E-85 fuel make it unsuitable for use when ambient temperatures fall below 0°F (-18°C). In the range of 0°F (-18°C) to 32°F (0°C), an increase in the time it takes for your engine to start may be experienced, and a deterioration in driveability (sags and/or hesitations) until the engine is fully warmed up. These issues may be improved with the use of seasonally adjusted E-85 fuel.

**NOTE:** Use of the engine block heater (if equipped) may improve engine start time when using E-85 fuel when the ambient temperature is less than 32°F (0°C).



## Cruising Range

Because E-85 fuel contains less energy per gallon/liter than gasoline, an increase in fuel consumption will be experienced. The miles per gallon (mpg)/kilometers per liter and the driving range will decrease by approximately 30%, compared to gasoline operation.

## Replacement Parts

All fuel and engine components in your Flexible Fuel Vehicle (FFV) are designed to be compatible with ethanol. Ethanol compatible service components are required.

### **CAUTION!**

**Replacing fuel system components with non-ethanol compatible components can damage your vehicle.**

## Maintenance

### **CAUTION!**

**Do not use ethanol mixture greater than 85% in your vehicle. It will cause difficulty in cold starting and may affect drivability.**

## ADDING FUEL

The fuel filler cap is located behind the fuel filler door, on the passenger side of the vehicle. If the fuel filler cap is lost or damaged, be sure the replacement fuel filler cap has been designed for use with this vehicle.

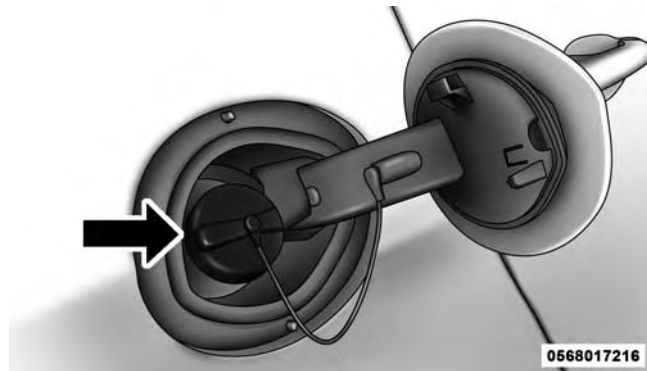

Fuel Filler Cap (Gas Cap)

### WARNING!

- Never have any smoking materials lit in or near the vehicle when the gas cap is removed or the tank is being filled.
- Never add fuel when the engine is running. This is in violation of most state and federal fire regulations and may cause the MIL to turn on.
- A fire may result if gasoline is pumped into a portable container that is inside of a vehicle. You could be burned. Always place gas containers on the ground while filling.

**CAUTION!**

- **Damage to the fuel system or emission control system could result from using an improper fuel filler cap. A poorly fitting cap could let impurities into the fuel system. Also, a poorly fitting aftermarket cap can cause the “Malfunction Indicator Light (MIL)” to illuminate, due to fuel vapors escaping from the system.**
- **A poorly fitting fuel filler cap may cause the MIL to turn on.**
- **To avoid fuel spillage and overfilling, do not “top off” the fuel tank after filling.**

1. Put the vehicle in park and switch the ignition off.
2. Push the center-rear edge of the fuel filler door (9 o'clock position) and release to open.

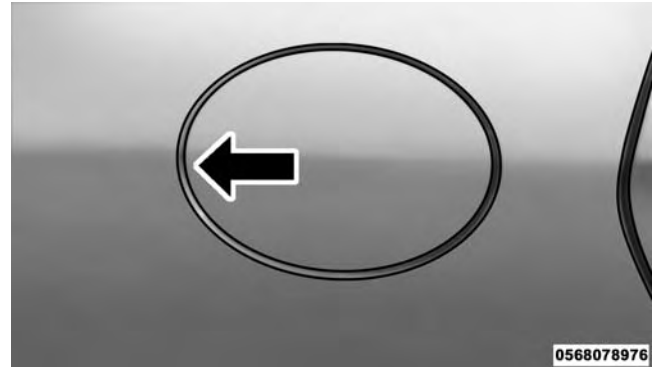

5

**Fuel Filler Cap Release**

3. Remove the fuel filler cap and hang fuel filler cap by tether on fuel fill door to prevent damage to body side.

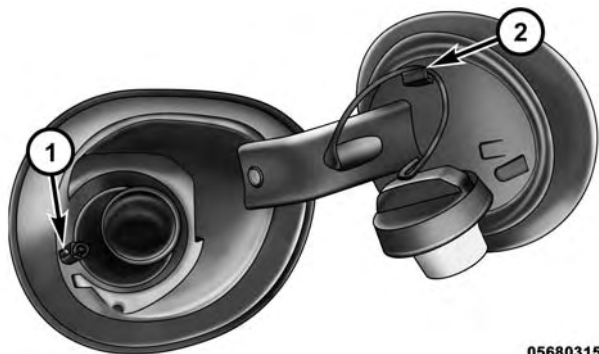

0568031507

### Fuel Filler Door and Fuel Filler Cap Tether Hook

- 1 — Fuel Filler Door Actuator  
2 — Fuel Filler Cap Tether Hook

4. When the fuel nozzle “clicks” or shuts off, the fuel tank is full.

5. After you have stopped pumping fuel, remove the fuel filler nozzle and replace the fuel filler cap.
6. Tighten the fuel filler cap about one quarter turn until you hear one click. This is an indication that the fuel filler cap is properly tightened.
7. To close the fuel filler door, push the center-rear edge (9 o’clock position) of the fuel filler door and then release. The fuel filler door will latch closed.

### NOTE:

- In certain cold conditions, ice may prevent the fuel filler door from opening. If this occurs, lightly push on the fuel filler door around the perimeter to break the ice build up.
- If the fuel filler cap is not tightened properly, the MIL will come on. Be sure the fuel filler cap is tightened every time the vehicle is refueled.

## Loose Fuel Filler Cap Message

If the vehicle diagnostic system determines that the fuel filler cap is loose, improperly installed, or damaged, a “CHECK GASCAP” message will be displayed in the Electronic Vehicle Information Center (EVIC) or Driver Information Display (DID). Refer to “Electronic Vehicle Information (EVIC) or “Driver Information Display (DID)” in “Understanding Your Instrument Panel” for further information. Tighten the fuel filler cap until a “clicking” sound is heard. This is an indication that the fuel filler cap is properly tightened. Refer to “Onboard Diagnostic System” in “Maintaining Your Vehicle” for further information.

## VEHICLE LOADING

### Certification Label

As required by National Highway Traffic Safety Administration regulations, your vehicle has a certification label affixed to the driver’s side door or pillar.

This label contains the month and year of manufacture, Gross Vehicle Weight Rating (GVWR), Gross Axle Weight Rating (GAWR) front and rear, and Vehicle Identification Number (VIN). A Month-Day-Hour (MDH) number is included on this label and indicates the Month, Day and Hour of manufacture. The bar code that appears on the bottom of the label is your VIN.

### Gross Vehicle Weight Rating (GVWR)

The GVWR is the total permissible weight of your vehicle including driver, passengers, vehicle, options and cargo. The label also specifies maximum capacities of front and

rear axle systems (GAWR). Total load must be limited so GVWR and front and rear GAWR are not exceeded.

### **Payload**

The payload of a vehicle is defined as the allowable load weight a truck can carry, including the weight of the driver, all passengers, options and cargo.

### **Gross Axle Weight Rating (GAWR)**

The GAWR is the maximum permissible load on the front and rear axles. The load must be distributed in the cargo area so that the GAWR of each axle is not exceeded.

Each axle GAWR is determined by the components in the system with the lowest load carrying capacity (axle, springs, tires or wheels). Heavier axles or suspension components sometimes specified by purchasers for increased durability does not necessarily increase the vehicle's GVWR.

### **Tire Size**

The tire size on the Vehicle Certification Label represents the actual tire size on your vehicle. Replacement tires must be equal to the load capacity of this tire size.

### **Rim Size**

This is the rim size that is appropriate for the tire size listed.

### **Inflation Pressure**

This is the cold tire inflation pressure for your vehicle for all loading conditions up to full GAWR.

### **Curb Weight**

The curb weight of a vehicle is defined as the total weight of the vehicle with all fluids, including vehicle fuel, at full capacity conditions, and with no occupants or cargo loaded into the vehicle. The front and rear curb weight values are determined by weighing your vehicle on a commercial scale before any occupants or cargo are added.

## Loading

The actual total weight and the weight of the front and rear of your vehicle at the ground can best be determined by weighing it when it is loaded and ready for operation.

The entire vehicle should first be weighed on a commercial scale to insure that the GVWR has not been exceeded. The weight on the front and rear of the vehicle should then be determined separately to be sure that the load is properly distributed over the front and rear axle. Weighing the vehicle may show that the GAWR of either the front or rear axles has been exceeded but the total load is within the specified GVWR. If so, weight must be shifted from front to rear or rear to front as appropriate until the specified weight limitations are met. Store the heavier items down low and be sure that the weight is distributed equally. Stow all loose items securely before driving.

Improper weight distributions can have an adverse effect on the way your vehicle steers and handles and the way the brakes operate.

### CAUTION!

**Do not load your vehicle any heavier than the GVWR or the maximum front and rear GAWR. If you do, parts on your vehicle can break, or it can change the way your vehicle handles. This could cause you to lose control. Also overloading can shorten the life of your vehicle.**

5

## TRAILER TOWING

Trailer towing with this vehicle is not recommended.

**RECREATIONAL TOWING (BEHIND MOTORHOME, ETC.)****Towing This Vehicle Behind Another Vehicle**

Towing Condition	Wheel OFF the Ground	Front-Wheel Drive (FWD) Models	All-Wheel Drive (AWD) Models
Flat Tow	NONE	NOT ALLOWED	NOT ALLOWED
Dolly Tow	Front	OK	NOT ALLOWED
	Rear	NOT ALLOWED	NOT ALLOWED
On Trailer	ALL	OK	OK

**NOTE:**

- You must ensure that the Auto Park Brake feature is disabled before towing this vehicle, to avoid inadvertent Electric Park Brake engagement. The Auto Park Brake feature is enabled or disabled via the customer programmable features in the Uconnect Settings.
- When recreational towing your vehicle, always follow applicable state and provincial laws. Contact state and provincial Highway Safety offices for additional details.
- If your vehicle is disabled and in need of commercial towing service please refer to "Towing A Disabled Vehicle" in "What To Do In Emergencies".



## Recreational Towing — Front-Wheel Drive (FWD) Models

**DO NOT** flat tow this vehicle. Damage to the drivetrain will result.

Recreational towing for front-wheel drive models is allowed **ONLY** if the front wheels are **OFF** the ground. This may be accomplished using a tow dolly or vehicle trailer. If using a tow dolly, follow this procedure:

1. Properly secure the dolly to the tow vehicle, following the dolly manufacturer's instructions.
2. Drive the front wheels onto the tow dolly.
3. Apply the parking brake.
4. Place the transmission in PARK.
5. Turn the engine OFF.
6. Properly secure the front wheels to the dolly, following the dolly manufacturer's instructions.
7. Turn the ignition to the ON/RUN position, but do not start the engine.
8. Press and hold the brake pedal.
9. Release the parking brake.
10. Turn the ignition OFF.
11. Remove the Key Fob.
12. Release the brake pedal.

**CAUTION!**

- **DO NOT** flat tow this vehicle. Damage to the drivetrain will result. If this vehicle requires towing, make sure the drive wheels are **OFF** the ground.
- Ensure that the Electric Park Brake is released, and remains released, while being towed.
- Towing this vehicle in violation of the above requirements can cause severe transmission damage. Damage from improper towing is not covered under the New Vehicle Limited Warranty.

**Recreational Towing — All-Wheel Drive (AWD) Models**

Recreational towing is not allowed. These models do not have a **NEUTRAL (N)** position in the power transfer unit.

**NOTE:** This vehicle may be towed on a flatbed or vehicle trailer provided all four wheels are **OFF** the ground.

**CAUTION!**

Towing this vehicle with **ANY** of its wheels on the ground can cause severe transmission and/or power transfer unit damage. Damage from improper towing is not covered under the New Vehicle Limited Warranty.

# WHAT TO DO IN EMERGENCIES

## CONTENTS

■ HAZARD WARNING FLASHERS . . . . .	.547	■ JACKING AND TIRE CHANGING . . . . .	.561
■ IF YOUR ENGINE OVERHEATS . . . . .	.547	□ Jack Location/Spare Tire Stowage . . . . .	.561
■ WHEEL AND TIRE TORQUE SPECIFICATIONS . . . . .	.548	□ Preparations For Jacking . . . . .	.563
□ Torque Specifications . . . . .	.548	□ Jacking Instructions . . . . .	.564
■ TIRE SERVICE KIT — IF EQUIPPED . . . . .	.550	□ Road Tire Installation . . . . .	.572
□ Tire Service Kit Storage . . . . .	.550	■ JUMP-STARTING PROCEDURES . . . . .	.574
□ Tire Service Kit Components And Operation . . . . .	.552	□ Preparations For Jump-Start . . . . .	.575
□ Tire Service Kit Usage Precautions . . . . .	.552	□ Jump-Starting Procedure . . . . .	.576
□ Sealing A Tire With Tire Service Kit . . . . .	.555	■ FREEING A STUCK VEHICLE . . . . .	.578
		■ MANUAL PARK RELEASE . . . . .	.580

546 WHAT TO DO IN EMERGENCIES

---

■ TOWING A DISABLED VEHICLE . . . . .	.583	□ All-Wheel Drive (AWD) Models . . . . .	.587
□ Front-Wheel Drive (FWD) Models . . . . .	.586		

## HAZARD WARNING FLASHERS

The Hazard Warning flasher switch is located in the switch bank below the radio screen.



Push the switch to turn on the Hazard Warning flasher. When the switch is activated, all directional turn signals will flash on and off to warn oncoming traffic of an emergency. Push the switch a second time to turn off the Hazard Warning flashers.

This is an emergency warning system and it should not be used when the vehicle is in motion. Use it when your vehicle is disabled and it is creating a safety hazard for other motorists.

When you must leave the vehicle to seek assistance, the Hazard Warning flashers will continue to operate even though the ignition is placed in the OFF position.

**NOTE:** With extended use the Hazard Warning flashers may wear down your battery.

## IF YOUR ENGINE OVERHEATS

In any of the following situations, you can reduce the potential for overheating by taking the appropriate action.

- On the highways — slow down.
- In city traffic — while stopped, place the transmission in NEUTRAL, but do not increase the engine idle speed.

**NOTE:** There are steps that you can take to slow down an impending overheat condition:

- If your air conditioner (A/C) is on, turn it off. The A/C system adds heat to the engine cooling system and turning the A/C off can help remove this heat.
- You can also turn the temperature control to maximum heat, the mode control to floor and the blower control to high. This allows the heater core to act as a supplement to the radiator and aids in removing heat from the engine cooling system.

**CAUTION!**

Driving with a hot cooling system could damage your vehicle. If the temperature gauge reads "H," pull over and stop the vehicle. Idle the vehicle with the air conditioner turned off until the pointer drops back into the normal range. If the pointer remains on the "H," turn the engine off immediately and call for service.

**WARNING!**

You or others can be badly burned by hot engine coolant (antifreeze) or steam from your radiator. If you see or hear steam coming from under the hood, do not open the hood until the radiator has had time to cool. Never try to open a cooling system pressure cap when the radiator or coolant bottle is hot.

**WHEEL AND TIRE TORQUE SPECIFICATIONS**

Proper lug nut/bolt torque is very important to ensure that the wheel is properly mounted to the vehicle. Any time a wheel has been removed and reinstalled on the vehicle the lug nuts/bolts should be torqued using a properly calibrated torque wrench.

**Torque Specifications**

Lug Nut/Bolt Torque	**Lug Nut/ Bolt Size	Lug Nut/ Bolt Socket Size
100 Ft-Lbs (135 N·m)	M12 x 1.25	19 mm

\*\*Use only your Authorized Dealer recommended lug nuts/bolts and clean or remove any dirt or oil before tightening.

Inspect the wheel mounting surface prior to mounting the tire and remove any corrosion or loose particles.

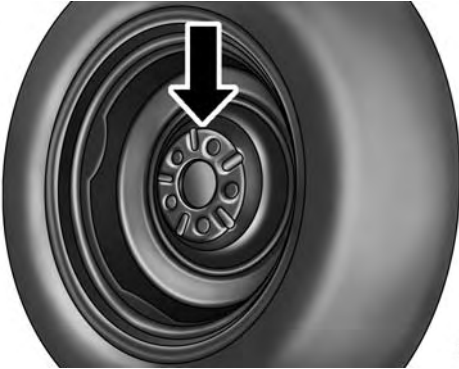

**Wheel Mounting Surface**

0605005441

Tighten the lug nuts/bolts in a star pattern until each nut/bolt has been tightened twice.

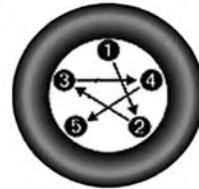
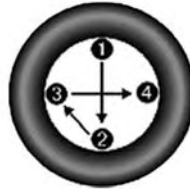

0605006372

### Torque Patterns

After 25 miles (40 km) check the lug nut/bolt torque to be sure that all the lug nuts/bolts are properly seated against the wheel.

**WARNING!**

To avoid the risk of forcing the vehicle off the jack, do not tighten the lug nuts fully until the vehicle has been lowered. Failure to follow this warning may result in personal injury.

**TIRE SERVICE KIT — IF EQUIPPED**

Small punctures up to ¼" (6 mm) in the tire tread can be sealed with Tire Service Kit. Foreign objects (e.g., screws or nails) should not be removed from the tire. Tire Service Kit can be used in outside temperatures down to approximately -4°F (-20°C).

This kit will provide a temporary tire seal, allowing you to drive your vehicle up to 100 miles (160 km) with a maximum speed of 55 mph (90 km/h).

**Tire Service Kit Storage**

The Tire Service Kit is stowed under an access cover in the trunk.

1. Open the trunk.
2. Lift the access cover using the pull strap.



**Pull Strap**



3. Remove the fastener securing the Tire Service Kit.

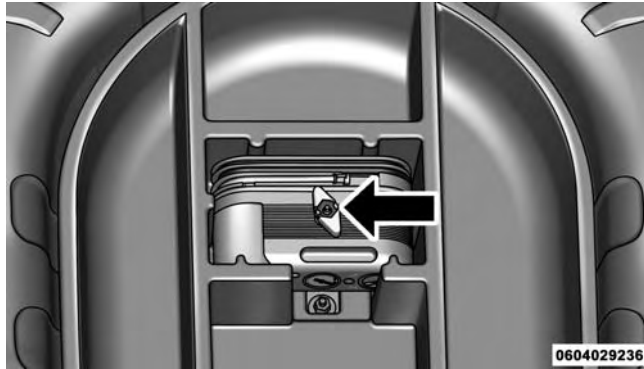

Tire Service Kit Fastener

4. Remove Tire Service Kit.

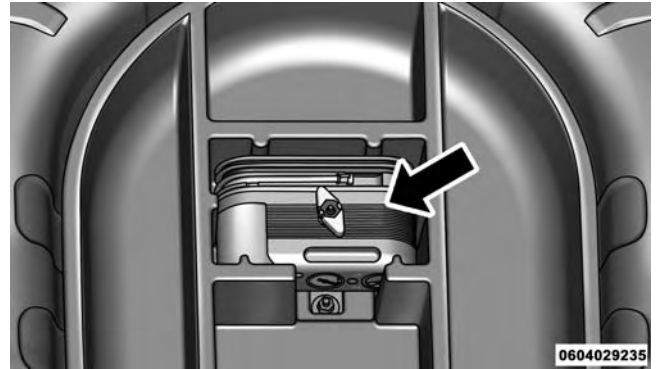

Tire Service Kit

## Tire Service Kit Components And Operation

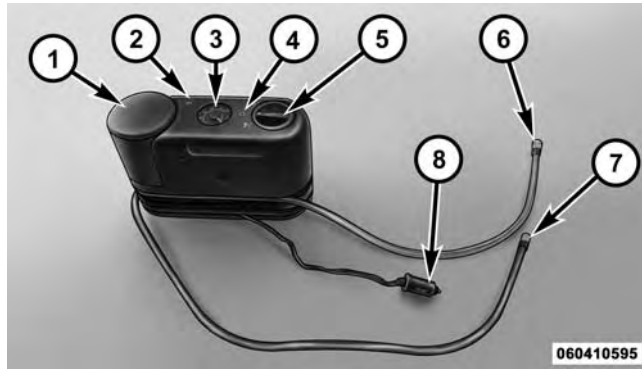

**Tire Service Kit Components**

- 1 — Sealant Bottle
- 2 — Deflation Button
- 3 — Pressure Gauge
- 4 — Power Button
- 5 — Mode Select Knob
- 6 — Sealant Hose (Clear)
- 7 — Air Pump Hose (Black)
- 8 — Power Plug (located on bottom side of Tire Service Kit)

## Tire Service Kit Usage Precautions

- Replace the Tire Service Kit Sealant Bottle (1) and Sealant Hose (6) prior to the expiration date (printed at the lower right hand corner on the bottle label) to assure optimum operation of the system. Refer to “Sealing a Tire with Tire Service Kit” section (F) “Sealant Bottle and Hose Replacement”.



0604018634

### Tire Service Kit Expiration Date Location

- The Sealant Bottle (1) and Sealant Hose (6) are a one tire application use and need to be replaced after each use. Always replace these components immediately at your original equipment vehicle dealer.
- When the Tire Service Kit sealant is in a liquid form, clean water, and a damp cloth will remove the material

from the vehicle or tire and wheel components. Once the sealant dries, it can easily be peeled off and properly discarded.

- For optimum performance, make sure the valve stem on the wheel is free of debris before connecting the Tire Service Kit.
- You can use the Tire Service Kit air pump to inflate bicycle tires. The kit also comes with two needles, located in the Accessory Storage Compartment (on the bottom of the air pump) for inflating sport balls, rafts, or similar inflatable items. However, use only the Air Pump Hose (7) and make sure the Mode Select Knob (5) is in the Air Mode when inflating such items to avoid injecting sealant into them. The Tire Service Kit Sealant is only intended to seal punctures less than 1/4 inch (6 mm) diameter in the tread of your vehicle.
- Do not lift or carry the Tire Service Kit by the hoses.

**WARNING!**

- Do not attempt to seal a tire on the side of the vehicle closest to traffic. Pull far enough off the road to avoid the danger of being hit when using the Tire Service Kit.
- Do not use Tire Service Kit or drive the vehicle under the following circumstances:
  - If the puncture in the tire tread is approximately 1/4 inch (6 mm) or larger.
  - If the tire has any sidewall damage.
  - If the tire has any damage from driving with extremely low tire pressure.
  - If the tire has any damage from driving on a flat tire.
  - If the wheel has any damage.
  - If you are unsure of the condition of the tire or the wheel.

**WARNING! (Continued)**

- Keep Tire Service Kit away from open flames or heat source.
- A loose Tire Service Kit thrown forward in a collision or hard stop could endanger the occupants of the vehicle. Always stow the Tire Service Kit in the place provided. Failure to follow these warnings can result in injuries that are serious or fatal to you, your passengers, and others around you.
- Take care not to allow the contents of Tire Service Kit to come in contact with hair, eyes, or clothing. Tire Service Kit sealant is harmful if inhaled, swallowed, or absorbed through the skin. It causes skin, eye, and respiratory irritation. Flush immediately with plenty of water if there is any contact with eyes or skin. Change clothing as soon as possible, if there is any contact with clothing.

(Continued)



(Continued)

**WARNING! (Continued)**

- **Tire Service Kit Sealant solution contains latex. In case of an allergic reaction or rash, consult a physician immediately. Keep Tire Service Kit out of reach of children. If swallowed, rinse mouth immediately with plenty of water and drink plenty of water. Do not induce vomiting! Consult a physician immediately.**

**Sealing A Tire With Tire Service Kit****(A) Whenever You Stop To Use Tire Service Kit:**

1. Pull over to a safe location and turn on the vehicle's Hazard Warning flashers.
2. Verify that the valve stem (on the wheel with the deflated tire) is in a position that is near to the ground. This will allow the Tire Service Kit Hoses (6) and (7) to reach the valve stem and keep the Tire Service Kit flat

on the ground. This will provide the best positioning of the kit when injecting the sealant into the deflated tire and running the air pump. Move the vehicle as necessary to place the valve stem in this position before proceeding.

3. Place the transmission in PARK and turn Off the ignition.
4. Set the parking brake.

**(B) Setting Up To Use Tire Service Kit:**

1. Push in the Mode Select Knob (5) and turn to the Sealant Mode position.
2. Uncoil the Sealant Hose (6) and then remove the cap from the fitting at the end of the hose.
3. Place the Tire Service Kit flat on the ground next to the deflated tire.

4. Remove the cap from the valve stem and then screw the fitting at the end of the Sealant Hose (6) onto the valve stem.
5. Uncoil the Power Plug (8) and insert the plug into the vehicle's 12 Volt power outlet.

**NOTE:** Do not remove foreign objects (e.g., screws or nails) from the tire.

### **(C) Injecting Tire Service Kit Sealant Into The Deflated Tire:**

- Always start the engine before turning ON the Tire Service Kit.
- After pushing the Power Button (4), the sealant (white fluid) will flow from the Sealant Bottle (1) through the Sealant Hose (6) and into the tire.

**NOTE:** Sealant may leak out through the puncture in the tire.

**If the sealant (white fluid) does not flow within 0 – 10 seconds through the Sealant Hose (6):**

1. Push the Power Button (4) to turn Off the Tire Service Kit. Disconnect the Sealant Hose (6) from the valve stem. Make sure the valve stem is free of debris. Reconnect the Sealant Hose (6) to the valve stem. Check that the Mode Select Knob (5) is in the Sealant Mode position and not Air Mode. Push the Power Button (4) to turn On the Tire Service Kit.
2. Connect the Power Plug (8) to a different 12 Volt power outlet in your vehicle or another vehicle, if available. Make sure the engine is running before turning ON the Tire Service Kit.
3. The Sealant Bottle (1) may be empty due to previous use. Call for assistance.

**NOTE:** If the Mode Select Knob (5) is on Air Mode and the pump is operating, air will dispense from the Air Pump Hose (7) only, not the Sealant Hose (6).

**If the sealant (white fluid) does flow through the Sealant Hose (6):**

1. Continue to operate the pump until sealant is no longer flowing through hose (typically takes 30 - 70 seconds). As the sealant flows through the Sealant Hose (6), the Pressure Gauge (3) can read as high as 70 psi (4.8 Bar). The Pressure Gauge (3) will decrease quickly from approximately 70 psi (4.8 Bar) to the actual tire pressure when the Sealant Bottle (1) is empty.
2. The pump will start to inject air into the tire immediately after the Sealant Bottle (1) is empty. Continue to operate the pump and inflate the tire to the pressure indicated on the tire pressure label on the driver-side

latch pillar (recommended pressure). Check the tire pressure by looking at the Pressure Gauge (3).

**If the tire does not inflate to at least 26 psi (1.8 Bar) pressure within 15 minutes:**

- The tire is too badly damaged. Do not attempt to drive the vehicle further. Call for assistance.

**NOTE:** If the tire becomes over-inflated, push the Deflation Button to reduce the tire pressure to the recommended inflation pressure before continuing.

**If the tire inflates to the recommended pressure or is at least 26 psi (1.8 Bar) pressure within 15 minutes:**

1. Push the Power Button (4) to turn off the Tire Service Kit.
2. Remove the Speed Limit sticker from the top of the Sealant Bottle (1) and place the sticker on the instrument panel.

3. Immediately disconnect the Sealant Hose (6) from the valve stem, reinstall the cap on the fitting at the end of the hose, and place the Tire Service Kit in the vehicle storage location. Quickly proceed to (D) "Drive Vehicle."

**CAUTION!**

- The metal end fitting from Power Plug (8) may get hot after use, so it should be handled carefully.
- Failure to reinstall the cap on the fitting at the end of the Sealant Hose (6) can result in sealant contacting your skin, clothing, and the vehicle's interior. It can also result in sealant contacting internal Tire Service Kit components which may cause permanent damage to the kit.

**(D) Drive Vehicle:**

Immediately after injecting sealant and inflating the tire, drive the vehicle 5 miles (8 km) or 10 minutes to ensure distribution of the Tire Service Kit Sealant within the tire. Do not exceed 55 mph (90 km/h).

**WARNING!**

**Tire Service Kit is not a permanent flat tire repair. Have the tire inspected and repaired or replaced after using Tire Service Kit. Do not exceed 55 mph (90 km/h) until the tire is repaired or replaced. Failure to follow this warning can result in injuries that are serious or fatal to you, your passengers, and others around you.**



**(E) After Driving:**

Pull over to a safe location. Refer to “Whenever You Stop to Use Tire Service Kit” before continuing.

1. Push in the Mode Select Knob (5) and turn to the Air Mode position.
2. Uncoil the power plug and insert the plug into the vehicle’s 12 Volt power outlet.
3. Uncoil the Air Pump Hose (7) (black in color) and screw the fitting at the end of hose (7) onto the valve stem.
4. Check the pressure in the tire by reading the Pressure Gauge (3).

**If tire pressure is less than 19 psi (1.3 Bar):**

The tire is too badly damaged. Do not attempt to drive the vehicle further. Call for assistance.

**If the tire pressure is 19 psi (1.3 Bar) or higher:**

1. Push the Power Button (4) to turn on Tire Service Kit and inflate the tire to the pressure indicated on the tire and loading information label on the driver-side door opening.

**NOTE:** If the tire becomes over-inflated, push the Deflation Button to reduce the tire pressure to the recommended inflation pressure before continuing.

2. Disconnect the Tire Service Kit from the valve stem, reinstall the cap on the valve stem and unplug from 12 Volt outlet.
3. Place the Tire Service Kit in its proper storage area in the vehicle.
4. Have the tire inspected and repaired or replaced at the earliest opportunity at an authorized dealer or tire service center.

5. Replace the Sealant Bottle (1) and Sealant Hose (6) assembly at your authorized dealer as soon as possible. Refer to (F) "Sealant Bottle and Hose Replacement."
4. Clean any remaining sealant from the Tire Service Kit housing.
5. Position the new Sealant Bottle (1) in the housing so that the Sealant Hose (6) aligns with the hose slot in the front of the housing. Push the bottle into the housing. An audible click will be heard indicating the bottle is locked into place.

**NOTE:** When having the tire serviced, advise the authorized dealer or service center that the tire has been sealed using the Tire Service Kit.

**(F) Sealant Bottle And Hose Replacement:**

1. Uncoil the Sealant Hose (6) (clear in color).
2. Locate the round Sealant Bottle release button in the recessed area under the sealant bottle.
3. Push the Sealant Bottle release button. The Sealant Bottle (1) will pop up. Remove the bottle and dispose of it accordingly.
6. Verify that the cap is installed on the fitting at the end of the Sealant Hose (6) and return the hose to its storage area (located on the bottom of the air pump).
7. Return the Tire Service Kit to its storage location in the vehicle.

## JACKING AND TIRE CHANGING

### WARNING!

- Do not attempt to change a tire on the side of the vehicle close to moving traffic. Pull far enough off the road to avoid the danger of being hit when operating the jack or changing the wheel.
- Being under a jacked-up vehicle is dangerous. The vehicle could slip off the jack and fall on you. You could be crushed. Never put any part of your body under a vehicle that is on a jack. If you need to get under a raised vehicle, take it to a service center where it can be raised on a lift.
- Never start or run the engine while the vehicle is on a jack.

*(Continued)*

### WARNING! *(Continued)*

- The jack is designed to be used as a tool for changing tires only. The jack should not be used to lift the vehicle for service purposes. The vehicle should be jacked on a firm level surface only. Avoid ice or slippery areas.

### Jack Location/Spare Tire Stowage

The jack, wheel chocks and spare tire are stowed under an access cover in the trunk. Follow these steps to access the jack, wheel chocks and spare tire.

6

1. Open the trunk.
2. Lift the access cover using the pull strap.



**Pull Strap**

3. Remove the fastener securing the jack and spare tire.



**Jack And Spare Tire Fastener**

4. Remove the scissors jack, wheel bolt wrench and wheel chocks from the spare wheel as an assembly. Remove the chocks from the jack assembly. Turn the jack screw to the left to loosen the wheel bolt wrench, and remove the wrench from the jack assembly.
5. Remove the spare tire.

**WARNING!**

A loose tire or jack thrown forward in a collision or hard stop could endanger the occupants of the vehicle. Always stow the jack parts and the spare tire in the places provided. Have the deflated (flat) tire repaired or replaced immediately.

**Preparations For Jacking**

1. Park the vehicle on a firm level surface as far from the edge of the roadway as possible. Avoid icy or slippery areas.

**WARNING!**

Do not attempt to change a tire on the side of the vehicle close to moving traffic, pull far enough off the road to avoid being hit when operating the jack or changing the wheel.

2. Turn on the Hazard Warning flasher.
3. Set the parking brake.
4. Place the shifter into the park position.
5. Turn the ignition off to the LOCK position.
6. Chock both the front and rear of the wheel diagonally opposite of the jacking position. For example, if changing the right front tire, chock the left rear wheel. Place both chocks under the tire.



**NOTE:** Passengers should not remain in the vehicle when the vehicle is being jacked.

## Jacking Instructions

### WARNING!

Carefully follow these tire changing warnings to help prevent personal injury or damage to your vehicle:

- Always park on a firm, level surface as far from the edge of the roadway as possible before raising the vehicle.
- Turn on the Hazard Warning flasher.
- Chock the wheel diagonally opposite the wheel to be raised.
- Set the parking brake firmly and set an automatic transmission in PARK.
- Never start or run the engine with the vehicle on a jack.

### WARNING! (Continued)

- Do not let anyone sit in the vehicle when it is on a jack.
- Do not get under the vehicle when it is on a jack. If you need to get under a raised vehicle, take it to a service center where it can be raised on a lift.
- Only use the jack in the positions indicated and for lifting this vehicle during a tire change.
- If working on or near a roadway, be extremely careful of motor traffic.
- To assure that spare tires, flat or inflated, are securely stowed, spares must be stowed with the valve stem facing the ground.

*(Continued)*



Jack Warning Label

**CAUTION!**

Do not attempt to raise the vehicle by jacking on locations other than those indicated in the Jacking Instructions for this vehicle.

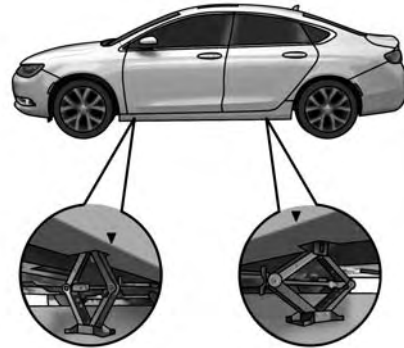

Jacking Locations

1. Remove the jack, wheel bolt wrench and wheel chocks from the spare wheel as an assembly. Remove the chocks from the jack assembly.

0606037057

**NOTE:** The jack handle attaches to the side of the jack with two attachment points. When the jack is partially expanded, the tension between the two attachment points holds the jack handle in place.



0606037059

Removing Jack Handle From Jack

2. Chock both the front and rear of the wheel diagonally opposite of the jacking position. For example, if changing the right front tire, chock the left rear wheel. Place both chocks under the tire.
3. If equipped with aluminum wheels where the center cap covers the wheel bolts, use the wheel bolt wrench to pry the center cap off carefully before raising the vehicle.
4. Before raising the vehicle, use the wheel bolt wrench to loosen, but not remove, the wheel bolts on the wheel with the flat tire. Turn the wheel bolts counter-clockwise one turn while the wheel is still on the ground.
5. Place the jack underneath the notched lift area that is closest to the flat tire.





Front Body Flange

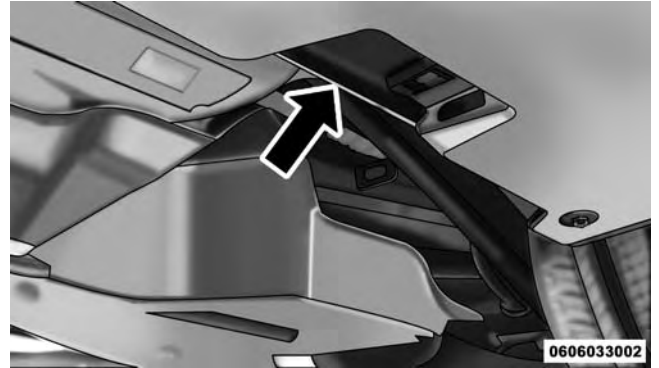

Rear Body Flange

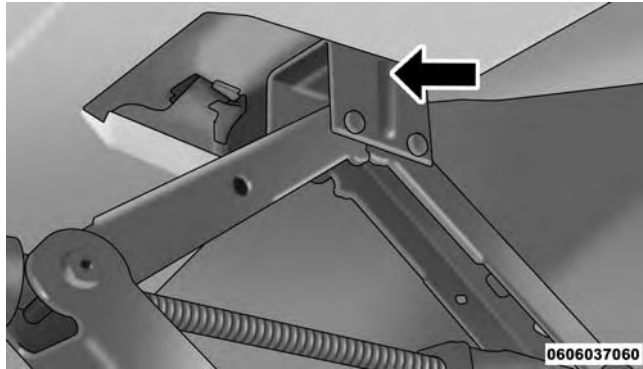

Front Body Flange Engaged

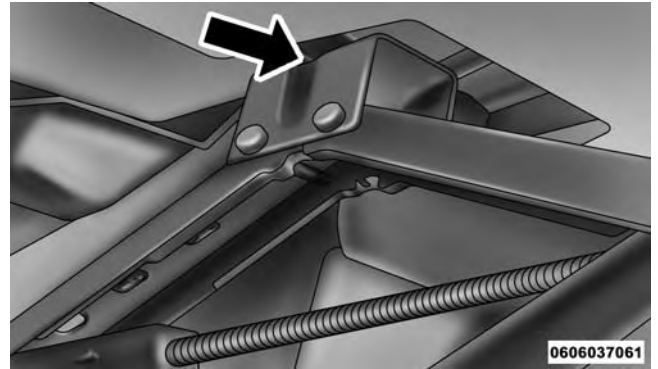

Rear Body Flange Engaged

6. Turn the jack screw clockwise to firmly engage the jack saddle with the lift area of the sill flange, centering the jack saddle between the locating notches on the sill flange.
7. Raise the vehicle just enough to remove the flat tire and install the spare tire.

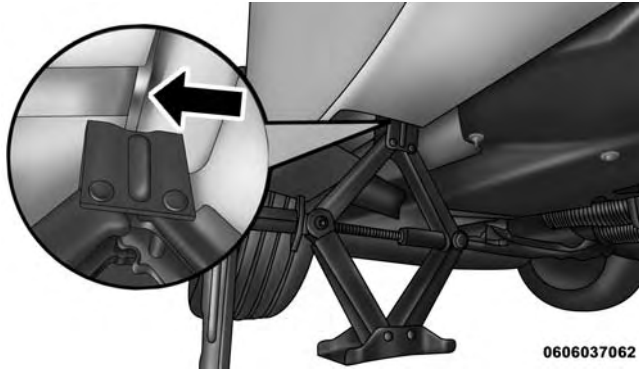

Front Jacking Location

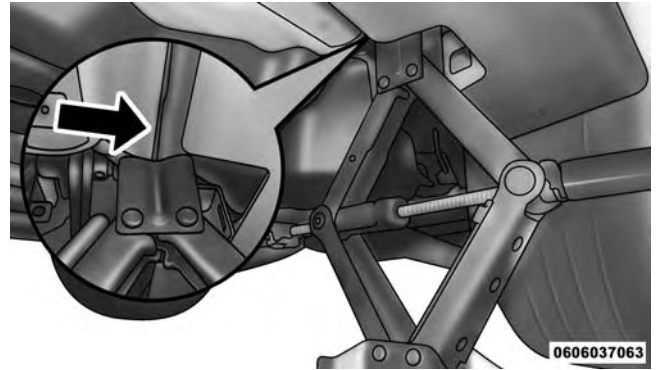

Rear Jacking Location

**WARNING!**

Raising the vehicle higher than necessary can make the vehicle less stable. It could slip off the jack and hurt someone near it. Raise the vehicle only enough to remove the tire.

## 570 WHAT TO DO IN EMERGENCIES

8. Remove the wheel bolts and tire.
9. Mount the spare tire.

### CAUTION!

Be sure to mount the spare tire with the valve stem facing outward. The vehicle could be damaged if the spare tire is mounted incorrectly.

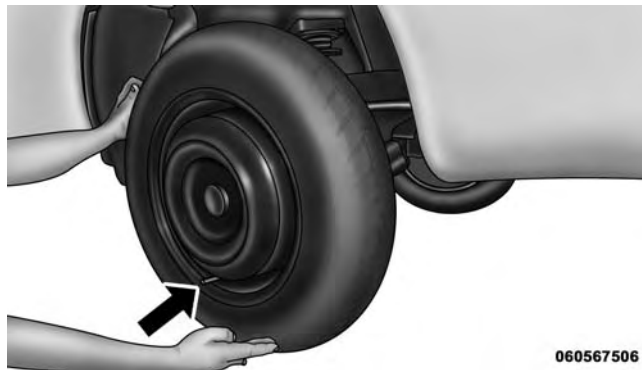

060567506

Mounting Spare Tire

**NOTE:**

- For vehicles so equipped, do not attempt to install a center cap or wheel cover on the compact spare.
  - Refer to “Compact Spare Tire” and to “Limited-Use Spare” under “Tires—General Information” in “Starting and Operating” for additional warnings, cautions, and information about the spare tire, its use, and operation.
10. Install the wheel bolts with the threaded end of the wheel bolt toward the wheel. Lightly tighten the wheel bolts.

**WARNING!**

**To avoid the risk of forcing the vehicle off the jack, do not fully tighten the wheel bolts until the vehicle has been lowered. Failure to follow this warning may result in serious injury.**

11. Lower the vehicle to the ground by turning the jack handle counterclockwise.
12. Finish tightening the wheel bolts. Push down on the wrench while at the end of the handle for increased leverage. Tighten the wheel bolts in a star pattern until each wheel bolt has been tightened twice. Refer to “Torque Specifications” in this section for proper lug bolt torque. If in doubt about the correct tightness, have them checked with a torque wrench by your authorized dealer or at a service station.
13. Lower the jack until it is free. Remove the wheel chocks. Reassemble the lug wrench to the jack assembly and stow it in the spare tire area. Securely stow the jack, tools, chocks and flat tire. Release the parking brake before driving the vehicle.

**WARNING!**

A loose tire or jack thrown forward in a collision or hard stop could endanger the occupants of the vehicle. Always stow the jack parts and the spare tire in the places provided. Have the deflated (flat) tire repaired or replaced immediately.

**Road Tire Installation****Vehicles Equipped With Wheel Covers**

1. Mount the road tire on the axle.
2. To ease the installation process for steel wheels with wheel covers, install two wheel bolts on the wheel which are on each side of the valve stem. Install the wheel bolts with the threaded end of the bolt toward the wheel. Lightly tighten the wheel bolts.

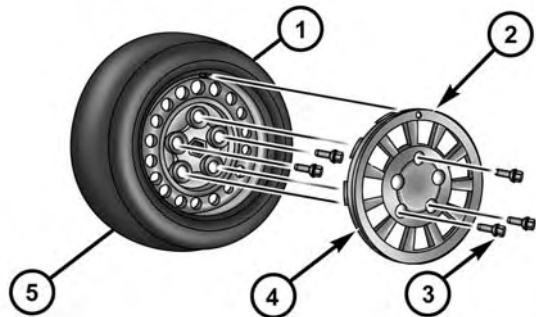

060567721

**Tire And Wheel Cover Or Center Cap**

- |                 |                 |
|-----------------|-----------------|
| 1 — Valve Stem  | 4 — Wheel Cover |
| 2 — Valve Notch | 5 — Road Wheel  |
| 3 — Wheel Bolt  |                 |

3. Align the valve notch in the wheel cover with the valve stem on the wheel. Install the cover by hand, snapping the cover over the two wheel bolts. Do not use a hammer or excessive force to install the cover.
4. Install the remaining wheel bolts and lightly tighten.
6. Finish tightening the wheel bolts. Push down on the wrench while at the end of the handle for increased leverage. Tighten the wheel bolts in a star pattern until each wheel bolt has been tightened twice. Refer to "Torque Specifications" in this section for proper lug bolt torque. If in doubt about the correct tightness, have them checked with a torque wrench by your authorized dealer or service station.

**WARNING!**

**To avoid the risk of forcing the vehicle off the jack, do not tighten the lug nuts fully until the vehicle has been lowered. Failure to follow this warning may result in serious injury.**

5. Lower the vehicle to the ground by turning the jack handle counterclockwise.
7. Lower the jack until it is free. Remove the wheel chocks. Reassemble the lug wrench to the jack assembly and stow it in the spare tire area. Secure the assembly using the means provided. Release the parking brake before driving the vehicle.
8. After 25 miles (40 km) check the wheel bolt torque with a torque wrench to ensure that all wheel bolts are properly seated against the wheel.

## Road Tire Installation

1. Mount the road tire on the axle.
2. Install the remaining wheel bolts and lightly tighten.

### WARNING!

**To avoid the risk of forcing the vehicle off the jack, do not tighten the lug nuts fully until the vehicle has been lowered. Failure to follow this warning may result in serious injury.**

3. Lower the vehicle to the ground by turning the jack handle counterclockwise.
4. Finish tightening the wheel bolts. Push down on the wrench while at the end of the handle for increased leverage. Tighten the wheel bolts in a star pattern until each wheel bolt has been tightened twice. Refer to “Torque Specifications” in this section for the proper

lug bolt torque. If in doubt about the correct tightness, have them checked with a torque wrench by your authorized dealer or service station.

5. Lower the jack until it is free. Remove the wheel chocks. Reassemble the lug wrench to the jack assembly and stow it in the spare tire area. Secure the assembly using the means provided. Release the parking brake before driving the vehicle.
6. After 25 miles (40 km) check the wheel bolt torque with a torque wrench to ensure that all wheel bolts are properly seated against the wheel.

## JUMP-STARTING PROCEDURES

If your vehicle has a discharged battery it can be jump-started using a set of jumper cables and a battery in another vehicle or by using a portable battery booster pack. Jump-starting can be dangerous if done improperly so please follow the procedures in this section carefully.



**NOTE:** When using a portable battery booster pack follow the manufacturer's operating instructions and precautions.

### CAUTION!

Do not use a portable battery booster pack or any other booster source with a system voltage greater than 12 Volts or damage to the battery, starter motor, alternator or electrical system may occur.

### WARNING!

Do not attempt jump-starting if the battery is frozen. It could rupture or explode and cause personal injury.

## Preparations For Jump-Start

The battery in your vehicle is located in the front of the engine compartment, behind the left headlight assembly.

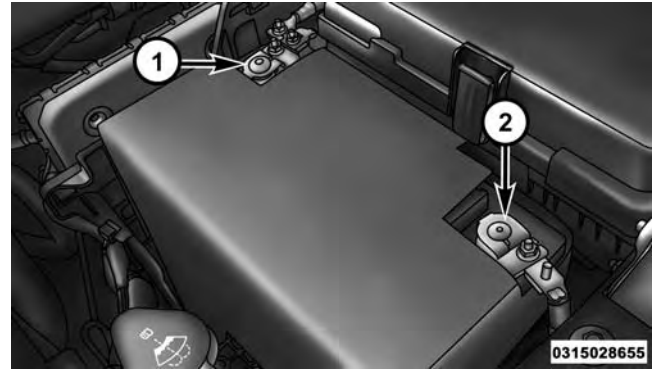

- 1 — Positive Battery Post
- 2 — Negative Battery Post

**WARNING!**

- Take care to avoid the radiator cooling fan whenever the hood is raised. It can start anytime the ignition switch is ON. You can be injured by moving fan blades.
- Remove any metal jewelry such as rings, watch bands and bracelets that could make an inadvertent electrical contact. You could be seriously injured.
- Batteries contain sulfuric acid that can burn your skin or eyes and generate hydrogen gas which is flammable and explosive. Keep open flames or sparks away from the battery.

1. Set the parking brake, shift the automatic transmission into PARK and turn the ignition to LOCK.
2. Turn off the heater, radio, and all unnecessary electrical accessories.

3. If using another vehicle to jump-start the battery, park the vehicle within the jumper cables reach, set the parking brake and make sure the ignition is OFF.

**WARNING!**

Do not allow vehicles to touch each other as this could establish a ground connection and personal injury could result.

**Jump-Starting Procedure****WARNING!**

Failure to follow this jump-starting procedure could result in personal injury or property damage due to battery explosion.

**CAUTION!**

Failure to follow these procedures could result in damage to the charging system of the booster vehicle or the discharged vehicle.

**Connecting The Jumper Cables**

1. Connect the positive (+) end of the jumper cable to the positive (+) post of the discharged vehicle.
2. Connect the opposite end of the positive (+) jumper cable to the positive (+) post of the booster battery.
3. Connect the negative (-) end of the jumper cable to the negative (-) post of the booster battery.
4. Connect the opposite end of the negative (-) jumper cable to a good engine ground (exposed metal part of the discharged vehicle's engine) away from the battery and the fuel injection system.

**WARNING!**

Do not connect the jumper cable to the negative (-) post of the discharged battery. The resulting electrical spark could cause the battery to explode and could result in personal injury. Only use the specific ground point, do not use any other exposed metal parts.

5. Start the engine in the vehicle that has the booster battery, let the engine idle a few minutes, and then start the engine in the vehicle with the discharged battery.
6. Once the engine is started, remove the jumper cables in the reverse sequence:

## Disconnecting The Jumper Cables

1. Disconnect the negative (-) end of the jumper cable from the engine ground of the vehicle with the discharged battery.
2. Disconnect the opposite end of the negative (-) jumper cable from the negative (-) post of the booster battery.
3. Disconnect the positive (+) end of the jumper cable from the positive (+) post of the booster battery.
4. Disconnect the opposite end of the positive (+) jumper cable from the positive (+) post of the vehicle with the discharged battery.

If frequent jump-starting is required to start your vehicle you should have the battery and charging system inspected at your authorized dealer.

### CAUTION!

**Accessories plugged into the vehicle power outlets draw power from the vehicle's battery, even when not in use (i.e., cellular devices, etc.). Eventually, if plugged in long enough without engine operation, the vehicle's battery will discharge sufficiently to degrade battery life and/or prevent the engine from starting.**

## FREEING A STUCK VEHICLE

If your vehicle becomes stuck in mud, sand or snow, it can often be moved using a rocking motion. Turn the steering wheel right and left to clear the area around the front wheels. Then shift back and forth between DRIVE and REVERSE while gently pressing the accelerator.

**NOTE:** Shifts between DRIVE and REVERSE can only be achieved at wheel speeds of 5 mph (8 km/h) or less. Whenever the transmission remains in NEUTRAL for more than two seconds, you must press the brake pedal to engage DRIVE or REVERSE.

Use the least amount of accelerator pedal pressure that will maintain the rocking motion without spinning the wheels or racing the engine.

**NOTE:** Push the "ESC Off" switch to place the Electronic Stability Control (ESC) system in "Partial Off" mode, before rocking the vehicle. Refer to "Electronic Brake Control" in "Starting And Operating" for further information. Once the vehicle has been freed, push the "ESC Off" switch again to restore "ESC On" mode.

### CAUTION!

**Racing the engine or spinning the wheels may lead to transmission overheating and failure. Allow the engine to idle with the transmission in NEUTRAL for at least one minute after every five rocking-motion cycles. This will minimize overheating and reduce the risk of transmission failure during prolonged efforts to free a stuck vehicle.**

### CAUTION!

- **When "rocking" a stuck vehicle by shifting between DRIVE and REVERSE, do not spin the wheels faster than 15 mph (24 km/h), or drivetrain damage may result.**

*(Continued)*

**CAUTION!** *(Continued)*

- Revving the engine or spinning the wheels too fast may lead to transmission overheating and failure. It can also damage the tires. Do not spin the wheels above 30 mph (48 km/h) while in gear (no transmission shifting occurring).

**WARNING!**

Fast spinning tires can be dangerous. Forces generated by excessive wheel speeds may cause damage, or even failure, of the axle and tires. A tire could explode and injure someone. Do not spin your vehicle's wheels faster than 30 mph (48 km/h) or for longer than 30 seconds continuously without stopping when you are stuck and do not let anyone near a spinning wheel, no matter what the speed.

**MANUAL PARK RELEASE****WARNING!**

Always secure your vehicle by fully applying the parking brake, before activating the Manual Park Release. Activating the Manual Park Release will allow your vehicle to roll away if it is not secured by the parking brake or by proper connection to a tow vehicle. Activating the Manual Park Release on an unsecured vehicle could lead to serious injury or death for those in or around the vehicle.

In order to move the vehicle in cases where the transmission will not shift out of PARK (such as a dead battery), a Manual Park Release is available.

Follow these steps to activate the Manual Park Release:

1. Apply the parking brake.

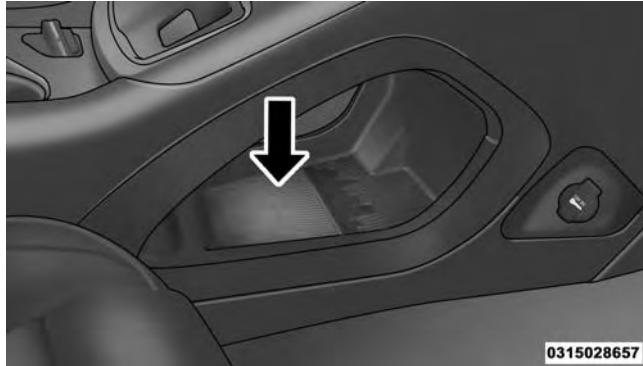

Manual Park Release location

2. Using a small screwdriver or similar tool, remove the Manual Park Release access cover, which is underneath the rubber storage bin liner in the center console pass-through.

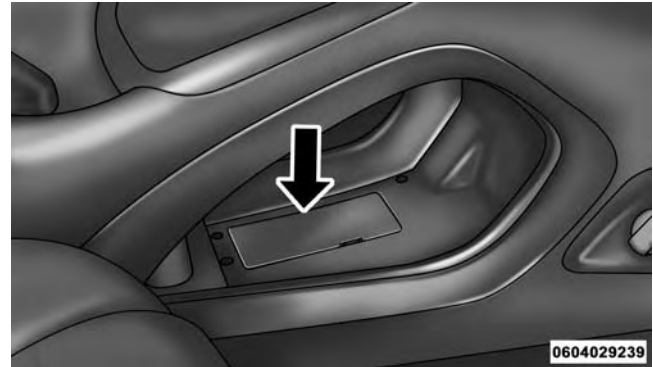

Manual Park Release Cover

3. Unsnap the tether from the Manual Park Release lever, and use it to pull the lever upwards.

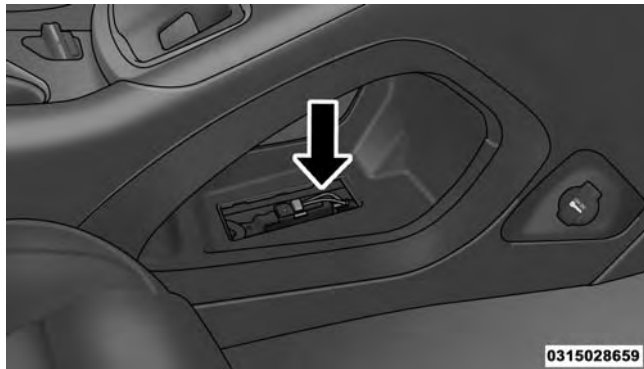

**Manual Park Release Tether**

4. Pull the tether to rotate the lever up and rearward, until it locks vertically in place. Verify that the Manual Park Release lever is locked in the released position.

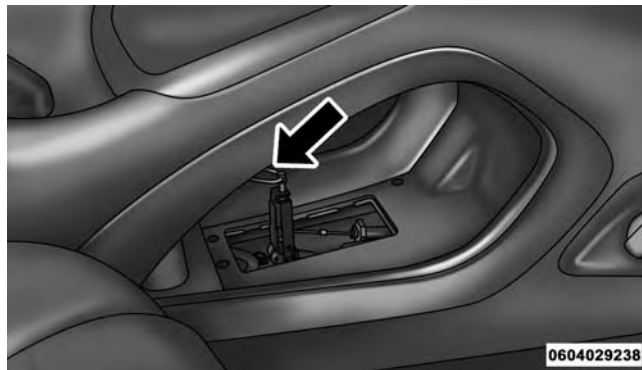

**Locked Position**

5. The vehicle is now out of PARK and can be moved. Release the parking brake only when the vehicle is securely connected to a tow vehicle.



**To reset the Manual Park Release:**

1. Pull the tether upwards to unlock the lever.
2. Rotate the Manual Park Release lever forward and down to its original position.
3. Re-install the access cover and the rubber storage bin liner.

**TOWING A DISABLED VEHICLE**

This section describes procedures for towing a disabled vehicle using a commercial towing service.

6

<b>Towing Condition</b>	<b>Wheel OFF the Ground</b>	<b>FWD MODELS</b>	<b>AWD MODELS</b>
Flat Tow	NONE	NOT ALLOWED	NOT ALLOWED
Wheel Lift Or Dolly Tow	Front	OK	NOT ALLOWED
	Rear	NOT ALLOWED	NOT ALLOWED
Flatbed	ALL	BEST METHOD	ONLY METHOD

Proper towing or lifting equipment is required to prevent damage to your vehicle. Use only tow bars and other equipment designed for this purpose, following equipment manufacturer's instructions. Use of safety chains is mandatory. Attach a tow bar or other towing device to main structural members of the vehicle, not to bumpers or associated brackets. State and local laws regarding vehicles under tow must be observed.

**NOTE:**

- You must ensure that the Auto Park Brake feature is disabled before towing this vehicle, to avoid inadvertent Electric Park Brake engagement. The Auto Park Brake feature is enabled or disabled via the customer programmable features in the Uconnect Settings.

- Vehicles with a discharged battery or total electrical failure when the electric parking brake (EPB) is engaged, will need a wheel dolly or jack to raise the rear wheels off the ground when moving the vehicle onto a flatbed.

**Vehicle Recovery Tow Points**

Your vehicle is equipped with Vehicle Recovery Points that can be used to recover a disabled vehicle, located on the underbody of the vehicle.

**NOTE:**

- Ensure that the towing service tow hooks are properly seated and secured in the attachment points.
- This recovery tow feature should be used by a trained professional only.
- Use approved receptacle location to free the disabled vehicle from its environment.

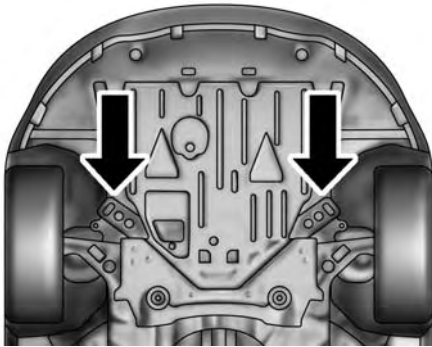

0615061108

Front Of Vehicle Recovery Points

**CAUTION!****Recovery feature:**

- Is to be used by a professional **ONLY**.
- Is used only to provide recovery of the vehicle.
- Is **NOT** to be used to recover secondary vehicle.
- Is **NOT** to be used for transporting the vehicle over the road, i.e. "Flat Towing".

**Recovery load should:**

- Be applied at constant speed.
- Be applied parallel to the center line of the length of the vehicle.
- Not be an abrupt acceleration.

If you must use the accessories (wipers, defrosters, etc.) while being towed, the ignition must be in the ON/RUN position, not the ACC position.

**NOTE:** The Safehold feature will engage the Electric Park Brake whenever the driver's door is opened (if the ignition is ON, transmission is not in PARK, and brake pedal is released). If you are towing this vehicle with the ignition in the ON/RUN position, you must manually disable the Electric Park Brake each time the driver's door is opened, by pressing the brake pedal and then pushing the EPB switch down.

If the key fob is unavailable, or the vehicle's battery is discharged, refer to "Manual Park Release" in this section for instructions on shifting the transmission out of PARK for towing.

### CAUTION!

- **Do not use sling-type equipment when towing. Vehicle damage may occur.**
- **When securing the vehicle to a flatbed truck, do not attach to front or rear suspension components. Damage to your vehicle may result from improper towing.**
- **Ensure that the Electric Park Brake is released, and remains released, while being towed.**

### Front-Wheel Drive (FWD) Models

The manufacturer recommends towing your vehicle with all four wheels **OFF** the ground using a flatbed.

If flatbed equipment is not available, this vehicle must be towed with the front wheels **OFF** the ground (using a towing dolly, or wheel lift equipment with the front wheels raised).

**NOTE:** Ensure that the Electric Park Brake is released, and remains released, while being towed.

### CAUTION!

Towing this vehicle in violation of the above requirements can cause severe transmission damage. Damage from improper towing is not covered under the New Vehicle Limited Warranty.

### All-Wheel Drive (AWD) Models

The manufacturer requires towing with all four wheels OFF the ground. Acceptable methods are to tow the vehicle on a flatbed, or with one end of the vehicle raised and the opposite end on a towing dolly.

### CAUTION!

- **DO NOT** tow this vehicle with ANY of its wheels on the ground. Damage to the drivetrain will result.
- Front or rear wheel lifts must not be used. Internal damage to the transmission or power transfer unit will occur if a front or rear wheel lift is used when towing.
- Towing this vehicle in violation of the above requirements can cause severe transmission and/or power transfer unit damage. Damage from improper towing is not covered under the New Vehicle Limited Warranty.



# MAINTAINING YOUR VEHICLE

## CONTENTS

■ ENGINE COMPARTMENT — 2.4L . . . . .	.591	■ MAINTENANCE PROCEDURES . . . . .	.597
■ ENGINE COMPARTMENT — 3.6L . . . . .	.592	□ Engine Oil . . . . .	.598
■ ONBOARD DIAGNOSTIC SYSTEM — OBD II .	.593	□ Engine Oil Filter . . . . .	.601
□ Onboard Diagnostic System (OBD II)		□ Engine Air Cleaner Filter . . . . .	.602
Cybersecurity . . . . .	.593	□ Maintenance-Free Battery . . . . .	.602
□ Loose Fuel Filler Cap Message . . . . .	.594	□ Air Conditioner Maintenance . . . . .	.604
■ EMISSIONS INSPECTION AND MAINTENANCE		□ Body Lubrication . . . . .	.608
PROGRAMS . . . . .	.595	□ Windshield Wiper Blades . . . . .	.608
■ REPLACEMENT PARTS . . . . .	.596	□ Adding Washer Fluid . . . . .	.609
■ DEALER SERVICE . . . . .	.596	□ Exhaust System . . . . .	.609

## 590 MAINTAINING YOUR VEHICLE

- Cooling System . . . . .612
- Brake System . . . . .618
- Automatic Transmission . . . . .620
- Appearance Care And Protection From Corrosion . . . . .622
- FUSES . . . . .628
  - Power Distribution Center (Fuses). . . . .629
  - Interior Fuses . . . . .642
- VEHICLE STORAGE . . . . .643
- REPLACEMENT BULBS . . . . .644
- BULB REPLACEMENT . . . . .646
  - Low Beam And High Beam Headlamps . . . . .646
  - Front Turn Signal Lamp . . . . .649
  - Front Side Marker Lamps . . . . .651
  - Front Fog Lamp . . . . .652
  - Backup Lamps (Passenger Side) . . . . .653
  - Backup Lamps (Driver Side). . . . .654
  - Stop/Rear Turn Signal Lamp . . . . .656
  - License Plate Lamp . . . . .657
- FLUID CAPACITIES . . . . .658
- FLUIDS, LUBRICANTS, AND GENUINE PARTS . . . . .659
  - Engine . . . . .659
  - Chassis . . . . .662



## ENGINE COMPARTMENT — 2.4L

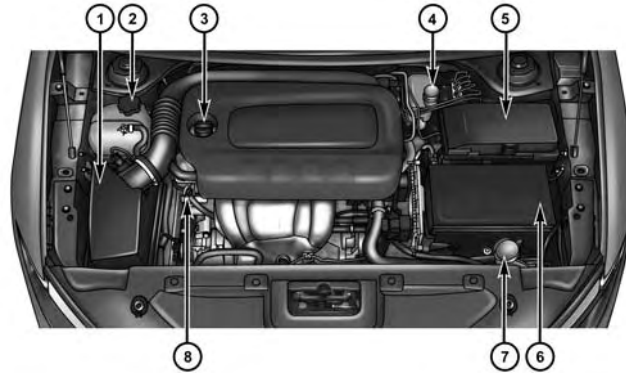

0703017217

- 1 — Air Cleaner Filter
- 2 — Engine Coolant Pressure Cap
- 3 — Oil Fill Cap
- 4 — Brake Fluid Reservoir

- 5 — Power Distribution Center (Fuses)
- 6 — Battery
- 7 — Washer Fluid Reservoir
- 8 — Engine Oil Dipstick

## ENGINE COMPARTMENT — 3.6L

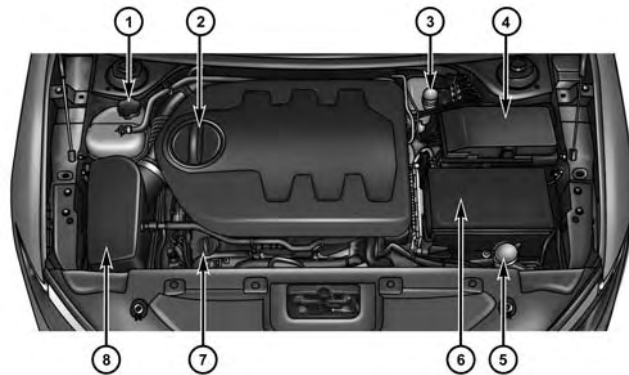

0744017218

1 — Engine Coolant Reservoir

2 — Engine Oil Filter Access Cover

3 — Brake Fluid Reservoir

4 — Power Distribution Center (Fuses)

5 — Washer Fluid Reservoir

6 — Battery

7 — Engine Oil Fill

8 — Air Cleaner Filter

## ONBOARD DIAGNOSTIC SYSTEM — OBD II

Your vehicle is equipped with a sophisticated Onboard Diagnostic system called OBD II. This system monitors the performance of the emissions, engine, and automatic transmission control systems. When these systems are operating properly, your vehicle will provide excellent performance and fuel economy, as well as engine emissions well within current government regulations.

If any of these systems require service, the OBD II system will turn on the Malfunction Indicator Light (MIL). It will also store diagnostic codes and other information to assist your service technician in making repairs. Although your vehicle will usually be drivable and not need towing, see your authorized dealer for service as soon as possible.

### CAUTION!

- **Prolonged driving with the MIL on could cause further damage to the emission control system. It could also affect fuel economy and driveability. The vehicle must be serviced before any emissions tests can be performed.**
- **If the MIL is flashing while the engine is running, severe catalytic converter damage and power loss will soon occur. Immediate service is required.**

### Onboard Diagnostic System (OBD II) Cybersecurity

Your vehicle is required to have an Onboard Diagnostic system (OBD II) and a connection port to allow access to information related to the performance of your emissions controls. Authorized service technicians may need to access this information to assist with the diagnosis and service of your vehicle and emissions system.

**WARNING!**

- **ONLY** an authorized service technician should connect equipment to the OBD II connection port in order to diagnose or service your vehicle.
- If unauthorized equipment is connected to the OBD II connection port, such as a driver-behavior tracking device, it may:
  - Be possible that vehicle systems, including safety related systems, could be impaired or a loss of vehicle control could occur that may result in an accident involving serious injury or death.
  - Access, or allow others to access, information stored in your vehicle systems, including personal information.

For further information, refer to “Privacy Practices” and “Uconnect CyberSecurity” in “All About Uconnect Access” in your Owner’s Manual Radio Supplement and “Cybersecurity” in “Understanding Your Instrument Panel” in your Owner’s Manual on the DVD.

**Loose Fuel Filler Cap Message**

If the vehicle diagnostic system determines that the fuel filler cap is loose, improperly installed, or damaged, a “CHECK GASCAP” message will be displayed in the Electronic Vehicle Information Center (EVIC) or Driver Information Display (DID). Refer to “Electronic Vehicle Information (EVIC) or “Driver Information Display (DID)” in “Understanding Your Instrument Panel” for further information. Tighten the fuel filler cap until a “clicking” sound is heard. This is an indication that the fuel filler cap is properly tightened. Refer to “Onboard Diagnostic System” in “Maintaining Your Vehicle” for further information.

## EMISSIONS INSPECTION AND MAINTENANCE PROGRAMS

In some localities, it may be a legal requirement to pass an inspection of your vehicle's emissions control system. Failure to pass could prevent vehicle registration.



For states that require an Inspection and Maintenance (I/M), this check verifies the "Malfunction Indicator Light (MIL)" is functioning and is not on when the engine is running, and that the OBD II system is ready for testing.

Normally, the OBD II system will be ready. The OBD II system may **not** be ready if your vehicle was recently serviced, recently had a dead battery or a battery replacement. If the OBD II system should be determined not ready for the I/M test, your vehicle may fail the test.

Your vehicle has a simple ignition actuated test, which you can use prior to going to the test station. To check if your vehicle's OBD II system is ready, you must do the following:

1. Cycle the ignition switch to the ON position, but do not crank or start the engine.

**NOTE:** If you crank or start the engine, you will have to start this test over.

2. As soon as you cycle the ignition switch to the ON position, you will see the Malfunction Indicator Light (MIL) symbol come on as part of a normal bulb check.
3. Approximately 15 seconds later, one of two things will happen:
  - The MIL will flash for about 10 seconds and then return to being fully illuminated until you turn OFF the ignition or start the engine. This means that your vehicle's OBD II system is **not ready** and you should **not** proceed to the I/M station.

- The MIL will not flash at all and will remain fully illuminated until you place the ignition in the off position or start the engine. This means that your vehicle's OBD II system is **ready** and you can proceed to the I/M station.

If your OBD II system is **not ready**, you should see your authorized dealer or repair facility. If your vehicle was recently serviced or had a battery failure or replacement, you may need to do nothing more than drive your vehicle as you normally would in order for your OBD II system to update. A recheck with the above test routine may then indicate that the system is **now ready**.

Regardless of whether your vehicle's OBD II system is ready or not, if the MIL is illuminated during normal vehicle operation you should have your vehicle serviced before going to the I/M station. The I/M station can fail your vehicle because the MIL is on with the engine running.

## REPLACEMENT PARTS

Use of genuine MOPAR parts for normal/scheduled maintenance and repairs is highly recommended to ensure the designed performance. Damage or failures caused by the use of non-MOPAR parts for maintenance and repairs will not be covered by the New Vehicle Limited Warranty.

## DEALER SERVICE

Your authorized dealer has the qualified service personnel, special tools, and equipment to perform all service operations in an expert manner. Service Manuals are available which include detailed service information for your vehicle. Refer to these Service Manuals before attempting any procedure yourself.

**NOTE:** Intentional tampering with emissions control systems may void your warranty and could result in civil penalties being assessed against you.

### WARNING!

You can be badly injured working on or around a motor vehicle. Only do service work for which you have the knowledge and the proper equipment. If you have any doubt about your ability to perform a service job, take your vehicle to a competent mechanic.

### MAINTENANCE PROCEDURES

The pages that follow contain the **required** maintenance services determined by the engineers who designed your vehicle.

Besides those maintenance items specified in the fixed "Maintenance Schedule", there are other components which may require servicing or replacement in the future.

### CAUTION!

- Failure to properly maintain your vehicle or perform repairs and service when necessary could result in more costly repairs, damage to other components or negatively impact vehicle performance. Immediately have potential malfunctions examined by an authorized dealer or qualified repair center.
- Your vehicle has been built with improved fluids that protect the performance and durability of your vehicle and also allow extended maintenance intervals. Do not use chemical flushes in these components as the chemicals can damage your engine,

*(Continued)*

**CAUTION! (Continued)**

transmission or air conditioning. Such damage is not covered by the New Vehicle Limited Warranty. If a flush is needed because of component malfunction, use only the specified fluid for the flushing procedure.

**Engine Oil****Checking Oil Level**

To assure proper engine lubrication, the engine oil must be maintained at the correct level. Check the oil level at regular intervals, such as every month. The best time to check the engine oil level is about five minutes after a fully warmed up engine is shut off.

Checking the oil while the vehicle is on level ground will improve the accuracy of the oil level readings.

There are three possible dipstick types,

- Crosshatched zone.
- Crosshatched zone marked SAFE.
- Crosshatched zone marked with MIN at the low end of the range and MAX at the high end of the range.

**NOTE:** Always maintain the oil level within the cross-hatch markings on the dipstick.

Adding 1 quart (1.0 liters) of oil when the reading is at the low end of the dipstick range will raise the oil level to the high end of the range marking.

**CAUTION!**

**Overfilling or underfilling the crankcase will cause aeration or loss of oil pressure. This could damage your engine.**



## Change Engine Oil

The oil change indicator system will remind you that it is time to take your vehicle in for scheduled maintenance. Refer to the “Maintenance Schedule” for further information.

**NOTE:** Under no circumstances should oil change intervals exceed 10,000 miles (16,000 km), twelve months or 350 hours of engine run time, whichever comes first. The 350 hours of engine run or idle time is generally only a concern for fleet customers.

## Engine Oil Selection

For best performance and maximum protection under all types of operating conditions, the manufacturer only recommends engine oils that are API Certified and meet the requirements of FCA US Material Standard MS-6395.

## American Petroleum Institute (API) Engine Oil Identification Symbol



This symbol means that the oil has been certified by the American Petroleum Institute (API). The manufacturer only recommends API Certified engine oils.

This symbol certifies 0W-20, 5W-20, 0W-30, 5W-30 and 10W-30 engine oils.

### CAUTION!

**Do not use chemical flushes in your engine oil as the chemicals can damage your engine. Such damage is not covered by the New Vehicle Limited Warranty.**

### Engine Oil Viscosity (SAE Grade) — 2.0L, 2.4L Engine

MOPAR SAE 0W-20 engine oil approved to FCA US Material Standard MS-6395 such as Pennzoil, Shell Helix or equivalent is recommended for all operating temperatures. This engine oil improves low temperature starting and vehicle fuel economy.

The engine oil filler cap also shows the recommended engine oil viscosity for your engine. For information on engine oil filler cap location, refer to “Engine Compartment” in this section.

Lubricants which do not have both the engine oil certification mark and the correct SAE viscosity grade number should not be used.

### Engine Oil Viscosity — 3.6L Engine

MOPAR SAE 5W-20 engine oil approved to FCA US Material Standard MS-6395 such as Pennzoil, Shell Helix or equivalent is recommended for all operating temperatures. This engine oil improves low temperature starting and vehicle fuel economy.

The engine oil filler cap also shows the recommended engine oil viscosity for your engine. For information on engine oil filler cap location, refer to the “Engine Compartment” illustration in this section.

**NOTE:** MOPAR SAE 5W-30 engine oil approved to FCA US Material Standard MS-6395 such as Pennzoil, Shell Helix or equivalent may be used when SAE 5W-20 engine oil meeting MS-6395 is not available.

Lubricants which do not have both the engine oil certification mark and the correct SAE viscosity grade number should not be used.

## Synthetic Engine Oils

You may use synthetic engine oils provided the recommended oil quality requirements are met, and the recommended maintenance intervals for oil and filter changes are followed.

Synthetic engine oils which do not have both the engine oil certification mark and the correct SAE viscosity grade number should not be used.

## Materials Added To Engine Oil

The manufacturer strongly recommends against the addition of any additives (other than leak detection dyes) to the engine oil. Engine oil is an engineered product and its performance may be impaired by supplemental additives.

## Disposing Of Used Engine Oil And Oil Filters

Care should be taken in disposing of used engine oil and oil filters from your vehicle. Used oil and oil filters,

indiscriminately discarded, can present a problem to the environment. Contact your authorized dealer, service station or governmental agency for advice on how and where used oil and oil filters can be safely discarded in your area.

## Engine Oil Filter

The engine oil filter should be replaced with a new filter at every engine oil change.

## Engine Oil Filter Selection

This manufacturer's engines have a full-flow type disposable oil filter. Use a filter of this type for replacement. The quality of replacement filters varies considerably. Only high quality filters should be used to assure most efficient service. MOPAR engine oil filters are high quality oil filters and are recommended.

## Engine Air Cleaner Filter

Refer to the “Maintenance Schedule” for the proper maintenance intervals.

**NOTE:** Be sure to follow the “Sever Duty Conditions” maintenance interval if applicable.

### **WARNING!**

**The air induction system (air cleaner, hoses, etc.) can provide a measure of protection in the case of engine backfire. Do not remove the air induction system (air cleaner, hoses, etc.) unless such removal is necessary for repair or maintenance. Make sure that no one is near the engine compartment before starting the vehicle with the air induction system (air cleaner, hoses, etc.) removed. Failure to do so can result in serious personal injury.**

## Engine Air Cleaner Filter Selection

The quality of replacement engine air cleaner filters varies considerably. Only high quality filters should be used to assure most efficient service. MOPAR engine air cleaner filters are a high quality filter and are recommended.

## Maintenance-Free Battery

Your vehicle is equipped with a maintenance-free battery. You will never have to add water, nor is periodic maintenance required.

**WARNING!**

- Battery fluid is a corrosive acid solution and can burn or even blind you. Do not allow battery fluid to contact your eyes, skin, or clothing. Do not lean over a battery when attaching clamps. If acid splashes in eyes or on skin, flush the area immediately with large amounts of water. Refer to "Jump-Starting Procedures" in "What To Do In Emergencies" for further information.
- Battery gas is flammable and explosive. Keep flame or sparks away from the battery. Do not use a booster battery or any other booster source with an output greater than 12 Volts. Do not allow cable clamps to touch each other.
- Battery posts, terminals, and related accessories contain lead and lead compounds. Wash hands after handling.

**CAUTION!**

- It is essential when replacing the cables on the battery that the positive cable is attached to the positive post and the negative cable is attached to the negative post. Battery posts are marked positive (+) and negative (-) and are identified on the battery case. Cable clamps should be tight on the terminal posts and free of corrosion.
- If a "fast charger" is used while the battery is in the vehicle, disconnect both vehicle battery cables before connecting the charger to the battery. Do not use a "fast charger" to provide starting voltage.

## Air Conditioner Maintenance

For best possible performance, your air conditioner should be checked and serviced by an authorized dealer at the start of each warm season. This service should include cleaning of the condenser fins and a performance test. Drive belt tension should also be checked at this time.

### WARNING!

- Use only refrigerants and compressor lubricants approved by the manufacturer for your air conditioning system. Some unapproved refrigerants are flammable and can explode, injuring you. Other unapproved refrigerants or lubricants can cause the system to fail, requiring costly repairs. Refer to Warranty Information Book, located on the DVD, for further warranty information.

### WARNING! (Continued)

- The air conditioning system contains refrigerant under high pressure. To avoid risk of personal injury or damage to the system, adding refrigerant or any repair requiring lines to be disconnected should be done by an experienced technician.

### CAUTION!

Do not use chemical flushes in your air conditioning system as the chemicals can damage your air conditioning components. Such damage is not covered by the New Vehicle Limited Warranty.

(Continued)



## Refrigerant Recovery And Recycling HFO 1234yf

HFO 1234yf Air Conditioning Refrigerant is a hydrofluoroolefine HFO that is endorsed by the Environmental Protection Agency and is an ozone-saving product. The manufacturer recommends that air conditioning service be performed by authorized dealer using recovery and recycling equipment.

**NOTE:** Use only manufacturer approved A/C system PAG compressor oil, and refrigerants.

## A/C Air Filter

### WARNING!

Do not remove the A/C air filter while the blower is operating or personal injury may result.

The A/C air filter is located in front of the evaporator on the lower right of center console. Perform the following procedure to replace the filter:

1. Remove the passenger side console closeout cover, by inserting fingers between bottom of side panel (at rear) and the carpet. Pull outboard to disengage the 3 clips.
2. Pull the console closeout cover rearward to disengage the front retaining tab and remove the cover.

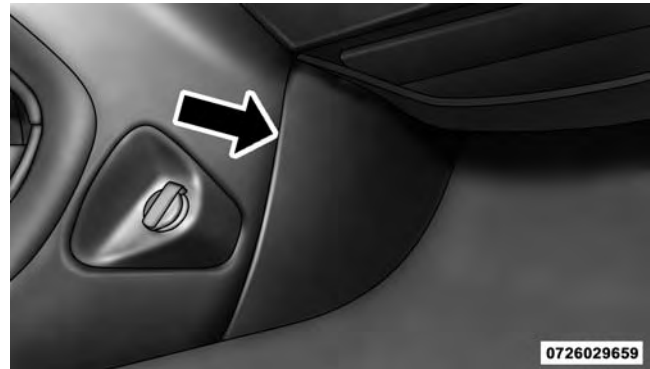

Console Closeout Panel

- Carefully remove 3 push pins holding the hush panel and remove the part.
- Remove the filter door by pushing down the tab on the top bottom of the door and lift the tab at the top of the door to release the cover then rotate remove the door out and lift up.

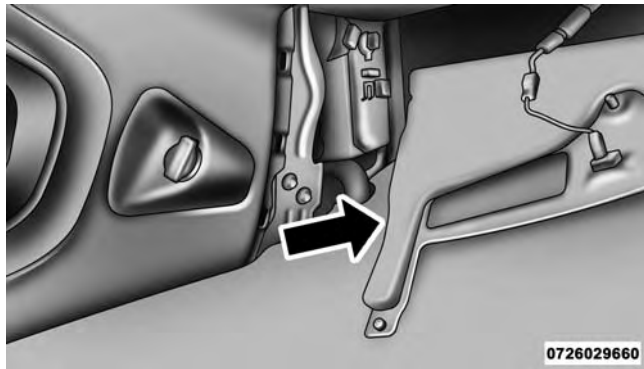

Hush Panel

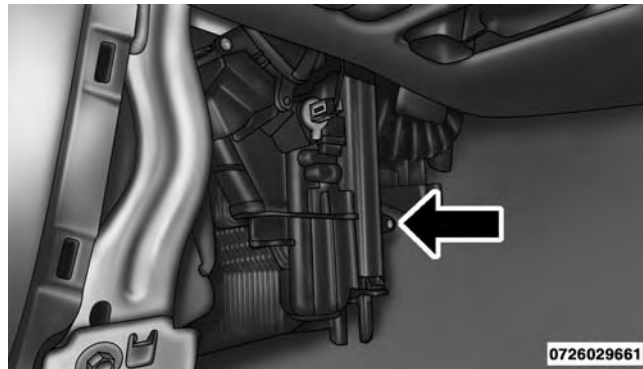

Air Filter Cover Location



5. Remove the A/C air filter by pulling it straight out of the housing. Take note of the air filter position flow direction indicators.
6. Install the A/C air filter with the air filter position indicators pointing in the same direction as removal.

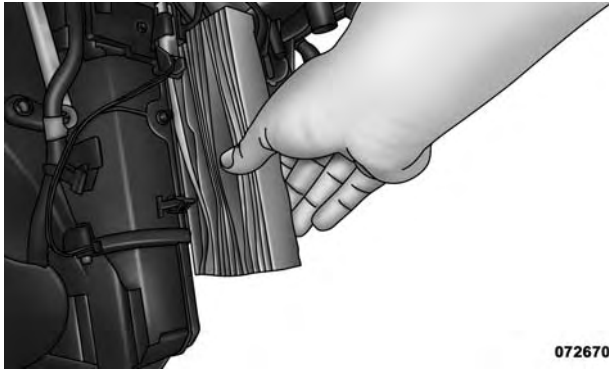

A/C Air Filter

072670493

**CAUTION!**

The A/C air filter is identified with an arrow to indicate airflow direction through the filter. Failure to properly install the filter will result in the need to replace it more often.

7. Install the passenger side hush panel under the dash panel and console closeout.

Refer to the "Maintenance Schedule" for the proper maintenance intervals.

## Body Lubrication

Locks and all body pivot points, including such items as seat tracks, door hinge pivot points and rollers, liftgate, tailgate, decklid, sliding doors and hood hinges, should be lubricated periodically with a lithium based grease, such as MOPAR Spray White Lube to assure quiet, easy operation and to protect against rust and wear. Prior to the application of any lubricant, the parts concerned should be wiped clean to remove dust and grit; after lubricating excess oil and grease should be removed. Particular attention should also be given to hood latching components to ensure proper function. When performing other underhood services, the hood latch, release mechanism and safety catch should be cleaned and lubricated.

The external lock cylinders should be lubricated twice a year, preferably in the Fall and Spring. Apply a small amount of a high quality lubricant, such as MOPAR Lock Cylinder Lubricant directly into the lock cylinder.

## Windshield Wiper Blades

Clean the rubber edges of the wiper blades and the windshield periodically with a sponge or soft cloth and a mild nonabrasive cleaner. This will remove accumulations of salt or road film.

Operation of the wipers on dry glass for long periods may cause deterioration of the wiper blades. Always use washer fluid when using the wipers to remove salt or dirt from a dry windshield.

Avoid using the wiper blades to remove frost or ice from the windshield. Keep the blade rubber out of contact with petroleum products such as engine oil, gasoline, etc.

**NOTE:** Life expectancy of wiper blades varies depending on geographical area and frequency of use. Poor performance of blades may be present with chattering, marks, water lines or wet spots. If any of these conditions are present, clean the wiper blades or replace as necessary.

## Adding Washer Fluid

The fluid reservoir is located in the front of the engine compartment. Be sure to check the fluid level in the reservoir at regular intervals. Fill the reservoir with windshield washer solvent (not radiator antifreeze) and operate the system for a few seconds to flush out the residual water.

When refilling the washer fluid reservoir, take some washer fluid and apply it to a cloth or towel and wipe clean the wiper blades, this will help blade performance.

To prevent freeze-up of your windshield washer system in cold weather, select a solution or mixture that meets or exceeds the temperature range of your climate. This rating information can be found on most washer fluid containers.

### WARNING!

**Commercially available windshield washer solvents are flammable. They could ignite and burn you. Care must be exercised when filling or working around the washer solution.**

## Exhaust System

The best protection against carbon monoxide entry into the vehicle body is a properly maintained engine exhaust system.

If you notice a change in the sound of the exhaust system; or if the exhaust fumes can be detected inside the vehicle; or when the underside or rear of the vehicle is damaged; have an authorized technician inspect the complete exhaust system and adjacent body areas for broken, damaged, deteriorated, or mispositioned parts. Open seams or loose connections could permit exhaust fumes to seep into the passenger compartment. In addition, have the

exhaust system inspected each time the vehicle is raised for lubrication or oil change. Replace as required.

### WARNING!

- Exhaust gases can injure or kill. They contain carbon monoxide (CO), which is colorless and odorless. Breathing it can make you unconscious and can eventually poison you. To avoid breathing CO, refer to “Safety Tips/Exhaust Gas” in “Things To Know Before Starting Your Vehicle” for further information.
- A hot exhaust system can start a fire if you park over materials that can burn. Such materials might be grass or leaves coming into contact with your exhaust system. Do not park or operate your vehicle in areas where your exhaust system can contact anything that can burn.

### CAUTION!

- The catalytic converter requires the use of unleaded fuel only. Leaded gasoline will destroy the effectiveness of the catalyst as an emissions control device and may seriously reduce engine performance and cause serious damage to the engine.
- Damage to the catalytic converter can result if your vehicle is not kept in proper operating condition. In the event of engine malfunction, particularly involving engine misfire or other apparent loss of performance, have your vehicle serviced promptly. Continued operation of your vehicle with a severe malfunction could cause the converter to overheat, resulting in possible damage to the converter and vehicle.

Under normal operating conditions, the catalytic converter will not require maintenance. However, it is important to keep the engine properly tuned to assure proper catalyst operation and prevent possible catalyst damage.

**NOTE:** Intentional tampering with emissions control systems can result in civil penalties being assessed against you.

In unusual situations involving grossly malfunctioning engine operation, a scorching odor may suggest severe and abnormal catalyst overheating. If this occurs, stop the vehicle, turn off the engine and allow it to cool. Service, including a tune-up to manufacturer's specifications, should be obtained immediately.

To minimize the possibility of catalytic converter damage:

- Do not shut off the engine or interrupt the ignition, when the transmission is in gear and the vehicle is in motion.
- Do not try to start the engine by pushing or towing the vehicle.
- Do not idle the engine with any spark plug wires disconnected or removed, such as when diagnostic testing, or for prolonged periods during very rough idle or malfunctioning operating conditions.

## Cooling System

### WARNING!

**You or others can be badly burned by hot engine coolant (antifreeze) or steam from your radiator. If you see or hear steam coming from under the hood, do not open the hood until the radiator has had time to cool. Never try to open a cooling system pressure cap when the radiator or coolant bottle is hot.**

### Engine Coolant Checks

Check the engine coolant (antifreeze) protection every 12 months (before the onset of freezing weather, where applicable). If the engine coolant (antifreeze) is dirty, the system should be drained, flushed, and refilled with fresh OAT coolant (conforming to MS.90032) by an authorized dealer. Check the front of the A/C condenser

for any accumulation of bugs, leaves, etc. If dirty, clean by gently spraying water from a garden hose vertically down the face of the condenser.

Check the engine cooling system hoses for brittle rubber, cracking, tears, cuts, and tightness of the connection at the coolant recovery bottle and radiator. Inspect the entire system for leaks.

With the engine at normal operating temperature (but not running), check the cooling system pressure cap for proper vacuum sealing by draining a small amount of engine coolant (antifreeze) from the radiator drain cock. If the cap is sealing properly, the engine coolant (antifreeze) will begin to drain from the coolant recovery bottle. **DO NOT REMOVE THE COOLANT PRESSURE CAP WHEN THE COOLING SYSTEM IS HOT.**

## Cooling System — Drain, Flush And Refill

**NOTE:** Some vehicles require special tools to add coolant properly. Failure to fill these systems properly could lead to severe internal engine damage. If any coolant is needed to be added to the system please contact your local authorized dealer.

If the engine coolant (antifreeze) is dirty or contains visible sediment, have an authorized dealer clean and flush with OAT coolant (antifreeze) (conforming to MS.90032).

Refer to the “Maintenance Schedule” for the proper maintenance intervals.

### Selection Of Coolant

Refer to “Fluids, Lubricants, And Genuine Parts” in “Maintaining Your Vehicle” for further information.

### CAUTION!

- **Mixing of engine coolant (antifreeze) other than specified Organic Additive Technology (OAT) engine coolant (antifreeze), may result in engine damage and may decrease corrosion protection. Organic Additive Technology (OAT) engine coolant is different and should not be mixed with Hybrid Organic Additive Technology (HOAT) engine coolant (antifreeze) or any “globally compatible” coolant (antifreeze). If a non-OAT engine coolant (antifreeze) is introduced into the cooling system in an emergency, the cooling system will need to be drained, flushed, and refilled with fresh OAT coolant (conforming to MS.90032), by an authorized dealer as soon as possible.**
- **Do not use water alone or alcohol-based engine coolant (antifreeze) products. Do not use additional**

*(Continued)*

**CAUTION! (Continued)**

**rust inhibitors or antirust products, as they may not be compatible with the radiator engine coolant and may plug the radiator.**

- **This vehicle has not been designed for use with propylene glycol-based engine coolant (antifreeze). Use of propylene glycol-based engine coolant (antifreeze) is not recommended.**

**Adding Coolant**

Your vehicle has been built with an improved engine coolant (OAT coolant conforming to MS.90032) that allows extended maintenance intervals. This engine coolant (antifreeze) can be used up to ten years or 150,000 miles (240,000 km) before replacement. To prevent reducing this extended maintenance period, it is important that you use the same engine coolant (OAT coolant conforming to MS.90032) throughout the life of your vehicle.

Please review these recommendations for using Organic Additive Technology (OAT) engine coolant (antifreeze) that meets the requirements of FCA Material Standard MS.90032. When adding engine coolant (antifreeze):

- We recommend using MOPAR Antifreeze/Coolant 10 Year/150,000 Mile Formula OAT (Organic Additive Technology) that meets the requirements of FCA Material Standard MS.90032.
- Mix a minimum solution of 50% OAT engine coolant that meets the requirements of FCA Material Standard MS.90032 and distilled water. Use higher concentrations (not to exceed 70%) if temperatures below  $-34^{\circ}\text{F}$  ( $-37^{\circ}\text{C}$ ) are anticipated.
- Use only high purity water such as distilled or deionized water when mixing the water/engine coolant (antifreeze) solution. The use of lower quality water will reduce the amount of corrosion protection in the engine cooling system.



Please note that it is the owner's responsibility to maintain the proper level of protection against freezing according to the temperatures occurring in the area where the vehicle is operated.

**NOTE:**

- Some vehicles require special tools to add coolant properly. Failure to fill these systems properly could lead to severe internal engine damage. If any coolant is needed to be added to the system, please contact your local authorized dealer.
- Mixing engine coolant (antifreeze) types is not recommended and can result in cooling system damage. If HOAT and OAT coolant are mixed in an emergency, have a authorized dealer drain, flush, and refill with OAT coolant (conforming to MS.90032) as soon as possible.

### Cooling System Pressure Cap

The cap must be fully tightened to prevent loss of engine coolant (antifreeze), and to ensure that engine coolant (antifreeze) will return to the radiator from the coolant recovery tank.

The cap should be inspected and cleaned if there is any accumulation of foreign material on the sealing surfaces.

#### **WARNING!**

- **Do not open hot engine cooling system. Never add engine coolant (antifreeze) when the engine is overheated. Do not loosen or remove the cap to cool an overheated engine. Heat causes pressure to build up in the cooling system. To prevent scalding or injury, do not remove the pressure cap while the system is hot or under pressure.**

*(Continued)*

**WARNING! (Continued)**

- Do not use a pressure cap other than the one specified for your vehicle. Personal injury or engine damage may result.

**Disposal Of Used Engine Coolant**

Used ethylene glycol-based engine coolant (antifreeze) is a regulated substance requiring proper disposal. Check with your local authorities to determine the disposal rules for your community. To prevent ingestion by animals or children, do not store ethylene glycol-based engine coolant in open containers or allow it to remain in puddles on the ground. If ingested by a child or pet, seek emergency assistance immediately. Clean up any ground spills immediately.

**Coolant Level**

The coolant bottle provides a quick visual method for determining that the coolant level is adequate. With the engine OFF and cold, the level of the engine coolant (antifreeze) in the bottle should be between the ranges indicated on the bottle.

The radiator normally remains completely full, so there is no need to remove the radiator/coolant pressure cap unless checking for engine coolant (antifreeze) freeze point or replacing coolant. Advise your service attendant of this. As long as the engine operating temperature is satisfactory, the coolant bottle need only be checked once a month.

When additional engine coolant (antifreeze) is needed to maintain the proper level, only OAT coolant that meets the requirements of FCA Material Standard MS.90032 should be added to the coolant bottle. Do not overfill.

## Points To Remember

**NOTE:** When the vehicle is stopped after a few miles/kilometers of operation, you may observe vapor coming from the front of the engine compartment. This is normally a result of moisture from rain, snow, or high humidity accumulating on the radiator and being vaporized when the thermostat opens, allowing hot engine coolant (antifreeze) to enter the radiator.

If an examination of your engine compartment shows no evidence of radiator or hose leaks, the vehicle may be safely driven. The vapor will soon dissipate.

- Do not overfill the coolant expansion bottle.
- Check the coolant freeze point in the radiator and in the coolant expansion bottle. If engine coolant (antifreeze) needs to be added, the contents of the coolant expansion bottle must also be protected against freezing.

- If frequent engine coolant (antifreeze) additions are required, the cooling system should be pressure tested for leaks.
- Maintain engine coolant (antifreeze) concentration at a minimum of 50% OAT coolant (conforming to MS.90032) and distilled water for proper corrosion protection of your engine which contains aluminum components.
- Make sure that the coolant expansion bottle overflow hoses are not kinked or obstructed.
- Keep the front of the radiator clean. If your vehicle is equipped with air conditioning, keep the front of the condenser clean.
- Do not change the thermostat for Summer or Winter operation. If replacement is ever necessary, install **ONLY** the correct type thermostat. Other designs may result in unsatisfactory engine coolant (antifreeze) performance, poor gas mileage, and increased emissions.

## Brake System

In order to assure brake system performance, all brake system components should be inspected periodically. Refer to the “Maintenance Schedule” for the proper maintenance intervals.

### WARNING!

**Riding the brakes can lead to brake failure and possibly a collision. Driving with your foot resting or riding on the brake pedal can result in abnormally high brake temperatures, excessive lining wear, and possible brake damage. You would not have your full braking capacity in an emergency.**

## Brake Master Cylinder

The fluid in the master cylinder should be checked when performing under hood services or immediately if the “Brake Warning Light” is illuminated.

Be sure to clean the top of the master cylinder area before removing the cap. If necessary, add fluid to bring the fluid level up to the requirements described on the brake fluid reservoir. With disc brakes, fluid level can be expected to fall as the brake pads wear. Brake fluid level should be checked when pads are replaced. However, low fluid level may be caused by a leak and a checkup may be needed.

Use only manufacturer’s recommended brake fluid. Refer to “Fluids, Lubricants, And Genuine Parts” in “Maintaining Your Vehicle” for further information.

**WARNING!**

- Use only manufacturer's recommended brake fluid. Refer to "Fluids, Lubricants, And Genuine Parts" in "Maintaining Your Vehicle" for further information. Using the wrong type of brake fluid can severely damage your brake system and/or impair its performance. The proper type of brake fluid for your vehicle is also identified on the original factory installed hydraulic master cylinder reservoir.
- To avoid contamination from foreign matter or moisture, use only new brake fluid or fluid that has been in a tightly closed container. Keep the master cylinder reservoir cap secured at all times. Brake fluid in an open container absorbs moisture from the air resulting in a lower boiling point. This may

**WARNING! (Continued)**

- cause it to boil unexpectedly during hard or prolonged braking, resulting in sudden brake failure. This could result in a collision.
- Overfilling the brake fluid reservoir can result in spilling brake fluid on hot engine parts, causing the brake fluid to catch fire. Brake fluid can also damage painted and vinyl surfaces, care should be taken to avoid its contact with these surfaces.
- Do not allow petroleum based fluid to contaminate the brake fluid. Brake seal components could be damaged, causing partial or complete brake failure. This could result in a collision.

(Continued)

## Automatic Transmission

### Selection Of Lubricant

It is important to use the proper transmission fluid to ensure optimum transmission performance and life. Use only the manufacturer's specified transmission fluid. Refer to "Fluids, Lubricants, And Genuine Parts" in this section for fluid specifications. It is important to maintain the transmission fluid at the correct level using the recommended fluid.

**NOTE:** No chemical flushes should be used in any transmission; only the approved lubricant should be used.

### CAUTION!

**Using a transmission fluid other than the manufacturer's recommended fluid may cause deterioration in transmission shift quality and/or torque converter shudder. Refer to "Fluids, Lubricants, And Genuine Parts" in this section for fluid specifications.**

### Special Additives

The manufacturer strongly recommends against using any special additives in the transmission. Automatic Transmission Fluid (ATF) is an engineered product and its performance may be impaired by supplemental additives. Therefore, do not add any fluid additives to the transmission. Avoid using transmission sealers as they may adversely affect seals.

**CAUTION!**

Do not use chemical flushes in your transmission as the chemicals can damage your transmission components. Such damage is not covered by the New Vehicle Limited Warranty.

**CAUTION!**

If a transmission fluid leak occurs, visit your authorized dealer immediately. Severe transmission damage may occur. Your authorized dealer has the proper tools to adjust the fluid level accurately.

**Fluid Level Check**

The fluid level is preset at the factory and does not require adjustment under normal operating conditions. Routine fluid level checks are not required, therefore the transmission has no dipstick. Your authorized dealer can check your transmission fluid level using special service tools. If you notice fluid leakage or transmission malfunction, visit your authorized dealer immediately to have the transmission fluid level checked. Operating the vehicle with an improper fluid level can cause severe transmission damage.

**Fluid And Filter Changes**

Under normal operating conditions, the fluid installed at the factory will provide satisfactory lubrication for the life of the vehicle.

Routine fluid and filter changes are not required. However, change the fluid and filter if the fluid becomes contaminated (with water, etc.), or if the transmission is disassembled for any reason.

## Appearance Care And Protection From Corrosion

### Protection Of Body And Paint From Corrosion

Vehicle body care requirements vary according to geographic locations and usage. Chemicals that make roads passable in snow and ice and those that are sprayed on trees and road surfaces during other seasons are highly corrosive to the metal in your vehicle. Outside parking, which exposes your vehicle to airborne contaminants, road surfaces on which the vehicle is operated, extreme hot or cold weather and other extreme conditions will have an adverse effect on paint, metal trim, and underbody protection.

The following maintenance recommendations will enable you to obtain maximum benefit from the corrosion resistance built into your vehicle.

### What Causes Corrosion?

Corrosion is the result of deterioration or removal of paint and protective coatings from your vehicle.

The most common causes are:

- Road salt, dirt and moisture accumulation.
- Stone and gravel impact.
- Insects, tree sap and tar.
- Salt in the air near seacoast localities.
- Atmospheric fallout/industrial pollutants.

### Washing

- Wash your vehicle regularly. Always wash your vehicle in the shade using MOPAR Car Wash, or a mild car wash soap, and rinse the panels completely with clear water.



- If insects, tar, or other similar deposits have accumulated on your vehicle, use MOPAR Super Kleen Bug and Tar Remover to remove.
- Use a high quality cleaner wax, such as MOPAR Cleaner Wax to remove road film, stains and to protect your paint finish. Take care never to scratch the paint.
- Avoid using abrasive compounds and power buffing that may diminish the gloss or thin out the paint finish.

### CAUTION!

- **Do not use abrasive or strong cleaning materials such as steel wool or scouring powder that will scratch metal and painted surfaces.**
- **Use of power washers exceeding 1,200 psi (8 274 kPa) can result in damage or removal of paint and decals.**

### Special Care

- If you drive on salted or dusty roads or if you drive near the ocean, hose off the undercarriage at least once a month.
- It is important that the drain holes in the lower edges of the doors, rocker panels, and trunk be kept clear and open.
- If you detect any stone chips or scratches in the paint, touch them up immediately. The cost of such repairs is considered the responsibility of the owner.
- If your vehicle is damaged due to a collision or similar cause that destroys the paint and protective coating, have your vehicle repaired as soon as possible. The cost of such repairs is considered the responsibility of the owner.

- If you carry special cargo such as chemicals, fertilizers, de-icer salt, etc., be sure that such materials are well packaged and sealed.
- If a lot of driving is done on gravel roads, consider mud or stone shields behind each wheel.
- Use MOPAR Touch Up Paint on scratches as soon as possible. Your authorized dealer has touch up paint to match the color of your vehicle.

### Wheel And Wheel Trim Care

- All wheels and wheel trim, especially aluminum and chrome plated wheels, should be cleaned regularly with a mild soap and water to prevent corrosion.
- To remove heavy soil and/or excessive brake dust, use MOPAR Wheel Cleaner.

**NOTE:** If your vehicle is equipped with Dark Vapor or Black Satin Chrome wheels DO NOT USE wheel cleaners, abrasives or polishing compounds. They will permanently damage this finish and such damage is not covered by the New Vehicle Limited Warranty. USE ONLY MILD SOAP AND WATER WITH A SOFT CLOTH. Used on a regular basis this is all that is required to maintain this finish.

### CAUTION!

**Do not use scouring pads, steel wool, a bristle brush, or metal polishes. Do not use oven cleaner. These products may damage the wheel's protective finish. Avoid automatic car washes that use acidic solutions or harsh brushes that may damage the wheel's protective finish. Only MOPAR Wheel Cleaner or equivalent is recommended.**

## Stain Repel Fabric Cleaning Procedure — If Equipped

Stain Repel seats may be cleaned in the following manner:

- Remove as much of the stain as possible by blotting with a clean, dry towel.
- Blot any remaining stain with a clean, damp towel.
- For tough stains, apply MOPAR Total Clean, or a mild soap solution to a clean, damp cloth and remove stain. Use a fresh, damp towel to remove soap residue.
- For grease stains, apply MOPAR Multi-Purpose Cleaner to a clean, damp cloth and remove stain. Use a fresh, damp towel to remove soap residue.
- Do not use any harsh solvents or any other form of protectants on Stain Repel products.

## Interior Care

Use MOPAR Total Clean to clean fabric upholstery and carpeting.

Use MOPAR Total Clean to clean vinyl upholstery.

MOPAR Total Clean is specifically recommended for leather upholstery.

Your leather upholstery can be best preserved by regular cleaning with a damp soft cloth. Small particles of dirt can act as an abrasive and damage the leather upholstery and should be removed promptly with a damp cloth. Stubborn soils can be removed easily with a soft cloth and MOPAR Total Clean. Care should be taken to avoid soaking your leather upholstery with any liquid. Please do not use polishes, oils, cleaning fluids, solvents, detergents, or ammonia-based cleaners to clean your leather upholstery. Application of a leather conditioner is not required to maintain the original condition.

**WARNING!**

Do not use volatile solvents for cleaning purposes. Many are potentially flammable, and if used in closed areas they may cause respiratory harm.

**CAUTION!**

Direct contact of air fresheners, insect repellents, suntan lotions, or hand sanitizers to the plastic, painted, or decorated surfaces of the interior may cause permanent damage. Wipe away immediately.

**CAUTION!**

Damage caused by these type of products may not be covered by your New Vehicle Limited Warranty.

**CAUTION!**

Do not use Alcohol and Alcohol-based and/or Keton based cleaning products to clean leather seats, as damage to the seat may result.

**Cleaning Headlights**

Your vehicle is equipped with plastic headlights and fog lights that are lighter and less susceptible to stone breakage than glass headlights.

Plastic is not as scratch resistant as glass and therefore different lens cleaning procedures must be followed.

To minimize the possibility of scratching the lenses and reducing light output, avoid wiping with a dry cloth. To remove road dirt, wash with a mild soap solution followed by rinsing.

Do not use abrasive cleaning components, solvents, steel wool or other aggressive material to clean the lenses.

## Glass Surfaces

All glass surfaces should be cleaned on a regular basis with MOPAR Glass Cleaner, or any commercial household-type glass cleaner. Never use an abrasive type cleaner. Use caution when cleaning the inside rear window equipped with electric defrosters or windows equipped with radio antennas. Do not use scrapers or other sharp instrument that may scratch the elements.

When cleaning the rear view mirror, spray cleaner on the towel or cloth that you are using. Do not spray cleaner directly on the mirror.

## Cleaning Plastic Instrument Cluster Lenses

The lenses in front of the instruments in this vehicle are molded in clear plastic. When cleaning the lenses, care must be taken to avoid scratching the plastic.

1. Clean with a wet soft cloth. A mild soap solution may be used, but do not use high alcohol content or abrasive cleaners. If soap is used, wipe clean with a clean damp cloth.
2. Dry with a soft cloth.

## Seat Belt Maintenance

Do not bleach, dye or clean the belts with chemical solvents or abrasive cleaners. This will weaken the fabric. Sun damage can also weaken the fabric.

If the belts need cleaning, use a mild soap solution or lukewarm water. Do not remove the belts from the vehicle to wash them. Dry with a soft cloth.

Replace the belts if they appear frayed or worn or if the buckles do not work properly.

**WARNING!**

A frayed or torn belt could rip apart in a collision and leave you with no protection. Inspect the belt system periodically, checking for cuts, frays, or loose parts. Damaged parts must be replaced immediately. Do not disassemble or modify the system. Seat belt assemblies must be replaced after a collision if they have been damaged (i.e., bent retractor, torn webbing, etc.).

**FUSES****WARNING!**

- When replacing a blown fuse, always use an appropriate replacement fuse with the same amp rating as the original fuse. Never replace a fuse

**WARNING! (Continued)**

with another fuse of higher amp rating. Never replace a blown fuse with metal wires or any other material. Failure to use proper fuses may result in serious personal injury, fire and/or property damage.

- Before replacing a fuse, make sure that the ignition is off and that all the other services are switched off and/or disengaged.
- If the replaced fuse blows again, contact an authorized dealer.
- If a general protection fuse for safety systems (air bag system, braking system), power unit systems (engine system, gearbox system) or steering system blows, contact an authorized dealer.

*(Continued)*

## Power Distribution Center (Fuses)

The Power Distribution Center is located in the engine compartment near the battery. This center contains cartridge fuses, mini-fuses, micro-fuses, circuit breakers and relays. A label that identifies each component is printed on the inside of the cover.

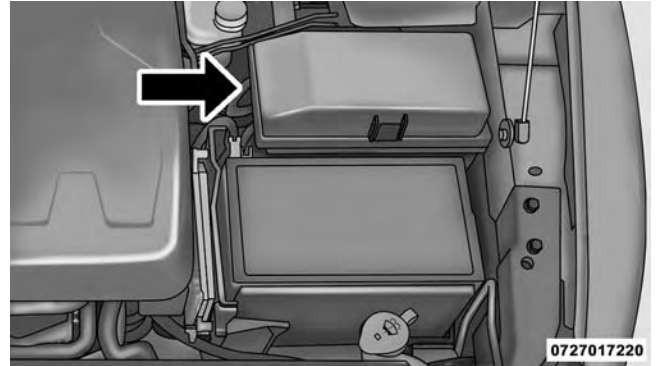

Power Distribution Center

Cavity	Cartridge Fuse	Blade Fuse	Description
F06	–	–	Not Used
F07	–	–	Not Used
F08	–	25 Amp Clear	Engine Control Module (ECM)/Fuel Inj.

Cavity	Cartridge Fuse	Blade Fuse	Description
F09	–	–	Not Used
F10	–	20 Amp Yellow	Power Transfer Unit (PTU) – If Equipped
F11	–	–	Not Used
F12	–	20 Amp Yellow	Brake Vacuum Pump – If Equipped
F13	–	10 Amp Red	Engine Control Module (ECM)/VSM (Engine Stop/Start Only)
F14	–	10 Amp Red	Drivetrain Control Module (DTCM)/Power Transfer Unit (PTU) – If Equipped/RDM/Brake System Module (BSM)/Brake Pedal Switch/EPB (Electric Park Brake)
F15	–	–	Not Used



Cavity	Cartridge Fuse	Blade Fuse	Description
F16	–	20 Amp Yellow	Ignition Coil
F17	–	–	Not Used
F18	–	–	Not Used
F19	40 Amp Green	–	Starter Solenoid
F20	–	10 Amp Red	A/C Compressor Clutch
F21	–	–	Not Used
F22	–	5 Amp Tan	Radiator Fan Enable
F23	–	70 Amp Tan	Body Controller Module (BCM) – Feed 2
F23	–	50 Amp Red	Voltage Stability Module (VSM) #2 – If Equipped With Engine Stop/Start Option
F24	–	–	Not Used

Cavity	Cartridge Fuse	Blade Fuse	Description
F25B	–	20 Amp Yellow	Front Washer Pump – If Equipped with Engine Stop/Start Option
F26	–	–	Not Used
F27	–	–	Not Used
F28	–	15 Amp Blue	Transmission Control Module (TCM)
F29	–	–	Not Used
F30	–	10 Amp Red	Engine Control Module (ECM)/EPS/Fuel Pump Relay Feed
F31	–	–	Not Used
F32	–	–	Not Used
F33	–	–	Not Used
F34	–	–	Not Used

Cavity	Cartridge Fuse	Blade Fuse	Description
F35	–	–	Not Used
F36	–	–	Not Used
F37	50 Amp Red	–	Radiator Fan PWM Controller
F38	–	–	Not Used
F39	40 Amp Green	–	HVAC Blower Motor
F40	–	–	Not Used
F41	50 Amp Red	–	Voltage Stability Module (VSM) #1 – If Equipped With Engine Stop/Start Option
F41	60 Amp Yellow	—	Body Controller Module (BCM) – Feed 1
F42	–	–	Not Used
F43	–	20 Amp Yellow	Fuel Pump Motor
F44	–	–	Not Used

Cavity	Cartridge Fuse	Blade Fuse	Description
F45	30 Amp Pink	–	Passenger Door Module (PDM) – If Equipped
F46	25 Amp Clear	–	Sunroof – If Equipped
F47	–	–	Not Used
F48	30 Amp Pink	–	Driver Door Module (DDM)
F49	30 Amp Pink	–	Power Inverter (115V A/C) – If Equipped
F50	30 Amp Pink	–	Windshield Wiper Smart Motor (WWSM)
F51	–	–	Not Used
F52	–	–	Not Used
F53	30 Amp Pink	–	Brake System Module BSM & Valves
F54	30 Amp Pink	–	Body Controller Module (BCM) – Feed 3

Cavity	Cartridge Fuse	Blade Fuse	Description
F55	–	10 Amp Red	Blind Spot Sensors/ Compass/Rearview Camera – If Equipped
F56	–	15 Amp Blue	Ignition Node Module (IGNM)/RF Hub
F57	–	–	Not Used
F58	–	10 Amp Red	Occupant Classification Module/Voltage Stability Module (VSM) #2 – If Equipped With Engine Stop/ Start Option
F59	30 Amp Pink	–	Drivetrain Control Module (DTCM)
F60	–	20 Amp Yellow	Power Outlet – Center Con- sole
F61	–	–	Not Used

Cavity	Cartridge Fuse	Blade Fuse	Description
F62	–	–	Not Used
F63	–	20 Amp Yellow	Front Heated Seats – If Equipped
F64	–	20 Amp Yellow	Heated Steering Wheel – If Equipped
F65	–	10 Amp Red	In Vehicle Temperature Sensor/Humidity Sensor/ Driver Assist System Module (DASM)/Park Assist (PAM) – If Equipped With Engine Stop/Start Option
F66	–	15 Amp Blue	Instrument Panel Cluster (IPC)/Electronic Climate Control (ECC)

Cavity	Cartridge Fuse	Blade Fuse	Description
F67	–	10 Amp Red	In Vehicle Temperature Sensor/Humidity Sensor/ Drivers Assist System Module (DASM)/Park Assist (PAM) – If Equipped
F68	–	–	Not Used
F69	–	10 Amp Red	Gear Shift Module (GSM)/ Active Grill Shutter (AGS). – If Equipped/EPB SW
F70	–	5 Amp Tan	Intelligent Battery Sensor (IBS) – If Equipped with Engine Stop/Start Option
F71	–	20 Amp Yellow	HID Headlamp Right – If Equipped with Engine Stop/ Start Option

Cavity	Cartridge Fuse	Blade Fuse	Description
F72	–	10 Amp Red	Heated Mirrors – If Equipped
F73	–	–	Not Used
F74	30 Amp Pink	–	Rear Defroster/Defogger
F75	–	20 Amp Yellow	Cigar Lighter
F76	–	10 Amp Red	Drivers Window SW– If Equipped
F77	–	10 Amp Red	UCI Port/Brake Pedal Switch
F78	–	10 Amp Red	Diagnostic Port/Steering Column Control Module (SCCM)
F79	–	10 Amp Red	Integrated Center Stack (ICS)/Switch Bank/Instrument Panel Cluster (IPC)/EPB SW
F80	–	20 Amp Yellow	Radio



Cavity	Cartridge Fuse	Blade Fuse	Description
F81	–	–	Not Used
F82	–	–	Not Used
F83	20 Amp Blue	–	Engine Control Module (ECM)
F84	30 Amp Pink	–	Electric Park Brake (EPB) – Left
F85	–	–	Not Used
F86	–	20 Amp Yellow	Horns – If Equipped With Engine Stop/Start Option
F87A	–	20 Amp Yellow	HID Headlamp Left – If Equipped Engine Stop/Start Option

Cavity	Cartridge Fuse	Blade Fuse	Description
F88	–	10 Amp Red	Collision Mitigation Module (CMM)/Electrochromatic Mirror/Haptic Lane Feedback Module (Half)/ Humidity Sensor– If Equipped
F89	–	–	Not Used
F90	–	–	Not Used
F91	–	–	Not Used
F92	–	–	Not Used
F93	40 Amp Green	–	Brake System Module (BSM) – Pump Motor – If Equipped
F94	30 Amp Pink	–	Electric Park Brake (EPB) – Right

Cavity	Cartridge Fuse	Blade Fuse	Description
F95	–	10 Amp Red	Electrochromatic Mirror/ Rain/Pass. Window SW/ Power Outlet Console Illumination/Sensor/Sunroof – If Equipped
F96	–	10 Amp Red	Occupant Restraint Control- ler (ORC) (Airbag)
F97	–	10 Amp Red	Occupant Restraint Control- ler (ORC) (Airbag)
F98	–	25 Amp Clear	Audio Amplifier – If Equipped
F99	–	–	Not Used
F100	–	–	Not Used

## Interior Fuses

The interior fuse panel is located in the passenger compartment on the left side dash panel under the instrument panel.

Cavity	Blade Fuse	Description
F13	15 Amp Blue	Low Beam Left
F32	10 Amp Red	Interior Lighting
F36	10 Amp Red	Intrusion Module / Siren
F37	7.5 Amp Brown	Aux. Switch Bank Module (ASBM)
F38	20 Amp Yellow	All Doors Lock/Unlock
F43	20 Amp Yellow	Washer Pump Front
F48	20 Amp Yellow	Horns
F49	7.5 Amp Brown	Lumbar Support
F51	10 Amp Red	Driver Window Switch / Power Mirrors – If Equipped

Cavity	Blade Fuse	Description
F53	7.5 Amp Brown	UCI Port (USB & AUX)
F89	5 Amp Tan	Trunk Lamp
F91	5 Amp Tan	Fog Lamp Front Left
F92	5 Amp Tan	Fog Lamp Front Right
F93	10 Amp Red	Low Beam Right

## VEHICLE STORAGE

If you are leaving your vehicle dormant for more than 21 days you may want to take steps to protect your battery. You may:

- Disconnect the negative cable from the battery.
- Anytime you store your vehicle, or keep it out of service (i.e. vacation) for two weeks or more, run the air conditioning system at idle for about five minutes in the fresh air and high blower setting. This will ensure adequate system lubrication to minimize the possibility of compressor damage when the system is started again.

**REPLACEMENT BULBS****Interior Bulbs**

	<b>Bulb Number</b>
Front Courtesy/Reading Lamp	578/W5W
Center Courtesy/Reading Lamp	578/W5W
Visor Vanity Lamp	A6220
Glove Compartment Lamp	A6220
Shift Indicator Lamp	IKLE14140
Rear Compartment (Trunk) Lamp	579
<b>NOTE:</b> For lighted switches, see your authorized dealer for replacement.	

## Exterior Bulbs

	Bulb Number
High Intensity Discharge Headlamp	HID (Serviced at Authorized Dealer)
Bi-Halogen Headlamp	9005HL+
Daytime Running Lamp	LED (Serviced at Authorized Dealer)
Front Turn Signal Lamp	PWY24W SV
Side Marker Lamp	W3W
Front Park Lamp	LED (Serviced at Authorized Dealer)
Front Fog Lamp	H11
LED Front Fog Lamp	LED (Serviced at Authorized Dealer)
Center High Mounted Stop (CHMSL) Lamp	LED (Serviced at Authorized Dealer)
Stop/Turn Signal Lamp	W21W
Rear Tail/Side Marker Lamp	LED (Serviced at Authorized Dealer)
Backup Lamp	921
License Lamp	W5W

## BULB REPLACEMENT

**NOTE:** Lens fogging can occur under certain atmospheric conditions. This will usually clear as atmospheric conditions change to allow the condensation to change back into a vapor. Turning the lamps on will usually accelerate the clearing process.

### Low Beam And High Beam Headlamps

#### Bi-Xenon High Intensity Discharge (HID) Headlamps — If Equipped

The headlamps contain a type of high voltage discharge light source. High voltage can remain in the circuit even with the headlamp switch off. Because of this, you should not attempt to service a HID headlamp light source yourself. If an HID headlamp light source fails, take your vehicle to an authorized dealer for service.

**NOTE:** On vehicles equipped with HID headlamps, when the headlamps are turned on, there is a blue hue to the lights. This diminishes and becomes more white after approximately 10 seconds, as the system charges.

### WARNING!

**A transient high voltage occurs at the bulb sockets of HID headlamps when the headlamp switch is turned ON. It may cause serious electrical shock or electrocution if not serviced properly. See your authorized dealer for service.**



## Bi-Halogen Headlamps

1. Remove the top pushpin on the headlamp access door in the wheel liner to access the headlamp assembly.



Access Door

2. Reach behind the headlamp housing to access the headlamp bulb cap.
3. Firmly grasp the headlamp bulb cap and rotate it counterclockwise to unlock it.

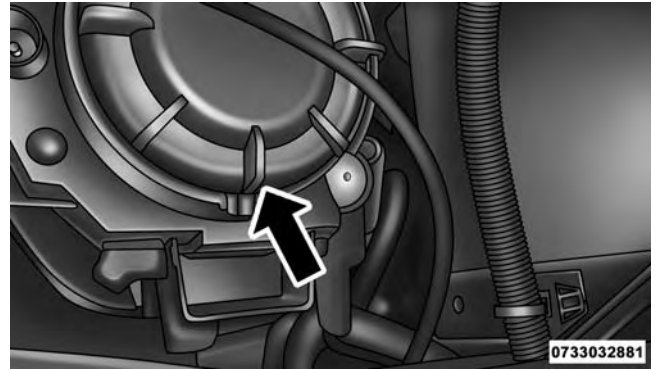

Headlamp Bulb Cap

4. Firmly grasp the headlamp bulb socket assembly and rotate counterclockwise to remove from the housing.

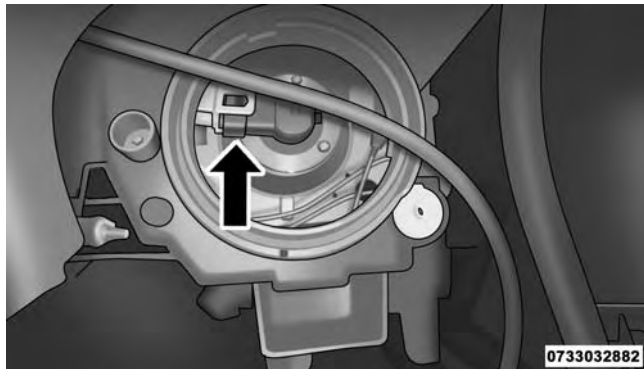

Headlamp Bulb Socket

5. Disconnect the bulb from the electrical connector and then connect the replacement bulb.

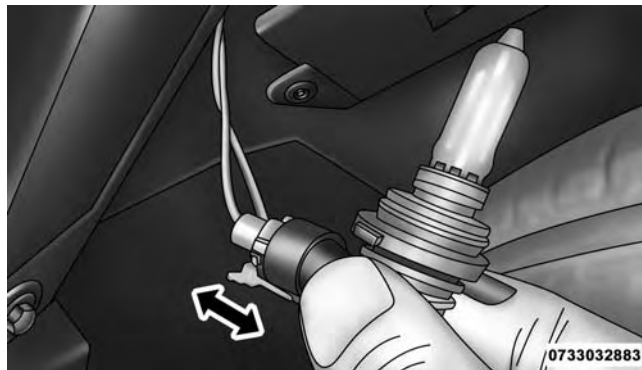

Headlamp Bulb

**CAUTION!**

Do not touch the new bulb with your fingers. Oil contamination will severely shorten bulb life. If the bulb comes in contact with any oily surface, clean the bulb with rubbing alcohol.

6. Install the bulb and connector assembly into the headlamp housing and rotate clockwise to lock it in place.
7. Install the headlamp bulb cap in the headlamp housing and rotate clockwise to lock it in place.
8. Lock headlamp access door in wheel liner.

### Front Turn Signal Lamp

1. Open the hood.

**NOTE:** Removal of the air cleaner filter housing may be necessary prior to replacing bulbs in the lamp assembly on the passenger side of the vehicle.

2. Remove the beauty cover, by removing all push pins and lifting beauty cover.

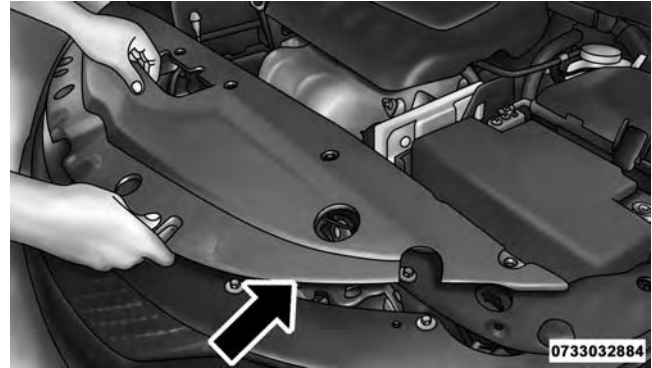

Beauty Cover

3. Remove the brace by removing the four fasteners and loosening the 5th inboard fastener.
4. Twist the front turn signal lamp socket assembly counterclockwise, and then remove the front turn signal lamp assembly from the lamp housing.

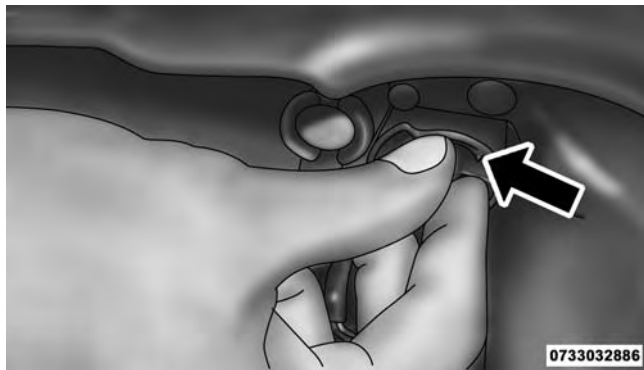

**Front Turn Signal Lamp Socket**

5. Pull the bulb out of the socket and insert the replacement bulb.
6. Install the front turn signal lamp socket assembly into the housing, and rotate the front turn signal lamp socket clockwise to lock it in place.

7. Install air cleaner filter housing, if removed.
8. Install brace, brace bolts and tighten as shown.

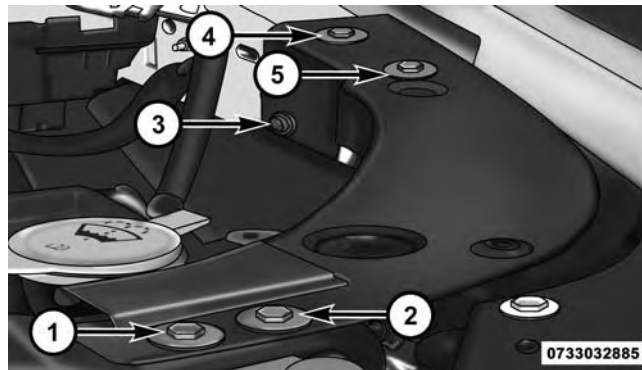

**Brace Bolt Tightening Sequence**

9. Install beauty cover.

## Front Side Marker Lamps

1. Remove the three fasteners from the inner wheel liner and carefully peel back liner for access.

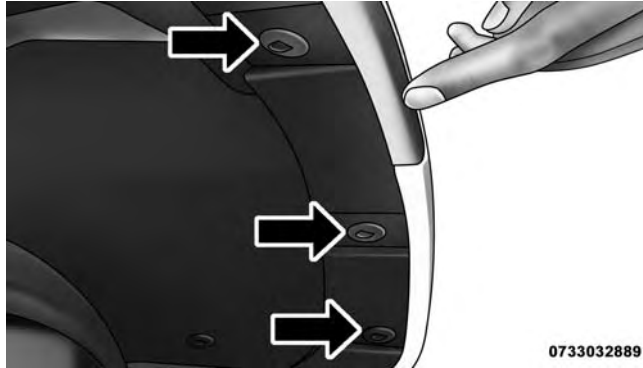

Inner Wheel Liner Fasteners

0733032889

2. Firmly grasp the front side marker lamp socket and rotate 1/4 turn counterclockwise to remove it from the lamp assembly.



0733032890

7

### Front Side Marker Lamp Bulb Removal

3. Remove bulb from the front side marker lamp socket and replace with a new bulb.
4. Install front side marker lamp socket in lamp assembly and rotate 1/4 turn clockwise to lock into place.
5. Position the inner wheel liner in place and install the three fasteners.

## Front Fog Lamp

1. Remove the three fasteners from the lower closeout, and peel down the lower closeout.

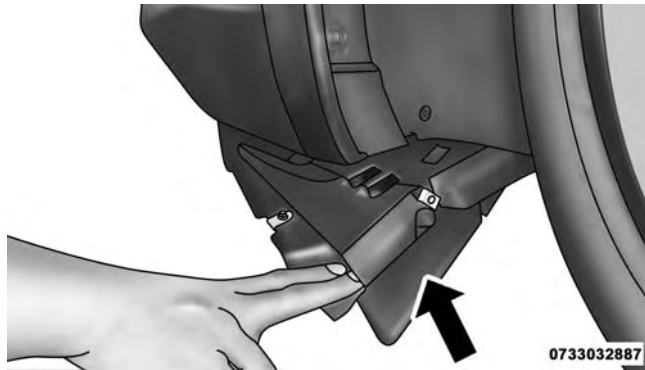

Lower Closeout

2. Reach behind the fog lamp housing to access the bulb.

3. Rotate the front fog lamp socket counterclockwise, and remove the bulb and socket assembly from the front fog lamp housing.

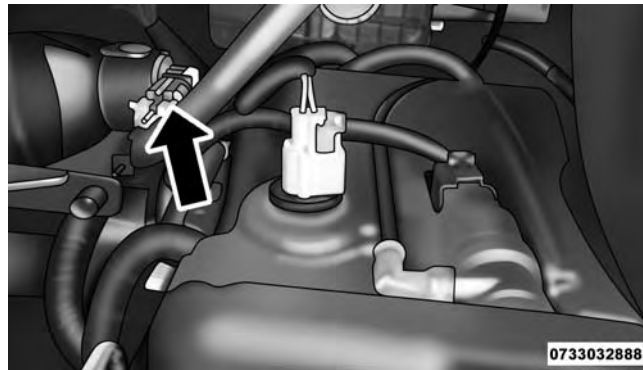

Front Fog Lamp Socket

4. Pull the bulb out of the socket and insert the replacement bulb.

**CAUTION!**

**Do not touch the new bulb with your fingers. Oil contamination will severely shorten bulb life. If the bulb comes in contact with any oily surface, clean the bulb with rubbing alcohol.**

5. Install the front fog lamp socket assembly into the into the front fog lamp housing, and rotate the connector clockwise to lock it in place.
6. Position the lower closeout panel in place and secure with the three fasteners.

**Backup Lamps (Passenger Side)**

1. Open trunk lid.
2. Remove the passenger side access cover.
3. Remove the inner trunk lid handle cover.
4. Remove the two screws and remove the inner trunk lid handle.

**NOTE:** If necessary remove any additional inner deck lid trim push pins to gain access.

5. Gently pull back the inner deck panel behind the trunk lid lamp housing to expose the backup lamp socket.



Inner Deck Panel

6. Rotate the backup lamp socket counter clockwise 1/4 turn to remove the backup lamp socket from the trunk lid lamp housing.

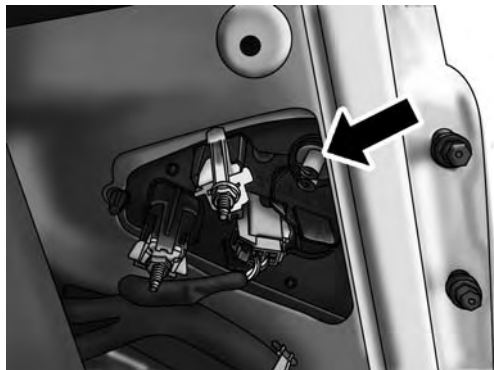

0733029301

Backup Lamp Socket

7. Remove the bulb from the socket and install the replacement bulb.

8. Install the backup lamp socket into the trunk lid lamp housing.
9. Rotate backup lamp socket clockwise 1/4 turn to lock it into place.
10. Reposition the inner deck panel and secure with a push pin if removed.
11. Install access cover.

### Backup Lamps (Driver Side)

1. Open trunk lid.
2. Remove the drivers side access cover.
3. Remove inner deck lid support push pin.

**NOTE:** If necessary remove any additional inner deck lid trim push pins to gain access.

4. Gently pull back the inner deck panel behind the trunk lid lamp housing to expose the backup lamp socket.



**NOTE:** passenger side shown the drivers side is similar.

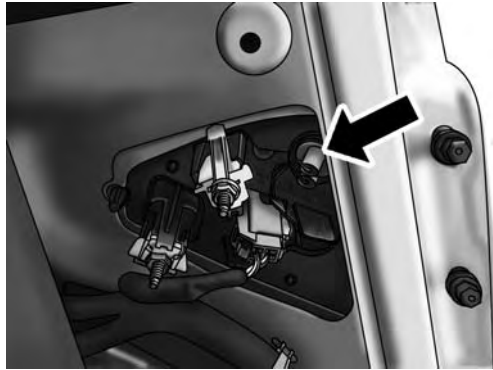

**Backup Lamp Socket**

0733029301

5. Rotate the backup lamp socket counter clockwise 1/4 turn to remove the backup lamp socket from the trunk lid lamp housing.
6. Remove the bulb from the socket and install the replacement bulb.
7. Install the backup lamp socket into the trunk lid lamp housing.
8. Rotate backup lamp socket clockwise 1/4 turn to lock it into place.
9. Reposition the inner deck panel and secure with a push pin if removed.
10. Install the access cover.

## Stop/Rear Turn Signal Lamp

1. Open the trunk lid.
2. Remove the tail lamp housing beauty cover by grasping the top edge and pulling rearward to expose the tail lamp housing bolts.

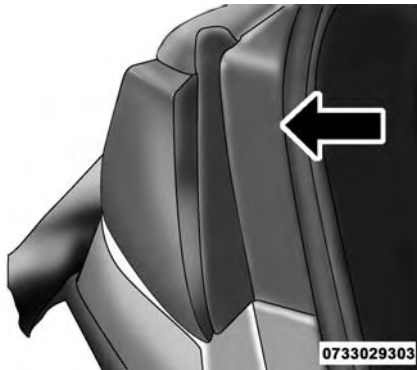

Tail Lamp Beauty Cover

3. Remove the tail lamp housing bolts

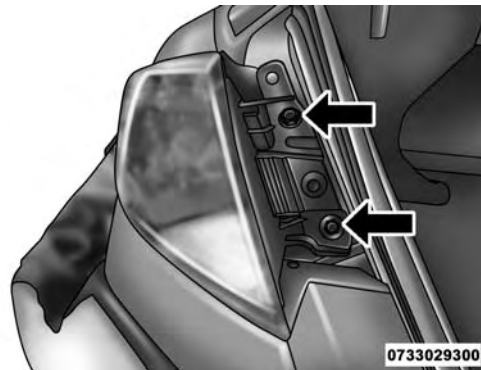

Tail Lamp Bolts

4. Pull the tail lamp housing directly rearward to dislodge the two out bored ball studs from the socket fasteners.

**NOTE:** It may be necessary to use significant force to remove the two out bored ball studs from the socket fasteners to remove the tail lamp housing.

5. Rotate the stop/rear turn signal lamp socket 1/4 turn counterclockwise and remove it from the tail lamp housing.
6. Remove the bulb from the socket and install the replacement bulb.
7. Install the bulb socket into the tail lamp housing and rotate the bulb socket 1/4 turn clockwise to lock it in place.
8. Install the tail lamp housing.
9. Install the tail lamp housing beauty cover.

### License Plate Lamp

1. Remove the screw of the license plate lamp assembly and pull down on the license plate lamp assembly to remove.
2. Remove the bulb from the socket and install the replacement bulb.
3. Install the license plate lamp assembly.

## FLUID CAPACITIES

	U.S.	Metric
<b>Fuel (Approximate)</b>		
2.4L and 3.6L Engines	15.8 Gallons	60 Liters
<b>Engine Oil With Filter</b>		
2.4 Liter Engine (SAE 0W-20, API Certified)	5.5 Quarts	5.2 Liters
3.6 Liter Engine (SAE 5W-20, API Certified)	6 Quarts	5.6 Liters
<b>Cooling System*</b>		
2.4 Liter Engine (MOPAR Antifreeze/Engine Coolant 10 Year/150,000 Mile Formula)	7.2 Quarts	6.8 Liters
3.6 Liter Engine (MOPAR Antifreeze/Engine Coolant 10 Year/150,000 Mile Formula)	8.7 Quarts	8.2 Liters
* Includes heater and coolant reservoir filled to MAX level.		

## FLUIDS, LUBRICANTS, AND GENUINE PARTS

### Engine

Component	Fluid, Lubricant, or Genuine Part
Engine Coolant	We recommend you use MOPAR Antifreeze/Coolant 10 Year/150,000 Mile Formula OAT (Organic Additive Technology) or equivalent meeting the requirements of FCA Material Standard MS.90032.
Engine Oil – 2.4L Engine	We recommend you use SAE 0W-20 API Certified Engine Oil, meeting the requirements of FCA US Material Standard MS-6395 such as MOPAR, Pennzoil, and Shell Helix. Refer to your engine oil filler cap for correct SAE grade.
Engine Oil – 3.6L Engine	We recommend you use API Certified SAE 5W-20 Engine Oil, meeting the requirements of FCA US Material Standard MS-6395 such as MOPAR, Pennzoil, and Shell Helix. Refer to your engine oil filler cap for correct SAE grade.

<b>Component</b>	<b>Fluid, Lubricant, or Genuine Part</b>
Engine Oil Filter	We recommend you use a MOPAR Engine Oil Filter.
Spark Plugs	We recommend you use MOPAR Spark Plugs.
Fuel Selection – 2.4L Engine	87 Octane, 0-15% Ethanol.
Fuel Selection – 2.4L Flex Fuel (E85) Engine – If Equipped	87 Octane, Up To 85% Ethanol.
Fuel Selection – 3.6L Engine	87 Octane, 0-15% Ethanol.
Fuel Selection – 3.6L Flex Fuel (E85) Engine – If Equipped	87 Octane, Up To 85% Ethanol.

**CAUTION!**

- Mixing of engine coolant (antifreeze) other than specified Organic Additive Technology (OAT) engine coolant (antifreeze), may result in engine damage and may decrease corrosion protection. Organic Additive Technology (OAT) engine coolant is different and should not be mixed with Hybrid Organic Additive Technology (HOAT) engine coolant (antifreeze) or any “globally compatible” coolant (antifreeze). If a non-OAT engine coolant (antifreeze) is introduced into the cooling system in an emergency, the cooling system will need to be drained, flushed, and refilled with fresh OAT coolant (conforming to MS.90032), by an authorized dealer as soon as possible.

*(Continued)*

**CAUTION! (Continued)**

- Do not use water alone or alcohol-based engine coolant (antifreeze) products. Do not use additional rust inhibitors or antirust products, as they may not be compatible with the radiator engine coolant and may plug the radiator.
- This vehicle has not been designed for use with propylene glycol-based engine coolant (antifreeze). Use of propylene glycol-based engine coolant (antifreeze) is not recommended.

## Chassis

Component	Fluid, Lubricant, or Genuine Part
Automatic Transmission	Use only MOPAR ZF 8&9 Speed ATF Automatic Transmission Fluid, or equivalent. Failure to use the correct fluid may affect the function or performance of your transmission.
Brake Master Cylinder	We recommend you use MOPAR DOT 3 Brake Fluid, SAE J1703 should be used. If DOT 3, SAE J1703 brake fluid is not available, then DOT 4 is acceptable. Use only recommended brake fluids.



---

# MAINTENANCE SCHEDULES

## CONTENTS

---

■ MAINTENANCE SCHEDULE . . . . .	.664	□ Maintenance Chart . . . . .	.666
----------------------------------	------	-------------------------------	------

## MAINTENANCE SCHEDULE

Your vehicle is equipped with an automatic oil change indicator system. The oil change indicator system will remind you that it is time to take your vehicle in for scheduled maintenance.

Based on engine operation conditions, the oil change indicator message will illuminate. This means that service is required for your vehicle. Operating conditions such as frequent short-trips, trailer tow, extremely hot or cold ambient temperatures will influence when the “Oil Change Required” message is displayed. Severe Operating Conditions can cause the change oil message to illuminate as early as 3,500 miles (5,600 km) since last reset. Have your vehicle serviced as soon as possible, within the next 500 miles (805 km).

Your authorized dealer will reset the oil change indicator message after completing the scheduled oil change. If a scheduled oil change is performed by someone other

than your authorized dealer, the message can be reset by referring to the steps described under “Oil Change Reset” in “Electronic Vehicle Information Center (EVIC)” or “Driver Information Display (DID)” in “Understanding Your Instrument Panel” for further information.

**NOTE:** Under no circumstances should oil change intervals exceed 10,000 miles (16,000 km), twelve months or 350 hours of engine run time, whichever comes first. The 350 hours of engine run or idle time is generally only a concern for fleet customers.

### Severe Duty All Models

Change Engine Oil at 4,000 miles (6,500 km) if the vehicle is operated in a dusty and off road environment or is operated predominately at idle or only very low engine RPM's. This type of vehicle use is considered Severe Duty.

**Once A Month Or Before A Long Trip:**

- Check engine oil level.
- Check windshield washer fluid level.
- Check tire pressure and look for unusual wear or damage. Rotate tires at the first sign of irregular wear, even if it occurs before the oil indicator system turns on.
- Check the fluid levels of the coolant reservoir and brake master cylinder, fill as needed.
- Check function of all interior and exterior lights.

**Required Maintenance Intervals**

Refer to the maintenance schedules on the following page for the required maintenance intervals.

<b>At Every Oil Change Interval As Indicated By Oil Change Indicator System:</b>
• Change oil and filter
• Rotate the tires. <b>Rotate at the first sign of irregular wear, even if it occurs before the oil indicator system turns on.</b>
• Inspect battery and clean and tighten terminals as required
• Inspect brake pads, shoes, rotors, drums, hoses and park brake
• Inspect engine cooling system protection and hoses
• Inspect exhaust system
• Inspect engine air cleaner if using in dusty or off-road conditions

## Maintenance Chart

Mileage:	20,000	30,000	40,000	50,000	60,000	70,000	80,000	90,000	100,000	110,000	120,000	130,000	140,000	150,000
Or Years:	2	3	4	5	6	7	8	9	10	11	12	13	14	15
Or Kilometers:	32,000	48,000	64,000	80,000	96,000	112,000	128,000	144,000	160,000	176,000	192,000	208,000	224,000	240,000
<b>Additional Inspections</b>														
Inspect the CV joints.	X		X		X		X		X		X		X	
Inspect front suspension, boot seals, tie rod ends, and replace if necessary.	X		X		X		X		X		X		X	
Inspect the brake linings, parking brake function.	X		X		X		X		X		X		X	
Inspect front accessory drive belt, tensioner, idler pulley, and replace if necessary														X

Mileage:	20,000	30,000	40,000	50,000	60,000	70,000	80,000	90,000	100,000	110,000	120,000	130,000	140,000	150,000
Or Years:	2	3	4	5	6	7	8	9	10	11	12	13	14	15
Or Kilometers:	32,000	48,000	64,000	80,000	96,000	112,000	128,000	144,000	160,000	176,000	192,000	208,000	224,000	240,000
<b>Additional Maintenance</b>														
Replace engine air cleaner filter.		X			X			X			X			X
Replace air conditioning/cabin air filter.	X		X		X		X		X		X		X	
Replace spark plugs **									X					
Flush and replace the engine coolant at 10 years or 150,000 miles (240,000 km) whichever comes first.									X					X
Inspect and replace PCV valve if necessary.									X					

\*\* The spark plug change interval is mileage based only, yearly intervals do not apply.

**WARNING!**

- You can be badly injured working on or around a motor vehicle. Do only service work for which you have the knowledge and the right equipment. If you have any doubt about your ability to perform a service job, take your vehicle to a competent mechanic.
- Failure to properly inspect and maintain your vehicle could result in a component malfunction and effect vehicle handling and performance. This could cause an accident.

# IF YOU NEED CONSUMER ASSISTANCE

## CONTENTS

---

■ SUGGESTIONS FOR OBTAINING SERVICE FOR YOUR VEHICLE . . . . .	.671	□ Puerto Rico And U.S. Virgin Islands . . . . .	.673
□ Prepare For The Appointment. . . . .	.671	□ Customer Assistance For The Hearing Or Speech Impaired (TDD/TTY). . . . .	.673
□ Prepare A List . . . . .	.671	□ Service Contract . . . . .	.673
□ Be Reasonable With Requests . . . . .	.671	■ WARRANTY INFORMATION . . . . .	.675
■ IF YOU NEED ASSISTANCE . . . . .	.671	■ MOPAR PARTS . . . . .	.675
□ FCA US LLC Customer Center . . . . .	.672	■ REPORTING SAFETY DEFECTS . . . . .	.675
□ FCA Canada Inc. Customer Center . . . . .	.672	□ In The 50 United States And Washington, D.C. . . . .	.675
□ In Mexico Contact . . . . .	.673	□ In Canada. . . . .	.676

**670 IF YOU NEED CONSUMER ASSISTANCE**

■ PUBLICATION ORDER FORMS . . . . .	.676	□ Traction Grades . . . . .	.678
■ DEPARTMENT OF TRANSPORTATION UNIFORM TIRE QUALITY GRADES . . . . .	.677	□ Temperature Grades. . . . .	.678
□ Treadwear. . . . .	.677		



## SUGGESTIONS FOR OBTAINING SERVICE FOR YOUR VEHICLE

### Prepare For The Appointment

If you are having warranty work done, be sure to have the right papers with you. Take your warranty folder. All work to be performed may not be covered by the warranty. Discuss additional charges with the service manager. Keep a maintenance log of your vehicle's service history. This can often provide a clue to the current problem.

### Prepare A List

Make a written list of your vehicle's problems or the specific work you want done. If you've had an accident or work done that is not on your maintenance log, let the service advisor know.

### Be Reasonable With Requests

If you list a number of items and you must have your vehicle by the end of the day, discuss the situation with the service advisor and list the items in order of priority. At many authorized dealers, you may obtain a rental vehicle at a minimal daily charge. If you need a rental, it is advisable to make these arrangements when you call for an appointment.

## IF YOU NEED ASSISTANCE

The manufacturer and its authorized dealer are vitally interested in your satisfaction. We want you to be happy with our products and services.

Warranty service must be done by an authorized dealer. We strongly recommend that you take the vehicle to an authorized dealer. They know your vehicle the best, and are most concerned that you get prompt and high quality service. The manufacturer's authorized dealer have the

## 672 IF YOU NEED CONSUMER ASSISTANCE

facilities, factory-trained technicians, special tools, and the latest information to ensure the vehicle is fixed correctly and in a timely manner.

This is why you should always talk to an authorized dealer service manager first. Most matters can be resolved with this process.

- If for some reason you are still not satisfied, talk to the general manager or owner of the authorized dealer. They want to know if you need assistance.
- If an authorized dealer is unable to resolve the concern, you may contact the manufacturer's customer center.

Any communication to the manufacturer's customer center should include the following information:

- Owner's name and address
- Owner's telephone number (home and office)

- Authorized dealer name
- Vehicle Identification Number (VIN)
- Vehicle delivery date and mileage

### **FCA US LLC Customer Center**

P.O. Box 21-8004

Auburn Hills, MI 48321-8004

Phone: (800) 247-9753

### **FCA Canada Inc. Customer Center**

P.O. Box 1621

Windsor, Ontario N9A 4H6

Phone: (800) 465-2001 English / (800) 387-9983 French

**In Mexico Contact**

Av. Prolongacion Paseo de la Reforma, 1240

Sante Fe C.P. 05109

Mexico, D. F.

In Mexico City: 5081-7568

Outside Mexico City: 1-800-505-1300

**Puerto Rico And U.S. Virgin Islands**

Customer Service Chrysler International Services LLC

P.O. Box 191857

San Juan 00919-1857

Tel.: (787) 782-5757

Fax: (787) 782-3345

**Customer Assistance For The Hearing Or Speech Impaired (TDD/TTY)**

To assist customers who have hearing difficulties, the manufacturer has installed special TDD (Telecommunication Devices for the Deaf) equipment at its customer center. Any hearing or speech impaired customer, who has access to a TDD or a conventional teletypewriter (TTY) in the United States, can communicate with the manufacturer by dialing 1-800-380-CHRY.

Canadian residents with hearing difficulties that require assistance can use the special needs relay service offered by Bell Canada. For TTY teletypewriter users, dial 711 and for Voice callers, dial 1-800-855-0511 to connect with a Bell Relay Service operator.

**Service Contract**

You may have purchased a service contract for a vehicle to help protect you from the high cost of unexpected repairs after the manufacturer's New Vehicle Limited

Warranty expires. The manufacturer stands behind only the manufacturer's service contracts. If you purchased a manufacturer's service contract, you will receive Plan Provisions and an Owner Identification Card in the mail within three weeks of the vehicle delivery date. If you have any questions about the service contract, call the manufacturer's Service Contract National Customer Hotline at 1-800-521-9922 (Canadian residents, call (800) 465-2001 English / (800) 387-9983 French).

The manufacturer will not stand behind any service contract that is not the manufacturer's service contract. It is not responsible for any service contract other than the manufacturer's service contract. If you purchased a service contract that is not a manufacturer's service contract, and you require service after the manufacturer's New Vehicle Limited Warranty expires, please refer to the contract documents, and contact the person listed in those documents.

We appreciate that you have made a major investment when you purchased the vehicle. An authorized dealer has also made a major investment in facilities, tools, and training to assure that you are absolutely delighted with the ownership experience. You will be pleased with their sincere efforts to resolve any warranty issues or related concerns.

**WARNING!**

**Engine exhaust (internal combustion engines only), some of its constituents, and certain vehicle components contain, or emit, chemicals known to the State of California to cause cancer and birth defects, or other reproductive harm. In addition, certain fluids contained in vehicles and certain products of component wear contain, or emit, chemicals known to the State of California to cause cancer and birth defects, or other reproductive harm.**

## WARRANTY INFORMATION

See the Warranty Information Booklet, located on the DVD, for the terms and provisions of FCA US LLC warranties applicable to this vehicle and market.

## MOPAR PARTS

MOPAR fluids, lubricants, parts, and accessories are available from an authorized dealer. They are recommended for your vehicle in order to help keep the vehicle operating at its best.

## REPORTING SAFETY DEFECTS

### In The 50 United States And Washington, D.C.

If you believe that your vehicle has a defect that could cause a crash or cause injury or death, you should immediately inform the National Highway Traffic Safety Administration (NHTSA) in addition to notifying the manufacturer.

If NHTSA receives similar complaints, it may open an investigation, and if it finds that a safety defect exists in a group of vehicles, it may order a recall and remedy campaign. However, NHTSA cannot become involved in individual problems between you, your authorized dealer, and the manufacturer.

To contact NHTSA, you may either call the Auto Safety Hotline toll free at 1-888-327-4236 (TTY: 1-800-424-9153), or go to <http://www.safercar.gov>; or write to: Administrator, NHTSA, 1200 New Jersey Avenue, SE., West Building, Washington, D.C. 20590.

You can also obtain other information about motor vehicle safety from <http://www.safercar.gov>.

## In Canada

If you believe that your vehicle has a safety defect, you should contact the Customer Service Department immediately. Canadian customers who wish to report a safety defect to the Canadian government should contact Transport Canada, Motor Vehicle Defect Investigations and Recalls at 1-800-333-0510 or go to <http://www.tc.gc.ca/roadsafety/>

## PUBLICATION ORDER FORMS

To order the following manuals, you may use either the website or the phone numbers listed below. Visa, Mastercard, American Express, and Discover orders are accepted. If you prefer mailing your payment, please call for an order form.

**NOTE:** A street address is required when ordering manuals (no P.O. Boxes).

## Service Manuals

These comprehensive Service Manuals provide the information that students and professional technicians need in diagnosing/troubleshooting, problem solving, maintaining, servicing, and repairing FCA US LLC vehicles. A complete working knowledge of the vehicle, system, and/or components is written in straightforward language with illustrations, diagrams, and charts.

## Diagnostic Procedure Manuals

Diagnostic Procedure Manuals are filled with diagrams, charts and detailed illustrations. These practical manuals make it easy for students and technicians to find and fix problems on computer-controlled vehicle systems and features. They show exactly how to find and correct problems the first time, using step-by-step troubleshooting and drivability procedures, proven diagnostic tests and a complete list of all tools and equipment.

## Owner's Manuals

These Owner's Manuals have been prepared with the assistance of service and engineering specialists to acquaint you with specific FCA US LLC vehicles. Included are starting, operating, emergency and maintenance procedures as well as specifications, capabilities and safety tips.

Call toll free at:

- 1-800-890-4038 (U.S.)
- 1-800-387-1143 (Canada)

Or

Visit us on the Worldwide Web at:

- [www.techauthority.com](http://www.techauthority.com)

## DEPARTMENT OF TRANSPORTATION UNIFORM TIRE QUALITY GRADES

The following tire grading categories were established by the National Highway Traffic Safety Administration. The specific grade rating assigned by the tire's manufacturer in each category is shown on the sidewall of the tires on your vehicle.

All passenger vehicle tires must conform to Federal safety requirements in addition to these grades.

### Treadwear

The Treadwear grade is a comparative rating, based on the wear rate of the tire when tested under controlled conditions on a specified government test course. For example, a tire graded 150 would wear one and one-half times as well on the government course as a tire graded 100. The relative performance of tires depends upon the actual conditions of their use, however, and may depart

significantly from the norm due to variations in driving habits, service practices, and differences in road characteristics and climate.

### **Traction Grades**

The Traction grades, from highest to lowest, are AA, A, B, and C. These grades represent the tire's ability to stop on wet pavement, as measured under controlled conditions on specified government test surfaces of asphalt and concrete. A tire marked C may have poor traction performance.

#### **WARNING!**

**The traction grade assigned to this tire is based on straight-ahead braking traction tests, and does not include acceleration, cornering, hydroplaning, or peak traction characteristics.**

### **Temperature Grades**

The temperature grades are A (the highest), B, and C, representing the tire's resistance to the generation of heat and its ability to dissipate heat, when tested under controlled conditions on a specified indoor laboratory test wheel. Sustained high temperature can cause the material of the tire to degenerate and reduce tire life, and excessive temperature can lead to sudden tire failure. The grade C corresponds to a level of performance, which all passenger vehicle tires must meet under the Federal Motor Vehicle Safety Standard No. 109. Grades B and A represent higher levels of performance on the laboratory test wheel, than the minimum required by law.



**WARNING!**

The temperature grade for this tire is established for a tire that is properly inflated and not overloaded. Excessive speed, under-inflation, or excessive loading, either separately or in combination, can cause heat buildup and possible tire failure.



---

# INDEX

About Your Brakes . . . . .	.478	Knee Impact Bolsters . . . . .	.74
Adaptive Cruise Control (ACC) (Cruise Control) . . .	.184	Maintaining Your Air Bag System . . . . .	.84
Adding Engine Coolant (Antifreeze) . . . . .	.614	Redundant Air Bag Warning Light . . . . .	.83
Additives, Fuel . . . . .	.530	Side Air Bags . . . . .	.75
Adjust . . . . .		Transporting Pets . . . . .	.108
Down . . . . .	.143	Air Bag Deployment . . . . .	.61
Forward . . . . .	.143	Air Bag Light . . . . .	.82, 111, 324
Rearward . . . . .	.143	Air Bag Maintenance . . . . .	.84
Up . . . . .	.143	Air Cleaner, Engine (Engine Air Cleaner Filter) . . .	.602
Air Bag . . . . .	.61, 62	Air Conditioner Maintenance . . . . .	.604
Advance Front Air Bag . . . . .	.62, 63, 64	Air Conditioning . . . . .	.402, 407
Air Bag Operation . . . . .	.64	Air Conditioning Controls . . . . .	.402, 407
Air Bag Warning Light . . . . .	.65, 82	Air Conditioning Filter . . . . .	.423, 605
Driver Knee Air Bag . . . . .	.75	Air Conditioning, Operating Tips . . . . .	.422, 424
Enhanced Accident Response . . . . .	.81	Air Conditioning Refrigerant . . . . .	.604, 605
Event Data Recorder (EDR) . . . . .	.85	Air Conditioning System . . . . .	.402, 407, 421, 604
Front Air Bag . . . . .	.61, 62, 65	Air Filter . . . . .	.602
Front Passenger Knee Air Bag . . . . .	.75	Air Pressure, Tires . . . . .	.504
If A Deployment Occurs . . . . .	.80		

Alarm		Automatic High Beams . . . . .	.164
Arm The System . . . . .	.19	Automatic Temperature Control (ATC) . . . . .	.421
Disarm The System . . . . .	.20	Automatic Transaxle . . . . .	.455
Rearming The System . . . . .	.19	Automatic Transmission . . . . .	.457, 621
Tamper Alert . . . . .	.21	Adding Fluid . . . . .	.621, 662
Vehicle Security Alarm . . . . .	.19	Fluid And Filter Changes . . . . .	.621
Alarm, Panic . . . . .	.24	Fluid Change . . . . .	.621
Alarm (Security Alarm) . . . . .	.327	Fluid Level Check . . . . .	.620, 621
All Wheel Drive (AWD) . . . . .	.467	Fluid Type . . . . .	.620, 662
Alterations/Modifications, Vehicle . . . . .	.7	Special Additives . . . . .	.620
Antifreeze (Engine Coolant) . . . . .	.613, 658	Autostick . . . . .	.465
Disposal . . . . .	.616	Auto Unlock, Doors . . . . .	.34
Anti-Lock Brake System (ABS) . . . . .	.479	Auto Up Power Windows . . . . .	.43
Anti-Lock Warning Light . . . . .	.343	Axle Lubrication . . . . .	.662
Appearance Care . . . . .	.622	Battery . . . . .	.329, 602
Assist, Hill Start . . . . .	.482	Charging System Light . . . . .	.329
Auto Down Power Windows . . . . .	.43	Keyless Transmitter Replacement (RKE) . . . . .	.25
Automatic Door Locks . . . . .	.34	Remote Battery Replacement . . . . .	.25
Automatic Headlights . . . . .	.162		

Transmitter Battery Replacement . . . . .	.25	Caps, Filler	
Belts, Seat . . . . .	.111	Fuel . . . . .	.536
Body Mechanism Lubrication . . . . .	.608	Oil (Engine) . . . . .	.591, 592, 600
B-Pillar Location . . . . .	.498	Radiator (Coolant Pressure) . . . . .	.615
Brake Assist System . . . . .	.481	Carbon Monoxide Warning . . . . .	.110, 532
Brake Control System, Electronic . . . . .	.478	Cargo Area Features . . . . .	.307
Brake Fluid . . . . .	.662	Cargo Compartment . . . . .	.307
Brake System . . . . .	.478, 618	Car Washes . . . . .	.622
Anti-Lock (ABS) . . . . .	.478	Certification Label . . . . .	.539
Fluid Check . . . . .	.618, 662	Chains, Tire . . . . .	.515
Master Cylinder . . . . .	.618	Changing A Flat Tire . . . . .	.561
Warning Light . . . . .	.325	Chart, Tire Sizing . . . . .	.493
Brake/Transmission Interlock . . . . .	.457	Check Engine Light (Malfunction Indicator Light) . . . . .	.595
Brightness, Interior Lights . . . . .	.170	Checking Your Vehicle For Safety . . . . .	.109
Bulb Replacement . . . . .	.644, 646, 651	Checks, Safety . . . . .	.109
Bulbs, Light . . . . .	.113, 644, 651	Child Restraint . . . . .	.86
Camera, Rear . . . . .	.271	Child Restraints	
Capacities, Fluid . . . . .	.658	Booster Seats . . . . .	.90
		Center Seat LATCH . . . . .	.99

Child Restraints . . . . .	.86	Cold Weather Operation . . . . .	.452
Child Seat Installation . . . . .	.103, 105	Compact Spare Tire . . . . .	.510
How To Stow An Unused ALR Seat Belt . . . . .	.101	Console, Floor . . . . .	.302
Infants And Child Restraints . . . . .	.88	Console, Overhead . . . . .	.274
Install A LATCH-Compatible Child Restraint . . . . .	.100	Contract, Service . . . . .	.673
Installing Child Restraints Using The Vehicle Seat Belt . . . . .	.102	Coolant Pressure Cap (Radiator Cap) . . . . .	.615
LATCH Positions . . . . .	.94	Cooling System . . . . .	.612
Locating The LATCH Anchorages . . . . .	.98	Adding Coolant (Antifreeze) . . . . .	.614
Lower Anchors And Tethers For Children . . . . .	.93	Coolant Capacity . . . . .	.658
Older Children And Child Restraints . . . . .	.89	Coolant Level . . . . .	.616
Seating Positions . . . . .	.92	Disposal Of Used Coolant . . . . .	.616
Using The Top Tether Anchorage . . . . .	.106	Drain, Flush, And Refill . . . . .	.613
Child Safety Locks . . . . .	.34	Inspection . . . . .	.612, 616
Clean Air Gasoline . . . . .	.528	Points To Remember . . . . .	.617
Cleaning . . . . .		Pressure Cap . . . . .	.615
Wheels . . . . .	.624	Radiator Cap . . . . .	.615
Climate Control . . . . .	.402	Selection Of Coolant (Antifreeze) . . . . .	.613, 658, 659
Coin Holder . . . . .	.302	Corrosion Protection . . . . .	.622
		Cruise Control (Speed Control) . . . . .	.184, 374

Cruise Light . . . . .	.350, 351, 352	Door Ajar . . . . .	.334
Cupholders . . . . .	.300	Door Ajar Light . . . . .	.334
Customer Assistance . . . . .	.671	Door Locks	
		Child-Protection Door Lock — Rear Doors . . . . .	.34
Data Recorder, Event . . . . .	.85	Door Locks . . . . .	.24, 31
Daytime Brightness, Interior Lights. . . . .	.171	Key Fob . . . . .	.31, 33
Daytime Running Lights . . . . .	.165	Key Fob Emergency Key . . . . .	.25, 34
Dealer Service. . . . .	.596	Manual Door Locks . . . . .	.31
Deck Lid, Emergency Release . . . . .	.47	Power Door Locks . . . . .	.33
Deck Lid, Power Release . . . . .	.45	Remote . . . . .	.31
Defroster, Rear Window. . . . .	.311	Remote Keyless Entry (RKE) . . . . .	.31, 33
Defroster, Windshield . . . . .	.111, 405	Door Locks, Automatic . . . . .	.34
Diagnostic System, Onboard . . . . .	.593	Door Opener, Garage. . . . .	.277
Dimmer Switch, Headlight. . . . .	.168	Driver Information Display (DID)	
Dipsticks		Controls . . . . .	.367
Oil (Engine) . . . . .	.598	Display . . . . .	.367
Disabled Vehicle Towing . . . . .	.583	Driver Information Display (DID) . . . . .	.367
Disposal		Instrument Cluster . . . . .	.367
Antifreeze (Engine Coolant) . . . . .	.616	Messages . . . . .	.357, 370



Driver's Seat Back Tilt . . . . .	.147	Electronic Vehicle Information Center (EVIC) Setup Menu . . . . .	.354
Driving		EVIC Display . . . . .	.354
Through Flowing, Rising, Or Shallow Standing Water . . . . .	.469	EVIC Messages . . . . .	.357, 370
E-85 Fuel . . . . .	.532	Selectable Menu Items . . . . .	.359
Electrical Power Outlets. . . . .	.295	Emergency Deck Lid Release . . . . .	.47
Electric Parking Brake . . . . .	.471	Emergency, In Case Of	
Electric Rear Window Defrost. . . . .	.311	Hazard Warning Flasher . . . . .	.547
Electric Remote Mirrors . . . . .	.132	Jacking . . . . .	.561
Electronic Brake Control System . . . . .	.478	Jump Starting . . . . .	.574
Anti-Lock Brake System . . . . .	.479	Overheating . . . . .	.547
Traction Control System . . . . .	.485	Towing . . . . .	.583
Electronic Speed Control (Cruise Control) . . . . .	.180, 184	Emergency Trunk Release . . . . .	.47
Electronic Stability Control (ESC) . . . . .	.485	Emission Control System Maintenance . . . . .	.595
Electronic Throttle Control Warning Light . . . . .	.331	Engine. . . . .	.591, 592
Electronic Vehicle Information Center (EVIC) . . . . .	.271	Air Cleaner . . . . .	.602
Change Engine Oil . . . . .	.356, 369	Block Heater . . . . .	.454
Electronic Vehicle Information Center (EVIC) . . . . .	.354	Break-In Recommendations . . . . .	.108
		Checking Oil Level . . . . .	.598

Coolant (Antifreeze) . . . . .	.659	Event Data Recorder . . . . .	.85
Cooling . . . . .	.612	Exhaust Gas Caution . . . . .	.110, 532
Exhaust Gas Caution . . . . .	.110, 532	Exhaust System . . . . .	.110, 609
Fails To Start . . . . .	.453	Exterior Lighting . . . . .	.161, 651
Flooded, Starting . . . . .	.453	Exterior Lights . . . . .	.113, 651
Fuel Requirements . . . . .	.528		
Jump Starting . . . . .	.574	Filters	
Oil . . . . .	.598, 658, 659	Air Cleaner . . . . .	.602
Oil Filler Cap . . . . .	.591, 592, 600	Air Conditioning . . . . .	.423, 605
Oil Filter . . . . .	.601	Engine Oil . . . . .	.601, 659
Oil Selection . . . . .	.599, 658	Engine Oil Disposal . . . . .	.601
Oil Synthetic . . . . .	.601	Flashers	
Overheating . . . . .	.547	Hazard Warning . . . . .	.547
Starting . . . . .	.451	Turn Signal . . . . .	.113, 167, 349, 649
Engine Oil Viscosity . . . . .	.600	Flash-To-Pass . . . . .	.168
Engine Oil Viscosity Chart . . . . .	.600	Flexible Fuel Vehicles	
Enhanced Accident Response Feature . . . . .	.81	Cruising Range . . . . .	.535
Entry System, Illuminated . . . . .	.22	Engine Oil . . . . .	.534
Ethanol . . . . .	.529, 532	Fuel Requirements . . . . .	.532, 533

Maintenance . . . . .	.535	Additives . . . . .	.530
Replacement Parts . . . . .	.535	Clean Air . . . . .	.528
Starting . . . . .	.534	Ethanol . . . . .	.529, 532
Flooded Engine Starting . . . . .	.453	Filler Cap (Gas Cap) . . . . .	.536
Floor Console . . . . .	.302	Gasoline . . . . .	.528
Fluid, Brake . . . . .	.662	Light . . . . .	.342
Fluid Capacities . . . . .	.658	Materials Added . . . . .	.530
Fluid Leaks . . . . .	.113	Methanol . . . . .	.529
Fluid Level Checks		Octane Rating . . . . .	.528, 659
Brake . . . . .	.618	Requirements . . . . .	.528
Engine Oil . . . . .	.598	Specifications . . . . .	.659
Fluids, Lubricants And Genuine Parts . . . . .	.659	Tank Capacity . . . . .	.658
Fog Lights . . . . .	.166, 652	Fuel, Flexible . . . . .	.532
Fog Light Service . . . . .	.652	Fuses . . . . .	.628
Folding Rear Seat . . . . .	.154	Garage Door Opener (HomeLink) . . . . .	.277, 285
Forward Collision Warning . . . . .	.211	Gas Cap (Fuel Filler Cap) . . . . .	.536
Freeing A Stuck Vehicle . . . . .	.578	Gasoline, Clean Air . . . . .	.528
Front Position Light . . . . .	.651	Gasoline, Reformulated . . . . .	.528
Fuel . . . . .	.528		

Gear Ranges . . . . .	.459	Time Delay . . . . .	.163
Glass Cleaning . . . . .	.627	Head Restraints . . . . .	.150
GVWR. . . . .	.539	Head Rests. . . . .	.150
Hazard		Heated Mirrors . . . . .	.132
Driving Through Flowing, Rising, Or Shallow		Heater. . . . .	.402, 407
Standing Water . . . . .	.469	Heater, Engine Block . . . . .	.454
Hazard Warning Flasher . . . . .	.547	High Beam/Low Beam Select (Dimmer) Switch . . .	.168
Headlights		Hill Start Assist. . . . .	.482
Automatic . . . . .	.162	Holder, Coin. . . . .	.302
Bulb Replacement . . . . .	.647	HomeLink (Garage Door Opener). . . . .	.277
Cleaning . . . . .	.626	Ignition	
Delay . . . . .	.163	Key . . . . .	.12
High Beam/Low Beam Select Switch . . . . .	.168	Illuminated Entry . . . . .	.22
Lights On Reminder . . . . .	.165	Courtesy Lights . . . . .	.22
On With Wipers . . . . .	.162	Front Courtesy Overhead Console . . . . .	.22
Passing . . . . .	.168	Illuminated Entry . . . . .	.22
Replacing . . . . .	.646, 647	Remote Keyless Entry (RKE) Transmitter . . . . .	.22
Switch . . . . .	.161	Inside Rearview Mirror . . . . .	.122, 123

Instrument Cluster . . . . .	.317, 320, 328, 333, 345, 349	Panic Alarm . . . . .	.24
Instrument Cluster . . . . .	.356, 369	Programming Additional Key Fobs . . . . .	.18, 25
Instrument Panel And Controls . . . . .	.316	Programming Additional Transmitters . . . . .	.18, 25
Instrument Panel Lens Cleaning . . . . .	.627	Remote Battery Replacement . . . . .	.25
Interior Appearance Care . . . . .	.625	Remote Keyless Entry (RKE) . . . . .	.13, 22
Interior Fuses . . . . .	.642	Unlatch The Trunk . . . . .	.24
Interior Lights . . . . .	.170	Unlock The Doors . . . . .	.23
Intermittent Wipers (Delay Wipers) . . . . .	.174	Key-In Reminder . . . . .	.15
Introduction . . . . .	.4	Keyless Enter-N-Go . . . . .	.36
Inverter Outlet (115V) . . . . .	.299	Enter The Trunk . . . . .	.24, 36
		Key Fob . . . . .	.36
Jacking Instructions . . . . .	.564	Lock The Vehicle's Doors . . . . .	.24, 36
Jack Location . . . . .	.561	Passive Entry . . . . .	.36
Jack Operation . . . . .	.561, 564	Passive Entry Programming . . . . .	.36
Jump Starting . . . . .	.574	Remote Control . . . . .	.36
Key Fob		Unlock From The Driver's Side . . . . .	.23, 36
Emergency Key . . . . .	.13	Unlock From The Passenger Side . . . . .	.23, 36
Lock The Doors . . . . .	.24	Keyless Entry System . . . . .	.22
		Keyless Go . . . . .	.12

Keys . . . . .	.12	Cruise . . . . .	.350, 351, 352
Lane Change And Turn Signals . . . . .	.167	Daytime Running . . . . .	.165
Lane Change Assist. . . . .	.168	Dimmer Switch, Headlight . . . . .	.167, 168
LaneSense . . . . .	.216	Engine Temperature Warning . . . . .	.328
Lap/Shoulder Belts. . . . .	.51	Exterior . . . . .	.113, 651
Latches . . . . .	.113	Fog . . . . .	.166, 652
Lead Free Gasoline . . . . .	.528	Front Replacement . . . . .	.651
Leaks, Fluid . . . . .	.113	Hazard Warning Flasher . . . . .	.547
Life Of Tires. . . . .	.513	Headlights . . . . .	.161, 647
Light Bulbs . . . . .	.113, 644, 651	Headlights On Reminder . . . . .	.165
Light Replacement . . . . .	.644, 651	Headlights On With Wipers . . . . .	.162
Lights. . . . .	.113, 161, 644	Headlight Switch . . . . .	.161
Air Bag . . . . .	.82, 111, 324	High Beam . . . . .	.168
Automatic Headlights . . . . .	.162	High Beam/Low Beam Select . . . . .	.168
Battery Saver . . . . .	.172	Illuminated Entry . . . . .	.22
Brake Assist Warning . . . . .	.488	Instrument Cluster . . . . .	.161
Brake Warning . . . . .	.325	Intensity Control . . . . .	.170
Bulb Replacement . . . . .	.646, 651	Interior . . . . .	.170
		License . . . . .	.657

Lights On Reminder . . . . .	.165	Automatic Door . . . . .	.34
Low Fuel . . . . .	.342	Auto Unlock . . . . .	.34
Malfunction Indicator (Check Engine) . . . . .	.335	Child Protection . . . . .	.34
Parade Mode (Daytime Brightness) . . . . .	.171	Door . . . . .	.31
Park . . . . .	.348	Power Door . . . . .	.33
Passing . . . . .	.168	Low Tire Pressure System . . . . .	.518
Reading . . . . .	.168, 275	Lubrication, Body . . . . .	.608
Seat Belt Reminder . . . . .	.323	Lug Nuts . . . . .	.548
Security Alarm . . . . .	.327	Maintenance Free Battery . . . . .	.602
Service . . . . .	.646	Maintenance Procedures . . . . .	.597
Side Marker . . . . .	.649, 651	Maintenance Schedule . . . . .	.664
Tire Pressure Monitoring (TPMS) . . . . .	.339, 518	Malfunction Indicator Light (Check Engine) . . . . .	.335, 595
Traction Control . . . . .	.488	Manual, Service . . . . .	.676
Turn Signal . . . . .	.113, 167, 349, 649	Marker Lights, Side . . . . .	.649
Vanity Mirror . . . . .	.133	Master Cylinder (Brakes) . . . . .	.618
Warning (Instrument Cluster Description) . . . . .	.328, 349	Memory Feature (Memory Seat) . . . . .	.155
Loading Vehicle . . . . .	.539	Memory Seat . . . . .	.155
Tires . . . . .	.498	Memory Seats And Radio . . . . .	.155
Locks . . . . .	.31		

Methanol . . . . .	.529	Oil, Engine . . . . .	.598, 659
Mirrors . . . . .	.122	Capacity . . . . .	.658
Electric Powered . . . . .	.132	Change Interval . . . . .	.599
Electric Remote . . . . .	.132	Checking . . . . .	.598
Exterior Folding . . . . .	.130	Dipstick . . . . .	.598
Heated . . . . .	.132	Disposal . . . . .	.601
Outside . . . . .	.130	Filter . . . . .	.601, 659
Rearview . . . . .	.122, 123	Filter Disposal . . . . .	.601
Vanity . . . . .	.133	Identification Logo . . . . .	.599
Modifications/Alterations, Vehicle . . . . .	.7	Materials Added To . . . . .	.601
Monitor, Tire Pressure System . . . . .	.518	Pressure Warning Light . . . . .	.330
MOPAR Parts . . . . .	.596, 675	Recommendation . . . . .	.599, 658
MTBE/ETBE . . . . .	.529	Synthetic . . . . .	.601
Multi-Function Control Lever . . . . .	.167	Viscosity . . . . .	.600, 658
 		Oil Filter, Change . . . . .	.601
New Vehicle Break-In Period . . . . .	.108	Oil Filter, Selection . . . . .	.601
 		Oil Pressure Light . . . . .	.330
Occupant Restraints . . . . .	.47	Onboard Diagnostic System . . . . .	.593
Octane Rating, Gasoline (Fuel) . . . . .	.528, 659	Opener, Garage Door (HomeLink) . . . . .	.277



Operating Precautions . . . . .	.593	Mirrors . . . . .	.132
Operator Manual (Owner's Manual) . . . . .	.4	Outlet (Auxiliary Electrical Outlet) . . . . .	.295, 299
Outside Rearview Mirrors . . . . .	.130	Sunroof . . . . .	.287, 291
Overhead Console. . . . .	.274	Windows . . . . .	.41
Overheating, Engine . . . . .	.547	Power Seats	
Owner's Manual (Operator Manual) . . . . .	.4, 676	Down . . . . .	.143
		Forward . . . . .	.143
Paint Care . . . . .	.622	Rearward . . . . .	.143
Panic Alarm. . . . .	.24	Up . . . . .	.143
Parking Brake. . . . .	.471	Pregnant Women And Seat Belts . . . . .	.57
ParkSense System, Rear. . . . .	.222, 232	Preparation For Jacking . . . . .	.563
Passing Light . . . . .	.168	Pretensioners	
Personalized Menu Bar . . . . .	.425	Seat Belts . . . . .	.58
Pets . . . . .	.108	Radial Ply Tires . . . . .	.506
Placard, Tire And Loading Information . . . . .	.499	Radiator Cap (Coolant Pressure Cap) . . . . .	.615
Power		Radio Frequency	
Brakes . . . . .	.478	General Information . . . . .	.16, 18, 27, 30, 41
Deck Lid Release . . . . .	.45	Radio Operation . . . . .	.400
Door Locks . . . . .	.33		

Radio Remote Controls . . . . .	.399	Panic Alarm . . . . .	.24
Radio (Sound Systems) . . . . .	.398	Programming Additional Key Fobs . . . . .	.18, 25
Rain Sensitive Wiper System . . . . .	.176	Programming Additional Transmitters . . . . .	.18, 25
Rear Camera . . . . .	.271	Remote Battery Replacement . . . . .	.25
Rear Cupholder . . . . .	.301	Remote Keyless Entry (RKE) . . . . .	.13, 22
Rear ParkSense System . . . . .	.222, 232	Transmitter Battery Replacement . . . . .	.25
Rear Seat, Folding . . . . .	.154	Unlatch The Trunk . . . . .	.24
Rear Window Defroster . . . . .	.311	Unlock The Doors . . . . .	.23
Rear Window Features . . . . .	.311	Remote Sound System (Radio) Controls . . . . .	.399
Recorder, Event Data . . . . .	.85	Remote Starting	
Recreational Towing . . . . .	.542	Enter Remote Start Mode . . . . .	.29
Reformulated Gasoline . . . . .	.528	EVIC Remote Start Abort Message . . . . .	.28
Refrigerant . . . . .	.605	Exit Remote Start Mode . . . . .	.30
Reminder, Lights On . . . . .	.165	How To Use Remote Start . . . . .	.28
Reminder, Seat Belt . . . . .	.49	Remote Starting System . . . . .	.27
Remote Control		To Exit Remote Start Mode And Drive The	
Starting System . . . . .	.27	Vehicle . . . . .	.30
Remote Keyless Entry (RKE)		Remote Starting System . . . . .	.27
Lock The Doors . . . . .	.24	Remote Trunk Release . . . . .	.45

Replacement Bulbs . . . . .	.644	Energy Management Feature . . . . .	.58
Replacement Parts . . . . .	.596	Lap/Shoulder Belt Operation . . . . .	.53
Replacement Tires . . . . .	.513	Lap/Shoulder Belts . . . . .	.51
Reporting Safety Defects . . . . .	.675	Lap/Shoulder Belt Untwisting . . . . .	.55
Restraint, Head . . . . .	.150	Pregnant Women . . . . .	.57
Restraints, Child . . . . .	.86	Seat Belt Extender . . . . .	.56
Restraints, Occupant . . . . .	.47	Seat Belt Pretensioner . . . . .	.58
Rotation, Tires . . . . .	.516	Seat Belt Reminder . . . . .	.49
		Seat Belt System . . . . .	.47
Safety Checks Inside Vehicle . . . . .	.111	Seat Belt Maintenance . . . . .	.627
Safety Checks Outside Vehicle . . . . .	.113	Seat Belt Reminder . . . . .	.49
Safety Defects, Reporting . . . . .	.675	Seat Belts . . . . .	.49, 111
Safety, Exhaust Gas . . . . .	.110	Adjustable Shoulder Belt . . . . .	.56
Safety Information, Tire . . . . .	.491	Adjustable Upper Shoulder Anchorage . . . . .	.56
Safety Tips . . . . .	.109	Child Restraint . . . . .	.86
Schedule, Maintenance . . . . .	.664	Extender . . . . .	.56
Seat Belt		Front Seat . . . . .	.49, 51, 53
Adjustable Upper Shoulder Belt Anchorage . . . . .	.56	Inspection . . . . .	.111
Automatic Locking Retractor (ALR) . . . . .	.58	Operating Instructions . . . . .	.53

Pregnant Women . . . . .	.57	Rearming The System . . . . .	.19
Pretensioners . . . . .	.58	Security Alarm . . . . .	.19
Rear Seat . . . . .	.51	Tamper Alert . . . . .	.21
Reminder . . . . .	.323	Selection Of Coolant (Antifreeze) . . . . .	.659
Untwisting Procedure . . . . .	.55	SENTRY KEY	
Seats. . . . .	.142, 143, 148	Immobilizer . . . . .	.16
Adjustment . . . . .	.142, 143, 146	Key Programming . . . . .	.18
Easy Entry . . . . .	.158	Replacement Keys . . . . .	.18
Head Restraints . . . . .	.150	Service Assistance . . . . .	.671
Heated . . . . .	.148	Service Contract . . . . .	.673
Memory . . . . .	.155	Service Manuals . . . . .	.676
Rear Folding . . . . .	.154	Shifting	
Seatback Release . . . . .	.147	Automatic Transmission . . . . .	.457
Tilting . . . . .	.147	Shoulder Belts . . . . .	.51
Vented . . . . .	.149	Side View Mirror Adjustment. . . . .	.130
Ventilated . . . . .	.149	Signals, Turn. . . . .	.113, 167, 349, 649
Security Alarm . . . . .	.327	Snow Chains (Tire Chains). . . . .	.515
Arm The System . . . . .	.19	Snow Tires . . . . .	.508
Disarm The System . . . . .	.20	Spare Tire . . . . .	.509, 510, 511, 561

Spark Plugs . . . . .	.659	Wheel, Heated . . . . .	.179
Specifications		Wheel, Tilt . . . . .	.178
Fuel (Gasoline) . . . . .	.659	Steering Wheel Audio Controls . . . . .	.399
Oil . . . . .	.659	Steering Wheel Mounted Sound System Controls . . . . .	.399
Speed Control		Storage . . . . .	.643
Accel/Decel . . . . .	.182, 183	Storage, Vehicle . . . . .	.423, 643
Accel/Decel (ACC Only) . . . . .	.191	Storing Your Vehicle . . . . .	.643
Cancel . . . . .	.182	Stuck, Freeing. . . . .	.578
Speed Control (Cruise Control) . . . . .	.180, 184	Sunglasses Storage . . . . .	.276
Starting . . . . .	.27, 451	Sun Roof . . . . .	.287, 291
Cold Weather . . . . .	.452	Sun Visor Extension . . . . .	.133
Engine Fails To Start . . . . .	.453	Supplemental Restraint System - Air Bag . . . . .	.62
Remote . . . . .	.27	Synthetic Engine Oil . . . . .	.601
Starting And Operating . . . . .	.451	System, Remote Starting . . . . .	.27
Starting Procedures . . . . .	.451	Telescoping Steering Column . . . . .	.178
Steering		Temperature Control, Automatic (ATC) . . . . .	.421
Column Controls . . . . .	.167	Tilt Steering Column . . . . .	.178
Column Lock . . . . .	.178	Time Delay, Headlight . . . . .	.163
Tilt Column . . . . .	.178		

Tip Start . . . . .	.452	Replacement . . . . .	.513
Tire And Loading Information Placard . . . . .	.498, 499	Rotation . . . . .	.516
Tire Markings . . . . .	.491	Safety . . . . .	.491, 503
Tires. . . . .	.113, 503, 509, 677	Sizes . . . . .	.493
Aging (Life Of Tires) . . . . .	.513	Snow Tires . . . . .	.508
Air Pressure . . . . .	.503	Spare Tire . . . . .	.509, 510, 511, 561
Chains . . . . .	.515	Spinning . . . . .	.511
Changing . . . . .	.561	Tread Wear Indicators . . . . .	.512
Compact Spare . . . . .	.510	Tire Safety Information . . . . .	.491
General Information . . . . .	.503, 509	Tire Service Kit. . . . .	.550, 552
High Speed . . . . .	.506	To Open Hood . . . . .	.159
Inflation Pressures . . . . .	.504	Towing . . . . .	.541
Jacking . . . . .	.561, 564	Disabled Vehicle . . . . .	.583
Life Of Tires . . . . .	.513	Recreational . . . . .	.542
Load Capacity . . . . .	.498, 499	Towing Vehicle Behind A Motorhome . . . . .	.542
Pressure Monitor System (TPMS) . . . . .	.360, 373, 518	Traction . . . . .	.468
Pressure Warning Light . . . . .	.339	Traction Control . . . . .	.485
Quality Grading . . . . .	.677	Trailer Towing . . . . .	.541
Radial . . . . .	.506	Transaxle . . . . .	.455



Automatic . . . . .	.455	Uconnect Settings . . . . .	.23, 24
Autostick . . . . .	.465	Uconnect 8.4A/8.4AN Voice Recognition	
Operation . . . . .	.455	Additional Information . . . . .	.446
Transmission . . . . .	.457	Do Not Disturb . . . . .	.444
Automatic . . . . .	.457, 620	General Information . . . . .	.445
Maintenance . . . . .	.620	Siri Eyes Free . . . . .	.444
Transmitter Battery Service (Remote Keyless Entry) . .	.25	Uconnect Access	
Transmitter, Garage Door Opener (HomeLink) . . . .	.277	Vehicle Health Alert . . . . .	.438
Transmitter Programming (Remote Keyless Entry) . .	.25	Uconnect Settings . . . . .	.23, 24, 34
Transmitter, Remote Keyless Entry (RKE) . . . . .	.22	Uconnect Voice Command . . . . .	.426
Transporting Pets . . . . .	.108	Uniform Tire Quality Grades . . . . .	.677
Tread Wear Indicators . . . . .	.512	Universal Transmitter . . . . .	.277
Trunk Lid (Deck Lid) . . . . .	.45, 47	Unleaded Gasoline . . . . .	.528
Trunk Release, Emergency . . . . .	.47	Untwisting Procedure, Seat Belt . . . . .	.55
Trunk Release Remote Control . . . . .	.45	Vanity Mirrors . . . . .	.133
Turn Signals . . . . .	.167, 349, 649	Vehicle Identification Number (VIN) . . . . .	.6
Uconnect		Vehicle Loading . . . . .	.499, 539
Operation . . . . .	.398	Vehicle Modifications/Alterations . . . . .	.7

Vehicle Storage . . . . .	.423, 643	Power . . . . .	.41
Viscosity, Engine Oil . . . . .	.600	Power Windows . . . . .	.41
Voice Recognition System (VR). . . . .	.426	Rear Passenger Window Controls . . . . .	.41
Warning Flasher, Hazard . . . . .	.547	Reset Auto-Up . . . . .	.44
Warnings And Cautions . . . . .	.6	Wind Buffeting . . . . .	.45
Warranty Information . . . . .	.675	Window Controls . . . . .	.41
Washers, Windshield. . . . .	.172, 609	Window Lockout . . . . .	.44
Washing Vehicle . . . . .	.622	Windshield Defroster . . . . .	.111
Water		Windshield Washers . . . . .	.172, 609
Driving Through . . . . .	.469	Fluid . . . . .	.609
Wheel And Wheel Trim . . . . .	.624	Windshield Wiper Blades . . . . .	.608
Wheel And Wheel Trim Care . . . . .	.624	Windshield Wipers . . . . .	.172
Wind Buffeting . . . . .	.45, 290, 295	Wiper Blade Replacement . . . . .	.608
Window Fogging . . . . .	.423	Wipers, Intermittent . . . . .	.174
Windows . . . . .	.41	Wipers, Rain Sensitive . . . . .	.176
Auto Down . . . . .	.43	Wrecker Towing . . . . .	.583
Driver/Passenger Window Controls . . . . .	.41		
Express Up And Down . . . . .	.43		



## **INSTALLATION OF RADIO TRANSMITTING EQUIPMENT**

Special design considerations are incorporated into this vehicle's electronic system to provide immunity to radio frequency signals. Mobile two-way radios and telephone equipment must be installed properly by trained personnel. The following must be observed during installation.

The positive power connection should be made directly to the battery and fused as close to the battery as possible. The negative power connection should be made to body sheet metal adjacent to the negative battery connection. This connection should not be fused.

Antennas for two-way radios should be mounted on the roof or the rear area of the vehicle. Care should be used in mounting antennas with magnet bases. Magnets may affect the accuracy or operation of the compass on vehicles so equipped.

The antenna cable should be as short as practical and routed away from the vehicle wiring when possible. Use only fully shielded coaxial cable.

Carefully match the antenna and cable to the radio to ensure a low Standing Wave Ratio (SWR).

Mobile radio equipment with output power greater than normal may require special precautions.

All installations should be checked for possible interference between the communications equipment and the vehicle's electronic systems.

CHRYSLER



STICK WITH THE SPECIALISTS®

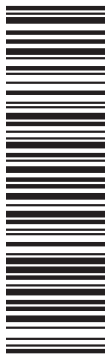

16UF-126-AB

©2015 FCA US LLC. All Rights Reserved.

Chrysler is a registered trademark of FCA US LLC.

Information Provided by:  
**DEALER**  
E-PROCESS



Second Edition Rev 1  
Printed in U.S.A.