

Card/Stickers/Pocket (Sleeve)

IMPORTANT:

- **The Pro Trailer Backup Assist depends on how and where you place these stickers.**
- **DO NOT ATTEMPT TO PLACE THE STICKERS UNTIL YOU READ THROUGH ALL OF STEP 3 ON PAGES 10 AND 11 FOR STICKER PLACEMENT DETAILS.**



ProTrailerBackupAssist.com

Scan the QR code for a additional resources of the Pro Trailer Backup Assist set up.

This Quick Start Guide is not intended to replace your vehicle Owner's Manual which contains more detailed information concerning the features of your vehicle, as well as important safety warnings designed to help reduce the risk of injury to you and your passengers. Please read your entire Owner's Manual carefully as you begin learning about your new vehicle and refer to the appropriate chapters when questions arise. All information contained in this Quick Start Guide was accurate at the time of duplication. We reserve the right to change features, operation and/or functionality of any vehicle specification at any time. Your Ford dealer is the best source for the most current information. For detailed operating and safety information, please consult your Owner's Manual.

WARNING

Driving while distracted can result in loss of vehicle control, crash and injury. We strongly recommend that you use extreme caution when using any device that may take your focus off the road. Your primary responsibility is the safe operation of your vehicle. We recommend against the use of any hand-held device while driving and encourage the use of voice-operated systems when possible. Make sure you are aware of all applicable local laws that may affect the use of electronic devices while driving.

United States
Ford Customer
Relationship Center
1-800-392-3673 (FORD)
(TDD for the hearing
impaired: 1-800-232-5952)
owner.ford.com

 @FordService

Canada
Ford Customer
Relationship Centre
1-800-565-3673 (FORD)
ford.ca

 @FordServiceCA

LEARN MORE ABOUT YOUR NEW VEHICLE

Scan the country-appropriate QR code with your smartphone (make sure you have a scanner app installed) and you can access even more information about your vehicle.



owner.ford.com (U.S.)



ford.ca (Canada)

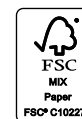

September 2015
First Printing
Quick Start Guide
Pro Trailer Backup Assist
Litho in U.S.A.
GL3J19G217 CA



2016 F-150 Pro Trailer Backup Assist QUICK START GUIDE



What is the Pro Trailer Backup Assist?

The Pro Trailer Backup Assist control knob on your instrument panel will forever change how you look at backing up a trailer.

Turn the knob in the direction you want the trailer to go and the system takes over the steering to get it there. This frees you to focus on monitoring the mirrors and applying the brake and accelerator.

The setup starts with you **placing a sticker** in a specific spot on your trailer, **taking a few measurements** and entering them into the system.

It is very important to follow the setup procedure carefully to ensure correct placement of the sticker. This guide walks you through that process, step by step, and lets you be on your way.

Let's get started!



How Do I Use It?

Set up this feature by following all six steps listed in this guide. Scan the QR code with your smartphone to see the step-by-step videos. See the next page for what you need to complete the set up.

1. Position your truck and trailer. **p 5.**
 2. Follow the information display prompts. **pp 6–9.**
 3. Place the sticker. **pp 10–11.**
 4. Measure key points. **pp 12–13.**
 5. Enter your measurements into the information display. **pp 14–15.**
 6. Confirm the sticker location and calibrate the system. **pp 16–17.**
- Feature Operation. **pp 18–22.**



ProTrailerBackupAssist.com

Scan the QR code for step-by-step videos for the Pro Trailer Backup Assist set up.

To set up this feature, use the:

- (a) **5-way controls** on your steering column
- (b) **Information display** in your instrument cluster
- (c) **Pro Trailer Backup Assist control knob**
- (d) **Center display**



What You Need for Set Up

This guide with the measurement card and the stickers in the inside back cover pocket

Tape measure (English or Metric)

Pen to record your measurements in the guide

Step-by-Step Videos (optional)

An adult or older child assistant to help you with measurements (optional)

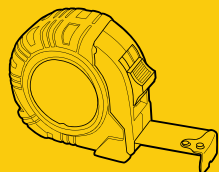
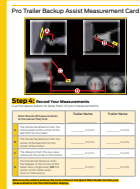

ProTrailerBackupAssist.com



Pro Trailer Backup Assist Feature Set Up

Read and follow all of these steps carefully to get the best results.

Step 1: Position Your Truck and Trailer

- Hitch your conventional trailer to the truck. For additional information on hitching your trailer, refer to the towing chapter of your owner's manual.
- Park your truck and hitched trailer on a level surface.



- Make sure that the trailer and truck are in line with each other. You can do this by putting the truck in drive (D) and pulling straight forward.



Pro Trailer Backup Assist Feature Set Up

Step 2: Follow the Information Display Prompts

Once you begin the setup, do not shut off your vehicle. Press the center button on the knob located to the right of the steering wheel to begin setting up the Pro Trailer Backup Assist.

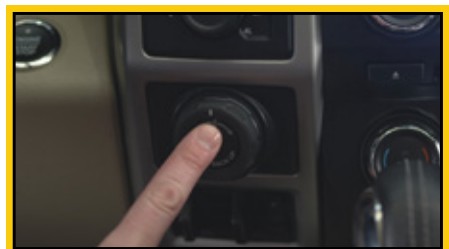

Press the down arrow on the left hand-side of the 5-way steering wheel controls to highlight **Add Trailer**. Press **OK** to confirm.



5-way controls

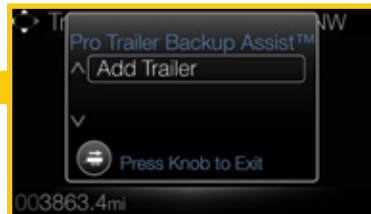

Information display

Set Up Your Trailer

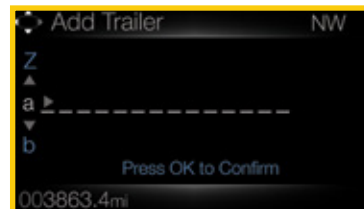

Name your trailer.

Use the 5-way steering wheel controls to choose the alphanumeric characters. Press the right arrow to advance to the next letter. When finished spelling out the name of the trailer, press **OK** to confirm. To delete a letter, press the up or down arrow key until you see a blank.

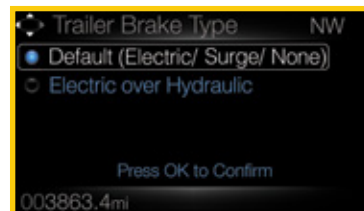

Select the type of brake system for your trailer.

Select **Default** if your trailer has electric, surge or no brakes. Press **OK** to select and advance to the next screen.

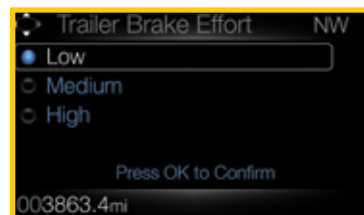

Select the brake effort for your trailer.

The default value is **Low** and is the recommended setting for most trailers. If your trailer's brakes require more initial voltage, or if you prefer more aggressive trailer braking, then select either the **Medium** or the **High** setting.

Pro Trailer Backup Assist Feature Set Up

Select your trailer type.

Use the images to the right to help you determine your trailer type. If you have a conventional trailer, select **Conventional**.

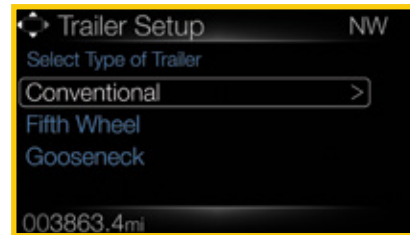

Note: Pro Trailer Backup Assist only supports conventional trailers.

Conventional Trailers Examples

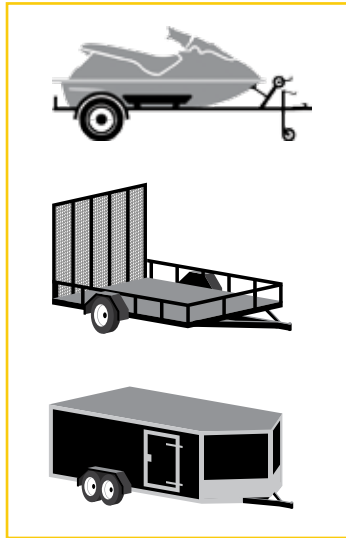

Non-Conventional Trailers Examples

You cannot use the Pro Trailer Backup Assist with Fifth Wheel and Gooseneck type trailers.

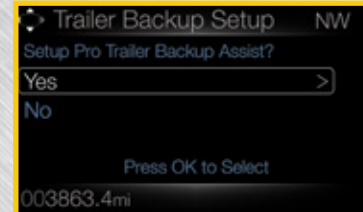
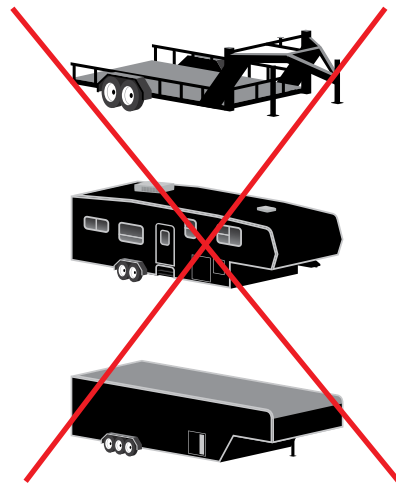

Next, a message appears in the information display asking if you want to add Pro Trailer Backup Assist.



Straighten out the trailer, if necessary.

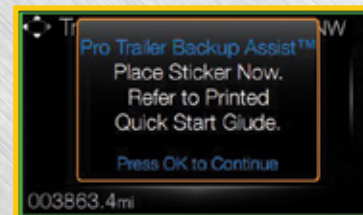

The information display directs you to this Quick Start Guide for how to proceed.

Pro Trailer Backup Assist Feature Set Up

Step 3: Placing the Sticker

You need to place the **entire sticker** in the green zone on the trailer as outlined in the diagram on the next page. The sticker is in the back cover pocket of this guide.



Rear view camera

Note: An assistant can help you complete the tasks on the next page.

Make sure to gather the following items before exiting the vehicle:



Sticker and measurement card (provided inside the back cover pocket of this guide).

Tape measure and pen (not provided).

Outside the Vehicle



- Take the measurement card and the sticker from the back of this guide, a tape measure and a pen, and walk back to your trailer.
- Determine where to place the sticker. You must place it in the green zone as indicated in the diagram below.
- Confirm that the sticker is visible using the center display. An assistant can remain inside the vehicle to help you do this.

Sticker Placement Diagram

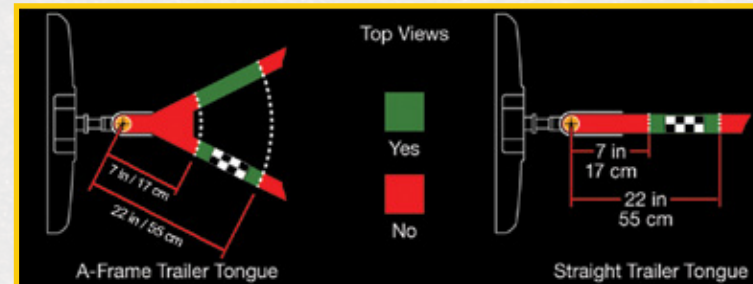

Note: You must place the **entire sticker** within the green zone. Once you place the sticker, you cannot move it. Do not attempt to re-use stickers. Use a new sticker.

Sticker Placement Tips

- Perform sticker placement when temperatures are above 32° F (0° C).
- Put the sticker on a flat, dry, clean horizontal surface.
- Using a tape measure, find a place to put the **entire sticker** in range as shown below:
 - Within the green zone.
 - Between 7 inches (17 cm) and 22 inches (55 cm) from the trailer ball hitch.
- Make sure no hardware will obstruct the view from the camera to the sticker (jack handle, wiring, etc.)
- Place the sticker.

Pro Trailer Backup Assist Feature Set Up

Step 4: Measuring Key Points

Outside the Vehicle

Now that the sticker is in place, you must take a few measurements.

For the system to perform its best, it is important to make sure that the measurements you take are accurate.

Record all four distances on your measurement card, located in the back cover pocket of this guide.

Pro Trailer Backup Assist Measurement Card

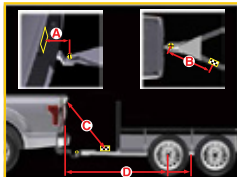

Step 4: Record Your Measurements

Use the space below to keep track of your measurements.

Note: Round off measurements to the nearest half-inch.	Trailer Name	Trailer Name
A. The horizontal distance from the license plate to the center of the ball hitch on the trailer.	_____ in (cm)	_____ in (cm)
B. The horizontal distance from the center of the ball hitch to the center of the sticker.	_____ in (cm)	_____ in (cm)
C. The distance from the rear-view camera to the center of the sticker.	_____ in (cm)	_____ in (cm)
D. The horizontal distance from the tailgate to the center of the trailer axle (single axle) OR the center of the trailer axles (two or more axles).	_____ in (cm)	_____ in (cm)

Return to the vehicle and use the instructions in the Quick Start Guide to enter your measurements into the information display.

Measurement Tips

- When you take your measurements, round off your numbers to the nearest half-inch increment.
- If a distance ends in one-quarter of a measurement unit or greater, round up to the next half-increment. If not, round down. For example, 12 ¼ inches would be rounded up to 12 ½. 12 ⅛ inches would be rounded down to 12.
- Be sure to use the measurement unit that is consistent with what your vehicle uses. Use inches if your vehicle is set to U.S. units. Use centimeters if your vehicle is set to Metric units.

Note: An easy way to check to see which units your vehicle uses is to look for outside temperature readings or estimated fuel economy. Fahrenheit or miles indicates U.S. units. Celsius or kilometers indicates Metric units.

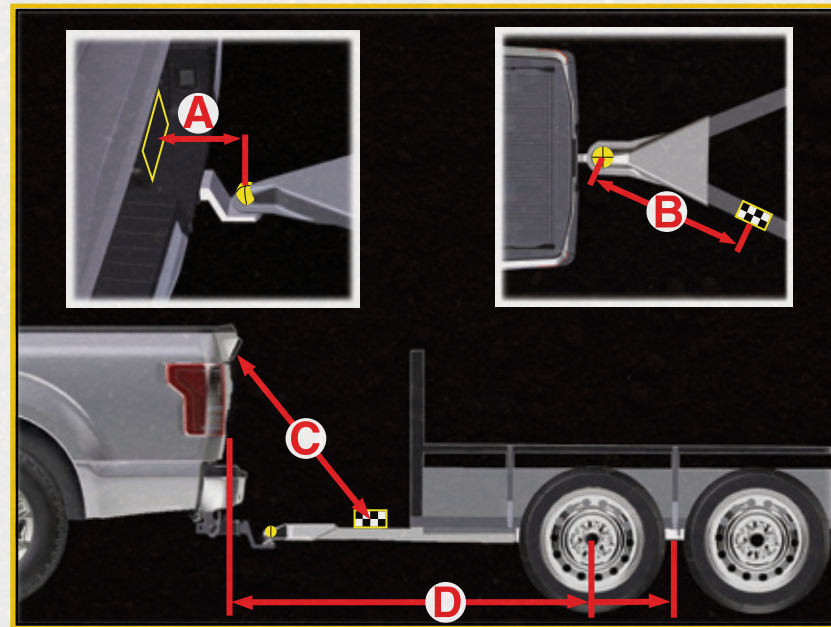

Measurement A

The horizontal distance from the license plate to the center of the ball hitch on the trailer.

Measurement B

The horizontal distance from the center of the ball hitch to the center of the sticker.

Measurement C

The distance from the rear-view camera to the center of the sticker.

Measurement D

The horizontal distance from the tailgate to the center of the trailer axle (single axle) **OR** the center of the trailer axles (two or more axles).

Pro Trailer Backup Assist Feature Set Up

Step 5: Enter Your Measurements into the Information Display

Inside the Vehicle

For this part of the setup, use the information display and your **5-way steering wheel controls** to enter the four measurements.

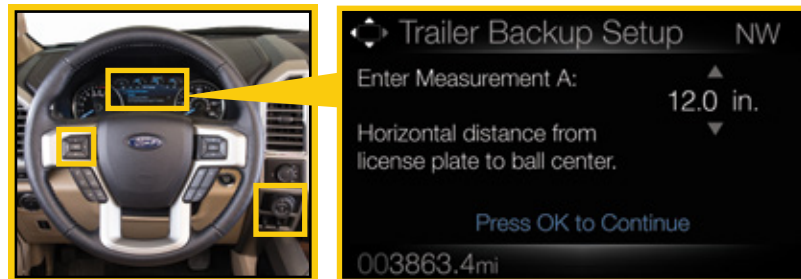

Entering Your Measurements

- Use the up/down arrows to increase or decrease the numbers as needed. Press **OK** to confirm each measurement. The screen prompts you to add the next measurement.
- Refer to the measurements you recorded on your measurement card and enter each one into the information display.

Once you add your last measurement, the information display shows you all of your entered measurements. Review and confirm.

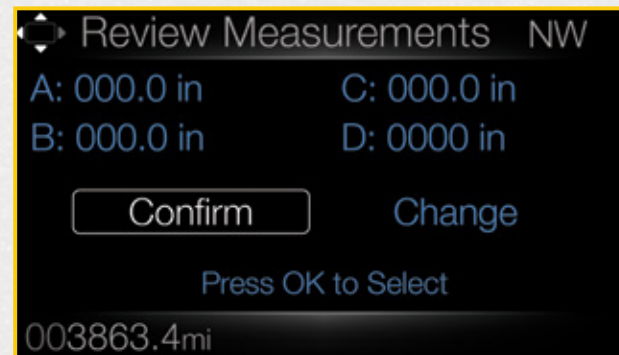

Note: If you want to revise your measurements, highlight **Change** and press **OK**. Otherwise, press the arrow to highlight **Confirm** and press **OK**.

Pro Trailer Backup Assist Feature Set Up

Step 6: Confirming the Sticker Location

Inside the Vehicle

Look for the circle in the center display.

Is that your sticker?

Use the steering wheel controls to select **Yes** or **No**.

If you select **No**, you may need to repeat the setup procedure from the beginning.

Note: If your system cannot locate the sticker, try the following:

- Clean the rear view camera lens.
- Make sure you place the entire sticker between 7 inches (17 cm) and 22 inches (55 cm) from the trailer ball hitch.
- Refer to your Owner's Manual for additional support.

You'll see a confirmation message when you successfully confirm the target.

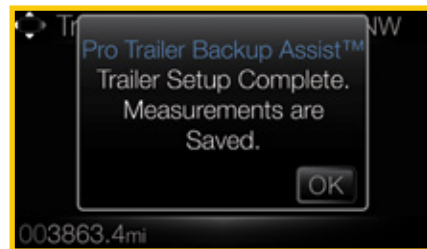
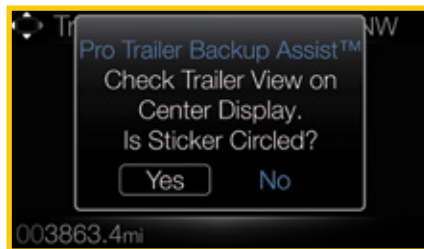

Calibrating The System

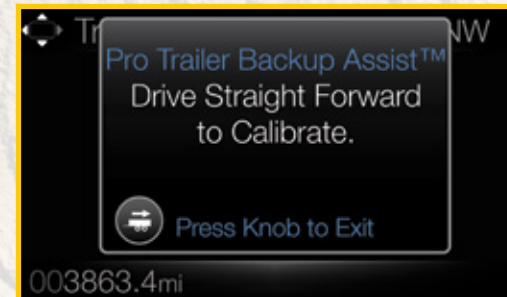

To complete the setup, you need to drive the vehicle straight forward between 4 to 24 mph (6 to 39 kph) as directed by the information display.

Note: If you turn the steering wheel during this time, calibration pauses. The information display then prompts you to drive straight forward to complete the calibration.



The information display shows a message while the system calibrates and another screen appears when the system completes the calibration.

Note: For best results, we do not recommend calibrating the system at night.

Feature Operation

- To use, press the center button on the knob and watch the information display screen. Use the steering wheel controls to highlight your trailer, then press **OK** to select.

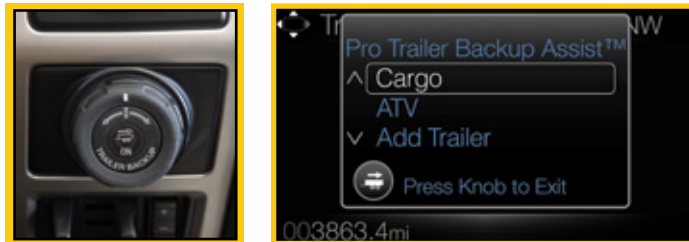

- Once the system locates your sticker, the screen prompts you to shift into reverse (R) to activate the feature.



Note: The system cannot operate if your hands are on the steering wheel. Remove your hands from the steering wheel to resume system operation.



- Continue following the screen prompts on the information display.



Note: You may need to drive forward to straighten your trailer.



Feature Operation

- Take your hands off the steering wheel and turn the Pro Trailer Backup Assist knob instead. The knob acts as the steering wheel for your trailer.

Note: The further you turn the knob, the sharper the trailer turns.



- Turn and hold the knob left (counterclockwise) when you want the trailer to go to the left.

TIPS

- Find an area where you can safely become familiar with the response of your vehicle and trailer when using the system.
- Try backing up straight and then turning the knob slowly in the direction you want to go.



- Turn and hold the knob to the right (clockwise) when you want the trailer to go to the right.

- Quickly turning and releasing the knob results in a jerky movement of the vehicle.

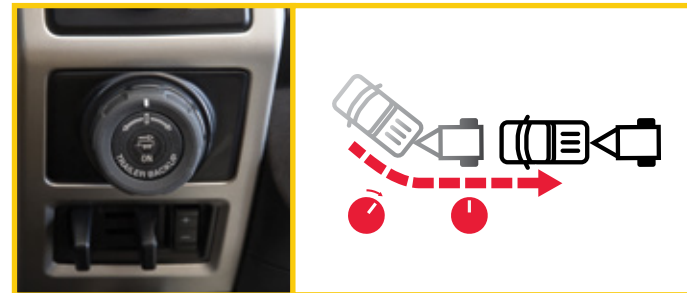

- Once you have the trailer moving in the direction you want it to go, release the knob. You control the accelerator and brakes while the system steers the truck to keep the trailer moving straight back.

Note: If you attempt to accelerate beyond the system's threshold, the system automatically limits your vehicle's speed.

TIPS

- As soon as you release the knob or turn it back to the center position, the vehicle starts following the trailer's path.
- CAUTION:** Always keep your hand close to the control knob. You may need to redirect the trailer quickly.
- Turn and hold the knob continuously for sharper vehicle and trailer turns.

Feature Operation

Even when using the Pro Trailer Backup Assist feature, be sure to use all visibility aids to help you to back up your trailer safely.

Use your vehicle mirrors as your primary aid. Be sure to include the windows and the rear view camera image to view the trailer direction and determine the trailer placement.

Note: *Driving aids do not replace the need to watch where the vehicle and trailer are moving and brake when necessary. Refer to your **Owner's Manual** for safety information, more details and limitations.*

Note: *To prevent your trailer from accumulating miles and the trailer information status appearing when you restart your vehicle after disconnecting your trailer, you need to deactivate your trailer. Use the information display, go to the **Towing** menu and then the **Select Trailer** option. Choose **No active trailer**. To learn more about using your information display, see the **Information Displays** chapter in your **Owner's Manual** for details.*

