



E-Class

Sedan and Wagon
Operator's Manual

E-Class Sedan and Wagon Operator's Manual



2125847502

Order no. 6515 3655 13 Part no. 212 584 75 02 Edition A-2016



Mercedes-Benz

Symbols

Registered trademarks:

- Bluetooth® is a registered trademark of Bluetooth SIG Inc.
- DTS is a registered trademark of DTS, Inc.
- Dolby and MLP are registered trademarks of DOLBY Laboratories.
- BabySmart™, ESP® and PRE-SAFE® are registered trademarks of Daimler AG.
- HomeLink® is a registered trademark of Johnson Controls.
- iPod® and iTunes® are registered trademarks of Apple Inc.
- Logic7® is a registered trademark of Harman International Industries.
- Microsoft® and Windows media® are registered trademarks of Microsoft Corporation.
- SIRIUS is a registered trademark of Sirius XM Radio Inc.
- HD Radio is a registered trademark of iBiquity Digital Corporation.
- Gracenote® is a registered trademark of Gracenote, Inc.
- ZAGATSurvey® and related brands are registered trademarks of ZagatSurvey, LLC.

In this Operator's Manual you will find the following symbols:

WARNING

Warning notes make you aware of dangers which could pose a threat to your health or life, or to the health and life of others.

Environmental note

Environmental notes provide you with information on environmentally aware actions or disposal.

 Notes on material damage alert you to dangers that could lead to damage to your vehicle.

 Practical tips or further information that could be helpful to you.

▶ This symbol indicates an instruction that must be followed.

▶ Several of these symbols in succession indicate an instruction with several steps.

(▷ This symbol tells you where you can find more information about a topic.

▷▷ This symbol indicates a warning or an instruction that is continued on the next page.

Dis-
play This text indicates a message in the multifunction/COMAND/Audio display.



This symbol tells you that you can find further information in the Digital Operator's Manual.

Publication details

Internet

Further information about Mercedes-Benz vehicles and about Daimler AG can be found on the following websites:

<http://www.mbusa.com> (USA only)

<http://www.mercedes-benz.ca> (Canada only)

Editorial office

©Daimler AG: not to be reprinted, translated or otherwise reproduced, in whole or in part, without written permission from Daimler AG.

Vehicle manufacturer

Daimler AG
Mercedesstraße 137
70327 Stuttgart
Germany

Welcome to the world of Mercedes-Benz

We urge you to read this Operator's Manual carefully and familiarize yourself with the vehicle before driving. For your own safety and a longer vehicle life, follow the instructions and warning notices in this manual. Ignoring them could result in damage to the vehicle or personal injury to you or others.

Vehicle damage caused by failure to follow instructions is not covered by the Mercedes-Benz Limited Warranty.

This Operator's Manual provides information on the most important functions of your vehicle.

Additional information on convenience functions can be found in COMAND in your Digital Operator's Manual.

The equipment or product designation of your vehicle may vary depending on:

- model
- order
- country specification
- availability

Mercedes-Benz therefore reserves the right to introduce changes in the following areas:

- design
- equipment
- technical features

The equipment in your vehicle may therefore differ from that shown in the descriptions and illustrations.

The following are integral components of the vehicle:

- Digital Operator's Manual
- Operator's Manual
- Maintenance Booklet
- Equipment-dependent supplements

Keep these documents in the vehicle at all times. If you sell the vehicle, always pass all documents on to the new owner.

You can also use the E-Class Guide smartphone app:



Apple® iOS



Android™

Please note that the Mercedes-Benz Guides App may not yet be available in your country.

The technical documentation team at Daimler AG wishes you safe and pleasant motoring.

Mercedes-Benz USA, LLC
Mercedes-Benz Canada, Inc.
A Daimler Company



Index	4	At a glance	35
Digital Operator's Manual	25	Safety	47
Introduction	27	Opening and closing	89
		Seats, steering wheel and mirrors ..	113
		Lights and windshield wipers	119
		Climate control	129
		Driving and parking	135
		On-board computer and displays	187
		Audio 20/COMAND	213
		Stowage and features	237
		Maintenance and care	261
		Roadside Assistance	269
		Wheels and tires	287
		Technical data	333

1, 2, 3 ...

4ETS (Electronic Traction System)

see ETS/4ETS (Electronic Traction System)

4MATIC (permanent all-wheel drive)

Function/notes 168

12 V socket

see Sockets

115 V socket 251**360° camera**

Cleaning 268

Function/notes 173

A**ABS (Anti-lock Braking System)**

Display message 192

Function/notes 75

Warning lamp 205

Access data of the mobile phone network provider

Making entries 234

Selecting 233

Accident

Automatic measures after an accident 67

Activating/deactivating cooling with air dehumidification 133**Active Blind Spot Assist**

Activating/deactivating (on-board computer) 190

Display message 191

Function/information 180

Active Driving Assistance package .. 180**Active Lane Keeping Assist**

Activating/deactivating (on-board computer) 190

Display message 191

Function/information 183

Active multicontour seat 116**Active Parking Assist**

Display message 191

Function/notes 170

Important safety notes 170

ADAPTIVE BRAKE 84**Adaptive Brake Assist**

Function/notes 80

Adaptive Damping System (ADS) 167**Adaptive Highbeam Assist**

Display message 191

Function/notes 122

Switching on/off 123

Address book

see also Digital Operator's Manual 214

Air bags

Deployment 63

Display message 198

Front air bag (driver, front passenger) 56

Important safety notes 54

Introduction 54

Knee bag 56

Occupant Classification System (OCS) 58

PASSENGER AIR BAG OFF indicator lamp 49

Pelvis air bag 57

Side impact air bag 56

Window curtain air bag 57

Air-conditioning system

see Climate control

AIRMATIC

Function/notes 166

Alarm

ATA (Anti-Theft Alarm system) 87

Switching off (ATA) 87

Switching the function on/off (ATA) 87

Alarm system

see ATA (Anti-Theft Alarm system)

Ambient lighting

Setting the brightness (on-board computer) 190

Setting the color (on-board computer) 190

AMG adaptive sport suspension system 167**AMG menu (on-board computer)** 190**Animals in the vehicle** 75**Anti-lock braking system**

see ABS (Anti-lock Braking System)

- Anti-Theft Alarm system**
see ATA (Anti-Theft Alarm system)
- Ashtray** 251
- Assistance display (on-board computer)** 190
- Assistance menu (on-board computer)** 190
- ASSYST PLUS**
Displaying a service message 266
Hiding a service message 266
Notes 266
Resetting the service interval display 266
Service message 266
Special service requirements 266
- ATA (Anti-Theft Alarm system)**
Activating/deactivating 87
Function 87
Switching off the alarm 87
- ATTENTION ASSIST**
Activating/deactivating 190
Display message 191
Function/notes 175
- Audio 20**
Components 216
Controller 222
Display 217
Functions 216
- Authorized Mercedes-Benz Center**
see Qualified specialist workshop
- Authorized workshop**
see Qualified specialist workshop
- AUTO lights**
Display message 191
- Automatic car wash (care)** 267
- Automatic engine start (ECO start/stop function)** 141
- Automatic engine switch-off (ECO start/stop function)** 141
- Automatic headlamp mode** 121
- Automatic transmission**
Accelerator pedal position 144
Automatic drive program 144
Changing gear 144
DIRECT SELECT lever 142
Display message 191
Drive program display 143
Driving tips 144
Emergency running mode 144
Engaging drive position 143
Engaging neutral 143
Engaging park position (AMG vehicles) 142
Engaging park position automatically 143
Engaging reverse gear 143
Engaging the park position 143
Kickdown 144
Manual drive program 144
Manual drive program (AMG vehicles) 144
Overview 142
Problem (malfunction) 144
Program selector button 144
Pulling away 140
Selector lever 142
Starting the engine 140
Steering wheel paddle shifters 144
Transmission position display 142
Transmission position display (DIRECT SELECT lever) 143
Transmission positions 144
- Automatic transmission emergency mode** 144

B

- Back button** 222
- BAS (Brake Assist System)** 76
- BAS PLUS (Brake Assist System PLUS) with Cross-Traffic Assist**
Function/notes 76
Important safety notes 77
- Battery (SmartKey)**
Checking 93
Replacing 93
- Battery (vehicle)**
Charging 278
Important safety notes 275
Jump starting 279
- Belt**
see Seat belts
- Blind Spot Assist**
Activating/deactivating 190

- Activating/deactivating (on-board computer) 190
 - Notes/function 178
 - see Active Blind Spot Assist
 - BlueTEC**
 - Adding DEF 149
 - BlueTEC (DEF)** 341
 - Bluetooth®**
 - Connecting another mobile phone 231
 - Entering the passcode 229
 - Searching for a mobile phone 229
 - see also Digital Operator's Manual 214
 - Telephony 227
 - Box (trunk)** 245
 - Brake Assist**
 - see BAS (Brake Assist System)
 - Brake fluid**
 - Display message 194
 - Notes 342
 - Brake force distribution**
 - see EBD (electronic brake force distribution)
 - Brake lamps**
 - Display message 191
 - Brakes**
 - ABS 75
 - Adaptive Brake Assist 80
 - BAS 76
 - BAS PLUS with Cross-Traffic Assist 76
 - Brake fluid (notes) 342
 - Display message 192
 - High-performance brake system 154
 - HOLD function 165
 - Important safety notes 154
 - Maintenance 154
 - Parking brake 152
 - Riding tips 154
 - Warning lamp 204
 - Breakdown**
 - see Flat tire
 - Brightness control (instrument cluster lighting)** 37
 - Bulbs**
 - see Replacing bulbs
 - Buttons and controller** 222
- C
- California**
 - Important notice for retail customers and lessees 29
 - Calling up a malfunction**
 - see Display messages
 - Car**
 - see Vehicle
 - Car key**
 - see SmartKey
 - Care**
 - 360° camera 268
 - Car wash 267
 - Carpets 268
 - Display 268
 - Exterior lights 268
 - Gear or selector lever 268
 - Interior 268
 - Matte finish 268
 - Notes 266
 - Paint 268
 - Plastic trim 268
 - Power washer 268
 - Rear view camera 268
 - Roof lining 268
 - Seat belt 268
 - Seat cover 268
 - Sensors 268
 - Tail pipes 268
 - Trim pieces 268
 - Washing by hand 268
 - Wheels 268
 - Windows 268
 - Wiper blades 268
 - Wooden trim 268
 - Cargo compartment**
 - Opening/closing (from outside, HANDS-FREE ACCESS) 99
 - Cargo compartment cover**
 - Important safety notes 243
 - Cargo compartment enlargement** ... 241
 - Cargo compartment floor** 248
 - Cargo net**
 - Attaching 245
 - Important safety information 244

Cargo tie down rings	242	Problem with the rear window defroster	133
CD		Problems with cooling with air dehumidification	133
see also Digital Operator's Manual	214	Rear control panel	132
CD player (on-board computer)	190	Refrigerant	344
Center console		Refrigerant filling capacity	344
Lower section	42	Setting the air distribution	133
Lower section (AMG vehicles)	43	Setting the air vents	133
Upper section	41	Setting the airflow	133
Central locking		Setting the climate mode	133
Automatic locking (on-board computer)	190	Setting the temperature	133
Locking/unlocking (SmartKey)	90	Switching air-recirculation mode on/off	133
Changing bulbs		Switching on/off	133
High-beam headlamps	124	Switching residual heat on/off	133
Turn signals (front)	125	Switching the rear window defroster on/off	133
Child		Switching the ZONE function on/off	133
Restraint system	69	Coat hooks	245
Child seat		Cockpit	
Forward-facing restraint system	73	Overview	36
LATCH-type (ISOFIX) child seat anchors	70	see Instrument cluster	
On the front-passenger seat	73	Collapsible spare wheel	
Rearward-facing restraint system	73	Inflating	331
Top Tether	71	see Emergency spare wheel	
Child-proof locks		COLLISION PREVENTION ASSIST PLUS	
Important safety notes	73	Display message	191
Rear doors	74	Operation/notes	78
Children		COMAND	
Special seat belt retractor	69	Components	216
Cigarette lighter	251	Control panel	219
Cleaning		Controller	222
Mirror turn signal	268	Display	217
Clear button	222	Functions	216
Climate control		Combination switch	121
Automatic climate control (3-zone)	132	Combined cargo cover and net	243
Controlling automatically	133	Connecting a USB device	
Cooling with air dehumidification ..	133	see also Digital Operator's Manual	214
Defrosting the windows	133	Consumption statistics (on-board computer)	190
Defrosting the windshield	133	Control panel	221
Dual-zone automatic climate control	131	Controller	222
General notes	130	Convenience box	245
Indicator lamp	133		
Maximum cooling	133		
Overview of systems	130		

- Coolant (engine)**
 Checking the level 265
 Display message 199
 Filling capacity 343
 Important safety notes 342
 Temperature (on-board computer) 190
 Temperature gauge 188
 Warning lamp 209
- Cooling**
 see Climate control
- Copyright** 34
- Cornering light function**
 Display message 191
 Function/notes 121
- Crash-responsive emergency lighting** 123
- Cruise control**
 Activation conditions 156
 Cruise control lever 156
 Deactivating 156
 Display message 191
 Driving system 155
 Function/notes 155
 Important safety notes 155
 Selecting 156
 Setting a speed 156
 Storing and maintaining current speed 156
- Cup holder**
 Center console 251
 Important safety notes 251
 Rear compartment 251
- Customer Assistance Center (CAC)** 32
- Customer Relations Department** 32
- D**
- Dashboard**
 see Instrument cluster
- Data**
 see Technical data
- Daytime running lamps**
 Display message 191
 Switching on/off (on-board computer) 190
 Switching on/off (switch) 121
- Declarations of conformity** 31
- DEF**
 Adding 149
 Filling capacity 341
 Important safety notes 341
- Delayed switch-off**
 Exterior lighting (on-board computer) 190
 Interior lighting 190
- Diagnostics connection** 31
- Diesel** 339
- Digital Operator's Manual**
 Help 25
 Introduction 25
- Digital speedometer** 190
- DIRECT SELECT lever**
 Automatic transmission 142
- Display (cleaning instructions)** 268
- Display messages**
 ASSYST PLUS 266
 Calling up (on-board computer) 191
 Driving systems 191
 Engine 199
 General notes 191
 Hiding (on-board computer) 191
 KEYLESS-GO 191
 Lights 191
 Safety systems 192
 SmartKey 191
 Tires 200
 Vehicle 201
- Distance recorder** 190
 see Odometer
 see Trip odometer
- Distance warning (warning lamp)** 210
- Distance warning function**
 Function/notes 79
- DISTRONIC PLUS**
 Activating 158
 Activation conditions 158
 Deactivating 161
 Display message 191
 Displays in the multifunction display 161
 Function/notes 156
 Important safety notes 157

Setting the specified minimum distance	161	PRE-SAFE® Brake	84
Stopping	160	STEER CONTROL	86
Doors		Driving systems	
Automatic locking (on-board computer)	190	360° camera	173
Automatic locking (switch)	95	Active Blind Spot Assist	180
Central locking/unlocking (SmartKey)	90	Active Driving Assistance package	180
Control panel	45	Active Lane Keeping Assist	183
Display message	191	Active Parking Assist	170
Emergency locking	96	AIRMATIC	166
Emergency unlocking	96	AMG adaptive sport suspension system	167
Important safety notes	95	ATTENTION ASSIST	175
Opening (from inside)	95	Blind Spot Assist	178
Drinking and driving	153	Cruise control	155
Drive program		Display message	191
Automatic	144	DISTRONIC PLUS	156
Display	142	DISTRONIC PLUS with Steering Assist and Stop&Go Pilot	163
Display (DIRECT SELECT lever)	143	HOLD function	165
Manual	144	Lane Keeping Assist	179
Manual (AMG vehicles)	144	Lane Tracking package	177
SETUP (on-board computer)	190	PARKTRONIC	168
Drive program selector	144	RACE START (AMG vehicles)	166
Driver's door		Rear view camera	171
see Doors		Traffic Sign Assist	176
Driving abroad		Driving tips	
Mercedes-Benz Service	266	AMG ceramic brakes	154
Driving on flooded roads	155	Automatic transmission	144
Driving safety systems		Brakes	154
ABS (Anti-lock Braking System)	75	Break-in period	136
ADAPTIVE BRAKE	84	Downhill gradient	154
Adaptive Brake Assist	80	Drinking and driving	153
BAS (Brake Assist System)	76	Driving in winter	155
BAS PLUS with Cross-Traffic Assist	76	Driving on flooded roads	155
COLLISION PREVENTION ASSIST PLUS	78	Driving on wet roads	155
Distance warning function	79	Exhaust check	154
EBD (electronic brake force distribution)	84	Fuel	153
ESP® (Electronic Stability Program)	80	General	153
ETS/4ETS (Electronic Traction System)	81	Hydroplaning	155
Important safety information	75	Icy road surfaces	155
Overview	75	Limited braking efficiency on salted roads	154
		Snow chains	291
		Wet road surface	154
		DVD video	
		Operating (on-board computer)	190

see also Digital Operator's Manual 214

E

E10

see Fuel

EASY-ENTRY feature

Activating/deactivating 190
Function/notes 117

EASY-EXIT feature

Function/notes 117
Switching on/off 190

EASY-PACK cargo compartment management system 246

EASY-PACK folding floor

Important safety notes 248

EASY-PACK folding luggage-compartment floor

Opening and closing 249

EASY-PACK load-securing kit

Components and storage 246
Inserting the brackets into the loading rail 247

EASY-PACK rear sill protector 249

EASY-PACK trunk box 245

EBD (electronic brake force distribution)

Display message 194
Function/notes 84

ECO display

Function/notes 154

ECO start/stop function

Automatic engine start 141
Automatic engine switch-off 141
Deactivating/activating 141
General information 141
Important safety notes 141
Introduction 141

Electronic Stability Program

see ESP® (Electronic Stability Program)

Emergency

Automatic measures after an accident 67

Emergency release

Driver's door 96
Fuel filler flap 147
Trunk 103

Vehicle 96

Emergency spare wheel

General notes 329
Important safety notes 329
Removing 329
Storage location 329
Stowing 330
Technical data 332

Emergency Tensioning Devices

Activation 63

Emergency unlocking

Tailgate 103

Emissions control

Service and warranty information 28

Engine

Check Engine warning lamp 202
Display message 199
ECO start/stop function 141
Engine number 337
Irregular running 142
Jump-starting 279
Starting problems 142
Starting the engine with the SmartKey 140
Starting with KEYLESS-GO 140
Switching off 152
Tow-starting (vehicle) 284

Engine electronics

Problem (malfunction) 142

Engine oil

Adding 264
Checking the oil level 263
Checking the oil level using the dipstick 264
Display message 191
Filling capacity 342
Notes about oil grades 341
Notes on oil level/consumption 263
Temperature (on-board computer) 190

Entering an address

see also Digital Operator's Manual 214

ESP® (Electronic Stability Program)

Activating/deactivating (except AMG vehicles) 81

- Activating/deactivating (on-board computer, except AMG vehicles) 190
 - AMG menu (on-board computer) ... 190
 - Characteristics 81
 - Deactivating/activating (button in AMG vehicles) 82
 - Deactivating/activating (except AMG vehicles) 190
 - Display message 192
 - ETS/4ETS 81
 - Function/notes 80
 - General notes 80
 - Important safety information 81
 - Trailer stabilization 84
 - Warning lamp 206
 - ETS/4ETS (Electronic Traction System)** 81
 - Exhaust check** 154
 - Exhaust tail pipe (cleaning instructions)** 268
 - Exterior lighting**
 - Setting options 120
 - see Lights
 - Exterior mirrors**
 - Adjusting 117
 - Dipping (automatic) 117
 - Folding in when locking (on-board computer) 190
 - Folding in/out (automatically) 117
 - Folding in/out (electrically) 117
 - Setting 117
 - Storing settings (memory function) 117
 - Storing the parking position 117
 - Eyeglasses compartment** 239
- F**
- Favorites**
 - Adding 223
 - Deleting 224
 - Displaying and calling up 223
 - Moving 224
 - Overview 223
 - Renaming 224
 - Filler cap**
 - see Fuel filler flap
 - Flat tire**
 - MOExtended tires 272
 - Preparing the vehicle 271
 - TIREFIT kit 273
 - see Emergency spare wheel
 - Floormats** 259
 - Frequencies**
 - Mobile phone 334
 - Two-way radio 334
 - Front fog lamps**
 - Display message 191
 - Fuel**
 - Additives 339
 - Consumption statistics 190
 - Displaying the current consumption 190
 - Displaying the range 190
 - Driving tips 153
 - Flexible fuel vehicles 340
 - Fuel gauge 37
 - Grade (gasoline) 338
 - Important safety notes 337
 - Premium-grade unleaded gasoline 338
 - Problem (malfunction) 149
 - Quality (diesel) 339
 - Refueling 145
 - Tank content/reserve fuel 338
 - Fuel filler flap**
 - Emergency release 147
 - Opening 146
 - Fuel level**
 - Calling up the range (on-board computer) 190
 - Fuel tank**
 - Capacity 338
 - Problem (malfunction) 149
 - Fuse allocation chart (vehicle tool kit)** 270
 - Fuses**
 - Allocation chart 284
 - Before changing 284
 - Fuse box in the cargo compartment 285
 - Fuse box in the engine compartment 285
 - Fuse box in the trunk 285
 - Important safety notes 284

G

Garage door opener	
Clearing the memory	259
General notes	256
Important safety notes	257
Opening/closing the garage door ..	259
Programming (button in the rear-view mirror)	257
Synchronizing the rolling code	257
Gear indicator (on-board computer)	190
Gear or selector lever (cleaning guidelines)	268
Genuine parts	27
Glove box	239
Google™ Local Search	
see also Digital Operator's Manual	214

H

HANDS-FREE ACCESS	99
Hazard warning lamps	120
Head bags	
Display message	196
Head restraints	
Adjusting	116
Adjusting (rear)	116
see NECK-PRO head restraints	
see NECK-PRO luxury head restraints	
Headlamps	
Fogging up	120
see Automatic headlamp mode	
Heating	
see Climate control	
High-beam headlamps	
Adaptive Highbeam Assist	122
Changing bulbs	124
Display message	191
Switching on/off	121
Hill start assist	141
HOLD function	
Activating	165
Deactivating	166
Function/notes	165

Home address

see also Digital Operator's Manual 214

Hood

Closing	263
Display message	201
Important safety notes	262
Opening	262

Hydroplaning

I

Ignition lock

see Key positions

Immobilizer

Indicator and warning lamps

COLLISION PREVENTION ASSIST PLUS	210
--	-----

Indicator lamps

see Warning and indicator lamps

Indicators

see Turn signals

Insect protection on the radiator 263

Instrument cluster

Overview	37
Settings	190
Warning and indicator lamps	38

Instrument cluster lighting

Interior lighting

Automatic control	123
Delayed switch-off (on-board computer)	190
Emergency lighting	123
Manual control	123
Overview	123
Reading lamp	123
Setting the brightness of the ambient lighting (on-board computer)	190
Setting the brightness of the display/switch (on-board computer) ..	190
Setting the color of the ambient lighting (on-board computer)	190

Internet

Selecting/setting access data	232
Setting up an Internet connection ..	232

- iPod®**
 see also Digital Operator's Manual 214
- J**
- Jack**
 Storage location 270
 Using 310
- Jump starting (engine)** 279
- K**
- Key positions**
 KEYLESS-GO 138
 SmartKey 137
- KEYLESS-GO**
 Deactivation 91
 Display message 191
 Locking 91
 Removing the Start/Stop button ... 139
 Start/Stop button 138
 Starting the engine 140
 Unlocking 91
- Kickdown**
 Driving tips 144
 Manual drive program 145
- Knee bag** 56
- L**
- Lamps**
 see Warning and indicator lamps
- Lane Keeping Assist**
 Activating/deactivating 190
 Function/information 179
- Lane Tracking package** 177
- Lap time (RACETIMER)** 190
- LATCH-type (ISOFIX) child seat anchors** 70
- License plate lamp (display message)** 191
- Light function, active**
 Display message 191
- Light sensor (display message)** 191
- Lights**
 Activating/deactivating the interior lighting delayed switch-off 190
 Adaptive Highbeam Assist 122
 Automatic headlamp mode 121
 Cornering light function 121
 Hazard warning lamps 120
 High beam flasher 121
 High-beam headlamps 121
 Light switch 120
 Low-beam headlamps 121
 Parking lamps 121
 Rear fog lamp 121
 Setting the brightness of the ambient lighting (on-board computer) 190
 Setting the brightness of the display/switch (on-board computer) .. 190
 Setting the color of the ambient lighting (on-board computer) 190
 Standing lamps 121
 Switching the daytime running lamps on/off (on-board computer) 190
 Switching the daytime running lamps on/off (switch) 121
 Switching the exterior lighting delayed switch-off on/off (on-board computer) 190
 Switching the surround lighting on/off (on-board computer) 190
 Turn signals 121
 see Replacing bulbs
- List of access data**
 New provider 233
- List of mobile phone network providers**
 With the selected provider 233
- Loading guidelines** 238
- Locking**
 see Central locking
- Locking (doors)**
 Automatic 95
 Emergency locking 96
 From inside (central locking button) 95
- Locking centrally**
 see Central locking
- Locking verification signal (on-board computer)** 190

- Low-beam headlamps**
 Display message 191
 Switching on/off 121
- Luggage holder (EASY-PACK load-securing kit)** 247
- Lumbar support**
 Adjusting the 4-way lumbar support 116
- M**
- M+S tires** 290
- Malfunction message**
 see Display messages
- Matte finish (cleaning instructions)** 268
- mbrace**
 Call priority 256
 Display message 191
 Downloading destinations (COMAND) 252
 Downloading routes 252
 Emergency call 253
 General notes 252
 Geo fencing 252
 Locating a stolen vehicle 252
 MB info call button 255
 Remote vehicle locking 252
 Roadside Assistance button 254
 Search & Send 252
 Self-test 252
 Speed alert 252
 System 252
 Triggering the vehicle alarm 252
 Vehicle remote malfunction diagnosis 252
 Vehicle remote unlocking 252
- Mechanical key**
 Function/notes 92
 Inserting 92
 Locking vehicle 96
 Removing 92
 Unlocking the driver's door 96
- Media Interface**
 see Separate operating instructions
- Memory card (audio)** 190
- Memory function** 117
- Mercedes-Benz Intelligent Drive**
 360° camera 173
 ABS (Anti-lock Brake System) 75
 Active Blind Spot Assist 180
 Active Lane Keeping Assist 183
 Active Parking Assist 170
 ATTENTION ASSIST 175
 BAS (Brake Assist) 76
 BAS PLUS (Brake Assist PLUS) with Cross-Traffic Assist 76
 Blind Spot Assist 178
 COLLISION PREVENTION ASSIST PLUS 78
 Cruise control 155
 DISTRONIC PLUS 156
 DISTRONIC PLUS with Steering Assist and Stop&Go Pilot 163
 ESP® (Electronic Stability Program) 80
 General notes 155
 Lane Keeping Assist 179
 PARKTRONIC 168
 PRE-SAFE® (anticipatory occupant protection) 66
 PRE-SAFE® Brake 84
 PRE-SAFE® PLUS (anticipatory occupant protection PLUS) 67
 Rear view camera 171
 Traffic Sign Assist 176
- Message memory (on-board computer)** 191
- Messages**
 see Display messages
- Mirrors**
 see Exterior mirrors
 see Rear-view mirror
 see Vanity mirror (in the sun visor)
- Mobile phone**
 Authorizing 229
 Connecting (Bluetooth® interface) 227
 Connecting another mobile phone 231
 De-authorizing 231
 Enabling for Internet access 233
 Frequencies 334
 Installation 334

Menu (on-board computer)	190
Transmission output (maximum)	334
Modifying the programming (SmartKey)	92
MOExtended tires	272
Mounting wheels	
Lowering the vehicle	313
Mounting a new wheel	313
Preparing the vehicle	309
Raising the vehicle	310
Removing a wheel	312
Securing the vehicle against rolling away	310
MP3	
Operation	190
see also Digital Operator's Manual	214
see separate operating instructions	
Multifunction display	
Function/notes	188
Permanent display	190
Multifunction steering wheel	
Operating the on-board computer ..	189
Overview	39
Music files	
see also Digital Operator's Manual	214

N

Navigation	
Menu (on-board computer)	190
see also Digital Operator's Manual	214
Showing/hiding the menu	225
Switching to	225
see separate operating instructions	
NECK-PRO head restraints	
Operation	65
Resetting triggered	65
NECK-PRO luxury head restraints	
Important safety notes	65
Operation	65
Resetting when triggered	66
Notes on breaking-in a new vehicle	136

O

Occupant Classification System (OCS)	
Conditions	58
Faults	62
Operation	58
System self-test	60
Occupant safety	
Automatic measures after an accident	67
Children in the vehicle	68
Important safety notes	49
Introduction to the restraint system	48
Occupant Classification System (OCS)	58
PASSENGER AIR BAG indicator lamps	49
Pets in the vehicle	75
PRE-SAFE® (anticipatory occupant protection)	66
PRE-SAFE® PLUS (anticipatory occupant protection PLUS)	67
Restraint system warning lamp	49
OCS	
Conditions	58
Faults	62
Operation	58
System self-test	60
Odometer	190
Oil	
see Engine oil	
On-board computer	
AMG menu	190
Assistance menu	190
Audio menu	190
Convenience submenu	190
Display messages	191
Displaying a service message	266
DISTRONIC PLUS	161
Factory settings submenu	190
Important safety notes	188
Instrument cluster submenu	190
Lighting submenu	190
Menu overview	190
Message memory	191
Navigation menu	190

- Operation 189
 - RACETIMER 190
 - Service menu 190
 - Settings menu 190
 - Standard display 190
 - Telephone menu 190
 - Trip menu 190
 - Vehicle submenu 190
 - Video DVD operation 190
 - Online and Internet functions**
 - Enabling a mobile phone for Internet access 233
 - Manually setting the access data of the mobile phone network provider 233
 - Selecting the access data of the mobile phone network provider 233
 - Setting up an Internet connection .. 232
 - Operating safety**
 - Declaration of conformity 31
 - Important safety notes 30
 - Operating system**
 - see On-board computer
 - Operation**
 - Digital Operator's Manual 25
 - Operator's Manual**
 - Vehicle equipment 28
 - Outside temperature display** 188
 - Overhead control panel** 44
 - Override feature**
 - Rear side windows 74
- P
- Paint code number** 336
 - Paintwork (cleaning instructions)** ... 268
 - Panic alarm** 48
 - Panorama roof with power tilt/sliding panel**
 - Important safety notes 106
 - Opening/closing 108
 - Opening/closing the roller sun-blind 109
 - Problem (malfunction) 111
 - Resetting 109
 - Parking**
 - Important safety notes 151
 - Parking brake 152
 - Position of exterior mirror, front-passenger side 117
 - Rear view camera 171
 - see PARKTRONIC
 - Parking aid**
 - Active Parking Assist 170
 - see Exterior mirrors
 - see PARKTRONIC
 - Parking assistance**
 - see PARKTRONIC
 - Parking brake**
 - Display message 191
 - Notes/function 152
 - PARKTRONIC**
 - Deactivating/activating 170
 - Driving system 168
 - Function/notes 168
 - Important safety notes 168
 - Problem (malfunction) 170
 - Range of the sensors 169
 - Warning display 170
 - PASSENGER AIR BAG**
 - Display message 198
 - Problems (malfunction) 198
 - PASSENGER AIR BAG OFF**
 - Indicator lamp 49
 - Pets in the vehicle** 75
 - Phone book**
 - see also Digital Operator's Manual 214
 - Phone call**
 - Dialing 232
 - Plastic hooks** 242
 - Plastic trim (cleaning instructions)** 268
 - Power washers** 268
 - Power windows**
 - see Side windows
 - PRE-SAFE® (anticipatory occupant protection)**
 - Display message 191
 - Operation 66
 - PRE-SAFE® Brake**
 - Activating/deactivating 190
 - Display message 191
 - Function/notes 84
 - Important safety notes 85

- Warning lamp 210
- PRE-SAFE® PLUS (anticipatory occupant protection PLUS)**
- Operation 67
- Program selector button** 144
- Protection against theft**
- ATA (Anti-Theft Alarm system) 87
- Immobilizer 87
- Protection of the environment**
- General notes 27
- Pulling away**
- Automatic transmission 140
- General notes 140
- Q**
- QR code**
- Mercedes-Benz Guide App 1
- Rescue card 33
- Qualified specialist workshop** 31
- R**
- RACE START (AMG vehicles)** 166
- RACETIMER (on-board computer)** 190
- Radiator cover** 263
- Radio**
- Displaying radio text 236
- Overview 235
- Selecting a station 190
- Setting the waveband 235
- Switching on 234
- see separate operating instructions
- Radio mode**
- see also Digital Operator's Manual 214
- Radio-wave reception/transmission in the vehicle**
- Declaration of conformity 31
- Reading lamp** 123
- Rear fog lamp**
- Display message 191
- Switching on/off 121
- Rear seats**
- Folding the backrest forwards/back 240
- Rear sill protector** 249
- Rear view camera**
- Cleaning instructions 268
- Displays in the Audio display 173
- Displays in the COMAND display ... 173
- Function/notes 171
- Switching on/off 172
- Rear window blind** 251
- Rear window defroster**
- Problem (malfunction) 133
- Switching on/off 133
- Rear window wiper**
- Replacing the wiper blade 126
- Switching on/off 125
- Rear-view mirror**
- Anti-glare (manual) 117
- Dipping (automatic) 117
- Refrigerant (air-conditioning system)**
- Important safety notes 344
- Refueling**
- Fuel gauge 37
- Important safety notes 145
- Refueling process 146
- see Fuel
- Remote control**
- Garage door opener 256
- Programming (garage door opener) 257
- Replacing bulbs**
- Important safety notes 123
- Overview of bulb types 124
- Reporting safety defects** 32
- Rescue card** 33
- Reserve (fuel tank)**
- see Fuel
- Reserve fuel**
- Display message 191
- Warning lamp 202
- see Fuel
- Residual heat (climate control)** 133
- Restraint system**
- Display message 195
- Introduction 48
- Warning lamp 208
- Warning lamp (function) 49
- Reverse gear**
- Engaging (automatic transmission) 142

- Reversing feature**
- Panorama sliding sunroof 107
 - Roller sunblinds 109
 - Side windows 104
 - Sliding sunroof 107
 - Trunk lid/tailgate 97
- Reversing lamps (display message)** 191
- Roadside Assistance (breakdown)** 29
- Roller sunblind**
- Panorama roof with power tilt/
sliding panel 108
 - Rear side windows 251
 - Rear window 251
- Roof lining and carpets (cleaning guidelines)** 268
- Roof load (maximum)** 344
- Route (navigation)**
- see Route guidance (navigation)
- Route guidance**
- see also Digital Operator's Manual 214
- Route guidance (navigation)** 190

S

Safety

- Children in the vehicle 68

Safety system

- see Driving safety systems

SD memory card

- see also Digital Operator's Manual 214

Search & Send

- see also Digital Operator's Manual 214

Seat belts

- Adjusting the driver's and front-passenger seat belt 53
- Adjusting the height 52
- center rear-compartment seat 53
- Cleaning 268
- Correct usage 51
- Fastening 52
- Important safety guidelines 50
- Introduction 50
- Releasing 53

- Switching belt adjustment on/off (on-board computer) 190
- Warning lamp 202
- Warning lamp (function) 54

Seats

- Active multicontour seat 116
- Adjusting (electrically) 116
- Adjusting the 4-way lumbar support 116
- Adjusting the head restraint 116
- Cleaning the cover 268
- Correct driver's seat position 114
- Folding the backrest (rear compartment) forwards/back 241
- Important safety notes 115
- Seat heating problem 117
- Storing settings (memory function) 117
- Switching seat heating on/off 116
- Switching seat ventilation on/off .. 116

Securing cargo

- 242

Selecting stations

- Radio 235

Sensors (cleaning instructions)

- 268

Service menu (on-board computer)

- 190

Service products

- Brake fluid 342
- Coolant (engine) 342
- DEF special additives 341
- Engine oil 341
- Fuel 337
- Important safety notes 337
- Refrigerant (air-conditioning system) 344
- Washer fluid 343

Setting access data

- Online and Internet 233

Setting the air distribution

- 133

Setting the airflow

- 133

Setting the date/time format

- see also Digital Operator's Manual 214

Setting the language

- see also Digital Operator's Manual 214

- Setting the time**
 see also Digital Operator's Manual 214
- Settings**
 Factory (on-board computer) 190
 On-board computer 190
- SETUP (on-board computer)** 190
- Side impact air bag** 56
- Side marker lamp (display message)** 191
- Side windows**
 Cleaning 268
 Important safety information 104
 Opening/closing (all) 105
 Opening/closing (front) 105
 Problem (malfunction) 106
 Resetting 105
- SIRIUS services**
 see also Digital Operator's Manual 214
- Sliding sunroof**
 Important safety notes 106
 Opening/closing 107
 Problem (malfunction) 111
 Resetting 108
 see Panorama roof with power tilt/sliding panel
- SmartKey**
 Changing the battery 93
 Changing the programming 92
 Checking the battery 93
 Display message 191
 Door central locking/unlocking 90
 Important safety notes 90
 Loss 94
 Mechanical key 92
 Overview 90
 Positions (ignition lock) 137
 Problem (malfunction) 94
 Starting the engine 140
- SMS**
 see also Digital Operator's Manual 214
- Snow chains** 291
- Sockets**
 Center console 251
 General notes 251
 Luggage compartment 251
- Rear compartment 251
- Spare wheel**
 Stowing 330
- Special seat belt retractor** 69
- Specialist workshop** 31
- Speed, controlling**
 see Cruise control
- Speedometer**
 In the Instrument cluster 37
 Segments 188
 Selecting the unit of measurement 190
 see Instrument cluster
- SPORT handling mode**
 Activating/deactivating (AMG vehicles) 82
 Warning lamp 207
- Standing lamps**
 Display message 191
 Switching on/off 121
- Start/stop function**
 see ECO start/stop function
- Starting (engine)** 139
- STEER CONTROL** 86
- Steering (display message)** 201
- Steering Assist and Stop&Go Pilot (DISTRONIC PLUS)**
 Activating/deactivating 190
 Display message 191
- Steering assistant STEER CONTROL**
 see STEER CONTROL
- Steering wheel**
 Adjusting (electrically) 117
 Button overview 39
 Buttons (on-board computer) 189
 Important safety notes 117
 Paddle shifters 144
 Steering wheel heating 117
 Storing settings (memory function) 117
- Steering wheel (cleaning instructions)** 268
- Steering wheel heating**
 Switching on/off 117
- Steering wheel paddle shifters** 144
- Stopwatch (RACETIMER)** 190

- Stowage areas** 238
- Stowage compartments**
- Armrest (under) 239
 - Center console 239
 - Cup holders 251
 - Display message) 191
 - Eyeglasses compartment 239
 - Glove box 239
 - Important safety information 239
 - Rear 239
 - Stowage net 239
 - Under driver's seat/front-passenger seat 239
- Stowage net** 239
- Stowage well beneath the trunk floor** 248
- Summer tires** 290
- Sun visor** 251
- Sun surround lighting (on-board computer)** 190
- Suspension tuning**
- AIRMATIC 167
 - SETUP (on-board computer) 190
- Switching air-recirculation mode on/off** 133
- T**
- Tachometer** 188
- Tail lamps**
- Display message 191
- Tailgate**
- Display message 201
 - Emergency unlocking 103
 - Important safety notes 96
 - Limiting the opening angle 102
 - Opening dimensions 344
 - Opening/closing (automatically from inside) 101
 - Opening/closing (automatically from outside) 98
 - Opening/closing (from outside) 97
- Tank**
- see Fuel tank
- Tank content**
- Fuel gauge 37
- Technical data**
- Capacities 337
 - Emergency spare wheel 332
 - Information 334
 - Tires/wheels 314
 - Vehicle data 344
- Telephone**
- Accepting a call 190, 231
 - Authorizing a mobile phone (connecting) 229
 - Connecting a mobile phone (general information) 227
 - De-authorizing (disconnecting) a mobile phone 231
 - Ending an active call 232
 - Entering phone numbers 232
 - Establishing the connection from the mobile phone 230
 - Making a call 232
 - Menu (on-board computer) 190
 - Number from the phone book 190
 - Reconnecting a mobile phone automatically 231
 - Redialing 190
 - Rejecting a call 232
 - Rejecting/ending a call 190
 - see also Digital Operator's Manual 214
 - Switching between mobile phones 231
 - Using the telephone 231
- Telephone number**
- Entering 232
- Telescopic rod (EASY-PACK load-securing kit)** 248
- Temperature**
- Coolant 188
 - Coolant (on-board computer) 190
 - Engine oil (on-board computer) 190
 - Outside temperature 188
 - Setting (climate control) 133
- Through-loading feature** 239
- Timing (RACETIMER)** 190
- Tire pressure**
- Calling up (on-board computer) 294
 - Checking manually 294
 - Display message 200
 - Maximum 294
 - Not reached (TIREFIT) 274
 - Notes 292

Reached (TIREFIT)	274	Load index (definition)	307
Recommended	291	Maximum load on a tire (definition)	308
Tire pressure monitor		Maximum loaded vehicle weight (definition)	307
Checking the tire pressure electronically	296	Maximum permissible tire pressure (definition)	308
Function/notes	294	Maximum tire load	305
General notes	294	Maximum tire load (definition)	308
Important safety notes	295	MOExtended tires	290
Radio type approval for the tire pressure monitor	297	Optional equipment weight (definition)	308
Restarting	297	PSI (pounds per square inch) (definition)	308
Warning lamp	211	Replacing	309
Warning message	296	Service life	290
Tire-change tool kit	270	Sidewall (definition)	308
TIREFIT kit	273	Speed rating (definition)	307
Tires		Storing	309
Aspect ratio (definition)	308	Structure and characteristics (definition)	306
Average weight of the vehicle occupants (definition)	307	Temperature	302
Bar (definition)	306	TIN (Tire Identification Number) (definition)	308
Changing a wheel	309	Tire bead (definition)	308
Characteristics	306	Tire pressure (definition)	308
Checking	289	Tire pressures (recommended)	307
Curb weight (definition)	308	Tire size (data)	314
Definition of terms	306	Tire size designation, load-bearing capacity, speed rating	303
Direction of rotation	309	Tire tread	289
Display message	200	Tire tread (definition)	308
Distribution of the vehicle occupants (definition)	309	Total load limit (definition)	309
DOT (Department of Transportation) (definition)	307	Traction	302
DOT, Tire Identification Number (TIN)	306	Traction (definition)	308
GAWR (Gross Axle Weight Rating) (definition)	307	Tread wear	302
General notes	314	Uniform Tire Quality Grading Standards	301
GVW (Gross Vehicle Weight) (definition)	307	Uniform Tire Quality Grading Standards (definition)	307
GVWR (Gross Vehicle Weight Rating) (definition)	307	Wear indicator (definition)	308
Important safety notes	288	Wheel and tire combination	316
Increased vehicle weight due to optional equipment (definition)	307	Wheel rim (definition)	307
Information on driving	288	see Flat tire	
Kilopascal (kPa) (definition)	307	Top Tether	71
Labeling (overview)	303	Tow-starting	
Load bearing index (definition)	308	Emergency engine starting	284
Load index	305	Important safety notes	281

- Towing a trailer**
- Cleaning the trailer tow hitch 268
 - ESP® (Electronic Stability Program) 84
- Towing away**
- Important safety guidelines 281
 - Installing the towing eye 282
 - Removing the towing eye 283
 - With both axles on the ground 283
 - With the rear axle raised 283
- Towing eye** 270
- Traffic reports**
- see also Digital Operator's Manual 214
- Traffic Sign Assist**
- Activating/deactivating the warning function 190
 - Function/notes 176
 - Important safety notes 177
 - Instrument cluster display 177
- Transfer case** 145
- Transmission**
- see Automatic transmission
- Transmission position display** 143
- Transmission position display (DIRECT SELECT lever)** 143
- Transporting the vehicle** 283
- Trim pieces (cleaning instructions)** 268
- Trip computer (on-board computer)** 190
- Trip odometer**
- Calling up 190
 - Resetting (on-board computer) 190
- Trunk**
- Emergency release 103
 - Important safety notes 96
 - Locking separately 102
 - Opening/closing (automatically from inside) 101
 - Opening/closing (automatically from outside) 98
 - Opening/closing (from outside, HANDS-FREE ACCESS) 99
 - Opening/closing (manually from outside) 97
- Trunk lid**
- Display message 191
 - Opening dimensions 344
- Trunk load (maximum)** 344
- Turn signals**
- Changing bulbs (front) 125
 - Display message 191
 - Switching on/off 121
- Two-way radio**
- Frequencies 334
 - Installation 334
 - Transmission output (maximum) 334
- Type identification plate**
- see Vehicle identification plate

U

Unlocking

- Emergency unlocking 96
- From inside the vehicle (central unlocking button) 95

V

Vanity mirror (in the sun visor) 252

Vehicle

- Correct use 32
- Data acquisition 33
- Display message 201
- Equipment 28
- Individual settings 190
- Limited Warranty 32
- Loading 298
- Locking (in an emergency) 96
- Locking (SmartKey) 90
- Lowering 313
- Maintenance 29
- Parking for a long period 153
- Pulling away 140
- Raising 310
- Reporting problems 32
- Securing from rolling away 310
- Towing away 281
- Transporting 283
- Unlocking (in an emergency) 96
- Unlocking (SmartKey) 90
- Vehicle data 344
- Vehicle data 344

- Vehicle dimensions** 344
- Vehicle emergency locking** 96
- Vehicle identification number**
see VIN
- Vehicle identification plate** 336
- Vehicle level**
AIRMATIC 166
- Vehicle maintenance**
see ASSYST PLUS
- Vehicle tool kit** 270
- Video**
see also Digital Operator's Manual 214
- Video (DVD)** 190
- VIN**
Seat 336
Type plate 336
- Voice Control System**
see Separate operating instructions
- W**
- Warning and indicator lamps**
ABS 205
Brakes 204
Check Engine 202
Coolant 209
Distance warning 210
ESP® 206
ESP® OFF 207
Fuel tank 202
General notes 202
Overview 38
PASSENGER AIR BAG OFF 49
Reserve fuel 202
Restraint system 208
Seat belt 202
SPORT handling mode 207
Tire pressure monitor 211
- Warranty** 28
- Washer fluid**
Display message 191
- Wheel and tire combination**
see Tires
- Wheel bolt tightening torque** 313
- Wheel chock** 310
- Wheels**
Changing a wheel 309
- Checking 289
- Cleaning 268
- Emergency spare wheel 329
- General notes 314
- Important safety notes 288
- Information on driving 288
- Interchanging/changing 309
- Mounting a new wheel 313
- Mounting a wheel 309
- Removing a wheel 312
- Storing 309
- Tightening torque 313
- Wheel size/tire size 314
- Window curtain air bag**
Operation 57
- Windows**
see Side windows
- Windshield**
Defrosting 133
- Windshield washer fluid**
see Windshield washer system
- Windshield washer system**
Adding washer fluid 266
Important safety notes 343
- Windshield wipers**
Problem (malfunction) 127
Rear window wiper 125
Replacing the wiper blades 125
Switching on/off 125
- Winter driving**
Important safety notes 290
Slippery road surfaces 155
Snow chains 291
- Winter operation**
Radiator cover 263
- Winter tires**
M+S tires 290
- Wiper blades**
Cleaning 268
Important safety notes 125
Replacing (rear window) 126
Replacing (windshield) 126
- Wooden trim (cleaning instructions)** 268
- Workshop**
see Qualified specialist workshop

Z

ZONE function

Switching on/off 133

Introduction

The printed Operator's Manual provides information about the safe operation of your vehicle. The Digital Operator's Manual additionally describes further functions and equipment installed in your vehicle. The vehicle functions and functions of Audio 20 or COMAND are described in the Digital Operator's Manual. You can call up the Digital Operator's Manual via Audio 20 or COMAND.

- i** You will not incur any costs when calling up the Digital Operator's Manual. The Digital Operator's Manual works without connecting to the Internet.

There are three ways to access the topics of the Digital Operator's Manual:

• Visual search

The visual search allows you to explore your vehicle "virtually". Starting from either the vehicle exterior view or interior view, you can access many of the different topics covered by the Digital Operator's Manual. To access the vehicle interior section, select the "Vehicle interior" view.

• Keyword search

The keyword search allows you to search for a keyword by entering characters. Further information can be found in the Digital Operator's Manual in the "Audio 20" or "COMAND" section under the "Character entry (telephony)" keyword.





• Contents

You can select individual sections in the contents.

- i** The Digital Operator's Manual is deactivated for safety reasons while driving.

Operation

Calling up the Digital Operator's Manual

- ▶ Press the  button in the center console. The overview relating to the vehicle appears.
- ▶ Select the "Operator's Manual" menu item by turning  or pressing  the controller.
- ▶ Confirm  the message about the warning and safety notes. The basic menu for the Digital Operator's Manual appears.

Operating the Digital Operator's Manual



General notes









Please observe the information about the operation of the controller ([▷ page 222](#)).

Content pages

The content pages can be accessed by means of a visual search, a keyword search or using the contents.



- ▶ **To scroll forwards/backwards:** turn  the controller.
- ▶ **To display in full-screen or animation:** slide  the controller to the left .

- ▶ **To select information texts or save bookmarks:** slide  the controller to the right ②.
- ▶ **To select a link:** slide  the controller downwards ③.
- ▶ **To exit a content page:** select the  symbol ④.
- ▶ **To call up the basic menu of the Digital Operator's Manual:** select  symbol ⑤.
- ▶ **To switch functions to Audio 20 or COMAND using the buttons on the center console:** press the , ,  or  button.
The selected menu appears. The Digital Operator's Manual remains open in the background.

Protection of the environment

General notes

Environmental note

Daimler's declared policy is one of comprehensive environmental protection.

The objectives are for the natural resources that form the basis of our existence on this planet to be used sparingly and in a manner that takes the requirements of both nature and humanity into account.

You too can help to protect the environment by operating your vehicle in an environmentally responsible manner.

Fuel consumption and the rate of engine, transmission, brake and tire wear are affected by these factors:

- operating conditions of your vehicle
- your personal driving style

You can influence both factors. You should bear the following in mind:

Operating conditions:

- avoid short trips as these increase fuel consumption.
- always make sure that the tire pressures are correct.
- do not carry any unnecessary weight.
- remove roof racks once you no longer need them.
- a regularly serviced vehicle will contribute to environmental protection. You should therefore adhere to the service intervals.
- always have service work carried out at a qualified specialist workshop.

Personal driving style:

- do not depress the accelerator pedal when starting the engine.
- do not warm up the engine when the vehicle is stationary.
- drive carefully and maintain a safe distance from the vehicle in front.
- avoid frequent, sudden acceleration and braking.

- change gear in good time and use each gear only up to $\frac{2}{3}$ of its maximum engine speed.
- switch off the engine in stationary traffic.
- keep an eye on the vehicle's fuel consumption.

Environmental concerns and recommendations

Wherever the operating instructions require you to dispose of materials, first try to regenerate or re-use them. Observe the relevant environmental rules and regulations when disposing of materials. In this way you will help to protect the environment.

Genuine Mercedes-Benz parts

Environmental note

Daimler AG also supplies reconditioned major assemblies and parts which are of the same quality as new parts. They are covered by the same Limited Warranty entitlements as new parts.

! Air bags and Emergency Tensioning Devices, as well as control units and sensors for these restraint systems, may be installed in the following areas of your vehicle:

- doors
- door pillars
- door sills
- seats
- cockpit
- instrument cluster
- center console

Do not install accessories such as audio systems in these areas. Do not carry out repairs or welding. You could impair the operating efficiency of the restraint systems.

Have aftermarket accessories installed at a qualified specialist workshop.

You could jeopardize the operating safety of your vehicle if you use parts, tires and wheels as well as accessories relevant to safety which have not been approved by Mercedes. This could lead to malfunctions in safety-relevant systems, e.g. the brake system. Use only genuine Mercedes-Benz parts or parts of equal quality. Only use tires, wheels and accessories that have been specifically approved for your vehicle.

Genuine Mercedes-Benz parts are subject to strict quality control. Every part has been specifically developed, manufactured or selected for and adapted to Mercedes-Benz vehicles. Only genuine Mercedes-Benz parts should therefore be used.

More than 300,000 different genuine Mercedes-Benz parts are available for Mercedes-Benz models.

All authorized Mercedes-Benz Centers maintain a supply of genuine Mercedes-Benz parts for necessary service and repair work. In addition, strategically located parts delivery centers provide quick and reliable parts service.

Always specify the vehicle identification number (VIN) when ordering genuine Mercedes-Benz parts (▷ page 336).

Operator's Manual

Vehicle equipment

This Operator's Manual describes all models and all standard and optional equipment of your vehicle available at the time of going to print. Country-specific differences are possible. Bear in mind that your vehicle may not feature all functions described here. This also applies to safety-relevant systems and functions. The equipment in your vehicle may therefore differ from that shown in the descriptions and illustrations.

The original purchase agreement lists all systems installed in your vehicle.

Should you have any questions concerning equipment and operation, please consult an authorized Mercedes-Benz Center.

The Operator's Manual and Maintenance Booklet are important documents and should be kept in the vehicle.

Service and vehicle operation

Warranty

The implied warranty for your vehicle applies in accordance with the warranty terms and conditions in the Service and Warranty Information booklet.

Your authorized Mercedes-Benz Center will replace and repair all factory-installed parts in accordance with the following warranty terms and conditions:

- New Vehicle Limited Warranty
- Emission System Warranty
- Emission Performance Warranty
- California, Connecticut, Maine, Massachusetts, New York, Pennsylvania, Rhode Island and Vermont Emission Control System Warranty
- State warranty enforcement laws (lemon laws)

Replacement parts and accessories are covered by the Mercedes-Benz Parts and Accessories warranties. These are available at any authorized Mercedes-Benz Center.

- i** Should you lose your Service and Warranty Information booklet, have an authorized Mercedes-Benz Center arrange for a replacement. The new Service and Warranty Information booklet will be posted to you.

Information for customers in California

Under California law you may be entitled to a replacement of your vehicle or a refund of the purchase price or lease price, if after a reasonable number of repair attempts Mercedes-Benz USA, LLC and/or its authorized repair or service facilities fail to fix one or more substantial defects or malfunctions in the vehicle that are covered by its express warranty. During the period of 18 months from original delivery of the vehicle or the accumulation of 18,000 miles (approximately 29,000 km) on the odometer of the vehicle, whichever occurs first, a reasonable number of repair attempts is presumed for a retail buyer or lessee if one or more of the following occurs:

- (1) the same substantial defect or malfunction results in a condition that is likely to cause death or serious bodily injury if the vehicle is driven, that defect or malfunction has been subject to repair two or more times, and you have directly notified Mercedes-Benz USA, LLC in writing of the need for its repair,
- (2) the same substantial defect or malfunction of a less serious nature than category (1) has been subject to repair four or more times and you have directly notified us in writing of the need for its repair, or
- (3) the vehicle is out of service by reason of repair of the same or different substantial defects or malfunctions for a cumulative total of more than 30 calendar days.

Please send your written notice to:
 Mercedes-Benz USA, LLC
 Customer Assistance Center
 One Mercedes Drive
 Montvale, NJ 07645-0350

Maintenance

The Service and Warranty Booklet describes all the necessary maintenance work which should be done at regular intervals.

Always have the Service and Warranty Booklet with you when you bring the vehicle to an authorized Mercedes-Benz Center. The service advisor will record every service for you in the Service and Warranty Booklet.

Roadside Assistance

The Mercedes-Benz Roadside Assistance Program offers technical help in the event of a breakdown. Calls to the toll-free Roadside Assistance Hotline are answered by our agents 24 hours a day, 365 days a year.

1-800-FOR-MERCEdes(1-800-367-6372) (USA)

1-800-387-0100 (Canada)

For additional information, refer to the Mercedes-Benz Roadside Assistance Program brochure (USA) or the "Roadside Assistance" section in the Service and Warranty booklet (Canada). You will find both in your vehicle literature portfolio.

Change of address or change of ownership

In the event of a change of address, please send us the "Notification of Address Change" in the Service and Guarantee booklet or simply call the Mercedes-Benz Customer Assistance Center (USA) at the hotline number 1-800-FOR-MERCEdes(1-800-367-6372) or Customer Service Center (Canada) at 1-800-387-0100. This will assist us in contacting you in a timely manner should the need arise.

If you sell your Mercedes, please leave the entire literature in the vehicle so that it is available to the next owner.



If you have purchased a used car, please send us the "Notification of Used Car Purchase" in

the Service and Guarantee booklet or simply call the Mercedes-Benz Customer Assistance Center (USA) at the hotline number 1-800-FOR-MERCEDES(1-800-367-6372) or Customer Service (Canada) at 1-800-387-0100.

Vehicle operation outside the USA and Canada

If you plan to operate your vehicle in foreign countries, please be aware that:

- service facilities or replacement parts may not be readily available.
- unleaded fuel for vehicles with a catalytic converter may not be available. Leaded fuel may cause damage to the catalytic converter.
- the fuel may have a considerably lower octane rating. Unsuitable fuel can cause engine damage.

Some Mercedes-Benz models are available for delivery in Europe through our European Delivery Program. For details, consult an authorized Mercedes-Benz Center or write to one of the following addresses.

In the USA

Mercedes-Benz USA, LLC
European Delivery Department
One Mercedes Drive
Montvale, NJ 07645-0350

In Canada

Mercedes-Benz Canada, Inc.
European Delivery Department
98 Vanderhoof Avenue
Toronto, Ontario M4G 4C9

Operating safety

Important safety notes

WARNING

If you do not have the prescribed service/maintenance work or any required repairs

carried out, this can result in malfunctions or system failures. There is a risk of an accident. Always have the prescribed service/maintenance work as well as any required repairs carried out at a qualified specialist workshop.

WARNING

Flammable material such as leaves, grass or twigs may ignite if they come into contact with hot parts of the exhaust system. There is a risk of fire.

When driving off road or on unpaved roads, check the vehicle's underside regularly. In particular, remove parts of plants or other flammable materials which have become trapped. In the case of damage, contact a qualified specialist workshop.

WARNING

Modifications to electronic components, their software as well as wiring can impair their function and/or the function of other networked components. In particular, systems relevant to safety could also be affected. As a result, these may no longer function as intended and/or jeopardize the operating safety of the vehicle. There is an increased risk of an accident and injury.

Never tamper with the wiring as well as electronic components or their software. You should have all work to electrical and electronic equipment carried out at a qualified specialist workshop.

 There is a risk of damage to the vehicle if:

- the vehicle becomes stuck, e.g. on a high curb or an unpaved road
- you drive too fast over an obstacle, e.g. a curb or a hole in the road
- a heavy object strikes the undercarriage or parts of the chassis

In situations like this, the body, the undercarriage, chassis parts, wheels or tires could be damaged without the damage being visible. Components damaged in this way can unexpectedly fail or, in the case of

an accident, no longer withstand the strain they are designed to.

If the underbody paneling is damaged, combustible materials such as leaves, grass or twigs can gather between the underbody and the underbody paneling. If these materials come in contact with hot parts of the exhaust system, they can catch fire.

In such situations, have the vehicle checked and repaired immediately at a qualified specialist workshop. If on continuing your journey you notice that driving safety is impaired, pull over and stop the vehicle immediately, paying attention to road and traffic conditions. In such cases, consult a qualified specialist workshop.

Declarations of conformity

Vehicle components which receive and/or transmit radio waves

USA: "The wireless devices of this vehicle comply with Part 15 of the FCC Rules. Operation is subject to the following two conditions: 1) These devices may not cause harmful interference, and 2) These devices must accept any interference received, including interference that may cause undesired operation. Changes or modifications not expressly approved by the party responsible for compliance could void the user's authority to operate the equipment."

Canada: "The wireless devices of this vehicle comply with Industry Canada license-exempt RSS standard(s). Operation is subject to the following two conditions: (1) These devices may not cause interference, and (2) These devices must accept any interference, including interference that may cause undesired operation of the device."

Diagnostics connection

The diagnostics connection is only intended for the connection of diagnostic equipment at a qualified specialist workshop.

WARNING

If you connect equipment to the diagnostics connection in the vehicle, it may affect the operation of the vehicle systems. As a result, the operating safety of the vehicle could be affected. There is a risk of an accident.

Do not connect any equipment to a diagnostics connection in the vehicle.

WARNING

Objects in the driver's footwell can restrict the pedal travel or obstruct a depressed pedal. The operating and road safety of the vehicle is jeopardized. There is a risk of an accident.

Make sure that all objects in the vehicle are stowed correctly, and that they cannot enter the driver's footwell. Install the floormats securely and as specified in order to ensure sufficient clearance for the pedals. Do not use loose floormats and do not place floormats on top of one another.

! If the engine is switched off and equipment on the diagnostics connection is used, the starter battery may discharge.

Connecting equipment to the diagnostics connection can lead to emissions monitoring information being reset, for example. This may lead to the vehicle failing to meet the requirements of the next emissions test during the main inspection.

Qualified specialist workshop

An authorized Mercedes-Benz Center is a qualified specialist workshop. It has the necessary specialist knowledge, tools and qualifications to correctly carry out the work required on your vehicle. This is especially the case for work relevant to safety.

Observe the notes in the Maintenance Booklet.

Always have the following work carried out at an authorized Mercedes-Benz Center:

- work relevant to safety
- service and maintenance work
- repair work
- alterations, installation work and modifications
- work on electronic components

Correct use

If you remove any warning stickers, you or others could fail to recognize certain dangers. Leave warning stickers in position.

Observe the following information when driving your vehicle:

- the safety notes in this manual
- the vehicle technical data
- traffic rules and regulations
- laws and safety standards pertaining to motor vehicles

Problems with your vehicle

If you should experience a problem with your vehicle, particularly one that you believe may affect its safe operation, we urge you to contact an authorized Mercedes-Benz Center immediately to have the problem diagnosed and rectified. If the problem is not resolved to your satisfaction, please discuss the problem again with a Mercedes-Benz Center or contact us at one of the following addresses.

In the USA

Customer Assistance Center
Mercedes-Benz USA, LLC
One Mercedes Drive
Montvale, NJ 07645-0350

In Canada

Customer Relations Department
Mercedes-Benz Canada, Inc.

98 Vanderhoof Avenue
Toronto, Ontario M4G 4C9

Reporting safety defects

USA only:

The following text is published as required of manufacturers under Title 49, Code of U.S. Federal Regulations, Part 575 pursuant to the "National Traffic and Motor Vehicle Safety Act of 1966".

If you believe that your vehicle has a defect which could cause a crash or could cause injury or death, you should immediately inform the National Highway Traffic Safety Administration (NHTSA) in addition to notifying Mercedes-Benz USA, LLC.

If NHTSA receives similar complaints, it may open an investigation, and if it finds that a safety defect exists in a group of vehicles, it may order a recall and remedy campaign. However, NHTSA cannot become involved in individual problems between you, your dealer, or Mercedes-Benz USA, LLC.

To contact NHTSA, you may call the Vehicle Safety Hotline toll-free at 1-888-327-4236 (TTY: 1-800-424-9153); go to <http://www.safercar.gov>; or write to: Administrator, NHTSA, 400 Seventh Street, SW., Washington, DC 20590.

You can also obtain other information about motor vehicle safety from

<http://www.safercar.gov>

Limited Warranty

- Follow the instructions in this manual about the proper operation of your vehicle as well as about possible vehicle damage. Damage to your vehicle that arises from culpable contraventions against these instructions is not covered either by the Mercedes-Benz Limited Warranty or by the New or Used-Vehicle Warranty.

QR codes for the rescue card

The QR codes are secured in the fuel filler flap and on the opposite side on the B-pillar. In the event of an accident, rescue services can use the QR code to quickly find the appropriate rescue card for your vehicle. The current rescue card contains the most important information about your vehicle in a compact form, e.g. the routing of the electric cables.

You can find more information under https://portal.aftersales.i.daimler.com/public/content/asportal/en/communication/informationen_fuer/QRCode.html.

Data stored in the vehicle

Data recording

This vehicle is capable of recording diagnostic information relating to vehicle operation, malfunctions, and user settings. This may include information about the performance or status of various systems, including but not limited to, engine, throttle, steering or brake systems, that is stored and can be read out with suitable devices, particularly when the vehicle is serviced. The data obtained is used to properly diagnose and service your vehicle or to further optimize and develop vehicle functions.

COMAND/mbrace (Canada: TELEAID)

If the vehicle is equipped with COMAND or mbrace, additional data about the vehicle's operation, the use of the vehicle in certain situations, and the location of the vehicle may be compiled through COMAND or the mbrace system.

For additional information please refer to the COMAND User Manual and/or the mbrace Terms and Conditions.

Event data recorders

This vehicle is equipped with an event data recorder (EDR). The main purpose of an EDR is to record data that will assist in understanding how a vehicle's systems performed in certain crash or near crash-like situations, such as during air bag deployment or when hitting a road obstacle. The EDR is designed to record data related to vehicle dynamics and safety systems for a short period of time, typically 30 seconds or less.

The EDR in this vehicle is designed to record such data as:

- how various systems in your vehicle are operating
- whether or not the driver and passenger seat belts are fastened
- how far (if at all) the driver is depressing the accelerator and/or brake pedal and
- how fast the vehicle is traveling

This data can help provide a better understanding of the circumstances in which crashes and injuries occur. NOTE: EDR data is recorded by your vehicle only if a non-trivial crash situation occurs; no data is recorded by the EDR under normal driving conditions and no personal data (e.g., name, gender, age, and crash location) are recorded. However, other parties, such as law enforcement, can combine the EDR data with the type of personal identification data routinely acquired during a crash investigation.

To read data recorded by an EDR, special equipment is required, and access to the vehicle or the EDR is needed. In addition to the vehicle manufacturer, other parties that have the special equipment, such as law enforcement, can read the information by accessing the vehicle or the EDR.

EDR data may be used in civil and criminal matters as a tool in accident reconstruction, accident claims, and vehicle safety. Since the Crash Data Retrieval CDR tool that is used to extract data from the EDR is commercially available, Mercedes-Benz USA, LLC

("MBUSA") expressly disclaims any and all liability arising from the extraction of this information by unauthorized Mercedes-Benz personnel.

MBUSA will not share EDR data with others without the consent of the vehicle owners or, if the vehicle is leased, without the consent of the lessee. Exceptions to this representation include responses to subpoenas by law enforcement; by federal, state or local government; in connection with or arising out of litigation involving MBUSA or its subsidiaries and affiliates; or, as required by law.

Warning: The EDR is a component of the Restraint System Module. Tampering with, altering, modifying or removing the EDR component may result in a malfunction of the Restraint System Module and other systems. State laws or regulations regarding EDRs that conflict with federal regulation are pre-empted. This means that in the event of such conflict, the federal regulation governs. As of February 2013, 13 states have enacted laws relating to EDRs.

Information on copyright

General information

Information on license for free and open-source software used in your vehicle and its electronic components is available on the following website:



<http://www.mercedes-benz.com/opensource>



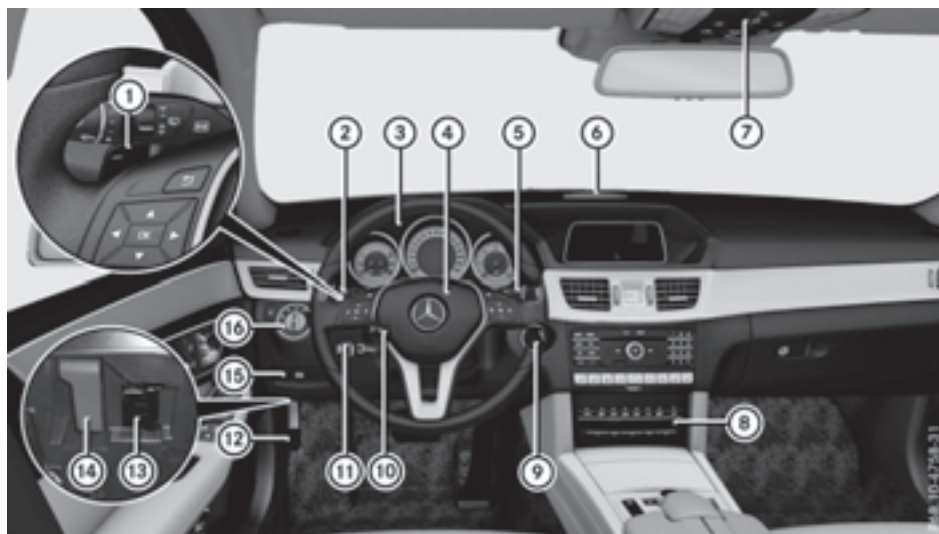

Cockpit	36
Instrument cluster	37
Multifunction steering wheel	39
Center console	41
Overhead control panel	44
Door control panel	45

Cockpit

At a glance





	Function	Page
①	Steering wheel paddle shifters	
②	Combination switch	121
③	Instrument cluster	37
④	Horn	
⑤	DIRECT SELECT lever	142
⑥	PARKTRONIC warning display	168
⑦	Overhead control panel	44
⑧	Climate control systems	130
⑨	Ignition lock	137
	Start/Stop button	138

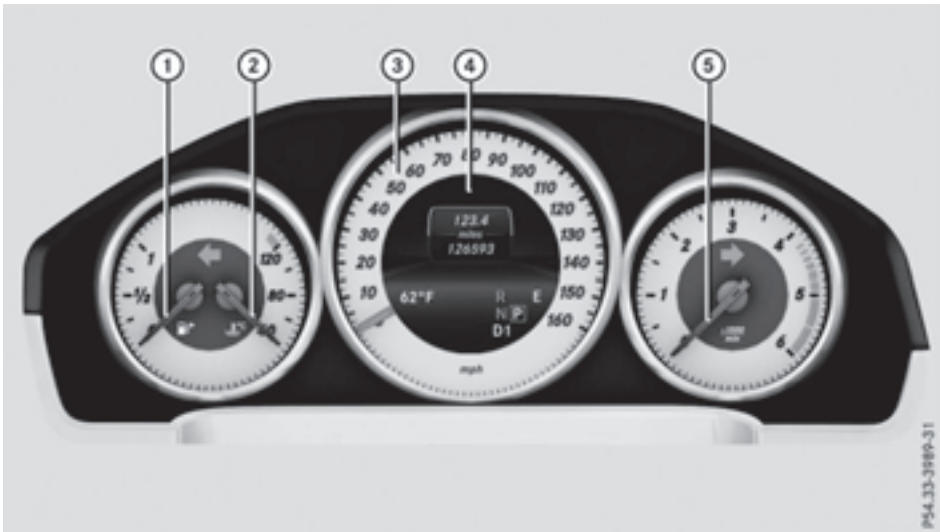

	Function	Page
⑩	Adjusts the steering wheel electrically	117
	Steering wheel heating	
⑪	Cruise control lever	
⑫	Parking brake	
⑬	Diagnostics connection	31
⑭	Opens the hood	262
⑮	Releases the parking brake	
⑯	Light switch	120

Instrument cluster

Displays



	Function	Page
①	Fuel gage Fuel filler flap location indicator  : the fuel filler cap is on the right-hand side.	
②	Coolant temperature	

	Function	Page
③	Speedometer with segments	
④	Multifunction display	
⑤	Tachometer	

Information on displaying the outside temperature in the multifunction display can be found under "Outside temperature display" (▷ page 188).

- i** Set the instrument cluster lighting via the on-board computer, see the Digital operator's manual.

Warning and indicator lamps

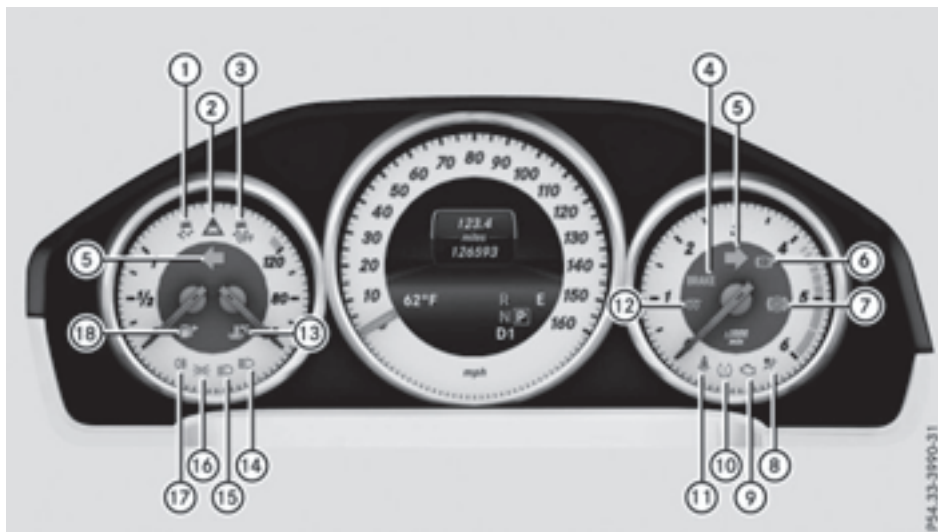

P54.33-3990-31

	Function	Page
①	ESP® SPORT handling mode in AMG vehicles	206 207
②	Distance warning	210
③	ESP® OFF	206
④	BRAKE Brakes (USA only)	204
⑤	Turn signals	
⑥	Brakes (Canada only)	204
⑦	ABS	205
⑧	Restraint system	48
⑨	Check Engine	
⑩	Tire pressure monitor	211

	Function	Page
⑪	Seat belt	202
⑫	Diesel engine: pre-glow ESP® in AMG vehicles	 207
⑬	Coolant	209
⑭	High-beam head-lamps	
⑮	Low-beam head-lamps	
⑯	Parking lamps	
⑰	This lamp has no function	
⑱	Reserve fuel	

Multifunction steering wheel

At a glance



	Function	Page
①	Multifunction display	
②	Audio 20 or COMAND display	
③	 Vehicles with Audio 20: switches on voice-operated control for navigation (see manufacturer's operating instructions) Vehicles with COMAND: switches on the Voice Control System (see the separate operating instructions)	

	Function	Page
④	 Rejects or ends a call Exits the telephone book/redial memory Makes or accepts a call Switches to the redial memory Adjusts the volume Mute	
⑤	 Selects a menu Selects a submenu or scrolls through lists Confirms a selection Hides display messages	

	Function	Page
⑥	 Back Vehicles with Audio 20: switches off voice-operated control of the navigation	189

	Function	Page
	(see the manufacturer's Operating Instructions) Vehicles with COMAND: switches off the Voice Con- trol System (see the sepa- rate Operating Instruc- tions)	

Center console

Center console, upper section



At a glance

	Function	Page		Function	Page
①	Audio system or COMAND		⑦	Indicator lamp	58
②	Seat heating	116	⑧	ATA indicator lamp	87
③	Seat ventilation		⑨	Retracts the rear seat head restraints (Wagon)	
④	PARKTRONIC	168	⑩	Sedan: rear window roller sunblind	
⑤	ECO start/stop function (AMG vehicles)				
⑥	Hazard warning lamps	120			

Center console, lower section

At a glance

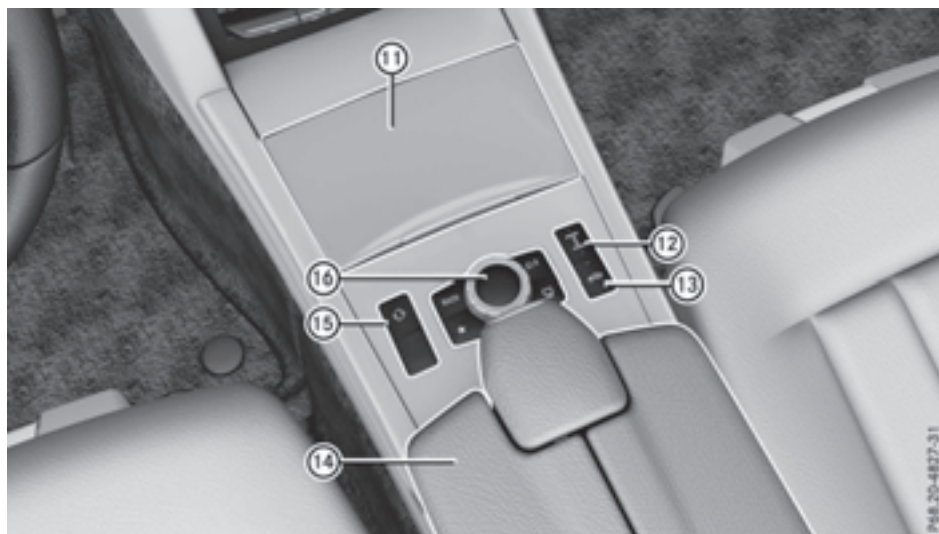

	Function	Page
11	Stowage compartment Ashtray Cigarette lighter Cup holder	
12	Adjusts the suspension setting	
13	Sets the vehicle level	

	Function	Page
14	Stowage compartment with Media Interface	
15	Selects the drive program	
16	COMAND controller	

Center console, lower section (AMG vehicles)

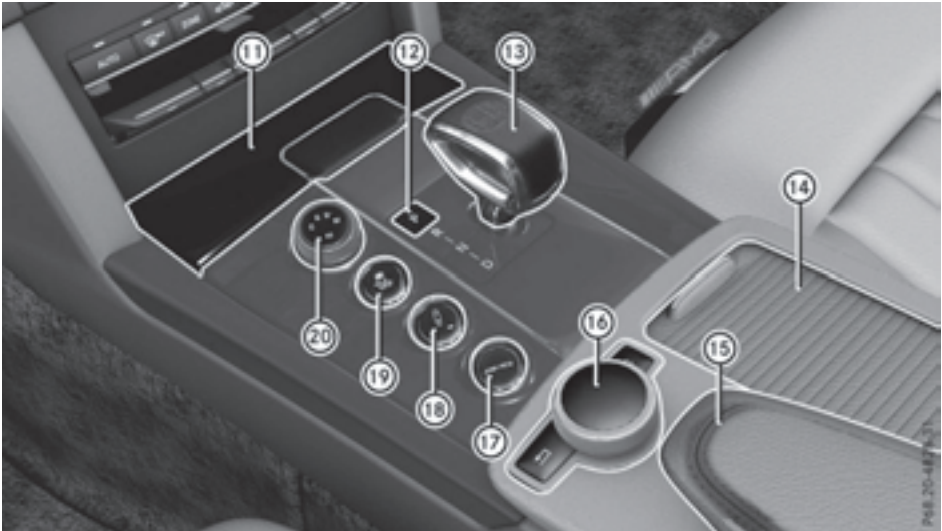

At a glance

	Function	Page		Function	Page
⑪	Ashtray Cigarette lighter		⑰	Calls up or saves the suspension setting	
⑫	Engages park position P	152	⑱	Adjusts the suspension setting	
⑬	Selector lever	142	⑲	ESP®	82
⑭	Cup holder		⑳	Drive program selector	
⑮	Stowage compartment with Media Interface				
⑯	Audio or COMAND controller				

Overhead control panel

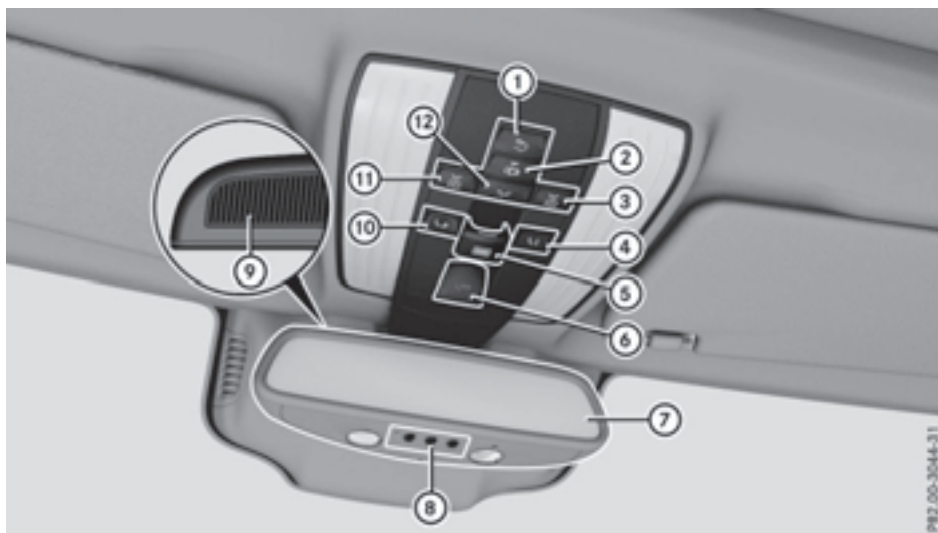

	Function	Page
①	Switches the rear interior lighting on/off	
②	Switches the automatic interior lighting control on/off	
③	Switches the right-hand reading lamp on/off	
④	Opens/closes the sliding sunroof Opens/closes the panorama roof with power tilt/sliding panel with roller sunblinds	107 108
⑤	MB Info call button (mbrace system)	255
⑥	SOS button (mbrace system)	253

	Function	Page
⑦	Rear-view mirror	
⑧	Buttons for the garage door opener	257
⑨	Microphone for mbrace (emergency call system), telephone and Voice Control System (see the separate operating instructions)	
⑩	Roadside Assistance call button (mbrace system)	254
⑪	Switches the left-hand reading lamp on/off	
⑫	Switches the front interior lighting on/off	

Door control panel

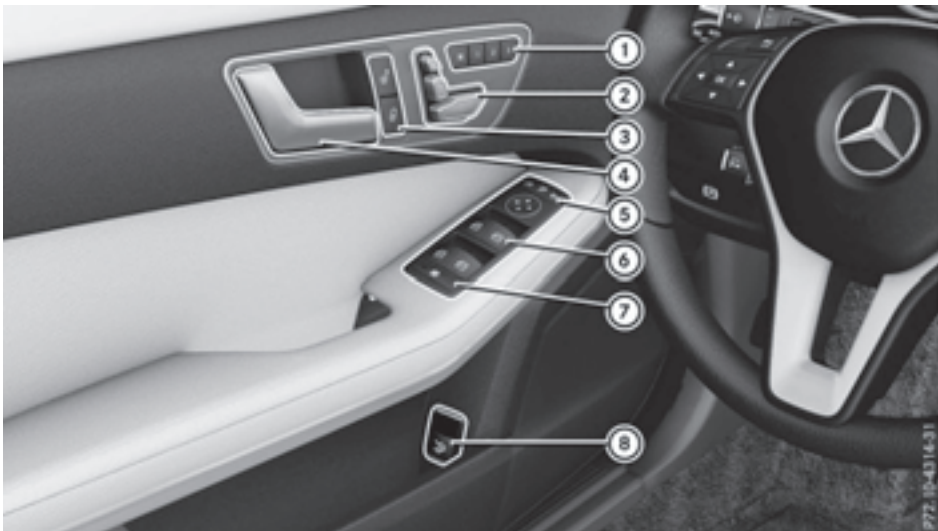

At a glance

	Function	Page		Function	Page
①	 Stores settings for the seat, exterior mirrors and steering wheel		⑥	Opens/closes the side windows	
②	Adjusts the seats electrically		⑦	Activates/deactivates the override feature for the side windows in the rear compartment	
③	Unlocks/locks the vehicle		⑧	Opens/closes the trunk lid/tailgate	101
④	Opens the door				
⑤	 Adjusts and folds the exterior mirrors in/out electrically				

Useful information	48
Panic alarm	48
Occupant safety	48
Children in the vehicle	68
Pets in the vehicle	75
Driving safety systems	75
Protection against theft	87

Useful information

- i** This Operator's Manual describes all models and all standard and optional equipment of your vehicle available at the time of publication of the Operator's Manual. Country-specific differences are possible. Please note that your vehicle may not be equipped with all features described. This also applies to safety-related systems and functions.
- i** Read the information on qualified specialist workshops (▷ page 31).

Panic alarm



- ▶ **To activate:** press the **PANIC** button ① for approximately one second. A visual and audible alarm is triggered if the alarm system is armed.
 - ▶ **To deactivate:** press the **PANIC** button ① again.
- or
- ▶ Insert the SmartKey into the ignition lock.
- or, on vehicles with KEYLESS-GO:
- ▶ Press the Start/Stop button.
The SmartKey must be in the vehicle.

Occupant safety

Restraint system: introduction

The restraint system can reduce the risk of vehicle occupants coming into contact with parts of the vehicle's interior in the event of an accident. The restraint system can also reduce the forces to which vehicle occupants are subjected during an accident.

The restraint system comprises:

- Seat belt system
- Air bags
- Child restraint system
- Child seat securing systems

The components of the restraint system work in conjunction with each other. They can only deploy their protective function if, at all times, all vehicle occupants:

- have fastened their seat belts correctly (▷ page 51)
- have adjusted their seat and head restraint properly (▷ page 115).

As the driver, you also have to make sure that the steering wheel is adjusted correctly.

Observe the information relating to the correct driver's seat position (▷ page 114).

You also have to make sure that an air bag can inflate properly if deployed (▷ page 54).

An air bag supplements a correctly worn seat belt. As an additional safety device, the air bag increases the level of protection for vehicle occupants in the event of an accident. For example, if, in the event of an accident, the protection offered by the seat belt is sufficient, the air bags are not deployed. When an accident occurs, only the air bags that increase protection in that particular accident situation are deployed. However, seat belts and air bags generally do not protect against objects penetrating the vehicle from the outside.

Information on restraint system operation can be found under "Triggering of the Emergency Tensioning Devices and air bags"

(▷ page 63).

For more information about children traveling with you in the vehicle and on child restraint systems, see "Children in the vehicle" (▷ page 68).

Important safety notes

WARNING

Modifications to the restraint system may cause it to no longer work as intended. The restraint system may then not perform its intended protective function and may fail in an accident or trigger unexpectedly, for example. This poses an increased risk of injury or even fatal injury.

Never modify parts of the restraint system. Never tamper with the wiring, the electronic components or their software.

If it is necessary to modify an air bag system to accommodate a person with disabilities, contact an authorized Mercedes-Benz Center for details. USA only: for further information contact our Customer Assistance Center at 1-800-FOR-MERcedes (1-800-367-6372).

Restraint system warning lamp

The functions of the restraint system are checked after the ignition is switched on and at regular intervals while the engine is running. Therefore, malfunctions can be detected in good time.

The  restraint system warning lamp in the instrument cluster lights up when the ignition is switched on. It goes out no later than a few seconds after the vehicle is started. The components of the restraint system are in operational readiness.

A malfunction has occurred if the  restraint system warning lamp:

- does not light up after the ignition is switched on
- does not go out after a few seconds with the engine running
- lights up again while the engine is running

WARNING

If restraint system is malfunctioning, restraint system components may be triggered unintentionally or might not be triggered at all in the event of an accident with a high rate of vehicle deceleration. This can affect the Emergency Tensioning Device or air bag, for example. This poses an increased risk of injury or even fatal injury.

Have the restraint system checked and repaired in a qualified specialist workshop as soon as possible.

PASSENGER AIR BAG OFF indicator lamp



PASSENGER AIR BAG OFF indicator lamp  is part of the Occupant Classification System (OCS).

The PASSENGER AIR BAG OFF indicator lamp informs you about the status of the front-passenger front air bag.

If the PASSENGER AIR BAG OFF indicator lamp:

- **is lit:** the front-passenger front air bag is deactivated. It will then not be deployed in the event of an accident.
- **does not light up:** the front-passenger front air bag is enabled. If, in the event of an accident, all deployment criteria are met, the front-passenger front air bag is deployed.

Depending on the person in the front-passenger seat, the front-passenger front air bag must either be deactivated or enabled; see the following points. You must make sure of this both before and during a journey.

- **Children in a child restraint system:** whether the front-passenger front air bag is enabled or deactivated depends on the installed child restraint system, and the age and size of the child. Therefore, be sure to observe the notes on the "Occupant Classification System (OCS)" (▷ page 58) and on "Children in the vehicle" (▷ page 68). There you will also find instructions on rearward and forward-facing child restraint systems on the front-passenger seat.
- **All other persons:** depending on the classification of the person in the front-passenger seat, the front-passenger front air bag is enabled or deactivated (▷ page 58). Be sure to observe the notes on "Seat belts" (▷ page 50) and "Air bags" (▷ page 54). There you can also find information on the correct seat position.

Seat belts

Introduction

Seat belts are the most effective means of restricting the movement of vehicle occupants in the event of an accident or the vehicle rolling over. This reduces the risk of vehicle occupants coming into contact with parts of the vehicle interior or being ejected from the vehicle. Furthermore, the seat belt helps to keep the vehicle occupant in the best position in relation to the air bag.

The seat belt system comprises:

- Seat belts
- Emergency Tensioning Devices for the front seat belts and the outer seat belts in the rear
- Seat belt force limiters for the front seat belts and the outer seat belts in the rear

If the seat belt is pulled out of the belt outlet quickly or with a jerky movement, the belt retractor locks. The belt strap cannot be extracted any further.

The Emergency Tensioning Device tightens the seat belt in an accident, pulling the belt close against the body. However it does not pull the vehicle occupant back in the direction of the backrest.

The Emergency Tensioning Device does not correct an incorrect seat position or the routing of an incorrectly fastened seat belt.

When triggered, a seat belt force limiter helps to reduce the force exerted by the seat belt on the vehicle occupant.

The seat belt force limiters for the front seats are synchronized with the front air bags, which absorb part of the deceleration force. This can reduce the force exerted on the vehicle occupants during an accident.

! If the front-passenger seat is unoccupied, do not insert the belt tongue into the buckle of the front-passenger seat. This may otherwise lead to the triggering of the Emergency Tensioning Device in the event of an accident, which will then need to be replaced.

Important safety notes

The use of seat belts and child restraint systems is required by law in:

- all 50 states
- the U.S. territories
- the District of Columbia
- all Canadian provinces

Even where this is not required by law, all vehicle occupants should correctly fasten their seat belts before starting the journey.

WARNING

If the seat belt is incorrectly fastened, it cannot protect as intended. Furthermore, an incorrectly fastened seat belt can cause additional injury, for example, in an accident, during braking or when abruptly changing direc-

tion. This poses an increased risk of injury or even fatal injury.

Make sure that all vehicle occupants are seated properly with a correctly fastened seat belt.

WARNING

The seat belt does not offer the intended level of protection if you have not moved the backrest to an almost vertical position. When braking or in the event of an accident, you could slide underneath the seat belt and sustain abdomen or neck injuries, for example. This poses an increased risk of injury or even fatal injury.

Adjust the seat properly before beginning your journey. Always ensure that the backrest is in an almost vertical position and that the shoulder section of your seat belt is routed across the center of your shoulder.

WARNING

Persons under 5 ft (1.50 m) in height cannot fasten the seat belt correctly without an additional suitable restraint system. If the seat belt is incorrectly fastened, it cannot protect as intended. Furthermore, an incorrectly fastened seat belt can cause additional injury, for example, in an accident, during braking or an abrupt change of direction. This poses an increased risk of injury or even fatal injury.

For this reason, always secure persons under 5 ft (1.50 m) in height in suitable restraint systems.

If a child younger than twelve years old and under 5 ft (1.50 m) in height is traveling in the vehicle:

- always secure the child in a child restraint system suitable for this Mercedes-Benz vehicle. The child restraint system must be appropriate to the age, weight and size of the child
- always observe the instructions and safety notes in the "Children in the vehicle" section of this Operator's Manual

(▷ page 68) in addition to the child restraint system manufacturer's installation instructions

- be sure to observe the instructions and safety notes on the "Occupant classification system (OCS)" (▷ page 58)

WARNING

The seat belts may not perform their intended protective function if:

- they are damaged, modified, extremely dirty, bleach or dyed
- the seat belt buckle is damaged or extremely dirty
- the Emergency Tensioning Devices, belt anchorages or inertia reels have been modified

Seat belts may sustain non-visible damage in an accident, e.g. due to glass splinters. Modified or damaged seat belts may tear or fail, e.g. in an accident. Modified Emergency Tensioning Devices could accidentally trigger or fail to deploy when necessary. This poses an increased risk of injury or even fatal injury.

Never modify the seat belts, Emergency Tensioning Devices, belt anchorages or inertia reels. Make sure that the seat belts are undamaged, not worn out and clean. Following an accident, have the seat belts checked immediately at a qualified specialist workshop.

Only use seat belts that have been approved for your vehicle by Mercedes-Benz. Any such modifications could invalidate the vehicle's general operating permit.

Proper use of the seat belts

Observe the safety notes on the seat belt (▷ page 50).

All vehicle occupants must be wearing the seat belt correctly before beginning the journey. Also make sure that all vehicle occupants are always wearing the seat belt correctly while the vehicle is in motion.

When fastening the seat belt, always make sure that:

- the seat belt tongue is only inserted to the belt buckle belonging to that seat.
- the seat belt is tight across your body. Avoid wearing bulky clothing, e.g. a winter coat.
- the seat belt is not twisted. Only then can the forces which occur be distributed over the area of the belt.
- the shoulder section of the belt is always routed across the center of your shoulder. The shoulder section of the belt must not come into contact with your neck or be routed under your arm. Where possible, adjust the seat belt to the appropriate height.
- the lap belt passes tightly and as low down as possible across your lap. The lap belt must always be routed across your hip joints and not across your abdomen. This applies particularly to pregnant women. If necessary, push the lap belt down to your hip joint and pull it tight using the shoulder section of the belt.
- the seat belt is not routed across sharp, pointed or fragile objects. If you have such items located on or in your clothing, e.g. pens, keys or eyeglasses, store these in a suitable place.
- only one person is using a seat belt at a time. Infants and children must never travel sitting on the lap of a vehicle occupant. In the event of an accident, they could be crushed between the vehicle occupant and seat belt.
- objects are never secured with a seat belt if the seat belt is also being used by one of the vehicle's occupants.

Seat belts are only intended to secure and restrain vehicle occupants. Always observe the "Loading guidelines" for securing objects, luggage or loads (▷ page 238).

Fastening and adjusting the seat belts

Observe the safety notes on the seat belt (▷ page 50) and the notes on correct use of seat belts (▷ page 51).

If the center rear seat belt is being used, also observe the information about the seat belt for the center rear seat (▷ page 53).



- ▶ Adjust the seat (▷ page 114). The seat backrest must be in an almost vertical position.
- ▶ Pull the seat belt smoothly from belt outlet ③ and engage belt tongue ② into belt buckle ①. The seat belt on the driver's seat and the front-passenger seat may be tightened automatically, see "Belt adjustment" (▷ page 53).
- ▶ If necessary, pull upwards on the shoulder section of the seat belt to tighten the belt across your body.



Wagon: you can also adjust the belt height on the outer rear bench seats.

The shoulder section of the seat belt must always be routed across the center of the shoulder. Adjust the belt outlet if necessary.

- ▶ **To raise:** slide the belt outlet upwards. The belt outlet will engage in various positions.
- ▶ **To lower:** hold belt outlet release ④ and slide belt outlet downwards.
- ▶ Let go of belt outlet release ④ in the desired position and make sure that the belt outlet engages.

All seat belts in the vehicle with the exception of the driver's seat belt and the seat belt on the folding bench seat in the cargo compartment are equipped with a special seat belt retractor, to which a child restraint system can be secured. Further information can be found under "Special seat belt retractor" (▷ page 69).

Seat belt for the center rear seat

If the left-hand rear seat backrest is folded down and back up again, the rear center seat belt may lock. The seat belt can then not be pulled out.

- ▶ **To release the rear center seat belt:** pull the seat belt out approximately 1 in (25 mm) at the belt outlet on the backrest and then release it again. The seat belt is retracted and released.

Releasing seat belts

- ! Make sure that the seat belt is fully rolled up. Otherwise, the seat belt or belt tongue will be trapped in the door or in the seat mechanism. This could damage the door, the door trim panel and the seat belt. Damaged seat belts can no longer fulfill their protective function and must be replaced. Visit a qualified specialist workshop.



- ▶ Press release button ①, hold belt tongue ② firmly and guide it back towards belt outlet ③.

Seat belt adjustment

The seat-belt adjustment is an integral part of the PRE-SAFE® convenience function. This function adjusts the driver's and front-passenger seat belt to the upper body of the occupants.

The belt strap is tightened slightly when:



- the belt tongue is engaged in the buckle and
- the ignition is switched on

The seat-belt adjustment will apply a certain retraction force if any slack is detected between the vehicle occupant and the seat belt. Do not hold on to the seat belt tightly while it is adjusting.

You can switch the seat-belt adjustment on and off in the on-board computer.

Belt warning for the driver and front passenger



The  seat belt warning lamp in the instrument cluster is a reminder that all vehicle occupants must wear their seat belts. It may light up continuously or flash. In addition, there may be a warning tone.

Regardless of whether the driver's seat belt has already been fastened, the  seat belt warning lamp lights up for six seconds each time the engine is started. If, after six seconds, the driver or front-passenger seat belt has not been fastened and the doors are closed, the  seat belt warning lamp lights up. As soon as the driver's and front-passenger seat belts are fastened or a front door is opened again, the  seat belt warning lamp goes out.

If the driver's seat belt is not fastened after the engine is started, an additional warning tone will sound. This warning tone stops after six seconds or when the driver's seat belt is fastened.

If the vehicle's speed exceeds 15 mph (25 km/h) once and the driver's and front-passenger seat belts are not fastened, a warning tone sounds. A warning tone also sounds with increasing intensity for 60 seconds or until the driver or front passenger have fastened their seat belts.

If the driver or front passenger unfasten their seat belts during the journey, the seat belt warning is activated again.

-  For more information on the  seat belt warning lamp, see "Warning and indicator lamps in the instrument cluster, seat belts" (> page 202).

Air bags

Introduction

The installation point of an air bag can be recognized by the AIR BAG symbol.

An air bag complements the correctly fastened seat belt. It is no substitute for the seat belt. The air bag provides additional protection in applicable accident situations.

Not all air bags are deployed in an accident. The different air bag systems function independently from one another (> page 63).

However, no system available today can completely eliminate injuries and fatalities.

It is also not possible to rule out a risk of injury caused by an air bag due to the high speed at which the air bag must be deployed.

Important safety notes

WARNING

If you do not sit in the correct seat position, the air bag cannot protect as intended and could even cause additional injury when deployed. This poses an increased risk of injury or even fatal injury.

To avoid hazardous situations, always make sure that all of the vehicle's occupants:

- have fastened their seat belts correctly, including pregnant women
- are sitting correctly and maintain the greatest possible distance to the air bags
- follow the following instructions

Always make sure that there are no objects between the air bag and the vehicle's occupants.

- Adjust the seats properly before beginning your journey. Always make sure that the seat is in an almost upright position. The center of the head restraint must support the head at about eye level.
- Move the driver's and front-passenger seats as far back as possible. The driver's seat position must allow the vehicle to be driven safely.

- Only hold the steering wheel on the outside. This allows the air bag to be fully deployed.
- Always lean against the backrest while driving. Do not lean forwards or lean against the door or side window. You may otherwise be in the deployment area of the air bags.
- Always keep your feet in the footwell in front of the seat. Do not put your feet on the dashboard, for example. Your feet may otherwise be in the deployment area of the air bag.
- For this reason, always secure persons less than 5 ft (1.50 m) tall in suitable restraint systems. Up to this height, the seat belt cannot be worn correctly.

If a child is traveling in your vehicle, also observe the following notes:

- Always secure children under twelve years of age and less than 5 ft (1.50 m) tall in suitable child restraint systems.
- Child restraint systems should be installed on the rear seats.
- Only secure a child in a rearward-facing child restraint system on the front-passenger seat when the front-passenger front air bag is deactivated. If the PASSENGER AIR BAG OFF indicator lamp is permanently lit, the front-passenger front air bag is deactivated (▷ page 49).
- Always observe the instructions and safety notes on the "Occupant Classification System (OCS)" (▷ page 58) and on "Children in the vehicle" (▷ page 68) in addition to the child restraint system manufacturer's installation instructions.

Objects in the vehicle interior may prevent an air bag from functioning correctly.

Before starting your journey and to avoid risks resulting from the speed of the air bag as it deploys, make sure that:

- there are no people, animals or objects between the vehicle occupants and an air bag.
- there are no objects between the seat, door and B-pillar.
- no hard objects, e.g. coat hangers, hang on the grab handles or coat hooks.
- no accessories, such as cup holders, are attached to the vehicle within the deployment area of an air bag, e.g. to doors, side windows, rear side trim or side walls.
- no heavy, sharp-edged or fragile objects are in the pockets of your clothing. Store such objects in a suitable place.

 **WARNING**

If you modify the air bag cover or affix objects such as stickers to it, the air bag can no longer function correctly. There is an increased risk of injury.

Never modify an air bag cover or affix objects to it.

 **WARNING**

Sensors to control the air bags are located in the doors. Modifications or work not performed correctly to the doors or door paneling, as well as damaged doors, can lead to the function of the sensors being impaired. The air bags might therefore not function properly any more. Consequently, the air bags cannot protect vehicle occupants as they are designed to do. There is an increased risk of injury.

Never modify the doors or parts of the doors. Always have work on the doors or door paneling carried out at a qualified specialist workshop.

Front air bags



Driver's air bag ① deploys in front of the steering wheel. Front-passenger front air bag ② deploys in front of and above the glove box.

When deployed, the front air bags offer additional head and thorax protection for the occupants in the front seats.

The PASSENGER AIR BAG OFF indicator lamp informs you about the status of the front-passenger front air bag (▷ page 49).

The front-passenger front air bag will only deploy if:

- the system, based on the OCS weight sensor readings, detects that the front-passenger seat is occupied (▷ page 58)
- the PASSENGER AIR BAG OFF indicator lamp is not lit (▷ page 58)
- the restraint system control unit predicts a high accident severity

Driver's knee bag



Driver's knee bag ① deploys under the steering column. The driver's knee bag is triggered together with the front air bag.

The driver's knee bag offers additional thigh, knee and lower leg protection for the occupant in the driver's seat.

Side impact air bags

⚠ WARNING

Unsuitable seat covers could restrict or even prevent the deployment of the air bags integrated into the seats. Consequently, the air bags cannot protect vehicle occupants as they are designed to do. In addition, the function of the Occupant Classification System (OCS) could be restricted. This poses an increased risk of injury or even fatal injury.

You should only use seat covers that have been approved for the respective seat by Mercedes-Benz.



Example: Sedan

Front side impact air bags ① and rear side impact air bags ② deploy next to the outer bolster of the seat backrest.

When deployed, the side impact air bag offers additional thorax protection. However, it does not protect the:

- head
- neck
- arms

In the event of a side impact, the side impact air bag is deployed on the side on which the impact occurs.

The side impact air bag on the front-passenger side (front) deploys under the following conditions:

- the OCS system detects that the front-passenger seat is occupied or
- the belt tongue is engaged in the belt buckle of the front-passenger seat

If the belt tongue is engaged in the belt buckle, the side impact air bag on the front-passenger side deploys if an appropriate accident situation occurs. In this case, deployment is independent of whether the front-passenger seat is occupied or not.

Pelvis air bags

WARNING

Unsuitable seat covers could restrict or even prevent the deployment of the air bags integrated into the seats. Consequently, the air bags cannot protect vehicle occupants as they are designed to do. In addition, the function of the Occupant Classification System (OCS) could be restricted. This poses an increased risk of injury or even fatal injury. You should only use seat covers that have been approved for the respective seat by Mercedes-Benz.



Pelvis air bags (1) deploy below next to the outer seat cushions.

When activated, the pelvis air bag enhances the level of protection of the vehicle occupants on the side of the vehicle on which the impact occurs.

The pelvis air bag is deployed on the side of the impact.

The pelvis air bag on the front-passenger side does not deploy under the following conditions:

- OCS has detected that the front-passenger seat is unoccupied.
- the front-passenger seat belt is not fastened.

If the belt tongue is engaged in the belt buckle, the pelvis air bag on the front-passenger side deploys if an appropriate accident situation occurs. In this case, deployment is independent of whether the front-passenger seat is occupied or not.

Window curtain air bags

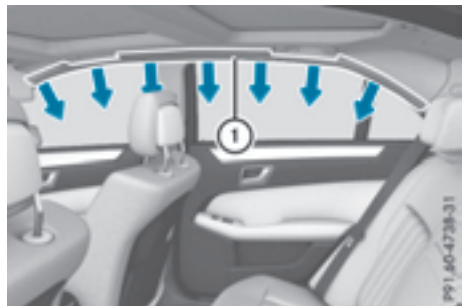

Example: Sedan

Window curtain air bags (1) are integrated into the side of the roof frame and deployed in the area from the A-pillar to the C-pillar.

When deployed, the window curtain air bag enhances the level of protection for the head. However, it does not protect the chest or arms.

In the event of a side impact, the window curtain air bag is deployed on the side on which the impact occurs.

If the system determines that they can offer additional protection to that provided by the seat belt, a window curtain air bag may be deployed in other accident situations

(▷ page 63).

Occupant Classification System (OCS)

Introduction

The Occupant Classification System (OCS) categorizes the person in the front-passenger seat. Depending on that result, the front-passenger front air bag is either enabled or deactivated.

The system does not deactivate:

- the side impact air bag
- the pelvis air bag
- the window curtain air bag
- the Emergency Tensioning Devices

Prerequisites

To be classified correctly, the front passenger must sit:

- with the seat belt fastened correctly
- in an almost upright position with their back against the seat backrest
- with their feet resting on the floor, if possible

If the front passenger does not observe these conditions, OCS may produce a false classification, e.g. because the front passenger:

- transfers their weight by supporting themselves on a vehicle armrest
- sits in such a way that their weight is raised from the seat cushion

If it is absolutely necessary to install a child restraint system on the front-passenger seat, be sure to observe the correct positioning of the child restraint system. Never place objects under or behind the child restraint system, e.g. cushions. The entire base of the child restraint system must always rest on the seat cushion of the front-passenger seat. The backrest of the forward-facing child restraint system must lie as flat as possible against the backrest of the front-passenger seat.

The child restraint system must not touch the roof or be subjected to a load by the head restraint. Adjust the angle of the seat back-

rest and the head restraint position accordingly.

Only then can OCS be guaranteed to function correctly. Always observe the child restraint system manufacturer's installation instructions.

Occupant Classification System operation (OCS)



PASSENGER AIR BAG OFF indicator lamp ① shows you whether the front-passenger front air bag is deactivated.

- Turn the SmartKey to position **1** or **2** in the ignition lock or on vehicles with KEYLESS-GO, press the Start/Stop button once or twice.

The system carries out self-diagnostics.

The PASSENGER AIR BAG OFF indicator lamp must light up for approximately six seconds. The PASSENGER AIR BAG OFF indicator lamp then displays the status of the front-passenger front air bag. If the status of the front-passenger front air bag changes while the vehicle is in motion, an air bag display message may appear in the instrument cluster (> page 198). When the front-passenger seat is occupied, always pay attention to the PASSENGER AIR BAG OFF indicator lamp. Be aware of the status of the front-passenger front air bag both before and during the journey.

If the PASSENGER AIR BAG OFF indicator lamp:

- **is lit:** the front-passenger front air bag is deactivated. It will then not be deployed in the event of an accident.
- **does not light up:** the front-passenger front air bag is enabled. If, in the event of an accident, all deployment criteria are met, the front-passenger front air bag is deployed.

WARNING

If the PASSENGER AIR BAG OFF indicator lamp is lit, the front-passenger front air bag is disabled. It will not be deployed in the event of an accident and cannot perform its intended protective function. A person in the front-passenger seat could then, for example, come into contact with the vehicle's interior, especially if the person is sitting too close to the dashboard. This poses an increased risk of injury or even fatal injury.

When the front-passenger seat is occupied, always ensure that:

- the classification of the person in the front-passenger seat is correct and the front-passenger front air bag is enabled or disabled in accordance with the person in the front-passenger seat
- the front-passenger seat has been moved back as far back as possible.
- the person is seated correctly.

Make sure, both before and during the journey, that the status of the front-passenger front air bag is correct.

WARNING

If you secure a child in a child restraint system on the front-passenger seat and the PASSENGER AIR BAG OFF indicator lamp is off, the front-passenger front air bag can deploy in the event of an accident. The child could be struck by the air bag. This poses an increased risk of injury or even fatal injury.

Make sure that the front-passenger front air bag has been disabled. The PASSENGER AIR BAG OFF indicator lamp must be lit.

WARNING

If you secure a child in a forward-facing child restraint system on the front-passenger seat and you position the front-passenger seat too close to the dashboard, the child could, in the event of an accident:

- come into contact with the vehicle's interior if the PASSENGER AIR BAG OFF indicator lamp is lit, for example
- be struck by the air bag if the PASSENGER AIR BAG OFF indicator lamp is off

This poses an increased risk of injury or even fatal injury.

Move the front-passenger seat as far back as possible. Always make sure that the shoulder belt strap is correctly routed from the vehicle belt sash guide to the shoulder belt guide on the child restraint system. The shoulder belt strap must be routed forwards and downwards from the vehicle belt sash guide. If necessary, adjust the vehicle belt sash guide and the front-passenger seat accordingly. Always observe the child restraint system manufacturer's installation instructions.

If OCS determines that:

- the front-passenger seat is unoccupied, the PASSENGER AIR BAG OFF indicator lamp lights up after the system self-test and remains lit. This indicates that the front-passenger front air bag is deactivated.
- the front-passenger seat is occupied by a child of up to twelve months old, in a standard child restraint system, the PASSENGER AIR BAG OFF indicator lamp lights up after the system self-test and remains lit. This indicates that the front-passenger front air bag is deactivated.

But even in the case of a twelve-month-old child, in a standard child restraint system, the PASSENGER AIR BAG OFF indicator lamp can go out after the system self-test.

This indicates that the front-passenger front air bag is activated. The result of the classification is dependent on, among other factors, the child restraint system and the child's stature. It is recommended that you install the child restraint system on a suitable rear seat.

- the front-passenger seat is occupied by a person of smaller stature (e.g. a teenager or small adult), the PASSENGER AIR BAG OFF indicator lamp lights up and remains lit after the system self-test depending on the result of the classification or, alternatively, goes out.
 - If the PASSENGER AIR BAG OFF indicator lamp is off, move the front-passenger seat as far back as possible. Alternatively, a person of smaller stature can sit on a rear seat.
 - If the PASSENGER AIR BAG OFF indicator lamp is lit, a person of smaller stature should not use the front-passenger seat.
- the front-passenger seat is occupied by an adult or a person of a stature corresponding to that of an adult, the PASSENGER AIR BAG OFF indicator lamp goes out after the system self-test. This indicates that the front-passenger front air bag is activated.

If children are traveling in the vehicle, be sure to observe the notes on "Children in the vehicle" (▷ page 68).

When OCS is malfunctioning, the red  restraint system warning lamp in the instrument cluster and the PASSENGER AIR BAG OFF indicator lamp light up simultaneously. The front-passenger front air bag is deactivated in this case and does not deploy during an accident. Have the system checked by qualified technicians as soon as possible. Consult an authorized Mercedes-Benz Center. The front-passenger seat should only be repaired at an authorized Mercedes-Benz Center.

If the front-passenger seat, the seat cover or the seat cushion is damaged, have the necessary repair work carried out at an authorized Mercedes-Benz Center.

For safety reasons, Mercedes-Benz recommends that you only use seat accessories that have been approved by Mercedes-Benz. If the driver's air bag deploys, this does not mean that the front-passenger front air bag will also deploy. The Occupant Classification System (OCS) categorizes the occupant in the front-passenger seat. Depending on that result, the front-passenger front air bag is either enabled or deactivated.

System self-test

DANGER

If the PASSENGER AIR BAG OFF indicator lamp does not light up during the system self-test, then the system is malfunctioning. The front-passenger front air bag might be triggered unintentionally or might not be triggered at all in the event of an accident with high deceleration. This poses an increased risk of injury or even fatal injury.

In this case the front-passenger seat may not be used. Do not install a child restraint system on the front-passenger seat. Have the Occupant Classification System (OCS) checked and repaired immediately at a qualified specialist workshop.

DANGER

If the PASSENGER AIR BAG OFF indicator lamp remains lit after the system self-test, the front-passenger front air bag is disabled. It will not be deployed in the event of an accident. In this case, the front-passenger front air bag cannot perform its intended protective function, e.g. when a person is seated in the front-passenger seat.

That person could, for example, come into contact with the vehicle's interior, especially if the person is sitting too close to the dashboard. This poses an increased risk of injury or even fatal injury.

When the front-passenger seat is occupied, always ensure that:

- the classification of the person in the front-passenger seat is correct and the front-passenger front air bag is enabled or disabled in accordance with the person in the front-passenger seat
- the person is seated properly with a correctly fastened seatbelt
- the front-passenger seat has been moved back as far back as possible

If the PASSENGER AIR BAG OFF indicator lamp remains lit when it should not, the front-passenger seat may not be used. Do not install a child restraint system on the front-passenger seat. Have the Occupant Classification System (OCS) checked and repaired immediately at a qualified specialist workshop.

WARNING

Objects between the seat surface and the child restraint system could affect OCS operation. This could result in the front-passenger air bag not functioning as intended during an accident. This poses an increased risk of injury or even fatal injury.

Do not place any objects between the seat surface and the child restraint system. The entire base of the child restraint system must always rest on the seat cushion of the front-passenger seat. The backrest of the forward-facing child restraint system must, as far as possible, be resting on the backrest of the front-passenger seat. Always comply with the child restraint system manufacturer's installation instructions.

After the system self-test, the PASSENGER AIR BAG OFF indicator lamp displays the status of the front-passenger front air bag (▷ page 58).

For more information about the OCS, see "Problems with the Occupant Classification System" (▷ page 62).

Problems with the Occupant Classification System (OCS)

Be sure to observe the notes on "System self-test" (▷ page 60).

Problem	Possible causes/consequences and ► Solutions
<p>The PASSENGER AIR BAG OFF indicator lamp lights up and remains lit, even though the front-passenger seat is occupied by an adult or a person of a stature corresponding to that of an adult.</p>	<p>The classification of the person on the front-passenger seat is incorrect.</p> <ul style="list-style-type: none"> ► Make sure the conditions for a correct classification of the person on the front-passenger seat are met (▷ page 58). ► If the PASSENGER AIR BAG OFF indicator lamp remains lit, the front-passenger seat may not be used. ► Have OCS checked as soon as possible at an authorized Mercedes-Benz Center.
<p>The PASSENGER AIR BAG OFF indicator lamp does not light up and/or does not stay on.</p> <p>The front-passenger seat is:</p> <ul style="list-style-type: none"> • unoccupied • occupied by the weight of a child up to 12 months old in a child restraint system 	<p>OCS is malfunctioning.</p> <ul style="list-style-type: none"> ► Make sure there is nothing between the seat cushion and the child seat. ► Make sure that the entire base of the child restraint system rests on the seat cushion of the front-passenger seat. The backrest of the forward-facing child restraint system must lie as flat as possible against the backrest of the front-passenger seat. If necessary, adjust the position of the front-passenger seat. ► When installing the child restraint system, make sure that the seat belt is tight. Do not pull the seat belt tight using the front-passenger seat adjustment. This could result in the seat belt and the child restraint system being pulled too tightly. ► Check for correct installation of the child restraint system. Make sure that the head restraint does not apply a load to the child restraint system. If necessary, adjust the head restraint accordingly. ► Make sure that no objects are applying additional weight onto the seat. ► If the PASSENGER AIR BAG OFF indicator lamp remains off, do not install a child restraint system on the front-passenger seat. It is recommended that you install the child restraint system on a suitable rear seat. ► Have OCS checked as soon as possible at an authorized Mercedes-Benz Center.

Deployment of Emergency Tensioning Devices and air bags

Important safety notes

WARNING

The air bag parts are hot after an air bag has been deployed. There is a risk of injury.

Do not touch the air bag parts. Have a deployed air bag replaced at a qualified specialist workshop as soon as possible.

WARNING

A deployed air bag no longer offers any protection and cannot provide the intended protection in an accident. There is an increased risk of injury.

Have the vehicle towed to a qualified specialist workshop in order to have a deployed air bag replaced.

It is important for your safety and that of your passenger to have deployed air bags replaced and to have any malfunctioning air bags repaired. This will help to make sure the air bags continue to perform their protective function for the vehicle occupants in the event of a crash.

WARNING

Pyrotechnic Emergency Tensioning Devices that have been deployed are no longer operational and are unable to perform their intended protective function. This poses an increased risk of injury or even fatal injury.

Therefore, have pyrotechnic Emergency Tensioning Devices which have been triggered immediately replaced at a qualified specialist workshop.

An electric motor is used by PRE-SAFE® to trigger the tightening of the seat belt in hazardous situations. This procedure is reversible.

If Emergency Tensioning Devices are triggered or air bags are deployed, you will hear a bang, and a small amount of powder may also

be released. The  restraint system warning lamp lights up.

Only in rare cases will the bang affect your hearing. The powder that is released generally does not constitute a health hazard, but it may cause short-term breathing difficulties in people with asthma or other respiratory problems. To avoid this, you may wish to get out of the vehicle or open the windows as soon as it is safe to do so.

Air bags and pyrotechnic Emergency Tensioning Devices (ETDs) contain perchlorate material, which may require special handling and regard for the environment. National guidelines must be observed during disposal. In California, see www.dtsc.ca.gov/HazardousWaste/Perchlorate/index.cfm.

Method of operation

During the first stage of a collision, the restraint system control unit evaluates important physical data relating to vehicle deceleration or acceleration, such as:

- duration
- direction
- intensity

Based on the evaluation of this data, the restraint system control unit triggers the Emergency Tensioning Devices during a frontal or rear collision.

An Emergency Tensioning Device can only be triggered, if:

- the ignition is switched on
- the components of the restraint system are operational; see "Restraint system warning lamp" (> page 49)
- the belt tongue is engaged in the buckle on the respective front-passenger seat

The Emergency Tensioning Devices in the rear compartment are triggered independently of the lock status of the seat belts.

If the restraint system control unit detects a more severe accident, further components of

the restraint system are activated independently of each other in certain frontal collision situations:

- Front air bags and driver's knee bag
- Window curtain air bag, if the system determines that deployment can offer additional protection to that provided by the seat belt

The front-passenger front air bag is activated or deactivated depending on the person on the front-passenger seat. The front-passenger front air bag can only deploy in an accident if the PASSENGER AIR BAG OFF indicator lamp is off. Observe the information on the PASSENGER AIR BAG OFF indicator lamp (▷ page 49).

Your vehicle has two-stage front air bags. During the first deployment stage, the front air bag is filled with propellant gas to reduce the risk of injuries. The front air bag is fully deployed with the maximum amount of propellant gas if a second deployment threshold is reached within a few milliseconds.

The activation threshold of the Emergency Tensioning Devices and the air bag are determined by evaluating the rate of vehicle deceleration or acceleration which occurs at various points in the vehicle. This process is pre-emptive in nature. Deployment should take place in good time at the start of the collision.

The rate of vehicle deceleration or acceleration and the direction of the force are essentially determined by:

- the distribution of forces during the collision
- the collision angle
- the deformation characteristics of the vehicle
- the characteristics of the object with which the vehicle has collided

Factors which can only be seen and measured after a collision has occurred do not play a decisive role in the deployment of an air bag. Nor do they provide an indication of air bag deployment.

The vehicle can be deformed considerably, without an air bag being deployed. This is the case if only parts which are relatively easily deformed are affected and the rate of deceleration is not high. Conversely, air bags may be deployed even though the vehicle suffers only minor deformation. This is the case if, for example, very rigid vehicle parts such as longitudinal body members are hit, and sufficient deceleration occurs as a result.

If the restraint system control unit detects a side impact or if the vehicle rolls over, the applicable components of the restraint system are activated independently of each other depending on the apparent type of accident.

- Side impact air bags and pelvis air bag on the side of impact, independently of the Emergency Tensioning Device and the use of the seat belt on the driver's seat and outer seats in the second row
 - the OCS system detects that the front-passenger seat is occupied or
 - the belt tongue is engaged in the belt buckle of the front-passenger seat
- Window curtain air bag on the side of impact, independently of the use of the seat belt and independently of whether the front-passenger seat is occupied
- Emergency Tensioning Device, if the system determines that deployment can offer additional protection in this situation
- Window curtain air bags on the driver's and front-passenger side in certain situations when the vehicle rolls over, if the system determines that deployment can offer additional protection to that provided by the seat belt

i Not all air bags are deployed in an accident. The different air bag systems work independently of each other.

How the air bag system works is determined by the severity of the accident detected, especially the vehicle deceleration or acceleration and the apparent type of accident:

- frontal collision
- side impact
- rollover

NECK-PRO head restraints/NECK-PRO luxury head restraints

Important safety notes

WARNING

The function of the head restraint may be impaired if you:

- attach objects such as coat hangers to the head restraints, for example
- use head restraint covers

If you do so, the head restraints cannot fulfill their intended protective function in the event of an accident. In addition, objects attached to the head restraints could endanger other vehicle occupants. There is an increased risk of injury.

Do not attach any objects to the head restraints and do not use head restraint covers.

Method of operation

NECK-PRO head restraints/NECK-PRO luxury head restraints offer additional protection against head and neck injuries. In the event of a rear collision of a certain severity, the NECK-PRO head restraints/NECK-PRO luxury head restraints on the driver's and front-passenger seats are moved forwards and upwards. This provides better head support.

If the NECK-PRO head restraints/NECK-PRO luxury head restraints have been triggered in an accident, reset the NECK-PRO head restraints/NECK-PRO luxury head restraints on the driver's seat and the front-passenger seat (▷ page 65). Otherwise, the additional

protection will not be available in the event of another rear-end collision. You can see that a NECK-PRO head restraint/NECK-PRO luxury head restraint has been triggered if it is tilted forward and can no longer be adjusted.

Mercedes-Benz recommends that you have the functionality of the NECK-PRO head restraints/NECK-PRO luxury head restraints checked at a qualified specialist workshop after a rear-end collision.

Resetting a triggered NECK-PRO head restraint/NECK-PRO luxury head restraint

NECK-PRO head restraints



Do not insert your finger between the cushion of the head restraint and the cover. Pay particular attention while resetting the NECK-PRO head restraints.

- ▶ Tilt the top of the NECK-PRO head restraint cushion forwards in the direction of arrow ①.
- ▶ Push the NECK-PRO head restraint cushion down as far as it will go in the direction of arrow ②.
- ▶ With your hand flat, firmly push the NECK-PRO head restraint cushion backwards in the direction of arrow ③ until it engages.
- ▶ Repeat this procedure for the second NECK-PRO head restraint.

i Resetting the NECK-PRO head restraints requires a lot of strength. If you have difficulty resetting the NECK-PRO head

restraints, have this work carried out at a qualified specialist workshop.

NECK-PRO luxury head restraints

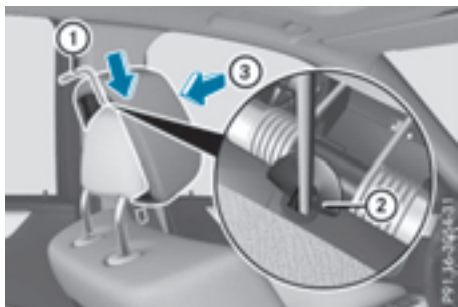

Do not insert your finger between the cushion of the head restraint and the cover. Pay particular attention while resetting the NECK-PRO luxury head restraints.

- ▶ Remove resetting tool ① from the vehicle document wallet.
- ▶ Slide resetting tool ① into guide ② between the NECK-PRO luxury head restraint and the rear cover of the head restraint.
- ▶ Push resetting tool ① downwards until you hear the head restraint deployment mechanism engage.
- ▶ Pull out resetting tool ①.
- ▶ With your hand flat, firmly push the NECK-PRO luxury head restraint cushion backwards in the direction of arrow ③ until it engages.
- ▶ Repeat this procedure for the second NECK-PRO luxury head restraint.
- ▶ Put resetting tool ① back into the vehicle document wallet.

i If you have difficulty resetting the NECK-PRO luxury head restraints, have this work carried out at a qualified specialist workshop.

PRE-SAFE® (anticipatory occupant protection system)

Introduction

In certain hazardous situations, PRE-SAFE® takes pre-emptive measures to protect the vehicle occupants.

Important safety notes

! Make sure that there are no objects in the footwell or behind the seats. There is a danger that the seats and/or objects could be damaged when PRE-SAFE® is activated.

Although your vehicle is equipped with PRE-SAFE®, the possibility of injury in the event of an accident cannot be ruled out. Always adapt your driving style to suit the prevailing road and weather conditions and maintain a safe distance from the vehicle in front. Drive carefully.

Function

PRE-SAFE® intervenes:

- in emergency braking situations, e.g. when BAS is activated
- in critical driving situations, e.g. when physical limits are exceeded and the vehicle understeers or oversteers severely
- on vehicles with the Driving Assistance package: if BAS PLUS intervenes powerfully or the radar sensor system detects an imminent danger of collision in certain situations

PRE-SAFE® takes the following measures depending on the hazardous situation detected:

- the front seat belts are pre-tensioned.
- the front-passenger seat is adjusted if it is in an unfavorable position.
- if the vehicle skids, the sliding sunroof and the side windows are closed so that only a small gap remains. The panorama roof with

power tilt/sliding panel is completely closed.

- the air pressure in the side bolsters of the seat backrests of the front active multicontour seats is raised.

If the hazardous situation passes without resulting in an accident, PRE-SAFE® slackens the belt pre-tensioning. On vehicles with active multicontour seats, the air pressure in the side bolsters is reduced again. All settings made by PRE-SAFE® can then be reversed.

If the seat belt pre-tensioning is not reduced:

- ▶ Move the seat backrest or seat back slightly when the vehicle is stationary. The seat belt pre-tensioning is reduced and the locking mechanism is released.

The seat-belt adjustment is an integral part of the PRE-SAFE® convenience function. You will find information on the convenience function under "Belt adjustment" (▷ page 53).

PRE-SAFE® PLUS (anticipatory occupant protection system PLUS)

Introduction

PRE-SAFE® PLUS is only available in vehicles with the Driving Assistance package.

Using the radar sensor system, PRE-SAFE® PLUS is able to detect that a head-on or rear-end collision is imminent. In certain hazardous situations, PRE-SAFE® PLUS takes pre-emptive measures to protect the vehicle occupants.

Important safety notes

The intervention of PRE-SAFE® PLUS cannot prevent an imminent collision.

The driver is not warned about the intervention of PRE-SAFE® PLUS.

PRE-SAFE® PLUS does not intervene if the vehicle is backing up.

PRE-SAFE® PLUS does not perform braking actions while the vehicle is in motion or when Parking Guidance is active.

Function

PRE-SAFE® PLUS intervenes in certain situations if the radar sensor system detects an imminent head-on or rear-end collision.

PRE-SAFE® PLUS takes the following measures depending on the hazardous situation detected:

- if the radar sensor system detects that a head-on collision is imminent, the seat belts are pre-tensioned.
- if the radar sensor system detects that a rear-end collision is imminent:
 - the brake pressure is increased if the driver applies the brakes when the vehicle is stationary.
 - the seat belts are pre-tensioned.

The PRE-SAFE® PLUS braking application is canceled:

- if the accelerator pedal is depressed when a gear is engaged
- if the risk of a collision passes or is no longer detected
- if DISTRONIC PLUS indicates an intention to pull away

If the hazardous situation passes without resulting in an accident, the original settings are restored.

Automatic measures after an accident

Immediately after an accident, the following measures are implemented, depending on the type and severity of the impact:

- the hazard warning lamps are activated
- the emergency lighting is activated
- the vehicle doors are unlocked
- the front side windows are lowered

- vehicles with a memory function: the electrically adjustable steering wheel is raised
- the engine is switched off and the fuel supply is cut off
- vehicles with mbrace: automatic emergency call
- vehicles with the hybrid drive system: the hybrid system and the high-voltage electrical system are deactivated

Children in the vehicle

Important safety notes

Accident statistics show that children secured in the rear seats are safer than children secured in the front-passenger seat. For this reason, Mercedes-Benz strongly advises that you install a child restraint system on a rear seat. Children are generally better protected there.

If a child under 12 years of age and under 5 ft (1.50 m) in height is traveling in the vehicle:

- always secure the child in a child restraint system suitable for Mercedes-Benz vehicles. The child restraint system must be appropriate to the age, weight and size of the child
- be sure to observe the instructions and safety notes in this section in addition to the child restraint system manufacturer's installation instructions
- be sure to observe the instructions and safety notes on the "Occupant classification system (OCS)" (▷ page 58)

Do not install a rearward-facing child restraint system on the center rear seat.

WARNING

If you leave children unsupervised in the vehicle, they could set it in motion by, for example:

- release the parking brake.
- shift the automatic transmission out of the parking position **P**.
- start the engine.

In addition, they may operate vehicle equipment and become trapped. There is a risk of an accident and injury.

When leaving the vehicle, always take the SmartKey with you and lock the vehicle. Never leave children unsupervised in the vehicle.

WARNING

If persons, particularly children are subjected to prolonged exposure to extreme heat or cold, there is a risk of injury, possibly even fatal. Never leave children unattended in the vehicle.

WARNING

If the child restraint system is subjected to direct sunlight, parts may get very hot. Children may burn themselves on these parts, particularly on the metal parts of the child restraint system. There is a risk of injury.

If you leave the vehicle, taking the child with you, always ensure that the child restraint system is not exposed to direct sunlight. Protect it with a blanket, for example. If the child restraint system has been exposed to direct sunlight, let it cool down before securing the child in it. Never leave children unattended in the vehicle.

Always ensure that all vehicle occupants have their seat belts fastened correctly and are sitting properly. Particular attention must be paid to children.

Observe the safety notes on the seat belt (▷ page 50) and the notes on correct use of seat belts (▷ page 51).

A booster seat may be necessary to achieve proper seat belt positioning for children over 41 lbs (18 kg) until they reach a height where a three-point seat belt fits properly without a booster seat.

Special seat belt retractor

WARNING

If the seat belt is released while driving, the child restraint system will no longer be secured properly. The special seat belt retractor is disabled and the inertia reel draws in a portion of the seat belt. The seat belt cannot be immediately refastened. There is an increased risk of injury, possibly even fatal. Stop the vehicle immediately, paying attention to road and traffic conditions. Reactivate the special seat belt retractor and secure the child restraint system properly.

All seat belts except the driver's seat belt and the folding bench seat belts in the cargo compartment are equipped with a special seat belt retractor. When activated, the special seat belt retractor ensures that the seat belt will not slacken once the child restraint system has been secured.

Installing a child restraint system:

- ▶ Always comply with the child restraint system manufacturer's installation instructions.
- ▶ Pull the seat belt smoothly from the belt outlet.
- ▶ Engage the seat belt tongue in the belt buckle.

Activating the special seat belt retractor:

- ▶ Pull the seat belt out fully and let the inertia reel retract it again. While the seat belt is retracting, you should hear a ratcheting sound. The special seat belt retractor is activated.
- ▶ Push the child seat restraint system down so that the seat belt is tight and does not loosen.

Removing a child restraint system and deactivating the special seat belt retractor:

- ▶ Always comply with the child restraint system manufacturer's installation instructions.
- ▶ Press the release button of the belt buckle, hold the belt tongue firmly and guide it back towards the belt outlet. The special seat belt retractor is deactivated.

Child restraint system

The use of seat belts and child restraint systems is required by law in:

- all 50 states
- the U.S. territories
- the District of Columbia
- all Canadian provinces

Do not install a rearward-facing child restraint system on the center rear seat.

You can obtain further information about the correct child restraint system from any authorized Mercedes-Benz Center.

WARNING

If the child restraint system is installed incorrectly on a suitable seat, it cannot protect as intended. The child cannot then be restrained in the event of an accident, heavy braking or sudden changes of direction. There is an increased risk of injury, possibly even fatal.

Make sure that you observe the child restraint system manufacturer's installation instructions and the notes on use. Please ensure, that the base of the child restraint system is always resting completely on the seat cushion. Never place objects, e.g. cushions, under or behind the child restraint system. Only use child restraint systems with the original cover designed for them. Only replace damaged covers with genuine covers.

⚠ WARNING

If the child restraint system is installed incorrectly or is not secured, it can come loose in the event of an accident, heavy braking or a sudden change in direction. The child restraint system could be thrown about, striking vehicle occupants. There is an increased risk of injury, possibly even fatal.

Always install child restraint systems properly, even if they are not being used. Make sure that you observe the child restraint system manufacturer's installation instructions.

You will find further information on stowing objects, luggage or loads under "Loading guidelines" (> page 238).

⚠ WARNING

Child restraint systems or their securing systems which have been damaged or subjected to a load in an accident can no longer protect as intended. The child cannot then be restrained in the event of an accident, heavy braking or sudden changes of direction. There is an increased risk of injury, possibly even fatal.

Replace child restraint systems which have been damaged or subjected to a load in an accident as soon as possible. Have the securing systems on the child restraint system checked at a qualified specialist workshop, before you install a child restraint system again.

The securing systems of child restraint systems are:

- the seat belt system
- the LATCH-type (ISOFIX) securing rings
- the Top Tether anchorages

If it is absolutely necessary to carry a child on the front-passenger seat, be sure to observe the information on the "Occupant Classification System (OCS)" (> page 58). There you will also find information on deactivating the front-passenger front air bag.

All child restraint systems must meet the following standards:

- U.S. Federal Motor Vehicle Safety Standards 213 and 225
- Canadian Motor Vehicle Safety Standards 213 and 210.2

Confirmation that the child restraint system corresponds to the standards can be found on an instruction label on the child restraint system. This confirmation can also be found in the installation instructions that are included with the child restraint system.

Observe the warning labels in the vehicle interior and on the child restraint system.

LATCH-type (ISOFIX) child seat securing system**⚠ WARNING**

LATCH-type (ISOFIX) child restraint systems do not offer sufficient protective effect for children whose weight is greater than 48 lbs (22 kg) who are secured using the safety belt integrated in the child restraint system. In the event of an accident, a child might not be restrained correctly. This poses an increased risk of injury or even fatal injury.

If the child weighs more than 48 lbs (22 kg), only use LATCH-type (ISOFIX) child restraint systems with which the child is also secured with the vehicle seat belt. Also secure the child restraint system with the Top Tether belt, if available.

Always comply with the manufacturer's installation and operating instructions for the child restraint system used.

Before every trip, make sure that the LATCH-type (ISOFIX) child restraint system is engaged correctly in both LATCH-type (ISOFIX) securing rings

! When installing the child restraint system, make sure that the seat belt for the middle seat does not get trapped. The seat belt could otherwise be damaged.



When installing the LATCH-type (ISOFIX) child restraint system, fold protective caps ② of LATCH-type (ISOFIX) securing rings ① inwards.

- ▶ Install the LATCH-type (ISOFIX) child restraint system on both LATCH-type (ISOFIX) securing rings ①.

ISOFIX is a standardized securing system for specially designed child restraint systems on the rear seats. LATCH-type (ISOFIX) securing rings ① for two LATCH-type (ISOFIX) child restraint systems are installed on the left and right rear seats.

Non-LATCH-type (ISOFIX) child seats may also be used and can be installed using the vehicle's seat belt system. Install the child seat according to the manufacturer's instructions.

Top Tether

Introduction

Top Tether provides an additional connection between the child restraint system secured with a LATCH-type (ISOFIX) child seat mount and the vehicle. This helps reduce the risk of injury even further. If the child restraint system is equipped with a Top Tether belt, this should always be used.

Important safety notes

WARNING

If the rear seat backrests are not locked, they could fold forwards in the event of an acci-

dent, heavy braking or sudden changes of direction. As a result, child restraint systems cannot perform their intended protective function. Rear seat backrests that are not locked can also cause additional injuries, e.g. in the event of an accident. This poses an increased risk of injury or even fatal injury.

Always lock rear seat backrests after installing a Top Tether belt. Observe the lock verification indicator. Adjust the rear seat backrests so that they are in an upright position.

If the rear seat backrest is not engaged and locked, this will be shown in the multifunction display in the instrument cluster. A warning tone also sounds.

Top Tether anchorages

Sedan

The Top Tether anchorage points are installed in the rear compartment behind the head restraints.

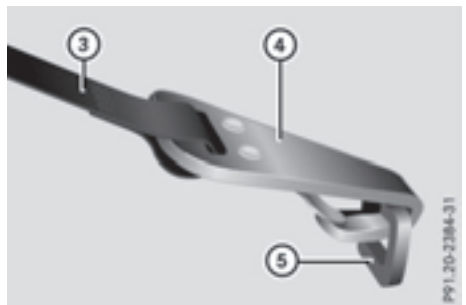

- ▶ Move head restraint ① upwards.
- ▶ Fold up cover ② of Top Tether anchorage ⑤.
- ▶ Install the LATCH-type (ISOFIX) child restraint system with Top Tether. Always comply with the child restraint system manufacturer's installation instructions when doing so.
- ▶ Route Top Tether belt ③ under head restraint ① between the two head restraint bars.
- ▶ Hook Top Tether hook ④ into Top Tether anchorage ⑤.
- ▶ Make sure that Top Tether belt ③ is not twisted.
- ▶ Tension Top Tether belt ③. Always comply with the child restraint system manufacturer's installation instructions when doing so.
- ▶ Fold down cover ② of Top Tether anchorage ⑤.
- ▶ Move head restraint ① back down again slightly if necessary (▷ page 116). Make sure that you do not interfere with the correct routing of Top Tether belt ③.

Wagon

The Top Tether anchorages are located on the rear side of the rear seat backrests.

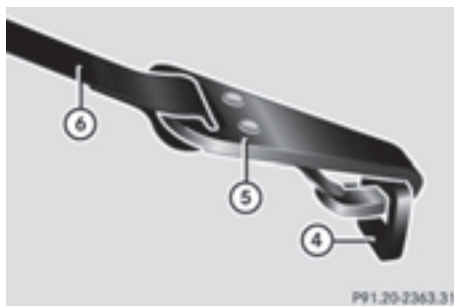
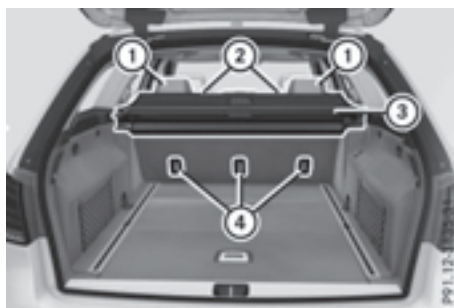

- ▶ Move head restraint ① upwards.
- ▶ Remove combined cargo cover and net ③ (▷ page 243).
- ▶ Install the LATCH-type (ISOFIX) child restraint system with Top Tether. Always comply with the child restraint system manufacturer's installation instructions when doing so.
- ▶ Route Top Tether belt ⑥ under head restraint ① between the two head restraint bars.
- ▶ Hook Top Tether hook ⑤ into Top Tether anchorage ④ on the back of rear seat backrest ②.
- ▶ Make sure that Top Tether belt ⑥ is not twisted.
- ▶ Tension Top Tether belt ⑥. Always comply with the child restraint system manufacturer's installation instructions when doing so.
- ▶ Move head restraint ① back down again slightly if necessary (▷ page 116). Make

sure that you do not interfere with the correct routing of Top Tether belt ⑥.

- ▶ Install combined cargo cover and net ③ (▷ page 243).

Child restraint system on the front-passenger seat

General notes

Accident statistics show that children secured in the rear seats are safer than children secured in the front-passenger seat. For this reason, Mercedes-Benz strongly advises that you install the child restraint system on a rear seat.

If it is absolutely necessary to install a child restraint system on the front-passenger seat, be sure to observe the instructions and safety notes on the "Occupant Classification System (OCS)" (▷ page 58).

You can thus avoid the risks that could arise as a result of:

- an incorrectly categorized person in the front-passenger seat
- the unintentional deactivation of the front-passenger front air bag
- the unsuitable positioning of the child restraint system, e.g. too close to the dashboard

Rearward-facing child restraint system

If it is absolutely necessary to install a rearward-facing child restraint system on the front-passenger seat, always make sure that the front-passenger front air bag is deactivated. Only if the PASSENGER AIR BAG OFF indicator lamp is permanently lit (▷ page 49) is the front-passenger front air bag deactivated.

Always observe the child restraint system manufacturer's installation and operating instructions.

Forward-facing child restraint system

If it is absolutely necessary to install a forward-facing child restraint system on the front-passenger seat, always move the front-passenger seat as far back as possible. The entire base of the child restraint system must always rest on the seat cushion of the front-passenger seat. The backrest of the child restraint system must lie as flat as possible against the backrest of the front-passenger seat. The child restraint system must not touch the roof or be subjected to a load by the head restraint. Adjust the angle of the seat backrest and the head restraint position accordingly. Always make sure that the shoulder belt strap is correctly routed from the vehicle belt outlet to the shoulder belt guide on the child restraint system. The shoulder belt strap must be routed forwards and downwards from the vehicle belt outlet. If necessary, adjust the vehicle belt outlet and the front-passenger seat accordingly.

Always observe the child restraint system manufacturer's installation and operating instructions.

Child-proof locks

Important safety notes

WARNING

If children are traveling in the vehicle, they could:

- open doors, thus endangering other people or road users
- exit the vehicle and be caught by oncoming traffic
- operate vehicle equipment and become trapped

There is a risk of an accident and injury.

Always activate the child-proof locks and override feature if children are traveling in the vehicle. When leaving the vehicle, always take the key with you and lock the vehicle. Never leave children unattended in the vehicle.

Override feature for:

- the rear doors (▷ page 74)
- the rear side windows (▷ page 74)

WARNING

If you leave children unsupervised in the vehicle, they could set it in motion by, for example:

- release the parking brake.
- shift the automatic transmission out of the parking position **P**.
- start the engine.

In addition, they may operate vehicle equipment and become trapped. There is a risk of an accident and injury.

When leaving the vehicle, always take the SmartKey with you and lock the vehicle. Never leave children unsupervised in the vehicle.

WARNING

If persons, particularly children are subjected to prolonged exposure to extreme heat or cold, there is a risk of injury, possibly even fatal. Never leave children unattended in the vehicle.

WARNING

If the child restraint system is subjected to direct sunlight, parts may get very hot. Children may burn themselves on these parts, particularly on the metal parts of the child restraint system. There is a risk of injury.

If you leave the vehicle, taking the child with you, always ensure that the child restraint system is not exposed to direct sunlight. Protect it with a blanket, for example. If the child restraint system has been exposed to direct sunlight, let it cool down before securing the child in it. Never leave children unattended in the vehicle.

Child-proof locks for the rear doors

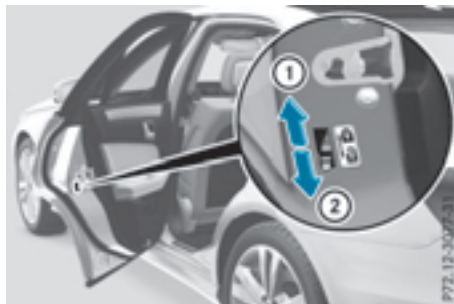

Child-proof lock, rear door (example: Sedan)

You secure each door individually with the child-proof locks on the rear doors. A door secured with a child-proof lock cannot be opened from inside the vehicle. When the vehicle is unlocked, the door can be opened from the outside.

- ▶ **To activate:** press the child-proof lock lever up in the direction of arrow ①.
- ▶ Make sure that the child-proof locks are working properly.
- ▶ **To deactivate:** press the child-proof lock lever down in the direction of arrow ②.

Override feature for the rear side windows



- ▶ **To activate/deactivate:** press button ②. If indicator lamp ① is lit, operation of the rear side windows is disabled. Operation is only possible using the switches in the driver's door. If indicator lamp ① is off, oper-

ation is possible using the switches in the rear compartment.

Pets in the vehicle

WARNING

If you leave animals unattended or unsecured in the vehicle, they could press buttons or switches, for example.

As a result, they could:

- activate vehicle equipment and become trapped, for example
- activate or deactivate systems, thereby endangering other road users

Unsecured animals could also be flung around the vehicle in the event of an accident or sudden steering or braking, thereby injuring vehicle occupants. There is a risk of an accident and injury.

Never leave animals unattended in the vehicle. Always secure animals properly during the journey, e.g. use a suitable animal transport box.

- PRE-SAFE® Brake (▷ page 84)
- STEER CONTROL (▷ page 86)

Important safety notes

If you fail to adapt your driving style or if you are inattentive, the driving safety systems can neither reduce the risk of an accident nor override the laws of physics. Driving safety systems are merely aids designed to assist driving. You are responsible for maintaining the distance to the vehicle in front, for vehicle speed, for braking in good time, and for staying in lane. Always adapt your driving style to suit the prevailing road and weather conditions and maintain a safe distance from the vehicle in front. Drive carefully.

The driving safety systems described only work as effectively as possible when there is adequate contact between the tires and the road surface. Pay particular attention to the information regarding tires, recommended minimum tire tread depths etc. in the "Wheels and tires" section (▷ page 288).

In wintry driving conditions, always use winter tires (M+S tires) and if necessary, snow chains. Only in this way will the driving safety systems described in this section work as effectively as possible.

Driving safety systems

Overview of driving safety systems

In this section, you will find information about the following driving safety systems:

- ABS (**A**nti-**l**ock **B**raking **S**ystem) (▷ page 75)
- BAS (**B**rake **A**ssist **S**ystem) (▷ page 76)
- BAS PLUS (**B**rake **A**ssist **S**ystem **P**LU**S**) with Cross-Traffic Assist (▷ page 76)
- COLLISION PREVENTION ASSIST PLUS (distance warning function and Adaptive Brake Assist) (▷ page 78)
- ESP® (**E**lectronic **S**tability **P**rogram) (▷ page 80)
- EBD (**E**lectronic **B**rake force **D**istribution) (▷ page 84)
- ADAPTIVE BRAKE (▷ page 84)

ABS (Anti-lock Braking System)

General information

ABS regulates brake pressure in such a way that the wheels do not lock when you brake. This allows you to continue steering the vehicle when braking.

The yellow  ABS warning lamp in the instrument cluster lights up when the ignition is switched on. It goes out when the engine is running.

Important safety notes

- ⓘ Observe the "Important safety notes" section (▷ page 75).

⚠ WARNING

If ABS is faulty, the wheels could lock when braking. The steerability and braking characteristics may be severely impaired. Additionally, further driving safety systems are deactivated. There is an increased danger of skidding and accidents.

Drive on carefully. Have ABS checked immediately at a qualified specialist workshop.

When ABS is malfunctioning, other systems, including driving safety systems, will also become inoperative. Observe the information on the ABS warning lamp (▷ page 205) and display messages which may be shown in the instrument cluster (▷ page 192).

ABS works from a speed of about 5 mph (8 km/h), regardless of road-surface conditions. ABS works on slippery surfaces, even if you only brake gently.

Braking

- ▶ **If ABS intervenes:** continue to depress the brake pedal vigorously until the braking situation is over.
- ▶ **To make a full brake application:** depress the brake pedal with full force.

If ABS intervenes when braking, you will feel a pulsing in the brake pedal.

The pulsating brake pedal can be an indication of hazardous road conditions, and functions as a reminder to take extra care while driving.

BAS (Brake Assist System)

General information

BAS operates in emergency braking situations. If you depress the brake pedal quickly, BAS automatically boosts the braking force, thus shortening the stopping distance.

Important safety notes

- ⓘ Observe the "Important safety notes" section (▷ page 75).

⚠ WARNING

If BAS is malfunctioning, the braking distance in an emergency braking situation is increased. There is a risk of an accident.

In an emergency braking situation, depress the brake pedal with full force. ABS prevents the wheels from locking.

Braking

- ▶ Keep the brake pedal firmly depressed until the emergency braking situation is over. ABS prevents the wheels from locking.

The brakes will function as usual once you release the brake pedal. BAS is deactivated.

BAS PLUS (Brake Assist PLUS) with Cross-Traffic Assist

General information

- ⓘ Observe the "Important safety notes" section (▷ page 75).

BAS PLUS is only available on vehicles with the Driving Assistance package.

For BAS PLUS to assist you when driving, the radar sensor system and the camera system must be operational.

With the help of a sensor system and a camera system, BAS PLUS can detect obstacles:

- that are in the path of your vehicle for an extended period of time
- that cross the path of your vehicle

In addition, pedestrians in the path of your vehicle can be detected.

BAS PLUS detects pedestrians by using typical characteristics such as the body contours and posture of a person standing upright.

If the radar sensor system or the camera system is malfunctioning, BAS PLUS functions are restricted or no longer available. The

brake system is still available with complete brake boosting effect and BAS.

- i** Observe the restrictions described in the "Important safety notes" section" (▷ page 77).

BAS PLUS can help you to minimize the risk of a collision with a vehicle or a pedestrian and reduce the effects of such a collision. If BAS PLUS detects a danger of collision, you are assisted when braking.

Important safety notes

WARNING

BAS PLUS cannot always clearly identify objects and complex traffic situations.

In such cases, BAS PLUS may:

- intervene unnecessarily
- not intervene

There is a risk of an accident.

Always pay careful attention to the traffic situation and be ready to brake. Terminate the intervention in a non-critical driving situation.

WARNING

BAS PLUS does not react:

- to small people, e.g. children
- to animals
- to oncoming vehicles
- when cornering

As a result, BAS PLUS may not intervene in all critical situations. There is a risk of an accident.

Always pay careful attention to the traffic situation and be ready to brake.

In the event of snowfall or heavy rain, the recognition can be impaired.

Recognition by the radar sensor system is also impaired in the event of:

- there is dirt on the sensors or anything else covering the sensors
- there is interference by other radar sources

- there are strong radar reflections, for example in parking garages
- a narrow vehicle traveling in front, e.g. a motorbike
- a vehicle traveling in front on a different line
- vehicles quickly moving into the radar sensor system detection range

Recognition by the camera system is also impaired in the event of:

- dirt on the camera or if the camera is covered
- there is glare on the camera system, e.g. from the sun being low in the sky
- darkness
- if:
 - pedestrians move quickly, e.g. into the path of the vehicle
 - the camera system no longer recognizes a pedestrian as a person due to special clothing or other objects
 - a pedestrian is concealed by other objects
 - the typical outline of a person is not distinguishable from the background

Following damage to the front end of the vehicle, have the configuration and operation of the radar sensors checked at a qualified specialist workshop. This also applies to collisions at low speeds where there is no visible damage to the front of the vehicle.

Following damage to the windshield, have the configuration and operation of the camera system checked at a qualified specialist workshop.

Function

To avoid a collision, BAS PLUS calculates the brake force necessary if:

- you approach an obstacle, and
- BAS PLUS has detected a risk of collision

When driving at a speed under 20 mph (30 km/h): if you depress the brake pedal, BAS PLUS is activated. The increase in brake

pressure will be carried out at the last possible moment.

When driving at a speed above 20 mph (30 km/h): if you depress the brake pedal sharply, BAS PLUS automatically raises the brake pressure to a value adapted to the traffic situation.

BAS PLUS provides braking assistance in hazardous situations with vehicles in front within a speed range between 4 mph (7 km/h) and 155 mph (250 km/h).

Up to a speed of approximately 44 mph (70 km/h), BAS PLUS may react to:

- stationary objects in the path of your vehicle, e.g. stopped or parked vehicles
- pedestrians in the path of your vehicle
- objects crossing your path and that are recognized in the detection range of the sensors

i If BAS PLUS demands particularly high braking force, preventative passenger protection measures (PRE-SAFE®) are activated simultaneously.

- ▶ Keep the brake pedal depressed until the emergency braking situation is over. ABS prevents the wheels from locking.

BAS PLUS is deactivated and the brakes function as usual, if:

- you release the brake pedal.
- there is no longer a risk of collision.
- no obstacle is detected in front of your vehicle.
- you depress the accelerator pedal.
- you activate kickdown.

COLLISION PREVENTION ASSIST PLUS

General information

COLLISION PREVENTION ASSIST PLUS consists of a distance warning function with an autonomous braking function and adaptive Brake Assist.

COLLISION PREVENTION ASSIST PLUS can help you to minimize the risk of a front-end collision with a vehicle ahead or reduce the effects of such a collision.

If COLLISION PREVENTION ASSIST PLUS detects that there is a risk of a collision, you will be warned visually and acoustically. If you do not react to the visual and audible collision warning, autonomous braking can be initiated in critical situations. If you apply the brake yourself in a critical situation, the COLLISION PREVENTION ASSIST PLUS adaptive Brake Assist assists you.

Activating or deactivating

COLLISION PREVENTION ASSIST PLUS is activated after every ignition cycle. You can activate or deactivate COLLISION PREVENTION ASSIST PLUS in the on-board computer (> page 190). When deactivated, the distance warning function and the autonomous braking function are also deactivated.

If COLLISION PREVENTION ASSIST PLUS is deactivated, the  symbol appears in the assistance graphics display.

Important safety notes

In particular, the detection of obstacles can be impaired if:

- there is dirt on the sensors or anything else covering the sensors
 - there is snow or heavy rain
 - there is interference by other radar sources
 - there are strong radar reflections, for example in parking garages
 - a narrow vehicle traveling in front, e.g. a motorbike
 - a vehicle traveling in front on a different line
 - new vehicles or after a service on the COLLISION PREVENTION ASSIST PLUS system
- Observe the notes in the section on breaking-in (> page 136).

Following damage to the front end of the vehicle, have the configuration and operation of

the radar sensor checked at a qualified specialist workshop. This also applies to collisions at low speeds where there is no visible damage to the front of the vehicle.

Distance warning function

General information

The distance warning function can help you to minimize the risk of a front-end collision with a vehicle ahead or reduce the effects of such a collision. If the distance warning function detects that there is a risk of a collision, you will be warned visually and acoustically.

Important safety notes

i Observe the "Important safety notes" section for driving safety systems (▷ page 75).

WARNING

The distance warning function does not react:

- to people or animals
- to oncoming vehicles
- to crossing traffic
- when cornering

Thus, the distance warning function cannot provide a warning in all critical situations.

There is a risk of an accident.

Always pay careful attention to the traffic situation and be ready to brake.

WARNING

The distance warning function cannot always clearly identify objects and complex traffic situations.

In such cases, the distance warning function may:

- give an unnecessary warning
- not give a warning

There is a risk of an accident.

Always pay careful attention to the traffic situation and do not rely solely on the distance warning function.

Function

Starting at a speed of around 4 mph (7 km/h), the distance warning function warns you if you rapidly approach a vehicle in front. An intermittent warning tone will then sound, and the  distance warning lamp will light up in the instrument cluster.

► Brake immediately in order to increase the distance from the vehicle in front.

or

► Take evasive action, provided it is safe to do so.

Due to the nature of the system, particularly complicated but non-critical driving conditions may also cause the system to display a warning.

With the help of the radar sensor system, the distance warning function can detect obstacles that are in the path of your vehicle for an extended period of time.

Up to a speed of around 44 mph (70 km/h), the distance warning function can also react to stationary obstacles, such as stopped or parked vehicles.

Autonomous braking function

If the driver does not react to the distance warning signal in a critical situation, COLLISION PREVENTION ASSIST PLUS can assist with the autonomous braking function.

The autonomous braking function:

- gives the driver more time to react to critical driving situations
- can help the driver to avoid an accident or
- reduces the effects of an accident

The autonomous braking function is available in the following speed ranges:

- from 4 mph (7 km/h) to approx. 65 mph (105 km/h) for moving objects
- from 4 mph (7 km/h) to approx. 31 mph (50 km/h) for stationary objects

If the autonomous braking function requires a particularly high braking force, preventative

passenger protection measures (PRE-SAFE®) are activated simultaneously.

Adaptive Brake Assist

i Observe the "Important safety notes" section (▷ page 75).

Adaptive Brake Assist provides braking assistance in hazardous situations at speeds above 4 mph (7 km/h). It uses radar sensor technology to assess the traffic situation.

⚠ WARNING

Adaptive Brake Assist cannot always clearly identify objects and complex traffic situations.

In such cases, Adaptive Brake Assist can:

- intervene unnecessarily
- not intervene

There is a risk of an accident.

Always pay careful attention to the traffic situation and be ready to brake. Terminate the intervention in a non-critical driving situation.

⚠ WARNING

Adaptive Brake Assist does not react:

- to people or animals
- to oncoming vehicles
- to crossing traffic
- when cornering

As a result, the Adaptive Brake Assist may not intervene in all critical conditions. There is a risk of an accident.

Always pay careful attention to the traffic situation and be ready to brake.

Due to the nature of the system, particularly complicated but non-critical driving conditions may also cause Brake Assist to intervene.

If adaptive Brake Assist is not available due to a malfunction in the radar sensor system, the brake system remains available with full brake boosting effect and BAS.

With the help of adaptive Brake Assist, the distance warning signal can detect obstacles that are in the path of your vehicle for an extended period of time.

If adaptive Brake Assist detects a risk of collision with the vehicle in front, it calculates the braking force necessary to avoid a collision. If you apply the brakes forcefully, adaptive Brake Assist will automatically increase the braking force to a level suitable for the traffic conditions.

- ▶ Keep the brake pedal depressed until the emergency braking situation is over. ABS prevents the wheels from locking.

The brakes will work normally again if:

- you release the brake pedal.
- there is no longer any danger of a collision.
- no obstacle is detected in front of your vehicle.

Adaptive Brake Assist is then deactivated.

If adaptive Brake Assist demands particularly high braking force, preventative passenger protection measures (PRE-SAFE®) are activated simultaneously.

Up to a speed of approximately 155 mph (250 km/h), adaptive Brake Assist is capable of reacting to moving objects that have already been detected as such at least once over the period of observation.

Up to a speed of approximately 44 mph (70 km/h), adaptive Brake Assist reacts to stationary obstacles.

ESP® (Electronic Stability Program)

General notes

i Observe the "Important safety notes" section (▷ page 75).

ESP® monitors driving stability and traction, i.e. power transmission between the tires and the road surface.

If ESP® detects that the vehicle is deviating from the direction desired by the driver, one

or more wheels are braked to stabilize the vehicle. The engine output is also modified to keep the vehicle on the desired course within physical limits. ESP® assists the driver when pulling away on wet or slippery roads. ESP® can also stabilize the vehicle during braking.

ETS/4ETS (Electronic Traction System)

- ⓘ Observe the "Important safety notes" section (▷ page 75).

ETS traction control is part of ESP®. On vehicles with 4MATIC, 4ETS is part of ESP®.

Traction control brakes the drive wheels individually if they spin. This enables you to pull away and accelerate on slippery surfaces, for example if the road surface is slippery on one side. In addition, more drive torque is transferred to the wheel or wheels with traction. Traction control remains active, even if you deactivate ESP®.

Important safety notes

- ⓘ Observe the "Important safety notes" section (▷ page 75).

WARNING



If ESP® is malfunctioning, ESP® is unable to stabilize the vehicle. Additionally, further driving safety systems are deactivated. This increases the risk of skidding and an accident.

Drive on carefully. Have ESP® checked at a qualified specialist workshop.

- ❗ Vehicles with 4MATIC: function or performance tests may only be carried out on a 2-axle dynamometer. Before you operate the vehicle on such a dynamometer, please consult a qualified workshop. You could otherwise damage the drive train or the brake system.

Vehicles without 4MATIC: observe the notes on ESP® (▷ page 283) when towing the vehicle with a raised rear axle.

ESP® is only deactivated if the  warning lamp is lit continuously.

If the  warning lamp and the  warning lamp are lit continuously, ESP® not available due to a malfunction.

Observe the information on warning lamps (▷ page 206) and display messages which may be shown in the instrument cluster (▷ page 192).

- ⓘ Only use wheels with the recommended tire sizes. Only then will ESP® function properly.

Characteristics of ESP®

General information

If the  ESP warning lamp goes out before beginning the journey, ESP® is automatically active.

If ESP® intervenes, the  ESP® warning lamp flashes in the instrument cluster.

If ESP® intervenes:

- ▶ Do not deactivate ESP® under any circumstances.
- ▶ Only depress the accelerator pedal as far as necessary when pulling away.
- ▶ Adapt your driving style to suit the prevailing road and weather conditions.

ECO start/stop function

The ECO start/stop function switches the engine off automatically when the vehicle stops moving. The engine starts automatically when the driver wants to pull away again. ESP® remains in its previously selected status. **Example:** if ESP® was deactivated before the engine was switched off, ESP® remains deactivated when the engine is switched on again.

Deactivating/activating ESP® (except AMG vehicles)

Important safety notes

- ⓘ Observe the "Important safety notes" section (▷ page 75).

You can select between the following states of ESP®:

- ESP® is activated.
- ESP® is deactivated.

WARNING

If you deactivate ESP®, ESP® no longer stabilizes the vehicle. There is an increased risk of skidding and an accident.

Only deactivate ESP® in the situations described in the following.

- ❗ Avoid spinning the driven wheels for an extended period with ESP® deactivated. You could otherwise damage the drivetrain.

It may be best to deactivate ESP® in the following situations:

- when using snow chains
- in deep snow
- on sand or gravel

- ❗ Activate ESP® as soon as the situations described above no longer apply. ESP® will otherwise not be able to stabilize the vehicle if the vehicle starts to skid or a wheel starts to spin.

Deactivating/activating ESP®

You can deactivate or activate ESP® via the on-board computer (> page 190).

ESP® deactivated:

The  ESP® OFF warning lamp in the instrument cluster lights up.

ESP® activated:

The  ESP® OFF warning lamp in the instrument cluster goes out.

Characteristics when ESP® is deactivated

If ESP® is deactivated and one or more wheels start to spin, the  ESP® warning lamp in the instrument cluster flashes. In such situations, ESP® will not stabilize the vehicle.

If you deactivate ESP®:

- ESP® no longer improves driving stability.
- engine torque is no longer limited and the drive wheels are able to spin.
The spinning of the wheels results in a cutting action for better traction on loose surfaces.
- traction control is still activated.
- ESP® still provides support when you brake.

Deactivating/activating ESP® (AMG vehicles)

Important safety notes

- ❗ Observe the "Important safety notes" section (> page 75).

You can select between the following states of ESP®:

- ESP® is activated.
- SPORT handling mode is activated.
- ESP® is deactivated.

WARNING

When SPORT handling mode is activated, there is a greater risk of skidding and accidents.

Only activate SPORT handling mode in the situations described in the following.

WARNING

If you deactivate ESP®, ESP® no longer stabilizes the vehicle. There is an increased risk of skidding and an accident.

Only deactivate ESP® in the situations described in the following.

- ❗ Avoid spinning the driven wheels for an extended period with ESP® deactivated. You could otherwise damage the drivetrain.

In the following situations, it may be better to activate SPORT handling mode or deactivate ESP®:

- when using snow chains
- in deep snow
- on sand or gravel
- on specially designated roads when the vehicle's own oversteering and understeering characteristics are desired

Driving in SPORT handling mode or without ESP® requires an extremely qualified and experienced driver.

- i** Activate ESP® as soon as the situations described above no longer apply. ESP® will otherwise not be able to stabilize the vehicle if the vehicle starts to skid or a wheel starts to spin.

Deactivating/activating ESP®



► To activate SPORT handling mode:

briefly press button ①.

The **SPORT** SPORT handling mode warning lamp in the instrument cluster lights up. The **SPORT handling mode** message appears in the multifunction display.

► To deactivate SPORT handling mode:

briefly press button ①.

The **SPORT** SPORT handling mode warning lamp in the instrument cluster goes out.

► To deactivate ESP®: press button ① until the **ESP OFF** ESP® OFF warning lamp lights up in the instrument cluster.

The **OFF** message appears in the multifunction display.

► To activate ESP®: briefly press button ①.

The **ESP OFF** ESP® OFF warning lamp in the instrument cluster goes out. The **ON** message appears in the multifunction display.

Characteristics of activated SPORT handling mode

If SPORT handling mode is activated and one or more wheels start to spin, the **ESP** ESP® warning lamp in the instrument cluster flashes. ESP® only stabilizes the vehicle to a limited degree.

When SPORT handling mode is activated:

- ESP® only improves driving stability to a limited degree.
- traction control is still activated.
- engine torque is restricted to a limited degree and the drive wheels are able to spin.

The spinning of the wheels results in a cutting action for better traction on loose surfaces.

- ESP® still provides support when you brake firmly.

Characteristics when ESP® is deactivated

If ESP® is deactivated and one or more wheels start to spin, the **ESP** ESP® warning lamp in the instrument cluster does not flash. In such situations, ESP® will not stabilize the vehicle.

If you deactivate ESP®:

- ESP® no longer improves driving stability.
- engine torque is restricted to a limited degree and the drive wheels are able to spin.

The spinning of the wheels results in a cutting action for better traction on loose surfaces.

- traction control is still activated.
- PRE-SAFE® is no longer available, nor is it activated if you brake firmly and ESP® intervenes.

- PRE-SAFE® Brake is no longer available, it is also not activated if you brake firmly and ESP® intervenes.
- ESP® still provides support when you brake firmly.

ESP® trailer stabilization

General information

If your vehicle/trailer combination begins to swerve, ESP® assists you in this situation. ESP® slows the vehicle down by braking and limiting the engine output until the vehicle/trailer combination has stabilized.

Important safety notes

WARNING

If road and weather conditions are poor, trailer stabilization will not be able to prevent the vehicle/trailer combination from swerving. Trailers with a high center of gravity can tip over before ESP® can detect this. There is a risk of an accident.

Always adapt your driving style to the prevailing road and weather conditions.

If your vehicle with trailer (vehicle/trailer combination) begins to lurch, you can only stabilize the vehicle/trailer combination by depressing the brake firmly.

ESP® trailer stabilization is active above speeds of about 65 km/h.

ESP® trailer stabilization does not work if ESP® is deactivated or disabled because of a malfunction.

EBD (electronic brake force distribution)

General information

EBD monitors and controls the brake pressure on the rear wheels to improve driving stability while braking.

Important safety notes

-  Observe the "Important safety notes" section for driving safety systems (▷ page 75).

WARNING

If EBD is malfunctioning, the rear wheels can lock, e.g. under full braking. This increases the risk of skidding and an accident.

You should therefore adapt your driving style to the different handling characteristics. Have the brake system checked at a qualified specialist workshop.

Observe information regarding indicator and warning lamps (▷ page 205) as well as display messages (▷ page 194).

ADAPTIVE BRAKE

-  Observe the "Important safety notes" section (▷ page 75).

ADAPTIVE BRAKE enhances braking safety and offers increased braking comfort. In addition to the braking function, ADAPTIVE BRAKE also has the HOLD function (▷ page 165) and hill start assist (▷ page 141).

PRE-SAFE® Brake

General information

-  Observe the "Important safety notes" section (▷ page 75).

PRE-SAFE® Brake is only available for vehicles with the Driving Assistance package.

For PRE-SAFE® Brake to assist you when driving, the radar sensor system and the camera system must be switched on and be operational.

With the help of the radar sensor system and the camera system, PRE-SAFE® Brake can detect obstacles that are in front of your vehicle for an extended period of time.

In addition, pedestrians in the path of your vehicle can be detected.

PRE-SAFE® Brake detects pedestrians using typical characteristics such as the body contours and posture of a person standing upright.

Observe the restrictions described in the "Important safety notes" section (> page 85).

PRE-SAFE® Brake can help you to minimize the risk of a collision with a vehicle ahead or a pedestrian, and reduce the effects of such a collision. If PRE-SAFE® Brake has detected a risk of collision, you will be warned visually and acoustically as well as by automatic braking.

Important safety notes

WARNING

PRE-SAFE® Brake will initially brake your vehicle by a partial application of the brakes if a danger of collision is detected. There may be a collision unless you brake yourself. Even after subsequent full application of the brakes a collision cannot always be avoided, particularly when approaching at too high a speed. There is a risk of an accident.

Always apply the brakes yourself and try to take evasive action, provided it is safe to do so.

WARNING

PRE-SAFE® Brake cannot always clearly identify objects and complex traffic conditions.

In these cases, PRE-SAFE® Brake may:

- give an unnecessary warning and then brake the vehicle
- not give a warning or intervene

There is a risk of an accident.

Always pay particular attention to the traffic situation and be ready to brake, especially if PRE-SAFE® Brake warns you. Terminate the intervention in a non-critical driving situation.

In order to maintain the appropriate distance to the vehicle in front and thus prevent a collision, you must apply the brakes yourself.

PRE-SAFE® Brake can also brake the vehicle automatically under the following conditions:

- the driver and front-passenger have their seat belts fastened and
- the vehicle speed is between approximately 4 mph (7 km/h) and 124 mph (200 km/h)

At a speed of up to approximately 44 mph (70 km/h), PRE-SAFE® Brake can also detect:

- stationary objects in the path of your vehicle, e.g. stopped or parked vehicles
- pedestrians in the path of your vehicle

WARNING

PRE-SAFE® Brake does not react:

- to small people, e.g. children
- to animals
- to oncoming vehicles
- to crossing traffic
- when cornering

As a result, PRE-SAFE® Brake may neither give warnings nor intervene in all critical situations. There is a risk of an accident.

Always pay careful attention to the traffic situation and be ready to brake.

In the event of snowfall or heavy rain, the recognition can be impaired.

Recognition by the radar sensor system is also impaired in the event of:

- there is dirt on the sensors or anything else covering the sensors
- there is interference by other radar sources
- there are strong radar reflections, for example in parking garages
- a narrow vehicle traveling in front, e.g. a motorbike
- a vehicle traveling in front on a different line relative to the center of your vehicle

Recognition by the camera system is also impaired in the event of:

- dirt on the camera or if the camera is covered
- there is glare on the camera system, e.g. from the sun being low in the sky
- darkness
- if:
 - pedestrians move quickly, e.g. into the path of the vehicle
 - the camera system no longer recognizes a pedestrian as a person due to special clothing or other objects
 - a pedestrian is concealed by other objects
 - the typical outline of a person is not distinguishable from the background

Following damage to the front end of the vehicle, have the configuration and operation of the radar sensors checked at a qualified specialist workshop. This also applies to collisions at low speeds where there is no visible damage to the front of the vehicle.

Following damage to the windshield, have the configuration and operation of the camera system checked at a qualified specialist workshop.

Function

► **To activate/deactivate:** activate or deactivate PRE-SAFE® Brake in the on-board computer (► page 190).

If the PRE-SAFE® Brake is not activated, the  symbol appears in the multifunction display.

Starting at a speed of around 4 mph (7 km/h), this function warns you if you rapidly approach a vehicle in front. An intermittent warning tone will then sound and the  distance warning lamp will light up in the instrument cluster.

► Brake immediately to defuse the situation.
or

► Take evasive action provided it is safe to do so.

If there is an increased risk of collision, preventive passenger protection measures (PRE-SAFE®) are activated.

If the risk of collision with the vehicle in front remains and you do not brake, take evasive action or accelerate significantly, the vehicle may perform automatic emergency braking, up to the point of full brake application. Automatic emergency braking is not performed until immediately prior to an imminent accident.

You can prevent the intervention of the PRE-SAFE® Brake at any time by:

- depressing the accelerator pedal further.
- activating kickdown.
- releasing the brake pedal.

The braking action of PRE-SAFE® Brake is ended automatically if:

- you maneuver to avoid the obstacle.
- there is no longer a risk of collision.
- there is no longer an obstacle detected in front of your vehicle.

STEER CONTROL

General information

STEER CONTROL helps you by transmitting a noticeable steering force to the steering wheel in the direction required for vehicle stabilization.

This steering assistance is provided in particular if:

- both right wheels or both left wheels are on a slippery road surface when you brake heavily.
- the vehicle starts to skid.

Important safety notes

- ⓘ Observe the "Important safety notes" section (▷ page 75).

No steering support is provided by STEER CONTROL, if:

- ESP® is malfunctioning.
- the lighting is faulty.

Power steering will, however, continue to function.

Protection against theft

Immobilizer

The immobilizer prevents your vehicle from being started without the correct SmartKey.

- ▶ **To activate with the SmartKey:** remove the SmartKey from the ignition lock.
- ▶ **To activate with KEYLESS-GO:** switch the ignition off and open the driver's door.
- ▶ **To deactivate:** switch on the ignition.

When leaving the vehicle, always take the SmartKey with you and lock the vehicle. Anyone can start the engine if a valid SmartKey has been left inside the vehicle.

- ⓘ The immobilizer is always deactivated when you start the engine.

In the event that the engine cannot be started (yet the vehicle's battery is charged), the system is not operational. Contact an authorized Mercedes-Benz Center or call 1-800-FOR-MERCEdes (in the USA) or 1-800-387-0100 (in Canada).

ATA (anti-theft alarm system)



- ▶ **To arm:** lock the vehicle with the SmartKey or KEYLESS-GO.

Indicator lamp ⓘ flashes. The alarm system is armed after approximately 15 seconds.



- ▶ **To disarm:** unlock the vehicle with the SmartKey or KEYLESS-GO.

or

- ▶ Insert the SmartKey into the ignition lock.

A visual and audible alarm is triggered if the alarm system is armed and you open:

- a door
- the vehicle with the mechanical key
- the trunk lid/tailgate
- the hood

- ▶ **To switch the alarm off with the SmartKey:** press the  or  button on the SmartKey.

The alarm is switched off.

or

- ▶ Remove the Start/Stop button from the ignition lock.
- ▶ Insert the SmartKey into the ignition lock. The alarm is switched off.

- **To stop the alarm using KEYLESS-GO:**
grasp the outside door handle. The SmartKey must be outside the vehicle.
The alarm is switched off.

or

- Press the Start/Stop button on the dashboard. The SmartKey must be inside the vehicle.
The alarm is switched off.

The alarm is not switched off, even if you close the open door that triggered it, for example.

i If the alarm continues for more than 30 seconds, the mbrace emergency call system automatically notifies the Customer Assistance Center. This is done either by text message or data connection. The emergency call system sends the message or data provided that:

- you have subscribed to the mbrace service.
- the mbrace service has been activated properly.
- the necessary mobile phone network is available.

Useful information	90
SmartKey	90
Doors	95
Trunk/cargo compartment	96
Side windows	104
Sliding sunroof	106

Useful information

i This Operator's Manual describes all models and all standard and optional equipment of your vehicle available at the time of publication of the Operator's Manual. Country-specific differences are possible. Please note that your vehicle may not be equipped with all features described. This also applies to safety-related systems and functions.

i Read the information on qualified specialist workshops (▷ page 31).

SmartKey

Important safety notes

WARNING

If children are left unsupervised in the vehicle, they could:

- open the doors, thus endangering other people or road users.
- get out and disrupt traffic.
- operate the vehicle's equipment.

Additionally, children could set the vehicle in motion if, for example, they:

- release the parking brake.
- shifting the automatic transmission out of park position **P**
- Start the engine.

There is a risk of an accident and injury.

When leaving the vehicle, always take the SmartKey with you and lock the vehicle. Never leave children or animals unattended in the vehicle. Always keep the SmartKey out of reach of children.

WARNING

If you attach heavy or large objects to the SmartKey, the SmartKey could be unintentionally turned in the ignition lock. This could cause the engine to be switched off. There is a risk of an accident.

Do not attach any heavy or large objects to the SmartKey. Remove any bulky key rings before inserting the SmartKey into the ignition lock.



- !** Keep the SmartKey away from strong magnetic fields. Otherwise, the remote control function could be affected. Strong magnetic fields can occur in the vicinity of powerful electrical installations.

Do not keep the SmartKey:

- with electronic devices, e.g. a mobile phone or another SmartKey.
- with metallic objects, e.g. coins or metal foil.
- inside metallic objects, e.g. a metal case. This can affect the functionality of the SmartKey.

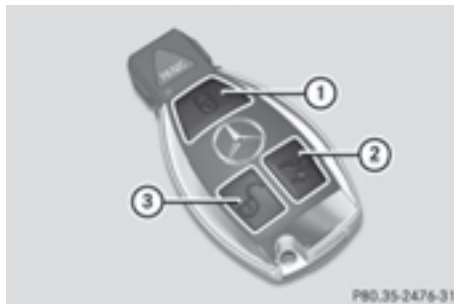
SmartKey functions



- ①  To lock the vehicle
- ②  To open/close the trunk lid/tailgate
- ③  To unlock the vehicle

► **To lock centrally:** press the  button.

The SmartKey centrally locks/unlocks:

- the doors
- the trunk lid/tailgate
- the fuel filler flap

The turn signals flash once when unlocking and three times when locking.

You can also set an audible signal to confirm that the vehicle has been locked. The audible

signal can be activated and deactivated using the on-board computer (▷ page 190).

When it is dark, the surround lighting also comes on if it is activated in the on-board computer (▷ page 190).

KEYLESS-GO

General notes

Bear in mind that the engine can be started by any of the vehicle occupants if there is a KEYLESS-GO key in the vehicle.

Locking/unlocking centrally

You can start, lock or unlock the vehicle using KEYLESS-GO. To do this, you only need carry the SmartKey with you. You can combine the functions of KEYLESS-GO with those of a conventional SmartKey. Unlock the vehicle by using KEYLESS-GO, for instance, and lock it using the  button on the SmartKey.

When locking or unlocking with KEYLESS-GO, the distance between the SmartKey and the corresponding door handle must not be greater than 3 ft (1 m).

A check which periodically establishes a radio connection between the vehicle and the SmartKey determines whether a valid SmartKey is in the vehicle. This occurs, for example:

- when the external door handles are touched
- when starting the engine
- while the vehicle is in motion



▶ **To unlock the vehicle:** touch the inner surface of the door handle.

▶ **To lock the vehicle:** touch sensor surface ①.

▶ **Convenience closing feature:** touch recessed sensor surface ② for an extended period.

For further information on the convenience closing feature, see the Digital Operator's Manual, keyword "Convenience closing".



(Example: Sedan)

▶ **To unlock the trunk lid/tailgate:** pull the handle on the trunk lid/tailgate.

The vehicle only unlocks the trunk lid/tailgate.

Deactivating and activating

If you do not intend to use a key for an extended period of time, you can deactivate the KEYLESS-GO function of the SmartKey. The SmartKey will then use very little power, thereby conserving battery power. For the purposes of activation/deactivation, the vehicle must not be nearby.

▶ **To deactivate:** press the  button on the SmartKey twice in rapid succession. The battery check lamp of the SmartKey (▷ page 93) flashes twice briefly and

lights up once, then KEYLESS-GO is deactivated.

- ▶ **To activate:** press any button on the SmartKey or insert the SmartKey into the ignition lock. KEYLESS-GO and all of its associated features are available again.

Changing the settings of the locking system

You can find information about this in the Digital Operator's Manual.

Mechanical key

General notes

If the vehicle can no longer be locked or unlocked with the SmartKey, use the mechanical key.

If you use the mechanical key to unlock and open the driver's door or the trunk lid/tailgate, the anti-theft alarm system will be triggered (▷ page 87).

There are several ways to turn off the alarm:

- ▶ **To deactivate the alarm with the SmartKey:** press the  or  button on the SmartKey.

or

- ▶ Insert the SmartKey into the ignition lock.

or

- ▶ **To deactivate the alarm with KEYLESS-GO:** press the Start/Stop button in the ignition lock. The SmartKey must be in the vehicle.

or

- ▶ Lock or unlock the vehicle using KEYLESS-GO. The SmartKey must be outside the vehicle.

If you unlock the vehicle using the mechanical key, the fuel filler flap will not be unlocked automatically.

- ▶ **To unlock the fuel filler flap:** insert the SmartKey into the ignition lock.

Removing the mechanical key



- ▶ Push release catch ① in the direction of the arrow and at the same time remove mechanical key ② from the SmartKey.

For further information about:

- unlocking the driver's door (▷ page 96)
- unlocking the trunk (▷ page 103)
- unlocking the tailgate (▷ page 103)
- locking the vehicle (▷ page 96)





Inserting the mechanical key

- ▶ Push mechanical key ② completely into the SmartKey until it engages and release catch ① is back in its basic position.

SmartKey battery

Checking the battery



- ▶ Press the  or  button.
The battery is working properly if battery check lamp ① lights up briefly.
The battery is discharged if battery check lamp ① does not light up briefly.
- ▶ Change the battery (▷ page 93).
- i** If the SmartKey battery is checked within the signal reception range of the vehicle, pressing the  or  button:
 - locks or
 - unlocks the vehicle
- i** You can get a battery at any qualified specialist workshop.

Replacing the battery

You require a CR 2025 3 V cell battery.

- ▶ Take the mechanical key out of the SmartKey (▷ page 92).

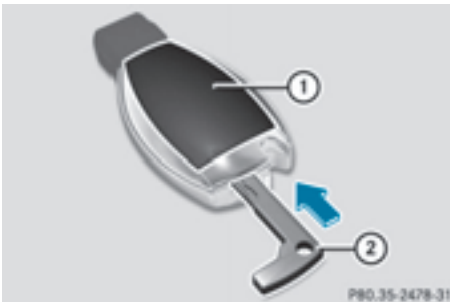

- ▶ Press mechanical key ② into the opening in the SmartKey in the direction of the arrow until battery compartment cover ① opens. Do not hold battery compartment cover ① closed while doing so.
- ▶ Remove battery compartment cover ①.

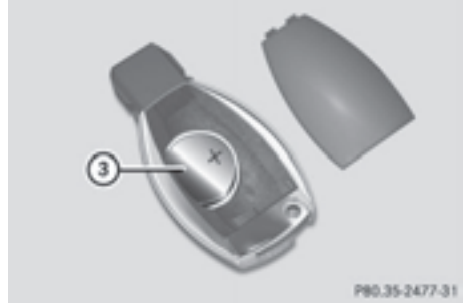

- ▶ Repeatedly tap the SmartKey against your palm until battery ③ falls out.
- ▶ Insert the new battery with the positive terminal facing upwards. Use a lint-free cloth to do so.
- ▶ Make sure that the surface of the battery is free of lint, grease and other contaminants.
- ▶ Insert the front tabs of battery compartment cover ① into the housing and then press to close it.
- ▶ Insert mechanical key ② into the SmartKey.
- ▶ Check the function of all SmartKey buttons on the vehicle.

Problems with the SmartKey

Problem	Possible causes/consequences and ► Solutions
<p>You can no longer lock or unlock the vehicle using the SmartKey.</p>	<p>The SmartKey battery is discharged or nearly discharged.</p> <ul style="list-style-type: none"> ► Check the SmartKey battery (▷ page 93) and replace it if necessary (▷ page 93). <p>If this does not work:</p> <ul style="list-style-type: none"> ► Unlock (▷ page 96) or lock (▷ page 96) the vehicle using the mechanical key. <p>The SmartKey is faulty.</p> <ul style="list-style-type: none"> ► Unlock (▷ page 96) or lock (▷ page 96) the vehicle using the mechanical key. ► Have the SmartKey checked at a qualified specialist workshop.
<p>You can no longer lock or unlock the vehicle using KEYLESS-GO.</p>	<p>The SmartKey battery is discharged or nearly discharged.</p> <ul style="list-style-type: none"> ► Check the SmartKey battery (▷ page 93) and replace it if necessary (▷ page 93). <p>If this does not work:</p> <ul style="list-style-type: none"> ► Unlock (▷ page 96) or lock (▷ page 96) the vehicle using the mechanical key. <p>There is interference from a powerful source of radio waves.</p> <ul style="list-style-type: none"> ► Unlock (▷ page 96) or lock (▷ page 96) the vehicle using the mechanical key. <p>KEYLESS-GO is malfunctioning.</p> <ul style="list-style-type: none"> ► Lock/unlock the vehicle using the remote control function of the SmartKey. ► Have the vehicle and SmartKey checked at a qualified specialist workshop. <p>If the vehicle can also not be locked/unlocked using the remote control function:</p> <ul style="list-style-type: none"> ► Unlock (▷ page 96) or lock (▷ page 96) the vehicle using the mechanical key. ► Have the vehicle and SmartKey checked at a qualified specialist workshop.
<p>You have lost a SmartKey.</p>	<ul style="list-style-type: none"> ► Have the SmartKey deactivated at a qualified specialist workshop. ► Report the loss immediately to the vehicle insurers. ► If necessary, have the locks changed as well.

Problem	Possible causes/consequences and ► Solutions
You have lost the mechanical key.	<ul style="list-style-type: none"> ► Report the loss immediately to the vehicle insurers. ► If necessary, have the locks changed as well.
The engine cannot be started using the SmartKey.	<p>the on-board voltage is too low.</p> <ul style="list-style-type: none"> ► Switch off non-essential consumers, e.g. seat heating or interior lighting, and try to start the engine again. <p>If this does not work:</p> <ul style="list-style-type: none"> ► Check the starter battery and charge it if necessary (► page 278). <p>or</p> <ul style="list-style-type: none"> ► Jump-start the vehicle (► page 279). <p>or</p> <ul style="list-style-type: none"> ► Consult a qualified specialist workshop.
The engine cannot be started using KEYLESS-GO. The SmartKey is in the vehicle.	<p>The vehicle is locked.</p> <ul style="list-style-type: none"> ► Unlock the vehicle and try to start the vehicle again.
	<p>There is interference from a powerful source of radio waves.</p> <ul style="list-style-type: none"> ► Start your vehicle with the SmartKey in the ignition lock.

Doors

Important safety notes

WARNING

If children are left unsupervised in the vehicle, they could:

- open the doors, thus endangering other people or road users.
- get out and disrupt traffic.
- operate the vehicle's equipment.

Additionally, children could set the vehicle in motion if, for example, they:

- release the parking brake.
- shifting the automatic transmission out of park position **P**
- Start the engine.

There is a risk of an accident and injury.

When leaving the vehicle, always take the SmartKey with you and lock the vehicle. Never leave children or animals unattended in the

vehicle. Always keep the SmartKey out of reach of children.

Ideally, place luggage or loads in the trunk/cargo compartment. Observe the loading guidelines (► page 238).

Information in the Digital Operator's Manual

In the Digital Operator's Manual you will find information on the following topics:

- Unlocking and opening doors from the inside
- Centrally locking and unlocking the vehicle from the inside
- Automatic locking feature

Unlocking the driver's door (mechanical key)

If the vehicle can no longer be unlocked with the SmartKey, use the mechanical key.

- ▶ Take the mechanical key out of the SmartKey (▷ page 92).
- ▶ Insert the mechanical key into the lock of the driver's door as far as it will go.



- ▶ Turn the mechanical key counter-clockwise to position **1**.
The door is unlocked.
- ▶ Turn the mechanical key back and remove it.
- ▶ Insert the mechanical key into the SmartKey.

If you use the mechanical key to unlock and open the driver's door, the anti-theft alarm system will be triggered (▷ page 87).

Locking the vehicle (mechanical key)

If the vehicle can no longer be locked with the SmartKey, use the mechanical key.

- ▶ Open the driver's door.
- ▶ Close the front-passenger door, the rear doors and the trunk lid/tailgate.
- ▶ Press the locking button (▷ page 95).
- ▶ Check whether the locking knobs on the front-passenger door and the rear doors are still visible. Press down the locking knobs by hand, if necessary.
- ▶ Close the driver's door.

- ▶ Take the mechanical key out of the SmartKey (▷ page 92).
- ▶ Insert the mechanical key into the lock of the driver's door as far as it will go.



- ▶ Turn the mechanical key clockwise to position **1**.
The door is unlocked.
- ▶ Turn the mechanical key back and remove it.
- ▶ Make sure that the doors and the trunk lid/tailgate are locked.
- ▶ Insert the mechanical key into the SmartKey.

Trunk/cargo compartment**Important safety notes****⚠ WARNING**

Combustion engines emit poisonous exhaust gases such as carbon monoxide. Exhaust gases can enter the vehicle interior if the trunk lid/tailgate is open when the engine is running, especially if the vehicle is in motion. There is a risk of poisoning.

Always switch off the engine before opening the trunk lid/tailgate. Never drive with the trunk lid/tailgate open.

- ❗ The trunk lid/tailgate swings upwards and to the rear when opened. Therefore, make sure that there is sufficient clearance above and behind the trunk lid/tailgate.

Ideally, place luggage or loads in the trunk/cargo compartment. Observe the loading guidelines (▷ page 238).

Do not leave the SmartKey in the trunk/cargo compartment. You could otherwise lock yourself out.

Sedan without the trunk lid convenience closing feature: the trunk lid can be:

- opened and closed manually from outside
- opened automatically from outside
- opened automatically from inside
- locked separately
- opened with the emergency release button
- unlocked with the mechanical key

Sedan with the trunk lid convenience closing feature: the trunk lid can be:

- opened and closed manually from outside
- opened and closed automatically from outside
- opened and closed automatically from inside
- locked separately
- opened with the emergency release button
- unlocked with the mechanical key

Wagon: you can:

- open and close the tailgate manually from outside
- open the tailgate manually from inside (Wagon with a folding bench seat)
- open and close the tailgate automatically from outside
- open and close the tailgate automatically from inside
- limit the opening angle of the tailgate
- unlock the tailgate using the mechanical key

Trunk lid/tailgate reversing feature

The trunk lid/tailgate is equipped with an automatic reversing feature. It reacts if a solid object obstructs or restricts the trunk lid/tailgate during the closing procedure. The

trunk lid/tailgate opens again automatically. The automatic reversing feature is only an aid and is not a substitute for your attentiveness to the trunk lid/tailgate while it is closing.

WARNING

The reversing feature does not react:

- to soft, light and thin objects, e.g. small fingers
- over the last 1/3 in (8 mm) of the closing movement

This means that the reversing feature cannot prevent someone being trapped in these situations. There is a risk of injury.

Make sure that no body parts are in close proximity during the closing procedure.

If somebody becomes trapped:

- press the  button on the SmartKey, or
- pull or press the remote operating switch on the driver's door or
- press the closing or locking button on the trunk lid/tailgate, or
- pull the handle on the trunk lid/tailgate

Opening/closing from outside

Opening



Handle (example: Sedan)

- ▶ Press the  button on the SmartKey.
- ▶ **Sedan:** pull handle ①.
- ▶ Raise the trunk lid.



Wagon: if you pull handle ① and keep it in this position, you can open the tailgate man-

ually. If you release the handle, the tailgate opens automatically.

Closing



Recess (example: Sedan)

- ▶ Pull the trunk lid/tailgate down using recess ①.
- ▶ **Wagon:** let the tailgate drop and engage in the lock.
- ▶ If necessary, lock the vehicle with the  button on the SmartKey (▶ page 90) or with KEYLESS-GO (▶ page 91).
- ▶ If necessary, lock the vehicle with the  button on the SmartKey (▶ page 90) or with KEYLESS-GO (▶ page 91).
- ▶ If necessary, lock the vehicle with the  button on the SmartKey (▶ page 90).

i If a KEYLESS-GO key is detected in the trunk/cargo compartment, the trunk lid/tailgate will not lock.

Sedan: the trunk lid then opens again.

Opening/closing automatically from outside

Important safety notes

WARNING

Parts of the body could become trapped during automatic closing of the trunk lid/tailgate. Moreover, people, e.g. children, may be standing in the closing area or may enter the closing area during the closing process. There is a risk of injury.

Make sure that nobody is in the vicinity of the closing area during the closing process.

Use one of the following options to stop the closing process:

- press the  button on the SmartKey.
- pull or press the remote operating switch on the driver's door.
- press the closing or locking button on the trunk lid/tailgate.
- pull the handle on the trunk lid/tailgate

WARNING

Combustion engines emit poisonous exhaust gases such as carbon monoxide. Exhaust gases can enter the vehicle interior if the trunk lid/tailgate is open when the engine is running, especially if the vehicle is in motion. There is a risk of poisoning.

Always switch off the engine before opening the trunk lid/tailgate. Never drive with the trunk lid/tailgate open.

! The trunk lid/tailgate swings upwards and to the rear when opened. Therefore, make sure that there is sufficient clearance above and behind the trunk lid/tailgate.

Opening

You can open the trunk lid/tailgate automatically with the SmartKey or the handle in the trunk lid/tailgate.

- ▶ Press and hold the  button on the SmartKey until the trunk lid/tailgate opens.

or

- ▶ If the trunk lid/tailgate is unlocked, pull the trunk lid/tailgate handle and let it go again immediately.(▶ page 97)(▶ page 97)

Closing



Closing button and locking button (example: Sedan)

Sedan: on vehicles with the trunk lid remote closing feature, you can close the trunk lid automatically. For vehicles with trunk lid remote closing feature and KEYLESS-GO: you can simultaneously close the trunk lid and lock the vehicle.

Wagon: for vehicles with KEYLESS-GO, you can simultaneously close the tailgate and lock the vehicle.

- ▶ **To close:** press closing button ① in the trunk lid/tailgate.
- ▶ **To simultaneously close the trunk lid/tailgate and lock the vehicle:**

Press closing button ② in the trunk lid/tailgate. The KEYLESS-GO key must be in the rear detection range of the vehicle. The trunk lid/tailgate closes.

If all the doors are closed, the vehicle locks.

- ❗ If KEYLESS-GO detects a SmartKey in the trunk/cargo compartment, the trunk lid/tailgate opens again after it is closed. If KEYLESS-GO detects a second SmartKey outside the vehicle, the trunk lid/tailgate remains closed.

HANDS-FREE ACCESS

Important safety notes

⚠ WARNING

The vehicle's exhaust system may be very hot. You could burn yourself by touching the exhaust system if you use HANDS-FREE ACCESS. There is a risk of injury. Always ensure that you only make the kicking movement within the detection range of sensors.

- ❗ If the key is within the rear detection range of KEYLESS-GO, situations such as the following could lead to the unintentional opening of the trunk lid/tailgate:

- using a car wash
- using a power washer

Make sure that the SmartKey is at least 10 ft (3 m) away from the vehicle.

General notes

Sedan: with KEYLESS-GO and HANDS-FREE ACCESS, you can open or close the trunk lid or stop the closing procedure without using your hands.

Wagon: with KEYLESS-GO and HANDS-FREE ACCESS, you can open or close the tailgate or stop the procedure without using your hands. This is useful if you have your hands full. To do this, make a kicking movement under the bumper with your foot.

Observe the following points:

- Carry your KEYLESS-GO key about your person. The KEYLESS-GO key must be in the rear detection range of the vehicle.
- When making the kicking movement, make sure that you are standing firmly on the ground and that there is sufficient clearance to the rear of the vehicle. You could otherwise lose your balance e.g. on ice.



(Example: Sedan)

- Always ensure that you only make the kicking movement within the detection range of sensors ①.
- Stand at least 12 in (30 cm) away from the rear area while doing so.
- Do not come into contact with the bumper while making the kicking movement. Otherwise, the sensors may not function correctly.
- HANDS-FREE ACCESS does not function when the engine is started.
- If a KEYLESS-GO key is within the rear detection range of KEYLESS-GO, HANDS-FREE ACCESS could be triggered. For this reason, the trunk lid/tailgate could open or close unintentionally, e.g. if you:
 - sit down on the edge of the trunk/edge of the cargo compartment.
 - set something down or lift something up behind the vehicle.
 - polish the rear of the vehicle.

Do not carry the KEYLESS-GO key about your person in these situations or in situations similar to these. You can thus avoid unintentionally opening or closing the trunk lid/tailgate.

- Dirt caused by road salt around sensors ① may restrict functionality.
- Using the HANDS-FREE ACCESS with a prosthetic leg may restrict functionality.

Operation

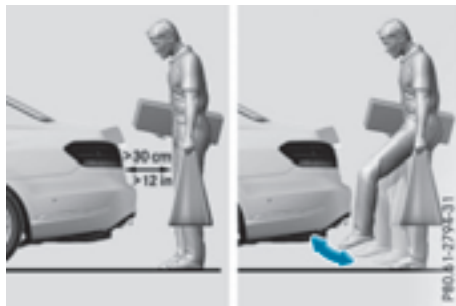

(Example: Sedan)

- ▶ **To open/close:** kick into sensor detection range ① under the bumper with your foot. **Sedan:** you will hear a warning tone while the trunk lid is closing.

Wagon: you will hear a warning tone while the tailgate is opening or closing.

- ▶ **If the trunk lid/tailgate does not open after several attempts:** wait at least ten seconds, then move your foot under the bumper again.

i If you hold your foot under the bumper for too long, the trunk lid/ tailgate does not open or close. Repeat the leg movement more quickly if this occurs.

Sedan: to cancel the closing procedure:

- move your foot in sensor detection range ① under the bumper
 - pull the handle on the outside of the trunk lid
 - press the closing button in the trunk lid, or
 - press the  button on the SmartKey
- If the closing procedure of the trunk lid is canceled, the trunk lid opens again automatically.

Wagon: to stop the opening or closing procedure:

- move your foot in sensor detection range ① under the bumper
- pull the handle on the outside of the tailgate

- press the closing or locking button on the tailgate or
 - press the  button on the SmartKey
- If the tailgate closing procedure has been stopped:
- move your foot under the bumper again and the tailgate will open
- If the tailgate opening procedure has been stopped:
- kick with your foot under the bumper again and the tailgate will close

Opening/closing automatically from inside

Important safety notes

WARNING

Parts of the body could become trapped during automatic closing of the trunk lid/tailgate. Moreover, people, e.g. children, may be standing in the closing area or may enter the closing area during the closing process. There is a risk of injury.

Make sure that nobody is in the vicinity of the closing area during the closing process.

Use one of the following options to stop the closing process:

- press the  button on the SmartKey.
- pull or press the remote operating switch on the driver's door.
- press the closing or locking button on the trunk lid/tailgate.
- pull the handle on the trunk lid/tailgate

WARNING

The trunk lid/tailgate can be automatically opened or closed even if the SmartKey is not in the vehicle. If children are left unsupervised in the vehicle, they could activate the functions. There is a risk of injury.

When leaving the vehicle, always take the SmartKey with you and lock the vehicle. Never leave children unsupervised in the vehicle.

WARNING

Combustion engines emit poisonous exhaust gases such as carbon monoxide. Exhaust gases can enter the vehicle interior if the trunk lid/tailgate is open when the engine is running, especially if the vehicle is in motion. There is a risk of poisoning.

Always switch off the engine before opening the trunk lid/tailgate. Never drive with the trunk lid/tailgate open.

- ! The trunk lid/tailgate swings upwards and to the rear when opened. Therefore, make sure that there is sufficient clearance above and behind the trunk lid/tailgate.

Opening and closing



- ▶ **To open:** pull remote operating switch for the trunk lid/tailgate ① until the trunk lid/tailgate opens.
- ▶ **To close (Sedan):** press remote operating switch for trunk lid ① until the trunk lid is completely closed.
- ▶ **To close (Wagon):** turn the SmartKey to position 1 or 2 in the ignition lock.
- ▶ Press remote operating switch for tailgate ① until the tailgate is completely closed.

You can open and close the trunk lid/tailgate from the driver's seat when the vehicle is stationary and unlocked.

Limiting the opening angle of the tailgate (Wagon)

Important safety notes

- ! Make sure there is sufficient clearance to open the tailgate fully when setting the opening angle. The tailgate could otherwise be damaged. Ideally, set the opening angle outside.

Activating

You can limit the opening angle of the tailgate. This is possible in the top half of its opening range, up to approximately 8 in (20 cm) before the stop.

- ▶ **To open the tailgate:** pull the handle on the tailgate.
- ▶ **To stop the opening procedure at the desired position:** press the closing button (▷ page 98) in the tailgate or pull the handle on the outside of the tailgate again.
- ▶ **To store the position:** press and hold the closing button in the tailgate until you hear a short tone. The opening angle limiter is activated. The tailgate will now stop in the stored position when opening.

Deactivating

- ▶ Press and hold the closing button (▷ page 98) in the tailgate until you hear two short tones.

Opening the tailgate from inside the vehicle (Wagon with a folding bench seat)

General notes

- ! The tailgate swings upwards and to the rear when opened. Therefore, make sure that there is sufficient clearance above and behind the tailgate.

- i Tailgate opening dimensions (▷ page 344).

Opening



Inside of tailgate

- ▶ **To unlock the tailgate:** slide locking catch ② to the right.
- ▶ **To open:** pull the top of handle ①.
- ▶ Swing the tailgate upwards.
- ▶ **To lock the tailgate:** slide locking catch ② to the left.

Locking the trunk separately (Sedan)

You can lock the trunk separately. If you then unlock the vehicle centrally, the trunk remains locked and cannot be opened.

- ▶ Close the trunk lid.
- ▶ Take the mechanical key out of the Smart-Key (▷ page 92).

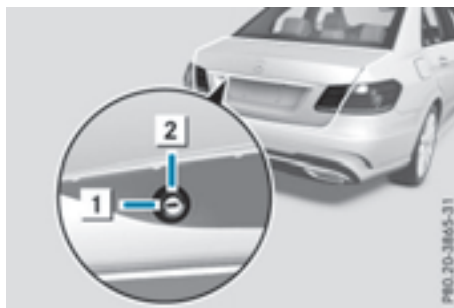

- ▶ Insert the mechanical key into the trunk lid lock as far as it will go.
- ▶ Turn the mechanical key clockwise from position **1** to position **2**.
- ▶ Remove the mechanical key.
- ▶ Insert the mechanical key into the SmartKey.

Unlocking the trunk (Sedan)

! The trunk lid swings upwards when opened. Therefore, make sure that there is sufficient clearance above the trunk lid.

If the trunk cannot be unlocked with the SmartKey or KEYLESS-GO, use the mechanical key.

If you use the mechanical key to unlock and open the trunk lid, the anti-theft alarm system will be triggered (▷ page 87).

- ▶ Take the mechanical key out of the SmartKey (▷ page 92).
- ▶ Insert the mechanical key into the trunk lid lock as far as it will go.

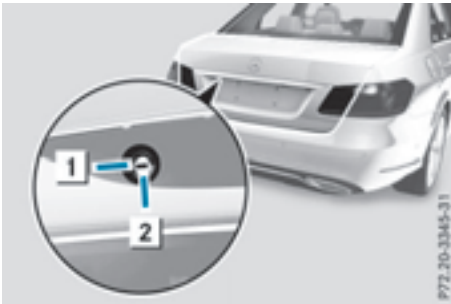

- ▶ Turn the mechanical key from position **1** counter-clockwise as far as it will go to position **2**.
The trunk is unlocked.
- ▶ Turn the mechanical key back to position **1** and remove it.
- ▶ Insert the mechanical key into the SmartKey.

Trunk emergency release (Sedan)

You can open the trunk lid from inside the vehicle with the emergency release button.



- ▶ Press emergency release button **1** briefly.
The trunk lid unlocks and opens.

The trunk lid can be unlocked and opened with the trunk lid emergency release when the vehicle is stationary or while driving.

The trunk lid emergency release does not open the trunk lid if the battery is disconnected or discharged.

Trunk lid emergency release light:

- emergency release button **1** flashes for 30 minutes after the trunk lid is opened.
- emergency release button **1** flashes for 60 minutes after the trunk lid is closed.

Tailgate emergency release (Wagon)

General notes

! The tailgate swings upwards and to the rear when opened. Therefore, make sure that there is sufficient clearance above and behind the tailgate.

- i** Tailgate opening dimensions (▷ page 344).

If the tailgate can no longer be opened from outside the vehicle, use the emergency release on the inside of the tailgate.

On vehicles with a folding bench seat, you can use the handle to open the tailgate from inside the vehicle (▷ page 97).

Opening

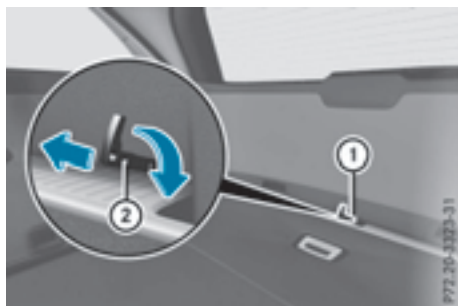

- ▶ Fold the rear seat backrest forwards (▷ page 241).
- ▶ Remove cargo compartment cover (▷ page 243).
- ▶ Take the mechanical key out of the SmartKey (▷ page 92).
- ▶ Insert mechanical key ② into the opening in paneling ①.
- ▶ Turn mechanical key ② 90° clockwise.
- ▶ Push mechanical key ② in the direction of the arrow and open the tailgate.
- ▶ Insert the mechanical key into the SmartKey.

Side windows

Important safety notes

WARNING

While opening the side windows, body parts could become trapped between the side window and the door frame as the side window moves. There is a risk of injury.

Make sure that nobody touches the side window during the opening procedure. If somebody becomes trapped, release the switch or pull the switch to close the side window again.

WARNING

While closing the side windows, body parts in the closing area could become trapped. There is a risk of injury.

When closing make sure that no parts of the body are in the closing area. If somebody becomes trapped, release the switch or press the switch to open the side window again.

WARNING

If children operate the side windows they could become trapped, particularly if they are left unsupervised. There is a risk of injury.

Activate the override feature for the rear side windows. When leaving the vehicle, always take the SmartKey with you and lock the vehicle. Never leave children unsupervised in the vehicle.

Side window reversing feature

The side windows are equipped with an automatic reversing feature. If a solid object blocks or restricts a side window during the closing process, the side window opens again automatically. However, the automatic reversing feature is only an aid and does not relieve you of the responsibility of paying attention when closing a side window.

WARNING

The reversing feature does not react:

- to soft, light and thin objects, e.g. small fingers
- over the last 1/6 in(4 mm) of the closing movement
- during resetting
- when closing the side window again manually immediately after automatic reversing

This means that the reversing feature cannot prevent someone being trapped in these situations. There is a risk of injury.

Make sure that no body parts are in close proximity during the closing procedure. If someone becomes trapped, press the switch to open the side window again.

Information in the Digital Operator's Manual

In the Digital Operator's Manual you will find information on the following topics:

- Opening and closing the side windows
- Convenience opening
- Convenience closing feature
- Resetting the side windows

Problems with the side windows

WARNING

If you close a side window again immediately after it has been blocked or reset, the side window closes with increased or maximum force. The reversing feature is then not active. Parts of the body could be trapped in the closing area in the process. This poses an increased risk of injury or even fatal injury.

Make sure that no parts of the body are in the closing area. To stop the closing process, release the switch or push the switch again to reopen the side window.

Problem	Possible causes/consequences and ► Solutions
A side window cannot be closed because it is blocked by objects, e.g. leaves in the window guide.	<ul style="list-style-type: none"> ► Remove the objects. ► Close the side window.
A side window cannot be closed and you cannot see the cause.	<p>If a side window is obstructed during closing and reopens again slightly:</p> <ul style="list-style-type: none"> ► Immediately after the window blocks, pull the corresponding switch again until the side window has closed. The side window is closed with increased force. <p>If a side window is obstructed again during closing and reopens again slightly:</p> <ul style="list-style-type: none"> ► Immediately after the window blocks, pull the corresponding switch again until the side window has closed. The side window is closed without the anti-entrapment feature.

Sliding sunroof

Important safety notes

Your vehicle may be equipped with a sliding sunroof or a panorama roof with power tilt/sliding panel. In this section, the term "sliding sunroof" refers to both types of sliding sunroof.

WARNING

While opening and closing the sliding sunroof, body parts in close proximity could become trapped. There is a risk of injury.

Make sure that no body parts are in close proximity during the opening and closing procedures.

If somebody becomes trapped:

- release the switch immediately, or
- during automatic operation, push the switch briefly in any direction

The opening or closing procedure will be stopped.

WARNING

If children operate the sliding sunroof they could become trapped, particularly if they are left unsupervised. There is a risk of injury.

When leaving the vehicle, always take the SmartKey with you and lock the vehicle. Never leave children unsupervised in the vehicle.

! Only open the sliding sunroof if it is free of snow and ice. Otherwise, malfunctions may occur.

Do not allow anything to protrude from the sliding sunroof. Otherwise, the seals could be damaged.

! The weather can change abruptly. It could start to rain or snow. Make sure that the sliding sunroof is closed when you leave the vehicle. The vehicle electronics can be damaged if water enters the vehicle interior.

i Resonance noises can occur in addition to the usual airflow noises when the sliding sunroof is open. They are caused by minor pressure fluctuations in the vehicle interior. Change the position of the sliding sunroof or open a side window slightly to reduce or eliminate these noises.

Sliding sunroof reversing feature

Your vehicle may be equipped with a sliding sunroof or a panorama roof with power tilt/sliding panel. In this section, the term "sliding sunroof" refers to both types of sliding sunroof.

The sliding sunroof is equipped with an automatic reversing feature. If a solid object blocks or restricts the sliding sunroof during the closing process, the sliding sunroof opens again automatically. However, the automatic reversing feature is only an aid and does not relieve you of the responsibility of paying attention when closing the sliding sunroof.

⚠ WARNING

The reversing feature does not react:

- to soft, light and thin objects, e.g. small fingers
- over the last 1/6 in (4 mm) of the closing movement
- during resetting
- when closing the sliding sunroof again manually immediately after automatic reversing

This means that the reversing feature cannot prevent someone being trapped in these situations. There is a risk of injury.

Make sure that no body parts are in close proximity during the closing procedure.

If somebody becomes trapped:

- release the switch immediately, or
- press the switch in any direction during the automatic closing process

The closing process is stopped.

Operating the sliding sunroof

Opening and closing

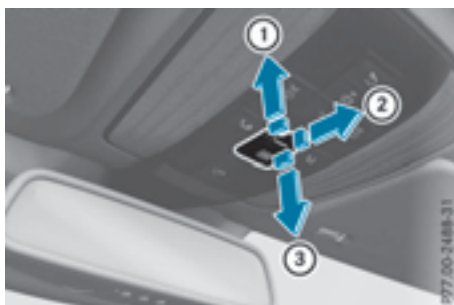

Overhead control panel

- ① To raise
- ② To open
- ③ To close/lower

► Turn the SmartKey to position **1** or **2** in the ignition lock.

► Press or pull the  switch in the corresponding direction.

i If you press the  switch beyond the point of resistance, an automatic opening/closing process is started in the corresponding direction. You can stop automatic operation by pressing/pulling the switch again.

i The automatic opening and raising feature is available only when the sliding sunroof is closed.

The sun protection cover automatically opens along with the sliding sunroof. You can open or close the sun protection cover manually when the sliding sunroof is raised or closed.

- i** You can continue to operate the sliding sunroof after switching off the engine or removing the SmartKey from the ignition lock. This function remains active for five minutes or until you open a front door.

Resetting

- !** If the sliding sunroof still cannot be opened or closed fully after resetting, contact a qualified specialist workshop.

Reset the sliding sunroof if it does not move smoothly.

- ▶ Turn the SmartKey to position **2** in the ignition lock.
- ▶ Raise the sliding sunroof fully at the rear (▷ page 107).
- ▶ Keep the  switch pressed for another second.
- ▶ Make sure that the sliding sunroof can be fully opened and closed again (▷ page 107).
- ▶ If this is not the case, repeat the steps above again.

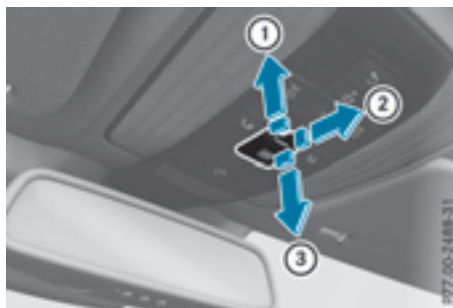

Operating the panorama roof with power tilt/sliding panel



Overhead control panel

- ① To raise
- ② To open
- ③ To close/lower

The panorama roof with power tilt/sliding panel can only be operated when the roller sunblind is open.

- ▶ **To open and close:** turn the SmartKey to position **1** or **2** in the ignition lock.
- ▶ Press or pull the  switch in the corresponding direction.
- i** If you press the  switch beyond the point of resistance, an automatic opening/closing process is started in the corresponding direction. You can stop automatic operation by pressing/pulling the switch again.

Operating the roller sunblind for the panorama roof with power tilt/sliding panel

Important safety notes

WARNING

Parts of the body could become trapped between the roller sunblind and frame or sliding sunroof during automatic opening or closing. There is a risk of injury.

When opening or closing, make sure that no body parts are in the sweep of the roller sunblind.

If somebody becomes trapped:

- release the switch immediately, or
- during automatic operation, push the switch briefly in any direction

The opening/closing process is briefly stopped. The roller sunblind then returns to its initial position.

The roller sunblind shields the vehicle interior from sunlight. The two roller sunblinds can only be opened and closed together when the panorama roof with power tilt/sliding panel is closed.

Roller sunblind reversing feature

The roller sunblind is equipped with an automatic reversing feature. If a solid object blocks or restricts the roller sunblind during the closing process, the roller sunblind opens again automatically. The automatic reversing feature is only an aid and is not a substitute for your attentiveness to the roller sunblind while it is closing.

WARNING

The reversing function does not react in particular to soft, light and thin objects, e.g. small fingers. This means that the reversing feature cannot prevent someone being trapped in these situations. There is a risk of injury.

When closing the roller sunblind, make sure that no body parts are in the sweep area.

If somebody becomes trapped:

- release the switch immediately, or
- press the switch in any direction during the automatic closing process

The closing process is briefly stopped. The roller sunblind then returns to its initial position.

Opening and closing

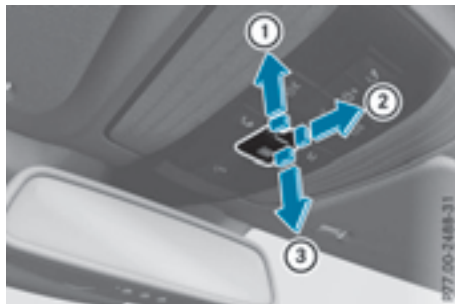

Overhead control panel

- ① To raise
- ② To open
- ③ To close/lower

► Turn the SmartKey to position **1** or **2** in the ignition lock.

► Press or pull the  switch in the corresponding direction.

i If you press or pull the  switch beyond the point of resistance, an automatic opening/closing process is started in the corresponding direction. You can stop automatic operation by pressing or pulling again.

Resetting the panorama roof with power tilt/sliding panel and roller sunblind



! If the panorama roof with power tilt/sliding panel and the roller sunblinds cannot be fully opened or closed after resetting, contact a qualified specialist workshop.

Reset the panorama roof with power tilt/sliding panel and the roller sunblinds if the panorama roof with power tilt/sliding panel or the roller sunblinds do not move smoothly.

► Turn the SmartKey to position **1** or **2** in the ignition lock.

► Pull the  switch repeatedly to the point of resistance in the direction of arrow **③**

until the panorama roof with power tilt/sliding panel is fully closed (▷ page 109).

- ▶ Keep the  switch pulled for an additional second.
- ▶ Pull the  switch repeatedly to the point of resistance in the direction of arrow ③ until the roller sunblinds are fully closed.
- ▶ Keep the  switch pulled for an additional second.
- ▶ Make sure that the panorama roof with power tilt/sliding panel (▷ page 108) and the roller sunblinds (▷ page 109) can be fully opened again.
- ▶ If this is not the case, repeat the steps above again.

Problems with the sliding sunroof

Your vehicle may be equipped with a sliding sunroof or a panorama roof with power tilt/sliding panel. In this section, the term "sliding sunroof" refers to both types of sliding sunroof.

WARNING

If you close the sliding sunroof again immediately after it has been blocked or reset, the sliding sunroof closes with increased or maximum force. The reversing feature is then not active. Parts of the body could be trapped in the closing area in the process. This poses an increased risk of injury or even fatal injury.



Make sure that no parts of the body are in the closing area.

If somebody becomes trapped:

- release the switch immediately, or
- press the switch in any direction during the automatic closing process

The closing process is stopped.

! If the sliding sunroof still cannot be opened or closed as a result of a malfunction, contact a qualified specialist workshop.

Problem	Possible causes/consequences and ► Solutions
The sliding sunroof cannot be closed and you cannot see the cause.	<p>If the sliding sunroof is obstructed during closing and reopens again slightly:</p> <p>► Immediately after the sliding sunroof blocks, pull the  switch in the overhead control panel down to the point of resistance and hold it until the sliding sunroof is closed. The sliding sunroof is closed with increased force.</p> <p>If the sliding sunroof is obstructed again during closing and then reopens slightly:</p> <p>► Immediately after the sliding sunroof blocks, pull the  switch in the overhead control panel down to the point of resistance and hold it until the sliding sunroof is closed. The sliding sunroof is closed without the anti-entrapment feature.</p>

Useful information	114
Correct driver's seat position	114
Seats	115
Steering wheel	117
Mirrors	117
Memory function	117

Useful information

- i** This Operator's Manual describes all models and all standard and optional equipment of your vehicle available at the time of publication of the Operator's Manual. Country-specific differences are possible. Please note that your vehicle may not be equipped with all features described. This also applies to safety-related systems and functions.
- i** Read the information on qualified specialist workshops (▷ page 31).

Correct driver's seat position

⚠ WARNING

You could lose control of your vehicle if you do the following while driving:

- adjust the driver's seat, head restraint, steering wheel or mirrors
- fasten the seat belt

There is a risk of an accident.

Adjust the driver's seat, head restraint, steering wheel and mirror and fasten your seat belt before starting the engine.



- ▶ Observe the safety guidelines on seat adjustment (▷ page 115).
- ▶ Make sure that seat ③ is adjusted properly.

Electrical seat adjustment (▷ page 116)

When adjusting the seat, make sure that:

- you are as far away from the driver's air bag as possible
- you are sitting in a normal upright position
- you can fasten the seat belt properly
- you have moved the backrest to an almost vertical position
- you have set the seat cushion angle so that your thighs are gently supported
- you can depress the pedals properly
- ▶ Check whether the head restraint is adjusted properly.

When doing so, make sure that you have adjusted the head restraint so that the back of your head is supported at eye level by the center of the head restraint.

- ▶ Observe the safety guidelines on steering wheel adjustment (▷ page 117).
- ▶ Make sure that steering wheel ① is adjusted properly.

Adjusting the steering wheel electrically
(▷ page 117)

When adjusting the steering wheel, make sure that:

- you can hold the steering wheel with your arms slightly bent
- you can move your legs freely
- you can see all the displays in the instrument cluster clearly
- ▶ Observe the safety guidelines for seat belts (▷ page 50).
- ▶ Check whether you have fastened seat belt ② properly (▷ page 52).

The seat belt should:

- fit snugly across your body
- be routed across the middle of your shoulder
- be routed in your pelvic area across the hip joints
- ▶ Before starting off, adjust the rear-view mirror and the exterior mirrors in such a way that you have a good view of road and traffic conditions (▷ page 117).
- ▶ **Vehicles with a memory function:** save the seat, steering wheel and exterior mirror settings with the memory function (▷ page 117).

Seats

Important safety notes

WARNING

Children could become trapped if they adjust the seats, particularly when unattended. There is a risk of injury.

When leaving the vehicle, always take the SmartKey with you and lock the vehicle. Never leave children unsupervised in the vehicle.

The seats can still be adjusted when there is no SmartKey in the ignition lock.

WARNING

If the head restraints are not installed or not adjusted correctly, they cannot provide protection as intended. There is an increased risk of injury in the head and neck area, e.g. in the event of an accident or when braking.

Always drive with the head restraints installed. Before driving off, make sure for every vehicle occupant that the center of the head restraint supports the back of the head at about eye level.

Observe the safety notes on "Air bags" (▷ page 54) and "Children in the Vehicle" (▷ page 68).

WARNING

You could lose control of your vehicle if you do the following while driving:

- adjust the driver's seat, head restraint, steering wheel or mirrors
- fasten the seat belt

There is a risk of an accident.

Adjust the driver's seat, head restraint, steering wheel and mirror and fasten your seat belt before starting the engine.

WARNING

If you adjust the seat height carelessly, you or other vehicle occupants could be trapped and thereby injured. Children in particular could accidentally press the electrical seat adjustment buttons and become trapped. There is a risk of injury.

While moving the seats, make sure that your hands or other body parts do not get under the lever assembly of the seat adjustment system.

WARNING

When you adjust a seat, you or other vehicle occupants could become trapped, e.g. on the seat guide rail. There is a risk of injury.

Make sure when adjusting a seat that no one has any body parts in the sweep of the seat.

! To avoid damage to the seats and the seat heating, observe the following information:

- keep liquids from spilling on the seats. If liquid is spilled on the seats, dry them as soon as possible.
- if the seat covers are damp or wet, do not switch on the seat heating. The seat heating should also not be used to dry the seats.
- clean the seat covers as recommended; see the "Interior care" section.
- do not transport heavy loads on the seats. Do not place sharp objects on the seat cushions, e.g. knives, nails or tools. The seats should only be occupied by passengers, if possible.
- when the seat heating is in operation, do not cover the seats with insulating materials, e.g. blankets, coats, bags, seat covers, child seats or booster seats.

! Make sure that there are no objects in the footwell under or behind the seats when moving the seats back. There is a risk that the seats and/or the objects could be damaged.

i The head restraints in the front seats are installed with the NECK-PRO system (> page 65). For this reason, it is not possible to remove the head restraints from the front seats.

Vehicles without the through-loading feature: the head restraints cannot be removed from the rear compartment seats. For more information, contact a qualified specialist workshop.

Information in the Digital Operator's Manual

In the Digital Operator's Manual you will find information on the following topics:

- Adjusting the seats
- Adjusting the head restraints
- Adjusting the active multicontour seat

- Adjusting the 4-way lumbar support
- Folding bench seat in the cargo compartment (Wagon)
- Switching the seat ventilation on/off

Switching the seat heating on/off

Switching on/off

! WARNING

Repeatedly switching on the seat heating can cause the seat cushion and backrest pads to become very hot. The health of persons with limited temperature sensitivity or a limited ability to react to excessively high temperatures may be affected or they may even suffer burn-like injuries. There is a risk of injury. Therefore, do not switch the seat heating on repeatedly.



Driver's and front-passenger seat



Canada only: rear seat

The three red indicator lamps in the button indicate the heating level you have selected.

Driver's and front-passenger seat: the system automatically switches down from level **3** to level **2** after approximately eight minutes.

Rear seat: the system automatically switches down from level **3** to level **2** after approximately five minutes.

The system automatically switches down from level **2** to level **1** after approximately ten minutes.

The system automatically switches off approximately 20 minutes after it is set to level **1**.

- ▶ Turn the SmartKey to position **1** or **2** in the ignition lock (▷ page 137).
 - ▶ **To switch on:** press button ① repeatedly until the desired heating level is set.
 - ▶ **To switch off:** press button ① repeatedly until all the indicator lamps go out.
- i** If the battery voltage is too low, the seat heating may switch off.

Problems with the seat heating

You can find information about this in the Digital Operator's Manual.

Steering wheel

Important safety notes

WARNING

You could lose control of your vehicle if you do the following while driving:

- adjust the driver's seat, head restraint, steering wheel or mirrors
- fasten the seat belt

There is a risk of an accident.

Adjust the driver's seat, head restraint, steering wheel and mirror and fasten your seat belt before starting the engine.

WARNING

Children could injure themselves if they adjust the steering wheel. There is a risk of injury.

When leaving the vehicle, always take the SmartKey with you and lock the vehicle. Never leave children unsupervised in the vehicle.

The electrically adjustable steering wheel can still be adjusted when there is no SmartKey in the ignition lock.

Information in the Digital Operator's Manual

In the Digital Operator's Manual you will find information on the following topics:

- Adjusting the steering wheel
- Steering wheel heating
- EASY-ENTRY/EXIT feature

Mirrors

In the Digital Operator's Manual you will find information on the following topics:

- Rear-view mirror
- Exterior mirrors
- Automatic anti-glare mirrors
- Parking position for the exterior mirror on the front-passenger side

Memory function

In the Digital Operator's Manual you will find information on the following topics:

- Storing settings
- Calling up a stored setting

Useful information	120
Exterior lighting	120
Interior lighting	123
Replacing bulbs	123
Windshield wipers	125

Useful information

i This Operator's Manual describes all models and all standard and optional equipment of your vehicle available at the time of publication of the Operator's Manual. Country-specific differences are possible. Please note that your vehicle may not be equipped with all features described. This also applies to safety-related systems and functions.

i Read the information on qualified specialist workshops (▷ page 31).

Exterior lighting

General notes

For reasons of safety, Mercedes-Benz recommends that you drive with the lights switched on even during the daytime. Therefore, your vehicle is equipped with special daytime running lamps. In some countries, operation of the headlamps varies due to legal requirements and self-imposed obligations.

If you wish to drive during the daytime without lights, switch off the daytime running lamps function in the on-board computer (▷ page 190).

Information in the Digital Operator's Manual

In the Digital Operator's Manual you will find information on the following topics:

- Hazard warning lamps
- Headlamps fogged up on the inside

Setting the exterior lighting

Setting options

Exterior lighting can be set using:

- the light switch
- the combination switch (▷ page 121)
- the on-board computer (▷ page 190)

Light switch

Operation

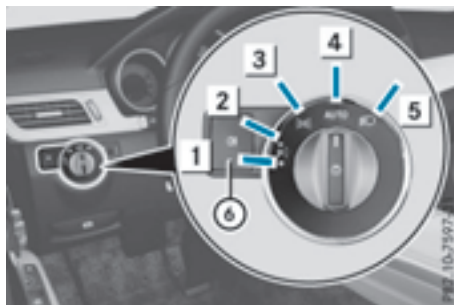

- | | | |
|----------|-------------|--|
| 1 | | Left-hand standing lamps |
| 2 | | Right-hand standing lamps |
| 3 | | Parking lamps, license plate and instrument cluster lighting |
| 4 | AUTO | Automatic headlamp mode, controlled by the light sensor |
| 5 | | Low-beam/high-beam headlamps |
| 6 | | Rear fog lamp |

If you hear a warning tone when you leave the vehicle, the lights may still be switched on.

► Turn the light switch to **AUTO**.

The exterior lighting (except the parking/standing lamps) switches off automatically if you:

- remove the SmartKey from the ignition lock
- open the driver's door with the SmartKey in position **0**

Information in the Digital Operator's Manual

In the Digital Operator's Manual you will find information on the following topics:

- Automatic headlamp mode
- Daytime running lamps
- Low-beam headlamps
- Rear fog lamp
- Parking lamps
- Standing lamps

Combination switch

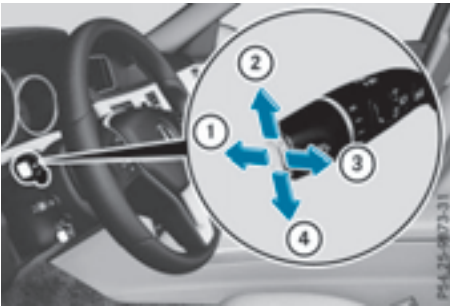

- ① High-beam headlamps
- ② Turn signal, right
- ③ High-beam flasher
- ④ Turn signal, left

In the Digital Operator's Manual you will find information on the following topics:

- Turn signal
- High-beam headlamps
- High-beam flasher

Cornering light function



The cornering light function improves the illumination of the road over a wide angle in the direction you are turning, enabling better visibility in tight bends, for example. It can only be activated when the low-beam headlamps are switched on.

Active:

- if you are driving at speeds below 25 mph (40 km/h) and switch on the turn signal or turn the steering wheel
- if you are driving at speeds between 25 mph (40 km/h) and 45 mph (70 km/h) and turn the steering wheel

The cornering lamp may remain lit for a short time, but is automatically switched off after no more than three minutes.

Adaptive Highbeam Assist

General notes



You can use this function to set the headlamps to change between low beam and high beam automatically. The system recognizes vehicles with their lights on, either approaching from the opposite direction or traveling in front of your vehicle, and consequently switches the headlamps from high beam to low beam.

The system automatically adapts the low-beam headlamp range depending on the distance to the other vehicle. Once the system no longer detects any other vehicles, it reactivates the high-beam headlamps.

The system's optical sensor is located behind the windshield near the overhead control panel.

Important safety notes

WARNING

Adaptive Highbeam Assist does not recognize road users:

- who have no lights, e.g. pedestrians
- who have poor lighting, e.g. cyclists
- whose lighting is blocked, e.g. by a barrier

In very rare cases, Adaptive Highbeam Assist may fail to recognize other road users that have lights, or may recognize them too late. In this or similar situations, the automatic high-beam headlamps will not be deactivated or activated regardless. There is a risk of an accident.

Always carefully observe the traffic conditions and switch off the high-beam headlamps in good time.

Adaptive Highbeam Assist cannot take into account road, weather or traffic conditions. Adaptive Highbeam Assist is only an aid. You are responsible for adjusting the vehicle's lighting to the prevailing light, visibility and traffic conditions.

In particular, the detection of obstacles can be restricted if there is:

- poor visibility, e.g. due to fog, heavy rain or snow
- dirt on the sensors or the sensors are obscured

Switching Adaptive Highbeam Assist on/off

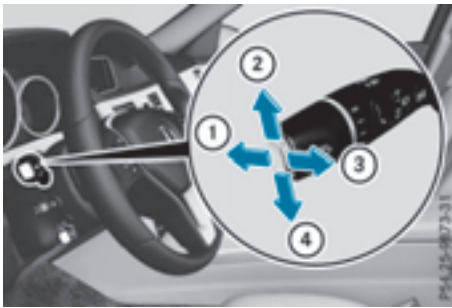

- ① High-beam headlamps
- ② Turn signal, right
- ③ High-beam flasher
- ④ Turn signal, left

- ▶ **To switch on:** turn the light switch to **AUTO**.
- ▶ Press the combination switch beyond the pressure point in the direction of arrow ①. The  indicator lamp in the multifunction display lights up when it is dark and the light sensor activates the low-beam headlamps.



If you are driving at speeds above approximately 16 mph (25 km/h):

The headlamp range is set automatically depending on the distance between the vehicle and other road users.

If you are driving at speeds above approximately 19 mph (30 km/h) and no other road users have been detected:

The high-beam headlamps are switched on automatically. The  indicator lamp in the instrument cluster also lights up.

If you are driving at speeds below approximately 16 mph (25 km/h) or other road users have been detected or the roads are adequately lit:

The high-beam headlamps are switched off automatically. The  indicator lamp in the instrument cluster goes out. The 

indicator lamp in the multifunction display remains lit.

- ▶ **To switch off:** move the combination switch back to its normal position or move the light switch to another position. The  indicator lamp in the instrument cluster goes out.

Interior lighting

An overview of the interior lighting and the overhead control panel can be found in the "At a glance" section.

In the Digital Operator's Manual you will find information on the following topics:

- Automatic interior lighting control
- Manual interior lighting control
- Crash-responsive emergency lighting

Replacing bulbs

Important safety notes

WARNING

Bulbs, lamps and connectors can get very hot when operating. If you change a bulb, you could burn yourself on these components. There is a risk of injury.

Allow these components to cool down before changing a bulb.

Vehicles with static LED headlamps:

Do not use a bulb that has been dropped or if its glass tube has been scratched.

The bulb may explode if:

- you touch it
- it is hot
- you drop it
- you scratch it

Only operate bulbs in enclosed lamps designed for that purpose. Only install spare bulbs of the same type and the specified voltage.

Marks on the glass tube reduce the service life of the bulbs. Do not touch the glass tube with your bare hands. If necessary, clean the glass tube when cold with alcohol or spirit and rub it off with a lint-free cloth.

Protect bulbs from moisture during operation. Do not allow bulbs to come into contact with liquids.

Replace only the bulbs listed (▷ page 124). Have the bulbs that you cannot replace yourself changed at a qualified specialist workshop.

If you require assistance changing bulbs, consult a qualified specialist workshop.

If the new bulb still does not light up, consult a qualified specialist workshop.

Bulbs and lamps are an important aspect of vehicle safety. You must therefore make sure that these function correctly at all times.

Have the headlamp setting checked regularly.

Vehicles with static LED headlamps

The front and rear light clusters of your vehicle are equipped with LED light bulbs. Do not replace the bulbs yourself. Contact a qualified specialist workshop which has the necessary specialist knowledge and tools to carry out the work required.

Lamps are an important aspect of vehicle safety. You must therefore make sure that these function correctly at all times. Have the headlamp setting checked regularly.

Overview: changing bulbs/bulb types

You can change the following bulbs. The bulb type can be found in the legend.



Static LED headlamps

- ① High-beam headlamp: H7 55 W
- ② Turn signal lamp: PSY 24 W

Changing the front bulbs

High-beam headlamps (static LED headlamps)

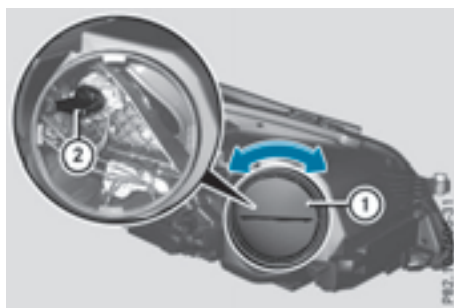

- ▶ Switch off the lights.
- ▶ Open the hood.
- ▶ Turn housing cover ① counter-clockwise and pull it out.
- ▶ Using the handle extension, turn bulb holder ② counter-clockwise and pull it out.
- ▶ Take the bulb out of bulb holder ②.
- ▶ Insert the new bulb into bulb holder ②.
- ▶ Insert bulb holder ② into the lamp and turn it clockwise.
- ▶ Align housing cover ① and turn it clockwise until it engages.

Turn signal (static LED headlamps)

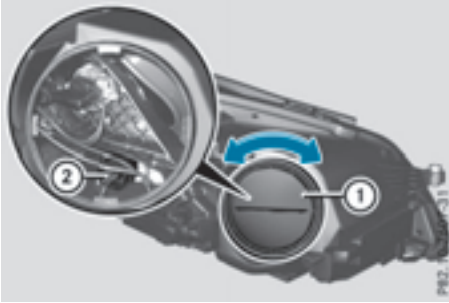

- ▶ Switch off the lights.
- ▶ Open the hood.
- ▶ Turn housing cover ① counter-clockwise and pull it out.
- ▶ Turn bulb holder ② counter-clockwise and pull it out.
- ▶ Take the bulb out of bulb holder ②.
- ▶ Insert the new bulb into bulb holder ②.
- ▶ Insert bulb holder ② into the lamp and turn it clockwise.
- ▶ Align housing cover ① and turn it clockwise until it engages.

Windshield wipers

Switching the windshield wipers on/off

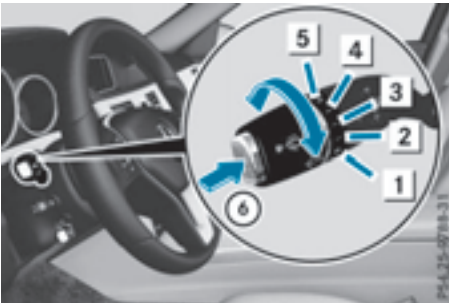

- ① 0 Windshield wiper off
- ② ... Intermittent wipe, low (rain sensor set to low sensitivity)
- ③ Intermittent wipe, high (rain sensor set to high sensitivity)

- ④ — Continuous wipe, slow
- ⑤ = Continuous wipe, fast
- ⑥ ☔ Single wipe
- ☔ To wipe with washer fluid

If the wiper blades are worn, the windshield will no longer be wiped properly. This could prevent you from observing the traffic conditions.

Switching the rear window wiper on/off

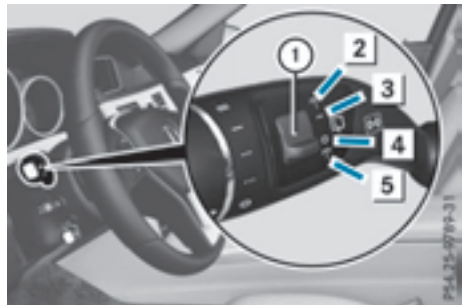

- ① ☐ Switch
- ② ☔ Wipes with washer fluid
- ③ | Switches on intermittent wiping
- ④ 0 Switches off intermittent wiping
- ⑤ ☔ Wipes with washer fluid

- ▶ Turn the SmartKey to position 1 or 2 in the ignition lock.
- ▶ Turn switch ① on the combination switch to the corresponding position. When the rear window wiper is switched on, a symbol appears in the assistance graphic in the instrument cluster.

Replacing the wiper blades

Important safety notes

⚠ WARNING

If the windshield wipers begin to move while you are changing the wiper blades, you could

be trapped by the wiper arm. There is a risk of injury.

Always switch off the windshield wipers and ignition before changing the wiper blades.

! To avoid damaging the wiper blades, make sure that you touch only the wiper arm of the wiper.

! Never open the hood/tailgate if a wiper arm has been folded away from the windshield/rear window.

Never fold a windshield wiper arm without a wiper blade back onto the windshield/rear window.

Hold the windshield wiper arm firmly when you change the wiper blade. If you release the wiper arm without a wiper blade and it falls onto the windshield/rear window, the windshield/rear window may be damaged by the force of the impact.

Mercedes-Benz recommends that you have the wiper blades changed at a qualified specialist workshop.

Replacing the wiper blades

Removing the wiper blades

- ▶ Remove the SmartKey from the ignition lock or turn it to position **0** (KEYLESS-GO).
- ▶ Fold the wiper arm away from the windshield.



- ▶ Firmly press release knob ① and pull wiper blade ② upwards from the wiper arm in the direction of the arrow.

Installing the wiper blades



- ▶ Position new wiper blade ① in the retainer on the wiper arm and slide it into place in the direction of the arrow. The wiper blade audibly engages.
- ▶ Make sure that the wiper blade is seated correctly.
- ▶ Fold the wiper arm back onto the windshield.

Replacing the rear window wiper blade

Removing a wiper blade



- ▶ Remove the SmartKey from the ignition lock.
- ▶ Fold wiper arm ① away from the rear window.
- ▶ Position wiper blade ② at a right angle to wiper arm ①.
- ▶ Hold wiper arm ① and press wiper blade ② in the direction of the arrow until it releases.
- ▶ Remove wiper blade ②.

Installing a wiper blade

- ▶ Place new wiper blade ② onto wiper arm ①.
- ▶ Hold wiper arm ① and press wiper blade ② in the opposite direction to the arrow until it engages.
- ▶ Make sure that wiper blade ② is seated correctly.
- ▶ Position wiper blade ② parallel to wiper arm ①.
- ▶ Fold wiper arm ① back onto the rear window.

Problems with the windshield wipers

You can find information about this in the Digital Operator's Manual.

Useful information	130
Overview of climate control systems	130
Operating the climate control systems	133

Useful information

- i** This Operator's Manual describes all models and all standard and optional equipment of your vehicle available at the time of publication of the Operator's Manual. Country-specific differences are possible. Please note that your vehicle may not be equipped with all features described. This also applies to safety-related systems and functions.
- i** Read the information on qualified specialist workshops (▷ page 31).

Overview of climate control systems

General notes

Observe the settings recommended on the following pages. The windows could otherwise fog up.

To prevent the windows from fogging up:

- switch off climate control only briefly
- switch on air-recirculation mode only briefly
- switch on the cooling with air dehumidification function
- switch on the defrost windshield function briefly, if required

Climate control regulates the temperature and the humidity in the vehicle interior and filters undesirable substances out of the air.

Climate control can only be operated when the engine is running. Optimum operation is only achieved with the side windows and roof closed.

The residual heat function can only be activated or deactivated if the ignition is switched off (see the Digital Operator's Manual, keyword "Residual heat").

- i** Ventilate the vehicle for a brief period during warm weather, e.g. using the convenience opening feature (see the Digital Operator's Manual, keyword "Convenience opening"). This will speed up the cooling

process and the desired interior temperature will be reached more quickly.

- i** The integrated filter filters out most particles of dust and soot and completely filters out pollen. It also reduces gaseous pollutants and odors. A clogged filter reduces the amount of air supplied to the vehicle interior. For this reason, you should always observe the interval for replacing the filter, which is specified in the Maintenance Booklet. As it depends on environmental conditions, e.g. heavy air pollution, the interval may be shorter than stated in the Maintenance Booklet.
- i** It is possible that the residual heat function may be activated automatically an hour after the SmartKey is removed. The vehicle is then ventilated for 30 minutes to dry the automatic climate control.

Control panel for dual-zone automatic climate control

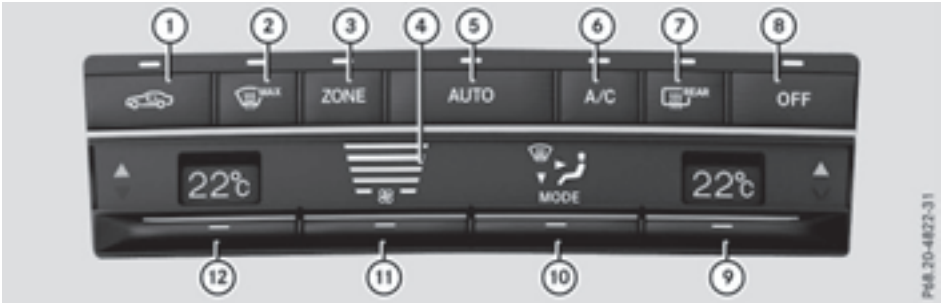

P48-20-4823-31

Canada only

- ① Switches air-recirculation mode on/off
- ② Defrosts the windshield
- ③ Switches the ZONE function on/off
- ④ Display
- ⑤ Sets climate control to automatic
- ⑥ Switches cooling with air dehumidification on/off
- ⑦ Switches the rear window defroster on/off
- ⑧ Activates/deactivates the air conditioning
- ⑨ Sets the temperature, right
- ⑩ Sets the air distribution
- ⑪ Sets the airflow
- ⑫ Sets the temperature, left

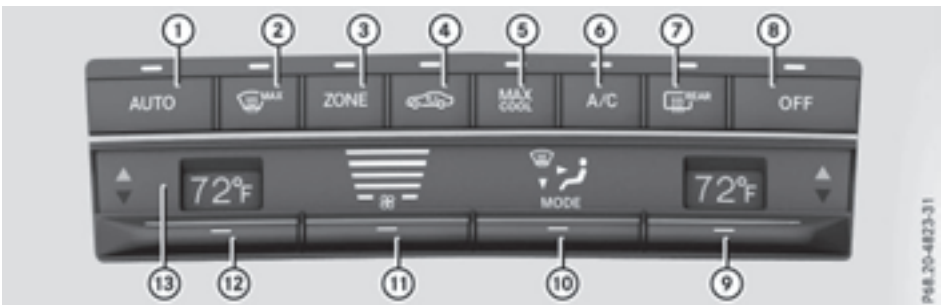

P48-20-4823-31

USA only

- ① Sets climate control to automatic
- ② Defrosts the windshield
- ③ Switches the ZONE function on/off
- ④ Switches air-recirculation mode on/off
- ⑤ Switches the maximum cooling MAX COOL on or off
- ⑥ Switches cooling with air dehumidification on/off
- ⑦ Switches the rear window defroster on/off

- ⑧ Activates/deactivates the air conditioning
- ⑨ Sets the temperature, right
- ⑩ Sets the air distribution
- ⑪ Sets the airflow
- ⑫ Sets the temperature, left
- ⑬ Display

Control panel for 3-zone automatic climate control

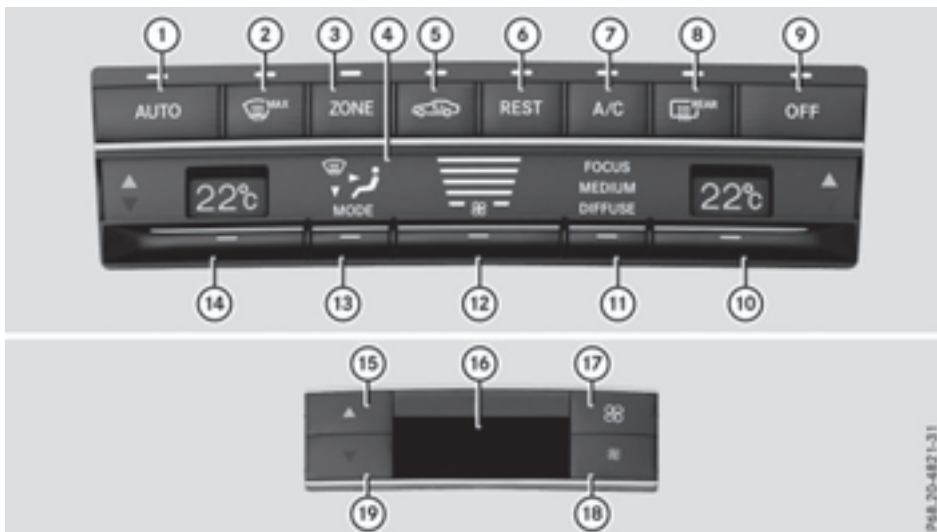

Canada only

Front control panel

- ① Sets climate control to automatic
- ② Defrosts the windshield
- ③ Switches the ZONE function on/off
- ④ Display
- ⑤ Switches air-recirculation mode on/off
- ⑥ Switches the residual heat on or off
- ⑦ Switches cooling with air dehumidification on/off
- ⑧ Switches the rear window defroster on/off
- ⑨ Activates/deactivates the air conditioning
- ⑩ Sets the temperature, right
- ⑪ Adjusts the climate mode settings
- ⑫ Sets the airflow
- ⑬ Sets the air distribution
- ⑭ Sets the temperature, left

Rear control panel

- ⑮ Increases the temperature
- ⑯ Display
- ⑰ Increases the airflow
- ⑱ Reduces the airflow
- ⑲ Reduces the temperature

Operating the climate control systems

In the Digital Operator's Manual you will find information on the following topics:

- Switching climate control on/off
- Activating/deactivating cooling with air dehumidification
- Setting climate control to automatic
- Adjusting the climate mode settings
- Setting the temperature
- Setting the air distribution
- Setting the airflow
- Switching the ZONE function on/off
- Defrosting the windshield
- MAX COOL maximum cooling
- Defrosting the windows
- Switching the rear window defroster on/off
- Activating/deactivating air-recirculation mode
- Activating/deactivating the residual heat function
- Setting the air vents

Useful information	136
Notes on breaking-in a new vehicle	136
Driving	137
Automatic transmission	142
Refueling	145
Parking	151
Driving tips	153
Driving systems	155

Useful information

- i** This Operator's Manual describes all models and all standard and optional equipment of your vehicle available at the time of publication of the Operator's Manual. Country-specific differences are possible. Please note that your vehicle may not be equipped with all features described. This also applies to safety-related systems and functions.
- i** Read the information on qualified specialist workshops (▷ page 31).

Notes on breaking-in a new vehicle

Important safety notes

The sensor system of some driving and driving safety systems adjusts automatically while a certain distance is being driven after the vehicle has been delivered or after repairs. Full system effectiveness is not reached until the end of this teach-in procedure.

New and replaced brake pads and discs only reach their optimum braking effect after several hundred kilometers of driving. Compensate for this by applying greater force to the brake pedal.

The first 1000 miles (1500 km)

The more you look after the engine when it is new, the more satisfied you will be with its performance in the future.

- You should therefore drive at varying vehicle and engine speeds for the first 1000 miles (1500 km).
- Avoid heavy loads, e.g. driving at full throttle, during this period.

- Change gear in good time, before the tachometer needle is $\frac{2}{3}$ of the way to the red area of the tachometer.
- Try to avoid depressing the accelerator pedal beyond the point of resistance (kick-down).

Additional breaking-in notes for AMG vehicles:

- Do not drive faster than 85 mph (140 km/h) for the first 1,000 miles (1,500 km).
- Only allow the engine to reach a maximum engine speed of 4,500 rpm briefly.
- Change gear in good time.

After 1000 miles (1500 km), you can increase the engine speed gradually and accelerate the vehicle to full speed.

- i** You should also observe these notes on breaking in if the engine or parts of the drive train on your vehicle have been replaced.
- i** Always observe the respective maximum permissible speed.

AMG vehicles with self-locking rear axle differential

Your vehicle is equipped with a self-locking differential on the rear axle.

Change the oil to improve protection of the rear axle differential:

- after a breaking-in period of 1,850 miles (3,000 km)
- every 31,000 miles (50,000 km) or 3 years

These oil changes prolong the service life of the differential. Have the oil change carried out at a qualified specialist workshop.

Driving

Important safety notes

 WARNING

Objects in the driver's footwell can restrict the pedal travel or obstruct a depressed pedal. The operating and road safety of the vehicle is jeopardized. There is a risk of an accident.

Make sure that all objects in the vehicle are stowed correctly, and that they cannot enter the driver's footwell. Install the floor mats securely and as specified in order to ensure sufficient clearance for the pedals. Do not use loose floor mats and do not place floor mats on top of one another.

 WARNING

Unsuitable footwear can hinder correct usage of the pedals, e.g.:

- shoes with thick soles
- shoes with high heels
- slippers

There is a risk of an accident.

Wear suitable footwear to ensure correct usage of the pedals.

 WARNING

If you switch off the ignition while driving, safety-relevant functions are only available with limitations, or not at all. This could affect, for example, the power steering and the brake boosting effect. You will require considerably more effort to steer and brake. There is a risk of an accident.

Do not switch off the ignition while driving.

 WARNING

If the parking brake has not been fully released when driving, the parking brake can:

- overheat and cause a fire
- lose its hold function.

There is a risk of fire and an accident. Release the parking brake fully before driving off.

 Do not warm up the engine with the vehicle stationary. Drive off immediately. Avoid high engine speeds and driving at full throttle until the engine has reached its operating temperature.

Only shift the automatic transmission to the desired drive position when the vehicle is stationary.

Where possible, avoid spinning the drive wheels when pulling away on slippery roads. You could otherwise damage the drive train.





 **AMG vehicles:** at low engine oil temperatures below 68 °F (+20 °C), the maximum engine speed is restricted in order to protect the engine. To protect the engine and maintain smooth engine operation, avoid driving at full throttle when the engine is cold.

HYBRID vehicles: make sure that you read the "HYBRID" supplement included in the vehicle literature. Otherwise, you may not recognize dangers.

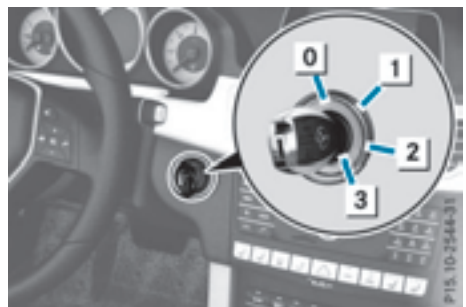
SmartKey positions

SmartKey



-  To remove the SmartKey (shift the transmission to position **P**)
-  Power supply for some consumers, such as the windshield wipers
-  Ignition (power supply for all consumers) and drive position
-  To start the engine

- ❗ The SmartKey can be turned in the ignition lock even if it is not the correct SmartKey for the vehicle. The ignition is not switched on. The engine cannot be started.

KEYLESS-GO

General notes

Vehicles with KEYLESS-GO are equipped with SmartKeys featuring the integrated KEYLESS-GO function and a detachable Start/Stop button.

The Start/Stop button must be inserted in the ignition lock and the SmartKey must be in the vehicle.

When you insert the Start/Stop button into the ignition lock, the system needs approximately two seconds recognition time. You can then use the Start/Stop button.

Pressing the Start/Stop button several times in succession corresponds to the different key positions in the ignition lock. This is only the case if you are not depressing the brake pedal.

If you depress the brake pedal and press the Start/Stop button, the engine starts immediately.

A check which periodically establishes a radio connection between the vehicle and the SmartKey determines whether a valid SmartKey is in the vehicle. This occurs, for example, when starting the engine.

To start the vehicle without actively using the SmartKey:

- the Start/Stop button must be inserted in the ignition lock.
- the SmartKey must be in the vehicle.
- the vehicle must not be locked with the SmartKey or KEYLESS-GO (> page 91).

Do not keep the KEYLESS-GO key:

- with electronic devices, e.g. a mobile phone or another SmartKey.
- with metallic objects, e.g. coins or metal foil.
- inside metallic objects, e.g. a metal case.

This can affect the functionality of KEYLESS-GO.

If you lock the vehicle with the SmartKey's remote control or with KEYLESS-GO, after a short time:

- you will not be able to switch on the ignition with the Start/Stop button.
- you will not be able to start the engine with the Start/Stop button until the vehicle is unlocked again.

If you lock the vehicle centrally using the button on the front door (> page 95), you can continue to start the engine with the Start/Stop button.

The engine can be switched off while the vehicle is in motion by pressing and holding the Start/Stop button for three seconds. This function operates independently of the ECO start/stop automatic engine switch-off function.

Key positions with KEYLESS-GO

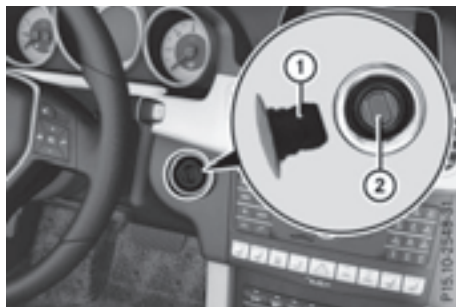

- ① Start/Stop button
- ② Ignition lock

As soon as the ignition is switched on, all the indicator lamps in the instrument cluster light up. Further information on situations where an indicator lamp either fails to go out after starting the engine or lights up while driving (> page 204).

If Start/Stop button ① has not yet been pressed, this corresponds to the key being removed from the ignition.

- **To switch on the power supply:** press Start/Stop button ① once.
The power supply is switched on. You can now activate the windshield wipers, for example.

The power supply is switched off again if:

- the driver's door is opened and
- you press Start/Stop button ① twice when in this position

- **To switch on the ignition:** press Start/Stop button ① twice.

The ignition is switched on.

The ignition is switched off when:

- the driver's door is opened and
- you press Start/Stop button ① twice when in this position

Removing the Start/Stop button

You can remove the Start/Stop button from the ignition lock and start the vehicle as normal using the SmartKey.

It is only possible to switch between Start/Stop button mode and SmartKey operation when the transmission is in position **P**.

- Remove Start/Stop button ① from ignition lock ②.

You do not have to remove the Start/Stop button from the ignition lock when you leave the vehicle. You should, however, always take the SmartKey with you when leaving the vehicle. As long as the SmartKey is in the vehicle:

- the vehicle can be started using the Start/Stop button
- the electrically powered equipment can be operated

Starting the engine

Important safety notes

WARNING

If children are left unsupervised in the vehicle, they could:

- open the doors, thus endangering other people or road users.
- get out and disrupt traffic.
- operate the vehicle's equipment.

Additionally, children could set the vehicle in motion if, for example, they:

- release the parking brake.
- shifting the automatic transmission out of park position **P**
- Start the engine.

There is a risk of an accident and injury.

When leaving the vehicle, always take the SmartKey with you and lock the vehicle. Never leave children or animals unattended in the vehicle. Always keep the SmartKey out of reach of children.

WARNING

Combustion engines emit poisonous exhaust gases such as carbon monoxide. Inhaling these exhaust gases leads to poisoning. There is a risk of fatal injury. Therefore never leave the engine running in enclosed spaces without sufficient ventilation.

WARNING

Flammable materials introduced through environmental influence or by animals can ignite if in contact with the exhaust system or parts of the engine that heat up. There is a risk of fire.

Carry out regular checks to make sure that there are no flammable foreign materials in the engine compartment or in the exhaust system.

-  Do not depress the accelerator when starting the engine.

General notes

- i** **Vehicles with a gasoline engine:** the catalytic converter is preheated for up to 30 seconds after a cold start. The sound of the engine may change during this time.

Automatic transmission

- ▶ Shift the transmission to position **P**. The transmission position display in the multifunction display shows **P**.
- i** You can start the engine in transmission position **P** and **N**.

Starting procedure with the SmartKey

- i** To start the engine using the SmartKey instead of KEYLESS-GO, pull the Start/Stop button out of the ignition lock.
- ▶ **Vehicles with diesel engine:** turn the key to position **2** in the ignition lock (▷ page 137).
The  preglow indicator lamp in the instrument cluster lights up.
- ▶ Turn the key to position **3** in the ignition lock and release it as soon as the engine is running (▷ page 137).
- i** **Vehicles with a diesel engine:** you can start the engine without preglow if the engine is warm.

Using KEYLESS-GO to start the engine

- i** The Start/Stop button can be used to start the vehicle manually without inserting the SmartKey into the ignition lock. The Start/Stop button must be inserted in the ignition lock and the SmartKey must be in the vehicle. This mode for starting the engine operates independently of the ECO start/stop automatic engine start function.

- ▶ Depress the brake pedal and keep it depressed.
- ▶ Press the Start/Stop button once (▷ page 138).

Vehicles with a gasoline engine: the engine starts.

Vehicles with a diesel engine: preglow is activated and the engine starts.

Pulling away

General notes

WARNING

If the engine speed is above the idling speed and you engage transmission position **D** or **R**, the vehicle could pull away suddenly. There is a risk of an accident.

When engaging transmission position **D** or **R**, always firmly depress the brake pedal and do not simultaneously accelerate.

- !** If a warning tone sounds and the **Release Park. Brake** message appears in the multifunction display, the parking brake is still applied. Release the parking brake.

Depress the accelerator carefully when pulling away.

The vehicle locks centrally once you have pulled away. The locking knobs in the doors drop down.

You can open the doors from the inside at any time.

You can also deactivate the automatic locking feature (▷ page 190).

It is only possible to shift the transmission from position **P** to the desired position if you depress the brake pedal. If you do not depress the brake pedal, the DIRECT SELECT lever can still be moved but the parking lock remains engaged.

- i** Upshifts take place at higher engine speeds after a cold start. This helps the

catalytic converter to reach its operating temperature more quickly.

Hill start assist

Hill start assist helps you when pulling away forwards or in reverse on an uphill gradient. It holds the vehicle for a short time after you have removed your foot from the brake pedal. This gives you enough time to move your foot from the brake pedal to the accelerator pedal and to depress it before the vehicle begins to roll.

WARNING

After a short time, hill start assist will no longer brake your vehicle and it could roll away. There is a risk of an accident and injury.

Therefore, quickly move your foot from the brake pedal to the accelerator pedal. Never leave the vehicle when it is held by hill start assist.

Hill start assist is not active if:

- you are pulling away on a level road or on a downhill gradient.
- the transmission is in position **N**.
- the parking brake is applied.
- ESP® is malfunctioning.

ECO start/stop function

Introduction

The ECO start/stop function switches the engine off automatically if the vehicle is stopped under certain conditions.

The engine starts automatically when the driver wants to pull away again. The ECO start/stop function thereby helps you to reduce the fuel consumption and emissions of your vehicle.

Important safety notes

WARNING

If the engine is switched off automatically and you exit the vehicle, the engine is restarted automatically. The vehicle may begin moving. There is a risk of accident and injury.

If you wish to exit the vehicle, always turn off the ignition and secure the vehicle against rolling away.

General notes



① ECO start/stop display

Hybrid vehicles: observe the notes on the ECO start/stop function in the "HYBRID" supplement.

The ECO start/stop function is activated whenever you start the engine using the SmartKey or the Start/Stop button.

If the engine has been switched off automatically by the ECO start/stop function, the **ECO** symbol is shown in the multifunction display.

AMG vehicles: the AMG menu in the multifunction display additionally shows the **Stop/Start active** message.

AMG vehicles: the ECO start/stop function is only available in drive program **C**.

Information in the Digital Operator's Manual

In the Digital Operator's Manual you will find information on the following topics:

- Automatic engine switch-off
- Automatic engine start
- Deactivating or activating the ECO start/stop function

Problems with the engine

You can find information about this in the Digital Operator's Manual.

Automatic transmission

Important safety notes

WARNING

If the engine speed is above the idling speed and you engage transmission position **D** or **R**, the vehicle could pull away suddenly. There is a risk of an accident.

When engaging transmission position **D** or **R**, always firmly depress the brake pedal and do not simultaneously accelerate.

WARNING

The automatic transmission switches to neutral position **N** when you switch off the engine. The vehicle may roll away. There is a risk of an accident.





After switching off the engine, always switch to parking position **P**. Prevent the parked vehicle from rolling away by applying the parking brake.

HYBRID vehicles: make sure that you read the "HYBRID" supplement included in the vehicle literature. Otherwise, you may not recognize dangers.

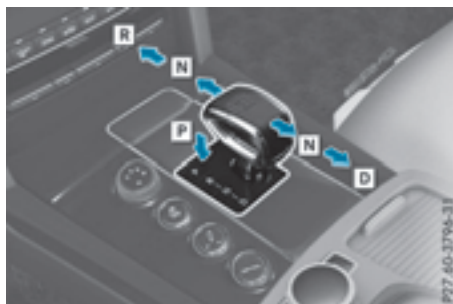
Selector lever (AMG vehicles)

Overview of transmission positions



-  Park position with parking lock
-  Reverse gear
-  Neutral
-  Drive

Information in the Digital Operator's Manual





In the Digital Operator's Manual you will find information on the following topics:

- Transmission position and drive program display
- Engaging park position P

DIRECT SELECT lever

Overview of transmission positions



-  Park position with parking lock
-  Reverse gear
-  Neutral
-  Drive

The DIRECT SELECT lever is on the right of the steering column.

The DIRECT SELECT lever always returns to its original position. The current transmission position **P**, **R**, **N** or **D** appears in the transmission position display in the multifunction display. You can find information about this in the Digital Operator's Manual.

Information in the Digital Operator's Manual

In the Digital Operator's Manual you will find information on the following topics:

- Transmission position and drive program display
- Engaging park position **P**
- Engaging park position **P** automatically
- Engaging reverse gear **R**
- Engaging drive position **D**

Shifting to neutral **N**

WARNING

If children are left unsupervised in the vehicle, they could:

- open the doors, thus endangering other people or road users.
- get out and disrupt traffic.
- operate the vehicle's equipment.

Additionally, children could set the vehicle in motion if, for example, they:

- release the parking brake.
- shifting the automatic transmission out of park position **P**
- Start the engine.

There is a risk of an accident and injury.

When leaving the vehicle, always take the SmartKey with you and lock the vehicle. Never leave children or animals unattended in the vehicle. Always keep the SmartKey out of reach of children.

- ▶ If the transmission is in position **D** or **R**: push the DIRECT SELECT lever up or down to the first point of resistance.
- ▶ If the transmission is in position **P**: depress the brake pedal and push the DIRECT SELECT lever up or down to the first point of resistance.

If you switch the engine off with the transmission in position **R** or **D**, the automatic transmission shifts to **N** automatically.

With the SmartKey: if you then open the driver's door or the front-passenger door or remove the SmartKey from the ignition, the automatic transmission shifts to **P** automatically.

With KEYLESS-GO: if you then open the driver's or front-passenger door, the automatic transmission shifts to **P**.

If you want the automatic transmission to remain in neutral **N**, e.g. when having the vehicle cleaned in an automatic car wash with a towing system:

Using the SmartKey:

- ▶ Switch on the ignition.
- ▶ Depress the brake pedal and keep it depressed.
- ▶ Shift to neutral **N**.
- ▶ Release the brake pedal.
- ▶ Release the parking brake.
- ▶ Switch off the ignition and leave the SmartKey in the ignition lock.

Using KEYLESS-GO:

- ▶ Remove the Start/Stop button from the ignition lock.
- ▶ Insert the SmartKey into the ignition lock.
- ▶ Switch on the ignition.
- ▶ Depress the brake pedal and keep it depressed.
- ▶ Shift to neutral **N**.
- ▶ Release the brake pedal.

- ▶ Release the parking brake.
- ▶ Switch off the ignition and leave the Smart-Key in the ignition lock.

Information in the Digital Operator's Manual

In the Digital Operator's Manual you will find information on the following topics:

- Transmission positions
- Driving tips
- Program selector button
- Steering wheel paddle shifters
- Automatic drive program
- Problems with the transmission

Manual drive program (AMG vehicles)

General information

In this drive program, you can permanently change gear yourself by using the steering wheel paddle shifters. The transmission must be in position **D**.

- i** In addition to permanent drive program **M**, you can also activate temporary drive program **M**; see the Digital Operator's Manual.

Switching on the manual drive program

- ▶ Turn the drive program selector (> page 144) until **M** appears in the multifunction display.
The indicator **M** on the drive program selector lights up in red.

The manual drive program is only available for AMG vehicles.

Manual drive program **M** is different from drive programs **S** and **S+** with regard to spontaneity, responsiveness and smoothness of gear changes.

Manual drive program **M** can be selected using the drive program selector. In manual

drive program **M**, you can change gear using the steering wheel paddle shifters if the transmission is in position **D**. The gear currently selected and engaged is shown in the multifunction display.

Upshifting

- ▶ Pull the right-hand steering wheel paddle shifter.
The automatic transmission shifts up to the next gear.

AMG vehicles

- !** In manual drive program **M**, the automatic transmission does not shift up automatically even when the engine limiting speed for the current gear is reached. When the engine limiting speed is reached, the fuel supply is cut to prevent the engine from overrevving. Always make sure that the engine speed does not reach the red area of the tachometer. There is otherwise a risk of engine damage.



- ① Gear indicator
- ② Upshift indicator

Before the engine speed reaches the red area, an upshift indicator will be shown in the multifunction display.

- ▶ When the **UP** message appears in the multifunction display, pull on the right-hand steering wheel paddle shifter.

Shift recommendation



The gearshift recommendations assist you in adopting an economical driving style. The recommended gear is shown in the multifunction display.

- ▶ If relevant gearshift recommendation ① appears in the multifunction display on the instrument cluster, pull on the right-hand steering wheel paddle shifter (see the Digital Operator's Manual).
The automatic transmission shifts to recommended gear ②.

Information in the Digital Operator's Manual

In the Digital Operator's Manual you will find information on the following topics:

- Downshifting
- Kickdown
- Switching off the manual drive program

Transfer case

This section is only valid for vehicles with 4-wheel drive (4MATIC). Power is always transmitted to both axles.

- ! Performance tests may only be carried out on a 2-axle dynamometer. The brake system or transfer case could otherwise be damaged. Contact a qualified specialist workshop for a performance test.

- ! To prevent ESP® from intervening, the ignition must be switched off (SmartKey or the Start/Stop button in position **0** or **1**) if:

- the parking brake is being tested on a brake dynamometer.
- the vehicle is being towed with only one axle raised (not permitted for vehicles with 4MATIC).

The brake system could otherwise be damaged.

- ! Vehicles with 4MATIC must not be towed with either the front or the rear axle raised, as doing so will damage the transmission.

Refueling

Important safety notes

WARNING

Fuel is highly flammable. If you handle fuel incorrectly, there is a risk of fire and explosion.

You must avoid fire, open flames, creating sparks and smoking. Switch off the engine and, if applicable, the auxiliary heating before refueling.

WARNING

Fuel is poisonous and hazardous to health. There is a risk of injury.

You must make sure that fuel does not come into contact with your skin, eyes or clothing and that it is not swallowed. Do not inhale fuel vapors. Keep fuel away from children.

If you or others come into contact with fuel, observe the following:

- Wash away fuel from skin immediately using soap and water.
- If fuel comes into contact with your eyes, immediately rinse them thoroughly with clean water. Seek medical assistance without delay.

- If fuel is swallowed, seek medical assistance without delay. Do not induce vomiting.
- Immediately change out of clothing which has come into contact with fuel.

⚠ WARNING

Electrostatic buildup can create sparks and ignite fuel vapors. There is a risk of fire and explosion.

Always touch the vehicle body before opening the fuel filler flap or touching the fuel pump nozzle. Any existing electrostatic buildup is thereby discharged.

⚠ WARNING

Vehicles with a diesel engine:

If you mix diesel fuel with gasoline, the flash point is lower than that of pure diesel fuel. When the engine is running, exhaust system components could overheat without being noticed. There is a risk of fire.

Never refuel with gasoline. Never mix gasoline with diesel fuel.

- ❗ Do not use diesel to refuel vehicles with a gasoline engine. Do not switch on the ignition if you accidentally refuel with the wrong fuel. Otherwise, the fuel will enter the fuel system. Even small amounts of the wrong fuel could result in damage to the fuel system and the engine. Notify a qualified specialist workshop and have the fuel tank and fuel lines drained completely.
- ❗ Do not use gasoline to refuel vehicles with a diesel engine. Do not switch on the ignition if you accidentally refuel with the wrong fuel. Otherwise, the fuel will enter the fuel system. Even small amounts of the wrong fuel could result in damage to the fuel system and the engine. The repair costs are high. Notify a qualified specialist workshop and have the fuel tank and fuel lines drained completely.

- ❗ Overfilling the fuel tank could damage the fuel system.

❗ Take care not to spill any fuel on painted surfaces. You could otherwise damage the paintwork.

❗ Use a filter when refueling from a fuel can. Otherwise, the fuel lines and/or injection system could be blocked by particles from the fuel can.

Do not get into the vehicle again during the refueling process. Otherwise, electrostatic charge could build up again.

If you overfill the fuel tank, fuel could spray out when the fuel pump nozzle is removed.

ℹ Flexible Fuel vehicles can be recognized by the **Ethanol up to E85** sticker on the inside of the fuel filler flap.

Refueling

General information

Pay attention to the important safety notes (> page 145).

The fuel filler flap is unlocked or locked automatically when you unlock or lock the vehicle with the key or using KEYLESS-GO.

The position of the fuel filler cap is displayed  in the instrument cluster. The arrow next to the filling pump indicates the side of the vehicle.

Opening the fuel filler flap

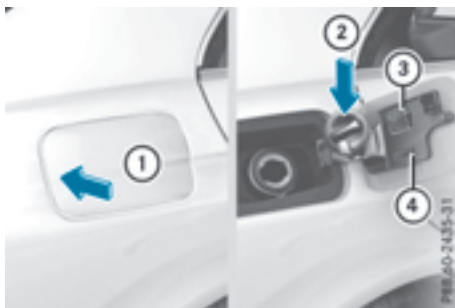

Opening the fuel filler flap (example: Sedan)

- ① To open the fuel filler flap
- ② To insert the fuel filler cap

- ③ Tire pressure table
- ④ Instruction label for fuel type to be refueled
- ▶ Switch off the engine.
- ▶ Remove the SmartKey from the ignition lock.

or, on vehicles with KEYLESS-GO:

- ▶ Open the driver's door.
The on-board electronics now have status **0**. This is the same as the SmartKey having been removed.
The driver's door can be closed again.
- ▶ Press the fuel filler flap in the direction of arrow ①.
The fuel filler flap opens slightly.
- ▶ Open the fuel filler flap fully.
- ▶ Turn the fuel filler cap counterclockwise and remove it.
- ▶ **Sedan:** insert the fuel filler cap into the bracket on the inside of fuel filler flap ②.

or

- ▶ **Wagon:** insert the fuel filler cap into the recesses in the fuel filler flap hinge arm horizontally from above.
- ▶ Completely insert the filler neck of the fuel pump nozzle into the tank, hook in place and refuel.
- ▶ Only fill the tank until the pump nozzle switches off.

Do not add any more fuel after the pump stops filling for the first time. Otherwise, fuel may leak out.

Vehicles with a diesel engine: the filler neck is designed for refueling at diesel filling pumps.

Closing the fuel filler flap

- ▶ Replace the cap on the filler neck and turn clockwise until it engages audibly.
- ▶ Press the fuel filler flap closed until it engages audibly.

Close the fuel filler flap before locking the vehicle. Otherwise, the locking pin of the cen-

tral locking prevents the fuel filler flap from closing.

If you are driving with the fuel filler cap open, the  reserve fuel warning lamp flashes. A message appears in the multifunction display (▷ page 191).

Fuel filler flap emergency release



- ▶ **Sedan:** open the trunk lid.
- ▶ Slide down the parcel net.
- ▶ Open the right-hand side trim panel.
- ▶ Detach the emergency release from retainer ①.
- ▶ Pull the emergency release in the direction of arrow ②.
The fuel filler flap is unlocked.
- ▶ Open the fuel filler flap.

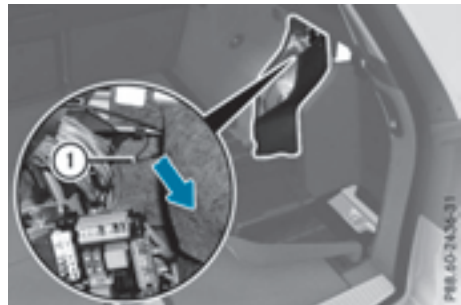

- ▶ **Wagon:** open the tailgate.
- ▶ Open the right-hand side trim panel.
- ▶ Fold down the paneling.

- ▶ Pull emergency release ① in the direction of the arrow.
The fuel filler flap is unlocked.
- ▶ Open the fuel filler flap.

Problems with fuel and the fuel tank

This section provides descriptions of and solutions to safety-relevant problems. Descriptions of and solutions to further problems can be found in the Digital Operator's Manual.

Problem	Possible causes/consequences and ► Solutions
Fuel is leaking from the vehicle.	<p> WARNING</p> <p>The fuel line or the fuel tank is faulty. Risk of explosion or fire.</p> <ul style="list-style-type: none"> ► Apply the electric parking brake. ► Switch off the engine. ► Remove the SmartKey from the ignition lock. <p>or, on vehicles with KEYLESS-GO:</p> <ul style="list-style-type: none"> ► Open the driver's door. The on-board electronics now have status 0. This is the same as the SmartKey having been removed. ► Do not restart the engine under any circumstances. ► Consult a qualified specialist workshop.

DEF (BlueTEC vehicles only)

Important notes on use

To function properly, BlueTEC exhaust gas aftertreatment must be operated with the reducing agent DEF. Adding DEF is one of the tasks performed during maintenance. Under normal operating conditions, a tank of DEF lasts until the next service due date.

When the supply of DEF is almost used up, the **Check Additive See Operator's Manual** message is shown in the multifunction display.

When the DEF supply drops to a minimum, the **Remaining Starts: 16** message is shown in the multifunction display.

If the **Remaining Starts: 16** message appears in the multifunction display, you can start the engine another 16 times. If DEF is not refilled, you will subsequently be **unable to start the engine**.

- Add at least 1 gal (3.8 l) of DEF.
 - Switch on the ignition for at least 60 seconds.
 - Start the engine.
-  Have the DEF tank refilled at a qualified specialist workshop.

Use the special DEF refill bottle when adding DEF between maintenance intervals. Contact an authorized Mercedes-Benz Center with any questions or, if necessary, contact Roadside Assistance (▷ page 29).

If the outside temperature is below 12 °F (-11 °C) it may be difficult to top up. If DEF is frozen and there is an active warning indicator, it may not be possible to add DEF. Park the vehicle in a warmer place, e.g. in a garage, until DEF has become fluid again. It will then be possible to add DEF again. Alternatively, have the DEF tank refilled at a qualified specialist workshop.

Further information about BlueTEC exhaust gas aftertreatment and DEF is available at any authorized Mercedes-Benz Center.

Important notes on topping up

DEF is a water-soluble fluid for the exhaust gas aftertreatment of diesel engines. It is:

- not poisonous
- colorless and odorless
- not flammable

When you open the DEF container, small amounts of ammonia vapor may be released. Ammonia vapors have a pungent odor and are particularly irritating to the skin, to mucous membranes and to the eyes. You may experience a burning sensation in your eyes, nose and throat. Coughing and watering of the eyes are possible.

Do not inhale ammonia vapors. Fill the DEF tank only in well-ventilated areas.

DEF must not come into contact with your skin, eyes or clothing and must not be swallowed. Keep DEF away from children.

If you or other persons come into contact with DEF, observe the following:

- Rinse DEF from your skin immediately with soap and water.
- If DEF comes into contact with your eyes, immediately rinse them thoroughly with clean water. Seek medical assistance without delay.
- If DEF has been swallowed, rinse your mouth out immediately. Drink plenty of water. Seek medical assistance without delay.
- Change out of clothing contaminated with DEF immediately.

! Only use DEF in accordance with ISO 22241. Do not mix any additives with DEF, and do not dilute DEF with water. This may destroy the BlueTEC exhaust gas aftertreatment system.

! Rinse surfaces that have come into contact with DEF immediately with water or remove DEF using a damp cloth and cold water. If the DEF has already crystallized, use a sponge and cold water to clean it.

residues crystallize after time and contaminate the affected surfaces.

! DEF is not a fuel additive and must not be added to the fuel tank. If DEF is added to the fuel tank, this can lead to engine damage.

! Only screw on the DEF refill bottle hand-tight. It could otherwise be damaged.

The DEF filler neck is under the trunk floor.

- ▶ Switch the ignition off.
- ▶ Open the trunk.
- ▶ Lift up the trunk floor (▷ page 248).



- ▶ Turn DEF cap ① counter-clockwise and remove it.



- ▶ Turn DEF filler cap ② counter-clockwise and open it. Filler cap ② is secured with a plastic strip.



- ▶ Unscrew the protective cap from DEF refill bottle (3).
 - ▶ Set DEF refill bottle (3) as shown on the filler neck and screw it clockwise until it is hand-tight.
 - ▶ Press DEF refill bottle (3) downwards. The DEF tank is filled. This may take up to one minute.
- i** To top up between service intervals, fill the DEF tank with approximately 1 gal (3.8 l) of DEF. 1 gal (3.8 l) DEF is equivalent to approximately 2 DEF refill bottles. Then have the DEF supply checked at a qualified specialist workshop and completely refilled if necessary.
- ▶ Release DEF refill bottle (3). When DEF refill bottle (3) is no longer pressed down, filling stops. DEF refill bottle (3) can be removed when it has been only partially emptied.
 - ▶ Turn DEF refill bottle (3) counter-clockwise and remove it.
 - ▶ Install DEF filler cap (2) on the filler neck and turn it clockwise.



- ▶ Replace DEF cover (1) as shown and turn it clockwise as far as it will go.
- ▶ Fold the trunk floor down.
- ▶ Close the trunk lid.
- ▶ Drive faster than 10 mph (16 km/h). The **Check Additive See Operator's Manual** message goes out after approximately one minute.

i If the **Check Additive See Operator's Manual** message continues to be shown in the multifunction display, add an additional bottle of DEF.

For further information on DEF, see (▶ page 341).

Parking

Important safety notes

WARNING

Flammable material such as leaves, grass or twigs may ignite if they come into contact with hot parts of the exhaust system or exhaust gas flow. There is a risk of fire.

Park the vehicle so that no flammable materials come into contact with parts of the vehicle which are hot. Take particular care not to park on dry grassland or harvested grain fields.

WARNING

If you switch off the ignition while driving, safety-relevant functions are only available with limitations, or not at all. This could affect, for example, the power steering and the brake boosting effect. You will require considerably more effort to steer and brake. There is a risk of an accident.

Do not switch off the ignition while driving.

⚠ WARNING

If you leave children unsupervised in the vehicle, they could set it in motion by, for example:

- release the parking brake.
- shift the automatic transmission out of the parking position **P**.
- start the engine.

In addition, they may operate vehicle equipment and become trapped. There is a risk of an accident and injury.

When leaving the vehicle, always take the SmartKey with you and lock the vehicle. Never leave children unsupervised in the vehicle.

- ! Always secure the vehicle correctly against rolling away. Otherwise, the vehicle or its drivetrain could be damaged.

To ensure that the vehicle is secured against rolling away unintentionally:

- the parking brake must be applied.
- the transmission must be in position **P** and the SmartKey must be removed from the ignition lock.
- the front wheels must be turned towards the curb on steep uphill or downhill gradients.

Switching off the engine**Important safety notes****⚠ WARNING**

The automatic transmission switches to neutral position **N** when you switch off the engine. The vehicle may roll away. There is a risk of an accident.

After switching off the engine, always switch to parking position **P**. Prevent the parked vehicle from rolling away by applying the parking brake.

Information in the Digital Operator's Manual

A description of how to switch off the engine can be found in the Digital Operator's Manual.

Parking brake**⚠ WARNING**

If you must brake the vehicle with the parking brake, the braking distance is considerably longer and the wheels could lock. There is an increased danger of skidding and accidents.

Only use the parking brake to brake the vehicle when the service brake is faulty. Do not apply the parking brake too firmly. If the wheels lock, release the parking brake until the wheels begin turning again.

⚠ WARNING

If you leave children unsupervised in the vehicle, they could set it in motion by, for example:



- release the parking brake.
- shift the automatic transmission out of the parking position **P**.
- start the engine.

In addition, they may operate vehicle equipment and become trapped. There is a risk of an accident and injury.

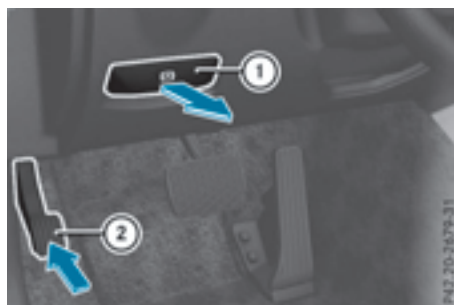
When leaving the vehicle, always take the SmartKey with you and lock the vehicle. Never leave children unsupervised in the vehicle.



If you brake the vehicle with the parking brake, the brake lamps will not light up.

- ▶ **To apply:** depress parking brake ② firmly. When the engine is running, the **BRAKE** (USA only) or  (Canada only) indicator lamp lights up in the instrument cluster.
- ▶ **To release:** depress the brake pedal and keep it depressed.
- ▶ Pull release handle ①. When the ignition is switched on or the engine is running, the **BRAKE** (USA only) or  (Canada only) indicator lamp goes out in the instrument cluster.

Parking the vehicle for a long period

You can find information about this in the Digital Operator's Manual.

Driving tips

General notes

Important safety notes

WARNING

If you switch off the ignition while driving, safety-relevant functions are only available with limitations, or not at all. This could affect, for example, the power steering and the brake boosting effect. You will require considerably more effort to steer and brake. There is a risk of an accident.

Do not switch off the ignition while driving.

WARNING

If you operate mobile communication equipment while driving, you will be distracted from traffic conditions. You could also lose control of the vehicle. There is a risk of an accident. Only operate this equipment when the vehicle is stationary.

Observe the legal requirements for the country in which you are driving. Some jurisdictions prohibit the driver from using a mobile phone while driving a vehicle.

If you make a call while driving, always use hands-free mode. Only operate the telephone when the traffic situation permits. If you are unsure, pull over to a safe location and stop before operating the telephone.

Bear in mind that at a speed of only 30 mph (approximately 50 km/h), the vehicle covers a distance of 44 ft (approximately 14 m) per second.

Drive sensibly – save fuel

Observe the following tips to save fuel:

- ▶ The tires should always be inflated to the recommended tire pressure.
- ▶ Remove unnecessary loads.
- ▶ Remove roof racks when they are not needed.
- ▶ Warm up the engine at low engine speeds.
- ▶ Avoid frequent acceleration or braking.
- ▶ Have all maintenance work carried out as indicated by the service intervals in the Maintenance Booklet or by the service interval display.

Fuel consumption also increases when driving in cold weather, in stop-start traffic and in hilly terrain.

Drinking and driving

WARNING

Drinking and driving and/or taking drugs and driving are very dangerous combinations. Even a small amount of alcohol or drugs can affect your reflexes, perceptions and judgment.

The possibility of a serious or even fatal accident is greatly increased when you drink or take drugs and drive.

Do not drink or take drugs and drive or allow anyone to drive who has been drinking or taking drugs.

Emission control

WARNING

Combustion engines emit poisonous exhaust gases such as carbon monoxide. Inhaling these exhaust gases leads to poisoning. There is a risk of fatal injury. Therefore never leave the engine running in enclosed spaces without sufficient ventilation.

Certain engine systems are designed to keep the level of poisonous components in exhaust fumes within legal limits.

These systems only work at peak efficiency if they are serviced exactly in accordance with the manufacturer's specifications. For this reason, only have work on the engine carried out by qualified and authorized Mercedes-Benz technicians.

The engine settings must not be changed under any circumstances. Furthermore, all specific service work must be carried out at regular intervals and in accordance with the Mercedes-Benz service requirements. Details can be found in the Maintenance Booklet.

ECO display

You can find information about this in the Digital Operator's Manual.

Braking

Important safety notes

WARNING

If you shift down on a slippery road surface in an attempt to increase the engine's braking effect, the drive wheels could lose their grip. There is an increased danger of skidding and accidents.

Do not shift down for additional engine braking on a slippery road surface.

Downhill gradients

You can find information about this in the Digital Operator's Manual.

Heavy and light loads

WARNING

If you rest your foot on the brake pedal while driving, the braking system can overheat. This increases the stopping distance and can even cause the braking system to fail. There is a risk of an accident.

Never use the brake pedal as a footrest. Never depress the brake pedal and the accelerator pedal at the same time.

Further information can be found in the Digital Operator's Manual.

Wet roads

You can find information about this in the Digital Operator's Manual.

Limited braking performance on salt-treated roads

You can find information about this in the Digital Operator's Manual.

Servicing the brakes

You can find information about this in the Digital Operator's Manual.

AMG high-performance and ceramic brakes

You can find information about this in the Digital Operator's Manual.

Driving on wet roads

Information in the Digital Operator's Manual

In the Digital Operator's Manual you will find information on the following topics:

- Hydroplaning
- Driving on flooded roads

Winter driving

WARNING

If you shift down on a slippery road surface in an attempt to increase the engine's braking effect, the drive wheels could lose their grip. There is an increased danger of skidding and accidents.

Do not shift down for additional engine braking on a slippery road surface.

DANGER

If the exhaust pipe is blocked or adequate ventilation is not possible, poisonous gases such as carbon monoxide (CO) may enter the vehicle. This is the case, e.g. if the vehicle becomes trapped in snow. There is a risk of fatal injury.

If you leave the engine or the auxiliary heating running, make sure the exhaust pipe and area around the vehicle are clear of snow. To ensure an adequate supply of fresh air, open a window on the side of the vehicle that is not facing into the wind.

Further information can be found in the Digital Operator's Manual.

Driving systems

Mercedes-Benz Intelligent Drive

Mercedes-Benz Intelligent Drive stands for innovative driver assistance and safety systems which enhance comfort and support the driver in critical situations. With these intelligent co-ordinated systems Mercedes-Benz

has set a milestone on the path towards autonomous driving.

Mercedes-Benz Intelligent Drive embraces all elements of active and passive safety in one well thought out system – for the safety of the vehicle occupants and that of other road users.

Further information on driving safety systems (> page 75).

Cruise Control

General notes

Cruise control maintains a constant road speed for you. It brakes automatically in order to avoid exceeding the set speed. On long and steep downhill gradients, especially if the vehicle is laden, you must shift to a lower gear in time. By doing so, you will make use of the braking effect of the engine. This relieves the load on the brake system and prevents the brakes from overheating and wearing too quickly.

Use cruise control only if road and traffic conditions make it appropriate to maintain a steady speed for a prolonged period. You can store any road speed above 20 mph (30 km/h).

Important safety notes

If you fail to adapt your driving style, cruise control can neither reduce the risk of an accident nor override the laws of physics. Cruise control cannot take into account the road, traffic and weather conditions. Cruise control is only an aid. You are responsible for the distance to the vehicle in front, for vehicle speed, for braking in good time and for staying in your lane.

Do not use cruise control:

- in road and traffic conditions which do not allow you to maintain a constant speed e.g. in heavy traffic or on winding roads
- on slippery road surfaces. Braking or accelerating could cause the drive wheels to lose traction and the vehicle could then skid
- when there is poor visibility, e.g. due to fog, heavy rain or snow

If there is a change of drivers, advise the new driver of the speed stored.

WARNING

If you call up the stored speed and it differs from the current speed, the vehicle accelerates or decelerates. If you do not know the stored speed, the vehicle could accelerate or brake unexpectedly. There is a risk of an accident.

Pay attention to the road and traffic conditions before calling up the stored speed. If you do not know the stored speed, store the desired speed again.

Cruise control lever

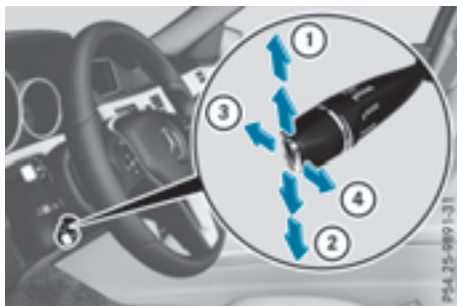

- ① To activate or increase speed
- ② To activate or reduce speed
- ③ To deactivate cruise control
- ④ To activate at the current speed/last stored speed

When you activate cruise control, the stored speed is shown in the multifunction display for five seconds.

Information in the Digital Operator's Manual

In the Digital Operator's Manual you will find information on the following topics:

- Activation conditions
- Storing, maintaining and calling up a speed
- Setting a speed
- Deactivating cruise control

DISTRONIC PLUS

General notes

DISTRONIC PLUS regulates the speed and automatically helps you maintain the distance to the vehicle detected in front. Vehicles are detected with the aid of the radar sensor system. DISTRONIC PLUS brakes automatically so that the set speed is not exceeded.

Change into a lower gear in good time on long and steep downhill gradients. This is especially important if the vehicle is laden. By doing so, you will make use of the braking effect of the engine. This relieves the load on the brake system and prevents the brakes from overheating and wearing too quickly.

If DISTRONIC PLUS detects that there is a risk of a collision, you will be warned visually and acoustically. DISTRONIC PLUS cannot prevent a collision without your intervention. An intermittent warning tone will then sound and the distance warning lamp will light up in the instrument cluster. Brake immediately in order to increase the distance to the vehicle in front or take evasive action provided it is safe to do so.

For DISTRONIC PLUS to assist you when driving, the radar sensor system must be switched on and operational; see "Radar sensor system" in the index.

DISTRONIC PLUS operates in range between 0 mph (0 km/h) and 120 mph (200 km/h).

Do not use DISTRONIC PLUS while driving on roads with steep gradients.

As DISTRONIC PLUS transmits radar waves, it can resemble the radar detectors of the responsible authorities. You can refer to the relevant chapter in the Operator's Manual if questions are asked about this.

i USA only: This device has been approved by the FCC as a "Vehicular Radar System". The radar sensor is intended for use in an automotive radar system only. Removal, tampering, or altering of the device will void any warranties, and is not permitted by the FCC. Do not tamper with, alter, or use in any non-approved way.

Any unauthorized modification to this device could void the user's authority to operate the equipment.

i Canada only: This device complies with RSS-210 of Industry Canada. Operation is subject to the following two conditions:

1. This device may not cause harmful interference, and

2. This device must accept any interference received, including interference that may cause undesired operation of the device.

Removal, tampering, or altering of the device will void any warranties, and is not permitted. Do not tamper with, alter, or use in any non-approved way.

Any unauthorized modification to this device could void the user's authority to operate the equipment.

Important safety notes

WARNING

Hybrid vehicles: be sure to read the "HYBRID" supplement. Otherwise, you could fail to recognize dangers.

WARNING

DISTRONIC PLUS does not react to:

- people or animals
- stationary obstacles on the road, e.g. stopped or parked vehicles
- oncoming and crossing traffic

As a result, DISTRONIC PLUS may neither give warnings nor intervene in such situations.

There is a risk of an accident.

Always pay careful attention to the traffic situation and be ready to brake.

WARNING

DISTRONIC PLUS cannot always clearly identify other road users and complex traffic situations.

In such cases, DISTRONIC PLUS may:

- give an unnecessary warning and then brake the vehicle
- neither give a warning nor intervene
- accelerate or brake unexpectedly

There is a risk of an accident.

Continue to drive carefully and be ready to brake, in particular when warned to do so by DISTRONIC PLUS.

WARNING

DISTRONIC PLUS brakes your vehicle with up to 50% of the maximum possible deceleration. If this braking force is insufficient, DISTRONIC PLUS warns you visually and audibly. There is a risk of an accident.

In such cases, apply the brakes yourself and try to take evasive action.

! If DISTRONIC PLUS or the HOLD function is activated, the vehicle brakes automatically in certain situations.

To prevent damage to the vehicle, deactivate DISTRONIC PLUS and the HOLD function in the following or other similar situations:

- when towing the vehicle
- in the car wash

If you fail to adapt your driving style, DISTRONIC PLUS can neither reduce the risk of accident nor override the laws of physics. DISTRONIC PLUS cannot take into account the road, traffic and weather conditions. DISTRONIC PLUS is only an aid. You are responsible for the distance to the vehicle in

front, for vehicle speed, for braking in good time and for staying in your lane.

Do not use DISTRONIC PLUS:

- in road and traffic conditions which do not allow you to maintain a constant speed, e.g. in heavy traffic or on winding roads
- on slippery road surfaces. Braking or accelerating could cause the drive wheels to lose traction and the vehicle could then skid
- when there is poor visibility, e.g. due to fog, heavy rain or snow

DISTRONIC PLUS may not detect narrow vehicles driving in front, e.g. motorcycles, or vehicles driving on a different lane.

In particular, the detection of obstacles can be impaired if:

- there is dirt on the sensors or anything else covering the sensors
- there is snow or heavy rain
- there is interference by other radar sources
- there are strong radar reflections, for example, in parking garages

If DISTRONIC PLUS no longer detects a vehicle in front, DISTRONIC PLUS may unexpectedly accelerate the vehicle to the stored speed.

This speed may:

- be too high if you are driving in a filter lane or an exit lane
- be so high in the right lane that you pass vehicles driving on the left (left-hand drive countries)
- be so high in the left lane that you pass vehicles driving on the right (right-hand drive countries)

If there is a change of drivers, advise the new driver of the speed stored.

Cruise control lever

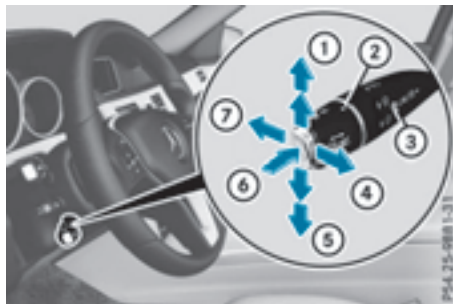

- ① To store the current speed or a higher speed
- ② To store the current speed or a lower speed
- ③ To deactivate DISTRONIC PLUS
- ④ To store the current speed or call up the last stored speed
- ⑤ To set the specified minimum distance

Activating DISTRONIC PLUS

Activation conditions

In order to activate DISTRONIC PLUS, the following conditions must be fulfilled:

- the engine must be started. It may take up to two minutes after pulling away before DISTRONIC PLUS is operational.
- the parking brake must be released.
- ESP® must be active, but not intervening.
- Active Parking Assist must not be activated.
- the transmission must be in position **D**.
- the driver's door must be closed when you shift from **P** to **D** or your seat belt must be fastened.
- the front-passenger door and rear doors must be closed.
- the vehicle must not skid.

Activating

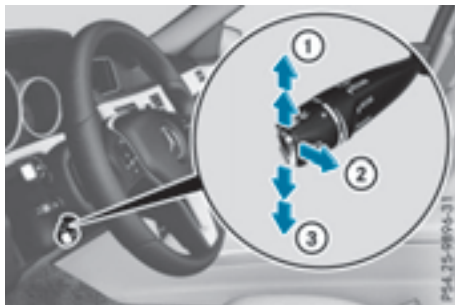

- ▶ Briefly pull the cruise control lever towards you ② or press it up ① or down ③. DISTRONIC PLUS is selected.
- ▶ Press the cruise control lever repeatedly up ① or down ③ until the desired speed is set.
- ▶ Remove your foot from the accelerator pedal.
Your vehicle adapts its speed to that of the vehicle in front, but only up to the desired stored speed.

If the vehicle in front of you is stationary, you can only activate DISTRONIC PLUS once your vehicle is stationary as well.

- ❗ If you do not fully release the accelerator pedal, the **DISTRONIC PLUS Override** message appears in the multifunction display. The set distance to a slower-moving vehicle in front will then not be maintained. You will be driving at the speed you determine by the position of the accelerator pedal.

You can also activate DISTRONIC PLUS when stationary. The lowest speed that can be set is 18 mph (30 km/h).

- ▶ Briefly pull the cruise control lever towards you ③ up ① or down ④. DISTRONIC PLUS is selected.

Activating at the current speed/last stored speed

⚠ WARNING

If you call up the stored speed and it differs from the current speed, the vehicle accelerates or decelerates. If you do not know the stored speed, the vehicle could accelerate or brake unexpectedly. There is a risk of an accident.

Pay attention to the road and traffic conditions before calling up the stored speed. If you do not know the stored speed, store the desired speed again.

- ▶ Briefly pull the cruise control lever towards you ④.
- ▶ Remove your foot from the accelerator pedal.
DISTRONIC PLUS is activated. The first time it is activated, the current speed is stored. Otherwise, it sets the vehicle cruise speed to the previously stored value.

Driving with DISTRONIC PLUS

Pulling away and driving

- ▶ **If you want to pull away with DISTRONIC PLUS:** remove your foot from the brake pedal.
 - ▶ Briefly pull the cruise control lever towards you ③.
- or
- ▶ Accelerate briefly.
Your vehicle pulls away and adapts its speed to that of the vehicle in front.
If no vehicle is detected in front, your vehicle accelerates to the set speed.

- ❗ The vehicle can also pull away when it is facing an unidentified obstacle or is driving on a different line from another vehicle. The vehicle then brakes automatically. There is a risk of an accident. Be ready to brake at all times.

If there is no vehicle in front, DISTRONIC PLUS operates in the same way as cruise control.

If DISTRONIC PLUS detects that the vehicle in front has slowed down, it brakes your vehicle. In this way, the distance you have selected is maintained.

If DISTRONIC PLUS detects a faster-moving vehicle in front, it increases the driving speed. However, the vehicle is only accelerated up to the speed you have stored.

Selecting the drive program

DISTRONIC PLUS supports a sporty driving style when you have selected the **S** or **M** (AMG vehicles: **S**, **S+** or **M**) driving program (▷ page 144). Acceleration behind the vehicle in front or to the set speed is then noticeably more dynamic. If you have selected the **E** or **E+** (AMG vehicles: **C**) driving program, the vehicle accelerates more gently. This setting is recommended in stop-and-start traffic.

Selecting the drive program

DISTRONIC PLUS supports a sporty driving style when you have selected the **S** or **M** (AMG vehicles: **S**, **S+** or **M**) driving program (▷ page 144). Acceleration behind the vehicle in front or to the set speed is then noticeably more dynamic. If you have selected the **E** or **E+** (AMG vehicles: **C**) driving program, the vehicle accelerates more gently. This setting is recommended in stop-and-start traffic.

Changing lanes

If you change to the passing lane, DISTRONIC PLUS supports you when:

- you are driving faster than 45 mph (70 km/h)
- DISTRONIC PLUS is maintaining the distance to a vehicle in front
- you have switched on the corresponding turn signal
- DISTRONIC PLUS does not detect a danger of collision

If these conditions are fulfilled, your vehicle is accelerated. Acceleration will be interrupted if changing lanes takes too long or if the distance between your vehicle and the vehicle in front becomes too small.

- ❗ When changing lanes, DISTRONIC PLUS monitors the left lane on left-hand drive vehicles and the right lane on right-hand drive vehicles.

Stopping

WARNING

When leaving the vehicle, even if it is braked only by DISTRONIC PLUS, it could roll away if:

- there is a malfunction in the system or in the voltage supply.
- DISTRONIC PLUS has been deactivated with the cruise control lever, e.g. by a vehicle occupant or from outside the vehicle.
- the electrical system in the engine compartment, the battery or the fuses have been tampered with.
- the battery is disconnected.
- the accelerator pedal has been depressed, e.g. by a vehicle occupant.

There is a risk of an accident.

If you wish to exit the vehicle, always turn off DISTRONIC PLUS and secure the vehicle against rolling away.

For further information on deactivating DISTRONIC PLUS (▷ page 161).

If DISTRONIC PLUS detects that the vehicle in front is stopping, it brakes your vehicle until it is stationary.

Once your vehicle is stationary, it remains stationary and you do not need to depress the brake.

Depending on the specified minimum distance, your vehicle will come to a standstill at a sufficient distance behind the vehicle in front. The specified minimum distance is set using the control on the cruise control lever.

When DISTRONIC PLUS is activated, the transmission is shifted automatically to position **P** if:

- the driver's door is open and the driver's seat belt is unfastened.
- the engine is switched off, unless it is automatically switched off by the ECO start/stop function.
- a system malfunction occurs.
- the power supply is not sufficient.

Information in the Digital Operator's Manual

In the Digital Operator's Manual you will find information on the following topics:

- Setting a speed
- Setting the specified minimum distance
- DISTRONIC PLUS displays in the instrument cluster

Deactivating DISTRONIC PLUS

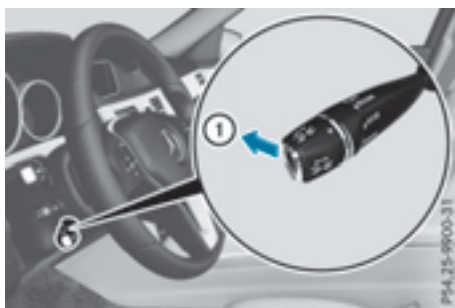

There are several ways to deactivate DISTRONIC PLUS:

- ▶ Briefly press the cruise control lever forwards ①.

or

- ▶ Brake, unless the vehicle is stationary

When you deactivate DISTRONIC PLUS, you will see the **DISTRONIC PLUS Off** message in the multifunction display for approximately five seconds.

① The last speed stored remains stored until you switch off the engine.

① DISTRONIC PLUS is not deactivated if you depress the accelerator pedal.

DISTRONIC PLUS is automatically deactivated if:

- you engage the parking brake
- ESP® intervenes or you deactivate ESP®
- the transmission is in the **P**, **R** or **N** position
- you pull the cruise control lever towards you in order to pull away and the front-passenger door or one of the rear doors is open
- the vehicle is skidding
- you activate Active Parking Assist

If DISTRONIC PLUS is deactivated, you will hear a warning tone. You will see the **DISTRONIC PLUS Off** message in the multifunction display for approximately five seconds.

Tips for driving with DISTRONIC PLUS

General notes

Pay particular attention in the following traffic situations:

- Cornering, going into and coming out of a bend
- Vehicles traveling on a different line
- Other vehicles changing lanes
- Narrow vehicles
- Obstructions and stationary vehicles
- Crossing vehicles

In such situations, brake if necessary. DISTRONIC PLUS is then deactivated.

Cornering, going into and coming out of a bend

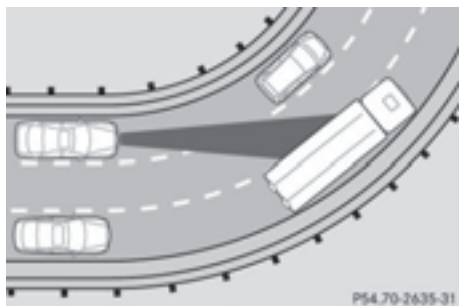

The ability of DISTRONIC PLUS to detect vehicles when cornering is limited. Your vehicle may brake unexpectedly or late.

Vehicles traveling on a different line

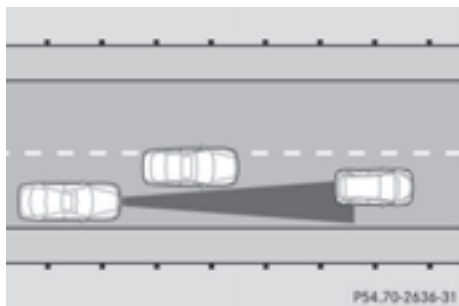

DISTRONIC PLUS may not detect vehicles traveling on a different line. The distance to the vehicle in front will be too short.

Other vehicles changing lanes

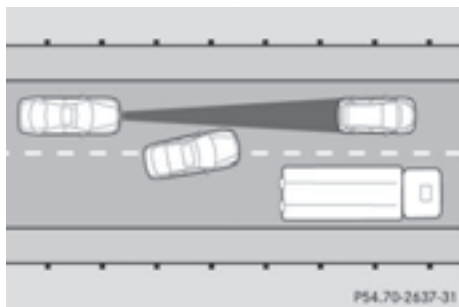

DISTRONIC PLUS has not detected the vehicle cutting in yet. The distance to this vehicle will be too short.

Narrow vehicles

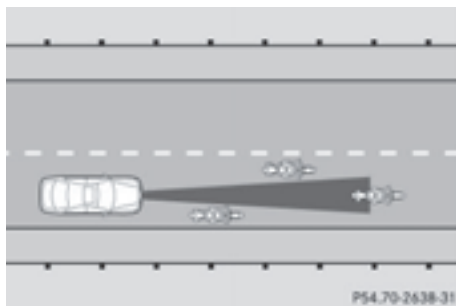

DISTRONIC PLUS has not yet detected the vehicle in front on the edge of the road, because of its narrow width. The distance to the vehicle in front will be too short.

Obstructions and stationary vehicles

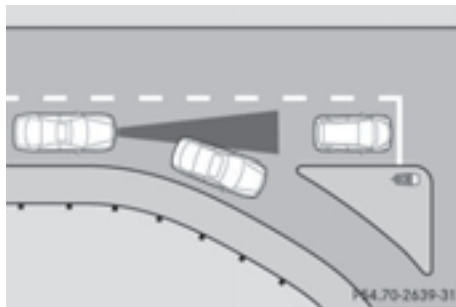

DISTRONIC PLUS does not brake for obstacles or stationary vehicles. If, for example, the detected vehicle turns a corner and reveals an obstacle or stationary vehicle, DISTRONIC PLUS will not brake for these.

Crossing vehicles

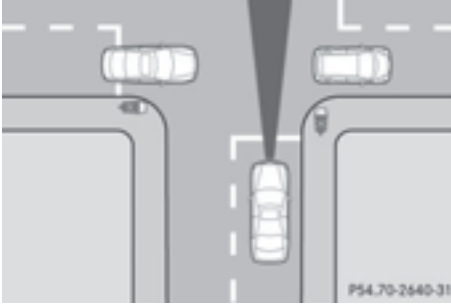

DISTRONIC PLUS may mistakenly detect vehicles that are crossing your lane. Activating DISTRONIC PLUS at traffic lights with crossing traffic, for example, could cause your vehicle to pull away unintentionally.

DISTRONIC PLUS with Steering Assist and Stop&Go Pilot

General notes



DISTRONIC PLUS with Steering Assist and Stop&Go Pilot aids you in keeping the vehicle in the center of the driving lane by means of moderate steering interventions in the speed range from 0 - 125 mph (0 - 200 km/h).

It monitors the area in front of your vehicle by means of multifunction camera ①, at the top of the windshield.

At speeds of 0 - 37 mph (0 - 60 km/h), Stop&Go Pilot focuses on the vehicle in front, taking into account lane markings, e.g. when following vehicles in a traffic jam.

At speeds of more than 37 mph (60 km/h) Steering Assist focuses on detected lane

markings (left and right), and only on the vehicle in front if lane markings are missing. If these conditions are not present, Steering Assist and Stop&Go Pilot cannot provide assistance.

DISTRONIC PLUS must be active in order for the function to be available.

Important safety notes

If you fail to adapt your driving style, DISTRONIC PLUS with Steering Assist and Stop&Go Pilot can neither reduce the risk of an accident nor override the laws of physics. It cannot take account of road, weather and traffic conditions. DISTRONIC PLUS with Steering Assist and Stop&Go Pilot is only an aid. You are responsible for the distance to the vehicle in front, for vehicle speed, for braking in good time and for staying in your lane.

DISTRONIC PLUS with Steering Assist and Stop&Go Pilot does not detect road and traffic conditions. If you are following a vehicle which is driving towards the edge of the road, your vehicle could come into contact with the curb or other road boundaries. Be particularly aware of other road users, e.g. cyclists, that are directly next to your vehicle.

Obstacles such as building site huts on the lane or projecting out into the lane are not detected.

An inappropriate steering intervention, e.g. after intentionally driving over a lane marking, can be corrected at any time if you steer slightly in the opposite direction.

DISTRONIC PLUS with Steering Assist and Stop&Go Pilot cannot continuously keep your vehicle in lane. In some cases, the steering intervention is not sufficient to bring the vehicle back to the lane. In such cases, you must steer the vehicle yourself to ensure that it does not leave the lane.

The support provided by the system can be impaired if:

- there is poor visibility, e.g. due to insufficient illumination of the road, or due to snow, rain, fog or spray
- there is glare, e.g. from oncoming traffic, the sun or reflections (e.g. when the road surface is wet)
- the windshield is dirty, fogged up, damaged or covered, for instance by a sticker, in the vicinity of the camera
- no, or several, unclear lane markings are present for one lane, e.g. in a construction area
- the lane markings are worn away, dark or covered up, e.g. by dirt or snow
- the distance to the vehicle in front is too small and the lane markings thus cannot be detected
- the lane markings change quickly, e.g. lanes branch off, cross one another or merge
- the road is narrow and winding
- there are strong shadows cast on the road

The system is switched to passive and no longer assists you by performing steering interventions if:

- you actively change lanes
- you switch on the turn signal
- take your hands off the steering wheel or do not steer for a prolonged period of time

i After you have finished changing lanes, Steering Assist and Stop&Go Pilot are automatically active again.

DISTRONIC PLUS Steering Assist does not provide assistance:

- on very sharp corners
- when a loss of tire pressure or a defective tire has been detected and displayed.

Pay attention also to the important safety notes for DISTRONIC PLUS (▷ page 157).

The steering interventions are carried out with a limited steering moment. The system

requires the driver to keep his hands on the steering wheel and to steer himself.

If you do not steer yourself or if you take your hands off the steering wheel for a prolonged period of time, the system will first alert you with a visual warning. A steering wheel symbol appears in the multifunction display. If you have still not started to steer and have not taken hold of the steering wheel after five seconds at the latest, a warning tone also sounds to remind you to take control of the vehicle. Steering Assist and Stop&Go Pilot are switched to passive. DISTRONIC PLUS remains active.

Activating Steering Assist and Stop&Go Pilot

- ▶ Activate the DISTRONIC PLUS with Steering Assist and Stop&Go Pilot function using the on-board computer (▷ page 190). The **DTR+: Steering Assistant On** message appears in the multifunction display. Steering Assist and Stop&Go Pilot are active.

Information in the multifunction display



If Steering Assist and Stop&Go Pilot are activated but not ready for a steering intervention, steering wheel symbol ① appears in gray. If the system provides you with support by means of steering interventions, symbol ① is shown in green.

Deactivating Steering Assist and Stop&Go Pilot

- ▶ Deactivate the DISTRONIC PLUS with Steering Assist and Stop&Go Pilot function using the on-board computer (▷ page 190). The **DTR+: Steering Assistant Off** message appears in the multifunction display.

play. Steering Assist and Stop&Go Pilot are deactivated.

When DISTRONIC PLUS is deactivated or not available, Steering Assist and Stop&Go Pilot are deactivated automatically.

HOLD function

General notes

The HOLD function can assist the driver in the following situations:

- when pulling away, especially on steep slopes
- when maneuvering on steep slopes
- when waiting in traffic

The vehicle is kept stationary without the driver having to depress the brake pedal.

The braking effect is canceled and the HOLD function deactivated when you depress the accelerator pedal to pull away.

Important safety notes

WARNING

When leaving the vehicle, it can still roll away despite being braked by the HOLD function if:

- there is a malfunction in the system or in the voltage supply.
- the HOLD function has been deactivated by pressing the accelerator pedal or the brake pedal, e.g. by a vehicle occupant.
- the electrical system in the engine compartment, the battery or the fuses have been tampered with.
- the battery is disconnected

There is a risk of an accident.

If you wish to exit the vehicle, always turn off the HOLD function and secure the vehicle against rolling away.

! If DISTRONIC PLUS or the HOLD function is activated, the vehicle brakes automatically in certain situations.

To prevent damage to the vehicle, deactivate DISTRONIC PLUS and the HOLD function in the following or other similar situations:

- when towing the vehicle
- in the car wash

Activation conditions

You can activate the HOLD function if:

- the vehicle is stationary
- the engine is running or if it has been automatically switched off by the ECO start/stop function
- the driver's door is closed or your seat belt is fastened
- the parking brake is released
- the transmission is in position **D**, **R** or **N**
- DISTRONIC PLUS is deactivated

Activating the HOLD function



- ▶ Make sure that the activation conditions are met.
- ▶ Depress the brake pedal.
- ▶ Quickly depress the brake pedal further until **HOLD**  appears in the multifunction display.

The HOLD function is activated. You can release the brake pedal.

- i** If depressing the brake pedal the first time does not activate the HOLD function, wait briefly and then try again.

Deactivating the HOLD function

The HOLD function is deactivated automatically if:

- you accelerate and the transmission is in position **D** or **R**.
- you shift the transmission to position **P**.
- you depress the brake pedal again with a certain amount of pressure until **HOLD** disappears from the multifunction display.
- you activate DISTRONIC PLUS.

When the HOLD function is activated, the transmission is shifted automatically to position **P** if:

- the driver's door is open and the driver's seat belt is unfastened.
- the engine is switched off, unless it is automatically switched off by the ECO start/stop function.
- a system malfunction occurs.
- the power supply is not sufficient.

RACE START

Important safety notes

- ❗ Observe the safety notes for the SPORT handling mode (▷ page 82).

RACE START is intended solely for activation on dedicated race circuits.

RACE START enables optimal acceleration from a standing start. The precondition for this is a suitable high-grip road surface.

- ❗ RACE START is only available in AMG vehicles.

Information in the Digital Operator's Manual

In the Digital Operator's Manual you will find information on the following topics:

- Conditions for activation
- Activating RACE START

AIRMATIC

Vehicle level

Important safety notes

WARNING

When the vehicle is being lowered, people could become trapped if their limbs are between the vehicle body and the wheels or underneath the vehicle. There is a risk of injury.

Make sure no one is underneath the vehicle or in the immediate vicinity of the wheel arches when the vehicle is being lowered.

WARNING

Vehicles with level control:

The vehicle is slightly lowered if:

- you have selected comfort suspension tuning and
- you lock the vehicle within approximately 60 seconds of switching off the engine

You and people in the vicinity of the wheel arch or the underbody may thus become trapped. There is a risk of injury.

Make sure that nobody is in the vicinity of the wheel arch or the underbody when you lock the vehicle.

- ❗ The vehicle is lowered by about 15 mm if:

- you have selected "Comfort tuning"
- you switch off the engine and then
- you lock the vehicle within approximately 60 seconds

When parking, position your vehicle so that it does not make contact with the curb as the vehicle is lowered. Your vehicle could otherwise be damaged.

If you unlock the vehicle within 60 seconds of having switched the engine off, the vehicle is lowered slightly when Comfort suspension mode is selected.

Your vehicle regulates its height automatically. All-round level control ensures the best possible suspension and constant ground

clearance, even with a laden vehicle. Further general information on the vehicle level can be found in the Digital Operator's Manual.

Setting the vehicle level

Select the "Normal" setting for normal road surfaces and "Raised" for driving with snow chains or on particularly poor road surfaces. Your selection remains stored even if you remove the SmartKey from the ignition lock.

Setting raised level



- ▶ Start the engine.

If indicator lamp ① is not lit:

- ▶ Press the ② button.
Indicator lamp ① lights up. The vehicle height is adjusted to raised level.
The **Vehicle Rising** message appears in the display.

The "Raised level" setting is canceled if you:

- drive at a speed over approximately 75 mph (120 km/h)
- drive for approximately three minutes at a speed over 50 mph (80 km/h).

The "Raised level" remains active when you are not driving within these speed ranges.

Setting the normal level

- ▶ Start the engine.

If indicator lamp ① is lit:

- ▶ Press button ②.
Indicator lamp ① goes out. The vehicle is adjusted to normal level.

Suspension tuning

General notes

You can find information about this in the Digital Operator's Manual.

AMG adaptive sport suspension system

Information in the Digital Operator's Manual

In the Digital Operator's Manual you will find information on the following topics:

- Vehicle level
- Rear axle level control
- Suspension tuning

Important safety notes

⚠ WARNING

When the vehicle is being lowered, people could become trapped if their limbs are between the vehicle body and the wheels or underneath the vehicle. There is a risk of injury.

Make sure no one is underneath the vehicle or in the immediate vicinity of the wheel arches when the vehicle is being lowered.

⚠ WARNING

Vehicles with level control:

The vehicle is slightly lowered if:

- you have selected comfort suspension tuning and
- you lock the vehicle within approximately 60 seconds of switching off the engine

You and people in the vicinity of the wheel arch or the underbody may thus become trapped. There is a risk of injury.

Make sure that nobody is in the vicinity of the wheel arch or the underbody when you lock the vehicle.

! The vehicle is lowered by about 0.8 in (20 mm) if:

- you have selected "Comfortable tuning"
- you switch off the engine and then
- you lock the vehicle within approximately 60 seconds

When parking, position your vehicle so that it does not make contact with the curb as the vehicle is lowered. Your vehicle could otherwise be damaged.

Vehicle level

Important safety notes

WARNING

When the vehicle is being lowered, people could become trapped if their limbs are between the vehicle body and the wheels or underneath the vehicle. There is a risk of injury.

Make sure no one is underneath the vehicle or in the immediate vicinity of the wheel arches when the vehicle is being lowered.

The vehicle may be lowered if you press the suspension setting selector button or the AMG button. The vehicle also lowers if it is stationary.

! If Sport or Sport + suspension tuning has been selected, the vehicle's ground clearance decreases. Make sure that no objects become trapped or that the vehicle does not become damaged, for example, on the curb.

i The vehicle level may change visibly at the rear axle if you park the vehicle and the outside temperature changes. If the temperature drops, the vehicle level lowers; with an increase in temperature, the vehicle level rises.

4MATIC (permanent four-wheel drive)

If you fail to adapt your driving style, 4MATIC can neither reduce the risk of accident nor

override the laws of physics. 4MATIC cannot take account of road, weather and traffic conditions. 4MATIC is only an aid. You are responsible for the distance to the vehicle in front, for vehicle speed, for braking in good time and for staying in your lane.

If a drive wheel spins due to insufficient grip:

- Only depress the accelerator pedal as far as necessary when pulling away.
- Accelerate less when driving.

! Never tow the vehicle with one axle raised. This may damage the transfer case. Damage of this sort is not covered by the Mercedes-Benz Limited Warranty. All wheels must remain either on the ground or be fully raised. Observe the instructions for towing the vehicle with all wheels in full contact with the ground.

i In wintry driving conditions, the maximum effect of 4MATIC can only be achieved if you use winter tires (M+S tires), with snow chains if necessary.

4MATIC ensures that all four wheels are permanently driven. Together with ESP[®], it improves the traction of your vehicle whenever a drive wheel spins due to insufficient grip.

PARKTRONIC

Important safety notes

PARKTRONIC is an electronic parking aid with ultrasonic sensors. It monitors the area around your vehicle using six sensors in the front bumper and six sensors in the rear bumper. PARKTRONIC indicates visually and audibly the distance between your vehicle and an object.

PARKTRONIC is only an aid. It is not a replacement for your attention to your immediate surroundings. You are always responsible for safe maneuvering, parking and exiting a parking space. When maneuvering, parking or pulling out of a parking space, make sure that

there are no persons, animals or objects in the area in which you are maneuvering.

! When parking, pay particular attention to objects above or below the sensors, such as flower pots or trailer drawbars. PARKTRONIC does not detect such objects when they are in the immediate vicinity of the vehicle. You could damage the vehicle or the objects.

The sensors may not detect snow and other objects that absorb ultrasonic waves.

Ultrasonic sources such as an automatic car wash, the compressed-air brakes on a truck or a pneumatic drill could cause PARKTRONIC to malfunction.

PARKTRONIC may not function correctly on uneven terrain.

PARKTRONIC is activated automatically when you:

- switch on the ignition
- shift the transmission to position **D**, **R** or **N**
- release the parking brake

PARKTRONIC is deactivated at speeds above 11 mph (18 km/h). It is reactivated at lower speeds.

Range of the sensors

General notes

PARKTRONIC does not take objects into consideration that are:

- below the detection range, e.g. people, animals or objects.
- above the detection range, e.g. overhanging loads, truck overhangs or loading ramps.



① Sensors in the front bumper, left-hand side (example)

The sensors must be free from dirt, ice or slush. They can otherwise not function correctly. Clean the sensors regularly, taking care not to scratch or damage them (▷ page 268).

Range

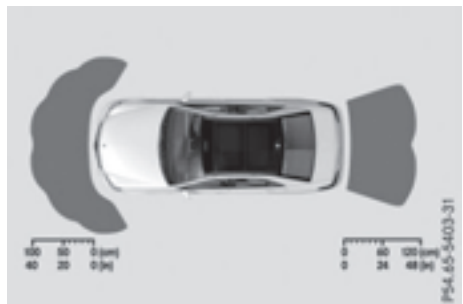
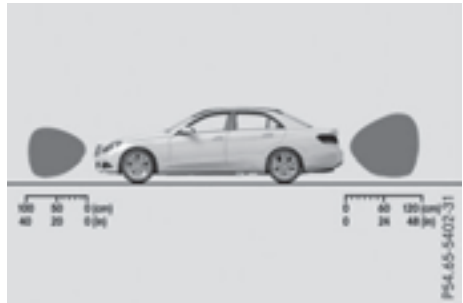

Example: top view

Front sensors

Center	Approx. 40 in (approx. 100 cm)
Corners	Approx. 24 in (approx. 60 cm)

Rear sensors

Center	Approx. 48 in (approx. 120 cm)
Corners	Approx. 32 in (approx. 80 cm)

Minimum distance

Center	Approx. 8 in (approx. 20 cm)
Corners	Approx. 6 in (approx. 15 cm)

If there is an obstacle within this range, the relevant warning displays light up and a warning tone sounds. If the distance falls below the minimum, the distance may no longer be shown.

Information in the Digital Operator's Manual

In the Digital Operator's Manual you will find information on the following topics:

- Warning displays
- Deactivating/activating PARKTRONIC
- Problems with PARKTRONIC

Active Parking Assist

General notes

Active Parking Assist is an electronic parking aid with ultrasound. It measures the road on both sides of the vehicle. A parking symbol indicates a suitable parking space. Active steering intervention and brake application

can assist you during parking. You may also use PARKTRONIC (▷ page 168).

- i** The active braking application is only available on vehicles with automatic transmission.

Important safety notes

Active Parking Assist is merely an aid. It is not a replacement for your attention to your immediate surroundings. You are always responsible for safe maneuvering, parking and exiting a parking space. Make sure that no persons, animals or objects are in the maneuvering range.

When PARKTRONIC is switched off, Active Parking Assist is also unavailable.

WARNING

If there are objects above the detection range:

- Active Park Assist may steer too early
- the vehicle may not stop in front of these objects.

You may cause a collision as a result. There is a risk of an accident.

If there are objects above the detection range, stop and deactivate Active Parking Assist.

WARNING

While parking or pulling out of a parking space, the vehicle swings out and can drive onto areas of the oncoming lane. This could result in a collision with another road user. There is a risk of an accident.

Pay attention to other road users. Stop the vehicle if necessary or cancel the Active Parking Assist parking procedure.

- !** If unavoidable, you should drive over obstacles such as curbs slowly and not at a sharp angle. Otherwise, you may damage the wheels or tires.

Active Parking Assist may possibly indicate parking spaces which are not suitable for parking, for example:

- where parking or stopping is prohibited
- in front of driveways or entrances and exits
- on unsuitable surfaces

Parking tips:

- On narrow roads, drive as close to the parking space as possible.
- Parking spaces that are littered or overgrown might be identified or measured incorrectly.
- Parking spaces that are partially occupied by trailer drawbars might not be identified as such or be measured incorrectly.
- Snowfall or heavy rain may lead to a parking space being measured inaccurately.
- Pay attention to the PARKTRONIC (▷ page 170) warning messages during the parking procedure.
- You can intervene in the steering procedure to correct it at any time. Active Parking Assist will then be canceled.
- When transporting a load which protrudes from your vehicle, you should not use Active Parking Assist.
- Never use Active Parking Assist when snow chains are installed.
- Make sure that the tire pressures are always correct. This has a direct influence on the parking characteristics of the vehicle.

Use Active Parking Assist for parking spaces:

- parallel or at right angles to the direction of travel
- that are on straight roads, not bends
- that are on the same level as the road, e.g. not on the pavement

Information in the Digital Operator's Manual

In the Digital Operator's Manual you will find information on the following topics:

- Detecting parking spaces
- Parking
- Exiting a parking space
- Canceling Active Parking Assist

Rear view camera

General notes



Example: Sedan

Rear view camera ① is an optical parking and maneuvering aid. It shows the area behind your vehicle with guidelines in the Audio 20 or COMAND display.

The area behind the vehicle is displayed as a mirror image, as in the rear view mirror.

i The text shown in the Audio 20 or COMAND display depends on the language setting. The following are examples of rear view camera messages in the COMAND display.

Important safety notes

The rear view camera is only an aid. It is not a replacement for your attention to your immediate surroundings. You are always responsible for safe maneuvering and parking. When maneuvering or parking, make sure that there are no persons, animals or objects in the area in which you are maneuvering.

Under the following circumstances, the rear view camera will not function, or will function in a limited manner:

- if the trunk lid or tailgate is open
- in heavy rain, snow or fog
- at night or in very dark places
- if the camera is exposed to very bright light
- if the area is lit by fluorescent bulbs or LED lighting (the display may flicker)
- if there is a sudden change in temperature, e.g. when driving into a heated garage in winter
- if the camera lens is dirty or obstructed. Observe the notes on cleaning (> page 268)
- if the rear of your vehicle is damaged. In this event, have the camera position and setting checked at a qualified specialist workshop

The field of vision and other functions of the rear view camera may be restricted due to additional accessories on the rear of the vehicle (e.g. license plate holder, bicycle rack).

On vehicles with height-adjustable chassis, leaving the standard height can result in inaccuracies in the guide lines, depending on technical conditions.

i The rear view camera is protected from raindrops and dust by means of a flap. When the rear view camera is activated, this flap opens.

The flap closes again when:

- you have finished the maneuvering process
- you switch off the engine
- you open the trunk

Observe the notes on cleaning (> page 268).

For technical reasons, the flap may remain open briefly after the rear view camera has been deactivated.

! Objects not at ground level may appear to be further away than they actually are, e.g.:

- the bumper of a parked vehicle
- the drawbar of a trailer
- the ball coupling of a trailer tow hitch
- the rear section of an HGV
- a slanted post

Use the guidelines only for orientation.

Approach objects no further than the bottom-most guideline.

The rear view camera may show a distorted view of obstacles, show them incorrectly or not at all. The rear view camera does not show objects in the following positions:

- very close to the rear bumper
- under the rear bumper
- in the area immediately above the tailgate handle

Activating/deactivating the rear view camera

- ▶ **To activate:** make sure that the SmartKey is in position **2** in the ignition lock.
- ▶ Make sure that the **Activation by R gear** function is selected in Audio 20 or COMAND, see the Digital Operator's Manual.
- ▶ Engage reverse gear. The rear view camera flap opens. The area behind the vehicle is shown with guide lines in the Audio 20 or COMAND display. The image from the rear view camera is available throughout the maneuvering process.

To deactivate: the rear view camera deactivates if you shift the transmission to **P** or after driving forwards a short distance.

Information in the Digital Operator's Manual

In the Digital Operator's Manual you will find information on the following topics:

- Messages in the Audio 20 or COMAND display
- "Reverse parking" function
- Wide-angle function

360° camera

General notes

The 360° camera is a system consisting of four cameras.

The system analyzes images from the following cameras:

- Rear view camera
- Front camera
- Two cameras in the exterior rear view mirrors

The cameras capture the immediate surroundings of the vehicle. The system supports you, e.g. when parking or if vision is restricted at an exit.

You can show pictures from the 360° camera in full-screen mode or in six different split-screen views on the COMAND/Audio 20 display. A split-screen view also includes a top view of the vehicle. This view is calculated from the data supplied by the installed cameras (virtual camera).

The six split-screen views are:

- top view and picture from the rear view camera (130° viewing angle)
- top view and image from the front camera (130° viewing angle without displaying the maximum steering wheel angle)
- top view and enlarged rear view
- top view and enlarged front view
- top view and images from the side mirror cameras (rear wheel view)
- top view and images from the side mirror cameras (front wheel view)

When the function is active and you shift the transmission from **D** or **R** to **N**, the dynamic guidelines are hidden.

When you change between transmission positions **D** and **R**, you see the previously selected front or rear view.

Distances measured by PARKTRONIC will also be optically displayed:

- in split screen view as red or yellow brackets around the vehicle icon in the top view, or
- at the bottom right as red or yellow brackets around the vehicle symbol in full-screen mode

The line thickness and color of the brackets show how far the vehicle is from an object.

- yellow brackets with thin lines: PARKTRONIC is active
- yellow brackets with normal lines: an object is present in close range of the vehicle
- red line: an object is present in the immediate close range of the vehicle

Important safety notes

The 360° camera is only an aid and may show a distorted view of obstacles, show them incorrectly or not at all. The 360° camera is not a substitute for attentive driving.

You are always responsible for safe maneuvering and parking. When maneuvering or parking, make sure that there are no persons, animals or objects in the area in which you are maneuvering.

You are always responsible for safety, and must always pay attention to your surroundings when parking and maneuvering. This applies to the areas behind, in front of and beside the vehicle. You could otherwise endanger yourself and others.

The 360° camera will not function or will function in a limited manner:

- if the doors are open
- if the exterior mirrors are folded in

- if the trunk lid/tailgate is open
- in heavy rain, snow or fog
- at night or in very dark places
- if the cameras are exposed to very bright light
- if the area is lit by fluorescent bulbs or LED lighting (the display may flicker)
- if there is a sudden change in temperature, e.g. when driving into a heated garage in winter
- if the camera lenses are dirty or covered
- if the vehicle components in which the cameras are installed are damaged. In this event, have the camera position and setting checked at a qualified specialist workshop.

Do not use the 360° camera in this case. You can otherwise injure others or cause damage to objects or the vehicle.

Guide lines are always shown at road level.

On vehicles with height-adjustable chassis, depending on technical conditions, leaving the standard height can result in:

- inaccuracies in the guide lines
- inaccuracies in the display of generated images (top view)

Activation conditions

The 360° camera image can be displayed if:



- your vehicle is equipped with a 360° camera
- the SmartKey is in position **2** in the ignition lock
- COMAND/Audio 20 is switched on
- the **360° Camera** function is switched on

Switching on the 360° camera

- ▶ Press the  button in the center console for longer than two seconds. Depending on whether position **D** or **R** is engaged, the following is shown:

- a split screen with top view and the image from the front camera or
- a split screen with top view and the image from the rear view camera

or

- ▶ Press the  button in the center console. The vehicle menu is displayed.
- ▶ Select **360° Camera** and press  to confirm. Depending on whether position **D** or **R** is engaged, the following is shown:
 - a split screen with top view and the image from the front camera or
 - a split screen with top view and the image from the rear view camera



Activating the 360° camera using reverse gear



The 360° camera images can be automatically displayed by engaging reverse gear.

- ▶ Make sure that the SmartKey is in position **2** in the ignition lock.
- ▶ Make sure that the **Activation by R gear** function is selected in COMAND/Audio 20 (see the separate COMAND/Audio 20 operating instructions).
- ▶ **To show the 360° camera image:** engage reverse gear. The area behind the vehicle is shown in the COMAND/Audio 20 display in split-screen mode. You see the top view of the vehicle and the image from the rear view camera.

Selecting the split-screen and full screen displays

Switching between split screen views

- ▶ To switch to the line with the vehicle icons: slide  the controller.
- ▶ To select one of the vehicle icons: turn  the controller.

► **To switch to 180° View:** turn  the controller to select **180° View** and press  to confirm.

i The **180° View** option is only available in the following views:

- Top view with picture from the rear view camera
- Top view with picture from the front camera

Information in the Digital Operator's Manual



In the Digital Operator's Manual you will find information on the following topics:

- Displays in the COMAND/Audio 20 display
- Wide-angle function
- Object detection

Exiting 360° camera display mode

The 360° camera display is stopped

- when you select transmission position **P**, or
- when you are driving at moderate speeds

The previous display appears on the COMAND/Audio 20 display. You can also switch the display by selecting the  symbol in the display and pressing  the controller to confirm.

ATTENTION ASSIST

General notes

ATTENTION ASSIST helps you during long, monotonous journeys, such as on highways. It is active in the 37 mph (60 km/h) to 125 mph (200 km/h) range. If ATTENTION ASSIST detects typical indicators of fatigue or increasing lapses in concentration on the part of the driver, it suggests taking a break.

Important safety notes

ATTENTION ASSIST is only an aid to the driver. It might not always recognize fatigue or increasing inattentiveness in time or fail to recognize them at all. The system is not a substitute for a well-rested and attentive driver.

The functionality of ATTENTION ASSIST is restricted and warnings may be delayed or not occur at all:

- if the length of the journey is less than approximately 30 minutes
 - if the road condition is poor, e.g. if the surface is uneven or if there are potholes
 - if there is a strong side wind
 - if you have adopted a sporty driving style with high cornering speeds or high rates of acceleration
 - if you are predominantly driving at a speed below 37 mph (60 km/h) or above 124 mph (200 km/h)
 - if you are driving with the DISTRONIC PLUS Steering Assist activated
 - if the time has been set incorrectly
 - in active driving situations, such as when you change lanes or change your speed
- ATTENTION ASSIST is reset when you continue your journey and starts assessing your tiredness again if:
- you switch off the engine
 - you take off your seat belt and open the driver's door, e.g. for a change of drivers or to take a break

Displaying the attention level

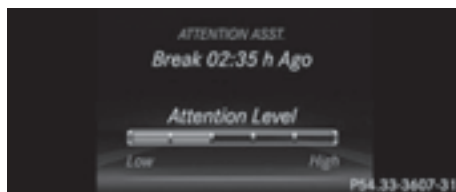

You can have current status information displayed in the assistance menu (▷ page 190) of the on-board computer.

- ▶ Select the Assistance display for ATTENTION ASSIST using the on-board computer (▷ page 190).

The following information is displayed:

- length of the journey since the last break.
- the attention level determined by ATTENTION ASSIST, displayed in a bar display in five levels from high to low.
- if ATTENTION ASSIST is unable to calculate the attention level and cannot output a warning, the **System Suspended** message appears. The bar display then changes the display, e.g. if you are driving at a speed below 37 mph (60 km/h) or above 124 mph (200 km/h).

Activating ATTENTION ASSIST

- ▶ Activate ATTENTION ASSIST using the on-board computer (▷ page 190).
The system determines the attention level of the driver depending on the setting selected:

Standard selected: the sensitivity with which the system determines the attention level is set to normal.

Sensitive selected: the sensitivity is set higher. The attention level detected by Attention Assist is adapted accordingly and the driver is warned earlier.

When ATTENTION ASSIST is deactivated, the  symbol and OFF appear in the multifunction display in the assistance display when the engine is running.

When ATTENTION ASSIST has been deactivated, it is automatically reactivated after the engine has been stopped. The sensitivity selected corresponds to the last selection activated (standard/sensitive).

Warning in the multifunction display

If fatigue or increasing lapses in concentration are detected, a warning appears in the multifunction display: **Attention Assist: Take a Break!**

In addition to the message shown in the multifunction display, you will then hear a warning tone.

- ▶ If necessary, take a break.
- ▶ Confirm the message by pressing the  button on the steering wheel.

On long journeys, take regular breaks in good time to allow yourself to rest properly. If you do not take a break, you will be warned again after 15 minutes at the earliest. This will only happen if ATTENTION ASSIST still detects typical indicators of fatigue or increasing lapses in concentration.

Traffic Sign Assist

General notes

Traffic Sign Assist displays the maximum speed permitted to the driver in the instrument cluster. The data and general traffic regulations stored in the navigation system are used to determine the current speed limit.

As Traffic Sign Assist is a map-based system, traffic signs put up temporarily (e.g. near roadworks) are not detected.

If a traffic sign that is relevant to your vehicle is passed, the display of the speed limits is updated.

Traffic signs with a restriction indicated by an additional sign (e.g. in wet conditions) are also shown.

The traffic signs are only displayed with the restrictions if:

- the regulation must be observed with the restriction, or
- Traffic Sign Assist is unable to determine whether the restriction applies



If Traffic Sign Assist is unable to determine a maximum permitted speed from any of the

available sources, no speed limit is displayed in the instrument cluster either.



Traffic Sign Assist is not available in all countries. In this case, symbol ① is shown in the assistance graphic display (▷ page 190).

Important safety notes

Traffic Sign Assist is only an aid and is not always able to correctly display speed limits. Traffic signs always have priority over the Traffic Sign Assist display.

The system may be either functionally impaired or temporarily unavailable if the information in the digital street map of the navigation system is incorrect or out of date.

Instrument cluster display

Displaying the assistance graphic

- ▶ Call up the assistance graphics display function using the on-board computer (▷ page 190).
- ▶ Select the Traffic Sign Assist display. Detected traffic signs are displayed in the instrument cluster.

Speed limit with unknown restriction



- ① Maximum permitted speed
- ② Maximum permitted speed for vehicles for which the restriction in the additional sign is relevant
- ③ Additional sign for unknown restriction

A maximum permitted speed of 100 mph (100 km/h) and a speed limit of 80 km/h (80 mph) apply with an unknown restriction.

Speed limits in wet conditions



- ① Maximum permitted speed
- ② Additional signs for wet conditions

A maximum permitted speed of 80 mph (80 km/h) applies in wet conditions and if Traffic Sign Assist has determined that the restriction must be observed.

Canceling the speed limit



The speed limit no longer applies ①.

- ❗ The unit for the speed limit (km/h or mph) depends on the country in which you are driving. It is generally neither shown on the traffic sign nor on the instrument cluster but must be taken into account when observing the maximum permitted speed.

Lane Tracking package

General notes

The Lane Tracking package consists of Blind Spot Assist (▷ page 178) and Lane Keeping Assist (▷ page 179).

Blind Spot Assist

General notes

Blind Spot Assist uses a radar sensor system to monitor the areas on both sides of your vehicle. It supports you from a speed of approximately 20 mph (30 km/h). A warning display in the exterior mirrors draws your attention to vehicles detected in the monitored area. If you then switch on the corresponding turn signal to change lanes, you will also receive an optical and audible collision warning. Blind Spot Assist uses sensors in the rear bumper for monitoring purposes.

Important safety notes

WARNING

Blind Spot Assist does not react to:

- vehicles overtaken too closely on the side, placing them in the blind spot area
- vehicles which approach with a large speed differential and overtake your vehicle

As a result, Blind Spot Assist may not give warnings in such situations. There is a risk of an accident.

Always observe the traffic conditions carefully, and maintain a safe lateral distance.

Blind Spot Assist is only an aid. It may fail to detect some vehicles and is no substitute for attentive driving. Always ensure that there is sufficient distance to the side for other road users and obstacles.

USA only:

This device has been approved by the FCC as a "Vehicular Radar System". The radar sensor is intended for use in an automotive radar system only. Removing, tampering with, or altering the device will void any warranties, and is not permitted by the FCC. Do not tamper with, alter, or use in any non-approved way.

Any unauthorized modification to this device could void the user's authority to operate the equipment.

Monitoring range of the sensors

In particular, the detection of obstacles can be impaired if:

- there is dirt on the sensors or anything else covering the sensors
- there is poor visibility, e.g. due to fog, heavy rain, snow or spray
- there are narrow vehicles, e.g. motorcycles or bicycles
- the road has very wide lanes
- the road has narrow lanes
- you are not driving in the middle of the lane
- there are barriers or similar lane borders

Vehicles in the monitoring range are then not indicated.

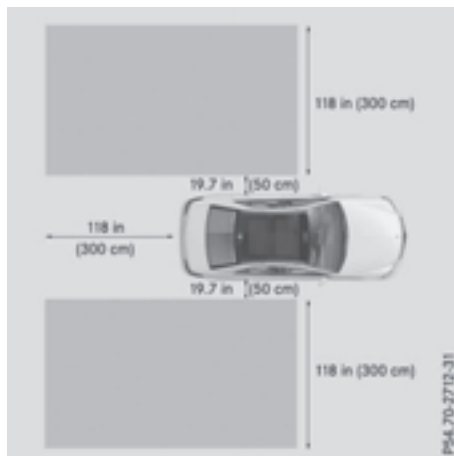

Example: Sedan

Blind Spot Assist monitors the area up to 10 ft (3 m) behind your vehicle and directly next to your vehicle, as shown in the diagram.

If the lanes are narrow, vehicles driving in the lane beyond the lane next to your vehicle may be indicated, especially if the vehicles are not driving in the middle of their lane. This may be the case if there are vehicles driving at the inner edge of their lanes.

Due to the nature of the system:

- warnings may be issued in error when driving close to crash barriers or similar solid lane borders.
- the warning is canceled when driving for an extended period next to long vehicles, such as trucks.

The two radar sensors for Blind Spot Assist are integrated into the sides of the rear bumper. Make sure that the bumper is free of dirt, ice or slush in the vicinity of the sensors. The sensors must not be covered, for example by cycle racks or overhanging loads. Following a severe impact or in the event of damage to the bumpers, have the function of the sensors checked at a qualified specialist workshop. Blind Spot Assist may otherwise not work properly.

Indicator and warning display



- ① Indicator lamp (yellow)
Warning lamp (red)

Blind Spot Assist is not active at speeds below approximately 20 mph (30 km/h). Vehicles in the monitoring range are then not indicated.

When Blind Spot Assist is activated, indicator lamp ① in the exterior mirrors lights up yellow at speeds of up to 20 mph (30 km/h). At speeds above 20 mph (30 km/h), the indicator lamp goes out and Blind Spot Assist is operational.

If a vehicle is detected within the blind spot monitoring range at speeds above 20 mph (30 km/h), warning lamp ① on the corresponding side lights up red. This warning is

always emitted when a vehicle enters the blind spot monitoring range from behind or from the side. When you overtake a vehicle, the warning only occurs if the difference in speed is less than 7 mph (12 km/h).

The yellow indicator lamp goes out if reverse gear is engaged. In this event, Blind Spot Assist is no longer active.

The brightness of the indicator or warning lamps is adjusted automatically according to the ambient light.

Information in the Digital Operator's Manual

In the Digital Operator's Manual you can find information about:

- Collision warning
- Switching on Blind Spot Assist

Lane Keeping Assist

General notes



Lane Keeping Assist monitors the area in front of your vehicle with camera ①, which is mounted at the top of the windshield. Active Lane Keeping Assist detects lane markings on the road and can warn you before you leave your lane unintentionally.

This function is available in the range between 40 mph and 120 mph (60 km/h and 200 km/h).

A warning may be given if a front wheel passes over a lane marking. It will warn you by means of intermittent vibration in the steering wheel for up to 1.5 seconds.

Important safety notes

WARNING

Lane Keeping Assist may not always clearly recognize lane markings.

In this case, Lane Keeping Assist may:

- give an unnecessary warning
- not give a warning

There is a risk of an accident.

Always pay particular attention to the traffic situation and stay in lane, in particular if warned by Lane Keeping Assist.

WARNING

The Lane Keeping Assist warning does not return the vehicle to the original lane. There is a risk of an accident.

You should always steer, brake or accelerate yourself, in particular if warned by Lane Keeping Assist.

If you fail to adapt your driving style, Lane Keeping Assist can neither reduce the risk of an accident nor override the laws of physics. Lane Keeping Assist cannot take into account the road, traffic and weather conditions. Lane Keeping Assist is merely an aid. You are responsible for the distance to the vehicle in front, for vehicle speed, for braking in good time and for staying in your lane.

The Lane Keeping Assist does not keep the vehicle in the lane.

The system may be impaired or may not function if:

- there is poor visibility, e.g. due to insufficient illumination of the road, or due to snow, rain, fog or spray
- there is glare, e.g. from oncoming traffic, the sun or reflections (e.g. when the road surface is wet)
- the windshield is dirty, fogged up, damaged or covered, for instance by a sticker, in the vicinity of the camera
- there are no, several or unclear lane markings for a lane, e.g. in areas with road construction work

- the lane markings are worn away, dark or covered up, e.g. by dirt or snow
- the distance to the vehicle in front is too small and the lane markings thus cannot be detected
- the lane markings change quickly, e.g. lanes branch off, cross one another or merge
- the road is narrow and winding
- there are strong shadows cast on the road

Switching on Lane Keeping Assist

You can find information about this in the Digital Operator's Manual.

Active Driving Assistance package

General notes

The Active Driving Assistance package consists of DISTRONIC PLUS (▷ page 156), Active Blind Spot Assist (▷ page 180) and Active Lane Keeping Assist (▷ page 183).

Active Blind Spot Assist

General notes

Active Blind Spot Assist uses a radar sensor system, pointed toward the rear of the vehicle, to monitor the area to the sides of the vehicle which the driver is unable to see. A warning display in the exterior mirrors draws your attention to vehicles detected in the monitored area. If you then switch on the corresponding turn signal to change lanes, you will also receive a visual and audible collision warning. If a risk of lateral collision is detected, corrective braking may help you avoid a collision. Before a course-correcting brake application, Active Blind Spot Assist evaluates the space in the direction of travel and at the sides of the vehicle. For this, Active Blind Spot Assist uses the forward-facing radar sensors.

Active Blind Spot Assist supports you from a speed of approximately 20 mph (30 km/h).

Important safety notes

Active Blind Spot Assist is only an aid and is not a substitute for attentive driving.

WARNING

Active Blind Spot Assist does not react to:

- vehicles overtaken too closely on the side, placing them in the blind spot area
- vehicles which approach with a large speed differential and overtake your vehicle

As a result, Active Blind Spot Assist may neither give warnings nor intervene in such situations. There is a risk of an accident.

Always observe the traffic conditions carefully, and maintain a safe lateral distance.

USA only:

This device has been approved by the FCC as a "Vehicular Radar System". The radar sensor is intended for use in an automotive radar system only. Removing, tampering with, or altering the device will void any warranties, and is not permitted by the FCC. Do not tamper with, alter, or use in any non-approved way.

Any unauthorized modification to this device could void the user's authority to operate the equipment.

Canada only: This device complies with RSS-210 of Industry Canada. Operation is subject to the following two conditions:

1. This device may not cause harmful interference, and
2. This device must accept any interference received, including interference that may cause undesired operation of the device.

Removal, tampering, or altering of the device will void any warranties, and is not permitted. Do not tamper with, alter, or use in any non-approved way.

Any unauthorized modification to this device could void the user's authority to operate the equipment.

Radar sensors

The Active Blind Spot Assist radar sensors are integrated into the front and rear bumpers and behind a cover in the radiator trim. Make sure that the bumpers and the cover in the radiator grill are free of dirt, ice or slush. The rear sensors must not be covered, for example by cycle racks or overhanging cargo. Following a severe impact or in the event of damage to the bumpers, have the function of the radar sensors checked at a qualified specialist workshop. Active Blind Spot Assist may otherwise no longer work properly.

Monitoring area

WARNING

Active Blind Spot Assist does not detect all traffic situations and road users. There is a risk of an accident.

Always make sure that there is sufficient distance on the side for other traffic or obstacles.

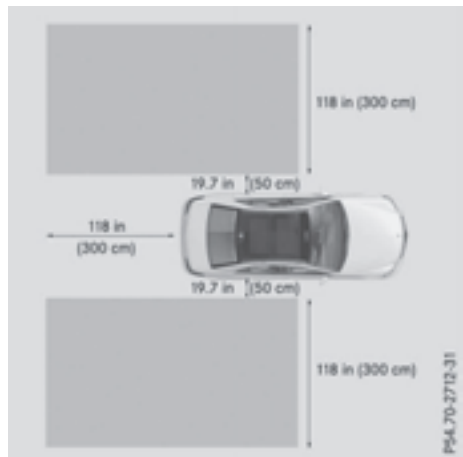

Example: Sedan

Active Blind Spot Assist monitors the area up to 10 ft (3.0 m) behind your vehicle and directly next to your vehicle, as shown in the diagram.

The detection of obstacles can be impaired in the case of:

- there is dirt on the sensors or anything else covering the sensors
- poor visibility, e.g. due to rain, snow or spray

Vehicles in the monitoring range are then not indicated or indicated with a delay.

Active Blind Spot Assist may not detect narrow vehicles, such as motorcycles or bicycles, or may only detect them too late.

If the lanes are narrow, vehicles driving in the lane beyond the lane next to your vehicle may be indicated, especially if the vehicles are not driving in the middle of their lane. This may be the case if there are vehicles at the edge of their lane.

Due to the nature of the system:

- warnings may be issued in error when driving close to crash barriers or similar solid lane borders.
- the warning is canceled when driving for an extended period next to long vehicles, such as trucks.

Warning display



① Warning display

Active Blind Spot Assist is not active at speeds below approximately 20 mph (30 km/h). Vehicles in the monitoring range are then not indicated.

When Active Blind Spot Assist is activated, indicator lamp ① in the exterior mirrors lights up yellow at speeds of up to 20 mph (30 km/h). At speeds above 20 mph

(30 km/h), the indicator lamp goes out and Active Blind Spot Assist is operational.

If a vehicle is detected within the blind spot monitoring range at speeds above 20 mph (30 km/h), warning lamp ① on the corresponding side lights up red. This warning is always given when a vehicle enters the blind spot monitoring range from behind or from the side. When you overtake a vehicle, the warning only occurs if the difference in speed is less than 7 mph (12 km/h).

The yellow indicator lamp goes out if reverse gear is engaged. Active Blind Spot Assist is not operational.

The brightness of the warning lamps is automatically adapted to the brightness of the surroundings.

Visual and acoustic collision warning

If you switch on the turn signals to change lanes and a vehicle is detected in the side monitoring range, you receive a visual and acoustic collision warning. You then hear a double warning tone and red warning lamp ① flashes. If the turn signal remains on, detected vehicles are indicated by the flashing of red warning lamp ①. There are no further warning tones.

Course-correcting brake application

If Active Blind Spot Assist detects a risk of a lateral collision in the monitoring range, a course-correcting brake application is carried out. This is meant to assist you in avoiding a collision.

⚠ WARNING

A course-correcting brake application cannot always prevent a collision. There is a risk of an accident.

Always steer, brake or accelerate yourself, especially if Active Blind Spot Assist warns you or makes a course-correcting brake application. Always maintain a safe distance at the sides.



Example: Sedan

If a course-correcting brake application occurs, red warning lamp ① flashes in the exterior mirror and a dual warning tone sounds. In addition, display ② appears in the multifunction display underlining the danger of a side collision.

In very rare cases, the system may make an inappropriate brake application. An inappropriate course-correcting brake application may be interrupted at any time if you steer slightly in the opposite direction or accelerate, for example.

The course-correcting brake application is available in the speed range between 20 mph (30 km/h) and 120 mph (200 km/h).

Either no braking application, or a course-correcting brake application adapted to the driving situation occurs if:

- there are vehicles or obstacles, e.g. crash barriers, located on both sides of your vehicle.
- a vehicle approaches you too closely at the side.

- you have adopted a sporty driving style with high cornering speeds.
- you clearly brake or accelerate.
- a driving safety system intervenes, e.g. ESP® or PRE-SAFE® Brake.
- ESP® is switched off.
- a loss of tire pressure or a defective tire is detected.

Information in the Digital Operator's Manual

In the Digital Operator's Manual you will find information on the following topics:

- Switching on Active Blind Spot Assist

Active Lane Keeping Assist

General notes



Active Lane Keeping Assist monitors the area in front of your vehicle by means of multifunction camera ① at the top of the windshield. Various different areas to the front, rear and side of your vehicle are also monitored with the aid of the radar sensor system. Active Lane Keeping Assist detects lane markings on the road and can warn you before you leave your lane unintentionally. If you do not react to the warning, a lane-correcting application of the brakes can bring the vehicle back into the original lane.

This function is available in the range between 40 mph and 120 mph (60 km/h and 200 km/h).

For Active Lane Keeping Assist to assist you when driving, the radar sensor system must be operational

Important safety notes

If you fail to adapt your driving style, Active Lane Keeping Assist can neither reduce the risk of accident nor override the laws of physics. Active Lane Keeping Assist cannot take account of road and weather conditions. It may not recognize traffic situations. Active Lane Keeping Assist is only an aid. You are responsible for the distance to the vehicle in front, for vehicle speed, for braking in good time and for staying in your lane.

Active Lane Keeping Assist cannot continuously keep your vehicle in its lane.

WARNING

Active Lane Keeping Assist cannot always clearly detect lane markings.

In such cases, Active Lane Keeping Assist can:

- give an unnecessary warning and then make a course-correcting brake application to the vehicle
- not give a warning or intervene

There is a risk of an accident.

Always pay particular attention to the traffic situation and keep within the lane, especially if Active Lane Keeping Assist alerts you. Terminate the intervention in a non-critical driving situation.

The system may be impaired or may not function if:

- there is poor visibility, e.g. due to insufficient illumination of the road, or due to snow, rain, fog or spray
- there is glare, e.g. from oncoming traffic, the sun or reflections (e.g. when the road surface is wet)
- the windshield is dirty, fogged up, damaged or covered, for instance by a sticker, in the vicinity of the camera

- the radar sensors in the front or rear bumpers or the radiator trim are dirty, e.g. obscured by snow
- there are no, several or unclear lane markings for a lane, e.g. in areas with road construction work
- the lane markings are worn away, dark or covered up, e.g. by dirt or snow
- the distance to the vehicle in front is too small and the lane markings thus cannot be detected
- the lane markings change quickly, e.g. lanes branch off, cross one another or merge
- the road is narrow and winding
- there are strong shadows cast on the road

If no vehicle is detected in the adjacent lane and broken lane markings are detected, no lane-correcting brake application is made.

Warning vibration in the steering wheel

A warning may be given if a front wheel passes over a lane marking. It will warn you by means of intermittent vibration in the steering wheel for up to 1.5 seconds.

Lane-correcting brake application

WARNING

A lane-correcting brake application cannot always bring the vehicle back into the original lane. There is a risk of an accident.

Always steer, brake or accelerate yourself, especially if Active Lane Keeping Assist warns you or makes a lane-correcting brake application.

WARNING

Active Lane Keeping Assist only detects traffic conditions or road users to a limited extent. In very rare cases, the system may make an inappropriate brake application, e.g. after intentionally driving over a solid lane marking. There is a risk of an accident.

An inappropriate brake application may be interrupted at any time if you steer slightly in the opposite direction. Always make sure that

there is sufficient distance on the side for other traffic or obstacles.

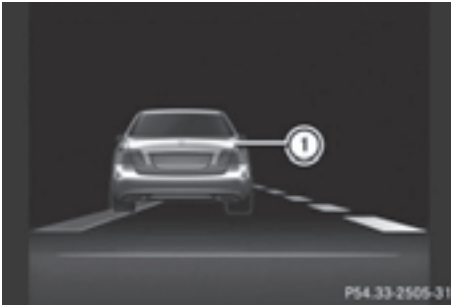

Example: Sedan

If you leave your lane, under certain circumstances the vehicle will brake briefly on one side. This is meant to assist you in bringing the vehicle back to the original lane.

If a lane-correcting brake application occurs, display ① appears in the multifunction display.

A lane-correcting brake application can be made after driving over a lane marking recognized as being solid or broken. Before this, a warning must be given by means of intermittent vibration in the steering wheel. In addition, a lane with lane markings on both sides must be recognized.

In the case of a broken lane marking being detected, a lane-correcting brake application can only be made if a vehicle has been detected in the adjacent lane. The following vehicles can have an influence on brake application: oncoming traffic, vehicles that are overtaking and vehicles that are driving parallel to your vehicle.

i A further lane-correcting brake application can only occur after your vehicle has returned to the original lane.

No lane-correcting brake application occurs if:

- you clearly and actively steer, brake or accelerate.
- you cut the corner on a sharp bend.

- you have adopted a sporty driving style with high cornering speeds or high rates of acceleration.
- you have switched on the turn signals.
- a driving safety system intervenes, e.g. ESP®, PRE-SAFE® Brake or Active Blind Spot Assist.
- ESP® is switched off.
- the transmission is not in position **D**.
- an obstacle has been detected in the lane in which you are driving.
- when a loss of tire pressure or a defective tire has been detected and displayed.

There is a possibility that the Active Lane Keeping Assist could misjudge the given traffic situation. An inappropriate brake application may be interrupted at any time if you:

- steer slightly in the opposite direction
- switch on the turn signal
- clearly brake or accelerate

A lane-correcting brake application is interrupted automatically if:

- a driving safety system intervenes, e.g. ESP®, PRE-SAFE® Brake or Active Blind Spot Assist.
- lane markings can no longer be recognized.

Information in the Digital Operator's Manual

In the Digital Operator's Manual you will find information on the following topics:

- Switching on Active Lane Keeping Assist

Useful information	188
Important safety notes	188
Displays and operation	188
Menus and submenus	190
Display messages	191
Warning and indicator lamps in the instrument cluster	202

Useful information

- i** This Operator's Manual describes all models and all standard and optional equipment of your vehicle available at the time of publication of the Operator's Manual. Country-specific differences are possible. Please note that your vehicle may not be equipped with all features described. This also applies to safety-related systems and functions.
- i** Read the information on qualified specialist workshops (▷ page 31).

Important safety notes

WARNING

If you operate information systems and communication equipment integrated in the vehicle while driving, you will be distracted from traffic conditions. You could also lose control of the vehicle. There is a risk of an accident. Only operate the equipment when the traffic situation permits. If you are not sure that this is possible, park the vehicle paying attention to traffic conditions and operate the equipment when the vehicle is stationary.

You must observe the legal requirements for the country in which you are currently driving when operating the on-board computer.

WARNING

If the instrument cluster has failed or malfunctioned, you may not recognize function restrictions in systems relevant to safety. The operating safety of your vehicle may be impaired. There is a risk of an accident. Drive on carefully. Have the vehicle checked at a qualified specialist workshop immediately.

The on-board computer only shows messages or warnings from certain systems in the multifunction display. You should therefore make

sure your vehicle is operating safely at all times.

If the operating safety of your vehicle is impaired, pull over as soon as it is safe to do so. Contact a qualified specialist workshop. Hybrid vehicles: always read the HYBRID operating instructions. You could otherwise fail to recognize dangers e.g. due to high voltage.

For an overview, see the instrument panel illustration (▷ page 37).

Displays and operation

Information in the Digital Operator's Manual

In the Digital Operator's Manual you will find information on the following topics:

- Coolant temperature display
- Tachometer
- Speedometer with segments
- Multifunction display
- Outside temperature display

Operating the on-board computer

Overview



- ① Multifunction display
- ③ Right control panel
- ④ Left control panel
- ⑤ Back button

► **To activate the on-board computer:** turn the SmartKey to position **1** in the ignition lock.

You can control the multifunction display and the settings in the on-board computer using the buttons on the multifunction steering wheel.

Left control panel



- Calls up the menu and menu bar



Press briefly:



- Scrolls in lists
- Selects a submenu or function
- Vehicles with Audio 20: in the **Audio** menu, selects the previous or next stored station, when the preset list or station list is active, or an audio track
- Vehicles with COMAND: in the **Audio** menu, selects the previous or next station, when the preset list or station list is active, or an audio track or video scene
- In the **Te1** (telephone) menu: switches to the phone book and selects a name or telephone number



Press and hold:







- Vehicles with Audio 20: in the **Audio** menu, selects the previous or next station, when the preset list or station list is active, selects an audio track using rapid scrolling, or selects a video scene
- Vehicles with COMAND: in the **Audio** menu, selects a preset list or station list in the desired frequency range or an audio track or video scene using rapid scrolling
- In the **Te1** (Telephone) menu: starts rapid scrolling if the phone book is open





- Confirms the selection or display message
- In the **Te1** (Telephone) menu: switches to the telephone book and starts dialing the selected number

Right control panel



	<ul style="list-style-type: none"> • Rejects or ends a call • Exits the telephone book/redial memory
	<ul style="list-style-type: none"> • Makes or accepts a call • Switches to the redial memory
 	<ul style="list-style-type: none"> • Adjusts the volume
	<ul style="list-style-type: none"> • Mute

Back button

	<p>Press briefly:</p> <ul style="list-style-type: none"> • Back • Vehicles with Audio 20: Switches off voice-operated control for navigation (see manufacturer's operating instructions) • Vehicles with COMAND: Switches off the Voice Control System (see the separate operating instructions) • Hides display messages or calls up the last Trip menu function used • Exits the telephone book/redial memory
	<p>Press and hold:</p> <ul style="list-style-type: none"> • Calls up the standard display in the Trip menu

Menus and submenus

Menu overview

Press the  or  button on the steering wheel to call up the menu bar and select a menu.

Operating the on-board computer
(> page 189).

You can find more information on the individual menus in the Digital Operator's Manual. Depending on the equipment installed in the vehicle, you can call up the following menus:

- **Trip** menu
- **Navi** menu (navigation instructions)
- **Audio** menu
- **Tel** menu (telephone)
- **DriveAssist** menu (assistance)
- **Serv.** menu
- **Sett.** menu (settings)
- **AMG** menu in AMG vehicles

Display messages

Introduction

General notes

This section describes display messages relevant to safety together with their solutions. A description of other messages and their solutions can be found in the Digital Operator's Manual.

Display messages appear in the multifunction display.

Display messages with graphic displays may be shown in simplified form in the Operator's Manual and may therefore differ from the multifunction display.



Please respond in accordance with the display messages and follow the additional notes in this Operator's Manual.

Certain display messages are accompanied by an audible warning tone or a continuous tone.

When the ignition is switched off, all display messages are deleted, apart from some high-priority display messages. Once the causes of the high-priority display messages have been rectified, the corresponding display messages are also deleted.

When you stop and park the vehicle, please observe the notes on the HOLD function (▷ page 165) and parking (▷ page 151).

Hiding display messages







- ▶ Press the  or  button on the steering wheel to hide the display message. The display message is cleared.

The multifunction display shows high-priority display messages in red. Some high-priority display messages cannot be hidden.

The multifunction display shows these messages continuously until the causes for the messages have been remedied.

Message memory

The on-board computer saves certain display messages in the **message memory**. You can call up the display messages:

- ▶ Press the  or  button on the steering wheel to select the **Serv.** menu. If there are display messages, the multifunction display shows **2 Messages**, for example.
- ▶ Press the  or  button to select the entry, e.g. **2 Messages**.
- ▶ Press  to confirm.
- ▶ Press the  or  button to scroll through the display messages.

Safety systems

Display messages



Currently Unavailable See Operator's Manual

Possible causes/consequences and ► Solutions

ABS (Anti-lock Braking System), ESP® (Electronic Stability Program), BAS (Brake Assist System), the HOLD function, PRE-SAFE® and hill start assist are temporarily unavailable.

BAS PLUS with Cross-Traffic Assist, COLLISION PREVENTION ASSIST PLUS, PRE-SAFE® PLUS and PRE-SAFE® Brake may also have failed.

In addition, the ,  and  warning lamps light up in the instrument cluster.

ATTENTION ASSIST is deactivated.

For example, the on-board voltage may be insufficient.

 **WARNING**

The brake system continues to function normally, but without the functions listed above. The wheels could therefore lock if you brake hard, for example.

The steerability and braking characteristics may be severely affected. The braking distance in an emergency braking situation can increase.

If ESP® is not operational, ESP® is unable to stabilize the vehicle. There is an increased risk of skidding and an accident.

► Drive on carefully.

If the display message disappears, the functions mentioned above are available again.

If the multifunction display still shows the display message:

► Drive on carefully.





► Visit a qualified specialist workshop.



Inoperative See Operator's Manual

ABS, ESP®, BAS, the HOLD function, PRE-SAFE® and hill start assist are not available due to a malfunction.





BAS PLUS with Cross-Traffic Assist, COLLISION PREVENTION ASSIST PLUS, PRE-SAFE® PLUS and PRE-SAFE® Brake may also have failed.

The  (USA only) or  (Canada only), ,  and  warning lamps in the instrument cluster also light up.

ATTENTION ASSIST is deactivated.

 **WARNING**

The brake system continues to function normally, but without the functions listed above. The wheels could therefore lock if you brake hard, for example.

Display messages	Possible causes/consequences and ► Solutions
	<p>The steerability and braking characteristics may be severely affected. The braking distance in an emergency braking situation can increase.</p> <p>If ESP® is not operational, ESP® is unable to stabilize the vehicle. There is an increased risk of skidding and an accident.</p> <ul style="list-style-type: none"> ► Drive on carefully. ► Visit a qualified specialist workshop immediately.
 <p>Inoperative See Operator's Manual</p>	<p>ESP®, BAS, the HOLD function, PRE-SAFE® and hill start assist are not available due to a malfunction.</p> <p>BAS PLUS with Cross-Traffic Assist, COLLISION PREVENTION ASSIST PLUS, PRE-SAFE® PLUS and PRE-SAFE® Brake may also have failed.</p> <p>In addition, the  and  warning lamps light up in the instrument cluster.</p> <p>The self-diagnosis function might not be complete, for example. ATTENTION ASSIST is deactivated.</p> <p> WARNING</p> <p>The brake system continues to function normally, but without the functions listed above.</p> <p>The braking distance in an emergency braking situation can thus increase.</p> <p>If ESP® is not operational, ESP® is unable to stabilize the vehicle. There is an increased risk of skidding and an accident.</p> <ul style="list-style-type: none"> ► Drive on carefully. ► Visit a qualified specialist workshop.

Display messages



Inoperative See
Operator's Manual

Possible causes/consequences and ► Solutions

EBD (electronic brake force distribution), ABS, ESP[®], BAS, the HOLD function, PRE-SAFE[®] and hill start assist are not available due to a malfunction.

BAS PLUS with Cross-Traffic Assist, COLLISION PREVENTION ASSIST PLUS, PRE-SAFE[®] PLUS and PRE-SAFE[®] Brake may also have failed.

In addition, the ,  and  warning lamps light up in the instrument cluster and a warning tone sounds.

 **WARNING**

The brake system continues to function normally, but without the functions listed above. The front and rear wheels could therefore lock if you brake hard, for example.

The steerability and braking characteristics may be severely affected. The braking distance in an emergency braking situation can increase.

If ESP[®] is not operational, ESP[®] is unable to stabilize the vehicle. There is an increased risk of skidding and an accident.

- Drive on carefully.
- Visit a qualified specialist workshop immediately.

BRAKE (USA
only)  (Canada
only)

Check Brake Fluid
Level









There is not enough brake fluid in the brake fluid reservoir. In addition, the **BRAKE** (USA only) or  (Canada only) warning lamp lights up in the instrument cluster and a warning tone sounds.

 **WARNING**

The braking effect may be impaired.

There is a risk of an accident.

- Pull over and stop the vehicle safely as soon as possible, paying attention to road and traffic conditions. Do not continue driving under any circumstances.
- Secure the vehicle against rolling away (► page 151).
- Consult a qualified specialist workshop.
- Do not add brake fluid. This does not correct the malfunction.

Display messages	Possible causes/consequences and ► Solutions
 <p>SRS. Malfunction Service Required</p>	<p>The restraint system is faulty. The  warning lamp also lights up in the instrument cluster.</p> <p>⚠ WARNING</p> <p>The air bags or Emergency Tensioning Devices may either be triggered unintentionally or, in the event of an accident, may not be triggered.</p> <p>There is an increased risk of injury.</p> <p>► Visit a qualified specialist workshop.</p> <p>Observe the additional information on restraint systems (► page 48).</p>
 <p>Front Left Malfunction Service Required or Front Right Malfunction Service Required</p>	<p>The restraint system has malfunctioned at the front on the left or right. The  warning lamp also lights up in the instrument cluster.</p> <p>⚠ WARNING</p> <p>The air bags or Emergency Tensioning Devices may either be triggered unintentionally or, in the event of an accident, may not be triggered.</p> <p>There is an increased risk of injury.</p> <p>► Visit a qualified specialist workshop.</p>
 <p>Rear Left Malfunction Service Required or Rear Right Malfunction Service Required</p>	<p>The restraint system has malfunctioned at the rear on the left or right. The  warning lamp also lights up in the instrument cluster.</p> <p>⚠ WARNING</p> <p>The air bags or Emergency Tensioning Devices may either be triggered unintentionally or, in the event of an accident, may not be triggered.</p> <p>There is an increased risk of injury.</p> <p>► Visit a qualified specialist workshop.</p>
 <p>Rear Center Malfunction Service Required</p>	<p>The restraint system has malfunctioned at the rear center. The  warning lamp also lights up in the instrument cluster.</p> <p>⚠ WARNING</p> <p>The air bags or Emergency Tensioning Devices may either be triggered unintentionally or, in the event of an accident, may not be triggered.</p> <p>There is an increased risk of injury.</p> <p>► Visit a qualified specialist workshop.</p>

Display messages

Possible causes/consequences and ► Solutions



Left Side Curtain
Airbag Malfunction
Service Required
or Right Side Cur-
tain Airbag Mal-
function Service
Required

There is a malfunction in the left-hand or right-hand window curtain air bag.

The  warning lamp also lights up in the instrument cluster.

 **WARNING**

The left or right window curtain air bag may either be triggered unintentionally or, in the event of an accident, may not be triggered.

There is an increased risk of injury.



► Visit a qualified specialist workshop.



Display messages	Possible causes/consequences and ► Solutions
<p>Front Passenger Airbag Disabled See Operator's Manual</p>	<p>The front-passenger air bag is deactivated during the journey, even though:</p> <ul style="list-style-type: none"> • an adult or • a person of the corresponding stature is on the front-passenger seat <p>If additional forces are applied to the seat, the system may interpret the occupant's weight as lower than it actually is.</p> <p> WARNING</p> <p>The front-passenger air bag does not deploy during an accident. There is an increased risk of injury.</p> <ul style="list-style-type: none"> ► Pull over and stop the vehicle safely as soon as possible, paying attention to road and traffic conditions. ► Secure the vehicle against rolling away (▷ page 151). ► Switch the ignition off. ► Have the occupant get out of the vehicle. ► Keep the seat unoccupied, close the front-passenger door and switch on the ignition. ► Observe the PASSENGER AIR BAG OFF indicator lamp in the center console and the multifunction display and check the following: <ul style="list-style-type: none"> Seat unoccupied and ignition switched on: <ul style="list-style-type: none"> • the PASSENGER AIR BAG OFF indicator lamp must then light up and remain lit. If the indicator lamp is on, OCS has disabled the front-passenger front air bag (▷ page 58) • the Front Passenger Airbag Enabled See Operator's Manual or Front Passenger Airbag Disabled See Operator's Manual display messages must not be shown in the multifunction display ► Wait for a period of at least 60 seconds until the necessary system checks have been completed. ► Make sure that the display messages do not appear in the multifunction display. <p>If these conditions are fulfilled, the front-passenger seat can be occupied again. Whether the PASSENGER AIR BAG OFF indicator lamp remains lit or goes out depends on how OCS classifies the occupant.</p> <p>If the conditions are not fulfilled, the system is not operating correctly.</p> <ul style="list-style-type: none"> ► Visit a qualified specialist workshop immediately.







Display messages	Possible causes/consequences and ► Solutions
	Observe the additional information on OCS (► page 58).
<p data-bbox="82 213 331 336">Front Passenger Airbag Enabled See Operator's Manual</p>	<p data-bbox="342 213 1005 272">The front-passenger air bag is enabled during the journey, even though:</p> <ul data-bbox="342 280 1005 408" style="list-style-type: none"> • a child, a small adult or an object weighing less than the system's weight threshold is located on the front-passenger seat or • the front-passenger seat is unoccupied <p data-bbox="342 416 1005 475">The system may detect objects or forces applying additional weight on the seat.</p> <p data-bbox="342 483 505 520">⚠ WARNING</p> <p data-bbox="342 528 1005 587">The air bag may deploy unintentionally. There is an increased risk of injury.</p> <ul data-bbox="342 595 1005 1137" style="list-style-type: none"> ► Pull over and stop the vehicle safely as soon as possible, paying attention to road and traffic conditions. ► Secure the vehicle against rolling away (► page 151). ► Switch the ignition off. ► Open the front-passenger door. ► Remove the child and the child restraint system from the front-passenger seat. ► Make sure that there are no objects on the seat adding to the weight. The system may otherwise detect the additional weight and interpret the seat occupant's weight as greater than it actually is. ► Keep the seat unoccupied, close the front-passenger door and switch on the ignition. ► Observe the PASSENGER AIR BAG OFF indicator lamp in the center console and the multifunction display and check the following: <p data-bbox="342 1145 1005 1171">Seat unoccupied and ignition switched on:</p> <ul data-bbox="342 1179 1005 1422" style="list-style-type: none"> • the PASSENGER AIR BAG OFF indicator lamp must then light up and remain lit. If the indicator lamp is on, OCS (Occupant Classification System) has disabled the front-passenger front air bag (► page 58) • the Front Passenger Airbag Enabled See Operator's Manual or Front Passenger Airbag Disabled See Operator's Manual display messages must not be shown in the multifunction display

Display messages	Possible causes/consequences and ► Solutions
	<ul style="list-style-type: none"> ► Wait for a period of at least 60 seconds until the necessary system checks have been completed. ► Make sure that the display messages do not appear in the multifunction display. <p>If these conditions are fulfilled, the front-passenger seat can be occupied again. Whether the PASSENGER AIR BAG OFF indicator lamp remains lit or goes out depends on how OCS classifies the occupant.</p> <p>If the conditions are not fulfilled, the system is not operating correctly.</p> <ul style="list-style-type: none"> ► Visit a qualified specialist workshop immediately. <p>Observe the additional information on OCS (► page 58).</p>

Engine

Display messages	Possible causes/consequences and ► Solutions
 <p data-bbox="116 775 333 861">Coolant Too Hot Stop Vehicle Turn Engine Off</p>	<p>The coolant is too hot. A warning tone also sounds.</p> <p> WARNING</p> <p>Do not drive when your engine is overheated. This can cause some fluids which may have leaked into the engine compartment to catch fire.</p> <p>Steam from the overheated engine can also cause serious burns which can occur just by opening the hood.</p> <p>There is a risk of injury.</p> <ul style="list-style-type: none"> ► Pull over and stop the vehicle safely and switch off the engine, paying attention to road and traffic conditions. ► Secure the vehicle against rolling away (► page 151). ► Wait until the engine has cooled down. ► Make sure that the air supply to the engine radiator is not blocked, e.g. by snow, slush or ice. ► Do not start the engine again until the display message goes out and the coolant temperature is below 248 °F (120 °C). Otherwise, the engine could be damaged. ► Pay attention to the coolant temperature display. ► If the temperature increases again, visit a qualified specialist workshop immediately. <p>Under normal operating conditions and with the specified coolant level, the coolant temperature may rise to 248 °F (120 °C).</p>

Tires	
Display messages	Possible causes/consequences and ► Solutions
Check Tires	<p>The tire pressure in one or more tires has dropped significantly. The wheel position is displayed in the multifunction display. A warning tone also sounds.</p> <p> WARNING</p> <p>With tire pressures which are too low, there is a risk of the following hazards:</p> <ul style="list-style-type: none"> • they may burst, especially as the load and vehicle speed increase. • they may wear excessively and/or unevenly, which may greatly impair tire traction. • the driving characteristics, as well as steering and braking, may be greatly impaired. <p>There is a risk of an accident.</p> <ul style="list-style-type: none"> ► Stop the vehicle without making any sudden steering or braking maneuvers. Pay attention to the traffic conditions as you do so. ► Secure the vehicle against rolling away (▷ page 151). ► Check the tires and, if necessary, follow the instructions for a flat tire (▷ page 271). ► Check the tire pressure (▷ page 294). ► If necessary, correct the tire pressure.
Warning Tire Malfunction	<p>The tire pressure in one or more tires has dropped suddenly. The wheel position is shown in the multifunction display.</p> <p> WARNING</p> <p>If you drive with a flat tire, there is a risk of the following hazards:</p> <ul style="list-style-type: none"> • a flat tire affects the ability to steer or brake the vehicle. • you could lose control of the vehicle. • continued driving with a flat tire will cause excessive heat build-up and possibly a fire. <p>There is a risk of an accident.</p> <ul style="list-style-type: none"> ► Stop the vehicle without making any sudden steering or braking maneuvers. Pay attention to the traffic conditions as you do so. ► Secure the vehicle against rolling away (▷ page 151). ► Check the tires and, if necessary, follow the instructions for a flat tire (▷ page 271).

Vehicle	
Display messages	Possible causes/consequences and ► Solutions
<p>Risk of Rolling Away Vehicle Not in 'P'</p>	<p>The driver's door is open or not fully closed and the selector lever is in position R, N or D. A warning tone also sounds.</p> <p> WARNING</p> <p>The vehicle may roll away. There is a risk of an accident.</p> <ul style="list-style-type: none"> ► Shift the selector lever to position P. ► Secure the vehicle against rolling away (▷ page 151). ► Close the driver's door completely.
	<p>Wagon: the tailgate is open.</p> <p> WARNING</p> <p>When the engine is running, exhaust gases can enter the vehicle interior if the tailgate is open. There is a risk of poisoning.</p> <ul style="list-style-type: none"> ► Close the tailgate.
	<p>The hood is open. A warning tone also sounds.</p> <p> WARNING</p> <p>The open hood may block your view when the vehicle is in motion. There is a risk of an accident.</p> <ul style="list-style-type: none"> ► Pull over and stop the vehicle safely as soon as possible, paying attention to road and traffic conditions. ► Secure the vehicle against rolling away (▷ page 151). ► Close the hood.
 <p>Power Steering Malfunction See Operator's Manual</p>	<p>The power steering is malfunctioning. A warning tone also sounds.</p> <p> WARNING</p> <p>You will need to use more force to steer. There is a risk of an accident.</p> <ul style="list-style-type: none"> ► Check whether you are able to apply the extra force required. ► If you are able to steer safely: carefully drive on to a qualified specialist workshop. ► If you are unable to steer safely: do not drive on. Contact the nearest qualified specialist workshop.

Warning and indicator lamps in the instrument cluster



General notes

This section describes indicator and warning lamps in the instrument cluster relevant to safety and solutions. A description of other indicator and warning lamps in the instrument cluster and their solutions can be found in the Digital Operator's Manual.

Some systems carry out a self-diagnosis when the ignition is switched on. Therefore, some indicator and warning lamps may light up or flash temporarily. This behavior is non-critical. These indicator and warning lamps only indicate a malfunction if they light up or flash after starting the engine or whilst driving.







Safety



Seat belts









Problem	Possible causes/consequences and ► Solutions
 <p>After starting the engine, the red seat belt warning lamp lights up for 6 seconds.</p>	<p>The seat belt warning lamp reminds the driver and front passenger to fasten their seat belts.</p> <p>► Fasten your seat belt (▷ page 52).</p>
 <p>After starting the engine, the red seat belt warning lamp lights up. In addition, a warning tone sounds for up to 6 seconds.</p>	<p>The driver's seat belt is not fastened.</p> <p>► Fasten your seat belt (▷ page 52). The warning tone ceases.</p>
 <p>The red seat belt warning lamp lights up after the engine starts, as soon as the driver's or the front-passenger door is closed.</p>	<p>The driver or front passenger has not fastened their seat belt.</p> <p>► Fasten your seat belt (▷ page 52). The warning lamp goes out.</p>
	<p>There are objects on the front-passenger seat.</p> <p>► Remove the objects from the front-passenger seat and stow them in a secure place. The warning lamp goes out.</p>





Problem	Possible causes/consequences and ► Solutions
 <p>The red seat belt warning lamp flashes and an intermittent audible warning sounds.</p>	<p>The driver or front passenger has not fastened their seat belt. The vehicle is being driven faster than 15 mph (25 km/h) or has briefly been driven faster than 15 mph (25 km/h).</p> <ul style="list-style-type: none"> ► Fasten your seat belt (► page 52). The warning lamp goes out and the intermittent warning tone ceases. <p>There are objects on the front-passenger seat. The vehicle is being driven faster than 15 mph (25 km/h) or has briefly been driven faster than 15 mph (25 km/h).</p> <ul style="list-style-type: none"> ► Remove the objects from the front-passenger seat and stow them in a secure place. The warning lamp goes out and the intermittent warning tone ceases.





Safety systems



Problem	Possible causes/consequences and ► Solutions
<p> (USA only)  (Canada only)</p> <p>The red brake system warning lamp comes on while the engine is running. A warning tone also sounds.</p>	<p> WARNING</p> <p>The brake boosting effect is malfunctioning and the braking characteristics may be affected. There is a risk of an accident.</p> <ul style="list-style-type: none"> ► Pull over and stop the vehicle safely as soon as possible, paying attention to road and traffic conditions. Do not continue driving under any circumstances. ► Secure the vehicle against rolling away (▷ page 151). ► Consult a qualified specialist workshop. ► Observe the additional display messages in the multifunction display.
<p> (USA only)  (Canada only)</p> <p>The red brake system warning lamp comes on while the engine is running. A warning tone also sounds.</p>	<p> WARNING</p> <p>There is not enough brake fluid in the brake fluid reservoir. The braking effect may be impaired. There is a risk of an accident.</p> <ul style="list-style-type: none"> ► Pull over and stop the vehicle safely as soon as possible, paying attention to road and traffic conditions. Do not continue driving under any circumstances. ► Secure the vehicle against rolling away (▷ page 151). ► Do not add brake fluid. Adding more will not remedy the malfunction. ► Consult a qualified specialist workshop. ► Observe the additional display messages in the multifunction display.

Problem	Possible causes/consequences and ► Solutions
 <p>The yellow ABS warning lamp is lit while the engine is running.</p>	<p>ABS (Anti-lock Braking System) is deactivated due to a malfunction. Therefore, BAS (Brake Assist System), BAS PLUS with Cross-Traffic Assist, COLLISION PREVENTION ASSIST PLUS, ESP® (Electronic Stability Program), PRE-SAFE®, PRE-SAFE® PLUS, PRE-SAFE® Brake, the HOLD function and hill start assist, for example, are also deactivated. ATTENTION ASSIST is deactivated.</p> <p> WARNING</p> <p>The brake system continues to function normally, but without the functions listed above. The wheels could therefore lock if you brake hard, for example.</p> <p>The steerability and braking characteristics may be severely affected. The braking distance in an emergency braking situation can increase.</p> <p>If ESP® is not operational, ESP® is unable to stabilize the vehicle. There is an increased risk of skidding and an accident.</p> <ul style="list-style-type: none"> ► Observe the additional display messages in the multifunction display. ► Drive on carefully. ► Visit a qualified specialist workshop. <p>If the ABS control unit is faulty, there is also a possibility that other systems, such as the navigation system or the automatic transmission, will not be available.</p>

Problem	Possible causes/consequences and ► Solutions
 <p>The yellow ABS warning lamp is lit while the engine is running. A warning tone also sounds.</p>	<p>EBD is not available due to a malfunction. Therefore, ABS, BAS, BAS PLUS with Cross-Traffic Assist, COLLISION PREVENTION ASSIST PLUS, ESP[®], PRE-SAFE[®], PRE-SAFE[®] PLUS, PRE-SAFE[®] Brake, the HOLD function and hill start assist, for example, are also unavailable.</p> <p>ATTENTION ASSIST is deactivated.</p> <p> WARNING</p> <p>The brake system continues to function normally, but without the functions listed above. The front and rear wheels could therefore lock if you brake hard, for example.</p> <p>The steerability and braking characteristics may be severely affected. The braking distance in an emergency braking situation can increase.</p> <p>If ESP[®] is not operational, ESP[®] is unable to stabilize the vehicle. There is an increased risk of skidding and an accident.</p> <ul style="list-style-type: none"> ► Observe the additional display messages in the multifunction display. ► Drive on carefully. ► Visit a qualified specialist workshop.
<p> (USA only)</p> <p> (Canada only)</p> <p>  </p> <p>The red brake warning lamp, the yellow ESP[®] and ESP[®] OFF warning lamps and the yellow ABS warning lamp are lit while the engine is running.</p>	<p>ABS and ESP[®] are not available due to a malfunction. Therefore, BAS, BAS PLUS with Cross-Traffic Assist, COLLISION PREVENTION ASSIST PLUS, EBD, PRE-SAFE[®], PRE-SAFE[®] PLUS, PRE-SAFE[®] Brake, the HOLD function and hill start assist, for example, are also unavailable.</p> <p>ATTENTION ASSIST is deactivated.</p> <p> WARNING</p> <p>The brake system continues to function normally, but without the functions listed above. The front and rear wheels could therefore lock if you brake hard, for example.</p> <p>The steerability and braking characteristics may be severely affected. The braking distance in an emergency braking situation can increase.</p> <p>If ESP[®] is not operational, ESP[®] is unable to stabilize the vehicle. There is an increased risk of skidding and an accident.</p> <ul style="list-style-type: none"> ► Observe the additional display messages in the multifunction display. ► Drive on carefully. ► Visit a qualified specialist workshop.





Problem	Possible causes/consequences and ► Solutions
 <p>The yellow ESP® warning lamp flashes while the vehicle is in motion.</p>	<p>ESP® or traction control has intervened because there is a risk of skidding or at least one wheel has started to spin. Cruise control or DISTRONIC PLUS is deactivated.</p> <ul style="list-style-type: none"> ► When pulling away, only depress the accelerator pedal as far as necessary. ► Ease off the accelerator pedal while the vehicle is in motion. ► Adapt your driving style to suit the road and weather conditions. ► Do not deactivate ESP®. <p>In rare cases (► page 81) it may be best to deactivate ESP®. Observe the important safety notes on ESP® (► page 81).</p>
 <p>The yellow ESP® OFF warning lamp is lit while the engine is running.</p>	<p>ESP® is deactivated.</p> <p> WARNING</p> <p>If ESP® is switched off, ESP® is unable to stabilize the vehicle. Further driving systems or driving safety systems are thus restricted, e.g. Active Blind Spot Assist. The system does not perform braking actions.</p> <p>There is an increased risk of skidding and an accident.</p> <ul style="list-style-type: none"> ► Reactivate ESP®. <p>In rare cases (► page 81) it may be best to deactivate ESP®. Observe the important safety notes on ESP® (► page 81).</p> <ul style="list-style-type: none"> ► Adapt your driving style to suit the road and weather conditions. <p>If ESP® cannot be activated:</p> <ul style="list-style-type: none"> ► Drive on carefully. ► Have ESP® checked at a qualified specialist workshop.
 <p>AMG vehicles only: The yellow SPORT handling mode warning lamp is lit while the engine is running.</p>	<p>SPORT handling mode is activated.</p> <p> WARNING</p> <p>When SPORT handling mode is switched on, ESP® is unable to stabilize the vehicle.</p> <p>There is an increased risk of skidding and an accident.</p> <ul style="list-style-type: none"> ► Only switch to SPORT handling mode in accordance with the conditions described in the "Activating/deactivating SPORT handling mode" section (► page 82).

Problem	Possible causes/consequences and ► Solutions
 <p>The yellow ESP[®] and ESP[®] OFF warning lamps are lit while the engine is running.</p>	<p>ESP[®], BAS, BAS PLUS with Cross-Traffic Assist, COLLISION PREVENTION ASSIST PLUS, PRE-SAFE[®], PRE-SAFE[®] PLUS, PRE-SAFE[®] Brake, the HOLD function and hill start assist are unavailable due to a malfunction. ATTENTION ASSIST is deactivated.</p> <p> WARNING</p> <p>The brake system continues to function normally, but without the functions listed above. The braking distance in an emergency braking situation can thus increase. If ESP[®] is not operational, ESP[®] is unable to stabilize the vehicle. There is an increased risk of skidding and an accident.</p> <ul style="list-style-type: none"> ► Observe the additional display messages in the multifunction display. ► Drive on carefully. ► Visit a qualified specialist workshop.
 <p>The red restraint system warning lamp is lit while the engine is running.</p>	<p>The restraint system is faulty.</p> <p> WARNING</p> <p>The air bags or Emergency Tensioning Devices may either be triggered unintentionally or, in the event of an accident, may not be triggered. There is an increased risk of injury.</p> <ul style="list-style-type: none"> ► Observe the additional display messages in the multifunction display. ► Drive on carefully. ► Have the restraint system checked immediately at a qualified specialist workshop. <p>Observe the additional information on restraint systems (► page 48).</p>

Engine	
Problem	Possible causes/consequences and ► Solutions
 <p>The red coolant warning lamp comes on while the engine is running. A warning tone also sounds.</p>	<p>The coolant temperature has exceeded 248 °F (120 °C). The air-flow to the engine radiator may be blocked or the coolant level may be too low.</p> <p> WARNING</p> <p>The engine is not being cooled sufficiently and may be damaged. Do not drive when your engine is overheated. This can cause some fluids which may have leaked into the engine compartment to catch fire.</p> <p>Steam from the overheated engine can also cause serious burns which can occur just by opening the hood.</p> <p>There is a risk of injury.</p> <ul style="list-style-type: none"> ► Observe the additional display messages in the multifunction display. ► Pull over and stop the vehicle safely and switch off the engine, paying attention to road and traffic conditions. ► Secure the vehicle against rolling away (► page 151). ► Leave the vehicle and keep a safe distance from the vehicle until the engine has cooled down. ► Check the coolant level and add coolant, observing the warning notes (► page 265). ► If you need to add coolant more often than usual, have the engine coolant system checked. ► Make sure that the air supply to the engine radiator is not blocked, e.g. by snow, slush or ice. ► At coolant temperatures below 248 °F (120 °C), drive to the nearest qualified specialist workshop. ► Avoid subjecting the engine to heavy loads, e.g. driving in mountainous terrain, and stop-and-go traffic.

Driving systems

Problem	Possible causes/consequences and ► Solutions
 <p>The red distance warning lamp lights up while the vehicle is in motion. A warning tone also sounds.</p>	<p>You are approaching a vehicle, a pedestrian or a stationary obstacle in your line of travel at too high a speed.</p> <ul style="list-style-type: none"> ► Be prepared to brake immediately. ► Pay careful attention to the traffic situation. You may have to brake or take evasive action. <p>Observe the additional information on PRE-SAFE® Brake (► page 84).</p> <p>Observe the additional information on the distance warning function of COLLISION PREVENTION ASSIST PLUS (► page 78).</p>

Tires	
Problem	Possible causes/consequences and ► Solutions
 <p>The yellow tire pressure monitor warning lamp (pressure loss/malfunction) is lit.</p>	<p>The tire pressure monitor has detected a loss of pressure in at least one of the tires.</p> <p> WARNING</p> <p>With tire pressures which are too low, there is a risk of the following hazards:</p> <ul style="list-style-type: none"> • they may burst, especially as the load and vehicle speed increase. • they may wear excessively and/or unevenly, which may greatly impair tire traction. • the driving characteristics, as well as steering and braking, may be greatly impaired. <p>There is a risk of an accident.</p> <ul style="list-style-type: none"> ► Stop the vehicle without making any sudden steering or braking maneuvers. Pay attention to the traffic conditions as you do so. ► Secure the vehicle against rolling away (▷ page 151). ► Observe the additional display messages in the multifunction display. ► Check the tires and, if necessary, follow the instructions for a flat tire (▷ page 271). ► Check the tire pressure (▷ page 294). ► If necessary, correct the tire pressure.
 <p>The yellow tire pressure monitor warning lamp (pressure loss/malfunction) flashes for approximately one minute and then remains lit.</p>	<p>The tire pressure monitor is faulty.</p> <p> WARNING</p> <p>The system is possibly unable to recognize or register low tire pressure.</p> <p>There is a risk of an accident.</p> <ul style="list-style-type: none"> ► Observe the additional display messages in the multifunction display. ► Visit a qualified specialist workshop.

General notes	214
Important safety notes	214
Function restrictions	215
Audio 20/COMAND operating system	216

General notes

The Audio 20/COMAND section in these operating instructions describes the basic operating principles. More information can be found in the Digital Operator's Manual.

Important safety notes

WARNING

Modifications to electronic components, their software as well as wiring can impair their function and/or the function of other networked components. In particular, systems relevant to safety could also be affected. As a result, these may no longer function as intended and/or jeopardize the operating safety of the vehicle. There is an increased risk of an accident and injury.

Never tamper with the wiring as well as electronic components or their software. You should have all work to electrical and electronic equipment carried out at a qualified specialist workshop.

If you make any changes to the vehicle electronics, the general operating permit is rendered invalid.

WARNING

If you operate information systems and communication equipment integrated in the vehicle while driving, you will be distracted from traffic conditions. You could also lose control of the vehicle. There is a risk of an accident.

Only operate the equipment when the traffic situation permits. If you are not sure that this is possible, park the vehicle paying attention to traffic conditions and operate the equipment when the vehicle is stationary.

You must observe the legal requirements for the country in which you are currently driving when operating Audio 20/COMAND.

Audio 20/COMAND calculates the route to the destination without taking account of the following, for example:

- traffic lights
- stop and yield signs
- merging lanes
- parking or stopping in a no parking/no stopping zone
- other road and traffic rules and regulations
- narrow bridges

Audio 20/COMAND can give incorrect navigation commands if the actual street/traffic situation does not correspond with the digital map's data. Digital maps do not cover all areas nor all routes in an area. For example, a route may have been diverted or the direction of a one-way street may have changed.

For this reason, you must always observe road and traffic rules and regulations during your journey. Road and traffic rules and regulations always have priority over the system's driving recommendations.

Navigation announcements are intended to direct you while driving without diverting your attention from the road and driving.

Please always use this feature instead of consulting the map display for directions. Looking at the icons or map display can distract you from traffic conditions and driving, and increase the risk of an accident.

Bear in mind that at a speed of only 30 mph (approximately 50 km/h) your vehicle covers a distance of 44 feet (approximately 14 m) per second.

This equipment complies with FCC radiation exposure limits set forth for uncontrolled equipment and meets the FCC radio frequency (RF) Exposure Guidelines in Supplement C to OET65.

This equipment has very low levels of RF energy that is deemed to comply without maximum permissive exposure evaluation (MPE). But it is desirable that it should be installed and operated with at least 8 inches (20 cm) and more between the radiator and a

person's body (excluding extremities: hands, wrists, feet and legs.)

Function restrictions

For safety reasons, some functions are restricted or unavailable while the vehicle is in motion. You will notice this, for example, because either you will not be able to select certain menu items or a message will appear to this effect.

Audio 20/COMAND operating system

Overview

Components



- ① Display for Audio 20/COMAND
- ② Audio 20/COMAND control panel
- ③ Controller and buttons

Audio 20/COMAND consists of:

- the display
 - the control panel with a single drive or DVD changer
 - the controller and buttons
 - a slot for an SD card
 - two connection options for USB or Media Interface in the center console
- An iPod® is connected via USB cable.

Functions

- **HD FM radio/HD AM radio/satellite radio**
- **Media**
 - COMAND media support: audio CD, MP3 CD, DVD video, two connection options for USB or Media Interface (e.g. iPod®), SD card, Bluetooth audio

Audio 20 media support: if a single drive is available, audio CD and MP3 CD, two connection options for USB or Media

Interface (e.g. iPod®), SD card, Bluetooth audio

If the Media Interface is available, an iPod® can be connected directly to the USB.

- Music search using all media

- **Sound system**

You can select from the following sound systems:

- harman/kardon® Logic7® surround sound system
- Bang & Olufsen BeoSound AMG sound system (COMAND)

• Navigation system

- Navigation via the hard drive (COMAND)
- Navigation via an SD card (if available for Audio 20)
- Destination entry, e.g. using keyword search (COMAND)
- Realistic 3D map with textured city models
- Personal POIs and routes using SD memory card (COMAND)
- Navigation functions, e.g. compass display (COMAND)
- Dynamic route guidance with traffic reports via SIRIUS satellite radio (COMAND)

• Communication

- Messaging functions: text messages, e-mail (COMAND)
- Address book (COMAND)
- Internet browser (COMAND)
- Mercedes-Benz Apps with Google™, Local Search, Destination/Route download, Facebook, Google Street View™, stock prices, news and much more
- Mercedes-Benz mobile website
- WiFi interface for the connection of a smartphone to COMAND
- WiFi hotspot functionality to connect a tablet PC or notebook in order to enable access to the Internet using the customer's mobile phone (COMAND)

• SIRIUS Weather (COMAND)

- Weather data as an information chart (current forecast, 5-day preview, detailed information)
- Weather data on the weather map, e.g. rain radar data, storm characteristics

and the track of tropical cyclones (hurricanes, tornadoes)

• Vehicle functions

- Vehicle settings, e.g. fuel consumption
- 360° camera
- Rear view camera
- Seat functions

• Favorites button (if available)

Fast access to favorites functions using the favorites button on the controller

Display

General notes

! Do not use the space in front of the display for storage. Objects placed here could damage the display or impair its function. Avoid any direct contact with the display surface. Pressure on the display surface may result in impairments to the display, which could be irreversible.

Wearing polarized sunglasses may impair your ability to read the display.

The display has an automatic temperature-controlled switch-off feature. The brightness is automatically reduced if the temperature is too high. The display may then temporarily switch off completely.

Overview



The example shows the display in SD memory card mode in COMAND.

In the status bar at the top you will see the time and other displays, depending on the settings.

Below it you will see the main display field. The climate control status display is briefly displayed when you operate the climate control system.

Cleaning instructions

! Do not touch the display. The display has a very sensitive high-gloss surface; there is a risk of scratching. If you have to clean the screen, however, use a mild cleaning agent and a soft, lint-free cloth.





The display must be switched off and have cooled down before you start cleaning. Clean the display screen, when necessary, with a commercially available microfiber cloth and cleaning agent for TFT/LCD displays. Do not apply pressure to the display surface when cleaning it, as this could cause irreversible damage to the display. Then, dry the surface with a dry microfiber cloth.

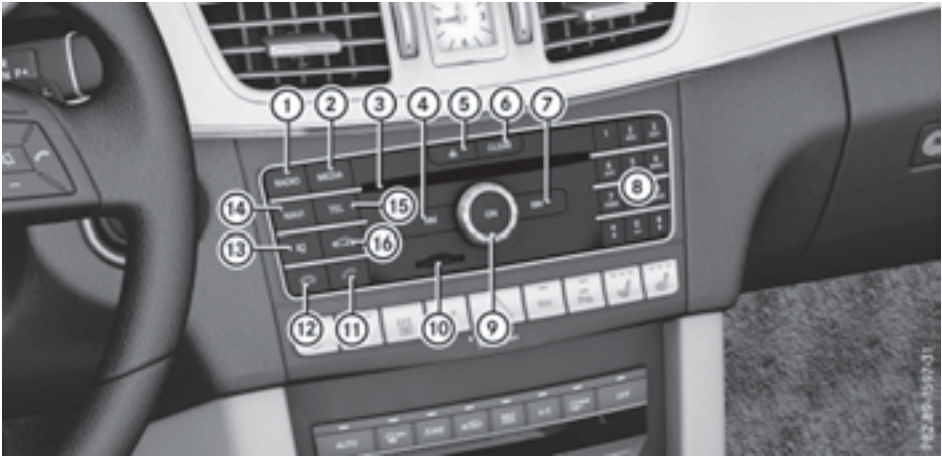



Avoid using alcoholic thinners, gasoline or abrasive cleaning agents. These could damage the display surface.

COMAND control panel











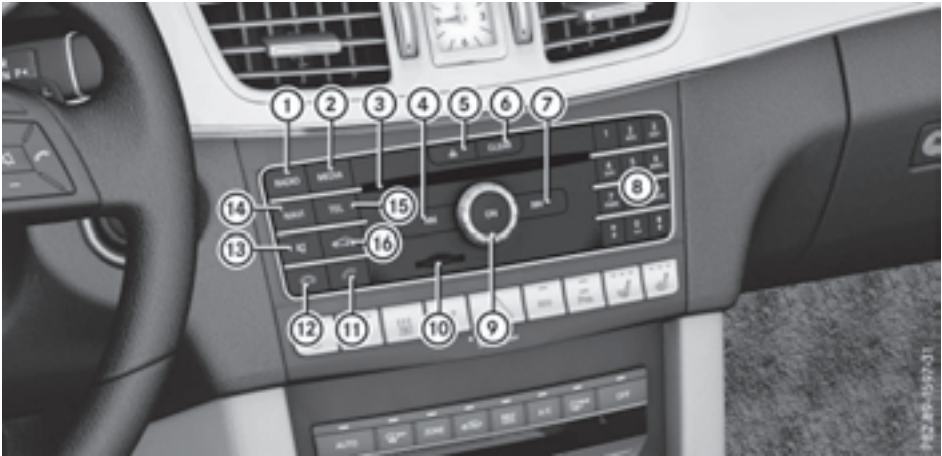













	Function	Page		Function	Page
①	Switches to radio mode Calls up the Radio menu	234 235	⑥	Clear button <ul style="list-style-type: none"> Deletes characters Deletes an entry 	222
②	Switches to the last selected media mode Calls up the Media menu	 	⑦	Selects the next station from the station list Skips forwards to a track Fast forward	
③	Inserts and removes a CD/DVD from the single drive (COMAND, Audio 20) Inserts a CD/DVD into the DVD changer (COMAND) Removes a CD/DVD from the DVD changer (COMAND)	 	⑧	Number pad <ul style="list-style-type: none"> Saves a station Mobile phone authorization Telephone number entry Searches for a contact Character entry # Display of the current track being played (if track information is supported for the data carrier) * Selects stations by entering the frequency manually * Selects a track 	
④	Selects the previous station from the station list Skips backwards to a track Rewinds	 			
⑤	Loads/ejects the CD/DVD <ul style="list-style-type: none"> Single disc drive (Audio 20, COMAND) DVD changer (COMAND) 	 			

	Function	Page
⑨	Switches Audio 20/ COMAND on/off Adjusts the volume	 
⑩	Inserts/removes an SD memory card	
⑪	Accepts a call Makes a call Redial Accepts a new call when a call is being made (call wait- ing)	190 232  
⑫	Rejects a call Ends an active call	232 232

	Function	Page
⑬	Switches the sound on or off Switches navigation announcements off (COMAND)	 
⑭	Switches to navigation mode Calls up the navigation sys- tem menu	225 
⑮	Calls up the telephone menu	
⑯	Calls up vehicle settings	

Audio 20 control panel



	Function	Page		Function	Page	
①	Switches to radio mode Calls up the Radio menu	234 235		⑧	Number pad • Saves a station • Authorizes (connects) a mobile phone • Telephone number entry • Searches for a contact ☑ Selects stations by entering the frequency manually ☑ Selects a track	190 232      
②	Switches to the last selected media mode Calls up the Media menu	 		⑨	Switches Audio 20 on/off Adjusts the volume	 
③	Inserts and removes a CD from the single drive (if single drive available)			⑩	Inserts/removes an SD memory card	
④	Selects the previous station from the station list Skips backwards to a track	 		⑪	Accepts a call Makes a call Redial Accepts a new call when a call is being made (call waiting)	190 232  
⑤	Loads/ejects CDs (if button available) ☑ Single drive			⑫	Rejects a call Ends an active call	 
⑥	Clear button • Deletes characters • Deletes an entry	222				
⑦	Selects the next station from the station list Skips forwards to a track	 				

	Function	Page
13	Switches the sound on or off Switches off navigation announcements	
14	Calls up the sound menu Switches to navigation mode	

	Function	Page
15	Calls up the telephone menu	
16	Calls up vehicle settings	

Buttons and controller

Overview



- ① Clear button
- ② Switches the display on/off
- ③ Favorites button (if available)
- ④ Back button
- ⑤ Controller

Instead of the display on/off button, the vehicle may be equipped with the seat function button.

AMG vehicles: the controller is equipped with buttons ① and ④.

Controller

The controller in the center console lets you:

- select menu items on the display
- enter characters
- select a destination on the map
- save entries

The controller can be:

- turned
- slid left or right

- slid forwards or back
- slid diagonally
- pressed briefly or pressed and held

Back button

You can use the button to exit a menu or to call up the basic display of the current operating mode.

- ▶ **To exit the menu:** briefly press the button.
Audio 20/COMAND changes to the next higher menu level in the current operating mode.
- ▶ **To call up the basic display:** press the button for longer than two seconds.
Audio 20/COMAND changes to the basic display of the current operating mode.

Clear button

- ▶ **To delete individual characters:** briefly press the button on the control panel.
or
- ▶ Briefly press the clear button on the controller.
- ▶ **To delete an entire entry:** press and hold the button on the control panel.
or
- ▶ Press and hold the clear button on the controller.

Favorites button

You can assign predefined functions using the favorites button and call them up by pressing the button.

Display off button

You can switch the display on and off with the  button.

Favorites

Overview of favorites



- ① To add a new favorite (▷ page 223)
- ② To rename a selected favorite (▷ page 224)
- ③ To move a selected favorite (▷ page 224)
- ④ To delete a selected favorite (▷ page 224)

Displaying the favorites overview

- ▶ Press the favorites button on the controller. The favorites are displayed.
- ▶ To show the menu bar: slide  the controller.

You can manage a total of 20 favorites.

Further information on how to select and display a favorite (▷ page 223).

Displaying and selecting favorites

- ▶ Press the favorites button on the controller. The favorites are displayed.
- ▶ To select a favorite: turn the controller.
- ▶ To call up a favorite: press the controller.

Adding favorites

Adding predefined favorites

- ▶ Press the favorites button on the controller. The favorites are displayed.
- ▶ To show the menu bar: slide  the controller.
- ▶ To select **Reassign**: turn and press the controller. The categories for the available favorites are displayed.
 - **Navigation**
 - **Entertainment**
 - **Tel**
 - **Vehicle**
- ▶ To select a category: turn the controller and press to confirm. The corresponding favorites are displayed.
- ▶ To select the desired favorite: turn and press the controller.
- ▶ To store the favorite in the desired order: turn and press the controller. The favorite has been added. If a favorite is stored over another favorite, the favorite underneath is deleted.

Adding your own favorites

You can store phone numbers from the phone book, radio stations, preferred media or navigation locations as favorites.

You can store phone numbers from the phone book, preferred media or radio stations as favorites.

A phone number from the phone book is used as an example.

- ▶ To store the phone number as a favorite: press and hold the favorites button on the controller until the favorites are displayed.
- ▶ To store the favorite in the desired order: turn and press the controller. The favorite has been added. If a favorite is stored over another favorite, the favorite underneath is deleted.

Renaming favorites

- ▶ Press the favorites button on the controller. The favorites are displayed.
- ▶ To select the favorite to be renamed: turn the controller.
- ▶ To show the menu bar: slide  the controller.
- ▶ To select **Rename**: turn and press the controller.
- ▶ To finish the entry: select **OK**. The favorite has been renamed.

Moving favorites



- ▶ Press the favorites button on the controller. The favorites are displayed.
- ▶ To select the favorite to be moved: turn the controller.
- ▶ To show the menu bar: slide  the controller.
- ▶ To select **Move**: turn and press the controller.
- ▶ To store the favorite in the desired order: turn and press the controller. The favorite has been moved.

If a favorite is stored over another favorite, the favorite underneath is deleted.

Deleting favorites

- ▶ Press the favorites button on the controller. The favorites are displayed.
- ▶ To select the favorite to be deleted: turn the controller.

- ▶ To show the menu bar: slide  the controller.
 - ▶ To select **Delete**: turn and press the controller.
 - ▶ To select **Yes**: turn and press the controller. The favorite is deleted.
- or
- ▶ To select **No**: turn and press the controller. The process is canceled.

Vehicle settings



Calling up vehicle settings

- ▶ Press the  button.
- or
- ▶ Press **Vehicle** in the main function bar. The vehicle menu is displayed.
 - ▶ To select **Vehicle Settings**: turn and press the controller. The **Vehicle Settings** menu is active.
 - ▶ To select the desired vehicle setting: turn and press the controller. The main area with the setting element is active.

Selecting a different vehicle setting:

- ▶ To activate the menu for selecting the vehicle setting: slide  the controller.

Exiting the vehicle settings:

- ▶ To select  in the display: slide  and press the controller.

Navigation

Introduction

Important safety notes

WARNING

If you operate information systems and communication equipment integrated in the vehicle while driving, you will be distracted from traffic conditions. You could also lose control of the vehicle. There is a risk of an accident.

Only operate the equipment when the traffic situation permits. If you are not sure that this is possible, park the vehicle paying attention to traffic conditions and operate the equipment when the vehicle is stationary.

You must observe the legal requirements for the country in which you are currently driving when operating the navigation system.

General notes

Audio 20 is equipped with MARGIN® MAP PILOT (see the manufacturer's operating instructions).

Further information on navigation using COMAND can be found in the Digital Operator's Manual.

Among other things, correct functioning of the navigation system depends on GPS reception. In certain situations, GPS reception may be impaired, there may be interference or there may be no reception at all, e.g. in tunnels or parking garages.

At vehicle speeds of above 5 km/h, data entries are restricted.

- i** The functionality of a roof antenna (telephone, GPS) may be impaired if roof carriers are used.

Switching to navigation mode

- ▶ Press the **NAVI** button.
The map shows the vehicle's current position.

Showing/hiding the menu

- ▶ **To show:** slide **⊙** the controller when the map appears.
- ▶ **To hide:** press the **☐** button.

Destination entry

General notes

The information given relating to destination entry applies to COMAND. For information on Audio 20, see the manufacturer's operating instructions.

Destination entry options

Destination entry may be blocked while driving, depending on the country specifications.

Address input
Keyword search using fragments of words
From the list of last destinations (up to 50 destinations)
Selecting a contact from the address book (contact with navigation data Ⓡ)
Selecting a POI (e.g. gas station, restaurant) for different positions
On the map
Entering intermediate destinations
From Mercedes-Benz Apps Requirement (USA): mbrace is activated for the Mercedes-Benz Apps. Requirement (Canada): a mobile phone is connected via Bluetooth® or USB with COMAND.
Entering geo-coordinates

Example: address entry

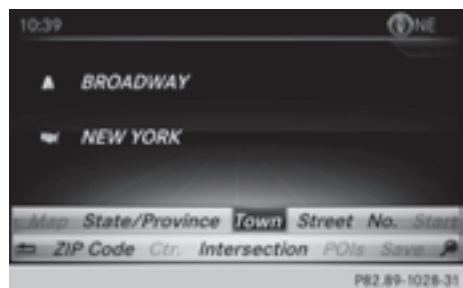

- ▶ Show the menu (▷ page 225).
- ▶ To select **Destination**: turn and press the controller.
- ▶ Select **Address Entry**.
- ▶ Enter the address, e.g. as a city, street and house number.

Calculating the route

- ▶ To confirm **Start**: press the controller. The route is calculated with the current route type.

Selecting a route type

- ▶ Show the menu (▷ page 225).
- ▶ To select **Settings**: turn and press the controller.
- ▶ Select **Route Settings**.
- ▶ Select a route type. The route type is used for the next route calculation. If **Dynamic Traffic Route**, **Dynamic TRF**, **Route After Request** or **Eco Route** has been selected, traffic reports on the route are taken into account.
- ❗ You can map the route to the destination yourself with up to four intermediate stops.

Route guidance

Navigation announcements and route guidance displays guide you to your destination. The information given relating to destination entry applies to COMAND. For information on Audio 20, see the manufacturer's operating instructions.



- ❗ Audio 20/COMAND can give incorrect navigation commands if the actual street/traffic situation does not correspond with the digital map's data. Road and traffic rules and regulations always have priority over system driving recommendations.



Before and during a change of direction, the map is shown on the left side of the display and a view of the intersection or a 3D image

on the right. Lane recommendations (white directional arrows) may be shown at the bottom of the display for multilane roads.

Navigation announcements

- ▶ To adjust the volume: during a navigation announcement, turn the  control knob.
- ▶ To switch off: during a navigation announcement, press the  button on the COMAND control panel.

Route information

- ▶ Show the menu (▷ page 225).
- ▶ To select **Route**: turn and press the controller.
- ▶ **To display destination information**: select **Destination Information**.
- ▶ **To display the route list**: select **Route List**.
- ▶ **To display the current position**: select **Where am I?**.

Canceling/continuing route guidance

- ▶ Press the controller.
- ▶ To select **Destination**: turn and press the controller.
- ▶ Select **Cancel Active Route Guidance** or **Continue Route Guidance**.

Real-time traffic reports

The information given relating to destination entry applies to COMAND. For information on Audio 20, see the manufacturer's operating instructions.

In order to receive real-time traffic reports via satellite radio, you need to subscribe to SIRIUS XM Satellite Radio Traffic Message Service.

COMAND can receive traffic reports via satellite radio and take account of these for route guidance in the navigation system. Received traffic reports are displayed on the map either as text or as symbols.

- ▶ To switch to navigation mode: press the **NAVI** button.
- ▶ To show the menu: slide  the controller.
- ▶ To select **Traffic**: turn and press the controller.
If satellite signals cannot be received or there are no traffic reports, you will see a message to this effect.
- ▶ To close the report: press the controller.

Map functions

General notes

The information given relating to destination entry applies to COMAND. For information on Audio 20, see the manufacturer's operating instructions.





Setting the map scale

Requirement: the map is in full screen mode, the menu is faded out (▷ page 225).

- ▶ Turn the controller until the desired scale is set.

Moving the map

Requirement: the map is in full screen mode, the menu is faded out (▷ page 225).

- ▶ Slide , ,  or  the controller.
The crosshair is shown. The map moves in the corresponding direction under the crosshair.
- i** Pressing the controller selects a destination in the map.

Selecting map orientation

- ▶ Show the menu (▷ page 225).
- ▶ To select **Options**: turn and press the controller.
- ▶ Select **Map Orientation**.
The **•** dot indicates the current setting.
- ▶ Turn and press the controller.
The map orientation is set.

Building images and elevation modeling

In small map scales (20 m, 50 m), important buildings are depicted realistically on the map; other buildings are shown as models. Selected cities are realistically depicted using elevation modeling.

Calling up the online map display

Requirement: a mobile phone with a data package must be connected to COMAND.



- ▶ Show the menu (▷ page 225).
- ▶ Slide  the controller twice.
- ▶ Press the controller.
The navigation menu appears.
- ▶ Turn the controller until **Online Map Display** is brought to the front.
- ▶ Press the controller.
The online connection is established. Once the connection is established, the Google™ Maps map shows the vicinity of the current vehicle position.

Connecting and disconnecting a mobile phone

Prerequisites

For telephony via the Bluetooth® interface, you require a Bluetooth®-capable mobile phone. The mobile phone must support Hands-Free Profile 1.0 or above.

Activating Bluetooth® in Audio 20/COMAND

- ▶ Press the  button in the center console.
The **Vehicle** menu appears.
- ▶ To select **System Settings**: slide , turn and press the controller to confirm.
- ▶ To select **Activate Bluetooth**: turn and press the controller.
This switches Bluetooth® on or off .

On the mobile phone

- ▶ Switch on the mobile phone and enter the PIN when prompted to do so (see the manufacturer's operating instructions).
- ▶ Activate Bluetooth® and, if necessary, Bluetooth® visibility for other devices (see the manufacturer's operating instructions). This visibility is for restricted periods of time on some mobile phones (see the manufacturer's operating instructions).
- ▶ Set the Bluetooth® device name for the mobile phone if necessary.

The Bluetooth® device names for all of one manufacturer's products might be identical. To make it possible to clearly identify your mobile phone, change the device name (see the manufacturer's operating instructions). The name can be freely selected.

If the mobile phone supports the PBAP (Phone Book Access Profile) and MAP (Message Access Profile) Bluetooth® profiles, the following information will be transmitted after you connect:

- Phone book
- Call lists
- Messages

The battery of the mobile phone should always be kept sufficiently charged in order to prevent malfunctions.

- ❗ Not all mobile phones available on the market are equally suitable. You can obtain more detailed information about suitable mobile phones and about the connection between the mobile phone and Audio 20/COMAND on the Internet at <http://www.mbusa-mobile.com>.

You can also obtain more information by calling.

In the USA, you can get in touch with the Mercedes-Benz Customer Assistance Center on 1-800-FOR-MERCEDES (1-800-367-6372).

In Canada, you can get in touch with the Customer Relations Center on 1-800-387-0100.

- ❗ Some displays (e.g. the signal strength) depend on the supported version of the Hands-Free Profile.

Procedure and general information

Searching for and authorizing (connecting) a mobile phone

Before using your mobile phone with Audio 20/COMAND for the first time, you will need to search (▷ page 229) for the phone and then authorize it (▷ page 229). Depending on the mobile phone, authorization either takes place by means of Secure Simple Pairing or by entering a passkey. Audio 20/COMAND automatically makes the system suitable for your mobile phone available. You can recognize Secure Simple Pairing by a code which is displayed in Audio 20/COMAND and on the mobile phone. You can recognize the passkey system by the fact that you have to enter a code on the mobile phone and in Audio 20/COMAND. The mobile phone is always connected automatically after authorization.

If Audio 20/COMAND does not detect your mobile phone, this may be due to particular security settings on your mobile phone. You can also start the search procedure and authorization on the mobile phone (▷ page 230).

Device-specific information on authorizing and connecting Bluetooth®-capable mobile phones can be found on the Internet at <http://www.mercedes-benz.com/connect>.

You can authorize up to 15 mobile phones. Only one mobile phone can be connected to Audio 20/COMAND at any one time.

De-authorizing (disconnecting) a mobile phone

The connection is terminated automatically if you leave the receiver range of Audio 20/

COMAND or deactivate Bluetooth® on your mobile phone.

If you no longer want the Bluetooth® connection to be established automatically, the mobile phone must be de-authorized (disconnected) (▷ page 231).

Searching for a mobile phone

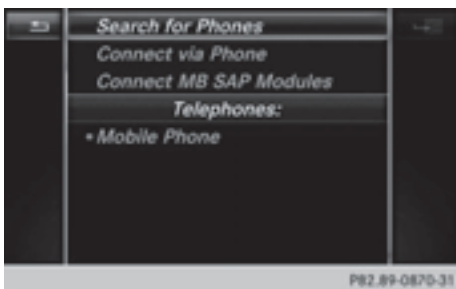

- ▶ To call up the telephone menu: press the **TEL** button.
- ▶ To switch to the menu bar in the telephone menu: slide **⊙↓** the controller.
- ▶ To select **Connect Device**: turn the controller and press to confirm. The device list is displayed.
- ▶ To select **Search for Phones**: turn and press the controller. A message is displayed that Bluetooth® must be activated on the mobile phone and must be made visible to other devices.
- ▶ To select **Start Search**: press the controller. The available mobile phones are displayed in the device list.



The duration of the search depends on the number of Bluetooth® telephones within range and their characteristics.

If a new phone is found, it appears in the device list with the  symbol. You can now authorize (connect) the mobile phone found (▷ page 229).

If the device list is already full, you will be requested to de-authorize a mobile phone (▷ page 231).

When you call up the device list again, de-authorized devices will be removed from the list. To update the device list, start the search again.

Symbols in the device list

Symbol	Explanation
	New mobile phone found, not yet authorized.
	Mobile phone is authorized, but is not connected.
•	Mobile phone is authorized and connected.

Authorizing a mobile phone (connecting)

Authorization via Secure Simple Pairing

Once Audio 20/COMAND has found your mobile phone, you can authorize (connect) it.

- ▶ To select a mobile phone from the device list: turn the controller and press to confirm. A code is displayed in Audio 20/COMAND and on the mobile phone.

The code is the same

- ▶ **Audio 20/COMAND**: select **Yes**.
- ▶ **Mobile phone**: confirm the code. Depending on the mobile phone used, you may have to confirm the connection to Audio 20/COMAND as well as confirm for the PBAP and MAP Bluetooth® profiles. The prompt to confirm may take up to two minutes to be displayed. You may also save the confirmation on the mobile phone (see the manufacturer's operating instructions). The mobile phone is now authorized and connected to Audio 20/COMAND. You can now speak using the hands-free system.

Further information on setting the transmission and reception volume of the mobile phone can be found in the Digital Operator's Manual.

The code is different

- ▶ **Audio 20/COMAND:** select **No**.
The process is canceled. Repeat the authorization.

Authorization via passkey entry (access code)

Once Audio 20/COMAND has found your mobile phone, you can authorize (connect) it.

- ▶ To select the Bluetooth® name of the desired mobile phone in the device list: turn and press the controller.
The input menu for the passkey is displayed.

The passkey is a one- to sixteen-digit number combination which you can choose yourself.

- ▶ **Audio 20/COMAND:** enter the passkey using the character bar.
- ▶ Select once all the numbers have been entered.
- ▶ **Mobile phone:** enter the same passkey and confirm your entry. Depending on the mobile phone used, you may have to confirm the connection to Audio 20/COMAND as well as confirm for the PBAP and MAP Bluetooth® profiles. The prompt to confirm may take up to two minutes to be displayed. You may also save the confirmation on the mobile phone (see the manufacturer's operating instructions).
The mobile phone is now authorized and connected to Audio 20/COMAND. You can now speak using the hands-free system.

Further information on setting the transmission and reception volume of the mobile phone can be found in the Digital Operator's Manual.

If the **Authorization Failed** message appears, you may have entered a different passkey or exceeded the prescribed time limit. Repeat the procedure.

- ❗ Some mobile phones require a passkey with four or more digits.

- ❗ If you wish to re-authorize the mobile phone after de-authorizing it, you can choose another passkey for it.

Establishing the connection from the mobile phone

The Bluetooth® device name of Audio 20/COMAND is "MB Bluetooth".

- ▶ **Audio 20/COMAND:** call up the telephone menu.
- ▶ To switch to the menu bar: slide  the controller.
- ▶ To select **Connect Device:** turn the controller and press to confirm.
The device list is displayed.
- ▶ To select **Connect via Phone:** turn and press the controller.
A message is displayed, stating that you can start the search on your mobile phone.
- ▶ **Mobile phone:** start the search for a Bluetooth® device (see manufacturer's operating instructions).
Audio 20/COMAND is displayed with the name "MB Bluetooth" in the mobile phone's device list.
- ▶ Select "MB Bluetooth".
A prompt appears in the Audio 20/COMAND display asking whether the mobile phone should be authorized.
- ▶ **Audio 20/COMAND:** select **Yes**.
If **No** is selected, the procedure is canceled. If your mobile phone supports Secure Simple Pairing, a code is now displayed on both devices.

The code is the same

- ▶ **Audio 20/COMAND:** select **Yes**.
- ▶ **Mobile phone:** confirm the code. Depending on the mobile phone used, you may have to confirm the connection to Audio 20/COMAND as well as confirm for the PBAP and MAP Bluetooth® profiles. The prompt to confirm may take up to two minutes to be displayed. You may also save

the confirmation on the mobile phone (see the manufacturer's operating instructions). The mobile phone is now authorized and connected to Audio 20/COMAND. You can now speak using the hands-free system.

The code is different

- ▶ **Audio 20/COMAND:** select **No**.
The process is canceled. Repeat the procedure.

If your mobile phone does not support Secure Simple Pairing, you can find more information about connecting the mobile phone in the Digital Operator's Manual.

Reconnecting automatically

Audio 20/COMAND always searches for the last connected mobile phone.

If no connection can be made to the most recently connected mobile phone, the system searches for the mobile phone that was connected before that one.

Switching between mobile phones

If you have authorized more than one mobile phone, you can switch between the individual phones.

- ▶ To call up the telephone menu: press the **TEL** button.
- ▶ To show the menu bar: slide **☉↓** the controller.
- ▶ To select **Connect Device:** turn the controller and press to confirm.
The device list is displayed.
- ▶ To select the desired mobile phone: turn and press the controller.
The selected mobile phone is searched for and connected if it is within Bluetooth® range and if Bluetooth® is activated.

Only one mobile phone can be connected at any one time. The currently connected mobile phone is indicated by the • dot in the device list.

- i** You can only switch to another authorized mobile phone if you are not currently making a call.

De-authorizing (disconnecting) a mobile phone

Mercedes-Benz USA, LLC recommends De-authorization in Audio 20/COMAND and on the mobile phone. Subsequent authorization may otherwise fail.

- ▶ To call up the telephone menu: press the **TEL** button.
- ▶ To show the menu bar: slide **☉↓** the controller.
- ▶ To select **Connect Device:** turn the controller and press to confirm.
- ▶ To highlight the desired mobile phone in the device list: turn the controller.
- ▶ To select **☐☐☐**: slide **☉→** the controller.
- ▶ To select **Deauthorize:** turn and press the controller.
A prompt appears, asking whether you really wish to de-authorize this device.
- ▶ To select **Yes:** turn and press the controller.
The mobile phone is de-authorized.

- i** Before re-authorizing the mobile phone, you should also delete the device name **MB Bluetooth** from your mobile phone's Bluetooth® list.

Using the telephone

Accepting a call

- ▶ To select **Accept:** press the controller.
- or
- ▶ Press **☐☐☐** on the multifunction steering wheel.
The call is accepted.



Further information on the functions you can use during a call can be found in the Digital Operator's Manual.

- i** You can also accept the call by voice command using the Voice Control System (see the separate operating instructions).
- i** If the phone number of the caller is transferred, it appears in the display. If the phone number is saved in the phone book, the contact's name is also displayed. If the phone number is not transferred, **Unknown** is shown in the display.

Rejecting a call



- ▶ To select **Reject**: turn the controller and press to confirm.
- or
- ▶ Press  on the multifunction steering wheel.

Ending an active call



- ▶ To select  in the telephone menu: turn and press the controller.
- or
- ▶ Press  on the multifunction steering wheel.
The active call is ended.

Making a call

Using the telephone menu



- ▶ To call up the telephone menu: press the  button.
- ▶ To select all numbers one after the other in the telephone menu: turn and press the controller each time.
- ▶ To select  in the telephone menu: turn and press the controller.
The call is made.

Using call lists

- ▶ To call up the telephone menu: press the  button.
- ▶ To switch to the menu bar: slide  the controller.
- ▶ To select **Call Lists**: turn and press the controller.

- ▶ To select **Calls Received** or **Calls Dialed**: turn and press the controller.
The relevant list is displayed.
- ▶ To select an entry and make a call: turn and press the controller.

Using the phone book

- ▶ To call up the telephone menu: press the  button.
- ▶ To select **Name** in the telephone menu: turn and press the controller.
The phone book is displayed with an active character bar.
- ▶ To select characters: turn the controller and press to confirm.
The first contact with the selected first character is highlighted in the phone book.
- ▶ Select the characters of the contact you are searching for one by one, pressing and confirming with the controller each time.
- ▶ To end the search: select  .
The contacts in the phone book are displayed.
- ▶ To select a contact: turn and press the controller.

If a contact contains more than one phone number:

- ▶ To select a telephone number: turn and press the controller.

Further information on the phone book can be found in the Digital Operator's Manual.

Setting up an Internet connection

Procedure and general information

USA: to use Mercedes-Benz Apps and Internet access, mbrace must be activated and operational. Furthermore, mbrace must be activated for Mercedes-Benz Apps and Internet access. No further settings are required.

Canada: in order to set up a mobile phone for Internet access, your mobile phone must be connected via Bluetooth® to Audio 20/COMAND. If you are using Internet access for

the first time, you must enable the connected mobile phone for Internet access (▷ page 233). If the connected mobile phone supports the Bluetooth® PAN profile, you do not need to make additional settings. The Internet connection is established. If the connected mobile phone does not support the named Bluetooth® profile, predefined (▷ page 233) or manual access data (▷ page 233) must be set.

Enabling the mobile phone for Internet access

- ▶ To call up the telephone menu: press the **TEL** button.
- ▶ To switch to the main function bar: slide ↑⊙ the controller.
- ▶ To select **TEL**/🌐: press the controller.
- ▶ To select **Internet**: turn and press the controller.
The menu with the Internet functions is displayed.
- ▶ To switch to the menu bar: slide ⊙↓ the controller.
- ▶ To select **Settings**: turn and press the controller.
- ▶ To select **Configure Internet Settings**: turn and press the controller.
The device list is displayed.
- ▶ To select **Search for Bluetooth Phone**: turn and press the controller.
Mobile phones are displayed that:
 - are connected with Audio 20/COMAND
 - fulfill the conditions for the Internet functions
 - have not yet been set up for the Internet function

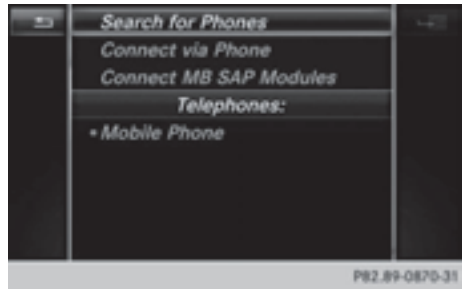

- ▶ To select a mobile phone from the device list: turn the controller and press to confirm.
If the mobile phone supports the Bluetooth® PAN profile, Internet access is set up. You can use the Internet functions.
If the connected mobile phone does not support the named Bluetooth® profile, predefined (▷ page 233) or personalized access data (▷ page 233) must be set.

Setting access data of the mobile phone network provider

Selecting the predefined access data of the mobile phone network provider

- ▶ To select **Predefined Settings**: turn and press the controller.
A list of countries appears.
- ▶ To select **Confirm Settings**: turn and press the controller.

If the mobile phone network provider provides multiple access data options, the relevant access data still has to be selected. This depends on the data package used, for example.

Manually setting the access data of the mobile phone network provider

- ▶ To select **Manual Settings**: turn and press the controller.
An overview of the provider settings appears.
- ▶ Set access data (▷ page 234).
- ▶ To confirm settings: select **Confirm Settings** and turn and press the controller.

The access data for the mobile phone network provider is selected once for the mobile phone connected and is loaded again each time the mobile phone is connected.

You must set the access data of the mobile phone network provider who provides the SIM card and the associated data package (access settings) for the connected mobile phone. The access data remains the same when you are in a different country (roaming). The access data of another network is **not** selected.

Setting access data

Set the access data in accordance with your data package. You can contact your mobile phone network provider to obtain the precise access data.

Explanation of the access data

Input field	Meaning
Phone Number:	Access number for establishing the connection The access number depends on the mobile phone used. For GSM/UMTS mobile phones, *99***1# is used as a standard.
Access Point:	APN network access point (Access Point Name) You can obtain this information from your mobile phone network provider. Entry is not necessary for all mobile phone network providers and mobile phones.
PDP Type:	Internet protocol used. You can obtain this information from your mobile phone network provider.

Input field	Meaning
User ID:	The user identification can be obtained from your mobile phone network provider. Entry is not necessary for all mobile phone network providers.
Password:	The password can be obtained from your mobile phone network provider. Entry is not necessary for all mobile phone network providers.
Auto DNS:	Automatic allocation of DNS servers is activated. If the function is deactivated, the DNS server addresses must be entered manually. DNS (Domain Name Service)
DNS1: DNS2:	Fields for entering the DNS server addresses manually. The address can be obtained from your mobile phone network provider.

Radio mode

Switching to

- Press the **RADIO** button.
The radio display appears. You will hear the last station played on the last waveband selected.

Overview



Example COMAND

- ① Main function bar
- ② Status bar with compass display
- ③ Main display field with available stations and relevant information
- ④ Display of radio station selected
- ⑤ Radio menu bar

Selecting the main function bar

- ▶ Slide $\uparrow\odot$ the controller.

Selecting the menu bar

- ▶ Slide $\odot\downarrow$ the controller.

Menu options

- ▶ In radio mode: slide $\odot\downarrow$ the controller. The radio menu bar appears.
- ▶ To select **Options**: turn and press the controller.

The following setting options are available to you:

- **Tag This Track**: saves track information on an Apple® device for a later purchase option via iTunes®
- **Enter Frequency**: manual frequency entry
- **Current Station/Channel Listing**: list of available stations
- **Edit Station Preset**: selects and edits station presets

- **Show Station Information**: switches artist and track display and station name on/off
- **HD Radio**: switches HD Radio on/off

Setting the waveband

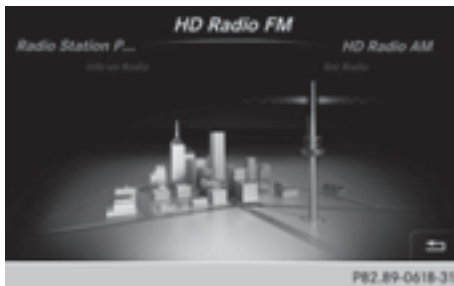

- ▶ **Using the button**: in radio mode press the **RADIO** button.
 - ▶ Turn the controller until the required waveband is in the center. Press the controller.
- or
- ▶ **Using the radio menu bar**: in radio mode, slide $\odot\downarrow$ the controller.
 - ▶ To select **Band/Preset**: turn and press the controller.
 - ▶ Turn the controller until the required waveband is selected. Press the controller.

Selecting a station

- **To select via the main display field**: in radio mode, turn the controller until the desired station is in the center.
- **Via the "Options" menu**: using **Current Station/Channel Listing** or **Enter Frequency** select or enter the desired station.
- **Using the search function (COMAND)**: in radio mode, select P in the menu bar and enter the first letters of the desired station using the controller.

Radio text/radio text plus

This function is not available in all countries.

- ▶ **To switch on radio text:** in radio mode, select **Info** in the menu bar. Additional information from the current station is displayed.

Useful information	238
Stowage areas	238
Features	251

Useful information

- i** This Operator's Manual describes all models and all standard and optional equipment of your vehicle available at the time of publication of the Operator's Manual. Country-specific differences are possible. Please note that your vehicle may not be equipped with all features described. This also applies to safety-related systems and functions.
- i** Read the information on qualified specialist workshops (▷ page 31).

Stowage areas

Loading guidelines

WARNING

If objects, luggage or loads are not secured or not secured sufficiently, they could slip, tip over or be flung around and thereby hit vehicle occupants. There is a risk of injury, particularly in the event of sudden braking or a sudden change in direction.

Always store objects so that they cannot be flung around. Secure objects, luggage or loads against slipping or tipping before the journey.

WARNING

Combustion engines emit poisonous exhaust gases such as carbon monoxide. Exhaust gases can enter the vehicle interior if the trunk lid/tailgate is open when the engine is running, especially if the vehicle is in motion. There is a risk of poisoning.

Always switch off the engine before opening the trunk lid/tailgate. Never drive with the trunk lid/tailgate open.

WARNING

The exhaust tail pipe and tail pipe trim can become very hot. If you come into contact with these parts of the vehicle, you could burn yourself. There is a risk of injury.

Always be particularly careful around the exhaust tail pipe and the tail pipe trim. Allow these components to cool down before touching them.

The handling characteristics of a laden vehicle are dependent on the distribution of the load within the vehicle. For this reason, you should observe the following notes when transporting a load:

- Never exceed the maximum permissible gross vehicle mass or the gross axle weight rating for the vehicle (including occupants). The values are specified on the vehicle identification plate on the B-pillar of the driver's door.
- The trunk/cargo compartment is the preferred place to store objects.
- Position heavy loads as far forwards as possible and as low down in the trunk/cargo compartment as possible.
- The load must not protrude above the upper edge of the seat backrests.
- Always place the load against the rear or front seat backrests. Make sure that the seat backrests are securely locked into place.
- Always place the load behind unoccupied seats if possible.
- Use the cargo tie-down rings and the parcel nets to transport loads and luggage.
- Use cargo tie-down rings and fastening materials appropriate for the weight and size of the load.
- When transporting objects in the cargo compartment, the combined cargo cover and net must always be installed (cargo compartment cover and cargo net).
- Secure the load with sufficiently strong and wear-resistant tie-downs. Pad sharp edges for protection.

Stowage spaces

Important safety notes

WARNING

If objects in the passenger compartment are stowed incorrectly, they can slide or be thrown around and hit vehicle occupants. There is a risk of injury, particularly in the event of sudden braking or a sudden change in direction.

- Always stow objects so that they cannot be thrown around in such situations.
- Always make sure that objects do not protrude from stowage spaces, parcel nets or stowage nets.
- Close the lockable stowage spaces while driving.
- Always stow and secure heavy, hard, pointed, sharp-edged, fragile or bulky objects in the trunk/cargo compartment.

Observe the loading guidelines (▷ page 238).

Information in the Digital Operator's Manual

In the Digital Operator's Manual you will find information on the following topics:

- Glove box
- Eyeglasses compartment
- Stowage compartment in the center console
- Stowage compartment under the armrest
- Stowage compartment under the front seats
- Stowage compartment in the rear
- Stowage net in the rear

Stowage nets

Stowage nets are located in the front-passenger footwell and on the left-hand side of the trunk/cargo compartment.

Observe the loading guidelines (▷ page 238) and the safety notes regarding stowage spaces (▷ page 239).

Through-loading facility in the rear



The through-loading facility is opened from the trunk.

- ▶ Fold down the rear seat armrest.
- ▶ Press release catch ①.

The flap opens downwards.

Observe the loading guidelines (▷ page 238).

Through-loading facility in the rear bench seat (Sedan)

Important safety notes

WARNING

If the rear bench seat/rear seat and seat backrest are not engaged they could fold forwards, e.g. when braking suddenly or in the event of an accident.

- The vehicle occupant would thereby be pushed into the seat belt by the rear bench seat/rear seat or by the seat backrest. The seat belt can no longer offer the intended level of protection and could even cause injuries.
- Objects or loads in the trunk cannot be restrained by the seat backrest.

There is an increased risk of injury.

Before every trip, make sure that the seat backrests and the rear bench seat/rear seat are engaged.

Observe the loading guidelines (▷ page 238). The left-hand and right-hand rear seat backrests can be folded down separately to increase the trunk capacity.

Folding the seat backrest forward



i Vehicles with memory function: when you fold one or both parts of the rear seat backrest forwards, the respective front seat moves forward slightly, when necessary, in order to avoid contact.

- ▶ Vehicles without memory function: if necessary, move the driver's or front-passenger seat forward.
- ▶ Open the trunk.
- ▶ Pull right-hand or left-hand rear seat backrest release handle ①.

The corresponding rear seat backrest is released.

The rear seat head restraints are lowered.

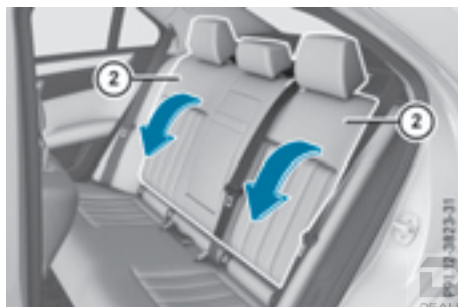

- ▶ Fold rear seat backrest ② forwards.
- ▶ Move the driver's or front-passenger seat back if necessary.

Folding the seat backrest back

i Make sure that the seat belt does not become trapped when folding the rear seat backrest back. Otherwise, it could be damaged.

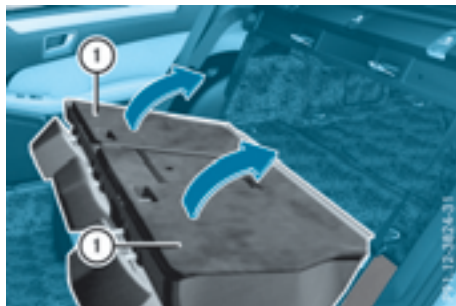

- ▶ Move the driver's or front-passenger seat forward if necessary.

- ▶ Fold rear seat backrest ① back until it engages.

If the rear seat backrest is not engaged and locked, this will be shown in the multifunction display in the instrument cluster. A warning tone also sounds.

- ▶ Adjust the head restraints if necessary.
- ▶ Move the driver's or front-passenger seat back if necessary.

i You should always engage the rear seat backrests if you do not need the through-loading feature. This will prevent unauthorized access to the trunk from the vehicle interior.

EASY-PACK through-loading facility in the rear bench seat (Wagon)

Important safety notes

WARNING

If the rear bench seat/rear seat and seat backrest are not engaged they could fold forwards, e.g. when braking suddenly or in the event of an accident.

- The vehicle occupant would thereby be pushed into the seat belt by the rear bench seat/rear seat or by the seat backrest. The seat belt can no longer offer the intended level of protection and could even cause injuries.
- Objects or loads in the trunk/cargo compartment cannot be restrained by the seat backrest.

There is an increased risk of injury.

Before every trip, make sure that the seat backrests and the rear bench seat/rear seat are engaged.

Observe the loading guidelines (▷ page 238).

Folding the rear seat backrests forward

! When folding the rear seat backrest forwards, ensure that there are no items lying on the seat cushions. These items could otherwise be damaged or could themselves damage the rear seats.

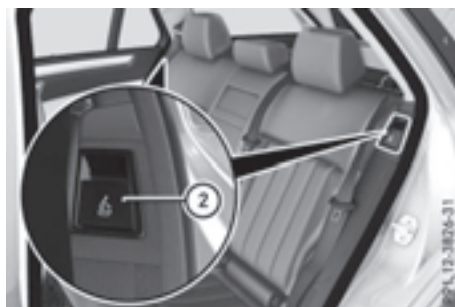

The left-hand and right-hand rear seat backrests can be folded forwards separately to increase the cargo compartment capacity. The combined cargo cover and net can remain installed.

- i** When you fold one or both parts of the rear seat backrests forwards, the headrests are also lowered if necessary. In the case of vehicles with memory function, the respective front seat is moved forwards slightly to avoid contact with the seat behind it.
 - ▶ Vehicles without memory function: if necessary, move the driver's or front-passenger seat forward.
 - ▶ Pull the left-hand or right-hand release handle at the rear in cargo compartment ① or at the side beside backrests ②. The corresponding backrest folds forwards.
 - ▶ Move the driver's or front-passenger seat back if necessary.

Folding the rear seat backrest back

! Make sure that the seat belt does not become trapped when folding the rear seat backrest back. Otherwise, it could be damaged.



- ▶ Move the driver's or front-passenger seat forward if necessary.
- ▶ Fold seat backrest ① back until it engages. If the rear seat backrest is not engaged and locked, this will be shown in the multifunction display in the instrument cluster. A warning tone also sounds.
- ▶ Adjust the head restraints if necessary (▷ page 116).
- ▶ Move the driver's or front-passenger seat back if necessary.

Securing cargo

Plastic hooks (Sedan)



On vehicles without a through-loading feature in the rear bench seat, six plastic hooks are installed to the trunk floor.

Cargo tie-down rings

General notes

Observe the following notes on securing loads:

- Observe the loading guidelines (▷ page 238).
- Secure the load using the cargo tie-down rings.
- Distribute the load on the cargo tie-down rings evenly.
- Do not use elastic straps or nets to secure a load, as these are only intended as an anti-slip protection for light loads.
- Do not route tie-downs across sharp edges or corners.
- Pad sharp edges for protection.

Trunk/cargo compartment



Cargo tie-down rings ① (Sedan)



Cargo tie-down rings ① (Wagon)

EASY-PACK cargo compartment cover (Wagon)

Important safety notes

WARNING

On its own, the cargo compartment cover cannot secure or restrain heavy objects, items of luggage and heavy loads. You could be hit by an unsecured load during sudden changes in direction, braking or in the event of an accident. There is an increased risk of injury or even fatal injury.

Always store objects so that they cannot be flung around. Secure objects, luggage or loads against slipping or tipping over, e.g. by using tie downs, even if you are using the cargo compartment cover.

- ❗ When loading the vehicle, make sure that you do not stack the load in the cargo compartment higher than the lower edge of the side windows. Do not place heavy objects on top of the cargo compartment cover.

The cargo compartment cover and the cargo net are attached to anchorages on the right and left in the cargo compartment as a combined cargo cover and net.

When the tailgate is opened, the cargo compartment cover is automatically raised to make loading easier. It is automatically lowered again when the tailgate is closed.

When the cargo compartment cover is clipped in, there should be no objects obstructing the downwards movement of the cover in the cargo compartment when the tailgate is closed. The cargo compartment cover will otherwise be raised again.

Extending/retracting the cargo compartment cover

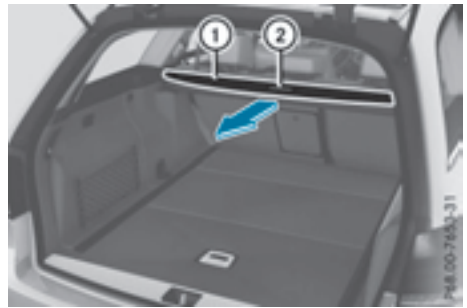

- **To extend:** pull cargo compartment cover ① back by grab handle ② and clip it into the retainers on the left and right.

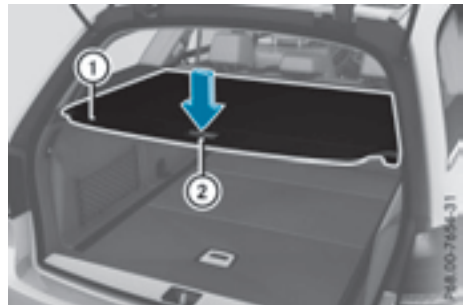

- **To retract:** unhook cargo compartment cover ① from the retainers on the left and right and guide it forwards by grab handle ② until it is fully retracted.

Installing/removing the combined cargo cover and net

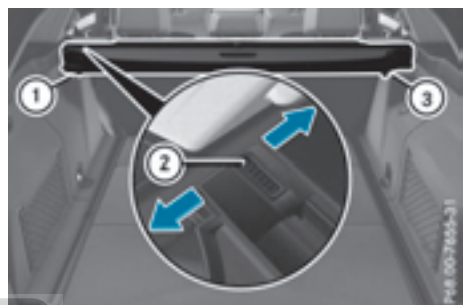

You can reach the combined cargo cover and net to install and remove it from the cargo compartment and, with the seat backrest folded forwards, from the left-hand rear door.

- ▶ Make sure that the cargo net and the cargo compartment cover are rolled up.
- ▶ **To remove:** press button ②.
- ▶ Fold the combined cargo cover and net forwards on the left-hand side with the seat backrest folded forwards, and fold it backwards with the seat backrest folded up.
- ▶ First, detach the combined cargo cover and net from left-hand catch ① and then remove it from right-hand fixture ③.
- ▶ **To install:** push the combined cargo cover and net up to the stop into right-hand fixture ③.
- ▶ Place the combined cargo cover and net into the left-hand fixture and push it into catch ① until the combined cargo cover and net engages audibly.



- ▶ Make sure that red lock status indicator ④ is no longer visible. The combined cargo cover and net will otherwise not be locked in place.

Attaching the combined cargo cover and net to the rear seat backrest

- ! If you have attached the combined cargo cover and net to a rear seat backrest that is folded forwards, do not fold the backrest back.

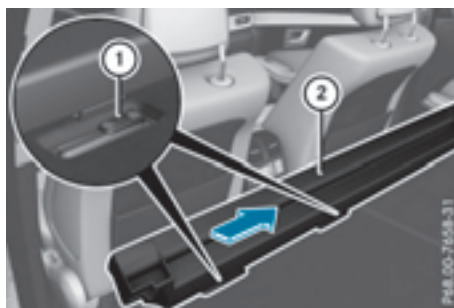

- ▶ Fold the left and right seat backrest forwards (▷ page 241).
- ▶ Insert combined cargo cover and net ② into two guides ① and push it up to the stop in the direction of the arrow.

Cargo net (Wagon)

Important safety notes

⚠ WARNING

On its own, the cargo net cannot secure or restrain heavy objects, items of luggage and heavy loads. You could be hit by an unsecured load during sudden changes in direction, braking or in the event of an accident. There is an increased risk of injury or even fatal injury. Always store objects so that they cannot be flung around. Secure objects, luggage or loads against slipping or tipping over, e.g. by using tie downs, even if you are using the cargo net.

It is important to use a cargo net if you load the vehicle with small objects above the seat backrests. For safety reasons, always use a cargo net when transporting loads.

Damaged cargo nets can no longer fulfill their protective function and must be replaced. Visit a qualified specialist workshop.

Cargo net without cargo compartment enlargement

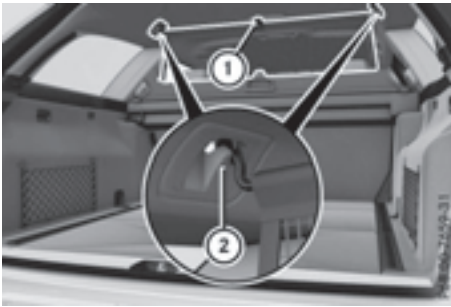

- ▶ Pull the cargo net up by tab ① and hook it into eyelets ②.

Cargo net with cargo compartment enlargement



- ▶ Make sure that the cargo net is attached to the rear seat backrest (▷ page 243).
- ▶ Guide the cargo net up by tab ① and hook it into eyelets ②.

Coat hooks on the tailgate (Wagon)



- ① Coat hook

EASY-PACK trunk box (Sedan)

Important safety notes

WARNING

When the load surface moves up, your hands may become trapped on the frame of the EASY-PACK trunk box. There is a risk of injury. When the load surface moves up, make sure that your hands are not within the sweep of the load surface. If someone becomes trapped, carefully push the center of the load surface downward.

- ❗ When the EASY-PACK trunk box is pulled out, no objects may be placed on the frame of the box, nor should the frame be pushed from above. Otherwise, the box could be damaged.
- ❗ Sharp-edged, pointed or fragile objects can damage the EASY-PACK trunk box and then be thrown out. There is a risk of injury. Do not transport sharp-edged, pointed or fragile objects in the EASY-PACK trunk box. Always store and secure these or similar objects in the trunk outside of the EASY-PACK trunk box.
- ❗ If you exceed the maximum permitted load of the EASY-PACK trunk box, objects can be thrown out of the EASY-PACK trunk box and strike vehicle occupants. There is a risk of injury, particularly in the event of

sudden braking or a sudden change in direction.

Always observe the maximum permitted load of the EASY-PACK trunk box. Always store and secure heavy objects in the trunk outside of the EASY-PACK trunk box.

The maximum permitted load of the EASY-PACK trunk box is 22 lbs (10 kg). With a load of above approximately 11 lbs (5 kg), the bottom of the box moves downward until it rests on the mat of the trunk floor. Thus, overloading of the box is avoided.

Adjusting the height to any position

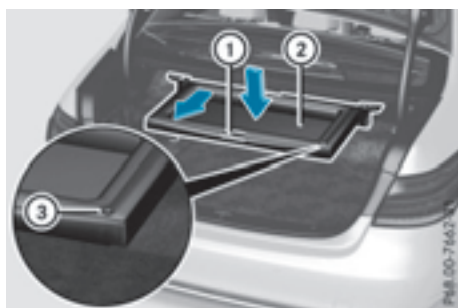

- ▶ Pull the box out by handle ① in the direction of the arrow all the way to the stop.
- ▶ **Lowering the load surface:** push the center of load surface ② down by hand in the direction of the arrow until load surface ② has reached the desired position and the box is the desired size.
- ▶ **To raise the load surface:** press switch ③. Load surface ② of the box moves up automatically.
- ▶ **To stow the box:** push the box in by handle ① all the way to the stop.

Removing and installing

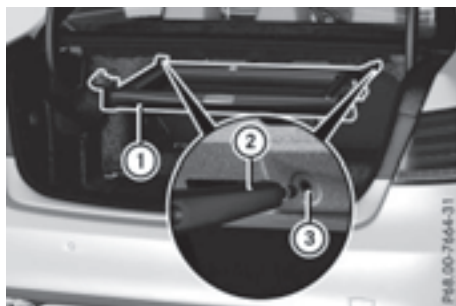

- ▶ **To install:** insert retainer ② of box ① into slots ③



- ▶ Raise box ① and press hooks ⑤ into anchorage ④ as far as they will go.
 - ▶ Turn left-hand rotating catch ⑥ clockwise and right-hand rotating catch ⑥ counter-clockwise by 90°.
 - ▶ **To remove:** turn left-hand rotating catch ⑥ counter-clockwise and right-hand rotating catch ⑥ clockwise by 90°.
 - ▶ Move box ① downwards and pull it out from anchorages ④.
- ❗ Store the EASY-PACK trunk box on a flat surface after removal, e.g. on a suitable shelf.

EASY-PACK load-securing kit (Wagon)

Components and storage

The EASY-PACK load-securing kit allows you to use your cargo compartment for a variety

of purposes. The accessory parts are located under the cargo compartment floor.

- ▶ Open the EASY-PACK folding luggage-compartment floor (▷ page 249).



EASY-PACK load-securing kit accessory parts

- ① Telescopic rod
- ② Bag containing the brackets and luggage holder

Inserting the brackets into the loading rail

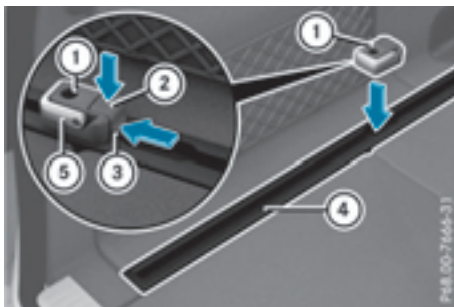

- ▶ Insert bracket ① into the center of loading rail ④.
- ▶ Press release button ② and push bracket ① into the desired position in loading rail ④.
- ▶ Let go of release button ②.
- ▶ Press locking button ③. Bracket ① is locked in loading rail ④.
- ▶ If necessary, fold cargo tie-down ring ⑤ upwards.

Luggage holder

- ❗ Only use the luggage holder to secure cargo with a maximum weight of 15.4 lbs (7 kg) and with dimensions that the luggage holder can safely and securely contain.

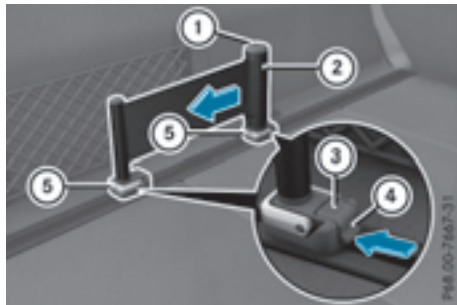

The luggage holder can be used to secure light loads against the side wall of the cargo compartment to prevent them from moving around.

- ▶ **To install:** insert two brackets ⑤ into the left or right loading rail (▷ page 247).
- ▶ Press release button ① of the luggage holder and pull the strap out slightly.
- ▶ Insert luggage holder ② into brackets ⑤ and, while doing so, press release button ③ and push the luggage holder downwards until it engages.
- ▶ Press release button ① of the luggage holder and pull the strap out in the direction of the arrow.
- ▶ Place the load between the strap and the cargo compartment side wall.
- ▶ Using one hand, press locking button ① of the luggage holder.
- ▶ With your other hand, let the strap go slowly until the load is secured.
- ▶ Make sure that locking button ④ on brackets ⑤ is pressed. This keeps brackets ⑤ in place on the loading rail.
- ▶ **To remove:** press release button ③ on respective bracket ⑤ and remove luggage holder ② by pulling upwards and out.

Telescopic rod

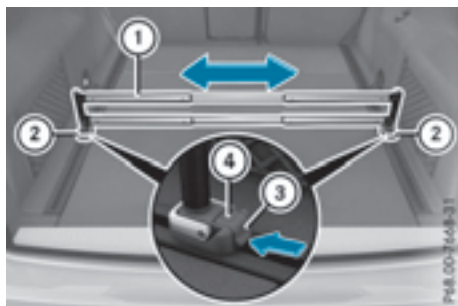

The telescopic rod can be used to secure the load against the rear seats to prevent it from moving around.

- ▶ **To install:** insert one bracket (2) into both the left and the right loading rails and slide it to the desired position (▷ page 247).
- ▶ Insert telescopic rod (1) into brackets (2) and, while doing so, press release button (4) and push the rod downwards until it engages.
- ▶ Make sure that locking button (3) on brackets (2) is pressed. This keeps brackets (2) in place on the loading rail.
- ▶ **To remove:** press release button (4) on respective bracket (2) and remove telescopic rod (1) by pulling it upwards and out.

Stowage well under the trunk floor (Sedan)

- ❗ Unhook the handle before again before closing the trunk lid and clip it in securely to prevent the handle flap from protruding. Otherwise, you could damage the handle.



The TIREFIT kit, the vehicle tool kit, etc. are located in the stowage compartment.

- ▶ **To open:** pull handle (1) up.



- ▶ Hook handle (1) into rain trough (2).

EASY-PACK folding floor with stowage compartment under the cargo compartment floor (Wagon)

Important safety notes

⚠ WARNING

If you drive when the EASY-PACK folding floor is open, objects could be flung around, thus striking vehicle occupants. There is a risk of injury, particularly in the event of sudden braking or a sudden change in direction. Always close the EASY-PACK folding floor before a journey.

- ❗ Do not apply pressure to the EASY-PACK folding luggage-compartment floor when it is fully open. You may otherwise damage

the hinges of the EASY-PACK folding luggage-compartment floor.

- ❗ Vehicles with a B&O sound system: do not remove the EASY-PACK folding floor. Removing the EASY-PACK folding floor will cause the cable set or the amplifier to be damaged because the amplifier module is screwed to the underside of the EASY-PACK folding floor.

Opening and closing the folding cargo compartment floor



The parts of the EASY-PACK load-securing kit are contained beneath the EASY-PACK folding floor. Beneath the insert, you will find, for example, the TIREFIT kit or the emergency spare wheel and the vehicle tool kit.

- ▶ **To open:** open the tailgate.
- ▶ Holding the ribbing, press handle ① downwards ②. Handle ① folds upwards.



- ▶ Pull EASY-PACK folding luggage-compartment floor ③ in the direction of the arrow

by handle ① until it reaches the desired position and engages in side ④.

- ▶ **To close:** disengage the EASY-PACK folding luggage-compartment floor and pull it back.
- ▶ Press the EASY-PACK folding luggage-compartment floor down ② until it engages.

Installing and removing the folding cargo compartment floor

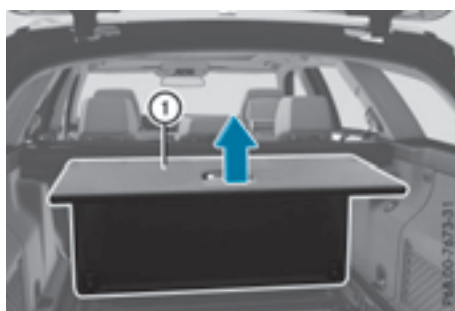

120° position

- ▶ Remove the combined cargo cover and net (▷ page 243).
- ▶ **To remove:** move EASY-PACK folding luggage-compartment floor ① into the 120° position and lift it upwards.
- ▶ **To install:** push EASY-PACK folding luggage-compartment floor ① to the stop, move it into the 120° position and make sure it engages audibly.
- ▶ Pull EASY-PACK folding luggage-compartment floor ① forwards.

EASY-PACK rear sill protector (Wagon)

- ❗ Before closing the tailgate, refasten the EASY-PACK rear sill protector on the underside of the EASY-PACK folding luggage-compartment floor.

The EASY-PACK rear sill protector could otherwise be damaged.



The EASY-PACK rear sill protector is attached to the underside of the EASY-PACK folding cargo compartment floor by means of magnets. It is designed to prevent clothing becoming stained and the paintwork being scratched when loading.

- ▶ Open the EASY-PACK folding luggage-compartment floor (▷ page 249).
- ▶ Use tab ② to detach EASY-PACK rear sill protector ① from the magnets and place it over the loading sill.
- ▶ Close the EASY-PACK folding cargo compartment floor.

Roof carrier

Important safety notes

WARNING

When you load the roof, the center of gravity of the vehicle rises and the driving characteristics change. If you exceed the maximum roof load, the driving characteristics, as well as steering and braking, will be greatly impaired. There is a risk of an accident.

Never exceed the maximum roof load and adjust your driving style.

- ❗ Mercedes-Benz recommends that you only use roof carriers that have been tested and approved for Mercedes-Benz vehicles. This helps to prevent damage to the vehicle.

Position the load on the roof carrier in such a way that the vehicle will not sustain damage even when it is in motion.

Ensure that when the roof carrier is installed:

- you can raise the sliding sunroof or the panorama roof with power tilt/sliding panel fully (depending on the vehicle's equipment)
- you can open the tailgate or trunk lid fully
- the roof carrier does not come into contact with the antenna

- ❗ To avoid damaging or scratching the covers, do not use metallic or hard objects to open them.

You will find information on the maximum roof load in the "Technical data" section (▷ page 344).

An incorrectly secured roof carrier or roof load may become detached from the vehicle. You must therefore ensure that you observe the roof carrier manufacturer's installation instructions.

Attaching the roof carrier (Sedan)

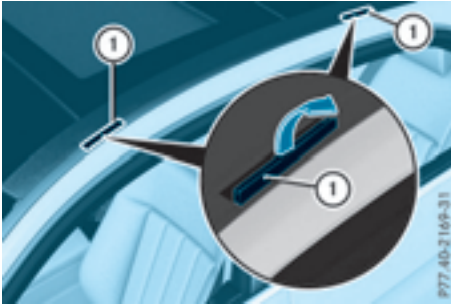

Vehicles with a steel roof or sliding sunroof (illustration)



Vehicles with a panorama roof with power tilt/sliding panel

- ▶ Open covers ① carefully in the direction of the arrow.
- ▶ Fold covers ① upwards.
- ▶ Only secure the roof carrier to the anchor points under covers ①.
- ▶ Observe the manufacturer's installation instructions.

Attaching the roof carrier (Wagon)

- ▶ Secure the roof carrier to the roof rails.
- ▶ Observe the manufacturer's installation instructions.

Features

Information in the Digital Operator's Manual

In the Digital Operator's Manual you will find information on the following topics:

- Cup holder
- Bottle holder
- Roller sunblinds on the rear side windows
- Rear window roller sunblind (Sedan)
- Ashtray
- Cigarette lighter
- 12 V sockets
- 115 V socket

Sun visors

Overview

WARNING

If the mirror cover of the vanity mirror is folded up when the vehicle is in motion, you could be blinded by incident light. There is a risk of an accident.

Always keep the mirror cover folded down while driving.

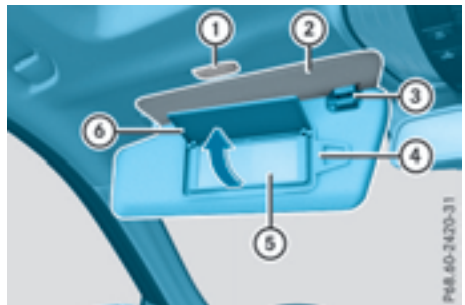

- ① Mirror light
- ② Additional sun visor
- ③ Bracket
- ④ Retaining clip, e.g. for a car park ticket
- ⑤ Vanity mirror
- ⑥ Mirror cover

Information in the Digital Operator's Manual

In the Digital Operator's Manual you will find information on the following topics:

- Vanity mirror in the sun visor
- Glare from the side

mbrace

Information in the Digital Operator's Manual

In the Digital Operator's Manual you will find information on the following topics:

- Downloading destinations in COMAND
- Search & Send
- Vehicle remote opening
- Vehicle remote closing
- Stolen vehicle recovery service
- Vehicle remote malfunction diagnosis
- Downloading routes
- Speed alert
- Geo fencing
- Triggering the vehicle alarm

 The mbrace system is only available in the USA.

General notes

The mbrace system is only available in the USA.

You must have a license agreement to activate the mbrace service. Make sure that your system is activated and operational. To log in, press the  MB Info call button. If any of the steps mentioned are not carried out, the system may not be activated.

If you have questions about the activation, contact one of the following telephone hot-lines:

Mercedes-Benz Customer Assistance Center at 1-800-FOR-MERCEdes (1-800-367-6372) or 1-866-990-9007

Shortly after successfully registering with the mbrace service, a user ID and password will be sent to you by mail. You can use this password to log onto the mbrace area under "Owners Online" at <http://www.mbusa.com>.

The system is available if:



- it has been activated and is operational
- the corresponding mobile phone network is available for transmitting data to the Customer Center
- a service subscription is available
- the starter battery is sufficiently charged

Determining the location of the vehicle on a map is only possible if:

- GPS reception is available.
- the vehicle position can be forwarded to the Customer Assistance Center.

The mbrace system

To adjust the volume during a call, proceed as follows:

► Press the  or  button on the multifunction steering wheel.

or

► Use the COMAND/Audio 20 volume control.

The system offers various services, e.g.:





- Automatic and manual emergency call
- Roadside Assistance call
- MB Info call

You can find information and a description of all available features under "Owners Online" at <http://www.mbusa.com>.

System self-test

After you have switched on the ignition, the system carries out a self-diagnosis.

A malfunction in the system has been detected if one of the following occurs:

- The indicator lamp in the SOS button does not come on during the system self-test.
- The indicator lamp in the  Roadside Assistance button does not light up during self-diagnosis of the system.
- The indicator lamp in the  MB Info call button does not light up during self-diagnosis of the system.
- The indicator lamp in one or more of the following buttons continues to light up red after the system self-diagnosis:
 - SOS button
 -  Roadside Assistance call button
 -  MB Info call button
- The **Inoperative** or the **Service Not Activated** message appears in the multifunction display after the system self-diagnosis.

If a malfunction is indicated as outlined above, the system may not operate as expected. In the event of an emergency, help will have to be summoned by other means.

Have the system checked at the nearest authorized Mercedes-Benz Center or contact the following service hotlines:

Mercedes-Benz Customer Assistance Center at 1-800-FOR-MERCedes (1-800-367-6372) or 1-866-990-9007

Emergency call

Important safety notes

WARNING

It can be dangerous to remain in the vehicle, even if you have pressed the SOS button in an emergency if:

- you see smoke inside or outside of the vehicle, e.g. if there is a fire after an accident
- the vehicle is on a dangerous section of road
- the vehicle is not visible or cannot easily be seen by other road users, particularly when dark or in poor visibility conditions

There is a risk of an accident and injury.

Leave the vehicle immediately in this or similar situations as soon as it is safe to do so. Move to a safe location along with other vehicle occupants. In such situations, secure the vehicle in accordance with national regulations, e.g. with a warning triangle.

General notes

Observe the notes on system activation ( page 252).

An emergency call is dialed automatically if an air bag or Emergency Tensioning Device is triggered. You cannot end an automatically triggered emergency call yourself.

An emergency call can also be initiated manually.

As soon as the emergency call has been initiated, the indicator lamp in the SOS button flashes. The **Connecting Call** message appears in the multifunction display.

The audio output is muted.

Once the connection has been made, the **Call Connected** message appears in the multifunction display.

All important information on the emergency is transmitted, for example:

- current location of the vehicle (as determined by the GPS system)
- vehicle identification number
- information on the severity of the accident

Shortly after the emergency call has been initiated, a voice connection is automatically established between the Customer Assistance Center and the vehicle occupants.

- If the vehicle occupants respond, the Mercedes-Benz Customer Assistance Center attempts to get more information on the emergency.
- If there is no response from the vehicle occupants, an ambulance is immediately sent to the vehicle.

If no voice connection can be established to the Mercedes-Benz Customer Assistance Center, the system has been unable to initiate an emergency call.

This can occur, for example, if the relevant mobile phone network is not available. The indicator lamp in the SOS button flashes continuously.

The **Call Failed** message appears in the multifunction display and must be confirmed. In this case, summon assistance by other means.

Making an emergency call



► **To initiate an emergency call manually:** press cover ① briefly to open.

► Press SOS button ② briefly. The indicator lamp in SOS button ② flashes until the emergency call is concluded.

► Wait for a voice connection to the Mercedes-Benz Customer Assistance Center.

► After the emergency call, close cover ①.

If the mobile phone network is unavailable, mbrace will not be able to make the emergency call. If you leave the vehicle immediately after pressing the SOS button, you will not know whether mbrace placed the emergency call. In this case, always summon assistance by other means.

Roadside Assistance button



► **To call Roadside Assistance:** press Roadside Assistance button ①.

This initiates a call to the Mercedes-Benz Customer Assistance Center.

The indicator lamp in Roadside Assistance button ① flashes while the call is active.

The **Connecting Call** message appears in the multifunction display. The audio output is muted.

If a connection can be made, the **Call Connected** message appears in the multifunction display.

If a mobile phone network and GPS reception are available, the system transfers data to the Mercedes-Benz Customer Assistance Center, for example:

- current location of the vehicle
- vehicle identification number

The COMAND/Audio 20 display indicates that a call is active. During the call, you can change to the navigation menu by pressing the NAVI button in COMAND/Audio 20, for example.

Voice output is not available in this case.

A voice connection is established between the Mercedes-Benz Customer Assistance Center and the vehicle occupants.

From the remote malfunction diagnosis, the Mercedes-Benz Customer Assistance Center can ascertain the nature of the problem. In the Digital Operator's Manual, you will find information on remote malfunction diagnosis.

The Mercedes-Benz Customer Assistance Center either sends a qualified Mercedes-Benz technician or makes arrangements for your vehicle to be transported to the nearest authorized Mercedes-Benz Center.

You may be charged for services such as repair work and/or towing.

You can find more information in the separate mbrace manual.

The system has not been able to initiate a Roadside Assistance call, if:

- the indicator lamp for Roadside Assistance call button  is flashing continuously.
- no voice connection to the Mercedes-Benz Customer Assistance Center was established.

This can occur if the relevant mobile phone network is not available, for example.

The **Call Failed** message appears in the multifunction display.

► **To end a call:** press the  button on the multifunction steering wheel.

or

► Press the corresponding COMAND/Audio 20 button for ending a phone call.

MB Info call button



► **To call MB Info:** press MB Info call button ①.

This initiates a call to the Mercedes-Benz Customer Assistance Center.

The indicator lamp in MB Info call button ① flashes while the connection is being made. The **Connecting Call** message appears in the multifunction display. The audio output is muted.

If a connection can be made, the **Call Connected** message appears in the multifunction display.

If a mobile phone network and GPS reception are available, the system transfers data to the Mercedes-Benz Customer Assistance Center, for example:

- current location of the vehicle
- vehicle identification number

The COMAND/Audio 20 display indicates that a call is active. During the call, you can change to the navigation menu by pressing the NAVI button in COMAND/Audio 20, for example.

Voice output is not available in this case.

A voice connection is established between the Mercedes-Benz Customer Assistance Center and the vehicle occupants.

You receive information about operating your vehicle, about the nearest authorized Mercedes-Benz Center and about other products and services from Mercedes-Benz.

You can find further information on the mbrace system under "Owners Online" at <http://www.mbusa.com>.

The system has not been able to initiate an MB Info call, if:

- the indicator lamp in MB Info call button  is flashing continuously.
- no voice connection to the Mercedes-Benz Customer Assistance Center was established.

This can occur if the relevant mobile phone network is not available, for example.

The **Call Failed** message appears in the multifunction display.

► **To end a call:** press the  button on the multifunction steering wheel.

or

► Press the corresponding COMAND/Audio 20 button for ending a phone call.

Call priority

When service calls are active, e.g. Roadside Assistance or MB Info calls, an emergency call can still be initiated. In this case, an emergency call will take priority and override all other active calls.

The indicator lamp of the respective button flashes until the call is ended.

An emergency call can only be terminated by the Mercedes-Benz Customer Assistance Center.

All other calls can be ended by pressing:

- the  button on the multifunction steering wheel
- the corresponding button in COMAND/Audio 20 to end the voice call

When a call is initiated, the audio system is muted.

The mobile phone is no longer connected to COMAND/Audio 20.

However, if you want to use your mobile phone, do so only when the vehicle is stationary and in a safe location.

Garage door opener

General notes

The HomeLink® garage door opener integrated in the rear-view mirror allows you to operate up to three different door and gate systems.

Use the integrated garage door opener only on garage doors that:

- have safety stop and reverse features and
- meet current U.S. federal safety standards

Once programmed, the integrated garage door opener in the rear-view mirror will assume the function of the garage door system's remote control. Please also read the operating instructions for the garage door system.

When programming a garage door opener, park the vehicle outside the garage. Do not run the engine while programming.

Certain garage door drives are incompatible with the integrated garage door opener. If you have difficulty programming the integrated garage door opener, contact an authorized Mercedes-Benz Center.

Alternatively, you can call the following telephone assistance services:

- **USA:** Mercedes-Benz Customer Assistance Center at 1-800-FOR-MERCEdes
- **Canada:** Customer Service at 1-800-387-0100
- HomeLink® hotline 1-800-355-3515 (free of charge)

More information on HomeLink® and/or compatible products is also available online at <http://www.homelink.com>.

Notes on the declaration of conformity
(► page 31).

USA: FCC ID: CB2HMIHL4
Canada: IC: 279B-HMIHL4

Important safety notes

WARNING

When you operate or program the garage door with the integrated garage door opener, persons in the range of movement of the garage door can become trapped or struck by the garage door. There is a risk of injury.

When using the integrated garage door opener, always make sure that nobody is within the range of movement of the garage door.

WARNING

Combustion engines emit poisonous exhaust gases such as carbon monoxide. Inhaling these exhaust gases leads to poisoning. There is a risk of fatal injury. Therefore never leave the engine running in enclosed spaces without sufficient ventilation.

Programming

Programming buttons

Pay attention to the "Important safety notes" (▷ page 257).

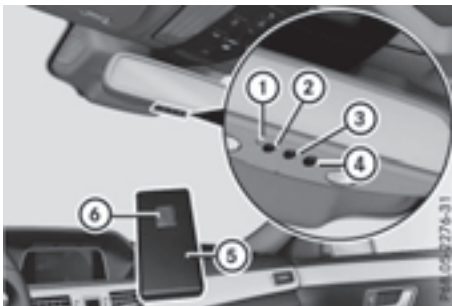

Garage door remote control ⑤ is not included with the integrated garage door opener.

- ▶ Turn the SmartKey to position **2** in the ignition lock (▷ page 137).
- ▶ Select one of buttons ② to ④ to use to control the garage door drive.

- ▶ **To start programming mode:** press and hold one of buttons ② to ④ on the integrated garage door opener.

The garage door opener is now in programming mode. After a short time, indicator lamp ① lights up yellow.

Indicator lamp ① lights up yellow as soon as button ②, ③ or ④ is programmed for the first time. If the selected button has already been programmed, indicator lamp ① will only light up yellow after ten seconds have elapsed.

- ▶ Release button ②, ③ or ④. Indicator lamp ① flashes yellow.
- ▶ **To program the remote control:** point garage door remote control ⑤ towards buttons ② to ④ on the rear-view mirror at a distance of 2 to 8 inches (5 to 20 cm).
- ▶ Press and hold button ⑥ on remote control ⑤ until indicator lamp ① lights up green. When indicator lamp ① lights up green: programming is finished.

When indicator lamp ① flashes green: programming was successful. The next step is to synchronize the rolling code (▷ page 257).

- ▶ Release button ⑥ on remote control ⑤ for the garage door drive system. If indicator lamp ① lights up red: repeat the programming procedure for the corresponding button on the rear-view mirror. When doing so, vary the distance between remote control ⑤ and the rear-view mirror.

The required distance between remote control ⑤ and the integrated garage door opener depends on the garage door drive system. Several attempts might be necessary. You should test every position for at least 25 seconds before trying another position.

Synchronizing the rolling code

Pay attention to the "Important safety notes" (▷ page 257).

If the garage door system uses a rolling code, you will also have to synchronize the garage

door system with the integrated garage door opener in the rear-view mirror. To do this you will need to use the programming button on the door drive control panel. The programming button may be positioned in different places depending on the manufacturer. It is usually located on the door drive unit on the garage ceiling.

Familiarize yourself with the garage door drive operating instructions, e.g. under "Programming of additional remote controls", before carrying out the following steps.

Your vehicle must be within reach of the garage door or gate opener drive. Make sure that neither your vehicle nor any persons/objects are present within the sweep of the door or gate.

- ▶ Turn the SmartKey to position **2** in the ignition lock (> page 137).
- ▶ Get out of the vehicle.
- ▶ Press the programming button on the door drive unit.

Usually, you now have 30 seconds to initiate the next step.

- ▶ Get into the vehicle.
 - ▶ Press previously programmed button **②**, **③** or **④** on the integrated garage door opener until the door closes.
- The rolling code synchronization is then complete.

Notes on programming the remote control

Canadian radio frequency laws require a "break" (or interruption) of the transmission signals after broadcasting for a few seconds. Therefore, these signals may not last long enough for the integrated garage door opener. The signal is not recognized during programming. Comparable with Canadian law, some U.S. garage door openers also feature a "break".

Proceed as follows:

- if you live in Canada
 - if you have difficulties programming the garage door opener (regardless of where you live) when using the programming steps.
- ▶ Press and hold one of buttons **②** to **④** on the integrated garage door opener. After a short time, indicator lamp **①** lights up yellow.
 - ▶ Release the button. Indicator lamp **①** flashes yellow.
 - ▶ Press button **⑥** of garage door remote control **⑤** for two seconds, then release it for two seconds.
 - ▶ Press button **⑥** again for two seconds.
 - ▶ Repeat this sequence on button **⑥** of remote control **⑤** until indicator lamp **①** lights up green. When indicator lamp **①** lights up green: programming is finished. When indicator lamp **①** flashes green: programming was successful. The next step is to synchronize the rolling code.
 - ▶ Release button **⑥** of remote control **⑤** of the garage door drive. If indicator lamp **①** lights up red: repeat the programming process for the corresponding button on the rear-view mirror. When doing so, vary the distance between remote control **⑤** and the rear-view mirror. The required distance between remote control **⑤** and the integrated garage door opener depends on the garage door drive system. Several attempts might be necessary. You should test every position for at least 25 seconds before trying another position.

Problems when programming

If you are experiencing problems programming the integrated garage door opener on the rear-view mirror, take note of the following instructions:

- Check the transmitter frequency used by garage door drive remote control ⑤ and whether it is supported. The transmitter frequency can usually be found on the back of the garage door drive remote control. The integrated garage door opener is compatible with devices that have units which operate in the frequency range of 280 to 433 MHz.
- Replace the batteries in garage door remote control ⑤. This increases the likelihood that garage door remote control ⑤ will transmit a strong and precise signal to the integrated garage door opener.
- When programming, hold remote control ⑤ at varying distances and angles from the button which you are programming. Try various angles at a distance between 2 and 12 inches (5 to 30 cm) or at the same angle but at varying distances.
- If another remote control is available for the same garage door drive, repeat the same programming steps with this remote control. Before performing these steps, make sure that new batteries have been installed in garage door drive remote control ⑤.
- Note that some remote controls only transmit for a limited amount of time (the indicator lamp on the remote control goes out). Press button ⑥ on remote control ⑤ again before transmission ends.
- Align the antenna cable of the garage door opener unit. This can improve signal reception/transmission.

Opening/closing the garage door

After it has been programmed, the integrated garage door opener performs the function of the garage door system remote control.

Please also read the operating instructions for the garage door system.

- ▶ Turn the SmartKey to position **2** in the ignition lock (> page 137).
- ▶ Press button ②, ③ or ④ which you have programmed to operate the garage door.
 - Garage door system with a fixed code: indicator lamp ① lights up green.
 - Garage door system with a rolling code: indicator lamp ① flashes green.
 The transmitter will transmit a signal as long as the button is pressed. The transmission is halted after a maximum of ten seconds and indicator lamp ① lights up yellow.
- ▶ Press button ②, ③ or ④ again if necessary.

Clearing the memory

Make sure that you clear the memory of the integrated garage door opener before selling the vehicle.

- ▶ Turn the SmartKey to position **2** in the ignition lock (> page 137).
- ▶ Press and hold buttons ② and ④. The indicator lamp initially lights up yellow and then green.
- ▶ Release buttons ② and ④. The memory of the integrated garage door opener in the rear-view mirror is cleared.

Floormats

WARNING

Objects in the driver's footwell can restrict the pedal travel or obstruct a depressed pedal. The operating and road safety of the vehicle is jeopardized. There is a risk of an accident.

Make sure that all objects in the vehicle are stowed correctly, and that they cannot enter the driver's footwell. Install the floormats securely and as specified in order to ensure sufficient clearance for the pedals. Do not use

loose floormats and do not place floormats on top of one another.

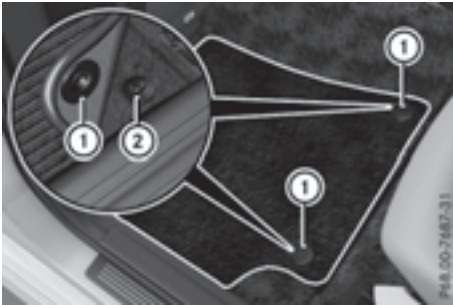

- ▶ Slide the seat backwards.
- ▶ **To install:** place the floormat in the footwell.
- ▶ Press studs ① onto retainers ②.
- ▶ **To remove:** pull the floormat off retainers ②.
- ▶ Remove the floormat.

Useful information	262
Engine compartment	262
Maintenance	266
Care	266

Useful information

- i** This Operator's Manual describes all models and all standard and optional equipment of your vehicle available at the time of publication of the Operator's Manual. Country-specific differences are possible. Please note that your vehicle may not be equipped with all features described. This also applies to safety-related systems and functions.
- i** Read the information on qualified specialist workshops (▷ page 31).

Engine compartment

Hood

Important safety notes

WARNING

If the hood is unlatched, it may open up when the vehicle is in motion and block your view. There is a risk of an accident.
Never unlatch the hood while driving. Before every trip, ensure that the hood is locked.

WARNING

When opening and closing the hood, it may suddenly fall into the closed position. There is a risk of injury to persons within range of movement of the hood.
Open and close the hood only when no one is within its range of movement.

WARNING

Opening the hood when the engine is overheated or when there is a fire in the engine compartment could expose you to hot gases or other service products. There is a risk of injury.
Let an overheated engine cool down before opening the hood. If there is a fire in the engine compartment, keep the hood closed and contact the fire department.

WARNING

The engine compartment contains moving components. Certain components, such as the radiator fan, may continue to run or start again suddenly when the ignition is off. There is a risk of injury.

If you need to do any work inside the engine compartment:

- switch off the ignition
- never reach into the area where there is a risk of danger from moving components, such as the fan rotation area
- remove jewelry and watches
- keep items of clothing and hair, for example, away from moving parts

WARNING

The ignition system and the fuel injection system work under high voltage. If you touch components which are under voltage, you could get an electric shock. There is a risk of injury.

Never touch components of the ignition system or fuel injection system when the ignition is switched on.

WARNING

Hybrid vehicles: be sure to read the "HYBRID" supplement. Otherwise, you could fail to recognize dangers.

Opening the hood

WARNING

Certain components in the engine compartment, such as the engine, radiator and parts of the exhaust system, can become very hot. Working in the engine compartment poses a risk of injury.

Where possible, let the engine cool down and touch only the components described in the following.

⚠ WARNING

When the hood is open and the windshield wipers are set in motion, you can be injured by the wiper linkage. There is a risk of injury. Always switch off the windshield wipers and the ignition before opening the hood.

- ❗ Make sure that the windshield wipers are not folded away from the windshield. You could otherwise damage the windshield wipers or the hood.



- ▶ Make sure that the windshield wipers are turned off.
- ▶ Pull release lever ① on the hood. The hood is released.



- ▶ Reach into the gap, pull hood catch handle ② up and lift the hood. If you lift the hood by approximately 15 in (40 cm), the hood is opened and held open automatically by the gas-filled strut.

Closing the hood

- ▶ Lower the hood and let it fall from a height of approximately 8 in (20 cm).
- ▶ Check that the hood has engaged properly. If the hood can be raised slightly, it is not properly engaged. Open it again and close it with a little more force.

Radiator

Vehicles with a diesel engine: do not cover the radiator, for example with a winter front or bug cover. The readings of the on-board-diagnostic system may otherwise be inaccurate. Some of these readings are required by law and must be accurate at all times.

Engine oil**General notes****⚠ WARNING**

Hybrid vehicles: be sure to read the "HYBRID" supplement. Otherwise, you could fail to recognize dangers.

Depending on your driving style, the vehicle consumes up to 0.9 US qt (0.8 liters) of oil per 600 miles (1,000 km). The oil consumption may be higher than this when the vehicle is new or if you frequently drive at high engine speeds.

Depending on the engine, the oil dipstick may be in a different location.

When checking the oil level:

- park the vehicle on a level surface.
- the engine should be switched off for approximately five minutes if the engine is at normal operating temperature.
- if the engine is not at normal operating temperature, e.g. if the engine was only started briefly, wait about 30 minutes before carrying out the measurement.

Checking the oil level using the oil dipstick

WARNING

Certain components in the engine compartment, such as the engine, radiator and parts of the exhaust system, can become very hot. Working in the engine compartment poses a risk of injury.

Where possible, let the engine cool down and touch only the components described in the following.

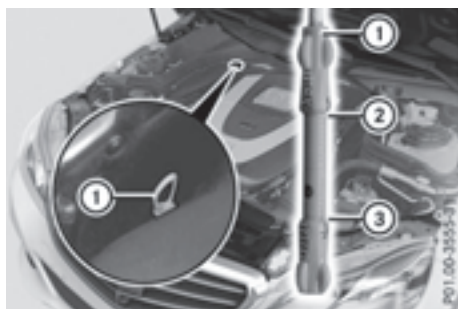

Example: vehicles with a gasoline engine

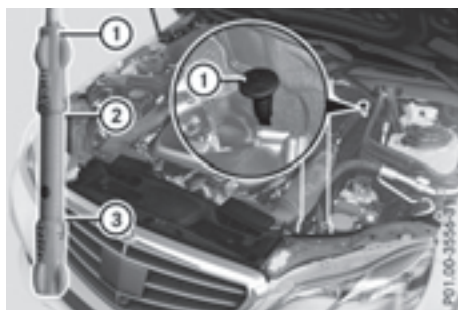

Example: vehicles with a diesel engine

- ▶ Pull oil dipstick ① out of the dipstick guide tube.
- ▶ Wipe off oil dipstick ①.
- ▶ Slowly slide oil dipstick ① into the guide tube to the stop, and take it out again. If the level is between MIN mark ③ and MAX mark ②, the oil level is correct.
- ▶ If the oil level has dropped to MIN mark ③ or below, add 1.1 US qt (1.0 liter) engine oil.

Adding engine oil

WARNING

Certain components in the engine compartment, such as the engine, radiator and parts of the exhaust system, can become very hot. Working in the engine compartment poses a risk of injury.

Where possible, let the engine cool down and touch only the components described in the following.

WARNING

If engine oil comes into contact with hot components in the engine compartment, it may ignite. There is a risk of fire and injury.

Make sure that engine oil is not spilled next to the filler neck. Let the engine cool down and thoroughly clean the engine oil off the components before starting the engine.

Environmental note

When adding oil, take care not to spill any. If oil enters the soil or waterways, it is harmful to the environment.

- ❗ Only use engine oils and oil filters that have been approved for vehicles with a service system. You can obtain a list of the engine oils and oil filters tested and approved in accordance with the Mercedes-Benz Specifications for Service Products at any Mercedes-Benz Service center.

Damage to the engine or exhaust system is caused by the following:

- using engine oils and oil filters that have not been specifically approved for the service system
- replacing engine oil and oil filters after the interval for replacement specified by the service system has been exceeded
- using engine oil additives.

- ❗ Do not add too much oil. adding too much engine oil can result in damage to the

engine or to the catalytic converter. Have excess engine oil siphoned off.



Example

- ▶ Turn cap ① counter-clockwise and remove it.
- ▶ Add engine oil.
If the oil level is at or below the MIN mark on the oil dipstick, add 1.1 US qt (1.0 l) of engine oil.
- ▶ Replace cap ① on the filler neck and turn clockwise.
Ensure that the cap locks into place securely.
- ▶ Check the oil level again with the oil dipstick (▷ page 264).

Further information on engine oil (▷ page 341).

Additional service products

Checking coolant level

⚠ WARNING

Certain components in the engine compartment, such as the engine, radiator and parts of the exhaust system, can become very hot. Working in the engine compartment poses a risk of injury.

Where possible, let the engine cool down and touch only the components described in the following.

⚠ WARNING

The engine cooling system is pressurized, particularly when the engine is warm. When opening the cap, you could be scalded by hot coolant spraying out. There is a risk of injury. Let the engine cool down before opening the cap. Wear eye and hand protection when opening the cap. Open the cap slowly half a turn to allow pressure to escape.



- ▶ Park the vehicle on a level surface.
Only check the coolant level when the vehicle is on a level surface and the engine has cooled down.
- ▶ Turn the SmartKey to position **2** in the ignition lock (▷ page 137).
On vehicles with KEYLESS-GO, press the Start/Stop button twice (▷ page 138).
- ▶ Check the coolant temperature display in the instrument cluster.
The coolant temperature must be below 158 °F (70 °C).
- ▶ Turn the SmartKey to position **0** in the ignition lock (▷ page 137).
- ▶ Slowly turn cap ① half a turn counter-clockwise to allow excess pressure to escape.
- ▶ Turn cap ① further counter-clockwise and remove it.
If the coolant is at the level of marker bar ③ in the filler neck when cold, there is enough coolant in coolant expansion tank ②.
If the coolant level is approximately 0.6 in (1.5 cm) above marker bar ③ in the filler

neck when warm, there is enough coolant in expansion tank ②.

- ▶ If necessary, add coolant that has been tested and approved by Mercedes-Benz.
- ▶ Replace cap ① and turn it clockwise as far as it will go.

For further information on coolant, see (> page 342).

Adding washer fluid to the windshield washer system

WARNING

Certain components in the engine compartment, such as the engine, radiator and parts of the exhaust system, can become very hot. Working in the engine compartment poses a risk of injury.

Where possible, let the engine cool down and touch only the components described in the following.

WARNING

Windshield washer concentrate could ignite if it comes into contact with hot engine components or the exhaust system. There is a risk of fire and injury.

Make sure that no windshield washer concentrate is spilled next to the filler neck.



- ▶ **To open:** pull cap ① upwards by the tab.
- ▶ Add the premixed washer fluid.
- ▶ **To close:** press cap ① onto the filler neck until it engages.

If the washer fluid level drops below the recommended minimum of 1 liter, a message appears in the multifunction display prompting you to add washer fluid.

Further information on windshield washer fluid/antifreeze (> page 343).

Maintenance

ASSYST PLUS

The Digital Operator's Manual contains more information on the ASSYST PLUS service interval display.

Care

General notes

Environmental note

Dispose of empty packaging and cleaning cloths in an environmentally responsible manner.

- ❗ For cleaning your vehicle, do not use any of the following:

- dry, rough or hard cloths
- abrasive cleaning agents
- solvents
- cleaning agents containing solvents

Do not scrub.

Do not touch the surfaces or protective films with hard objects, e.g. a ring or ice scraper. You could otherwise scratch or damage the surfaces and protective film.

- ❗ Do not park the vehicle for an extended period straight after cleaning it, particularly after having cleaned the wheels with wheel cleaner. Wheel cleaners could cause increased corrosion of the brake discs and brake pads/linings. For this reason, you should drive for a few minutes after cleaning. Braking heats the brake discs and the brake pads/linings, thus drying them. The vehicle can then be parked.

Regular care of your vehicle is a condition for retaining the quality in the long term.

Use care products and cleaning agents recommended and approved by Mercedes-Benz.

Exterior care

Automatic car wash

WARNING

Braking efficiency is reduced after washing the vehicle. There is a risk of an accident.

After the vehicle has been washed, brake carefully while paying attention to the traffic conditions until full braking power is restored.

- !** If DISTRONIC PLUS or the HOLD function is activated, the vehicle brakes automatically in certain situations.

To prevent damage to the vehicle, deactivate DISTRONIC PLUS and the HOLD function in the following or other similar situations:

- when towing the vehicle
- in the car wash

- !** Never clean your vehicle in a Touchless Automatic Car Wash as these use special cleaning agents. These cleaning agents can damage the paintwork or plastic parts.

- !** Make sure that:

- the side windows and the sliding sunroof are fully closed.
- the ventilation/heating is switched off (the OFF button has been pressed).
- the windshield wiper switch is in position **O**.

Otherwise, the vehicle might be damaged.

- !** In car washes with a towing mechanism, make sure that the automatic transmission is in transmission position **N**, otherwise the vehicle could be damaged.

- Vehicles with a SmartKey:

Do not remove the SmartKey from the ignition lock. Do not open the driver's

door or front-passenger door when the engine is switched off. Otherwise, the automatic transmission selects park position **P** automatically and locks the wheels. You can prevent this by shifting the automatic transmission to **N** beforehand.

- Vehicles with KEYLESS-GO:

Do not open the driver's door or front-passenger door when the engine is switched off. Otherwise, the automatic transmission selects park position **P** automatically and locks the wheels.

- !** If the key is within the rear detection range of KEYLESS-GO, situations such as the following could lead to the unintentional opening of the trunk lid/tailgate:

- using a car wash
- using a power washer

Make sure that the SmartKey is at least 10 ft (3 m) away from the vehicle.

Observe the following to make sure that the automatic transmission stays in position **N**:

- ▶ Make sure the vehicle is stationary and the ignition is switched off.
- ▶ Turn the SmartKey to position **2** in the ignition lock (▷ page 137). Use the SmartKey instead of the Start/Stop button on vehicles with KEYLESS-GO.
- ▶ Depress and hold the brake pedal.
- ▶ Shift the automatic transmission to position **N**.
- ▶ Release the brake pedal.
- ▶ Release the parking brake.
- ▶ Switch off the ignition and leave the SmartKey in the ignition lock.

You can wash the vehicle in an automatic car wash from the very start.

If the vehicle is very dirty, pre-wash it before cleaning it in an automatic car wash.

After using an automatic car wash, wipe off wax from the windshield and the wiper blades. This will prevent smears and reduce

wiping noises caused by residue on the windshield.

Information in the Digital Operator's Manual

In the Digital Operator's Manual you will find information on the following topics:

- Washing by hand
- Power washers
- Cleaning the paintwork
- Matte finish care
- Cleaning the wheels
- Cleaning the windows
- Cleaning wiper blades
- Cleaning the exterior lighting
- Cleaning the mirror turn signals
- Cleaning the sensors
- Cleaning the rear view camera
- Cleaning the 360° camera
- Cleaning the exhaust pipes

Interior care

In the Digital Operator's Manual you will find information on the following topics:

- Cleaning the display
- Cleaning the plastic trim
- Cleaning the steering wheel and gear or selector lever
- Cleaning genuine wood and trim strips
- Cleaning the seat covers
- Cleaning the seat belts
- Cleaning the headliner and carpets

Useful information	270
Where will I find...?	270
Flat tire	271
Battery (vehicle)	275
Jump-starting	279
Towing and tow-starting	281
Fuses	284

Useful information

i This Operator's Manual describes all models and all standard and optional equipment of your vehicle available at the time of publication of the Operator's Manual. Country-specific differences are possible.

Please note that your vehicle may not be equipped with all features described. This also applies to safety-related systems and functions.

i Read the information on qualified specialist workshops (▷ page 31).

- ⑤ Towing eye
- ⑥ Jack
- ⑦ Alignment bolt
- ⑧ Fuse allocation chart
- ⑨ Lug wrench

► Open the trunk lid/tailgate.

► **Sedan:** lift up the floor of the trunk (▷ page 248).

► **Wagon:** remove the seat cushions of the folding bench seat; see the Digital Operator's Manual, keyword "Folding bench seat (cargo compartment)".

Where will I find...?

Vehicle tool kit

General notes

The vehicle tool kit can be found in the stowage well under the trunk floor (▷ page 248) or cargo compartment floor (▷ page 249).

Depending on the vehicle equipment, the vehicle tool kit is on the left-hand side or the right-hand side in the stowage well under the trunk floor/cargo compartment floor.

Vehicles with a spare wheel/"Minispare" emergency spare wheel

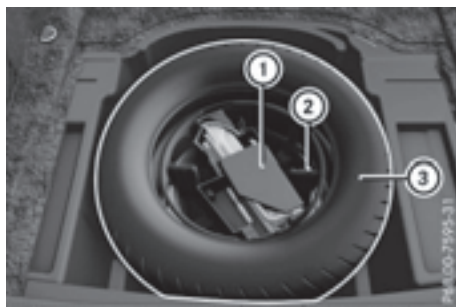

(Example: equipment and country-specific variations possible)

- ① Vehicle tool kit tray
- ② Stowage well
- ③ Spare wheel/"Minispare" emergency spare wheel

► Open the trunk lid/tailgate.

► **Sedan:** lift up the floor of the trunk (▷ page 248).

► **Wagon:** remove the seat cushions of the folding bench seat; see the Digital Operator's Manual, keyword "Folding bench seat (cargo compartment)".

The vehicle tool kit contains:

- Folding wheel chock
- Fuse allocation chart
- Jack

Vehicles with a TIREFIT kit

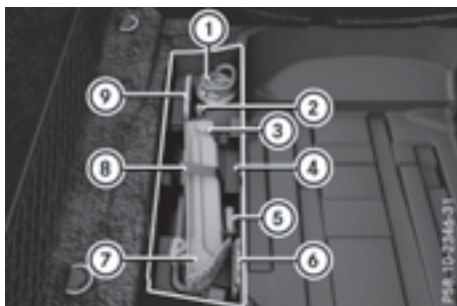

Vehicle tool kit in the left-hand stowage well (example: equipment and country-specific variations possible)

- ① Tire sealant filler bottle
- ② Folding wheel chock
- ③ One pair of gloves (under jack)
- ④ Tire inflation compressor

- Alignment bolt
- One pair of gloves
- Lug wrench
- Towing eye

Vehicles with a collapsible spare wheel

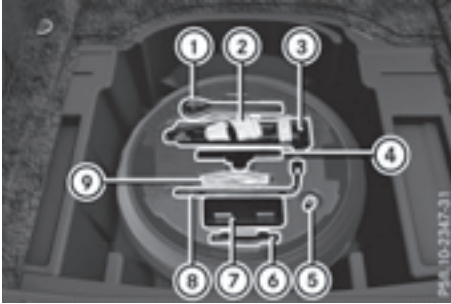

(Example: equipment and country-specific variations possible)

- ① Towing eye
 - ② One pair of gloves
 - ③ Jack
 - ④ Folding wheel chock
 - ⑤ Alignment bolt
 - ⑥ Sheet for faulty wheel
 - ⑦ Tire inflation compressor
 - ⑧ Lug wrench
 - ⑨ Fuse allocation chart
- ▶ Open the trunk lid/tailgate.
 - ▶ **Sedan:** lift up the floor of the trunk (▷ page 248).
 - ▶ **Wagon:** remove the seat cushions of the folding bench seat; see the Digital Operator's Manual, keyword "Folding bench seat (cargo compartment)".

Flat tire

Preparing the vehicle

Your vehicle may be equipped with:

- MOExtended tires (tires with run-flat properties) (▷ page 272)

Vehicle preparation is not necessary on vehicles with MOExtended tires

- a TIREFIT kit (▷ page 270)
- an emergency spare wheel (▷ page 329)

Vehicles equipped with MOExtended tires are not equipped with a TIREFIT kit at the factory. It is therefore recommended that you additionally equip your vehicle with a TIREFIT kit if you mount tires that do not feature run-flat properties, e.g. winter tires. A TIREFIT kit may be obtained from a qualified specialist workshop.

Information on changing/mounting a wheel (▷ page 309).

- ▶ Stop the vehicle on solid, non-slippery and level ground, as far away as possible from traffic.
- ▶ Switch on the hazard warning lamps.
- ▶ Secure the vehicle against rolling away (▷ page 151).
- ▶ If possible, bring the front wheels into the straight-ahead position.
- ▶ Vehicles with AIRMATIC: make sure that "normal" level is selected (▷ page 166).
- ▶ Switch off the engine.
- ▶ Remove the SmartKey from the ignition lock.

or, on vehicles with KEYLESS-GO:

- ▶ Open the driver's door. The on-board electronics now have status **0**. This is the same as the SmartKey having been removed.
- ▶ Remove the Start/Stop button from the ignition lock (▷ page 138).
- ▶ Make sure that the passengers are not endangered as they do so. Make sure that no one is near the danger area while a wheel is being changed. Anyone who is not directly assisting in the wheel change should, for example, stand behind the barrier.
- ▶ Get out of the vehicle. Pay attention to traffic conditions when doing so.
- ▶ Close the driver's door.



MOExtended tires (tires with run-flat properties)

General notes

With MOExtended tires (tires with run flat characteristics), you can continue to drive your vehicle even if there is a total loss of pressure in one or more tires. The affected tire must not show any clearly visible damage.

You can recognize MOExtended tires by the MOExtended marking which appears on the sidewall of the tire. You will find this marking next to the tire size designation, the load-bearing capacity and the speed index (▷ page 303).

MOExtended tires may only be used in conjunction with an active tire pressure monitor.

If a pressure loss warning message appears in the multifunction display:

- observe the instructions in the display messages (▷ page 200).
- check the tire for damage.
- if driving on, observe the following notes.

The driving distance possible in run-flat mode is approximately 50 miles (80 km) when the vehicle is partially laden and approximately 18 miles (30 km) when the vehicle is fully laden.

In addition to the vehicle load, the driving distance possible depends upon:

- vehicle speed
- road condition
- outside temperature

The driving distance possible in run-flat mode may be reduced by extreme driving conditions/maneuvers, or it can be increased through a moderate style of driving.

The driving distance possible in run-flat mode is counted from the moment the tire pressure loss warning appears in the multifunction display.

You must not exceed a maximum speed of 50 mph (80 km/h).

When replacing one or all tires, please observe the following specifications for your vehicle's tires:

- size
- the type and
- the "MOExtended" mark

If a tire has gone flat and cannot be replaced with a MOExtended tire, a standard tire may be used as a temporary measure. Make sure that you use the proper size and type (summer or winter tire).

Vehicles equipped with MOExtended tires are not equipped with a TIREFIT kit at the factory. It is therefore recommended that you additionally equip your vehicle with a TIREFIT kit if you mount tires that do not feature run-flat properties, e.g. winter tires. A TIREFIT kit may be obtained from a qualified specialist workshop.

Important safety notes

WARNING

When driving in emergency mode, the driving characteristics deteriorate, e.g. when cornering, accelerating quickly and when braking. There is a risk of an accident.

Do not exceed the stated maximum speed. Avoid abrupt steering and driving maneuvers, and driving over obstacles (curbs, potholes, off-road). This applies in particular to a laden vehicle.

Stop driving in emergency mode if:

- you hear banging noises.
- the vehicle starts to shake.
- you see smoke and smell rubber.
- ESP® is intervening constantly.
- there are tears in the sidewalls of the tire.

After driving in emergency mode, have the wheel rims checked at a qualified specialist workshop with regard to their further use. The defective tire must be replaced in every case.

TIREFIT kit

Important safety notes

TIREFIT is a tire sealant.

You can use TIREFIT to seal punctures of up to 0.16 in (4 mm), particularly those in the tire tread. You can use TIREFIT at outside temperatures down to -4 °F (-20 °C).

⚠ WARNING

In the following situations, the tire sealant is unable to provide sufficient breakdown assistance, as it is unable to seal the tire properly:

- there are cuts or punctures in the tire larger than those mentioned above.
- the wheel rim is damaged.
- you have driven at very low tire pressures or on a flat tire.

There is a risk of an accident.

Do not drive the vehicle. Contact a qualified specialist workshop.

⚠ WARNING

The tire sealant is harmful and causes irritation. It must not come into contact with your skin, eyes or clothing or be swallowed. Do not inhale TIREFIT fumes. Keep tire sealant away from children. There is a risk of injury.

If you come into contact with the tire sealant, observe the following:

- Rinse off the tire sealant from your skin immediately with water.
- If the tire sealant comes into contact with your eyes, immediately rinse them thoroughly with clean water.
- If tire sealant is swallowed, immediately rinse your mouth out thoroughly and drink plenty of water. Do not induce vomiting, and seek medical attention immediately.
- Immediately change out of clothing which has come into contact with tire sealant.
- If an allergic reaction occurs, seek medical attention immediately.

! Do not operate the tire inflation compressor for longer than eight minutes at a time without a break. It may otherwise overheat.

The tire inflation compressor can be operated again once it has cooled down.

Comply with the manufacturer's safety instructions on the sticker on the tire inflation compressor.

Using the TIREFIT kit

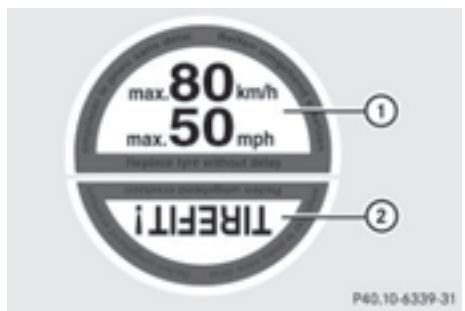

- ▶ Do not remove any foreign objects which have penetrated the tire, e.g. screws or nails.
- ▶ Remove the tire sealant bottle, the accompanying TIREFIT sticker and the tire inflation compressor from the stowage well underneath the trunk floor/cargo compartment floor (▷ page 270).
- ▶ Affix part ① of the TIREFIT sticker to the instrument cluster within the driver's field of vision.
- ▶ Affix part ② of the TIREFIT sticker near the valve on the wheel with the defective tire.

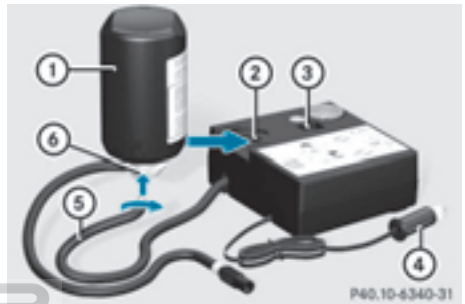

- ▶ Pull plug ④ with the cable and hose ⑤ out of the housing.
- ▶ Screw hose ⑤ onto flange ⑥ of tire sealant bottle ①.
- ▶ Place tire sealant bottle ① head downwards into recess ② of the tire inflation compressor.

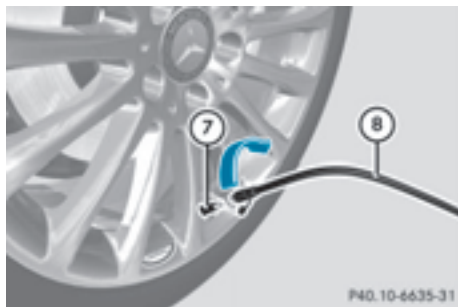

- ▶ Remove the cap from valve ⑦ on the faulty tire.
- ▶ Screw filler hose ⑧ onto valve ⑦.
- ▶ Insert connector ④ into a 12 V socket (> page 251) in your vehicle.
- ▶ Turn the SmartKey to position 1 in the ignition lock (> page 137).
- ▶ Press on/off switch ③ on the tire inflation compressor to I.

The tire inflation compressor is switched on. The tire is inflated.

First, tire sealant is pumped into the tire.

The pressure can briefly rise to approximately 500 kPa (5 bar/73 psi).

Do not switch off the tire inflation compressor during this phase.

- ▶ Allow the tire inflation compressor to run for five minutes. The tire should then have attained a pressure of at least 180 kPa (1.8 bar/26 psi).

If a pressure of 180 kPa (1.8 bar/26 psi) has been attained after five minutes, see "Tire pressure reached" (> page 274).

If a tire pressure of 180 kPa (1.8 bar/26 psi) has not been attained after five minutes, see "Tire pressure not reached" (> page 274).

If tire sealant leaks out, allow it to dry. It can then be removed like a layer of film.

If your clothes are soiled with tire sealant, have them cleaned with perchloroethylene at a dry cleaner as soon as possible.

Tire pressure not reached

If a pressure of 180 kPa (1.8 bar/26 psi) has not been attained after five minutes:

- ▶ Switch off the tire inflation compressor.
- ▶ Unscrew the filler hose from the valve of the faulty tire.
- ▶ Very slowly drive forwards or reverse approximately 30 ft (10 m).
- ▶ Pump up the tire again.

After a maximum of five minutes the tire pressure must be at least 180 kPa (1.8 bar/26 psi).

WARNING

If the required tire pressure is not reached after the specified time, the tire is too badly damaged. The tire sealant cannot repair the tire in this instance. Damaged tires and a tire pressure that is too low can significantly impair the vehicle's braking and driving characteristics. There is a risk of accident.

Do not continue driving. Contact a qualified specialist workshop.

Tire pressure reached

WARNING

A tire temporarily sealed with tire sealant impairs the driving characteristics and is not suitable for higher speeds. There is a risk of accident.

You should therefore adapt your driving style accordingly and drive carefully. Do not exceed the specified maximum speed with a tire that has been repaired using tire sealant.

The maximum speed for a tire sealed with tire sealant is 50 mph (80 km/h). The upper part of the TIREFIT sticker must be affixed to the

instrument cluster in the driver's field of vision.

- ❗ Residue from the tire sealant may come out of the filler hose after use. This could cause stains.

Therefore, place the filler hose in the plastic bag which contained the TIREFIT kit.

🔌 Environmental note

Have the used tire sealant bottle disposed of professionally, e.g. at a qualified specialist workshop.

If a tire pressure of 180 kPa (1.8 bar/26 psi) has been attained after five minutes:

- ▶ Switch off the tire inflation compressor.
- ▶ Unscrew the filler hose from the valve of the faulty tire.
- ▶ Stow the tire sealant bottle and the tire inflation compressor.
- ▶ **Pull away immediately.**
- ▶ Stop after driving for approximately ten minutes and check the tire pressure with the tire inflation compressor. The tire pressure must now be at least 130 kPa (1.3 bar/19 psi).

⚠️ WARNING

If the required tire pressure is not reached after driving for a short period, the tire is too badly damaged. The tire sealant cannot repair the tire in this instance. Damaged tires and a tire pressure that is too low can significantly impair the vehicle's braking and driving characteristics. There is a risk of accident.

Do not continue driving. Contact a qualified specialist workshop.

- ❗ In cases such as the one mentioned above, contact an authorized Mercedes-Benz Center. Or call 1-800-FOR-MERCEdes (in the USA) or 1-800-387-0100 (in Canada).
- ▶ Correct the tire pressure if it is still at least 130 kPa (1.3 bar/19 psi). See the Tire and Loading Information placard on the driver's

side B-pillar or the tire pressure table in the fuel filler flap for values.

- ▶ **To increase the tire pressure:** switch on the tire inflation compressor.

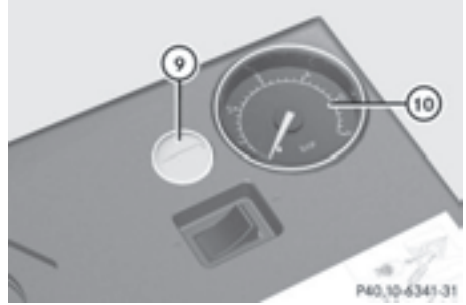

- ▶ **To reduce the tire pressure:** depress pressure release button ⑨ next to pressure gauge ⑩.
- ▶ When the tire pressure is correct, unscrew the filler hose from the valve of the sealed tire.
- ▶ Screw the valve cap onto the tire valve of the sealed tire.
- ▶ Pull the tire sealant bottle out of the tire inflation compressor. The filler hose remains attached to the tire sealant bottle.
- ▶ Drive to the nearest qualified specialist workshop and have the tire changed there.
- ▶ Have the tire sealant bottle replaced as soon as possible at a qualified specialist workshop.
- ▶ Have the tire sealant bottle replaced every four years at a qualified specialist workshop.

Battery (vehicle)

Important safety notes

Special tools and expert knowledge are required when working on the battery, e.g. removal and installation. You should therefore have all work involving the battery carried out at a qualified specialist workshop.

⚠ WARNING

Work carried out incorrectly on the battery can lead, for example, to a short circuit and thus damage the vehicle electronics. This can lead to function restrictions applying to safety-relevant systems, e.g the lighting system, the ABS (anti-lock braking system) or the ESP® (Electronic Stability Program). The operating safety of your vehicle may be restricted. You could lose control of the vehicle, for example:

- when braking
- in the event of abrupt steering maneuvers and/or when the vehicle's speed is not adapted to the road conditions

There is a risk of an accident.

In the event of a short circuit or a similar incident, contact a qualified specialist workshop immediately. Do not drive any further. You should have all work involving the battery carried out at a qualified specialist workshop.

For further information about ABS and ESP®, see (▷ page 75) and (▷ page 80).

⚠ WARNING

Electrostatic build-up can lead to the creation of sparks, which could ignite the highly explosive gases of a battery. There is a risk of an explosion.

Before handling the battery, touch the vehicle body to remove any existing electrostatic build-up.

The highly flammable gas mixture forms when charging the battery as well as when jump-starting.

Always make sure that neither you nor the battery is electrostatically charged. A build-up of electrostatic charge can be caused, for example:

- by wearing clothing made from synthetic fibers
- due to friction between clothing and seats

- if you push or pull the battery across the carpet or other synthetic materials
- if you wipe the battery with a cloth

⚠ WARNING

During the charging process, a battery produces hydrogen gas. If a short circuit occurs or sparks are created, the hydrogen gas can ignite. There is a risk of an explosion.

- Make sure that the positive terminal of a connected battery does not come into contact with vehicle parts.
- Never place metal objects or tools on a battery.
- It is important that you observe the described order of the battery terminals when connecting and disconnecting a battery.
- When jump-starting, make sure that the battery poles with identical polarity are connected.
- It is particularly important to observe the described order when connecting and disconnecting the jumper cables.
- Never connect or disconnect the battery terminals while the engine is running.

⚠ WARNING

Battery acid is caustic. There is a risk of injury. Avoid contact with skin, eyes or clothing. Do not inhale any battery gases. Do not lean over the battery. Keep children away from batteries. Wash away battery acid immediately with plenty of clean water and seek medical attention.

♻ Environmental note

Batteries contain dangerous substances. It is against the law to dispose of them with the household rubbish. They must be collected separately and recycled to protect the environment.

Dispose of batteries in an environmentally friendly manner. Take discharged



batteries to a qualified specialist workshop or a special collection point for used batteries.

! Have the battery checked regularly at a qualified specialist workshop.

Observe the service intervals in the Maintenance Booklet or contact a qualified specialist workshop for more information.

! You should have all work involving the battery carried out at a qualified specialist workshop. In the exceptional case that it is necessary for you to disconnect the battery yourself, make sure that:

- you switch off the engine and remove the SmartKey. On vehicles with KEYLESS-GO, ensure that the ignition is switched off. Check that all the indicator lamps in the instrument cluster are off. Otherwise, electronic components, such as the alternator, may be damaged.
- you first remove the negative terminal clamp and then the positive terminal clamp. Never swap the terminal clamps. Otherwise, the vehicle's electronic system may be damaged.
- the transmission is locked in position **P** after disconnecting the battery. The vehicle is secured against rolling away. You can then no longer move the vehicle.

The battery and the cover of the positive terminal clamp must be installed securely during operation.

Comply with safety precautions and take protective measures when handling batteries.



Risk of explosion.



Fire, open flames and smoking are prohibited when handling the battery. Avoid creating sparks.



Battery acid is caustic. Avoid contact with skin, eyes or clothing.

Wear suitable protective clothing, especially gloves, apron and face-guard.

Rinse any acid spills immediately with clear water. Contact a physician if necessary.

Wear eye protection.



Keep children away.



Observe this Operator's Manual.

HYBRID vehicles: make sure that you read the "HYBRID" supplement included in the vehicle literature. You could otherwise fail to recognize dangers e.g. due to high voltage.

For safety reasons, Mercedes-Benz recommends that you only use batteries which have been tested and approved for your vehicle by Mercedes-Benz. These batteries provide increased impact protection to prevent vehicle occupants from suffering acid burns should the battery be damaged in the event of an accident.

In order for the battery to achieve the maximum possible service life, it must always be sufficiently charged.

The vehicle battery, like other batteries, can discharge over time if you do not use the vehicle. In this case, have the battery disconnected at a qualified specialist workshop. You can also charge the battery with a charger recommended by Mercedes-Benz. Contact a qualified specialist workshop for further information.

Have the battery condition of charge checked more frequently if you use the vehicle mainly for short trips or if you leave it standing idle for a lengthy period. Consult a qualified spe-

cialist workshop if you wish to leave your vehicle parked for a long period of time.

- i** Remove the SmartKey if you park the vehicle and do not require any electrical consumers. The vehicle will then use very little energy, thus conserving battery power.
- i** If the power supply has been interrupted, e.g. if you reconnect the battery, you will have to:
 - set the clock. Information on setting the clock can be found in the Digital Operator's Manual.
On vehicles with COMAND and a navigation system, the clock is set automatically.
 - reset the function for folding the exterior mirrors in/out automatically, by folding the mirrors out once (▷ page 117).

Charging the battery

WARNING

During charging and jump-starting, explosive gases can escape from the battery. There is a risk of an explosion.

Particularly avoid fire, open flames, creating sparks and smoking. Ensure there is sufficient ventilation while charging and jump-starting. Do not lean over a battery.

WARNING

Battery acid is caustic. There is a risk of injury. Avoid contact with skin, eyes or clothing. Do not inhale any battery gases. Do not lean over the battery. Keep children away from batteries. Wash away battery acid immediately with plenty of clean water and seek medical attention.

WARNING

A discharged battery can freeze at temperatures below freezing point. When jump-starting the vehicle or charging the battery, gases

can escape from the battery. There is a risk of an explosion.

Allow the frozen battery to thaw out before charging it or jump-starting.

- !** Only use battery chargers with a maximum charging voltage of 14.8 V.
- !** Only charge the battery using the jump-starting connection point.

The jump-starting connection point is in the engine compartment (▷ page 279).

- ▶ Open the hood.
- ▶ Connect the battery charger to the positive terminal and ground point in the same order as when connecting the donor battery in the jump-starting procedure (▷ page 279).

If the indicator /warning lamps do not light up at low temperatures, it is very likely that the discharged battery has frozen. In this case, you may neither charge the battery nor jump-start the vehicle. The service life of a thawed-out battery may be shorter. The starting characteristics may be impaired, especially at low temperatures. Have the thawed-out battery checked at a qualified specialist workshop. Never charge a battery still installed in the vehicle unless a battery charger unit approved by Mercedes-Benz is being used . A battery charger unit specially adapted for Mercedes-Benz vehicles and tested and approved by Mercedes-Benz is available as an accessory. It permits the charging of the battery in its installed position. Contact an authorized Mercedes-Benz Center for further information and availability. Read the battery charger's operating instructions before charging the battery.

Jump-starting

For the jump-starting procedure, use only the jump-starting connection point, consisting of a positive terminal and a ground point, in the engine compartment.

WARNING

Battery acid is caustic. There is a risk of injury.

Avoid contact with skin, eyes or clothing. Do not inhale any battery gases. Do not lean over the battery. Keep children away from batteries. Wash away battery acid immediately with plenty of clean water and seek medical attention.

WARNING

During charging and jump-starting, explosive gases can escape from the battery. There is a risk of an explosion.

Particularly avoid fire, open flames, creating sparks and smoking. Ensure there is sufficient ventilation while charging and jump-starting. Do not lean over a battery.

WARNING

During the charging process, a battery produces hydrogen gas. If a short circuit occurs or sparks are created, the hydrogen gas can ignite. There is a risk of an explosion.

- Make sure that the positive terminal of a connected battery does not come into contact with vehicle parts.
- Never place metal objects or tools on a battery.
- It is important that you observe the described order of the battery terminals when connecting and disconnecting a battery.
- When jump-starting, make sure that the battery poles with identical polarity are connected.
- It is particularly important to observe the described order when connecting and disconnecting the jumper cables.
- Never connect or disconnect the battery terminals while the engine is running.

WARNING

A discharged battery can freeze at temperatures below freezing point. When jump-starting the vehicle or charging the battery, gases can escape from the battery. There is a risk of an explosion. Allow the frozen battery to thaw out before charging it or jump-starting.

! **Vehicles with a gasoline engine:** avoid repeated and lengthy starting attempts. Otherwise, the catalytic converter could be damaged by non-combusted fuel.

HYBRID vehicles: make sure that you read the "HYBRID" supplement included in the vehicle literature. You could otherwise fail to recognize dangers e.g. due to high voltage.

Do not start the vehicle using a rapid charging device. If your vehicle's battery is discharged, the engine can be jump-started from another vehicle or from a second battery using jumper cables. Observe the following points:

- The battery is not accessible in all vehicles. If the other vehicle's battery is not accessible, jump-start the vehicle using a second battery or a jump-starting device.
- **Vehicles with a gasoline engine:** only jump-start the vehicle when the engine and exhaust system are cold.
- Do not start the engine if the battery is frozen. Let the battery thaw first.
- Only jump-start from batteries with a 12 V voltage rating.
- Only use jumper cables which have a sufficient cross-section and insulated terminal clamps.
- If the battery is fully discharged, leave the battery that is being used to jump-start connected for a few minutes before attempting to start. This charges the battery slightly.
- Make sure that the two vehicles do not touch.

Make sure that:

- the jumper cables are not damaged.
- when the jumper cables are connected to the battery, uninsulated sections of the terminal clamp do not come into contact with other metal sections.
- the jumper cables cannot come into contact with parts which can move when the engine is running, such as the V-belt pulley or the fan.
- ▶ Apply the parking brake firmly.
- ▶ Shift the transmission to position **P**.
- ▶ Switch off all electrical consumers, e.g. rear window defroster, lighting, etc.
- ▶ Open the hood.

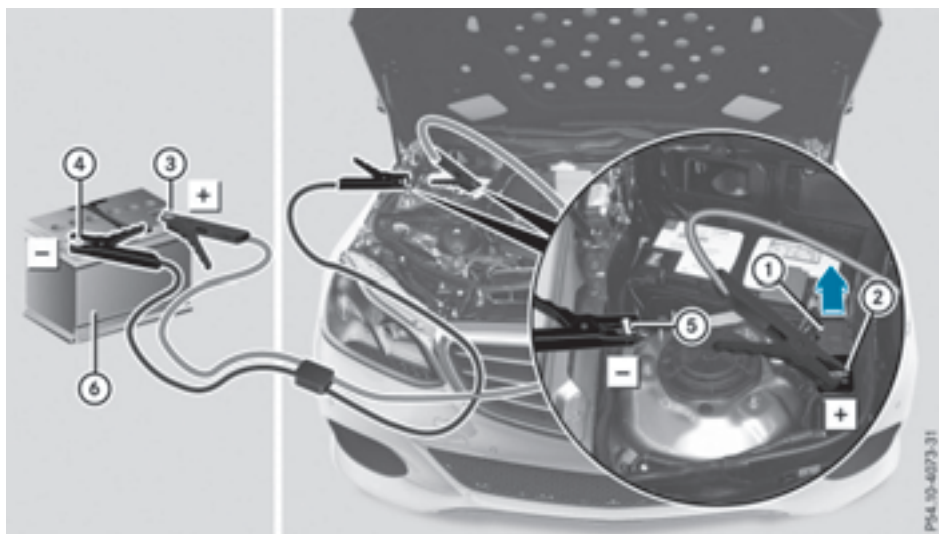

Position number ⑥ identifies the charged battery of the other vehicle or an equivalent jump-starting device.

- ▶ Slide cover ① of positive terminal ② in the direction of the arrow.
 - ▶ Connect positive terminal ② on your vehicle to positive terminal ③ of donor battery ⑥ using the jumper cable, always begin with positive terminal ② on your own vehicle first.
 - ▶ Start the engine of the donor vehicle and run it at idling speed.
 - ▶ Connect negative terminal ④ of donor battery ⑥ to ground point ⑤ of your vehicle using the jumper cable, connecting the jumper cable to battery of other vehicle ⑥ first.
 - ▶ Start the engine.
 - ▶ Before disconnecting the jumper cables, let the engine run for several minutes.
 - ▶ First, remove the jumper cables from ground point ⑤ and negative terminal ④, then from positive clamp ② and positive terminal ③. Begin each time at the contacts on your own vehicle first.
 - ▶ Close cover ① of positive clamp ② after removing the jumper cables.
 - ▶ Have the battery checked at a qualified specialist workshop.
- i** Jump-starting is not considered to be a normal operating condition.
- i** Jumper cables and further information regarding jump-starting can be obtained at any qualified specialist workshop.

Towing and tow-starting

Important safety notes

WARNING

Functions relevant to safety are restricted or no longer available if:

- the engine is not running.
- the brake system or the power steering is malfunctioning.
- there is a malfunction in the voltage supply or the vehicle's electrical system.

If your vehicle is being towed, much more force may be necessary to steer or brake. There is a risk of an accident.

In such cases, use a tow bar. Before towing, make sure that the steering moves freely.

WARNING

When towing or tow-starting another vehicle and its weight is greater than the permissible gross weight of your vehicle, the:

- the towing eye could detach itself
- the vehicle/trailer combination could roll-over.

There is a risk of an accident.

When towing or tow-starting another vehicle, its weight should not be greater than the permissible gross weight of your vehicle.

- i** Details on the permissible gross vehicle weight of your vehicle can be found on the vehicle identification plate (▷ page 336).

! If DISTRONIC PLUS or the HOLD function is activated, the vehicle brakes automatically in certain situations.

To prevent damage to the vehicle, deactivate DISTRONIC PLUS and the HOLD function in the following or other similar situations:

- when towing the vehicle
- in the car wash

! Only secure the tow rope or tow bar at the towing eyes. Otherwise, the vehicle could be damaged.

! Do not use the towing eye for recovery, this could damage the vehicle. If in doubt, recover the vehicle with a crane.

! When towing, pull away slowly and smoothly. If the tractive power is too high, the vehicles could be damaged.

! Do not tow with sling-type equipment. This could damage the vehicle.

! When towing vehicles with KEYLESS-GO, use the key instead of the Start/Stop button. Otherwise, the automatic transmission may shift to position **P** when the driver's or front-passenger door are opened, which could lead to damage to the transmission.

! The vehicle can be towed a maximum of 30 miles (50km). The towing speed of 30 mph (50 km/h) must not be exceeded. If the vehicle has to be towed more than 30 miles (50km), the entire vehicle must be raised and transported.

! If you tow or tow-start another vehicle, its weight must not exceed the maximum permissible gross vehicle weight of your vehicle.

HYBRID vehicles: make sure that you read the "HYBRID" supplement included in the vehicle literature. You could otherwise fail to recognize dangers e.g. due to high voltage.

It is better to have the vehicle transported than to have it towed away.

If the vehicle has suffered transmission damage, have it transported on a transporter or trailer.

The automatic transmission must be in position **N** when the vehicle is being towed.

The battery must be connected and charged. Otherwise, you:

- cannot turn the SmartKey to position **2** in the ignition lock
- cannot shift the automatic transmission to position **N**

In the event of damage to the electrical system

If the battery is defective, the automatic transmission will be locked in position **P**. To shift the automatic transmission to position

N, you must provide power to the vehicle's electrical system in the same way as when jump-starting (▷ page 279).

Have the vehicle transported on a transporter or trailer.

i Disarm the automatic locking feature (▷ page 95). You could otherwise be locked out when pushing or towing the vehicle.

Installing/removing the towing eye

Installing the towing eye

WARNING

The exhaust tail pipe may be very hot. There is a risk of burns when removing the rear cover. Do not touch the exhaust pipe. Take particular care when removing the rear cover.

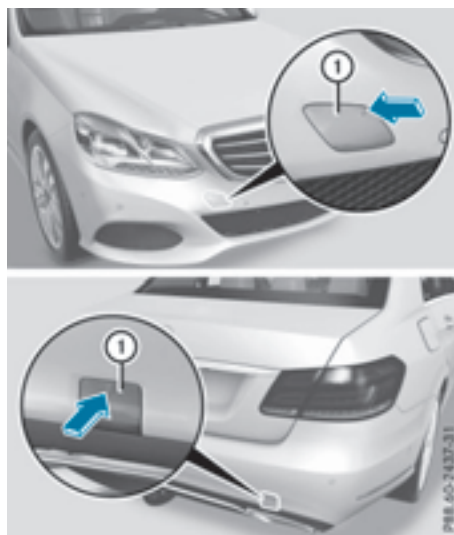

Towing eye covers (example: Sedan)

The mountings for the removable towing eyes are located in the bumpers. They are at the front and at the rear, behind the covers.

- ▶ Remove the towing eye from the vehicle tool kit (▷ page 270).
- ▶ Press the mark on cover  inwards in the direction of the arrow.

- ▶ Take cover ① off the opening.
- ▶ Screw in the towing eye clockwise as far as it will go and tighten it.

Removing the towing eye

- ▶ Unscrew and remove the towing eye.
- ▶ Attach cover ① to the bumper and press until it engages.
- ▶ Place the towing eye in the vehicle tool kit.

Towing a vehicle with both axles on the ground

It is important that you observe the safety instructions when towing away your vehicle (▷ page 281).

The automatic transmission automatically shifts to position **P** when you open the driver's or front-passenger door or when you remove the SmartKey from the ignition lock. In order to ensure that the automatic transmission stays in position **N** when towing the vehicle, you must observe the following points:

- ▶ Make sure that the vehicle is stationary and the SmartKey in the ignition lock is in position **0**.
- ▶ Turn the SmartKey to position **2** in the ignition lock.

On vehicles with KEYLESS-GO, use the SmartKey instead of the Start/Stop button (▷ page 139).

- ▶ Depress and hold the brake pedal.
- ▶ Shift the automatic transmission to position **N**.
- ▶ Release the brake pedal.
- ▶ Release the parking brake.
- ▶ Switch on the hazard warning lamps, see the Digital Operator's Manual.
- ▶ Leave the SmartKey in position **2** in the ignition lock.

- ▶ **i** When towing with the hazard warning lamps switched on, use the combination switch as usual to signal a change of direc-

tion. In this case, only the indicator lamps for the direction of travel flash. After resetting the combination switch, the hazard warning lamp starts flashing again.

Towing the vehicle with the rear axle raised

- ▶ **!** Vehicles with 4MATIC must not be towed with either the front or the rear axle raised, as doing so will damage the transmission.
- ▶ **!** Vehicles with automatic transmission must not be towed with the rear axle raised. The vehicle/trailer combination may otherwise swerve or even roll over.
- ▶ **!** The ignition must be switched off if you are towing the vehicle with the rear axle raised. Intervention by ESP® could otherwise damage the brake system.

Transporting the vehicle

- ▶ **!** You may only secure the vehicle by the wheels, not by parts of the vehicle such as axle or steering components. Otherwise, the vehicle could be damaged.

The towing eye can be used to pull the vehicle onto a trailer or transporter for transporting purposes.

- ▶ Turn the SmartKey to position **2** in the ignition lock.
- ▶ Shift the automatic transmission to position **N**.

As soon as the vehicle has been loaded:

- ▶ Prevent the vehicle from rolling away by applying the parking brake.
- ▶ Shift the automatic transmission to position **P**.
- ▶ Turn the SmartKey to position **0** in the ignition lock and remove the SmartKey from the ignition lock.
- ▶ Secure the vehicle.

Notes on 4MATIC vehicles

! Vehicles with 4MATIC must not be towed with either the front or the rear axle raised, as doing so will damage the transmission.

If the vehicle has transmission damage or damage to the front or rear axle, have it transported on a transporter or trailer.

In the event of damage to the electrical system

If the battery is defective, the automatic transmission will be locked in position **P**. To shift the automatic transmission to position **N**, you must provide power to the vehicle's electrical system in the same way as when jump-starting (▷ page 279).

Have the vehicle transported on a transporter or trailer.

Tow-starting (emergency engine starting)

! Vehicles with automatic transmission must not be started by tow-starting. This could otherwise damage the transmission.

i You can find information on "Jump-starting" under (▷ page 279).

Fuses

Important safety notes

WARNING

If you manipulate or bridge a faulty fuse or if you replace it with a fuse with a higher amperage, the electric cables could be overloaded. This could result in a fire. There is a risk of an accident and injury.

Always replace faulty fuses with the specified new fuses having the correct amperage.

! Only use fuses that have been approved for Mercedes-Benz vehicles and which have the correct fuse rating for the system concerned. Otherwise, components or systems could be damaged.

The fuses in your vehicle serve to close down faulty circuits. If a fuse blows, all the components on the circuit and their functions stop operating.

Blown fuses must be replaced with fuses of the same rating, which you can recognize by the color and value. The fuse ratings are listed in the fuse allocation chart.

If a newly inserted fuse also blows, have the cause traced and rectified at a qualified specialist workshop, e.g. an authorized Mercedes-Benz Center.

Before changing a fuse

Pay attention to the important safety notes (▷ page 284).

- ▶ Secure the vehicle against rolling away (▷ page 151).
- ▶ Switch off the engine.
- ▶ Switch off all electrical consumers.
- ▶ Remove the SmartKey from the ignition lock.

or, on vehicles with KEYLESS-GO:

- ▶ Open the driver's door.
The on-board electronics now have status **O**. This is the same as the SmartKey having been removed.

The driver's door can be closed again.

All indicator lamps in the instrument cluster must be off.

The fuses are located in various fuse boxes:

- Fuse box in the engine compartment on the left-hand side of the vehicle, when viewed in the direction of travel
- Fuse box in the trunk/cargo compartment on the right-hand side of the vehicle, when viewed in the direction of travel

The fuse allocation chart is located in the vehicle tool kit in the stowage compartment under the trunk/cargo compartment floor (▷ page 270).

Fuse box in the engine compartment

Pay attention to the important safety notes (▷ page 284).

WARNING

When the hood is open and the windshield wipers are set in motion, you can be injured by the wiper linkage. There is a risk of injury.

Always switch off the windshield wipers and the ignition before opening the hood.

- ❗ Make sure that no moisture can enter the fuse box when the cover is open.
- ❗ When closing the cover, make sure that it is lying correctly on the fuse box. Moisture seeping in or dirt could otherwise impair the operation of the fuses.

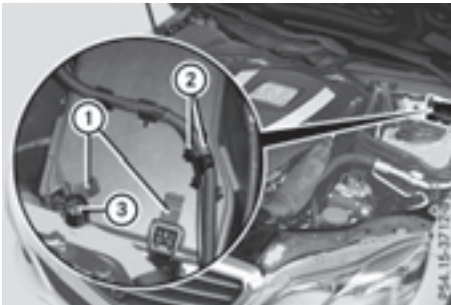

- ▶ Make sure that the windshield wipers are turned off.
- ▶ Open the hood.
- ▶ Use a dry cloth to remove any moisture from the fuse box.
- ▶ **To open:** remove lines ② from the guides.
- ▶ Move lines ② aside. Route the lines behind connection ③ to do this.
- ▶ Open clamp ①.
- ▶ Remove the fuse box cover forwards.
- ▶ **To close:** check whether the seal is lying correctly in the cover.
- ▶ Insert the cover at the rear of the fuse box into the retainer.
- ▶ Fold down cover and close clamps ①.

- ▶ Secure lines ② in the guides.
- ▶ Close the hood.

Fuse box in the trunk

Pay attention to the important safety notes (▷ page 284).

- ❗ Make sure that no moisture can enter the fuse box when the cover is open.
- ❗ When closing the cover, make sure that it is lying correctly on the fuse box. Moisture seeping in or dirt could otherwise impair the operation of the fuses.



- ▶ Open the trunk lid.
- ▶ **To open:** release cover ① at the top right and left-hand sides with a flat object.
- ▶ Open cover ① downwards in the direction of the arrow.

Fuse box in the cargo compartment

Pay attention to the important safety notes (▷ page 284).

- ❗ Make sure that no moisture can enter the fuse box when the cover is open.
- ❗ When closing the cover, make sure that it is lying correctly on the fuse box. Moisture seeping in or dirt could otherwise impair the operation of the fuses.

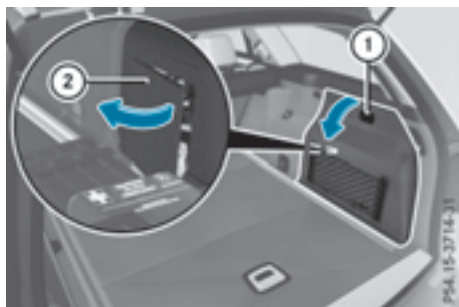

- ▶ Open the tailgate.
- ▶ **To open:** pull handle ① on the cover.
- ▶ Open the cover downwards.
- ▶ Swing paneling ② forwards.

Useful information	288
Important safety notes	288
Operation	288
Winter operation	290
Tire pressure	291
Loading the vehicle	298
All about wheels and tires	301
Changing a wheel	309
Wheel and tire combinations	314
Emergency spare wheel	329

Useful information

- i** This Operator's Manual describes all models and all standard and optional equipment of your vehicle available at the time of publication of the Operator's Manual. Country-specific differences are possible. Please note that your vehicle may not be equipped with all features described. This also applies to safety-related systems and functions.
- i** Read the information on qualified specialist workshops (▷ page 31).

Important safety notes

WARNING

If wheels and tires of the wrong size are used, the wheel brakes or suspension components may be damaged. There is a risk of an accident.

Always replace wheels and tires with those that fulfill the specifications of the original part.

When replacing wheels, make sure to use the correct:

- designation
- model

When replacing tires, make sure to use the correct:

- designation
- manufacturer
- model

WARNING

A flat tire severely impairs the driving, steering and braking characteristics of the vehicle. There is a risk of accident.

Tires without run-flat characteristics:

- do not drive with a flat tire.
- immediately replace the flat tire with your emergency spare wheel or spare wheel, or consult a qualified specialist workshop.

Tires with run-flat characteristics:

- pay attention to the information and warning notices on MOExtended tires (tires with run-flat characteristics).

Accessories that are not approved for your vehicle by Mercedes-Benz or are not being used correctly can impair the operating safety.

Before purchasing and using non-approved accessories, visit a qualified specialist workshop and ask about:

- suitability
- legal stipulations
- factory recommendations

Information on the sizes and types of wheels and tires for your vehicle can be found under "Wheel/tire combinations" (▷ page 314).

Information on tire pressure can be found:

- on the vehicle's Tire and Loading Information placard on the B-pillar (▷ page 298)
- on the tire pressure label on the fuel filler flap (▷ page 146)
- under "Tire pressure" (▷ page 291)

Operation

Information on driving

Check the tire pressure when the vehicle is heavily laden and adjust prior to a trip.

While driving, pay attention to vibrations, noises and unusual handling characteristics, e.g. pulling to one side. This may indicate that the wheels or tires are damaged. If you suspect that a tire is defective, reduce your speed immediately. Stop the vehicle as soon as possible to check the wheels and tires for damage. Hidden tire damage could also be causing the unusual handling characteristics. If you find no signs of damage, have the tires and wheels checked at a qualified specialist workshop.

When parking your vehicle, make sure that the tires do not get deformed by the curb or

other obstacles. If it is necessary to drive over curbs, speed humps or similar elevations, try to do so slowly and at an obtuse angle. Otherwise, the tires, particularly the sidewalls, may be damaged.

Regular checking of wheels and tires

⚠ WARNING

Damaged tires can cause tire inflation pressure loss. As a result, you could lose control of your vehicle. There is a risk of accident.

Check the tires regularly for signs of damage and replace any damaged tires immediately.

Regularly check the wheels and tires of your vehicle for damage at least once a month, as well as after driving off-road or on rough roads. Damaged wheels can cause a loss of tire pressure. Pay particular attention to damage such as:

- cuts in the tires
- punctures
- tears in the tires
- bulges on tires
- deformation or severe corrosion on wheels

Regularly check the tire tread depth and the condition of the tread across the whole width of the tire (▷ page 289). If necessary, turn the front wheels to full lock in order to inspect the inner side of the tire surface.

All wheels must have a valve cap to protect the valve against dirt and moisture. Do not mount anything onto the valve other than the standard valve cap or other valve caps approved by Mercedes-Benz for your vehicle. Do not use any other valve caps or systems, e.g. tire pressure monitoring systems.

Regularly check the pressure of all the tires particularly prior to long trips. Adjust the tire pressure as necessary (▷ page 291).

Observe the notes on the emergency spare wheel (▷ page 329).

The service life of tires depends, among other things, on the following factors:

- Driving style
- Tire pressure
- Distance covered

Notes on tire tread

⚠ WARNING

Insufficient tire tread will reduce tire traction. The tire is no longer able to dissipate water. This means that on wet road surfaces, the risk of hydroplaning increases, in particular where speed is not adapted to suit the driving conditions. There is a risk of accident.

If the tire pressure is too high or too low, tires may exhibit different levels of wear at different locations on the tire tread. Thus, you should regularly check the tread depth and the condition of the tread across the entire width of all tires.

Minimum tire tread depth for:

- Summer tires: 1/8 in (3 mm)
- M+S tires: 1/4 in (4 mm)

For safety reasons, replace the tires before the legally prescribed limit for the minimum tire tread depth is reached.

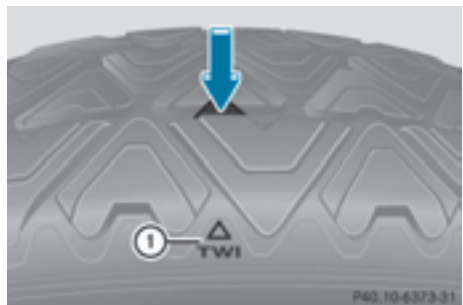

Marking ① shows where the bar indicator (arrow) for tread wear is integrated into the tire tread.

Tread wear indicators (TWI) are required by law. Six indicators are positioned on the tire tread. They are visible once a tread depth of

approximately $\frac{1}{16}$ in (1.6 mm) has been reached. If this is the case, the tire is so worn that it must be replaced.

Selecting, mounting and replacing tires

- Only mount tires and wheels of the same type and make.
Exception: it is permissible to install a different type or make in the event of a flat tire. Observe the "MOExtended tires (tires with run-flat characteristics)" section (▷ page 272).
- Only mount tires of the correct size onto the wheels.
- Break in new tires at moderate speeds for the first 60 miles (100 km). They only reach their full performance after this distance.
- Do not drive with tires which have too little tread depth, as this significantly reduces the traction on wet roads (hydroplaning).
- Replace the tires after six years at the latest, regardless of wear.

Observe the notes on the emergency spare wheel (▷ page 329).

MOExtended tires (tires with run-flat properties)

With MOExtended tires (tires with run flat characteristics), you can continue to drive your vehicle even if there is a total loss of pressure in one or more tires.

MOExtended tires may only be used in conjunction with an active tire pressure monitor and only on wheels specifically tested by Mercedes-Benz.

Notes on driving with MOExtended tires with a flat tire (▷ page 272).

Vehicles equipped with MOExtended tires are not equipped with a TIREFIT kit at the factory. It is therefore recommended that you additionally equip your vehicle with a TIREFIT kit if you mount tires that do not feature run-flat

properties, e.g. winter tires. A TIREFIT kit can be obtained from a qualified specialist workshop.

Winter operation

General notes

You can find information about this in the Digital Operator's Manual.

Driving with summer tires

At temperatures below 45 °F (+7 °C), summer tires lose elasticity and therefore traction and braking power. Change the tires on your vehicle to M+S tires. Using summer tires at very cold temperatures could cause cracks to form, thereby damaging the tires permanently. Mercedes-Benz cannot accept responsibility for this type of damage.

WARNING

Damaged tires can cause tire inflation pressure loss. As a result, you could lose control of your vehicle. There is a risk of accident.

Check the tires regularly for signs of damage and replace any damaged tires immediately.

M+S tires

WARNING

M+S tires with a tire tread depth of less than $\frac{1}{8}$ in (4 mm) are not suitable for use in winter and do not provide sufficient traction. There is a risk of an accident.

M+S tires with a tread depth of less than $\frac{1}{8}$ in (4 mm) must be replaced immediately.

Further information can be found in the Digital Operator's Manual.

Snow chains

⚠ WARNING

If snow chains are installed to the front wheels, they may drag against the vehicle body or chassis components. This could cause damage to the vehicle or the tires. There is a risk of an accident.

To avoid hazardous situations:

- never install snow chains to the front wheels
- always install snow chains in pairs to the rear wheels.

Further information can be found in the Digital Operator's Manual.

Tire pressure

Tire pressure specifications

Important safety notes

⚠ WARNING

Underinflated or overinflated tires pose the following risks:

- the tires may burst, especially as the load and vehicle speed increase.
- the tires may wear excessively and/or unevenly, which may greatly impair tire traction.
- the driving characteristics, as well as steering and braking, may be greatly impaired.

There is a risk of an accident.

Follow recommended tire inflation pressures and check the pressure of all the tires including the spare wheel:

- monthly, at least
- if the load changes
- before beginning a long journey
- under different operating conditions, e.g. off-road driving

If necessary, correct the tire pressure.

- ① The specifications on the sample Tire and Loading Information placard and tire pressure tables are examples. Tire pressure specifications are vehicle-specific and may deviate from the data shown here. The tire pressure specifications that are valid for your vehicle can be found on the Tire and Loading Information placard and tire pressure table on the vehicle.

General notes

The recommended tire pressures for the tires mounted at the factory can be found on the labels described here.

Operation with an emergency spare wheel: information on operation with an emergency spare wheel can be found in the general notes in the "Emergency spare wheel" section (▷ page 329).

Further information on tire pressures can be obtained at a qualified specialist workshop.

Tire and Loading Information placard

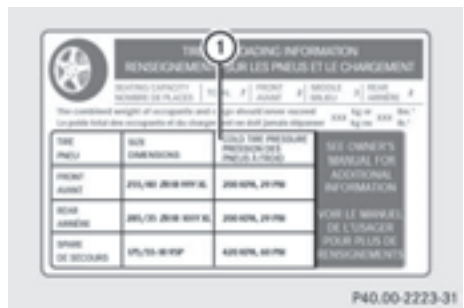

- ① Recommended tire pressures

The Tire and Loading Information placard is on the B-pillar on the driver's side (▷ page 298).

The Tire and Loading Information placard contains the recommended tire pressures for cold tires. The recommended tire pressures are valid for the maximum permissible load and up to the maximum permissible vehicle speed.

Tire pressure table

The tire pressure table is on the inside of the fuel filler flap.

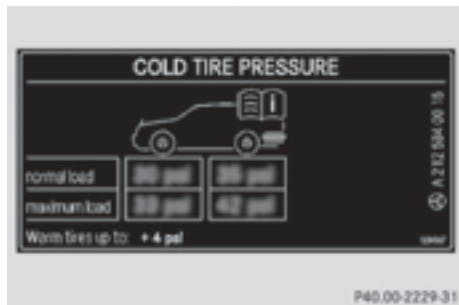

Example: tire pressure table for all tires permitted for this vehicle by the factory

The tire pressure table contains the recommended pressures for cold tires for various operating conditions, i.e. differing load and speed conditions.

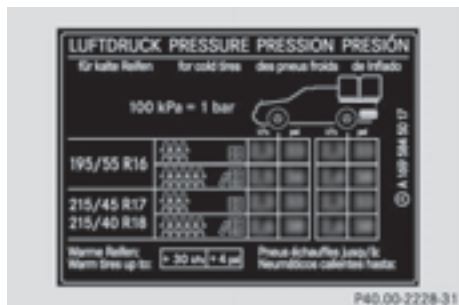

Example: tire pressure table with tire dimensions
 If a tire size precedes a tire pressure, the tire pressure information following is only valid for that tire size. The load conditions "partially laden" and "fully laden" are defined in the table for different numbers of occupants and amounts of luggage. The actual number of seats may differ.

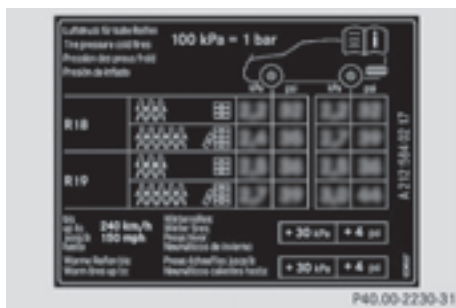

Some tire pressure tables show only the rim diameters instead of the full tire size, e.g. **R18**. The rim diameter is part of the tire size and can be found on the tire sidewall (▷ page 303).

If the tire pressures have been set to the lower values for lighter loads and/or lower road speeds, the pressures should be reset to the higher values:

- if you want to drive with an increased load and/or
- if you want to drive at higher road speeds

i The tire pressures for increased loads and/or higher road speeds, shown in the tire pressure table, may have a negative effect on driving comfort.

If the tire pressure is not set correctly, this can lead to an excessive build-up of heat and a sudden loss of pressure.

For more information, contact a qualified specialist workshop.

Important notes on tire pressure

⚠ WARNING

If the tire pressure drops repeatedly, the wheel, valve or tire may be damaged. Tire pressure that is too low may result in a tire blow-out. There is a risk of an accident.

- Check the tire for foreign objects.
- Check whether the wheel is losing air or the valve is leaking.

If you are unable to rectify the damage, contact a qualified specialist workshop.

WARNING

If you fit unsuitable accessories onto tire valves, the tire valves may be overloaded and malfunction, which can cause tire pressure loss. Due to their design, retrofitted tire pressure monitors keep the tire valve open. This can also result in tire pressure loss. There is a risk of an accident.

Only screw the standard valve cap or other valve caps approved by Mercedes-Benz for your vehicle onto the tire valve.

Use a suitable pressure gauge to check the tire pressure. The outer appearance of a tire does not permit any reliable conclusion about the tire pressure. On vehicles equipped with the electronic tire pressure monitor, the tire pressure can be checked in the on-board computer.

The tire temperature and pressure increase when the vehicle is in motion. This is dependent on the driving speed and the load.

Therefore, you should only correct tire pressures when the tires are cold.

The tires are cold:

- if the vehicle has been parked without direct sunlight on the tires for at least three hours and
- if the vehicle has not been driven further than 1 mile (1.6 km)

The tire temperature changes depending on the outside temperature, the vehicle speed and the tire load. If the tire temperature changes by 18 °F (10 °C), the tire pressure changes by approximately 10 kPa (0.1 bar/1.5 psi). Take this into account when checking the pressure of warm tires. Only correct the tire pressure if it is too low for the current operating conditions. If you check the tire pressure when the tires are warm, the resulting value will be higher than if the tires were cold. This is normal. Do not reduce the tire

pressure to the value specified for cold tires. The tire pressure would otherwise be too low. Observe the recommended tire pressures for cold tires:

- on the Tire and Loading Information placard on the B-pillar on the driver's side
- in the tire pressure table on the inside of the fuel filler flap

Underinflated or overinflated tires

Underinflated tires

WARNING

Tires with pressure that is too low can overheat and burst as a consequence. In addition, they also suffer from excessive and/or irregular wear, which can severely impair the braking properties and the driving characteristics. There is a risk of an accident.

Avoid tire pressures that are too low in all the tires, including the spare wheel.

Underinflated tires may:

- overheat, leading to tire defects
- adversely affect handling
- wear excessively and/or unevenly
- have an adverse effect on fuel consumption

Overinflated tires

WARNING

Tires with excessively high pressure can burst because they are damaged more easily by road debris, potholes etc. In addition, they also suffer from irregular wear, which can severely impair the braking properties and the driving characteristics. There is a risk of an accident.

Avoid tire pressures that are too high in all the tires, including the spare wheel.

Overinflated tires may:

- increase the braking distance
- adversely affect handling

- wear excessively and/or unevenly
- have an adverse effect on ride comfort
- be more susceptible to damage

Maximum tire pressures



- ① Example: maximum permissible tire pressure

Never exceed the maximum permissible tire inflation pressure. Always observe the recommended tire pressure for your vehicle when adjusting the tire pressure (▷ page 291).

- i** The actual values for tires are vehicle-specific and may deviate from the values in the illustration.

Checking the tire pressures

Important safety notes

Observe the notes on tire pressure (▷ page 291).

Information on air pressure for the tires on your vehicle can be found:

- on the vehicle's Tire and Loading Information placard on the B-pillar
- on the tire pressure label on the fuel filler flap
- in the "Tire pressure" section

Checking tire pressures manually

To determine and set the correct tire pressure, proceed as follows:

- ▶ Remove the valve cap of the tire that is to be checked.
- ▶ Press the tire pressure gauge securely onto the valve.
- ▶ Read the tire pressure and compare it to the recommended value on the Tire and Loading Information placard or the tire pressure table (▷ page 291).
- ▶ If the tire pressure is too low, increase the tire pressure to the recommended value.
- ▶ If the tire pressure is too high, release air. To do so, press down the metal pin in the valve, using the tip of a pen for example. Then check the tire pressure again using the tire pressure checker.
- ▶ Screw the valve cap onto the valve.
- ▶ Repeat these steps for the other tires.

Tire pressure monitor

General notes

If a tire pressure monitor is installed, the vehicle's wheels have sensors that monitor the tire pressures in all four tires. The tire pressure monitor warns you if the pressure drops in one or more of the tires. The tire pressure monitor only functions if the corresponding sensors are installed in all wheels.

Information on tire pressures is displayed in the multifunction display. After a few minutes of driving, the current tire pressure of each tire is shown in the **Service** menu of the multifunction display, see illustration (example).



Example: Sedan, current tire pressure display

For information on the message display, refer to the "Checking the tire pressure electronically" section (▷ page 296).

Important safety notes

WARNING

Each tire, including the spare (if provided), should be checked at least once every two weeks when cold and inflated to the pressure recommended by the vehicle manufacturer on the Tire and Loading Information placard on the driver's door B-pillar or the tire pressure label on the inside of the fuel filler flap. If your vehicle has tires of a different size than the size indicated on the Tire and Loading Information placard or, if available, the tire pressure label, you should determine the proper tire pressure for those tires.

As an added safety feature, your vehicle has been equipped with a tire pressure monitoring system (TPMS) that illuminates a low tire pressure telltale when one or more of your tires are significantly underinflated. Accordingly, when the low tire pressure telltale lights up, you should stop and check your tires as soon as possible, and inflate them to the proper pressure. Driving on a significantly underinflated tire causes the tire to overheat and can lead to tire failure.

Underinflation also reduces fuel efficiency and tire tread life, and may affect the vehicle's handling and stopping ability. Please note that the TPMS is not a substitute for proper tire maintenance, and it is the driver's responsibility to maintain correct tire pressure, even if underinflation has not reached the level to trigger illumination of the TPMS low tire pressure telltale.

Your vehicle has also been equipped with a TPMS malfunction indicator to indicate when the system is not operating properly. The TPMS malfunction indicator is combined with the low tire pressure telltale. When the system detects a malfunction, the warning lamp will flash for approximately a minute and then remain continuously illuminated. This

sequence will be repeated every time the vehicle is started as long as the malfunction exists. When the malfunction indicator is illuminated, the system may not be able to detect or signal low tire pressure as intended.

TPMS malfunctions may occur for a variety of reasons, including the installation of incompatible replacement or alternate tires or wheels on the vehicle that prevent the TPMS from functioning properly. Always check the TPMS malfunction telltale after replacing one or more tires or wheels on your vehicle to ensure that the replacement or alternate Tires and wheels allow the TPMS to continue to function properly.

It is the driver's responsibility to set the tire pressure to that recommended for cold tires which is suitable for the operating situation (▷ page 291). Note that the correct tire pressure for the current operating situation must first be taught-in to the tire pressure monitor. If there is a substantial loss of pressure, the warning threshold for the warning message is aligned to the reference values taught-in. Restart the tire pressure monitor after adjusting the pressure of the cold tires (▷ page 297). The current pressures are saved as new reference values. As a result, a warning message will appear if the tire pressure drops significantly.

The tire pressure monitor does not warn you of an incorrectly set tire pressure. Observe the notes on the recommended tire pressure (▷ page 291).

The tire pressure monitor is not able to warn you of a sudden loss of pressure, e.g. if the tire is penetrated by a foreign object. In the event of a sudden loss of pressure, bring the vehicle to a halt by braking carefully. Avoid abrupt steering maneuvers.

The tire pressure monitor has a yellow warning lamp in the instrument cluster for indicating a pressure loss or malfunction. Whether the warning lamp flashes or lights up indicates whether a tire pressure is too low or the tire pressure monitor is malfunctioning:





- if the warning lamp is lit continuously, the tire pressure on one or more tires is significantly too low. The tire pressure monitor is not malfunctioning.
- if the warning lamp flashes for around a minute and then remains lit constantly, the tire pressure monitor is malfunctioning.

In addition to the warning lamp, a message appears in the multifunction display. Observe the information on display messages (▷ page 200).

It may take up to ten minutes for a malfunction of the tire pressure monitor to be indicated. A malfunction will be indicated by the tire pressure warning lamp flashing for approximately one minute and then remaining lit. When the malfunction has been rectified, the tire pressure warning lamp goes out after a few minutes of driving.

The tire pressure values indicated by the on-board computer may differ from those measured at a gas station with a pressure gauge. The tire pressures shown by the on-board computer refer to those measured at sea level. At high altitudes, the tire pressure values indicated by a pressure gauge are higher than those shown by the on-board computer. In this case, do not reduce the tire pressures. The operation of the tire pressure monitor can be affected by interference from radio transmitting equipment (e.g. radio headphones, two-way radios) that may be being operated in or near the vehicle.

Checking the tire pressure electronically

- ▶ Make sure that the SmartKey is in position **2** in the ignition lock (▷ page 137).
- ▶ Press the  or  button on the steering wheel to select the **Service** menu.
- ▶ Press the  or  button to select **Tire Pressure**.
- ▶ Press the  button.
The current tire pressure of each tire is shown in the multifunction display.

If the vehicle has been parked for over 20 minutes, the **Tire pressure will be displayed after driving a few minutes** message appears.

After a teach-in process, the tire pressure monitor automatically detects new wheels or new sensors. As long as a clear allocation of the tire pressure value to the individual wheels is not possible, the **Tire Pressure Monitor Active** display message is shown instead of the tire pressure display. The tire pressures are already being monitored.

If an emergency spare wheel is mounted, the system may continue to show the tire pressure of the wheel that has been removed for a few minutes. If this occurs, note that the value displayed for the position where the spare wheel is mounted is not the same as the current tire pressure of the emergency spare wheel.

Tire pressure monitor warning messages

If the tire pressure monitor detects a pressure loss in one or more tires, a warning message is shown in the multifunction display and the yellow tire pressure monitor warning lamp comes on.

- If the **Correct Tire Pressure** message appears in the multifunction display, the tire pressure in at least one tire is too low

and must be corrected at the next opportunity.

- If the **Check Tires** message appears in the multifunction display, the tire pressure in one or more tires has dropped significantly and the tires must be checked.
- If the **Warning Tire Malfunction** message appears in the multifunction display, the tire pressure in one or more tires has dropped suddenly and the tires must be checked.

Observe the instructions and safety notes in the display messages in the "Tires" section (▷ page 200).

If the wheel positions on the vehicle are rotated, the tire pressures may be displayed for the wrong positions for a short time. This is rectified after a few minutes of driving, and the tire pressures are displayed for the correct positions.







Restarting the tire pressure monitor

When you restart the tire pressure monitor, all existing warning messages are deleted and the warning lamps go out. The monitor uses the currently set tire pressures as the reference values for monitoring. In most cases, the tire pressure monitor will automatically detect the new reference values after you have changed the tire pressure. However, you can also define reference values manually as described here. The tire pressure monitor then monitors the new tire pressure values.

- ▶ Set the tire pressure to the value recommended for the corresponding driving situation on the Tire and Loading Information placard on the driver's side B-pillar (▷ page 291).

Additional tire pressure values for different loads can also be found on the tire pressure table on the inside of the fuel filler flap (▷ page 291).

- ▶ Make sure that the tire pressure is correct on all four wheels.

- ▶ Make sure that the SmartKey is in position **2** in the ignition lock.
- ▶ Press the  or  button on the steering wheel to select the **Service** menu.
- ▶ Press the  or  button to select **Tire Pressure**.
- ▶ Press the  button.
The multifunction display shows the current tire pressure for the individual tires or the **Tire pressure will be displayed after driving a few minutes** message.
- ▶ Press the  button.
The **Use Current Pressures as New Reference Values** message appears in the multifunction display.

If you wish to confirm the restart:

- ▶ Press the  button.
The **Tire Press. Monitor Restarted** message appears in the multifunction display.
After driving for a few minutes, the system checks whether the current tire pressures are within the specified range. The new tire pressures are then accepted as reference values and monitored.

If you wish to cancel the restart:

- ▶ Press the  button.
The tire pressure values stored at the last restart will continue to be monitored.

Radio type approval for the tire pressure monitor

In certain countries, a radio type approval for the tire pressure monitor may be required. The radio type approval number for the tire pressure monitor can be found in the "Wheels and tires" section of the Digital Operator's Manual.

Loading the vehicle

Instruction labels for tires and loads

WARNING

Overloaded tires can overheat, causing a blowout. Overloaded tires can also impair the steering and driving characteristics and lead to brake failure. There is a risk of accident.

Observe the load rating of the tires. The load rating must be at least half of the GAWR of your vehicle. Never overload the tires by exceeding the maximum load.

Two instruction labels on your vehicle show the maximum possible load.

- (1) The Tire and Loading Information placard is on the B-pillar on the driver's side. The Tire and Loading Information placard shows the maximum permissible number of occupants and the maximum permissible vehicle load. It also contains details of the tire sizes and corresponding pressures for tires mounted at the factory.
- (2) The vehicle identification plate is on the B-pillar on the driver's side. The vehicle identification plate informs you of the gross vehicle weight rating. It is made up of the vehicle weight, all vehicle occupants, the fuel and the cargo. You can also find information about the maximum gross axle weight rating on the front and rear axle.

The maximum gross axle weight rating is the maximum weight that can be carried by one axle (front or rear axle). Never exceed the maximum load or the maximum gross axle weight rating for the front or rear axle.



B-pillar (example: Sedan)

① B-pillar, driver's side

Maximum permissible gross vehicle weight rating

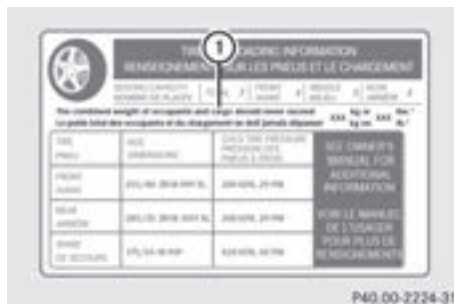

- Specification for maximum gross vehicle weight ① is listed in the Tire and Loading Information placard: "The combined weight of occupants and cargo should never exceed XXX kilograms or XXX lbs."

The gross weight of all vehicle occupants, load and luggage must not exceed the specified value.

-  The specifications shown on the Tire and Loading Information placard in the illustration are examples. The maximum permissible gross vehicle weight rating is vehicle-specific and may differ from that in the illustration. You can find the valid maximum permissible gross vehicle weight rating for your vehicle on the Tire and Loading Information placard.

Number of seats

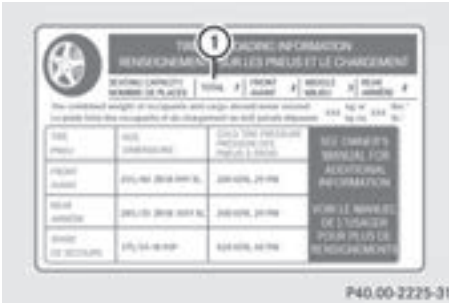

Maximum number of seats ① indicates the maximum number of occupants allowed to travel in the vehicle. This information can be found on the Tire and Loading Information placard.

i The specifications shown on the Tire and Loading Information placard in the illustration are examples. The number of seats is vehicle-specific and can differ from the details shown. The number of seats in your vehicle can be found on the Tire and Loading Information placard.

Determining the correct load limit

Step-by-step instructions

The following steps have been developed as required of all manufacturers under Title 49, Code of U.S. Federal Regulations, Part 575 pursuant to the "National Traffic and Motor Vehicle Safety Act of 1966".

- ▶ **Step 1:** Locate the statement "The combined weight of occupants and cargo should never exceed XXX kg or XXX lbs." on your vehicle's Tire and Loading Information placard.
- ▶ **Step 2:** Determine the combined weight of the driver and passengers that will be riding in your vehicle.
- ▶ **Step 3:** Subtract the combined weight of the driver and passengers from XXX kilograms or XXX lbs.

▶ **Step 4:** The resulting figure equals the available amount of cargo and luggage load capacity. For example, if the "XXX" amount equals 1400 lbs and there will be five 150-lb passengers in your vehicle, the amount of available cargo and luggage load capacity is 650 lbs ($1400 - 750 (5 \times 150) = 650$ lbs).

▶ **Step 5:** Determine the combined weight of luggage and cargo being loaded on the vehicle. That weight may not safely exceed the available cargo and luggage load capacity calculated in step 4.

Example: steps 1 to 3

The following table shows examples on how to calculate total and cargo load capacities with varying seating configurations and number and size of occupants. The following examples use a load limit of 1500 lbs (680 kg). **This is for illustration purposes only.** Make sure you are using the actual load limit for your vehicle stated on your vehicle's Tire and Loading Information placard (▷ page 298).

The greater the combined weight of the occupants, the lower the maximum luggage load.

Step 1

	Example 1	Example 2	Example 3
Combined maximum weight of occupants and cargo (data from the Tire and Loading Information placard)	1500 lbs (680 kg)	1500 lbs (680 kg)	1500 lbs (680 kg)

Step 2

	Example 1	Example 2	Example 3
Number of people in the vehicle (driver and occupants)	5	3	1
Distribution of the occupants	Front: 2 Rear: 3	Front: 1 Rear: 2	Front: 1
Weight of the occupants	Occupant 1: 150 lbs (68 kg) Occupant 2: 180 lbs (82 kg) Occupant 3: 160 lbs (73 kg) Occupant 4: 140 lbs (63 kg) Occupant 5: 120 lbs (54 kg)	Occupant 1: 200 lbs (91 kg) Occupant 2: 190 lbs (86 kg) Occupant 3: 150 lbs (68 kg)	Occupant 1: 150 lbs (68 kg)
Gross weight of all occupants	750 lbs (340 kg)	540 lbs (245 kg)	150 lbs (68 kg)

Step 3

	Example 1	Example 2	Example 3
Permissible load (maximum gross vehicle weight rating from the Tire and Loading Information placard minus the gross weight of all occupants)	1500 lbs (680 kg) - 750 lbs (340 kg) = 750 lbs (340 kg)	1500 lbs (680 kg) - 540 lbs (245 kg) = 960 lbs (435 kg)	1500 lbs (680 kg) - 150 lbs (68 kg) = 1350 lbs (612 kg)

Vehicle identification plate

Even if you have calculated the total cargo carefully, you should still make sure that the gross vehicle weight rating and the gross axle weight rating are not exceeded. Details can be found on the vehicle identification plate on the B-pillar on the driver's side of the vehicle (▷ page 298).

Permissible Gross Vehicle Weight Rating (GVWR): the gross weight of the vehicle, all passengers, load and trailer load/noseweight (if applicable) must not exceed the permissible gross vehicle weight.

Gross Axle Weight Rating (GAWR): the maximum permissible weight that can be carried by one axle (front or rear axle).

To ensure that your vehicle does not exceed the maximum permissible values (gross vehicle weight and maximum gross axle weight rating), have your loaded vehicle (including driver, occupants, cargo, and full trailer load if applicable) weighed on a suitable vehicle weighbridge.

All about wheels and tires

Uniform Tire Quality Grading Standards

Overview of Tire Quality Grading Standards

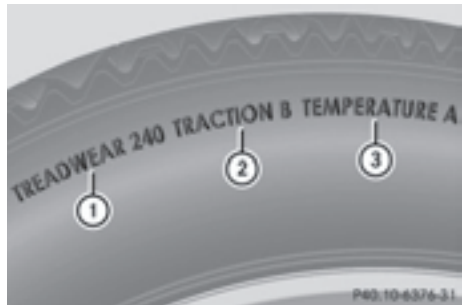

Uniform Tire Quality Grading Standards are U.S. government specifications. Their purpose is to provide drivers with uniform reliable information on tire performance data. Tire manufacturers have to grade tires using three performance factors: ① tread wear grade, ② traction grade and ③ temperature grade. These regulations do not apply to Canada. Nevertheless, all tires sold in North America are provided with the corresponding quality grading markings on the sidewall of the tire. Quality grades can be found, where applicable, on the tire sidewall between tread shoulder and maximum section width.

Example:

- **Tread wear grade:** 200
- **Traction grade:** AA
- **Temperature grade:** A

All passenger car tires must conform to the statutory safety requirements in addition to these grades.

- i** The actual values for tires are vehicle-specific and may deviate from the values in the illustration.

Treadwear

The tread wear grade is a comparative rating based on the wear rate of the tire when tested under controlled conditions on a specified U.S. government course. For example, a tire graded 150 would wear one and one-half times as well on the government course as a tire graded 100.

The relative performance of tires depends upon the actual conditions of their use, however, and may depart significantly from the norm due to variations in driving habits, service practices and differences in road characteristics and climate.

Traction

WARNING

The traction grade assigned to this tire is based on straight-ahead braking traction tests, and does not include acceleration, cornering, hydroplaning, or peak traction characteristics.

- !** Avoid wheelspin. This can lead to damage to the drive train.

The traction grades – from highest to lowest – are AA, A, B and C. Those grades represent the tire's ability to stop on wet pavement as measured under controlled conditions on specified government test surfaces of asphalt and concrete. A tire marked C may have poor traction performance.

The safe speed on a wet, snow covered or icy road is always lower than on dry road surfaces.

You should pay special attention to road conditions when temperatures are around freezing point.

Mercedes-Benz recommends a minimum tread depth of $\frac{1}{8}$ in (4 mm) on all four winter tires. Observe the legally required minimum tire tread depth (> page 289). Winter tires can reduce the braking distance on snow-covered surfaces in comparison with summer tires. The braking distance is still much further than on surfaces that are not icy or covered with snow. Take appropriate care when driving. Further information on winter tires (M+S tires) can be found in the Digital Operator's Manual.

Temperature

WARNING

The temperature grade for this tire is established for a tire that is properly inflated and not overloaded. Excessive speed, underinflation, or excessive loading, either separately or in combination, can cause excessive heat build-up and possible tire failure.

The temperature grades are A (the highest), B, and C, representing the tire's resistance to the generation of heat and its ability to dissipate heat when tested under controlled conditions on a specified indoor laboratory test wheel. Sustained high temperature can cause the material of the tire to degenerate and reduce tire life, and excessive temperature can lead to sudden tire failure. The grade C corresponds to a level of performance which all passenger car tires must meet under the Federal Motor Vehicle Safety Standard No. 109. Grades B and A represent higher levels of performance on the laboratory test wheel than the minimum required by law.

Tire labeling

Overview

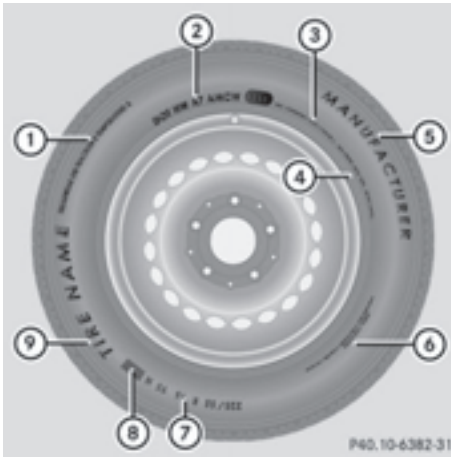

- ① Uniform Tire Quality Grading Standards (▷ page 307)
- ② Department of Transportation, Tire Identification Number (▷ page 306)
- ③ Maximum load rating (▷ page 305)
- ④ Maximum tire pressures (▷ page 294)
- ⑤ Manufacturer
- ⑥ Tire material (▷ page 306)
- ⑦ Tire size designation, load-bearing capacity and speed rating (▷ page 303)
- ⑧ Load index (▷ page 305)
- ⑨ Tire name

The markings described above are on the tire in addition to the tire name (sales designation) and the manufacturer's name.

- ⓘ Tire data is vehicle-specific and may deviate from the data in the example.

Tire size designation, load-bearing capacity and speed rating

⚠ WARNING

Exceeding the stated tire load-bearing capacity and the approved maximum speed could lead to tire damage or the tire bursting. There is a risk of accident.

Therefore, only use tire types and sizes approved for your vehicle model. Observe the tire load rating and speed rating required for your vehicle.

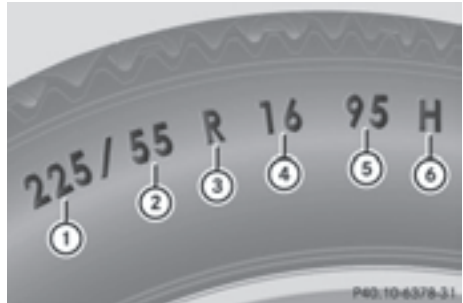

- ① Tire width
- ② Nominal aspect ratio in %
- ③ Tire code
- ④ Rim diameter
- ⑤ Load bearing index
- ⑥ Speed rating

General: depending on the manufacturer's standards, the size imprinted in the tire wall may not contain any letters or may contain one letter that precedes the size description. If there is no letter preceding the size description (as shown above): these are passenger vehicle tires according to European manufacturing standards.

If "P" precedes the size description: these are passenger vehicle tires according to U.S. manufacturing standards.

If "LT" precedes the size description: these are light truck tires according to U.S. manufacturing standards.

If "T" precedes the size description: compact emergency wheels with high tire pressure that are only designed for temporary use in an emergency.

Tire width: tire width ① shows the nominal tire width in millimeters.

Aspect ratio: aspect ratio ② is the size ratio between the tire height and tire width and is shown in percent. The aspect ratio is calcu-

lated by dividing the tire width by the tire height.

Tire code: tire code ③ specifies the tire type. "R" represents radial tires; "D" represents diagonal tires; "B" represents diagonal radial tires.

Rim diameter: rim diameter ④ is the diameter of the bead seat, not the diameter of the rim flange. The rim diameter is specified in inches (in).

Load-bearing index: load-bearing index ⑤ is a numerical code that specifies the maximum load-bearing capacity of a tire.

Do not overload the tires by exceeding the specified load limit. The maximum permissible load can be found on the vehicle's Tire and Loading Information placard on the B-pillar on the driver's side (▷ page 298).

Example:

Load-bearing index 91 indicates a maximum load of 1,356 lb (615 kg) that the tires can bear. For further information on the maximum tire load in kilograms and lbs, see (▷ page 305).

For further information on the load bearing index, see "Load index" (▷ page 305).

Speed rating: speed rating ⑥ specifies the approved maximum speed of the tire.

i Tire data is vehicle-specific and may deviate from the data in the example.

Regardless of the speed rating, always observe the speed limits. Drive carefully and adapt your driving style to the traffic conditions.

Summer tires

Index	Speed rating
Q	up to 100 mph (160 km/h)
R	up to 106 mph (170 km/h)
S	up to 112 mph (180 km/h)
T	up to 118 mph (190 km/h)

Index	Speed rating
H	up to 130 mph (210 km/h)
V	up to 149 mph (240 km/h)
W	up to 168 mph (270 km/h)
Y	up to 186 mph (300 km/h)
ZR...Y	up to 186 mph (300 km/h)
ZR...(..Y)	over 186 mph (300 km/h)
ZR	over 149 mph (240 km/h)

- Optionally, tires with a maximum speed of over 149 mph (240 km/h) may have "ZR" in the size description, depending on the manufacturer (e.g. 245/40 ZR 18).

- If a service specification is available, the maximum speed is limited according to the speed rating in the service specification. Example: 245/40 ZR18 97 Y. In this example, "97 Y" is the service specification. The letter "Y" represents the speed rating. The maximum speed of the tire is limited to 186 mph (300 km/h).

If the size description of your tire includes "ZR" and there are no service specifications, ask the tire manufacturer in order to find out the maximum speed.

- The size description for all tires with maximum speeds of over 186 mph (300 km/h) must include "ZR", **and** the service specification must be given in parentheses. Example: 275/40 ZR 18 (99 Y). Speed rating "(Y)" indicates that the maximum speed of the tire is over 186 mph (300 km/h). Ask the tire manufacturer about the maximum speed.

All-weather tires and winter tires

Index	Speed rating
Q M+S ¹	up to 100 mph (160 km/h)
T M+S ¹	up to 118 mph (190 km/h)

¹ Or M+S  for winter tires.



Index	Speed rating
H M+S ¹	up to 130 mph (210 km/h)
V M+S ¹	up to 149 mph (240 km/h)

i Not all tires with the M+S marking provide the driving characteristics of winter tires. In addition to the M+S marking, winter tires also have the  snowflake symbol on the tire wall. Tires with this marking fulfill the requirements of the Rubber Manufacturers Association (RMA) and the Rubber Association of Canada (RAC) regarding the tire traction on snow. They have been especially developed for driving on snow.

An electronic speed limiter prevents your vehicle from exceeding the following speeds:

- all vehicles (except AMG vehicles): 130 mph (210 km/h)
- AMG vehicles: 155 mph (250 km/h)
- AMG vehicles with Performance Package (Wagon): 174 mph (280 km/h)
- AMG vehicles with Performance Package (Sedan): 186 mph (300 km/h)

The speed rating of tires mounted at the factory may be higher than the maximum speed that the electronic speed limiter permits.

Make sure that your tires have the required speed rating, e.g. when buying new tires. The required speed rating for your vehicle can be found in the "Tires" section (▷ page 314).

Further information about reading tire data can be obtained from any qualified specialist workshop.

Load index



In addition to the load bearing index, load index **1** may be imprinted after the letters that identify speed index **6** on the sidewall of the tire (▷ page 303).

- If no specification is given: no text (as in the example above), represents a standard load (SL) tire
- XL or Extra Load: represents a reinforced tire
- Light Load: represents a light load tire
- C, D, E: represents a load range that depends on the maximum load that the tire can carry at a certain pressure

i Tire data is vehicle-specific and may deviate from the data in the example.

Maximum load rating



Maximum tire load **1** is the maximum permissible weight for which the tire is approved. Do not overload the tires by exceeding the specified load limit. The maximum permissi-

¹ Or M+S  for winter tires.

ble load can be found on the vehicle's Tire and Loading Information placard on the B-pillar on the driver's side (▷ page 298).

- i** The actual values for tires are vehicle-specific and may deviate from the values in the illustration.

DOT, Tire Identification Number (TIN)

US tire regulations stipulate that every tire manufacturer or retreader must imprint a TIN in or on the sidewall of each tire produced.



The TIN is a unique identification number. The TIN enables the tire manufacturers or retreaders to inform purchasers of recalls and other safety-relevant matters. It makes it possible for the purchaser to easily identify the affected tires.

The TIN is made up of manufacturer identification code (2), tire size (3), tire type code (4) and manufacturing date (5).

DOT (Department of Transportation): tire symbol (1) marks that the tire complies with the requirements of the U.S. Department of Transportation.

Manufacturer identification code: manufacturer identification code (2) provides details on the tire manufacturer. New tires have a code with two symbols. Retreaded tires have a code with four symbols.

For further information about retreaded tires, see (▷ page 288).

Tire size: identifier (3) describes the tire size.

Tire type code: tire type code (4) can be used by the manufacturer as a code to describe specific characteristics of the tire.

Date of manufacture: date of manufacture (5) provides information about the age of a tire. The first and second positions represent the week of manufacture, starting with "01" for the first calendar week. Positions three and four represent the year of manufacture. For example, a tire that is marked "26 14" was manufactured in week 26 in 2014.

- i** Tire data is vehicle-specific and may deviate from the data in the example.

Tire characteristics



This information describes the type of tire cord and the number of layers in sidewall (1) and under tire tread (2).

- i** Tire data is vehicle-specific and may deviate from the data in the example.

Definition of terms for tires and loading

Tire ply composition and material used

Describes the number of plies or the number of layers of rubber-coated fabric in the tire tread and sidewall. These are made of steel, nylon, polyester and other materials.

Bar

Metric unit for tire pressure. 14.5038 pounds per square inch (psi) and 100 kilopascals (kPa) are the equivalent of 1 bar.

DOT (Department of Transportation)

DOT-marked tires fulfill the requirements of the U S Department of Transportation.

Normal occupant weight

The number of occupants for which the vehicle is designed multiplied by 68 kilograms (150 lbs).

Uniform Tire Quality Grading Standards

A uniform standard to grade the quality of tires with regards to tread quality, tire traction and temperature characteristics. The quality grading assessment is made by the manufacturer following specifications from the U.S. government. The ratings are molded into the sidewall of the tire.

Recommended tire pressures

The recommended tire pressure applies to the tires mounted at the factory.

The Tire and Loading Information placard contains the recommended tire pressures for cold tires on a fully loaded vehicle and for the maximum permissible vehicle speed.

The tire pressure table contains the recommended pressures for cold tires for various operating conditions, i.e. differing load and speed conditions.

Increased vehicle weight due to optional equipment

The combined weight of all standard and optional equipment available for the vehicle, regardless of whether it is actually installed on the vehicle or not.

Rim

This is the part of the wheel on which the tire is mounted.

GAWR (Gross Axle Weight Rating)

The GAWR is the maximum gross axle weight rating. The actual load on an axle must never exceed the gross axle weight rating. The gross axle weight rating can be found on the vehicle identification plate on the B-pillar on the driver's side.

Speed rating

The speed rating is part of the tire identification. It specifies the speed range for which the tire is approved.

GVW (Gross Vehicle Weight)

The gross vehicle weight includes the weight of the vehicle including fuel, tools, the spare wheel, accessories installed, occupants, luggage and the drawbar noseweight, if applicable. The gross vehicle weight must not exceed the gross vehicle weight rating GVWR as specified on the vehicle identification plate on the B-pillar on the driver's side.

GVWR (Gross Vehicle Weight Rating)

The GVWR is the maximum permissible gross weight of a fully loaded vehicle (the weight of the vehicle including all accessories, occupants, fuel, luggage and the drawbar noseweight, if applicable). The gross vehicle weight rating is specified on the vehicle identification plate on the B-pillar on the driver's side.

Maximum loaded vehicle weight

The maximum weight is the sum of:

- the curb weight of the vehicle
- the weight of the accessories
- the load limit
- the weight of the factory installed optional equipment

Kilopascal (kPa)

Metric unit for tire pressure. 6.9 kPa corresponds to 1 psi. Another unit for tire pressure is bar. 100 kilopascals (kPa) are the equivalent of 1 bar.

Load index

In addition to the load-bearing index, the load index may also be imprinted on the sidewall of the tire. This specifies the load-bearing capacity more precisely.

Curb weight

The weight of a vehicle with standard equipment including the maximum capacity of fuel, oil and coolant. It also includes the air-conditioning system and optional equipment if these are installed in the vehicle, but does not include passengers or luggage.

Maximum load rating

The maximum load rating is the maximum permissible weight in kilograms or lbs for which a tire is approved.

Maximum permissible tire pressure

Maximum permissible tire pressure for one tire.

Maximum load on one tire

Maximum load on one tire. This is calculated by dividing the maximum axle load of one axle by two.

PSI (pounds per square inch)

A standard unit of measure for tire pressure.

Aspect ratio

Relationship between tire height and tire width in percent.

Tire pressure

Pressure inside the tire applying an outward force to every square inch of the tire's surface. The tire pressure is specified in pounds per square inch (psi), in kilopascal (kPa) or in bar. The tire pressure should only be corrected when the tires are cold.

Cold tire pressure

The tires are cold:

- if the vehicle has been parked without direct sunlight on the tires for at least three hours and
- if the vehicle has not been driven further than 1 mile (1.6 km)

Tread

The part of the tire that comes into contact with the road.

Bead

The tire bead ensures that the tire sits securely on the wheel. There are several steel wires in the bead to prevent the tire from coming loose from the wheel rim.

Sidewall

The part of the tire between the tread and the bead.

Weight of optional extras

The combined weight of those optional extras that weigh more than the replaced standard parts and more than 2.3 kg (5 lbs). These optional extras, such as high-performance brakes, level control, a roof rack or a high-performance battery, are not included in the curb weight and the weight of the accessories.

TIN (Tire Identification Number)

This is a unique identifier which can be used by a tire manufacturer to identify tires, for example for a product recall, and thus identify the purchasers. The TIN is made up of the manufacturer's identity code, tire size, tire type code and the manufacturing date.

Load bearing index

The load bearing index (also load index) is a code that contains the maximum load bearing capacity of a tire.

Traction

Traction is the result of friction between the tires and the road surface.

Tread wear indicators

Narrow bars (tread wear bars) that are distributed over the tire tread. If the tire tread is level with the bars, the wear limit of $\frac{1}{16}$ in (1.6 mm) has been reached.

Occupant distribution

The distribution of occupants in a vehicle at their designated seating positions.

Total load limit

Nominal load and luggage load plus 68 kg (150 lbs) multiplied by the number of seats in the vehicle.

Changing a wheel

Flat tire

The "Breakdown assistance" section (▷ page 271) contains information and notes on how to deal with a flat tire. Information on driving with MOExtended tires in the event of a flat tire can be found under "MOExtended tires (tires with run-flat characteristics)" (▷ page 272).

Vehicle with emergency spare wheel: in the event of a flat tire, the emergency spare wheel is mounted as described under "Mounting a wheel" (▷ page 309).

Rotating the wheels

WARNING

Interchanging the front and rear wheels may severely impair the driving characteristics if the wheels or tires have different dimensions. The wheel brakes or suspension components may also be damaged. There is a risk of accident.

Rotate front and rear wheels only if the wheels and tires are of the same dimensions.

! On vehicles equipped with a tire pressure monitor, electronic components are located in the wheel.

Tire-mounting tools should not be used near the valve. This could damage the electronic components.

Only have tires changed at a qualified specialist workshop.

Always observe the instructions and safety notes in the "Mounting a wheel" section (▷ page 309).

The wear patterns on the front and rear tires differ, depending on the operating conditions. Rotate the wheels before a clear wear pattern has formed on the tires. Front tires typically wear more on the shoulders and the rear tires in the center.

If your vehicle's tire configuration allows, you can rotate the wheels according to the intervals in the tire manufacturer's warranty book in your vehicle documents. If no warranty book is available, the tires should be rotated every 3,000 to 6,000 miles (5,000 to 10,000 km), or earlier if tire wear requires. Do not change the direction of wheel rotation.

Clean the contact surfaces of the wheel and the brake disc thoroughly every time a wheel is rotated. Check the tire pressure and reactivate the tire pressure monitor if necessary (▷ page 297).

Direction of rotation

Tires with a specified direction of rotation have additional benefits, e.g. if there is a risk of hydroplaning. These advantages can only be gained if the tires are installed corresponding to the direction of rotation.

An arrow on the sidewall of the tire indicates its correct direction of rotation.

Storing wheels

Store wheels that are not being used in a cool, dry and preferably dark place. Protect the tires from oil, grease, gasoline and diesel.

Mounting a wheel

Preparing the vehicle

- ▶ Stop the vehicle on solid, non-slippery and level ground.
- ▶ Apply the parking brake.

- ▶ Bring the front wheels into the straight-ahead position.
- ▶ Shift the transmission to position **P**.
- ▶ Vehicles with AIRMATIC: make sure that "normal" level is selected (▷ page 166).
- ▶ Switch off the engine.
- ▶ Remove the SmartKey from the ignition lock.

or, on vehicles with KEYLESS-GO:

- ▶ Open the driver's door.
The on-board electronics now have status **0**. This is the same as the SmartKey having been removed.
- ▶ Remove the Start/Stop button from the ignition lock (▷ page 138).
- ▶ If included in the vehicle equipment, remove the tire-change tool kit from the vehicle (▷ page 270).
- ▶ Safeguard the vehicle against rolling away.

Securing the vehicle to prevent it from rolling away

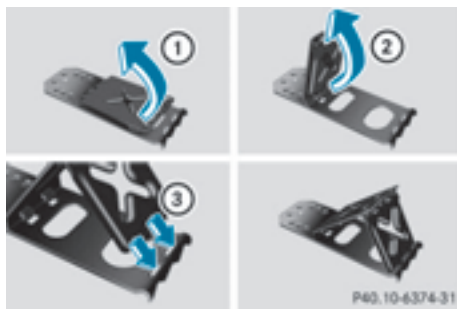

If your vehicle is equipped with a wheel chock, it can be found in the tire-change tool kit (▷ page 270).

The folding wheel chock is an additional safety measure to prevent the vehicle from rolling away, for example when changing a wheel.

- ▶ Fold both plates upwards ①.
- ▶ Fold out lower plate ②.
- ▶ Guide the lugs on the lower plate fully into the openings in base plate ③.



Securing the vehicle on level ground (example: Sedan)

- ▶ **On level ground:** place chocks or other suitable items under the front and rear of the wheel that is diagonally opposite the wheel you wish to change.



Securing the vehicle on slight downhill gradients (example: Sedan)

- ▶ **On light downhill gradients:** place chocks or other suitable items in front of the wheels of the front and rear axle.

Raising the vehicle

WARNING

If you do not position the jack correctly at the appropriate jacking point of the vehicle, the jack could tip over with the vehicle raised. There is a risk of injury.

Only position the jack at the appropriate jacking point of the vehicle. The base of the jack must be positioned vertically, directly under the jacking point of the vehicle.

! The jack is designed exclusively for jacking up the vehicle at the jacking points. Otherwise, your vehicle could be damaged.

Observe the following when raising the vehicle:

- To raise the vehicle, only use the vehicle-specific jack that has been tested and approved by Mercedes-Benz. If used incorrectly, the jack could tip over with the vehicle raised.
- The jack is designed only to raise and hold the vehicle for a short time while a wheel is being changed. It is not suited for performing maintenance work under the vehicle.
- Avoid changing the wheel on uphill and downhill slopes.
- Before raising the vehicle, secure it from rolling away by applying the parking brake and inserting wheel chocks. Never disengage the parking brake while the vehicle is raised.
- The jack must be placed on a firm, flat and non-slip surface. On a loose surface, a large, flat, load-bearing underlay must be used. On a slippery surface, a non-slip underlay must be used, e.g. rubber mats.
- Do not use wooden blocks or similar objects as a jack underlay. Otherwise, the jack will not be able to achieve its load-bearing capacity due to the restricted height.
- Make sure that the distance between the underside of the tires and the ground does not exceed 1.2 in (3 cm).
- Never place your hands and feet under the raised vehicle.
- Do not lie under the vehicle.
- Do not start the engine when the vehicle is raised.
- Do not open or close a door or the trunk lid/ tailgate when the vehicle is raised.
- Make sure that no persons are present in the vehicle when the vehicle is raised.

AMG vehicles with Performance Studio equipment: the wheel bolts are covered by a hub cap. Before you can unscrew the wheel bolts, you must remove the hub cap.



- ▶ **To remove:** turn the center cover of hub cap ① counter-clockwise and remove.
- ▶ **To install:** before installing, ensure that hub cap ① is in the open position. To do this, turn the center cover counter-clockwise.
- ▶ Position hub cap ① and turn the center cover clockwise until hub cap ① engages physically and audibly.
- ▶ Make sure that hub cap ① is installed securely.



- ▶ Using lug wrench ②, loosen the bolts on the wheel you wish to change by about one full turn. Do not unscrew the bolts completely.



Jacking points (example: Sedan)

The jacking points are located just behind the front wheel housings and just in front of the rear wheel housings (arrows).

AMG vehicles and vehicles with AMG equipment: to protect the vehicle body, the vehicle has covers next to the jacking points on the outer sills.



Cover, front (example: vehicles with AMG Sports package)

► **AMG vehicles and vehicles with AMG equipment:** fold cover (3) upwards.

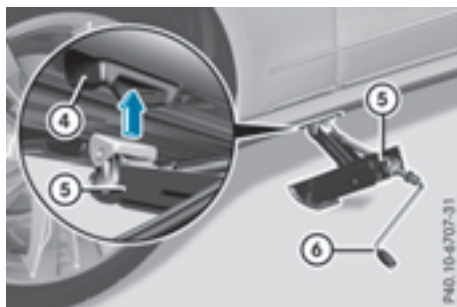

► Position jack (5) at jacking point (4).

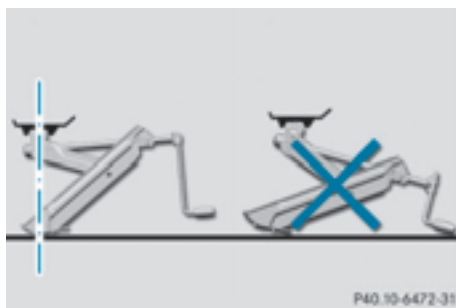

- Make sure the foot of the jack is directly beneath the jacking point.
- Turn crank (6) clockwise until jack (5) sits completely on jacking point (4). The base of the jack must lie evenly on the ground.
- Turn crank (6) until the tire is raised a maximum of 1.2 in (3 cm) from the ground.

Removing a wheel

AMG vehicles: during removal and repositioning of the wheel, the wheel rim can strike the ceramic-brake disc and damage it. Therefore, you should proceed carefully and get a second person assist to you. Alternatively, you can use a second alignment bolt.

Do not place wheel bolts in sand or on a dirty surface. The bolt and wheel hub threads could otherwise be damaged when you screw them in.



- ▶ Unscrew the uppermost wheel bolt completely.
- ▶ Screw alignment bolt ① into the thread instead of the wheel bolt.
- ▶ Unscrew the remaining wheel bolts fully.
- ▶ Remove the wheel.

Mounting a new wheel

WARNING

Oiled or greased wheel bolts or damaged wheel bolts/hub threads can cause the wheel bolts to come loose. As a result, you could lose a wheel while driving. There is a risk of accident.

Never oil or grease wheel bolts. In the event of damage to the threads, contact a qualified specialist workshop immediately. Have the damaged wheel bolts or hub threads replaced/renewed. Do not continue driving.

WARNING

If you tighten the wheel bolts or wheel nuts when the vehicle is raised, the jack could tip over. There is a risk of injury.

Only tighten the wheel bolts or wheel nuts when the vehicle is on the ground.

Always pay attention to the instructions and safety notes in the "Changing a wheel" section (▷ page 309).

Only use wheel bolts that have been designed for the wheel and the vehicle. For safety reasons, Mercedes-Benz recommends that you only use wheel bolts which have been approved for Mercedes-Benz vehicles and the respective wheel.

- ❗ **AMG vehicles:** during removal and repositioning of the wheel, the wheel rim can strike the ceramic-brake disc and damage it. Therefore, you should proceed carefully and get a second person assist to you. Alternatively, you can use a second alignment bolt.

- ❗ To prevent damage to the paintwork, hold the wheel securely against the wheel hub while screwing in the first wheel bolt.

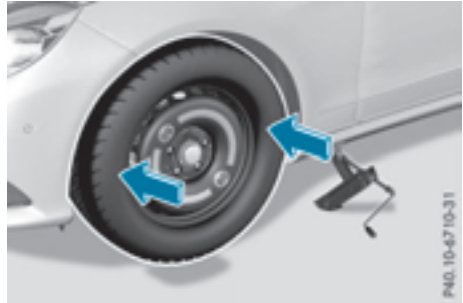

- ▶ Clean the wheel and wheel hub contact surfaces.
- ▶ Slide the wheel to be mounted onto the alignment bolt and push it on.
- ▶ Tighten the wheel bolts until they are finger-tight.
- ▶ Unscrew the alignment bolt.
- ▶ Tighten the last wheel bolt until it is finger-tight.
- ▶ **Vehicles with a collapsible spare wheel:** inflate the collapsible spare wheel (▷ page 331). Only then lower the vehicle.

Lowering the vehicle

WARNING

The wheels could work loose if the wheel nuts and bolts are not tightened to the specified tightening torque. There is a risk of accident.

Have the tightening torque immediately checked at a qualified specialist workshop after a wheel is changed.

- ❗ **Vehicles with a collapsible spare wheel:** before lowering the vehicle, inflate the collapsible spare wheel with the tire inflation compressor. The wheel rim could otherwise be damaged.

- ▶ Turn the crank of the jack counter-clockwise until the vehicle is once again standing firmly on the ground.
- ▶ Place the jack to one side.

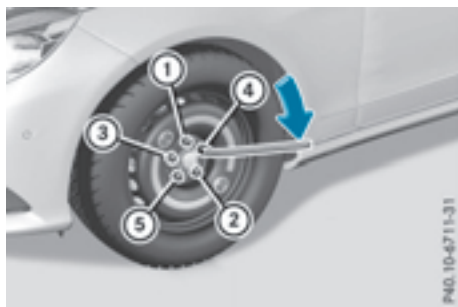

- ▶ Tighten the wheel bolts evenly in a cross-wise pattern in the sequence indicated (① to ⑤). The specified tightening torque is **96 lb-ft (130 Nm)**.
- ▶ Turn the jack back to its initial position.
- ▶ Stow the jack and the rest of the vehicle tools in the trunk/cargo compartment again.
- ▶ **AMG vehicles and vehicles with AMG equipment:** insert the cover into the outer sill.
- ▶ Check the tire pressure of the newly mounted wheel and adjust it if necessary. Observe the recommended tire pressure (▷ page 291).

i All wheels mounted must be equipped with functioning sensors.

Wheel and tire combinations

General notes

- !** For safety reasons, Mercedes-Benz recommends that you only use tires and wheels which have been approved by Mercedes-Benz specifically for your vehicle.

These tires have been specially adapted for use with the control systems, such as ABS or ESP®, and are marked as follows:

- MO = Mercedes-Benz Original
- MOE = Mercedes-Benz Original Extended (tires featuring run-flat characteristics)
- MO1 = Mercedes-Benz Original (only certain AMG tires)

Mercedes-Benz Original Extended tires may only be used on wheels that have been specifically approved by Mercedes-Benz.

Only use tires, wheels or accessories tested and approved by Mercedes-Benz. Certain characteristics, e.g. handling, vehicle noise emissions or fuel consumption, may otherwise be adversely affected. In addition, when driving with a load, tire dimension variations could cause the tires to come into contact with the bodywork and axle components. This could result in damage to the tires or the vehicle.

Mercedes-Benz accepts no liability for damage resulting from the use of tires, wheels or accessories other than those tested and approved.

Information on tires, wheels and approved combinations can be obtained from any qualified specialist workshop.

Overview of abbreviations used in the following tire tables:

- BA: both axles
- FA: front axle
- RA: rear axle

The recommended pressures for various operating conditions can be found:

- on the Tire and Loading Information placard with the recommended tire pressures on the B-pillar on the driver's side
- in the tire pressure table on the inside of the fuel filler flap

Observe the notes on recommended tire pressures under various operating conditions (▷ page 291).

Check tire pressures regularly, and only when the tires are cold. Comply with the maintenance recommendations of the tire manufacturer in the vehicle document wallet.

Notes on the vehicle equipment – always equip the vehicle with:

- tires of the same size on a given axle (left/right)
- the same type of tires at a given time (summer tires, winter tires, MOExtended tires)
Exception: it is permissible to install a different type or make in the event of a flat tire. Observe the "MOExtended tires (tires with run-flat characteristics)" section (> page 272).

Vehicles equipped with MOExtended tires are not equipped with a TIREFIT kit at the factory. It is therefore recommended that you additionally equip your vehicle with a TIREFIT kit if you mount tires that do not feature run-flat properties, e.g. winter tires. A TIREFIT kit may be obtained from a qualified specialist workshop.

- i** Not all wheel and tire combinations are available at the factory for all countries.
- i** On the following pages, you can find information on approved wheel rims and tire sizes for equipping your vehicle with winter tires. Winter tires are not available at the factory as standard equipment or optional extras.

If you would like to equip your vehicle with approved winter tires, you may also, in certain circumstances, require rims of the appropriate size. The size of the approved winter tires may deviate from that of the standard tires. This is dependent on the model and the equipment installed at the factory.

The tires and wheel rims, as well as further information, can be obtained at a qualified specialist workshop.

Tires

E 250 BlueTEC

Summer tires

R18

Tires	Alloy wheels
BA: 245/40 R18 97 Y XL	BA: 8.5 J x 18 H2 Wheel offset: 1.89 in (48 mm)
FA: 245/40 R18 97 Y XL RA: 265/35 R18 97 Y XL ²	FA: 8.5 J x 18 H2 Wheel offset: 1.89 in (48 mm) RA: 9.0 J x 18 H2 Wheel offset: 2.13 in (54 mm)

All-weather tires

R17

Tires	Alloy wheels
BA: 245/45 R17 99 H XL M+S	BA: 8.0 J x 17 H2 Wheel offset: 1.89 in (48 mm)
BA: 245/45 R17 95 H XL M+S ³	BA: 8.0 J x 17 H2 Wheel offset: 1.89 in (48 mm)
BA: 245/45 R17 99 H XL M+S	BA: 8.5 J x 17 H2 Wheel offset: 1.89 in (48 mm)
BA: 245/45 R17 95 H XL M+S ³	BA: 8.5 J x 17 H2 Wheel offset: 1.89 in (48 mm)



R18

Tires	Alloy wheels
BA: 245/40 R18 97 V XL M+S	BA: 8.5 J x 18 H2 Wheel offset: 1.89 in (48 mm)
FA: 245/40 R18 97 V XL M+S RA: 265/40 R18 97 V XL M+S	FA: 8.5 J x 18 H2 Wheel offset: 1.89 in (48 mm) RA: 9.0 J x 18 H2 Wheel offset: 2.13 in (54 mm)

² Use of snow chains not permitted. Observe the notes in the "Snow chains" section.

³ Available as MOExtended tires.

Winter tires**R17**

Tires	Alloy wheels
BA: 245/45 R17 99 H XL M+S  ³	BA: 8.0 J x 17 H2 Wheel offset: 1.89 in (48 mm)
BA: 245/45 R17 99 H XL M+S  ³	BA: 8.5 J x 17 H2 Wheel offset: 1.89 in (48 mm)

R18

Tires	Alloy wheels
BA: 245/40 R18 97 H XL M+S 	BA: 8.5 J x 18 H2 Wheel offset: 1.89 in (48 mm)

E 250 BlueTEC 4MATIC**Summer tires****R18**

Tires	Alloy wheels
BA: 245/40 R18 97 Y XL	BA: 8.5 J x 18 H2 Wheel offset: 1.89 in (48 mm)

All-weather tires**R17**

Tires	Alloy wheels
BA: 245/45 R17 99 H XL M+S	BA: 8.0 J x 17 H2 Wheel offset: 1.89 in (48 mm)
BA: 245/45 R17 95 H M+S ³	BA: 8.0 J x 17 H2 Wheel offset: 1.89 in (48 mm)
BA: 245/45 R17 99 H XL M+S	BA: 8.5 J x 17 H2 Wheel offset: 1.89 in (48 mm)
BA: 245/45 R17 95 H M+S ³	BA: 8.5 J x 17 H2 Wheel offset: 1.89 in (48 mm)



³ Available as MOExtended tires.

R18

Tires	Alloy wheels
BA: 245/40 R18 97 V XL M+S	BA: 8.5 J x 18 H2 Wheel offset: 1.89 in (48 mm)

Winter tires

R17

Tires	Alloy wheels
BA: 245/45 R17 99 H XL M+S  ³	BA: 8.0 J x 17 H2 Wheel offset: 1.89 in (48 mm)
BA: 245/45 R17 99 H XL M+S  ³	BA: 8.5 J x 17 H2 Wheel offset: 1.89 in (48 mm)

R18

Tires	Alloy wheels
BA: 245/40 R18 97 H XL M+S 	BA: 8.5 J x 18 H2 Wheel offset: 1.89 in (48 mm)

E 300 4MATIC

Summer tires

R18

Tires	Alloy wheels
BA: 245/40 R18 97 Y XL	BA: 8.5 J x 18 H2 Wheel offset: 1.89 in (48 mm)

All-weather tires

R17

Tires	Alloy wheels
BA: 245/45 R17 99 H XL M+S	BA: 8.0 J x 17 H2 Wheel offset: 1.89 in (48 mm)
BA: 245/45 R17 95 H XL M+S ³	BA: 8.0 J x 17 H2 Wheel offset: 1.89 in (48 mm)



³ Available as MOExtended tires.

Tires	Alloy wheels
BA: 245/45 R17 99 H XL M+S	BA: 8.5 J x 17 H2 Wheel offset: 1.89 in (48 mm)
BA: 245/45 R17 95 H XL M+S ³	BA: 8.5 J x 17 H2 Wheel offset: 1.89 in (48 mm)

R18

Tires	Alloy wheels
BA: 245/40 R18 97 V XL M+S	BA: 8.5 J x 18 H2 Wheel offset: 1.89 in (48 mm)

Winter tires**R17**

Tires	Alloy wheels
BA: 245/45 R17 99 H XL M+S  ³	BA: 8.0 J x 17 H2 Wheel offset: 1.89 in (48 mm)
BA: 245/45 R17 99 H XL M+S  ³	BA: 8.5 J x 17 H2 Wheel offset: 1.89 in (48 mm)

R18

Tires	Alloy wheels
BA: 245/40 R18 97 H XL M+S 	BA: 8.5 J x 18 H2 Wheel offset: 1.89 in (48 mm)

E 350**Summer tires****R18**

Tires	Alloy wheels
FA: 245/40 R18 97 Y XL RA: 265/35 R18 97 Y XL	FA: 8.5 J x 18 H2 Wheel offset: 1.89 in (48 mm) RA: 9.0 J x 18 H2 Wheel offset: 2.13 in (54 mm)

³ Available as MOExtended tires.

All-weather tires

R17



Tires	Alloy wheels
BA: 245/45 R17 99 H XL M+S	BA: 8.0 J x 17 H2 Wheel offset: 1.89 in (48 mm)
BA: 245/45 R17 95 H XL M+S ³	BA: 8.0 J x 17 H2 Wheel offset: 1.89 in (48 mm)
BA: 245/45 R17 99 H XL M+S	BA: 8.5 J x 17 H2 Wheel offset: 1.89 in (48 mm)
BA: 245/45 R17 95 H XL M+S ³	BA: 8.5 J x 17 H2 Wheel offset: 1.89 in (48 mm)

R18

Tires	Alloy wheels
BA: 245/40 R18 97 V XL M+S	BA: 8.5 J x 18 H2 Wheel offset: 1.89 in (48 mm)
FA: 245/40 R18 97 V XL M+S RA: 265/40 R18 97 V XL M+S	FA: 8.5 J x 18 H2 Wheel offset: 1.89 in (48 mm) RA: 9.0 J x 18 H2 Wheel offset: 2.13 in (54 mm)

Winter tires

R17

Tires	Alloy wheels
BA: 245/45 R17 99 H XL M+S  ³	BA: 8.0 J x 17 H2 Wheel offset: 1.89 in (48 mm)
BA: 245/45 R17 99 H XL M+S  ³	BA: 8.5 J x 17 H2 Wheel offset: 1.89 in (48 mm)

R18

Tires	Alloy wheels
BA: 245/40 R18 97 H XL M+S 	BA: 8.5 J x 18 H2 Wheel offset: 1.89 in (48 mm)

³ Available as MOExtended tires.

E 350 4MATIC**Summer tires****R18**

Tires	Alloy wheels
BA: 245/40 R18 97 Y XL	BA: 8.5 J x 18 H2 Wheel offset: 1.89 in (48 mm)



All-weather tires**R17**

Tires	Alloy wheels
BA: 245/45 R17 99 H XL M+S	BA: 8.0 J x 17 H2 Wheel offset: 1.89 in (48 mm)
BA: 245/45 R17 95 H XL M+S ^{3, 4}	BA: 8.0 J x 17 H2 Wheel offset: 1.89 in (48 mm)
BA: 245/45 R17 99 H XL M+S	BA: 8.5 J x 17 H2 Wheel offset: 1.89 in (48 mm)
BA: 245/45 R17 95 H M+S ^{3, 4}	BA: 8.5 J x 17 H2 Wheel offset: 1.89 in (48 mm)

R18

Tires	Alloy wheels
BA: 245/40 R18 97 V XL M+S	BA: 8.5 J x 18 H2 Wheel offset: 1.89 in (48 mm)

Winter tires**R17**

Tires	Alloy wheels
BA: 245/45 R17 99 H XL M+S  ³	BA: 8.0 J x 17 H2 Wheel offset: 1.89 in (48 mm)
BA: 245/45 R17 99 H XL M+S  ³	BA: 8.5 J x 17 H2 Wheel offset: 1.89 in (48 mm)

³ Available as MOExtended tires.⁴ Only for Sedan.

R18

Tires	Alloy wheels
BA: 245/40 R18 97 H XL M+S  4	BA: 8.5 J x 18 H2 Wheel offset: 1.89 in (48 mm)

E 400

Summer tires

R17

Tires	Alloy wheels
BA: 245/45 R17 95 W	BA: 8.0 J x 17 H2 Wheel offset: 1.89 in (48 mm)
BA: 245/45 R17 99 Y XL ³	BA: 8.0 J x 17 H2 Wheel offset: 1.89 in (48 mm)
BA: 245/45 R17 95 W	BA: 8.5 J x 17 H2 Wheel offset: 1.89 in (48 mm)
BA: 245/45 R17 99 Y XL ³	BA: 8.5 J x 17 H2 Wheel offset: 1.89 in (48 mm)

R18

Tires	Alloy wheels
FA: 245/40 R18 97 Y XL RA: 265/35 R18 97 Y XL ²	FA: 8.5 J x 18 H2 Wheel offset: 1.89 in (48 mm) RA: 9.0 J x 18 H2 Wheel offset: 2.13 in (54 mm)

All-weather tires

R17

Tires	Alloy wheels
BA: 245/45 R17 99 H XL M+S	BA: 8.0 J x 17 H2 Wheel offset: 1.89 in (48 mm)
BA: 245/45 R17 95 H XL M+S ³	BA: 8.0 J x 17 H2 Wheel offset: 1.89 in (48 mm)

4 Only for Sedan.

3 Available as MOExtended tires.





2 Use of snow chains not permitted. Observe the notes in the "Snow chains" section.

Tires	Alloy wheels
BA: 245/45 R17 99 H XL M+S	BA: 8.5 J x 17 H2 Wheel offset: 1.89 in (48 mm)
BA: 245/45 R17 95 H XL M+S ³	BA: 8.5 J x 17 H2 Wheel offset: 1.89 in (48 mm)

R18

Tires	Alloy wheels
BA: 245/40 R18 97 V XL M+S	BA: 8.5 J x 18 H2 Wheel offset: 1.89 in (48 mm)

Winter tires**R17**

Tires	Alloy wheels
BA: 245/45 R17 95 H M+S 	BA: 8.0 J x 17 H2 Wheel offset: 1.89 in (48 mm)
BA: 245/45 R17 99 H XL M+S  ³	BA: 8.0 J x 17 H2 Wheel offset: 1.89 in (48 mm)
BA: 245/45 R17 95 H M+S 	BA: 8.5 J x 17 H2 Wheel offset: 1.89 in (48 mm)
BA: 245/45 R17 99 H XL M+S  ³	BA: 8.5 J x 17 H2 Wheel offset: 1.89 in (48 mm)

R18

Tires	Alloy wheels
BA: 245/40 R18 97 H XL M+S 	BA: 8.5 J x 18 H2 Wheel offset: 1.89 in (48 mm)

³ Available as MOExtended tires.

E 400 4MATIC

Summer tires

R17

Tires	Alloy wheels
BA: 245/45 R17 95 W ⁵	BA: 8.0 J x 17 H2 Wheel offset: 1.89 in (48 mm)
BA: 245/45 R17 99 Y XL ³	BA: 8.0 J x 17 H2 Wheel offset: 1.89 in (48 mm)
BA: 245/45 R17 95 W ⁵	BA: 8.5 J x 17 H2 Wheel offset: 1.89 in (48 mm)
BA: 245/45 R17 99 Y XL ³	BA: 8.5 J x 17 H2 Wheel offset: 1.89 in (48 mm)

R18

Tires	Alloy wheels
BA: 245/40 R18 97 Y XL	BA: 8.5 J x 18 H2 Wheel offset: 1.89 in (48 mm)

All-weather tires

R17

Tires	Alloy wheels
BA: 245/45 R17 99 H XL M+S	BA: 8.0 J x 17 H2 Wheel offset: 1.89 in (48 mm)
BA: 245/45 R17 95 H XL M+S ^{3, 4}	BA: 8.0 J x 17 H2 Wheel offset: 1.89 in (48 mm)
BA: 245/45 R17 99 H XL M+S	BA: 8.5 J x 17 H2 Wheel offset: 1.89 in (48 mm)
BA: 245/45 R17 95 H XL M+S ^{3, 4}	BA: 8.5 J x 17 H2 Wheel offset: 1.89 in (48 mm)





⁵ Estate only.³ Available as MOExtended tires.⁴ Only for Sedan.

R18

Tires	Alloy wheels
BA: 245/40 R18 97 V XL M+S	BA: 8.5 J x 18 H2 Wheel offset: 1.89 in (48 mm)
BA: 245/40 R18 97 Y XL M+S	BA: 8.5 J x 18 H2 Wheel offset: 1.89 in (48 mm)

Winter tires

R17

Tires	Alloy wheels
BA: 245/45 R17 95 H M+S  4	BA: 8.0 J x 17 H2 Wheel offset: 1.89 in (48 mm)
BA: 245/45 R17 99 H XL M+S  3	BA: 8.0 J x 17 H2 Wheel offset: 1.89 in (48 mm)
BA: 245/45 R17 95 H M+S  4	BA: 8.5 J x 17 H2 Wheel offset: 1.89 in (48 mm)
BA: 245/45 R17 99 H XL M+S  3	BA: 8.5 J x 17 H2 Wheel offset: 1.89 in (48 mm)

R18

Tires	Alloy wheels
BA: 245/40 R18 97 H XL M+S 	BA: 8.5 J x 18 H2 Wheel offset: 1.89 in (48 mm)

E 550 4MATIC

Summer tires

R18

Tires	Alloy wheels
BA: 245/40 R18 97 Y XL	BA: 8.5 J x 18 H2 Wheel offset: 1.89 in (48 mm)

4 Only for Sedan.

3 Available as MOExtended tires.

All-weather tires**R18**

Tires	Alloy wheels
BA: 245/40 R18 97 V XL M+S	BA: 8.5 J x 18 H2 Wheel offset: 1.89 in (48 mm)

Winter tires**R18**

Tires	Alloy wheels
BA: 245/40 R18 97 V XL M+S 	BA: 8.5 J x 18 H2 Wheel offset: 1.89 in (48 mm)

E 63 AMG**Summer tires****R18**

Tires	Alloy wheels
FA: 255/40 ZR18 (99 Y) XL MO ^{1,6} RA: 285/35 ZR18 (101 Y) XL MO ^{1,2,6}	FA: 9.0 J x 18 H2 Wheel offset: 1.46 in (37 mm) RA: 9.5 J x 18 H2 Wheel offset: 2.05 in (52 mm)

R19

Tires	Alloy wheels
FA: 255/35 ZR19 (96 Y) XL ⁷ RA: 285/30 ZR19 (98 Y) XL ^{2,7}	FA: 9.0 J x 19 H2 Wheel offset: 1.46 in (37 mm) RA: 9.5 J x 19 H2 Wheel offset: 2.05 in (52 mm)



⁶ Not in connection with a ceramic brake system.

² Use of snow chains not permitted. Observe the notes in the "Snow chains" section.





⁷ Observe notes on "Large wheels" under "General notes" in "Wheel/tire combinations".

Winter tires

R18

Tires	Alloy wheels
FA: 255/40 R18 99 V XL M+S  6	FA: 9.0 J x 18 H2
RA: 255/40 R18 99 V XL M+S  6	Wheel offset: 1.46 in (37 mm)
	RA: 9.5 J x 18 H2
	Wheel offset: 2.05 in (52 mm)

R19

Tires	Alloy wheels
FA: 255/35 R19 96 V XL M+S  7	FA: 9.0 J x 19 H2
RA: 255/35 R19 96 V XL M+S  7, 8	Wheel offset: 1.46 in (37 mm)
	RA: 9.5 J x 19 H2
	Wheel offset: 2.05 in (52 mm)
FA: 255/35 R19 96 V XL M+S  7	FA: 9.0 J x 19 H2
RA: 285/30 R19 98 V XL M+S  2, 7	Wheel offset: 1.46 in (37 mm)
	RA: 9.5 J x 19 H2
	Wheel offset: 2.05 in (52 mm)

E 63 AMG S-MODEL 4MATIC

Summer tires

R19

Tires	Alloy wheels
FA: 255/35 ZR19 (96 Y) XL ⁷	FA: 9.0 J x 19 H2
RA: 285/30 ZR19 (98 Y) XL ^{2,7}	Wheel offset: 1.46 in (37 mm)
	RA: 9.5 J x 19 H2
	Wheel offset: 2.05 in (52 mm)

⁶ Not in connection with a ceramic brake system.





⁷ Observe notes on "Large wheels" under "General notes" in "Wheel/tire combinations".

⁸ Only fine-link snow chains are permitted.

² Use of snow chains not permitted. Observe the notes in the "Snow chains" section.

Winter tires

R19

Tires	Alloy wheels
FA: 255/35 R19 96 V XL M+S  7, 9 RA: 255/35 R19 96 V XL M+S  7, 8, 9	FA: 9.0 J x 19 H2 Wheel offset: 1.46 in (37 mm) RA: 9.5 J x 19 H2 Wheel offset: 2.05 in (52 mm)
FA: 255/35 R19 96 V XL M+S  7 RA: 285/30 R19 98 V XL M+S  2, 7	FA: 9.0 J x 19 H2 Wheel offset: 1.46 in (37 mm) RA: 9.5 J x 19 H2 Wheel offset: 2.05 in (52 mm)

E 63 AMG 4MATIC





Summer tires

R19

Tires	Alloy wheels
FA: 255/35 ZR19 (96 Y) XL ⁷ RA: 285/30 ZR19 (98 Y) XL ^{2,7}	FA: 9.0 J x 19 H2 Wheel offset: 1.46 in (37 mm) RA: 9.5 J x 19 H2 Wheel offset: 2.05 in (52 mm)

Winter tires

R19

Tires	Alloy wheels
FA: 255/35 R19 96 V XL M+S  7, 9 RA: 255/35 R19 96 V XL M+S  7, 8, 9	FA: 9.0 J x 19 H2 Wheel offset: 1.46 in (37 mm) RA: 9.5 J x 19 H2 Wheel offset: 2.05 in (52 mm)
FA: 255/35 R19 96 V XL M+S  7 RA: 285/30 R19 98 V XL M+S  2, 7	FA: 9.0 J x 19 H2 Wheel offset: 1.46 in (37 mm) RA: 9.5 J x 19 H2 Wheel offset: 2.05 in (52 mm)

7 Observe notes on "Large wheels" under "General notes" in "Wheel/tire combinations".

9 Wagon: maximum permissible speed 220 km/h.

8 Only fine-link snow chains are permitted.

2 Use of snow chains not permitted. Observe the notes in the "Snow chains" section.

Emergency spare wheel

Important safety notes

WARNING

The wheel or tire size as well as the tire type of the spare wheel or emergency spare wheel and the wheel to be replaced may differ. Mounting an emergency spare wheel may severely impair the driving characteristics. There is a risk of an accident.

To avoid hazardous situations:

- adapt your driving style accordingly and drive carefully.
- never mount more than one spare wheel or emergency spare wheel that differs in size.
- only use a spare wheel or emergency spare wheel of a different size briefly.
- do not switch ESP® off.
- have a spare wheel or emergency spare wheel of a different size replaced at the nearest qualified specialist workshop. Observe that the wheel and tire dimensions as well as the tire type must be correct.

When using an emergency spare wheel or spare wheel of a different size, you must not exceed the maximum speed of 50 mph (80 km/h).

Snow chains must not be mounted on emergency spare wheels.

General notes

You should regularly check the pressure of the emergency spare wheel, particularly prior to long trips, and correct the pressure as necessary (▷ page 291). The value on the wheel is valid. In addition, the emergency spare wheel tire pressure can be found under "Technical data" (▷ page 332).

An emergency spare wheel may also be mounted against the direction of rotation. Observe the time restriction on use as well as the speed limitation specified on the emergency spare wheel.

Replace the tires after six years at the latest, regardless of wear. This also applies to the emergency spare wheel.

i When you are driving with the emergency spare wheel mounted, the tire pressure monitor cannot function reliably. Only restart the tire pressure monitor when the defective wheel has been replaced with a new wheel.

If an emergency spare wheel is mounted, the system may continue to show the tire pressure of the wheel that has been removed for a few minutes. The value displayed for the mounted emergency spare wheel is not the same as the current tire pressure of the emergency spare wheel.

"Minispare" emergency spare wheel/collapsible spare wheel

Opening the stowage well

Sedan: the emergency spare wheel can be found in the stowage well under the trunk floor.

▶ Lift the trunk floor upwards (▷ page 248).

Wagon: the emergency spare wheel is located in the stowage well under the cargo compartment floor.

▶ Remove the seat cushions of the folding bench seat; see the Digital Operator's Manual, keyword "Folding bench seat (cargo compartment)".

▶ Lift the cargo compartment floor up.

Removing the emergency spare wheel (Sedan)

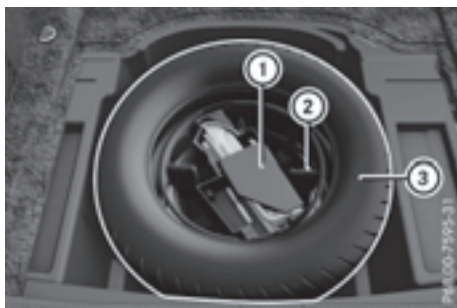

(Example: equipment and country-specific variations possible)

- ▶ Remove vehicle tool kit tray ①.
- ▶ Turn stowage well ② counter-clockwise and remove it.
- ▶ Remove "Minispare" emergency spare wheel ③.

Removing the emergency spare wheel (Wagon)



Example: emergency spare wheel

- ▶ Remove vehicle tool kit tray ① by recess ②.
- ▶ Remove "Minispare" emergency spare wheel ③.

Removing the emergency spare wheel (AMG vehicles)

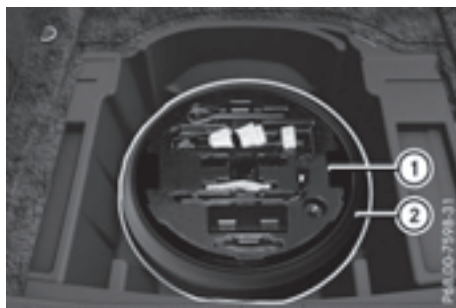

- ▶ Reach into cutout ① in the tool holder and lift it up.
- ▶ Remove collapsible spare wheel ②.

Always observe the instructions and safety notes in the "Mounting a wheel" section (> page 309).

Stowing a used collapsible spare wheel

- ❗ Only place the collapsible spare wheel in the vehicle when it is dry. Otherwise, moisture may get into the vehicle.

Take the following steps to stow a used collapsible spare wheel. It will not otherwise fit into the spare wheel well. Mercedes-Benz recommends that you have this work performed at a qualified specialist workshop, e.g. at an authorized Mercedes-Benz Center.

- ▶ Unscrew the valve cap from the valve.
- ▶ Use the back of the valve cap to unscrew the valve insert from the valve and release the air.
- ❗ Fully deflating the tires can take a few minutes.
- ▶ Screw the valve insert back into the valve.
- ▶ Screw the valve cap back on.

- ▶ Remove the protective sheet from the vehicle tool kit and pull it over the collapsible spare wheel.
- ▶ Stow the collapsible spare wheel in the emergency spare wheel well under the trunk/cargo compartment.

Inflating the collapsible spare wheel

- ❗ **Inflate the collapsible spare wheel using the tire inflation compressor before lowering the vehicle. The wheel rim could otherwise be damaged.**
- ❗ **Do not operate the tire inflation compressor for longer than eight minutes at a time without a break. It may otherwise overheat. The tire inflation compressor can be operated again once it has cooled down.**

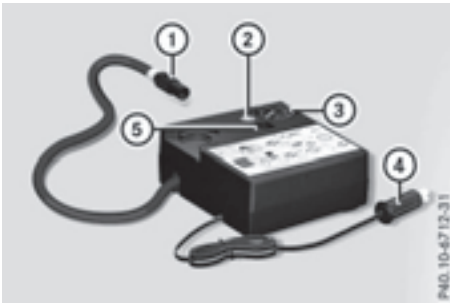

- ▶ Mount the collapsible spare wheel as described (▷ page 309).
The collapsible spare wheel must be mounted before it is inflated.
- ▶ Pull connector ④ and the hose out of the housing.
- ▶ Remove the cap from the valve on the collapsible spare wheel.
- ▶ Screw union nut ① of the hose onto the valve.
- ▶ Make sure on/off switch ⑤ of the tire inflation compressor is set to **0**.
- ▶ Insert connector ④ into a 12 V socket (▷ page 251) in your vehicle.
- ▶ Turn the SmartKey to position **1** in the ignition lock (▷ page 137).
- ▶ Press on/off switch ⑤ on the tire inflation compressor to **I**.
The tire inflation compressor is switched on. The tire is inflated. The tire pressure is shown on pressure gauge ③.
- ▶ Inflate the tire to the specified tire pressure.
The specified tire pressure is printed on the yellow label of the emergency spare wheel.
- ▶ When the specified tire pressure has been reached, press on/off switch ⑤ on the electric air pump to **0**.
The tire inflation compressor is switched off.
- ▶ Turn the SmartKey to position **0** in the ignition lock.
- ▶ If the tire pressure is higher than the specified pressure, press pressure release valve button ② until the correct tire pressure has been reached.
- ▶ Unscrew air hose union nut ① from the valve.
- ▶ Screw the cap onto the valve of the collapsible spare wheel again.
- ▶ Stow connector ④ and the hose in the lower section of the tire inflation compressor.
- ▶ Stow the tire inflation compressor in the vehicle.

Technical data

All vehicles (except AMG vehicles)

"Minispare" emergency spare wheel

Models with 4-cylinder engine

Tires	Alloy wheels
T 155/70 R17 110 M Tire pressure: 420 kPa (4.2 bar/61 psi)	4.0 B x 17 H2 Wheel offset: 1.54 in (39 mm)

Models with 6-cylinder engine

Tires	Alloy wheels
T 155/70 R17 110 M Tire pressure: 420 kPa (4.2 bar/61 psi)	4.0 B x 17 H2 Wheel offset: 1.34 in (34 mm)

Models with 8-cylinder engine

Tires	Alloy wheels
T 155/60 R18 107 M Tire pressure: 420 kPa (4.2 bar/61 psi)	4.5 B x 18 H2 Wheel offset: 1.42 in (36 mm)

AMG vehicles

Collapsible spare wheel

Tires	Alloy wheels
175/50 - 19 97 P Tire pressure: 350 kPa (3.5 bar/51 psi)	6.5 B x 19 H2 Wheel offset: 0.55 in (14 mm)

Useful information	334
Information regarding technical data	334
Vehicle electronics	334
Identification plates	336
Service products and filling capaci- ties	337
Vehicle data	344

Useful information

- i** This Operator's Manual describes all models and all standard and optional equipment of your vehicle available at the time of publication of the Operator's Manual. Country-specific differences are possible. Please note that your vehicle may not be equipped with all features described. This also applies to safety-related systems and functions.
- i** Read the information on qualified specialist workshops (▷ page 31).

Information regarding technical data

WARNING

HYBRID vehicles: It is imperative that you read the HYBRID Supplemental Operating Instructions included in your vehicle literature portfolio. You may otherwise not receive all necessary safety information and warning for the operation of your vehicle.

- i** The data stated here specifically refers to a vehicle with standard equipment. Consult an authorized Mercedes-Benz Center for the data for all vehicle variants and trim levels.

Vehicle electronics

Retrofitting two-way radios and mobile phones (RF transmitters)

WARNING

The electromagnetic radiation from modified or incorrectly retrofitted RF-transmitters can interfere with the vehicle electronics. This can compromise the operational safety of the vehicle. There is a risk of an accident.

You should have all work to electrical and electronic equipment carried out at a qualified specialist workshop.

WARNING

The electromagnetic radiation from incorrectly operated RF transmitters can interfere with the vehicle electronics, for example:

- if the RF transmitter is not connected with an exterior antenna
- the exterior antenna has been installed incorrectly or is not a low-reflection type

This can compromise the operational safety of the vehicle. There is a risk of an accident.

Have the low-reflection exterior antenna mounted at a qualified specialist workshop. When operating RF transmitters in the vehicle, always connect them with the low-reflection exterior antenna.

- !** The operating permit may be invalidated if the instructions for installation and use of RF transmitters are not observed.

In particular, the following conditions must be complied with:

- only approved wavebands may be used.
- compliance with the maximum permissible output in these wavebands is required.
- only approved antenna positions may be used.

Excessive levels of electromagnetic radiation may cause damage to your health and the health of others. Using an exterior antenna takes into account current scientific discussions relating to the possible health hazards that may result from electromagnetic fields. The following antenna positions may be used if RF transmitters have been properly installed:

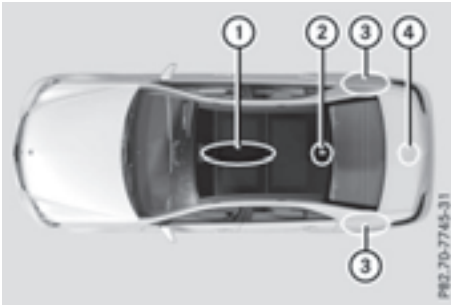

Sedan: approved antenna positions

- ① Front roof area
- ② Rear roof area
- ③ Rear fender
- ④ Trunk lid

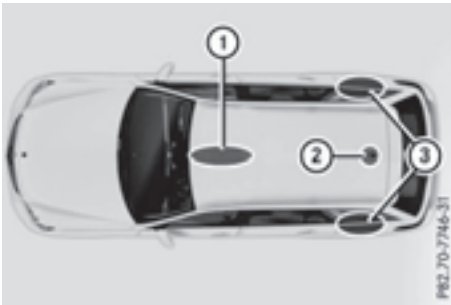

Wagon: approved antenna positions

- ① Front roof area
- ② Rear roof area
- ③ Rear fender

i When installing an antenna on the front roof area of vehicles with a sliding sunroof, observe the sweeping range of the roof.

On vehicles with panorama roof with power tilt/sliding panel, installing an antenna to the front or rear roof area is not permitted.

On the rear fenders, it is recommended to position the antenna on the side of the vehicle closest to the center of the road.

Use the Technical Specification ISO/TS 21609 when retrofitting RF transmitters (Road Vehicles - EMC guidelines for installation of aftermarket radio frequency transmitting equipment). Observe the legal requirements for retrofittings.

If your vehicle has installations for two-way radio equipment, use the power supply or antenna connections intended for use with the basic wiring. Be sure to observe the manufacturer's additional instructions when installing.

Deviations with respect to wavebands, maximum transmission outputs or antenna positions must be approved by Mercedes-Benz.

The maximum transmission output (PEAK) at the base of the antenna must not exceed the following values:

Waveband	Maximum transmission output
Short wave 3 - 54 MHz	100 W
4 m waveband 74 - 88 MHz	30 W
2 m waveband 144 - 174 MHz	50 W
Trunked radio/Tetra 380 - 460 MHz	10 W
70 cm waveband 400 - 460 MHz	35 W
Mobile communications (2G/3G/4G)	10 W

The following can be used in the vehicle without restrictions:

- RF transmitters with a maximum transmission output of up to 100 mW
- RF transmitters with transmission frequencies in the range 380-410 MHz and a maximum transmission output of 2 W (Tetra)
- Mobile telephones (2G/3G/4G)

There is no restriction for antenna positions on the outside of the vehicle for the following wavebands:

- Trunked radio/Tetra
- 70 cm waveband
- Mobile communications (2G/3G/4G)

Identification plates

Vehicle identification plate with vehicle identification number (VIN)



- Open the front left-hand door. You will see vehicle identification plate ①.



Example: vehicle identification plate (USA only)

- ② VIN
- ③ Vehicle model



Example: vehicle identification plate (Canada only)

- ② VIN
- ③ Paint code
- ① The data shown on the vehicle identification plate is used only as an example. This data is different for every vehicle and can deviate from the data shown here. You can find the data applicable to your vehicle on the vehicle identification plate.

Vehicle identification plate with vehicle identification number (VIN)



- Slide the right-hand front seat to its rearmost position.
- Fold floor covering ① upwards. You will see VIN ②.

Engine number

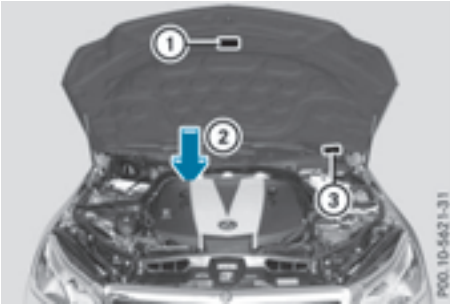

- ① Emission control information plate, including the certification of both federal and Californian emissions standards
- ② Engine number (stamped into the crankcase)
- ③ VIN (on the lower edge of the windshield)

Service products and filling capacities

Important safety notes

WARNING

Service products may be poisonous and hazardous to health. There is a risk of injury.

Comply with instructions on the use, storage and disposal of service products on the labels of the respective original containers. Always store service products sealed in their original containers. Always keep service products out of the reach of children.

Environmental note

Dispose of service products in an environmentally responsible manner.

Service products include the following:

- Fuels
- Exhaust gas aftertreatment additives, e.g. DEF
- Lubricants (e.g. engine oil, transmission oil)
- Coolant
- Brake fluid

- Windshield washer fluid
- Climate control system refrigerant

Components and service products must be matched. Only use products recommended by Mercedes-Benz. Damage which is caused by the use of products which have not been recommended is not covered by the Mercedes-Benz warranty or goodwill gestures. They are listed in this Mercedes-Benz Operator's Manual in the appropriate section.

Information on tested and approved products can be obtained at an authorized Mercedes-Benz Center or on the Internet at <http://bevo.mercedes-benz.com>.

You can recognize service products approved by Mercedes-Benz by the following inscription on the containers:

- MB-Freigabe (e.g. MB-Freigabe 229.51)
- MB Approval (e.g. MB Approval 229.51)

Other designations or recommendations indicate a level of quality or a specification in accordance with an MB Sheet Number (e.g. MB 229.5). They have not necessarily been approved by Mercedes-Benz.

Other identifications, for example:

- 0 W-30
- 5 W-30
- 5 W-40

Fuel

Important safety notes

WARNING

Fuel is highly flammable. If you handle fuel incorrectly, there is a risk of fire and explosion.

You must avoid fire, open flames, creating sparks and smoking. Switch off the engine and, if applicable, the auxiliary heating before refueling.

⚠ WARNING

Fuel is poisonous and hazardous to health. There is a risk of injury.

You must make sure that fuel does not come into contact with your skin, eyes or clothing and that it is not swallowed. Do not inhale fuel vapors. Keep fuel away from children.

If you or others come into contact with fuel, observe the following:

- Wash away fuel from skin immediately using soap and water.
- If fuel comes into contact with your eyes, immediately rinse them thoroughly with clean water. Seek medical assistance without delay.
- If fuel is swallowed, seek medical assistance without delay. Do not induce vomiting.
- Immediately change out of clothing which has come into contact with fuel.

Tank capacity

The total capacity of the fuel tank may vary depending on the equipment in the vehicle.

Model	Total capacity
AMG vehicles	17.4 US gal (66.0 l) or 21.1 US gal (80.0 l)
All other models	21.1 US gal (80.0 l)

Model	Of which reserve
AMG vehicles	Approx. 3.7 US gal (14.0 l)
All other models	Approx. 2.4 US gal (9.0 l)

Gasoline

Fuel grade

! Do not use diesel to refuel vehicles with a gasoline engine. Do not switch on the ignition if you accidentally refuel with the wrong fuel. Otherwise, the fuel will enter the fuel system. Even small amounts of the wrong fuel could result in damage to the fuel system and the engine. Notify a qualified specialist workshop and have the fuel tank and fuel lines drained completely.

! Only refuel using unleaded premium grade gasoline with at least 91 AKI/ 95 RON.

! Only use the fuel recommended. Operating the vehicle with other fuels can lead to engine failure.

! Do not use the following:

- E85 (gasoline with 85% ethanol)
- E100 (100% ethanol)
- M15 (gasoline with 15% methanol)
- M30 (gasoline with 30% methanol)
- M85 (gasoline with 85% methanol)
- M100 (100% methanol)
- Gasoline with metalliferous additives
- Diesel

Do not mix such fuels with the fuel recommended for your vehicle. Do not use additives. Otherwise, engine damage may occur. This does not include cleaning additives for the removal and prevention of residue build-up. Gasoline may only be mixed with cleaning additives recommended by Mercedes-Benz; see "Additives". You can obtain further information from any authorized Mercedes-Benz Center.

! To ensure the longevity and full performance of the engine, only premium-grade unleaded gasoline must be used.

If standard unleaded gasoline is unavailable and you have to refuel with unleaded gasoline of a lower grade, observe the following precautions:

- Only fill the fuel tank to half full with regular unleaded gasoline and fill the rest with premium-grade unleaded gasoline as soon as possible.
- Do not drive at the maximum speed.
- Avoid sudden acceleration and engine speeds over 3,000 rpm.

You will usually find information about the fuel grade on the pump. If you cannot find the label on the pump, ask the staff for assistance.

- i** For further information, consult a qualified specialist workshop or visit <http://www.mbusa.com> (USA only).
- i** E10 fuel contains up to 10% bioethanol. Your vehicle is E10-compatible. You can refuel your vehicle using E10 fuel.

As a temporary measure, if the recommended fuel is not available, you may also use regular unleaded gasoline with an octane rating of 87 AKI/91 RON. This may reduce engine performance and increase fuel consumption. Avoid driving at full throttle and sudden acceleration. Never refuel using fuel with a lower AKI.

Information on refueling (▷ page 146).

Additives

- !** Operating the engine with fuel additives added later can lead to engine failure. Do not mix fuel additives with fuel. This does not include additives for the removal and prevention of residue buildup. Gasoline must only be mixed with additives recommended by Mercedes-Benz. Comply with the instructions for use on the product label. More information about recommended additives can be obtained from any authorized Mercedes-Benz Center.

Mercedes-Benz recommends that you use branded fuels that have additives.



The quality of the fuel available in some countries may not be sufficient. Residue could build up in the injection system as a result. In such cases, and in consultation with an authorized Mercedes-Benz Center, the gasoline may be mixed with the cleaning additive recommended by Mercedes-Benz. You must observe the notes and mixing ratios specified on the container.

Diesel

Fuel grade

WARNING

If you mix diesel fuel with gasoline, the flash point is lower than that of pure diesel fuel. When the engine is running, exhaust system components could overheat without being noticed. There is a risk of fire.

Never refuel with gasoline. Never mix gasoline with diesel fuel.

- !** Only use commercially available vehicular ULTRA-LOW SULFUR DIESEL FUEL (ULSD, 15 ppm maximum sulfur content) that meets the ASTM D975 standard. If you do not refuel with ULSD, you may damage the BlueTEC exhaust gas aftertreatment system of the vehicle.
- !** Do not use gasoline to refuel vehicles with a diesel engine. Do not mix diesel fuel with gasoline, kerosene or paraffin. This may otherwise result in damage to the fuel system and engine.

You will usually find information about the fuel grade on the pump. If you cannot find the label on the pump, ask the staff for assistance.

- i** For further information, consult a qualified specialist workshop or visit <http://www.mbusa.com> (USA only).

Information on refueling (▷ page 146).

Low outside temperatures

- i** Diesel fuel with improved cold flow properties is available during the winter months. Further information about fuel properties can be obtained from oil companies, e.g. at gas stations.

Bio-diesel – FAME (fatty acid methyl ester)

Mercedes-Benz USA approves the use of bio-diesel B5 for all BlueTEC diesel engines. The concentration of bio-diesel in the ULSD may not exceed 5% by volume.

Pure bio-diesel and diesel fuel with a higher percentage of bio-diesel, such as B20, can damage the engine and the fuel system. For this reason, they are not approved.

For more information, consult the gas station staff. The bio-diesel B5 label on the gasoline pump must clearly state that the standard for ULSD has been fulfilled. If the label is not clear, do not refuel the vehicle.

Do not refuel your vehicle with fuels unless they have been approved by Mercedes-Benz. Information on refueling (▷ page 146).

Flexible Fuel vehicles

Important safety notes

WARNING

Fuel is highly flammable. If you handle fuel incorrectly, there is a risk of fire and explosion.

You must avoid fire, open flames, creating sparks and smoking. Switch off the engine and, if applicable, the auxiliary heating before refueling.

WARNING

Fuel is poisonous and hazardous to health. There is a risk of injury.

You must make sure that fuel does not come into contact with your skin, eyes or clothing and that it is not swallowed. Do not inhale fuel vapors. Keep fuel away from children.

If you or others come into contact with fuel, observe the following:

- Wash away fuel from skin immediately using soap and water.
- If fuel comes into contact with your eyes, immediately rinse them thoroughly with clean water. Seek medical assistance without delay.
- If fuel is swallowed, seek medical assistance without delay. Do not induce vomiting.
- Immediately change out of clothing which has come into contact with fuel.

Flexible Fuel vehicles can be refueled with the following fuel types:

- premium-grade unleaded gasoline
- E85 fuel
- a mixture of E85 fuel and premium-grade unleaded gasoline

- i** Flexible Fuel vehicles can be recognized by the **Ethanol up to E85** sticker on the inside of the fuel filler flap.

Fuel consumption

The energy content of E85 fuel is less than that of the same amount of premium-grade gasoline. The amount of fuel consumed when operating the vehicle with E85 fuel is therefore higher than with premium-grade gasoline.

Maintenance

Inform your authorized Mercedes-Benz Center that you are operating or have operated the vehicle with E85 fuel.

Low outside temperatures

If the outside temperature is below 32 °F (0 °C), the starting procedure can take noticeably longer when operating with E85 fuel. E85 fuel is not suitable for use at outside temperatures under -4 °F (-20 °C).

DEF**Important safety notes**

Comply with the important safety notes for service products when handling DEF (▷ page 337).

DEF is a water-soluble fluid for the exhaust gas aftertreatment of diesel engines. It is:

- not poisonous
- colorless and odorless
- not flammable

When you open the DEF container, small amounts of ammonia vapor may be released.

Ammonia vapors have a pungent odor and are particularly irritating to the skin, to mucous membranes and to the eyes. You may experience a burning sensation in your eyes, nose and throat. Coughing and watering of the eyes are possible.

Do not inhale ammonia vapors. Fill the DEF tank only in well-ventilated areas.

Low outside temperatures

DEF freezes at a temperature of approximately 12 °F (-11 °C). The vehicle is delivered from the factory equipped with a DEF pre-heating system. Winter operation can thus be guaranteed even at temperatures below 12 °F (-11 °C).

Additives

! Only use DEF in accordance with ISO 22241. Do not use additives with DEF and do not dilute DEF with water. This may destroy the BlueTEC exhaust gas aftertreatment system.

Purity

! Impurities in DEF (e.g. due to other service products, cleaning agents or dust) lead to:

- increased emission values
- damage to the catalytic converter

- engine damage
- malfunctions in the BlueTEC exhaust gas aftertreatment system

Assuring the purity of DEF is particularly important with respect to avoiding malfunctions in the BlueTEC exhaust gas aftertreatment system.

If DEF is pumped out of the DEF tank, e.g. during repair work, it must not be returned to the tank. The purity of the fluid can no longer be guaranteed.

Filling capacities

Model	Total capacity
All models	6.7 US gal (25.5 l)

Engine oil**General notes**

! Never use engine oil or an oil filter of a specification other than is necessary to fulfill the prescribed service intervals. Do not change the engine oil or oil filter in order to achieve longer replacement intervals than those prescribed. You could otherwise cause engine damage or damage to the exhaust gas aftertreatment.

Follow the instructions in the service interval display regarding the oil change. Otherwise, you may damage the engine and the exhaust gas aftertreatment.

When handling engine oil, observe the important safety notes on service products (▷ page 337).

The engine oils are matched to the performance of Mercedes-Benz engines and service intervals. You should therefore only use engine oils and oil filters that are approved for vehicles with maintenance systems.

For a list of approved engine oils and oil filters, consult an authorized Mercedes-Benz Cen-

ter. Or visit the website <http://bevo.mercedes-benz.com>.
The table shows which engine oils have been approved for your vehicle.

Model	MB Approval
All models	229.5

Use only SAE 0W-40 or SAE 5W-40 engine oils for AMG vehicles.

- i** MB approval is indicated on the oil containers.

Filling capacities

The following values refer to an oil change including the oil filter.

Model	Capacity
AMG vehicles	9.0 US qt (8.5 l)
E 550 4MATIC	8.5 US qt (8.0 l)
All other models	6.9 US qt (6.5 l)

Brake fluid

WARNING

The brake fluid constantly absorbs moisture from the air. This lowers the boiling point of the brake fluid. If the boiling point of the brake fluid is too low, vapor pockets may form in the brake system when the brakes are applied hard. This would impair braking efficiency. There is a risk of an accident.

You should have the brake fluid renewed at the specified intervals.

Comply with the important safety notes for service products when handling brake fluid (▷ page 337).

The brake fluid change intervals can be found in the Maintenance Booklet.

Only use brake fluid approved by Mercedes-Benz according to MB Approval 331.0.

Information about approved brake fluid can be obtained at any qualified specialist workshop or on the Internet at <http://bevo.mercedes-benz.com>.

- i** Have the brake fluid regularly replaced at a qualified specialist workshop and the replacement confirmed in the Maintenance Booklet.

Coolant

Important safety notes

WARNING

If antifreeze comes into contact with hot components in the engine compartment, it may ignite. There is a risk of fire and injury.

Let the engine cool down before you add antifreeze. Make sure that antifreeze is not spilled next to the filler neck. Thoroughly clean the antifreeze from components before starting the engine.

- !** Only add coolant that has been premixed with the desired antifreeze protection. You could otherwise damage the engine.

Further information on coolants can be found in the Mercedes-Benz Specifications for Service Products, MB BeVo 310.1, e.g. on the Internet at <http://bevo.mercedes-benz.com>. Or contact a qualified specialist workshop.

- !** Always use a suitable coolant mixture, even in countries where high temperatures prevail.

Otherwise, the engine cooling system is not sufficiently protected from corrosion and overheating.

- i** Have the coolant regularly replaced at a qualified specialist workshop and the replacement confirmed in the Maintenance Booklet.

Comply with the important safety precautions for service products when handling coolant (▷ page 337).

The coolant is a mixture of water and anti-freeze/corrosion inhibitor. It performs the following tasks:

- corrosion protection
- antifreeze protection
- raising the boiling point

If the coolant has antifreeze protection down to -35 °F (-37 °C), the boiling point of the coolant during operation is approximately 266 °F (130 °C).

The antifreeze/corrosion inhibitor concentration in the engine cooling system should:

- be at least 50%. This will protect the engine cooling system against freezing down to approximately -35 °F (-37 °C).
- not exceed 55% (antifreeze protection down to -49 °F [-45 °C]). Otherwise, heat will not be dissipated as effectively.

Mercedes-Benz recommends an antifreeze/corrosion inhibitor concentrate in accordance with MB Specifications for Service Products 3 10.1.

- i** When the vehicle is first delivered, it is filled with a coolant mixture that ensures adequate antifreeze and corrosion protection.
- i** The coolant is checked with every maintenance interval at a qualified specialist workshop.

Filling capacities

Model	Capacity
E 400 E 400 4MATIC	Approx. 10.9 US qt (10.3 l)
E 250 BlueTEC E 250 BlueTEC 4MATIC	Approx. 11.0 US qt (10.4 l)
E 63 AMG E 63 AMG 4MATIC	Approx. 11.4 US qt (10.8 l)

Model	Capacity
E 550 4MATIC E 63 AMG S- MODEL 4MATIC	Approx. 11.5 US qt (10.9 l)
All other models	Approx. 10.1 US qt (9.6 l)

Windshield washer system

Important safety notes

WARNING

Windshield washer concentrate could ignite if it comes into contact with hot engine components or the exhaust system. There is a risk of fire and injury.

Make sure that no windshield washer concentrate is spilled next to the filler neck.

! Do not add distilled or de-ionized water to the washer fluid container. Otherwise, the level sensor may be damaged.

! Only MB SummerFit and MB WinterFit washer fluid should be mixed together. The spray nozzles may otherwise become blocked.

Comply with the important safety notes for service products when handling washer fluid (▷ page 337).

At temperatures above freezing:

- ▶ Fill the washer fluid reservoir with a mixture of water and windshield washer fluid, e.g. MB SummerFit.

Add 1 part MB SummerFit to 100 parts water.

At temperatures below freezing:

- ▶ Fill the washer fluid reservoir with a mixture of water and washer fluid, e.g. MB WinterFit.

For the correct mixing ratio refer to the information on the antifreeze reservoir.

- ① Add windshield washer fluid, e.g. MB SummerFit or MB WinterFit, to the washer fluid all year round.

Climate control system refrigerant

Important safety notes

The climate control system of your vehicle is filled with refrigerant R-134a.

The instruction label regarding the refrigerant type used can be found on the radiator cross member.

- ❗ Only the refrigerant R-134a and the PAG oil approved by Mercedes-Benz may be used. The approved PAG oil may not be mixed with any other PAG oil that is not approved for R-134a refrigerant. Otherwise, the climate control system may be damaged.

Service work, such as topping up refrigerant or replacing components, may only be carried out by a qualified specialist workshop. All applicable regulations must be adhered to, SAE standard J639 included.

Always have work on the climate control system carried out at a qualified specialist workshop.

Refrigerant instruction label



Example: refrigerant instruction label

- ① Warning symbol
 ② Refrigerant filling capacity
 ③ Applicable standards

- ④ PAG oil part number
 ⑤ Type of refrigerant

Warning symbol ① advises you about:

- possible dangers
- having service work carried out at a qualified specialist workshop

Filling capacities

Missing values were not available at time of going to print.

AMG vehicles	Capacity
Refrigerant	22.6 ± 0.4 oz (640 ± 10 g)
PAG oil	

All other models	Capacity
Refrigerant	20.8 ± 0.4 oz (590 ± 10 g)
PAG oil	4.2 oz (120 g)

Vehicle data

General notes

Please note that for the specified vehicle data:

- the heights specified may vary as a result of:
 - tires
 - load
 - condition of the suspension
 - optional equipment
- optional equipment reduces the maximum payload.

Dimensions and weights



Missing values were not available at time of going to print.

Model, Sedan	① Opening height
AMG vehicles	68.7 in - 69.4 in (1744 mm - 1764 mm)
E 550 4MATIC	
All other models	69.4 in (1763 mm)

Missing values were not available at time of going to print.

Model, Wagon	① Max. headroom	② Opening height
AMG vehicles		82.1 in - 82.9 in (2086 mm - 2106 mm)
All other models	75.8 in (1925 mm)	80.6 in (2048 mm)

Missing values were not available at time of going to print.

All models (except AMG vehicles)	
Vehicle length, Sedan	192.1 in (4879 mm)
Vehicle length, Wagon	193.1 in (4905 mm)
Vehicle width including exterior mirrors	81.5 in (2071 mm)
Wheelbase	113.1 in (2874 mm)
Maximum roof load	220 lbs (100 kg)
Maximum trunk load, Sedan	220 lbs (100 kg)
Maximum trunk load, Wagon	

Model, Sedan (except AMG vehicles)	Vehicle height
E 550 4MATIC	
All other models	58.1 in (1477 mm)

Model, Wagon (except AMG vehicles)	Vehicle height
All models	59.4 in (1509 mm)

Model (except AMG vehicles)	Turning radius
E 350 E 400 E 250 BlueTEC	37.0 ft (11.28 m)
All other models	37.7 ft (11.50 m)

Missing values were not available at time of going to print.

AMG vehicles	
Vehicle length, Sedan	192.6 in (4892 mm)
Vehicle length, Wagon	193.1 in (4904 mm)
Vehicle width including exterior mirrors	81.5 in (2071 mm)
Wheelbase	113.1 in (2874 mm)
Maximum roof load	220 lbs (100 kg)
Maximum trunk load, Sedan	
Maximum trunk load, Wagon	

E 63 AMG E 63 AMG S-MODEL	Vehicle height
Sedan	57.1 in (1450 mm)
Wagon	59.1 in (1502 mm)

E 63 AMG 4MATIC E 63 AMG S-MODEL 4MATIC	Vehicle height
Sedan	57.7 in (1466 mm)
Wagon	59.9 in (1522 mm)

