

HYUNDAI



OWNER'S MANUAL

**Operation
Maintenance
Specifications**

All information in this Owner's Manual is current at the time of publication. However, HYUNDAI reserves the right to make changes at any time so that our policy of continual product improvement may be carried out.

This manual applies to all HYUNDAI models and includes descriptions and explanations of optional as well as standard equipment. As a result, you may find material in this manual that does not apply to your specific vehicle.

CAUTION: MODIFICATIONS TO YOUR HYUNDAI

Your HYUNDAI should not be modified in any way. Such modifications may adversely affect the performance, safety or durability of your HYUNDAI and may, in addition, violate conditions of the limited warranties covering the vehicle. Certain modifications may also be in violation of regulations established by the U.S. Department of Transportation and other federal or state agencies.

TWO-WAY RADIO OR CELLULAR TELEPHONE INSTALLATION

Your vehicle is equipped with electronic fuel injection and other electronic components. It is possible for an improperly installed/adjusted two-way radio or cellular telephone to adversely affect electronic systems. For this reason, we recommend that you carefully follow the radio manufacturer's instructions or consult your HYUNDAI dealer for precautionary measures or special instructions if you choose to install one of these devices.

SAFETY AND VEHICLE DAMAGE WARNING

This manual includes information titled as WARNING, CAUTION and NOTICE.
These titles indicate the following:

WARNING

This indicates that a condition may result in harm, serious injury or death to you or other persons if the warning is not heeded. Follow the advice provided with the warning.

CAUTION

This indicates that a condition may result in damage to your vehicle or its equipment if the caution is not heeded. Follow the advice provided with the caution.

*** NOTICE**

This indicates that interesting or helpful information is being provided.

FOREWORD

Thank you for choosing HYUNDAI. We are pleased to welcome you to the growing number of discriminating people who drive HYUNDAI. The advanced engineering and high-quality construction of each HYUNDAI we build is something of which we're very proud.

Your Owner's Manual will introduce you to the features and operation of your new HYUNDAI. It is suggested that you read it carefully because the information it contains can contribute greatly to the satisfaction you receive from your new car.

The manufacturer also recommends that all service and maintenance on your car be performed by an authorized HYUNDAI dealer. HYUNDAI dealers are prepared to provide high-quality service, maintenance and any other assistance that may be required.

HYUNDAI MOTOR AMERICA

Note : Because future owners will also need the information included in this manual, if you sell this HYUNDAI, please leave the manual in the vehicle for their use. Thank you.

CAUTION

Severe engine and transaxle damage may result from the use of poor quality fuels and lubricants that do not meet HYUNDAI specifications. You must always use high quality fuels and lubricants that meet the specifications listed on Page 8-4 in the Vehicle Specifications section of the Owner's Manual.

Copyright 2015 HYUNDAI Motor America. All rights reserved. No part of this publication may be reproduced, stored in any retrieval system or transmitted in any form or by any means without the prior written permission of HYUNDAI Motor America.

GUIDE TO HYUNDAI GENUINE PARTS

1. What are HYUNDAI Genuine Parts?

HYUNDAI Genuine Parts are the same parts used by HYUNDAI Motor Company to manufacture vehicles. They are designed and tested for the optimum safety, performance, and reliability to our customers.



2. Why should you use genuine parts?

HYUNDAI Genuine Parts are engineered and built to meet rigid manufacturing requirements.

Damage caused by using imitation, counterfeit or used salvage parts is not covered under the HYUNDAI New Vehicle Limited Warranty or any other HYUNDAI warranty.

In addition, any damage to or failure of HYUNDAI Genuine Parts caused by the installation or failure of an imitation, counterfeit or used salvage part is not covered by any HYUNDAI Warranty.



3. How can you tell if you are purchasing HYUNDAI Genuine Parts?

Look for the HYUNDAI Genuine Parts Logo on the package (see below).

HYUNDAI Genuine Parts exported to the U.S. are packaged with labels written only in English.

HYUNDAI Genuine Parts are only sold through authorized HYUNDAI Dealerships.

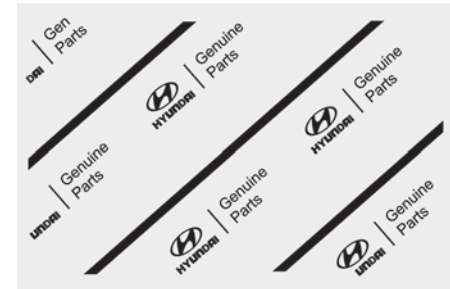

TABLE OF CONTENTS

Introduction

How to use this manual / Fuel requirements / Vehicle break-in process / Vehicle data collection and event data recorders

1

Your vehicle at a glance

Exterior overview / Interior overview / Instrument panel overview / Engine compartment

2

Safety features of your vehicle

Seats / Seat belts / Child restraint system / Air bag

3

Features of your vehicle

Keys / Door locks / Trunk / Windows / Hood / Fuel filler lid / Sunroof / Steering wheel / Mirrors / Instrument cluster / Lighting / Wipers & Washers / Climate control system / Audio system / Etc.

4

Driving your vehicle

Before driving / Engine start/stop button / Transaxle / Brake system / Cruise control system / Active ECO system / Winter driving / Vehicle load limit / Etc.

5

What to do in an emergency

Road warning / Emergency while driving / Emergency starting / Engine overheat / TPMS / Flat tire / Towing / Etc.

6

Maintenance

Engine compartment / Maintenance service / Engine oil / Engine coolant / Brake fluid / Washer fluid / Parking brake / Air cleaner / Wiper blades / Battery / Tire and wheels / Fuses / Light bulbs / Etc.

7

Specifications, Consumer information and Reporting safety defects

8

Index

I

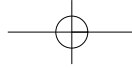

Introduction

1

- How to use this manual 1-2**
- Fuel requirements 1-3**
 - Gasoline containing alcohol and methanol 1-3
 - Other fuels 1-4
 - Gasoline containing MMT 1-4
 - Do not use methanol 1-4
 - Fuel Additives 1-4
- Vehicle break-in process 1-5**
- Vehicle data collection and event data recorders . 1-6**

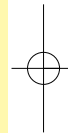
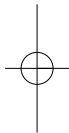

Information Provided by:

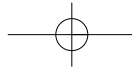

Introduction

HOW TO USE THIS MANUAL

We want to help you get the greatest possible driving pleasure from your vehicle. Your Owner's Manual can assist you in many ways. We strongly recommend that you read the entire manual. In order to minimize the chance of death or injury, you must read the WARNING and CAUTION sections in this manual.

Illustrations complement the words in this manual to best explain how to enjoy your vehicle. By reading your manual, you will learn about features, important safety information, and driving tips under various road conditions.

The general layout of the manual is provided in the Table of Contents. A good place to start is the index; it has an alphabetical listing of all information in your manual.

Sections: This manual has eight chapters plus an index. Each chapter begins with a brief list of contents so you can tell at a glance if that chapter has the information you want.

You will find various WARNINGS, CAUTIONS, and NOTICES in this manual. These WARNINGS were prepared to enhance your personal safety. You should carefully read and follow ALL procedures and recommendations provided in these WARNINGS, CAUTIONS and NOTICES.

WARNING

A WARNING indicates a situation in which harm, serious bodily injury, or death could result if the warning is ignored.

CAUTION

A CAUTION indicates a situation in which damage to your vehicle could result if the caution is ignored.

*** NOTICE**

A NOTICE indicates interesting or helpful information is being provided.

FUEL REQUIREMENTS

Your new vehicle is designed to use only unleaded fuel having a pump octane number $((R+M)/2)$ of 87 or higher. (Do not use methanol blended fuels.)

Your new vehicle is designed to obtain maximum performance with UNLEADED FUEL, as well as minimize exhaust emissions and spark plug fouling.

CAUTION

Never add any fuel system cleaning agents to the fuel tank other than what has been specified. (Consult an authorized HYUNDAI dealer for details.)

WARNING

- Do not "top off" after the nozzle automatically shuts off when refueling.
- Always check that the fuel cap is installed securely to prevent fuel spillage in the event of an accident.

Gasoline containing alcohol and methanol

Gasohol, a mixture of gasoline and ethanol (also known as grain alcohol), and gasoline or gasohol containing methanol (also known as wood alcohol) are being marketed along with or instead of leaded or unleaded gasoline.

Do not use gasohol containing more than 10% ethanol, and do not use gasoline or gasohol containing any methanol. Either of these fuels may cause drivability problems and damage to the fuel system, engine control system and emission control system.

Discontinue using gasohol of any kind if drivability problems occur.

Vehicle damage or drivability problems may not be covered by the manufacturer's warranty if they result from the use of:

1. Gasohol containing more than 10% ethanol.
2. Gasoline or gasohol containing methanol.
3. Leaded fuel or leaded gasohol.

"E85" fuel is an alternative fuel comprised of 85 percent ethanol and 15 percent gasoline, and is manufactured exclusively for use in Flexible Fuel Vehicles. "E85" is not compatible with your vehicle. Use of "E85" may result in poor engine performance and damage to your vehicle's engine and fuel system. HYUNDAI recommends that customers do not use fuel with an ethanol content exceeding 10 percent.

CAUTION

Your New Vehicle Limited Warranty does not cover damage to the fuel system or any performance problems caused by the use of "E85" fuel.

CAUTION

Never use gasohol which contains methanol. Discontinue use of any gasohol product which impairs driveability.

Introduction

Other fuels

Using fuels such as,

- Silicone (Si) contained fuel,
- Ferrocene (Fe) contained fuel, and
- Other metallic additives contained fuels,

may cause vehicle and engine damage. Also the Malfunction Indicator Lamp (MIL) may illuminate or cause plugging, misfiring, poor acceleration, engine stalling, catalyst melting, abnormal corrosion, life cycle reduction, etc.

*** NOTICE**

Damage to the fuel system or performance problem caused by the use of these fuels may not be covered by your New Vehicle Limited Warranty.

Gasoline containing MMT

Some gasoline contains harmful manganese-based fuel additives such as MMT (Methylcyclopentadienyl Manganese Tricarbonyl).

HYUNDAI does not recommend the use of gasoline containing MMT.

This type of fuel can reduce vehicle performance and affect your emission control system.

The malfunction indicator lamp on the cluster may come on.

Do not use methanol

Fuels containing methanol (wood alcohol) should not be used in your vehicle. This type of fuel can reduce vehicle performance and damage components of the fuel system, engine control system and emission control system.

⚠ CAUTION

Your New Vehicle Limited Warranty may not cover damage to the fuel system and any performance problems that are caused by the use of fuels containing methanol.

Fuel Additives

HYUNDAI recommends that you use good quality gasolines treated with detergent additives such as TOP TIER Detergent Gasoline, which help prevent deposit formation in the engine. These gasolines will help the engine run cleaner and enhance performance of the Emission Control System. For more information on TOP TIER Detergent Gasoline, please go to the website (www.toptiergas.com).

For customers who do not use TOP Tier Detergent Gasoline regularly, and have problems starting or the engine does not run smoothly, additives that you can buy separately may be added to the gasoline. If TOP TIER Detergent Gasoline is not available, one bottle of additive added to the fuel tank at every 7,500 miles or every engine oil change is recommended. Additives are available from your authorized HYUNDAI dealer along with information on how to use them. Do not mix other additives.

VEHICLE BREAK-IN PROCESS

Operation in foreign countries

If you are going to drive your vehicle in another country, be sure to:

- Observe all regulations regarding registration and insurance.
- Determine that acceptable fuel is available.

No special break-in period is needed. By following a few simple precautions for the first 600 miles (1,000 km) you may add to the performance, economy and life of your vehicle.

- Do not race the engine.
- While driving, keep your engine speed (rpm, or revolutions per minute) between 2,000 rpm and 4,000 rpm.
- Do not maintain a single speed for long periods of time, either fast or slow. Varying engine speed is needed to properly break-in the engine.
- Avoid hard stops, except in emergencies, to allow the brakes to seat properly.

▲ CALIFORNIA PROPOSITION 65 WARNING

Items contained in motor vehicles or emitted from them are known to the State of California to cause cancer and birth defects or reproductive harm.

These include:

- Gasoline and its vapors
- Engine exhaust
- Used engine oil
- Interior passenger compartment components and materials
- Component parts which are subject to heat and wear

In addition, battery posts, terminals and related accessories contain lead, lead compounds and other chemicals known to the State of California to cause cancer and reproductive harm.

Introduction

VEHICLE DATA COLLECTION AND EVENT DATA RECORDERS

This vehicle is equipped with an event data recorder (EDR). The main purpose of an EDR is to record, in certain crash or near crash-like situations, such as an air bag deployment or hitting a road obstacle, data that will assist in understanding how a vehicle's systems performed. The EDR is designed to record data related to vehicle dynamics and safety systems for a short period of time, typically 30 seconds or less. The EDR in this vehicle is designed to record such data as:

- How various systems in your vehicle were operating;
- Whether or not the driver and passenger safety belts were buckled/fastened;
- How far (if at all) the driver was depressing the accelerator and/or brake pedal; and,
- How fast the vehicle was traveling.

These data can help provide a better understanding of the circumstances in which crashes and injuries occur. **NOTE:** EDR data are recorded by your vehicle only if a non-trivial crash situation occurs; no data are recorded by the EDR under normal driving conditions and no personal data (e.g., name, gender, age, and crash location) are recorded. However, other parties, such as law enforcement, could combine the EDR data with the type of personally identifying data routinely acquired during a crash investigation.

To read data recorded by an EDR, special equipment is required, and access to the vehicle or the EDR is needed. In addition to the vehicle manufacturer, other parties, such as law enforcement, that have the special equipment, can read the information if they have access to the vehicle or the EDR.

Your vehicle at a glance

| | |
|---------------------------------|-----|
| Exterior overview (front)..... | 2-2 |
| Exterior overview (rear) | 2-3 |
| Interior overview | 2-4 |
| Instrument panel overview | 2-5 |
| Engine compartment | 2-6 |

EXTERIOR OVERVIEW I

■ Front

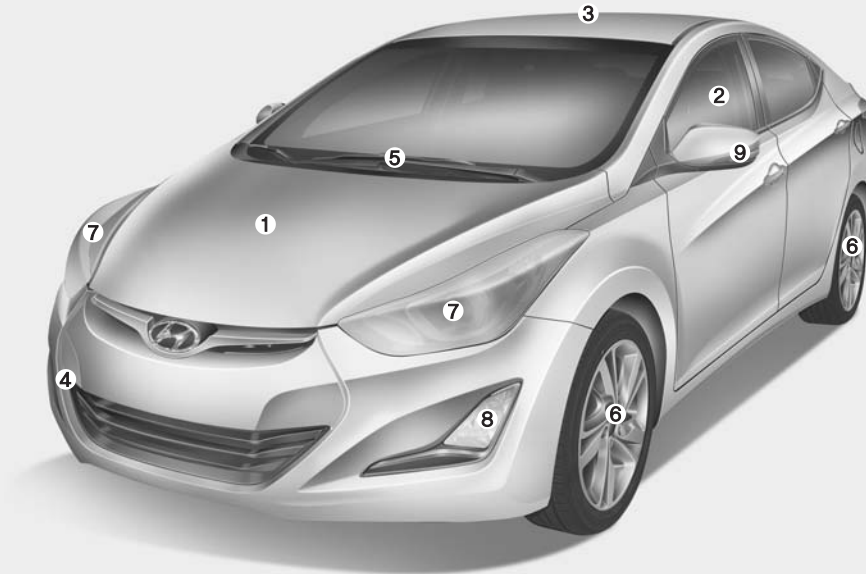

| | | | |
|---------------------------------|------|------------------------------|------|
| 1. Hood..... | 4-29 | 6. Tires and wheels | 7-47 |
| 2. Windows..... | 4-24 | 7. Headlight | 7-76 |
| 3. Sunroof* | 4-34 | 8. Fog light* | 7-80 |
| 4. Removable towing hook* | 6-29 | 9. Side repeater light*..... | 7-80 |
| 5. Wiper blade | 7-41 | *: if equipped | |

OMD014005N

EXTERIOR OVERVIEW II

■ Rear

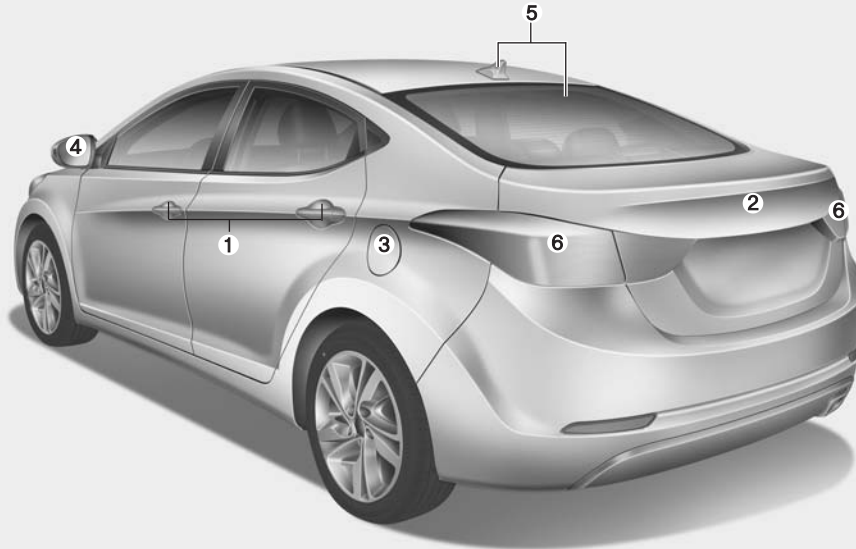

- | | | | |
|--------------------------|------|----------------------------------|-------|
| 1. Door lock | 4-14 | 4. Outside rearview mirror | 4-48 |
| 2. Trunk..... | 4-21 | 5. Antenna | 4-120 |
| 3. Fuel filler lid | 4-31 | 6. Rear combination lamp | 7-81 |

OMD014006N

INTERIOR OVERVIEW

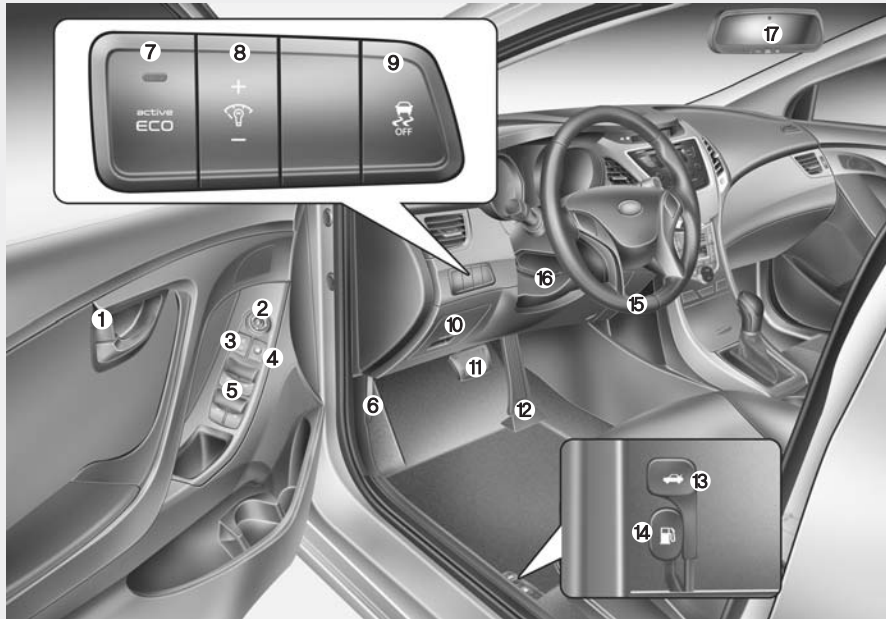

1. Inside door handle.....4-16
 2. Outside rearview mirror control switch*4-49
 3. Central door lock switch4-17
 4. Power window lock switch*4-27
 5. Power window switches.....4-24
 6. Hood release lever4-29
 7. Active ECO5-41
 8. Instrument panel illumination.....4-52
 9. ESC (Electronic Stability Control) OFF button5-34
 10. Fuse box.....7-64
 11. Brake pedal5-29
 12. Accelerator pedal5-8, 5-15
 13. Trunk lid release lever.....4-21
 14. Fuel filler door opener4-31
 15. Steering wheel.....4-38
 16. Steering wheel tilt lever4-39
 17. Inside rearview mirror.....4-42
- *: if equipped

OMD014001N

INSTRUMENT PANEL OVERVIEW



- 1. Instrument cluster4-51
 - 2. Horn.....4-41
 - 3. Driver's front air bag3-47
 - 4. Light control/Turn signals4-72, 4-75
 - 5. Wiper/Washer4-81
 - 6. Key ignition switch*/
Engine start/stop button*5-5, 5-9
 - 7. Cruise control switch*5-43
 - 8. Audio remote control*4-121
 - 9. Digital clock4-113
 - 10. Audio controls*4-135, 4-187
 - 11. Hazard warning flasher switch6-2
 - 12. Climate control system.....4-84, 4-94
 - 13. Shift lever5-18, 5-22
 - 14. Parking brake5-30
 - 15. Passenger's front air bag.....3-47
 - 16. Glove box.....4-111
 - 17. Seat warmer*3-19
 - 18. Cup holder4-115
- * : if equipped

* The actual instrument panel in the vehicle may differ from the illustration.

OMD014002N

ENGINE COMPARTMENT

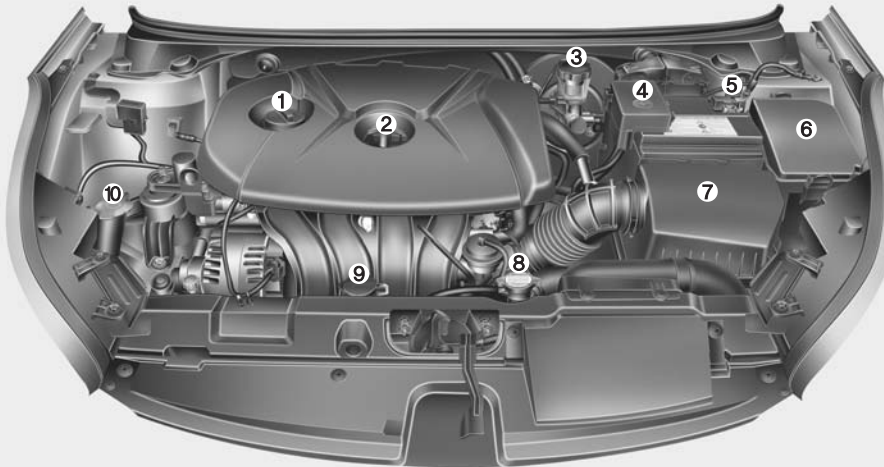

- 1. Engine oil filler cap7-31
- 2. Engine oil dipstick.....7-30
- 3. Brake/clutch fluid reservoir7-35
- 4. Positive battery terminal7-43
- 5. Negative battery terminal7-43
- 6. Fuse box.....7-66
- 7. Air cleaner7-37
- 8. Radiator cap7-32
- 9. Engine coolant reservoir.....7-33
- 10. Windshield washer fluid reservoir....7-36

※ The actual engine compartment in the vehicle may differ from the illustration.

OMD070047N

Safety features of your vehicle

- Important safety precautions 3-2
 - Always wear your seat belt 3-2
 - Restrain all children 3-2
 - Air bag hazards 3-2
 - Driver distraction 3-2
 - Control your speed 3-3
 - Keep your vehicle in safe condition 3-3
- Seats 3-4
 - Safety precautions 3-5
 - Front seats 3-6
 - Rear seats 3-12
 - Headrest 3-15
 - Seat warmers 3-19
- Seat belts 3-21
 - Seat belt safety precautions 3-21
 - Seat belt warning light 3-22
 - Seat belt restraint system 3-23
 - Additional seat belt safety precautions 3-29
 - Care of seat belts 3-32
- Child restraint system (CRS) 3-34
 - Selecting a Child Restraint System (CRS) 3-35
 - Installing a Child Restraint System (CRS) 3-37

- Air bag - advanced supplemental restraint system 3-45
 - Where are the air bags? 3-47
 - SRS components and functions 3-50
 - What to expect after an air bag inflates 3-54
 - Occupant Classification System (OCS) 3-55
 - Why Didn't My Air Bag Go Off in a Collision? ... 3-60
 - SRS care 3-65
 - Additional safety precautions 3-66
 - Air bag warning labels 3-67

IMPORTANT SAFETY PRECAUTIONS

You will find many safety precautions and recommendations throughout this section, and throughout this manual. The safety precautions in this section are among the most important.

Always wear your seat belt

A seat belt is your best protection in all types of accidents. Air bags are designed to supplement seat belts, not replace them. So even though your vehicle is equipped with air bags, ALWAYS make sure you and your passengers wear your seat belts, and wear them properly.

Restrain all children

All children under age 13 should ride in your vehicle properly restrained in a rear seat, not the front seat. Infants and small children should be restrained in an appropriate child restraint. Larger children should use a booster seat with the lap/shoulder belt until they can use the seat belt properly without a booster seat.

Air bag hazards

While air bags can save lives, they can also cause serious or fatal injuries to occupants who sit too close to them, or who are not properly restrained. Infants, young children, and shorter adults are at the greatest risk of being injured by an inflating air bag. Follow all instructions and warnings in this manual.

Driver distraction

Driver distraction presents a serious and potentially deadly danger, especially for inexperienced drivers. Safety should be the first concern when behind the wheel and drivers need to be aware of the wide array of potential distractions, such as drowsiness, reaching for objects, eating, personal grooming, other passengers, and using cellular phones, to name a few.

Drivers can become distracted when they take their eyes and attention off the road or their hands off the wheel to focus on activities other than driving. To reduce your risk of distraction or getting into an accident:

- ALWAYS set up your mobile devices (i.e., MP3 players, phones, navigation units, etc.) when your vehicle is parked or safely stopped.
- ONLY use your mobile device when allowed by laws and when conditions permit safe use. NEVER text or email while driving. Most states have laws prohibiting drivers from texting. Some states and cities also prohibit drivers from using handheld phones.

- NEVER let the use of a mobile device distract you from driving. You have a responsibility to your passengers and others on the road to always drive safely, with your hands on the wheel as well as your eyes and attention on the road.

Control your speed

Excessive speed is a major factor in crash injuries and deaths. Generally, the higher the speed, the greater the risk, but serious injuries can also occur at lower speeds. Never drive faster than is safe for current conditions, regardless of the maximum speed posted.

Keep your vehicle in safe condition

Having a tire blowout or a mechanical failure can be extremely hazardous. To reduce the possibility of such problems, check your tire pressures and condition frequently, and perform all regularly scheduled maintenance.

SEATS

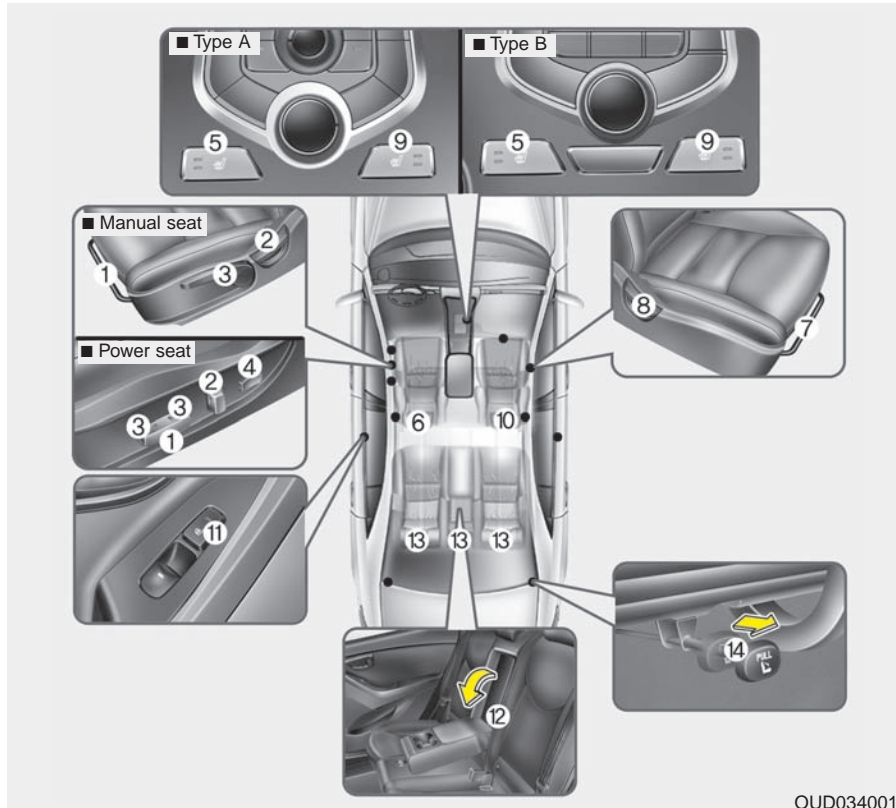

OULD034001N

Driver's seat

- (1) Seat adjustment, forward/rearward
- (2) Seatback recliner
- (3) Seat adjustment, height
- (4) Lumbar support*
- (5) Seat warmer*
- (6) Headrest adjustment

Front passenger seat

- (7) Seat adjustment, forward/rearward
- (8) Seatback recliner
- (9) Seat warmer*
- (10) Headrest adjustment

Rear seat

- (11) Seat warmer*
 - (12) Armrest
 - (13) Headrest adjustment
 - (14) Seat back folding knob (trunk)*
- * : if equipped

Safety precautions

Adjusting the seats so that you are sitting in a safe, comfortable position plays an important role in driver and passenger safety together with the seat belts and air bags in an accident.

WARNING

Do not use a cushion that reduces friction between the seat and the passenger. The passenger's hips may slide under the lap portion of the seat belt during an accident or a sudden stop. Serious or fatal internal injuries could result because the seat belt cannot operate normally.

Air bags

You can take steps to reduce the risk of being injured by an inflating air bag. Sitting too close to an air bag greatly increases the risk of injury in the event the air bag inflates.

The National Highway Traffic Safety Administration (NHTSA) recommends that drivers allow at least 10 inches (25 cm) between the center of the steering wheel and their chest.

WARNING

To reduce the risk of serious injury or death from an inflating air bag, take the following precautions:

- **Adjust the driver's seat as far to the rear as possible while maintaining the ability to maintain full control of the vehicle.**
- **Adjust the front passenger seat as far to the rear as possible.**
- **Hold the steering wheel by the rim with hands at the 9 o'clock and 3 o'clock positions to minimize the risk of injuries to your hands and arms.**
- **NEVER place anything or anyone between the steering wheel and the air bag.**
- **Do not allow the front passenger to place feet or legs on the dashboard to minimize the risk of leg injuries.**

Seat belts

Always fasten your seat belt before starting any trip.

At all times, passengers should sit upright and be properly restrained. Infants and small children must be restrained in appropriate child restraint systems. Children who have outgrown a booster seat and adults must be restrained using the seat belts.

⚠ WARNING

Take the following precautions when adjusting your seat belt:

- NEVER use one seat belt for more than one occupant.
- Always position the seatback upright with the lap portion of the seat belt snug and low across the hips.
- NEVER allow children or small infants to ride in a passenger's lap.
- Do not route the seat belt across your neck, across sharp edges, or reroute the shoulder strap away from your body.
- Do not allow the seat belt to become caught or jammed.

Front seats

⚠ WARNING

Take the following precautions when adjusting your seat:

- NEVER attempt to adjust the seat while the vehicle is moving. The seat could respond with unexpected movement and may cause loss of vehicle control resulting in an accident.
- Do not place anything under the front seats. Loose objects in the driver's foot area could interfere with the operation of the foot pedals, causing an accident.
- Do not allow anything to interfere with the normal position and proper locking of the seatback.
- Do not place a cigarette lighter on the floor or seat. When you operate the seat, gas may exit out of the lighter causing a fire.

⚠ WARNING

To prevent injury:

- Do not adjust your seat while wearing your seat belt. Moving the seat cushion forward may cause strong pressure on your abdomen.
- Do not allow your hands or fingers to get caught in the seat mechanisms while the seat is moving.

Manual adjustment

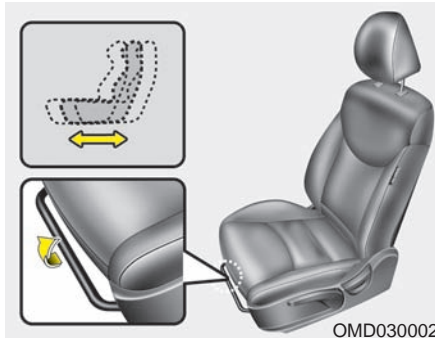

Forward and rearward adjustment

To move the seat forward or rearward:

1. Pull up the seat slide adjustment lever and hold it.
2. Slide the seat to the position you desire.
3. Release the lever and make sure the seat is locked in place. Move forward and rearward without using the lever. If the seat moves, it is not locked properly.

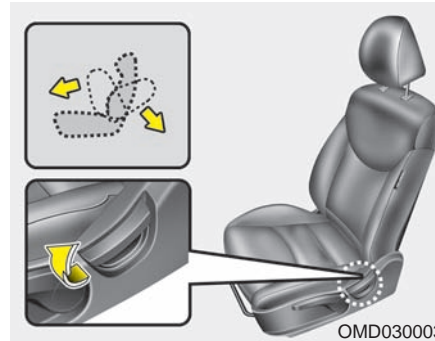

Seatback angle

To recline the seatback:

1. Lean forward slightly and lift up the seatback lever.
2. Carefully lean back on the seat and adjust the seatback to the position you desire.
3. Release the lever and make sure the seatback is locked in place. (The lever **MUST** return to its original position for the seatback to lock.)

Reclining seatback

Sitting in a reclined position when the vehicle is in motion can be dangerous. Even when buckled up, the protection of your restraint system (seat belts and air bags) is greatly reduced by reclining your seatback.

⚠ WARNING

NEVER ride with a reclined seatback when the vehicle is moving.

Riding with a reclined seatback increases your chance of serious or fatal injuries in the event of a collision or sudden stop.

Drivers and passengers should ALWAYS sit well back in their seats, properly belted, and with the seatbacks upright.

Seat belts must be snug against your hips and chest to work properly. When the seatback is reclined, the shoulder belt cannot do its job because it will not be snug against your chest. Instead, it will be in front of you. During an accident, you could be thrown into the seat belt, causing neck or other injuries.

The more the seatback is reclined, the greater chance the passenger's hips will slide under the lap belt or the passenger's neck will strike the shoulder belt.

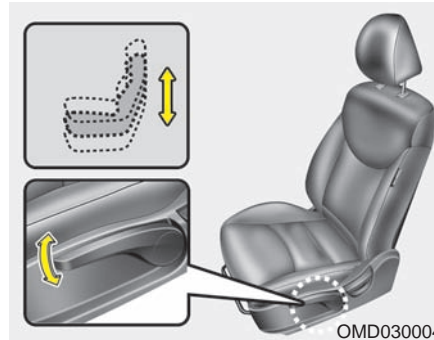

Seat cushion height (for driver's seat)

To change the height of the seat cushion:

- Push down on the lever several times, to lower the seat cushion.
- Pull up on the lever several times, to raise the seat cushion.

Power adjustment

The front seat can be adjusted by using the control switches located on the outside of the seat cushion. Before driving, adjust the seat to the proper position so that you can easily control the steering wheel, foot pedals and controls on the instrument panel.

⚠ WARNING

NEVER allow children in the vehicle unattended. The power seats are operable when the engine is turned off.

⚠ WARNING

To prevent damage to the seats:

- Always stop adjusting the seats when the seat has been adjusted as far forward or rearward as possible.
- Do not adjust the seats longer than necessary when the engine is turned off. This may result in unnecessary battery drain.
- Do not operate two or more seats at the same time. This may result in an electrical malfunction.

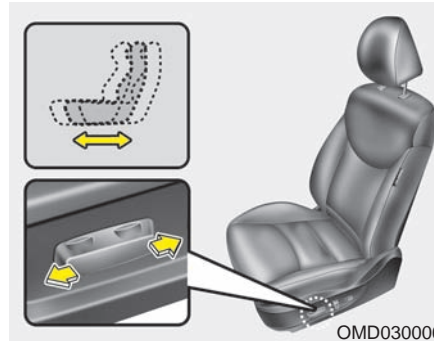

Forward and rearward adjustment

To move the seat forward or rearward:

1. Push the control switch forward or rearward.
2. Release the switch once the seat reaches the desired position.

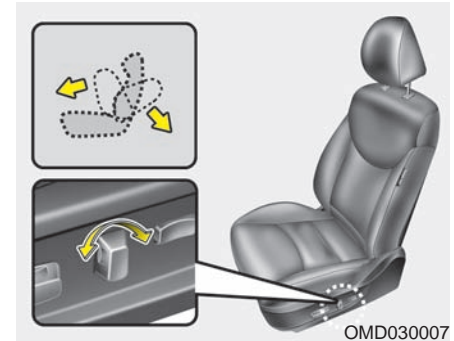

Seatback angle

To recline the seatback:

1. Push the control switch forward or rearward.
2. Release the switch once the seatback reaches the desired position.

Reclining seatback

Sitting in a reclined position when the vehicle is in motion can be dangerous. Even when buckled up, the protections of your restraint system (seat belts and air bags) is greatly reduced by reclining your seatback.

⚠ WARNING

NEVER ride with a reclined seatback when the vehicle is moving.

Riding with a reclined seatback increases your chance of serious or fatal injuries in the event of a collision or sudden stop.

Drivers and passengers should **ALWAYS** sit well back in their seats, properly belted, and with the seatbacks upright.

Seat belts must be snug against your hips and chest to work properly. When the seatback is reclined, the shoulder belt cannot do its job because it will not be snug against your chest. Instead, it will be in front of you. During an accident, you could be thrown into the seat belt, causing neck or other injuries.

The more the seatback is reclined, the greater chance the passenger's hips will slide under the lap belt or the passenger's neck will strike the shoulder belt.

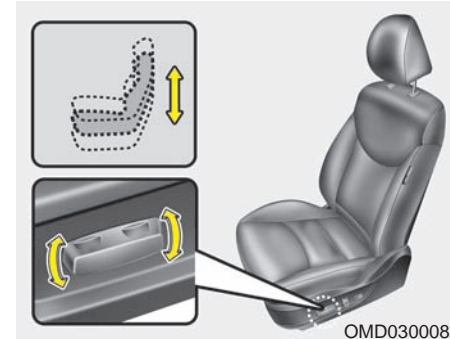

Seat cushion height (for driver's seat)

To change the height of the seat cushion:

1. Pull the front portion of the control switch up to raise or push down to lower the front part of the seat cushion. Pull the rear portion of the control switch up to raise or push down to lower the rear part of the seat cushion.
2. Release the switch once the seat reaches the desired position.

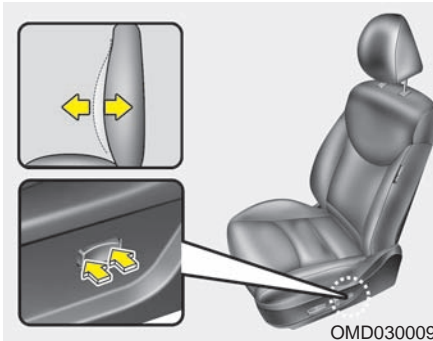

**Lumbar support
(for driver's seat, if equipped)**

To adjust the lumbar support:

1. Press the front portion of the switch to increase support or the rear portion of the switch to decrease support.
2. Release the switch once it reaches the desired position.

Seatback pocket

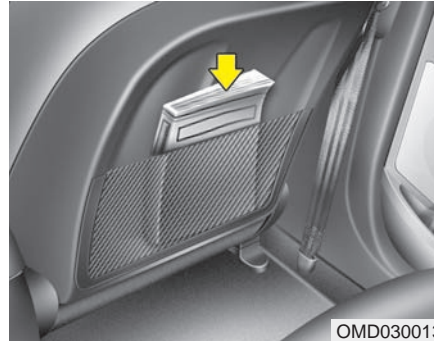

The seatback pocket is provided on the back of the front seatbacks.

⚠ WARNING

Do not put heavy or sharp objects in the seatback pockets. In an accident they could come loose from the pocket and injure occupants.

⚠ WARNING

To prevent the occupant classification system from malfunctioning:

- Do not place any items total weighing over 2.2 lbs (1 kg) in the seatback pocket on the passenger's seat.
- Do not hang onto the front passenger's seatback.

Rear seats

Folding the rear seat

The rear seatbacks can be folded to facilitate carrying long items or to increase the luggage capacity of the vehicle.

⚠ WARNING

- Never allow passengers to sit on top of the folded down seatback while the vehicle is moving. This is not a proper seating position and no seat belts are available for use. This could result in serious injury or death in case of an accident or sudden stop.
- Objects carried on the folded down seatback should not extend higher than the top of the front seatbacks. This could allow cargo to slide forward and cause injury or damage during sudden stops.

To fold down the rear seatback:

1. Set the front seatback to the upright position and if necessary, slide the front seat forward.
2. Lower the rear headrests to the lowest position.

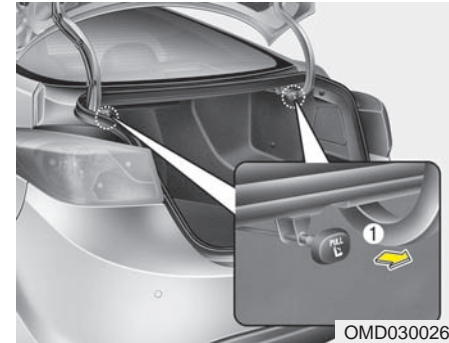

3. Pull on the seatback folding lever located in the trunk.



4. Fold the seatback toward the front of the vehicle.
5. To use the rear seat, lift and pull the seatback rearward. Pull the seatback firmly until it clicks into place. Make sure the seatback is locked in place.

When you return the seatback to its upright position, always be sure it has locked into position by pushing on the top of the seatback.

6. Return the rear seat belt to the proper position.

⚠ WARNING

When returning the rear seatback from a folded to an upright position, hold the seatback and return it slowly. Ensure that the seatback is completely locked into its upright position by pushing on the top of the seatback. In an accident or sudden stop, the unlocked seatback could allow cargo to move forward with great force and enter the passenger compartment, which could result in serious injury or death.

⚠ WARNING

Do not place objects in the rear seats, since they cannot be properly secured and may hit vehicle occupants in a collision causing serious injury or death.

⚠ WARNING

Make sure the engine is off, the shift lever is in P (Park), and the parking brake is securely applied whenever loading or unloading cargo. Failure to take these steps may allow the vehicle to move if the shift lever is inadvertently moved to another position.

Armrest

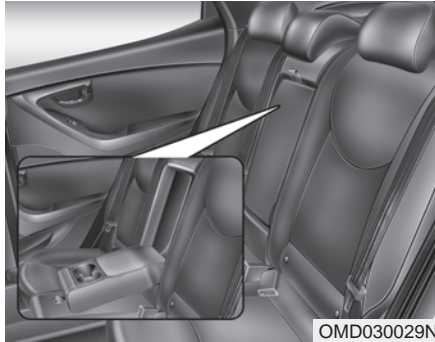

The armrest is located in the center of the rear seat. Pull the armrest down from the seatback to use it. You will find cup holders on the center armrest.

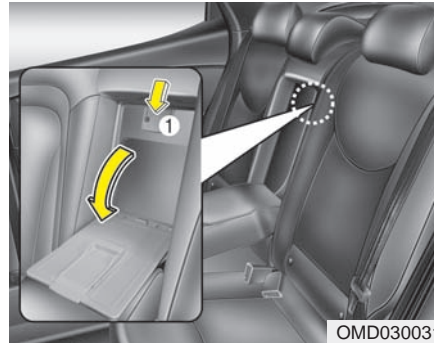

Carrying long/narrow cargo (if equipped)

Pull the armrest down using the strap provided on the armrest. Pull the cover down while pushing the release lever (1) down. Additional cargo space is provided to accommodate long/narrow cargo (skis, poles, lumber, etc.) not able to fit properly in the trunk when closed.

⚠ CAUTION

- ***Make sure the engine is off, the transaxle is in P and the parking brake is applied whenever loading or unloading cargo. Vehicle may move if shift lever is inadvertently moved to another position.***
- ***Be careful when loading cargo through the rear passenger seats to prevent damage to the vehicle interior.***
- ***When cargo is loaded through the rear passenger seats, ensure the cargo is properly secured to prevent it from moving while driving.***

Unsecured cargo in the passenger compartment can cause damage to the vehicle or injury to it's occupants.

Headrest

The vehicle's front and rear seats have adjustable headrests. The headrests provide comfort for passengers, but more importantly they are designed to help protect passengers from whiplash and other neck and spinal injuries during an accident, especially in a rear impact collision.

⚠️ WARNING

To reduce the risk of serious injury or death in an accident, take the following precautions when adjusting your headrests:

- Always properly adjust the headrests for all passengers **BEFORE** starting the vehicle.
- **NEVER** let anyone ride in a seat with the headrest removed.

(Continued)

(Continued)

- **Adjust the headrests so the middle of the headrests is at the same height as the height of the top of the eyes.**

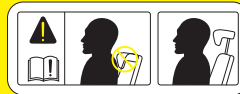

- **NEVER** adjust the headrest position of the driver's seat when the vehicle is in motion.
- **Adjust the headrest as close to the passenger's head as possible. Do not use a seat cushion that holds the body away from the seatback.**
- **Make sure the headrest locks into position after adjusting it.**

⚠️ WARNING

To prevent damage, **NEVER** hit or pull on the headrests.

Front seat headrest

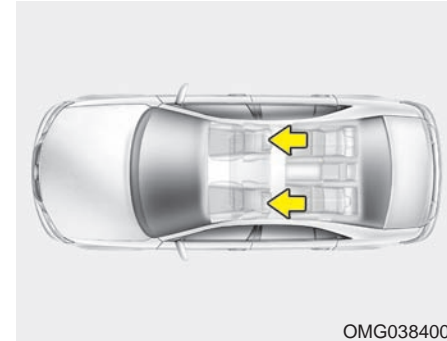

OMG038400

The driver's and front passenger's seats are equipped with adjustable headrests for the passengers safety and comfort.

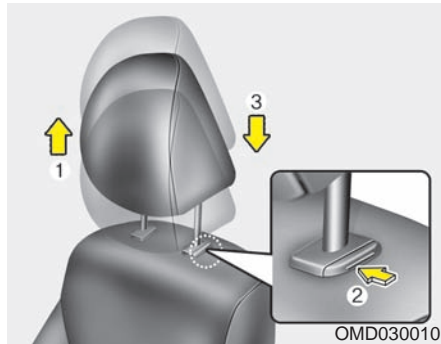

Adjusting the height up and down

To raise the headrest:

1. Pull it up to the desired position (1).

To lower the headrest:

1. Push and hold the release button (2) on the headrest support.
2. Lower the headrest to the desired position (3).

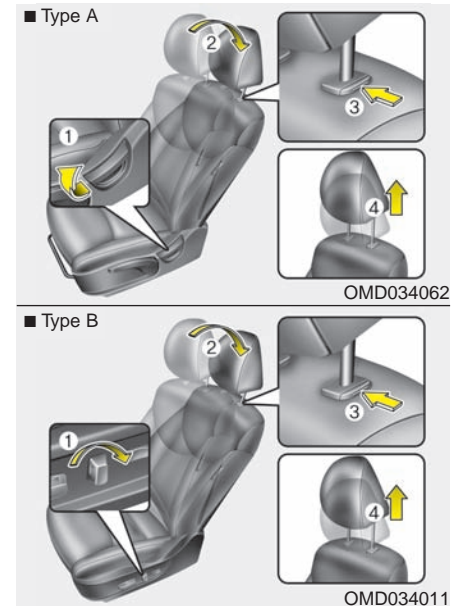
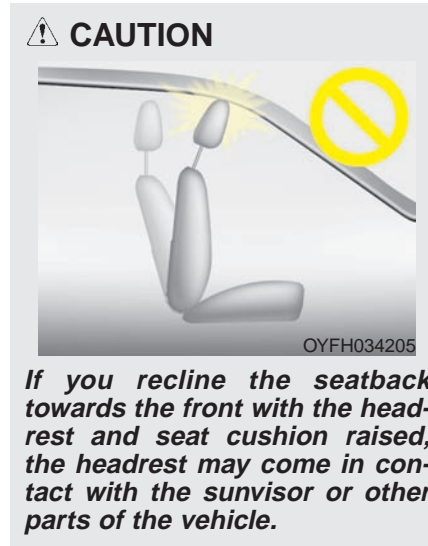

Removal/Reinstall

To remove the headrest:

1. Recline the seatback (2) with the recline lever or switch (1).
2. Raise headrest as far as it can go.
3. Press the headrest release button (3) while pulling the headrest up (4).

⚠ WARNING

NEVER allow anyone to ride in a seat with the headrest removed.

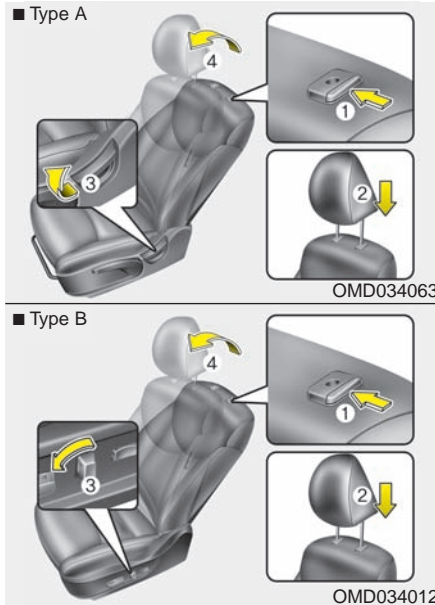

⚠ WARNING

Always make sure the headrest locks into position after re-installing and adjusting it properly.

To reinstall the headrest :

1. Put the headrest poles (2) into the holes while pressing the release button (1).
2. Recline the seatback (4) with the recline lever or switch (3).
3. Adjust the headrest to the appropriate height.

Rear seat headrest

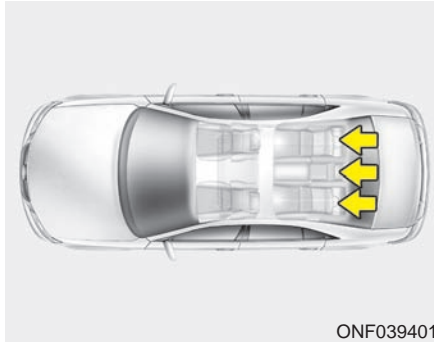

The rear seats are equipped with headrests in all the seating positions for the passenger's safety and comfort.

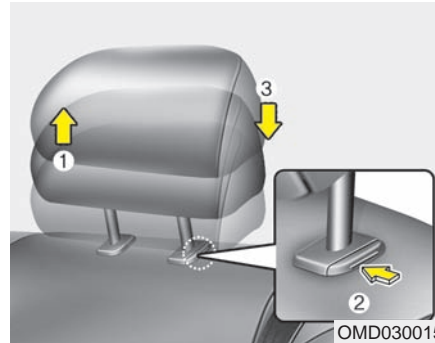

Adjusting the height up and down

To raise the headrest:

1. Pull it up to the desired position (1).

To lower the headrest:

1. Push and hold the release button (2) on the headrest support.
2. Lower the headrest to the desired position (3).

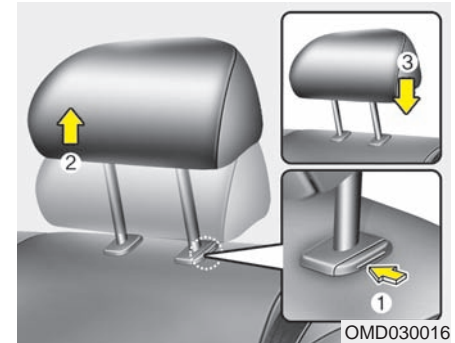

Removal/Reinstall

To remove the headrest:

1. Raise the headrest as far as it can go.
2. Press the release button (1) while pulling the headrest up (2).

⚠ WARNING
NEVER allow anyone to ride in a seat with the headrest removed.

To reinstall the headrest:

1. Recline the seatback.
2. Put the headrest poles (3) into the holes while pressing the release button (1).
3. Adjust the headrest to the appropriate height.

⚠ WARNING

Always make sure the headrest locks into position after reinstalling and adjusting it to properly protect the occupants.

Seat warmers

Seat warmers are provided to warm the seats during cold weather.

⚠ WARNING

The seat warmers can cause a **SERIOUS BURN**, even at low temperatures and especially if used for long periods of time.

Passengers must be able to feel if the seat is becoming too warm so they can turn it off, if needed.

People who cannot detect temperature change or pain to the skin should use extreme caution, especially the following types of passengers:

- Infants, children, elderly or disabled persons, or hospital outpatients.
- People with sensitive skin or who burn easily.
- Fatigued individuals.
- Intoxicated individuals.
- People taking medication that can cause drowsiness or sleepiness.

⚠ WARNING

NEVER place anything on the seat that insulates against heat when the seat warmer is in operation, such as a blanket or seat cushion. This may cause the seat warmer to overheat, causing a burn or damage to the seat.

⚠ CAUTION

To prevent damage to the seat warmers and seats:

- *Never use a solvent such as paint thinner, benzene, alcohol or gasoline to clean the seats.*
- *Do not place heavy or sharp objects on seats equipped with seat warmers.*

Front seat warmers (if equipped)

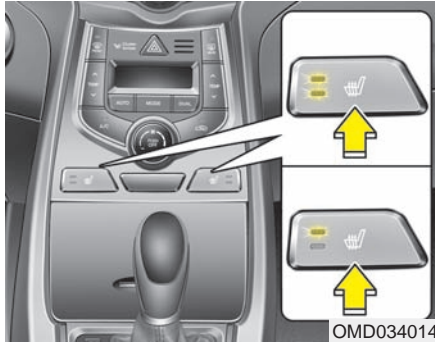

While the engine is running, push either of the switches to warm the driver's seat or front passenger's seat. During mild weather or under conditions where the operation of the seat warmer is not needed, keep the switches in the OFF position.

Each time you push the switch, the temperature setting of the seat is changed as follows :

OFF → HIGH (●●) → LOW (●)
↑

The seat warmer defaults to the OFF position whenever the ignition switch is placed in the ON position.

* NOTICE

With the seat warmer switch in the ON position, the heating system in the seat turns off or on automatically depending on the seat temperature.

Rear seat warmers (if equipped)

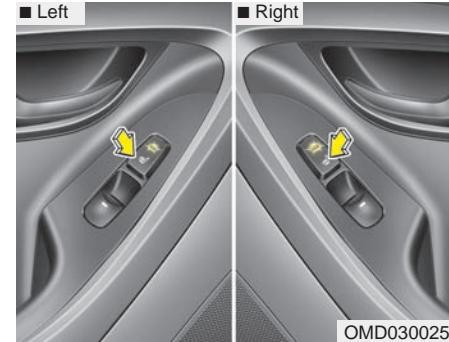

While the engine is running, push either switch to warm the rear seat. During mild weather or under conditions where the operation of the seat warmer is not needed, keep the switches in the "OFF" position.

* NOTICE

With the seat warmer switch in ON position, the heating system in the seat turns off or on automatically depending on the seat temperature.

SEAT BELTS

This section describes how to use the seat belts properly. It also describes some of the things not to do when using seat belts.

Seat belt safety precautions

Always fasten your seat belt and make sure all passengers have fastened their seat belts before starting any trip. Air bags are designed to supplement the seat belt as an additional safety device, but they are not a substitute. Most states require all occupants of a vehicle to wear seat belts.

⚠ WARNING

Seat belts must be used by ALL passengers whenever the vehicle is moving. Take the following precautions when adjusting and wearing seat belts:

- **ALWAYS** properly restrain children under age 13 in the rear seats.
- **NEVER** allow children to ride in the front passenger seat. If a child age 13 or older must be seated in the front seat, move the seat as far back as possible and properly restrain them in the seat belt.
- **NEVER** allow an infant or child to be carried on an occupant's lap.
- **NEVER** ride with the seatback reclined when the vehicle is moving.
- Do not allow children to share a seat or seat belt.
- Do not wear the shoulder belt under your arm or behind your back.

(Continued)

(Continued)

- Do not use the seat belt if it is twisted. A twisted seat belt will not protect you properly in an accident.
- Do not use a seat belt if the webbing or hardware is damaged.
- Do not latch the seat belt into the buckles of other seats.
- **NEVER** unfasten the seat belt while driving. This may cause loss of vehicle control resulting in an accident.
- Make sure there is nothing in the buckle interfering with the seat belt latch mechanism. This may prevent the seat belt from fastening securely.
- No modifications or additions should be made by the user which will either prevent the seat belt adjusting devices from operating to remove slack, or prevent the seat belt assembly from being adjusted to remove slack.

⚠ WARNING
 Damaged seat belts and seat belt assemblies will not operate properly. Always replace:

- Frayed, contaminated, or damaged webbing
- Damaged hardware
- The entire seat belt assembly after it has been worn in an accident, even if damage to webbing or assembly is not apparent

Seat belt warning light

Seat belt warning light (for driver's seat)



The driver's seat belt warning light and chime will come on according to the following table when the ignition switch is in the ON position.

| Conditions | | Warning Pattern | |
|------------------------|-------------------------------|---------------------------------------|-------|
| Seat Belt | Vehicle Speed | Light (Blink) | Chime |
| Unbuckled | | 6 seconds | |
| Buckled | | 6 seconds | None |
| Buckled → Unbuckled | Below 3 mph (5 km/h) | 6 seconds | None |
| | 3 mph~ 6 mph | 6 seconds | |
| | Above 6 mph (10 km/h) | 6 sec. ON / 24 sec. OFF (11 times) | |
| Unbuckled | Above 6 mph (10 km/h) ↓ | 6 seconds *1 ↓ | |
| | Below 3 mph (5 km/h) | Stop *2 | |

*1 : The Warning Pattern repeats 11 times with an interval of 24 seconds. If the driver's seat belt is buckled, the light will stop within 6 seconds and chime will stop immediately.

*2 : The light will stop within 6 seconds and chime will stop immediately.

Seat belt restraint system

Seat Belt-Driver's 3-point system with emergency locking retractor

To fasten your seat belt:

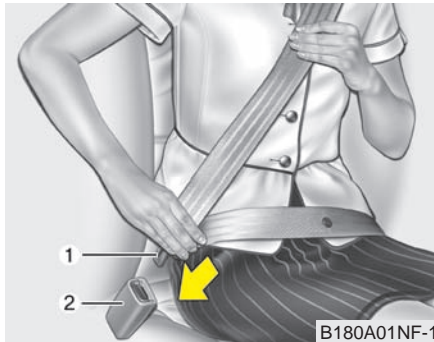

Pull the seat belt out of the retractor and insert the metal tab (1) into the buckle (2). There will be an audible "click" when the tab locks into the buckle.

The seat belt automatically adjusts to the proper length after the lap belt portion is adjusted manually so that it fits snugly around your hips. If you lean forward in a slow, easy motion, the belt will extend and move with you. If there is a sudden stop or impact, the belt will lock into position. It will also lock if you try to lean forward too quickly.

* NOTICE

If you are not able to smoothly pull enough of the seat belt out from the retractor, firmly pull the seat belt out and release it. After release, you will be able to pull the belt out smoothly.

Height adjustment

You can adjust the height of the shoulder belt anchor to one of the four different positions for maximum comfort and safety.

The shoulder portion should be adjusted so it lies across your chest and midway over your shoulder nearest the door, not over your neck.

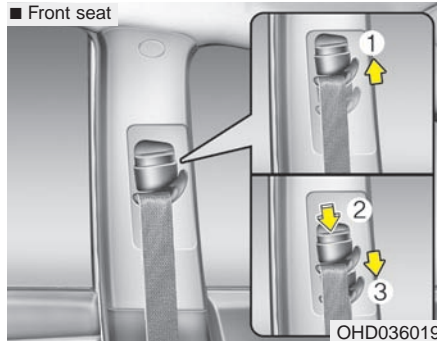

To adjust the height of the seat belt anchor, lower or raise the height adjuster into an appropriate position.

To raise the height adjuster, pull it up (1). To lower it, push it down (3) while pressing the height adjuster button (2).

Release the button to lock the anchor into position. Try sliding the height adjuster to make sure that it has locked into position.

⚠ WARNING

- Verify the shoulder belt anchor is locked into position at the appropriate height. Never position the shoulder belt across your neck or face. Improperly positioned seat belts can cause serious injuries in an accident.
- Failure to replace seat belts after an accident could leave you with damaged seat belts that will not provide protection in the event of another collision leading to personal injury or death. Replace your seat belts after being in an accident as soon as possible.

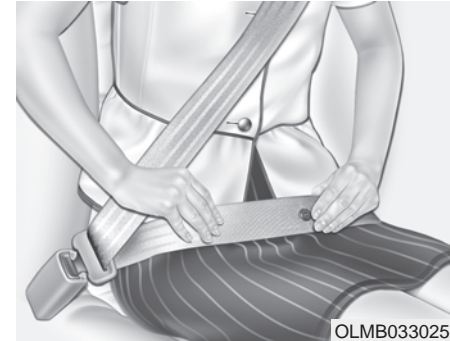

⚠ WARNING

Improperly positioned seat belts may increase the risk of serious injury in an accident. Take the following precautions when adjusting the seat belt:

- Position the lap portion of the seat belt as low as possible across your hips, not on your waist, so that it fits snugly.

(Continued)

(Continued)

- **Position one arm under the shoulder belt and the other over the belt, as shown in the illustration.**
- **Always position the shoulder belt anchor into the locked position at the appropriate height.**
- **Never position the shoulder belt across your neck or face.**

Seat Belt – Passenger’s 3-point system with combination locking retractor

This type of seat belt combines the features of both an emergency locking retractor seat belt and an automatic locking retractor seat belt. Combination retractor type seat belts are installed in the rear seat positions to help accommodate the installation of child restraint systems. Although a combination retractor is also installed in the front passenger seat position, NEVER place any infant restraint system in the front seat of the vehicle.

To fasten your seat belt:

Pull the seat belt out of the retractor and insert the metal tab into the buckle. There will be an audible "click" when the tab locks into the buckle. When not securing a child restraint, the seat belt operates in the same way as the driver's seat belt (Emergency Locking Retractor Type). It automatically adjusts to the proper length only after the lap belt portion of the seat belt is adjusted manually so that it fits snugly across your hips.

When the seat belt is fully extended from the retractor to allow the installation of a child restraint system, the seat belt operation changes to allow the belt to retract, but not to extend (Automatic Locking Retractor Type). Refer to "Using a Child Restraint System" in this chapter.

* NOTICE

Although the seat belt retractor provides the same level of protection for seated passengers in either emergency or automatic locking modes, the emergency locking mode allows seated passengers to move freely in their seat while keeping some tension on the belt. During a collision or sudden stop, the retractor automatically locks the belt to help restrain your body. To deactivate the automatic locking mode, allow the unbuckled seat belt to fully retract.

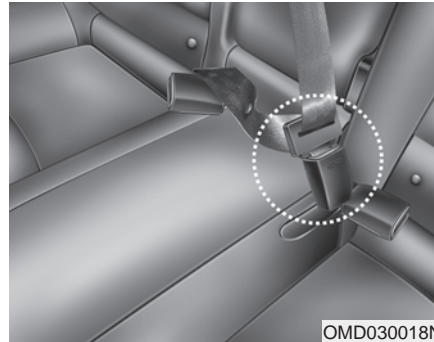

When using the rear center seat belt, the buckle with the “CENTER” mark must be used.

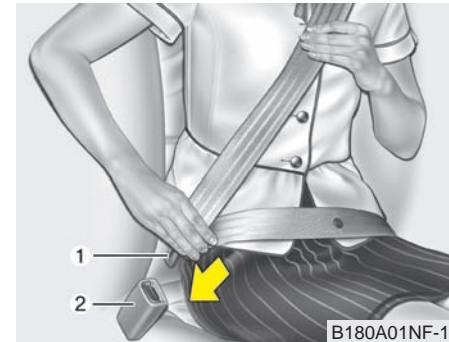

To release your seat belt:

Press the release button (1) in the locking buckle.

When it is released, the belt should automatically draw back into the retractor. If this does not happen, check the belt to be sure it is not twisted, then try again.

Pre-tensioner seat belt



Retractor Pre-tensioner

The retractor pre-tensioner, which is a supplement system of the seat belts and airbags, helps the driver and front passenger's upper body to be fastened surely to the seat by pulling the shoulder back instantly in certain frontal collisions.

The retractor pre-tensioner may be activated in crashes where the frontal collision is severe enough. The retractor pre-tensioner will be activated with the airbags.

Emergency Fastening Device (EFD)

Emergency Fastening Device(EFD), which is a supplement system of the seat belts, protects the driver and front passenger's lower body by pulling the pelvis back instantly in certain frontal collisions.

The EFD may be activated in crashes where the frontal collision is severe enough.

*** NOTICE**

The pre-tensioner will activate not only in a frontal collision but also in a side collision, if the vehicle is equipped with a side or curtain air bag.

⚠ WARNING

Pre-Tensioner Seat Belts that malfunction may not protect you properly during an accident. Take the following precautions:

- Always wear your seat belt and sit properly in your seat.
- Do not use the seat belt if it is loose or twisted. A loose or twisted seat belt will not protect you properly in an accident.
- Do not place anything near the buckle. This may adversely affect the buckle and cause it to function improperly.
- Always replace your pre-tensioners after activation or an accident.
- NEVER inspect, service, repair or replace the pre-tensioners yourself. This must be done by an authorized HYUNDAI dealer.
- Do not hit the seat belt assemblies.

⚠ WARNING

Do not touch the pre-tensioner seat belt assemblies for several minutes after they have been activated. When the pre-tensioner seat belt mechanism fires during a collision the pre-tensioner becomes hot and can burn you.

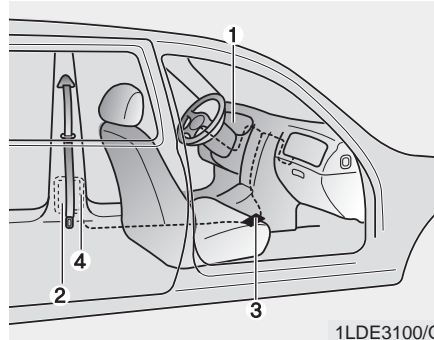

The Pre-Tensioner Seat Belt System consists mainly of the following components. Their locations are shown in the illustration above:

1. SRS air bag warning light
2. Retractor pre-tensioner assembly
3. SRS control module
4. Anchor pre-tensioner assembly

*** NOTICE**

The sensor that activates the SRS air bag is connected with the pre-tensioner seat belts. The SRS air bag warning light on the instrument panel will illuminate for approximately 6 seconds after the ignition switch is placed in the ON position, and then it should turn off.

If the pre-tensioner is not working properly, the warning light will illuminate even if the SRS air bag is not malfunctioning. If the warning light does not illuminate, stays illuminated or illuminates when the vehicle is being driven, have an authorized **HYUNDAI** dealer inspect the pre-tensioner seat belts and SRS air bags as soon as possible.

*** NOTICE**

- Both the driver's and front passenger's pre-tensioner seat belts may be activated in certain frontal or side collisions.
- The pre-tensioners will not be activated if the seat belts are not worn at the time of the collision.
- When the pre-tensioner seat belts are activated, a loud noise may be heard and fine dust, which may appear to be smoke, may be visible in the passenger compartment. These are normal operating conditions and are not hazardous.
- Although it is non-toxic, the fine dust may cause skin irritation and should not be breathed for prolonged periods. Wash all exposed skin areas thoroughly after an accident in which the pre-tensioner seat belts were activated.

Additional seat belt safety precautions

Seat belt use during pregnancy

The seat belt should always be used during pregnancy. The best way to protect your unborn child is to protect yourself by always wearing the seat belt.

Pregnant women should always wear a lap-shoulder seat belt. Place the shoulder belt across your chest, routed between your breasts and away from your neck. Place the shoulder belt across the chest, routed away from the neck. Place the lap belt below the belt line so that it fits snugly and as low as possible across the hips, not across the abdomen.

⚠ WARNING

To reduce the risk of serious injury or death to an unborn child during an accident, pregnant women should NEVER place the lap portion of the seat belt above or over the area of the abdomen where the unborn child is located.

Seat belt use and children

Infant and small children

All 50 states have child restraint laws which require children to travel in approved child restraint devices, including booster seats. The age at which seat belts can be used instead of child restraints differs among states, so you should be aware of the specific requirements in your state, and where you are travelling. Infant and child restraints must be properly placed and installed in a rear seat. For more information refer to the “Child Restraint Systems” in this chapter.

⚠ WARNING

ALWAYS properly restrain infants and small children in a child restraint appropriate for the child's height and weight.

To reduce the risk of serious injury or death to a child and other passengers, NEVER hold a child in your lap or arms when the vehicle is moving. The violent forces created during an accident will tear the child from your arms and throw the child against the interior of the vehicle.

Small children are best protected from injury in an accident when properly restrained in the rear seat by a child restraint system that meets the requirements of the Federal Motor Vehicle Safety Standards. Before buying any child restraint system, make sure that it has a label certifying that it meets Federal Motor Vehicle Safety Standard 213. The restraint must be appropriate for your child's height and weight. Check the label on the child restraint for this information. Refer to “Child Restraint Systems” in this chapter.

Larger children

Children under age 13 and who are too large for a booster seat must always occupy the rear seat and use the available lap/shoulder belts. A seat belt should lie across the upper thighs and be snug across the shoulder and chest to restrain the child safely. Check belt fit periodically. A child's squirming could put the belt out of position. Always have the LATCH system inspected by your authorized HYUNDAI dealer after an accident. An accident can damage the LATCH system and may not properly secure the child restraint.

If a larger child over age 13 must be seated in the front seat, the child must be securely restrained by the available lap/shoulder belt and the seat should be placed in the rear-most position.

If the shoulder belt portion slightly touches the child's neck or face, try placing the child closer to the center of the vehicle. If the shoulder belt still touches their face or neck they need to be returned to an appropriate booster seat.

WARNING

- **Always make sure children are wearing their seat belts and that they are properly adjusted before driving.**
- **NEVER allow the shoulder belt to contact the child's neck or face.**
- **Do not allow more than one child to use a single seat belt.**

Transporting an injured person

A seat belt should be used when an injured person is being transported. Consult a physician for specific recommendations.

One person per belt

Two people (including children) should never attempt to use a single seat belt. This could increase the severity of injuries in case of an accident.

Do not lie down

Sitting in a reclined position when the vehicle is in motion can be dangerous. Even when buckled up, the protections of your restraint system (seat belts and air bags) is greatly reduced by reclining your seatback.

To reduce the chance of injuries in the event of an accident and to achieve the maximum effectiveness of the restraint system, all passengers should be sitting up and the front and rear seats should be in an upright position when the car is moving. A seat belt cannot provide proper protection if the person is lying down in the rear seat or if the front or rear seats are in a reclined position.

⚠ WARNING

- **NEVER ride with a reclined seatback when the vehicle is moving.**
- **Riding with a reclined seatback increases your chance of serious or fatal injuries in the event of a collision or sudden stop.**
- **Drivers and passengers should always sit well back in their seats, properly belted, and with the seatbacks upright.**

Care of seat belts

Seat belt systems should never be disassembled or modified. In addition, care should be taken to assure that seat belts and belt hardware are not damaged by seat hinges, doors or other abuse.

Periodic inspection

All seat belts should be inspected periodically for wear or damage of any kind. Any damaged parts should be replaced as soon as possible.

Keep belts clean and dry

Seat belts should be kept clean and dry. If belts become dirty, they can be cleaned by using a mild soap solution and warm water. Bleach, dye, strong detergents or abrasives should not be used because they may damage and weaken the fabric.

When to replace seat belts

The entire seat belt assembly or assemblies should be replaced if the vehicle has been involved in an accident. This should be done even if no damage is visible. Additional questions concerning seat belt operation should be directed to an authorized HYUNDAI dealer.

CHILD RESTRAINT SYSTEM (CRS)

WARNING

Always properly restrain children in the rear seats of the vehicle.

Children of all ages are safer when restrained in the rear seat. A child riding in the front passenger seat can be forcefully struck by an inflating air bag resulting in SERIOUS INJURY or DEATH.

Children under age 13 must always ride in the rear seats and must always be properly restrained to minimize the risk of injury in an accident, sudden stop or sudden maneuver. According to accident statistics, children are safer when properly restrained in the rear seats than in the front seat. **Even with air bags, children can be seriously injured or killed.** Children too large for a child restraint must use the seat belts provided.

All 50 states have child restraint laws which require children to travel in approved child restraint devices. The laws governing the age or height/weight restrictions at which seat belts can be used instead of child restraints differs among states, so you should be aware of the specific requirements in your state, and where you are travelling.

Child restraint systems must be properly placed and installed in the rear seat. You must use a commercially available child restraint system that meets the requirements of the Federal Motor Vehicle Safety Standards (FMVSS).

Child restraint systems are generally designed to be secured in a vehicle seat by lap belt portion of a lap/shoulder belt, or by a LATCH system in the rear seats of the vehicle.

Child restraint system (CRS)

Infants and younger children must be restrained in an appropriate rear-facing or forward-facing CRS that has first been properly secured to the rear seat of the vehicle. Read and comply with the instructions for installation and use provided by the manufacturer of the child restraint.

WARNING

An improperly secured child restraint can increase the risk of **SERIOUS INJURY** or **DEATH** in an accident. Always take the following precautions when using a child restraint system:

- NEVER install a child or infant restraint in the front passenger's seat.
- Always properly secure the child restraint to a rear seat of the vehicle.

(Continued)

(Continued)

- Always follow the child restraint system manufacturer's instructions for installation and use.
- Always properly restrain your child in the child restraint.
- Do not use an infant carrier or a child safety seat that "hooks" over a seatback, it may not provide adequate protection in an accident.
- After an accident, have a HYUNDAI dealer check the child restraint system, seat belts, tether anchors and lower anchors.

Selecting a Child Restraint System (CRS)

When selecting a CRS for your child, always:

- Make sure the CRS has a label certifying that it meets applicable Federal Motor Vehicle Safety Standards (FMVSS 213).
- Select a child restraint based on your child's height and weight. The required label or the instructions for use typically provide this information.
- Select a child restraint that fits the vehicle seating position where it will be used.
- Read and comply with the warnings and instructions for installation and use provided with the child restraint system.

Child restraint system types

There are three main types of child restraint systems: rear-facing seats, forward-facing seats, and booster seats. They are classified according to the child's age, height and weight.

⚠ WARNING

If the vehicle headrest prevents proper installation of a child seat, the headrest of the respective seating position shall be readjusted or entirely removed.

Rear-facing child seats

⚠ WARNING

NEVER install a child or infant restraint in the front passenger's seat.

Placing a rear-facing child restraint in the front seat can result in SERIOUS INJURY or DEATH if the child restraint is struck by an inflating air bag.

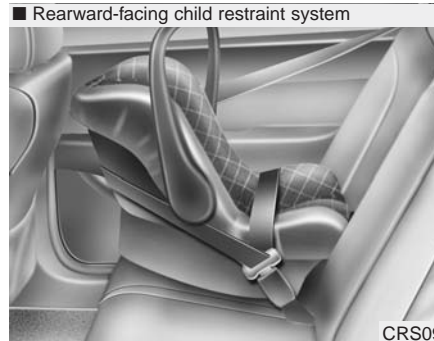

A rear-facing child seat provides restraint with the seating surface against the back of the child. The harness system holds the child in place, and in an accident, acts to keep the child positioned in the seat and reduce the stress to the neck and spinal cord.

All children under age one must always ride in a rear-facing infant child restraint.

Convertible and 3-in-1 child seats typically have higher height and weight limits for the rear-facing position, allowing you to keep your child rear-facing for a longer period of time.

Continue to use a rear-facing child seat for as long as your child will fit within the height and weight limits allowed by the child seat manufacturer. It's the best way to keep them safe. Once your child has outgrown the rear-facing child restraint, your child is ready for a forward-facing child restraint with a harness.



Forward-facing child restraints

A forward-facing child seat provides restraint for the child's body with a harness. Keep children in a forward-facing child seat with a harness until they reach the top height or weight limit allowed by your child restraint's manufacturer.

Once your child outgrows the forward-facing child restraint, your child is ready for a booster seat.

Booster seats

A booster seat is a restraint designed to improve the fit of the vehicle's seat belt system. A booster seat positions the seat belt so that it fits properly over the lap of your child. Keep your child in a booster seat until they are big enough to sit in the seat without a booster and still have the seat belt fit properly.

For a seat belt to fit properly, the lap belt must lie snugly across the upper thighs, not the stomach. The shoulder belt should lie snug across the shoulder and chest and not across the neck or face. Children under age 13 must always ride in the rear seats and must always be properly restrained to minimize the risk of injury.

Installing a Child Restraint System (CRS)

⚠ WARNING

Before installing your child restraint system always:

- Read and follow the instructions provided by the manufacturer of the child restraint.
- Read and follow the instructions regarding child restraint systems in this manual.

Failure to follow all warnings and instructions could increase the risk of the SERIOUS INJURY or DEATH if an accident occurs.

After selecting a proper child seat for your child, check to make sure it fits properly in your vehicle. Follow the instructions provided by the manufacturer when installing the child seat. Note these general steps when installing the seat to your vehicle:

- **Properly secure the child restraint to the vehicle.** All child restraints must be secured to the vehicle with the lap part of a lap/shoulder belt or with the LATCH system.
- **Make sure the child restraint is firmly secured.** After installing a child restraint to the vehicle, push and pull the seat forward and from side-to-side to verify that it is securely attached to the seat. A child restraint secured with a seat belt should be installed as firmly as possible. However, some side-to-side movement can be expected.

WARNING

A child restraint in a closed vehicle can become very hot. To prevent burns, check the seating surface and buckles before placing your child in the child restraint.

Lower Anchors and Tether for Children (LATCH) System

The LATCH system holds a child restraint during driving and in an accident. This system is designed to make installation of the child restraint easier and reduce the possibility of improperly installing your child restraint. The LATCH system uses anchors in the vehicle and attachments on the child restraint. The LATCH system eliminates the need to use seat belts to secure the child restraint to the rear seats.

Lower anchors are metal bars built into the vehicle. There are two lower anchors for each LATCH seating position that will accommodate a child restraint with lower attachments.

To use the LATCH system in your vehicle, you must have a child restraint with LATCH attachments.

The child seat manufacturer will provide you with instructions on how to use the child seat with its attachments for the LATCH lower anchors.

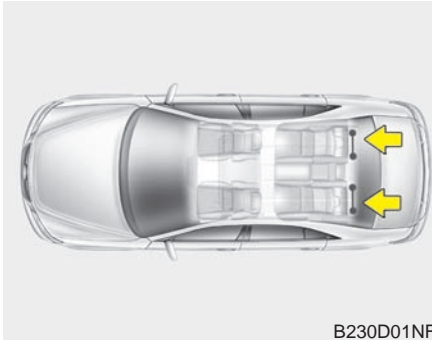

B230D01NF

LATCH anchors have been provided in the left and right outboard rear seating positions. Their locations are shown in the illustration. There are no LATCH anchors provided for the center rear seating position.

⚠ WARNING

Do not attempt to install a child restraint system using LATCH anchors in the rear center seating position. There are no LATCH anchors provided for this seat. Using the outboard seat anchors can damage the anchors which may break or fail in a collision resulting in serious injury or death.

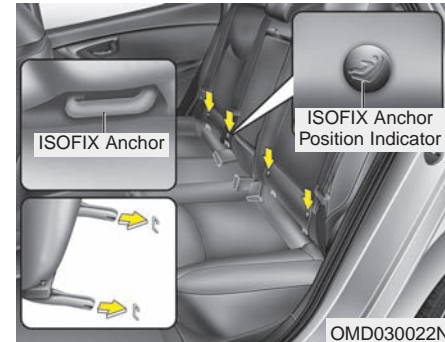

OMD030022N

The lower anchor position indicator symbols are located on the left and right rear seat backs to identify the position of the lower anchors in your vehicle (see arrows in illustration).

The LATCH anchors are located between the seatback and the seat cushion of the rear seat left and right outboard seating positions.

Securing a child restraint with the LATCH anchors system

To install a LATCH-compatible child restraint in either of the rear outboard seating positions:

1. Move the seat belt buckle away from the lower anchors.
2. Move any other objects away from the anchors that could prevent a secure connection between the child restraint and the lower anchors.
3. Place the child restraint on the vehicle seat, then attach the seat to the lower anchors according to the instructions provided by the child restraint manufacturer.
4. Follow the child restraint instructions for properly adjusting and tightening the lower attachments on the child restraint to the lower anchors.

⚠ WARNING

Take the following precautions when using the LATCH system:

- **Read and follow all installation instructions provided with your child restraint system.**
- **To prevent the child from reaching and taking hold of unretracted seat belts, buckle all unused rear seat belts and retract the seat belt webbing behind the child. Children can be strangled if a shoulder belt becomes wrapped around their neck and the seat belt tightens.**
- **NEVER attach more than one child restraint to a single anchor. This could cause the anchor or attachment to come loose or break.**

(Continued)

(Continued)

- **Always have the LATCH system inspected by your authorized HYUNDAI dealer after an accident. An accident can damage the LATCH system and may not properly secure the child restraint.**

*** NOTICE - Weight for LATCH system**

The recommended weight for the LATCH system is under 65lb (30kg).
How to calculate the child restraint weight :

Child restraint weight = 65lb (30kg) - Child weight

Securing a child restraint seat with “Tether Anchor” system

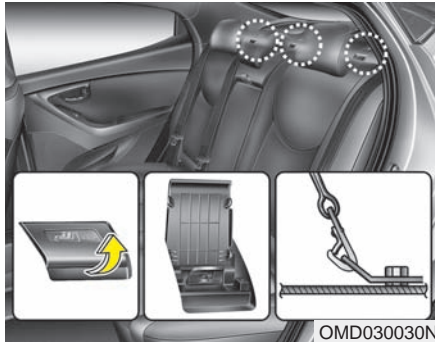

First, secure the child restraint with the LATCH lower anchors or the seat belt. If the child seat manufacturer recommends that the tether strap be attached, attach and tighten the tether strap to the tether anchor.

Tether anchors are located on the back of the rear seats.

⚠ WARNING

Take the following precautions when installing the tether strap:

- Read and follow all installation instructions provided with your child restraint system.
- **NEVER** attach more than one child restraint to a single tether anchor. This could cause the anchor or attachment to come loose or break.
- **Do not attach the tether strap to anything other than the correct tether anchor. It may not work properly if attached to something else.**
- **Do not use the tether anchors for adult seat belts or harnesses, or for attaching other items or equipment to the vehicle.**



To install the tether strap:

1. Route the child restraint tether strap over the child restraint seatback. Route the tether strap under the headrest and between the headrest posts, or route the tether strap over the top of the vehicle seatback. Make sure the strap is not twisted.
2. Connect the tether strap hook to the tether anchor, then tighten the tether strap according to the child seat manufacturer's instructions to firmly secure the child restraint to the seat.

3. Check that the child restraint is securely attached to the seat by pushing and pulling the seat forward and from side-to-side.

Securing a child restraint with a lap belt or lap/shoulder belt

When not using the LATCH system, all child restraints must be secured to a vehicle rear seat with the lap part of a lap/shoulder belt.

⚠ WARNING

ALWAYS place a rear-facing child restraint in the rear seat of the vehicle.

Placing a rear-facing child restraint in the front seat can result in serious injury or death if the child restraint is struck by an inflating air bag.

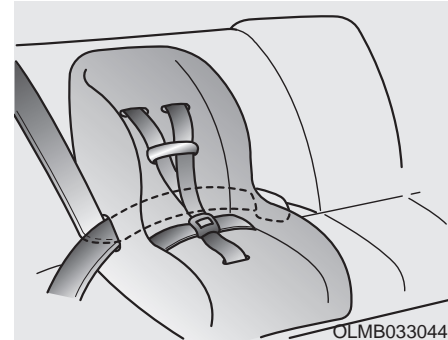

Automatic lock mode

Since all passenger seat belts move freely under normal conditions and only lock under extreme or emergency conditions (emergency locking mode), you must manually pull the seat belt all the way out to shift the retractor to the “Automatic Locking” mode to secure a child restraint.

The “Automatic Locking” mode will help prevent the normal movement of the child in the vehicle from causing the seat belt to loosen and compromise the child restraint system. To secure a child restraint system, use the following procedure.

To install a child restraint system on the rear seats, do the following:

1. Place the child restraint system on a rear seat and route the lap/shoulder belt around or through the child restraint, following the restraint manufacturer's instructions.

Be sure the seat belt webbing is not twisted.

*** NOTICE**

When using the rear center seat belt, you should also refer to “3-point Rear Center Seat Belt” in this chapter.

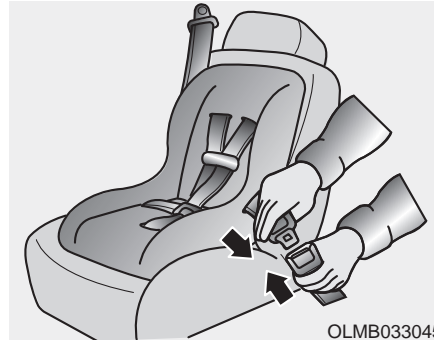

2. Fasten the lap/shoulder belt latch into the buckle. Listen for the distinct “click” sound.

*** NOTICE**

Position the release button so that it is easy to access in case of an emergency.



3. Pull the shoulder portion of the seat belt all the way out. When the shoulder portion of the seat belt is fully extended, it will shift the retractor to the “Automatic Locking” (child restraint) mode.

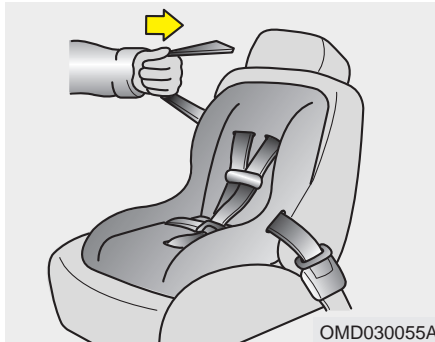

4. Slowly allow the shoulder portion of the seat belt to retract and listen for an audible “clicking” or “ratcheting” sound. This indicates that the retractor is in the “Automatic Locking” mode. If no distinct sound is heard, repeat steps 3 and 4.

5. Remove as much slack from the belt as possible by pushing down on the child restraint system while feeding the shoulder belt back into the retractor.
6. Push and pull on the child restraint system to confirm that the seat belt is holding it firmly in place. If it is not, release the seat belt and repeat steps 2 through 6.
7. Double check that the retractor is in the “Automatic Locking” mode by attempting to pull more of the seat belt out of the retractor. If you cannot, the retractor is in the “Automatic Locking” mode.

If your CRS manufacturer instructs or recommends you to use a tether anchor with the lap/shoulder belt, refer to the previous pages for more information.

* NOTICE

When the seat belt is allowed to retract to its fully stowed position, the retractor will automatically switch from the “Automatic Locking” mode to the emergency lock mode for normal adult usage.

⚠ WARNING

If the retractor is not in the “Automatic Locking” mode, the child restraint can move when your vehicle turns or stops suddenly. A child can be seriously injured or killed if the child restraint is not properly anchored in the car, including manually pulling the seat belt all the way out to shift the retractor to the “Automatic Locking” mode.

To remove the child restraint, press the release button on the buckle and then pull the lap/shoulder belt out of the restraint and allow the seat belt to retract fully.

AIR BAG - ADVANCED SUPPLEMENTAL RESTRAINT SYSTEM

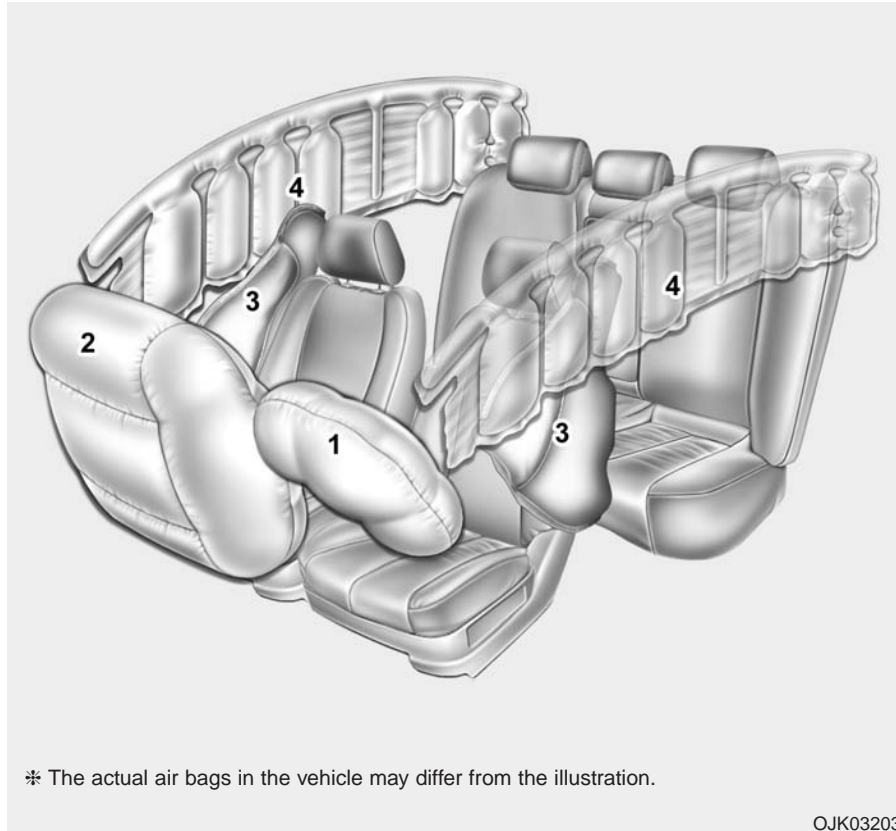

- (1) Driver's front air bag
- (2) Passenger's front air bag
- (3) Side impact air bag
- (4) Curtain air bag

* The actual air bags in the vehicle may differ from the illustration.

OJK032032

This vehicle is equipped with an Advanced Supplemental Air Bag System for the driver's seat and front passenger's seats.

The front air bags are designed to supplement the three-point seat belts. For these air bags to provide protection, the seat belts must be worn at all times when driving.

You can be severely injured or killed in an accident if you are not wearing a seat belt. Air bags are designed to supplement seat belts, but do not replace them. Also, air bags are not designed to deploy in every collision. In some accidents, the seat belts are the only restraint protecting you.

WARNING

AIR BAG SAFETY PRECAUTIONS

ALWAYS use seat belts and child restraints - every trip, every time, everyone! Even with air bags, you can be seriously injured or killed in a collision if you are improperly belted or not wearing your seat belt when the air bag inflates.

NEVER place a child in any child restraint or booster seat in the front passenger seat. An inflating air bag could forcefully strike the infant or child causing serious or fatal injuries.

ABC - Always Buckle Children under age 13 in the back seat. It is the safest place for children of any age to ride. If a child age 13 or older must be seated in the front seat, he or she must be properly belted and the seat should be moved as far back as possible.

All occupants should sit upright with the seatback in an upright position, centered on the seat cushion with their seat belt on, legs comfortably extended and their feet on the floor until the vehicle is parked and the engine is turned off. If an occupant is out of position during an accident, the rapidly deploying air bag may forcefully contact the occupant causing serious or fatal injuries.

You and your passengers should never sit or lean unnecessarily close to the air bags or lean against the door or center console.

Move your seat as far back as possible from front air bags, while still maintaining control of the vehicle. NHTSA recommends that drivers allow at least 10 inches (25 cm) between the center of the steering wheel and the chest.

Where are the air bags?

Driver's and passenger's front air bags

Your vehicle is equipped with a Advanced Supplemental Restraint System (SRS) and lap/shoulder belts at both the driver and passenger seating positions.

The SRS consists of air bags which are located in the center of the steering wheel and the passenger's side front panel pad above the glove box.

The air bags are labeled with the letters "AIR BAG" embossed on the pad covers.



The purpose of the SRS is to provide the vehicle's driver and front passengers with additional protection than that offered by the seat belt system alone. The SRS uses sensors to gather information about the driver's seat position, the driver's and front passenger's seat belt usage and impact severity.

⚠ WARNING

To reduce the risk of serious injury or death from an inflating front air bags, take the following precautions:

- Seat belts must be worn at all times to help keep occupants positioned properly.
- Move your seat as far back as possible from front air bags, while still maintaining control of the vehicle.
- Never lean against the door or center console.
- Do not allow the front passenger to place their feet or legs on the dashboard.
- No objects should be placed over or near the air bag modules on the steering wheel, instrument panel, and the front passenger's panel above the glove box. Such objects could cause harm if the vehicle is in a crash severe enough to cause the air bags to deploy.

Side impact air bags

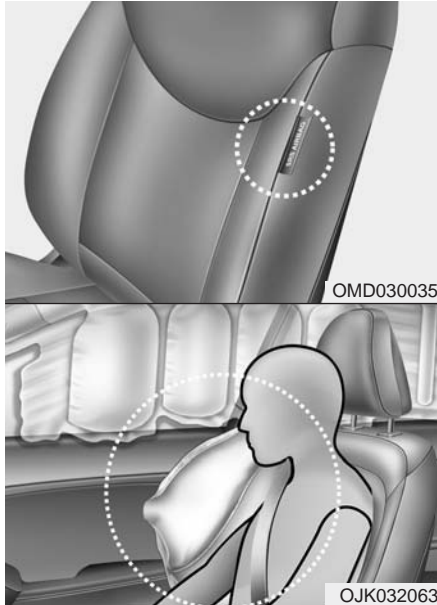

Your vehicle is equipped with a side impact air bag in each seat. The purpose of the air bag is to provide the vehicle's driver and the front passenger with additional protection than that offered by the seat belt alone.

The side impact air bags are designed to deploy only during certain side impact collisions, depending on the crash severity, angle, speed and point of impact.

The side impact air bags are not designed to deploy in all side impact.

⚠ WARNING

To reduce the risk of serious injury or death from an inflating side impact air bag, take the following precautions:

- Seat belts must be worn at all times to help keep occupants positioned properly.
- Do not allow passengers to lean their heads or bodies onto doors, put their arms on the doors, stretch their arms out of the window, or place objects between the doors and seats.
- Hold the steering wheel at the 9 o'clock and 3 o'clock positions, to minimize the risk of injuries to your hands and arms.
- Do not use any accessory seat covers. This could reduce or prevent the effectiveness of the system.
- Do not place any objects over the air bag or between the air bag and yourself.

(Continued)

(Continued)

- Do not place any objects between the door and the seat. They may become dangerous projectiles if the side impact air bag inflates.
- Do not install any accessories on the side or near the side impact air bags.
- Do not cause impact to the doors when the ignition switch is in the ON position or this may cause the side air bags to inflate.
- If the seat or seat cover is damaged, have the vehicle checked and repaired by an authorized HYUNDAI dealer.

Curtain air bags

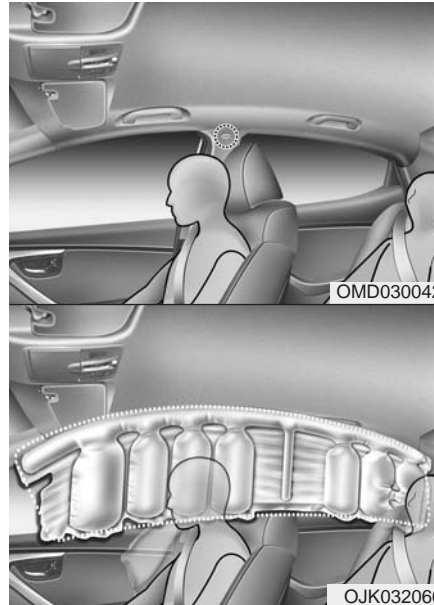

Curtain air bags are located along both sides of the roof rails above the front and rear doors.

They are designed to help protect the heads of the front seat occupants and the rear outboard seat occupants in certain side impact collisions.

The curtain air bags are designed to deploy only during certain side impact collisions, depending on the crash severity, angle, speed and impact.

The curtain air bags are not designed to deploy in all side impact.

⚠ WARNING

To reduce the risk of serious injury or death from an inflating curtain air bags, take the following precautions:

- All seat occupants must wear seat belts at all times to help keep occupants positioned properly.
- Properly secure child restraints as far away from the door as possible.
- Do not allow passengers to lean their heads or bodies onto doors, put their arms on the doors, stretch their arms out of the window, or place objects between the doors and seats.
- Do not open or repair the side curtain air bags.

SRS components and functions

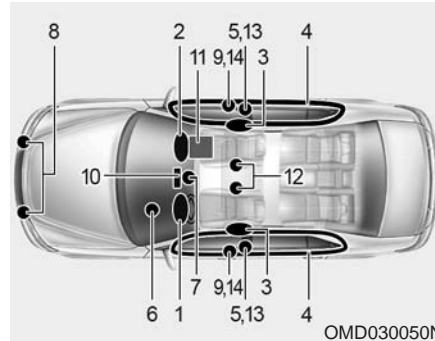

The SRS consists of the following components:

1. Driver's front air bag module
2. Passenger's front air bag module
3. Side impact air bag modules
4. Curtain air bag modules
5. Retractor pre-tensioner assemblies
6. Air bag warning light
7. SRS control module (SRSCM)
8. Front impact sensors
9. Side impact sensors

10. PASS AIR BAG "OFF" indicator (Front passenger's seat only)
11. Occupant classification system (Front passenger's seat only)
12. Driver's and front passenger's seat belt buckle sensors
13. Anchor pre-tensioner
14. Side pressure sensor

The SRSCM continually monitors all SRS components while the ignition switch is ON to determine if a crash impact is severe enough to require air bag deployment or pre-tensioner seat belt deployment.



SRS warning light

The SRS (Supplement Restraint System) air bag warning light on the instrument panel displays the air bag symbol depicted in the illustration. The system checks the air bag electrical system for malfunctions. The light indicates that there is a potential problem with your air bag system.

⚠ WARNING

If your SRS malfunctions, the air bag may not inflate properly during an accident increasing the risk of serious injury or death.

If any of the following conditions occur, your SRS is malfunctioning:

- **The light does not turn on for approximately six seconds when the ignition switch is placed in the ON position.**
- **The light stays on after illuminating for approximately six seconds.**
- **The light comes on while the vehicle is in motion.**
- **The light blinks when the engine is running.**

Have an authorized HYUNDAI dealer inspect the SRS as soon as possible if any of these conditions occur.

During a moderate to severe frontal collision, sensors will detect the vehicle's rapid deceleration. If the rate of deceleration is high enough, the control unit will inflate the front air bags.

The front air bags help protect the driver and front passenger by responding to frontal impacts in which seat belts alone cannot provide adequate restraint.

- Air bags are activated (able to inflate if necessary) only when the ignition switch is in the ON position.
- Air bags inflate in the event of a severe frontal or side collision to help protect the occupants from serious physical injury.
- There is no single speed at which the air bags will inflate. Generally, air bags are designed to inflate based upon the severity of a collision and its direction. These two factors determine whether the sensors produce an electronic deployment/inflation signal.

- Air bag deployment depends on a number of factors including vehicle speed, angles of impact and the density and stiffness of the vehicles or objects which your vehicle impacts during a collision. The determining factors are not limited to those mentioned above.
- The front air bags will completely inflate and deflate in an instant. It is virtually impossible for you to see the air bags inflate during an accident. It is much more likely that you will simply see the deflated air bags hanging out of their storage compartments after the collision.
- To help provide protection, the air bags must inflate rapidly. The speed of air bag inflation is a consequence of extremely short time in which to inflate the air bag between the occupant and the vehicle structures before the occupant impacts those structures. This speed of inflation reduces the risk of serious or life-threatening injuries and is thus a necessary part of air bag design.
However, the rapid air bag inflation can also cause injuries which can include facial abrasions, bruises and broken bones because the inflation speed also causes the air bags to expand with a great deal of force.
- There are even circumstances under which contact with the air bag can cause fatal injuries, especially if the occupant is positioned excessively close to the air bag.

You can take steps to reduce the risk of being injured by an inflating air bag. The greatest risk is sitting too close to the air bag. An air bag needs about 10 inches (25 cm) of space to inflate. NHTSA recommends that drivers allow at least 10 inches (25 cm) between the center of the steering wheel and the chest.

⚠ WARNING

To reduce the risk of serious injury or death from an inflating air bag, take the following precautions:

- **NEVER** place a child restraint in the front passenger seat.
Always properly restrain children under age 13 in the rear seats of the vehicle.
- Adjust the front passenger's and driver's seats as far to the rear as possible while allowing you to maintain full control of the vehicle.
- Hold the steering wheel with hands at the 9 o'clock and 3 o'clock positions.
- Never place anything or anyone between the air bag and the seat occupant.
- Do not allow the front passenger to place their feet or legs on the dashboard.

■ Driver's front air bag (1)



When the SRSCM detects a sufficiently severe impact to the front of the vehicle, it will automatically deploy the front air bags.

■ Driver's front air bag (2)

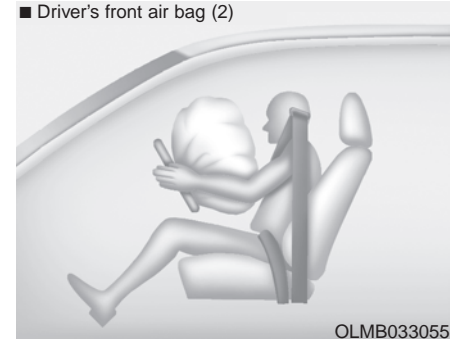

Upon deployment, tear seams molded directly into the pad covers will separate under pressure from the expansion of the air bags. Further opening of the covers allows full inflation of the air bags.

A fully inflated air bag, in combination with a properly worn seat belt, slows the driver's or the passenger's forward motion, reducing the risk of head and chest injury.

■ Driver's front air bag (3)



■ Passenger's front air bag



After complete inflation, the air bag immediately starts deflating, enabling the driver to maintain forward visibility and the ability to steer or operate other controls.

⚠ WARNING

To prevent objects from becoming dangerous projectiles when the passenger's air bag inflates:

- Do not install or place any objects (drink holder, CD holder, stickers, etc.) on the front passenger's panel above the glove box where the passenger's air bag is located.
- Do not install a container of liquid air freshener near the instrument cluster or on the instrument panel surface.

What to expect after an air bag inflates

After a frontal or side air bag inflates, it will deflate very quickly. Air bag inflation will not prevent the driver from seeing out of the windshield or being able to steer. Curtain air bags may remain partially inflated for some time after they deploy.

⚠ WARNING

After an air bag inflates, take the following precautions:

- Open your windows and doors as soon as possible after impact to reduce prolonged exposure to the smoke and powder released by the inflating air bag.
- Do not touch the air bag storage area's internal components immediately after an air bag has inflated. The parts that come into contact with an inflating air bag may be very hot.

(Continued)

(Continued)

- Always wash exposed skin areas thoroughly with luke-warm water and mild soap.
- Always have an authorized HYUNDAI dealer replace the air bag immediately after deployment. Air bags are designed to be used only once.

Noise and smoke from inflating air bag

When the air bags inflate, they make a loud noise and they leave smoke and powder in the air inside of the vehicle. This is normal and is a result of the ignition of the air bag inflator. After the air bag inflates, you may feel substantial discomfort in breathing because of the contact of your chest with both the seat belt and the air bag, as well as from breathing the smoke and powder. The powder may aggravate asthma for some people. If you experience breathing problems after an air bag deployment, seek medical attention immediately.

Though the smoke and powder are nontoxic, they may cause irritation to the skin, eyes, nose, throat, etc. If this is the case, wash and rinse with cold water immediately and seek medical attention if the symptoms persist.

Occupant Classification System (OCS)



Your vehicle is equipped with an Occupant Classification System (OCS) in the front passenger's seat. The OCS is designed to detect the presence of a properly-seated front passenger and determine if the passenger's front air bag should be enabled (may inflate) or not. The driver's front air bag is not affected or controlled by the OCS.

Main components of the Occupant Classification System

- A detection device located within the front passenger seat.
- Electronic system to determine whether the passenger air bag should be activated or deactivated.
- An indicator light located on the instrument panel which illuminates the words "PASSENGER AIR BAG OFF" indicating the front passenger air bag system is deactivated.
- The instrument panel air bag indicator light is interconnected with the OCS.

Front passenger seat adult occupants who are properly seated and wearing the seat belt properly, should not cause the passenger air bag to be automatically turned OFF. However, if the occupant does not sit in the seat properly (for example, by not sitting upright, by sitting on the edge of the seat, or by otherwise being out of position), this could cause the sensor to turn the air bag OFF.

You will find the "PASSENGER AIR BAG OFF" indicator on the center facia panel. This system detects the conditions 1-4 in the following table and activates or deactivates the front passenger air bag based on these conditions.

Always be sure that you and all vehicle occupants are seated properly and wearing the seat belt properly for the most effective protection by the air bag and the seat belt.

The OCS may not function properly if the passenger takes actions which can affect the classification system. These include:

- Failing to sit in an upright position.
- Leaning against the door or center console.
- Sitting towards the sides of the front of the seat.
- Putting their legs on the dashboard or resting them on other locations which reduce the passenger weight on the front seat.
- Wearing the seat belt improperly.
- Reclining the seatback.

Condition and operation in the front passenger Occupant Classification System

| Condition detected by the occupant classification system | Indicator/Warning light | | Devices |
|--|---|-------------------|-------------------------|
| | “PASSENGER AIR BAG OFF” indicator light | SRS warning light | Front passenger air bag |
| 1. Adult*1 | Off | Off | Activated |
| 2. Infant*2 or child restraint system with 12 months old*3 | On | Off | Deactivated |
| 3. Unoccupied | On | Off | Deactivated |
| 4. Malfunction in the system | Off | On | Activated |

- *1 The system judges a person of adult size as an adult. When a smaller adult sits in the front passenger seat, the system may recognize him/her as a child depending on his/her physique and posture.
- *2 Do not allow children to ride in the front passenger seat. When a larger child who has outgrown a child restraint system sits in the front passenger seat, the system may recognize him/her as an adult depending upon his/her physique or sitting position.
- *3 Never install a child restraint system on the front passenger seat.

⚠ WARNING

Riding in an improper position or placing weight on the front passenger's seat when it is unoccupied by a passenger adversely affects the OCS. To reduce the risk of serious injury or death:



- **NEVER** put a heavy load in the front seat or seatback pocket.

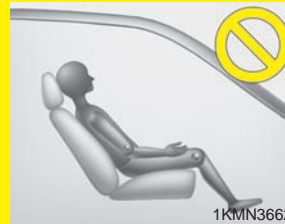

- **NEVER** ride with the seatback reclined when the vehicle is moving.



- **NEVER** place your feet on the front passenger seatback.



- **NEVER** place your feet or legs on the dashboard.



- **NEVER** sit with your hips shifted towards the front of the seat.



- **NEVER** lean on the door or center console or sit on one side of the front passenger seat.

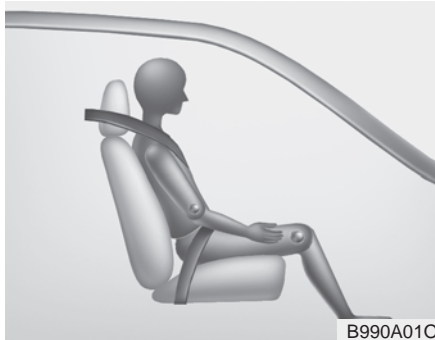

B990A010

Proper seated position for OCS

If the "PASSENGER AIR BAG OFF" indicator is on when an adult is seated in the front passenger seat, place the ignition switch to the LOCK/OFF position and ask the passenger to sit properly (sitting upright with the seat back in an upright position, centered on the seat cushion with their seat belt on, legs comfortably extended and their feet on the floor). Restart the engine and have the person remain in that position. This will allow the system to detect the person and to enable the passenger air bag. If the "PASSENGER AIR BAG OFF" indicator is still on, ask the passenger to move to the rear seat.

⚠ WARNING

Never allow an adult passenger to ride in the front passenger seat when the "PASSENGER AIR BAG OFF" indicator is illuminated. During a collision, the air bag will not inflate if the indicator is illuminated. Have your passenger move to the rear seat.

*** NOTICE**

The "PASSENGER AIR BAG OFF" indicator illuminates for approximately 4 seconds after the ignition switch is in the ON position or after the engine is started. If the front passenger seat is occupied, the OCS will then classify the front passenger after several more seconds.

Do Not Install a Child Restraint in the Front Passenger's Seat



Even though your vehicle is equipped with the OCS, never install a child restraint in the front passenger's seat. An inflating air bag can forcefully strike a child or restraint resulting in serious or fatal injury.

⚠ WARNING

- **NEVER** place a rear-facing or front-facing child restraint in the front passenger's seat of the vehicle.
- An inflating frontal air bag could forcefully strike a child resulting in serious injury or death.
- Always properly restrain children in an appropriate child restraint in the rear seat of the vehicle.

Why Didn't My Air Bag Go Off in a Collision? (Air bags are not designed to inflate in every collision.)

There are certain types of accidents in which the air bag would not be expected to provide additional protection. These include rear impacts, second or third collisions in multiple impact accidents, as well as low speed impacts. Damage to the vehicle indicates a collision energy absorption, and is not an indicator of whether or not an air bag should have inflated.

Air bag collision sensors

⚠ WARNING

To reduce the risk of an air bag deploying unexpectedly and causing serious injury or death:

- Do not hit or allow any objects to impact the locations where air bags or sensors are installed.
- Do not perform maintenance on or around the air bag sensors. If the location or angle of the sensors is altered, the air bags may deploy when they should not or may not deploy when they should.
- Do not install bumper guards or replace the bumper with a non-genuine HYUNDAI parts. This may adversely affect the collision and air bag deployment performance.
- Have all repairs conducted by an authorized HYUNDAI dealer.

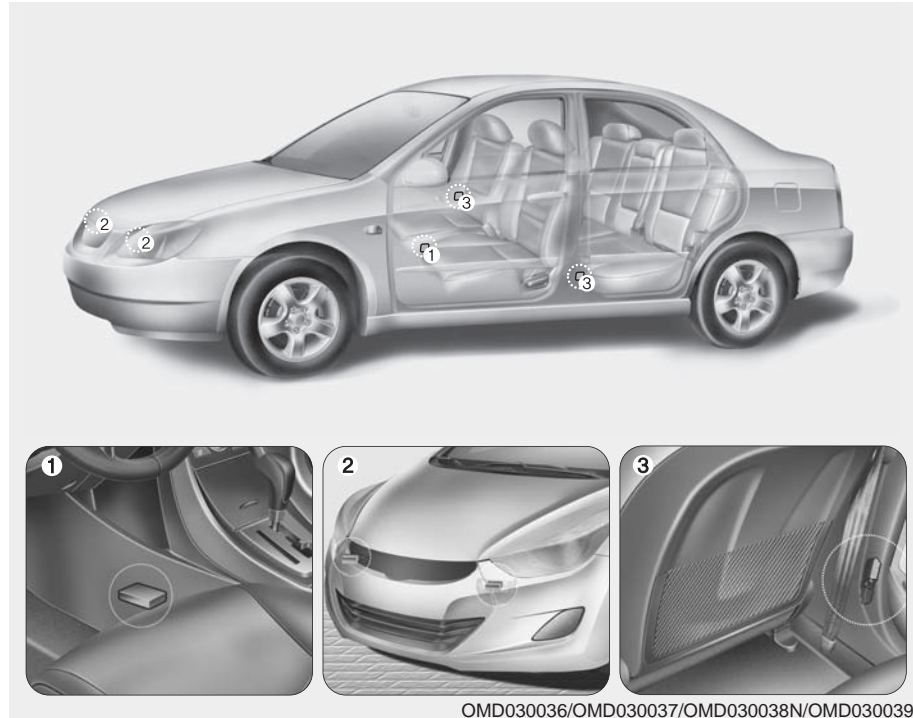

OMD030036/OMD030037/OMD030038N/OMD030039

- (1) SRS control module/Rollover sensor
- (2) Front impact sensor
- (3) Side impact sensor

Air bag deployment conditions

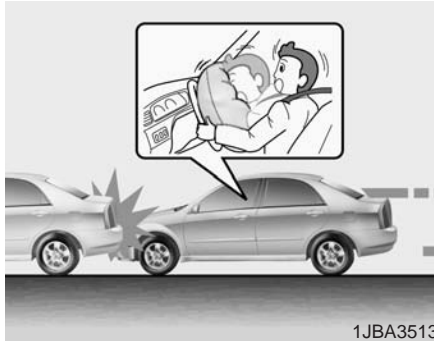

Front air bag

Front air bags are designed to inflate in a frontal collision depending on the intensity, speed, or angles of impact of the front collision.

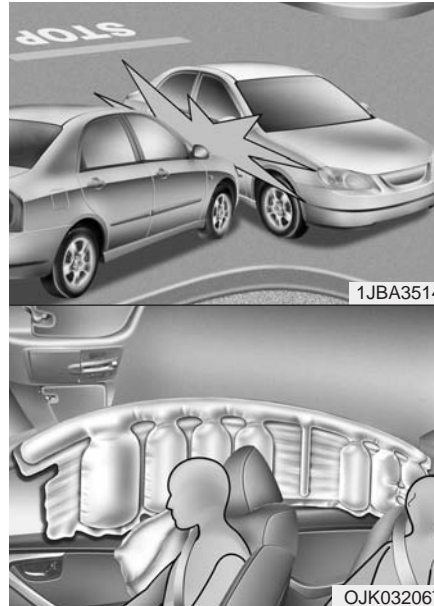

Side impact and curtain air bags

Side impact and curtain air bags are designed to inflate when an impact is detected by side collision sensors depending on the strength, speed, or angles of impact resulting from a side impact collision.

Although the driver's and front passenger's air bags are designed to inflate only in frontal collisions, they also may inflate in other types of collisions if the front impact sensors detect a sufficient impact. Side impact and curtain air bags are designed to inflate only in side impact collisions, but they may inflate in other collisions if the side impact sensors detect a sufficient impact.

If the vehicle chassis is impacted by bumps or objects on unimproved roads, the air bags may deploy. Drive carefully on unimproved roads or on surfaces not designed for vehicle traffic to prevent unintended air bag deployment.

Air bag non-deployment conditions



In certain low-speed collisions the air bags may not deploy. The air bags are designed not to deploy in such cases because they may not provide benefits beyond the protection of the seat belts.



Front air bags are not designed to inflate in rear collisions, because occupants are moved backward by the force of the impact. In this case, inflated air bags would not provide any additional benefit.

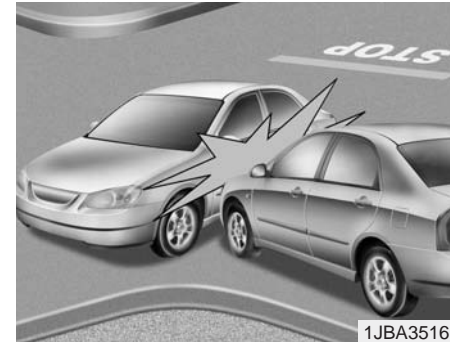

Front air bags may not inflate in side impact collisions, because occupants move in the direction of the collision, and thus in side impacts, front air bag deployment would not provide additional occupant protection.

However, side impact and curtain air bags may inflate depending on the intensity, vehicle speed and angles of impact.

Safety features of your vehicle

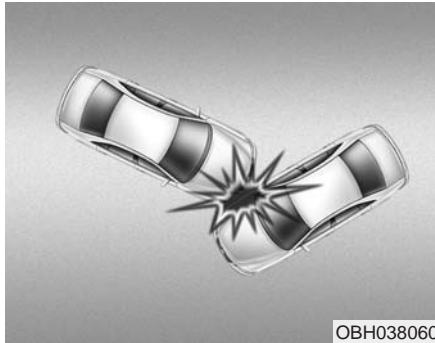

In an angled collision, the force of impact may direct the occupants in a direction where the air bags would not be able to provide any additional benefit, and thus the sensors may not deploy any air bags.

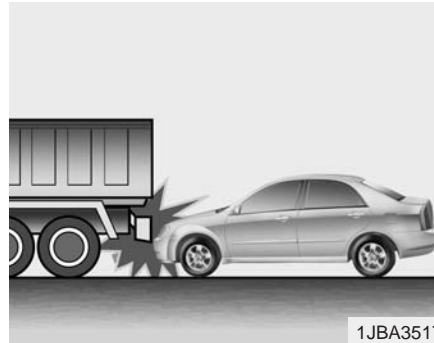

Just before impact, drivers often brake heavily. Such heavy braking lowers the front portion of the vehicle causing it to “ride” under a vehicle with a higher ground clearance. Air bags may not inflate in this “under-ride” situation because deceleration forces that are detected by sensors may be significantly reduced by such “underride” collisions.

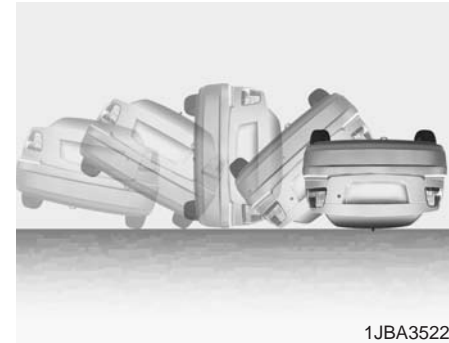

Air bags do not inflate in rollover accidents because vehicle can not detect rollover accident.

However, side and curtain air bags may inflate when the vehicle is rolled over after a side impact collision.

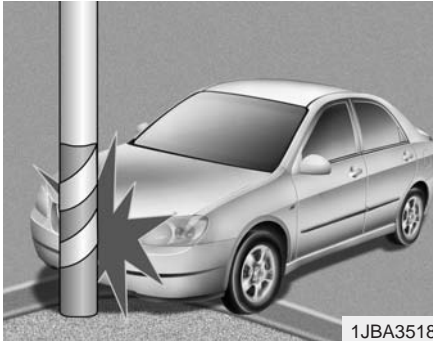

Air bags may not inflate if the vehicle collides with objects such as utility poles or trees, where the point of impact is concentrated and the collision energy is absorbed by the vehicle structure.

SRS care

The SRS is virtually maintenance-free and there are no parts you can safely service by yourself. If the SRS air bag warning light does not illuminate when the ignition switch is in the ON position, or continuously remains on, have your vehicle immediately inspected by an authorized HYUNDAI dealer.

Any work on the SRS system, such as removing, installing, repairing, or any work on the steering wheel, the front passenger's panel, front seats and roof rails must be performed by an authorized HYUNDAI dealer. Improper handling of the SRS system may result in serious personal injury.

⚠ WARNING

To reduce the risk of serious injury or death, take the following precautions:

- **Do not attempt to modify or disconnect the SRS components or wiring, including the addition of any kind of badges to the pad covers or modifications to the body structure.**
- **Do not place objects over or near the air bag modules on the steering wheel, instrument panel, or the front passenger's panel above the glove box.**
- **Clean the air bag pad covers with a soft cloth moistened with plain water. Solvents or cleaners could adversely affect the air bag covers and proper deployment of the system.**
- **Always have inflated air bags replaced by an authorized HYUNDAI dealer.**

(Continued)

(Continued)

- **If components of the air bag system must be discarded, or if the vehicle must be scrapped, certain safety precautions must be observed. Consult an authorized HYUNDAI dealer for the necessary information. Failure to follow these precautions could increase the risk of personal injury.**

Additional safety precautions

Passengers should not move out of or change seats while the vehicle is moving. A passenger who is not wearing a seat belt during a crash or emergency stop can be thrown against the inside of the vehicle, against other occupants, or be ejected from the vehicle.

Do not use any accessories on seat belts. Devices claiming to improve occupant comfort or reposition the seat belt can reduce the protection provided by the seat belt and increase the chance of serious injury in a crash

Do not modify the front seats.

Modification of the front seats could interfere with the operation of the supplemental restraint system sensing components or side air bags.

Do not place items under the front seats. Placing items under the front seats could interfere with the operation of the supplemental restraint system sensing components and wiring harnesses.

Do not cause impact to the doors. Impact to the doors when the ignition switch is in the ON position may cause the air bags to inflate.

Modifications to accommodate disabilities. If you require modification to your vehicle to accommodate a disability, contact the HYUNDAI Customer Connect Center at 1-877-378-8727.

Adding equipment to or modifying your air bag equipped vehicle

If you modify your vehicle by changing your vehicle's frame, bumper system, front end or side sheet metal or ride height, this may affect the operation of your vehicle's air bag system.

Air bag warning labels

■ Type A

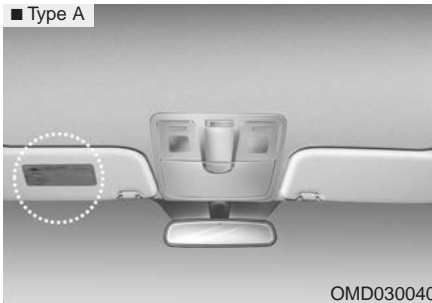

■ Type B



Air bag warning labels, required by the U.S. National Highway Traffic Safety Administration (NHTSA), are attached to alert the driver and passengers of potential risks of the air bag system.

Be sure to read all of the information about the air bags that are installed on your vehicle in this Owners Manual.

Features of your vehicle

| | | | |
|---|------|--|------|
| Accessing your vehicle | 4-3 | Sunroof | 4-34 |
| • Remote key | 4-3 | • Sunroof opening and closing | 4-34 |
| • Smart key | 4-7 | • Sliding the sunroof | 4-35 |
| • Immobilizer system | 4-12 | • Tilting the sunroof | 4-35 |
| Door locks | 4-14 | • Sunshade | 4-36 |
| • Outside the vehicle | 4-14 | Steering wheel | 4-38 |
| • Inside the vehicle | 4-16 | • Electric power steering (EPS) | 4-38 |
| • Auto door lock/unlock features | 4-18 | • Tilt steering / Telescope steering | 4-39 |
| • Child-protector rear door locks | 4-19 | • Driver selectable steering mode | 4-39 |
| Theft-alarm system | 4-20 | • Horn | 4-41 |
| Trunk | 4-21 | Mirrors | 4-42 |
| • Opening the trunk | 4-21 | • Inside rearview mirror | 4-42 |
| • Closing the trunk | 4-21 | • Outside rearview mirror | 4-48 |
| • Emergency trunk safety release | 4-22 | Instrument cluster | 4-51 |
| Windows | 4-24 | • Instrument cluster control | 4-52 |
| • Power windows | 4-24 | • Gauges | 4-53 |
| • Manual windows | 4-28 | • Transaxle shift indicator | 4-56 |
| Hood | 4-29 | • Trip computer | 4-56 |
| • Opening the hood | 4-29 | • Warning and indicator lights | 4-60 |
| • Closing the hood | 4-30 | Rearview camera | 4-71 |
| Fuel filler door | 4-31 | Light | 4-72 |
| • Opening the fuel filler door | 4-31 | • Exterior lights | 4-72 |
| • Closing the fuel filler door | 4-31 | • Interior lights | 4-78 |

| | | | |
|--|--------------|--------------------------------------|--------------|
| Wipers and washers | 4-81 | Interior features | 4-113 |
| • Windshield wipers | 4-81 | • Clock | 4-113 |
| • Windshield washers..... | 4-82 | • Outside temperature | 4-114 |
| Defroster | 4-83 | • Cup holder | 4-115 |
| • Rear window defroster | 4-83 | • Sunvisor | 4-116 |
| Manual climate control system | 4-84 | • Power outlet | 4-116 |
| • Heating and air conditioning | 4-85 | • Clothes hanger..... | 4-117 |
| • System operation..... | 4-90 | • Floor mat anchor(s)..... | 4-118 |
| • Climate control air filter..... | 4-92 | Audio system | 4-120 |
| Automatic climate control system | 4-94 | • Antenna | 4-120 |
| • Automatic heating and air conditioning | 4-95 | • Steering wheel audio control | 4-121 |
| • Manual heating and air conditioning | 4-96 | • Aux, USB and iPod® port | 4-122 |
| • System operation..... | 4-101 | • How vehicle audio works | 4-122 |
| • Climate control air filter..... | 4-103 | • Caring for disc..... | 4-125 |
| Windshield defrosting and defogging | 4-105 | | |
| • Manual climate control system | 4-105 | | |
| • Automatic climate control system | 4-106 | | |
| • Defogging logic..... | 4-107 | | |
| Storage compartment | 4-110 | | |
| • Center console storage | 4-110 | | |
| • Sliding armrest | 4-111 | | |
| • Glove box | 4-111 | | |
| • Sunglass holder | 4-112 | | |

ACCESSING YOUR VEHICLE

Remote key



Your HYUNDAI uses a remote key, which you can use to lock or unlock a door (and trunk).

1. Door Lock
2. Door Unlock
3. Trunk Unlock
4. Panic

Locking

To lock :

1. Close all doors, engine hood and trunk.
2. Press the Door Lock button (1) on the remote key.
3. The hazard warning lights will blink and the chime will sound once if the lock button is pressed once more within four seconds.
4. Make sure the doors are locked by checking the position of the door lock button inside the vehicle.

* NOTICE

After locking the doors, if you press the Door Lock button again within four seconds, the hazard warning lights will blink and the horn will sound one time to confirm that the doors are locked.

⚠ WARNING

Do not leave the keys in your vehicle with unsupervised children. Unattended children could place the key in the ignition switch and may operate power windows or other controls, or even make the vehicle move, which could result in serious injury or death.

Unlocking

To unlock:

1. Press the Door Unlock button (2) on the remote key.
2. The driver's door will unlock. The hazard warning lights will blink two times.

If you press the Door Unlock button again within four seconds, then all the doors will unlock.

*** NOTICE**

After unlocking the doors, the doors will lock automatically after 30 seconds unless a door is opened.

Trunk unlocking

To unlock:

1. Press the Trunk Unlock button (3) on the remote key for more than one second.
2. The hazard warning lights will blink two times. Once the trunk is opened and then closed, the trunk will lock automatically.

*** NOTICE**

- After unlocking the trunk, the trunk will lock automatically.
- The word "HOLD" is written on the button to inform you that you must press and hold the button for more than one second.

Panic button

Press the Panic button (4) for more than one second. The horn sounds and hazard warning lights flash for about 30 seconds.

To cancel the panic mode, press any button on the remote key.

Start-up

For detailed information refer to "Key Ignition Switch" in chapter 5.

⚠ CAUTION

To prevent damaging the remote key:

- **Keep the remote key away from water or any liquid and fire. If the inside of the remote key gets damp (due to drinks or moisture), or is heated, internal circuit may malfunction, excluding the car from the warranty.**
- **Avoid dropping or throwing the remote key.**
- **Protect the remote key from extreme temperatures.**

Mechanical key



If the remote key does not operate normally, you can lock or unlock the door by using the mechanical key.

Remote key precautions

The remote key will not work if any of the following occur:

- The key is in the ignition switch.
- You exceed the operating distance limit (about 90 feet [30 m]).
- The remote key battery is weak.
- Other vehicles or objects may be blocking the signal.
- The weather is extremely cold.
- The remote key is close to a radio transmitter such as a radio station or an airport which can interfere with normal operation of the remote key.

When the remote key does not work correctly, open and close the door with the mechanical key. If you have a problem with the remote key contact an authorized HYUNDAI dealer.

(Continued)

(Continued)

If the remote key is in close proximity to your mobile phone, the signal could be blocked by your mobile phones normal operational signals. This is especially important when the phone is active such as making and receiving calls, text messaging, and/or sending/receiving emails. Avoid placing the remote key and your mobile phone in the same pants or jacket pocket and always try to maintain an adequate distance between the two devices.

This device complies with Part 15 of the FCC rules.

Operation is subject to the following two conditions:

1. This device may not cause harmful interference, and
2. This device must accept any interference received, including interference that may cause undesired operation.

*** NOTICE**

Changes or modifications not expressly approved by the party responsible for compliance could void the user's authority to operate the device.

⚠ CAUTION

Keep the remote key away from electromagnetic materials that blocks electromagnetic waves to the key surface.

Battery replacement

If the remote key is not working properly, try replacing the battery with a new one.



Battery Type: CR2032

To replace the battery:

1. Insert a slim tool into the slot and gently pry open the cover.
2. Remove the old battery and insert the new battery. Make sure the battery position is correct.
3. Reinstall the rear cover of the remote key.

If you suspect your remote key might have sustained some damage, or you feel your remote key is not working correctly contact an authorized HYUNDAI dealer.

*** NOTICE**



An inappropriately disposed battery can be harmful to the environment and human health. Dispose the battery according to your local law(s) and regulation.

Smart key



Your HYUNDAI uses a Smart Key, which you can use to lock or unlock a door (and trunk) and even start the engine.

1. Door Lock
2. Door Unlock
3. Trunk Unlock
4. Panic

Locking

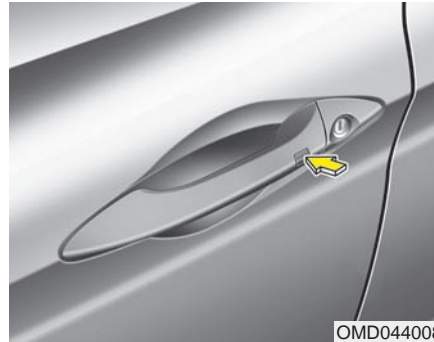

To lock :

1. Close all doors, engine hood and trunk.
2. Either press the door handle button or press the Door Lock button (1) on the smart key.

3. The hazard warning lights will blink and the chime will sound one time.
4. Make sure the doors are locked by checking the position of the door lock button inside the vehicle.

* NOTICE

The door handle button will only operate when the smart key is within 28~40 in. (0.7~1 m) from the outside door handle.

Even though you press the outside door handle button, the doors will not lock and the chime will sound for three seconds if any of the following occur:

- The Smart Key is in the vehicle.
- The Engine Start/Stop button is in ACC or ON position.
- Any door except the trunk is open.

⚠ WARNING

Do not leave the Smart Key in your vehicle with unsupervised children. Unattended children could press the Engine Start/Stop button and may operate power windows or other controls, or even make the vehicle move, which could result in serious injury or death.

Unlocking

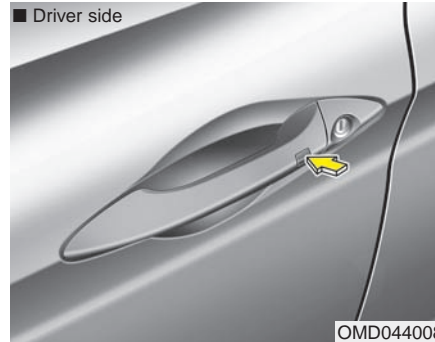

To unlock:

1. Carry the Smart Key.
2. Either press the door handle button or press the Door Unlock button (2) on the smart key.
3. The driver's door will unlock. The hazard warning lights will blink and the chime will sound two times.

If you press the Door Unlock button again within four seconds, then all the doors will unlock.

*** NOTICE**

- The door handle button will only operate when the smart key is within 28~40 in. (0.7~1 m) from the outside door handle. Other people can also open the doors without the smart key in possession.
- After unlocking the doors, the doors will lock automatically after 30 seconds unless a door is opened.

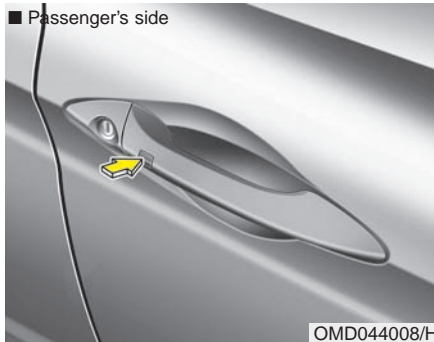

1. Carry the smart key.
2. Either press the door handle button or press the Door Unlock button (2) on the smart key.
3. The doors will unlock. The hazard warning lights will blink and the chime will sound two times.

Trunk unlocking

To unlock:

1. Carry the smart key.
2. Either press the trunk handle button or press the Trunk Unlock button (3) on the smart key for more than one second.
3. The hazard warning lights will blink two times.

Once the trunk is opened and then closed, the trunk will lock automatically.

*** NOTICE**

After unlocking the trunk, the trunk will lock automatically after 30 seconds unless the trunk is opened.

Panic button

Press the Panic button (4) for more than one second. The horn sounds and hazard warning lights flash for about 30 seconds.

To cancel the panic mode, press any button on the smart key.

Start-up

You can start the engine without inserting the key. For detailed information refer to the Engine Start/Stop button in chapter 5.

CAUTION

To prevent damaging the smart key:

- *Keep the smart key away from water or any liquid and fire. If the inside of the smart key gets damp (due to drinks or moisture), or is heated, internal circuit may malfunction, excluding the car from the warranty.*
- *Avoid dropping or throwing the smart key.*
- *Protect the smart key from extreme temperatures.*

Mechanical key

If the Smart Key does not operate normally, you can lock or unlock the door by using the mechanical key.

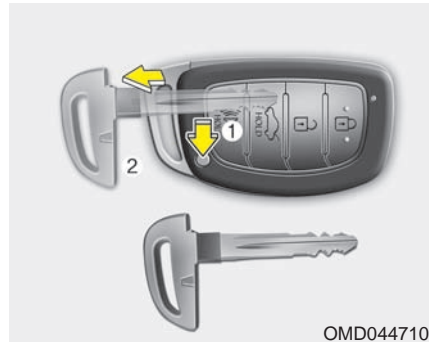

Press and hold the release button (1) and remove the mechanical key (2). Insert the mechanical key into the key hole on the door.

To reinstall the mechanical key, put the key into the hole and push it until a click sound is heard.

Loss of a smart key

A maximum of two smart keys can be registered to a single vehicle. If you happen to lose your smart key, it is recommended that you should immediately take the vehicle and remaining key to your authorized HYUNDAI dealer or tow the vehicle, if necessary.

Smart key precautions

The smart key will not work if any of the following occur:

- The smart key is close to a radio transmitter such as a radio station or an airport which can interfere with normal operation of the transmitter.
- The smart key is near a mobile two way radio system or a cellular phone.
- Another vehicle's smart key is being operated close to your vehicle.

When the smart key does not work correctly, open and close the door with the mechanical key. If you have a problem with the smart key, contact an authorized HYUNDAI dealer.

(Continued)

(Continued)

If the smart key is in close proximity to your mobile phone, the signal could be blocked by your mobile phones normal operational signals. This is especially important when the phone is active such as making and receiving calls, text messaging, and/or sending/receiving emails. Avoid placing the smart key and your mobile phone in the same pants or jacket pocket and always try to maintain an adequate distance between the two devices.

This device complies with Part 15 of the FCC rules.

Operation is subject to the following two conditions:

1. This device may not cause harmful interference, and
2. This device must accept any interference received, including interference that may cause undesired operation.

* NOTICE

Changes or modifications not expressly approved by the party responsible for compliance could void the user's authority to operate the device.



CAUTION

Keep the smart key away from electromagnetic materials that blocks electromagnetic waves to the key surface.

Battery replacement



If the Smart Key is not working properly, try replacing the battery with a new one.

Battery Type: CR2032

To replace the battery:

1. Pry open the rear cover of the smart key.
2. Remove the old battery and insert the new battery. Make sure the battery position is correct.
3. Reinstall the rear cover of the smart key.

If you suspect your smart key might have sustained some damage, or you feel your smart key is not working correctly, contact an authorized HYUNDAI dealer.

* NOTICE



An inappropriately disposed battery can be harmful to the environment and human health. Dispose the battery according to your local law(s) and regulation.

Immobilizer System

The immobilizer system protects your vehicle from theft. If an improperly coded key (or other device) is used, the engine's fuel system is disabled.

When the ignition switch is placed in the ON position, the immobilizer system indicator should come on briefly, then go off. If the indicator starts to blink, the system does not recognize the coding of the key.

Place the ignition switch to the LOCK/OFF position, then place the ignition switch to the ON position again.

The system may not recognize your key's coding if another immobilizer key or other metal object (i.e., key chain) is near the key. The engine may not start because the metal may interrupt the transponder signal from transmitting normally.

If the system repeatedly does not recognize the coding of the key, contact your HYUNDAI dealer.

Do not attempt to alter this system or add other devices to it. Electrical problems could result that may make your vehicle inoperable.

⚠ WARNING

In order to prevent theft of your vehicle, do not leave spare keys anywhere in your vehicle. Your immobilizer password is a customer unique password and should be kept confidential.

⚠ CAUTION

The transponder in your key is an important part of the immobilizer system. It is designed to give years of trouble-free service, however you should avoid exposure to moisture, static electricity and rough handling. Immobilizer system malfunction could occur.

This device complies with Part 15 of the FCC rules.

Operation is subject to the following two conditions:

1. This device may not cause harmful interference, and
2. This device must accept any interference received, including interference that may cause undesired operation.

*** NOTICE**

Changes or modifications not expressly approved by the party responsible for compliance could void the user's authority to operate the device.

DOOR LOCKS

Operating door locks from outside the vehicle

Mechanical key

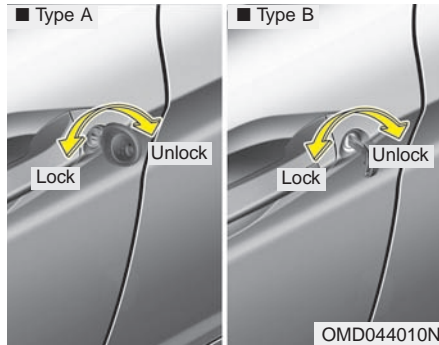

Turn the key toward the rear of the vehicle to unlock and toward the front of the vehicle to lock.

If you lock the door with a key, all vehicle doors will lock automatically. (if equipped with the central door lock system)

From the driver's door, turn the key to the right once to unlock the driver's door and once more within 4 seconds to unlock all doors. (if equipped with the central door lock system)

Once the doors are unlocked, they may be opened by pulling the door handle.

When closing the door, push the door by hand. Make sure that doors are closed securely.

Remote key



To lock the doors, press the Door Lock button (1) on the remote key.

Press the Door Unlock button (2) on the remote key, the driver's door will unlock. If you press the Door Unlock button on the remote key again within four seconds, then all the doors will unlock.

Once the doors are unlocked, they may be opened by pulling the door handle.

When closing the door, push the door by hand. Make sure that doors are closed securely.

*** NOTICE**

- In cold and wet climates, door lock and door mechanisms may not work properly due to freezing conditions.
- If the door is locked/unlocked multiple times in rapid succession with either the vehicle key or door lock switch, the system may stop operating temporarily in order to protect the circuit and prevent damage to system components.

Smart key

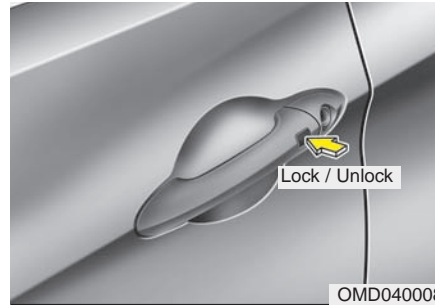

To lock the doors, press the button on the outside door handle while carrying the smart key with you or press the door lock button on the smart key.

Press the button on the outside door handle while carrying the smart key with you or press the door unlock button on the smart key, the driver's door will unlock. If you press the Door Unlock button on the smart key again within four seconds, then all the doors will unlock.

Once the doors are unlocked, they may be opened by pulling the door handle.

When closing the door, push the door by hand. Make sure that doors are closed securely.

*** NOTICE**

- In cold and wet climates, door lock and door mechanisms may not work properly due to freezing conditions.
- If the door is locked/unlocked multiple times in rapid succession with either the vehicle key or door lock switch, the system may stop operating temporarily in order to protect the circuit and prevent damage to system components.

Operating door locks from inside the vehicle

With the door lock button

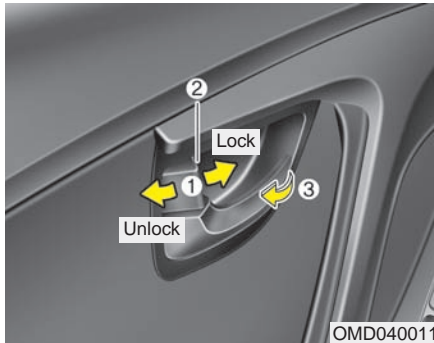

- To unlock a door, push the door lock button (1) to the “Unlock” position. The red mark (2) on the door lock button will be visible.
- To lock a door, push the door lock button (1) to the “Lock” position. If the door is locked properly, the red mark (2) on the door lock button will not be visible.

- To open a door, pull the door handle (3) outward.
- If the inner door handle of the driver’s (or front passenger’s) door is pulled when the door lock button is in the lock position, the button is unlocked and door opens.
- Front doors cannot be locked if the key is in the ignition switch and any front door is open.
- Doors cannot be locked if the smart key is in the vehicle and any door is open.

*** NOTICE**

If a power door lock ever fails to function while you are in the vehicle try one or more of the following techniques to exit:

Operate the door unlock feature repeatedly (both electronic and manual) while simultaneously pulling on the door handle.

Operate the other door locks and handles, front and rear.

Lower a front window and use the mechanical key to unlock the door from outside.

With the central door lock switch (if equipped)

■ Driver's door



OMD040012A

■ Passenger's door

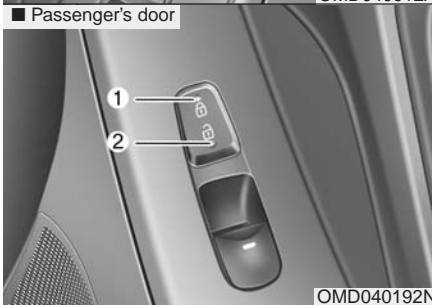

OMD040192N

When pressing the (🔒) portion (1) of the switch, all vehicle doors will lock.

- If the key is in the ignition switch and any door is opened, the doors will not lock even though the lock button (1) of the central door lock switch is pressed.
- If the smart key is in the vehicle and any door is opened, the doors will not lock even though the lock button (1) of the central door lock switch is pressed.

When pressing the (🔓) portion (2) of the switch, all vehicle doors will unlock.

⚠ WARNING

The doors should always be fully closed and locked while the vehicle is in motion. If the doors are unlocked, the risk of being thrown from the vehicle in a crash is increased.

⚠ WARNING

Do not leave children or animals unattended in your vehicle. An enclosed vehicle can become extremely hot, causing death or serious injury to unattended children or animals who cannot escape the vehicle. Children might operate features of the vehicle that could injure them, or they could encounter other harm, possibly from someone gaining entry to the vehicle.

⚠ WARNING - Always secure your vehicle

Leaving your vehicle unlocked increases the potential risk to you or others from someone hiding in your vehicle.

To secure your vehicle, while depressing the brake, move the shift lever to the P (Park) position (for automatic transaxle) or first gear or R (Reverse, for manual transaxle), engage the parking brake, and place the ignition switch in the LOCK/OFF position, close all windows, lock all doors, and always take the key with you.

⚠ WARNING

Opening a door when something is approaching may cause damage or injury. Be careful when opening doors and watch for vehicles, motorcycles, bicycles or pedestrians approaching the vehicle in the path of the door.

Auto door lock/unlock features

Impact sensing door unlock system (if equipped)

All doors will be automatically unlocked when an impact causes the air bags to deploy.

Speed sensing door lock system (if equipped)

All doors will be automatically locked when vehicle speed exceeds 9 mph (15 km/h).

Child-safety rear door locks

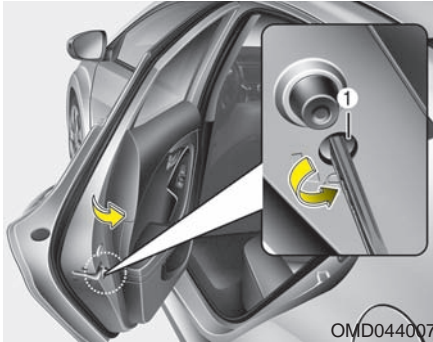

The child safety lock is provided to help prevent children seated in the rear from accidentally opening the rear doors. The rear door safety locks should be used whenever children are in the vehicle.

The child safety lock is located on the edge of each rear door. When the child safety lock is in the lock position (🔒), the rear door will not open if the inner door handle is pulled.

To utilize the child safety lock, insert a key (or screwdriver) into the hole (1) and turn it to the lock (🔒) position.

To allow a rear door to be opened from inside the vehicle, unlock the child safety lock.

⚠️ WARNING

If children accidentally open the rear doors while the vehicle is in motion, they could fall out of the vehicle. The rear door safety locks should always be used whenever children are in the vehicle.

THEFT-ALARM SYSTEM

This system helps to protect your vehicle and valuables. The horn will sound and the hazard warning lights will blink continuously if any of the following occurs:

- A door is opened without using the remote key or smart key.
- The trunk is opened without using the remote key or smart key.
- The engine hood is opened.

The alarm continues for 30 seconds, then the system resets. To turn off the alarm, unlock the doors with the remote key or smart key.

The Theft Alarm System automatically sets 30 seconds after you lock the doors and the trunk. For the system to activate, you must lock the doors and the trunk from outside the vehicle with the remote key or smart key or by pressing the button on the outside of the door handles with the smart key in your possession.

The hazard warning lights will blink and the chime will sound once to indicate the system is armed.

Once the security system is set, opening any door, the trunk, or the hood without using the remote key or smart key will cause the alarm to activate.

The Theft Alarm System will not set if the hood, the trunk, or any door is not fully closed. If the system will not set, check the hood, the trunk, or the doors are fully closed.

Do not attempt to alter this system or add other devices to it.

* NOTICE

- **Do not lock the doors until all passengers have left the vehicle. If the remaining passenger leaves the vehicle when the system is armed, the alarm will be activated.**
- **If the vehicle is not disarmed with the remote key or smart key, open the doors by using the mechanical key and place the ignition switch in the ON position (for remote key) or start the engine (for smart key) by directly pressing the Engine Start/Stop button with the smart key.**
- **When the system is disarmed but a door or trunk is not opened within 30 seconds, the system will be rearmed.**

TRUNK

Opening the trunk

1. Make sure the shift lever is in P (Park, for automatic transaxle) or first gear or R (Reverse, for manual transaxle) and set the parking brake.
2. Perform one of the following:

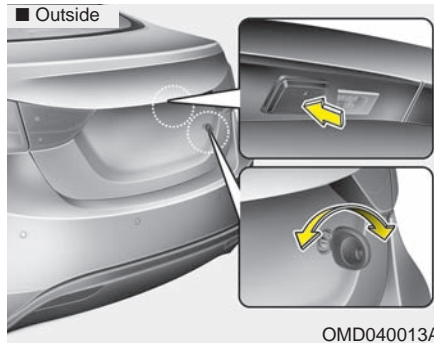

- Press the remote key or smart key Trunk Unlock button for more than one second.
- Press the button on the trunk itself with the smart key in your possession.
- Press the button on the trunk itself when all doors are unlocked.
- Use the mechanical key.

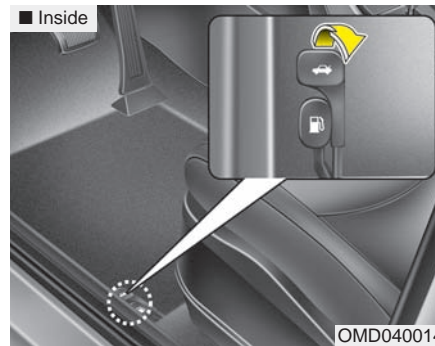

- Use the trunk release lever.

Closing the trunk

Lower the trunk lid and press down until it locks. To be sure the trunk lid is securely fastened, always check by trying to pull it up again.

* NOTICE

In cold and wet climates, trunk locks and trunk mechanisms may not work properly due to freezing conditions.

⚠ WARNING

Make sure there are no people or objects around the trunk before opening or closing the trunk.

⚠ CAUTION

Make certain that you close the trunk before driving your vehicle. Possible damage may occur to the trunk lift cylinders and attached hardware if the trunk is not closed prior to driving.

⚠ WARNING

The trunk lid should be always kept completely closed while the vehicle is in motion. If it is left open or ajar, poisonous exhaust gases may enter the vehicle and serious illness or death may result.

Emergency trunk safety release



Your vehicle is equipped with an Emergency Trunk Safety Release lever located inside the trunk. When someone is inadvertently locked in the trunk, the trunk can be opened by moving the lever in the direction of the arrow and pushing the trunk open.

⚠ WARNING

- You and your passengers must be aware of the location of the Emergency Trunk Safety Release lever in this vehicle and how to open the trunk in case you are accidentally locked in the trunk.
- NEVER allow anyone to occupy the trunk of the vehicle at any time. If the trunk is partially or totally latched and the person is unable to get out, serious injury or death could occur due to lack of ventilation, exhaust fumes and rapid heat build-up, or because of exposure to cold weather conditions. The trunk is also a highly dangerous location in the event of a crash because it is not a protected occupant space but is a part of the vehicle's crush zone.

(Continued)

(Continued)

- Your vehicle should be kept locked and the key should be kept out of the reach of children. Parents should teach their children about the dangers of playing in the trunk.
- Use the release lever for emergencies only.

WINDOWS

Power windows

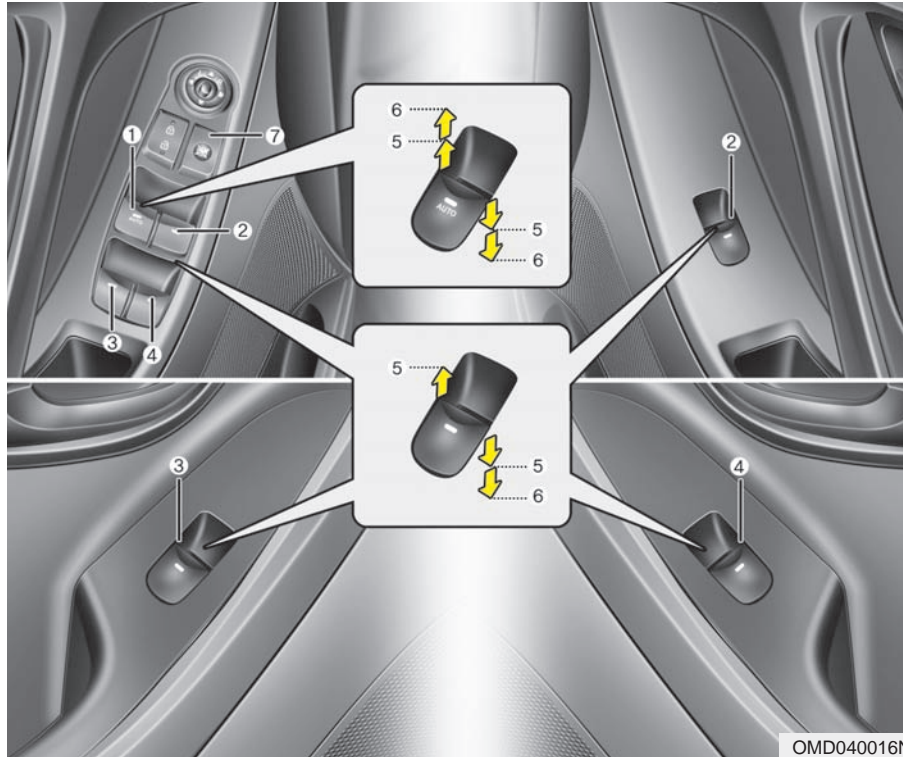

- (1) Driver's door power window switch
- (2) Front passenger's door power window switch
- (3) Rear door (left) power window switch
- (4) Rear door (right) power window switch
- (5) Window opening and closing
- (6) Automatic power window*
- (7) Power window lock switch

* : if equipped

The ignition switch must be in the ON position to be able to raise or lower the windows. Each door has a Power Window switch to control that door's window. The driver has a Power Window Lock switch which can block the operation of passenger windows. The power windows will operate for approximately 30 seconds after the ignition switch is placed in the ACC or LOCK/OFF position. However, if the front doors are opened, the Power Windows cannot be operated even within the 30 second period.

*** NOTICE**

- In cold and wet climates, power windows may not work properly due to freezing conditions.
- While driving with the rear windows down or with the sunroof (if equipped) opened (or partially opened), your vehicle may demonstrate a wind buffeting or pulsation noise. This noise is normal and can be reduced or eliminated by taking the following actions. If the noise occurs with one or both of the rear windows down, partially lower both front windows approximately one inch. If you experience the noise with the sunroof open, slightly close the sunroof.

Window opening and closing

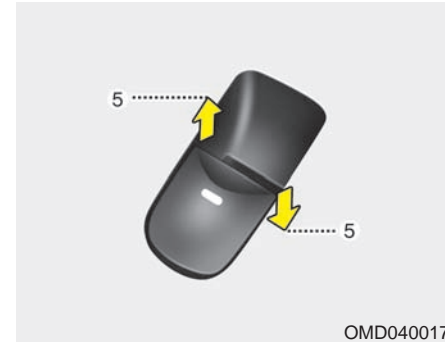

To open or close a window, press down or pull up the front portion of the corresponding switch to the first detent position (5).

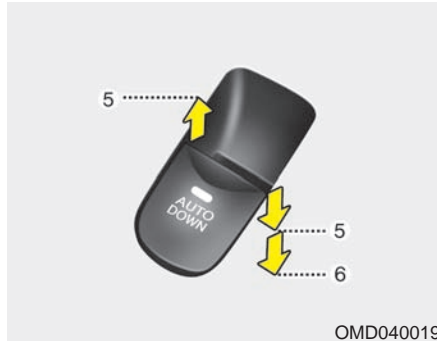

Auto down window (if equipped)

Pressing the power window switch momentarily to the second detent position (6) completely lowers the window even when the switch is released. To stop the window at the desired position while the window is in operation, pull up or press down and release the switch.

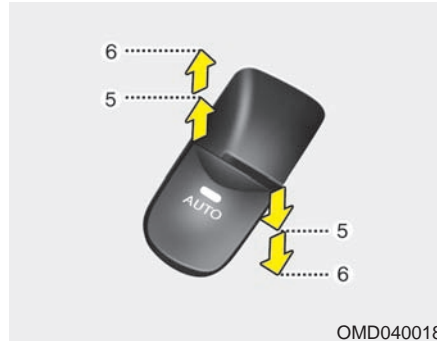

Auto up/down window (if equipped)

Pressing or pulling up the power window switch momentarily to the second detent position (6) completely lowers or lifts the window even when the switch is released. To stop the window at the desired position while the window is in operation, pull up or press down and release the switch.

To reset the power windows

If the power windows do not operate normally, the automatic power window system must be reset as follows:

1. Place the ignition switch to the ON position.
2. Close the window and continue pulling up on the power window switch for at least one second.

If the power windows do not operate properly after resetting, have the system checked by an authorized HYUNDAI dealer.

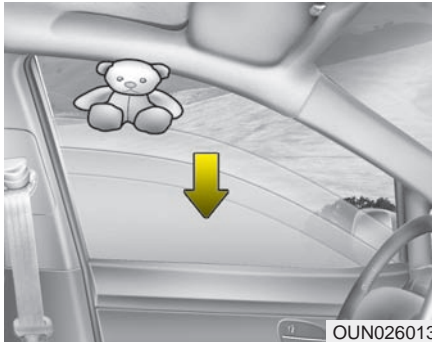

OUN026013

Automatic reversal (if equipped)

If a window senses any obstacle while it is closing automatically, it will stop and lower approximately 12 inches (30 cm) to allow the object to be cleared.

If the window detects the resistance while the power window switch is pulled up continuously, the window will stop upward movement then lower approximately 1 inch (2.5 cm).

If the power window switch is pulled up continuously again within 5 seconds after the window is lowered by the automatic window reversal feature, the automatic window reversal will not operate.

* NOTICE

The automatic reverse feature is only active when the “auto up” feature is used by fully pulling up the switch to the second detent.

⚠ WARNING

- Make sure body parts or other objects are safely out of the way before closing the windows to avoid injuries or vehicle damage.
- Objects less than 0.16 inch (4 mm) in diameter caught between the window glass and the upper window channel may not be detected by the automatic reverse window and the window will not stop and reverse direction.

Power window lock switch



OMD040020N

The driver can disable the power window switches on the passengers' doors by pressing the power window lock switch.

- The driver's control can operate the driver's power window.
- The front passenger's control cannot operate the front passenger's power window.
- The rear passenger's control cannot operate the rear passenger's power window.

CAUTION

- *To prevent possible damage to the power window system, do not open or close two windows or more at the same time. This will also ensure the longevity of the fuse.*
- *Never try to operate the main switch on the driver's door and the individual door window switch in opposite directions at the same time. If this is done, the window will stop and cannot be opened or closed.*

WARNING - Windows

- **NEVER** leave the keys in your vehicle with unsupervised children, when the engine is running.
- **NEVER** leave any child unattended in the vehicle. Even very young children may inadvertently cause the vehicle to move, entangle themselves in the windows, or otherwise injure themselves or others.
- Always double check to make sure all arms, hands, head and other obstructions are safely out of the way before closing a window.
- Do not allow children to play with the power windows. Keep the driver's door power window lock switch in the LOCK position (pressed). Serious injury can result from unintentional window operation by the child.
- Do not extend your head, arms or body outside the windows while driving.

HOOD

Opening the hood

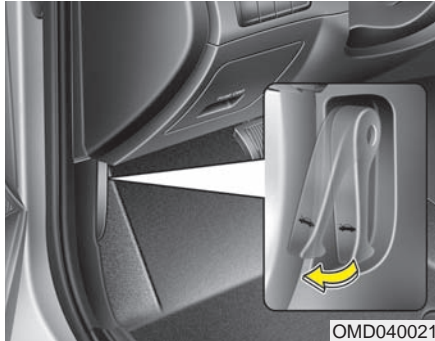

1. Make sure the shift lever is in P (Park, for automatic transaxle) or first gear or R (Reverse, for manual transaxle) and set the parking brake.
2. Pull the release lever to unlatch the hood. The hood should pop open slightly.

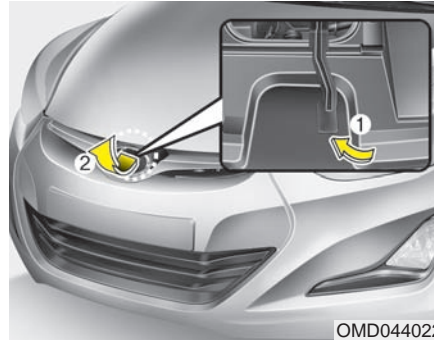

3. Raise the hood slightly, pull the secondary latch up (1) inside the hood center until it releases the hood and lift the hood (2).

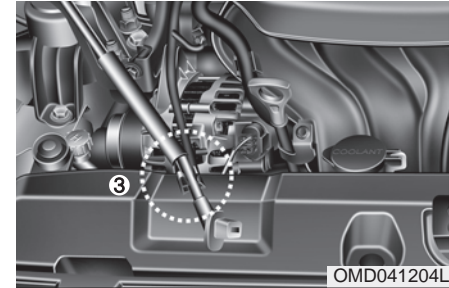

4. Pull out the support rod (3).
5. Hold the hood opened with the support rod (4).

⚠ WARNING - Support rod

- Grasp the support rod in the area wrapped in rubber. The rubber will help prevent you from being burned by hot metal when the engine is hot.
- The support rod must be inserted completely into the hole provided whenever you inspect the engine compartment. This will prevent the hood from falling and possibly injuring you.

Closing the hood

1. Before closing the hood, check the following:
 - All filler caps in engine compartment must be correctly installed.
 - Gloves, rags or any other combustible material must be removed from the engine compartment.
2. Return the support rod to its clip to prevent it from rattling.
3. Lower the hood halfway and push down to securely lock in place. Then double check to be sure the hood is secure.

⚠ WARNING

- Before closing the hood, ensure that all obstructions are removed from the hood opening.
- Always double check to be sure that the hood is firmly latched before driving away. If it is not latched, the hood could open while the vehicle is being driven, causing a total loss of visibility, which might result in an accident.
- Do not move the vehicle with the hood in the raised position, as vision is obstructed, which might result in an accident, and the hood could fall or be damaged.

FUEL FILLER DOOR

Opening the fuel filler door



The fuel filler door must be opened from inside the vehicle by pulling up the fuel filler door opener.

1. Turn the engine off.
2. Pull the fuel filler door opener up located on the floor, left side of the driver's seat.

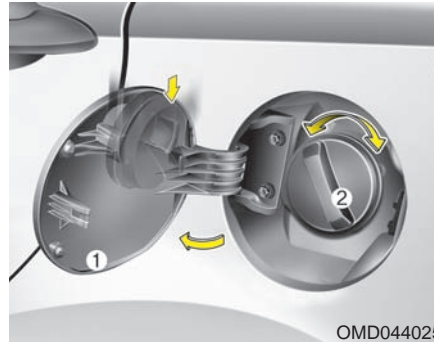

3. Pull the fuel filler door out (1) to fully open.
4. To remove the fuel tank cap (2), turn it counterclockwise. You may hear a hissing noise as the pressure inside the tank equalizes.
5. Place the cap on the fuel filler door.

* NOTICE

If the fuel filler door does not open because ice has formed around it, tap lightly or push on the door to break the ice and release the door. Do not pry on the door. If necessary, spray around the door with an approved de-icer fluid (do not use radiator anti-freeze) or move the vehicle to a warm place and allow the ice to melt.

Closing the fuel filler door

1. To install the fuel tank cap, turn it clockwise until it "clicks" one time.
2. Close the fuel filler door until it is latched securely.

⚠ WARNING

Gasoline is highly flammable and explosive. Failure to follow these guidelines may result in **SERIOUS INJURY** or **DEATH**:

- Read and follow all warnings posted at the gas station.
- Before refueling, note the location of the Emergency Gasoline Shut-Off, if available, at the gas station.
- Before touching the fuel nozzle, you should eliminate the potential build-up of static electricity by touching a metal part of the vehicle, a safe distance away from the fuel filler neck, nozzle, or other gas source, with your bare hand.

(Continued)

(Continued)

- Do not use cellular phones while refueling. Electric current and/or electronic interference from cellular phones can potentially ignite fuel vapors and cause a fire.
- Do not get back into a vehicle once you have begun refueling. You can generate a build-up of static electricity by touching, rubbing or sliding against any item or fabric capable of producing static electricity. Static electricity discharge can ignite fuel vapors causing a fire. If you must re-enter the vehicle, you should once again eliminate potentially dangerous static electricity discharge by touching a metal part of the vehicle, away from the fuel filler neck, nozzle or other gasoline source, with your bare hand.

(Continued)

(Continued)

- When using an approved portable fuel container, be sure to place the container on the ground prior to refueling. Static electricity discharge from the container can ignite fuel vapors causing a fire. Once refueling has begun, contact between your bare hand and the vehicle should be maintained until the filling is complete.
- Use only approved portable plastic fuel containers designed to carry and store gasoline.

(Continued)

(Continued)

- When refueling, always move the shift lever to the P (Park) position (for automatic transaxle) or first gear or R (Reverse, for manual transaxle), set the parking brake, and place the ignition switch to the LOCK/OFF position. Sparks produced by electrical components related to the engine can ignite fuel vapors causing a fire.
- Do not use matches or a lighter and do not smoke or leave a lit cigarette in your vehicle while at a gas station, especially during refueling.
- Do not over-fill or top-off your vehicle tank, which can cause gasoline spillage.

(Continued)

(Continued)

- If a fire breaks out during refueling, leave the vicinity of the vehicle, and immediately contact the manager of the gas station and then contact the local fire department. Follow any safety instructions they provide.
- If pressurized fuel sprays out, it can cover your clothes or skin and thus subject you to the risk of fire and burns. Always remove the fuel cap carefully and slowly. If the cap is venting fuel or if you hear a hissing sound, wait until the condition stops before completely removing the cap.
- Always check that the fuel cap is installed securely to prevent fuel spillage in the event of an accident.

*** NOTICE**

- Make sure to refuel your vehicle according to the "Fuel Requirements" suggested in chapter 1.
- Do not spill fuel on the exterior surfaces of the vehicle. Any type of fuel spilled on painted surfaces may damage the paint.



CAUTION

If the fuel filler cap requires replacement, use only a genuine HYUNDAI cap or the equivalent specified for your vehicle. An incorrect fuel filler cap can result in a serious malfunction of the fuel system or emission control system.

SUNROOF (IF EQUIPPED)



The ignition switch must be in the ON position before you can open or close the sunroof.

Sunroof opening and closing

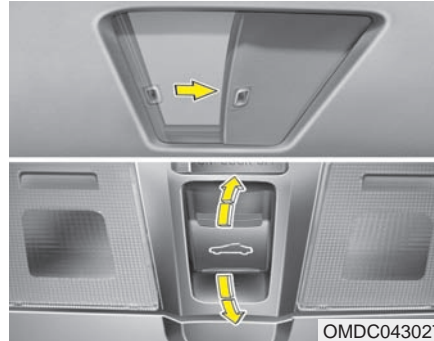

To open:

Press the sunroof control lever backward to the first detent position. Release the switch when you want the sunroof to stop.

To close:

Press the sunroof control lever backward to the first detent position. Release the switch when you want the sunroof to stop.

⚠ WARNING

Make sure heads, other body parts or other objects are safely out of the way before closing the windows to avoid injuries or vehicle damage.

Objects less than 0.16inch (4mm) in diameter caught between the sunroof glass and the front window channel may not be detected by the automatic reverse window and the window will not stop and reverse direction.

Sliding the sunroof

Pressing the sunroof control lever backward or forward momentarily to the second detent position completely opens or closes the sunroof even when the switch is released. To stop the sunroof at the desired position while the sunroof is in operation, press the sunroof control lever backward or forward and release the switch.

* NOTICE

To reduce wind noise while driving, it is recommended that you drive with the sunroof slightly closed (stop the sunroof about 2 inches (5 cm) before the maximum slide open position).

Automatic reversal



If the sunroof senses any obstacle while it is closing automatically, it will reverse direction then stop to allow the object to be cleared.

Tilting the sunroof

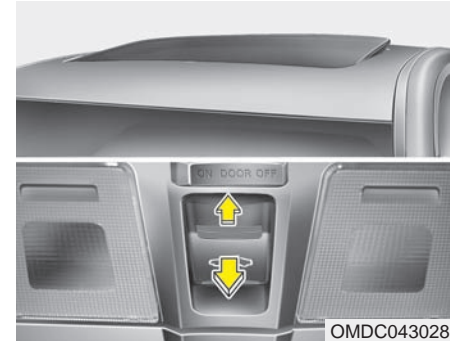

To tilt the sunroof open:

Push the sunroof control lever upward until the sunroof moves to the desired position.

To close the sunroof:

Pull the sunroof lever downward until the sunroof moves to the desired position.

⚠ WARNING

- Make sure heads, other body parts or other objects are safely out of the way before closing the sunroof to avoid injuries or vehicle damage.
- Never adjust the sunroof or sunshade while driving. This may cause loss of vehicle control resulting in an accident.
- To avoid serious injury or death, do not extend your head, arms or body outside the sunroof while driving.

⚠ CAUTION

- *Periodically remove any dirt that may accumulate on the sunroof guide rail or between the sunroof and roof panel, which can make a noise.*
- *Do not try to open the sunroof when the temperature is below freezing or when the sunroof is covered with snow or ice, the motor could be damaged.*
- *To prevent damage to the sunroof and the motor, do not continue to press the sunroof control lever after the sunroof is in the fully open, closed or tilt position(s).*

*** NOTICE**

After washing the vehicle or after a rain, be sure to wipe off the water on the sunroof before operating the sunroof.

Sunshade



The sunshade will open automatically with the sunroof when the glass panel moves. If you want it closed, move the sunshade manually.

⚠ CAUTION

The sunroof is made to slide together with the sunshade. Do not leave the sunshade closed while the sunroof is open.

To reset the sunroof

Sunroof needs to be reset if (in the followings)

- Battery is discharged or disconnected or the related fuse has been replaced or disconnected
 - The one-touch sliding function of the sunroof does not normally operate
1. The ignition switch must be in the ON position.
 2. Close the sunroof completely.
 3. Release the control lever.
 4. Push the control lever forward until the sunroof tilts and slightly moves up and down. Then, release the lever.
 5. Push the control lever forward until the sunroof is operated as follows:

TILT OPEN → SLIDE OPEN →
SLIDE CLOSE

Then, release the control lever.

If the sunroof does not operate properly after resetting, have the system checked by an authorized HYUNDAI dealer.

STEERING WHEEL

Electric power steering (EPS)

The system assists you with steering the vehicle. If the engine is off or if the power steering system becomes inoperative, the vehicle may still be steered, but it will require increased steering effort.

Also, the steering effort becomes heavier as the vehicle's speed increases and becomes lighter as the vehicle's speed decreases for better control of the steering wheel.

Should you notice any change in the effort required to steer during normal vehicle operation, we recommend that the system be checked by an authorized HYUNDAI dealer.

CAUTION

If the Electric Power Steering System does not operate normally, the warning light (⊗!) will illuminate on the instrument cluster. The steering wheel may become difficult to control or operate. Take your vehicle to an authorized HYUNDAI dealer and have the system checked as soon as possible.

* NOTICE

The following symptoms may occur during normal vehicle operation:

- The steering effort may be high immediately after placing the ignition switch in the ON position. This happens as the system performs the EPS system diagnostics. When the diagnostics is completed, the steering wheel will return to its normal condition.
- A click noise may be heard from the EPS relay after the ignition switch is placed to the ON or LOCK/OFF position.
- A motor noise may be heard when the vehicle is at stop or at a low driving speed.
- When you operate the steering wheel in low temperature, abnormal noise may occur. If temperature rises, the noise will disappear. This is a normal condition.

Tilt steering / Telescope steering

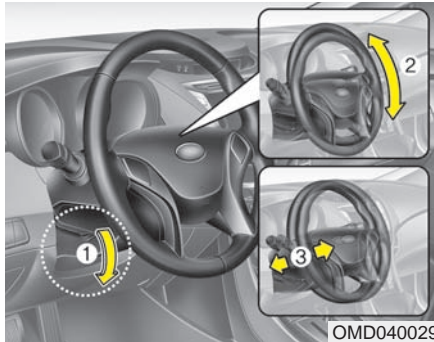

Pull down the lock-release lever (1) on the steering wheel column and adjust the steering wheel angle (2) and position (3, if equipped). Move the steering wheel, so it points toward your chest, not toward your face. Make sure you can see the instrument panel warning lights and gauges.

After adjusting, pull up the lock-release lever (1) to lock the steering wheel in place. Push the steering wheel both up and down to be certain it is locked in position. Always adjust the position of the steering wheel before driving.

⚠ WARNING
Never adjust the steering wheel while driving. This may cause loss of vehicle control resulting in an accident.

Driver selectable steering mode (if equipped)

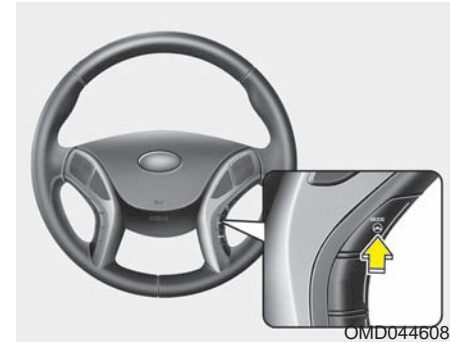

The Driver Selectable Steering Mode controls steering effort as driver's preference or road condition. You can select the desired steering mode by pressing the steering mode button. The driver selectable steering mode stays in the last mode selected when turning the engine on.

Features of your vehicle

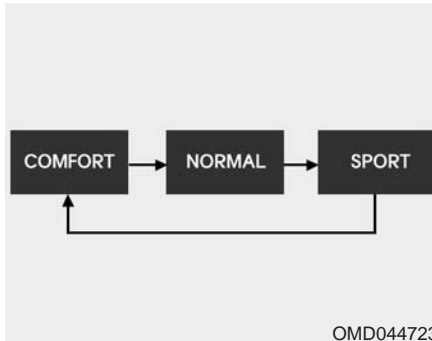

When the steering mode button is pressed, the selected steering mode will appear on the cluster.

If the steering mode button is pressed within 4 seconds, the steering mode will change as above pictures.

If the steering wheel mode button is not pressed for about 4 seconds, the cluster will change to the previous screen.

NORMAL mode

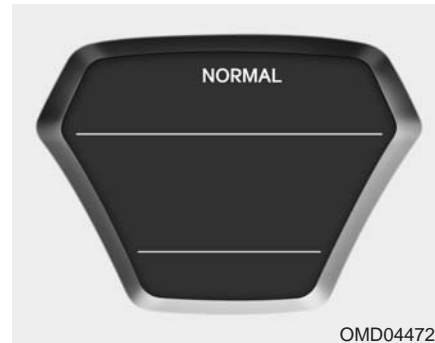

The **NORMAL** mode offers medium steering effort.

SPORT mode



The steering effort becomes heavier.

COMFORT mode

OMD044720

The steering effort comes lighter in COMFORT mode.

*** NOTICE**

For your safety, if you press the steering mode button to change the mode while turning the steering wheel, the cluster will change as you have selected, but the steering effort will not change. The steering effort will change to the selected mode, when the steering wheel is positioned to the center.

 **CAUTION**

- ***Be careful when changing the steering mode while driving.***
- ***When the Electric Power Steering is not working properly, the Driver Selectable Steering Mode will not work.***

Horn

OMD040030

To sound the horn, press the area indicated by the horn symbol on your steering wheel (see illustration). The horn will operate only when this area is pressed.

 **CAUTION**

Do not strike the horn severely to operate it, or hit it with your fist. Do not press on the horn with a sharp-pointed object.

MIRRORS

Inside rearview mirror

Before you start driving, adjust the rearview mirror to the center on the view through the rear window.

⚠ WARNING

Make sure your line of sight is not obstructed. Do not place objects in the rear seat, cargo area, or behind the rear headrests which could interfere with your vision through the rear window.

⚠ WARNING

To prevent serious injury during an accident or deployment of the air bag, do not modify the rearview mirror and do not install a wide mirror.

⚠ WARNING

NEVER adjust the mirror while driving. This may cause loss of vehicle control resulting in an accident.

Day/night rearview mirror (if equipped)

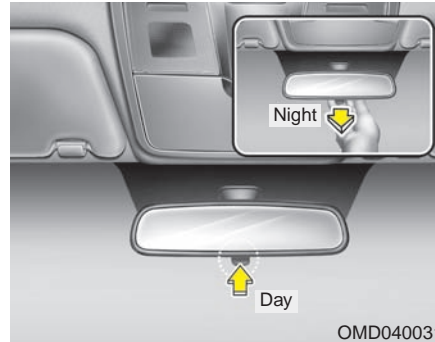

Make this adjustment before you start driving and while the day/night lever is in the day position.

Pull the day/night lever toward you to reduce glare from the headlights of the vehicles behind you during night driving.

Remember that you lose some rearview clarity in the night position.

Blue Link® center (if equipped)

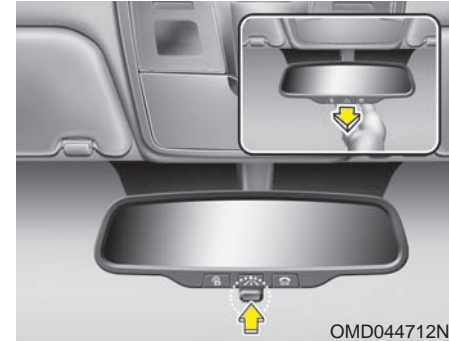

For details, refer to the Blue Link® Owner's Guide, Navigation Manual or Audio Manual. The Audio Manual is in this chapter.

Electric chromic mirror (ECM) with compass and HomeLink® system (if equipped)

Your vehicle may be equipped with a Gentex Automatic-Dimming Mirror and an Integrated HomeLink® Wireless Control System.

During nighttime driving, this feature will automatically detect and reduce rearview mirror glare. The HomeLink® Universal Transceiver allows you to activate your garage door(s), electric gate, home lighting, etc.

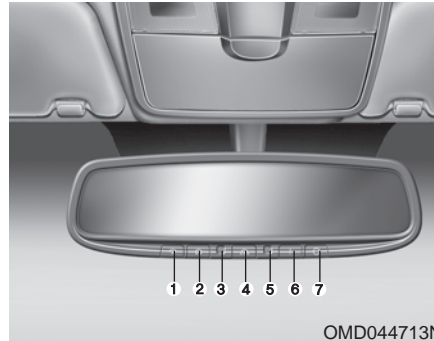

- (1) Channel 1 button
- (2) Channel 2 button
- (3) Status indicator LED
- (4) Channel 3 button
- (5) Rear light sensor
- (6) Dimming ON button
- (7) Dimming OFF button

Automatic-Dimming Night Vision Safety™ (NVS®) Mirror (if equipped)

CAUTION

The NVS® Mirror automatically reduces glare by monitoring light levels in the front and the rear of the vehicle. Any object that obstructs either light sensor will degrade the automatic dimming control feature.

For more information regarding NVS® mirrors and other applications, please refer to the Gentex website: www.gentex.com

The auto-dimming function can be controlled by pressing the ON/OFF button:

1. Pressing the OFF button (7) turns the auto-dimming function off which is indicated by the green Status Indicator LED turning off.
2. Pressing the ON button (6) again turns the auto-dimming function on which is indicated by the green Status Indicator LED turning on.

The mirror defaults to the ON position each time the vehicle is started.

Integrated HomeLink® Wireless Control System

The HomeLink® Wireless Control System can replace up to three hand-held radio-frequency (RF) transmitters with a single built-in device. This innovative feature will learn the radio frequency codes of most current transmitters to operate devices such as gate operators, garage door openers, entry door locks, security systems, even home lighting. Both standard and rolling code-equipped transmitters can be programmed by following the outlined procedures.

Additional HomeLink® information can be found at: www.homelink.com or by calling 1-800-355-3515.

Retain the original transmitter of the RF device you are programming for use in other vehicles as well as for future HomeLink® programming. It is also suggested that upon the sale of the vehicle, the programmed HomeLink® buttons be erased for security purposes.

⚠ WARNING

Before programming HomeLink® to a garage door opener or gate operator, make sure people and objects are out of the way of the device to prevent potential harm or damage. Do not use the HomeLink® with any garage door opener that lacks the safety stop and reverse features required by U.S. federal safety standards (this includes any garage door opener model manufactured before April 1, 1982). A garage door that cannot detect an object - signaling the door to stop and reverse - does not meet current U.S. federal safety standards. Using a garage door opener without these features increases the risk of serious injury or death.

Programming HomeLink®

Please note the following:

- When programming a garage door opener, it is advised to park the vehicle outside of the garage.
- It is recommended that a new battery be placed in the hand-held transmitter of the device being programmed to HomeLink® for quicker training and accurate transmission of the radio-frequency signal.
- Some vehicles may require the ignition switch to be placed in the ACC (or "Accessories") position for programming and/or operation of HomeLink®.
- In the event that there are still programming difficulties or questions after following the programming steps listed below, contact HomeLink® at: www.homelink.com or by calling 1-800-355-3515.

Rolling code programming

Rolling code devices which are "code-protected" and manufactured after 1996 may be determined by the following:

- Reference the device owner's manual for verification.
- The handheld transmitter appears to program the HomeLink® Universal Transceiver but does not activate the device.
- Press and hold the trained HomeLink button. The device has the rolling code feature if the indicator light flashes rapidly and then turns solid after 2 seconds.

To train rolling code devices, follow these instructions:

1. At the garage door opener receiver (motor-head unit) in the garage, locate the "learn" or "smart" button. This can usually be found where the hanging antenna wire is attached to the motor-head unit. Exact location and color of the button may vary by garage door opener brand. If there is difficulty locating the training button, reference the device owner's manual or please visit our Web site at www.homelink.com.
2. Firmly press and release the "learn" or "smart" button (which activates the "training light"). You will have 30 seconds to initiate step 3.
3. Return to the vehicle and firmly press, hold for two seconds and then release the desired HomeLink® button. Repeat the "press/hold/release" sequence a second time to complete the programming. (Some devices may require you to repeat this sequence a third time to complete the programming.)

4. Press and hold the just-trained HomeLink® button and observe the red Status Indicator LED. If the indicator light stays on constantly, programming is complete and your device should activate.
5. To program the remaining two HomeLink® buttons, follow either steps 1 through 4 above for other Rolling Code devices or steps 2 through 5 in Standard Programming for standard devices.

Standard programming

To train most devices, follow these instructions:

1. For first-time programming, press and hold the two outside buttons, HomeLink® Channel 1 and Channel 3 Buttons, until the indicator light begins to flash (after 20 seconds). Release both buttons. Do not hold the buttons for longer than 30 seconds.
 2. Position the end of your hand-held transmitter 1-3 inches (2-8 cm) away from the HomeLink® buttons while keeping the indicator light in view.
 3. Simultaneously press and hold both the HomeLink® and hand-held transmitter button. DO NOT release the buttons until step 4 has been completed.
 4. While continuing to hold the buttons the red Indicator Status LED will flash slowly and then rapidly after HomeLink® successfully trains to the frequency signal from the hand-held transmitter. Release both buttons.
5. Press and hold the just-trained HomeLink® button and observe the red Status Indicator LED. If the indicator light stays on constantly, programming is complete and your device should activate when the HomeLink® button is pressed and released.
 6. To program the remaining two HomeLink® buttons, follow steps 2 through 5.

Gate operator & Canadian programming

During programming, your handheld transmitter may automatically stop transmitting. Continue to press the Integrated HomeLink® Wireless Control System button (note steps 2 through 4 in the Standard Programming portion of this document) while you press and re-press ("cycle") your handheld transmitter every two seconds until the frequency signal has been learned. The indicator light will flash slowly and then rapidly after several seconds upon successful training.

Operating HomeLink®

To operate, simply press and release the programmed HomeLink® button. Activation will now occur for the trained device (i.e. garage door opener, gate operator, security system, entry door lock, home/office lighting, etc.). For convenience, the hand-held transmitter of the device may also be used at any time.

Reprogramming a single HomeLink® button

To program a new device to a previously trained HomeLink® button, follow these steps:

1. Press and hold the desired HomeLink® button. Do NOT release until step 4 has been completed.
2. When the indicator light begins to flash slowly (after 20 seconds), position the handheld transmitter 1 to 3 inches away from the HomeLink® surface.
3. Press and hold the handheld transmitter button. The HomeLink® indicator light will flash, first slowly and then rapidly.
4. When the indicator light begins to flash rapidly, release both buttons.
5. Press and hold the just-trained HomeLink® button and observe the red Status Indicator LED. If the indicator light stays on constantly, programming is complete and your new device should activate.

Erasing HomeLink® buttons

Individual buttons cannot be erased. However, to erase all three programmed buttons:

1. Press and hold the two outer HomeLink® buttons until the indicator light begins to flash-after 20 seconds.
2. Release both buttons. Do not hold for longer than 30 seconds.

The Integrated HomeLink® Wireless Control System is now in the training (learn) mode and can be programmed at any time following the appropriate steps in the Programming chapters above.

This device complies with Part 15 of the FCC Rules.

Operation is subject to the following two conditions:

1. This device may not cause harmful interference, and
2. This device must accept any interference received, including interference that may cause undesired operation.

⚠ WARNING

The transceiver has been tested and complies with FCC and Industry Canada rules. Changes or modifications not expressly approved by the party responsible for compliance could void the user's authority to operate the device.

Outside rearview mirror

Your vehicle is equipped with both left-hand and right-hand outside rearview mirrors.

⚠ WARNING - Rearview mirrors

- The right outside rearview mirror is convex. Objects seen in the mirror are closer than they appear.
- Use your interior rearview mirror or turn your head and look to determine the actual distance of following vehicles when changing lanes.

⚠ WARNING

Do not adjust or fold the outside rearview mirrors while driving. This may cause loss of vehicle control resulting in an accident.

⚠ CAUTION

- *Do not scrape ice off the mirror face; this may damage the surface of the glass.*
- *If the mirror is jammed with ice, do not adjust the mirror by force. Use an approved spray de-icer (not radiator antifreeze) spray, or a sponge or soft cloth with very warm water, or move the vehicle to a warm place and allow the ice to melt.*

Blind zone mirror (if equipped)

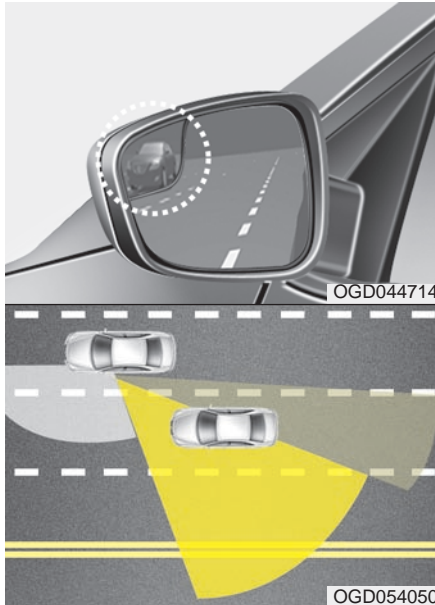

The Blind zone mirror (BZM) is a supplemental mirror that reduces the driver's blind zone by showing the rear side area of the vehicle. The blind zone mirror is equipped on the left-hand outside rearview mirror.

⚠ WARNING

- Always check the road condition while driving for unexpected situations even though the vehicle is equipped with a blind zone mirror.
- The blind zone mirror is a device made for convenience. Do not solely rely on the mirror but always pay attention to drive safely.

⚠ CAUTION

Do not clean the mirror with harsh abrasives, fuel or other petroleum based cleaning products.

Remote control



Electric type

Move the lever (1) to the L (Left) or R (Right) to select the rearview mirror you would like to adjust.

Use the mirror adjustment control to position the selected mirror up, down, left or right.

After adjustment, place the lever (1) in the center to prevent inadvertent adjustment.

⚠ CAUTION

- *The mirrors stop moving when they reach the maximum adjusting angles, but the motor continues to operate while the switch is pressed. Do not press the switch longer than necessary, the motor may be damaged.*
- *Do not attempt to adjust the outside rearview mirror by hand or the motor may be damaged.*

Folding the outside rearview mirror

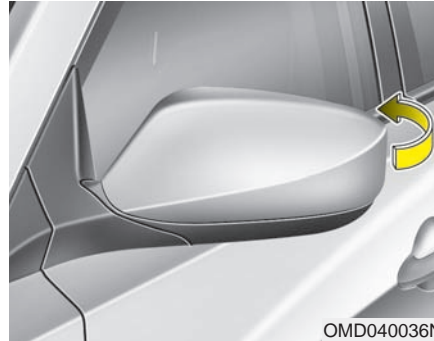

To fold the outside rearview mirror, grasp the housing of the mirror and then fold it toward the rear of the vehicle.

INSTRUMENT CLUSTER

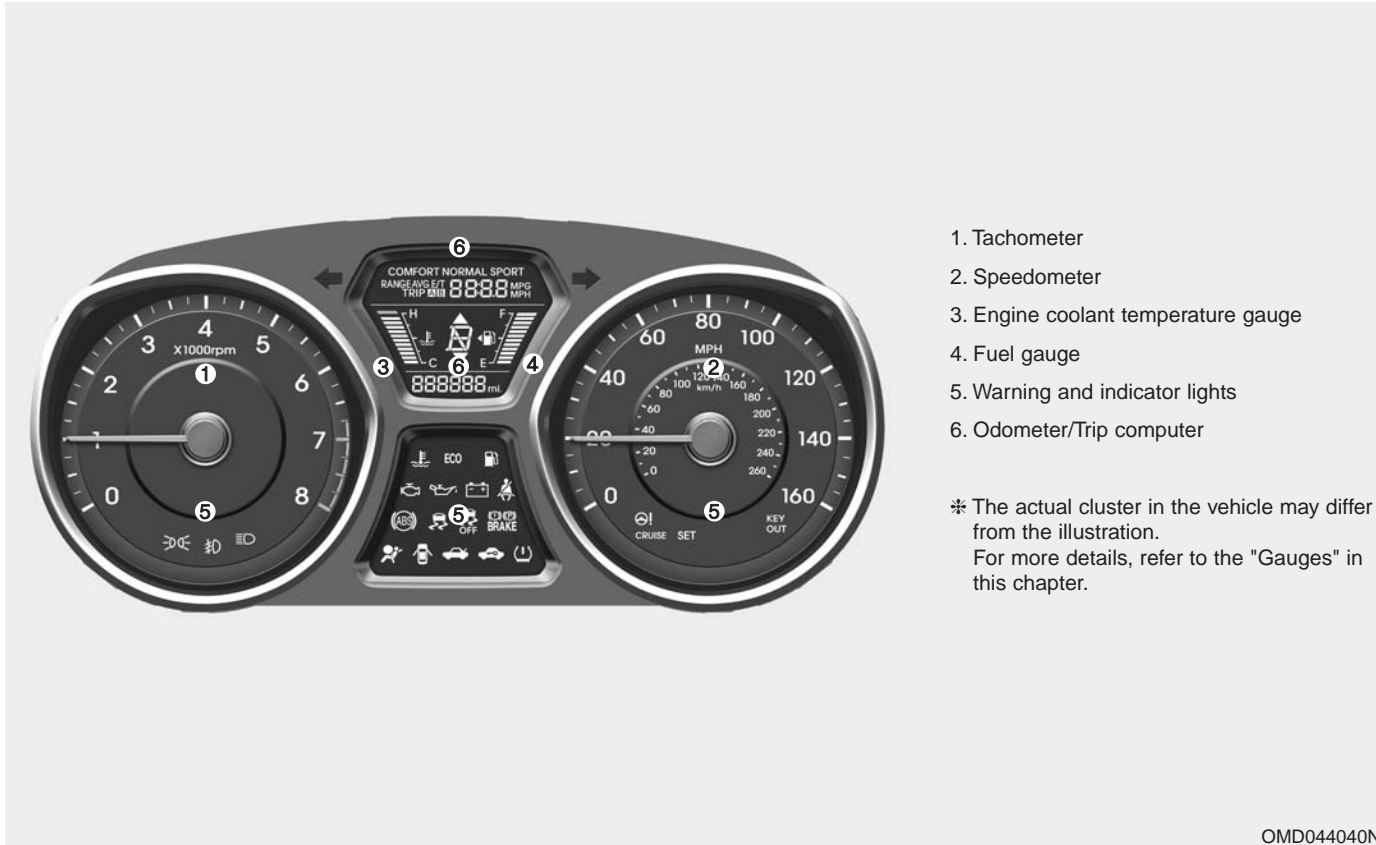

1. Tachometer
2. Speedometer
3. Engine coolant temperature gauge
4. Fuel gauge
5. Warning and indicator lights
6. Odometer/Trip computer

* The actual cluster in the vehicle may differ from the illustration.
For more details, refer to the "Gauges" in this chapter.

OMD044040N

Instrument Cluster Control

Adjusting Instrument Cluster Illumination

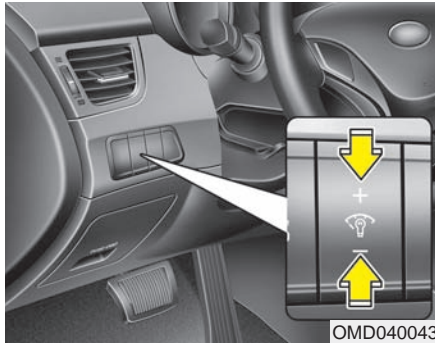

When the vehicle's parking lights or headlights are on, press the illumination control button to adjust the brightness of the instrument panel illumination.



- The brightness of the instrument panel illumination is displayed.
- If the brightness reaches to the maximum or minimum level, an alarm will sound.

Fuse switch ON

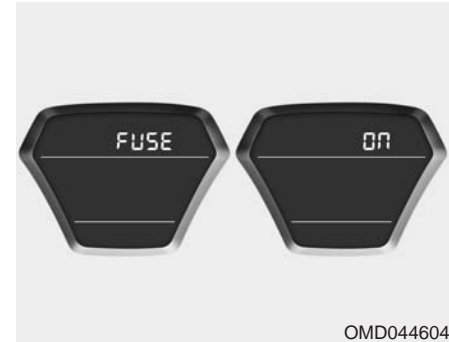

This warning message illuminates if the fuse switch under the steering wheel is OFF.

Turn the fuse switch ON.

For more details, refer to "Fuses" in chapter 7.

Gauges

Speedometer



The speedometer indicates the speed of the vehicle and is calibrated in miles per hour (mph) and/or kilometers per hour (km/h).

Tachometer



The tachometer indicates the approximate number of engine revolutions per minute (rpm).

Use the tachometer to select the correct shift points and to prevent lugging and/or over-revving the engine.



CAUTION

Do not operate the engine within the tachometer's RED ZONE. This may cause severe engine damage.



Information Provided by:

DEALER
IN-PROCESS

Engine Coolant Temperature Gauge



OMD044048N

This gauge shows the temperature of the engine coolant when the ignition switch is in the ON position.

CAUTION

If the gauge pointer moves beyond the normal range area toward the “H” position, it indicates overheating that may damage the engine.

Do not continue driving with an overheated engine. If your vehicle overheats, refer to “If the Engine Overheats” in chapter 6.

WARNING

Never remove the radiator cap when the engine is hot. The engine coolant is under pressure and could cause severe burns. Wait until the engine is cool before adding coolant to the reservoir.

Fuel Gauge



OMD044049N

This gauge indicates the approximate amount of fuel remaining in the fuel tank.

*** NOTICE**

- The fuel tank capacity is given in chapter 8.
- The fuel gauge is supplemented by a low fuel warning light, which will illuminate when the fuel tank is nearly empty.
- On inclines or curves, the fuel gauge pointer may fluctuate or the low fuel warning light may come on earlier than usual due to the movement of fuel in the tank.

⚠ WARNING - Fuel Gauge
 Running out of fuel can expose vehicle occupants to danger. You must stop and obtain additional fuel as soon as possible after the warning light comes on or when the gauge indicator comes close to the "E (Empty)" level.

⚠ CAUTION
 Avoid driving with a very low fuel level. Running out of fuel could cause the engine to mis-fire damaging the catalytic converter.

Odometer



The odometer indicates the total distance that the vehicle has been driven and should be used to determine when periodic maintenance should be performed.

- Odometer range : 0 ~ 999999 miles or kilometers.

Transaxle Shift Indicator

Automatic Transaxle Shift Indicator (if equipped)



This indicator displays which automatic transaxle shift lever is selected.

- Park : P
- Reverse : R
- Neutral : N
- Drive : D
- Sports Mode : 1, 2, 3, 4, 5, 6

Trip computer

Overview



Description

The trip computer is a microcomputer-controlled driver information system that displays information related to driving.

* NOTICE

Some driving information stored in the trip computer (for example Average Vehicle Speed) resets if the battery is disconnected.

Press the TRIP button for less than 1 second to select any mode as follows :

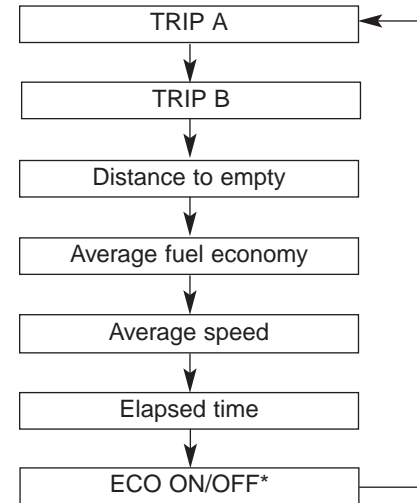

* : if equipped



Tripmeter (mi. or km)

TRIP A : Tripmeter A

TRIP B : Tripmeter B

This mode indicates the distance of individual trips selected since the last tripmeter reset.

The meter's working range is from 0.0 to 999.9 miles (0.0 to 999.9 km).

Pressing the RESET button for more than 1 second, when the tripmeter (TRIP A or TRIP B) is being displayed, clears the tripmeter to zero (0.0).



Distance to empty (mi. or km)

This mode indicates the estimated distance to empty based on the current fuel in the fuel tank and the amount of fuel delivered to the engine. When the remaining distance is below 30 miles (50 km), “---” will be displayed and the distance to empty indicator will blink.

The meter's working range is from 30 to 999 miles (50 to 999 km).



Average fuel economy (if equipped) (MPG or l/100 km)

This mode calculates the average fuel consumption from the total fuel used and the distance since the last average economy reset. The total fuel used is calculated from the fuel consumption input. For an accurate calculation, drive more than 0.03 miles (50 m).

Pressing the RESET button for more than 1 second, when the average fuel economy is being displayed, clears the average fuel consumption to zero (----).

Features of your vehicle

If the vehicle speed exceeds 1.6 MPH (1km/h) after being refueled with more than 1.6 gallons (6 l), the average fuel economy will be cleared to zero (----).



Average speed (MPH or km/h)

This mode calculates the average speed of the vehicle since the last average speed reset.

Even if the vehicle is not in motion, the average speed keeps changing while the engine is running.

Pressing the RESET button for more than 1 second, when the average speed is being displayed, clears the average speed to zero (---).



Elapsed time

This mode indicates the total time traveled since the last driving time reset.

Even if the vehicle is not in motion, the driving time keeps increasing while the engine is running.

The meter's working range is from 00:00~99:59.

Pressing the RESET button for more than 1 second, when the elapsed time is being displayed, clears the elapsed time to zero (00:00).

*** NOTICE**

- If the vehicle is not on level ground or the battery power has been interrupted, the “Distance to empty” function may not operate correctly.
The trip computer may not register additional fuel if less than 1.6 gallons (6 liters) of fuel are added to the vehicle.
- The fuel consumption and distance to empty values may vary significantly based on driving conditions, driving habits, and condition of the vehicle.
- The distance to empty value is an estimate of the available driving distance. This value may differ from the actual driving distance available.

ECO ON/OFF mode (if equipped)

You can turn the Manual transaxle shift indicator ON/OFF on the instrument cluster in this mode.

If you push the RESET button for more than 1 second in the ECO ON mode, ECO OFF is displayed on the screen and the Manual transaxle shift indicator turns off while driving.

If you want to display the Manual transaxle shift indicator again, press the RESET button for more than 1 second in the ECO OFF mode and then ECO ON mode is displayed in the screen.

Manual Transaxle Shift Indicator (if equipped)

This indicator informs you which gear is desired while driving to save fuel.

For example

▲3: Indicates that shifting up to the 3rd gear is desired (currently the shift lever is in the 2nd gear).

▼3: Indicates that shifting down to the 3rd gear is desired (currently the shift lever is in the 4th gear).

Warning and indicator lights

* NOTICE - Warning lights

Make sure that all warning lights are OFF after starting the engine. If any light is still ON, this indicates a situation that needs attention.

Air bag Warning Light



This warning light illuminates:

- Once you set the ignition switch or Engine Start/Stop Button to the ON position.
 - It illuminates for approximately 6 seconds and then goes off.
- When there is a malfunction with the SRS.

In this case, have your vehicle inspected by an authorized HYUNDAI dealer.

Seat Belt Warning Light



This warning light informs the driver that the seat belt is not fastened. For more details, refer to the “Seat Belts” in chapter 3.

Parking Brake & Brake Fluid Warning Light



This warning light illuminates:

- Once you set the ignition switch or Engine Start/Stop Button to the ON position.
 - It illuminates for approximately 3 seconds
 - It remains on if the parking brake is applied.
- When the parking brake is applied.
- When the brake fluid level in the reservoir is low.
 - If the warning light illuminates with the parking brake released, it indicates the brake fluid level is low.

If the brake fluid level in the reservoir is low:

1. Drive carefully to the nearest safe location and stop your vehicle.
2. With the engine stopped, check the brake fluid level immediately and add fluid as required (For more details, refer to “Brake Fluid” in chapter 7).

Then check all brake components for fluid leaks. If any leak on the brake system is found, the warning light remains on, or the brakes do not operate properly, do not drive the vehicle.

In this case, have your vehicle towed to an authorized HYUNDAI dealer and inspected.

Dual-diagonal braking system

Your vehicle is equipped with dual-diagonal braking systems. This means you still have braking on two wheels even if one of the dual systems should fail.

With only one of the dual systems working, more than normal pedal travel and greater pedal pressure are required to stop the vehicle.

Also, the vehicle will not stop in as short a distance with only a portion of the brake system working.

If the brakes fail while you are driving, shift to a lower gear for additional engine braking and stop the vehicle as soon as it is safe to do so.

⚠ WARNING - Parking Brake & Brake Fluid Warning Light

Driving the vehicle with a warning light ON is dangerous. If the Parking Brake & Brake Fluid Warning Light illuminates with the parking brake released, it indicates that the brake fluid level is low.

In this case, have your vehicle inspected by an authorized HYUNDAI dealer.

Anti-lock Brake System (ABS) Warning Light



This warning light illuminates:

- Once you set the ignition switch or Engine Start/Stop Button to the ON position.
 - It illuminates for approximately 3 seconds and then goes off.
- When there is a malfunction with the ABS (The normal braking system will still be operational without the assistance of the anti-lock brake system).

In this case, have your vehicle inspected by an authorized HYUNDAI dealer.

Electronic Brake force Distribution (EBD) System Warning Light



These two warning lights illuminate at the same time while driving:

- When the ABS and regular brake system may not work normally.

In this case, have your vehicle inspected by an authorized HYUNDAI dealer.

⚠ WARNING - Electronic Brake force Distribution (EBD) System Warning Light

When both ABS and Parking Brake & Brake Fluid Warning Lights are on, the brake system will not work normally and you may experience an unexpected and dangerous situation during sudden braking.

In this case, avoid high speed driving and abrupt braking.

Have your vehicle inspected by an authorized HYUNDAI dealer as soon as possible.

*** NOTICE - Electronic Brake force Distribution (EBD) System Warning Light**

When the ABS Warning Light is on or both ABS and Parking Brake & Brake Fluid Warning Lights are on, the speedometer, odometer, or trip-meter may not work. Also, the EPS Warning Light may illuminate and the steering effort may increase or decrease.

In this case, have your vehicle inspected by an authorized HYUNDAI dealer as soon as possible.

Electric Power Steering (EPS) Warning Light (if equipped)



This warning light illuminates:

- Once you set the ignition switch or Engine Start/Stop Button to the ON position.
 - It remains on until the engine is started.
- When there is a malfunction with the EPS.

In this case, have your vehicle inspected by an authorized HYUNDAI dealer.

Malfunction Indicator Lamp (MIL)



This warning light illuminates:

- Once you set the ignition switch or Engine Start/Stop Button to the ON position.
 - It remains on until the engine is started.
- When there is a malfunction with the emission control system.

In this case, have your vehicle inspected by an authorized HYUNDAI dealer.

⚠ CAUTION - Malfunction Indicator Lamp (MIL)

Driving with the Malfunction Indicator Lamp (MIL) on may cause damage to the emission control systems which could effect drivability and/or fuel economy.

⚠ CAUTION - Gasoline Engine

If the Malfunction Indicator Lamp (MIL) illuminates, potential catalytic converter damage is possible which could result in loss of engine power.

In this case, have your vehicle inspected by an authorized HYUNDAI dealer as soon as possible.

Charging System Warning Light



This warning light illuminates:

- Once you set the ignition switch or Engine Start/Stop Button to the ON position.
 - It remains on until the engine is started.
- When there is a malfunction with either the alternator or electrical charging system.

If there is a malfunction with either the alternator or electrical charging system:

1. Drive carefully to the nearest safe location and stop your vehicle.
2. Turn the engine off and check the alternator drive belt for looseness or breakage.

If the belt is adjusted properly, there may be a problem in the electrical charging system.

In this case, have your vehicle inspected by an authorized HYUNDAI dealer as soon as possible.

Engine Coolant Temperature Warning Light (if equipped)



This warning light illuminates:

- When the engine coolant temperature is above 248°F (120°C). This means that the engine is overheated and may be damaged.

If your vehicle is overheated, refer to “Overheating” in chapter 6.



CAUTION - Engine Overheating

Do not continue driving with the engine overheated. Otherwise engine may be damaged.

Engine Oil Pressure Warning Light



This warning light illuminates:

- Once you set the ignition switch or Engine Start/Stop Button to the ON position.
 - It remains on until the engine is started.
- When the engine oil pressure is low.

If the engine oil pressure is low:

1. Drive carefully to the nearest safe location and stop your vehicle.
2. Turn the engine off and check the engine oil level (For more details, refer to “Engine Oil” in chapter 7). If the level is low, add oil as required.

If the warning light remains on after adding oil or if oil is not available, have your vehicle inspected by an authorized HYUNDAI dealer as soon as possible.

CAUTION - Engine Oil Pressure Warning Light

- *If the engine does not stop immediately after the Engine Oil Pressure Warning Light is illuminated, severe damage could result.*
- *If the warning light stays on while the engine is running, it indicates that there may be serious engine damage or malfunction. In this case,*
 1. *Stop the vehicle as soon as it is safe to do so.*
 2. *Turn off the engine and check the oil level. If the oil level is low, fill the engine oil to the proper level.*
 3. *Start the engine again. If the warning light stays on after the engine is started, turn the engine off immediately. In this case, have your vehicle inspected by an authorized HYUNDAI dealer.*

Low Fuel Level Warning Light



This warning light illuminates:

When the fuel tank is nearly empty.

If the fuel tank is nearly empty, add fuel as soon as possible.

CAUTION - Low Fuel Level

Driving with the Low Fuel Level warning light on or with the fuel level below “E (Empty)” can cause the engine to misfire and damage the catalytic converter (if equipped).

Low Tire Pressure Warning Light



This warning light illuminates:

- Once you set the ignition switch or Engine Start/Stop Button to the ON position.
 - It illuminates for approximately 3 seconds and then goes off.
- When one or more of your tires are significantly underinflated.

For more details, refer to “Tire Pressure Monitoring System (TPMS)” in chapter 6.

This warning light remains on after blinking for approximately 60 seconds or repeats blinking and off at the intervals of approximately 3 seconds:

- When there is a malfunction with the TPMS.

In this case, have your vehicle inspected by an authorized HYUNDAI dealer as soon as possible.

For more details, refer to “Tire Pressure Monitoring System (TPMS)” in chapter 6.

⚠ WARNING - Low tire pressure

- Significantly low tire pressure makes the vehicle unstable and can contribute to loss of vehicle control and increased braking distances.
- Continued driving on low pressure tires will cause the tires to overheat and fail.

⚠ WARNING - Safe Stopping

- The TPMS cannot alert you to severe and sudden tire damage caused by external factors.
- If you notice any vehicle instability, immediately take your foot off the accelerator pedal, apply the brakes gradually with light force, and slowly move to a safe position off the road.

Door Ajar Warning Light



This warning light illuminates:
When a door is not closed securely.

Trunk Open Warning Light



This warning light illuminates:
When the trunk is not closed securely.

Electronic Stability Control (ESC) Indicator Light



This indicator light illuminates:

- Once you set the ignition switch or Engine Start/Stop Button to the ON position.
 - It illuminates for approximately 3 seconds and then goes off.
- When there is a malfunction with the ESC system.
 - In this case, have your vehicle inspected by an authorized HYUNDAI dealer.

This indicator light blinks:

While the ESC is operating.

For more details, refer to “Electronic Stability Control (ESC)” in chapter 5.

Electronic Stability Control (ESC) OFF Indicator Light



This indicator light illuminates:

- Once you set the ignition switch or Engine Start/Stop Button to the ON position.
 - It illuminates for approximately 3 seconds and then goes off.
- When you deactivate the ESC system by pressing the ESC OFF button.

For more details, refer to “Electronic Stability Control (ESC)” in chapter 5.

ECO Indicator Light (if equipped)

ECO

This indicator light illuminates:

When you activate the active ECO system by pressing the ACTIVE ECO button.

For more details, refer to “Active ECO System” in chapter 5.

Immobilizer Indicator Light (Without Smart Key) (if equipped)



This indicator light illuminates:

When the vehicle detects the immobilizer in your key properly while the ignition switch is ON.

- At this time, you can start the engine.
- The indicator light goes off after starting the engine.

This indicator light blinks:

When there is a malfunction with the immobilizer system.

In this case, have your vehicle inspected by an authorized HYUNDAI dealer.

Immobilizer Indicator Light (With Smart Key) (if equipped)



This indicator light illuminates for up to 30 seconds:

When the vehicle detects the smart key in the vehicle properly while the Engine Start/Stop Button is ACC or ON.

- At this time, you can start the engine.
- The indicator light goes off after starting the engine.

This indicator light blinks for a few seconds:

When the smart key is not in the vehicle.

- At this time, you can not start the engine.

This indicator light illuminates for 2 seconds and goes off:

When the vehicle can not detect the smart key which is in the vehicle while the Engine Start/Stop Button is ON.

In this case, have your vehicle inspected by an authorized HYUNDAI dealer.

This indicator light blinks:

- When the battery of the smart key is weak.
 - At this time, you can not start the engine. However, you can start the engine if you press the Engine Start/Stop Button with the smart key. (For more details, refer to “Starting the Engine” in section 5).
- When there is a malfunction with the immobilizer system.

In this case, have your vehicle inspected by an authorized HYUNDAI dealer.

Turn Signal Indicator Light

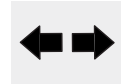

This indicator light blinks:

When you turn the turn signal light on.

If any of the following occurs, there may be a malfunction with the turn signal system. In this case, have your vehicle inspected by an authorized HYUNDAI dealer.

- The indicator light does not blink but illuminates.
- The indicator light blinks more rapidly.
- The indicator light does not illuminate at all.

High Beam Indicator Light



This indicator light illuminates:

- When the headlights are on and in the high beam position
- When the turn signal lever is pulled into the Flash-to-Pass position.

Light ON Indicator Light



This indicator light illuminates:

When the parking lights or headlights are on.

Front Fog Indicator Light (if equipped)



This indicator light illuminates:

When the front fog lights are on.

Cruise Indicator Light (if equipped)

CRUISE

This indicator light illuminates:

- When the cruise control system is enabled.

For more details, refer to “Cruise Control System” in chapter 5.

Cruise SET Indicator Light (if equipped)

SET

This indicator light illuminates:

- When the cruise control speed is set.

For more details, refer to “Cruise Control System” in chapter 5.

KEY OUT Indicator Light
(if equipped)**KEY
OUT**

When the ENGINE START/STOP button is in the ACC or ON position, if any door is open, the system checks for the smart key.

This indicator light blinks:

When the smart key is not in the vehicle and any door is open with the ignition switch or Engine Start/Stop button in the ACC or ON position.

- At this time, if you close all doors, the chime will also sound for approximately 5 seconds.
- The indicator will go off while the vehicle is moving.

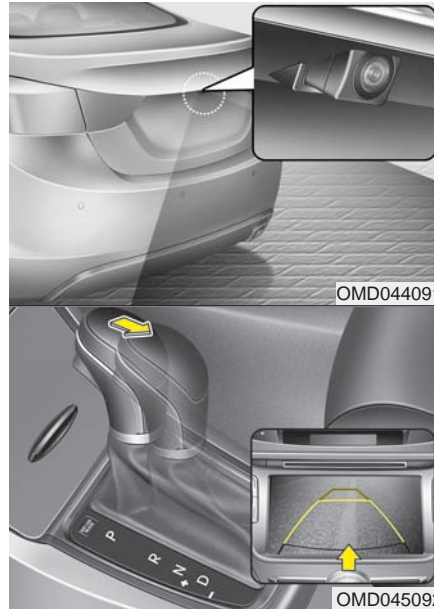
REARVIEW CAMERA (IF EQUIPPED)

The rearview camera will activate when the back-up light is ON with the engine start/stop button ON and the shift lever in the R position.

This system is a supplemental system that shows behind the vehicle through the monitor while backing-up.

⚠ WARNING

- This system is a supplementary function only. It is the responsibility of the driver to always check the inside/outside rearview mirror and the area behind the vehicle before and while backing up.
- Always keep the camera lens clean. If the lens is covered with foreign matter, the camera may not operate normally.

LIGHT

Exterior lights

Lighting control

■ Type A



OYFH041900N

■ Type B



OGD044900N

To operate the lights, turn the knob at the end of the control lever to one of the following positions:

■ Type A

- (1) DRL OFF (OFF) position
- (2) Parking light position
- (3) Headlight position
- (4) AUTO light position (if equipped)

■ Type B

- (1) OFF position
- (2) DRL ON position
- (3) Parking light position
- (4) Headlight position

Parking light position (㉟)

■ Type A



OYFH041901N

■ Type B



OGD044903N

When the light switch is in the parking light position (1st position), the parking lights, taillights, license plate lights and instrument panel lights are turned ON.

Headlight position ()

■ Type A



OYFH041902N

■ Type B



OGD044907N

When the light switch is in the headlight position (2nd position), the headlights, parking lights, taillights, license plate lights and instrument panel lights are turned ON.

* NOTICE

The ignition switch must be in the ON position to turn on the headlights.

AUTO light position (if equipped)

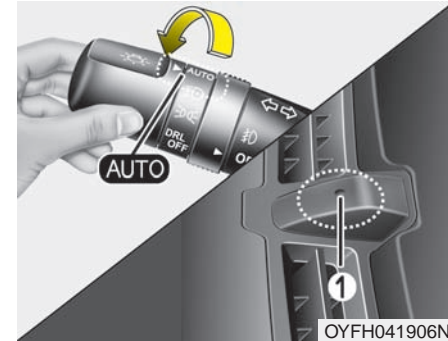

OYFH041906N

When the light switch is in the AUTO position, the parking (position) light and headlights will be turned ON or OFF automatically depending on the amount of light outside the vehicle.

Even with the AUTO light feature in operation, it is recommended to manually turn ON the lights when driving at night or in a fog, or when you enter dark areas, such as tunnels and parking facilities.

⚠ CAUTION

- *Do not cover or spill anything on the sensor (1) located on the instrument panel.*
- *Do not clean the sensor using a window cleaner, the cleanser may leave a light film which could interfere with sensor operation.*
- *If your vehicle has window tint or other types of metallic coating on the front windshield, the AUTO light system may not work properly.*

High beam operation

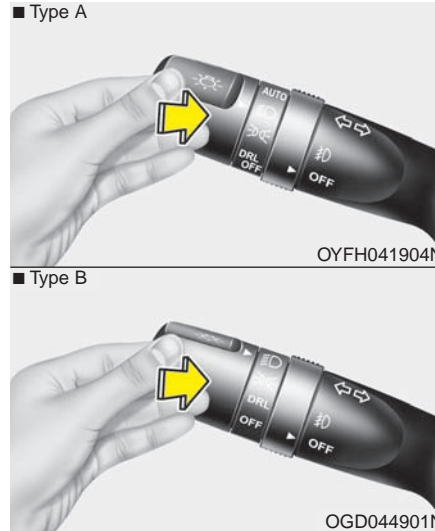

To turn on the high beam headlights, push the lever away from you. Pull it back for low beams.

The high beam indicator will light when the headlight high beams are switched on.

To prevent the battery from being discharged, do not leave the lights on for a prolonged time while the engine is not running.

⚠ WARNING

Do not use high beam when there are other vehicles approaching you. Using high beam could obstruct the other driver's vision.

■ Type A

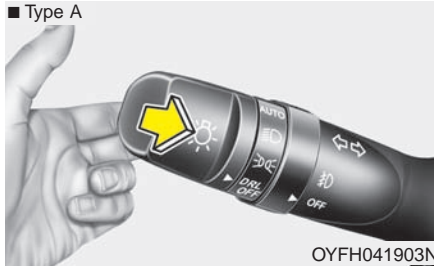

■ Type B



To flash the high beam headlights, pull the lever towards you, then release the lever. The high beams will remain ON as long as you hold the lever towards you.

Turn signals and lane change signals

■ Type A

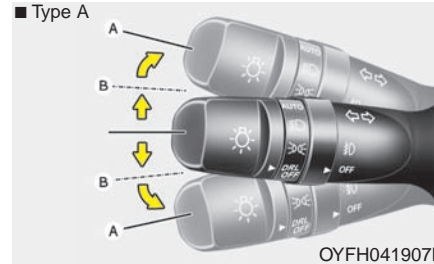

■ Type B

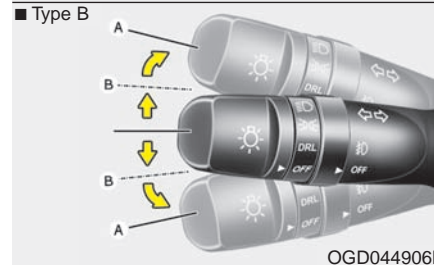

To signal a turn, move the lever up for a right turn or down for a left turn to position (A). The lever will return to the OFF position when the turn is completed.

To signal a lane change, move the turn signal lever slightly and hold it in position (B). The lever will return to the OFF position when released.

One-touch lane change function

To activate an one-touch lane change function, move the turn signal lever slightly and then release it. The lane change signals will blink 3 times.

* NOTICE

If the turn signal indicator stays on and does not flash, or if it flashes abnormally, a bulb may be burned out or have a poor electrical connection in the circuit. The bulb may require replacement.

Front fog light (if equipped)

■ Type A



■ Type B



Fog lights are used to provide improved visibility when visibility is poor due to fog, rain or snow, etc. Use the switch next to the headlight switch to turn the fog lights ON and OFF. The fog lights will turn on when fog light switch (1) is turned to ON after the parking lights are turned on.

To turn off the fog lights, turn the switch to the OFF position.

You can use the fog lights only when the headlights are on low beam. When the headlight switch is in the AUTO position, you can also use the fog lights when the headlights turn on automatically. The fog lights will go OFF when the headlights turn OFF.



CAUTION

When in operation, the fog lights consume large amounts of vehicle electrical power. Only use the fog lights when visibility is poor.

Battery saver function

The purpose of this feature is to prevent the battery from being discharged. The system automatically turns off the parking lights when the driver removes the ignition key or turns the engine off (for smart key) and opens the driver-side door.

With this feature, the parking lights will turn off automatically if the driver parks on the side of road at night.

If necessary, to keep the lights on when the ignition key is removed or the engine is turned off (for smart key), perform the following:

- 1) Open the driver-side door.
- 2) Turn the parking lights OFF and ON again using the light switch on the steering column.

Headlight escort function

If the key is removed from the ignition switch or placed in the ACC position or the LOCK/OFF position with the headlights ON, the headlights (and/or parking lights) remain on for about 5 minutes. However, if the driver's door is opened and closed, the headlights are turned off after 15 seconds.

The headlights can be turned off by pressing the LOCK button on the remote key or smart key twice or turning the light switch to the OFF or AUTO position. However, if you turn the light switch to the AUTO position when it is dark outside, the headlights will not be turned off.



CAUTION

If the driver gets out of the vehicle through other doors (except driver's door), the battery saver function does not operate and the headlamp delay function does not turn off automatically. Therefore, it causes the battery to be discharged. In this case, make sure to turn off the lamp before getting out of the vehicle.



Daytime running light (DRL) (if equipped)

The Daytime Running Lights (DRL) can make it easier for others to see the front of your vehicle during the day, especially after dawn and before sunset.

Type A

The DRL will turn off when:

1. The headlight is ON.
2. The light switch is in the DRL OFF position.
3. The parking brake is applied.
4. The engine is turned OFF.

Type B

The DRL will turn off when:

1. The headlight is ON.
2. The light switch is in the OFF position.
3. The parking brake is applied.
4. The engine is turned OFF.

Interior lights

CAUTION

Do not use the interior lights for extended periods when the engine is turned off or the battery will discharge.

WARNING

Do not use the interior lights when driving in the dark. The interior lights may obscure your view and cause an accident.

Automatic turn off function (if equipped)

When all doors are closed, if you lock the vehicle by using the remote key or smart key, all interior lamp will be off within 5 seconds.

If you do not operate anything in the vehicle after turning off the engine, the lights will turn off after 20 minutes.

Front lamps

- (1) Front Map Lamp
 (2) Front Room Lamp

Front Map Lamp:

Press either the right or left lens to turn the map lamp on or off. This light produces a spot beam for convenient use as a map lamp at night or as a personal lamp for the driver and the front passenger.

Front Room Lamp:

The Front Room Lamp Switch activates the front and rear room lamps when the switch is pressed in either of the three positions indicated below:

DOOR :

With the switch in this position, the front and rear room lamps come on when the front or rear doors are opened, or when the doors are unlocked by the remote key or smart key.

Once all doors are closed, the room lamps will go out gradually after about 30 seconds.

If a door is open with the ignition switch in the ACC position or the LOCK/OFF position, the lamps will remain on for about 20 minutes. If a door is open with the ignition switch in the ON position, the lamps will stay on continuously.

ON :

With the Front Room Lamp in this position, the front and rear room lamps remain on at all times.

OFF :

With the Front Room Lamp in this position the front and rear room lamps remain off at all times.

*** NOTICE**

When the map lamp (1) is turned ON by pressing the lens, the map lamp will not turn off even if the front room lamp switch is in the OFF position.

Rear lamp



Rear Room Lamp Switch:

Press this switch to turn the room lamp on and off.

CAUTION

Do not leave the lamp switches on for an extended period of time when the engine is turned off.

Trunk lamp

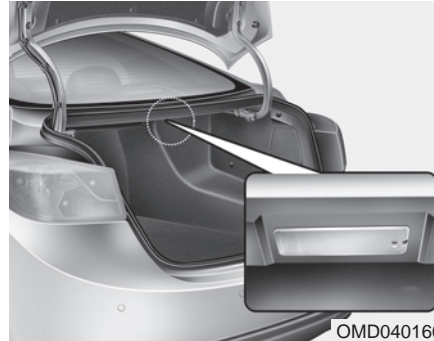

The trunk lamp comes on when the trunk is opened.

CAUTION

The trunk lamp comes on as long as the trunk lid is open. To prevent unnecessary charging system drain, close the trunk lid securely after using the trunk.

Vanity mirror lamp (if equipped)

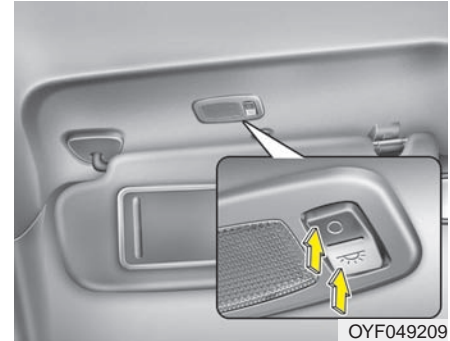

Push the switch to turn the light ON or OFF.

-  : The lamp will turn ON.
- O : The lamp will turn OFF.

CAUTION

To prevent unnecessary charging system drain, turn off the lamp by pushing the O button after using the lamp.

WIPERS AND WASHERS

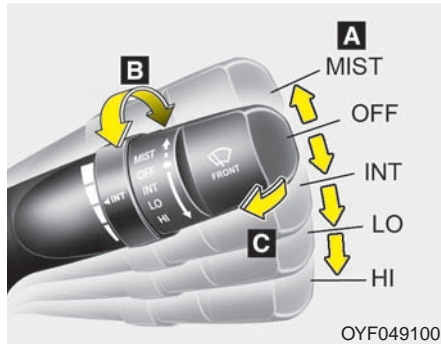

OYF049100

A : Wiper speed control

- MIST – Single wipe
- OFF Off
- INT – Intermittent wipe
- LO – Low wiper speed
- HI – High wiper speed

B : Intermittent or Auto control wiper time adjustment

C : Wash with brief wipes (if equipped)

Windshield wipers

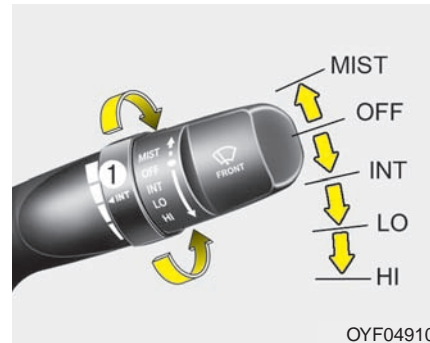

OYF049102

Operates as follows when the ignition switch is in the ON position.

MIST : For a single wipe push the lever upward and release. The wipers will operate continuously if the lever is held in this position.

OFF : Wiper is not in operation.

INT : Wiper operates intermittently at the same wiping intervals. To vary the speed setting, turn the speed control knob (1).

LO : The wiper runs at a lower speed.

HI : The wiper runs at a higher speed.

* NOTICE

If there is heavy accumulation of snow or ice on the windshield, defrost the windshield for about 10 minutes, or until the snow and/or ice is removed before using the windshield wipers to ensure proper operation.

Windshield washers

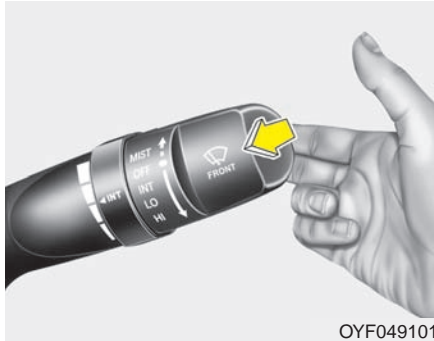

In the OFF position, pull the lever gently toward you to spray washer fluid on the windshield and to run the wipers 1-3 cycles. Use this function when the windshield is dirty.

The spray and wiper operation will continue until you release the lever. If the washer does not work, you may need to add washer fluid to the washer fluid reservoir.

⚠ WARNING

When the outside temperature is below freezing, ALWAYS warm the windshield using the defroster to prevent the washer fluid from freezing on the windshield and obscuring your vision which could result in an accident and serious injury or death.

⚠ CAUTION

- *To prevent possible damage to the washer pump, do not operate the washer when the fluid reservoir is empty.*
- *To prevent possible damage to the wipers or windshield, do not operate the wipers when the windshield is dry.*
- *To prevent damage to the wiper arms and other components, do not attempt to move the wipers manually.*

DEFROSTER

CAUTION

To prevent damage to the conductors bonded to the inside surface of the rear window, never use sharp instruments or window cleaners containing abrasives to clean the window.

* NOTICE

If you want to defrost and defog the front windshield, refer to “Windshield defrosting and defogging” in this chapter.

Rear window defroster

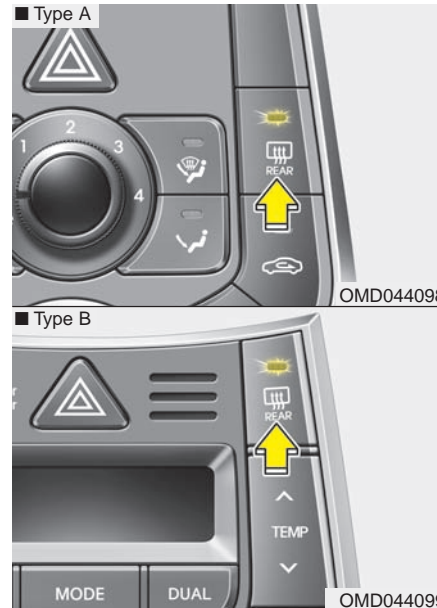

The defroster heats the window to remove frost, fog and thin ice from the rear window, while the engine is running.

To activate the rear window defroster, press the rear window defroster button located in the center facia switch panel.

The indicator on the rear window defroster button illuminates when the defroster is ON.

If there is heavy accumulation of snow on the rear window, brush it off before operating the rear defroster.

The rear window defroster automatically turns off after approximately 20 minutes or when the ignition switch is turned off. To turn off the defroster, press the rear window defroster button again.

Outside rearview mirror defroster (if equipped)

If your vehicle is equipped with the outside rearview mirror defrosters, they will operate at the same time you turn on the rear window defroster.



MANUAL CLIMATE CONTROL SYSTEM (IF EQUIPPED)



1. Front windshield defrost button
2. Mode selection buttons
3. Rear window defroster button
4. A/C (Air conditioning) button (if equipped)
5. Air intake control button
6. Fan speed control knob
7. Temperature control knob

OMD044100

Heating and air conditioning

1. Start the engine.
2. Set the mode to the desired position.
To improve the effectiveness of heating and cooling :
 - Heating: 
 - Cooling: 
3. Set the temperature control to the desired position.
4. Set the air intake control to the outside (fresh) air or recirculated air position.
5. Set the fan speed control to the desired speed.
6. If air conditioning is desired, turn the air conditioning system (if equipped) on.

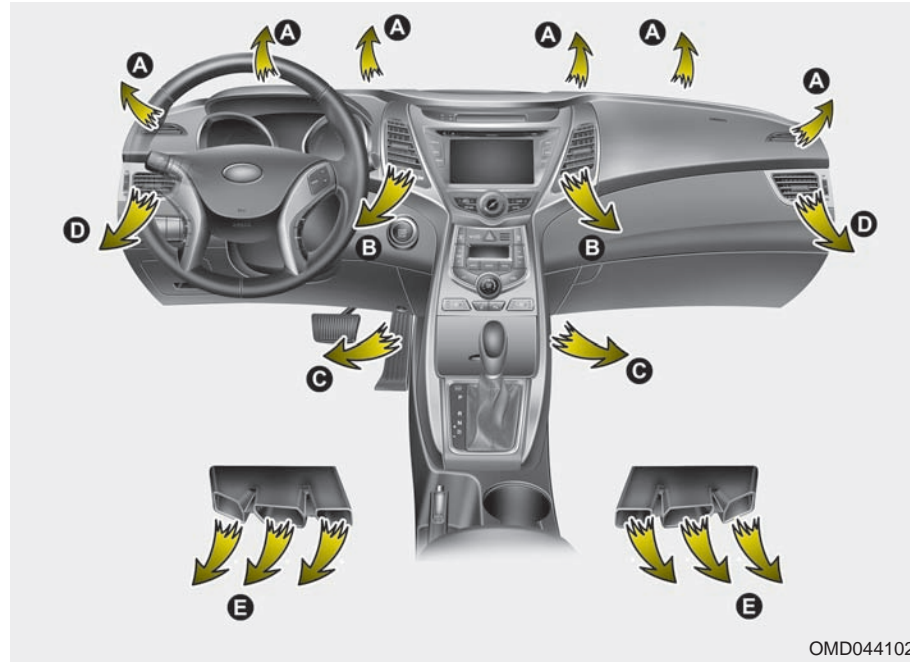

Mode selection

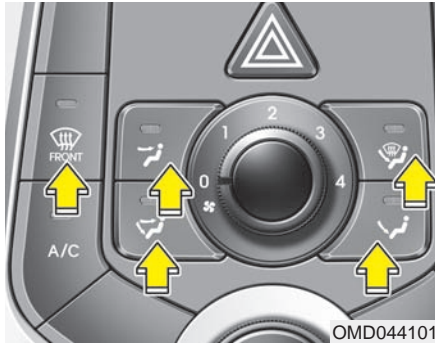

The mode selection knob controls the direction of the air flow through the ventilation system.

Air can be directed to the floor, dashboard outlets, or windshield. Five symbols are used to represent Face, Bi-Level, Floor, Floor-Defrost and Defrost air position.



Face-Level (B, D)

Air flow is directed toward the upper body and face. Additionally, each outlet can be controlled to direct the air discharged from the outlet.



Bi-Level (B, D, C, E)

Air flow is directed towards the face and the floor.



Floor-Level (A, C, D, E)

Most of the air flow is directed to the floor, with a small amount of the air being directed to the windshield, side window defrosters, and side vents.



Floor/Defrost-Level (A, C, D, E)

Most of the air flow is directed to the floor and the windshield with a small amount directed to the side window defrosters, and side vents.



Defrost-Level (A, D)

Most of the air flow is directed to the windshield with a small amount of air directed to the side vents.

MAX A/C-Level (B, D) (if equipped)



The MAX A/C mode is used to cool the inside of the vehicle faster. Air flow is directed toward the upper body and face.

In this mode, the air conditioning and the recirculated air position will be selected automatically.

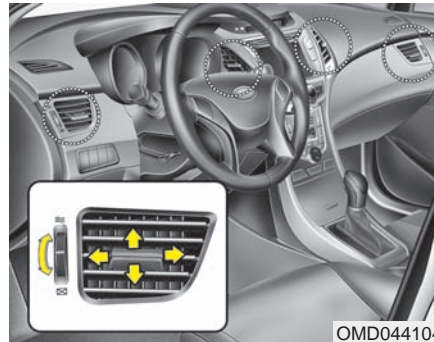

Instrument panel vents

The outlet vents can be opened or closed separately using the thumb-wheel.

Also, you can adjust the direction of air delivered from these vents using the vent control lever as shown.

Temperature control



The temperature control knob allows you to control the temperature of the air flowing from the ventilation system. To change the air temperature inside the vehicle, turn the knob to the right for warm air or left for cooler air.

Air intake control



This is used to select outside (fresh) air position or recirculated air position.

To change the air intake control position, push the control button.

Recirculated air position



The indicator light on the button illuminates when the recirculated air position is selected.

With the recirculated air position selected, air from the passenger compartment will be drawn through the climate control system and heated or cooled according to the function selected.

Outside (fresh) air position



With the outside (fresh) air position selected, air enters the vehicle from outside and is heated or cooled according to the function selected.

* NOTICE

Prolonged operation of the heater in the recirculated air position (without air conditioning selected) may cause fogging of the windshield and side windows and the air within the passenger compartment to become stale.

In addition, prolonged operation of the air conditioning with the recirculated air position selected will result in excessively dry air in the passenger compartment.

⚠ WARNING

- Continuous use of the climate control system in the recirculated air position may allow humidity to increase inside the vehicle which may fog the glass and obscure visibility.
- Do not sleep in a vehicle with the air conditioning or heating system on. It may cause serious harm or death due to a drop in the oxygen level and/or body temperature.
- Continue using the climate control system in the recirculated air position can cause drowsiness or sleepiness, and loss of vehicle control. Set the air intake control to the outside (fresh) air position as much as possible while driving.

Fan speed control



The ignition switch must be in the ON position for fan operation.

The fan speed control knob allows you to control the fan speed of the air flowing from the ventilation system. To change the fan speed, turn the knob to the right for higher speed or left for lower speed.

Setting the fan speed control knob to the "0" position turns off the fan.

To turn off the fan



To turn off the fan, turn the fan speed control knob to the "0" position.

Air conditioning





Press the A/C button to turn the air conditioning system on (indicator light will illuminate). Press the button again to turn the air conditioning system off.

System operation

Ventilation

1. Set the mode to the  position.
2. Set the air intake control to the outside (fresh) air position.
3. Set the temperature control to the desired position.
4. Set the fan speed control to the desired speed.

Heating

1. Set the mode to the  position.
 2. Set the air intake control to the outside (fresh) air position.
 3. Set the temperature control to the desired position.
 4. Set the fan speed control to the desired speed.
 5. If dehumidified heating is desired, turn the air conditioning system (if equipped) on.
- If the windshield fogs up, set the mode to the  ,  position.

Operation Tips

- To prevent dust or unpleasant fumes from entering the vehicle through the ventilation system, temporarily set the air intake control to the recirculated air position. Be sure to return the control to the fresh air position when the irritation has passed to keep fresh air in the vehicle. This will help keep the driver alert and comfortable.
- Air for the heating/cooling system is drawn in through the grilles just ahead of the windshield. Care should be taken that these are not blocked by leaves, snow, ice or other obstructions.
- To prevent interior fog on the windshield, set the air intake control to the fresh air position and fan speed to the desired position, turn on the air conditioning system, and adjust the temperature control to desired temperature.

Air conditioning

HYUNDAI Air Conditioning Systems are filled with environmentally friendly R-134a refrigerant.

1. Start the engine. Push the air conditioning button.
 2. Set the mode to the  position.
 3. Set the air intake control to the recirculated air position. However, prolonged operation of the recirculated air position will excessively dry the air. In this case, change the air position.
 4. Adjust the fan speed control and temperature control to maintain maximum comfort.
- When maximum cooling is desired, set the temperature control to the extreme left position then set the fan speed control to the highest speed.

*** NOTICE**

- **While using the air conditioning system, monitor the engine temperature gauge closely while driving up hills or in heavy traffic when outside temperatures are high. Air conditioning system operation may cause engine overheating. Continue to use the blower fan but turn the air conditioning system off if the engine temperature gauge indicates engine overheating.**
- **Opening the windows in humid weather while air conditioning operates may create water droplets inside the vehicle. Since excessive water droplets may cause damage to electrical equipment, air conditioning should only be used with the windows closed.**

Air conditioning system operation tips

- If the vehicle has been parked in direct sunlight during hot weather, open the windows for a short time to let the hot air inside the vehicle escape.
- To help reduce moisture inside of the windows on rainy or humid days, decrease the humidity inside the vehicle by operating the air conditioning system.
- During air conditioning system operation, you may occasionally notice a slight change in engine speed as the air conditioning compressor cycles. This is a normal system operation characteristic.
- Use the air conditioning system every month only for a few minutes to ensure maximum system performance.
- When using the air conditioning system, you may notice clear water dripping (or even puddling) on the ground under the passenger side of the vehicle. This is a normal system operation characteristic.

- Operating the air conditioning system in the recirculated air position provides maximum cooling, however, continual operation in this mode may cause the air inside the vehicle to become stale.
- During cooling operation, you may occasionally notice a misty air flow because of rapid cooling and humid air intake. This is a normal system operation characteristic.
- If you operate air conditioner excessively, the difference between the temperature of the outside air and that of the windshield could cause the outer surface of the windshield to fog up, causing loss of visibility. In this case, set the mode selection knob or button to the  position and fan speed control to the lower speed.

Climate control air filter

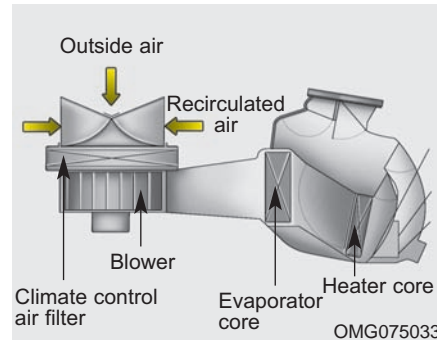

The climate control air filter installed behind the glove box filters the dust or other pollutants that come into the vehicle from the outside through the heating and air conditioning system. If dust or other pollutants accumulate in the filter over a period of time, the air flow from the air vents may decrease, resulting in moisture accumulation on the inside of the windshield even when the outside (fresh) air position is selected. If this happens, have the climate control air filter replaced by an authorized HYUNDAI dealer.

* NOTICE

- Replace the filter according to the Maintenance Schedule. If the vehicle is being driven in severe conditions such as dusty, rough roads, more frequent climate control air filter inspections and changes are required.
- When the air flow rate suddenly decreases, the system should be checked at an authorized HYUNDAI dealer.

Checking the amount of air conditioner refrigerant and compressor lubricant

When the amount of refrigerant is low, the performance of the air conditioning is reduced. Overfilling also has a negative influence on the air conditioning system.

Therefore, if abnormal operation is found, have the system inspected by an authorized HYUNDAI dealer.

CAUTION - Compressor damage

It is important that the correct type and amount of oil and refrigerant is used. Otherwise, damage to the compressor and abnormal system operation may occur.

WARNING



Because the refrigerant is at very high pressure, the air conditioning system should only be serviced by trained and certified technicians. It is important that the correct type and amount of oil and refrigerant is used, otherwise damage to the vehicle and personal injury may occur.

The air conditioning system should be serviced by an authorized HYUNDAI dealer.

Air Conditioning refrigerant label

■ Example

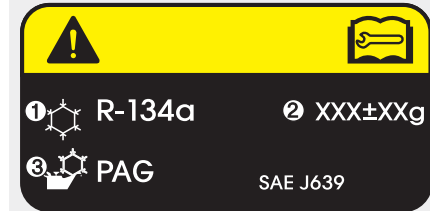

OMD043301N

* The actual Air Conditioning refrigerant label in the vehicle may differ from the illustration.

Each symbols and specification on air conditioning refrigerant label means as below ;

1. Classification of refrigerant
2. Amount of refrigerant
3. Classification of Compressor lubricant

Refer to chapter 8 for more detail location of air conditioning refrigerant label.

AUTOMATIC CLIMATE CONTROL SYSTEM (IF EQUIPPED)



1. Driver's temperature control button
2. Front windshield defrost button
3. Air intake control button
4. LCD display
5. AUTO (automatic control) button
6. OFF button
7. Fan speed control knob
8. Mode selection button
9. Dual temperature control selection button
10. Passenger's temperature control button
11. Rear window defrost button
12. A/C (Air conditioning) button

OMD044109

Automatic heating and air conditioning



1. Push the AUTO button.

The modes, fan speeds, air intake and air-conditioning will be controlled automatically by temperature setting.

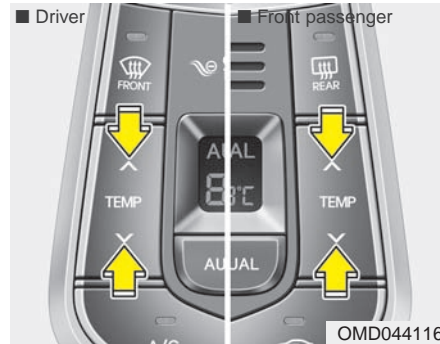

2. Press the temperature control button to set the desired temperature.

* NOTICE

- To turn the automatic operation off, select any button of the following:
 - Mode selection button
 - Front windshield defrost button (Press the button one more time to deselect the front windshield defroster function. The 'AUTO' sign will illuminate on the information display once again.)
 - Fan speed control button
 The selected function will be controlled manually while other functions operate automatically.
- For your convenience and to improve the effectiveness of the climate control, use the AUTO button and set the temperature to 73°F (23°C).

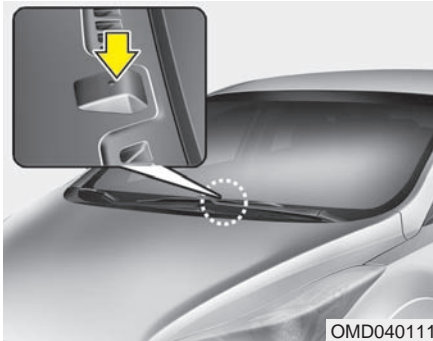

*** NOTICE**



Never place anything over the sensor located on the instrument panel to ensure better control of the heating and cooling system.

Manual heating and air conditioning

The heating and cooling system can be controlled manually by pressing buttons or turning knob(s) other than the AUTO button. In this case, the system works sequentially according to the order of buttons or knob(s) selected.

1. Start the engine.
2. Set the mode to the desired position.

For improving the effectiveness of heating and cooling;

- Heating: 
- Cooling: 

3. Set the temperature control to the desired position.
4. Set the air intake control to the outside (fresh) air position.
5. Set the fan speed control to the desired speed.
6. If air conditioning is desired, turn the air conditioning system on.

Press the AUTO button in order to convert to full automatic control of the system.

Mode selection



The mode selection button controls the direction of the air flow through the ventilation system.

The air flow outlet port is converted as follows:



Refer to the illustration in the "Manual climate control system".



Face-Level

Air flow is directed toward the upper body and face. Additionally, each outlet can be controlled to direct the air discharged from the outlet.



Bi-Level

Air flow is directed towards the face and the floor.



Floor-Level

Most of the air flow is directed to the floor, with a small amount of the air being directed to the windshield and side window defrosters.



Floor & Defrost

Most of the air flow is directed to the floor and the windshield with a small amount directed to the side window defrosters.



Defrost-Level

Most of the air flow is directed to the windshield with a small amount of air directed to the side window defrosters.

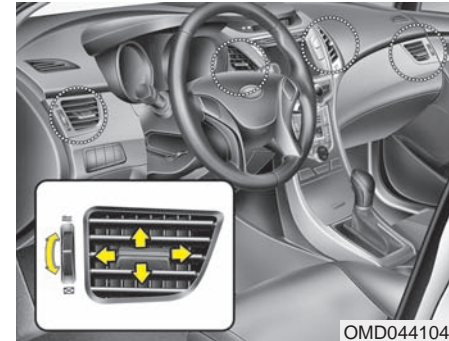

Instrument panel vents

The outlet vents can be opened or closed separately using the thumbwheel.

Also, you can adjust the direction of air delivered from these vents using the vent control lever as shown.

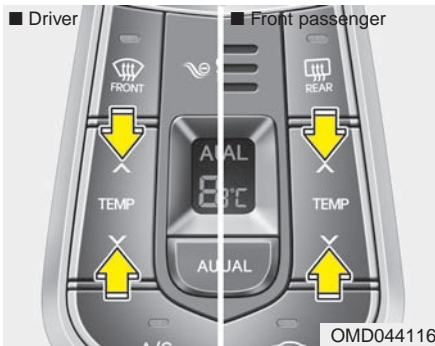

Temperature control

The temperature will increase by pushing the up button. Each push of the button will cause the temperature to increase by 1°F/0.5°C.

The temperature will decrease by pushing the down button. Each push of the button will cause the temperature to decrease by 1°F/0.5°C. When set to the lowest temperature setting, the air conditioning will operate continuously.



Adjusting the driver and passenger side temperature individually

1. Press the DUAL button to operate the driver and passenger side temperature individually. Pressing the right temperature control button will automatically switch to the DUAL mode as well.
2. Press the left temperature control button to adjust the driver side temperature. Press the right temperature control button to adjust the passenger side temperature.

When the driver side temperature is set to the highest or lowest temperature setting, the DUAL mode is deactivated for maximum heating or cooling.

Adjusting the driver and passenger side temperature equally

1. Press the DUAL button again to deactivate DUAL mode. The passenger side temperature will be set to the same temperature as the driver side temperature.
2. Press the left temperature control button. The driver and passenger side temperature will be adjusted equally.

Temperature unit conversion

If the battery has been discharged or disconnected, the temperature mode display will reset to Fahrenheit.

This is a normal condition. You can switch the temperature mode between Fahrenheit to Celsius as follows;

While pressing the OFF button, depress the AUTO button for 3 seconds or more. The display will change from Fahrenheit to Celsius, or from Celsius to Fahrenheit.

Air intake control

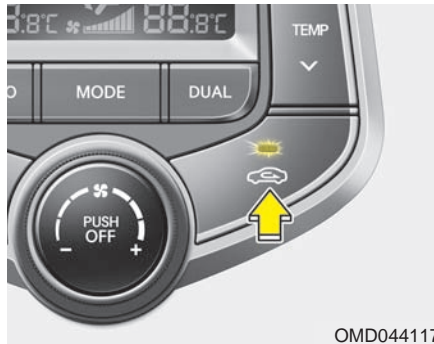

OMD044117

This is used to select the outside (fresh) air position or recirculated air position.

To change the air intake control position, push the control button.

Recirculated air position



The indicator light on the button illuminates when the recirculated air position is selected.

With the recirculated air position selected, air from the passenger compartment will be drawn through the climate control system and heated or cooled according to the function selected.

Outside (fresh) air position



The indicator light on the button will not illuminate when the outside (fresh) air position is selected.

With the outside (fresh) air position selected, air enters the vehicle from outside and is heated or cooled according to the function selected.

* NOTICE

Prolonged operation of the heater in the recirculated air position (without air conditioning selected) may cause fogging of the windshield and side windows and the air within the passenger compartment to become stale.

In addition, prolonged use of the air conditioning with the recirculated air position selected will result in excessively dry air in the passenger compartment.

⚠ WARNING

- Continuous use of the climate control system in the recirculated air position may allow humidity to increase inside the vehicle which may fog the glass and obscure visibility.
- Do not sleep in a vehicle with the air conditioning or heating system on. It may cause serious harm or death due to a drop in the oxygen level and/or body temperature.
- Continue using the climate control system in the recirculated air position can cause drowsiness or sleepiness, and loss of vehicle control. Set the air intake control to the outside (fresh) air position as much as possible while driving.

Fan speed control



The fan speed can be set to the desired speed by turning the fan speed control knob. The higher the fan speed is, the more air is delivered.

Air conditioning

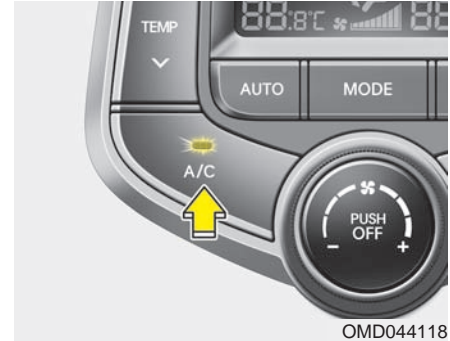

Push the A/C button to turn the air conditioning system on (indicator light will illuminate). Push the button again to turn the air conditioning system off.

OFF mode



OMD044119



Push the OFF button to turn off the air climate control system. However, you can still operate the mode and air intake buttons as long as the ignition switch is in the ON position.

System operation

Ventilation

1. Set the mode to the  position.
2. Set the air intake control to the outside (fresh) air position.
3. Set the temperature control to the desired position.
4. Set the fan speed control to the desired speed.

Heating

1. Set the mode to the  position.
 2. Set the air intake control to the outside (fresh) air position.
 3. Set the temperature control to the desired position.
 4. Set the fan speed control to the desired speed.
 5. If dehumidified heating is desired, turn the air conditioning system (if equipped) on.
- If the windshield fogs up, set the mode to the  ,  position.

Operation Tips

- To prevent dust or unpleasant fumes from entering the vehicle through the ventilation system, temporarily set the air intake control to the recirculated air position. Be sure to return the control to the fresh air position when the irritation has passed to keep fresh air in the vehicle. This will help keep the driver alert and comfortable.
- Air for the heating/cooling system is drawn in through the grilles just ahead of the windshield. Care should be taken that these are not blocked by leaves, snow, ice or other obstructions.
- To prevent interior fog on the windshield, set the air intake control to the fresh air position and fan speed to the desired position, turn on the air conditioning system, and adjust the temperature control to desired temperature.

Air conditioning

HYUNDAI Air Conditioning Systems are filled with environmentally friendly R-134a refrigerant.

1. Start the engine. Push the air conditioning button.
 2. Set the mode to the  position.
 3. Set the air intake control to the recirculated air position. However, prolonged operation of the recirculated air position will excessively dry the air. In this case, change the air position.
 4. Adjust the fan speed control and temperature control to maintain maximum comfort.
- When maximum cooling is desired, set the temperature control to the extreme left position then set the fan speed control to the highest speed.

*** NOTICE**

- **While using the air conditioning system, monitor the engine temperature gauge closely while driving up hills or in heavy traffic when outside temperatures are high. Air conditioning system operation may cause engine overheating. Continue to use the blower fan but turn the air conditioning system off if the engine temperature gauge indicates engine overheating.**
- **Opening the windows in humid weather while air conditioning operates may create water droplets inside the vehicle. Since excessive water droplets may cause damage to electrical equipment, air conditioning should only be used with the windows closed.**

Air conditioning system operation tips

- If the vehicle has been parked in direct sunlight during hot weather, open the windows for a short time to let the hot air inside the vehicle escape.
- To help reduce moisture inside of the windows on rainy or humid days, decrease the humidity inside the vehicle by operating the air conditioning system.
- During air conditioning system operation, you may occasionally notice a slight change in engine speed as the air conditioning compressor cycles. This is a normal system operation characteristic.
- Use the air conditioning system every month only for a few minutes to ensure maximum system performance.
- When using the air conditioning system, you may notice clear water dripping (or even puddling) on the ground under the passenger side of the vehicle. This is a normal system operation characteristic.

- Operating the air conditioning system in the recirculated air position provides maximum cooling, however, continual operation in this mode may cause the air inside the vehicle to become stale.
- During cooling operation, you may occasionally notice a misty air flow because of rapid cooling and humid air intake. This is a normal system operation characteristic.
- If you operate air conditioner excessively, the difference between the temperature of the outside air and that of the windshield could cause the outer surface of the windshield to fog up, causing loss of visibility. In this case, set the mode selection knob or button to the  position and fan speed control to the lower speed.

Climate control air filter

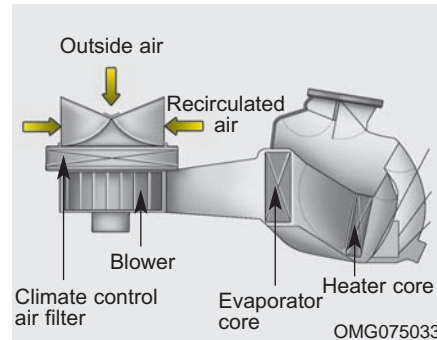

The climate control air filter installed behind the glove box filters the dust or other pollutants that come into the vehicle from the outside through the heating and air conditioning system. If dust or other pollutants accumulate in the filter over a period of time, the air flow from the air vents may decrease, resulting in moisture accumulation on the inside of the windshield even when the outside (fresh) air position is selected. If this happens, have the climate control air filter replaced by an authorized HYUNDAI dealer.

* NOTICE

- Replace the filter according to the Maintenance Schedule. If the vehicle is being driven in severe conditions such as dusty, rough roads, more frequent climate control air filter inspections and changes are required.
- When the air flow rate suddenly decreases, the system should be checked at an authorized HYUNDAI dealer.

Checking the amount of air conditioner refrigerant and compressor lubricant

When the amount of refrigerant is low, the performance of the air conditioning is reduced. Overfilling also has a negative influence on the air conditioning system.

Therefore, if abnormal operation is found, have the system inspected by an authorized HYUNDAI dealer.

CAUTION - Compressor damage

It is important that the correct type and amount of oil and refrigerant is used. Otherwise, damage to the compressor and abnormal system operation may occur.

WARNING



Because the refrigerant is at very high pressure, the air conditioning system should only be serviced by trained and certified technicians. It is important that the correct type and amount of oil and refrigerant is used, otherwise damage to the vehicle and personal injury may occur.

The air conditioning system should be serviced by an authorized HYUNDAI dealer.

Air Conditioning refrigerant label

■ Example

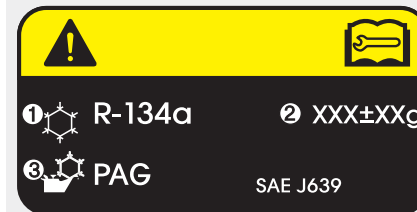

OMD043301N

* The actual Air Conditioning refrigerant label in the vehicle may differ from the illustration.



Each symbols and specification on air conditioning refrigerant label means as below ;

1. Classification of refrigerant
2. Amount of refrigerant
3. Classification of Compressor Lubricant

Refer to chapter 8 for more detail location of air conditioning refrigerant label.

WINDSHIELD DEFROSTING AND DEFOGGING

⚠ WARNING - Windshield heating

Do not use the  or  position during cooling operation in extremely humid weather. The difference between the temperature of the outside air and that of the windshield could cause the outer surface of the windshield to fog up, causing loss of visibility. In this case, set the mode selection knob or button to the  position and fan speed control knob or button to a lower speed.

- For maximum defrosting, set the temperature control to the extreme right/hot position and the fan speed control to the highest speed.
- If warm air to the floor is desired while defrosting or defogging, set the mode to the floor-defrost position.
- Before driving, clear all snow and ice from the windshield, rear window, outside rear view mirrors, and all side windows.
- Clear all snow and ice from the hood and air inlet in the cowl grill to improve heater and defroster efficiency and to reduce the probability of fogging up the inside of the windshield.



*** NOTE**

Be sure to keep the interior surface of the windshield clean by wiping it with a clean cloth and glass cleaner. This will help reduce the tendency of the glass fogging and also improve visibility.

Manual climate control system

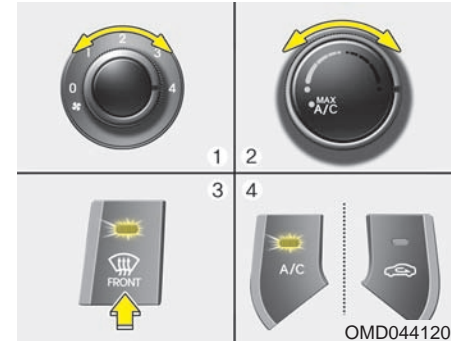
To defog inside windshield



1. Select any fan speed except "0" position.
2. Select desired temperature, except MAX A/C.
3. Select the  or  position.
4. The outside (fresh) air will be selected automatically.

If the outside (fresh) air position is not selected automatically, press the corresponding button manually.

To defrost outside windshield

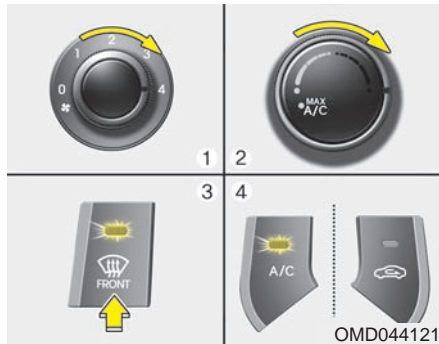

1. Set the fan speed to the highest (extreme right) position.
2. Set the temperature to the extreme hot position.
3. Select the position.
4. The outside (fresh) air will be selected automatically.

OMD044121

Automatic climate control system

To defog inside windshield

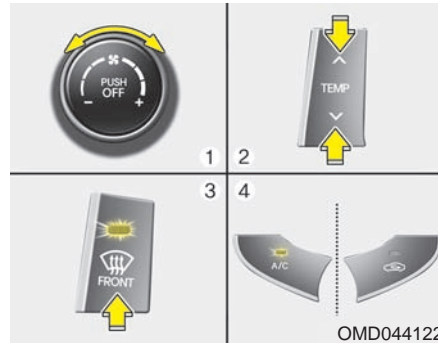

1. Select desired fan speed.
2. Select desired temperature.
3. Press the defrost button ().
4. The outside (fresh) air position will be selected automatically.

If the outside (fresh) air position is not selected automatically, adjust the corresponding button manually.

If the position is selected, lower fan speed is adjusted to a higher fan speed.

OMD044122

To defrost outside windshield

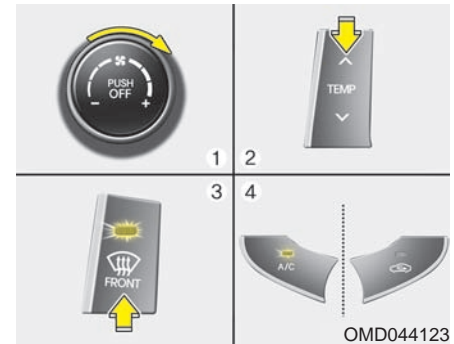



1. Set the fan speed to the highest (extreme right) position.
2. Set the temperature to the extreme hot (HI) position.
3. Press the defrost button ().
4. The outside (fresh) air position will be selected automatically.

If the position is selected, lower fan speed is adjusted to a higher fan speed.

OMD044123

Defogging logic

When defogging logic is operating, the air intake is controlled automatically (You can't control the air intake) according to certain conditions such as  or  position to reduce the probability of fogging up the inside of the windshield. To cancel or return the defogging logic, perform the following steps.

Manual climate control system

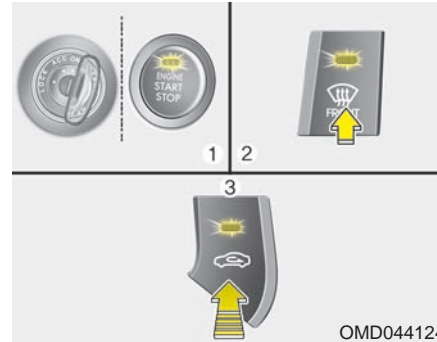



1. Turn the ignition switch to the ON position.
2. Press the defrost button ().
3. Push the air intake control button at least 5 times within 10 seconds.

The indicator light in the air intake control button will blink 3 times with 0.5 second of interval. It indicates that the defogging logic is canceled or returned to the programmed status.

If the battery has been discharged or disconnected, the system resets to the programmed defogging logic.

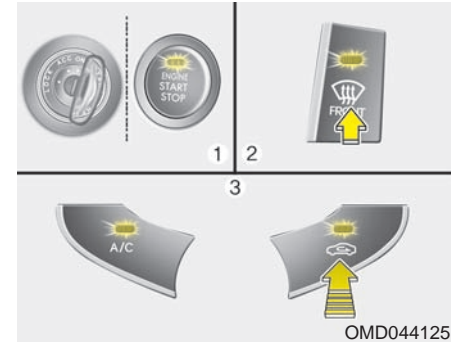
Automatic climate control system



1. Turn the ignition switch to the ON position.
2. Select the defrost position pressing defrost button ().
3. While holding the air conditioning button (A/C) pressed, press the air intake control button at least 5 times within 3 seconds.

The indicator on the air intake control button blinks 3 times with 0.5 second of interval. It indicates that the defogging logic is canceled or returned to the programmed status.

If the battery has been discharged or disconnected, the system resets to the programmed defogging logic.

Auto defogging system (if equipped)

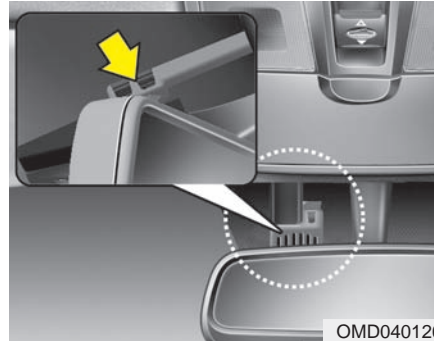

Auto defogging reduces the probability of fogging up the inside of the windshield by automatically sensing the moisture of inside the windshield. The auto defogging system operates when the heater or air conditioning is on.



This indicator illuminates when the auto defogging system senses the moisture of inside the windshield and operates.

Example if auto defogging does not defog inside the windshield at step 1 Operating the air conditioning, it tries to defog again at step 2 Outside air position.

- Step 1 : Operating the air conditioning
- Step 2 : Outside air position
- Step 3 : Blowing air toward the windshield
- Step 4 : Increasing air flow toward the windshield
- Step 5 : Maximizing the air conditioning

If your vehicle is equipped with the auto defogging system, it is automatically activated when the conditions are met. However, if you would like to cancel the auto defogging system, press the front defroster button for 3 seconds. The indicator will blink 3 times to notify you that the system is cancelled. To use the auto defogging system again, follow the procedures mentioned above.

If the battery has been disconnected or discharged, it resets to the auto defogging status.

* NOTICE

- When the air conditioning is turned on by Auto defogging system, if you try to turn off the air conditioning, the indicator will blink 3 times and the air conditioning will not be turned off.
- For efficiency, do not select recirculated air position while Auto defogging system is operating.

CAUTION

Do not remove the sensor cover located on the upper end of the driver side windshield glass. Damage to system parts could occur and may not be covered by your vehicle warranty.

STORAGE COMPARTMENT

⚠ WARNING - Flammable materials

Never store cigarette lighters, propane cylinders, or other flammable/explosive materials in the vehicle. These items may catch fire and/or explode if the vehicle is exposed to hot temperatures for extended periods.

⚠ WARNING

ALWAYS keep the storage compartment covers closed securely while driving. Items inside your vehicle are moving as fast as the vehicle. If you have to stop or turn quickly, or if there is a crash, the items may fly out of the compartment and may cause an injury if they strike the driver or a passenger.

⚠ CAUTION

To avoid possible theft, do not leave valuables in the storage compartment.

Center console storage

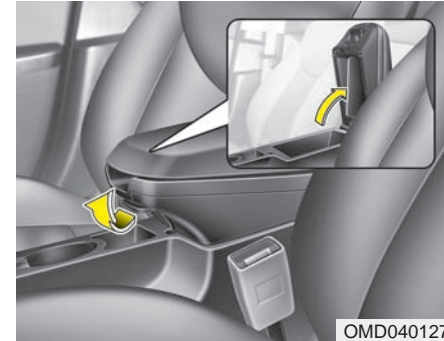

To open the center console storage, pull up the lever.

Sliding armrest (if equipped)

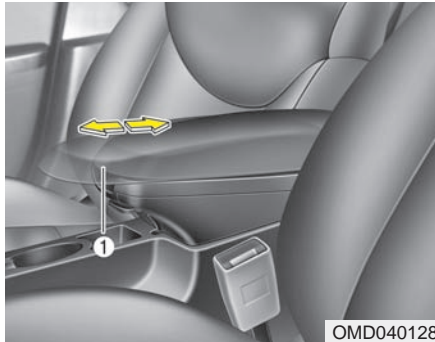

To move the armrest forward:
Grab the front portion of the armrest (1) then pull it forward.

To move the armrest rearward:
Push the armrest rearward.

⚠ WARNING

Do not grab the front portion of the armrest (1) when moving the armrest rearward. You may pinch your fingers.

Glove box

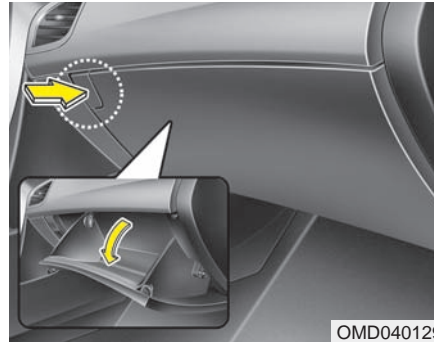

To open the glove box, push the button and the glove box will automatically open.

⚠ WARNING

ALWAYS close the glove box door after use. An open glove box door can cause serious injury to the passenger in an accident, even if the passenger is wearing a seat belt.

⚠ CAUTION

Do not keep food in the glove box for a long time.

Sunglass holder (if equipped)

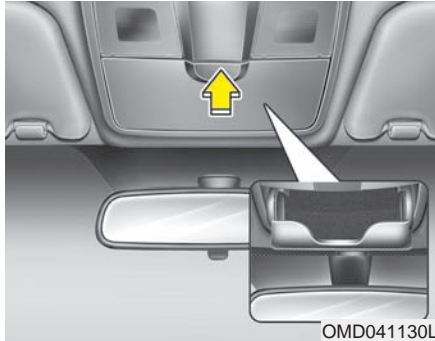

To open the sunglass holder:

Press the cover and the holder will slowly open. Place your sunglasses in the compartment door with the lenses facing out.

To close the sunglass holder:

Push back into position. Make sure the sunglass holder is closed while driving.

⚠ WARNING

- Do not keep objects except sunglasses inside the sunglass holder. Such objects can be thrown from the holder in the event of a sudden stop or an accident, possibly injuring the passengers in the vehicle.
- Do not open the sunglass holder while the vehicle is moving. The rear view mirror of the vehicle can be blocked by an open sunglass holder.
- Do not put the glasses forcibly into a sunglass holder. It may cause personal injury if you try to open it forcibly when the glasses are jammed in the holder.

INTERIOR FEATURES

Clock

With Audio system



⚠ WARNING

Do not adjust the clock while driving, you may lose steering control and cause an accident that results in severe personal injury or death.

Whenever the battery terminals or related fuses are disconnected, you must reset the time.

To set the time:

The ignition switch must be in the ACC position or the ON position.

• **H (Hour)**

Each time you press the "H" button, the clock will change backward by one hour. Pressing and holding the "H" button will change the clock backward continuously.

Release the button at the desired time.

• **M (Minute)**

Each time you press the "M" button, the clock will change backward by one minute. Pressing and holding the "M" button will change the clock backward continuously.

Release the button at the desired time.

• **Display conversion**

To change the 12 hour format to the 24 hour format, press the "H" and "M" button simultaneously for more than 4 seconds.

For example, if the "H" and "M" button is pressed when the time is 10:15 p.m., the display will change to 22:15

With Navigation system

The clock automatically sets itself to the correct time.

Outside temperature

The current outside temperature is displayed.

The outside temperature on the display may not change immediately like a general thermometer.

Temperature unit conversion (°C↔°F)



■ Type A

To change the temperature display between Fahrenheit and Centigrade (or Centigrade and Fahrenheit), press and hold the "H" button, then press the "M" button for 3 seconds.



■ Type B

To change the temperature display to Fahrenheit, press the "°F" button.

To change the temperature display to Centigrade, press the "°C" button.

Cup holder

■ Front

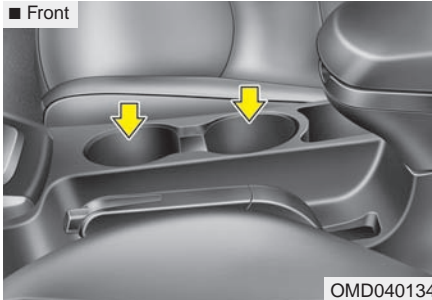

■ Rear

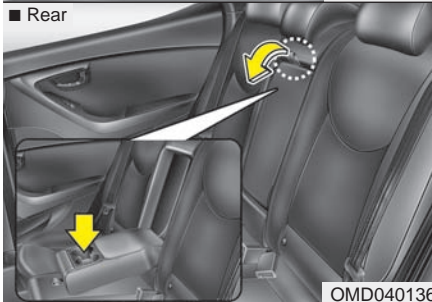

Cups or small beverage cans may be placed in the cup holders.

⚠ WARNING - Hot liquids

- Do not place uncovered cups with hot liquid in the cup holder while the vehicle is in motion. If hot liquid spills, you could be burned. Such a burn to the driver could cause loss of vehicle control resulting in an accident.
- Avoid abrupt starting and braking when the cup holder is in use to prevent spilling your drink. If hot liquid spills, you could be burned. Such a burn to the driver could cause loss of vehicle control resulting in an accident.
- Only use soft cups in the cup holders. Hard objects can injure you in an accident.

⚠ WARNING

Keep cans or bottles out of direct sun light and do not put them in a vehicle that is heated. It may explode.

⚠ CAUTION

- *When cleaning spilled liquids, do not dry the cup holder at high temperature. This may damage the chrome part of the cup holder.*
- *Keep your drinks sealed while driving to prevent spilling your drink. If liquid spills, it may get into the vehicle's electrical/electronic system and damage electrical/electronic parts.*

Sunvisor

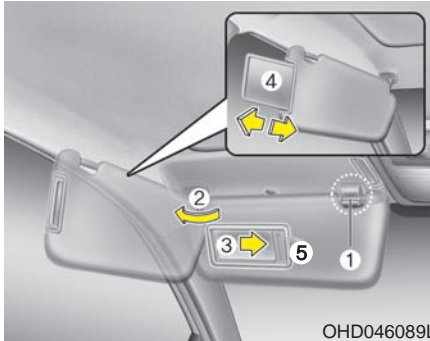

To use a sunvisor, pull it downward.
To use a sunvisor for a side window, pull it downward, unsnap it from the bracket (1) and swing it to the side (2).
To use the vanity mirror, pull down the sunvisor and slide the mirror cover (3).
Adjust the sunvisor forward or backward (4) as needed. Use the ticket holder (5) to hold tickets.

* NOTICE

- Always have the vanity mirror lamp switch in the OFF position when the vanity mirror lamp is not in use.
- Close the vanity mirror cover securely and return the sunvisor to its original position after use.

⚠ WARNING

For your safety, do not block your view when using the sunvisor.

⚠ CAUTION

Always use the sunvisor extension, after swinging the sunvisor to the side.

Power outlet

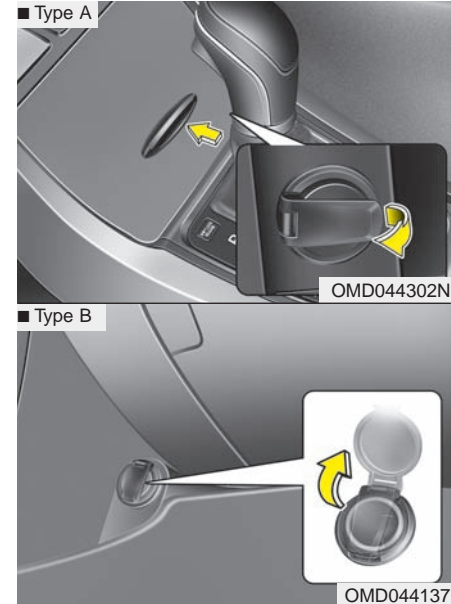

The power outlet is designed to provide power for mobile telephones or other devices designed to operate with vehicle electrical systems. The devices should draw less than 15 amps with the engine running.

⚠ WARNING

Avoid electrical shocks. Do not place your fingers or foreign objects (pin, etc.) into a power outlet or touch the power outlet with a wet hand.

⚠ CAUTION

To prevent damage to the Power Outlets:

- Use the power outlet only when the engine is running and remove the accessory plug after use. Using the accessory plug for prolonged periods of time with the engine off could cause the battery to discharge.
- Only use 12V electrical accessories which are less than 15A in electrical capacity.

(Continued)

(Continued)

- Adjust the air-conditioner or heater to the lowest operating level when using the power outlet.
- Close the cover when not in use.
- Some electronic devices can cause electronic interference when plugged into a vehicle's power outlet. These devices may cause excessive audio static and malfunctions in other electronic systems or devices used in your vehicle.
- Push the plug in as far as it will go. If good contact is not made, the plug may overheat or the internal temperature fuse may open.

Clothes hanger (if equipped)

■ Type A



■ Type B

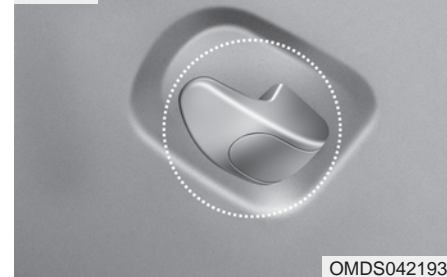

To hang items, pull down the upper portion of the hanger. (Type A)

These hangers are not designed to hold large or heavy items.

⚠ WARNING

Do not hang other objects except clothes. In an accident it may cause vehicle damage or personal injury.

Floor mat anchor(s)

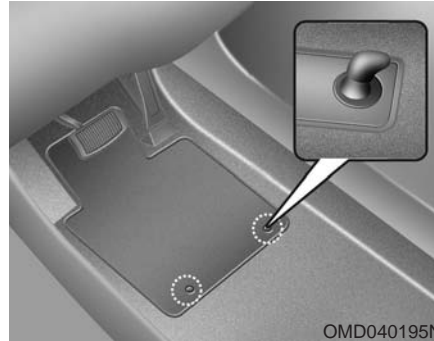

ALWAYS use the Floor Mat Anchors to attach the front floor mats to the vehicle. The anchors on the front floor carpet keep the floor mats from sliding forward.

Your vehicle was manufactured with driver's side floor mat anchors that are designed to securely hold the floor mat in place. To avoid any interference with pedal operation, HYUNDAI recommends that the HYUNDAI floor mat designed for use in your vehicle be installed.

⚠ WARNING

If a floor mat is the wrong size or not properly installed, it can interfere with the accelerator or the brake pedal while driving. Take the following precautions when installing any floor mat:

- ALWAYS ensure the floor mats are securely attached to the vehicle's floor mat anchor(s) and do not interfere with the accelerator or brake pedal before driving the vehicle.
- Use only the HYUNDAI floor mats designed for use in your vehicle.

(Continued)

(Continued)

- **Do not stack floor mats on top of one another (e.g. all-weather rubber mat on top of a carpeted floor mat).**
- **Only a single floor mat should be installed in each position.**
- **Do not place anything on top of the driver side floor mat.**
- **Do not place the floor mats bottom-side up or upside down.**

AUDIO SYSTEM

* NOTICE

- If you install an after market HID (high intensity discharge) head lamp, your vehicle's audio and electronic devices may malfunction.
- Prevent chemicals such as perfume, cosmetic oil, sun cream, hand cleaner, and air freshener from contacting the interior parts because they may cause damage or discoloration.

Antenna (if equipped)

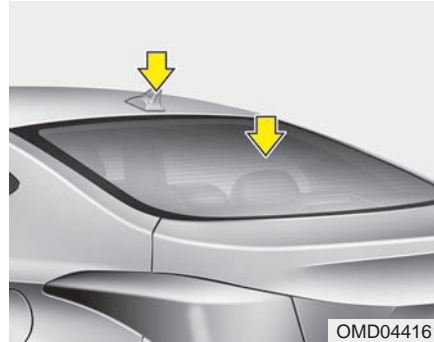

When the radio power switch is turned on while the ignition key is in either the "ON" or "ACC" position, your car will receive both AM and FM broadcast signals through the antenna in the rear window glass.

Shark fin antenna (if equipped)

The shark fin antenna will receive the transmit data.

CAUTION

- *Do not clean the inside of the rear window glass with a cleaner or scraper to remove foreign deposits as this may cause damage to the antenna elements.*
- *Avoid adding metallic coatings such as Nickel, Cadmium, and so on. These can disturb the reception of AM and FM broadcast signals.*

Steering wheel audio control (if equipped)

■ Type A



■ Type B

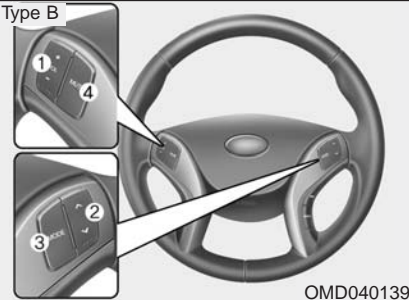

The steering wheel may incorporate audio control buttons.

CAUTION

Do not operate audio remote control buttons simultaneously.

1. VOLUME (VOL+/-)

- Push the lever upward (+) to increase the volume.
- Push the lever downward (-) to decrease the volume.

2. PRESET/SEEK (^/∨)

The SEEK/PRESET button has different functions based on the system mode.

For the following functions the button should be pressed for 0.8 second or more.

RADIO mode

It will function as the AUTO SEEK select button.

CD/USB/iPod mode

It will function as the FF/REW button.

If the SEEK/PRESET button is pressed for less than 0.8 second, it will work as follows in each mode.

RADIO mode

It will function as the PRESET STATION buttons.

CD/USB/iPod mode

It will function as TRACK UP/DOWN button.

3. MODE

Press the button to change audio source.

- FM(1~2) → AM → SAT(1~3) → CD
→ USB AUX(iPod) FM...

4. MUTE (if equipped)

- Press the button to mute the sound.
- Press the button to turn off the microphone during a telephone call.

Detailed information for audio control buttons are described in the following pages in this chapter.

Aux, USB and iPod® port



If your vehicle has an aux and/or USB(universal serial bus) port, you can use an aux port to connect audio devices and an USB port to plug in an USB and iPod.

* NOTICE

When using a portable audio device connected to the power outlet, noise may occur during playback. If this happens, use the power source of the portable audio device.

* iPod® is a trademark of Apple Inc.

How vehicle audio works

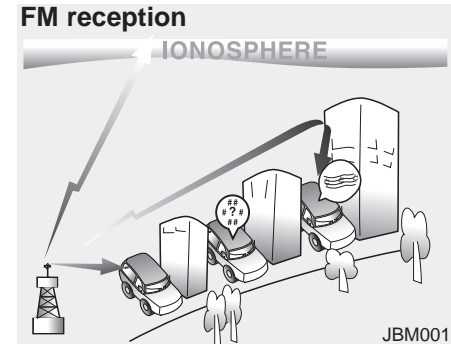

AM and FM radio signals are broadcast from transmitter towers located around your city. They are intercepted by the radio antenna on your vehicle. This signal is then processed by the radio and sent to your vehicle speakers.

When a strong radio signal has reached your vehicle, the precise engineering of your audio system ensures the best possible quality reproduction. However, in some cases the signal coming to your vehicle may not be strong and clear.

This can be due to factors, such as the distance from the radio station, closeness of other strong radio stations or the presence of buildings, bridges or other large obstructions in the area.

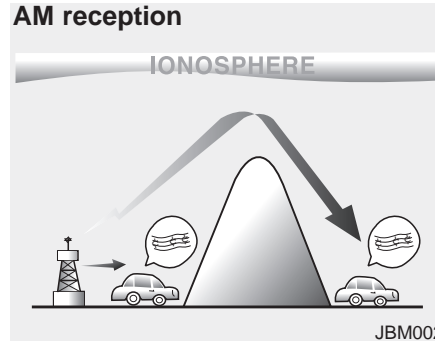

AM broadcasts can be received at greater distances than FM broadcasts. This is because AM radio waves are transmitted at low frequencies. These long distance, low frequency radio waves can follow the curvature of the earth rather than travelling straight. In addition, they curve around obstructions resulting in better signal coverage.

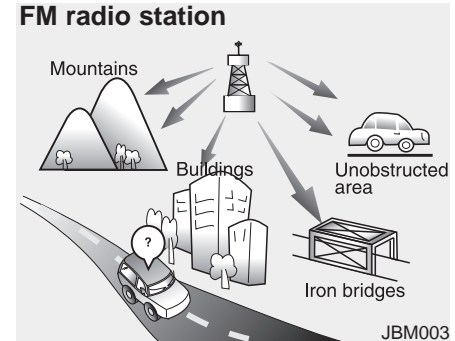

FM broadcasts are transmitted at high frequencies and do not bend to follow the earth's surface. Because of this, FM broadcasts generally begin to fade within short distances from the station. Also, FM signals are easily affected by buildings, mountains, and obstructions. This can lead to undesirable or unpleasant listening conditions which might lead you to believe a problem exists with your radio. The following conditions are normal and do not indicate radio trouble:

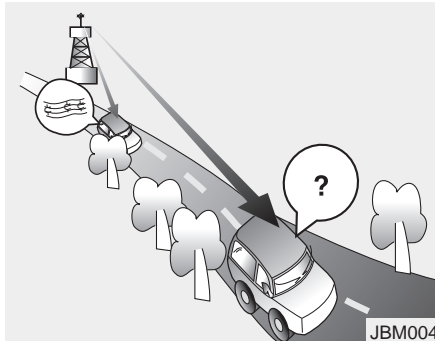

- Fading - As your vehicle moves away from the radio station, the signal will weaken and sound will begin to fade. When this occurs, we suggest that you select another stronger station.
- Flutter/Static - Weak FM signals or large obstructions between the transmitter and your radio can disturb the signal causing static or fluttering noises to occur. Reducing the treble level may lessen this effect until the disturbance clears.

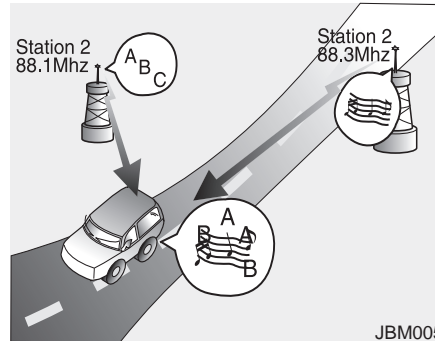

- Station Swapping - As an FM signal weakens, another more powerful signal near the same frequency may begin to play. This is because your radio is designed to lock onto the clearest signal. If this occurs, select another station with a stronger signal.
- Multi-Path Cancellation - Radio signals being received from several directions can cause distortion or fluttering. This can be caused by a direct and reflected signal from the same station, or by signals from two stations with close frequencies. If this occurs, select another station until the condition has passed.

Using a cellular phone or a two-way radio

When a cellular phone is used inside the vehicle, noise may be produced from the audio system. This does not mean that something is wrong with the audio equipment. In such a case, try to operate mobile devices as far from the audio equipment as possible.

CAUTION

When using a communication system such as a cellular phone or a radio set inside the vehicle, a separate external antenna must be fitted. When a cellular phone or a radio set is used with an internal antenna alone, it may interfere with the vehicle's electrical system and adversely affect safe operation of the vehicle.

WARNING

Do not use a cellular phone while driving. Stop at a safe location to use a cellular phone.

Caring for disc

- If the temperature inside the car is too high, open the car windows to ventilate before using the system.
- It is illegal to copy and use MP3/WMA files without permission. Use CDs that are created only by lawful means.
- Do not apply volatile agents, such as benzene and thinner, use normal cleaners and magnetic sprays made for analogue disc onto CDs.
- To prevent the disc surface from getting damaged, hold CDs by the edges or the center hole only.
- Clean the disc surface with a piece of soft cloth before playback (wipe it from the center to the outside edge).
- Do not damage the disc surface or attach pieces of sticky tape or paper.
- Make certain only CDs are inserted into the CD player (Do not insert more than one CD at a time).
- Keep CDs in their cases after use to protect them from scratches or dirt.

- Depending on the type of CD-R/CD-RW CDs, certain CDs may not operate normally according to the manufacturing companies. In such circumstances, continued use may cause malfunctions to your audio system.

* NOTICE - Playing an Incompatible Copy Protected Audio CD

Some copy protected CDs, which do not comply with international audio CD standards (Red Book), may not play on your car audio. Please note that inability to properly play a copy protected CD may indicate that the CD is defective, not the CD player.

NOTE:

Order of playing files (folders) :

1. Song playing order : ① to ⑭ sequentially.

2. Folder playing order :

*** If no song file is contained in the folder, that folder is not displayed.**

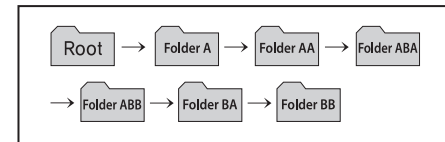

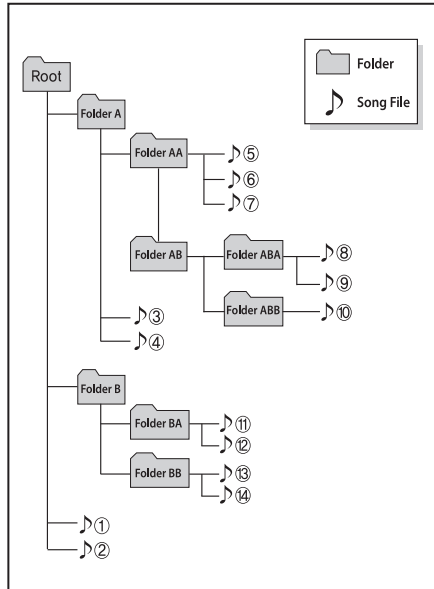

⚠ WARNING

- Do not stare at the screen while driving. Staring at the screen for prolonged periods of time could lead to traffic accidents.
- Do not disassemble, assemble, or modify the audio system. Such acts could result in accidents, fire, or electric shock.
- Using the phone while driving may lead to a lack of attention of traffic conditions and increase the likelihood of accidents. Use the phone feature after parking the vehicle.
- Heed caution not to spill water or introduce foreign objects into the device. Such acts could lead to smoke, fire, or product malfunction.

(Continued)

(Continued)

- Please refrain from use if the screen is blank or no sound can be heard as these signs may indicate product malfunction. Continued use in such conditions could lead to accidents (fires, electric shock) or product malfunctions.
- Do not touch the antenna during thunder or lightning as such acts may lead to lightning induced electric shock.
- Do not stop or park in parking-restricted areas to operate the product. Such acts could lead to traffic accidents.
- Use the system with the vehicle ignition turned on. Prolonged use with the ignition turned off could result in battery discharge.

⚠ CAUTION

- *Operating the device while driving could lead to accidents due to a lack of attention to external surroundings. First park the vehicle before operating the device.*
- *Adjust the volume to levels that allow the driver to hear sounds from outside of the vehicle. Driving in a state where external sounds cannot be heard may lead to accidents.*
- *Pay attention to the volume setting when turning the device on. A sudden output of extreme volume upon turning the device on could lead to hearing impairment. (Adjust the volume to a suitable levels before turning off the device.)*

(Continued)

(Continued)

- *Turn on the car ignition before using this device. Do not operate the audio system for long periods of time with the ignition turned off as such operations may lead to battery discharge.*
- *Do not subject the device to severe shock or impact. Direct pressure onto the front side of the monitor may cause damage to the LCD or touch screen.*
- *When cleaning the device, make sure to turn off the device and use a dry and smooth cloth. Never use tough materials, chemical cloths, or solvents (alcohol, benzene, thinners, etc.) as such materials may damage the device panel or cause color/quality deterioration.*

(Continued)

(Continued)

- *Do not place beverages close to the audio system. Spilling beverages may lead to system malfunction.*
- *In case of product malfunction, please contact your closest authorized Hyundai dealer.*
- *Placing the audio system within an electromagnetic environment may result in noise interference.*
- *Prevent caustic solutions such as perfume and cosmetic oil from contacting the dashboard because they may cause damage or discoloration.*

*** NOTICE - USING THE USB DEVICE**

- To use an external USB device, make sure the device is not connected when starting up the vehicle. Connect the device after starting up.
- If you start the engine when the USB device is connected, it may damage the USB device. (USB flashdrives are very sensitive to electric shock.)
- If the engine is started up or turned off while the external USB device is connected, the external USB device may not work.
- The System may not play unauthenticated MP3 or WMA files.
 - 1) It can only play MP3 files with the compression rate between 8Kbps~320Kbps.
 - 2) It can only play WMA music files with the compression rate between 8Kbps~320Kbps.
- Take precautions for static electricity when connecting or disconnecting the external USB device.

(Continued)

(Continued)

- An encrypted MP3 PLAYER is not recognizable.
- Depending on the condition of the external USB device, the connected external USB device can be unrecognizable.
- When the formatted byte/sector setting of External USB device is not either 512BYTE or 2048BYTE, then the device will not be recognized.
- Use only a USB device formatted to FAT 12/16/32.
- USB devices without USB I/F authentication may not be recognizable.
- Make sure the USB connection terminal does not come in contact with the human body or other objects.
- If you repeatedly connect or disconnect the USB device in a short period of time, it may break the device.
- You may hear a strange noise when connecting or disconnecting a USB device.

(Continued)

(Continued)

- If you disconnect the external USB device during playback in USB mode, the external USB device can be damaged or may malfunction. Therefore, disconnect the external USB device when the audio is turned off or in another mode. (e.g, Radio, CD)
- Depending on the type and capacity of the external USB device or the type of the files stored in the device, there is a difference in the time taken for recognition of the device.
- Do not use the USB device for purposes other than playing music files.
- Playing videos through the USB is not supported.
- Use of USB accessories such as rechargers or heaters using USB I/F may lower performance or cause trouble.

(Continued)

(Continued)

- If you use devices such as a USB hub purchased separately, the vehicle's audio system may not recognize the USB device. In that case, connect the USB device directly to the multimedia terminal of the vehicle.
- If the USB device is divided by logical drives, only the music files on the highest-priority drive are recognized by car audio.
- Devices such as MP3 Player/ Cellular phone/Digital camera can be unrecognizable by standard USB I/F can be unrecognizable.
- Charging through the USB may not be supported in some mobile devices.
- USB HDD or USB types liable to connection failures due to vehicle vibrations are not supported. (i-stick type)
- Some non-standard USB devices (METAL COVER TYPE USB) can be unrecognizable.

(Continued)

(Continued)

- Some USB flash memory readers (such as CF, SD, micro SD, etc.) or external-HDD type devices can be unrecognizable.
- Music files protected by DRM (DIGITAL RIGHTS MANAGEMENT) are not recognizable.
- The data in the USB memory may be lost while using this audio. Always back up important data on a personal storage device.
- Please avoid using USB memory products which can be used as key chains or cellular phone accessories as they could cause damage to the USB jack. Please make certain only to use plug type connector products.



*** NOTICE - USING THE iPod® DEVICE**

- iPhone® is a registered trade mark of Apple inc.
- Some iPod® models may not support communication protocol and files may not properly play.
Supported iPod® models:
- iPhone® 3GS/4
- iPod® touch 1st~4th generation
- iPod® nano 1st~6th generation
- iPod® classic
- The order of search or playback of songs in the iPod® can be different from the order searched in the audio system.
- If the iPod® is disabled due to its own malfunction, reset the iPod®. (Reset: Refer to iPod® manual)
- An iPod® may not operate normally on low battery.

(Continued)

(Continued)

- Some iPod® devices, such as the iPhone®, can be connected through the *Bluetooth*® Wireless Technology interface. The device must have audio *Bluetooth*® Wireless Technology capability (such as for stereo headphone *Bluetooth*® Wireless Technology). The device can play, but it will not be controlled by the audio system.
- To use iPod® features within the audio, use the cable provided upon purchasing an iPod® device.
- Skipping or improper operation may occur depending on the characteristics of your iPod®/ iPhone® device.
- If your iPhone® is connected to both the *Bluetooth*® Wireless Technology and USB, the sound may not be properly played. In your iPhone®, select the Dock connector or *Bluetooth*® Wireless Technology to change the sound output (source).

(Continued)

(Continued)

- When connecting iPod® with the iPod® Power Cable, insert the connector to the multimedia socket completely. If not inserted completely, communications between iPod® and audio may be interrupted.
- When adjusting the sound effects of the iPod® and the audio system, the sound effects of both devices will overlap and might reduce or distort the quality of the sound.
- Deactivate (turn off) the equalizer function of an iPod® when adjusting the audio system's volume, and turn off the equalizer of the audio system when using the equalizer of an iPod®.
- When not using iPod® with car audio, detach the iPod® cable from iPod®. Otherwise, iPod® may remain in accessory mode, and may not work properly.

* NOTICE - *Bluetooth*® Wireless Technology

- The *Bluetooth*® word mark and logos are registered trademarks owned by Bluetooth SIG, Inc. and any use of such marks is under license.
A *Bluetooth*® enabled call phone is required to use *Bluetooth*® wireless technology.
- *Bluetooth*® Wireless Technology phone compatibility can be checked by visiting www.hyundaiusa.com and under the SERVICE & PARTS - BLUETOOTH COMPATIBILITY menu.

*** NOTICE - BEFORE USING THE *Bluetooth*® HANDSFREE**

***What is Bluetooth*® ?**

- *Bluetooth*® refers to a short-distance wireless networking technology which uses a 2.4GHz ~ 2.48GHz frequency to connect various devices within a certain distance.
- Supported within PCs, external devices, *Bluetooth*® phones, PDAs, various electronic devices, and automotive environments, *Bluetooth*® allows data to be transmitted at high speeds without having to use a connector cable.
- *Bluetooth*® Handsfree refers to a device which allows the user to conveniently make phone calls with *Bluetooth*® mobile phones through the audio system.
- *Bluetooth*® Handsfree may not be supported in some mobile phones. To learn more about mobile device compatibility, visit www.hyundaiusa.com.

*** NOTICE - PRECAUTIONS FOR SAFE DRIVING**

- *Bluetooth*® is a feature that enables drivers to use handsfree while driving. Connecting the head unit with a *Bluetooth*® phone allows the user to conveniently make and receive calls and use contacts. Before using *Bluetooth*®, carefully read the contents of this user's manual.
- Excessive use or operations while driving may lead to negligent driving practices and result in accidents. Refrain from excessive operations while driving.
- Viewing the screen for prolonged periods of time is dangerous and may lead to accidents. When driving, view the screen only for short periods of time.

*** NOTICE - WHEN CONNECTING A *Bluetooth*® PHONE**

- Before connecting the head unit with the mobile phone, check to see that the mobile phone supports *Bluetooth*® features.
- Even if the phone supports *Bluetooth*®, the phone will not be found during device searches if the phone has been set to hidden state or the *Bluetooth*® power is turned off. Disable the hidden state or turn on the *Bluetooth*® power prior to searching/connecting with the Head unit.
- *Bluetooth* phone is automatically connected when the ignition is turned on.
- If you do not want automatic connection with your *Bluetooth*® device, turn off the *Bluetooth*® feature within your mobile phone.
- The Handsfree call volume and quality may differ depending on the mobile phone.

(Continued)

(Continued)

- Park the vehicle when connecting the head unit with the mobile phone.
- *Bluetooth*® connection may become intermittently disconnected in some mobile phones. Follow these steps to try again.
 1. Within the mobile phone, turn the *Bluetooth*® function off/on and try again.
 2. Turn the mobile phone power Off/On and try again.
 3. Completely remove the mobile phone battery, reboot, and then again.
 4. Reboot the Audio System and try again.
 5. Delete all paired devices, pair and try again.

* NOTICE - USING THE VOICE RECOGNITION

- When using the voice recognition feature, only commands listed within the user's manual are supported.
- Be aware that during the operation of the voice recognition system, pressing any key other than the  key terminate voice recognition mode.
- For superior voice recognition performance, position the microphone used for voice recognition above the head of the driver's seat and maintain a proper position when saying commands.
- Within the following situations, voice recognition may not function properly due to external sound.
 - When the windows and sunroof are open
 - When the wind of the cooling / heating device is strong
 - When entering and passing through tunnels

(Continued)

(Continued)

- When driving on rugged and uneven roads
- During severe rain (heavy rains, windstorms)
- Phone related voice commands can be used only when a *Bluetooth*® Wireless Technology device is connected.
- When making calls by stating a name, the corresponding contact must be downloaded and stored within the audio system.
- After downloading the *Bluetooth*® Wireless Technology phone book, it takes some time to convert the phone book data into voice information. During this time, voice recognition may not properly operate.
- Pronounce the voice commands naturally and clearly as if in a normal conversation.

The Bluetooth and Voice Recognition Manual is provided in two versions due to software version differences. Before reading the manual, check the following.

Press the  key in FM Radio screen

1. If you can find "FM <87.5~107.9>" on the screen,
 ▶ (Go to 4-254 page)

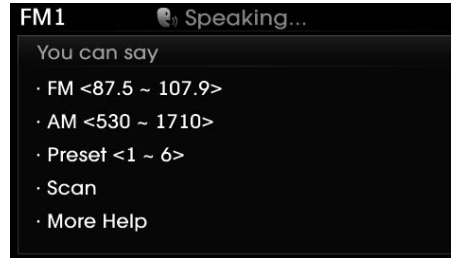
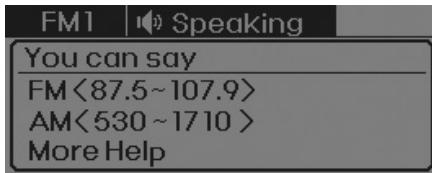

2. If you can find "FM <89.1>" on the screen,
 ▶ (Go to 4-134 page)

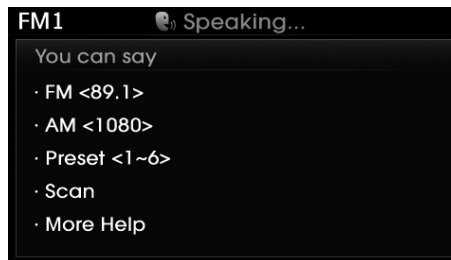
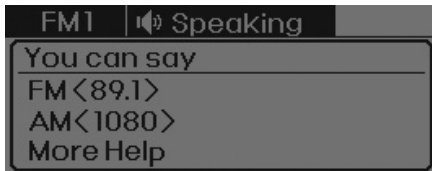

■ CD Player : AM1B0MDKN F/L, AM1B0MDAN F/L, AM1B1MDAN F/L



■ CD Player : AM180MDKN F/L, AM180MDAN F/L



* No  Bluetooth logo will be shown if the *Bluetooth*® Wireless Technology feature is not supported.

SYSTEM CONTROLLERS AND FUNCTIONS

Audio Head Unit



1. **EJECT**

- Ejects the disc.

2. **RADIO**

- Changes to FM/AM/SiriusXM mode.
- Each time the key is pressed, the mode is changed in order of FM1 → FM2 → AM → XM1 → XM2 → XM3

*In Setup>Display, the radio pop up screen will be displayed when [Mode Pop up] is turned **On**.

When the pop up screen is displayed, use the **TUNE** knob or keys **1** ~ **6** to select the desired mode.

3. **MEDIA**

- Changes to CD, USB, iPod, AUX, My Music, BT Audio modes.
- Each time the key is pressed, the mode is changed in order of CD, USB, iPod, AUX, My Music, BT Audio modes.

*In Setup>Display, the media pop up screen will be displayed when [Mode Pop up] is turned **On**.

When the pop up screen is displayed, use the **TUNE** knob or keys **1** ~ **5** to select the desired mode.

4. **PHONE**

- Operates Phone Screen

*When a phone is not connected, the connection screen is displayed.

5. **POWER/VOL knob**

- **Power Knob**: Turns power On/Off by pressing the knob
- **Volume Knob**: Sets volume by turning the knob left/right

6. **1** ~ **6** (Preset)

- **Radio Mode**: Saves frequencies (channels) or receives saved frequencies (channels)
- **CD, USB, iPod, My Music mode**
 - **1** : Repeat
 - **2** : Random
- In the Radio, Media, Setup, and Menu pop up screen, the number menu is selected.

7. **SEEK TRACK**

- **Radio Mode** : Automatically searches for broadcast frequencies.
- **CD, USB, iPod, My Music modes** :
 - Shortly press the key (under 0.8 seconds): Moves to next or previous song(file)
 - Press and hold the key (over 0.8 seconds): Rewinds or fast-forwards the current song(file)



8. **DISP**

- Each time the button is shortly pressed (under 0.8 seconds), it sets the screen Off → Screen On → Screen Off
- *Audio operation is maintained and only the screen will be turned Off. In the screen Off state, press any key to turn the screen On again.

9. **SCAN**

- Radio Mode
 - Shortly press the key (under 0.8 seconds): Previews each broadcast for 5 seconds each
 - Press and hold the key (over 0.8 seconds): Previews the broadcasts saved in Preset **1** ~ **6** for 5 seconds each.

* Press the **SCAN** key again to continue listening to the current frequency.

* SiriusXM RADIO does not support the Preset scan feature.

- CD, USB, iPod mode

- Shortly press the key (under 0.8 seconds): Previews each song (file) for 10 seconds each

* Press the **SCAN** key again to continue listening to the current song (file).

10. **SETUP**

- Shortly press the key (under 0.8 seconds) : Moves to the Display, Sound, Phone, System setting modes

11. **MENU**

- Displays menus for the current mode.

12. **TUNE** knob

- Radio mode : Changes frequency by turning the knob left/right
- CD, USB, iPod mode: Searches songs (files) by turning the knob left/right

*When the desired song is displayed, press the knob to play the song.

- Moves focus in all selection menus and selects menus

13. **CAT FOLDER**

- Radio Mode
 - SiriusXM RADIO : Category Search
- MP3 CD, USB mode : Folder Search
- iPod mode: Moves to parent folder

*May differ depending on the selected audio.

Audio Head Unit (For NON Bluetooth model)



14. **FM/AM**

- Changes to FM mode.
- Each time the key is pressed, the mode changed in order of FM1 → FM2 → AM.

15. **SAT**

- Changes to SiriusXM mode.

■ CD Player : AM110MDAN F/L



■ CD Player : AM110MDAN F/L



* No  Bluetooth logo will be shown if the *Bluetooth*[®] Wireless Technology feature is not supported.

SYSTEM CONTROLLERS AND FUNCTIONS

Audio Head Unit



1. **EJECT** (EJECT)

- Ejects the disc.

2. **RADIO**

- Changes to FM/AM mode.
- Each time the key is pressed, the mode is changed in order of FM1 → FM2 → AM

※In Setup>Display, the radio pop up screen will be displayed when [Mode Pop up] is turned **On**.

When the pop up screen is displayed, use the **TUNE** knob or keys **1** ~ **6** to select the desired mode.

3. **MEDIA**

- Changes to CD, USB, iPod, AUX, My Music, BT Audio modes.
- Each time the key is pressed, the mode is changed in order of CD, USB, iPod, AUX, My Music, BT Audio modes.

※In Setup>Display, the media pop up screen will be displayed when [Mode Pop up] is turned **On**.

When the pop up screen is displayed, use the **TUNE** knob or keys **1** ~ **5** to select the desired mode.

4. **PHONE**

- Operates Phone Screen

※When a phone is not connected, the connection screen is displayed.

5. **POWER/VOL knob**

- **Power Knob**: Turns power On/Off by pressing the knob
- **Volume Knob**: Sets volume by turning the knob left/right

6. **1** ~ **6** (Preset)

- **Radio Mode**: Saves frequencies (channels) or receives saved frequencies (channels)
- **CD, USB, iPod, My Music mode**
 - **1** : Repeat
 - **2** : Random
- In the Radio, Media, Setup, and Menu pop up screen, the number menu is selected.

7. **SEEK TRACK** (up/down arrows)

- **Radio Mode** : Automatically searches for broadcast frequencies.
- **CD, USB, iPod, My Music modes** :
 - Shortly press the key (under 0.8 seconds): Moves to next or previous song(file)
 - Press and hold the key (over 0.8 seconds): Rewinds or fast-forwards the current song(file)



8. **DISP**

- Each time the button is shortly pressed (under 0.8 seconds), it sets the screen Off → Screen On → Screen Off
- * Audio operation is maintained and only the screen will be turned Off. In the screen Off state, press any key to turn the screen On again.

9. **SCAN**

- Radio Mode
 - Shortly press the key (under 0.8 seconds): Previews each broadcast for 5 seconds each
 - Press and hold the key (over 0.8 seconds): Previews the broadcasts saved in Preset **1** ~ **6** for 5 seconds each.
- * Press the **SCAN** key again to continue listening to the current frequency.
- CD, USB, iPod mode
 - Shortly press the key (under 0.8 seconds): Previews each song (file) for 10 seconds each
- * Press the **SCAN** key again to continue listening to the current song (file).

10. **SETUP**

- Shortly press the key (under 0.8 seconds) : Moves to the Display, Sound, Phone, System setting modes

11. **MENU**

- Displays menus for the current mode.

12. **TUNE** knob

- Radio mode : Changes frequency by turning the knob left/right
- CD, USB, iPod mode: Searches songs (files) by turning the knob left/right
- * When the desired song is displayed, press the knob to play the song.
- Moves focus in all selection menus and selects menus

13. **FOLDER**

- MP3 CD, USB mode : Folder Search
- iPod mode: Moves to parent folder
- * May differ depending on the selected audio.

Audio Head Unit (For NON Bluetooth model)



14. **FM**
- Changes to FM mode.
 - Each time the key is pressed, the mode changed in order of FM1 → FM2.
15. **AM**
- Changes to AM mode.

SETUP

Display Settings

Press the **SETUP** key ▶ Select [Display] through **TUNE** knob or **1** key ▶ Select menu through **TUNE** knob



Mode Pop up

[Mode Pop up] ▶ Changes **On**/**Off** selection mode

- During On state, press the **RADIO** or **MEDIA** key to display the mode change pop up screen.

Media Display

When playing an MP3 file, select the desired display info from 'Folder/File' or 'Album/Artist/Song'.

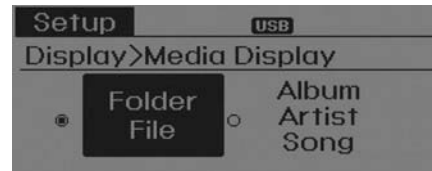

SOUND SETTINGS

Press the **SETUP** key ▶ Select [Sound] through **TUNE** knob or **2** key ▶ Select menu through **TUNE** knob

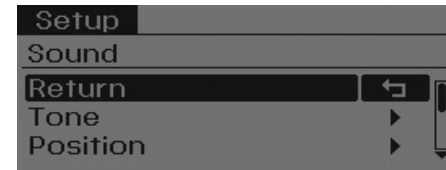

Tone

This menu allows you to set the Bass Middle, Treble

Select [Tone] ▶ Select menu through  Tune knob ▶ Turn  TUNE knob left/right to set



- Bass, Middle, Treble : Selects the sound tone
- Default : Restores default settings

*Return : While adjusting values, pressing the TUNE knob will restore the parent menu.



Position

This menu allows you to set the Fader, Balance.

Select [Position] ▶ Select menu through  Tune knob ▶ Turn  Tune knob left/right to set

- Fader, Balance : Selects the sound fader and balance
- Default : Restores default settings

*Return : While adjusting values, pressing the TUNE knob will restore the parent menu.

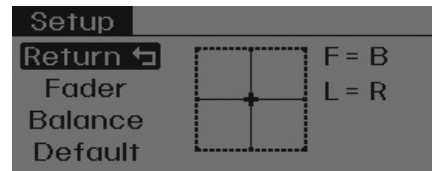

Speed Dependent Volume Control

This feature is used to automatically control the volume level according to the speed of the vehicle.

Select [SDVC] ▶ Turn SDVC On/Off by pressing the  Tune knob.



Voice Recognition Volume

Adjusts voice recognition volume.

Select [Voice Recognition Vol.]▶ Set volume of  TUNE knob

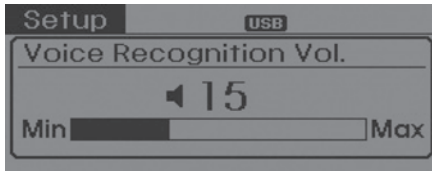

SYSTEM SETTINGS

Press the **SETUP** key ▶ Select [System] through tune knob or **4** key ▶ Select menu through **TUNE** knob

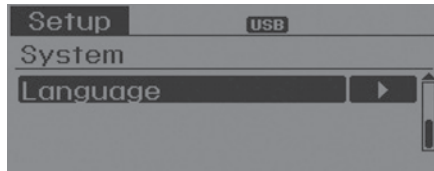
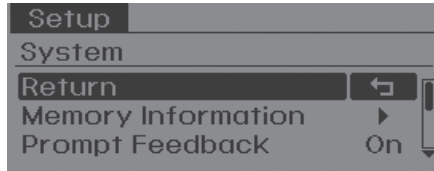

Memory Information

Displays currently used memory and total system memory.

Select [Memory Information] ▶ OK

The currently used memory is displayed on the left side while the total system memory is displayed on the right side.



Prompt Feedback

This feature is used to change voice command feedback between Normal and Expert modes.

Select [Prompt Feedback] ▶ Set through **TUNE** knob

- Normal(On) : This mode is for beginner users and provides detailed instructions during voice command operation.

- Expert(Off) : This mode is for expert users and omits some information during voice command operation. (When using Expert mode, guidance instructions can be heard through the [Help] or [Menu] commands.

Language

This menu is used to set the display and voice recognition language.

Select [Language] ▶ Set through **TUNE** knob

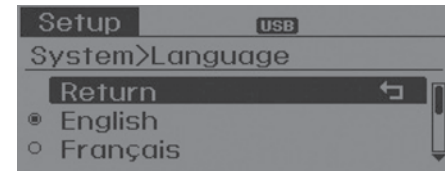

- *The system will reboot after the language is changed.
- *Language support by region
 - English, Francais, Espanol

RADIO : FM, AM OR SiriusXM





SEEK

Press the  key

- Shortly pressing the key (under 0.8 seconds): Changes the frequency.
- Pressing and holding the key (over 0.8 seconds): Automatically searches for the next frequency.



Preset SEEK

Press the  ~  key

- Shortly pressing the key (under 0.8 seconds): Plays the frequency saved in the corresponding key.
- Pressing and holding the key (over 0.8 seconds): Pressing and holding the desired key from  ~  will save the currently playing broadcast to the selected key and sound a BEEP.

SCAN

Press the  key

- Shortly pressing the key (under 0.8 seconds): The broadcast frequency increases and previews each broadcast for 5 seconds each. After scanning all frequencies, returns and plays the current broadcast frequency.
- Pressing and holding the key (over 0.8 seconds): Previews the broadcasts saved in Preset  ~  for 5 seconds each.

Selecting through manual search

Turn the  TUNE knob left/right to adjust the frequency.

MENU

Within **MENU** key are the A.Store (Auto Store) and Info functions.



① A.Store

Press the **MENU** key ▶ Set [A.Store] through **TUNE** knob or **1** key

Saves broadcasts with superior reception to **1** ~ **6** keys. If no frequencies are received, then the most recently received frequency will be broadcast.

SiriusXM® Satellite Radio information

Satellite Radio channels:

Enjoy SiriusXM Satellite Radio with a 3-month trial subscription to the Sirius Select package. You'll get over 140 channels, including commercial-free music, plus all your favorite sports, exclusive talk, entertainment, and a selection of premium programming. For more information and a complete list of SiriusXM channels, visit siriusxm.com in the United States, siriusxm.ca in Canada, or call SiriusXM at 1-888-539-7474.

Satellite Radio reception factors:

To receive the satellite signal, your vehicle has been equipped with a satellite radio antenna located on the roof of your vehicle. The vehicle roof provides the best location for an unobstructed, open view of the sky, a requirement of a satellite radio system. Like AM/FM, there are several factors that can affect satellite radio reception performance:

- **Antenna obstructions:** For optimal reception performance, keep the antenna clear of snow and ice build-up and keep luggage and other material as far away from the antenna as possible.
- **Terrain:** Hills, mountains, tall buildings, bridges, tunnels, freeway overpasses, parking garages, dense tree foliage and thunderstorms can interfere with your reception.

SiriusXM Satellite Radio service:

SiriusXM is a subscription-based satellite radio service that broadcasts music, sports, news and entertainment programming to radio receivers, which are available for installation in motor vehicles or factory installed, as well as for the home, portable and wireless devices, and through an Internet connection on personal computer.

Vehicles that are equipped with a factory installed SiriusXM Satellite Radio system include:

- Hardware and an introductory trial subscription term, which begins on the date of sale or lease of the vehicle.
- For a small upgrade fee, access to SiriusXM music channels, and other select channels over the Internet using any computer connected to the Internet (U.S. customers only).

For information on extended subscription terms, contact SiriusXM at 1-888-539-7474.

NOTE:

SiriusXM services require a subscription sold separately, or as a package, by Sirius XM Radio Inc. If you decide to continue service after your trial, the subscription plan you choose will automatically renew thereafter and you will be charged according to your chosen payment method at then-current rates. Fees and taxes apply. To cancel you must call SiriusXM at 1-866-635-2349. See SiriusXM Customer Agreement for complete terms at www.siriusxm.com. SiriusXM U.S. satellite and data services are available only in the 48 contiguous USA, DC and PR (with coverage limitations). SiriusXM satellite service is also available in Canada; see www.siriusxm.ca. All fees and programming subject to change. Sirius, XM and all related marks and logos are trademarks of Sirius XM Radio Inc.

SiriusXM RADIO

Using SiriusXM Satellite Radio

Your vehicle is equipped with a 3-month trial subscription to SiriusXM so you have access to over 140 channels of music, information, and entertainment programming.

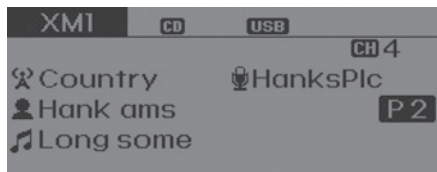

Activation

In order to extend or reactivate your Sirius Select subscription, you will need to contact SiriusXM Customer Care at 1-800-643-2112. Have your 12-digit RID (Radio Identification Number) / ESN (Electronic Serial Number) ready. To retrieve the RID / ESN, turn on the radio, press the **RADIO** key, and tune to channel zero.

Please note that the vehicle will need to be turned on, in Sirius mode, and have an unobstructed view of the sky in order for the radio to receive the activation signal.

SEEK

Press the **SEEK TRACK** key

- Shortly pressing the key (under 0.8 seconds): select previous or next channel.
 - Pressing and holding the key (over 0.8 seconds): continuously move to previous or next channel.
- *If the "Category" icon is displayed, channels are changed within the current category.

SCAN

Press the **SCAN** key

- Shortly pressing the key (under 0.8 seconds): Previews each broadcast for 10 seconds each
- *Press the **SCAN** key again to continue listening to the current frequency
- *If the "Category" icon is displayed, channels are changed within the current category.

Category

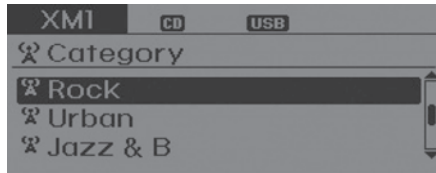

Press the  key ▶ Set through the 



- The display will indicate the category menus, highlight the category that the current channel belongs to.
- In the Category List Mode, press the  key to navigate category list.
- Press the tune knob to select the lowest channel in the highlighted category.
- *If channel is selected by selecting category, then the “CATEGORY” icon is displayed at the top of the screen.

Preset

Press the  ~  key

- Shortly pressing the key (under 0.8 seconds): Plays the frequency saved in the corresponding key.
- Pressing and holding the key (over 0.8 seconds): Pressing and holding the desired key from  ~  will save the current broadcast to the selected key and sound a BEEP.

* NOTICE - Troubleshooting



1. Antenna Error

If this message is displayed, the antenna or antenna cable is broken or unplugged. Please consult with your Hyundai dealership.





2. No Signal

If this message is displayed, it means that the antenna is covered and that the SiriusXM Satellite Radio signal is not available. Ensure the antenna is uncovered and has a clear view of the sky.

Tune

- Rotate  : Changes the channel number or scrolls category list.
- Press  : Selects the menu.

Menu

Select category menu through the  ▶ Press the  key ▶ Select  through the  knob or  key

Info (Information)

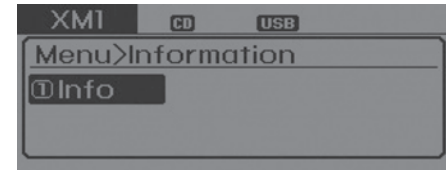

Displays the Artist/Song info of the current song.

BASIC METHOD OF USE : Audio CD / MP3 CD / USB / iPod® / My Music

Press the **MEDIA** key to change the mode in order of CD → USB(iPod®) → AUX → My Music → BT Audio.

The folder/file name is displayed on the screen.

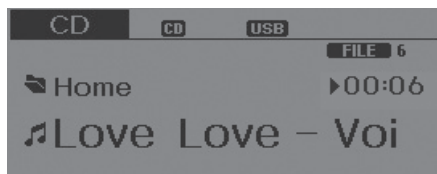

*The CD is automatically played when a CD is inserted.

*The USB music is automatically played when a USB is connected.

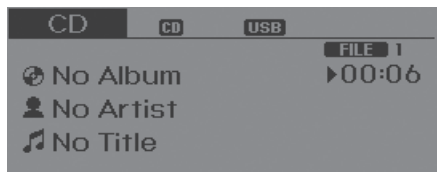

Repeat

While song (file) is playing ▶ **1** (RPT) key

Audio CD, MP3 CD, USB, iPod®, My Music mode: RPT on screen

- To repeat one song (Shortly pressing the key (under 0.8 seconds)): Repeats the current song.

MP3 CD, USB mode: FLD.RPT on screen

- To repeat folder (Pressing the key twice).

*Press the **1** key again to turn off repeat.

Random

While song (file) is playing ▶ **2 RDM** (RDM) key

Audio CD, iPod®, My Music mode: RDM on screen

- Random (press the key : Plays all songs in random order.

MP3 CD, USB mode: FLD.RDM on screen

- Folder Random (press the key : Plays all files within the current folder in random order.

MP3 CD, USB mode : ALL RDM on screen

- All Random (pressing twice): Plays all files in random order.

*Press the **2 RDM** key again to turn off repeat.

Changing Song/File

While song (file) is playing ▶  key

- Shortly pressing the key (under 0.8 seconds): Plays the current song from the beginning.
- *If the  key is pressed again within 1 second, the previous song is played.
- Pressing and holding the key (over 0.8 seconds): Rewinds the song.

While song (file) is playing ▶  key

- Shortly pressing the key (under 0.8 seconds): Plays the next song.
- Pressing and holding the key (over 0.8 seconds): Fast forwards the song.

Scan

While song (file) is playing ▶  key
Scans all songs for 10 seconds starting from the next song.

- *Press the  key again to turn off.
- *The SCAN function is not supported in iPod mode.

Folder Search : MP3 CD, USB Mode



While file is playing ▶  key
(Folder Up) key

- Searches the next folder.

While file is playing ▶  key
(Folder Down) key

- Searches the previous folder.
- *If a folder is selected by pressing the  TUNE knob, the first file within the selected folder will be played.

Searching Songs (File)

- Turning  TUNE knob : Searches for songs (files)
- Pressing  TUNE knob : Plays selected song (file).

MENU : Audio CD

Press the Audio CD mode **MENU** key to set the Repeat, Random, Information features.



Repeat

Press the **MENU** key ▶ Set [**1**RPT] through the **TUNE** knob or **1** key to repeat the current song.

*Press RPT again to turn off.

Random

Press the **MENU** key ▶ Set [**2**RDM] through the **TUNE** knob or **2** key to randomly play songs within the current CD.

*Press RDM again to turn off.

Information

Press the **MENU** key ▶ Set [**3**Info] through the **TUNE** knob or **3** key to display information of the current song.

*Press the **MENU** key to turn off info display.

MENU : MP3 CD / USB

Press the MP3 CD / USB mode **MENU** key to set the Repeat, Folder Random, Folder Repeat, All Random, Information, and Copy fea-



tures.

Repeat

Press the **MENU** key ▶ Set [**1**RPT] through the **TUNE** knob or **1** key to repeat the current song.

* Press RPT again to turn off.

Folder Random

Press the **MENU** key ▶ Set [**2**F.RDM] through the **TUNE** knob or **2** key to randomly play songs within the current folder.

* Press F.RDM again to turn off.

Folder Repeat

Press the **MENU** key ▶ Set [**3**F.RPT] through the **TUNE** knob or **3** key to repeat songs within the current folder.

* Press F.RPT again to turn off.

All Random

Press the **MENU** key ▶ Set [**4**A.RDM] through the **TUNE** knob or **4** key to randomly play all songs within the CD / USB.

* Press A.RDM again to turn off.

Information

Press the **MENU** key ▶ Set [**5**Info] through the **TUNE** knob or **5** key to display information of the current song.

* Press the **MENU** key to turn off info display.

Copy

Press the **MENU** key ▶ Set [**6**Copy] through the **TUNE** knob or **6** key.

- This is used to copy the current song into My Music. You can play the copied Music in My Music mode.

- * If another key is pressed while copying is in progress, a pop up asking you whether to cancel copying is displayed.

- * If another media is connected or inserted (USB, CD, iPod®, AUX) while copying is in progress, copying is canceled.

- * Music will not be played while copying is in progress.

MENU : iPod®

In iPod® mode, press the **MENU** key to set the Repeat, Random, Information and Search features.



Repeat

Press the **MENU** key ▶ Set [**1 RPT**] through the **TUNE** knob or **1 RPT** key to repeat the current song.

* Press RPT again to turn repeat off.

Random

Press the **MENU** key ▶ Set [**2 RDM**] through the **TUNE** knob or **2 RDM** key.

Plays all songs within the currently playing category in random order.

* Press RDM again to turn off.

Information

Press the **MENU** key ▶ Set [**3 Info**] through the **TUNE** knob or **3** key.

Displays information of the current song.

* Press the **MENU** key to turn off info display.

Search

Press the **MENU** key ▶ Set [**4 Search**] through the **TUNE** knob or **4** key.

Displays iPod® category list.

* Searching iPod® category is **MENU** key pressed, move to parent category.

MENU : My Music Mode

In My Music mode, press the **MENU** key to set the Repeat, Random, Information, Delete, Delete All, and Delete Selection features.



Repeat

Press the **MENU** key ▶ Set [**1 RPT**] through the **TUNE** knob or **1** key. Repeats the currently playing song.

* Press RPT again to turn repeat off.

Random

Press the **MENU** key ▶ Set [**2 RDM**] through the **TUNE** knob or **2** key.

Plays all songs within the currently playing folder in random order.

* Press RDM again to turn random off.

Information

Press the **MENU** key ▶ Set [**3**Info] through the **TUNE** knob or **3** key. Displays information of the current song.

*Press the **MENU** key to turn off info display.

Delete

Press the **MENU** key ▶ Set [**4**Delete] through the **TUNE** knob or **4** key.

- Deletes currently playing file

In the play screen, pressing delete will delete the currently playing song.

- Deletes file from list

① Select the file you wish to delete by using the **TUNE** knob.

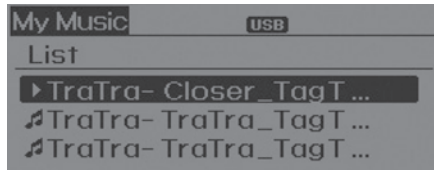

② Press the **MENU** key and select the delete menu to delete the selected file.

Delete All

Press the **MENU** key ▶ Set [**5**Del.All] through the **TUNE** knob or **5** key. Deletes all songs of My Music.

Delete Selection

Press the **MENU** key ▶ Set [**6**Del.Sel] through the **TUNE** knob or **6** key. Songs within My Music are selected and deleted.

① Select the songs you wish to delete from the list.

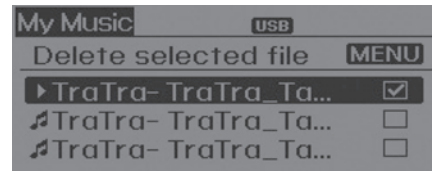

② After selecting, press the **MENU** key and select the delete menu.



AUX

AUX is used to play external MEDIA currently connected with the AUX terminal.

AUX mode will automatically start when an external device is connected to the AUX terminal.

If an external device is connected, you can also press the **MEDIA** key to change to AUX mode.

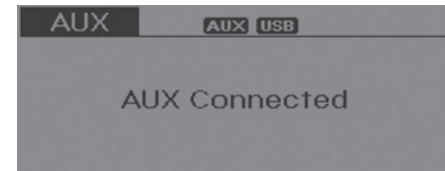

*AUX mode cannot be started unless there is an external device connected to the AUX terminal.

Bluetooth® Wireless Technology AUDIO

What is Bluetooth® Wireless Technology?

Bluetooth® Wireless Technology allows devices to be connected in a short distance, including hands-free devices, stereo headsets, wireless remote controllers, etc. For more information, visit the Bluetooth® Wireless Technology website at www.Bluetooth.com

Before using Bluetooth® Wireless Technology audio features

- Bluetooth® Wireless Technology audio may not be supported depending on the compatibility of your Bluetooth® Wireless Technology mobile phone.
- In order to use Bluetooth® Wireless Technology audio, you must first pair and connect the Bluetooth® Wireless Technology mobile phone.

- Bluetooth® Wireless Technology audio can be used only when the [Audio Streaming] of Phone is turned .

Starting Bluetooth® Wireless Technology Audio



- Press the **MEDIA** key to change the mode in order of CD → USB → AUX → My Music → BT Audio.
- If BT Audio is selected, Bluetooth® Wireless Technology audio will start playing.
- *Audio may not automatically start playing in some mobile phones.

Using the Bluetooth® Wireless Technology audio features

- Play / Stop

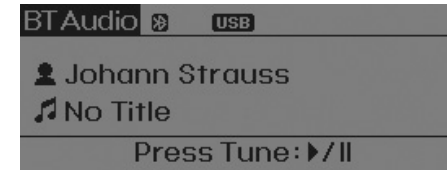
Press the  TUNE knob to play and pause the current song.



- * The title / artist info may not be supported in some mobile phone. When it is not supported, no title/ no artist will be displayed.
- Previous / Next song
Press  or  to play previous or next song.
- * The previous song / next song / play / pause functions may not be supported in some mobile phones.

PHONE (IF EQUIPPED)



Before using the *Bluetooth*® Wireless Technology phone features



- In order to use *Bluetooth*® Wireless Technology phone, you must first pair and connect the *Bluetooth*® Wireless Technology mobile phone.
- If the mobile phone is not paired or connected, it is not possible to enter Phone mode. Once a phone is paired or connected, the guidance screen will be displayed.
- If Priority is set upon vehicle ignition (IGN/ACC ON), the *Bluetooth*® Wireless Technology phone will be automatically connected. Even if you are outside, the first *Bluetooth*® Wireless Technology phone will be automatically connected once you are in the vicinity of the vehicle. If you do not want automatic *Bluetooth*® Wireless Technology phone connection, set the *Bluetooth*® Wireless Technology power to OFF.

Making a call using the Steering wheel remote controller



*The actual feature in the vehicle may differ from the illustration.

1. VOLUME key : Raises or lowers speaker volume.
2. MUTE key : Mutes the microphone during a call.
3.  key : Activates voice recognition.
4.  key : Places and transfers calls.
5.  key : Ends calls or cancels functions.

- Check call history and making call
 - Shortly press (under 0.8 seconds) the  key on the steering remote controller.
 - The call history list will be displayed on the screen.
 - Press the  key again to connect a call to the selected number.
- Redialing the most recently called number
 - Press and hold (over 0.8 seconds) the  key on the steering remote controller.
 - The most recently called number is redialed.

Bluetooth® Wireless Technology

Pairing a Bluetooth® Wireless Technology Device

What is Bluetooth® Wireless Technology Pairing?

Pairing refers to the process of synchronizing your *Bluetooth®* Wireless Technology phone or device with the car audio system for connection. Pairing is necessary to connect and use the *Bluetooth®* Wireless Technology feature.

⚠ WARNING

Driving while distracted can result in a loss of vehicle control that may lead to an accident, severe personal injury, and death. The driver's primary responsibility is in the safe and legal operation of a vehicle, and use of any handheld devices, other equipment, or vehicle systems which take the driver's eyes, attention and focus away from the safe operation of a vehicle or which are not permissible by law should never be used during operation of the vehicle.

Pairing **PHONE** key / key on the Steering Remote Controller

When No Devices have been Paired

1. Press the **PHONE** key or the  key on the steering remote controller. The following screen is displayed.

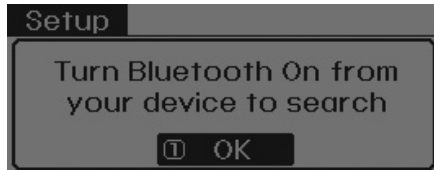

2. Select [OK] button to enter the Pair Phone screen.

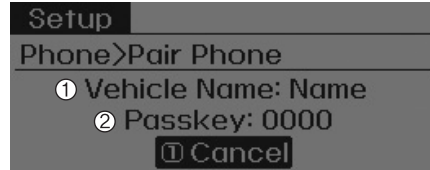

- 1) Vehicle Name : Name of device as shown when searching from your *Bluetooth*[®] Wireless Technology device
- 2) Passkey : Passkey used to pair the device
3. From your *Bluetooth*[®] Wireless Technology device (i.e. Mobile Phone), search and select your car audio system.

[Non SSP supported device]
(SSP: Secure Simple Pairing)

4. After a few moments, a screen is displayed where the passkey is entered.
Hear, enter the passkey "0000" to pair your *Bluetooth*[®] Wireless Technology device with the car audio system.

[SSP supported device]

4. After a few moments, a screen is displayed 6 digits passkey.
Hear, check the passkey on your *Bluetooth*[®] Wireless Technology device and confirm.



5. Once pairing is complete, the following screen is displayed.

Features of your vehicle

During the pairing process, make sure that all connection requests on the phone are accepted for phonebook download and to allow acceptance of all future connection requests. Visit <http://www.hyundaiusa.com/Bluetooth> for additional information on pairing your Bluetooth-enabled mobile phone, and to view a phone compatibility list.

* NOTICE



If *Bluetooth*® Wireless Technology devices are paired but none are currently connected, pressing the **PHONE** key or the  key on the steering wheel displays the following screen. Select [Pair] button to pair a new device or select [Connect] to connect a previously paired device.

Pairing through [PHONE] Setup

Press the **SETUP** key ▶ Select [Phone] ▶ Select [Pair Phone] ▶ Select  TUNE knob



1. The following steps are the same as those described in the section "When No Devices have been Paired" on the previous page.

* NOTICE

- *Bluetooth*[®] Wireless Technology features supported within the vehicle are as follows. Some features may not be supported depending on your *Bluetooth*[®] Wireless Technology device.
 - Outgoing/Incoming Handsfree calls

(Continued)

(Continued)

- Operations during a call (Switch to Private, Switch to call waiting, MIC on/off)
- Downloading Call History
- Downloading Mobile Contacts
- *Bluetooth*[®] Wireless Technology device auto connection
- Bluetooth Audio Streaming
- Up to five *Bluetooth*[®] Wireless Technology devices can be paired to the Car Handsfree system.
- Only one *Bluetooth*[®] Wireless Technology device can be connected at a time.
- Other devices cannot be paired while a *Bluetooth*[®] Wireless Technology device is connected.
- Only *Bluetooth*[®] Wireless Technology Handsfree and Bluetooth audio related features are supported.
- Bluetooth related operations are possible only within devices that support Handsfree or audio features, such as a *Bluetooth*[®] Wireless Technology mobile phone or a Bluetooth audio device.

(Continued)

(Continued)

- If a connected *Bluetooth*[®] Wireless Technology device becomes disconnected due to being out of communication range, turning the device OFF, or a *Bluetooth*[®] Wireless Technology communication error, corresponding *Bluetooth*[®] Wireless Technology devices are automatically searched and reconnected.
- If the system becomes unstable due to communication errors between the car Handsfree and the *Bluetooth*[®] Wireless Technology device, reset the device by turning off and back on again. Upon resetting *Bluetooth*[®] Wireless Technology device, the system will be restored.
- After pairing is complete, a contacts download request is sent once to the mobile phone. Some mobile phones may require confirmation upon receiving a download request, ensure your mobile phone accepts the connection. Refer to your phones user's manual for additional information regarding phone pairing and connections.

Connecting a Device

Press the **SETUP** key ▶ Select [Phone] ▶ Select [Paired Phone List]

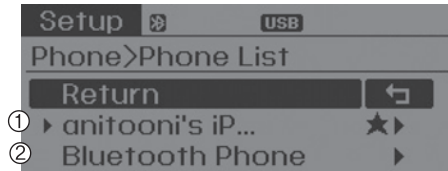

- 1) Connected Phone : Device that is currently connected
- 2) Paired Phone : Device that is paired but not connected

From the paired phone list, select the device you want to connect and select [Connect].

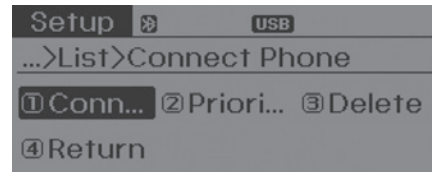

Changing Priority

What is Priority?

It is possible to pair up to five *Bluetooth*® Wireless Technology devices with the car audio system. The "Change Priority" feature is used to set the connection priority of paired phones.

Press the **SETUP** key ▶ Select [Phone] ▶ Select [Paired Phone List]

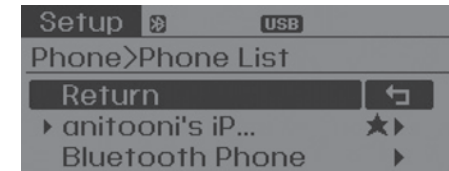

From the paired phone list, select the phone you want to switch to the highest priority, then select [Change Priority] button from the Menu. The selected device will be changed to the highest priority.

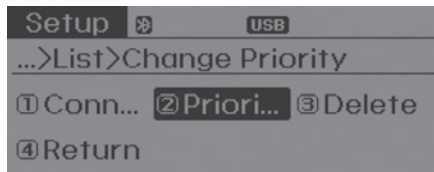

* NOTICE

Priority icon will be displayed when the selected phone is set as a priority phone.

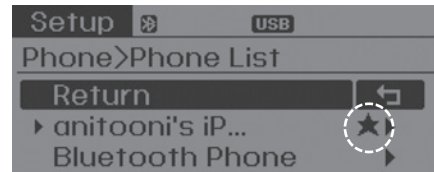

Disconnecting a Device

Press the **SETUP** key ▶ Select [Phone] ▶ Select [Paired Phone List]



From the paired phone list, select the currently connected device and select [Disconnect] button.

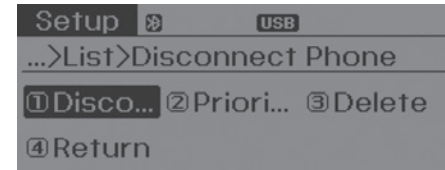

Deleting a Device

Press the **SETUP** key ▶ Select [Phone] ▶ Select [Paired Phone List]

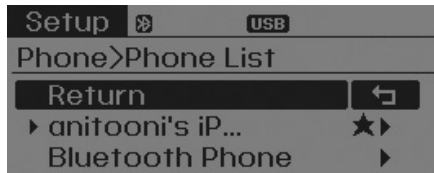

From the paired phone list, select the device you want to delete and select [Delete] button.

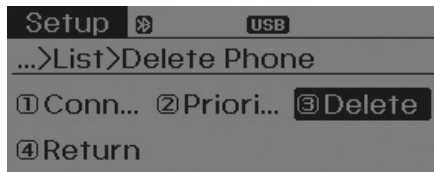

* NOTICE

- When deleting the currently connected device, the device will automatically be disconnected to proceed with the deleting process.
- If a paired *Bluetooth*® Wireless Technology device is deleted, the device's call history and contacts data will also be deleted.
- To re-use a deleted device, you must pair the device again.

USING *Bluetooth*[®] WIRELESS TECHNOLOGY (IF EQUIPPED)

Phone Menu Screen

Phone Menus

With a *Bluetooth*[®] Wireless Technology device connected, press the **PHONE** key to display the Phone menu screen.



- 1) Favorite : Up to 20 frequently used contacts saved for easy access
- 2) Call History : Device the call history list screen
- 3) Contacts : Displays the Contacts list screen
- 4) Setup : Displays Phone related settings.

* NOTICE

- If you select the [Call History] button but there is no call history data, a prompt is displayed which asks to download call history data.
- If you select the [Contacts] button but there is no contacts data stored, a prompt is displayed which asks to download contacts data.
- This feature may not be supported in some mobile phones. For more information on download support, refer to your mobile phone user's manual.

Answering Calls

Answering a Call

Answering a call with a *Bluetooth*[®] Wireless Technology device connected will display the following screen.

To accept the call, press  key on the steering wheel while the call is incoming.

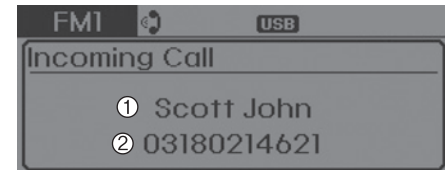

- 1) Caller : Displays the other party's name when the incoming caller is saved within your contacts
- 2) Incoming Number : Displays the incoming number

* NOTICE

- When an incoming call pop-up is displayed, most Audio and SETUP mode features are disabled. Only the call volume will operate.
- The telephone number may not be properly displayed in some mobile phones.

Favorites

Press the **PHONE** key ▶ Select [Favorites]



- 1) Saved favorite contact : Connects call upon selection
- 2) To add favorite : Downloaded contacts be saved as favorite.

* NOTICE

- To save Favorite, contacts should be downloaded.
- Contact saved in Favorites will not be automatically updated if the contact has been updated in the phone. To update Favorites, delete the Favorite and create a new Favorite.

Call History

Press the **PHONE** key ▶ Select [Call History]



A list of incoming, outgoing and missed calls is displayed.

- Call history may not be saved in the call history list in some mobile phones.
- Calls received with hidden caller ID will not be saved in the call history list.
- Calling through the call history is not possible when there is no call history stored or a *Bluetooth*® Wireless Technology phone is not connected.
- Up to 50 received, dialed and missed calls are stored in Call History.
- Time of received/dialed calls and call time information are not saved.

Contacts

Press the **PHONE** key ▶ Select [Contacts]

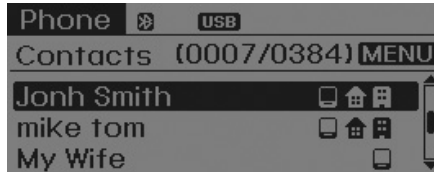

The list of saved phone book entries is displayed.

NOTE:

Find a contact in an alphabetical order, press the **MENU** key.

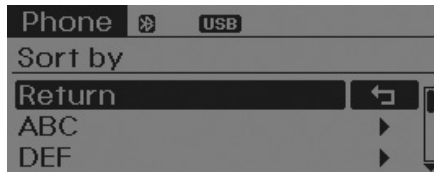

* NOTICE

- Up to 1,000 contacts saved in your *Bluetooth*® Wireless Technology phone can be downloaded into the car contacts. Contacts that have been downloaded to the car cannot be edited or deleted on the phone.
- Mobile phone contacts are managed separately for each paired *Bluetooth*® Wireless Technology device (max 5 devices x 1,000 contacts each). Previously downloaded data is maintained even if the *Bluetooth*® Wireless Technology device has been disconnected. (However, the contacts and call history saved to the phone will be deleted if a paired phone is deleted.)
- It is possible to download contacts during Bluetooth streaming audio.
- When downloading contacts, the icon will be displayed within the status bar.

(Continued)

(Continued)

- It is not possible to begin downloading a contact list when the contact download feature has been turned off within the *Bluetooth*® Wireless Technology device. In addition, some devices may require device authorization upon attempting to download contacts. If downloading does not normally occur, check the *Bluetooth*® Wireless Technology device settings or the screen state.
- The contacts download feature may not be supported in some mobile phones. For more information of supported *Bluetooth*® devices and function support, refer to your phone's user manual.

Bluetooth® Wireless Technology Setting

The *Bluetooth*® word mark and logos are registered trademarks owned by Bluetooth SIG, Inc. and any use of such marks by Hyundai is under license. Other trademarks and trade names are those of their respective owners. A *Bluetooth*® enabled cell phone is required to use *Bluetooth*® Wireless Technology.

⚠ WARNING

Driving while distracted can result in a loss of vehicle control that may lead to an accident, severe personal injury, and death. The driver's primary responsibility is in the safe and legal operation of a vehicle, and use of any handheld devices, other equipment, or vehicle systems which take the driver's eyes, attention and focus away from the safe operation of a vehicle or which are not permissible by law should never be used during operation of the vehicle.

Pairing a New Device

Press the **SETUP** key ▶ Select [Phone] ▶ Select [Pair Phone]



Bluetooth® Wireless Technology devices can be paired with the audio system.

For more information, refer to the "Pairing through Phone Setup" section within *Bluetooth*® Wireless Technology.

Viewing Paired Phone List

Press the **SETUP** key ▶ Select [Phone] ▶ Select [Paired Phone List]



This feature is used to view mobile phones that have been paired with the audio system. Upon selecting a paired phone, the setup menu is displayed.

For more information, refer to the "Setting *Bluetooth*® Wireless Technology Connection" section within *Bluetooth*® Wireless Technology.

- 1) Connect/Disconnect Phone : Connect/ disconnects currently selected phone
- 2) Change Priority : Sets currently selected phone to highest connection priority
- 3) Delete : Deletes the currently selected phone
- 4) Return : Moves to the previous screen

*** NOTICE BEFORE DOWNLOADING CONTACTS**

- Only contacts within connected phones can be downloaded. Also check to see that your mobile phone supports the download feature.
- To learn more about whether your mobile phone supports contacts downloads, refer to your mobile phone user's manual.
- The contacts for only the connected phone can be downloaded.

Downloading Contacts

Press the **SETUP** key ▶ Select [Phone] ▶ Select [Contacts Download]



As the contacts are downloaded from the mobile phone, a download progress bar is displayed.

*** NOTICE**

- Upon downloading phone contacts, the previous corresponding data is deleted.
- This feature may not be supported in some mobile phones.
- Voice Recognition may not operate while contacts are being downloaded.

Outgoing Volume

Press the **SETUP** key ▶ Select [Phone] ▶ Select [Outgoing Volume]

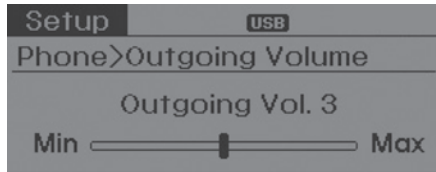

Use **TUNE** knob to adjust the outgoing volume level.

* NOTICE

While on a call, the volume can be changed by using the **SEEK TRACK** key.

Turning Bluetooth System Off

Press the **SETUP** key ▶ Select [Phone] ▶ Select [Bluetooth System Off]

Once *Bluetooth*® Wireless Technology is turned off, *Bluetooth*® Wireless Technology related features will not be supported within the audio system.

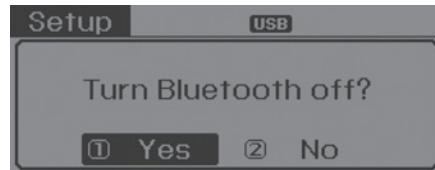
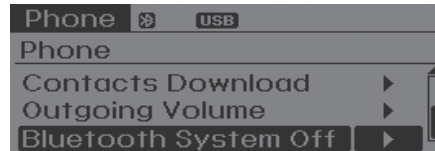

* NOTICE

To turn *Bluetooth*® Wireless Technology back on, go to **SETUP** ▶ [Phone] and select "Yes".

VOICE RECOGNITION

Using Voice Recognition

Starting Voice Recognition

Shortly press the  key on the steering wheel. Say a command.

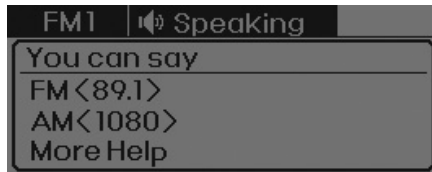

If prompt feedback is in [ON], then the system will say "Please say a command after the beep (BEEP)"

- If prompt feedback is in [OFF] mode, then the system will only say "(BEEP)"
- To change Prompt Feedback [On]/[Off], go to **SETUP** ▶ [System] ▶ [Prompt Feedback]

* NOTICE

For proper recognition, say the command after the voice instruction and beep tone.

Contact List Best Practices

- 1) Do not store single-name entries (e.g., "Bob", "Mom", "Kim", etc.). Instead, always use full names (including first and last names) for all contacts (e.g., use "Jacob Stevenson" instead of "Dad").
- 2) Do not use abbreviations (i.e., use "Lieutenant" instead of "Lt." or "Sergeant" instead of "Sgt.>").
- 3) Do not use acronyms (i.e., use "County Finance Department" instead of "CFD").
- 4) Do not use special characters (e.g., "@", "hyphen -", "asterisk **", "ampersand &").
- 5) If a name is not recognized from the contact list, change it to a more descriptive name (e.g., use "Grandpa Joseph" instead of "Pa Joe").

Skipping Prompt Messages

While prompt message is being stated ▶ Shortly press the  key on the steering remote controller

The prompt message is immediately ended and the beep tone will sound. After the "beep", say the voice command.

Re-starting Voice Recognition

While system waits for a command ▶ Shortly press the  key on the steering remote controller

The command wait state is immediately ended and the beep tone will sound. After the "beep", say the voice command.

ENDING VOICE RECOGNITION

While Voice Recognition is operating
▶ Press and hold the  key on the steering remote controller

* NOTICE

- While using voice command, pressing any steering wheel control or a different key will end voice command.
- When the system is waiting for a voice command, say “cancel” or “end” to end voice command.
- When the system is waiting for a voice command, press and hold the  key on the steering wheel to end voice command.

Voice Recognition and Phone Contact Tips:

The Hyundai Voice Recognition System may have difficulty understanding some accents or uncommon names.

When using Voice Recognition to place a call, speak in a moderate tone, with clear pronunciation To maximize the use of Voice Recognition, consider these guidelines when storing contacts:

- Do not store single-name entries (e.g., “Bob”, “Mom”, etc.). Instead, always use full names (including first and last names) for these contacts
- Do not use special characters (e.g., '@', '-', '*', '&', etc.)
- Do not use abbreviations (i.e., use “Lieutenant” instead of “Lt.”) or acronyms (i.e., use “County Finance Department” instead of “C. F. D.”; Be sure to say the name exactly as it is entered in the contacts list

Illustration on using voice commands

- Starting voice command.

Shortly pressing the  key (under 0.8 seconds):

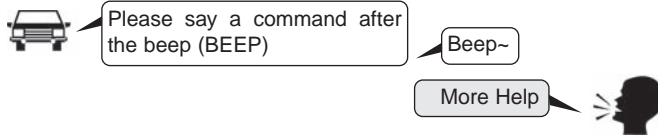

More Help
 Here are some examples of mode commands.
 You can say a radio type like 'FM', 'AM', or 'Satellite'.
 You can also say a media source like 'USB', 'My Music', or 'iPod'.
 Additionally, there are phone commands like "Contacts", 'Call History', or 'Dial Number'.
 You can find more detailed commands in the user's manual.
 Please say a command after the beep.

More Help
 Here are some examples of mode commands.
 You can say a radio type like 'FM', 'AM', or 'Satellite'.
 You can also say a media source like 'USB', 'My Music', or 'iPod'.
 Additionally, there are phone commands like "Contacts", 'Call History', or 'Dial Number'.
 You can find more detailed commands in the user's manual.
 Please say a command after the beep.

- Skipping Voice Recognition

Shortly pressing the  key (under 0.8 seconds):

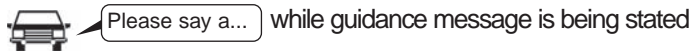

Shortly pressing the  key (under 0.8 seconds):



- Ending voice command.

Shortly pressing the  key (under 0.8 seconds):

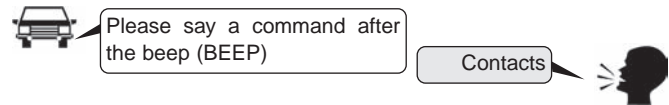

Voice Command List

- **Common Commands:** These commands can be used in most operations. (However a few commands may not be available during certain operations)

| Command | Function |
|-----------------------|---|
| More Help | Provides guidance on commands that can be used anywhere in the system. |
| Help | Provides guidance on commands that can be used within the current mode. |
| Call<Name> | Calls <Name> saved in Contacts Ex) Call "John Smith" |
| Call <Name> on Mobile | Calls <Name> to the number that is saved as "Mobile" in Contacts Ex) Call "John Smith" on Mobile |
| Call <Name> in Office | Calls <Name> to the number that is saved as "Office" in Contacts Ex) Call "John Smith" in Office |
| Call <Name> at Home | Calls <Name> to the number that is saved as "Home" in Contacts Ex) Call "John Smith" at Home |
| Call <Name> on Other | Calls <Name> to the number that is saved as "Other" in Contacts Ex) Call "John Smith" on Other |
| Phone | Provides guidance on Phone related commands. After saying this command, say "Favorites", "Call History", "Contacts" or "Dial Number" execute corresponding functions. |
| Favorites | Displays the Favorite screen. |
| Call History | Displays the Call History screen. |

| Command | Function |
|-------------------------|--|
| Contacts (Call by Name) | Displays the Contacts screen. After saying this command, say the name of a contact saved in the Contacts to automatically connect the call. |
| Dial Number | Displays the Dial number screen. After saying this command, you can say the number that you want to call. |
| Redial | Connects the last dialed call number. |
| Tutorial | Provides guidance on how to use voice recognition and Bluetooth [®] connections. |
| Radio | <ul style="list-style-type: none"> • When listening to the radio, displays the next radio screen. (FM1→FM2→AM→XM1→XM2→XM3→FM1) • When listening to a different mode, displays the most recently played radio screen. • When currently listening to the FM radio, maintains the current state. • When listening to a different mode, displays the most recently played FM screen. |
| FM1(FM One) | Displays the FM1 screen. |
| FM2(FM Two) | Displays the FM2 screen. |
| AM | Displays the AM screen. |

| Command | Function |
|-----------------------------|--|
| FM Preset 1~6 | Plays the most recently played broadcast saved in FM Preset 1~6. |
| AM Preset 1~6 | Plays the broadcast saved in AM Preset 1~6. |
| FM 87.5~107.9 | Plays the FM broadcast of the corresponding frequency. |
| AM 530~1710 | Plays the AM broadcast of the corresponding frequency. |
| XM(Satellite) | <ul style="list-style-type: none"> • When listening to the SiriusXM[®], maintains the current state. • When listening to a different mode, displays the most recently played SiriusXM[®] screen. |
| XM(Satellite)1~3 | Displays the selected SiriusXM [®] screen. |
| XM(Satellite) Channel 0~223 | Plays the selected SiriusXM [®] channel. |
| Media | Moves to the most recently played media screen. |
| CD | Plays the music saved in the CD. |
| USB | Plays USB music. |
| iPod [®] | Plays iPod music. |

| Command | Function |
|------------------------------|---|
| My Music | Plays the music saved in My Music. |
| AUX (Auxiliary) | Plays the connected external device. |
| Bluetooth [®] Audio | Plays the music saved in connected Bluetooth [®] device. |
| Mute | Mutes the sound. |
| Cancel (Exit) | Ends voice command. |

Features of your vehicle

- FM/AM radio commands: Commands available during FM, AM radio operation

| Command | Function |
|-------------|---|
| Preset 1~6 | Plays the broadcast station saved in Preset 1~6. |
| Scan | Scans receivable frequencies from the current broadcast and plays for 10 seconds each. |
| Preset Scan | Moves to the next preset from the current present and plays for 10 seconds each. |
| Information | Displays the information of the current broadcast. (This feature can be used when receiving RBDS broadcasts.) |

- Satellite radio commands: Commands that can be used while listening to Satellite Radio.

| Command | Function |
|---------------|---|
| Channel 0~255 | Play the selected Satellite Radio channel. |
| Scan | Scans receivable channels from the current broadcast and plays for 10 seconds each. |
| Preset 1~6 | Plays the broadcast saved in Preset 1~6. |
| Information | Displays the information of the current broadcast. |

- Audio CD commands: Commands available during Audio CD operation

| Command | Function |
|------------|---|
| Random | Randomly plays the tracks within the CD. |
| Random Off | Cancels random play to play tracks in sequential order. |
| Repeat | Repeats the current track. |
| Repeat Off | Cancels repeat play to play tracks in sequential order. |
| Track 1~30 | Plays the desired track number. |

- MP3 CD / USB commands: Commands available during USB and MP3 CD operation

| Command | Function |
|-----------------|--|
| Random | Randomly plays the files within the current folder. |
| Random Off | Cancels random play to play files in sequential order. |
| Repeat | Repeats the current file. |
| Repeat Off | Cancels repeat play to play files in sequential order. |
| Information | Displays the information screen of the current file. |
| Next Folder | Play the first file in the next folder |
| Previous Folder | Play the first file in the previous folder |

Features of your vehicle

- iPod® Commands: Commands available during iPod® operation

| Command | Function |
|------------|--|
| Random | Randomly plays the songs within the current category. |
| Random Off | Cancels random play to play songs in sequential order. |
| Repeat | Repeats the current song. |
| Repeat Off | Cancels repeat play to play songs in sequential order. |

- My Music Commands: Commands available during My Music operation

| Command | Function |
|------------|---|
| Random | Randomly plays all saved files. |
| Random Off | Cancels random play to play files in sequential order. |
| Repeat | Repeats the current file. |
| Repeat Off | Cancels repeat play to play files in sequential order. |
| Delete | Deletes the current file. You will bypass an additional confirmation process. |

- **Bluetooth®** Wireless Technology Audio Commands: Commands available during **Bluetooth®** Wireless Technology audio streaming from mobile phone operation Command Operation

| Command | Function |
|---------|----------------------------------|
| Play | Plays the currently paused song. |
| Pause | Pauses the current song. |

iPod® is a registered trademark of Apple Inc. iPod® mobile digital device sold separately. The **Bluetooth®** word mark and logos are registered trademarks owned by Bluetooth SIG, Inc. and any use of such marks by Hyundai is under license. **SiriusXM** services require a subscription sold separately, or as a package, by Sirius XM Radio Inc. If you decide to continue service after your trial, the subscription plan you choose will automatically renew thereafter and you will be charged according to your chosen payment method at then-current rates. Fees and taxes apply. To cancel you must call **SiriusXM** at 1-866-635-2349. See **SiriusXM** Customer Agreement for complete terms at www.siriusxm.com. **SiriusXM** U.S. satellite and data services are available only in the 48 contiguous USA, DC and PR (with coverage limitations). **SiriusXM** satellite service is also available in Canada; see www.siriusxm.ca. All fees and programming subject to change. **Sirius, XM** and all related marks and logos are trademarks of **Sirius XM Radio Inc.** **Android™** is a trademark of Google, Inc. **BlackBerry** is a registered trademark of Research In Motion Limited (RIM). All other marks, channel names and logos are the property of their respective owners. All rights reserved.

■ CD Player : AM9B0MDKN, AM9B0MDAN, AM9B1MDAN



■ CD Player : AM980MDKN, AM980MDAN



* No  Bluetooth logo will be shown if the *Bluetooth*® Wireless Technology feature is not supported.

SYSTEM CONTROLLERS AND FUNCTIONS

Audio Head Unit



1. **EJECT** (EJECT)
- Ejects the disc.

2. **RADIO**
- Convert to Radio mode.
 - Each time the key is pressed, the mode is changed in order of FM1, FM2, AM, XM1, XM2, XM3.

3. **MEDIA**
- Convert to Media Mode
 - Each time the key is pressed, the mode is changed in order of CD, USB(iPod®), AUX, My Music, BT Audio.

4. **PHONE** (for *Bluetooth*® Wireless Technology equipped model)
- Converts to Phone mode
 - ✳When a phone is not connected, the connection screen is displayed.

5. **POWER/VOL knob**
- **Power** : Press to turn power on/off.
 - **Volume** : Turn left/right to control volume.

6. **SEEK TRACK**
- When pressed shortly (under 0.8 seconds)
 - Radio mode : plays previous/next frequency.
 - Media (CD/USB/iPod®/My Music) modes : changes the track, Song(file)
 - When pressed and held (Over 0.8 seconds)
 - Radio mode : continuously changes the frequency. Upon release, plays the current frequency.
 - Media (CD/USB/iPod®/My Music) modes : rewinds or fast forwards the track or file
 - During a Handsfree call, controls the call volume.

7. **CAT FOLDER**
- SiriusXM RADIO : Category Search
 - MP3 CD/USB mode : Search Folder



8. **DISP**

- Turns the monitor display on/off.

9. **MUTE**

When the button is pressed, stopssound and "Audio Mute" is displayed on LCD.

10. **SCAN**

- Radio Mode : previews all receivable broadcasts for 5 seconds each.
- Media (CD/USB/My Music) modes : previews each song (file) for 10 seconds each.
- SiriusXM RADIO Mode : previews all receivable broadcasts for 10 seconds each.

11. **SETUP**

Converts to Setup mode.

12. **TUNE knob**

- Radio mode : turn to change broadcast frequencies.
- Media (CD/USB/iPod®/My Music) modes : turn to search tracks/channels/files.

13. **DISC-IN LED**

- LED that indicates whether a disc is inserted.

**Audio Head Unit
(For NON Bluetooth model)**



14. **FM/AM**

- Changes to FM mode.
- Each time the key is pressed, the mode changed in order of FM1 → FM2 → AM.

15. **SAT**

- Changes to SiriusXM RADIO mode.

■ CD Player : AM910MDAN



■ CD Player : AM900MDAN



* No  Bluetooth logo will be shown if the *Bluetooth*® Wireless Technology feature is not supported.

SYSTEM CONTROLLERS AND FUNCTIONS

Audio Head Unit



1. **EJECT** (EJECT)
- Ejects the disc.

2. **RADIO**

- Convert to Radio mode.
- Each time the key is pressed, the mode is changed in order of FM1, FM2, AM.

3. **MEDIA**

- Convert to Media Mode
- Each time the key is pressed, the mode is changed in order of CD, USB(iPod®), AUX, My Music, BT Audio.

4. **PHONE** (for *Bluetooth*® Wireless Technology equipped model)

- Converts to Phone mode
- ※When a phone is not connected, the connection screen is displayed.

5. **POWER/VOL knob**

- **Power** : Press to turn power on/off.
- **Volume** : Turn left/right to control volume.

6. **SEEK TRACK**

- When pressed shortly (under 0.8 seconds)
 - Radio mode : plays previous/next frequency.
 - Media (CD/USB/iPod®/My Music) modes : changes the track, Song(file)
- When pressed and held (Over 0.8 seconds)
 - Radio mode : continuously changes the frequency. Upon release, plays the current frequency.
 - Media (CD/USB/iPod®/My Music) modes : rewinds or fast forwards the track or file
 - During a Handsfree call, controls the call volume.

7. **FOLDER**

- MP3 CD/USB mode : Search Folder



8. DISP

- Turns the monitor display on/off.

9. MUTE

When the button is pressed, stopssound and "Audio Mute" is displayed on LCD.

10. SCAN

- Radio Mode : previews all receivable broadcasts for 5 seconds each.
- Media (CD/USB/My Music) modes : previews each song (file) for 10 seconds each.

11. SETUP

Converts to Setup mode.

12. TUNE knob

- Radio mode : turn to change broadcast frequencies.
- Media (CD/USB/iPod®/My Music) modes : turn to search tracks/ channels/files.

**Audio Head Unit
(For NON Bluetooth model)**



13. FM

- Changes to FM mode.
- Each time the key is pressed, the mode changed in order of FM1 → FM2.

14. AM

- Changes to AM mode.

Making a call using the Steering-wheel mounted controls



* The actual feature in the vehicle may differ from the illustration.

1. VOLUME

- Used to control volume.

2. SEEK

- When pressed shortly (under 0.8 seconds)
 - Radio mode : searches broadcast frequencies saved to presets.
 - Media(CD / USB / iPod® / My Music / BT Audio) modes : changes the track, file or chapter.
- When pressed and held (over 0.8 seconds)
 - Radio mode, automatically searches broadcast frequencies and channels
 - Media(CD / USB / iPod® / My Music) modes, rewinds or fast forwards the track or song(file)
 - BT Audio mode may not be supported in some mobile phones.

3. MUTE

- Mutes audio volume.

4. MODE

- Each time this key is pressed, the mode is changed in order of FM1 → FM2 → AM → XM1 → XM2 → XM3 → CD → USB or iPod → AUX → My Music → BT Audio
- If the media is not connected or a disc is not inserted, corresponding modes will be disabled.



5. 

- When pressed shortly
 - Starts voice recognition
 - When selecting during a voice prompt, stops the prompt and converts to voice command waiting state
- When pressed and held (over 0.8 seconds)
 - Ends voice recognition

6. 

- When pressed shortly
 - When pressed in the phone screen, displays call history screen
 - When pressed in the dial screen, makes a call
 - When pressed in the incoming call screen, answers the call
 - When pressed during call waiting, switches to waiting call (Call Waiting)

- When pressed and held (over 0.8 seconds)
 - When pressed in the *Bluetooth*[®] Wireless Technology Handsfree wait mode, redials the last call
 - When pressed during a *Bluetooth*[®] Wireless Technology Handsfree call, switches call back to mobile phone (Private)
 - When pressed while calling on the mobile phone, switches call back to *Bluetooth*[®] Wireless Technology Handsfree (Operates only when *Bluetooth*[®] Wireless Technology Handsfree is connected)

7. 

- Ends phone call

SIRIUSXM™ RADIO MODE

Features of your vehicle

Satellite radio reception

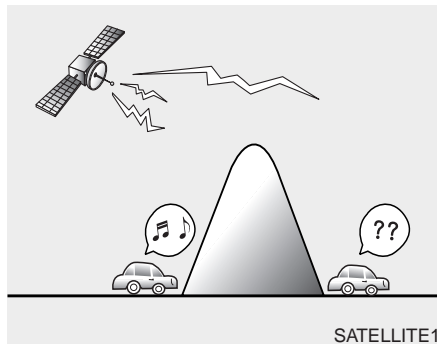

You may experience difficulties in receiving XM satellite™ radio signals in the following situations.

- If you are driving in a tunnel or a covered parking area.
- If you are driving beneath the top level of a multi-level freeway.
- If you are driving under a bridge.
- If you are driving next to a tall vehicle (such as a truck or a bus) that blocks the signal.

- If you are driving in a valley where the surrounding hills or peaks block the signal from the satellite.
- If you are driving on a mountain road where the signal is blocked by mountains.

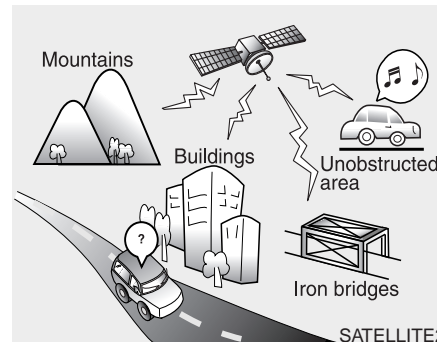

- If you are driving in an area with tall trees that block the signal (30 ft. /10m or more), for example on an road that goes through a dense forest.
- The signal can become weak in some areas that are not covered by the XM repeater network.

NOTE:

There may also be additional unforeseen circumstances leading to reception problems with the XM satellite™ radio signal.

Advisory Messages, such as 'CH Unavailable' may occur when starting XM Radio™.

SiriusXM® Satellite Radio information

Satellite Radio channels:

Enjoy SiriusXM Satellite Radio with a 3-month trial subscription to the Sirius Select package. You'll get over 140 channels, including commercial-free music, plus all your favorite sports, exclusive talk, entertainment, and a selection of premium programming. For more information and a complete list of SiriusXM channels, visit siriusxm.com in the United States, siriusxm.ca in Canada, or call SiriusXM at 1-888-539-7474.

Satellite Radio reception factors:

To receive the satellite signal, your vehicle has been equipped with a satellite radio antenna located on the roof of your vehicle. The vehicle roof provides the best location for an unobstructed, open view of the sky, a requirement of a satellite radio system. Like AM/FM, there are several factors that can affect satellite radio reception performance:

- **Antenna obstructions:** For optimal reception performance, keep the antenna clear of snow and ice build-up and keep luggage and other material as far away from the antenna as possible.
- **Terrain:** Hills, mountains, tall buildings, bridges, tunnels, freeway overpasses, parking garages, dense tree foliage and thunderstorms can interfere with your reception.

SiriusXM Satellite Radio service:

SiriusXM is a subscription-based satellite radio service that broadcasts music, sports, news and entertainment programming to radio receivers, which are available for installation in motor vehicles or factory installed, as well as for the home, portable and wireless devices, and through an Internet connection on personal computer.

Vehicles that are equipped with a factory installed SiriusXM Satellite Radio system include:

- Hardware and an introductory trial subscription term, which begins on the date of sale or lease of the vehicle.
- For a small upgrade fee, access to SiriusXM music channels, and other select channels over the Internet using any computer connected to the Internet (U.S. customers only).

For information on extended subscription terms, contact SiriusXM at 1-888-539-7474.

NOTE:

SiriusXM services require a subscription sold separately, or as a package, by Sirius XM Radio Inc. If you decide to continue service after your trial, the subscription plan you choose will automatically renew thereafter and you will be charged according to your chosen payment method at then-current rates. Fees and taxes apply. To cancel you must call SiriusXM at 1-866-635-2349. See SiriusXM Customer Agreement for complete terms at www.siriusxm.com. SiriusXM U.S. satellite and data services are available only in the 48 contiguous USA, DC and PR (with coverage limitations). SiriusXM satellite service is also available in Canada; see www.siriusxm.ca. All fees and programming subject to change. Sirius, XM and all related marks and logos are trademarks of Sirius XM Radio Inc.

SiriusXM RADIO MODE

Basic Mode Screen

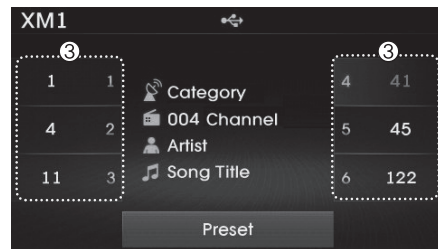
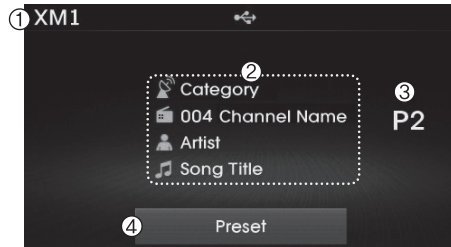

1. Mode Display
Displays currently operating mode.
2. Channel Information
Displays the category, channel number, channel name, artist and title information.
3. Preset
Displays currently playing preset number [1] ~ [6].
4. Preset Display
Displays saved presets.

Using SiriusXM Satellite Radio

Your Hyundai vehicle is equipped with a 3-month trial subscription to SiriusXM so you have access to over 140 channels of music, information, and entertainment programming.

Activation

In order to extend or reactivate your Sirius Select subscription, you will need to contact SiriusXM Customer Care at 1-800-643-2112. Have your 12-digit RID (Radio Identification Number) / ESN (Electronic Serial Number) ready. To retrieve the RID / ESN, turn on the radio, press the **RADIO** key, and tune to channel zero.

Please note that the vehicle will need to be turned on, in Sirius mode, and have an unobstructed view of the sky in order for the radio to receive the activation signal.

Using SEEK

Press the  key to play the previous/next channel.

*If the “Category” icon is displayed, channels are changed within the current category.

Using Tune

Turn the  TUNE knob to select the desired channel.

SCAN



Press the  key to scan all channels with superior reception for 10 seconds each.

Once scan is complete, the previously played channel will be restored.

During Scan, pressing the  key again will cancel the scan operation and restore the previously played channel.

If the “Category” icon is displayed, channels are changed within the current category.

Searching Categories

Select the category by using the  key and press the  TUNE knob to select.

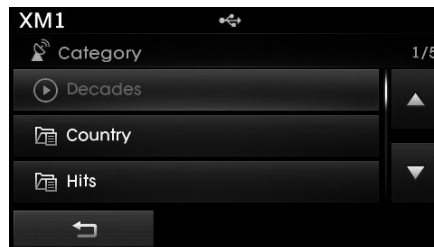

Channels for the selected category are played.

* NOTICE - Troubleshooting

1. Antenna Error

If this message is displayed, the antenna or antenna cable is broken or unplugged. Please consult with your Hyundai dealership.

2. Acquiring Signal

If this message is displayed, it means that the antenna is covered and that the SiriusXM Satellite Radio signal is not available. Ensure the antenna is uncovered and has a clear view of the sky.

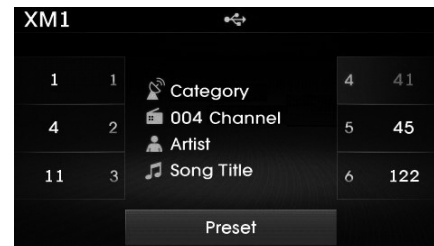

Selecting Presets/Saving Presets

Press the  button to display the broadcast information for the channel saved to each button.



Press the  ~  buttons to play the desired preset.

* NOTICE

While listening to a channel you want to save as a preset, press and hold one of the  ~  preset buttons (over 0.8 seconds) to save the current channel to the selected preset.

*** NOTICE - USING THE DISCS**

- This device has been manufactured to be compatible with software bearing the following logo marks.
- Do not clean discs with chemical solutions, such as record sprays, antistatic sprays, antistatic liquids, benzene, or thinners.
- After using a disc, put the disc back in its original case to prevent disc scratches.
- Hold discs by their edges or within the center hole to prevent damages to disc surfaces.
- Do not introduce foreign substances into the disc insert/eject slot. Introducing foreign substances could damage the device interior.
- Do not insert two discs simultaneously.
- When using CD-R/CD-RW discs, differences in disc reading and playing times may occur depending on the disc manufacturer, production method and the recording method as used by the user.

(Continued)

(Continued)

- Clean fingerprints and dust off the disc surface (coated side) with a soft cloth.
- The use of CD-R/CD-RW discs attached with labels may result in disc slot jams or difficulties in disc removal. Such discs may also result in noise while playing.
- Some CD-R/CD-RW discs may not properly operate depending on the disc manufacturer, production method and the record method as used by the user. If problems persist, trying using a different CD as continued use may result in malfunctions.
- The performance of this product may differ depending on the CD-RW Drive Software.
- Copy-protected CDs such as S-type CDs may not function in the device. DATA discs cannot be played. (However, such discs may still operate but will do so abnormally.)

(Continued)

(Continued)

- Do not use abnormally shaped discs (8cm, heart-shaped, octagon-shaped) as such discs could lead to malfunctions.
- If the disc is straddled on the disc slot without removal for 10 seconds, the disc will automatically be re-inserted into the disc player.
- Only genuine audio CDs are supported. Other discs may result in recognition failure (e.g. copy CD-R, CDs with labels)

MEDIA MODE

Pressing the **MEDIA** key will change the operating mode in order of CD → USB(iPod®) → AUX → My Music → BT Audio.

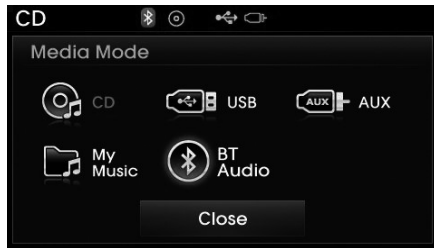

If [Mode Pop up] is turned on within **SETUP** ▶ [Display], then pressing the **MEDIA** key will display the Media Pop-up Mode screen.

Turn the **TUNE** knob to move the focus. Press the knob to select.

* NOTICE

The media mode pop up screen can be displayed only when there are two or more media modes turned on.

Title Icon

When a *Bluetooth*® Wireless Technology, iPod®, USB, or AUX device is connected or a CD is inserted, the corresponding mode icon will be displayed.



| Icon | Title |
|------|--|
| | <i>Bluetooth</i> ® Wireless Technology |
| | CD |
| | iPod® |
| | USB |
| | AUX |

AUDIO CD MODE

Basic Mode Screen



1. Mode

Displays currently operating mode.

2. Operation State

From Repeat/Random(Shuffle)/ Scan, displays the currently operating function.

3. Track Info

Displays information about the current track.

4. Play/Pause

Changes the play/pause state.

5. Play Time

Displays the current play time.

6. Info

Shows detailed information about the current track.

7. Random(Shuffle)

Turns the Random(Shuffle) feature on/off.

8. Repeat

Turns the Repeat feature on/off.

9. List

Moves to the list screen.

Using Audio CD Mode

Playing/Pausing CD Tracks

Once an audio CD is inserted, the mode will automatically start and begin playing.



While playing, press the **||** button to pause and press **▶** button to play.

* NOTICE

- Only genuine audio CDs are supported. Other discs may result in recognition failure (e.g. copy CD-R, CDs with labels)
- The artist and title information are displayed on the screen if track information is included within the audio CD.

Changing Tracks

Press the **SEEK TRACK** key to move to the previous or next track.

* NOTICE

- Pressing the **SEEK TRACK** key after the track has been playing for 2 seconds will start the current track from the beginning.
- Pressing the **SEEK TRACK** key before the track has been playing for 1 seconds will start the previous track.

Selecting from the List

Turn the **TUNE** knob left/right to search for the desired track.

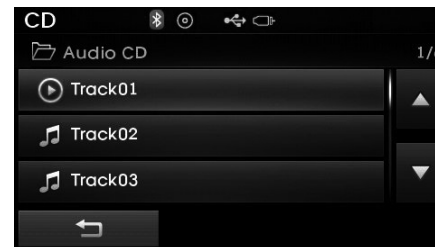

Once you find the desired track, press the **TUNE** knob to start playing.

Rewinding / Fast-forwarding Tracks

While playing, press and hold the **SEEK TRACK** key (over 0.8 seconds) to rewind or fast-forward the current track.

Scan

Press the **SCAN** key to play the first 10 seconds of each file.

Audio CD Mode Menu

Within this mode, you will have access to the Info, Random(Shuffle), Repeat and List features.



Info

Press the **Info** button to display details about the current disc.

Random(Shuffle)

Press the **Shuffle** button to play tracks in random(Shuffle) order.

Press the **Shuffle** button again to turn the Random(Shuffle) feature off.

- Random(Shuffle): Plays all tracks in random(Shuffle) order.

Repeat

Press the **Repeat** button to repeat the current track. Press the button again to turn the repeat feature off.

- Repeat : Repeats the current track.

List

Press the **List** button to display the track list screen.

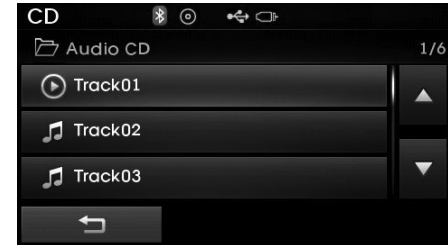

Turn the **TUNE** knob left/right to search for tracks. Once the desired track is displayed, press the knob to select and play.

MP3 CD MODE

Basic Mode Screen



1. Mode

Displays currently operating mode.

2. Operation State

From Repeat/Random(Shuffle)/ Scan, displays the currently operating function.

3. File Index

Displays the current file number.

4. File Info

Displays information about the current file.

5. Play/Pause

Changes the play/pause state.

6. Play Time

Displays the current play time.

7. Info

Shows detailed information about the current file.

8. Random(Shuffle)

Turns the Random(Shuffle) feature on/off.

9. Repeat

Turns the Repeat feature on/off.

10. Copy

Copies the current file into My Music

11. List

Moves to the list screen.

Using MP3 CD Mode

Playing/Pausing MP3 Files

Once an MP3 disc is inserted the mode will automatically start and being playing.



While playing, press the **||** button to pause and press **▶** button to play.



*** NOTICE**

If there are numerous files and folders within the disc, reading time could take more than 10 seconds and the list may not be displayed or song searches may not operate. Once loading is complete, try again.

Changing Files

Press the  key to move to the previous or next file.

* NOTICE

- Pressing the  key after the file has been playing for 2 seconds will start the current file from the beginning.
- Pressing the  key before the file has been playing for 1 seconds will start the previous file.

Selecting from the List

Turn the  knob left/right to search for the desired file.



Once you find the desired file, press the  knob to start playing.

Rewinding / Fast-forwarding Files

While playing, press and hold the  key (over 0.8 seconds) to rewind or fast-forward the current file.

Scan

Press the  key to play the first 10 seconds of each file.

Searching Folders

Press the  key to select and search folders.

Once the desired folder is displayed, press the  knob to select.

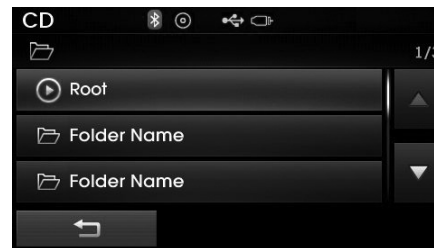

The first file within the selected folder will begin playing.

MP3 CD Mode Menu

Within this mode, you will have access to the Info, Random(Shuffle), Repeat, Copy and List features.



Info

Press the  button to display details about the current file.

* NOTICE

- When the 'Folder File' option is set as the default display within Display setup, the album/artist/file information are displayed as detailed file information.
- When the 'Album Artist Song' option is set as the default display, the folder name/file name are displayed as detailed file information.
- The title, artist and album info are displayed only when such information are recorded within the MP3 file ID3 tag.

Random(Shuffle)

Press the **Shuffle** button to play files in random(Shuffle) order.

Each time the button is pressed, the feature changes in order of Random (Shuffle) Folder → Random (Shuffle) All → Off.

- Random(Shuffle) Folder : Plays all files within the current folder in Random (Shuffle) order.
- Random(Shuffle) All : Plays all files in Random(Shuffle) order.

Repeat

Press the **Repeat** button to repeat the current file or folder.

Each time the button is pressed, the feature changes in order of Repeat → Repeat Folder → Off.

- Repeat: Repeats the current file.
- Repeat Folder: Repeats all files within the current Folder.

Copying Files

Press the **Copy** button to copy the current file into My Music.

* NOTICE

Selecting another feature during copying will display a pop-up asking whether you wish to cancel copying. To cancel, select 'Yes'.

List

Press the **List** button to display the file list screen.



Turn the **TUNE** knob left/right to search for files. Once the desired file is displayed, press the knob to select and play.

*** NOTICE - USING THE USB DEVICE**

- Connect the USB device after turning on the engine. The USB device may become damaged if it is already connected when the ignition is turned on. The USB device may not operate properly if the car ignition is turned on or off with the USB device connected.
- Heed caution to static electricity when connecting/disconnecting USB devices.
- Encoded MP3 Players will not be recognized when connected as an external device.
- When connecting an external USB device, the device may not properly recognize the USB is in some states.
- Only products formatted with byte/sectors under 64Kbyte will be recognized.
- This device recognizes USB devices formatted in FAT 12/16/32 file formats. This device does not recognize files in NTFS file format.

(Continued)

(Continued)

- Some USB devices may not be supported due to compatibility issues.
- Avoid contact between the USB connector with bodily parts or foreign objects.
- Repeated connecting/disconnecting of USB devices within short periods of time may result in product malfunction.
- A strange noise may occur when disconnecting the USB.
- Make sure to connect/disconnect external USB devices with the audio power turned off.
- The amount of time required to recognize the USB device may differ depending on the type, size or file formats stored in the USB. Such differences in time are not indications of malfunctions.
- The device only supports USB devices used to play music files.
- USB images and videos are not supported.

(Continued)

(Continued)

- Do not use the USB I/F to charge batteries or USB accessories that generate heat. Such acts may lead to worsened performance or damage to the device.
- The device may not recognize the USB device if separately purchased USB hubs and extension cables are being used. Connect the USB directly with the multimedia terminal of the vehicle.
- When using mass storage USB devices with separate logical drives, only files saved to the root drive can be played.
- Files may not properly operate if application programs are installed to the USBs.
- The device may not operate normally if MP3 Players, cellular phones, digital cameras, or other electronic devices (USB devices not recognized as portable disk drives) are connected with the device.

(Continued)

- Charging through the USB may not work for some mobile devices.
- The device may not support normal operation when using a USB memory type besides (Metal Cover Type) USB Memory.
- The device may not support normal operation when using formats such as HDD Type, CF, or SD Memory.
- The device will not support files locked by DRM (Digital Rights Management.)
- USB memory sticks used by connecting an Adaptor (SD Type or CF Type) may not be properly recognized.
- The device may not operate properly when using USB HDDs or USBs subject to connection failures caused by vehicle vibrations. (e.g. i-stick type)

(Continued)

(Continued)

- Avoid use of USB memory products that can also be used as key chains or mobile phone accessories. Use of such products may cause damage to the USB jack.
- Connecting an MP3 device or phone through various channels, such as AUX/BT or Audio/ USB mode may result in pop noises or abnormal operation.



USB MODE

Basic Mode Screen

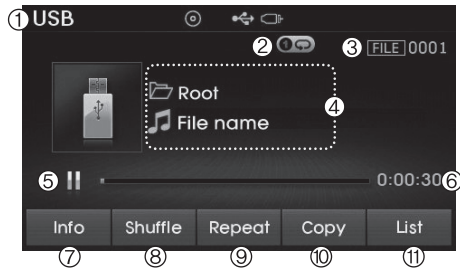

1. Mode

Displays currently operating mode.

2. Operation State

From Repeat/Random(Shuffle)/Scan, displays the currently operating function.

3. File Index

Displays the current file number.

4. File Info

Displays information about the current file.

5. Play/Pause

Changes the play/pause state.

6. Play Time

Displays the current play time.

7. Info

Displays detailed information for the current file.

8. Random(Shuffle)

Turns the Random(Shuffle) feature on/off.

9. Repeat

Turns the Repeat feature on/off.

10. Copy

Copies the current file into My Music.

11. List

Moves to the list screen.

Using USB Mode

Playing/Pausing USB Files

Once a USB is connected, the mode will automatically start and begin playing a USB file.



While playing, press the **||** button to pause and press **▶** button to play.

* NOTICE

- Loading may require additional time if there are many files and folders within the USB and result in faulty list display or file searching. Normal operations will resume once loading is complete.
- The device may not support normal operation when using a USB memory type besides (Metal Cover Type) USB Memory.

Changing Files

Press the **SEEK TRACK** keys to move to the previous or next file.

* NOTICE

- Pressing the **SEEK TRACK** key after the file has been playing for 2 seconds will start the current file from the beginning.
- Pressing the **SEEK TRACK** key before the file has been playing for 1 seconds will start the previous file.

Selecting from the List

Turn the **TUNE** knob left/right to search for the desired file.



Once you find the desired file, press the **TUNE** knob to start playing.

Rewinding / Fast-forwarding Files

While playing, press and hold the **SEEK TRACK** key (over 0.8 seconds) to rewind or fast-forward the current file.

Scan

Press the **SCAN** key to play the first 10 seconds of each file.

Searching Folders

Press the  key to select and search folders.

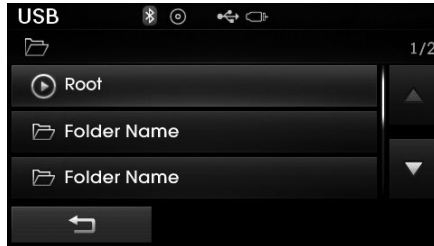

Once the desired folder is displayed, press the  TUNE knob to select.

The first file within the selected folder will begin playing.

USB Mode Menu

Within this mode, you will have access to the Info, Random(Shuffle), Repeat, Copy and List features.



Info

Press the  button to display details about the current file.

* NOTICE

- When the 'Folder File' option is set as the default display within Display setup, the album/artist/file information are displayed as detailed file information.
- When the 'Album Artist Song' option is set as the default display, the folder name/file name are displayed as detailed file information.
- The title, artist and album info are displayed only when such information are recorded within the MP3 file ID3 tag.

Random (Shuffle)

Press the  button to play files in random(Shuffle) order.

Each time the button is pressed, the feature changes in order of Random(Shuffle) Folder→Random(Shuffle) All→Off.

- Random(Shuffle) Folder : Plays the files in the current folder in random(Shuffle) order.
- Random(Shuffle) All : Plays all files in random(Shuffle) order.

Repeat

Press the **Repeat** button to repeat the current file or folder.

Each time the button is pressed, the feature changes in order of Repeat → Repeat Folder → Off.

- Repeat (Icon) : Repeats the current file.
- Repeat Folder (Icon) : Repeats all files within the current folder.

Copying Files

Press the **Copy** button to copy the current file into My Music.

*** NOTICE**

Selecting another feature during copying will display a pop-up asking whether you wish to cancel copying. To cancel, select 'Yes'.

List

Press the **List** button to display the file list screen.

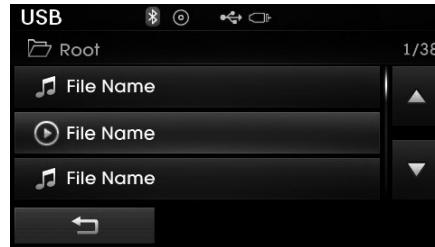

Turn the **ⓄTUNE** knob left/right to search for files. Once the desired file is displayed, press the knob to select and play.

*** NOTICE - USING THE iPod®
DEVICE**

- iPod® is a registered trademark of Apple Inc.
- In order to use the iPod® while operating the keys, you must use a dedicated iPod® cable. (the cable that is supplied when purchasing iPod®/iPhone® products)
- If the iPod® is connected to the vehicle while it is playing, a high pitch sound could occur for approximately 1-2 seconds immediately after connecting. If possible, connect the iPod to the vehicle with the iPod® stopped/paused.
- During ACC ON state, connecting the iPod® through the iPod® cable will charge the iPod® through the car audio system.
- When connecting with the iPod® cable, make sure to fully insert the jack to prevent communication interference.

(Continued)

(Continued)

- When the EQ features of an external device, such as the iPod®, and the audio system are both active, EQ effects could overlap and cause sound deterioration and distortion. Whenever possible, turn off the EQ feature within the external device upon use by connecting with the audio system.
- Noise may occur when an iPod® or AUX device is connected. When such devices are not being used, disconnect the device for storage.
- When the iPod® or AUX device power is connected to the power jack, playing the external device may result in noise. In such cases, disconnect the power connection before use.
- Skipping or improper operation may occur depending on the characteristics of your iPod®/Phone® device.

(Continued)

(Continued)

- If your iPhone® is connected to both the *Bluetooth®* Wireless Technology and USB, the sound may not be properly played. In your iPhone®, select the Dock connector or *Bluetooth®* Wireless Technology to change the sound output (source).
- iPod mode cannot be operated when the iPod® cannot be recognized due to versions that do not support communication protocols.
- For fifth generation iPod® Nano devices, the iPod® may not be recognized when the battery level is low. Please charge the iPod® for use.
- Search/play orders shown within the iPod® device may differ with the orders shown within the audio system.
- If the iPod® malfunctions due to an iPod® device defect, reset the iPod® and try again. (To learn more, refer to your iPod® manual)

(Continued)

(Continued)

- Some iPod®s may not sync with the System depending on its version. If the Media is removed before the Media is recognized, then the system may not properly restore the previously operated mode. (iPad® charging is not supported.)

iPod® Mode

Basic Mode Screen



1. Mode

Displays currently operating mode.

2. Operation State

From Repeat/Random(Shuffle), displays the currently operating function.

3. Song Index

Displays the current song/total number of songs.

4. Song Info

Displays information about the current song.

5. Play/Pause

Changes the play/pause state.

6. Play Time

Displays the current play time.

7. Random(Shuffle)

Turns the Random(Shuffle) feature on/off.

8. Repeat

Turns the Repeat feature on/off.

9. List



Moves to the list screen.

Using iPod® Mode

Playing/Pausing iPod® Songs

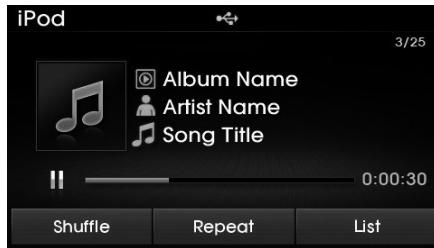
Once an iPod® is connected, the mode will automatically start and begin playing an iPod® song.



While playing, press the  button to pause and press  button to play.



* NOTICE

iPod®s with unsupported communication protocols may not properly operate in the audio system.

Changing Songs

Press the  key to move to the previous or next song.

* NOTICE

- Pressing the  key after the song has been playing for 2 seconds will start the current song from the beginning.
- Pressing the  key before the song has been playing for 1 second will start the previous song.
- Slight time differences may exist depending your iPod® product.

Rewinding / Fast-forwarding Songs

While playing, press and hold the  key (over 0.8 seconds) to rewind or fast-forward the current song.

Searching Categories

Turn the  TUNE knob left/right to search for the desired category.

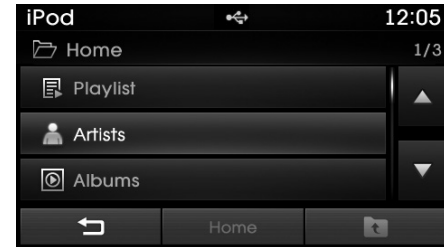

Once you find the desired category, press the  TUNE knob to select and play.



* NOTICE

There are eight categories that can be searched, including Playlists, Artists, Albums, Genres, Songs, Composers, Audiobooks and Podcasts.

Category Menu

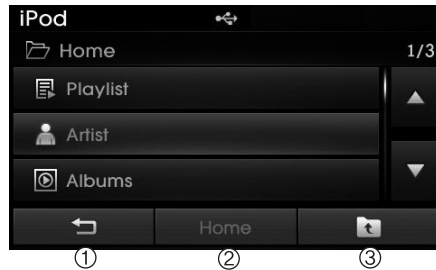
Within the iPod® Category menu, you will have access to the , Home, and  features.



1.  : Displays the play screen
2. Home : Moves to the iPod® root category screen
3.  : Moves to the previous category

* NOTICE

- If the search mode is accessed while playing a song, the most recently searched category is displayed.
- Search steps upon initial connection may differ depending on the type of iPod® device.

iPod® Mode Menu

Within this mode, you will have access to the Random(Shuffle), Repeat and List features.



Random(Shuffle)

Press the **Shuffle** button to play songs in random(Shuffle) order.

- Random(Shuffle) All : Plays all songs in Random(Shuffle) order.

Repeat

Press the **Repeat** button to repeat the current song. Press the button again to turn the repeat feature off.

- Repeat : Repeats the current song

List

Press the **List** button to display the Category Menu.

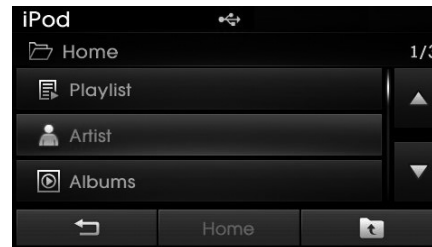

Turn the **TUNE** knob left/right to search for the desired category.

Once you find the desired category, press the **TUNE** knob to select and play.

AUX MODE

Using AUX Mode

Press the **MEDIA** key ▶ Select [AUX]

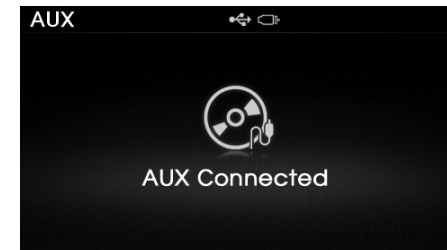

An external device can be connected to play music.

Connecting an External Device

External audio players (Camcorders, car VCR, etc.) can be played through a dedicated cable.

* NOTICE

- **If an external device connector is connected with the AUX terminal, then AUX mode will automatically operate. Once the connector is disconnected, the previous mode will be restored.**
- **AUX mode can be used only when an external audio player (camcorder, car VCR, etc.) has been connected.**
- **The AUX volume can be controlled separately from other audio modes.**
- **Connecting a connector jack to the AUX terminal without an external device will convert the system to AUX mode, but only output noise. When an external device is not being used, also remove the connector jack.**
- **When the external device power is connected to the power jack, playing the external device may output noise. In such cases, disconnect the power connection before use.**
- **Fully insert the AUX cable to the AUX jack upon use.**

MY MUSIC MODE

Basic Mode Screen



1. Mode

Displays currently operating mode.

2. Operation State

From Repeat/Random(Shuffle)/ Scan, displays the currently operating function.

3. File Index

Displays the current file/total number of files.

4. File Info

Displays information about the current file.

5. Play/Pause

Changes the play/pause state.

6. Play Time

Displays the current play time.

7. Info

Displays detailed information for the current file.

8. Random(Shuffle)

Turns the Random(Shuffle) feature on/off.

9. Repeat

Turns the Repeat feature on/off.

10. Delete

Deletes the current file.

11. List

Moves to the list screen.

Using My Music Mode

Playing/Pausing My Music Files

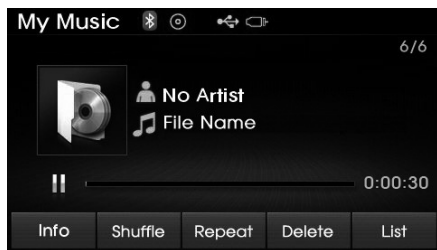

While playing, press the **||** button to pause and press **▶** button to play.

* NOTICE

If there are no files saved within My Music, the **My Music** button will be disabled.

Changing Files

Press the **SEEK TRACK** key to move to the previous or next file.

* NOTICE

- Pressing the **SEEK TRACK** key after the file has been playing for 2 seconds will start the current file from the beginning.
- Pressing the **SEEK TRACK** key before the file has been playing for 1 seconds will start the previous file.

Selecting from the List

Turn the **TUNE** knob left/right to search for the desired file.

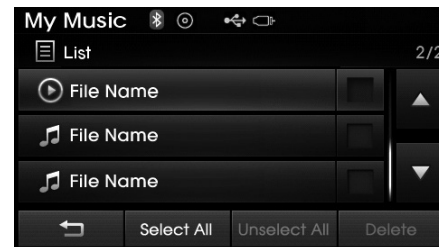

Once you find the desired file, press the **TUNE** knob to start playing.

Rewinding / Fast-forwarding Files

While playing, press and hold the **SEEK TRACK** key (over 0.8 seconds) to rewind or fast-forward the current file.

Scan

Press the **SCAN** key to play the first 10 seconds of each file.

My Music Mode Menu

Within this mode, you will have access to the Info, Random(Shuffle), Repeat, Delete and List features.

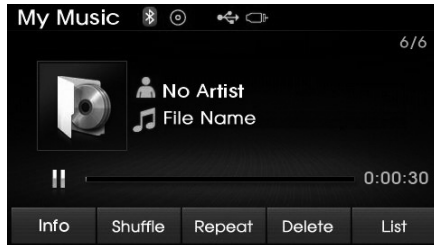

Info

Press the **Info** button to display details about the current file.

* NOTICE

The title, artist and album info are displayed only when such information is recorded within the MP3 file ID3 tag.

Random

Press the **Shuffle** button to play files in random order. Press the button again to turn the Random feature off.

Repeat

Press the **Repeat** button to repeat the current song. Press the button again to turn the repeat feature off.

Deleting Files

Press the **Delete** button to delete the current file.

List

Press the **List** button to display the file list screen.

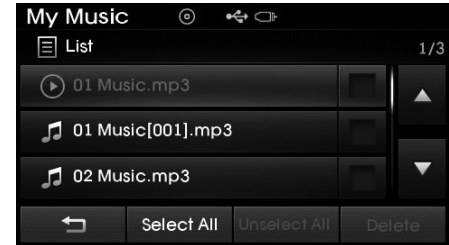

Turn the **TUNE** knob left/right to search for files. Once the desired file is displayed, press the knob to select and play.

List Menu

From the List screen, it is possible to delete files you previously saved into My Music.

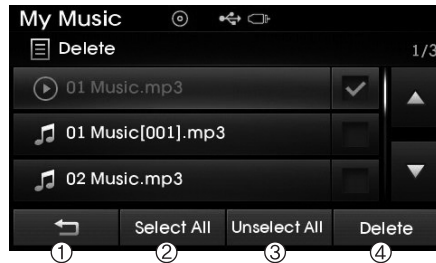

Press the **Select All** button or individually select the files you want to delete. Once files are selected, the **Unselect All** button and **Delete** buttons will be enabled.

- 1) **←** : Moves to the previous screen
- 2) **Select All**: Selects all files
- 3) **Unselect All**: Deselects all selected files
- 4) **Delete**: Deletes selected files

After selecting the files you want to delete, press the **Delete** button to delete the selected files.

* NOTICE

- If there is memory available, up to 6,000 files can be saved.
- Identical files cannot be copied more than 1,000 times.
- To check memory information, go to **SETUP** ▶ [System] ▶ [Memory Information]

*** NOTICE - USING THE
Bluetooth® Wireless
Technology Audio Mode**

- *Bluetooth*® Wireless Technology Audio Mode can be used only when a *Bluetooth*® Wireless Technology phone has been connected.
- *Bluetooth*® Wireless Technology Audio Mode will not be available when connecting mobile phones that do not support this feature.
- While *Bluetooth*® Wireless Technology Audio is playing, if the *Bluetooth*® Wireless Technology phone is connected, then the music will also stop.
- Moving the Track up/down while playing *Bluetooth*® Wireless Technology audio mode may result in pop noises in some mobile phones.
- *Bluetooth*® Wireless Technology streaming audio may not be supported in some mobile phones.

(Continued)

(Continued)

- When returning to *Bluetooth*® Wireless Technology Audio mode after ending a call, the mode may not automatically restart in some mobile phones.
- Receiving an incoming call or making an outgoing call while playing *Bluetooth*® Wireless Technology Audio may result in audio interference.





Bluetooth® Wireless Technology AUDIO MODE (IF EQUIPPED)

Using Bluetooth® Wireless Technology Audio Mode

Playing/Pausing Bluetooth® Wireless Technology Audio

Once a *Bluetooth®* Wireless Technology device is connected, the mode will automatically start.



While playing, press the  button to pause and press  button to play.

*** NOTICE**

The play/pause feature may operate differently depending on the mobile phone.

Changing Files

Press the  key to move to the previous or next file.

Setting Connection

If a *Bluetooth®* Wireless Technology device has not been connected, press the  key ▶ [Phone] button to display the *Bluetooth®* Wireless Technology connection screen.

It is possible to use the pair phone, connect/disconnect and delete features from your *Bluetooth®* Wireless Technology phone.

*** NOTICE**

If music is not yet playing from your mobile device after converting to *Bluetooth®* Wireless Technology Audio mode, pressing the play button once may start playing the mode. Check to see that music is playing from the *Bluetooth®* Wireless Technology device after converting to *Bluetooth®* Wireless Technology Audio Mode.

Pairing a *Bluetooth*[®] Wireless Technology Device

What is Bluetooth[®] *Wireless Technology Pairing?*

Pairing refers to the process of synchronizing your *Bluetooth*[®] Wireless Technology phone or device with the car audio system for connection. Pairing is necessary to connect and use the *Bluetooth*[®] Wireless Technology feature.

Pairing **PHONE** key / key on the Steering Remote Controller

When No Devices have been Paired

1. Press the **PHONE** key or the  key on the steering remote controller. The following screen is displayed.
2. Press the **OK** button to enter the Pair Phone screen.

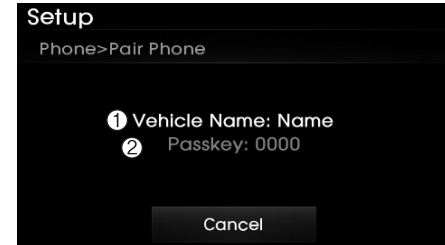
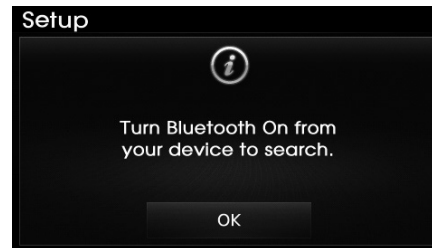

- 1) Vehicle Name : Name of device as shown when searching from your *Bluetooth*[®] Wireless Technology device
- 2) Passkey : Passkey used to pair the device
3. From your *Bluetooth*[®] Wireless Technology device (i.e. Mobile Phone), search and select your car audio system.

[Non SSP supported device]
(SSP: Secure Simple Pairing)

4. After a few moments, a screen is displayed where the passkey is entered.

Hear, enter the passkey "0000" to pair your *Bluetooth*[®] Wireless Technology device with the car audio system.

[SSP supported device]

4. After a few moments, a screen is displayed 6 digits passkey.

Hear, check the passkey on your *Bluetooth*[®] Wireless Technology device and confirm.

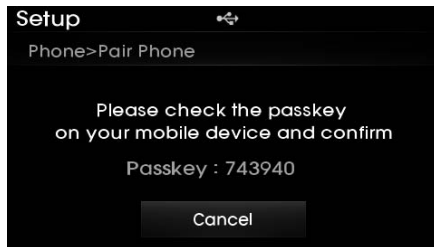

5. Once pairing is complete, the following screen is displayed.

* NOTICE



If *Bluetooth*[®] Wireless Technology devices are paired but none are currently connected, pressing the **[PHONE]** key or the **[↶]** key on the steering wheel displays the following screen. Press the **[Pair]** button to pair a new device or press the **[Connect]** to connect a previously paired device.

Pairing through **[PHONE]** Setup

Press the **[SETUP]** key ▶ Select **[Phone]** ▶ Select **[Pair Phone]** ▶ Select **[TUNE]** knob

(For USA)

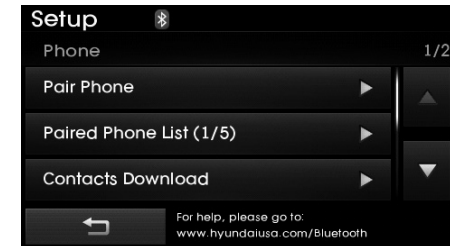

(For CANADA)

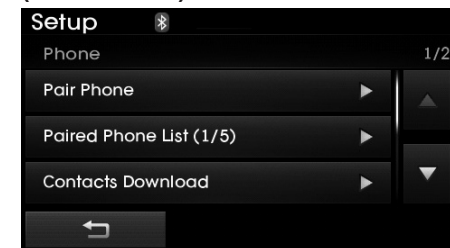

1. The following steps are the same as those described in the section "When No Devices have been Paired" on the previous page.

*** NOTICE**

- **Bluetooth®** Wireless Technology features supported within the vehicle are as follows. Some features may not be supported depending on your **Bluetooth®** Wireless Technology device.
 - **Outgoing/Incoming Handsfree calls**
 - **Operations during a call (Switch to Private, Switch to call waiting, MIC on/off)**
 - **Downloading Call History**
 - **Downloading Mobile Contacts**
 - **Bluetooth®** Wireless Technology device auto connection
 - **Bluetooth Audio Streaming**
- **Up to five Bluetooth®** Wireless Technology devices can be paired to the Car Handsfree system.
- **Only one Bluetooth®** Wireless Technology device can be connected at a time.
- **Other devices cannot be paired while a Bluetooth®** Wireless Technology device is connected.
- **Only Bluetooth®** Wireless Technology Handsfree and Bluetooth audio related features are supported.

(Continued)

(Continued)

- **Bluetooth** related operations are possible only within devices that support Handsfree or audio features, such as a **Bluetooth®** Wireless Technology mobile phone or a Bluetooth audio device.
- If a connected **Bluetooth®** Wireless Technology device becomes disconnected due to being out of communication range, turning the device OFF, or a **Bluetooth®** Wireless Technology communication error, corresponding **Bluetooth®** Wireless Technology devices are automatically searched and reconnected.
- If the system becomes unstable due to communication errors between the car Handsfree and the **Bluetooth®** Wireless Technology device, reset the device by turning off and back on again. Upon resetting **Bluetooth®** Wireless Technology device, the system will be restored.

(Continued)

(Continued)

- After pairing is complete, a contacts download request is sent once to the mobile phone. Some mobile phones may require confirmation upon receiving a download request, ensure your mobile phone accepts the connection. Refer to your phones user's manual for additional information regarding phone pairing and connections.

Connecting a Device

Press the **SETUP** key ▶ Select [Phone] ▶ Select [Paired Phone List]



- 1) Connected Phone : Device that is currently connected
- 2) Paired Phone : Device that is paired but not connected

From the paired phone list, select the device you want to connect and press the **Connect** button.

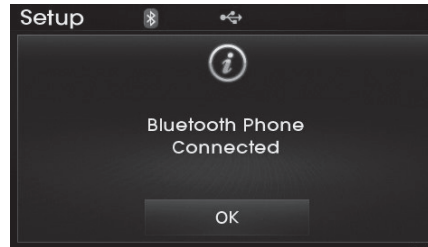

Changing Priority

What is Priority?

It is possible to pair up to five *Bluetooth*® Wireless Technology devices with the car audio system. The "Change Priority" feature is used to set the connection priority of paired phones.

Press the **SETUP** key ▶ Select [Phone] ▶ Select [Paired Phone List]



From the paired phone list, select the phone you want to switch to the highest priority, then press the **Change priority** button from the Menu. The selected device will be changed to the highest priority.

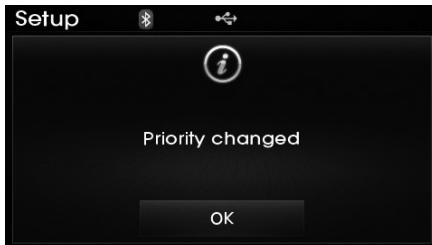

*** NOTICE**

Priority icon will be displayed when the selected phone is set as a priority phone.



Disconnecting a Device

Press the **SETUP** key ▶ Select [Phone] ▶ Select [Paired Phone List]



From the paired phone list, select the currently connected device and press the **Disconnect** button.

Deleting a Device

Press the **SETUP** key ▶ Select [Phone] ▶ Select [Paired Phone List]



From the paired phone list, select the device you want to delete and press the **Delete** button.

* NOTICE

- When deleting the currently connected device, the device will automatically be disconnected to proceed with the deleting process.
- If a paired *Bluetooth*® Wireless Technology device is deleted, the device's call history and contacts data will also be deleted.
- To re-use a deleted device, you must pair the device again.

USING Bluetooth® Wireless Technology

Phone Menu Screen

Phone Menus

With a Bluetooth® Wireless Technology device connected, press the **PHONE** key to display the Phone menu screen.

(For USA)



(For CANADA)

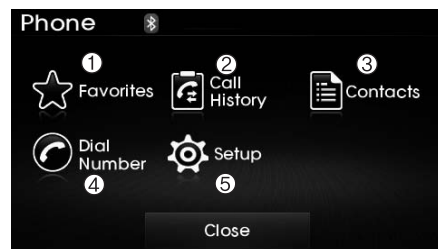

- 1) Favorite : Up to 20 frequently used contacts saved for easy access
- 2) Call History : Device the call history list screen
- 3) Contacts : Displays the Contacts list screen
- 4) Dial Number : Displays the dial screen where numbers can be dialed to make calls
- 5) Setup : Displays Phone related settings

* NOTICE

- If you press the [Call History] button but there is no call history data, a prompt is displayed which asks to download call history data.
- If you press the [Contacts] button but there is no contacts data stored, a prompt is displayed which asks to download contacts data.
- This feature may not be supported in some mobile phones. For more information on download support, refer to your mobile phone user's manual.

Favorites

Press the **PHONE** key ▶ Select [Favorites]

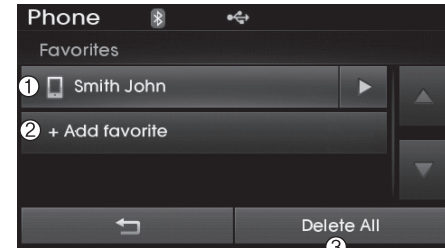

- 1) Saved favorite contact : Connects call upon selection
- 2) To add favorite : Downloaded contacts be saved as favorite.
- 3) Delete All : Delete all stored favorite contacts

* NOTICE

- To save Favorite, contacts should be downloaded.
- Contact saved in Favorites will not be automatically updated if the contact has been updated in the phone. To update Favorites, delete the Favorite and create a new Favorite.

Call History

Press the **PHONE** key ▶ Select [Call History]



A list of incoming, outgoing and missed calls is displayed.

Press the **Download** button to download the call history.

1) Call History :

- Displays recent calls (call history)
- Connects call upon selection

2) Download : Download Recent Call History

- Call history may not be saved in the call history list in some mobile phones.

- Calls received with hidden caller ID will not be saved in the call history list.
- Calling through the call history is not possible when there is no call history stored or a *Bluetooth*® Wireless Technology phone is not connected.
- Up to 50 received, dialed and missed calls are stored in Call History.
- Time of received/dialed calls and call time information are not saved.

Contacts

Press the **PHONE** key ▶ Select [Contacts]

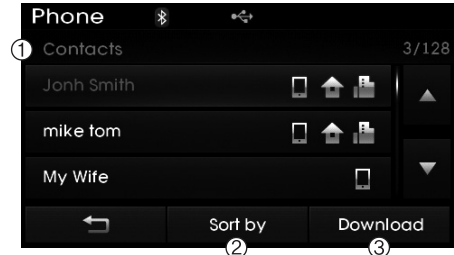
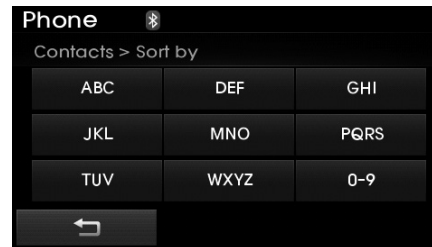

The list of saved phone book entries is displayed. Press the **Download** button to download the call history.

1) Contacts List :

- Displays downloaded contacts entries
- Connects call upon selection

2) Sort by : Find a contact in an alphabetical order.

3) Download : Download contacts entries

*** NOTICE**

- Up to 1,000 contacts saved in your *Bluetooth*® Wireless Technology phone can be downloaded into the car contacts. Contacts that have been downloaded to the car cannot be edited or deleted on the phone.
- Mobile phone contacts are managed separately for each paired *Bluetooth*® Wireless Technology device (max 5 devices x 1,000 contacts each). Previously downloaded data is maintained even if the *Bluetooth*® Wireless Technology device has been disconnected. (However, the contacts and call history saved to the phone will be deleted if a paired phone is deleted.)
- It is possible to download contacts during Bluetooth streaming audio.
- When downloading contacts, the icon will be displayed within the status bar.

(Continued)

(Continued)

- It is not possible to begin downloading a contact list when the contact download feature has been turned off within the *Bluetooth*® Wireless Technology device. In addition, some devices may require device authorization upon attempting to download contacts. If downloading does not normally occur, check the *Bluetooth*® Wireless Technology device settings or the screen state.
- The contacts download feature may not be supported in some mobile phones. For more information of supported *Bluetooth*® devices and function support, refer to your phone's user manual.

Calling by Dialing a Number

Press the **PHONE** key ▶ Select [Dial Number]

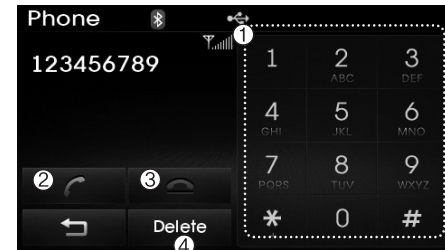

- 1) Dial Pad : Used to enter phone number
- 2) Call : If a number has been entered, calls the number. If no number has been entered, switches to call history screen
- 3) End : Deletes the entered phone number
- 4) Delete : Deletes entered numbers one digit at a time

Answering Calls

Answering a Call

Answering a call with a *Bluetooth®* Wireless Technology device connected will display the following screen.



- 1) Caller : Displays the other party's name when the incoming caller is saved within your contacts
- 2) Incoming Number : Displays the incoming number
- 3) Accept : Accepts the incoming call
- 4) Reject : Rejects the incoming call

* NOTICE

- When an incoming call pop-up is displayed, most Audio and SETUP mode features are disabled. Only the call volume will operate.
- The telephone number may not be properly displayed in some mobile phones.

During a Handsfree Call

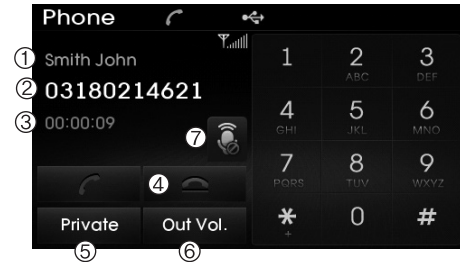

- 1) Caller : Displays the other party's name if the incoming caller is saved within your contacts
- 2) Incoming Number : Displays the incoming number
- 3) Call time : Displays the call time
- 4) End : Ends call
- 5) Private : Converts to Private mode
- 6) Out Vol. : Sets call volume as heard by the other party
- 7) Mute : Turns Mic Mute On/Off

* NOTICE

If the mic is muted, the other party will not be able to hear your voice.

Bluetooth® Wireless Technology Setting

Pairing a New Device

Press the **SETUP** key ▶ Select [Phone] ▶ Select [Pair Phone]

(For USA)

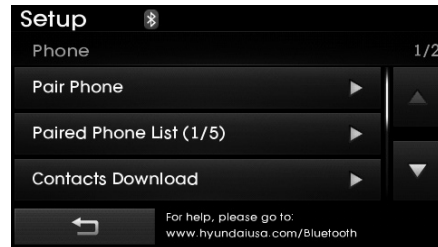

(For CANADA)

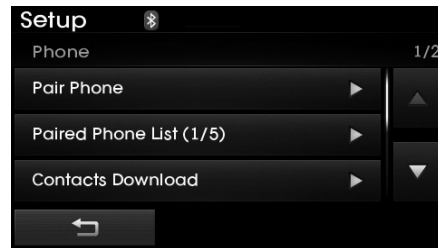

Bluetooth® Wireless Technology devices can be paired with the audio system.

For more information, refer to the "Pairing through Phone Setup" section within Bluetooth® Wireless Technology.

Viewing Paired Phone List

Press the **SETUP** key ▶ Select [Phone] ▶ Select [Paired Phone List]



This feature is used to view mobile phones that have been paired with the audio system. Upon selecting a paired phone, the setup menu is displayed.

For more information, refer to the "Setting Bluetooth® Wireless Technology Connection" section within Bluetooth® Wireless Technology.

- 1)  : Moves to the previous screen
- 2) Connect/Disconnect Phone : Connect/ disconnects currently selected phone
- 3) Delete : Deletes the currently selected phone
- 4) Change Priority : Sets currently selected phone to highest connection priority

* NOTICE BEFORE DOWNLOADING CONTACTS

- Only contacts within connected phones can be downloaded. Also check to see that your mobile phone supports the download feature.
- To learn more about whether your mobile phone supports contacts downloads, refer to your mobile phone user's manual.
- The contacts for only the connected phone can be downloaded.

Downloading Contacts

Press the **SETUP** key ▶ Select [Phone] ▶ Select [Contacts Download]

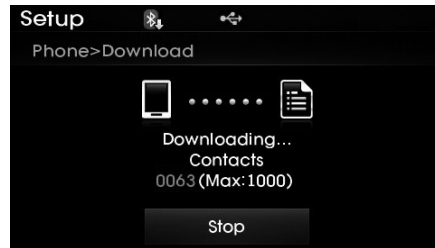

As the contacts are downloaded from the mobile phone, a download progress bar is displayed.

* NOTICE

- Upon downloading phone contacts, the previous corresponding data is deleted.
- This feature may not be supported in some mobile phones.
- Voice Recognition may not operate while contacts are being downloaded.

Outgoing Volume

Press the **SETUP** key ▶ Select [Phone] ▶ Select [Outgoing Volume]

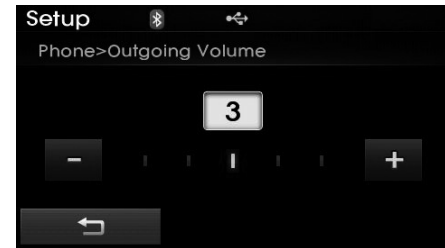

Use the **-**, **+** buttons to adjust the outgoing volume level.

* NOTICE

While on a call, the volume can be changed by using the **SEEK TRACK** key.

Turning Bluetooth System Off

Press the **SETUP** key ▶ Select [Phone] ▶ Select [Bluetooth System Off]

Once *Bluetooth*® Wireless Technology is turned off, *Bluetooth*® Wireless Technology related features will not be supported within the audio system.

(For USA)

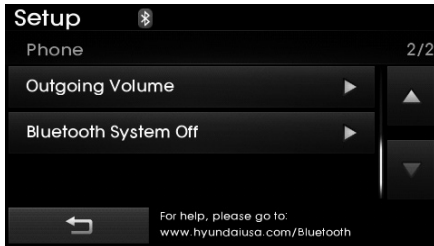

(For CANADA)

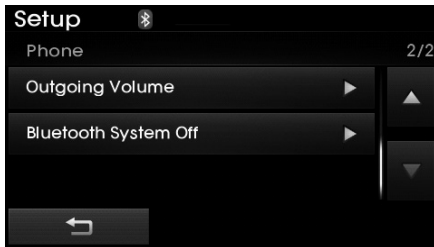

* NOTICE

To turn *Bluetooth*® Wireless Technology back on, go to **SETUP** ▶ [Phone] and press "Yes".

VOICE RECOGNITION

Using Voice Recognition

Starting Voice Recognition

Shortly press the  key on the steering wheel remote controller. Say a command.

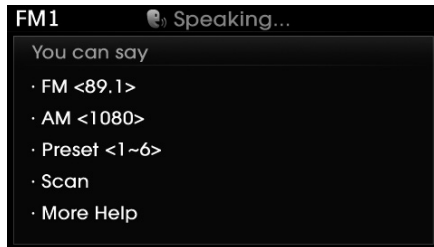

If prompt feedback is in [ON], then the system will say "Please say a command after the beep (BEEP)"

- If prompt feedback is in [OFF] mode, then the system will only say "(BEEP)"
- To change Prompt Feedback [On]/[Off], go to **SETUP** ▶ [System] ▶ [Prompt Feedback]

* NOTICE

For proper recognition, say the command after the voice instruction and beep tone.

Contact List Best Practices

- 1) Do not store single-name entries (e.g., "Bob", "Mom", "Kim", etc.). Instead, always use full names (including first and last names) for all contacts (e.g., use "Jacob Stevenson" instead of "Dad").
- 2) Do not use abbreviations (i.e., use "Lieutenant" instead of "Lt." or "Sergeant" instead of "Sgt.").
- 3) Do not use acronyms (i.e., use "County Finance Department" instead of "CFD").
- 4) Do not use special characters (e.g., "@", "hyphen -", "asterisk **", "ampersand &").
- 5) If a name is not recognized from the contact list, change it to a more descriptive name (e.g., use "Grandpa Joseph" instead of "Pa Joe").

Skipping Prompt Messages

While prompt message is being stated ▶ Shortly press the  key on the steering remote controller

The prompt message is immediately ended and the beep tone will sound. After the "beep", say the voice command.

Re-starting Voice Recognition

While system waits for a command ▶ Shortly press the  key on the steering remote controller

The command wait state is immediately ended and the beep tone will sound. After the "beep", say the voice command.

* Illustration on using voice commands

• **Starting voice command.**

Shortly pressing the  key (under 0.8 seconds):

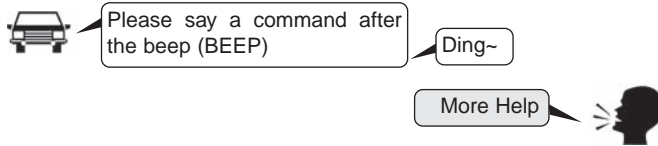

 More Help
 Here are some examples of mode commands.
 You can say a radio type like 'FM', 'AM', or 'Satellite'.
 You can also say a media source like 'USB', 'My Music', or 'iPod'.
 Additionally, there are phone commands like "Contacts", 'Call History', or 'Dial Number'.
 You can find more detailed commands in the user's manual.
 Please say a command after the beep.

• **Skipping Voice Recognition**

Shortly pressing the  key (under 0.8 seconds):



Shortly pressing the  key (under 0.8 seconds):

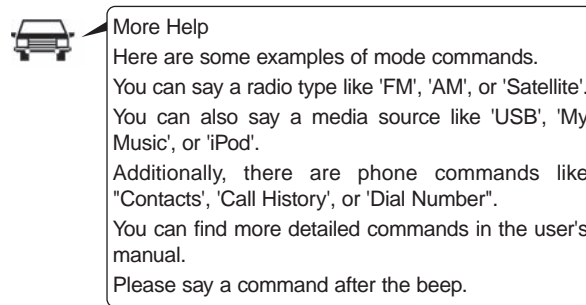

• **Ending voice command.**

Shortly pressing the  key (under 0.8 seconds):

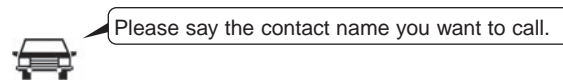
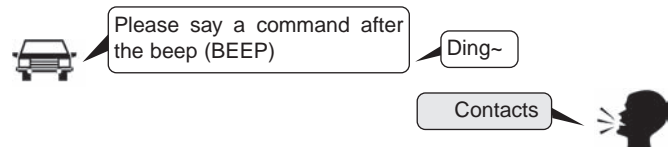

Voice Command List

- **Common Commands:** These commands can be used in most operations. (However a few commands may not be available during certain operations)

| Command | Function |
|-----------------------|---|
| More Help | Provides guidance on commands that can be used anywhere in the system. |
| Help | Provides guidance on commands that can be used within the current mode. |
| Call<Name> | Calls <Name> saved in Contacts Ex) Call "John Smith" |
| Call <Name> on Mobile | Calls <Name> to the number that is saved as "Mobile" in Contacts Ex) Call "John Smith" on Mobile |
| Call <Name> in Office | Calls <Name> to the number that is saved as "Office" in Contacts Ex) Call "John Smith" in Office |
| Call <Name> at Home | Calls <Name> to the number that is saved as "Home" in Contacts Ex) Call "John Smith" at Home |
| Call <Name> on Other | Calls <Name> to the number that is saved as "Other" in Contacts Ex) Call "John Smith" on Other |
| Phone | Provides guidance on Phone related commands. After saying this command, say "Favorites", "Call History", "Contacts" or "Dial Number" execute corresponding functions. |
| Favorites | Displays the Favorite screen. |
| Call History | Displays the Call History screen. |

| Command | Function |
|-------------------------|--|
| Contacts (Call by Name) | Displays the Contacts screen. After saying this command, say the name of a contact saved in the Contacts to automatically connect the call. |
| Dial Number | Displays the Dial number screen. After saying this command, you can say the number that you want to call. |
| Redial | Connects the last dialed call number. |
| Tutorial | Provides guidance on how to use voice recognition and Bluetooth® connections. |
| Radio | <ul style="list-style-type: none"> • When listening to the radio, displays the next radio screen. (FM1→FM2→AM→XM1→XM2→XM3→FM1) • When listening to a different mode, displays the most recently played radio screen. • When currently listening to the FM radio, maintains the current state. • When listening to a different mode, displays the most recently played FM screen. |
| FM1(FM One) | Displays the FM1 screen. |
| FM2(FM Two) | Displays the FM2 screen. |
| AM | Displays the AM screen. |

| Command | Function |
|--------------------|--|
| FM Preset 1~6 | Plays the most recently played broadcast saved in FM Preset 1~6. |
| AM Preset 1~6 | Plays the broadcast saved in AM Preset 1~6. |
| FM 87.5~107.9 | Plays the FM broadcast of the corresponding frequency. |
| AM 530~1710 | Plays the AM broadcast of the corresponding frequency. |
| XM (Satellite) | <ul style="list-style-type: none"> • When currently listening to the SiriusXM[®], maintains the current state. • When listening to a different mode, displays the most recently played SiriusXM[®] screen. |
| XM (Satellite) 1~3 | Displays the selected SiriusXM [®] screen. |
| XM Channel 0~223 | Plays the selected SiriusXM [®] channel. |
| Media | Moves to the most recently played media screen. |
| CD | Plays the music saved in the CD. |
| USB | Plays USB music. |
| iPod [®] | Plays iPod music. |

| Command | Function |
|------------------------------|---|
| My Music | Plays the music saved in My Music. |
| AUX (Auxiliary) | Plays the connected external device. |
| Bluetooth [®] Audio | Plays the music saved in connected Bluetooth [®] device. |
| Mute | Mutes the sound |
| Cancel (Exit) | Ends voice command. |

Features of your vehicle

- FM/AM radio commands: available during FM, AM radio operation

| Command | Function |
|-------------|--|
| Preset 1~6 | Plays the broadcast saved in Preset 1~6. |
| Scan | Scans receivable frequencies from the current broadcast and plays for 10 seconds each. |
| Preset Scan | Moves to the next preset from the current present and plays for 10 seconds each. |
| Information | Displays the information of the current broadcast.(This feature can be used when receiving RBDS broadcasts.) |

- Satellite radio commands: Commands that can be used while listening to Satellite Radio.

| Command | Function |
|---------------|---|
| Channel 0~255 | Play the selected Satellite Radio channel. |
| Scan | Scans receivable channels from the current broadcast and plays for 10 seconds each. |
| Preset 1~6 | Plays the broadcast saved in Preset 1~6. |
| Information | Displays the information of the current broadcast. |

- Audio CD commands: Commands available during Audio CD operation

| Command | Function |
|-------------|---|
| Play | Plays the currently paused track. |
| Pause | Pauses the current track. |
| Shuffle | Randomly plays the tracks within the CD. |
| Shuffle Off | Cancels random play to play tracks in sequential order. |
| Repeat | Repeats the current track. |
| Repeat Off | Cancels repeat play to play tracks in sequential order. |
| Track 1~30 | Plays the desired track number. |

- MP3 CD / USB commands: Commands available during USB and MP3 CD operation

| Command | Function |
|-----------------|--|
| Play | Plays the currently paused file. |
| Pause | Pauses the current file. |
| Shuffle | Randomly plays the files within the current folder. |
| Shuffle Off | Cancels random play to play files in sequential order. |
| Repeat | Repeats the current file. |
| Repeat Off | Cancels repeat play to play files in sequential order. |
| Next Folder | Play the first file in the next folder |
| Previous Folder | Play the first file in the previous folder |

Features of your vehicle

- iPod® Commands: Commands available during iPod® operation

| Command | Function |
|-------------|---|
| Play | Plays the currently paused song. |
| Pause | Pauses the current song. |
| Shuffle | Randomly plays the songs within the current category. |
| Shuffle Off | Cancel random play to play songs in sequential order. |
| Repeat | Repeats the current song. |
| Repeat Off | Cancel repeat play to play songs in sequential order. |

- My Music Commands: Commands available during My Music operation

| Command | Function |
|-------------|---|
| Play | Plays the currently paused file. |
| Pause | Pauses the current file. |
| Shuffle | Randomly plays all saved files. |
| Shuffle Off | Cancel random play to play files in sequential order. |
| Repeat | Repeats the current file. |
| Repeat Off | Cancel repeat play to play files in sequential order. |
| Delete | Deletes the current file. You will bypass an additional confirmation process. |

SETUP

Starting Mode

Press the **SETUP** key ▶ Select the Setup screen.

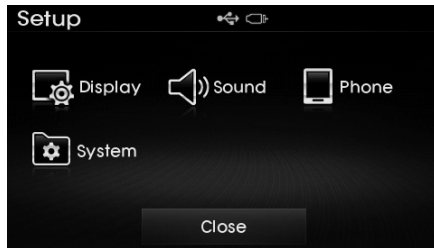

You can select and control options related to [Display], [Sound], [Clock/Calendar], [Phone] and [System].

Display Settings

Adjusting the Brightness

Press the **SETUP** key ▶ Select [Display] ▶ Select [Brightness]



Use the ◀, ▶ buttons to adjust the screen brightness or set the Brightness on Automatic, Daylight, or Night mode.

Press the **Default** button to reset.

- 1) Automatic : Adjusts the brightness automatically
- 2) Daylight : Always maintains the brightness on high
- 3) Night: Always maintains the brightness on low

Mode pop up

Press the **SETUP** key ▶ Select [Display] ▶ Select [Mode Pop up]



This feature is used to display the Pop-up Mode screen when entering radio and media modes.

When this feature is turned on, pressing the **RADIO** or **MEDIA** key will display the Pop-up Mode screen.

* NOTICE

The media Mode pop up screen can be displayed only when two or more media modes have been connected.

MP3 Information Display

Press the **SETUP** key ▶ Select [Display] ▶ Select [Media Display]



This feature is used to change the information displayed within USB and MP3 CD modes.

- 1) Folder File : Displays file name and folder name
- 2) Album Artist Song : Displays album name/artist name/song

Sound Settings

Sound Settings

Press the **SETUP** key ▶ Select [Sound] ▶ Select [Sound Setting]



Use the **◀**, **▶**, **▲**, **▼** buttons to adjust the Fader/Balance settings.

Use the **◀**, **▶** buttons to adjust the Bass/Middle/Treble settings.

Press the **Default** button to reset.

SDVC (Speed Dependent Volume Control)

Press the **SETUP** key ▶ Select [Sound]
▶ Select [Speed Dependent Vol.]

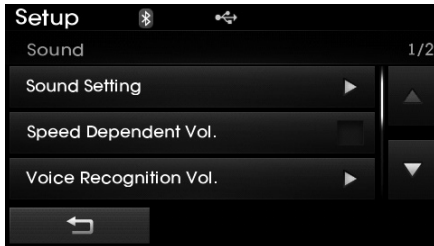

The volume level is controlled automatically according to the vehicle speed. SDVC can be set by selecting from On/Off.

Voice Recognition Volume

Press the **SETUP** key ▶ Select [Sound]
▶ Select [Voice Recognition Vol.]



Turn the **TUNE** knob to adjust the Voice Recognition volume.

Touch Screen Beep

Press the **SETUP** key ▶ Select [Sound]
▶ Select [Touch Screen Beep]

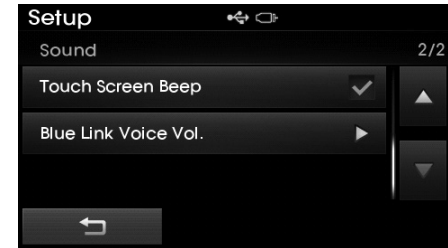

This feature is used to turn the touch screen beep on/off.

Blue Link Voice Volume

Press the **SETUP** key ▶ Select [Sound]
▶ Select [Blue Link Voice Vol.]



Turn the **TUNE** knob to adjust the Blue Link Voice Volume.

* Blue Link® may differ depending on the selected audio.

System Setting

Memory Information

Press the **SETUP** key ▶ Select [System] ▶ Select [Memory Information]

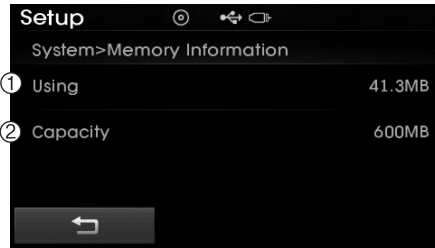

This feature displays information related to system memory.

- 1) Using : Displays capacity currently in use
- 2) Capacity : Displays total capacity

Prompt Feedback

Press the **SETUP** key ▶ Select [System] ▶ Select [Prompt Feedback]

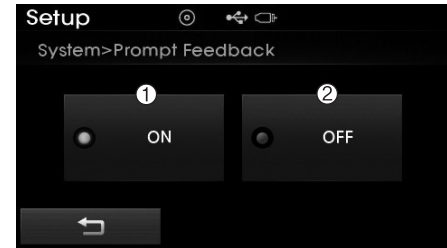

This feature is used to select the desired prompt feedback option from ON and OFF.

- 1) ON : When using voice recognition, provides detailed guidance prompts
- 2) OFF : When using voice recognition, omits some guidance prompts

Language

Press the **SETUP** key ▶ Select [System] ▶ Select [Language]

REAR VIEW CAMERA (if equipped)

- The system has been equipped with a rear view camera for user safety by allowing a wider rear range of vision.
- The rear view camera will automatically operate when the ignition key is turned ON and the shift lever is set to R (Reverse).
- The rear view camera will automatically stop operating when shift lever is selected out of R (Reverse).

CAUTION

- *The rear view camera has been equipped with an optical lens to provide a wider range of vision and may appear different from the actual distance. For safety, directly check the rear and left/right sides.*

Blue Link® (if equipped)

Hyundai aims to offer differentiated customer values through a 'Connected Car Life,' which is to provide consumers with fast and reliable IT technology. As consumers' lifestyles become more and more mobile in thanks to remarkable advances in smart phones, tablet PCs and overall wireless telecommunication, new lifestyle patterns demand seamless connection between one's office, home, outdoors and automobiles.

Automobile companies are now faced with the task of shifting their paradigm from vehicle-centered services to customer value-centered services, with the ultimate goal of securing global leadership in the field of vehicle IT and telematics.



Hyundai plans to achieve this by realizing a terminal platform flexible to changes in IT technology, cooperating with global IT companies, creating an eco-system and providing the latest contents & services based on an open environment.

Using the Room Mirror Key

Selecting the room mirror key will allow you to make service required inquiries, POI info searches, and emergency rescues by connecting to the Blue Link® Center.

Such features can be used only after subscribing to the Blue Link® service.



① (Blue Link® Center)

Makes requests for Blue Link® service related inquiries and consultations.

A call is connected to the Blue Link® service center employee.

Re-pressing the key will end the call. This feature does not operate when you are on a Bluetooth® phone call.

② (Blue Link® for POI)

• Blue Link® for Voice command

Starts Blue Link® voice command.

Voice receiving voice guidance, shortly press the button to convert to voice command mode. Press and hold the button to end voice command.

• TBT VR Commands

1. Navigate to

"Navigate to" voice command is used to request the download of route data for a new destination, saved destinations, daily routes and previous destinations.

2. Save Destination

"Save Destination" VR command is used to assign a voice tag to the last downloaded destination and store it in a destination directory.

NOTE:

The Turn by Turn(TBT) feature supports the store of ten(10) destinations in the TBT destinations directory.

3. Route Preview

"Route Preview" VR command allows the user to preview the route instructions (upcoming maneuver instructions) at any time during the route guidance.

4. Destinations List

"Destinations List" VR command allows the user to preview and delete the stored destinations with their associated voice tags in the Turn by Turn destinations directory.

5. Voice Guidance

"Voice Guidance" VR command allows the user to mute/unmute the Turn by Turn (TBT) direction announcements.

6. Suspend Route

"Suspend Route" VR command allows the user to suspend and pause Turn by Turn (TBT) route guidance while in the guidance mode.

7. Resume Route

"Resume Route" VR command allows the user to resume Turn by Turn (TBT) route guidance.

③ (Blue Link® for SOS)

In the case of an emergency, requests for help to the Blue Link® center.

Call is connected to the Blue Link® emergency rescue center. Re-pressing the key will end the call.

If already on a *Bluetooth®* phone call, the call will end to connect you to the Blue Link® Emergency Rescue Center.

CAUTION

- *You cannot talk simultaneously on the Bluetooth® phone and Blue Link® phone.*
- *While on a Bluetooth® call, pressing the  key or  key will display a message indicating that you are currently on a call.*
- *A message will be displayed if you receive a Bluetooth® Bluetooth® Wireless Technology call while already on a Blue Link® call. At this time, press the  key on the steering wheel remote controller to accept the call. The phone bell will not ring.*

Turn by Turn

The Turn by Turn feature can be used through Blue Link®.

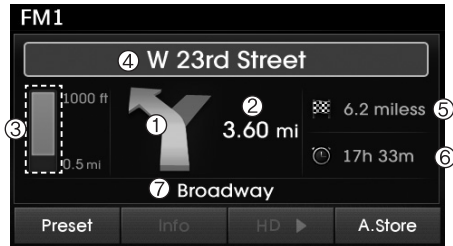

- 4.Next Street name
- 5.Distance to destination
- 6.Expected Time Arrival
- 7. Current Street name

* For information on specific Blue Link® operations, please refer to a separate manual.

- 1.Direction Indicator Image
- 2.Remaining distance until next point
- 3.The Count bar is divided into a total of 9 levels.

| | | | |
|---------|-------|---------|-------|
| 9 Level | 0.5mi | 8 Level | 0.4mi |
| 7 Level | 0.3mi | 6 Level | 0.2mi |
| 5 Level | 0.1mi | 4 Level | 400ft |
| 3 Level | 300ft | 2 Level | 200ft |
| 1 Level | 100ft | | |

iPod® is a registered trademark of Apple Inc. iPod® mobile digital device sold separately. The Bluetooth® word mark and logos are registered trademarks owned by Bluetooth SIG, Inc. and any use of such marks by Hyundai is under license. SiriusXM services require a subscription sold separately, or as a package, by Sirius XM Radio Inc. If you decide to continue service after your trial, the subscription plan you choose will automatically renew thereafter and you will be charged according to your chosen payment method at then-current rates. Fees and taxes apply. To cancel you must call SiriusXM at 1-866-635-2349. See SiriusXM Customer Agreement for complete terms at www.siriusxm.com. SiriusXM U.S. satellite and data services are available only in the 48 contiguous USA, DC and PR (with coverage limitations). SiriusXM satellite service is also available in Canada; see www.siriusxm.ca. All fees and programming subject to change.

Sirius, XM and all related marks and logos are trademarks of Sirius XM Radio Inc. Android™ is a trademark of Google, Inc. BlackBerry is a registered trademark of Research In Motion Limited (RIM). All other marks, channel names and logos are the property of their respective owners. All rights reserved.

■ CD Player : AM1B0MDKN F/L, AM1B0MDAN F/L, AM1B1MDAN F/L



■ CD Player : AM180MDKN F/L, AM180MDAN F/L



* No  Bluetooth logo will be shown if the *Bluetooth*® Wireless Technology feature is not supported.

SYSTEM CONTROLLERS AND FUNCTIONS

Audio Head Unit



1. **EJECT**

- Ejects the disc.

2. **RADIO**

- Changes to FM/AM/XM mode.
- Each time the key is pressed, the mode is changed in order of FM1 → FM2 → AM → XM1 → XM2 → XM3
- *In Setup>Display, the radio pop up screen will be displayed when [Mode Pop up] is turned **On**.

When the pop up screen is displayed, use the **TUNE** knob or keys **1** ~ **6** to select the desired mode.

3. **MEDIA**

- Changes to CD, USB, iPod, AUX, My Music, BT Audio modes.
- Each time the key is pressed, the mode is changed in order of CD, USB, iPod, AUX, My Music, BT Audio modes.

*In Setup>Display, the media pop up screen will be displayed when [Mode Pop up] is turned **On**.

When the pop up screen is displayed, use the **TUNE** knob or keys **1** ~ **5** to select the desired mode.

4. **PHONE**

- Operates Phone Screen
- *When a phone is not connected, the connection screen is displayed.

5. PWR/VOL knob

- **Power Knob**: Turns power On/Off by pressing the knob
- **Volume Knob**: Sets volume by turning the knob left/right

6. **1** ~ **6** (Preset)

- **Radio Mode**: Saves frequencies (channels) or receives saved frequencies (channels)
- **CD, USB, iPod, My Music mode**
 - **1** : Repeat
 - **2** : Random
- In the Radio, Media, Setup, and Menu pop up screen, the number menu is selected.

7. **SEEK TRACK**

- **Radio Mode** : Automatically searches for broadcast frequencies.
- **CD, USB, iPod, My Music modes** :
 - Shortly press the key (under 0.8 seconds): Moves to next or previous song(file)
 - Press and hold the key (over 0.8 seconds): Rewinds or fast-forwards the current song(file)



8. **DISP**

- Each time the button is shortly pressed (under 0.8 seconds), it sets the screen Off → Screen On → Screen Off
- *Audio operation is maintained and only the screen will be turned Off. In the screen Off state, press any key to turn the screen On again.

9. **SCAN**

- Radio Mode
 - Shortly press the key (under 0.8 seconds): Previews each broadcast for 5 seconds each
 - Press and hold the key (over 0.8 seconds): Previews the broadcasts saved in Preset **1** ~ **6** for 5 seconds each.

* Press the **SCAN** key again to continue listening to the current frequency.

* SiriusXM™ Radio does not support the Preset scan feature.

- CD, USB, iPod mode

- Shortly press the key (under 0.8 seconds): Previews each song (file) for 10 seconds each

* Press the **SCAN** key again to continue listening to the current song (file).

10. **SETUP**

- Shortly press the key (under 0.8 seconds) : Moves to the Display, Sound, Phone, System setting modes

11. **MENU**

- Displays menus for the current mode.

12. **TUNE** knob

- Radio mode : Changes frequency by turning the knob left/right
- CD, USB, iPod mode: Searches songs (files) by turning the knob left/right

*When the desired song is displayed, press the knob to play the song.

- Moves focus in all selection menus and selects menus

13. **CAT FOLDER**

- Radio Mode
 - SiriusXM™ RADIO : Category Search
- MP3, CD, USB mode : Folder Search
- iPod mode: Moves to parent folder
- *May differ depending on the selected audio.

Audio Head Unit (For NON Bluetooth model)



14. **FM/AM**

- Changes to FM mode.
- Each time the key is pressed, the mode changed in order of FM1 → FM2 → AM.

15. **SAT**

- Changes to SiriusXM™ mode.

■ CD Player : AM110MDAN F/L



* No ((XM)) will be shown if the SiriusXM™ feature is not supported.

■ CD Player : AM110MDAN F/L



* No  will be shown if the SiriusXM™ feature is not supported.

* No  Bluetooth logo will be shown if the Bluetooth® Wireless Technology feature is not supported.

SYSTEM CONTROLLERS AND FUNCTIONS

Audio Head Unit





1. (EJECT)

- Ejects the disc.

2. **RADIO**

- Changes to FM/AM/XM mode.
- Each time the key is pressed, the mode is changed in order of FM1 → FM2 → AM

※In Setup>Display, the radio pop up screen will be displayed when [Mode Pop up] is turned .

When the pop up screen is displayed, use the  TUNE knob or keys **1** ~ **6** to select the desired mode.

3. **MEDIA**

- Changes to CD, USB, iPod, AUX, My Music, BT Audio modes.
- Each time the key is pressed, the mode is changed in order of CD, USB, iPod, AUX, My Music, BT Audio modes.

※In Setup>Display, the media pop up screen will be displayed when [Mode Pop up] is turned .



When the pop up screen is displayed, use the  TUNE knob or keys **1** ~ **5** to select the desired mode.

4. **PHONE**

- Operates Phone Screen

※When a phone is not connected, the connection screen is displayed.

5. PWR/VOL knob

-  Power Knob: Turns power On/Off by pressing the knob
-  Volume Knob: Sets volume by turning the knob left/right

6. **1** ~ **6** (Preset)

- Radio Mode: Saves frequencies (channels) or receives saved frequencies (channels)
- CD, USB, iPod, My Music mode
 - **1** : Repeat
 - **2** : Random
- In the Radio, Media, Setup, and Menu pop up screen, the number menu is selected.

7.

- Radio Mode : Automatically searches for broadcast frequencies.
- CD, USB, iPod, My Music modes :
 - Shortly press the key (under 0.8 seconds): Moves to next or previous song(file)
 - Press and hold the key (over 0.8 seconds): Rewinds or fast-forwards the current song(file)

Features of your vehicle



8. **DISP**

- Each time the button is shortly pressed (under 0.8 seconds), it sets the screen Off → Screen On → Screen Off
- * Audio operation is maintained and only the screen will be turned Off. In the screen Off state, press any key to turn the screen On again.

9. **SCAN**

- Radio Mode
 - Shortly press the key (under 0.8 seconds): Previews each broadcast for 5 seconds each
 - Press and hold the key (over 0.8 seconds): Previews the broadcasts saved in Preset **1** ~ **6** for 5 seconds each.
- * Press the **SCAN** key again to continue listening to the current frequency.
- * XM Radio does not support the Preset scan feature.
- CD, USB, iPod mode
 - Shortly press the key (under 0.8 seconds): Previews each song (file) for 10 seconds each
- * Press the **SCAN** key again to continue listening to the current song (file).

10. **SETUP**

- Shortly press the key (under 0.8 seconds) : Moves to the Display, Sound, Phone, System setting modes

11. **MENU**

- Displays menus for the current mode.

12. **TUNE** knob

- Radio mode : Changes frequency by turning the knob left/right
- CD, USB, iPod mode: Searches songs (files) by turning the knob left/right
- * When the desired song is displayed, press the knob to play the song.
- Moves focus in all selection menus and selects menus

13. **FOLDER**

- MP3, CD, USB mode : Folder Search
- iPod mode: Moves to parent folder
- * May differ depending on the selected audio.

Audio Head Unit (For NON Bluetooth model)



14. **FM**

- Changes to FM mode.
- Each time the key is pressed, the mode changed in order of FM1 → FM2.

15. **AM**

- Changes to AM mode.

SETUP

Display Settings

Press the **SETUP** key ▶ Select [Display] through **TUNE** knob or **1** key ▶ Select menu through **TUNE** knob



Mode Pop up

[Mode Pop up] ▶ Changes **On**/**Off** selection mode

- During On state, press the **RADIO** or **MEDIA** key to display the mode change pop up screen.

Media Display

When playing an MP3 file, select the desired display info from 'Folder/File' or 'Album/Artist/Song'.



SOUND SETTINGS

Press the **SETUP** key ▶ Select [Sound] through **TUNE** knob or **2** key ▶ Select menu through **TUNE** knob

Sound Settings

This menu allows you to set the 'Bass, Middle, Treble' and the Sound Fader and Balance.

Select [Sound Settings] ▶ Select menu through **TUNE** knob ▶ Turn **TUNE** knob left/right to set

- Bass, Middle, Treble : Selects the sound tone.
 - Fader, Balance : Moves the sound fader and balance.
 - Default : Restores default settings.
- *Back : While adjusting values, pressing the **TUNE** knob will restore the parent menu.

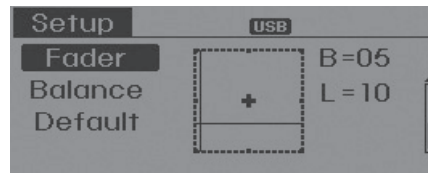
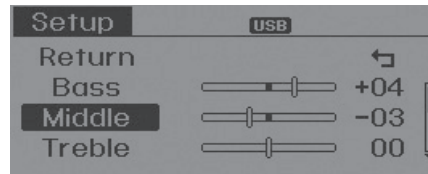

Speed Dependent Volume Control

This feature is used to automatically control the volume level according to the speed of the vehicle.

Select [SDVC] ▶ Turn SDVC On/Off by pressing the **Tune** knob.



Voice Recognition Volume

Adjusts voice recognition volume.

Select [Voice Recognition Vol.]▶ Set volume of  TUNE knob

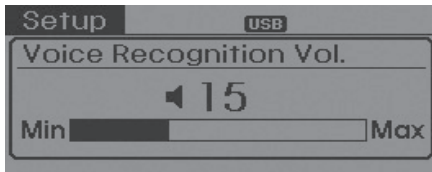

SYSTEM SETTINGS

Press the **SETUP** key ▶ Select [System] through tune knob or **4** key ▶ Select menu through **TUNE** knob

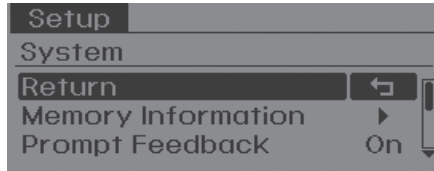

Memory Information

Displays currently used memory and total system memory.

Select [Memory Information] ▶ OK

The currently used memory is displayed on the left side while the total system memory is displayed on the right side.

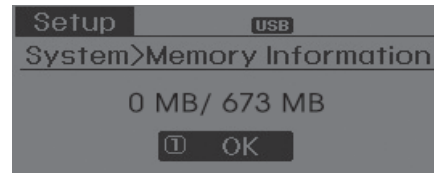

Prompt Feedback

This feature is used to change voice command feedback between Normal and Expert modes.

Select [Prompt Feedback] ▶ Set through **TUNE** knob

- Normal(On) : This mode is for beginner users and provides detailed instructions during voice command operation.

- Expert(Off) : This mode is for expert users and omits some information during voice command operation. (When using Expert mode, guidance instructions can be heard through the [Help] or [Menu] commands.

Language

This menu is used to set the display and voice recognition language.

Select [Language] ▶ Set through **TUNE** knob



- *The system will reboot after the language is changed.
- *Language support by region
 - English, Francais, Espanol

RADIO : FM, AM OR SIRIUSXM™

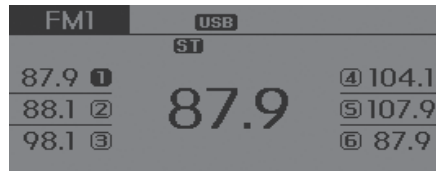



SEEK

Press the  key

- Shortly pressing the key (under 0.8 seconds): Changes the frequency.
- Pressing and holding the key (over 0.8 seconds): Automatically searches for the next frequency.



Preset SEEK

Press the  ~  key

- Shortly pressing the key (under 0.8 seconds): Plays the frequency saved in the corresponding key.
- Pressing and holding the key (over 0.8 seconds): Pressing and holding the desired key from  ~  will save the currently playing broadcast to the selected key and sound a BEEP.

SCAN

Press the  key

- Shortly pressing the key (under 0.8 seconds): The broadcast frequency increases and previews each broadcast for 5 seconds each. After scanning all frequencies, returns and plays the current broadcast frequency.
- Pressing and holding the key (over 0.8 seconds): Previews the broadcasts saved in Preset  ~  for 5 seconds each.

Selecting through manual search

Turn the  TUNE knob left/right to adjust the frequency.

- FM : Changes by 200KHz
- AM : Changes by 10KHz

MENU

Within **MENU** key are the A.Store (Auto Store) and Info functions.



1 A.Store

Press the **MENU** key ▶ Set [A.Store] through **TUNE** knob or **1** key

Saves broadcasts with superior reception to **1** ~ **6** keys. If no frequencies are received, then the most recently received frequency will be broadcast.

SIRIUSXM™ RADIO

Using XM satellite Radio

Your vehicle is equipped with a 3 month complimentary period of XM Satellite Radio. XM provides access to over 130 channels of music, information, and entertainment programming.

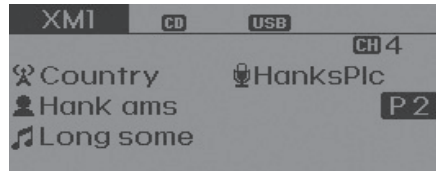

SEEK

Press the  key

- Shortly pressing the key (under 0.8 seconds): select previous or next channel.
- Pressing and holding the key (over 0.8 seconds): continuously move to previous or next channel.

*If the "Category" icon is displayed, channels are changed within the current category.

SCAN

Press the  key

- Shortly pressing the key (under 0.8 seconds): Previews each broadcast for 10 seconds each

*Press the  key again to continue listening to the current frequency

*If the "Category" icon is displayed, channels are changed within the current category.

Category

Press the  key ▶ Set through the  TUNE knob

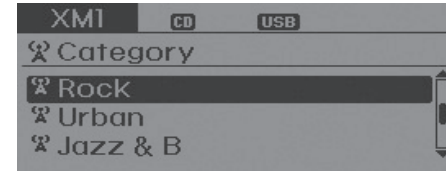



- The display will indicate the category menus, highlight the category that the current channel belongs to.
 - In the Category List Mode, press the  key to navigate category list.
 - Press the tune knob to select the lowest channel in the highlighted category.
- *If channel is selected by selecting category, then the "CATEGORY" icon is displayed at the top of the screen.

Preset



Press the **1** ~ **6** key

- Shortly pressing the key (under 0.8 seconds): Plays the frequency saved in the corresponding key.
- Pressing and holding the key (over 0.8 seconds): Pressing and holding the desired key from **1** ~ **6** will save the current broadcast to the selected key and sound a BEEP.

Tune

- Rotate  TUNE knob : Changes the channel number or scrolls category list.
- Press  TUNE knob : Selects the menu.

Menu

Select category menu through the  TUNE knob ▶ Press the **MENU** key
▶ Select [**I**Info] through the  TUNE knob or **1** key

Info (Information)

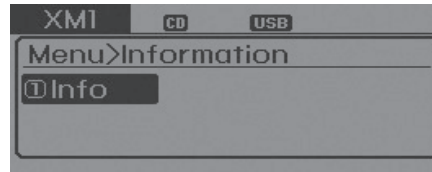

Displays the Artist/Song info of the current song.

BASIC METHOD OF USE : Audio CD / MP3 CD / USB / iPod® / My Music

Press the **MEDIA** key to change the mod mode in order of CD → USB(iPod®) → AUX → My Music → BT Audio.

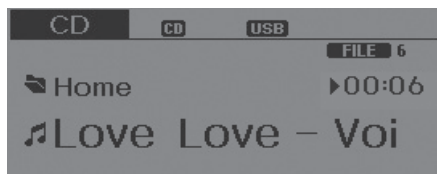

The folder/file name is displayed on the screen.

*The CD is automatically played when a CD is inserted.

*The USB music is automatically played when a USB is connected.

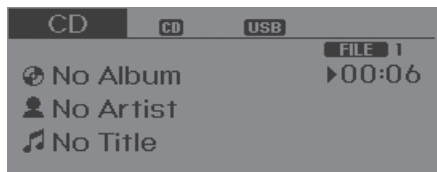

Repeat

While song (file) is playing ▶ **1** (RPT) key

Audio CD, MP3 CD, USB, iPod®, My Music mode: RPT on screen

- To repeat one song (Shortly pressing the key (under 0.8 seconds)): Repeats the current song.

MP3 CD, USB mode: FLD.RPT on screen

- To repeat folder (Pressing the key twice).

*Press the **1** key again to turn off repeat.

Random

While song (file) is playing ▶ **2 RDM** (RDM) key

Audio CD, iPod®, My Music mode: RDM on screen

- Random (press the key : Plays all songs in random order.

MP3 CD, USB mode: FLD.RDM on screen

- Folder Random (press the key : Plays all files within the current folder in random order.

MP3 CD, USB mode : ALL RDM on screen

- All Random (pressing twice): Plays all files in random order.

*Press the **2 RDM** key again to turn off repeat.

Changing Song/File

While song (file) is playing ▶  key

- Shortly pressing the key (under 0.8 seconds): Plays the current song from the beginning.
- *If the  key is pressed again within 1 second, the previous song is played.
- Pressing and holding the key (over 0.8 seconds): Rewinds the song.

While song (file) is playing ▶  key

- Shortly pressing the key (under 0.8 seconds): Plays the next song.
- Pressing and holding the key (over 0.8 seconds): Fast forwards the song.

Scan

While song (file) is playing ▶  key
Scans all songs for 10 seconds starting from the next song.

- *Press the  key again to turn off.
- *The SCAN function is not supported in iPod mode.

Folder Search : MP3 CD, USB Mode



While file is playing ▶  key
(Folder Up) key

- Searches the next folder.

While file is playing ▶  key
(Folder Down) key

- Searches the previous folder.
- *If a folder is selected by pressing the  TUNE knob, the first file within the selected folder will be played.

Searching Songs (File)

- Turning  TUNE knob : Searches for songs (files)
- Pressing  TUNE knob : Plays selected song (file).

MENU : Audio CD

Press the CD MP3 mode **MENU** key to set the Repeat, Random, Information features.



Repeat

Press the **MENU** key ▶ Set [**1**RPT] through the **TUNE** knob or **1** key to repeat the current song.

*Press RPT again to turn off.

Random

Press the **MENU** key ▶ Set [**2**RDM] through the **TUNE** knob or **2** key to randomly play songs within the current folder.

*Press RDM again to turn off.

Information

Press the **MENU** key ▶ Set [**3**Info] through the **TUNE** knob or **3** key to display information of the current song.

*Press the **MENU** key to turn off info display.

MENU : MP3 CD / USB

Press the CD MP3 mode **MENU** key to set the Repeat, Folder Random, Folder Repeat, All Random, Information, and Copy features.



Repeat

Press the **MENU** key ▶ Set [**1**RPT] through the **TUNE** knob or **1** key to repeat the current song.

* Press RPT again to turn off.

Folder Random

Press the **MENU** key ▶ Set [**2**F.RDM] through the **TUNE** knob or **2** key to randomly play songs within the current folder.

* Press F.RDM again to turn off.

Folder Repeat

Press the **MENU** key ▶ Set [**3**F.RPT] through the **TUNE** knob or **3** key to repeat songs within the current folder.

* Press F.RPT again to turn off.

All Random

Press the **MENU** key ▶ Set [**4**A.RDM] through the **TUNE** knob or **4** key to randomly play all songs within the CD.

* Press A.RDM again to turn off.

Information

Press the **MENU** key ▶ Set [**5**Info] through the **TUNE** knob or **5** key to display information of the current song.

* Press the **MENU** key to turn off info display.

Copy

Press the **MENU** key ▶ Set [**6**Copy] through the **TUNE** knob or **6** key.

This is used to copy the current song into My Music. You can play the copied Music in My Music mode.

* If another key is pressed while copying is in progress, a pop up asking you whether to cancel copying is displayed.

* If another media is connected or inserted (USB, CD, iPod®, AUX) while copying is in progress, copying is canceled.

* Music will not be played while copying is in progress.

MENU : iPod®

In iPod® mode, press the **MENU** key to set the Repeat, Random, Information and Search features.

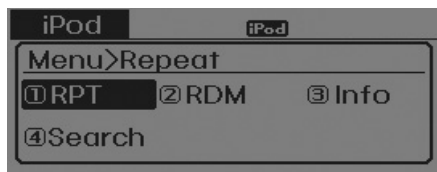

Repeat

Press the **MENU** key ▶ Set [**1**RPT] through the **TUNE** knob or **1** **RPT** key to repeat the current song.

* Press RPT again to turn repeat off.

Random

Press the **MENU** key ▶ Set [**2**RDM] through the **TUNE** knob or **2** **RDM** key.

Plays all songs within the currently playing category in random order.

* Press RDM again to turn off.

Information

Press the **MENU** key ▶ Set [**3**Info] through the **TUNE** knob or **3** key.

Displays information of the current song.

* Press the **MENU** key to turn off info display.

Search

Press the **MENU** key ▶ Set [**4**Search] through the **TUNE** knob or **4** key.

Displays iPod® category list.

* Searching iPod® category is **MENU** key pressed, move to parent category.

MENU : My Music Mode

In My Music mode, press the **MENU** key to set the Repeat, Random, Information, Delete, Delete All, and Delete Selection features.

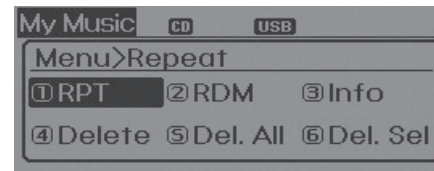

Repeat

Press the **MENU** key ▶ Set [**1**RPT] through the **TUNE** knob or **1** key. Repeats the currently playing song.

* Press RPT again to turn repeat off.

Random

Press the **MENU** key ▶ Set [**2**RDM] through the **TUNE** knob or **2** key.

Plays all songs within the currently playing folder in random order.

* Press RDM again to turn random off.

Information

Press the **MENU** key ▶ Set [**3**Info] through the **TUNE** knob or **3** key. Displays information of the current song.

*Press the **MENU** key to turn off info display.

Delete

Press the **MENU** key ▶ Set [**4**Delete] through the **TUNE** knob or **4** key.

- Deletes currently playing file

In the play screen, pressing delete will delete the currently playing song.

- Deletes file from list

① Select the file you wish to delete by using the **TUNE** knob.

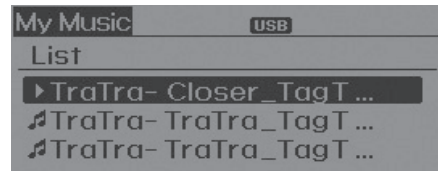

② Press the **MENU** key and select the delete menu to delete the selected file.

Delete All

Press the **MENU** key ▶ Set [**5**Del.All] through the **TUNE** knob or **5** key. Deletes all songs of My Music.

Delete Selection

Press the **MENU** key ▶ Set [**6**Del.Sel] through the **TUNE** knob or **6** key. Songs within My Music are selected and deleted.

① Select the songs you wish to delete from the list.

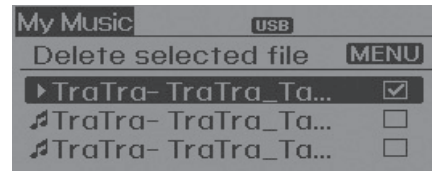

② After selecting, press the **MENU** key and select the delete menu.



AUX

AUX is used to play external MEDIA currently connected with the AUX terminal.

AUX mode will automatically start when an external device is connected to the AUX terminal.

If an external device is connected, you can also press the **MEDIA** key to change to AUX mode.



*AUX mode cannot be started unless there is an external device connected to the AUX terminal.

Bluetooth® Wireless Technology AUDIO

What is Bluetooth® Wireless Technology?

Bluetooth® Wireless Technology allows devices to be connected in a short distance, including hands-free devices, stereo headsets, wireless remote controllers, etc. For more information, visit the Bluetooth® Wireless Technology website at www.Bluetooth.com

Before using Bluetooth® Wireless Technology audio features

- Bluetooth® Wireless Technology audio may not be supported depending on the compatibility of your Bluetooth® Wireless Technology mobile phone.
- In order to use Bluetooth® Wireless Technology audio, you must first pair and connect the Bluetooth® Wireless Technology mobile phone.

- Bluetooth® Wireless Technology audio can be used only when the [Audio Streaming] of Phone is turned .

*Setting Bluetooth® Wireless Technology Audio Streaming : Press the **SETUP** key ▶ Select [Phone] through the tune knob or **3** key ▶ Select [Audio Streaming] through the  TUNE knob ▶ Set 

Starting Bluetooth® Wireless Technology Audio

- Press the **MEDIA** key to change the mode in order of CD → USB → AUX → My Music → BT Audio.
- If BT Audio is selected, Bluetooth® Wireless Technology audio will start playing.
- *Audio may not automatically start playing in some mobile phones.

Using the Bluetooth® Wireless Technology audio features

- Play / Stop

Press the  TUNE knob to play and pause the current song.

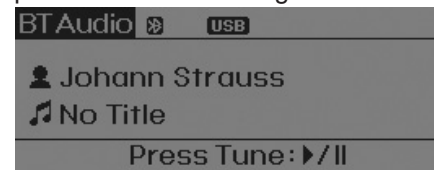

- *The play / pause functions may not be supported in some mobile phones.

PHONE (IF EQUIPPED)



Before using the *Bluetooth*® Wireless Technology phone features



- In order to use *Bluetooth*® Wireless Technology phone, you must first pair and connect the *Bluetooth*® Wireless Technology mobile phone.
- If the mobile phone is not paired or connected, it is not possible to enter Phone mode. Once a phone is paired or connected, the guidance screen will be displayed.
- If Priority is set upon vehicle ignition (IGN/ACC ON), the *Bluetooth*® Wireless Technology phone will be automatically connected. Even if you are outside, the first *Bluetooth*® Wireless Technology phone will be automatically connected once you are in the vicinity of the vehicle. If you do not want automatic *Bluetooth*® Wireless Technology phone connection, set the *Bluetooth*® Wireless Technology power to OFF.

Making a call using the Steering wheel remote controller



*The actual feature in the vehicle may differ from the illustration.

1. VOLUME button : Raises or lowers speaker volume.
2. MUTE button : Mute the microphone during a call.
3.  button : Places and transfers calls.
4.  button : Ends calls or cancels functions.

- Check call history and making call
 - ① Shortly press (under 0.8 seconds) the  key on the steering remote controller.
 - ② The call history list will be displayed on the screen.
 - ③ Press the  key again to connect a call to the selected number.
- Redialing the most recently called number
 - ① Press and hold (over 0.8 seconds) the  key on the steering remote controller.
 - ② The most recently called number is redialed.

Bluetooth® Wireless Technology

Pairing a Bluetooth® Wireless Technology Device

What is Bluetooth® Wireless Technology Pairing?

Pairing refers to the process of synchronizing your *Bluetooth®* Wireless Technology phone or device with the car audio system for connection. Pairing is necessary to connect and use the *Bluetooth®* Wireless Technology feature.

⚠ WARNING

Driving while distracted can result in a loss of vehicle control that may lead to an accident, severe personal injury, and death. The driver's primary responsibility is in the safe and legal operation of a vehicle, and use of any handheld devices, other equipment, or vehicle systems which take the driver's eyes, attention and focus away from the safe operation of a vehicle or which are not permissible by law should never be used during operation of the vehicle.

Pairing **PHONE** Key / Key on the Steering Remote Controller

When No Devices have been Paired

1. Press the **PHONE** key or the  key on the steering remote controller. The following screen is displayed.

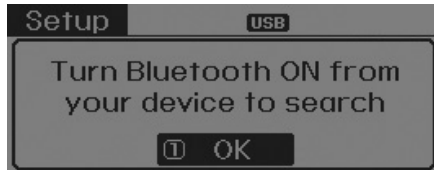

2. Select [OK] button to enter the Pair Phone screen.

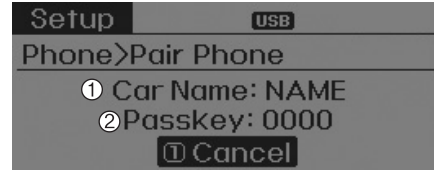

- 1) Car Name : Name of device as shown when searching from your *Bluetooth*[®] Wireless Technology device
- 2) Passkey : Passkey used to pair the device
3. From your *Bluetooth*[®] Wireless Technology device (i.e. Mobile Phone), search and select your car audio system.

[Non SSP supported device]
(SSP: Secure Simple Pairing)

4. After a few moments, a screen is displayed where the passkey is entered.
Hear, enter the passkey "0000" to pair your *Bluetooth*[®] Wireless Technology device with the car audio system.

[SSP supported device]

4. After a few moments, a screen is displayed 6 digits passkey .
Hear, check the passkey on your *Bluetooth*[®] Wireless Technology device and confirm.

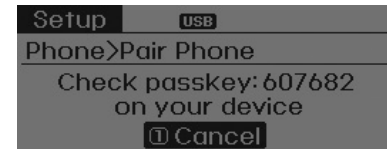

5. Once pairing is complete, the following screen is displayed.

During the pairing process, make sure that all connection requests on the phone are accepted for phonebook download and to allow acceptance of all future connection requests. Visit <http://www.hyundaiusa.com/Bluetooth> for additional information on pairing your Bluetooth-enabled mobile phone, and to view a phone compatibility list.

* NOTICE



If **Bluetooth®** Wireless Technology devices are paired but none are currently connected, pressing the **PHONE** key or the  key on the steering wheel displays the following screen. Select [Pair] button to pair a new device or select [Connect] to connect a previously paired device.

Pairing through [PHONE] Setup

Press the **SETUP** key ▶ Select [Phone] ▶ Select [Pair Phone] ▶ Select **TUNE** knob

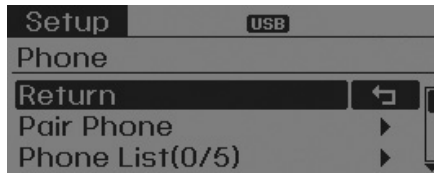

1. The following steps are the same as those described in the section "When No Devices have been Paired" on the previous page.

* NOTICE

- **Bluetooth®** Wireless Technology features supported within the vehicle are as follows. Some features may not be supported depending on your **Bluetooth®** Wireless Technology device.
 - **Outgoing/Incoming Handsfree calls**

(Continued)

(Continued)

- Operations during a call (Switch to Private, Switch to call waiting, MIC on/off)
- Downloading Call History
- Downloading Mobile Contacts
- **Bluetooth®** Wireless Technology device auto connection
- Bluetooth Audio Streaming
- Up to five **Bluetooth®** Wireless Technology devices can be paired to the Car Handsfree system.
- Only one **Bluetooth®** Wireless Technology device can be connected at a time.
- Other devices cannot be paired while a **Bluetooth®** Wireless Technology device is connected.
- Only **Bluetooth®** Wireless Technology Handsfree and Bluetooth audio related features are supported.
- Bluetooth related operations are possible only within devices that support Handsfree or audio features, such as a **Bluetooth®** Wireless Technology mobile phone or a Bluetooth audio device.

(Continued)

(Continued)

- If a connected **Bluetooth®** Wireless Technology device becomes disconnected due to being out of communication range, turning the device OFF, or a **Bluetooth®** Wireless Technology communication error, corresponding **Bluetooth®** Wireless Technology devices are automatically searched and reconnected.
- If the system becomes unstable due to communication errors between the car Handsfree and the **Bluetooth®** Wireless Technology device, reset the device by turning off and back on again. Upon resetting **Bluetooth®** Wireless Technology device, the system will be restored.
- After pairing is complete, a contacts download request is sent once to the mobile phone. Some mobile phones may require confirmation upon receiving a download request, ensure your mobile phone accepts the connection. Refer to your phones user's manual for additional information regarding phone pairing and connections.

Connecting a Device

Press the **SETUP** key ▶ Select [Phone] ▶ Select [Paired Phone List]

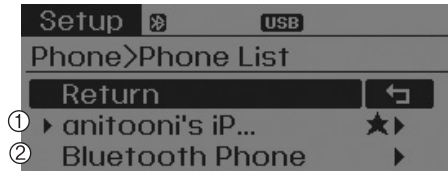

- 1) Connected Phone : Device that is currently connected
- 2) Paired Phone : Device that is paired but not connected

From the paired phone list, select the device you want to connect and select [Connect].

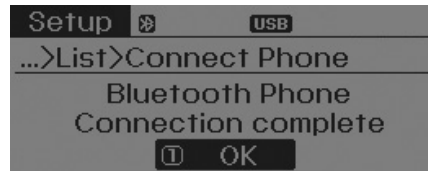
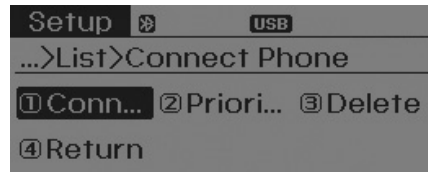

Changing Priority

What is Priority?

It is possible to pair up to five *Bluetooth*® Wireless Technology devices with the car audio system. The "Change Priority" feature is used to set the connection priority of paired phones.

Press the **SETUP** key ▶ Select [Phone] ▶ Select [Paired Phone List]

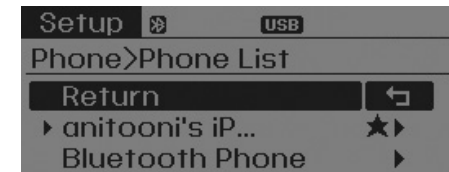

From the paired phone list, select the phone you want to switch to the highest priority, then select [Change Priority] button from the Menu. The selected device will be changed to the highest priority.

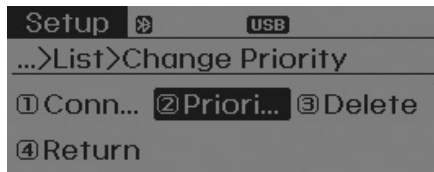

* NOTICE

Priority icon will be displayed when the selected phone is set as a priority phone.

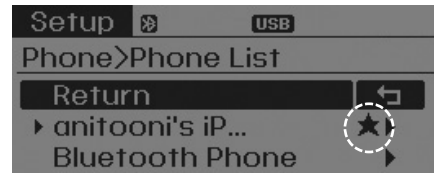

Disconnecting a Device

Press the **SETUP** key ▶ Select [Phone] ▶ Select [Paired Phone List]

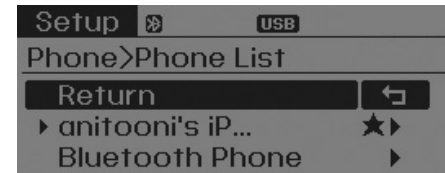

From the paired phone list, select the currently connected device and select [Disconnect] button.

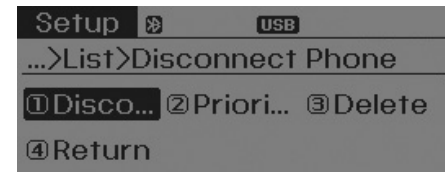

Deleting a Device

Press the **SETUP** key ▶ Select [Phone] ▶ Select [Paired Phone List]

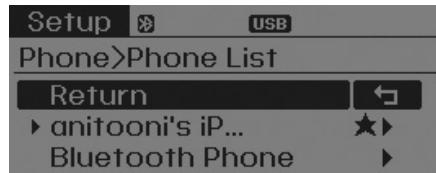

From the paired phone list, select the device you want to delete and select [Delete] button.

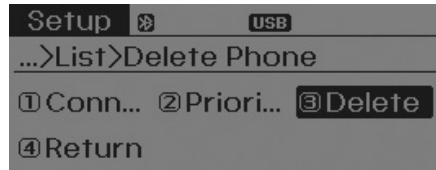

* NOTICE

- When deleting the currently connected device, the device will automatically be disconnected to proceed with the deleting process.
- If a paired *Bluetooth*® Wireless Technology device is deleted, the device's call history and contacts data will also be deleted.
- To re-use a deleted device, you must pair the device again.

USING *Bluetooth*[®] WIRELESS TECHNOLOGY (IF EQUIPPED)

Phone Menu Screen

Phone Menus

With a *Bluetooth*[®] Wireless Technology device connected, press the **PHONE** key to display the Phone menu screen.



- 1) Favorite : Up to 20 frequently used contacts saved for easy access
- 2) Call History : Device the call history list screen
- 3) Contacts : Displays the Contacts list screen
- 4) Setup : Displays Phone related settings.

* NOTICE

- If you select the [Call History] button but there is no call history data, a prompt is displayed which asks to download call history data.
- If you select the [Contacts] button but there is no contacts data stored, a prompt is displayed which asks to download contacts data.
- This feature may not be supported in some mobile phones. For more information on download support, refer to your mobile phone user's manual.

Answering Calls

Answering a Call

Answering a call with a *Bluetooth*[®] Wireless Technology device connected will display the following screen.

To accept the call, press  key on the steering wheel while the call is incoming.

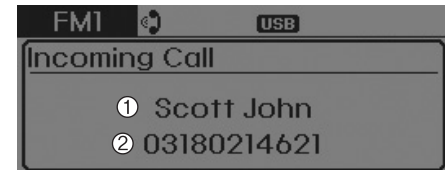

- 1) Caller : Displays the other party's name when the incoming caller is saved within your contacts
- 2) Incoming Number : Displays the incoming number

* NOTICE

- When an incoming call pop-up is displayed, most Audio and SETUP mode features are disabled. Only the call volume will operate.
- The telephone number may not be properly displayed in some mobile phones.
- When a call is answered with the mobile phone, the call mode will automatically revert to Private mode.

Favorites

Press the **PHONE** key ▶ Select [Favorites]



- 1) Saved favorite contact : Connects call upon selection
- 2) To add favorite : Downloaded contacts be saved as favorite.

* NOTICE

- To save Favorite, contacts should be downloaded.
- Contact saved in Favorites will not be automatically updated if the contact has been updated in the phone. To update Favorites, delete the Favorite and create a new Favorite.

Call History

Press the **PHONE** key ▶ Select [Call History]



A list of incoming, outgoing and missed calls is displayed.

- Call history may not be saved in the call history list in some mobile phones.
- Calls received with hidden caller ID will not be saved in the call history list.
- Calling through the call history is not possible when there is no call history stored or a *Bluetooth*® Wireless Technology phone is not connected.
- Up to 50 received, dialed and missed calls are stored in Call History.
- Time of received/dialed calls and call time information are not saved.

Contacts

Press the **PHONE** key ▶ Select [Contacts]

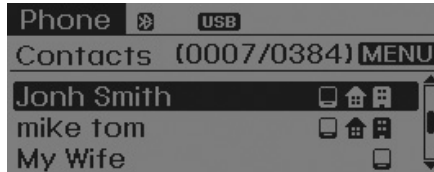

The list of saved phone book entries is displayed.

NOTE:

Find a contact in an alphabetical order, press the **MENU** key.

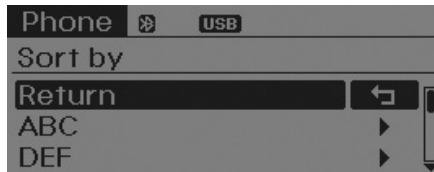

* NOTICE

- Up to 1,000 contacts saved in your *Bluetooth*® Wireless Technology phone can be downloaded into the car contacts. Contacts that have been downloaded to the car cannot be edited or deleted on the phone.
- Mobile phone contacts are managed separately for each paired *Bluetooth*® Wireless Technology device (max 5 devices x 1,000 contacts each). Previously downloaded data is maintained even if the *Bluetooth*® Wireless Technology device has been disconnected. (However, the contacts and call history saved to the phone will be deleted if a paired phone is deleted.)
- It is possible to download contacts during Bluetooth streaming audio.
- When downloading contacts, the icon will be displayed within the status bar.

(Continued)

(Continued)

- It is not possible to begin downloading a contact list when the contact download feature has been turned off within the *Bluetooth*® Wireless Technology device. In addition, some devices may require device authorization upon attempting to download contacts. If downloading does not normally occur, check the *Bluetooth*® Wireless Technology device settings or the screen state.
- The contacts download feature may not be supported in some mobile phones. For more information of supported *Bluetooth*® devices and function support, refer to your phone's user manual.

Bluetooth® Wireless Technology Setting

The *Bluetooth*® word mark and logos are registered trademarks owned by Bluetooth SIG, Inc. and any use of such marks by Hyundai is under license. Other trademarks and trade names are those of their respective owners. A *Bluetooth*® enabled cell phone is required to use *Bluetooth*® Wireless Technology.

⚠ WARNING

Driving while distracted can result in a loss of vehicle control that may lead to an accident, severe personal injury, and death. The driver's primary responsibility is in the safe and legal operation of a vehicle, and use of any handheld devices, other equipment, or vehicle systems which take the driver's eyes, attention and focus away from the safe operation of a vehicle or which are not permissible by law should never be used during operation of the vehicle.

Pairing a New Device

Press the **SETUP** key ▶ Select [Phone] ▶ Select [Pair Phone]



Bluetooth® Wireless Technology devices can be paired with the audio system.

For more information, refer to the "Pairing through Phone Setup" section within *Bluetooth*® Wireless Technology.

Viewing Paired Phone List

Press the **SETUP** key ▶ Select [Phone] ▶ Select [Paired Phone List]

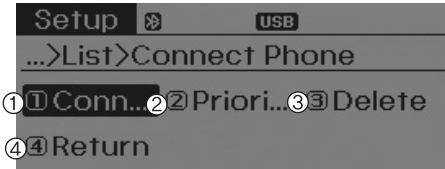
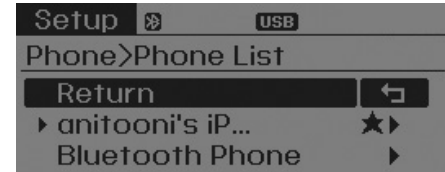

This feature is used to view mobile phones that have been paired with the audio system. Upon selecting a paired phone, the setup menu is displayed.

For more information, refer to the "Setting *Bluetooth*® Wireless Technology Connection" section within *Bluetooth*® Wireless Technology.

- 1) Connect/Disconnect Phone : Connect/ disconnects currently selected phone
- 2) Change Priority : Sets currently selected phone to highest connection priority
- 3) Delete : Deletes the currently selected phone
- 4) Return : Moves to the previous screen

*** NOTICE BEFORE DOWNLOADING CONTACTS**

- Only contacts within connected phones can be downloaded. Also check to see that your mobile phone supports the download feature.
- To learn more about whether your mobile phone supports contacts downloads, refer to your mobile phone user's manual.
- The contacts for only the connected phone can be downloaded.

Downloading Contacts

Press the **SETUP** key ▶ Select [Phone] ▶ Select [Contacts Download]



As the contacts are downloaded from the mobile phone, a download progress bar is displayed.

*** NOTICE**

- Upon downloading phone contacts, the previous corresponding data is deleted.
- This feature may not be supported in some mobile phones.
- Voice Recognition may not operate while contacts are being downloaded.

Outgoing Volume

Press the **SETUP** key ▶ Select [Phone] ▶ Select [Outgoing Volume]

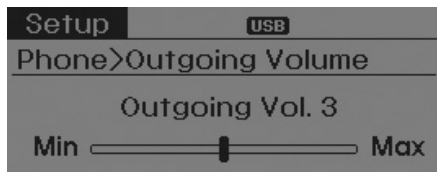

Use **TUNE** knob to adjust the outgoing volume level.

* NOTICE

While on a call, the volume can be changed by using the **SEEK TRACK** key.

Turning Bluetooth System Off

Press the **SETUP** key ▶ Select [Phone] ▶ Select [Bluetooth System Off]

Once *Bluetooth*® Wireless Technology is turned off, *Bluetooth*® Wireless Technology related features will not be supported within the audio system.

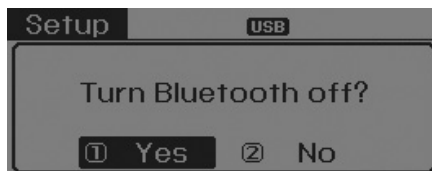
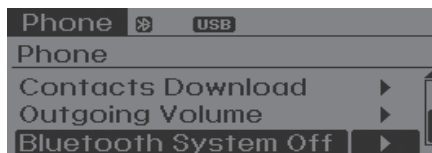

* NOTICE

To turn *Bluetooth*® Wireless Technology back on, go to **SETUP** ▶ [Phone] and select "Yes".

VOICE RECOGNITION

Using Voice Recognition

Starting Voice Recognition

Shortly press the  key on the steering wheel. Say a command.

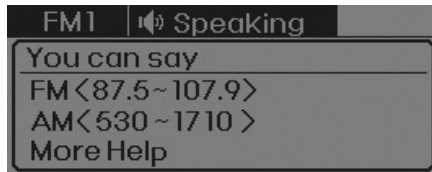

If prompt feedback is in [ON], then the system will say "Please say a command after the beep (BEEP)"

- If prompt feedback is in [OFF] mode, then the system will only say "(BEEP)"
- To change Prompt Feedback [On]/[Off], go to **SETUP** ► [System] ► [Prompt Feedback]

* NOTICE

For proper recognition, say the command after the voice instruction and beep tone.

Contact List Best Practices

- 1) Do not store single-name entries (e.g., "Bob", "Mom", "Kim", etc.). Instead, always use full names (including first and last names) for all contacts (e.g., use "Jacob Stevenson" instead of "Dad").
- 2) Do not use abbreviations (i.e., use "Lieutenant" instead of "Lt." or "Sergeant" instead of "Sgt.>").
- 3) Do not use acronyms (i.e., use "County Finance Department" instead of "CFD").
- 4) Do not use special characters (e.g., "@", "hyphen -", "asterisk **", "ampersand &").
- 5) If a name is not recognized from the contact list, change it to a more descriptive name (e.g., use "Grandpa Joseph" instead of "Pa Joe").

Skipping Prompt Messages

While prompt message is being stated ► Shortly press the  key on the steering remote controller

The prompt message is immediately ended and the beep tone will sound. After the "beep", say the voice command.

Re-starting Voice Recognition

While system waits for a command ► Shortly press the  key on the steering remote controller

The command wait state is immediately ended and the beep tone will sound. After the "beep", say the voice command.

ENDING VOICE RECOGNITION

While Voice Recognition is operating
▶ Press and hold the  key on the steering remote controller

* NOTICE

- While using voice command, pressing any steering wheel control or a different key will end voice command.
- When the system is waiting for a voice command, say “cancel” or “end” to end voice command.
- When the system is waiting for a voice command, press and hold the  key on the steering wheel to end voice command.

Voice Recognition and Phone Contact Tips:

The Hyundai Voice Recognition System may have difficulty understanding some accents or uncommon names.

When using Voice Recognition to place a call, speak in a moderate tone, with clear pronunciation To maximize the use of Voice Recognition, consider these guidelines when storing contacts:

- Do not store single-name entries (e.g., “Bob”, “Mom”, etc.). Instead, always use full names (including first and last names) for these contacts
- Do not use special characters (e.g., '@', '-', '*', '&', etc.)
- Do not use abbreviations (i.e., use “Lieutenant” instead of “Lt.”) or acronyms (i.e., use “County Finance Department” instead of “C. F. D.”; Be sure to say the name exactly as it is entered in the contacts list

Illustration on using voice commands

- Starting voice command.

Shortly pressing the  key (under 0.8 seconds):

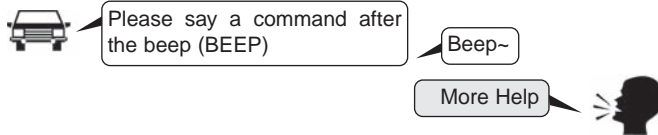



More Help
 Here are some examples of mode commands. You can say a radio type like 'FM', 'AM', or 'Satellite'. You can also say a media source like 'USB', 'My Music', or 'iPod'. Additionally, there are phone commands like "Contacts", 'Call History', or 'Dial Number". You can find more detailed commands in the user's manual. Please say a command after the beep.

More Help
 Here are some examples of mode commands. You can say a radio type like 'FM', 'AM', or 'Satellite'. You can also say a media source like 'USB', 'My Music', or 'iPod'. Additionally, there are phone commands like "Contacts", 'Call History', or 'Dial Number". You can find more detailed commands in the user's manual. Please say a command after the beep.

- Skipping Voice Recognition

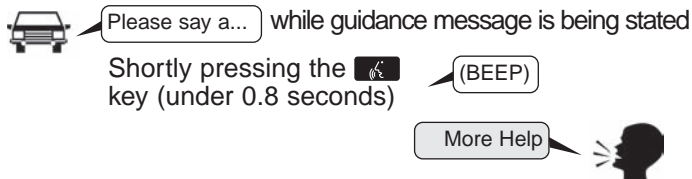
Shortly pressing the  key (under 0.8 seconds):



Shortly pressing the  key (under 0.8 seconds)

- End voice command.

Shortly pressing the  key (under 0.8 seconds):

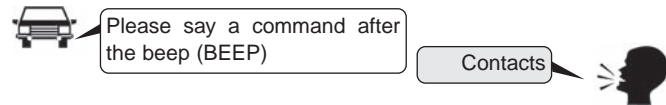

Contacts.
 Please say the name of the contact you want to call.



Voice Command List

- **Common Commands:** These commands can be used in most operations. (However a few commands may not be available during certain operations)

| Command | Function |
|-----------------------|---|
| More Help | Provides guidance on commands that can be used anywhere in the system. |
| Help | Provides guidance on commands that can be used within the current mode. |
| Call<Name> | Calls <Name> saved in Contacts Ex) Call "John Smith" |
| Call <Name> on Mobile | Calls <Name> to the number that is saved as "Mobile" in Contacts Ex) Call "John Smith" on Mobile |
| Call <Name> in Office | Calls <Name> to the number that is saved as "Office" in Contacts Ex) Call "John Smith" in Office |
| Call <Name> at Home | Calls <Name> to the number that is saved as "Home" in Contacts Ex) Call "John Smith" at Home |
| Call <Name> on Other | Calls <Name> to the number that is saved as "Other" in Contacts Ex) Call "John Smith" on Other |
| Phone | Provides guidance on Phone related commands. After saying this command, say "Favorites", "Call History", "Contacts" or "Dial Number" execute corresponding functions. |
| Favorites | Display the Favorite screen. |
| Call History | Displays the Call History screen. |

| Command | Function |
|-------------------------|--|
| Contacts (Call by Name) | Displays the Contacts screen. After saying this command, say the name of a contact saved in the Contacts to automatically connect the call. |
| Dial Number | Display the Dial number screen. After saying this command, you can say the number that you want to call. |
| Redial | Connects the most recently called number. |
| Tutorial | Provide guidance on how to use voice recognition and Bluetooth® connections. |
| Radio | <ul style="list-style-type: none"> • When listening to the radio, displays the next radio screen. (FM1→FM2→AM→XM1→XM2→XM3→FM1) • When listening to a different mode, displays the most recently played radio screen. • When currently listening to the FM radio, maintains the current state. • When listening to a different mode, displays the most recently played FM screen. |
| FM1(FM One) | Displays the FM1 screen. |
| FM2(FM Two) | Displays the FM2 screen. |
| AM | Displays the AM screen. |

| Command | Function |
|-------------------------|--|
| FM Preset 1~6 | Plays the most recently played broadcast saved in FM Preset 1~6. |
| AM Preset 1~6 | Plays the broadcast saved in AM Preset 1~6. |
| FM 87.5~107.9 | Plays the FM broadcast of the corresponding frequency. |
| AM 530~1710 | Plays the AM broadcast of the corresponding frequency. |
| SiriusXM™ | <ul style="list-style-type: none"> • When currently listening to the SiriusXM™, maintains the current state. • When listening to a different mode, displays the most recently played SiriusXM™ screen. |
| SiriusXM™ 1~3 | Displays the selected XM screen. |
| SiriusXM™ Channel 0~255 | Plays the selected XM channel. |
| Media | Moves to the most recently played media screen. |
| CD | Plays the music saved in the CD. |
| USB | Plays USB music. |
| iPod® | Plays iPod music. |

| Command | Function |
|------------------|---|
| My Music | Plays the music saved in My Music. |
| AUX (Auxiliary) | Plays the connected external device. |
| Bluetooth® Audio | Plays the music saved in connected Bluetooth® device. |
| Please repeat | Repeats the most recent comment. |
| Mute | Mutes the sound. |
| Cancel (Exit) | Ends voice command. |

Features of your vehicle

- FM/AM radio commands: Commands available during FM, AM radio operation

| Command | Function |
|-------------|---|
| Preset 1~6 | Plays the broadcast station saved in Preset 1~6. |
| Scan | Scans receivable frequencies from the current broadcast and plays for 10 seconds each. |
| Preset Scan | Moves to the next preset from the current present and plays for 10 seconds each. |
| Information | Displays the information of the current broadcast. (This feature can be used when receiving RBDS broadcasts.) |

- Satellite radio commands: Commands that can be used while listening to Satellite Radio.

| Command | Function |
|---------------|---|
| Channel 0~255 | Play the selected Satellite Radio channel. |
| Scan | Scans receivable channels from the current broadcast and plays for 10 seconds each. |
| Preset 1~6 | Plays the broadcast saved in Preset 1~6. |
| Information | Displays the information of the current broadcast. |

- Audio CD commands: Commands available during Audio CD operation

| Command | Function |
|------------|---|
| Random | Randomly plays the tracks within the CD. |
| Random Off | Cancels random play to play tracks in sequential order. |
| Repeat | Repeats the current track. |
| Repeat Off | Cancels repeat play to play tracks in sequential order. |
| Track 1~30 | Plays the desired track number. |

- MP3 CD / USB commands: Commands available during USB and MP3 CD operation

| Command | Function |
|-----------------|--|
| Random | Randomly plays the files within the current folder. |
| Random Off | Cancels random play to play files in sequential order. |
| Repeat | Repeats the current file. |
| Repeat Off | Cancels repeat play to play files in sequential order. |
| Information | Displays the information screen of the current file. |
| Next Folder | Play the first file in the next folder |
| Previous Folder | Play the first file in the previous folder |

Features of your vehicle

- iPod® Commands: Commands available during iPod® operation

| Command | Function |
|------------|--|
| Random | Randomly plays the songs within the current category. |
| Random Off | Cancels random play to play songs in sequential order. |
| Repeat | Repeats the current song. |
| Repeat Off | Cancels repeat play to play songs in sequential order. |

- My Music Commands: Commands available during My Music operation

| Command | Function |
|------------|---|
| Random | Randomly plays all saved files. |
| Random Off | Cancels random play to play files in sequential order. |
| Repeat | Repeats the current file. |
| Repeat Off | Cancels repeat play to play files in sequential order. |
| Delete | Deletes the current file. You will bypass an additional confirmation process. |

- **Bluetooth® Wireless Technology Audio Commands:** Commands available during *Bluetooth®* Wireless Technology audio streaming from mobile phone operation Command Operation

| Command | Function |
|---------|----------------------------------|
| Play | Plays the currently paused song. |
| Pause | Pauses the current song. |

SiriusXM™ service requires a subscription, sold separately, after 3-month trial included with vehicle purchase. If you decide to continue your SiriusXM™ service at the end of your trial subscription, the plan you choose will automatically renew and bill at then-current rates until you call us at 1-866-635-2349 to cancel. See our Customer Agreement for complete terms at www.siriusxm.com. Other fees and taxes apply. All fees and programming are subject to change. Sirius satellite service is available only to those at least 18 and older in the 48 contiguous USA, D.C., and PR (with coverage limitations). Our Internet radio service is available throughout our satellite service area and in AK and HI. Certain channels are not available on our Internet radio service or on mobile devices. SiriusXM Traffic available in select markets. See siriusxm.com/traffic for more information. © 2013 Sirius XM Radio Inc. Sirius, XM and all related marks and logos are trademarks of Sirius XM Radio Inc. iPod® is a registered trademark of Apple Inc. iPod® mobile digital device sold separately. The *Bluetooth®* word mark and logos are registered trademarks owned by Bluetooth SIG, Inc. and any use of such marks by Hyundai is under license. A *Bluetooth®* enabled cell phone is required to use *Bluetooth®* wireless technology. All rights reserved.

■ CD Player : AM9B0MDKN, AM9B0MDAN, AM9B1MDAN



■ CD Player : AM980MDKN, AM980MDAN



* No  Bluetooth logo will be shown if the *Bluetooth*[®] Wireless Technology feature is not supported.

SYSTEM CONTROLLERS AND FUNCTIONS

Audio Head Unit





1.  (EJECT)
• Ejects the disc.

2. **RADIO**
- Convert to Radio mode.
 - Each time the key is pressed, the mode is changed in order of FM1, FM2, AM, XM1, XM2, XM3.

3. **MEDIA**
- Convert to Media Mode
 - Each time the key is pressed, the mode is changed in order of CD, USB(iPod®), AUX, My Music, BT Audio.

4. **PHONE** (for *Bluetooth*® Wireless Technology equipped model)
- Converts to Phone mode
 - ✳When a phone is not connected, the connection screen is displayed.

5. PWR/VOL knob
-  Power : Press to turn power on/off.
 -  Volume : Turn left/right to control volume.

6. 
- When pressed shortly (under 0.8 seconds)
 - Radio mode : plays previous/next frequency.
 - Media (CD/USB/iPod®/My Music) modes : changes the track, Song(file)
 - When pressed and held (Over 0.8 seconds)
 - Radio mode : continuously changes the frequency. Upon release, plays the current frequency.
 - Media (CD/USB/iPod®/My Music) modes : rewinds or fast forwards the track or file
 - During a Handsfree call, controls the call volume.

7. 
- XM RADIO™ : Category Search
 - CD/USB/MP3 mode : Search Folder



8. **DISP**

- Turns the monitor display on/off.

9. **MUTE**

When the button is pressed, stopssound and "Audio Mute" is displayed on LCD.

10. **SCAN**

- Radio Mode : previews all receivable broadcasts for 5 seconds each.
- Media (CD/USB/My Music) modes : previews each song (file) for 10 seconds each.
- XM Mode : previews all receivable broadcasts for 10 seconds each.

11. **SETUP**

Converts to Setup mode.

12. **TUNE knob**

- Radio mode : turn to change broadcast frequencies.
- Media (CD/USB/iPod®/My Music) modes : turn to search tracks/channels/files.

13. **DISC-IN LED**

- LED that indicates whether a disc is inserted.

**Audio Head Unit
(For NON Bluetooth model)**



14. **FM/AM**

- Changes to FM mode.
- Each time the key is pressed, the mode changed in order of FM1 → FM2 → AM.

15. **SAT**

- Changes to SiriusXM™ mode.

■ CD Player : AM910MDAN



* No ((XM)) will be shown if the SiriusXM™ feature is not supported.

■ CD Player : AM900MDAN



* No ~~(XM)~~ will be shown if the SiriusXM™ feature is not supported.

* No Bluetooth logo will be shown if the Bluetooth® Wireless Technology feature is not supported.

SYSTEM CONTROLLERS AND FUNCTIONS

Audio Head Unit



1. **EJECT** (EJECT)
- Ejects the disc.

2. **RADIO**

- Convert to Radio mode.
- Each time the key is pressed, the mode is changed in order of FM1, FM2, AM.

3. **MEDIA**

- Convert to Media Mode
- Each time the key is pressed, the mode is changed in order of CD, USB(iPod®), AUX, My Music, BT Audio.

4. **PHONE** (for *Bluetooth*® Wireless Technology equipped model)

- Converts to Phone mode
- ※When a phone is not connected, the connection screen is displayed.

5. PWR/VOL knob

- **Power** : Press to turn power on/off.
- **Volume** : Turn left/right to control volume.

6. **SEEK TRACK**

- When pressed shortly (under 0.8 seconds)
 - Radio mode : plays previous/next frequency.
 - Media (CD/USB/iPod®/My Music) modes : changes the track, Song(file)
- When pressed and held (Over 0.8 seconds)
 - Radio mode : continuously changes the frequency. Upon release, plays the current frequency.
 - Media (CD/USB/iPod®/My Music) modes : rewinds or fast forwards the track or file
 - During a Handsfree call, controls the call volume.

7. **FOLDER**

- CD/USB/MP3 mode : Search Folder



8. DISP

- Turns the monitor display on/off.

9. MUTE

When the button is pressed, stopssound and "Audio Mute" is displayed on LCD.

10. SCAN

- Radio Mode : previews all receivable broadcasts for 5 seconds each.
- Media (CD/USB/My Music) modes : previews each song (file) for 10 seconds each.
- XM Mode : previews all receivable broadcasts for 10 seconds each.

11. SETUP

Converts to Setup mode.

12. TUNE knob

- Radio mode : turn to change broadcast frequencies.
- Media (CD/USB/iPod®/My Music) modes : turn to search tracks/ channels/files.

**Audio Head Unit
(For NON Bluetooth model)**



13. FM

- Changes to FM mode.
- Each time the key is pressed, the mode changed in order of FM1 → FM2.

14. AM

- Changes to AM mode.

Making a call using the Steering-wheel mounted controls



* The actual feature in the vehicle may differ from the illustration.

1. VOLUME

- Used to control volume.

2. SEEK

- When pressed shortly (under 0.8 seconds)
 - Radio mode : searches broadcast frequencies saved to presets.
 - Media(CD / USB / iPod® / My Music / BT Audio) modes : changes the track, file or chapter.
- When pressed and held (over 0.8 seconds)
 - Radio mode, automatically searches broadcast frequencies and channels
 - Media(CD / USB / iPod® / My Music) modes, rewinds or fast forwards the track or song(file)
 - BT Audio mode may not be supported in some mobile phones.

3. MUTE

- Mutes audio volume.

4. MODE

- Each time this key is pressed, the mode is changed in order of FM1 → FM2 → AM → XM1 → XM2 → XM3 → CD → USB or iPod → AUX → My Music → BT Audio
- If the media is not connected or a disc is not inserted, corresponding modes will be disabled.



5. 

- When pressed shortly
 - Starts voice recognition
 - When selecting during a voice prompt, stops the prompt and converts to voice command waiting state
- When pressed and held (over 0.8 seconds)
 - Ends voice recognition

6. 

- When pressed shortly
 - When pressed in the phone screen, displays call history screen
 - When pressed in the dial screen, makes a call
 - When pressed in the incoming call screen, answers the call
 - When pressed during call waiting, switches to waiting call (Call Waiting)
- When pressed and held (over 0.8 seconds)
 - When pressed in the *Bluetooth*[®] Wireless Technology Handsfree wait mode, redials the last call
 - When pressed during a *Bluetooth*[®] Wireless Technology Handsfree call, switches call back to mobile phone (Private)
 - When pressed while calling on the mobile phone, switches call back to *Bluetooth*[®] Wireless Technology Handsfree (Operates only when *Bluetooth*[®] Wireless Technology Handsfree is connected)

7. 

- Ends phone call

SIRIUSXM™ RADIO MODE

Features of your vehicle

Satellite radio reception

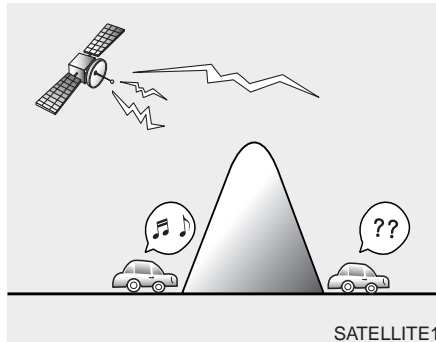

You may experience difficulties in receiving XM satellite™ radio signals in the following situations.

- If you are driving in a tunnel or a covered parking area.
- If you are driving beneath the top level of a multi-level freeway.
- If you are driving under a bridge.
- If you are driving next to a tall vehicle (such as a truck or a bus) that blocks the signal.

- If you are driving in a valley where the surrounding hills or peaks block the signal from the satellite.
- If you are driving on a mountain road where the signal is blocked by mountains.

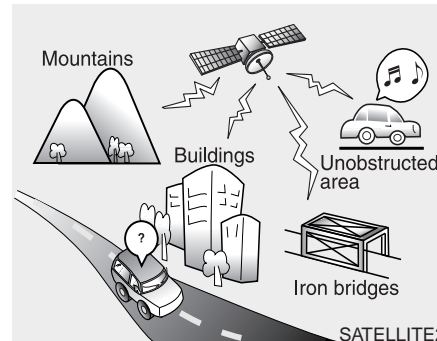

- If you are driving in an area with tall trees that block the signal (30 ft. /10m or more), for example on an road that goes through a dense forest.
- The signal can become weak in some areas that are not covered by the XM repeater network.

NOTE:

There may also be additional unforeseen circumstances leading to reception problems with the XM satellite™ radio signal.

Advisory Messages, such as 'CH Unavailable' may occur when starting XM Radio™.

Basic Mode Screen



1. Mode Display

Displays currently operating mode.

2. Channel Information

Displays the category, channel number, channel name, artist and title information.

3. Preset

Displays currently playing preset number [1] ~ [6].

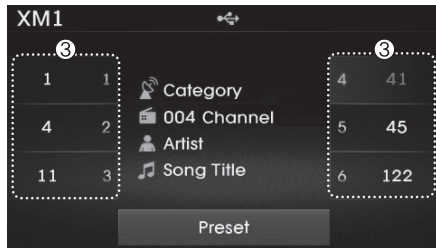

4. Preset Display

Displays saved presets.

Using SEEK

Press the **SEEK TRACK** key to play the previous/next channel.

*If the "Category" icon is displayed, channels are changed within the current category.

Using Tune

Turn the **TUNE** knob to select the desired channel.

SCAN

Press the **SCAN** key to scan all channels with superior reception for 10 seconds each.

Once scan is complete, the previously played channel will be restored.

During Scan, pressing the **SCAN** key again will cancel the scan operation and restore the previously played channel.

If the "Category" icon is displayed, channels are changed within the current category.

Searching Categories

Select the category by using the **CAT FOLDER** key and press the **TUNE** knob to select.

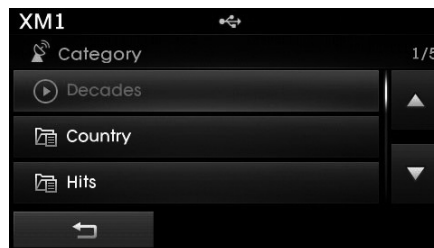

Channels for the selected category are played.

Selecting Presets/Saving Presets

Press the **Preset** button to display the broadcast information for the channel saved to each button.

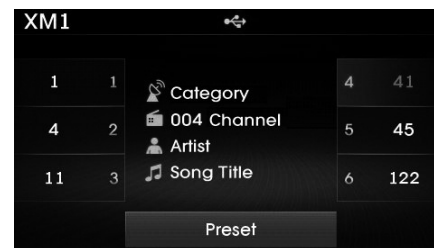

Press the **1** ~ **6** buttons to play the desired preset.

* NOTICE

While listening to a channel you want to save as a preset, press and hold one of the **1** ~ **6** preset buttons (over 0.8 seconds) to save the current channel to the selected preset.

*** NOTICE - USING THE DISCS**

- This device has been manufactured to be compatible with software bearing the following logo marks.
- Do not clean discs with chemical solutions, such as record sprays, antistatic sprays, antistatic liquids, benzene, or thinners.
- After using a disc, put the disc back in its original case to prevent disc scratches.
- Hold discs by their edges or within the center hole to prevent damages to disc surfaces.
- Do not introduce foreign substances into the disc insert/eject slot. Introducing foreign substances could damage the device interior.
- Do not insert two discs simultaneously.
- When using CD-R/CD-RW discs, differences in disc reading and playing times may occur depending on the disc manufacturer, production method and the recording method as used by the user.

(Continued)

(Continued)

- Clean fingerprints and dust off the disc surface (coated side) with a soft cloth.
- The use of CD-R/CD-RW discs attached with labels may result in disc slot jams or difficulties in disc removal. Such discs may also result in noise while playing.
- Some CD-R/CD-RW discs may not properly operate depending on the disc manufacturer, production method and the record method as used by the user. If problems persist, trying using a different CD as continued use may result in malfunctions.
- The performance of this product may differ depending on the CD-RW Drive Software.
- Copy-protected CDs such as S-type CDs may not function in the device. DATA discs cannot be played. (However, such discs may still operate but will do so abnormally.)

(Continued)

(Continued)

- Do not use abnormally shaped discs (8cm, heart-shaped, octagon-shaped) as such discs could lead to malfunctions.
- If the disc is straddled on the disc slot without removal for 10 seconds, the disc will automatically be re-inserted into the disc player.
- Only genuine audio CDs are supported. Other discs may result in recognition failure (e.g. copy CD-R, CDs with labels)

MEDIA MODE

Pressing the **MEDIA** key will change the operating mode in order of CD → USB (iPod®) → AUX → My Music → BT Audio.

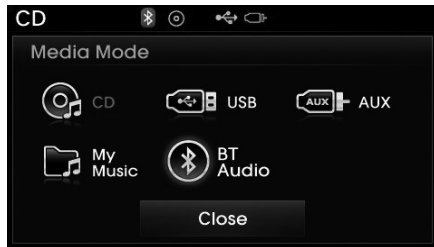

If [Mode Pop up] is turned on within **SETUP** ▶ [Display], then pressing the **MEDIA** key will display the Media Pop-up Mode screen.

Turn the **TUNE** knob to move the focus. Press the knob to select.





* NOTICE

The media mode pop up screen can be displayed only when there are two or more media modes turned on.

Title Icon

When a *Bluetooth*® Wireless Technology, iPod®, USB, or AUX device is connected or a CD is inserted, the corresponding mode icon will be displayed.



| Icon | Title |
|---|--|
|  | <i>Bluetooth</i> ® Wireless Technology |
|  | CD |
|  | iPod® |
|  | USB |
|  | AUX |

AUDIO CD MODE

Basic Mode Screen



1. Mode

Displays currently operating mode.

2. Operation State

From Repeat/Random(Shuffle)/ Scan, displays the currently operating function.

3. Track Info

Displays information about the current track.

4. Play/Pause

Changes the play/pause state.

5. Play Time

Displays the current play time.

6. Info

Shows detailed information about the current track.

7. Random(Shuffle)

Turns the Random(Shuffle) feature on/off.

8. Repeat

Turns the Repeat feature on/off.

9. List

Moves to the list screen.

Using Audio CD Mode

Playing/Pausing CD Tracks

Once an audio CD is inserted, the mode will automatically start and begin playing.



While playing, press the **||** button to pause and press **▶** button to play.

* NOTICE

- Only genuine audio CDs are supported. Other discs may result in recognition failure (e.g. copy CD-R, CDs with labels)
- The artist and title information are displayed on the screen if track information is included within the audio CD.

Changing Tracks

Press the **SEEK TRACK** key to move to the previous or next track.

* NOTICE

- Pressing the **SEEK TRACK** key after the track has been playing for 2 seconds will start the current track from the beginning.
- Pressing the **SEEK TRACK** key before the track has been playing for 1 seconds will start the previous track.

Selecting from the List

Turn the **TUNE** knob left/right to search for the desired track.



Once you find the desired track, press the **TUNE** knob to start playing.

Rewinding / Fast-forwarding Tracks

While playing, press and hold the **SEEK TRACK** key (over 0.8 seconds) to rewind or fast-forward the current track.

Scan

Press the **SCAN** key to play the first 10 seconds of each file.

Audio CD Mode Menu

Within this mode, you will have access to the Info, Random(Shuffle), Repeat and List features.



Info

Press the **Info** button to display details about the current disc.

Random(Shuffle)

Press the **Shuffle** button to play tracks in random(Shuffle) order.

Press the **Shuffle** button again to turn the Random(Shuffle) feature off.

- Random(Shuffle): Plays all tracks in random(Shuffle) order.

Repeat

Press the **Repeat** button to repeat the current track. Press the button again to turn the repeat feature off.

- Repeat : Repeats the current track.

List

Press the **List** button to display the track list screen.

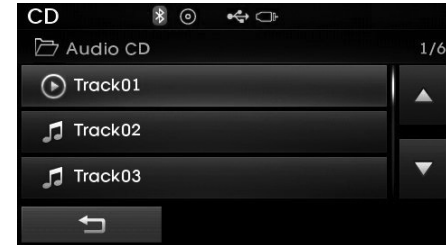

Turn the **TUNE** knob left/right to search for tracks. Once the desired track is displayed, press the knob to select and play.

MP3 CD MODE

Basic Mode Screen

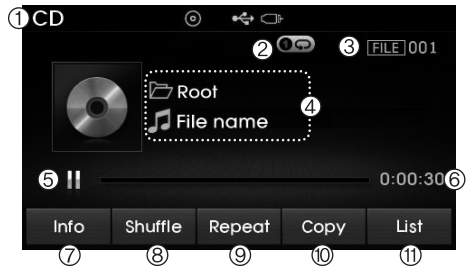

1. Mode

Displays currently operating mode.

2. Operation State

From Repeat/Random(Shuffle)/ Scan, displays the currently operating function.

3. File Index

Displays the current file number.

4. File Info

Displays information about the current file.

5. Play/Pause

Changes the play/pause state.

6. Play Time

Displays the current play time.

7. Info

Shows detailed information about the current file.

8. Random(Shuffle)

Turns the Random(Shuffle) feature on/off.

9. Repeat

Turns the Repeat feature on/off.

10. Copy

Copies the current file into My Music

11. List

Moves to the list screen.

Using MP3 CD Mode

Playing/Pausing MP3 Files

Once an MP3 disc is inserted the mode will automatically start and being playing.



While playing, press the **||** button to pause and press **▶** button to play.



*** NOTICE**

If there are numerous files and folders within the disc, reading time could take more than 10 seconds and the list may not be displayed or song searches may not operate. Once loading is complete, try again.

Changing Files

Press the  key to move to the previous or next file.

* NOTICE

- Pressing the  key after the file has been playing for 2 seconds will start the current file from the beginning.
- Pressing the  key before the file has been playing for 1 seconds will start the previous file.

Selecting from the List

Turn the  knob left/right to search for the desired file.



Once you find the desired file, press the  knob to start playing.

Rewinding / Fast-forwarding Files

While playing, press and hold the  key (over 0.8 seconds) to rewind or fast-forward the current file.

Scan

Press the  key to play the first 10 seconds of each file.

Searching Folders

Press the  key to select and search folders.

Once the desired folder is displayed, press the  knob to select.

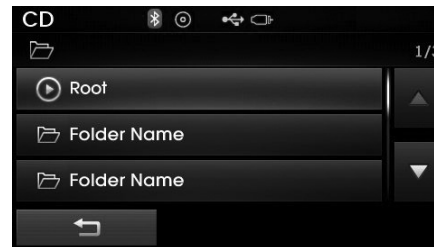

The first file within the selected folder will begin playing.

MP3 CD Mode Menu

Within this mode, you will have access to the Info, Random(Shuffle), Repeat, Copy and List features.



Info

Press the  button to display details about the current file.

* NOTICE

- When the 'Folder File' option is set as the default display within Display setup, the album/artist/file information are displayed as detailed file information.
- When the 'Album Artist Song' option is set as the default display, the folder name/file name are displayed as detailed file information.
- The title, artist and album info are displayed only when such information are recorded within the MP3 file ID3 tag.

Random (Shuffle)

Press the **Shuffle** button to play files in random (Shuffle) order.

Each time the button is pressed, the feature changes in order of Random (Shuffle) Folder → Random (Shuffle) All → Off.

- Random (Shuffle) Folder : Plays all files within the current folder in Random (Shuffle) order.
- Random (Shuffle) All : Plays all files in Random (Shuffle) order.

Repeat

Press the **Repeat** button to repeat the current file or folder.

Each time the button is pressed, the feature changes in order of Repeat → Repeat Folder → Off.

- Repeat: Repeats the current file.
- Repeat Folder: Repeats all files within the current Folder.

Copying Files

Press the **Copy** button to copy the current file into My Music.

* NOTICE

Selecting another feature during copying will display a pop-up asking whether you wish to cancel copying. To cancel, select 'Yes'.

List

Press the **List** button to display the file list screen.



Turn the **TUNE** knob left/right to search for files. Once the desired file is displayed, press the knob to select and play.

*** NOTICE - USING THE USB DEVICE**

- Connect the USB device after turning on the engine. The USB device may become damaged if it is already connected when the ignition is turned on. The USB device may not operate properly if the car ignition is turned on or off with the USB device connected.
- Heed caution to static electricity when connecting/disconnecting USB devices.
- Encoded MP3 Players will not be recognized when connected as an external device.
- When connecting an external USB device, the device may not properly recognize the USB is in some states.
- Only products formatted with byte/sectors under 64Kbyte will be recognized.
- This device recognizes USB devices formatted in FAT 12/16/32 file formats. This device does not recognize files in NTFS file format.

(Continued)

(Continued)

- Some USB devices may not be supported due to compatibility issues.
- Avoid contact between the USB connector with bodily parts or foreign objects.
- Repeated connecting/disconnecting of USB devices within short periods of time may result in product malfunction.
- A strange noise may occur when disconnecting the USB.
- Make sure to connect/disconnect external USB devices with the audio power turned off.
- The amount of time required to recognize the USB device may differ depending on the type, size or file formats stored in the USB. Such differences in time are not indications of malfunctions.
- The device only supports USB devices used to play music files.
- USB images and videos are not supported.

(Continued)

(Continued)

- Do not use the USB I/F to charge batteries or USB accessories that generate heat. Such acts may lead to worsened performance or damage to the device.
- The device may not recognize the USB device if separately purchased USB hubs and extension cables are being used. Connect the USB directly with the multimedia terminal of the vehicle.
- When using mass storage USB devices with separate logical drives, only files saved to the root drive can be played.
- Files may not properly operate if application programs are installed to the USBs.
- The device may not operate normally if MP3 Players, cellular phones, digital cameras, or other electronic devices (USB devices not recognized as portable disk drives) are connected with the device.

(Continued)

- Charging through the USB may not work for some mobile devices.
- The device may not support normal operation when using a USB memory type besides (Metal Cover Type) USB Memory.
- The device may not support normal operation when using formats such as HDD Type, CF, or SD Memory.
- The device will not support files locked by DRM (Digital Rights Management.)
- USB memory sticks used by connecting an Adaptor (SD Type or CF Type) may not be properly recognized.
- The device may not operate properly when using USB HDDs or USBs subject to connection failures caused by vehicle vibrations. (e.g. i-stick type)

(Continued)

(Continued)

- Avoid use of USB memory products that can also be used as key chains or mobile phone accessories. Use of such products may cause damage to the USB jack.
- Connecting an MP3 device or phone through various channels, such as AUX/BT or Audio/ USB mode may result in pop noises or abnormal operation.



USB MODE

Basic Mode Screen

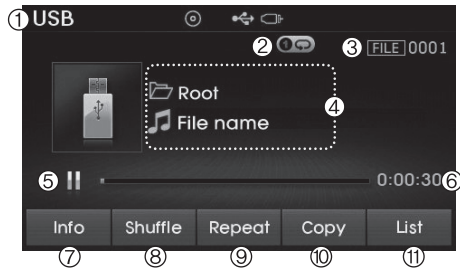

1. Mode

Displays currently operating mode.

2. Operation State

From Repeat/Random(Shuffle)/Scan, displays the currently operating function.

3. File Index

Displays the current file number.

4. File Info

Displays information about the current file.

5. Play/Pause

Changes the play/pause state.

6. Play Time

Displays the current play time.

7. Info

Displays detailed information for the current file.

8. Random(Shuffle)

Turns the Random(Shuffle) feature on/off.

9. Repeat

Turns the Repeat feature on/off.

10. Copy

Copies the current file into My Music.

11. List

Moves to the list screen.

Using USB Mode

Playing/Pausing USB Files

Once a USB is connected, the mode will automatically start and begin playing a USB file.



While playing, press the **||** button to pause and press **▶** button to play.

* NOTICE

- Loading may require additional time if there are many files and folders within the USB and result in faulty list display or file searching. Normal operations will resume once loading is complete.
- The device may not support normal operation when using a USB memory type besides (Metal Cover Type) USB Memory.

Changing Files

Press the **SEEK TRACK** keys to move to the previous or next file.

* NOTICE

- Pressing the **SEEK TRACK** key after the file has been playing for 2 seconds will start the current file from the beginning.
- Pressing the **SEEK TRACK** key before the file has been playing for 1 seconds will start the previous file.

Selecting from the List

Turn the **TUNE** knob left/right to search for the desired file.

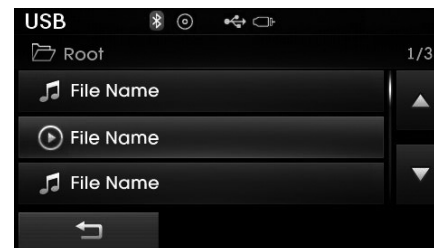

Once you find the desired file, press the **TUNE** knob to start playing.

Rewinding / Fast-forwarding Files

While playing, press and hold the **SEEK TRACK** key (over 0.8 seconds) to rewind or fast-forward the current file.

Scan

Press the **SCAN** key to play the first 10 seconds of each file.

Searching Folders

Press the  key to select and search folders.

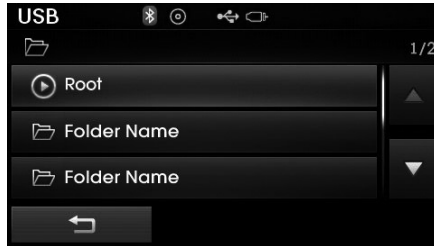

Once the desired folder is displayed, press the  TUNE knob to select.

The first file within the selected folder will begin playing.

USB Mode Menu

Within this mode, you will have access to the Info, Random (Shuffle), Repeat, Copy and List features.



Info

Press the  button to display details about the current file.

* NOTICE

- When the 'Folder File' option is set as the default display within Display setup, the album/artist/file information are displayed as detailed file information.
- When the 'Album Artist Song' option is set as the default display, the folder name/file name are displayed as detailed file information.
- The title, artist and album info are displayed only when such information are recorded within the MP3 file ID3 tag.

Random (Shuffle)

Press the  button to play files in random (Shuffle) order.

Each time the button is pressed, the feature changes in order of Random (Shuffle) Folder → Random (Shuffle) All → Off.

- Random (Shuffle) Folder : Plays the files in the current folder in random (Shuffle) order.
- Random (Shuffle) All : Plays all files in random (Shuffle) order.

Repeat

Press the **Repeat** button to repeat the current file or folder.

Each time the button is pressed, the feature changes in order of Repeat → Repeat Folder → Off.

- Repeat (Icon) : Repeats the current file.
- Repeat Folder (Icon) : Repeats all files within the current folder.

Copying Files

Press the **Copy** button to copy the current file into My Music.

*** NOTICE**

Selecting another feature during copying will display a pop-up asking whether you wish to cancel copying. To cancel, select 'Yes'.

List

Press the **List** button to display the file list screen.

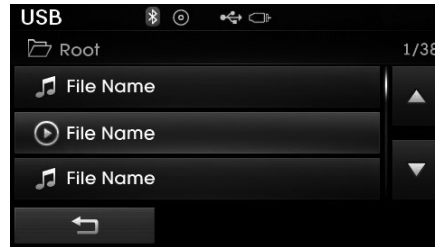

Turn the **TUNE** knob left/right to search for files. Once the desired file is displayed, press the knob to select and play.

*** NOTICE - USING THE iPod®
DEVICE**

- iPod® is a registered trademark of Apple Inc.
- In order to use the iPod® while operating the keys, you must use a dedicated iPod® cable. (the cable that is supplied when purchasing iPod®/iPhone® products)
- If the iPod® is connected to the vehicle while it is playing, a high pitch sound could occur for approximately 1-2 seconds immediately after connecting. If possible, connect the iPod to the vehicle with the iPod® stopped/paused.
- During ACC ON state, connecting the iPod® through the iPod® cable will charge the iPod® through the car audio system.
- When connecting with the iPod® cable, make sure to fully insert the jack to prevent communication interference.

(Continued)

(Continued)

- When the EQ features of an external device, such as the iPod®, and the audio system are both active, EQ effects could overlap and cause sound deterioration and distortion. Whenever possible, turn off the EQ feature within the external device upon use by connecting with the audio system.
- Noise may occur when an iPod® or AUX device is connected. When such devices are not being used, disconnect the device for storage.
- When the iPod® or AUX device power is connected to the power jack, playing the external device may result in noise. In such cases, disconnect the power connection before use.
- Skipping or improper operation may occur depending on the characteristics of your iPod®/Phone® device.

(Continued)

(Continued)

- If your iPhone® is connected to both the *Bluetooth®* Wireless Technology and USB, the sound may not be properly played. In your iPhone®, select the Dock connector or *Bluetooth®* Wireless Technology to change the sound output (source).
- iPod mode cannot be operated when the iPod® cannot be recognized due to versions that do not support communication protocols.
- For fifth generation iPod® Nano devices, the iPod® may not be recognized when the battery level is low. Please charge the iPod® for use.
- Search/play orders shown within the iPod® device may differ with the orders shown within the audio system.
- If the iPod® malfunctions due to an iPod® device defect, reset the iPod® and try again. (To learn more, refer to your iPod® manual)

(Continued)

(Continued)

- Some iPod®s may not sync with the System depending on its version. If the Media is removed before the Media is recognized, then the system may not properly restore the previously operated mode. (iPad® charging is not supported.)

iPod® MODE

Basic Mode Screen



1. Mode

Displays currently operating mode.

2. Operation State

From Repeat/Random (Shuffle), displays the currently operating function.

3. Song Index

Displays the current song/total number of songs.

4. Song Info

Displays information about the current song.

5. Play/Pause

Changes the play/pause state.

6. Play Time

Displays the current play time.

7. Random (Shuffle)

Turns the Random (Shuffle) feature on/off.

8. Repeat

Turns the Repeat feature on/off.

9. List



Moves to the list screen.

Using iPod® Mode

Playing/Pausing iPod® Songs

Once an iPod® is connected, the mode will automatically start and begin playing an iPod® song.



While playing, press the  button to pause and press  button to play.



* NOTICE

iPod®s with unsupported communication protocols may not properly operate in the audio system.

Changing Songs

Press the  key to move to the previous or next song.

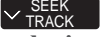
* NOTICE

- Pressing the  key after the song has been playing for 2 seconds will start the current song from the beginning.
- Pressing the  key before the song has been playing for 1 second will start the previous song.
- Slight time differences may exist depending your iPod® product.

Rewinding / Fast-forwarding Songs

While playing, press and hold the  key (over 0.8 seconds) to rewind or fast-forward the current song.

Searching Categories

Turn the  TUNE knob left/right to search for the desired category.

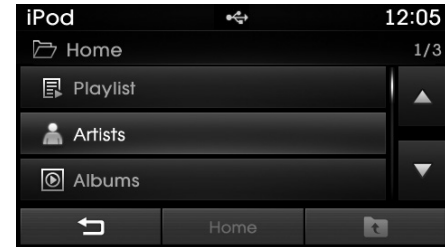

Once you find the desired category, press the  TUNE knob to select and play.



* NOTICE

There are eight categories that can be searched, including Playlists, Artists, Albums, Genres, Songs, Composers, Audiobooks and Podcasts.

Category Menu

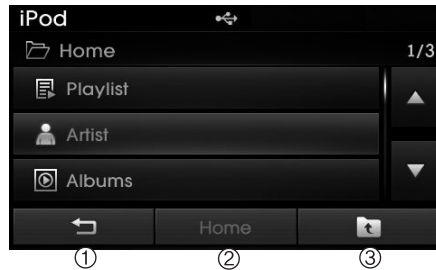
Within the iPod® Category menu, you will have access to the , Home, and  features.



1.  : Displays the play screen
2. Home : Moves to the iPod® root category screen
3.  : Moves to the previous category

* NOTICE

- If the search mode is accessed while playing a song, the most recently searched category is displayed.
- Search steps upon initial connection may differ depending on the type of iPod® device.

iPod® Mode Menu

Within this mode, you will have access to the Random(Shuffle), Repeat and List features.

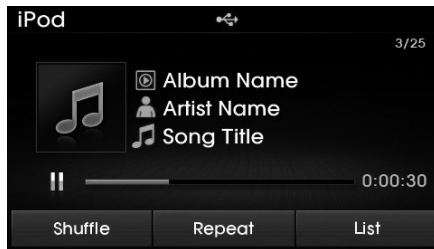

Random(Shuffle)

Press the **Shuffle** button to play songs in random(Shuffle) order.

- Random(Shuffle) All : Plays all songs in Random(Shuffle) order.

Repeat

Press the **Repeat** button to repeat the current song. Press the button again to turn the repeat feature off.

- Repeat : Repeats the current song

List

Press the **List** button to display the Category Menu.

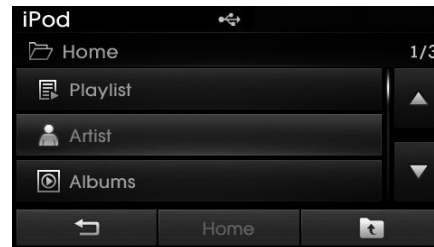

Turn the **TUNE** knob left/right to search for the desired category.

Once you find the desired category, press the **TUNE** knob to select and play.

AUX MODE

Using AUX Mode

Press the **MEDIA** key ▶ Select [AUX]

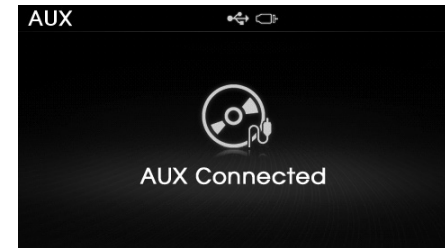

An external device can be connected to play music.

Connecting an External Device

External audio players (Camcorders, car VCR, etc.) can be played through a dedicated cable.

* NOTICE

- If an external device connector is connected with the AUX terminal, then AUX mode will automatically operate. Once the connector is disconnected, the previous mode will be restored.
- AUX mode can be used only when an external audio player (camcorder, car VCR, etc.) has been connected.
- The AUX volume can be controlled separately from other audio modes.
- Connecting a connector jack to the AUX terminal without an external device will convert the system to AUX mode, but only output noise. When an external device is not being used, also remove the connector jack.
- When the external device power is connected to the power jack, playing the external device may output noise. In such cases, disconnect the power connection before use.
- Fully insert the AUX cable to the AUX jack upon use.

MY MUSIC MODE

Basic Mode Screen



1. Mode

Displays currently operating mode.

2. Operation State

From Repeat/Random(Shuffle)/ Scan, displays the currently operating function.

3. File Index

Displays the current file/total number of files.

4. File Info

Displays information about the current file.

5. Play/Pause

Changes the play/pause state.

6. Play Time

Displays the current play time.

7. Info

Displays detailed information for the current file.

8. Random(Shuffle)

Turns the Random(Shuffle) feature on/off.

9. Repeat

Turns the Repeat feature on/off.

10. Delete

Deletes the current file.

11. List

Moves to the list screen.

Using My Music Mode

Playing/Pausing My Music Files

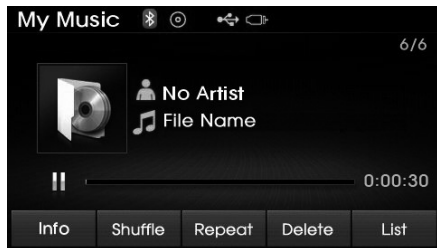

While playing, press the **||** button to pause and press **▶** button to play.

* NOTICE

If there are no files saved within My Music, the **My Music** button will be disabled.

Changing Files

Press the **SEEK TRACK** key to move to the previous or next file.

* NOTICE

- Pressing the **SEEK TRACK** key after the file has been playing for 2 seconds will start the current file from the beginning.
- Pressing the **SEEK TRACK** key before the file has been playing for 1 seconds will start the previous file.

Selecting from the List

Turn the **TUNE** knob left/right to search for the desired file.

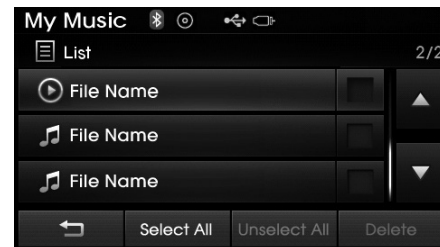

Once you find the desired file, press the **TUNE** knob to start playing.

Rewinding / Fast-forwarding Files

While playing, press and hold the **SEEK TRACK** key (over 0.8 seconds) to rewind or fast-forward the current file.

Scan

Press the **SCAN** key to play the first 10 seconds of each file.

My Music Mode Menu

Within this mode, you will have access to the Info, Random(Shuffle), Repeat, Delete and List features.

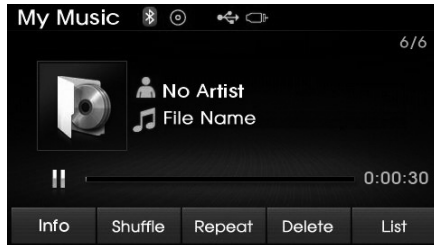

Info

Press the **Info** button to display details about the current file.

* NOTICE

The title, artist and album info are displayed only when such information is recorded within the MP3 file ID3 tag.

Random

Press the **Shuffle** button to play files in random order. Press the button again to turn the Random feature off.

Repeat

Press the **Repeat** button to repeat the current song. Press the button again to turn the repeat feature off.

Deleting Files

Press the **Delete** button to delete the current file.

List

Press the **List** button to display the file list screen.

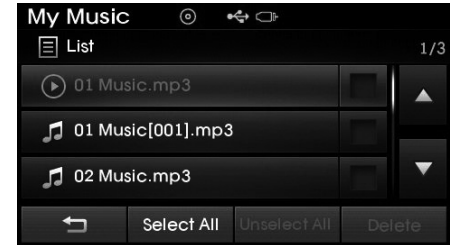

Turn the **TUNE** knob left/right to search for files. Once the desired file is displayed, press the knob to select and play.

List Menu

From the List screen, it is possible to delete files you previously saved into My Music.

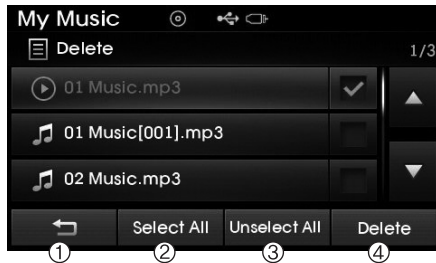

Press the **Select All** button or individually select the files you want to delete. Once files are selected, the **Unselect All** button and **Delete** buttons will be enabled.

- 1) **←** : Moves to the previous screen
- 2) **Select All**: Selects all files
- 3) **Unselect All**: Deselects all selected files
- 4) **Delete**: Deletes selected files

After selecting the files you want to delete, press the **Delete** button to delete the selected files.

* NOTICE

- If there is memory available, up to 6,000 files can be saved.
- Identical files cannot be copied more than 1,000 times.
- To check memory information, go to **SETUP** ▶ [System] ▶ [Memory Information]

*** NOTICE - USING THE
Bluetooth[®] Wireless
Technology Audio Mode**

- *Bluetooth*[®] Wireless Technology Audio Mode can be used only when a *Bluetooth*[®] Wireless Technology phone has been connected.
- *Bluetooth*[®] Wireless Technology Audio Mode will not be available when connecting mobile phones that do not support this feature.
- While *Bluetooth*[®] Wireless Technology Audio is playing, if the *Bluetooth*[®] Wireless Technology phone is connected, then the music will also stop.
- Moving the Track up/down while playing *Bluetooth*[®] Wireless Technology audio mode may result in pop noises in some mobile phones.
- *Bluetooth*[®] Wireless Technology streaming audio may not be supported in some mobile phones.

(Continued)

(Continued)

- When returning to *Bluetooth*[®] Wireless Technology Audio mode after ending a call, the mode may not automatically restart in some mobile phones.
- Receiving an incoming call or making an outgoing call while playing *Bluetooth*[®] Wireless Technology Audio may result in audio interference.



Information Provided by:

DEALER
PROCESS



Bluetooth® Wireless Technology AUDIO MODE (IF EQUIPPED)

Using Bluetooth® Wireless Technology Audio Mode

Playing/Pausing Bluetooth® Wireless Technology Audio

Once a Bluetooth® Wireless Technology device is connected, the mode will automatically start.



While playing, press the  button to pause and press  button to play.

*** NOTICE**

The play/pause feature may operate differently depending on the mobile phone.

Changing Files

Press the  key to move to the previous or next file.

Setting Connection

If a Bluetooth® Wireless Technology device has not been connected, press the **SETUP** key ▶[Phone] button to display the Bluetooth® Wireless Technology connection screen.

It is possible to use the pair phone, connect/disconnect and delete features from your Bluetooth® Wireless Technology phone.

*** NOTICE**

- If the Bluetooth® Wireless Technology audio is not operating properly, check whether the feature is turned off at **SETUP** ▶[Phone]▶[Streaming Audio]. If the feature is off, turn back on and try again.
- If music is not yet playing from your mobile device after converting to Bluetooth® Wireless Technology Audio mode, pressing the play button once may start playing the mode. Check to see that music is playing from the Bluetooth® Wireless Technology device after converting to Bluetooth® Wireless Technology Audio Mode.

Pairing a *Bluetooth*[®] Wireless Technology Device

What is *Bluetooth*[®] Wireless Technology Pairing?

Pairing refers to the process of synchronizing your *Bluetooth*[®] Wireless Technology phone or device with the car audio system for connection. Pairing is necessary to connect and use the *Bluetooth*[®] Wireless Technology feature.

Pairing **PHONE** Key / Key on the Steering Remote Controller

When No Devices have been Paired

1. Press the **PHONE** key or the  key on the steering remote controller. The following screen is displayed.
2. Press the **OK** button to enter the Pair Phone screen.

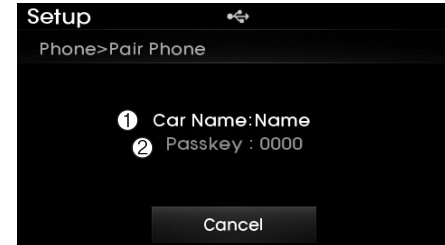
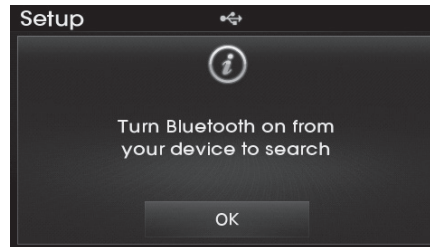

- 1) Car Name : Name of device as shown when searching from your *Bluetooth*[®] Wireless Technology device
- 2) Passkey : Passkey used to pair the device
3. From your *Bluetooth*[®] Wireless Technology device (i.e. Mobile Phone), search and select your car audio system.

[Non SSP supported device]
(SSP: Secure Simple Pairing)

4. After a few moments, a screen is displayed where the passkey is entered.

Hear, enter the passkey "0000" to pair your *Bluetooth*[®] Wireless Technology device with the car audio system.

[SSP supported device]

4. After a few moments, a screen is displayed 6 digits passkey.

Hear, check the passkey on your *Bluetooth*[®] Wireless Technology device and confirm.

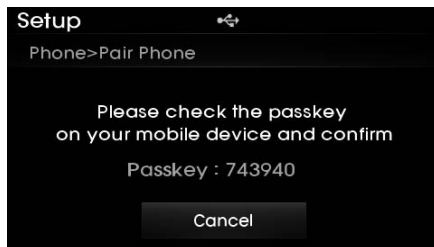

5. Once pairing is complete, the following screen is displayed.

* NOTICE

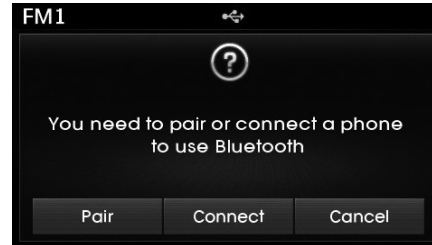

If *Bluetooth*[®] Wireless Technology devices are paired but none are currently connected, pressing the **PHONE** key or the  key on the steering wheel displays the following screen. Press the [Pair] button to pair a new device or press the [Connect] to connect a previously paired device.

Pairing through [PHONE] Setup

Press the **SETUP** key ▶ Select [Phone] ▶ Select [Pair Phone] ▶ Select  TUNE knob

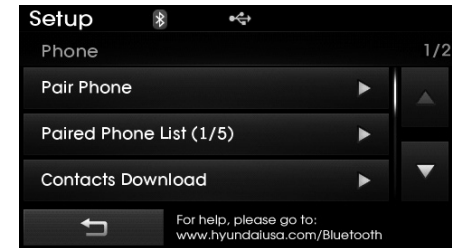

1. The following steps are the same as those described in the section "When No Devices have been Paired" on the previous page.

*** NOTICE**

- **Bluetooth®** Wireless Technology features supported within the vehicle are as follows. Some features may not be supported depending on your **Bluetooth®** Wireless Technology device.
 - **Outgoing/Incoming Handsfree calls**
 - **Operations during a call (Switch to Private, Switch to call waiting, MIC on/off)**
 - **Downloading Call History**
 - **Downloading Mobile Contacts**
 - **Bluetooth®** Wireless Technology device auto connection
 - **Bluetooth Audio Streaming**
- **Up to five Bluetooth®** Wireless Technology devices can be paired to the Car Handsfree system.
- **Only one Bluetooth®** Wireless Technology device can be connected at a time.
- **Other devices cannot be paired while a Bluetooth®** Wireless Technology device is connected.
- **Only Bluetooth®** Wireless Technology Handsfree and Bluetooth audio related features are supported.

(Continued)

(Continued)

- **Bluetooth** related operations are possible only within devices that support Handsfree or audio features, such as a **Bluetooth®** Wireless Technology mobile phone or a Bluetooth audio device.
- If a connected **Bluetooth®** Wireless Technology device becomes disconnected due to being out of communication range, turning the device OFF, or a **Bluetooth®** Wireless Technology communication error, corresponding **Bluetooth®** Wireless Technology devices are automatically searched and reconnected.
- If the system becomes unstable due to communication errors between the car Handsfree and the **Bluetooth®** Wireless Technology device, reset the device by turning off and back on again. Upon resetting **Bluetooth®** Wireless Technology device, the system will be restored.

(Continued)

(Continued)

- **After pairing is complete, a contacts download request is sent once to the mobile phone. Some mobile phones may require confirmation upon receiving a download request, ensure your mobile phone accepts the connection. Refer to your phones user's manual for additional information regarding phone pairing and connections.**

Connecting a Device

Press the **SETUP** key ▶ Select [Phone] ▶ Select [Paired Phone List]

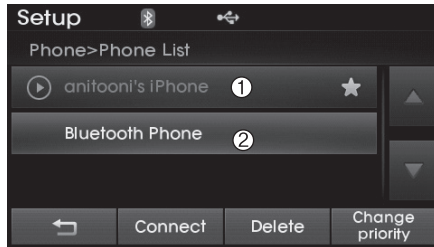

- 1) Connected Phone : Device that is currently connected
- 2) Paired Phone : Device that is paired but not connected

From the paired phone list, select the device you want to connect and press the **Connect** button.

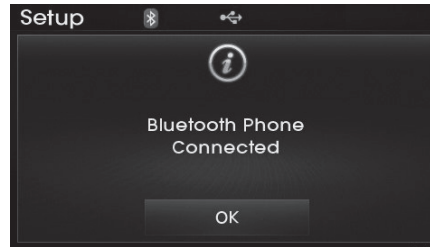

Changing Priority

What is Priority?

It is possible to pair up to five *Bluetooth*® Wireless Technology devices with the car audio system. The "Change Priority" feature is used to set the connection priority of paired phones.

Press the **SETUP** key ▶ Select [Phone] ▶ Select [Paired Phone List]



From the paired phone list, select the phone you want to switch to the highest priority, then press the **Change priority** button from the Menu. The selected device will be changed to the highest priority.

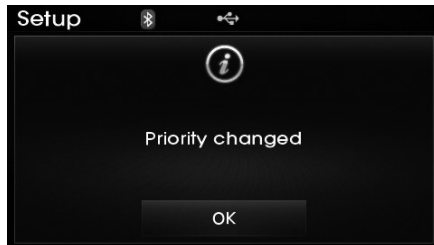

*** NOTICE**

Priority icon will be displayed when the selected phone is set as a priority phone.



Disconnecting a Device

Press the **SETUP** key ▶ Select [Phone] ▶ Select [Paired Phone List]



From the paired phone list, select the currently connected device and press the **Disconnect** button.

Deleting a Device

Press the **SETUP** key ▶ Select [Phone] ▶ Select [Paired Phone List]



From the paired phone list, select the device you want to delete and press the **Delete** button.

* NOTICE

- When deleting the currently connected device, the device will automatically be disconnected to proceed with the deleting process.
- If a paired *Bluetooth*® Wireless Technology device is deleted, the device's call history and contacts data will also be deleted.
- To re-use a deleted device, you must pair the device again.

USING Bluetooth® Wireless Technology

Phone Menu Screen

Phone Menus

With a Bluetooth® Wireless Technology device connected, press the **PHONE** key to display the Phone menu screen.



- 1) Favorite : Up to 20 frequently used contacts saved for easy access
- 2) Dial Number : Displays the dial screen where numbers can be dialed to make calls
- 3) Call History : Device the call history list screen

- 4) Contacts : Displays the Contacts list screen
- 5) Setup : Displays Phone related settings

* NOTICE

- If you press the [Call History] button but there is no call history data, a prompt is displayed which asks to download call history data.
- If you press the [Contacts] button but there is no contacts data stored, a prompt is displayed which asks to download contacts data.
- This feature may not be supported in some mobile phones. For more information on download support, refer to your mobile phone user's manual.

Favorites

Press the **PHONE** key ▶ Select [Favorites]

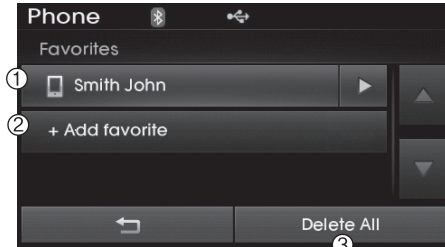

- 1) Saved favorite contact : Connects call upon selection
- 2) To add favorite : Downloaded contacts be saved as favorite.
- 3) Delete All : Delete all stored favorite contacts

* NOTICE

- To save Favorite, contacts should be downloaded.
- Contact saved in Favorites will not be automatically updated if the contact has been updated in the phone. To update Favorites, delete the Favorite and create a new Favorite.

Calling by Dialing a Number

Press the **PHONE** key ▶ Select [Dial Number]

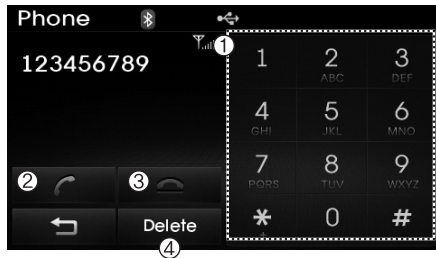

- 1) Dial Pad : Used to enter phone number
- 2) Call : If a number has been entered, calls the number. If no number has been entered, switches to call history screen
- 3) End : Deletes the entered phone number
- 4) Delete : Deletes entered numbers one digit at a time

Answering Calls

Answering a Call

Answering a call with a *Bluetooth®* Wireless Technology device connected will display the following screen.

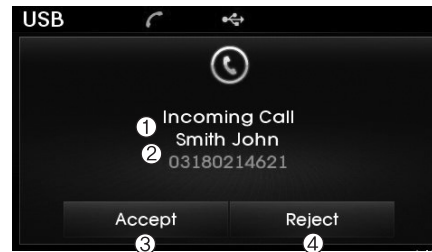

- 1) Caller : Displays the other party's name when the incoming caller is saved within your contacts
- 2) Incoming Number : Displays the incoming number
- 3) Accept : Accept the incoming call
- 4) Reject : Reject the incoming call

* NOTICE

- When an incoming call pop-up is displayed, most Audio and SETUP mode features are disabled. Only the call volume will operate.
- The telephone number may not be properly displayed in some mobile phones.
- When a call is answered with the mobile phone, the call mode will automatically revert to Private mode.

During a Handsfree Call



- 1) Caller : Displays the other party's name if the incoming caller is saved within your contacts
- 2) Incoming Number : Displays the incoming number
- 3) Call time : Displays the call time
- 4) End : Ends call
- 5) Private : Converts to Private mode
- 6) Out Vol. : Sets call volume as heard by the other party
- 7) Mute : Turns Mic Mute On/Off

* NOTICE

If the mic is muted, the other party will not be able to hear your voice.

Call History

Press the **PHONE** key ▶ Select [Call History]



A list of incoming, outgoing and missed calls is displayed.

Press the **Download** button to download the call history.

- 1) Call History :
 - Displays recent calls (call history)
 - Connects call upon selection
- 2) Download : Download Recent Call History

- Call history may not be saved in the call history list in some mobile phones.

- Calls received with hidden caller ID will not be saved in the call history list.
- Calling through the call history is not possible when there is no call history stored or a *Bluetooth*® Wireless Technology phone is not connected.
- Up to 50 received, dialed and missed calls are stored in Call History.
- Time of received/dialed calls and call time information are not saved.

Contacts

Press the **PHONE** key ▶ Select [Contacts]



The list of saved phone book entries is displayed. Press the **Download** button to download the call history.

- 1) Contacts List :
 - Displays downloaded contacts entries
 - Connects call upon selection
- 2) Sort by : Find a contact in an alphabetical order.
- 3) Download : Download contacts entries

* NOTICE

- Up to 1,000 contacts saved in your *Bluetooth*® Wireless Technology phone can be downloaded into the car contacts. Contacts that have been downloaded to the car cannot be edited or deleted on the phone.
- Mobile phone contacts are managed separately for each paired *Bluetooth*® Wireless Technology device (max 5 devices x 1,000 contacts each). Previously downloaded data is maintained even if the *Bluetooth*® Wireless Technology device has been disconnected. (However, the contacts and call history saved to the phone will be deleted if a paired phone is deleted.)
- It is possible to download contacts during *Bluetooth* streaming audio.
- When downloading contacts, the icon will be displayed within the status bar.

(Continued)

(Continued)

- It is not possible to begin downloading a contact list when the contact download feature has been turned off within the *Bluetooth*® Wireless Technology device. In addition, some devices may require device authorization upon attempting to download contacts. If downloading does not normally occur, check the *Bluetooth*® Wireless Technology device settings or the screen state.
- The contacts download feature may not be supported in some mobile phones. For more information of supported *Bluetooth*® devices and function support, refer to your phone's user manual.

Bluetooth® Wireless Technology Setting

Pairing a New Device

Press the **SETUP** key ▶ Select [Phone] ▶ Select [Pair Phone]

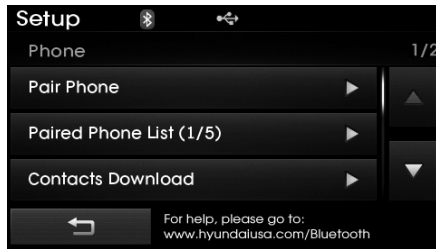

Bluetooth® Wireless Technology devices can be paired with the audio system.

For more information, refer to the "Pairing through Phone Setup" section within Bluetooth® Wireless Technology.

Viewing Paired Phone List

Press the **SETUP** key ▶ Select [Phone] ▶ Select [Paired Phone List]



This feature is used to view mobile phones that have been paired with the audio system. Upon selecting a paired phone, the setup menu is displayed.

For more information, refer to the "Setting Bluetooth® Wireless Technology Connection" section within Bluetooth® Wireless Technology.

- 1) : Moves to the previous screen
- 2) Connect/Disconnect Phone : Connect/ disconnects currently selected phone
- 3) Delete : Deletes the currently selected phone
- 4) Change Priority : Sets currently selected phone to highest connection priority

* NOTICE BEFORE DOWNLOADING CONTACTS

- Only contacts within connected phones can be downloaded. Also check to see that your mobile phone supports the download feature.
- To learn more about whether your mobile phone supports contacts downloads, refer to your mobile phone user's manual.
- The contacts for only the connected phone can be downloaded.

Downloading Contacts

Press the **SETUP** key ▶ Select [Phone] ▶ Select [Contacts Download]

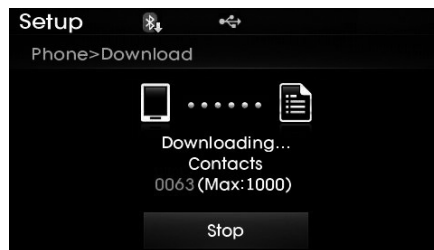

As the contacts are downloaded from the mobile phone, a download progress bar is displayed.

* NOTICE

- Upon downloading phone contacts, the previous corresponding data is deleted.
- This feature may not be supported in some mobile phones.
- Voice Recognition may not operate while contacts are being downloaded.

Outgoing Volume

Press the **SETUP** key ▶ Select [Phone] ▶ Select [Outgoing Volume]

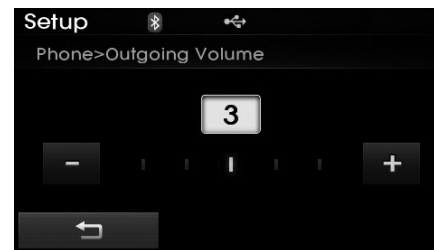

Use the **-**, **+** buttons to adjust the outgoing volume level.

* NOTICE

While on a call, the volume can be changed by using the **SEEK TRACK** key.

Turning Bluetooth System Off

Press the **SETUP** key ▶ Select [Phone] ▶ Select [Bluetooth System Off]

Once *Bluetooth*[®] *Wireless Technology* is turned off, *Bluetooth*[®] *Wireless Technology* related features will not be supported within the audio system.

*** NOTICE**

To turn *Bluetooth*[®] *Wireless Technology* back on, go to **SETUP** ▶ [Phone] and press "Yes".

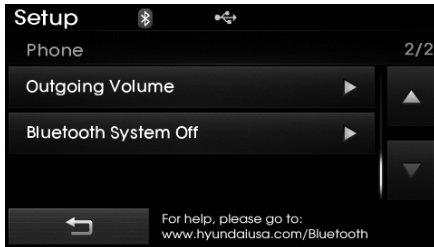

VOICE RECOGNITION

Using Voice Recognition

Starting Voice Recognition

Shortly press the  key on the steering wheel remote controller. Say a command.

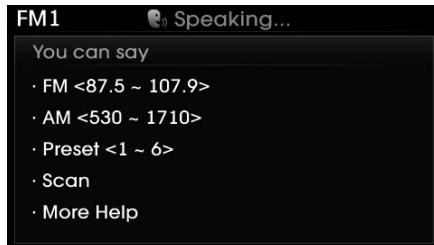

If prompt feedback is in [ON], then the system will say "Please say a command after the beep (BEEP)"

- If prompt feedback is in [OFF] mode, then the system will only say "(BEEP)"
- To change Prompt Feedback [On]/[Off], go to **SETUP** ▶ [System] ▶ [Prompt Feedback]

* NOTICE

For proper recognition, say the command after the voice instruction and beep tone.

Contact List Best Practices

- 1) Do not store single-name entries (e.g., "Bob", "Mom", "Kim", etc.). Instead, always use full names (including first and last names) for all contacts (e.g., use "Jacob Stevenson" instead of "Dad").
- 2) Do not use abbreviations (i.e., use "Lieutenant" instead of "Lt." or "Sergeant" instead of "Sgt.").
- 3) Do not use acronyms (i.e., use "County Finance Department" instead of "CFD").
- 4) Do not use special characters (e.g., "@", "hyphen -", "asterisk **", "ampersand &").
- 5) If a name is not recognized from the contact list, change it to a more descriptive name (e.g., use "Grandpa Joseph" instead of "Pa Joe").

Skipping Prompt Messages

While prompt message is being stated ▶ Shortly press the  key on the steering remote controller

The prompt message is immediately ended and the beep tone will sound. After the "beep", say the voice command.

Re-starting Voice Recognition

While system waits for a command ▶ Shortly press the  key on the steering remote controller

The command wait state is immediately ended and the beep tone will sound. After the "beep", say the voice command.

* Illustration on using voice commands

• **Starting voice command.**

Shortly pressing the  key (under 0.8 seconds):

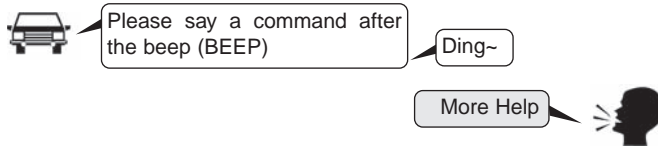



More Help
 Here are some examples of mode commands. You can say a radio type like 'FM', 'AM', or 'Satellite'. You can also say a media source like 'USB', 'My Music', or 'iPod'. Additionally, there are phone commands like 'Contacts', 'Call History', or 'Dial Number'. You can find more detailed commands in the user's manual. Please say a command after the beep.

More Help
 Here are some examples of mode commands. You can say a radio type like 'FM', 'AM', or 'Satellite'. You can also say a media source like 'USB', 'My Music', or 'iPod'. Additionally, there are phone commands like 'Contacts', 'Call History', or 'Dial Number'. You can find more detailed commands in the user's manual. Please say a command after the beep.

• **Skipping Voice Recognition**

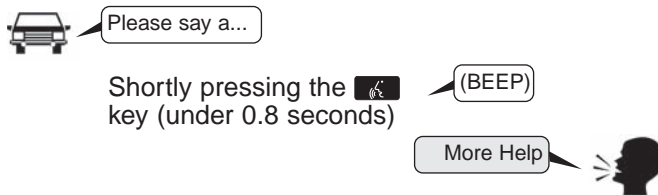
Shortly pressing the  key (under 0.8 seconds):



Shortly pressing the  key (under 0.8 seconds)

• **End voice command.**

Shortly pressing the  key (under 0.8 seconds):

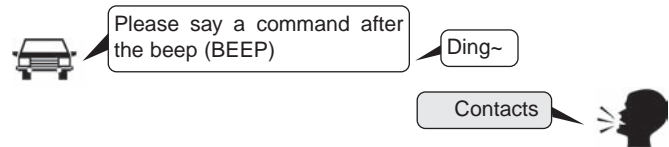

Contacts
 Please say the name of the contacts you want to call (BEEP)

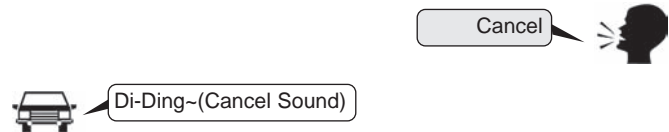

Voice Command List

- **Common Commands:** These commands can be used in most operations. (However a few commands may not be available during certain operations)

| Command | Function |
|-----------------------|---|
| More Help | Provides guidance on commands that can be used anywhere in the system. |
| Help | Provides guidance on commands that can be used within the current mode. |
| Call<Name> | Calls <Name> saved in Contacts Ex) Call "John Smith" |
| Call <Name> on Mobile | Calls <Name> to the number that is saved as "Mobile" in Contacts Ex) Call "John Smith" on Mobile |
| Call <Name> in Office | Calls <Name> to the number that is saved as "Office" in Contacts Ex) Call "John Smith" in Office |
| Call <Name> at Home | Calls <Name> to the number that is saved as "Home" in Contacts Ex) Call "John Smith" at Home |
| Call <Name> on Other | Calls <Name> to the number that is saved as "Other" in Contacts Ex) Call "John Smith" on Other |
| Phone | Provides guidance on Phone related commands. After saying this command, say "Favorites", "Call History", "Contacts" or "Dial Number" execute corresponding functions. |
| Favorites | Display the Favorite screen. |
| Call History | Displays the Call History screen. |

| Command | Function |
|-------------------------|--|
| Contacts (Call by Name) | Displays the Contacts screen. After saying this command, say the name of a contact saved in the Contacts to automatically connect the call. |
| Dial Number | Display the Dial number screen. After saying this command, you can say the number that you want to call. |
| Redial | Connects the most recently called number. |
| Tutorial | Provide guidance on how to use voice recognition and Bluetooth® connections. |
| Radio | <ul style="list-style-type: none"> • When listening to the radio, displays the next radio screen. (FM1→FM2→AM→XM1→XM2→XM3→FM1) • When listening to a different mode, displays the most recently played radio screen. • When currently listening to the FM radio, maintains the current state. • When listening to a different mode, displays the most recently played FM screen. |
| FM1(FM One) | Displays the FM1 screen. |
| FM2(FM Two) | Displays the FM2 screen. |
| AM | Displays the AM screen. |

| Command | Function |
|--------------------|--|
| FM Preset 1~6 | Plays the most recently played broadcast saved in FM Preset 1~6. |
| AM Preset 1~6 | Plays the broadcast saved in AM Preset 1~6. |
| FM 87.5~107.9 | Plays the FM broadcast of the corresponding frequency. |
| AM 530~1710 | Plays the AM broadcast of the corresponding frequency. |
| XM (Satellite) | <ul style="list-style-type: none"> • When currently listening to the SiriusXM™, maintains the current state. • When listening to a different mode, displays the most recently played SiriusXM™ screen. |
| XM (Satellite) 1~3 | Displays the selected SiriusXM™ screen. |
| XM Channel 0~255 | Plays the selected SiriusXM™ channel. |
| Media | Moves to the most recently played media screen. |
| CD | Plays the music saved in the CD. |
| USB | Plays USB music. |
| iPod® | Plays iPod music. |

| Command | Function |
|------------------|---|
| My Music | Plays the music saved in My Music. |
| AUX (Auxiliary) | Plays the connected external device. |
| Bluetooth® Audio | Plays the music saved in connected Bluetooth® device. |
| Please repeat | Repeats the most recent comment. |
| Mute | Mutes the sound |
| Cancel (Exit) | Ends voice command. |

Features of your vehicle

- FM/AM radio commands: available during FM, AM radio operation

| Command | Function |
|-------------|---|
| Preset 1~6 | Plays the broadcast saved in Preset 1~6. |
| Scan | Scans receivable frequencies from the current broadcast and plays for 10 seconds each. |
| Preset Scan | Moves to the next preset from the current present and plays for 10 seconds each. |
| Information | Displays the information of the current broadcast. (This feature can be used when receiving RBDS broadcasts.) |

- Satellite radio commands: Commands that can be used while listening to Satellite Radio.

| Command | Function |
|---------------|---|
| Channel 0~255 | Play the selected Satellite Radio channel. |
| Scan | Scans receivable channels from the current broadcast and plays for 10 seconds each. |
| Preset 1~6 | Plays the broadcast saved in Preset 1~6. |
| Information | Displays the information of the current broadcast. |

- Audio CD commands: Commands available during Audio CD operation

| Command | Function |
|-------------|---|
| Play | Plays the currently paused track. |
| Pause | Pauses the current track. |
| Shuffle | Randomly plays the tracks within the CD. |
| Shuffle Off | Cancels random play to play tracks in sequential order. |
| Repeat | Repeats the current track. |
| Repeat Off | Cancels repeat play to play tracks in sequential order. |
| Track 1~30 | Plays the desired track number. |

- MP3 CD / USB commands: Commands available during USB and MP3 CD operation

| Command | Function |
|-----------------|--|
| Play | Plays the currently paused file. |
| Pause | Pauses the current file. |
| Shuffle | Randomly plays the files within the current folder. |
| Shuffle Off | Cancels random play to play files in sequential order. |
| Repeat | Repeats the current file. |
| Repeat Off | Cancels repeat play to play files in sequential order. |
| Next Folder | Play the first file in the next folder |
| Previous Folder | Play the first file in the previous folder |

Features of your vehicle

- iPod® Commands: Commands available during iPod® operation

| Command | Function |
|-------------|--|
| Play | Plays the currently paused song. |
| Pause | Pauses the current song. |
| Shuffle | Randomly plays the songs within the current category. |
| Shuffle Off | Cancels random play to play songs in sequential order. |
| Repeat | Repeats the current song. |
| Repeat Off | Cancels repeat play to play songs in sequential order. |

- My Music Commands: Commands available during My Music operation

| Command | Function |
|-------------|---|
| Play | Plays the currently paused file. |
| Pause | Pauses the current file. |
| Shuffle | Randomly plays all saved files. |
| Shuffle Off | Cancels random play to play files in sequential order. |
| Repeat | Repeats the current file. |
| Repeat Off | Cancels repeat play to play files in sequential order. |
| Delete | Deletes the current file. You will bypass an additional confirmation process. |

SETUP

Starting Mode

Press the **SETUP** key ▶ Select the Setup screen.

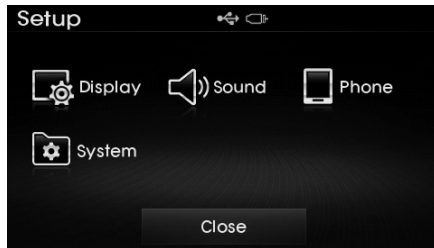

You can select and control options related to [Display], [Sound], [Clock/Calendar], [Phone] and [System].

Display Settings

Adjusting the Brightness

Press the **SETUP** key ▶ Select [Display] ▶ Select [Brightness]



Use the ◀, ▶ buttons to adjust the screen brightness or set the Brightness on Automatic, Daylight, or Night mode.

Press the **Default** button to reset.

- 1) Automatic : Adjusts the brightness automatically
- 2) Daylight : Always maintains the brightness on high
- 3) Night: Always maintains the brightness on low

Mode pop up

Press the **SETUP** key ▶ Select [Display] ▶ Select [Mode Pop up]

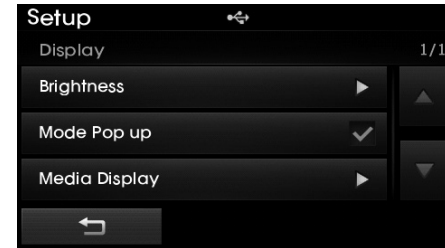

This feature is used to display the Pop-up Mode screen when entering radio and media modes.

When this feature is turned on, pressing the **RADIO** or **MEDIA** key will display the Pop-up Mode screen.

* NOTICE

The media Mode pop up screen can be displayed only when two or more media modes have been connected.

MP3 Information Display

Press the **SETUP** key ▶ Select [Display] ▶ Select [Media Display]



This feature is used to change the information displayed within USB and MP3 CD modes.

- 1) Folder File : Displays file name and folder name
- 2) Album Artist Song : Displays album name/artist name/song

Sound Settings

Sound Settings

Press the **SETUP** key ▶ Select [Sound] ▶ Select [Sound Setting]



Use the **◀**, **▶**, **▲**, **▼** buttons to adjust the Fader/Balance settings.

Use the **◀**, **▶** buttons to adjust the Bass/Middle/Treble settings.

Press the **Default** button to reset.

SDVC (Speed Dependent Volume Control)

Press the **SETUP** key ▶ Select [Sound]
▶ Select [Speed Dependent Vol.]

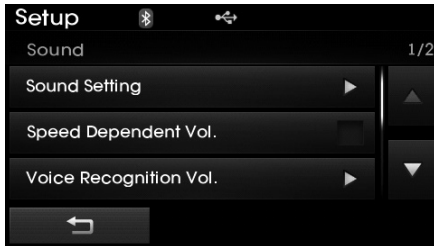

The volume level is controlled automatically according to the vehicle speed. SDVC can be set by selecting from On/Off.

Voice Recognition Volume

Press the **SETUP** key ▶ Select [Sound]
▶ Select [Voice Recognition Vol.]



Turn the **TUNE** knob to adjust the Voice Recognition volume.

Touch Screen Beep

Press the **SETUP** key ▶ Select [Sound]
▶ Select [Touch Screen Beep]

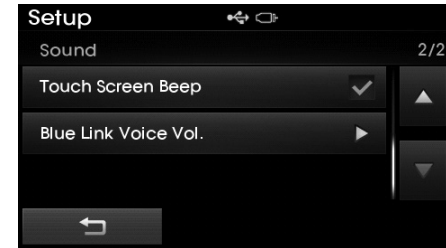

This feature is used to turn the touch screen beep on/off.

Blue Link Voice Volume

Press the **SETUP** key ▶ Select [Sound]
▶ Select [Blue Link Voice Vol.]



Turn the **TUNE** knob to adjust the Blue Link Voice Volume.

* Blue Link® may differ depending on the selected audio.

System Setting

Memory Information

Press the **SETUP** key ▶ Select [System] ▶ Select [Memory Information]

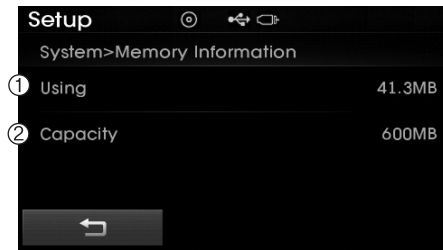

This feature displays information related to system memory.

- 1) Using : Displays capacity currently in use
- 2) Capacity : Displays total capacity

Prompt Feedback

Press the **SETUP** key ▶ Select [System] ▶ Select [Prompt Feedback]

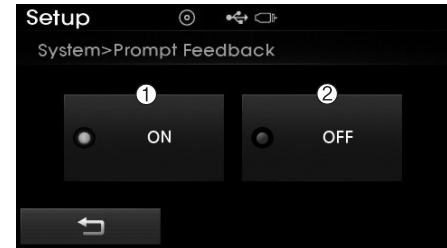

This feature is used to select the desired prompt feedback option from ON and OFF.

- 1) ON : When using voice recognition, provides detailed guidance prompts
- 2) OFF : When using voice recognition, omits some guidance prompts

Language

Press the **SETUP** key ▶ Select [System] ▶ Select [Language]

REAR VIEW CAMERA (if equipped)

- The system has been equipped with a rear view camera for user safety by allowing a wider rear range of vision.
- The rear view camera will automatically operate when the ignition key is turned ON and the shift lever is set to R (Reverse).
- The rear view camera will automatically stop operating when shift lever is selected out of R (Reverse).

CAUTION

- *The rear view camera has been equipped with an optical lens to provide a wider range of vision and may appear different from the actual distance. For safety, directly check the rear and left/right sides.*

Blue Link® (if equipped)

Hyundai aims to offer differentiated customer values through a 'Connected Car Life,' which is to provide consumers with fast and reliable IT technology. As consumers' lifestyles become more and more mobile in thanks to remarkable advances in smart phones, tablet PCs and overall wireless telecommunication, new lifestyle patterns demand seamless connection between one's office, home, outdoors and automobiles.

Automobile companies are now faced with the task of shifting their paradigm from vehicle-centered services to customer value-centered services, with the ultimate goal of securing global leadership in the field of vehicle IT and telematics.



Hyundai plans to achieve this by realizing a terminal platform flexible to changes in IT technology, cooperating with global IT companies, creating an eco-system and providing the latest contents & services based on an open environment.

Using the Room Mirror Key

Selecting the room mirror key will allow you to make service required inquiries, POI info searches, and emergency rescues by connecting to the Blue Link® Center.

Such features can be used only after subscribing to the Blue Link® service.

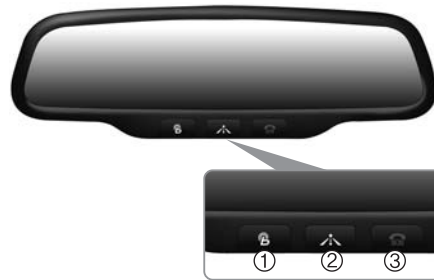

① (Blue Link® Center)

Makes requests for Blue Link® service related inquiries and consultations.

A call is connected to the Blue Link® service center employee.

Re-pressing the key will end the call.

This feature does not operate when you are on a Bluetooth® phone call.

② (Blue Link® for POI)

• Blue Link® for Voice command

Starts Blue Link® voice command.

Voice receiving voice guidance, shortly press the button to convert to voice command mode. Press and hold the button to end voice command.

• TBT VR Commands

1. Navigate to

"Navigate to" voice command is used to request the download of route data for a new destination, saved destinations, daily routes and previous destinations.

2. Save Destination

"Save Destination" VR command is used to assign a voice tag to the last downloaded destination and store it in a destination directory.

NOTE:

The Turn by Turn (TBT) feature supports the store of ten (10) destinations in the TBT destinations directory.

3. Route Preview

"Route Preview" VR command allows the user to preview the route instructions (upcoming maneuver instructions) at any time during the route guidance.

4. Destinations List

"Destinations List" VR command allows the user to preview and delete the stored destinations with their associated voice tags in the Turn by Turn destinations directory.

5. Voice Guidance

"Voice Guidance" VR command allows the user to mute/unmute the Turn by Turn (TBT) direction announcements.

6. Suspend Route

"Suspend Route" VR command allows the user to suspend and pause Turn by Turn (TBT) route guidance while in the guidance mode.

7. Resume Route

"Resume Route" VR command allows the user to resume Turn by Turn (TBT) route guidance.

③ (Blue Link® for SOS)

In the case of an emergency, requests for help to the Blue Link® center.

Call is connected to the Blue Link® emergency rescue center. Re-pressing the key will end the call.

If already on a Bluetooth® phone call, the call will end to connect you to the Blue Link® Emergency Rescue Center.

CAUTION

- **You cannot talk simultaneously on the Bluetooth® phone and Blue Link® phone.**
- **While on a Bluetooth® call, pressing the  key or  key will display a message indicating that you are currently on a call.**
- **A message will be displayed if you receive a Bluetooth® Wireless Technology call while already on a Blue Link® call. At this time, press the  key on the steering wheel remote controller to accept the call. The phone bell will not ring.**

Eco Coach



- What is Eco Coach?

Every 2.5 minutes, Eco Coach compares your fuel economy against the government tested average (EPA) or other similar Hyundai models (community), based on your preference. Each month, or after every tank fill up, Eco Coach rates your extended average and gives you a reward star if you best the average.

See your My Hyundai web page for more information.

- What does the bar graph and horizontal line mean?

The horizontal line is adjusted once per month or at each tank full, based on your preference; it represents the EPA combined average or community average fuel economy target.

- What is My Eco MPG?

Your actual fuel economy average over 2.5 minutes.

This value is also shown in bar graph as your "now" rating.

- What are Eco Rewards?

If you beat the average (the EPA or community), you will receive an Eco Reward point.

See your my Hyundai web page for more information.

[Eco Driving] will not operate if the vehicle ignition is not turned on. Please operate with the ignition turned on.

Turn by Turn

The Turn by Turn feature can be used through Blue Link®.

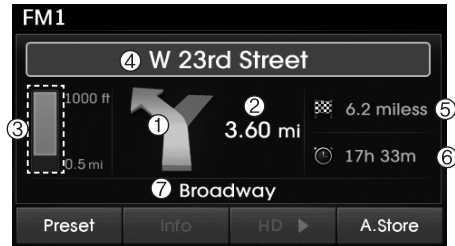

- 4.Next Street name
- 5.Distance to destination
- 6.Expected Time Arrival
- 7. Current Street name

* For information on specific Blue Link® operations, please refer to a separate manual.

- 1.Direction Indicator Image
- 2.Remaining distance until next point
- 3.The Count bar is divided into a total of 9 levels.

| | | | |
|---------|-------|---------|-------|
| 9 Level | 0.5mi | 8 Level | 0.4mi |
| 7 Level | 0.3mi | 6 Level | 0.2mi |
| 5 Level | 0.1mi | 4 Level | 400ft |
| 3 Level | 300ft | 2 Level | 200ft |
| 1 Level | 100ft | | |

DECLARATION OF CONFORMITY

FCC

This equipment has been tested and found to comply with the limits for a Class B digital device, pursuant to part 15 of the FCC Rules. These limits are designed to provide reasonable protection against harmful interference in a residential installation.

This equipment generates, uses and can radiate radio frequency energy and, if not installed and used in accordance with the instructions, may cause harmful interference to radio communications. However, there is no guarantee that interference will not occur in a particular installation. If this equipment does cause harmful interference to radio or television reception, which can be determined by turning the equipment off and on, the user is encouraged to try to correct the interference by one or more of the following measures:

- Reorient or relocate the receiving antenna.
- Increase the separation between the equipment and receiver.
- Connect the equipment into an outlet on a circuit different from that to which the receiver is connected.
- Consult the dealer or an experienced radio/TV technician for help.

Caution: Any changes or modifications to this device not explicitly approved by manufacturer could void your authority to operate this equipment.

This device complies with part 15 of the FCC Rules. Operation is subject to the following two conditions :

(1) This device may not cause harmful interference, and (2) this device must accept any interference received, including interference that may cause undesired operation.

This equipment complies with FCC radiation exposure limits set forth for an uncontrolled environment.

This equipment should be installed and operated with minimum 20cm between the and your body. This transmitter must not be collocated or operating in conjunction with any other antenna or transmitter unless authorized to do so by the FCC.

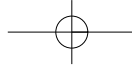

Driving your vehicle

| | | | |
|--|------|---|------|
| Before driving | 5-3 | Cruise control system | 5-43 |
| • Before entering the vehicle | 5-3 | Special driving conditions | 5-48 |
| • Before starting | 5-3 | • Hazardous driving conditions | 5-48 |
| Ignition switch | 5-5 | • Rocking the vehicle | 5-48 |
| • Key ignition switch | 5-5 | • Smooth cornering | 5-49 |
| • Engine Start/Stop button | 5-9 | • Driving at night | 5-49 |
| Manual transaxle | 5-18 | • Driving in the rain | 5-50 |
| • Manual transaxle operation | 5-18 | • Driving in flooded areas | 5-50 |
| • Good driving practices | 5-20 | Winter driving | 5-51 |
| Automatic transaxle | 5-22 | • Snow or icy conditions | 5-51 |
| • Automatic transaxle operation | 5-22 | • Use high quality ethylene glycol coolant | 5-53 |
| • Parking | 5-27 | • Check battery and cables | 5-53 |
| • Good driving practices | 5-27 | • Change to "winter weight" oil if necessary | 5-53 |
| Braking system | 5-29 | • Check spark plugs and ignition system | 5-53 |
| • Power brakes | 5-29 | • To keep locks from freezing | 5-53 |
| • Disc brakes wear indicator | 5-30 | • Use approved window washer anti-freeze in system .. | 5-53 |
| • Parking brake | 5-30 | • Don't let your parking brake freeze | 5-54 |
| • Anti-lock Brake System (ABS) | 5-32 | • Don't let ice and snow accumulate underneath | 5-54 |
| • Electronic Stability Control (ESC) | 5-34 | • Carry emergency equipment | 5-54 |
| • Vehicle Stability Management (VSM) | 5-38 | • Don't place foreign objects or materials in the | |
| • Hill-Start Assist Control (HAC) | 5-39 | engine compartment | 5-54 |
| • Good braking practices | 5-40 | Vehicle load limit | 5-55 |
| Driving assist system | 5-41 | • Tire loading information label | 5-56 |
| • Active ECO system | 5-41 | Trailer towing | 5-61 |

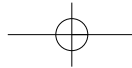

Driving your vehicle

⚠ WARNING

Carbon monoxide (CO) gas is toxic. Breathing CO can cause unconsciousness and death.

Engine exhaust contains carbon monoxide which cannot be seen or smelled.

Do not inhale engine exhaust.

If at any time you smell engine exhaust inside the vehicle, open the windows immediately. Exposure to CO can cause unconsciousness and death by asphyxiation.

Be sure the exhaust system does not leak.

The exhaust system should be checked whenever the vehicle is raised to change the oil or for any other purpose. If you hear a change in the sound of the exhaust or if you drive over something that strikes the underneath side of the vehicle, have the exhaust system checked as soon as possible by an authorized HYUNDAI dealer.

Do not run the engine in an enclosed area.

Letting the engine idle in your garage, even with the garage door open, is a hazardous practice. Run the engine only long enough to start the engine and to move the vehicle out of the garage.

Avoid idling the engine for prolonged periods with people inside the vehicle.

If it is necessary to idle the engine for a prolonged period with people inside the vehicle, be sure to do so only in an open area with the air intake set at "Fresh" and fan control set to high so fresh air is drawn into the interior.

Keep the air intakes clear.

To assure proper operation of the ventilation system, keep the ventilation air intakes located in front of the windshield clear of snow, ice, leaves, or other obstructions.

If you must drive with the trunk open:

Close all windows.

Open instrument panel air vents.

Set the air intake control at "Fresh", the air flow control at "Floor" or "Face", and the fan control set to high.

**⚠ WARNING - CALIFORNIA
PROPOSITION 65 WARNING**

Engine exhaust and a wide variety of automobile components including components found in the interior furnishings in a vehicle, contain or emit harmful chemicals known to the State of California to cause cancer and birth defects and reproductive harm. In addition, certain fluids contained in vehicles and certain products of components contain or emit chemicals known to the State of California to cause cancer and birth defects or other reproductive harm.

BEFORE DRIVING

Before entering the vehicle

- Be sure all windows, outside mirror(s), and outside lights are clean and unobstructed.
- Remove frost, snow, or ice.
- Visually check the tires for uneven wear and damage.
- Check under the vehicle for any sign of leaks.
- Be sure there are no obstacles behind you if you intend to back up.

Before starting

- Make sure the hood, the trunk, and the doors are securely closed and locked.
- Adjust the position of the seat and steering wheel.
- Adjust the inside and outside rearview mirrors.
- Verify all the lights work.
- Fasten your seatbelt. Check that all passengers have fastened their seatbelts.
- Check the gauges and indicators in the instrument panel and the messages on the instrument display when the ignition switch is in the ON position.
- Check that any items you are carrying are stored properly or fastened down securely.

Driving your vehicle

⚠ WARNING

To reduce the risk of **SERIOUS INJURY** or **DEATH**, take the following precautions:

- **ALWAYS** wear your seat belt. All passengers must be properly belted whenever the vehicle is moving. For more information, refer to "Seat Belts" in chapter 3.
- Always drive defensively. Assume other drivers or pedestrians may be careless and make mistakes.
- Stay focused on the task of driving. Driver distraction can cause accidents.
- Leave plenty of space between you and the vehicle in front of you.

⚠ WARNING

NEVER drink or take drugs and drive. Drinking or taking drugs and driving is dangerous and may result in an accident and **SERIOUS INJURY** or **DEATH**.

Drunk driving is the number one contributor to the highway death toll each year. Even a small amount of alcohol will affect your reflexes, perceptions and judgment. Just one drink can reduce your ability to respond to changing conditions and emergencies and your reaction time gets worse with each additional drink.

Driving while under the influence of drugs is as dangerous or more dangerous than driving under the influence of alcohol.

(Continued)

(Continued)

You are much more likely to have a serious accident if you drink or take drugs and drive. If you are drinking or taking drugs, don't drive. Do not ride with a driver who has been drinking or taking drugs. Choose a designated driver or call a taxi.

IGNITION SWITCH

⚠ WARNING

To reduce the risk of **SERIOUS INJURY** or **DEATH**, take the following precautions:

- **NEVER** allow children or any person who is unfamiliar with the vehicle to touch the ignition switch or related parts. Unexpected and sudden vehicle movement can occur.
- **NEVER** reach through the steering wheel for the ignition switch, or any other control, while the vehicle is in motion. The presence of your hand or arm in this area may cause a loss of vehicle control resulting in an accident.

Key ignition switch



Whenever the front door is opened, the ignition switch will illuminate, provided the ignition switch is not in the ON position. The light will go off immediately when the ignition switch is turned on or go off after about 30 seconds when the door is closed. (if equipped)

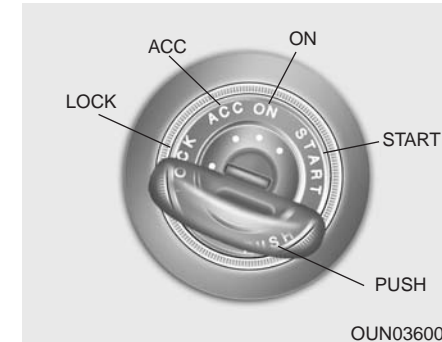

⚠ WARNING

- **NEVER** turn the ignition switch to the **LOCK** or **ACC** position while the vehicle is in motion except in an emergency. This will result in the engine turning off and loss of power assist for the steering and brake systems. This may lead to loss of directional control and braking function, which could cause an accident.

(Continued)

Driving your vehicle

(Continued)

- Before leaving the driver's seat, always make sure the shift lever is in 1st gear (for manual transaxle vehicle) or P (Park, for automatic transaxle vehicle) position, apply the parking brake, and turn ignition switch to the LOCK position.

Unexpected vehicle movement may occur if these precautions are not followed.

Key ignition switch positions

| Switch Position | Action | Notes |
|------------------------|---|---|
| LOCK | To turn the ignition switch to the LOCK position, push the key in slightly at the ACC position and turn the key towards the LOCK position. The ignition key can be removed in the LOCK position. | The steering wheel locks to protect the vehicle from theft. (if equipped) |
| ACC | Electrical accessories are usable. | The steering wheel unlocks. If difficulty is experienced turning the ignition switch to the ACC position, turn the key while turning the steering wheel right and left to release tension. |
| ON | This is the normal key position when the engine has started. All features and accessories are usable. The warning lights can be checked when you turn the ignition switch from ACC to ON. | Do not leave the ignition switch in the ON position when the engine is not running to prevent the battery from discharging. |
| START | To start the engine, turn the ignition switch to the START position. The switch returns to the ON position when you let go of the key. | The engine will crank until you release the key. |

Driving your vehicle

Starting the engine

WARNING

- **Always wear appropriate shoes when operating your vehicle. Unsuitable shoes, such as high heels, ski boots, sandals, flip-flops, etc., may interfere with your ability to use the brake, accelerator and clutch pedals.**
- **Do not start the vehicle with the accelerator pedal depressed. The vehicle can move and lead to an accident.**
- **Wait until the engine rpm is normal. The vehicle may suddenly move if the brake pedal is released when the rpm is high.**

Vehicle with manual transaxle:

1. Make sure the parking brake is applied.
2. Make sure the shift lever is in neutral.
3. Depress the clutch and brake pedals.
4. Turn the ignition switch to the START position. Hold the key (maximum of 10 seconds) until the engine starts and release it.

Vehicle with automatic transaxle:

1. Make sure the parking brake is applied.
2. Make sure the shift lever is in P (Park).
3. Depress the brake pedal.
4. Turn the ignition switch to the START position. Hold the key (maximum of 10 seconds) until the engine starts and release it.

* NOTICE

- Do not wait for the engine to warm up while the vehicle remains stationary. Start driving at moderate engine speeds. (Steep accelerating and decelerating should be avoided.)
- Always start the vehicle with your foot on the brake pedal. Do not depress the accelerator while starting the vehicle. Do not race the engine while warming it up.

⚠ CAUTION

To prevent damage to the vehicle:

- Do not hold the ignition key in the **START** position for more than 10 seconds. Wait 5 to 10 seconds before trying again.
- Do not turn the ignition switch to the **START** position with the engine running. It may damage the starter.
- If traffic and road conditions permit, you may put the shift lever in the **N (Neutral)** position while the vehicle is still moving and turn the ignition switch to the **START** position in an attempt to restart the engine.
- Do not push or tow your vehicle to start the engine.

Engine Start/Stop button



OMD054005

Whenever the front door is opened, the Engine Start/Stop button will illuminate and will go off 30 seconds after the door is closed.

Driving your vehicle

⚠ WARNING

To turn the engine off in an emergency:



Press and hold the Engine Start/Stop button for more than two seconds OR Rapidly press and release the Engine Start/Stop button three times (within three seconds).

If the vehicle is still moving, you can restart the engine without depressing the brake pedal by pressing the Engine Start/Stop button with the shift lever in the N (Neutral) position.

⚠ WARNING



- **NEVER** press the Engine Start/Stop button while the vehicle is in motion except in an emergency. This will result in the engine turning off and loss of power assist for the steering and brake systems. This may lead to loss of directional control and braking function, which could cause an accident.
- Before leaving the driver's seat, always make sure the shift lever is in the P (Park) position, set the parking brake, press the Engine Start/Stop button to the OFF position, and take the Smart Key with you. Unexpected vehicle movement may occur if these precautions are not followed.

Engine Stop/Start button positions**- Vehicle with manual transaxle**



| Button Position | Action | Notes |
|--|--|--|
| <p data-bbox="533 555 595 579">OFF</p>  <p data-bbox="472 858 656 882">Not illuminated</p> | <p data-bbox="707 563 1240 619">To turn off the engine, stop the vehicle and then press the Engine Start/Stop button.</p> | |
| <p data-bbox="533 898 595 922">ACC</p>  <p data-bbox="472 1201 656 1225">Orange indicator</p> | <ul data-bbox="707 906 1240 1026" style="list-style-type: none"> • Press the Engine Start/Stop button when the button is in the OFF position without depressing the clutch pedal. • Electrical accessories are usable. | <p data-bbox="1252 906 1800 1018">If you leave the Engine Start/Stop button in the ACC position for more than one hour, the battery power will turn off automatically to prevent the battery from discharging.</p> |

Driving your vehicle

- Vehicle with manual transaxle



| Button Position | Action | Notes |
|---|--|---|
| <p>ON</p>  <p>Blue indicator</p> | <ul style="list-style-type: none"> Press the Engine Start/Stop button while it is in the ACC position without depressing the clutch pedal. The warning lights can be checked before the engine is started. | <p>If you leave the Engine Start/Stop button in the ON position for more than one hour, the battery power will turn off automatically to prevent the battery from discharging.</p> |
| <p>START</p>  <p>Not illuminated</p> | <p>To start the engine, depress the clutch and brake pedals and press the Engine Start/Stop button with the shift lever in neutral.</p> | <p>If you press the Engine Start/Stop button without depressing the clutch pedal, the engine does not start and the Engine Start/Stop button changes as follows: OFF → ACC → ON → OFF</p> |

Engine Stop/Start button positions
- Vehicle with automatic transaxle

| Button Position | Action | Notes |
|--|---|---|
| <p>OFF</p>  <p>Not illuminated</p> | <p>To turn off the engine, press the Engine Start/Stop button with shift lever in P (Park). When you press the Engine Start/Stop button without the shift lever in P (Park), the Engine Start/Stop button does not turn to the OFF position, but turns to the ACC position.</p> | |
| <p>ACC</p>  <p>Orange indicator</p> | <ul style="list-style-type: none"> • Press the Engine Start/Stop button when the button is in the OFF position without depressing the brake pedal. • Electrical accessories are usable. | <p>If you leave the Engine Start/Stop button in the ACC position for more than one hour, the battery power will turn off automatically to prevent the battery from discharging.</p> |

Driving your vehicle

- Vehicle with automatic transaxle

| Button Position | Action | Notes |
|---|---|--|
| <p>ON</p>  <p>Blue indicator</p> | <ul style="list-style-type: none"> Press the Engine Start/Stop button while it is in the ACC position without depressing the brake pedal. The warning lights can be checked before the engine is started. | <p>If you leave the Engine Start/Stop button in the ON position for more than one hour, the battery power will turn off automatically to prevent the battery from discharging.</p> |
| <p>START</p>  <p>Not illuminated</p> | <p>To start the engine, depress the brake pedal and press the Engine Start/Stop button with the shift lever in the P (Park) or in the N (Neutral) position.</p> <p>For your safety, start the engine with the shift lever in the P (Park) position.</p> | <p>If you press the Engine Start/Stop button without depressing the brake pedal, the engine does not start and the Engine Start/Stop button changes as follows: OFF → ACC → ON → OFF</p> |

Starting the engine

⚠ WARNING

- Always wear appropriate shoes when operating your vehicle. Unsuitable shoes, such as high heels, ski boots, sandals, flip-flops, etc., may interfere with your ability to use the brake, accelerator and clutch pedals.
- Do not start the vehicle with the accelerator pedal depressed. The vehicle can move and lead to an accident.
- Wait until the engine rpm is normal. The vehicle may suddenly move if the brake pedal is released when the rpm is high.

*** NOTICE**

- The engine will start by pressing the Engine Start/Stop button, only when the smart key is in the vehicle.
- Even if the smart key is in the vehicle, if it is far away from the driver, the engine may not start.
- When the Engine Start/Stop button is in the ACC or ON position, if any door is open, the system checks for the smart key. If the smart key is not in the vehicle, the "🔑" indicator will blink, and if all doors are closed, the chime will also sound for about 5 seconds. The indicator will turn off while the vehicle is moving. Keep the smart key in the vehicle when using the ACC position or if the vehicle engine is ON.

Vehicle with manual transaxle:

1. Always carry the smart key with you.
2. Make sure the parking brake is applied.
3. Make sure the shift lever is in neutral.
4. Depress the clutch and brake pedals.
5. Press the Engine Start/Stop button.

Driving your vehicle

Vehicle with automatic transaxle:

1. Always carry the smart key with you.
2. Make sure the parking brake is applied.
3. Make sure the shift lever is in P (Park).
4. Depress the brake pedal.
5. Press the Engine Start/Stop button.

* NOTICE

- Do not wait for the engine to warm up while the vehicle remains stationary. Start driving at moderate engine speeds. (Steep accelerating and decelerating should be avoided.)
- Always start the vehicle with your foot on the brake pedal. Do not depress the accelerator while starting the vehicle. Do not race the engine while warming it up.

⚠ CAUTION

To prevent damage to the vehicle:

- **If the engine stalls while you are in motion, do not attempt to move the shift lever to the P (Park) position.**

If traffic and road conditions permit, you may put the shift lever in the N (Neutral) position while the vehicle is still moving and press the Engine Start/Stop button in an attempt to restart the engine.

- **Do not push or tow your vehicle to start the engine.**

⚠ CAUTION

To prevent damage to the vehicle:

Do not press the Engine Start/Stop button for more than 10 seconds except when the stop lamp fuse is blown.

When the stop lamp fuse is blown, you can't start the engine normally. Replace the fuse with a new one. If you are not able to replace the fuse, you can start the engine by pressing and holding the Engine Start/Stop button for 10 seconds with the Engine Start/Stop button in the ACC position.

For your safety always depress the brake and/or clutch pedal before starting the engine.



*** NOTICE**

If the smart key battery is weak or the smart key does not work correctly, you can start the engine by pressing the Engine Start/Stop button with the smart key in the direction of the picture above.

Driving your vehicle

MANUAL TRANSAXLE

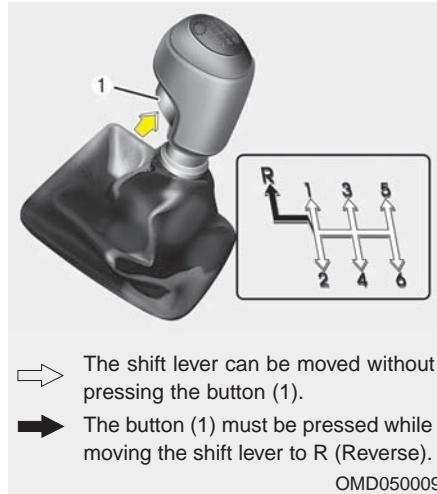

Manual transaxle operation

The manual transaxle has 6 forward gears. The transaxle is fully synchronized in all forward gears so shifting to either a higher or a lower gear is easily accomplished.

⚠ WARNING

Before leaving the driver's seat, always make sure the shift lever is in 1st gear when the vehicle is parked on a uphill and in R (Reverse) on a downhill, set the parking brake, and place the ignition switch in the LOCK/OFF position. Unexpected vehicle movement may occur if these precautions are not followed.

To shift to R (Reverse), make sure the vehicle has completely stopped, and then move the shift lever to neutral before moving into R (Reverse).

When you've come to a complete stop and it's hard to shift into 1st gear or R (Reverse):

1. Put the shift lever in neutral and release the clutch pedal.
2. Depress the clutch pedal, and then shift into first or R (Reverse) gear.

* NOTICE

During cold weather, shifting may be difficult until the transaxle lubricant has warmed up.

Using the clutch

The clutch pedal should be depressed all the way to the floor before:

- Starting the engine
The engine will not start without depressing the clutch pedal.
- Shifting

When releasing the clutch pedal, release it slowly. The clutch pedal should always be released while driving.

⚠ CAUTION

To prevent unnecessary wear or damage to the clutch:

- ***Do not rest your foot on the clutch pedal while driving.***
- ***Do not hold the vehicle with the clutch on an incline, while waiting for the traffic light, etc.***
- ***Always depress the clutch pedal down fully to prevent noise or damage.***
- ***Do not start with the 2nd (second) gear engaged except when you start on a slippery road.***

Downshifting

Downshift when you must slow down in heavy traffic or drive up a steep hill to prevent engine load.

Also, downshifting reduces the chance of stalling and can accelerate when you need to increase your speed again.

When the vehicle is going downhill, downshifting helps maintain safe speed by providing brake power from the engine and enables less wear on the brakes.

Driving your vehicle

CAUTION

To prevent damage to the engine, clutch and transaxle:

- **When downshifting from 5th gear to 4th gear, be careful not to inadvertently push the shift lever sideways engaging the 2nd gear. A drastic downshift may cause the engine speed to increase to the point the tachometer will enter the red-zone.**
- **Do not downshift more than two gear at a time or downshift the gear when the engine is running at high speed (5,000 RPM or higher).**

Good driving practices

- Never take the vehicle out of gear and coast down a hill. This is extremely dangerous.
- Don't "ride" the brakes. This can cause the brakes and related parts to overheat and malfunction.

When you are driving down a long hill, slow down and shift to a lower gear. Engine braking will help slow down the vehicle.

- Slow down before shifting to a lower gear. This will help avoid over-revving the engine, which can cause damage.
- Slow down when you encounter cross winds. This gives you much better control of your vehicle.
- Be sure the vehicle is completely stopped before you shift into R (Reverse) to prevent damage to the transaxle.

- Exercise extreme caution when driving on a slippery surface. Be especially careful when braking, accelerating or shifting gears. On a slippery surface, an abrupt change in vehicle speed can cause the drive wheels to lose traction and may cause loss of vehicle control resulting in an accident

WARNING

Do not use the engine brake (shifting from a higher gear to lower gear) rapidly on slippery roads. The vehicle may slip causing an accident.

⚠ WARNING

To reduce the risk of **SERIOUS INJURY** or **DEATH**:

- **ALWAYS** wear your seatbelt. In a collision, an unbelted occupant is significantly more likely to be seriously injured or killed than a properly belted occupant.
- Avoid high speeds when cornering or turning.
- Do not make quick steering wheel movements, such as sharp lane changes or fast, sharp turns.
- The risk of rollover is greatly increased if you lose control of your vehicle at highway speeds.
- Loss of control often occurs if two or more wheels drop off the roadway and the driver over steers to reenter the roadway.

(Continued)

(Continued)

- In the event your vehicle leaves the roadway, do not steer sharply. Instead, slow down before pulling back into the travel lanes.
- **HYUNDAI** recommends you follow all posted speed limits.







Information Provided by:

DEALER
E-PROCESS

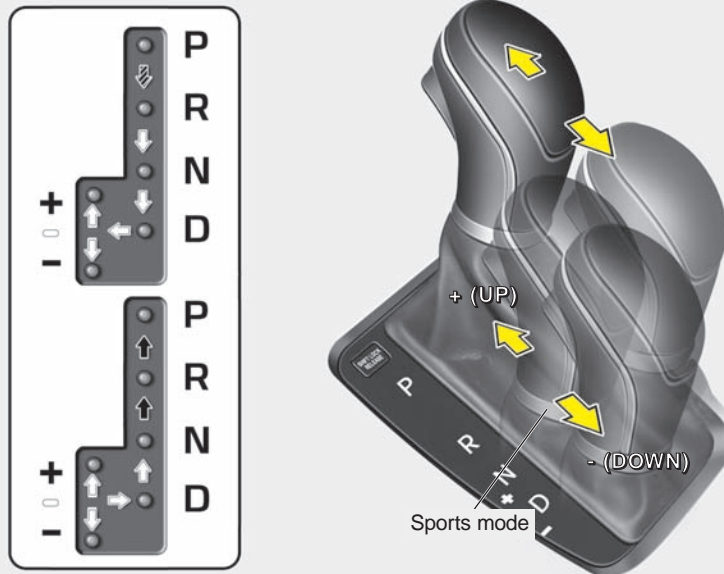
Driving your vehicle

AUTOMATIC TRANSAXLE



-  Depress the brake pedal, then move shift lever.
-  Press the shift button, then move shift lever.
-  Move shift lever.

OMD054010

Automatic transaxle operation

The automatic transaxle has six forward speeds and one reverse speed. The individual speeds are selected automatically in the D (Drive) position.

⚠ WARNING

To reduce the risk of serious injury or death:

- **ALWAYS** check the surrounding areas near your vehicle for people, especially children, before shifting a vehicle into D (Drive) or R (Reverse).
- Before leaving the driver's seat, always make sure the shift lever is in the P (Park) position, then set the parking brake, and place the ignition switch in the LOCK/OFF position. Unexpected and sudden vehicle movement can occur if these precautions are not followed.

The indicator in the instrument cluster displays the shift lever position when the ignition switch is in the ON position.

P (Park)

Always come to a complete stop before shifting into P (Park).

To shift from P (Park), you must depress firmly on the brake pedal and make sure your foot is off the accelerator pedal.

If you have done all of the above and still cannot shift the lever out of P (Park), see "Shift-Lock Release" on page 5-26.

The shift lever must be in P (Park) before turning the engine off.

⚠ WARNING

- **Shifting into P (Park) while the vehicle is in motion may cause you to lose control of the vehicle.**
- **After the vehicle has stopped, always make sure the shift lever is in P (Park), apply the parking brake, and turn the engine off.**
- **Do not use the P (Park) position in place of the parking brake.**

R (Reverse)

Use this position to drive the vehicle backward.

⚠ CAUTION

Always come to a complete stop before shifting into or out of R (Reverse); you may damage the transaxle if you shift into R (Reverse) while the vehicle is in motion.

Driving your vehicle

N (Neutral)

The wheels and transaxle are not engaged.

Use N (Neutral) if you need to restart a stalled engine. Shift into P (Park) if you need to leave your vehicle for any reason.

Always depress the brake pedal when you are shifting from N (Neutral) to another gear.

⚠ WARNING

- Do not shift into gear unless your foot is firmly on the brake pedal. Shifting into gear when the engine is running at high speed can cause the vehicle to move very rapidly. You could lose control of the vehicle.
- Do not drive with the shift lever in N (Neutral). The engine brake will not work and lead to an accident.

D (Drive)

This is the normal driving position. The transaxle will automatically shift through a 6-gear sequence, providing the best fuel economy and power.

For extra power when passing another vehicle or driving uphill, depress the accelerator fully. The transaxle will automatically downshift to the next lower gear (or gears, as appropriate).

Sports mode

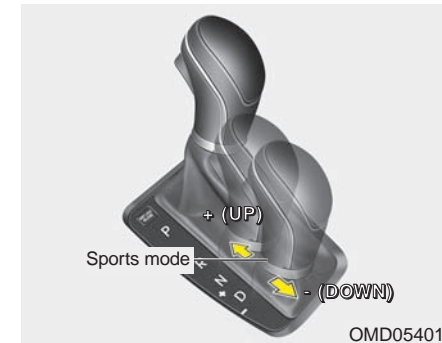

OMD054012

Whether the vehicle is stationary or in motion, sports mode is selected by pushing the shift lever from the D (Drive) position into the manual gate. To return to D (Drive) range operation, push the shift lever back into the main gate.

In Sports Mode, moving the shift lever backwards and forwards will allow you to select the desired range of gears for the current driving conditions.

+ (Up) : Push the lever forward once to shift up one gear.

- (Down) : Pull the lever backwards once to shift down one gear.

* NOTICE

- Only the six forward gears can be selected. To reverse or park the vehicle, move the shift lever to the R (Reverse) or P (Park) position as required.
- Downshifts are made automatically when the vehicle slows down. When the vehicle stops, 1st gear is automatically selected.
- When the engine rpm approaches the red zone the transaxle will upshift automatically.

(Continued)

(Continued)

- If the driver presses the lever to + (Up) or - (Down) position, the transaxle may not make the requested gear change if the next gear is outside of the allowable engine rpm range. The driver must execute upshifts in accordance with road conditions, taking care to keep the engine rpms below the red zone.
- When accelerating from a stop on a slippery road, push the shift lever forward into the + (Up) position. This causes the transaxle to shift into the 2nd gear which is better for smooth driving on a slippery road. Push the shift lever to the - (Down) side to shift back to the 1st gear.

Shift-lock system

For your safety, the automatic transaxle has a shift-lock system which prevents shifting the transaxle from P (Park) into R (Reverse) unless the brake pedal is depressed.

To shift the transaxle from P (Park) into R (Reverse):

1. Depress and hold the brake pedal.
2. Start the engine or place the ignition switch in the ON position.
3. Move the shift lever.

Driving your vehicle

Shift-lock release

If the shift lever cannot be moved from the P (Park) position into R (Reverse) position with the brake pedal depressed, continue depressing the brake, and then do the following:

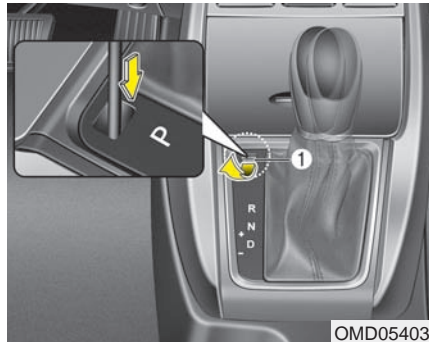

If you need to use the shift-lock release, have the system inspected by an authorized HYUNDAI dealer immediately.

1. Place the ignition switch in the LOCK/OFF position.
2. Apply the parking brake.
3. Carefully remove the cap (1) covering the shift-lock access hole.
4. Insert a screwdriver into the access hole and press down on the screwdriver.
5. Move the shift lever while holding down the screwdriver.
6. Remove the screwdriver from the shift-lock access hole then install the cap.

Ignition key interlock system

The ignition key cannot be removed unless the shift lever is in the P (Park) position.

Parking

Always come to a complete stop and continue to depress the brake pedal. Move the shift lever into the P (Park) position, apply the parking brake, and place the ignition switch in the LOCK/OFF position. Take the Key with you when exiting the vehicle.

Good driving practices

- Never move the shift lever from P (Park) or N (Neutral) to any other position with the accelerator pedal depressed.
- Never move the shift lever into P (Park) when the vehicle is in motion.

Be sure the vehicle is completely stopped before you attempt to shift into R (Reverse) or D (Drive).

- Do not move the shift lever to N (Neutral) when driving. Doing so may result in an accident because of a loss of engine braking and the transaxle could be damaged.
- Do not drive with your foot resting on the brake pedal. Even light, but consistent pedal pressure can result in the brakes overheating, brake wear and possibly even brake failure.
- When driving in sports mode, slow down before shifting to a lower gear. Otherwise, the lower gear may not be engaged if the engine RPM is outside of the allowable range.

⚠ WARNING

When you stay in the vehicle with the engine running, be careful not to depress the accelerator pedal for a long period of time. The engine or exhaust system may overheat and start a fire.

The exhaust gas and the exhaust system are very hot. Keep away from the exhaust system components.

Do not stop or park over flammable materials, such as dry grass, paper or leaves. They may ignite and cause a fire.

Driving your vehicle

- Always apply the parking brake when leaving the vehicle. Do not depend on placing the transaxle in P (Park) to keep the vehicle from moving.
- Exercise extreme caution when driving on a slippery surface. Be especially careful when braking, accelerating or shifting gears. On a slippery surface, an abrupt change in vehicle speed can cause the drive wheels to lose traction and may cause loss of vehicle control resulting in an accident
- Optimum vehicle performance and economy is obtained by smoothly depressing and releasing the accelerator.

⚠ WARNING

To reduce the risk of **SERIOUS INJURY or DEATH:**

- **ALWAYS wear your seatbelt. In a collision, an unbelted occupant is significantly more likely to be seriously injured or killed than a properly belted occupant.**
- **Avoid high speeds when cornering or turning.**
- **Do not make quick steering wheel movements, such as sharp lane changes or fast, sharp turns.**
- **The risk of rollover is greatly increased if you lose control of your vehicle at highway speeds.**
- **Loss of control often occurs if two or more wheels drop off the roadway and the driver over steers to reenter the roadway.**

(Continued)

(Continued)

- **In the event your vehicle leaves the roadway, do not steer sharply. Instead, slow down before pulling back into the travel lanes.**
- **HYUNDAI recommends you follow all posted speed limits.**

BRAKING SYSTEM

Power brakes

Your vehicle has power-assisted brakes that adjust automatically through normal usage.

If the engine is not running or is turned off while driving, the power assist for the brakes will not work. You can still stop your vehicle by applying greater force to the brake pedal than typical. The stopping distance, however, will be longer than with power brakes.

When the engine is not running, the reserve brake power is partially depleted each time the brake pedal is applied. Do not pump the brake pedal when the power assist has been interrupted.

Pump the brake pedal only when necessary to maintain steering control on slippery surfaces.

⚠ WARNING

Take the following precautions:

- **Do not drive with your foot resting on the brake pedal. This will create abnormal high brake temperatures, excessive brake lining and pad wear, and increased stopping distances.**
- **When descending a long or steep hill, shift to a lower gear and avoid continuous application of the brakes. Applying the brakes continuously will cause the brakes to overheat and could result in a temporary loss of braking performance.**

(Continued)

(Continued)

- **Wet brakes may impair the vehicle's ability to safely slow down; the vehicle may also pull to one side when the brakes are applied. Applying the brakes lightly will indicate whether they have been affected in this way. Always test your brakes in this fashion after driving through deep water. To dry the brakes, lightly tap the brake pedal to heat up the brakes while maintaining a safe forward speed until brake performance returns to normal. Avoid driving at high speeds until the brakes function correctly.**

Driving your vehicle

Disc brakes wear indicator

When your brake pads are worn and new pads are required, you will hear a high pitched warning sound from your front or rear brakes. You may hear this sound come and go or it may occur whenever you depress the brake pedal.

Please remember some driving conditions or climates may cause a brake squeal when you first apply (or lightly apply) the brakes. This is normal and does not indicate a problem with your brakes.

⚠ CAUTION

To avoid costly brake repairs, do not continue to drive with worn brake pads.

*** NOTICE**

Always replace brake pads as complete front or rear axle sets.

Parking brake

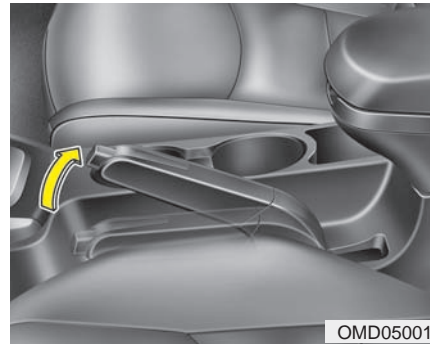

Always set the parking brake before leaving the vehicle, to apply:

Firmly depress the brake pedal.

Pull up the parking brake lever as far as possible.

⚠ WARNING

To reduce the risk of SERIOUS INJURY or DEATH, do not operate the parking brake while the vehicle is moving except in an emergency situation. It could damage the brake system and lead to an accident.

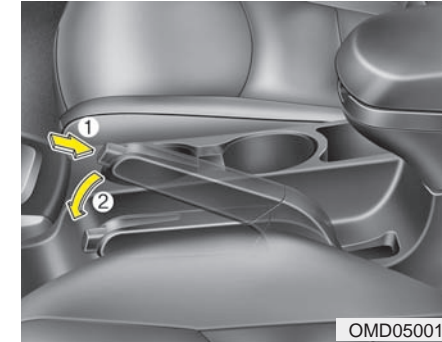

To release:

Firmly depress the brake pedal.

Slightly pull up the parking brake lever.

While pressing the release button (1), lower the parking brake (2).

If the parking brake does not release or does not release all the way, have the system checked by an authorized HYUNDAI dealer.

Driving your vehicle

WARNING

- Whenever leaving the vehicle or parking, always come to a complete stop and continue to depress the brake pedal. Move the shift lever into the 1st gear (for manual transaxle vehicle) or P (Park, for automatic transaxle vehicle) position, then apply the parking brake, and place the ignition switch in the LOCK/OFF position.
Vehicles with the parking brake not fully engaged are at risk for moving inadvertently and causing injury to yourself or others.
- NEVER allow anyone who is unfamiliar with the vehicle to touch the parking brake. If the parking brake is released unintentionally, serious injury may occur.
- Only release the parking brake when you are seated inside the vehicle with your foot firmly on the brake pedal.

CAUTION

- *Do not apply the accelerator pedal while the parking brake is engaged. If you depress the accelerator pedal with the parking brake engaged, warning will sound. Damage to the parking brake may occur.*
- *Driving with the parking brake on can overheat the braking system and cause premature wear or damage to brake parts. Make sure the parking brake is released and the Brake Warning Light is off before driving.*



Check the Parking Brake Warning Light by placing the ignition switch to the ON position (do not start the engine).

This light will be illuminated when the parking brake is applied with the ignition switch in the START or ON position.

Before driving, be sure the parking brake is released and the Brake Warning Light is OFF.

If the Parking Brake Warning Light remains on after the parking brake is released while engine is running, there may be a malfunction in the brake system. Immediate attention is necessary.

If at all possible, cease driving the vehicle immediately. If that is not possible, use extreme caution while operating the vehicle and only continue to drive the vehicle until you can reach a safe location.

Driving your vehicle

Anti-lock Brake System (ABS)

⚠ WARNING

An Anti-Lock Braking System (ABS) or an Electronic Stability Control (ESC) system will not prevent accidents due to improper or dangerous driving maneuvers. Even though vehicle control is improved during emergency braking, always maintain a safe distance between you and objects ahead of you. Vehicle speeds should always be reduced during extreme road conditions. The braking distance for cars equipped with ABS or ESC may be longer than for those without these systems in the following road conditions.

(Continued)

(Continued)

Drive your vehicle at reduced speeds during the following conditions:

- Rough, gravel or snow-covered roads.
- On roads where the road surface is pitted or has different surface height.
- Tire chains are installed on your vehicle.

The safety features of an ABS or ESC equipped vehicle should not be tested by high speed driving or cornering. This could endanger the safety of yourself or others.

ABS is an electronic braking system that helps prevent a braking skid. ABS allows the driver to steer and brake at the same time.

Using ABS

To obtain the maximum benefit from your ABS in an emergency situation, do not attempt to modulate your brake pressure and do not try to pump your brakes. Depress your brake pedal as hard as possible.

When you apply your brakes under conditions which may lock the wheels, you may hear sounds from the brakes, or feel a corresponding sensation in the brake pedal. This is normal and it means your ABS is active.

ABS does not reduce the time or distance it takes to stop the vehicle.

Always maintain a safe distance from the vehicle in front of you.

ABS will not prevent a skid that results from sudden changes in direction, such as trying to take a corner too fast or making a sudden lane change. Always drive at a safe speed for the road and weather conditions.

ABS cannot prevent a loss of stability. Always steer moderately when braking hard. Severe or sharp steering wheel movement can still cause your vehicle to veer into oncoming traffic or off the road.

On loose or uneven road surfaces, operation of the anti-lock brake system may result in a longer stopping distance than for vehicles equipped with a conventional brake system.

The ABS warning light () will stay on for several seconds after the ignition switch is in the ON position. During that time, the ABS will go through self-diagnosis and the light will go off if everything is normal. If the light stays on, you may have a problem with your ABS. Contact an authorized HYUNDAI dealer as soon as possible.

WARNING

If the ABS warning light () is on and stays on, you may have a problem with the ABS. Your power brakes will work normally. To reduce the risk of serious injury or death, contact your HYUNDAI dealer as soon as possible.

CAUTION

When you drive on a road having poor traction, such as an icy road, and apply your brakes continuously, the ABS will be active continuously and the ABS warning light () may illuminate. Pull your car over to a safe place and turn the engine off.

Restart the engine. If the ABS warning light is off, then your ABS system is normal. Otherwise, you may have a problem with your ABS system. Contact an authorized HYUNDAI dealer as soon as possible.

* NOTICE

When you jump start your vehicle because of a drained battery, the ABS warning light () may turn on at the same time. This happens because of the low battery voltage. It does not mean your ABS is malfunctioning. Have the battery recharged before driving the vehicle.



Information Provided by:

DEALER
E-PROCESS

Driving your vehicle

Electronic Stability Control (ESC)

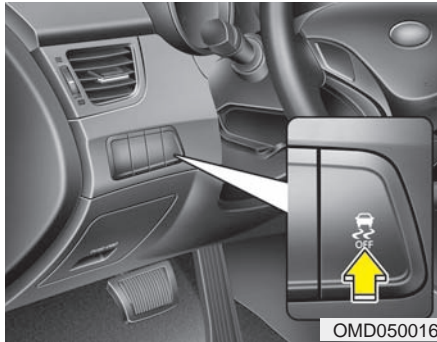

The Electronic Stability Control (ESC) system helps to stabilize the vehicle during cornering maneuvers.

ESC checks where you are steering and where the vehicle is actually going. ESC applies braking pressure to any one of the vehicle's brakes and intervenes in the engine management system to assist the driver with keeping the vehicle on the intended path. It is not a substitute for safe driving practices. Always adjust your speed and driving to the road conditions.

⚠ WARNING

Never drive too fast for the road conditions or too quickly when cornering. The ESC system will not prevent accidents.

Excessive speed in turns, abrupt maneuvers, and hydroplaning on wet surfaces can result in severe accidents.

ESC operation

ESC ON condition

When the ignition switch is in the ON position, the ESC and the ESC OFF indicator lights illuminate for approximately three seconds and goes off, then the ESC is turned on.

If this light stays on, your vehicle may have a malfunction with the ESC system. Have your vehicle checked by an authorized HYUNDAI dealer as soon as possible.

When operating



When the ESC is in operation, the ESC indicator light blinks:

- When you apply your brakes under conditions which may lock the wheels, you may hear sounds from the brakes, or feel a corresponding sensation in the brake pedal. This is normal and it means your ESC is active.
 - When the ESC activates, the engine may not respond to the accelerator as it does under routine conditions.
 - If the Cruise Control was in use when the ESC activates, the cruise control automatically disengages. The Cruise Control can be reengaged when the road conditions allow. See "Cruise Control System" later in this chapter.
- When moving out of the mud or driving on a slippery road, the engine rpm (revolutions per minute) may not increase even if you press the accelerator pedal deeply. This is to maintain the stability and traction of the vehicle and does not indicate a problem.



Information Provided by:

DEALER
E-PROCESS

Driving your vehicle

ESC OFF condition



To cancel ESC operation :

• State 1

Press the ESC OFF button shortly (ESC OFF indicator light illuminates). At this state, the engine control function does not operate. In other words, the traction control function does not operate but only the brake control function operates.

• State 2

Press the ESC OFF button for more than 3 seconds. ESC OFF indicator light illuminates and ESC OFF warning chime will sound. At this state, the engine control function and brake control function does not operate. In other words, the vehicle stability control function does not operate any more.

If the ignition switch is placed to the LOCK/OFF position when ESC is off, ESC remains off. Upon restarting the engine, the ESC will automatically turn on again.

Indicator lights

■ ESC indicator light (blinks)



■ ESC OFF indicator light (comes on)



When the ignition switch is placed to the ON position, the ESC indicator light illuminates, then goes off if the ESC system is operating normally.

The ESC indicator light blinks whenever the ESC is operating.

If ESC indicator light stays on, your vehicle may have a malfunction with the ESC system. When this warning light illuminates, have the vehicle checked by an authorized HYUNDAI dealer as soon as possible.

The ESC OFF indicator light comes on when the ESC is turned off with the button.

⚠ WARNING

When the ESC is blinking, this indicates the ESC is active:

Drive slowly and **NEVER** attempt to accelerate. **NEVER** press the ESC OFF button while the ESC indicator light is blinking or you may lose control of the vehicle resulting in an accident.

⚠ CAUTION

Driving with varying tire or wheel sizes may cause the ESC system to malfunction. When replacing tires, make sure they are the same size as your original tires for this vehicle.

ESC OFF usage

When Driving

The ESC OFF mode should only be used briefly to help free the vehicle if stuck in snow or mud by temporarily stopping operation of the ESC to maintain wheel torque.

To turn ESC off while driving, press the ESC OFF button while driving on a flat road surface.

⚠ CAUTION

To prevent damage to the transaxle:

- **Do not allow wheel(s) of one axle to spin excessively while the ESC, ABS, and brake warning lights are displayed. The repairs would not be covered by the vehicle warranty. Reduce engine power and do not spin the wheel(s) excessively while these lights are displayed.**
- **When operating the vehicle on a dynamometer, ensure the ESC is turned off (ESC OFF light illuminated).**

*** NOTICE**

Turning the ESC OFF does not affect ABS or standard brake system operation.

Driving your vehicle

Vehicle Stability Management (if equipped)

Vehicle Stability Management (VSM) helps ensure the vehicle stays stable when accelerating or braking suddenly on wet, slippery and rough roads where traction over the four tires can suddenly become uneven.

WARNING

Take the following precautions when using the Vehicle Stability Management (VSM):

- **ALWAYS check the speed and the distance to the vehicle ahead. The VSM is not a substitute for safe driving practices.**
- **Never drive too fast for the road conditions. The VSM system will not prevent accidents. Excessive speed in bad weather, slippery and uneven roads can result in severe accidents.**

VSM operation

VSM ON condition

The VSM operates when:

- The Electronic Stability Control (ESC) is on.
- Vehicle speed is approximately above 9mph (15 km/h) on curve roads.
- Vehicle speed is approximately above 18 mph (30 km/h) when the vehicle is braking on rough roads.

When operating

When you apply your brakes under conditions which may activate the ESC, you may hear sounds from the brakes, or feel a corresponding sensation in the brake pedal. This is normal and it means your VSM is active.

* NOTICE

The VSM does not operate when:



- **Driving on bank road such as gradient or incline**
- **Driving rearward.**
- **ESC OFF indicator light is on.**
- **EPS (Electric Power Steering) warning light () is on.**

VSM OFF condition

To cancel VSM operation, press the ESC OFF button. ESC OFF indicator light () will illuminate.

To turn on VSM, press the ESC OFF button again. The ESC OFF indicator light will go out.

WARNING

If ESC indicator light () or EPS warning light () stays on, your vehicle may have a malfunction with the VSM system. When the warning light illuminates have the vehicle checked by an authorized HYUNDAI dealer as soon as possible.

CAUTION

Driving with varying tire or wheel sizes may cause the ESC system to malfunction. When replacing tires, make sure they are the same size as your original tires for this vehicle.

Hill-Start Assist Control (HAC) (if equipped)

The Hill-Start Assist Control (HAC) helps prevent the vehicle from rolling backwards when starting a vehicle from a stop on a hill. The system operates the brakes automatically for approximately 2 seconds and releases the brake when the accelerator pedal is depressed or after 2 seconds.

WARNING

Always be ready to depress the accelerator pedal when starting off on a incline. The HAC activates only for approximately 2 seconds.

* NOTICE

- The HAC does not operate when the shift lever is in P (Park) or N (Neutral)
- The HAC activates even though the ESC (Electronic Stability Control) is off but does not activate when the ESC has malfunctioned.

Driving your vehicle

Good braking practices

⚠ WARNING

Whenever leaving the vehicle or parking, always come to a complete stop and continue to depress the brake pedal. Move the shift lever into the 1st gear (for manual transaxle vehicle) or P (Park, for automatic transaxle vehicle) position, then apply the parking brake, and place the ignition switch in the LOCK/OFF position.

Vehicles with the parking brake not fully engaged are at risk for moving inadvertently and causing injury to yourself or others.

Wet brakes can be dangerous! The brakes may get wet if the vehicle is driven through standing water or if it is washed. Your vehicle will not stop as quickly if the brakes are wet. Wet brakes may cause the vehicle to pull to one side.

To dry the brakes, apply the brakes lightly until the braking action returns to normal, taking care to keep the vehicle under control at all times. If the braking action does not return to normal, stop as soon as it is safe to do so and call an authorized HYUNDAI dealer for assistance.

DO NOT drive with your foot resting on the brake pedal. Even light, but constant pedal pressure can result in the brakes overheating, brake wear, and possibly even brake failure.

If a tire goes flat while you are driving, apply the brakes gently and keep the vehicle pointed straight ahead while you slow down. When you are moving slowly enough for it to be safe to do so, pull off the road and stop in a safe location.

Keep your foot firmly on the brake pedal when the vehicle is stopped to prevent the vehicle from rolling forward.

DRIVING ASSIST SYSTEM

Active ECO system

Active ECO operation

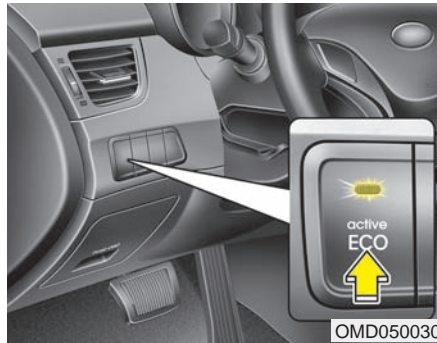

Active ECO helps improve fuel efficiency by controlling the engine and transaxle. Fuel-efficiency is determined by the driver's driving habits and road conditions.

- When the Active ECO button is pressed the ECO indicator (green) will illuminate to show that the Active ECO is operating.

- When the Active ECO is activated, it does not turn off even though the engine is restarted again. To turn off the system, press the active ECO button again.
- If Active ECO is turned off, it will return to normal mode.

When Active ECO is activated :

- Engine sound may change.
- Vehicle speed may slightly be reduced.
- Air conditioner performance may be affected.

* NOTICE

Active ECO is designed on the assumption of light to mild throttle driving style to control engine and transaxle in order to optimize fuel economy. A person with an aggressive throttle driving style may find the engine performance in Active ECO on mode to be unsatisfactory, and thus may not realize any fuel economy gain. In such an aggressive driver style case, it would be better to keep Active ECO off for best fuel economy. For best results, it is recommended to compare the performance of both modes to determine which is more effective for your driving style.

Driving your vehicle

Limitation of Active ECO operation

If the following conditions occur while Active ECO is operating, the effectiveness of the Active ECO may be limited even though the indicator is still on.

- When coolant temperature is low:
The system will be limited until engine temperature becomes normal.
- When driving up a hill:
The system will be limited to gain power when driving uphill because engine torque is required.
- When using sports mode:
The system will be limited according to shift request.

CRUISE CONTROL SYSTEM (IF EQUIPPED)

Cruise control operation

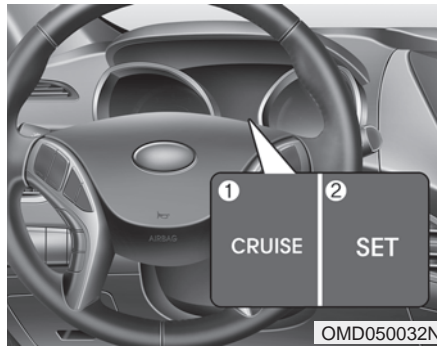

1. CRUISE indicator
2. SET indicator

The cruise control system allows you to drive at speeds above 20 mph (30 km/h) without depressing the accelerator pedal.

Cruise control switch

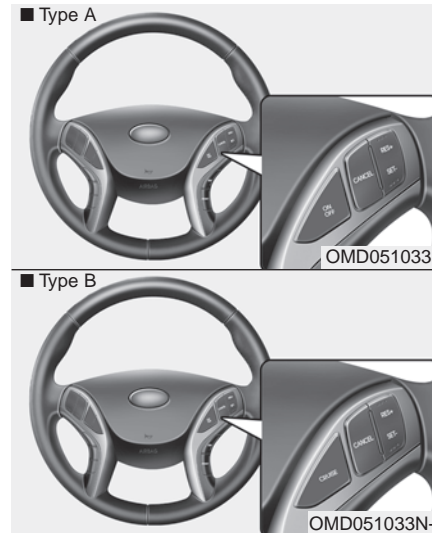

- CRUISE (ON/OFF):**
Turns cruise control system on or off.
- CANCEL:**
Cancels cruise control operation.
- RES+:**
Resumes or increases speed.
- SET-:**
Sets or decreases speed.

⚠ WARNING

Take the following precautions:

- If the cruise control is left on, (CRUISE indicator light in the instrument cluster illuminated) the cruise control can be activated unintentionally. Keep the cruise control system off (CRUISE indicator light OFF) when the cruise control is not in use, to avoid inadvertently setting a speed.
- Use the cruise control system only when traveling on open highways in good weather.
- Do not use the cruise control when it may not be safe to keep the vehicle at a constant speed:
 - Driving in heavy or varying speed traffic.
 - On slippery (rainy, icy or snow covered) roads.
 - Hilly or winding roads.
 - Very windy areas.

Driving your vehicle

To set cruise control speed

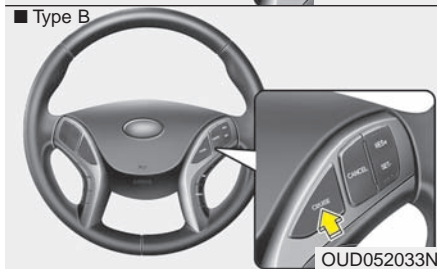
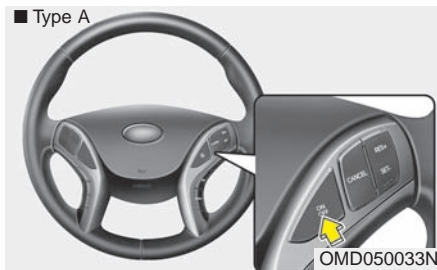

1. Push the CRUISE (ON/OFF) button on the steering wheel to turn the system on. The CRUISE indicator will illuminate.
2. Accelerate to the desired speed, which must be more than 20 mph (30 km/h).



3. Push the SET- switch, and release it. The SET indicator light will illuminate.
4. Release the accelerator pedal.

* NOTICE

The vehicle may slow down or speed up slightly while going uphill or downhill.

To increase cruise control speed

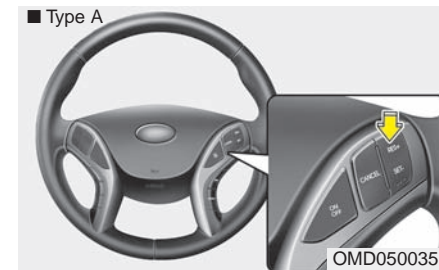

- Push the RES+ switch and hold it, while monitoring the SET speed on the instrument cluster. Release the switch when the desired speed is shown and the vehicle will accelerate to that speed.

- Push the RES+ switch and release it immediately. The cruising speed will increase 1 mph (1.6 km/h) each time the switch is operated in this manner.
- Depress the accelerator pedal. When the vehicle attains the desired speed, push the SET- switch.

To decrease cruise control speed



- Push the SET- switch and hold it. Your vehicle will gradually slow down. Release the switch at the speed you want to maintain.
- Push the SET- switch and release it immediately. The cruising speed will decrease 1.0 mph (1.6 km/h) each time the switch is operated in this manner.

- Lightly tap the brake pedal. When the vehicle attains the desired speed, push the SET- switch.

To temporarily accelerate with the cruise control ON

Depress the accelerator pedal. When you take your foot off the accelerator, the vehicle will return to the previously set speed.

If you push the SET- switch. at the increased speed, the cruise control will maintain the increased speed.

Driving your vehicle

Cruise control will be canceled when:

■ Type A



OMD050034N

■ Type B



OUD052034N

- Depressing the clutch pedal. (for manual transaxle vehicle)
- Moving the shift lever into N (Neutral). (for automatic transaxle vehicle)
- Decreasing the vehicle speed lower than the memory speed by 12 mph (20 km/h).
- Decreasing the vehicle speed to less than approximately 20 mph (30 km/h).
- The ESC (Electronic Stability Control) is operating. (if equipped)
- Downshifting to the 2nd gear with sports mode.

- Depressing the brake pedal.
- Pressing the CANCEL switch located on the steering wheel.
- Pushing the CRUISE (ON/OFF) button. Both the CRUISE indicator and the SET indicator will turn OFF.

*** NOTICE**

Each of the previous actions will cancel cruise control operation (the SET indicator light in the instrument cluster will go off), but only pressing the CRUISE (ON/OFF) button will turn the system off. If you wish to resume cruise control operation, push the RES+ switch located on your steering wheel. You will return to your previously preset speed, unless the system was turned off using the CRUISE (ON/OFF) button.

To resume preset cruising speed



To turn cruise control off

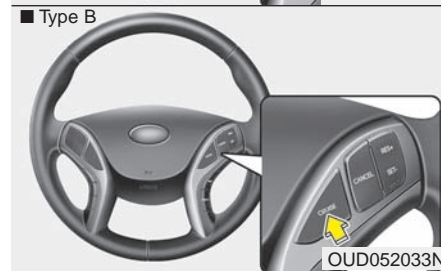
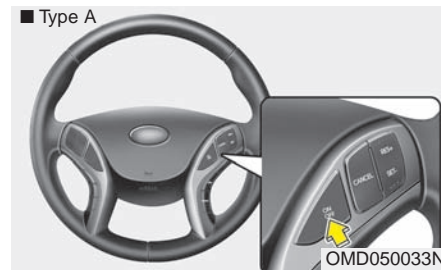

Push the RES+ switch. If the vehicle speed is over 20 mph (30 km/h), the vehicle will resume the preset speed.

- Push the CRUISE (ON/OFF) button (the CRUISE indicator light will go off).
- Turn the engine OFF.

Driving your vehicle

SPECIAL DRIVING CONDITIONS

Hazardous driving conditions

When hazardous driving conditions are encountered such as water, snow, ice, mud or sand:

Drive cautiously and allow extra distance for braking.

Avoid sudden movements in braking or steering.

If stuck in snow, mud, or sand, use second gear. Accelerate slowly to avoid spinning the drive wheels.

WARNING

Downshifting with an automatic transaxle, while driving on slippery surfaces can cause an accident. The sudden change in tire speed could cause the tires to skid. Be careful when downshifting on slippery surfaces.

Use sand, rock salt, or other non-slip material under the drive wheels to provide traction when stalled in ice, snow, or mud.

Rocking the vehicle

If it is necessary to rock the vehicle to free it from snow, sand, or mud, first turn the steering wheel right and left to clear the area around your front wheels. Then, shift back and forth between 1st and R (Reverse, for manual transaxle vehicle) or R (Reverse) and a forward gear (for automatic transaxle vehicle). Try to avoid spinning the wheels, and do not race the engine.

To prevent transaxle wear, wait until the wheels stop spinning before shifting gears. Release the accelerator pedal while shifting, and press lightly on the accelerator pedal while the transaxle is in gear. Slowly spinning the wheels in forward and reverse directions causes a rocking motion that may free the vehicle.

WARNING

If the tires spin at high speed the tires can explode, and you or others may be injured. Do not attempt this procedure if people or objects are anywhere near the vehicle.

The vehicle can overheat causing an engine compartment fire or other damage. Spin the wheels as little as possible and avoid spinning the wheels at speeds over 35 mph (56 km/h) as indicated on the speedometer.

CAUTION

If you are still stuck after rocking the vehicle a few times, have the vehicle pulled out by a tow vehicle to avoid engine overheating, possible damage to the transaxle, and tire damage. See "Towing" in chapter 6.

To prevent damage to the transaxle, turn OFF the ESC prior to rocking the vehicle.

Smooth cornering



Avoid braking or gear changing in corners, especially when roads are wet. Ideally, corners should always be taken under gentle acceleration.

Driving at night



Night driving presents more hazards than driving in the daylight. Here are some important tips to remember:

- Slow down and keep more distance between you and other vehicles, as it may be more difficult to see at night, especially in areas where there may not be any street lights.
- Adjust your mirrors to reduce the glare from other driver's headlights.

- Keep your headlights clean and properly aimed. Dirty or improperly aimed headlights will make it much more difficult to see at night.
- Avoid staring directly at the headlights of oncoming vehicles. You could be temporarily blinded, and it will take several seconds for your eyes to readjust to the darkness.

Driving your vehicle

Driving in the rain



Rain and wet roads can make driving dangerous. Here are a few things to consider when driving in the rain or on slick pavement:

- Slow down and allow extra following distance. A heavy rainfall makes it harder to see and increases the distance needed to stop your vehicle.
- Turn OFF your Cruise Control. (if equipped)
- Replace your windshield wiper blades when they show signs of streaking or missing areas on the windshield.

- Be sure your tires have enough tread. If your tires do not have enough tread, making a quick stop on wet pavement can cause a skid and possibly lead to an accident. See "Tire Tread" in chapter 7.
- Turn on your headlights to make it easier for others to see you.
- Driving too fast through large puddles can affect your brakes. If you must go through puddles, try to drive through them slowly.
- If you believe your brakes may be wet, apply them lightly while driving until normal braking operation returns.

Hydroplaning

If the road is wet enough and you are going fast enough, your vehicle may have little or no contact with the road surface and actually ride on the water. The best advice is SLOW DOWN when the road is wet. The risk of hydroplaning increases as the depth of tire tread decreases, refer to "Tire Tread" in chapter 7.

Driving in flooded areas

Avoid driving through flooded areas unless you are sure the water is no higher than the bottom of the wheel hub. Drive through any water slowly. Allow adequate stopping distance because brake performance may be reduced.

After driving through water, dry the brakes by gently applying them several times while the vehicle is moving slowly.

WINTER DRIVING

Snow or icy conditions

You need to keep sufficient distance between your vehicle and the vehicle in front of you.

Apply the brakes gently. Speeding, rapid acceleration, sudden brake applications, and sharp turns are potentially very hazardous practices. During deceleration, use engine braking to the fullest extent. Sudden brake applications on snowy or icy roads may cause skids to occur.

To drive your vehicle in deep snow, it may be necessary to use snow tires or to install tire chains on your tires.

Always carry emergency equipment. Some of the items you may want to carry include, tow straps or chains, a flashlight, emergency flares, sand, a shovel, jumper cables, a window scraper, gloves, ground cloth, coveralls, a blanket, etc.

Snow tires

⚠ WARNING

Snow tires should be equivalent in size and type to the vehicle's standard tires. Otherwise, the safety and handling of your vehicle may be adversely affected.

If you mount snow tires on your vehicle, make sure to use radial tires of the same size and load range as the original tires. Mount snow tires on all four wheels to balance your vehicle's handling in all weather conditions. The traction provided by snow tires on dry roads may not be as high as your vehicle's original equipment tires. Check with the tire dealer for maximum speed recommendations.

*** NOTICE**

Do not install studded tires without first checking local and municipal regulations for possible restrictions against their use.

Tire chains



Since the sidewalls of radial tires are thinner than other types of tires, they may be damaged by mounting some types of tire chains on them. Therefore, the use of snow tires is recommended instead of tire chains. Do not mount tire chains on vehicles equipped with aluminum wheels; if unavoidable use a wire type chain. If tire chains must be used, use genuine HYUNDAI parts and install the tire chain after reviewing the instructions provided with the tire chains. Damage to your vehicle caused by improper tire chain use is not covered by your vehicle manufacturer's warranty.

Driving your vehicle

WARNING

The use of tire chains may adversely affect vehicle handling:

- Drive less than 20 mph (30 km/h) or the chain manufacturer's recommended speed limit, whichever is lower.
- Drive carefully and avoid bumps, holes, sharp turns, and other road hazards, which may cause the vehicle to bounce.
- Avoid sharp turns or locked wheel braking.

*** NOTICE**

- Install tire chains on the front tires. It should be noted that installing tire chains on the tires will provide a greater driving force, but will not prevent side skids.
- Do not install studded tires without first checking local and municipal regulations for possible restrictions against their use.

Chain Installation

When installing tire chains, follow the manufacturer's instructions and mount them as tightly possible. Drive slowly (less than 20 mph (30 km/h)) with chains installed. If you hear the chains contacting the body or chassis, stop and tighten them. If they still make contact, slow down until the noise stops. Remove the tire chains as soon as you begin driving on cleared roads.

When mounting snow chains, park the vehicle on level ground away from traffic. Turn on the vehicle Hazard Warning Flasher and place a triangular emergency warning device behind the vehicle (if available). Always place the vehicle in P (Park), apply the parking brake and turn off the engine before installing snow chains.

CAUTION

When using tire chains:

- *Wrong size chains or improperly installed chains can damage your vehicle's brake lines, suspension, body and wheels.*
- *Use SAE "S" class or wire chains.*
- *If you hear noise caused by chains contacting the body, retighten the chain to prevent contact with the vehicle body.*
- *To prevent body damage, retighten the chains after driving 0.3~0.6 miles (0.5~1.0 km).*
- *Do not use tire chains on vehicles equipped with aluminum wheels. If unavoidable, use a wire type chain.*
- *Use wire chains less than 0.59 inch (15 mm) wide to prevent damage to the chain's connection.*

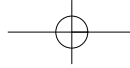

Use high quality ethylene glycol coolant

Your vehicle is delivered with high quality ethylene glycol coolant in the cooling system. It is the only type of coolant that should be used because it helps prevent corrosion in the cooling system, lubricates the water pump and prevents freezing. Be sure to replace or replenish your coolant in accordance with the maintenance schedule in section 7. Before winter, have your coolant tested to assure that its freezing point is sufficient for the temperatures anticipated during the winter.

Check battery and cables

Winter puts additional burdens on the battery system. Visually inspect the battery and cables as described in section 7. We recommend that the system be checked by an authorized HYUNDAI dealer.

Change to "winter weight" oil if necessary

In some climates it is recommended that a lower viscosity "winter weight" oil be used during cold weather. See section 8 for recommendations. If you aren't sure what weight oil you should use, we recommend that you consult an authorized HYUNDAI dealer.

Check spark plugs and ignition system

Inspect your spark plugs as described in section 7 and replace them if necessary. Also check all ignition wiring and components to be sure they are not cracked, worn or damaged in any way.

To keep locks from freezing

To keep the locks from freezing, squirt an approved de-icer fluid or glycerine into the key opening. If a lock is covered with ice, squirt it with an approved de-icing fluid to remove the ice. If the lock is frozen internally, you may be able to thaw it out by using a heated key. Handle the heated key with care to avoid injury.

Use approved window washer anti-freeze in system

To keep the water in the window washer system from freezing, add an approved window washer anti-freeze solution in accordance with instructions on the container. Window washer anti-freeze is available from an authorized HYUNDAI dealer and most auto parts outlets. Do not use engine coolant or other types of anti-freeze as these may damage the paint finish.

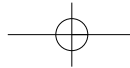
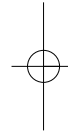
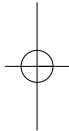

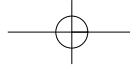

Driving your vehicle

Don't let your parking brake freeze

Under some conditions your parking brake can freeze in the engaged position. This is most likely to happen when there is an accumulation of snow or ice around or near the rear brakes or if the brakes are wet. If there is a risk the parking brake may freeze, apply it only temporarily while you put the shift lever in P (automatic transaxle) or in first or reverse gear (manual transaxle) and block the rear wheels so the vehicle cannot roll. Then release the parking brake.

Don't let ice and snow accumulate underneath

Under some conditions, snow and ice can build up under the fenders and interfere with the steering. When driving in severe winter conditions where this may happen, you should periodically check underneath the vehicle to be sure the movement of the front wheels and the steering components is not obstructed.

Carry emergency equipment

Depending on the severity of the weather, you should carry appropriate emergency equipment. Some of the items you may want to carry include tire chains, tow straps or chains, flashlight, emergency flares, sand, a shovel, jumper cables, a window scraper, gloves, ground cloth, coveralls, a blanket, etc.

Don't place foreign objects or materials in the engine compartment

Placement of foreign objects or materials which prevent cooling of the engine, in the engine compartment, may cause a failure or combustion. The manufacturer is not responsible for the damage caused by such placement.

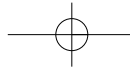
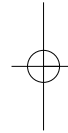
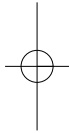

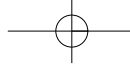

VEHICLE LOAD LIMIT

Two labels on your driver's door sill show how much weight your vehicle was designed to carry: the Tire and Loading Information Label and the Certification Label.

Before loading your vehicle, familiarize yourself with the following terms for determining your vehicle's weight ratings, from the vehicle's specifications and the Certification Label:

Base Curb Weight

This is the weight of the vehicle including a full tank of fuel and all standard equipment. It does not include passengers, cargo, or optional equipment.

Vehicle Curb Weight

This is the weight of your new vehicle when you picked it up from your dealer plus any aftermarket equipment.

Cargo Weight

This figure includes all weight added to the Base Curb Weight, including cargo and optional equipment.

GAW (Gross Axle Weight)

This is the total weight placed on each axle (front and rear) - including vehicle curb weight and all payload.

GAWR (Gross Axle Weight Rating)

This is the maximum allowable weight that can be carried by a single axle (front or rear). These numbers are shown on the Certification Label. The total load on each axle must never exceed its GAWR.

GVW (Gross Vehicle Weight)

This is the Base Curb Weight plus actual Cargo Weight plus passengers.

GVWR (Gross Vehicle Weight Rating)

This is the maximum allowable weight of the fully loaded vehicle (including all options, equipment, passengers and cargo). The GVWR is shown on the Certification Label located on the driver's door sill.

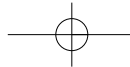
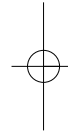
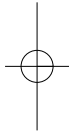

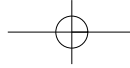

Driving your vehicle

Tire loading information label

Type A

| TIRE AND LOADING INFORMATION RENSEIGNEMENTS SUR LES PNEUS ET LE CHARGEMENT | | | | |
|--|--------------------|--|---|-------------------|
| SEATING CAPACITY NOMBRE DE PLACES | | TOTAL 5 | FRONT AVANT 2 | REAR ARRIÈRE 3 |
| The combined weight of occupants and cargo should never exceed 385 kg or 849 lbs. Le poids total des occupants et du chargement ne doit jamais dépasser 385 kg ou 849 lb. | | | | |
| TIRE PNEU | SIZE DIMENSIONS | COLD TIRE PRESSURE PRESSION DES PNEUS À FROID | SEE OWNER'S MANUAL FOR ADDITIONAL INFORMATION | |
| FRONT AVANT | P195/65R15 | 230kPa, 33psi | VOIR LE MANUEL DE L'USAGER POUR PLUS DE RENSEIGNEMENTS | |
| REAR ARRIÈRE | P195/65R15 | 230kPa, 33psi | | |
| SPARE DE SECOURS | NONE AUCUN | | | |

Type B

| TIRE AND LOADING INFORMATION RENSEIGNEMENTS SUR LES PNEUS ET LE CHARGEMENT | | | | |
|--|--------------------|--|---|-------------------|
| SEATING CAPACITY NOMBRE DE PLACES | | TOTAL 5 | FRONT AVANT 2 | REAR ARRIÈRE 3 |
| The combined weight of occupants and cargo should never exceed 385 kg or 849 lbs. Le poids total des occupants et du chargement ne doit jamais dépasser 385 kg ou 849 lb. | | | | |
| TIRE PNEU | SIZE DIMENSIONS | COLD TIRE PRESSURE PRESSION DES PNEUS À FROID | SEE OWNER'S MANUAL FOR ADDITIONAL INFORMATION | |
| FRONT AVANT | P205/55R16 | 230kPa, 33psi | VOIR LE MANUEL DE L'USAGER POUR PLUS DE RENSEIGNEMENTS | |
| REAR ARRIÈRE | P205/55R16 | 230kPa, 33psi | | |
| SPARE DE SECOURS | NONE AUCUN | | | |

Type C

| TIRE AND LOADING INFORMATION RENSEIGNEMENTS SUR LES PNEUS ET LE CHARGEMENT | | | | |
|--|--------------------|--|---|-------------------|
| SEATING CAPACITY NOMBRE DE PLACES | | TOTAL 5 | FRONT AVANT 2 | REAR ARRIÈRE 3 |
| The combined weight of occupants and cargo should never exceed 385 kg or 849 lbs. Le poids total des occupants et du chargement ne doit jamais dépasser 385 kg ou 849 lb. | | | | |
| TIRE PNEU | SIZE DIMENSIONS | COLD TIRE PRESSURE PRESSION DES PNEUS À FROID | SEE OWNER'S MANUAL FOR ADDITIONAL INFORMATION | |
| FRONT AVANT | P215/45R17 | 230kPa, 33psi | VOIR LE MANUEL DE L'USAGER POUR PLUS DE RENSEIGNEMENTS | |
| REAR ARRIÈRE | P215/45R17 | 230kPa, 33psi | | |
| SPARE DE SECOURS | NONE AUCUN | | | |

Type D

| TIRE AND LOADING INFORMATION RENSEIGNEMENTS SUR LES PNEUS ET LE CHARGEMENT | | | | |
|--|--------------------|--|---|-------------------|
| SEATING CAPACITY NOMBRE DE PLACES | | TOTAL 5 | FRONT AVANT 2 | REAR ARRIÈRE 3 |
| The combined weight of occupants and cargo should never exceed 385 kg or 849 lbs. Le poids total des occupants et du chargement ne doit jamais dépasser 385 kg ou 849 lb. | | | | |
| TIRE PNEU | SIZE DIMENSIONS | COLD TIRE PRESSURE PRESSION DES PNEUS À FROID | SEE OWNER'S MANUAL FOR ADDITIONAL INFORMATION | |
| FRONT AVANT | P195/65R15 | 230kPa, 33psi | VOIR LE MANUEL DE L'USAGER POUR PLUS DE RENSEIGNEMENTS | |
| REAR ARRIÈRE | P195/65R15 | 230kPa, 33psi | | |
| SPARE DE SECOURS | T125/80D15 | 420kPa, 60psi | | |

Type E

| TIRE AND LOADING INFORMATION RENSEIGNEMENTS SUR LES PNEUS ET LE CHARGEMENT | | | | |
|--|--------------------|--|---|-------------------|
| SEATING CAPACITY NOMBRE DE PLACES | | TOTAL 5 | FRONT AVANT 2 | REAR ARRIÈRE 3 |
| The combined weight of occupants and cargo should never exceed 385 kg or 849 lbs. Le poids total des occupants et du chargement ne doit jamais dépasser 385 kg ou 849 lb. | | | | |
| TIRE PNEU | SIZE DIMENSIONS | COLD TIRE PRESSURE PRESSION DES PNEUS À FROID | SEE OWNER'S MANUAL FOR ADDITIONAL INFORMATION | |
| FRONT AVANT | P205/55R16 | 230kPa, 33psi | VOIR LE MANUEL DE L'USAGER POUR PLUS DE RENSEIGNEMENTS | |
| REAR ARRIÈRE | P205/55R16 | 230kPa, 33psi | | |
| SPARE DE SECOURS | T125/80D15 | 420kPa, 60psi | | |

Type F

| TIRE AND LOADING INFORMATION RENSEIGNEMENTS SUR LES PNEUS ET LE CHARGEMENT | | | | |
|--|--------------------|--|---|-------------------|
| SEATING CAPACITY NOMBRE DE PLACES | | TOTAL 5 | FRONT AVANT 2 | REAR ARRIÈRE 3 |
| The combined weight of occupants and cargo should never exceed 385 kg or 849 lbs. Le poids total des occupants et du chargement ne doit jamais dépasser 385 kg ou 849 lb. | | | | |
| TIRE PNEU | SIZE DIMENSIONS | COLD TIRE PRESSURE PRESSION DES PNEUS À FROID | SEE OWNER'S MANUAL FOR ADDITIONAL INFORMATION | |
| FRONT AVANT | P215/45R17 | 230kPa, 33psi | VOIR LE MANUEL DE L'USAGER POUR PLUS DE RENSEIGNEMENTS | |
| REAR ARRIÈRE | P215/45R17 | 230kPa, 33psi | | |
| SPARE DE SECOURS | T125/80D15 | 420kPa, 60psi | | |

OMD054042N/OMD054041N/OMD054040N/OMD054045N/OMD054044N/OMD054043N

The label located on the driver's door sill gives the original tire size, cold tire pressures recommended for your vehicle, the number of people that can be in your vehicle and vehicle capacity weight.

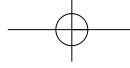

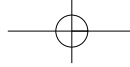

Driving your vehicle

Vehicle capacity weight

849 lbs. (385 kg)

Vehicle capacity weight is the maximum combined weight of occupants and cargo. If your vehicle is equipped with a trailer, the combined weight includes the tongue load.

Seating capacity

Total : 5 persons

(Front seat : 2 persons,

Rear seat : 3 persons)

Seating capacity is the maximum number of occupants including a driver, your vehicle may carry. However, the seating capacity may be reduced based upon the weight of all of the occupants, and the weight of the cargo being carried or towed. Do not overload the vehicle as there is a limit to the total weight, or load limit including occupants and cargo, the vehicle can carry.

Towing capacity

We do not recommend using this vehicle for trailer towing.

Cargo capacity

The cargo capacity of your vehicle will increase or decrease depending on the weight and the number of occupants and the tongue load, if your vehicle is equipped with a trailer.

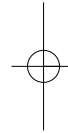
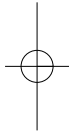

Information Provided by:

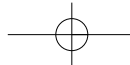

Driving your vehicle

Steps for determining correct load limit







1. Locate the statement "The combined weight of occupants and cargo should never exceed XXX kg or XXX lbs." on your vehicle's placard.
2. Determine the combined weight of the driver and passengers that will be riding in your vehicle.
3. Subtract the combined weight of the driver and passengers from XXX kg or XXX lbs.
4. The resulting figure equals the available amount of cargo and luggage load capacity. For example, if the "XXX" amount equals 1400 lbs. and there will be five 150 lb. passengers in your vehicle, the amount of available cargo and luggage load capacity is 650 lbs. (1400 - 750 (5 x 150) = 650 lbs.)
5. Determine the combined weight of luggage and cargo being loaded on the vehicle. That weight may not safely exceed the available cargo and luggage load capacity calculated in Step 4.

6. If your vehicle will be towing a trailer, load from your trailer will be transferred to your vehicle. Consult this manual to determine how this reduces the available cargo and luggage load capacity of your vehicle.

⚠ WARNING

Do not overload the vehicle as there is a limit to the total weight, or load limit, including occupants and cargo, the vehicle can carry. Overloading can shorten the life of the vehicle. If the GVWR or the GAWR is exceeded, parts on the vehicle can break, and it can change the handling of your vehicle. These could cause you to lose control and result in an accident.

Driving your vehicle

| | | | | | |
|-------------------------|--|----------|---|----------|--|
| <p>Example 1</p> | <p>Vehicle Capacity</p> <p>Maximum Load (849 lbs.) (385 kg)</p> | <p>≥</p> | <p></p> <p>Passenger Weight (150lbs. × 2 = 300 lbs.) (68 kg × 2 = 136kg)</p> | <p>+</p> | <p></p> <p>Cargo Weight (549 lbs.) (249 kg)</p> |
| <p>Example 2</p> | <p>Vehicle Capacity</p> <p>Maximum Load (849 lbs.) (385 kg)</p> | <p>≥</p> | <p></p> <p>Passenger Weight (150lbs. × 5 = 750 lbs.) (68 kg × 5 = 340kg)</p> | <p>+</p> | <p></p> <p>Cargo Weight (99 lbs.) (45 kg)</p> |
| <p>Example 3</p> | <p>Vehicle Capacity</p> <p>Maximum Load (849 lbs.) (385 kg)</p> | <p>≥</p> | <p></p> <p>Passenger Weight (163 lbs. × 5 = 815 lbs.) (74 kg × 5 = 370kg)</p> | <p>+</p> | <p></p> <p>Cargo Weight (34 lbs.) (15 kg)</p> |

Driving your vehicle

Certification label

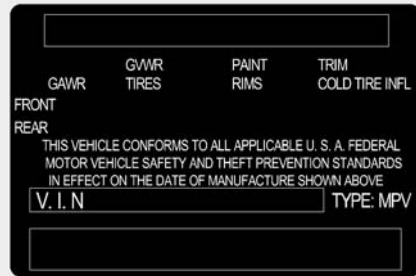

OEN056020

The certification label is located on the driver's door sill at the center pillar and shows the maximum allowable weight of the fully loaded vehicle. This is called the GVWR (Gross Vehicle Weight Rating). The GVWR includes the weight of the vehicle, all occupants, fuel and cargo.

This label also tells you the maximum weight that can be supported by the front and rear axles, called Gross Axle Weight Rating (GAWR).

The total weight of the vehicle, including all occupants, accessories, cargo, and trailer tongue load must not exceed the Gross Vehicle Weight Rating (GVWR) or the Gross Axle Weight Rating (GAWR). To find out the actual loads on your front and rear axles, you need to go to a weigh station and weigh your vehicle. Be sure to spread out your load equally on both sides of the centerline.

⚠ WARNING - Overloading

- **Never exceed the GVWR for your vehicle, the GAWR for either the front or rear axle and vehicle capacity weight. Exceeding these ratings can affect your vehicle's handling and braking ability, and cause an accident.**
- **Do not overload your vehicle. Overloading your vehicle can cause heat buildup in your vehicle's tires and possible tire failure, increased stopping distances and poor vehicle handling—all of which may result in a crash.**

⚠ CAUTION

Overloading your vehicle may cause damage. Repairs would not be covered by your warranty. Do not overload your vehicle.

⚠ WARNING

If you carry items inside your vehicle (e.g., suitcases, tools, packages, or anything else), they are moving as fast as the vehicle. If you have to stop, turn quickly, or if there is a crash, the items will keep going and can cause an injury if they strike the driver or a passenger.

- **Put items in the cargo area of your vehicle. Try to spread the weight evenly.**
- **Do not stack items, like suitcases, inside the vehicle above the tops of the seats.**
- **Do not leave an unsecured child restraint in your vehicle.**
- **When you carry something inside the vehicle, secure it.**

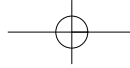

TRAILER TOWING

We do not recommend using this vehicle for trailer towing.

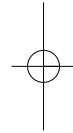
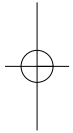

Information Provided by:

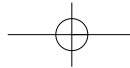

What to do in an emergency

- Hazard warning flasher 6-2
- In case of an emergency while driving 6-3
 - If the engine stalls while driving 6-3
 - If the engine stalls at a crossroad or crossing 6-3
 - If you have a flat tire while driving 6-3
- If the engine will not start 6-4
 - If the engine doesn't turn over or turns over slowly . . 6-4
 - If the engine turns over normally but doesn't start . . 6-4
- Jump starting 6-5
- If the engine overheats 6-8
- Tire Pressure Monitoring System (TPMS) 6-10
 - Low tire pressure telltale 6-11
 - TPMS malfunction indicator 6-13
 - Changing a tire with TPMS 6-14
- If you have a flat tire 6-15
 - With spare tire 6-15
 - Jack label 6-21
 - With Tire Mobility Kit (TMK) 6-22
- Towing 6-28
 - Towing service 6-28
 - Removable towing hook 6-29
 - Emergency towing 6-29

HAZARD WARNING FLASHER



All turn signal lights will flash simultaneously.

- The hazard warning flasher operates whether your vehicle is running or not.
- The turn signals do not work when the hazard flasher is on.

The hazard warning flasher serves as a warning to other drivers to exercise extreme caution when approaching, overtaking, or passing your vehicle.

It should be used whenever emergency repairs are being made or when the vehicle is stopped near the edge of a roadway.

To turn the hazard warning flasher on or off, press the hazard warning flasher button with the ignition switch in any position. The button is located in the center console switch panel.

IN CASE OF AN EMERGENCY WHILE DRIVING

If the engine stalls while driving

- Reduce your speed gradually, keeping a straight line. Move cautiously off the road to a safe place.
- Turn on your hazard warning flasher.
- Try to start the engine again. If your vehicle will not start, contact an authorized HYUNDAI dealer or seek other qualified assistance.

If the engine stalls at a cross-road or crossing

If the engine stalls at a crossroad or crossing, if safe to do so, move the shift lever to the N (Neutral) position and then push the vehicle to a safe location.

If you have a flat tire while driving

If a tire goes flat while you are driving:

- Take your foot off the accelerator pedal and let the vehicle slow down while driving straight ahead. Do not apply the brakes immediately or attempt to pull off the road as this may cause loss of vehicle control resulting in an accident. When the vehicle has slowed to such a speed that it is safe to do so, brake carefully and pull off the road. Drive off the road as far as possible and park on firm, level ground. If you are on a divided highway, do not park in the median area between the two traffic lanes.

- When the vehicle is stopped, press the hazard warning flasher button, move the shift lever into P (Park, for automatic transaxle vehicle) or neutral (for manual transaxle vehicle), apply the parking brake, and place the ignition switch in the LOCK/OFF position.
- Have all passengers get out of the vehicle. Be sure they all get out on the side of the vehicle that is away from traffic.
- When changing a flat tire, follow the instructions provided later in this chapter.

IF THE ENGINE WILL NOT START

If the engine doesn't turn over or turns over slowly

- Be sure the shift lever is in N (Neutral) or P (Park) if it is an automatic transaxle vehicle. The engine starts only when the shift lever is in N (Neutral) or P (Park).
- Check the battery connections to be sure they are clean and tight.
- Turn on the interior light. If the light dims or goes out when you operate the starter, the battery is drained.

Do not push or pull the vehicle to start it. This could cause damage to your vehicle. See instructions for "Jump Starting" provided in this chapter.

If the engine turns over normally but doesn't start

- Check the fuel level and add fuel if necessary.

If the engine still does not start, call an authorized HYUNDAI dealer for assistance.

WARNING

Push or pull starting the vehicle may cause the catalytic converter to overload which can lead to damage to the emission control system.

JUMP STARTING

Jump starting can be dangerous if done incorrectly. Follow the jump starting procedure in this section to avoid serious injury or damage to your vehicle. If in doubt about how to properly jump start your vehicle, we strongly recommend that you have a service technician or towing service do it for you.

WARNING

To prevent **SERIOUS INJURY** or **DEATH** to you or bystanders, always follow these precautions when working near or handling the battery:



Always read and follow instructions carefully when handling a battery.



Wear eye protection designed to protect the eyes from acid splashes.



Keep all flames, sparks, or smoking materials away from the battery.



Hydrogen is always present in battery cells, is highly combustible, and may explode if ignited.



Keep batteries out of reach of children.

(Continued)

(Continued)



Batteries contain sulfuric acid which is highly corrosive. Do not allow acid to contact your eyes, skin or clothing.

If acid gets into your eyes, flush your eyes with clean water for at least 15 minutes and get immediate medical attention. If acid gets on your skin, thoroughly wash the area. If you feel pain or a burning sensation, get medical attention immediately.

- When lifting a plastic-cased battery, excessive pressure on the case may cause battery acid to leak. Lift with a battery carrier or with your hands on opposite corners.
- Do not attempt to jump start your vehicle if your battery is frozen.

(Continued)

(Continued)

- **NEVER** attempt to recharge the battery when the vehicle's battery cables are connected to the battery.
- The electrical ignition system works with high voltage. **NEVER** touch these components with the engine running or when the ignition switch is in the ON position.

CAUTION

To prevent damage to your vehicle:

- *Only use a 12-volt power supply (battery or jumper system) to jump start your vehicle.*
- *Do not attempt to jump start your vehicle by push-starting.*

* **NOTICE**



An inappropriately disposed battery can be harmful to the environment and human health. Dispose the battery according to your local law(s) or regulation.

Jump starting procedure

1. Position the vehicles close enough that the jumper cables will reach, but do not allow the vehicles to touch.
2. Avoid fans or any moving parts in the engine compartment at all times, even when the vehicles are turned off.
3. Turn off all electrical devices such as radios, lights, air conditioning, etc. Put the vehicles in P (Park, for automatic transaxle vehicle) or neutral (for manual transaxle vehicle), and set the parking brakes. Turn both vehicles OFF.

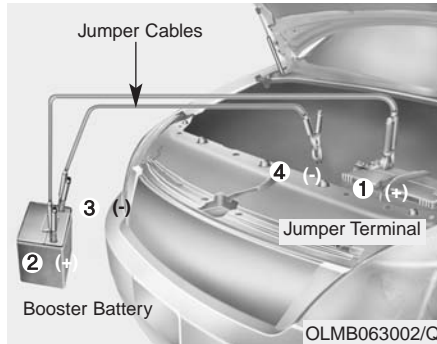

4. Connect the jumper cables in the exact sequence shown in the illustration. First connect one jumper cable to the red, positive (+) jumper terminal of your vehicle (1).
5. Connect the other end of the jumper cable to the red, positive (+) battery/jumper terminal of the assisting vehicle (2).
6. Connect the second jumper cable to the black, negative (-) battery of the assisting vehicle (3).

7. Connect the other end of the second jumper cable to the chassis ground of your vehicle (4).

Do not allow the jumper cables to contact anything except the correct battery or jumper terminals or the correct ground. Do not lean over the battery when making connections.

8. Start the engine of the assisting vehicle and let it run at approximately 2,000 rpm for a few minutes. Then start your vehicle.

If your vehicle will not start after a few attempts, it probably requires servicing. In this event please seek qualified assistance. If the cause of your battery discharging is not apparent, have your vehicle checked by an authorized HYUNDAI dealer.

Disconnect the jumper cables in the exact reverse order you connected them:

1. Disconnect the jumper cable from the chassis ground of your vehicle (4).
2. Disconnect the other end of the jumper cable from the black, negative (-) battery of the assisting vehicle (3).
3. Disconnect the second jumper cable from the red, positive (+) battery/jumper terminal of the assisting vehicle (2).
4. Disconnect the other end of the jumper cable from the red, positive (+) jumper terminal of your vehicle (1).

IF THE ENGINE OVERHEATS

If your temperature gauge indicates overheating, you experience a loss of power, or hear loud pinging or knocking, the engine may be overheating. If this happens, you should:

1. Pull off the road and stop as soon as it is safe to do so.
2. Place the shift lever in P (Park, for automatic transaxle vehicle) or neutral (for manual transaxle vehicle) and set the parking brake. If the air conditioning is ON, turn it OFF.
3. If engine coolant is running out under the vehicle or steam is coming out from the hood, stop the engine. Do not open the hood until the coolant has stopped running or the steaming has stopped. If there is no visible loss of engine coolant and no steam, leave the engine running and check to be sure the engine cooling fan is operating. If the fan is not running, turn the engine off.

WARNING



While the engine is running, keep hands, clothing and tools away from the moving parts such as the cooling fan and drive belt to prevent serious injury.

4. Check for coolant leaking from the radiator, hoses or under the vehicle. (If the air conditioning had been in use, it is normal for cold water to be draining from it when you stop.)
5. If engine coolant is leaking out, stop the engine immediately and call an authorized HYUNDAI dealer for assistance.

WARNING



NEVER remove the radiator cap or the drain plug while the engine and radiator are hot. Hot coolant and steam may blow out under pressure, causing serious injury.

Turn the engine off and wait until the engine cools down. Use extreme care when removing the radiator cap. Wrap a thick towel around it, and turn it counterclockwise slowly to the first stop. Step back while the pressure is released from the cooling system. When you are sure all the pressure has been released, press down on the cap, using a thick towel, and continue turning counterclockwise to remove it.

6. If you cannot find the cause of the overheating, wait until the engine temperature has returned to normal. Then, if coolant has been lost, carefully add coolant to the reservoir to bring the fluid level in the reservoir up to the halfway mark.
7. Proceed with caution, keeping alert for further signs of overheating. If overheating happens again, call an authorized HYUNDAI dealer for assistance.

 **CAUTION**

- *Serious loss of coolant indicates a leak in the cooling system and have the system checked by an authorized HYUNDAI dealer.*
- *When the engine overheats from low engine coolant, suddenly adding engine coolant may cause cracks in the engine. To prevent damage, add engine coolant slowly in small quantities.*

TIRE PRESSURE MONITORING SYSTEM (TPMS)



(1) Low Tire Pressure Telltale/
TPMS Malfunction Indicator

⚠ WARNING

Over-inflation or under-inflation can reduce tire life, adversely affect vehicle handling, and lead to sudden tire failure that may cause loss of vehicle control resulting in an accident.

Each tire, including the spare (if provided), should be checked monthly when cold and inflated to the inflation pressure recommended by the vehicle manufacturer on the vehicle placard or tire inflation pressure label. (If your vehicle has tires of a different size than the size indicated on the vehicle placard or tire inflation pressure label, you should determine the proper tire inflation pressure for those tires.)

As an added safety feature, your vehicle has been equipped with a tire pressure monitoring system (TPMS) that illuminates a low tire pressure telltale when one or more of your tires is significantly under-inflated. Accordingly, when the low tire pressure telltale illuminates, you should stop and check your tires as soon as possible, and inflate them to the proper pressure. Driving on a significantly under-inflated tire causes the tire to overheat and can lead to tire failure. Under-inflation also reduces fuel efficiency and tire tread life, and may affect the vehicle's handling and stopping ability.

Please note that the TPMS is not a substitute for proper tire maintenance, and it is the driver's responsibility to maintain correct tire pressure, even if under-inflation has not reached the level to trigger illumination of the TPMS low tire pressure telltale.

Your vehicle has also been equipped with a TPMS malfunction indicator to indicate when the system is not operating properly. The TPMS malfunction indicator is combined with the low tire pressure telltale. When the system detects a malfunction, the telltale will flash for approximately one minute and then remain continuously illuminated. This sequence will continue upon subsequent vehicle start-ups as long as the malfunction exists. When the malfunction indicator is illuminated, the system may not be able to detect or signal low tire pressure as intended.

TPMS malfunctions may occur for a variety of reasons, including the installation of replacement or alternate tires or wheels on the vehicle that prevent the TPMS from functioning properly. Always check the TPMS malfunction telltale after replacing one or more tires or wheels on your vehicle to ensure that the replacement or alternate tires and wheels allow the TPMS to continue to function properly.

* NOTICE

If the TPMS Low Tire Pressure Telltale does not illuminate for three seconds when the ignition switch is in the ON position or when the engine starts, or if it remains illuminated after coming on for approximately three seconds, take your vehicle to your nearest authorized HYUNDAI dealer and have the system checked.



Low Tire Pressure Telltale

The TPMS is not a substitute for manually checking tire pressure with a tire pressure gauge. Changes in temperature affect tire pressure. See “Tires and Wheels” in chapter 7 for proper tire inflating and tire pressure measurement procedures.

If the telltale illuminates, immediately reduce your speed, avoid hard cornering and anticipate increased stopping distances. You should stop and check your tires as soon as possible. Inflate the tires to the proper pressure as indicated on the vehicle’s placard or tire inflation pressure label located on the driver’s side door jamb. If you cannot reach a service station or if the tire cannot hold the newly added air, replace the low pressure tire with the spare tire.

The Low Tire Pressure Telltale will remain on and the TPMS Malfunction Indicator may blink for one minute and then remain illuminated (when the vehicle is driven approximately 20 minutes at speed above 15.5 mph (25 km/h)) until you have the low pressure tire repaired and replaced on the vehicle.

* NOTICE

The spare tire (if equipped) does not come with a tire pressure sensor.

CAUTION

In winter or cold weather, the Low Tire Pressure Telltale may be illuminated if the tire pressure was adjusted to the recommended tire inflation pressure in warm weather. It does not mean your TPMS is malfunctioning because the decreased temperature leads to a proportional lowering of tire pressure.

When you drive your vehicle from a warm area to a cold area or from a cold area to a warm area, or the outside temperature is greatly higher or lower, you should check the tire inflation pressure and adjust the tires to the recommended tire inflation pressure.

WARNING

- Significantly low tire pressure makes the vehicle unstable and can contribute to loss of vehicle control and increased braking distances.
- Continued driving on low pressure tires can cause the tires to overheat and fail.



TPMS Malfunction Indicator

The TPMS Malfunction Indicator comes on after it blinks for approximately one minute when there is a problem with the Tire Pressure Monitoring System.

Have the system checked by an authorized HYUNDAI dealer as soon as possible to determine the cause of the problem.

* NOTICE

The TPMS Malfunction Indicator may illuminate after blinking for one minute if the vehicle is near electric power supply cables or radio transmitters such as police stations, government and public offices, broadcasting stations, military installations, airports, transmitting towers, etc. Additionally, the TPMS Malfunction Indicator may illuminate if snow chains are used or electronic devices such as computers, chargers, remote starters, navigation, etc. This may interfere with normal operation of the TPMS.

This device complies with Part 15 of the FCC rules.

Operation is subject to the following two conditions:

1. This device may not cause harmful interference, and
2. This device must accept any interference received, including interference that may cause undesired

Changes or modifications not expressly approved by the party responsible for compliance could void the user's authority to operate the equipment.

Tampering with, modifying, or disabling the TPMS components may interfere with the system's ability to function and may void the warranty for that portion of the vehicle.

Changing a Tire with TPMS

If you have a flat tire, the Low Tire Pressure Telltale will illuminate. If you believe you have a flat tire or feel any vehicle instability, take your foot off the accelerator pedal and let the vehicle slow down while driving straight ahead. Do not apply the brakes immediately or attempt to pull off the road as this may cause a loss of control resulting in an accident. When the vehicle has slowed to such a speed that it is safe to do so, brake carefully and pull off the road. Drive off the road as far as possible and park on firm, level ground. If you are on a divided highway, do not park in the median area between the two traffic lanes. Replace the flat tire with the spare tire (if equipped).

CAUTION

To prevent damaging your tire pressure sensor, never use a puncture-repairing agents or tire sealants to repair and/or inflate a low pressure tire. If used, you will have to replace the tire pressure sensor.

The spare tire (if equipped) does not come with a tire pressure monitoring sensor. When the low pressure tire or the flat tire is replaced with the spare tire, the Low Tire Pressure Telltale will remain on. Also, the TPMS Malfunction Indicator will illuminate after blinking for one minute if the vehicle is driven at speed above 15.5 mph (25 km/h) for approximately 20 minutes.

Once the original tire equipped with a tire pressure monitoring sensor is reinflated to the recommended pressure and reinstalled on the vehicle, the Low Tire Pressure Telltale and TPMS Malfunction Indicator will go off within a few minutes.

If the indicators do not extinguish after a few minutes, please visit an authorized HYUNDAI dealer.

Each wheel is equipped with a tire pressure sensor mounted inside the tire behind the valve stem (except for the spare tire). You must use TPMS specific wheels. It is recommended that you always have your tires serviced by an authorized HYUNDAI dealer as soon as possible.

IF YOU HAVE A FLAT TIRE

With spare tire (if equipped)

⚠ WARNING

Changing a tire can be dangerous. Follow the instructions in this section when changing a tire to reduce the risk of serious injury or death.

Jack and tools

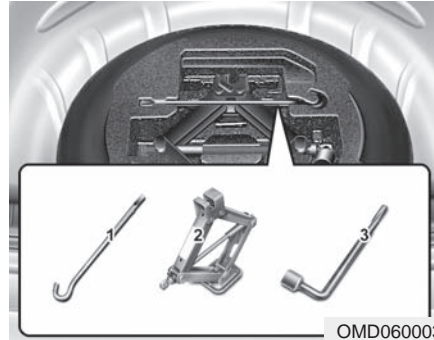

- ① Jack handle
- ② Jack
- ③ Wheel lug nut wrench

The jack, jack handle, and wheel lug nut wrench are stored in the luggage compartment under the luggage box cover.

The jack is provided for emergency tire changing only.

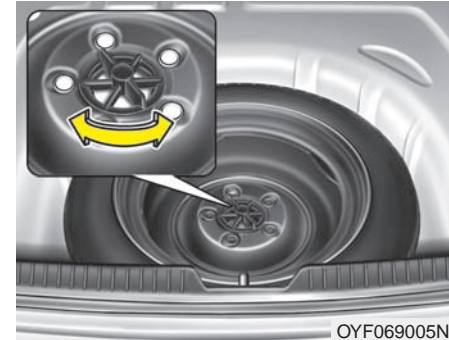

Turn the winged hold down bolt counterclockwise to remove the spare tire.

Store the spare tire in the same compartment by turning the winged hold down bolt clockwise.

To prevent the spare tire and tools from “rattling,” store them in their proper location.

Changing tires

⚠ WARNING

A vehicle can slip or roll off of a jack causing serious injury or death to you or those nearby. Take the following safety precautions:

- Never place any portion of your body under a vehicle that is supported by a jack.
- NEVER attempt to change a tire in the lane of traffic. ALWAYS move the vehicle completely off the road on level, firm ground away from traffic before trying to change a tire. If you cannot find a level, firm place off the road, call a towing service for assistance.
- Be sure to use the jack provided with the vehicle.

(Continued)

(Continued)

- ALWAYS place the jack on the designated jacking positions on the vehicle and NEVER on the bumpers or any other part of the vehicle for jacking support.
- Do not start or run the engine while the vehicle is on the jack.
- Do not allow anyone to remain in the vehicle while it is on the jack.
- Keep children away from the road and the vehicle.

Follow these steps to change your vehicle's tire:

1. Park on a level, firm surface.
2. Move the shift lever into P (Park, for automatic transaxle vehicle) or neutral (for manual transaxle vehicle), apply the parking brake, and place the ignition switch in the LOCK/OFF position.
3. Press the hazard warning flasher button.
4. Remove the wheel lug nut wrench, jack, jack handle, and spare tire from the vehicle.
5. Block both the front and rear of the tire diagonally opposite of the tire you are changing.



6. Insert the screwdriver into the groove of the wheel cap and pry gently to remove the wheel cap (if equipped).



7. Loosen the wheel lug nuts counter-clockwise one turn each in the order shown above, but do not remove any lug nuts until the tire has been raised off of the ground.

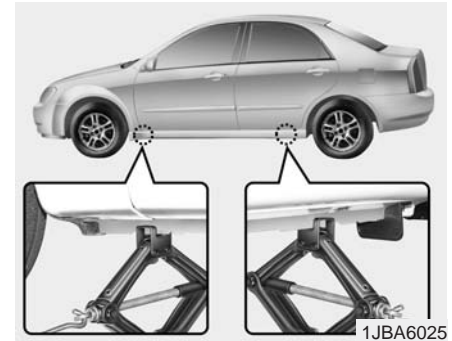

8. Place the jack at the designated jacking position under the frame closest to the tire you are changing. The jacking positions are plates welded to the frame with two tabs and a raised dot. Never jack any other position or part of the vehicle.



9. Insert the jack handle into the jack and turn it clockwise, raising the vehicle until the tire clears the ground. Make sure the vehicle is stable on the jack.

10. Loosen the lug nuts with the wheel lug nut wrench and remove them with your fingers. Remove the wheel from the studs and lay it flat on the ground out of the way. Remove any dirt or debris from the studs, mounting surfaces, and wheel.
11. Install the spare tire onto the studs of the hub.
12. Tighten the lug nuts with your fingers onto the studs with the smaller end of the lug nuts closest to the wheel.
13. Lower the vehicle to the ground by turning the jack handle counterclockwise.

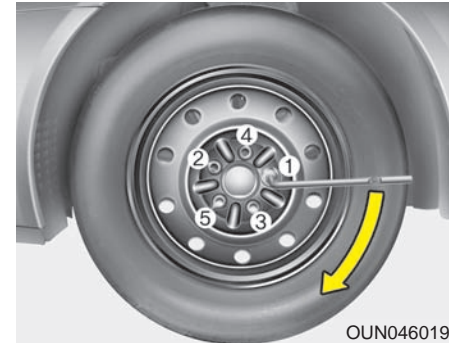

14. Use the wheel lug nut wrench to tighten the lug nuts in the order shown. Double-check each lug nut until they are tight. After changing tires, we recommend that an authorized HYUNDAI dealer tighten the lug nuts to their proper torque as soon as possible. **The wheel lug nut should be tightened to 65~79 lb.ft (9~11 kg.m).**

If you have a tire gauge, check the tire pressure (see “Tires and Wheels” in chapter 8 for tire pressure instructions.). If the pressure is lower or higher than recommended, drive slowly to the nearest service station and adjust it to the recommended pressure. Always reinstall the valve cap after checking or adjusting tire pressure. If the cap is not replaced, air may leak from the tire. If you lose a valve cap, buy another and install it as soon as possible. After changing tires, secure the flat tire and return the jack and tools to their proper storage locations.

*** NOTICE**

Check the tire pressure as soon as possible after installing a spare tire. Adjust it to the recommended pressure.

 **CAUTION**

Your vehicle has metric threads on the studs and lug nuts. Make certain during tire changing that the same nuts that were removed are reinstalled. If you have to replace your lug nuts make sure they have metric threads to avoid damaging the studs and ensure the wheel is properly secured to the hub. Consult an authorized HYUNDAI dealer for assistance.

If any of the equipment such as the jack, lug nuts, studs, or other equipment is damaged or in poor condition, do not attempt to change the tire and call for assistance.

Use of compact spare tires (if equipped)

Compact spare tires are designed for emergency use only. Drive carefully on the compact spare tire and always follow the safety precautions.

 **WARNING**

To prevent compact spare tire failure and loss of control possibly resulting in an accident:

- Use the compact spare tire only in an emergency.
- NEVER operate your vehicle over 50 mph (80 km/h).
- Do not exceed the vehicle’s maximum load rating or the load carrying capacity shown on the sidewall of the compact spare tire.
- Do not use the compact spare tire continuously. Repair or replace the original tire as soon as possible to avoid failure of the compact spare tire.

When driving with the compact spare tire mounted to your vehicle:

- Check the tire pressure after installing the compact spare tire. The compact spare tire should be inflated to 60 psi (420 kPa).
- Do not take this vehicle through an automatic car wash while the compact spare tire is installed.
- Do not use the compact spare tire on any other vehicle because this tire has been designed especially for your vehicle.
- The compact spare tire's tread life is shorter than a regular tire. Inspect your compact spare tire regularly and replace worn compact spare tires with the same size and design, mounted on the same wheel.
- Do not use more than one compact spare tire at a time.

* NOTICE

When the original tire and wheel are repaired and reinstalled on the vehicle, the lug nut torque must be set correctly to prevent wheel vibration. The correct lug nut tightening torque is 65-79 lb.ft (9-11 kg.m).

CAUTION

To prevent damaging the compact spare tire and your vehicle:

- *Drive slowly enough for the road conditions to avoid all hazards, such as a potholes or debris.*
- *Avoid driving over obstacles. The compact spare tire diameter is smaller than the diameter of a conventional tire and reduces the ground clearance approximately 1 inch (25 mm).*
- *Do not use tire chains on the compact spare tire. Because of the smaller size, a tire chain will not fit properly.*
- *Do not use the compact spare tire on any other wheels, nor should standard tires, snow tires, wheel covers or trim rings be used with the compact spare wheel.*

With Tire Mobility Kit (TMK, if equipped)

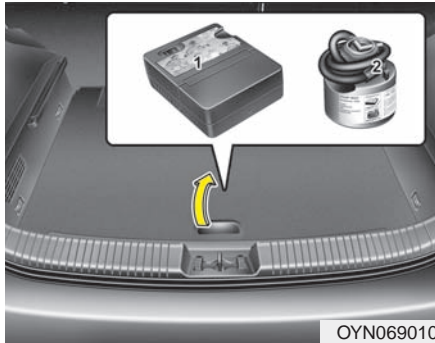

For safe operation, carefully read and follow the instructions in this manual before use.

- (1) Compressor
- (2) Sealant bottle

The Tire Mobility Kit is a temporary fix to the tire and the tire should be inspected by an authorized HYUNDAI dealer as soon as possible.

⚠ CAUTION - One sealant for one tire

When two or more tires are flat, do not use the tire mobility kit because the supported one sealant of Tire Mobility Kit is only used for one flat tire.

⚠ WARNING - Tire wall

Do not use the Tire Mobility Kit to repair punctures in the tire walls. This can result in an accident due to tire failure.

⚠ WARNING - Temporary fix

Have your tire repaired as soon as possible. The tire may lose air pressure at any time after inflating with the Tire Mobility Kit.

Introduction



With the Tire Mobility Kit you stay mobile even after experiencing a tire puncture.

The system of compressor and sealing compound effectively and comfortably seals most punctures in a passenger car tire caused by nails or similar objects and reinflates the tire.

After you ensured that the tire is properly sealed you can drive cautiously on the tire (distance up to 120 miles (200 km)) at a max. speed of (50mph (80 km/h)) in order to reach a service station or tire dealer for the tire replacement.

It is possible that some tires, especially with larger punctures or damage to the sidewall, cannot be sealed completely.

Air pressure loss in the tire may adversely affect tire performance.

For this reason, you should avoid abrupt steering or other driving maneuvers, especially if the vehicle is heavily loaded or if a trailer is in use.

The Tire Mobility Kit is not designed or intended as a permanent tire repair method and is to be used for one tire only.

This instruction shows you step by step how to temporarily seal the puncture simply and reliably.

Read the section "Notes on the safe use of the Tire Mobility Kit".

Notes on the safe use of the Tire Mobility Kit

- Park your car at the side of the road so that you can work with the Tire Mobility Kit away from moving traffic.
- To be sure your vehicle will not move, even when you're on fairly level ground, always set your parking brake.
- Only use the Tire Mobility Kit for sealing/inflation passenger car tires. Only punctured areas located within the tread region of the tire can be sealed using the tire mobility kit.
- Do not use on motorcycles, bicycles or any other type of tires.
- When the tire and wheel are damaged, do not use Tire Mobility Kit for your safety.
- Use of the Tire Mobility Kit may not be effective for tire damage larger than approximately 0.24 inch (6 mm).

Please contact the nearest HYUNDAI dealership if the tire cannot be made roadworthy with the Tire Mobility Kit.

- Do not use the Tire Mobility Kit if a tire is severely damaged by driving run flat or with insufficient air pressure.
- Do not remove any foreign objects such as nails or screws that have penetrated the tire.
- Provided the car is outdoors, leave the engine running. Otherwise operating the compressor may eventually drain the car battery.
- Never leave the Tire Mobility Kit unattended while it is being used.
- Do not leave the compressor running for more than 10 minutes at a time or it may overheat.
- Do not use the Tire Mobility Kit if the ambient temperature is below -22°F (-30°C).

Using the Tire Mobility Kit

1. Detach the speed restriction label (0) from the sealant bottle (1), and place it in a highly visible place inside the vehicle such as on the steering wheel to remind the driver not to drive too fast.
2. Screw connection hose (9) onto the connector of the sealant bottle.
3. Ensure that screw cap (8) is closed.
4. Unscrew the valve cap from the valve of the flat tire and screw filling hose (2) of the sealant bottle onto the valve.
5. Insert the sealant bottle into the housing (4) of the compressor so that the bottle is upright.



OYN069018

6. Ensure that the compressor is switched off, position 0.
7. Plug the compressor power cord into the vehicle power outlet.
8. With the engine start/stop button position on or ignition switch position on, switch on the compressor and let it run for approximately 5~7 minutes to fill the sealant up to proper pressure. (refer to the Tire and Wheels, chapter 8). The inflation pressure of the tire after filling is unimportant and will be checked/corrected later.

Be careful not to overinflate the tire and stay away from the tire when filling it.

⚠ CAUTION - Tire pressure
Do not attempt to drive your vehicle if the tire pressure is below 29 psi (200kpa). This could result in an accident due to sudden tire failure.

9. Switch off the compressor.
10. Detach the hoses from the sealant bottle connector and from the tire valve.

Return the Tire Mobility Kit to its storage location in the vehicle.

⚠ WARNING - Carbon monoxide
Do not leave your vehicle running in a poorly ventilated area for extended periods of time. Carbon monoxide poisoning and suffocation can occur.

Distributing the sealant

11. Immediately drive approximately 4~6miles (7~10km or about 10 minutes) to evenly distribute the sealant in the tire.

Do not exceed a speed of 50 mph (80 km/h). If possible, do not fall below a speed of 12 mph (20 km/h).

While driving, if you experience any unusual vibration, ride disturbance or noise, reduce your speed and drive with caution until you can safely pull off of the side of the road.

Call for road side service or towing.

When you use the Tire Mobility Kit, the tire pressure sensors and wheel may be damaged by sealant, remove the sealant stained with tire pressure sensors and wheel and inspect at an authorized dealer.

Checking the tire inflation pressure

1. After driving approximately 4~6miles (7~10km or about 10 minutes), stop at a safety location.

2. Connect connection hose (9) of the compressor directly to the tire valve.

3. Plug the compressor power cord into the vehicle power outlet.

4. Adjust the tire inflation pressure to the recommended tire inflation.

With the ignition on, proceed as follows.

- To increase the inflation pressure:

Switch on the compressor, position I. To check the current inflation pressure setting, briefly switch off the compressor.

*** NOTICE**

The pressure gauge may show higher than actual reading when the compressor is running. To get an accurate tire pressure, the compressor needs to be turned off.

- To reduce the inflation pressure:

Loosen the screw cap (8) on the compressor hose.

 **CAUTION - Tire pressure sensor**

When you use the Tire Mobility Kit including sealant not approved by HYUNDAI, the tire pressure sensors may be damaged by sealant. The sealant on the tire pressure sensor and wheel should be removed when you replace the tire with a new one and inspect the tire pressure sensors at an authorized dealer.

Technical Data

System voltage: DC 12 V

Working voltage: DC 10 - 15 V

Amperage rating: max. 15 A

Suitable for use at temperatures:

-22 ~ +158°F (-30 ~ +70°C)

Max. working pressure:

87 psi (6 bar)

Size

Compressor: 6.7 x 5.9 x 2.4 in.

(170 x 150 x 60 mm)

Sealant bottle: 3.3 x 3.0 ø in.

(85 x 77 ø mm)

Compressor weight:

1.8 lbs (0.8 kg)

Sealant volume:

12.2 cu. in. (200 ml)

TOWING

Towing service

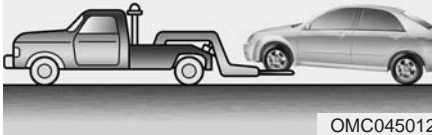
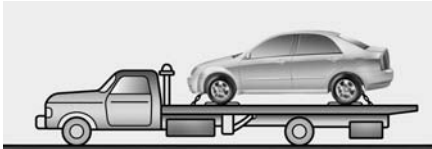

If emergency towing is necessary, we recommend having it done by an authorized HYUNDAI dealer or a commercial tow-truck service. Proper lifting and towing procedures are necessary to prevent damage to the vehicle. The use of wheel dollies or flatbed is recommended.

It is acceptable to tow the vehicle with the rear wheels on the ground (without dollies) and the front wheels off the ground. If any of the loaded wheels or suspension components are damaged or the vehicle is being towed with the front wheels on the ground, use a towing dolly under the front wheels.

When being towed by a commercial tow truck and wheel dollies are not used, the front of the vehicle should always be lifted, not the rear.

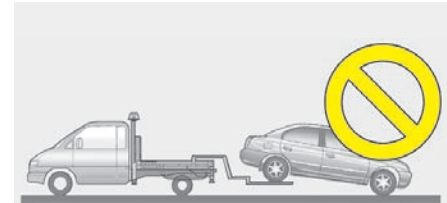

HXD03

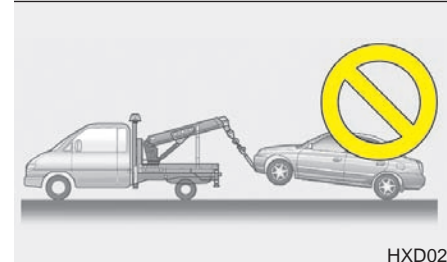

HXD02

CAUTION

- ***Do not tow the vehicle with the front wheels on the ground as this may cause damage to the vehicle.***
- ***Do not tow with sling-type equipment. Use a wheel lift or flatbed equipment.***

When towing your vehicle in an emergency without wheel dollies:

1. Place the ignition switch in the ACC position.
2. Place the shift lever in N (Neutral).
3. Release the parking brake.

CAUTION

Failure to place the shift lever in N (Neutral) when being towed with the front wheels on the ground can cause internal damage to the transaxle.

Removable towing hook

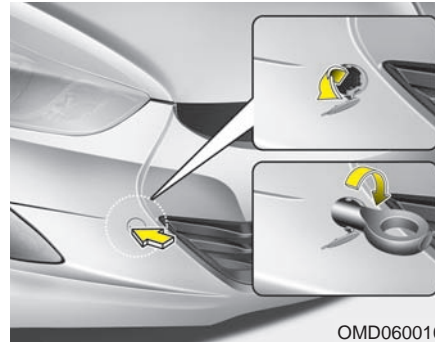

1. Open the trunk, and remove the towing hook from the tool case.
2. Remove the hole cover pressing the lower part of the cover on the front bumper.
3. Install the towing hook by turning it clockwise into the hole until it is fully secured.
4. Remove the towing hook and install the cover after use.

Emergency towing

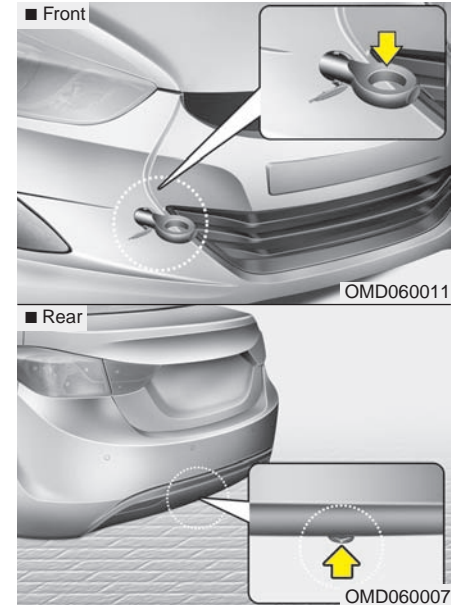

If towing is necessary, we recommend you have it done by an authorized HYUNDAI dealer or a commercial tow truck service.

What to do in an emergency

If towing service is not available in an emergency, your vehicle may be temporarily towed using a cable or chain secured to the emergency towing hook at the front (or rear) of the vehicle.

Use extreme caution when towing the vehicle with a cable or chain. A driver must be in the vehicle to steer it and operate the brakes.

Towing in this manner may be done only on hard-surfaced roads for a short distance and at low speeds. Also, the wheels, axles, power train, steering and brakes must all be in good condition.

Always follow these emergency towing precautions:

- Place the ignition switch in the ACC position so the steering wheel is not locked. (if equipped)
- Place the shift lever in N (Neutral).
- Release the parking brake.
- Depress the brake pedal with more force than normal since you will have reduced braking performance.
- More steering effort will be required because the power steering system will be disabled.
- Use a vehicle heavier than your own to tow your vehicle.
- The drivers of both vehicles should communicate with each other frequently.
- Before emergency towing, check that the hook is not broken or damaged.
- Fasten the towing cable or chain securely to the hook.
- Do not jerk the hook. Apply steady and even force.

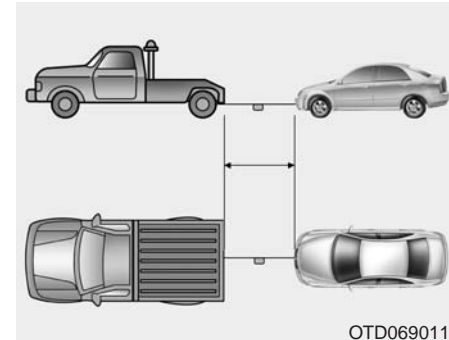

- Use a towing cable or chain less than 16 feet (5 m) long. Attach a white or red cloth (about 12 inches (30 cm) wide) in the middle of the cable or chain for easy visibility.
- Drive carefully so the towing cable or chain remains tight during towing.
- Before towing, check the automatic transaxle for fluid leaks under your vehicle. If the automatic transaxle fluid is leaking, flatbed equipment or a towing dolly must be used.

 **CAUTION**

To avoid damage to your vehicle and vehicle components when towing:

- *Always pull straight ahead when using the towing hooks. Do not pull from the side or at a vertical angle.*
- *Do not use the towing hooks to pull a vehicle out of mud, sand or other conditions from which the vehicle cannot be driven out under its own power.*
- *Limit the vehicle speed to 10 mph (15 km/h) and drive less than 1 mile (1.5 km) when towing to avoid serious damage to the automatic transaxle.*

Maintenance

| | | | |
|--|------|---|------|
| Engine compartment | 7-3 | Wiper blades | 7-41 |
| Maintenance services | 7-4 | • Blade inspection | 7-41 |
| • Owner's responsibility | 7-4 | • Blade replacement | 7-41 |
| • Owner maintenance precautions | 7-4 | Battery | 7-43 |
| Owner maintenance | 7-6 | • For best battery service | 7-44 |
| • Owner maintenance schedule | 7-7 | • Battery recharging | 7-45 |
| Scheduled maintenance services | 7-8 | • Reset features | 7-46 |
| Explanation of scheduled maintenance items | 7-26 | Tires and wheels | 7-47 |
| Engine oil | 7-30 | • Tire care | 7-47 |
| • Checking the engine oil level | 7-30 | • Recommended cold tire inflation pressures | 7-48 |
| • Checking the engine oil and filter | 7-31 | • Check tire inflation pressure | 7-49 |
| Engine coolant | 7-32 | • Tire rotation | 7-50 |
| • Checking the engine coolant level | 7-32 | • Wheel alignment and tire balance | 7-51 |
| • Changing engine coolant | 7-34 | • Tire replacement | 7-51 |
| Brake/clutch fluid | 7-35 | • Wheel replacement | 7-52 |
| • Checking the brake/clutch fluid level | 7-35 | • Tire traction | 7-52 |
| Washer fluid | 7-36 | • Tire maintenance | 7-53 |
| • Checking the washer fluid level | 7-36 | • Tire sidewall labeling | 7-53 |
| Parking brake | 7-36 | • Tire terminology and definitions | 7-57 |
| • Checking the parking brake | 7-36 | • All season tires | 7-60 |
| Air cleaner | 7-37 | • Summer tires | 7-60 |
| • Filter replacement | 7-37 | • Snow tires | 7-60 |
| Climate control air cleaner | 7-39 | • Radial-ply tires | 7-61 |
| • Filter inspection | 7-39 | • Low aspect ratio tires | 7-61 |



Fuses 7-63

- Instrument panel fuse replacement 7-64
- Memory fuse 7-65
- Engine compartment panel fuse replacement 7-66
- Fuse/relay panel description 7-68

Light bulbs 7-76

- Headlight, parking light, turn signal light, side marker and front fog light bulb replacement 7-76
- Side repeater light replacement 7-80
- Rear combination light bulb replacement 7-81
- High mounted stop light replacement 7-84
- License plate light bulb replacement 7-85
- Interior light bulb replacement 7-85

Appearance care 7-87

- Exterior care 7-87
- Interior care 7-93

Emission control system 7-94

- Crankcase emission control system 7-94
- Evaporative emission control system including onboard refueling vapor recovery (ORVR) 7-94
- Exhaust emission control system 7-95

California perchlorate notice 7-98

ENGINE COMPARTMENT

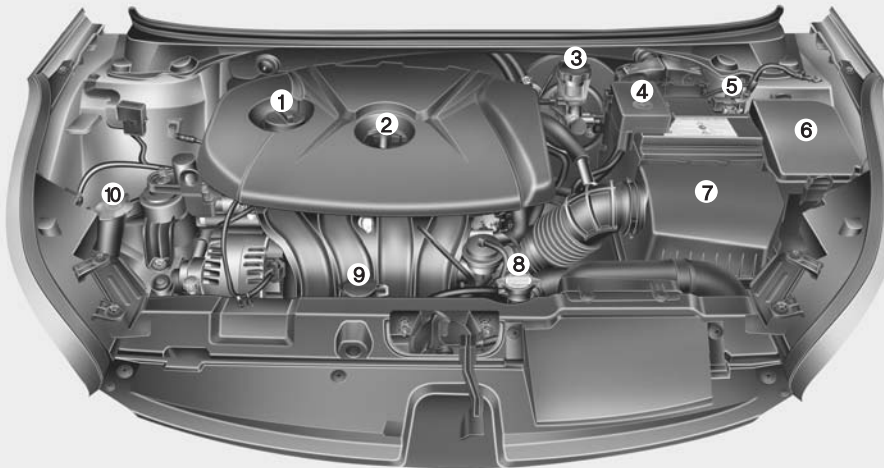

1. Engine oil filler cap
 2. Engine oil dipstick
 3. Brake/clutch* fluid reservoir
 4. Positive battery terminal
 5. Negative battery terminal
 6. Fuse box
 7. Air cleaner
 8. Radiator cap
 9. Engine coolant reservoir
 10. Windshield washer fluid reservoir
- * : if equipped

※ The actual engine room in the vehicle may differ from the illustration.

OMD070047N

MAINTENANCE SERVICES

You should exercise the utmost care to prevent damage to your vehicle and injury to yourself whenever performing any maintenance or inspection procedures.

We recommend you have your vehicle maintained and repaired by an authorized HYUNDAI dealer. An authorized HYUNDAI dealer meets HYUNDAI's high service quality standards and receives technical support from HYUNDAI in order to provide you with a high level of service satisfaction.

Owner's responsibility

Maintenance service and record retention are the owner's responsibility.

You should retain documents that show proper maintenance has been performed on your vehicle in accordance with the scheduled maintenance service charts shown on the following pages. You need this information to establish your compliance with the servicing and maintenance requirements of your vehicle warranties. Detailed warranty information is provided in your Owner's Handbook & Warranty Information booklet.

Repairs and adjustments required as a result of improper maintenance or a lack of required maintenance are not covered.

Owner maintenance precautions

Inadequate, incomplete or insufficient servicing may result in operational problems with your vehicle that could lead to vehicle damage, an accident, or personal injury. This chapter provides instructions only for the maintenance items that are easy to perform. Several procedures can be done only by an authorized HYUNDAI dealer with special tools.

Your vehicle should not be modified in any way. Such modifications may adversely affect the performance, safety or durability of your vehicle and may, in addition, violate conditions of the limited warranties covering the vehicle. Certain modifications may also be in violation of regulations established by the U.S. Department of Transportation and other federal or state agencies.

*** NOTICE**

Improper owner maintenance during the warranty period may affect warranty coverage. For details, read the separate **Owner's Handbook & Warranty Information** booklet provided with the vehicle. If you're unsure about any service or maintenance procedure, have it done by an authorized **HYUNDAI** dealer.

OWNER MAINTENANCE

⚠ WARNING

Performing maintenance work on a vehicle can be dangerous. If you lack sufficient knowledge and experience or the proper tools and equipment to do the work, have it done by an authorized HYUNDAI dealer. ALWAYS follow these precautions for performing maintenance work:

- Park your vehicle on level ground, move the shift lever into the P (Park, for automatic transaxle vehicle) position or neutral (for manual transaxle vehicle), apply the parking brake, place the ignition switch in the OFF position.
- Block the tires (front and back) to prevent the vehicle from moving.

Remove loose clothing or jewelry that can become entangled in moving parts.

(Continued)

(Continued)

- If you must run the engine during maintenance, do so out doors or in an area with plenty of ventilation.
- Keep flames, sparks, or smoking materials away from the battery and fuel-related parts.

The following lists are vehicle checks and inspections that should be performed by the owner or an authorized HYUNDAI dealer at the frequencies indicated to help ensure safe, dependable operation of your vehicle.

Any adverse conditions should be brought to the attention of your dealer as soon as possible.

These Owner Maintenance vehicle checks are generally not covered by warranties and you may be charged for labor, parts and lubricants used.

Owner maintenance schedule

When you stop for fuel:

- Check the engine oil level.
- Check coolant level in the engine coolant reservoir.
- Check the windshield washer fluid level.
- Check for low or under-inflated tires

WARNING

Be careful when checking your engine coolant level when the engine is hot. This may result in coolant being blown out of the opening and cause serious burns and other injuries.

While operating your vehicle:

- Note any changes in the sound of the exhaust or any smell of exhaust fumes in the vehicle.
- Check for vibrations in the steering wheel. Notice if there is any increased steering effort or looseness in the steering wheel, or change in its straight-ahead position.
- Notice if your vehicle constantly turns slightly or “pulls” to one side when traveling on smooth, level road.
- When stopping, listen and check for unusual sounds, pulling to one side, increased brake pedal travel or “hard-to-push” brake pedal.
- If any slipping or changes in the operation of your transaxle occurs, check the transaxle fluid level.
- Check the automatic transaxle P (Park) function.
- Check the parking brake.
- Check for fluid leaks under your vehicle (water dripping from the air conditioning system during or after use is normal).

At least monthly:

- Check coolant level in the engine coolant reservoir.
- Check the operation of all exterior lights, including the stoplights, turn signals and hazard warning flashers.
- Check the inflation pressures of all tires including the spare for tires that are worn, show uneven wear, or are damaged.
- Check for loose wheel lug nuts.

***At least twice a year:
(i.e., every Spring and Fall):***

- Check radiator, heater and air conditioning hoses for leaks or damage.
- Check windshield washer spray and wiper operation. Clean wiper blades with clean cloth dampened with washer fluid.
- Check headlight alignment.
- Check muffler, exhaust pipes, shields and clamps.
- Check the seat belts for wear and function.

At least once a year:

- Clean body and door drain holes.
- Lubricate door hinges and hood hinges.
- Lubricate door and hood locks and latches.
- Lubricate door rubber weather strips.
- Check the air conditioning system.
- Inspect and lubricate automatic transaxle linkage and controls.
- Clean the battery and terminals.
- Check the brake/clutch fluid level.

SCHEDULED MAINTENANCE SERVICES

Follow Normal Maintenance Schedule if the vehicle is usually operated where none of the following conditions apply. If any of the following conditions apply, you must follow the Maintenance Under Severe Usage Conditions.

- Repeated short distance driving.
- Driving in dusty conditions or sandy areas.
- Extensive use of brakes.
- Driving in areas where salt or other corrosive materials are used.
- Driving on rough or muddy roads.
- Driving in mountainous areas.
- Extended periods of idling or low speed operation.
- Driving for a prolonged period in cold temperatures and/or extremely humid climates.
- More than 50% driving in heavy city traffic during hot weather above 90°F (32°C).

For additional information or assistance see your authorized HYUNDAI dealer.

NORMAL MAINTENANCE SCHEDULE

The following maintenance services must be performed to ensure good emission control and performance. Keep receipts for all vehicle emission services to protect your warranty. Where both mileage and time are shown, the frequency of service is determined by whichever occurs first.

- *1 : Fuel filter & Fuel tank air filter are considered to be maintenance free but periodic inspection is recommended for this maintenance schedule depends on fuel quality. If there are some important safety matters like fuel flow restriction, surging, loss of power, hard starting problem, etc. replace the fuel filter immediately regardless of maintenance schedule and consult an authorized HYUNDAI dealer for details.
- *2 : The drive belt should be replaced when cracks occur or tension is reduced excessively.
- *3 : If TOP TIER Detergent Gasoline is not available, one bottle of additive is recommended. Additives are available from your authorized HYUNDAI dealer along with information on how to use them. Do not mix other additives.

NORMAL MAINTENANCE SCHEDULE (CONT.)

7,500 miles (12,000 km) or 6 months

- Rotate tire
- Inspect battery condition
- Inspect air cleaner filter
- Inspect vacuum hose
- Replace engine oil and filter
(7,500 miles (12,000 km) or 12 months)
- Add fuel additive ^{*3}
(7,500 miles (12,000 km) or 12 months)

※ Inspect : Inspect and if necessary, adjust, correct, clean or replace.

15,000 miles (24,000 km) or 12 months

- Rotate tire
- Inspect battery condition
- Inspect air cleaner filter
- Inspect vacuum hose
- Inspect air conditioning refrigerant
- Inspect brake hoses and lines
- Inspect drive shafts and boots
- Inspect exhaust pipe and muffler
- Inspect front brake disc/pads, calipers
 - Inspect rear brake disc/pads
- Inspect rear brake drums/linings (if equipped)
- Inspect steering gear box, linkage & boots/lower arm ball joint, upper arm ball joint
- Inspect suspension mounting bolts
- Replace climate control air filter
(for evaporator and blower unit)
- Replace engine oil and filter
(15,000 miles (24,000 km) or 24 months)
- Add fuel additive ^{*3}
(15,000 miles (24,000 km) or 24 months)

※ Inspect : Inspect and if necessary, adjust, correct, clean or replace.

NORMAL MAINTENANCE SCHEDULE (CONT.)**22,500 miles (36,000 km) or 18 months**

- Rotate tire
- Inspect battery condition
- Inspect air cleaner filter
- Inspect vacuum hose
- Replace engine oil and filter
(22,500 miles (36,000 km) or 36 months)
- Add fuel additive *³
(22,500 miles (36,000 km) or 36 months)

* Inspect : Inspect and if necessary, adjust, correct, clean or replace.

30,000 miles (48,000 km) or 24 months

- Rotate tire
- Inspect battery condition
- Inspect vacuum hose
- Inspect air conditioning refrigerant
- Inspect brake hoses and lines
- Inspect exhaust pipe and muffler
- Inspect front brake disc/pads, calipers
- Inspect rear brake disc/pads (if equipped)
- Inspect steering gear box, linkage & boots/lower arm ball joint, upper arm ball joint
- Inspect suspension mounting bolts
- Inspect brake/clutch (if equipped) fluid
- Inspect fuel filter *¹
- Inspect fuel lines, fuel hoses and connections
- Inspect fuel tank air filter (if equipped) *¹
- Inspect parking brake
- Inspect vapor hose and fuel filler cap
- Replace climate control air filter
(for evaporator and blower unit)
- Replace air cleaner filter

(Continued)

NORMAL MAINTENANCE SCHEDULE (CONT.)

(Continued)

- Replace engine oil and filter
(30,000 miles (48,000 km) or 48 months)
- Add fuel additive ^{*3}
(30,000 miles (48,000 km) or 48 months)

* Inspect : Inspect and if necessary, adjust, correct, clean or replace.

37,500 miles (60,000 km) or 30 months

- Rotate tire
- Inspect battery condition
- Inspect air cleaner filter
- Inspect vacuum hose
- Inspect manual transaxle fluid (if equipped)
- Replace engine oil and filter
(37,500 miles (60,000 km) or 60 months)
- Add fuel additive ^{*3}
(37,500 miles (60,000 km) or 60 months)

* Inspect : Inspect and if necessary, adjust, correct, clean or replace.

NORMAL MAINTENANCE SCHEDULE (CONT.)

45,000 miles (72,000 km) or 36 months

- Rotate tire
- Inspect battery condition
- Inspect air cleaner filter
- Inspect vacuum hose
- Inspect air conditioning refrigerant
- Inspect brake hoses and lines
- Inspect drive shafts and boots
- Inspect exhaust pipe and muffler
- Inspect front brake disc/pads, calipers
- Inspect rear brake disc/pads
- Inspect steering gear box, linkage & boots/lower arm ball joint, upper arm ball joint
- Inspect suspension mounting bolts
- Replace climate control air filter
(for evaporator and blower unit)
- Replace engine oil and filter
(45,000 miles (72,000 km) or 72 months)
- Add fuel additive *³
(45,000 miles (72,000 km) or 72 months)

* Inspect : Inspect and if necessary, adjust, correct, clean or replace.

52,500 miles (84,000 km) or 42 months

- Rotate tire
- Inspect battery condition
- Inspect air cleaner filter
- Inspect vacuum hose
- Replace engine oil and filter
(52,500 miles (84,000 km) or 84 months)
- Add fuel additive *³
(52,500 miles (84,000 km) or 84 months)

* Inspect : Inspect and if necessary, adjust, correct, clean or replace.

NORMAL MAINTENANCE SCHEDULE (CONT.)

60,000 miles (96,000 km) or 48 months

- Rotate tire
- Inspect battery condition
- Inspect vacuum hose
- Inspect air conditioning refrigerant
- Inspect brake hoses and lines
- Inspect exhaust pipe and muffler
- Inspect front brake disc/pads, calipers
- Inspect rear brake disc/pads (if equipped)
- Inspect rear brake drums/linings (if equipped)
- Inspect steering gear box, linkage & boots/lower arm ball joint, upper arm ball joint
- Inspect suspension mounting bolts
- Inspect brake/clutch (if equipped) fluid
- Inspect fuel filter *¹
- Inspect fuel lines, fuel hoses and connections
- Inspect fuel tank air filter (if equipped) *¹
- Inspect parking brake
- Inspect vapor hose and fuel filler cap
- Inspect drive belts *²
(First, 60,000 miles (96,000 km) or 72 months
after every 15,000 miles (24,000 km) or 24 months)

(Continued)

(Continued)

- Replace climate control air filter
(for evaporator and blower unit)
- Replace air cleaner filter
- Replace engine oil and filter
(60,000 miles (96,000 km) or 96 months)
- Replace coolant
(First, 60,000 miles (96,000 km) or 60 months after every
30,000 miles (48,000 km) or 24 months)
- Add fuel additive *³
(60,000 miles (96,000 km) or 96 months)

* Inspect : Inspect and if necessary, adjust, correct, clean or replace.

NORMAL MAINTENANCE SCHEDULE (CONT.)**67,500 miles (108,000 km) or 54 months**

- Rotate tire
- Inspect battery condition
- Inspect air cleaner filter
- Inspect vacuum hose
- Replace engine oil and filter
(67,500 miles (108,000 km) or 108 months)
- Add fuel additive ^{*3}
(67,500 miles (108,000 km) or 108 months)

* Inspect : Inspect and if necessary, adjust, correct, clean or replace.

75,000 miles (120,000 km) or 60 months

- Rotate tire
- Inspect battery condition
- Inspect air cleaner filter
- Inspect vacuum hose
- Inspect air conditioning refrigerant
- Inspect brake hoses and lines
- Inspect drive shafts and boots
- Inspect exhaust pipe and muffler
- Inspect front brake disc/pads, calipers
- Inspect rear brake disc/pads
- Inspect steering gear box, linkage & boots/lower arm ball joint, upper arm ball joint
- Inspect suspension mounting bolts
- Inspect manual transaxle fluid (if equipped)
- Inspect drive belts ^{*2}
(First, 60,000 miles (96,000 km) or 72 months after every 15,000 miles (24,000 km) or 24 months)
- Replace climate control air filter
(for evaporator and blower unit)

(Continued)

NORMAL MAINTENANCE SCHEDULE (CONT.)

(Continued)

- Replace engine oil and filter
(75,000 miles (120,000 km) or 120 months)
- Add fuel additive *³
(75,000 miles (120,000 km) or 120 months)

* Inspect : Inspect and if necessary, adjust, correct, clean or replace.

82,500 miles (132,000 km) or 66 months

- Rotate tire
- Inspect battery condition
- Inspect air cleaner filter
- Inspect vacuum hose
- Replace engine oil and filter
(82,500 miles (132,000 km) or 132 months)
- Add fuel additive *³
(82,500 miles (132,000 km) or 132 months)

* Inspect : Inspect and if necessary, adjust, correct, clean or replace.

NORMAL MAINTENANCE SCHEDULE (CONT.)**90,000 miles (144,000 km) or 72 months**

- Rotate tire
- Inspect battery condition
- Inspect vacuum hose
- Inspect air conditioning refrigerant
- Inspect brake hoses and lines
- Inspect exhaust pipe and muffler
- Inspect front brake disc/pads, calipers
- Inspect rear brake disc/pads
- Inspect steering gear box, linkage & boots/lower arm ball joint, upper arm ball joint
- Inspect suspension mounting bolts
- Inspect brake/clutch (if equipped) fluid
- Inspect fuel filter *¹
- Inspect fuel lines, fuel hoses and connections
- Inspect fuel tank air filter (if equipped) *¹
- Inspect parking brake
- Inspect vapor hose and fuel filler cap
- Inspect drive belts *²
(First, 60,000 miles (96,000 km) or 72 months
after every 15,000 miles (24,000 km) or 24 months)

(Continued)

(Continued)

- Replace climate control air filter
(for evaporator and blower unit)
- Replace air cleaner filter
- Replace engine oil and filter
(90,000 miles (144,000 km) or 144 months)
- Replace coolant
(First, 60,000 miles (96,000 km) or 60 months after every
30,000 miles (48,000 km) or 24 months)
- Add fuel additive *³
(90,000 miles (144,000 km) or 144 months)

*¹ Inspect : Inspect and if necessary, adjust, correct, clean or replace.

NORMAL MAINTENANCE SCHEDULE (CONT.)

97,500 miles (156,000 km) or 78 months

- Rotate tire
- Inspect battery condition
- Inspect air cleaner filter
- Inspect vacuum hose
- Replace engine oil and filter
(97,500 miles (156,000 km) or 156 months)
- Add fuel additive ^{*3}
(97,500 miles (156,000 km) or 156 months)

* Inspect : Inspect and if necessary, adjust, correct, clean or replace.

105,000 miles (168,000 km) or 84 months

- Rotate tire
- Inspect battery condition
- Inspect air cleaner filter
- Inspect vacuum hose
- Inspect air conditioning refrigerant
- Inspect brake hoses and lines
- Inspect drive shafts and boots
- Inspect exhaust pipe and muffler
- Inspect front brake disc/pads, calipers
- Inspect rear brake disc/pads (if equipped)
- Inspect rear brake drums/linings (if equipped)
- Inspect steering gear box, linkage & boots/lower arm ball joint, upper arm ball joint
- Inspect suspension mounting bolts
- Inspect drive belts ^{*2}
(First, 60,000 miles (96,000 km) or 72 months
after every 15,000 miles (24,000 km) or 24 months)
- Replace climate control air filter
(for evaporator and blower unit)
- Replace spark plugs (iridium coated)

(Continued)

NORMAL MAINTENANCE SCHEDULE (CONT.)

(Continued)

- Replace engine oil and filter
(105,000 miles (168,000 km) or 168 months)
- Add fuel additive ^{*3}
(105,000 miles (168,000 km) or 168 months)

* Inspect : Inspect and if necessary, adjust, correct, clean or replace.

112,500 miles (180,000 km) or 90 months

- Rotate tire
- Inspect battery condition
- Inspect air cleaner filter
- Inspect vacuum hose
- Inspect manual transaxle fluid (if equipped)
- Replace engine oil and filter
(112,500 miles (180,000 km) or 180 months)
- Add fuel additive ^{*3}
(112,500 miles (180,000 km) or 180 months)

* Inspect : Inspect and if necessary, adjust, correct, clean or replace.

NORMAL MAINTENANCE SCHEDULE (CONT.)

120,000 miles (192,000 km) or 96 months

- Rotate tire
- Inspect battery condition
- Inspect vacuum hose
- Inspect air conditioning refrigerant
- Inspect brake hoses and lines
- Inspect exhaust pipe and muffler
- Inspect front brake disc/pads, calipers
- Inspect rear brake disc/pads
- Inspect steering gear box, linkage & boots/lower arm ball joint, upper arm ball joint
- Inspect suspension mounting bolts
- Inspect brake/clutch (if equipped) fluid
- Inspect fuel filter *¹
- Inspect fuel lines, fuel hoses and connections
- Inspect fuel tank air filter (if equipped) *¹
- Inspect parking brake
- Inspect vapor hose and fuel filler cap
- Inspect drive belts *²
(First, 60,000 miles (96,000 km) or 72 months
after every 15,000 miles (24,000 km) or 24 months)

(Continued)

(Continued)

- Replace climate control air filter
(for evaporator and blower unit)
- Replace air cleaner filter
- Replace engine oil and filter
(120,000 miles (192,000 km) or 192 months)
- Replace coolant
(First, 60,000 miles (96,000 km) or 60 months after every
30,000 miles (48,000 km) or 24 months)
- Add fuel additive *³
(120,000 miles (192,000 km) or 192 months)

* Inspect : Inspect and if necessary, adjust, correct, clean or replace.

NORMAL MAINTENANCE SCHEDULE (CONT.)

127,500 miles (204,000 km) or 102 months

- Rotate tire
- Inspect battery condition
- Inspect air cleaner filter
- Inspect vacuum hose
- Replace engine oil and filter
(127,500 miles (204,000 km) or 204 months)
- Add fuel additive *³
(127,500 miles (204,000 km) or 204 months)

* Inspect : Inspect and if necessary, adjust, correct, clean or replace.

135,000 miles (216,000 km) or 108 months

- Rotate tire
- Inspect battery condition
- Inspect air cleaner filter
- Inspect vacuum hose
- Inspect air conditioning refrigerant
- Inspect brake hoses and lines
- Inspect drive shafts and boots
- Inspect exhaust pipe and muffler
- Inspect front brake disc/pads, calipers
- Inspect rear brake disc/pads
- Inspect steering gear box, linkage & boots/lower arm ball joint, upper arm ball joint
- Inspect suspension mounting bolts
- Inspect drive belts *²
(First, 60,000 miles (96,000 km) or 72 months after every 15,000 miles (24,000 km) or 24 months)
- Replace climate control air filter
(for evaporator and blower unit)
- Replace engine oil and filter
(135,000 miles (216,000 km) or 216 months)

(Continued)

NORMAL MAINTENANCE SCHEDULE (CONT.)

(Continued)

- Add fuel additive *³
(135,000 miles (216,000 km) or 216 months)

* Inspect : Inspect and if necessary, adjust, correct, clean or replace.

142,500 miles (228,000 km) or 114 months

- Rotate tire
- Inspect battery condition
- Inspect air cleaner filter
- Inspect vacuum hose
- Replace engine oil and filter
(142,500 miles (228,000 km) or 228 months)
- Add fuel additive *³ (142,500 miles
(228,000 km) or 228 months)

* Inspect : Inspect and if necessary, adjust, correct, clean or replace.

NORMAL MAINTENANCE SCHEDULE (CONT.)**150,000 miles (240,000 km) or 120 months**

- Rotate tire
- Inspect battery condition
- Inspect vacuum hose
- Inspect air conditioning refrigerant
- Inspect brake hoses and lines
- Inspect exhaust pipe and muffler
- Inspect front brake disc/pads, calipers
- Inspect rear brake disc/pads
- Inspect steering gear box, linkage & boots/lower arm ball joint, upper arm ball joint
- Inspect suspension mounting bolts
- Inspect brake/clutch (if equipped) fluid
- Inspect fuel filter *¹
- Inspect fuel lines, fuel hoses and connections
- Inspect fuel tank air filter (if equipped) *¹
- Inspect parking brake
- Inspect vapor hose and fuel filler cap
- Inspect manual transaxle fluid (if equipped)
- Inspect drive belts *²
(First, 60,000 miles (96,000 km) or 72 months
after every 15,000 miles (24,000 km) or 24 months)

(Continued)

(Continued)

- Replace climate control air filter
(for evaporator and blower unit)
- Replace air cleaner filter
- Replace engine oil and filter
(150,000 miles (240,000 km) or 240 months)
- Replace coolant
(First, 60,000 miles (96,000 km) or 60 months after every
30,000 miles (48,000 km) or 24 months)
- Add fuel additive *³
(150,000 miles (240,000 km) or 240 months)

* Inspect : Inspect and if necessary, adjust, correct, clean or replace.

No check, No service required

- Automatic transaxle fluid (if equipped)

MAINTENANCE UNDER SEVERE USAGE CONDITIONS

The following items must be serviced more frequently on cars normally used under severe driving conditions. Refer to the chart below for the appropriate maintenance intervals.

R : Replace I : Inspect and, after inspection, clean, adjust, repair or replace if necessary

| MAINTENANCE ITEM | MAINTENANCE OPERATION | MAINTENANCE INTERVALS | DRIVING CONDITION |
|---------------------------------|-----------------------|--|---------------------------------|
| Engine oil and filter | R | Every 3,750 miles (6,000 km) or 6 months | A, B, C, D, E, F, G, H, I, J, K |
| Air cleaner filter | R | More frequently | C, E |
| Spark plugs | R | More frequently | A, B, H, I, K |
| Automatic transaxle fluid | R | Every 60,000 miles (96,000 km) | A, C, E, F, G, I |
| Manual transaxle fluid | R | Every 75,000 miles (120,000 km) | A, C, E, F, G, I |
| Front brake disc/pads, calipers | I | More frequently | C, D, G, H |
| Rear brake disc/pads | I | More frequently | C, D, G, F |

| MAINTENANCE ITEM | MAINTENANCE OPERATION | MAINTENANCE INTERVALS | DRIVING CONDITION |
|--|-----------------------|---|---------------------|
| Parking brake | I | More frequently | C, D, G, H |
| Steering gear box, linkage & boots/ lower arm ball joint, upper arm ball joint | I | More frequently | C, D, E, F, G, H, I |
| Drive shafts and boots | I | Every 7,500 miles (12,000 km) or 6 months | C, D, E, F, G, H, I |
| Climate control air filter (for evaporator and blower unit) | R | More frequently | C, E |

SEVERE DRIVING CONDITIONS

- A-Repeatedly driving short distances of less than 5 miles (8 km) in normal temperature or less than 10 miles (16 km) in freezing temperature
- B-Extensive engine idling or low speed driving for long distances
- C-Driving on rough, dusty, muddy, unpaved, graveled or salt-spread roads
- D-Driving in areas using salt or other corrosive materials or in very cold weather
- E-Driving in sandy areas
- F-Driving in heavy traffic area over 90°F (32°C)
- G-Driving on uphill, downhill, or mountain road
- H-Towing a Trailer, or using a camper, or roof rack
- I -Driving as a patrol car, taxi, other commercial use or vehicle towing
- J -Driving over 106 mph (170 km/h)
- K-Frequently driving in stop-and-go conditions

EXPLANATION OF SCHEDULED MAINTENANCE ITEMS

Engine oil and filter

The engine oil and filter should be changed at the intervals specified in the maintenance schedule. If the car is being driven in severe conditions, more frequent oil and filter changes are required.

Drive belts

Inspect all drive belts for evidence of cuts, cracks, excessive wear or oil saturation and replace if necessary. Drive belts should be checked periodically for proper tension and adjusted as necessary.

Fuel filter

A clogged filter can limit the speed at which the vehicle may be driven, damage the emission system and cause multiple issues such as hard starting. If an excessive amount of foreign matter accumulates in the fuel tank, the filter may require replacement more frequently. After installing a new filter, run the engine for several minutes, and check for leaks at the connections. Fuel filters should be installed by an authorized HYUNDAI dealer.

Fuel lines, fuel hoses and connections

Check the fuel lines, fuel hoses and connections for leakage and damage. Have an authorized HYUNDAI dealer replace any damaged or leaking parts immediately.

Vapor hose and fuel filler cap

The vapor hose and fuel filler cap should be inspected at those intervals specified in the maintenance schedule. Make sure a new vapor hose or fuel filler cap is correctly replaced.

Vacuum crankcase ventilation hoses

Inspect the surface of hoses for evidence of heat and/or mechanical damage. Hard and brittle rubber, cracking, tears, cuts, abrasions, and excessive swelling indicate deterioration. Particular attention should be paid to examine those hose surfaces nearest to high heat sources, such as the exhaust manifold.

Inspect the hose routing to assure that the hoses do not come in contact with any heat source, sharp edges or moving component which might cause heat damage or mechanical wear. Inspect all hose connections, such as clamps and couplings, to make sure they are secure, and that no leaks are present. Hoses should be replaced immediately if there is any evidence of deterioration or damage.

Air cleaner filter

A genuine HYUNDAI air cleaner filter is recommended when the filter is replaced.

Spark plugs

Make sure to install new spark plugs of the correct heat range.

Cooling system

Check cooling system components, such as radiator, coolant reservoir, hoses and connections for leakage and damage. Replace any damaged parts.

Engine coolant

The coolant should be changed at the intervals specified in the maintenance schedule.

Automatic transaxle fluid (if equipped)

Automatic transaxle fluid should not be checked under normal usage conditions. But in severe conditions, the fluid should be changed at an authorized HYUNDAI dealer in accordance to the scheduled maintenance at the beginning of this chapter.

*** NOTICE**

Automatic transaxle fluid color is basically red.

As the vehicle is driven, the automatic transaxle fluid will begin to look darker. This is a normal condition and you should not judge the need to replace the fluid based upon the changed color.

CAUTION

The use of a non-specified fluid could result in transaxle malfunction and failure. Use only the specified automatic transaxle fluid (refer to “Recommended Lubricants and Capacities” in chapter 8).

Manual transaxle fluid (if equipped)

Inspect the manual transaxle fluid according to the maintenance schedule.

Brake hoses and lines

Visually check for proper installation, chafing, cracks, deterioration and any leakage. Replace any deteriorated or damaged parts immediately.

Brake/clutch fluid

Check brake/clutch fluid level in the brake/clutch fluid reservoir. The level should be between the MIN and the MAX marks on the side of the reservoir. Use only hydraulic brake/clutch fluid conforming to DOT 3 or DOT 4 specification.

Parking brake

Inspect the parking brake system including the parking brake pedal and cables.

Brake discs, pads, calipers and rotors

Check the pads for excessive wear, discs for run out and wear, and calipers for fluid leakage.

Exhaust pipe and muffler

Visually inspect the exhaust pipes, muffler and hangers for cracks, deterioration, or damage. Start the engine and listen carefully for any exhaust gas leakage. Tighten connections or replace parts as necessary.

Suspension mounting bolts

Check the suspension connections for looseness or damage. Retighten to the specified torque.

Steering gear box, linkage & boots/lower arm ball joint

With the vehicle stopped and the engine off, check for excessive free-play in the steering wheel. Check the linkage for bends or damage. Check the dust boots and ball joints for deterioration, cracks, or damage.

Replace any damaged parts.

Drive shafts and boots

Check the drive shafts, boots and clamps for cracks, deterioration, or damage. Replace any damaged parts and, if necessary, repack the grease.

Air conditioning refrigerant

Check the air conditioning lines and connections for leakage and damage.

ENGINE OIL

Checking the engine oil level

1. Follow all of the oil manufacturer's precautions.
2. Be sure the vehicle is on level ground in P (Park) with the parking brake set and the wheels blocked.
3. Turn the engine on and allow the engine to reach normal operating temperature.
4. Turn the engine off and wait about five minutes for the oil to return to the oil pan.
5. Pull the dipstick out, wipe it clean, and re-insert it fully.

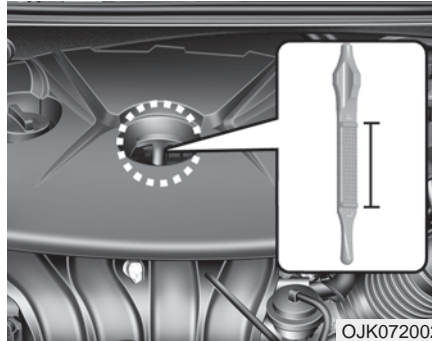

6. Pull the dipstick out again and check the level. The level should be between F and L.
7. If it is near or at L, add enough oil to bring the level to F.

* NOTICE

To prevent damage to your engine:

- Do not overfill with engine oil. Add oil in small quantities and recheck level to ensure engine is not overfilled.
- Do not spill engine oil when adding or changing engine oil. Use a funnel to help prevent oil from being spilled on engine components. Wipe off spilled oil immediately.

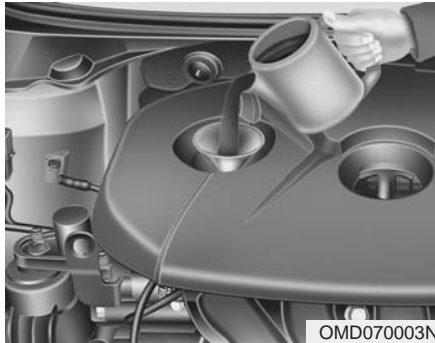

OMD070003N

* NOTICE

Use only the specified engine oil (refer to “Recommended Lubricants and Capacities” in chapter 8).

Checking the engine oil and filter



Have engine oil and filter changed by an authorized HYUNDAI dealer according to the Maintenance Schedule at the beginning of this chapter.

⚠ WARNING - CALIFORNIA PROPOSITION 65 WARNING

Engine oil contains chemicals known to the State of California to cause cancer, birth defects and reproductive harm. Used engine oil may cause irritation or cancer of the skin if left in contact with the skin for prolonged periods of time. Always protect your skin by washing your hands thoroughly with soap and warm water as soon as possible after handling used oil.

ENGINE COOLANT

The high-pressure cooling system has a reservoir filled with year-round antifreeze coolant. The reservoir is filled at the factory.

Check the antifreeze protection and coolant level at least once a year, at the beginning of the winter season and before traveling to a colder climate.

Checking the engine coolant level

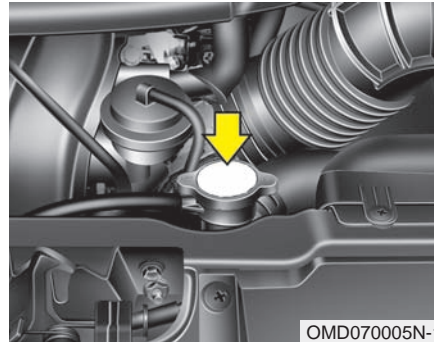

WARNING



Never remove the radiator cap or the drain plug while the engine and radiator are hot. Hot coolant and steam may blow out under pressure, causing serious injury.

(Continued)

(Continued)

Turn the engine off and wait until the engine cools down. Use extreme care when removing the radiator cap. Wrap a thick towel around it, and turn it counterclockwise slowly to the first stop. Step back while the pressure is released from the cooling system. When you are sure all the pressure has been released, press down on the cap, using a thick towel, and continue turning counterclockwise to remove it.

WARNING



The electric motor for the cooling fan may continue to operate or start up when the engine is not running and can cause serious injury. Keep hands, clothing and tools away from the rotating fan blades of the cooling fan.

The electric motor for the cooling fan is controlled by engine coolant temperature, refrigerant pressure and vehicle speed. As the engine coolant temperature decreases, the electric motor will automatically shut off. This is a normal condition. If your vehicle is equipped with GDI, the electric motor for the cooling fan may begin to operate at any time and continue to operate until you disconnect the negative battery cable.

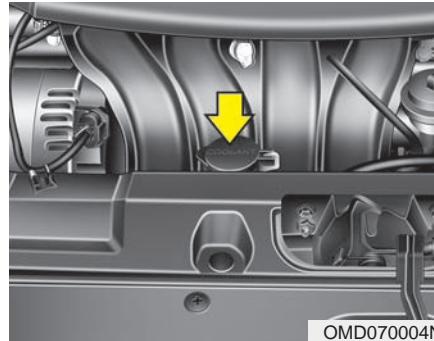

Check the condition and connections of all cooling system hoses and heater hoses. Replace any swollen or deteriorated hoses.

The coolant level should be filled between the F and the L marks on the side of the coolant reservoir when the engine is cool.

If the coolant level is low, add enough distilled (deionized) water to bring the level to the F mark, but do not overfill. If frequent additions are required, we recommend that you see an authorized HYUNDAI dealer for a cooling system inspection.

Recommended engine coolant

- When adding coolant, use only deionized water, distilled water or soft water for your vehicle and never mix hard water in the coolant filled at the factory.
- An improper coolant mixture can result in severe malfunction or engine damage.
- The engine in your vehicle has aluminum engine parts and must be protected by an ethylene-glycol-based coolant to prevent corrosion and freezing.
- Do not use alcohol or methanol coolant or mix them with the specified coolant.
- Do not use a solution that contains more than 60% antifreeze or less than 35% antifreeze, which would reduce the effectiveness of the solution.

For mixing percentage, refer to the following table:

| Ambient Temperature | Mixture Percentage (volume) | |
|---------------------|-----------------------------|-------|
| | Antifreeze | Water |
| 5°F (-15°C) | 35 | 65 |
| -13°F (-25°C) | 40 | 60 |
| -31°F (-35°C) | 50 | 50 |
| -49°F (-45°C) | 60 | 40 |

* NOTICE

If in doubt about the mix ratio, a 50% water and 50% antifreeze mix is the easiest to mix together as it will be the same quantity of each. It is suitable to use for most temperature ranges of -31°F and higher.

Changing engine coolant

Have coolant changed by an authorized HYUNDAI dealer according to the Maintenance Schedule at the beginning of this chapter.

WARNING

- Do not use engine coolant or antifreeze in the washer fluid reservoir.
- Engine coolant can severely obscure visibility when sprayed on the windshield and may cause loss of vehicle control resulting in an accident.
- Engine coolant may also cause damage to paint and body trim.



CAUTION

To prevent damage to engine parts, put a thick towel around the radiator cap before refilling the coolant to prevent the coolant from overflowing into engine parts, such as the generator.

BRAKE/CLUTCH FLUID

Checking the brake/clutch fluid level

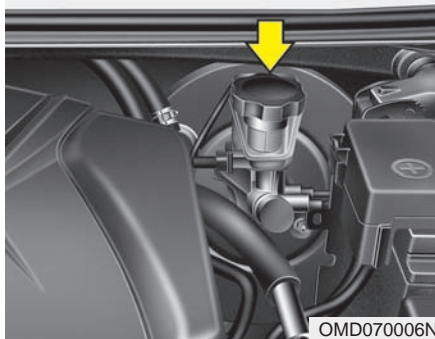

Check the fluid level in the reservoir periodically. The fluid level should be between MAX and MIN marks on the side of the reservoir.

Before removing the reservoir cap and adding brake/clutch fluid, clean the area around the reservoir cap thoroughly to prevent brake/clutch fluid contamination.

If the level is low, add the specified brake/clutch fluid to the MAX level. The level will fall with accumulated mileage.

This is a normal condition associated with the wear of the brake linings. If the fluid level is excessively low, have the brake/clutch system checked by an authorized HYUNDAI dealer.

⚠ WARNING

If the brake/clutch system requires frequent additions of fluid this could indicate a leak in the brake/clutch system. Have the vehicle inspected by an authorized HYUNDAI dealer.

⚠ WARNING

Do not allow brake/clutch fluid to come in contact with your eyes. If brake/clutch fluid comes in contact with your eyes, flush your eyes with clean water for at least 15 minutes and get immediate medical attention.

⚠ CAUTION

- **Do not allow brake/clutch fluid to contact the vehicle's body paint, as paint damage will result.**
- **brake/clutch fluid, which has been exposed to open air for an extended time should NEVER be used as its quality cannot be guaranteed. It should be disposed of properly.**
- **Do not use the wrong kind of brake/clutch fluid. A few drops of mineral based oil, such as engine oil, in your brake/clutch system can damage brake/clutch system parts.**

*** NOTICE**

Use only the specified brake/clutch fluid (refer to "Recommended Lubricants and Capacities" in chapter 8).

WASHER FLUID

Checking the washer fluid level

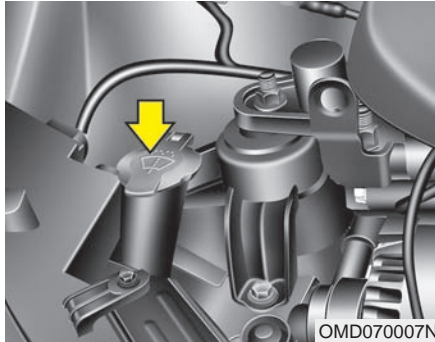

Check the fluid level in the washer fluid reservoir and add fluid if necessary. Plain water may be used if washer fluid is not available. However, use washer solvent with antifreeze characteristics in cold climates to prevent freezing.

CAUTION

To prevent serious injury or death, take the following safety precautions when using washer fluid:

- *Do not use engine coolant or antifreeze in the washer fluid reservoir.*
Engine coolant can severely obscure visibility when sprayed on the windshield and may cause loss of vehicle control resulting in an accident or damage to paint and body trim.
- *Do not allow sparks or flame to contact the washer fluid or the washer fluid reservoir. Washer fluid may contain alcohol and can be flammable.*
- *Do not drink washer fluid and avoid contact with skin. Washer fluid is poisonous to humans and animals.*
- *Keep washer fluid away from children and animals.*

PARKING BRAKE

Checking the parking brake

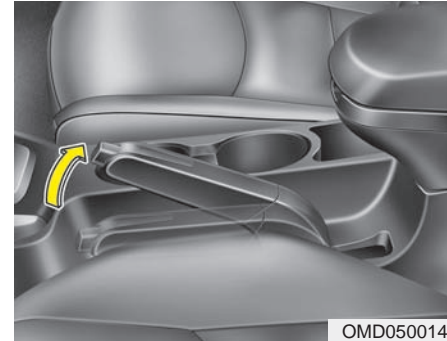

Check the stroke of the parking brake by counting the number of “clicks” heard while fully applying it from the released position. Also, the parking brake alone should securely hold the vehicle on a fairly steep grade. If the stroke is more or less than specified, have the parking brake adjusted by an authorized HYUNDAI dealer.

Stroke : 6 clicks at a force of 44 lbs (20 kg, 196 N)

AIR CLEANER

Filter replacement

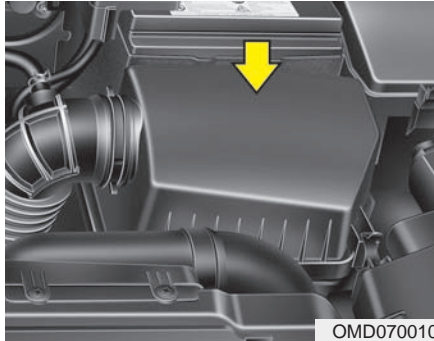

The air cleaner filter can be cleaned for inspection using compressed air. Do not attempt to wash or to rinse it, as water will damage the filter. If soiled, the air cleaner filter must be replaced.

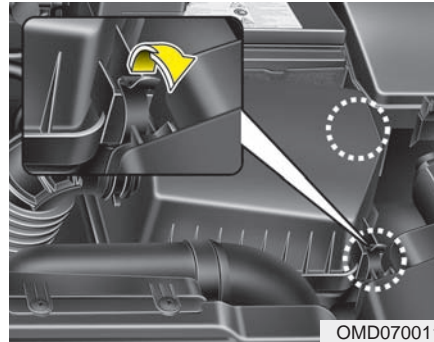

1. Loosen the air cleaner cover attaching clips and open the cover.
2. Wipe the inside of the air cleaner.

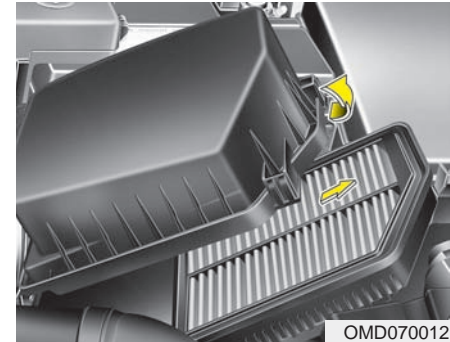

3. Replace the air cleaner filter.
4. Lock the cover with the cover attaching clips.

Replace the filter according to the Maintenance Schedule

* NOTICE

If the vehicle is operated in extremely dusty or sandy areas, replace the element more often than the usual recommended intervals (refer to “Maintenance Under Severe Usage Conditions” in this chapter).

CAUTION

- *Do not drive with the air cleaner filter removed. This will result in excessive engine wear.*
- *When removing the air cleaner filter, be careful that dust or dirt does not enter the air intake, or damage may result.*
- *Use HYUNDAI genuine parts, use of non-genuine parts could damage the air flow sensor.*

CLIMATE CONTROL AIR CLEANER

Filter inspection

The climate control air filter should be replaced according to the Maintenance Schedule. If the vehicle is operated in severely air-polluted cities or on dusty rough roads for a long period, it should be inspected more frequently and replaced earlier. When you replace the climate control air filter, replace it performing the following procedure, and be careful to avoid damaging other components.

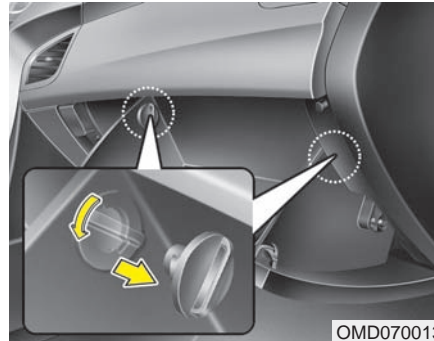

1. With the glove box open, remove the stoppers on both sides to allow the glove box to hang freely on the hinges.
2. Remove the support rod.

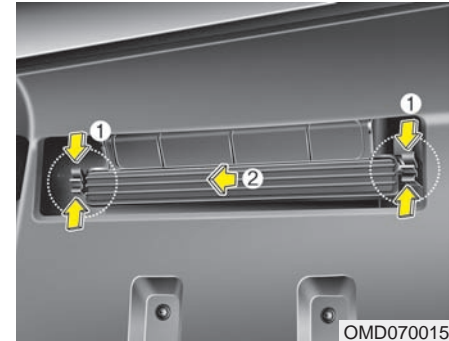

3. Remove the climate control air filter case by pulling out both sides of the cover.

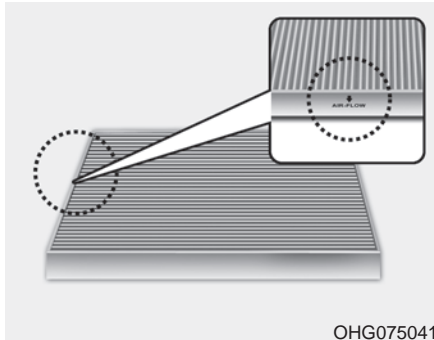

OHG075041

4. Replace the climate control air filter.
5. Reassemble in the reverse order of disassembly.

*** NOTICE**

Install a new climate control air filter in the correct direction with the arrow symbol (↓) facing downwards.

Otherwise, the climate control effects may decrease, possibly with a noise.

WIPER BLADES

Blade inspection

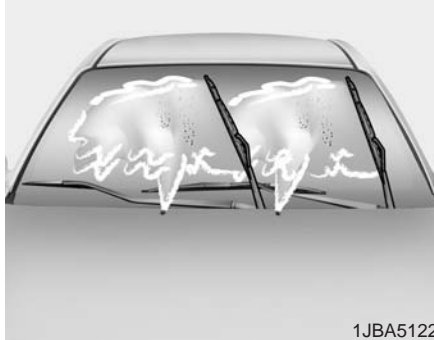

1JBA5122

Contamination of either the windshield or the wiper blades with foreign matter can reduce the effectiveness of the windshield wipers. Common sources of contamination are insects, tree sap, and hot wax treatments used by some commercial car washes. If the blades are not wiping properly, clean both the window and the blades with a clean cloth dampened with washer fluid.

CAUTION

To prevent damage to the wiper blades, arms or other components, do not:

- *Use gasoline, kerosene, paint thinner, or other solvents on or near them.*
- *Attempt to move the wipers manually.*
- *Use non-specified wiper blades.*

* NOTICE

Commercial hot waxes applied by automatic car washes have been known to make the windshield difficult to clean.

Blade replacement

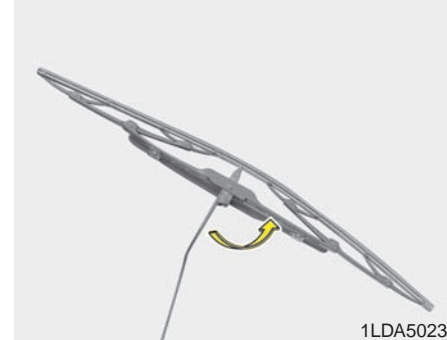

1LDA5023

■ Type A

1. Raise the wiper arm and slightly rotate the wiper blade assembly to expose the plastic locking clip.

CAUTION

Do not allow the wiper arm to fall against the windshield, since it may chip or crack the windshield.

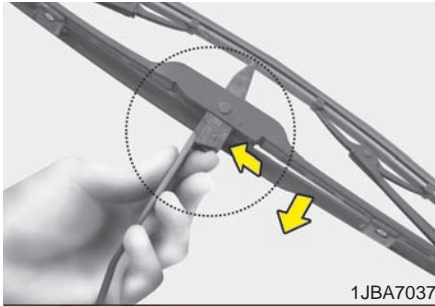

1JBA7037

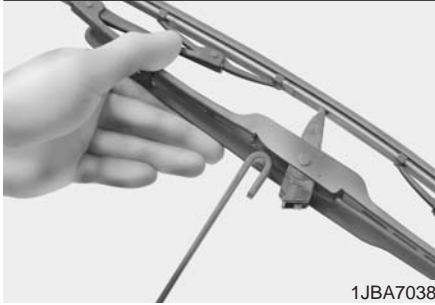

1JBA7038

2. Press the clip (1) and slide the blade assembly downward (2).
3. Lift it off the arm.
4. Install the blade assembly in the reverse order of removal.
5. Return the wiper arm on the windshield.



OHM078059

■ Type B

1. Raise the wiper arm.

⚠ CAUTION

Do not allow the wiper arm to fall against the windshield, since it may chip or crack the windshield.

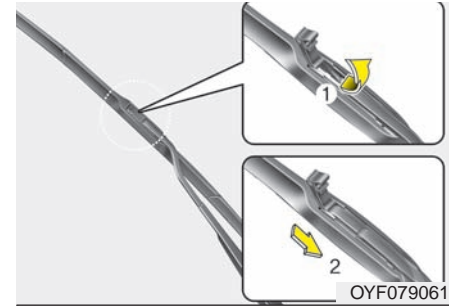

OYF079061

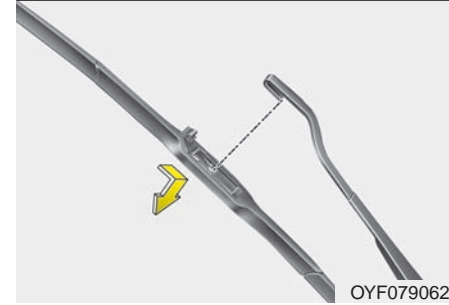

OYF079062

2. Lift up the wiper blade clip (1). Then pull down the blade assembly (2) and remove it.
3. Install the new blade assembly in the reverse order of removal.
4. Return the wiper arm on the windshield.

BATTERY

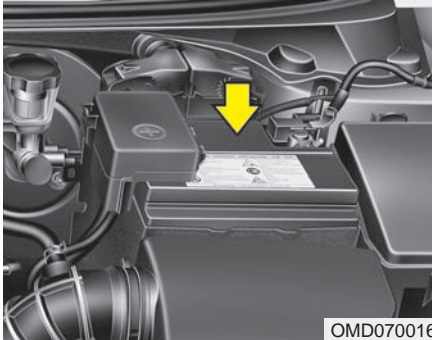

Jump starting can be dangerous if done incorrectly. Follow the jump starting procedure in this section to avoid serious injury or damage to your vehicle. If in doubt about how to properly jump start your vehicle, we strongly recommend that you have a service technician or towing service do it for you.

WARNING

To prevent **SERIOUS INJURY** or **DEATH** to you or bystanders, always follow these precautions when working near or handling the battery:



Always read and follow instructions carefully when handling a battery.



Wear eye protection designed to protect the eyes from acid splashes.



Keep all flames, sparks, or smoking materials away from the battery.



Hydrogen is always present in battery cells, is highly combustible, and may explode if ignited.



Keep batteries out of reach of children.

(Continued)

(Continued)



Batteries contain sulfuric acid which is highly corrosive. Do not allow acid to contact your eyes, skin or clothing.

If acid gets into your eyes, flush your eyes with clean water for at least 15 minutes and get immediate medical attention. If acid gets on your skin, thoroughly wash the area. If you feel pain or a burning sensation, get medical attention immediately.

- When lifting a plastic-cased battery, excessive pressure on the case may cause battery acid to leak. Lift with a battery carrier or with your hands on opposite corners.
- Do not attempt to jump start your vehicle if your battery is frozen.

(Continued)

(Continued)

- **NEVER** attempt to recharge the battery when the vehicle's battery cables are connected to the battery.
- The electrical ignition system works with high voltage. **NEVER** touch these components with the engine running or when the ignition switch is in the ON position.

 **WARNING - CALIFORNIA PROPOSITION 65 WARNING**

Battery posts, terminals, and related accessories contain lead and lead compounds, chemicals known to the State of California to cause cancer, birth defects and reproductive harm. Batteries also contain other chemicals known to the State of California to cause cancer. Wash hands after handling.

 **CAUTION**

- *When you do not use the vehicle for a long time in a low temperature area, disconnect the battery and keep it indoors.*
- *Always charge the battery fully to prevent battery case damage in low temperature areas.*

For best battery service

- Keep the battery securely mounted.
- Keep the battery top clean and dry.
- Keep the terminals and connections clean, tight, and coated with petroleum jelly or terminal grease.
- Rinse any spilled acid from the battery immediately with a solution of water and baking soda.

Battery recharging

By battery charger

Your vehicle has a maintenance-free, calcium-based battery.

- If the battery becomes discharged in a short time (because, for example, the headlights or interior lights were left on while the vehicle was not in use), recharge it by slow charging (trickle) for 10 hours.
- If the battery gradually discharges because of high electric load while the vehicle is being used, recharge it at 20-30A for two hours.

⚠ WARNING

Always follow these instructions when recharging your vehicle's battery to avoid the risk of **SERIOUS INJURY** or **DEATH** from explosions or acid burns:

- Before performing maintenance or recharging the battery, turn off all accessories and place the ignition switch in the LOCK/OFF position.
- Keep all flames, sparks, or smoking materials away from the battery.
- Always work outdoors or in an area with plenty of ventilation.
- Wear eye protection when checking the battery during charging.
- The battery must be removed from the vehicle and placed in a well ventilated area.

(Continued)

(Continued)

- Watch the battery during charging, and stop or reduce the charging rate if the battery cells begin boiling violently.
- The negative battery cable must be removed first and installed last when the battery is disconnected. Disconnect the battery charger in the following order:
 - (1) Turn off the battery charger main switch.
 - (2) Unhook the negative clamp from the negative battery terminal.
 - (3) Unhook the positive clamp from the positive battery terminal.
- Always use a genuine HYUNDAI approved battery when you replace the battery.

By jump starting

After a jump start from a good battery, drive the vehicle for 20-30 minutes before it is shutoff. The vehicle may not restart if you shut it off before the battery had a chance to adequately recharge. See “Jump Starting” in chapter 6 for more information on jump starting procedures.

*** NOTICE**



An inappropriately disposed battery can be harmful to the environment and human health. Dispose the battery according to your local law(s) or regulation.

Reset features

Some items need to be reset after the battery has been discharged or the battery has been disconnected. See chapter 4 for:

- Auto up/down window
- Sunroof
- Trip computer
- Climate control system
- Clock
- Audio system

TIRES AND WHEELS

⚠ WARNING

Tire failure may cause loss of vehicle control resulting in an accident. To reduce risk of **SERIOUS INJURY** or **DEATH**, take the following precautions:

- Inspect your tires monthly for proper inflation as well as wear and damage.
- The recommended cold tire pressure for your vehicle can be found in this manual and on the tire label located on the driver's side center pillar. Always use a tire pressure gauge to measure tire pressure. Tires with too much or too little pressure wear unevenly causing poor handling.
- Check the pressure of the spare (if equipped) every time you check the pressure of the other tires on your vehicle.

(Continued)

(Continued)

- Replace tires that are worn, show uneven wear, or are damaged. Worn tires can cause loss of braking effectiveness, steering) control, or traction.
- **ALWAYS** replace tires with the same size as each tire that was originally supplied with this vehicle. Using tires and wheels other than the recommended sizes could cause unusual handling characteristics, poor vehicle control, or negatively affect your vehicle's Anti-Lock Brake System (ABS) resulting in a serious accident.

Tire care

For proper maintenance, safety, and maximum fuel economy, you must always maintain recommended tire inflation pressures and stay within the load limits and weight distribution recommended for your vehicle.

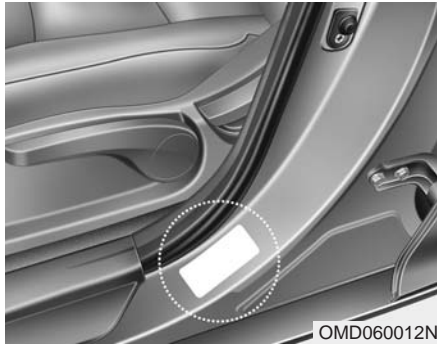

All specifications (sizes and pressures) can be found on a label attached to the driver's side center pillar

Recommended cold tire inflation pressures

All tire pressures (including the spare) should be checked when the tires are cold. "Cold tires" means the vehicle has not been driven for at least three hours or driven less than one mile (1.6 km).

Warm tires normally exceed recommended cold tire pressures by 4 to 6 psi (28 to 41 kPa). Do not release air from warm tires to adjust the pressure or the tires will be under-inflated. For recommended inflation pressure, refer to "Tire and Wheels" in chapter 8.

⚠ WARNING

Recommended pressures must be maintained for the best ride, vehicle handling, and minimum tire wear.

Over-inflation or under-inflation can reduce tire life, adversely affect vehicle handling, and lead to sudden tire failure that could result in loss of vehicle control resulting in an accident.

Severe under-inflation can lead to severe heat build-up, causing blowouts, tread separation and other tire failures that can result in the loss of vehicle control resulting in an accident. This risk is much higher on hot days and when driving for long periods at high speeds.

 **CAUTION**

Under-inflation results in excessive wear, poor handling and reduced fuel economy. Wheel deformation is also possible. Keep your tire pressures at the proper levels. If a tire frequently needs refilling, have it checked by an authorized HYUNDAI dealer.

Over-inflation produces a harsh ride, excessive wear at the center of the tire tread, and a greater possibility of damage from road hazards.

Check tire inflation pressure

Check your tires, including the spare tire, once a month or more.

How to check

Use a good quality tire pressure gauge to check tire pressure. You can not tell if your tires are properly inflated simply by looking at them. Radial tires may look properly inflated when they are under-inflated.

Remove the valve cap from the tire valve stem. Press the tire gauge firmly onto the valve to get a pressure measurement. If the cold tire inflation pressure matches the recommended pressure on the tire and loading information label, no further adjustment is necessary. If the pressure is low, add air until you reach the recommended pressure. Make sure to put the valve caps back on the valve stems. Without the valve cap, dirt or moisture could get into the valve core and cause air leakage. If a valve cap is missing, install a new one as soon as possible.

If you overfill the tire, release air by pushing on the metal stem in the center of the tire valve. Recheck the tire pressure with the tire gauge. Be sure to put the valve caps back on the valve stems. Without the valve cap, dirt or moisture could get into the valve core and cause air leakage. If a valve cap is missing, install a new one as soon as possible.

Tire rotation

To equalize tread wear, HYUNDAI recommends that the tires be rotated every 7,500 miles (12,000 km) or sooner if irregular wear develops.

During rotation, check the tires for correct balance.

When rotating tires, check for uneven wear and damage. Abnormal wear is usually caused by incorrect tire pressure, improper wheel alignment, out-of-balance wheels, severe braking or severe cornering. Look for bumps or bulges in the tread or side of tire. Replace the tire if you find either of these conditions. Replace the tire if fabric or cord is visible. After rotation, be sure to bring the front and rear tire pressures to specification and check lug nut tightness (proper torque is 65-79 lb.ft [9-11 kg.m]).

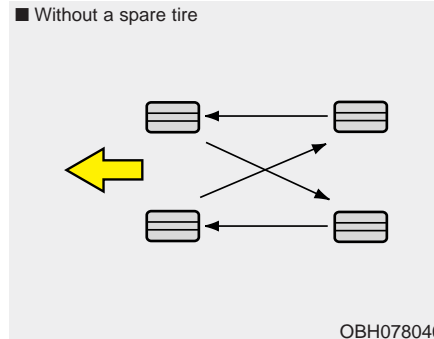

Disc brake pads should be inspected for wear whenever tires are rotated.

* NOTICE

Rotate radial tires that have an asymmetric tread pattern only from front to rear and not from right to left.

⚠ WARNING

- Do not use the compact spare tire for tire rotation.
- Do not mix bias ply and radial ply tires under any circumstances. This may cause unusual handling characteristics that may cause loss of vehicle control resulting in an accident.

Wheel alignment and tire balance

The wheels on your vehicle were aligned and balanced carefully at the factory to give you the longest tire life and best overall performance.

In most cases, you will not need to have your wheels aligned again. However, if you notice unusual tire wear or your vehicle pulling one way or the other, the alignment may need to be reset.

If you notice your vehicle vibrating when driving on a smooth road, your wheels may need to be rebalanced.

CAUTION

Improper wheel weights can damage your vehicle's aluminum wheels. Use only approved wheel weights.

Tire replacement

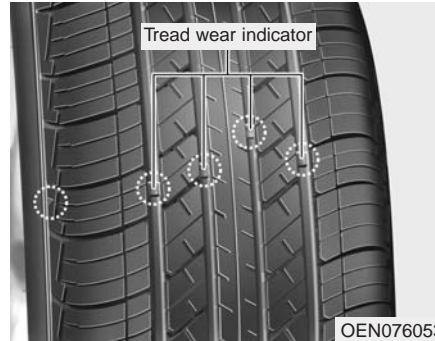

If the tire is worn evenly, a tread wear indicator will appear as a solid band across the tread. This shows there is less than 1/16 inch (1.6 mm) of tread left on the tire. Replace the tire when this happens.

Do not wait for the band to appear across the entire tread before replacing the tire.

WARNING

To reduce the risk of DEATH or SERIOUS INJURY:

Replace tires that are worn, show uneven wear, or are damaged. Worn tires can cause loss of braking effectiveness, steering control, and traction.

Always replace tires with the same size as each tire that was originally supplied with this vehicle. Using tires and wheels other than the recommended sizes could cause unusual handling characteristics, poor vehicle control, or negatively affect your vehicle's Anti-Lock Brake System (ABS) resulting in a serious accident.

Tires degrade over time, even when they are not being used. Regardless of the remaining tread, HYUNDAI recommends that tires be replaced after six (6) years of normal service.

(Continued)

(Continued)

Heat caused by hot climates or frequent high loading conditions can accelerate the aging process. Failure to follow this warning may cause sudden tire failure, which could lead to a loss of vehicle control resulting in an accident.

Compact spare tire replacement

A compact spare tire has a shorter tread life than a regular size tire. Replace it when you can see the tread wear indicator bars on the tire. The replacement compact spare tire should be the same size and design tire as the one provided with your new vehicle and should be mounted on the same compact spare tire wheel. The compact spare tire is not designed to be mounted on a regular size wheel, and the compact spare tire wheel is not designed for mounting a regular size tire.

⚠ WARNING

The original tire should be repaired or replaced as soon as possible to avoid failure of the spare and loss of vehicle control resulting in an accident. The compact spare tire is for emergency use only. Do not operate your vehicle over 50 mph (80 km/h) when using the compact spare tire.

Wheel replacement

When replacing the metal wheels for any reason, make sure the new wheels are equivalent to the original factory units in diameter, rim width and offset.

Tire traction

Tire traction can be reduced if you drive on worn tires, tires that are improperly inflated or on slippery road surfaces. Tires should be replaced when tread wear indicators appear. To reduce the possibility of losing control, slow down whenever there is rain, snow or ice on the road.

Tire maintenance

In addition to proper inflation, correct wheel alignment helps to decrease tire wear. If you find a tire is worn unevenly, have your dealer check the wheel alignment.

When you have new tires installed, make sure they are balanced. This will increase vehicle ride comfort and tire life. Additionally, a tire should always be rebalanced if it is removed from the wheel.

Tire sidewall labeling

This information identifies and describes the fundamental characteristics of the tire and also provides the tire identification number (TIN) for safety standard certification. The TIN can be used to identify the tire in case of a recall.

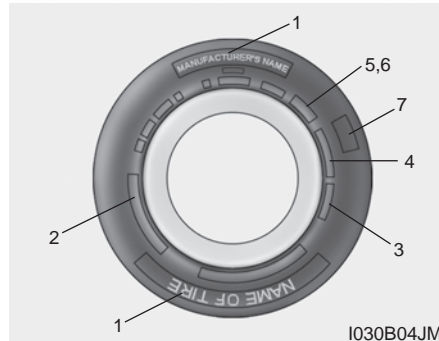

1. Manufacturer or brand name

Manufacturer or brand name is shown.

2. Tire size designation

A tire's sidewall is marked with a tire size designation. You will need this information when selecting replacement tires for your car. The following explains what the letters and numbers in the tire size designation mean.

Example tire size designation:

(These numbers are provided as an example only; your tire size designator could vary depending on your vehicle.)

P195/65R15 94H

P - Applicable vehicle type (tires marked with the prefix "P" are intended for use on passenger cars or light trucks; however, not all tires have this marking).

195 - Tire width in millimeters.

65 - Aspect ratio. The tire's section height as a percentage of its width.

R - Tire construction code (Radial).

15 - Rim diameter in inches.

94 - Load Index, a numerical code associated with the maximum load the tire can carry.

H - Speed Rating Symbol. See the speed rating chart in this section for additional information.

Wheel size designation

Wheels are also marked with important information that you need if you ever have to replace one. The following explains what the letters and numbers in the wheel size designation mean.

Example wheel size designation:

6.0JX15

6.0 - Rim width in inches.

J - Rim contour designation.

15 - Rim diameter in inches.

Tire speed ratings

The chart below lists many of the different speed ratings currently being used for passenger car tires. The speed rating is part of the tire size designation on the sidewall of the tire. This symbol corresponds to that tire's designed maximum safe operating speed.

| Speed Rating Symbol | Maximum Speed |
|---------------------|--------------------------|
| S | 112 mph (180 km/h) |
| T | 118 mph (190 km/h) |
| H | 130 mph (210 km/h) |
| V | 149 mph (240 km/h) |
| Z | Above 149 mph (240 km/h) |

3. Checking tire life (TIN : Tire Identification Number)

Any tires that are over six years old, based on the manufacturing date, (including the spare tire) should be replaced by new ones. You can find the manufacturing date on the tire sidewall (possibly on the inside of the wheel), displaying the DOT Code. The DOT Code is a series of numbers on a tire consisting of numbers and English letters. The manufacturing date is designated by the last four digits (characters) of the DOT code.

DOT : XXXX XXXX OOOO

The front part of the DOT means a plant code number, tire size and tread pattern and the last four numbers indicate week and year manufactured.

For example:

DOT XXXX XXXX 1615 represents that the tire was produced in the 16th week of 2015.

4. Tire ply composition and material

The number of layers or plies of rubber-coated fabric in the tire. Tire manufacturers also must indicate the materials in the tire, which include steel, nylon, polyester, and others. The letter "R" means radial ply construction; the letter "D" means diagonal or bias ply construction; and the letter "B" means belted-bias ply construction.

5. Maximum permissible inflation pressure

This number is the greatest amount of air pressure that should be put in the tire. Do not exceed the maximum permissible inflation pressure. Refer to the Tire and Loading Information label for recommended inflation pressure.

6. Maximum load rating

This number indicates the maximum load in kilograms and pounds that can be carried by the tire. When replacing the tires on the vehicle, always use a tire that has the same load rating as the factory installed tire.

7. Uniform tire quality grading

Quality grades can be found where applicable on the tire sidewall between tread shoulder and maximum section width.

For example:

TREAD wear 200
TRACTION AA
TEMPERATURE A

Tread wear

The tread wear grade is a comparative rating based on the wear rate of the tire when tested under controlled conditions on a specified government test course. For example, a tire graded 150 would wear one-and-a-half times ($1\frac{1}{2}$) as well on the government course as a tire graded 100.

The relative performance of tires depends upon the actual conditions of their use, however, and may depart significantly from the norm due to variations in driving habits, service practices and differences in road characteristics and climate.

These grades are molded on the sidewalls of passenger vehicle tires. The tires available as standard or optional equipment on your vehicle may vary with respect to grade.

Traction - AA, A, B & C

The traction grades, from highest to lowest, are AA, A, B and C. Those grades represent the tire's ability to stop on wet pavement as measured under controlled conditions on specified government test surfaces of asphalt and concrete. A tire marked C may have poor traction performance.

WARNING

The traction grade assigned to this tire is based on straight-ahead braking traction tests, and does not include acceleration, cornering, hydroplaning, or peak traction characteristics.

Temperature - A, B & C

The temperature grades are A (the highest), B and C representing the tire's resistance to the generation of heat and its ability to dissipate heat when tested under controlled conditions on a specified indoor laboratory test wheel.

Sustained high temperature can cause the material of the tire to degenerate and reduce tire life, and excessive temperature can lead to sudden tire failure. Grade C responds to a level of performance which all passenger car tires must meet under the Federal Motor Vehicle Safety Standard No. 109. Grades B and A represent higher levels of performance on the laboratory test wheel than the minimum required by law.

WARNING

The temperature grade for this tire is established for a tire that is properly inflated and not overloaded. Excessive speed, under-inflation, over-inflation, or excessive loading, either separately or in combination, can cause heat build-up and possible sudden tire failure.

This may cause loss of vehicle control resulting in an accident.

Tire terminology and definitions

Air Pressure

The amount of air inside the tire pressing outward on the tire. Air pressure is expressed in pounds per square inch (psi) or kilopascal (kPa).

Accessory Weight

This means the combined weight of optional accessories. Some examples of optional accessories are automatic transaxle, power seats, and air conditioning.

Aspect Ratio

The relationship of a tire's height to its width.

Belt

A rubber coated layer of cords that is located between the plies and the tread. Cords may be made from steel or other reinforcing materials.

Bead

The tire bead contains steel wires wrapped by steel cords that hold the tire onto the rim.

Bias Ply Tire

A pneumatic tire in which the plies are laid at alternate angles less than 90 degrees to the centerline of the tread.

Cold Tire Pressure

The amount of air pressure in a tire, measured in pounds per square inch (psi) or kilopascals (kPa) before a tire has built up heat from driving.

Curb Weight

This means the weight of a motor vehicle with standard and optional equipment including the maximum capacity of fuel, oil and coolant, but without passengers and cargo.

DOT Markings

A code molded into the sidewall of a tire signifying that the tire is in compliance with the U.S. Department of Transportation motor vehicle safety standards. The DOT code includes the Tire Identification Number (TIN), an alphanumeric designator which can also identify the tire manufacturer, production plant, brand and date of production.

GVWR

Gross Vehicle Weight Rating

GAWR FRT

Gross Axle Weight Rating for the Front Axle.

GAWR RR

Gross Axle Weight Rating for the Rear axle.

Intended Outboard Sidewall

The side of an asymmetrical tire, that must always face outward when mounted on a vehicle.

Kilopascal (kPa)

The metric unit for air pressure.

Light truck (LT) tire

A tire designated by its manufacturer as primarily intended for use on light-weight trucks or multipurpose passenger vehicles.

Load ratings

The maximum load that a tire is rated to carry for a given inflation pressure.

Load Index

An assigned number ranging from 1 to 279 that corresponds to the load carrying capacity of a tire.

Maximum Inflation Pressure

The maximum air pressure to which a cold tire may be inflated. The maximum air pressure is molded onto the sidewall.

Maximum Load Rating

The load rating for a tire at the maximum permissible inflation pressure for that tire.

Maximum Loaded Vehicle Weight

The sum of curb weight; accessory weight; vehicle capacity weight; and production options weight.

Normal Occupant Weight

The number of occupants a vehicle is designed to seat multiplied by 150 pounds (68 kg).

Occupant Distribution

Designated seating positions.

Outward Facing Sidewall

An asymmetrical tire has a particular side that faces outward when mounted on a vehicle. The outward facing sidewall bears white lettering or bears manufacturer, brand, and/or model name molding that is higher or deeper than the same moldings on the inner facing sidewall.

Passenger (P-Metric) tire

A tire used on passenger cars and some light duty trucks and multipurpose vehicles.

Ply

A layer of rubber-coated parallel cords

Pneumatic tire

A mechanical device made of rubber, chemicals, fabric and steel or other materials, that, when mounted on an automotive wheel, provides the traction and contains the gas or fluid that sustains the load.

Production options weight

The combined weight of installed regular production options weighing over 2.3 kg (5 lbs.) in excess of the standard items which they replace, not previously considered in curb weight or accessory weight, including heavy duty brakes, ride levelers, roof rack, heavy duty battery, and special trim.

Recommended Inflation Pressure

Vehicle manufacturer's recommended tire inflation pressure as shown on the tire placard.

Radial Ply Tire

A pneumatic tire in which the ply cords that extend to the beads are laid at 90 degrees to the centerline of the tread.

Rim

A metal support for a tire and upon which the tire beads are seated.

Sidewall

The portion of a tire between the tread and the bead.

Speed Rating

An alphanumeric code assigned to a tire indicating the maximum speed at which a tire can operate.

Traction

The friction between the tire and the road surface. The amount of grip provided.

Tread

The portion of a tire that comes into contact with the road.

Treadwear Indicators

Narrow bands, sometimes called "wear bars," that show across the tread of a tire when only 1/16 inch of tread remains.

UTQGS

Uniform Tire Quality Grading Standards is a tire information system that provides consumers with ratings for a tire's traction, temperature and treadwear. Ratings are determined by tire manufacturers using government testing procedures. The ratings are molded into the sidewall of the tire.

Vehicle Capacity Weight

The number of designated seating positions multiplied by 150 lbs. (68 kg) plus the rated cargo and luggage load.

Vehicle Maximum Load on the Tire

Load on an individual tire due to curb and accessory weight plus maximum occupant and cargo weight.

Vehicle Normal Load on the Tire

Load on an individual tire that is determined by distributing to each axle its share of the curb weight, accessory weight, and normal occupant weight and dividing by 2.

Vehicle Placard

A label permanently attached to a vehicle showing the original equipment tire size and recommended inflation pressure.

All season tires

HYUNDAI specifies all season tires on some models to provide good performance for use all year round, including snowy and icy road conditions. All season tires are identified by ALL SEASON and/or M+S (Mud and Snow) on the tire sidewall. Snow tires have better snow traction than all season tires and may be more appropriate in some areas.

Summer tires

HYUNDAI specifies summer tires on some models to provide superior performance on dry roads. Summer tire performance is substantially reduced in snow and ice. Summer tires do not have the tire traction rating M+S (Mud and Snow) on the tire side wall. If you plan to operate your vehicle in snowy or icy conditions, HYUNDAI recommends the use of snow tires or all season tires on all four wheels.

Snow tires

If you equip your car with snow tires, they should be the same size and have the same load capacity as the original tires. Snow tires should be installed on all four wheels; otherwise, poor handling may result. Snow tires should carry 4 psi (28 kPa) more air pressure than the pressure recommended for the standard tires on the tire label on the driver's side of the center pillar, or up to the maximum pressure shown on the tire sidewall, whichever is less. Do not drive faster than 75 mph (120 km/h) when your vehicle is equipped with snow tires.

Radial-ply tires

Radial-ply tires provide improved tread life, road hazard resistance and smoother high speed ride. The radial-ply tires used on this vehicle are of belted construction, and are selected to complement the ride and handling characteristics of your vehicle. Radial-ply tires have the same load carrying capacity, as bias-ply or bias belted tires of the same size, and use the same recommended inflation pressure. Mixing of radial-ply tires with bias-ply or bias belted tires is not recommended. Any combinations of radial-ply and bias-ply or bias belted tires when used on the same vehicle will seriously deteriorate vehicle handling. The best rule to follow is: Identical pairs of radial-ply tires should always be used as a set for the front tires and a set for the rear tires.

Longer wearing tires can be more susceptible to irregular tread wear. It is very important to follow the tire rotation interval in this chapter to achieve the tread life potential of these tires. Cuts and punctures in radial-ply tires are repairable only in the tread area, because of sidewall flexing. Consult your tire dealer for radial-ply tire repairs.

WARNING

Do not mix bias ply and radial ply tires under any circumstances. This may cause unusual handling characteristics that may cause loss of vehicle control resulting in an accident.

Low aspect ratio tires

Low aspect ratio tires, the aspect ratio is lower than 50, are provided for sporty looks.

Because low aspect ratio tires are optimized for handling and braking, it may be more uncomfortable to ride in and there is more noise compare with normal tires.

 **CAUTION**

Because the sidewall of the low aspect ratio tire is shorter than the normal, the wheel and tire of the low aspect ratio tire is easier to be damaged. So, follow the instructions below.

- *When driving on a rough road or off road, drive cautiously because tires and wheels may be damaged. And after driving, inspect tires and wheels.*
- *When passing over a pothole, speed bump, manhole, or curb stone, drive slowly so that the tires and wheels are not damaged.*
- *If the tire is impacted, we recommend that you inspect the tire condition or contact an authorized HYUNDAI dealer.*
- *To prevent damage to the tire, inspect the tire condition and pressure every 2,000 miles (3,000km).*

 **CAUTION**

- *It is not easy to recognize tire damage with your own eyes. But if there is the slightest hint of tire damage, have the tire checked or replaced because the tire damage may cause air leakage from the tire.*
- *If the tire is damaged by driving on a rough road, off road, pothole, manhole, or curb stone, it will not be covered by the warranty.*

FUSES

■ Blade type



Normal



Blown

■ Cartridge type



Normal



Blown

■ Multi fuse

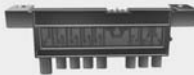

Normal



Blown



Normal



Blown

OLMB073029

A vehicle's electrical system is protected from electrical overload damage by fuses.

This vehicle has 2 (or 3) fuse panels, one located in the driver's side panel bolster, the other in the engine compartment near the battery.

If any of your vehicle's lights, accessories, or controls do not work, check the appropriate circuit fuse. If a fuse has blown, the element inside the fuse will be melted or broken.

If the electrical system does not work, first check the driver's side fuse panel. Before replacing a blown fuse, disconnect the negative battery cable. Always replace a blown fuse with one of the same rating.

If the replacement fuse blows, this indicates an electrical problem. Avoid using the system involved and immediately consult an authorized HYUNDAI dealer.

* NOTICE

Three kinds of fuses are used: blade type for lower amperage rating, cartridge type, and multi fuse for higher amperage ratings.

⚠ WARNING

NEVER replace a fuse with anything but another fuse of the same rating.

- A higher capacity fuse could cause damage and possibly a fire.
- Do not install a wire or aluminum foil instead of the proper fuse - even as a temporary repair. It may cause extensive wiring damage and possibly a fire.

⚠ CAUTION

Do not use a screwdriver or any other metal object to remove fuses because it may cause a short circuit and damage the system.

Instrument panel fuse replacement

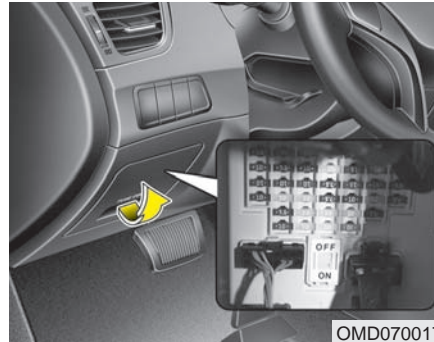

1. Turn the engine off.
2. Turn all other switches OFF.
3. Open the fuse panel cover.
4. Refer to the label on the inside of the fuse panel cover to locate the suspected fuse location

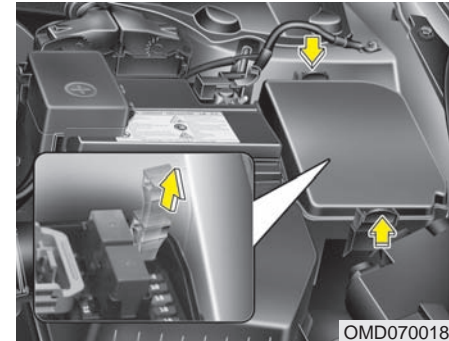

5. Pull the suspected fuse straight out. Use the removal tool provided in the engine compartment fuses panel.
6. Remove and check the suspected fuse; replace it if it is blown. Spare fuses are provided in the instrument panel fuse panels (or in the engine compartment fuse panel).
7. Push in a new fuse of the same rating, and make sure it fits tightly in the clips. If it fits loosely, consult an authorized HYUNDAI dealer.

In an emergency, if you do not have a spare fuse, use a fuse of the same rating from a circuit you may not need for operating the vehicle, such as the cigarette lighter fuse.

If the headlights or other electrical components do not work and the fuses are OK, check the fuse panel in the engine compartment. If a fuse is blown, it must be replaced.

Memory fuse

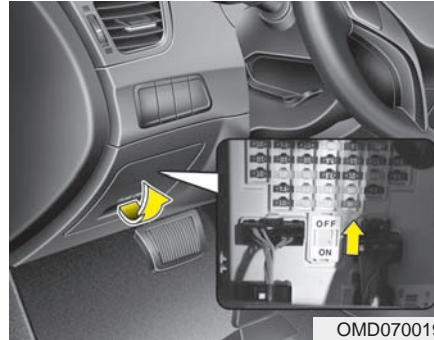

Always, put the fuse switch at the ON position.

If you move the switch to the OFF position, some items such as the audio and digital clock must be reset and the remote key (or smart key) may not work properly.



CAUTION

Always place the fuse switch in the ON position while driving the vehicle.



Engine compartment panel fuse replacement

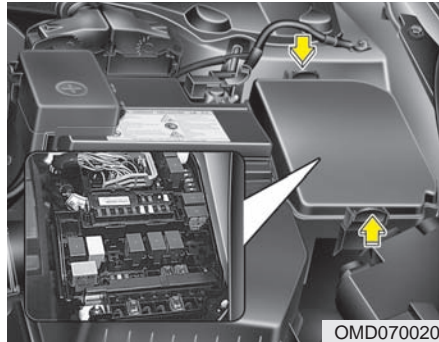

1. Turn the engine off.
2. Turn all other switches OFF.
3. Remove the fuse panel cover by pressing the tap and pulling up.
4. Remove and check the suspected fuse; replace it if it is blown. To remove or insert the fuse, use the fuse puller in the engine compartment fuse panel.
5. Push in a new fuse of the same rating, and make sure it fits tightly in the clips. If it fits loosely, consult an authorized HYUNDAI dealer.

Main fuse

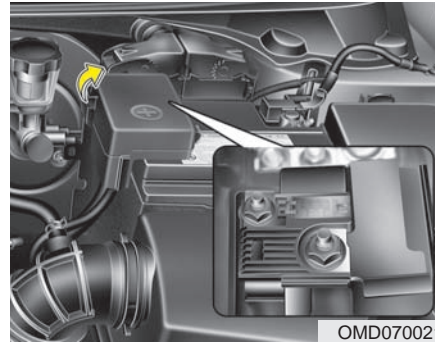

If the main fuse is blown, it must be removed as follows:

1. Turn off the engine.
2. Disconnect the negative battery cable.
3. Remove the fuse panel cover by pressing the tap and pulling it up.
4. Remove the nuts shown in the picture above.
5. Replace the fuse with a new one of the same rating.
6. Reinstall in the reverse order of removal.

* NOTICE

If the main fuse is blown, consult an authorized HYUNDAI dealer.

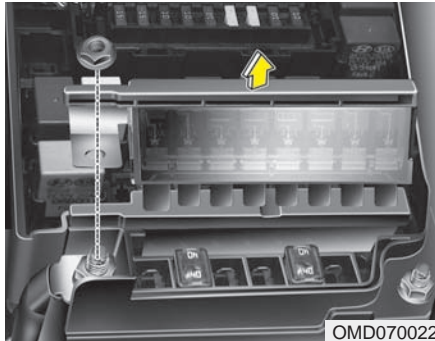
Multi fuse*** NOTICE**

If the multi fuse is blown, consult an authorized HYUNDAI dealer.

If the multi fuse is blown, it must be removed as follows:

1. Turn off the engine.
2. Disconnect the negative battery cable.
3. Remove the fuse panel cover by pressing the tap and pulling up.
4. Remove the bolts shown in the picture above.
5. Replace the fuse with a new one of the same rating.
6. Reinstall in the reverse order of removal.

Fuse/relay panel description
Instrument panel fuse panel



Inside the fuse/relay panel covers, you can find the fuse/relay label describing fuse/relay name and capacity.

*** NOTICE**

Not all fuse panel descriptions in this manual may be applicable to your vehicle. It is accurate at the time of printing. When you inspect the fuse panel in your vehicle, refer to the fuse panel label.

| | | | | | | |
|-------------------------------|-----------------------------|-----------------------------|------------------------------|-----------------------------------|----------------------------|-----------------------------|
| 7.5A START | 15A A/BAG | 7.5A A/BAG IND | 7.5A ¹ CLUSTER | 15A C/LIGHTER | 7.5A BCM | 7.5A A/CON SWITCH |
| ² 7.5A MODULE | 10A MDPS | ⁴ 7.5A MODULE | 20A IG1 | ³ 7.5A PDM | 20A POWER OUTLET FRT | ⁶ 10A MODULE |
| 10A HTD MIRR | ³ 7.5A MODULE | 10A BRAKE SWITCH | 15A SPARE | 15A SUNROOF | 15A SPARE | 15A SPARE |
| 10A BLOWER | 10A INTERIOR LAMP | 10A TRUNK | ¹ 7.5A MODULE | 15A SPARE | 15A S/HEATER RR | ⁷ 7.5A MODULE |
| ² 10A CLUSTER | 15A MULTIMEDIA | 25A P/WDW RH | ² 7.5A PDM | 10A SPARE | 25A WIPER FRT | ⁵ 7.5A MODULE |
| | 7.5A SPARE | 25A AMP | ¹ 25A PDM | 20A SPARE | 7.5A A/CON | |
| | 10A MEMORY | 25A P/WDW LH | 20A DR LOCK | ³ 30A P/SEAT DRV | | |
| USE THE DESIGNATED FUSE ONLY. | | | FUSE SWITCH | P/NO: 91941-3X820 | | |

OMD074063N

Instrument panel (Driver's side fuse panel)

| Fuse Name | Fuse rating | Protected Component |
|------------------|-------------|---|
| START | 7.5A | W/O Smart Key : ICM Relay Box(Burglar Alarm Relay), With Smart Key : A/T - Transaxle Range Switch, M/T - ECM, E/R Fuse & Relay Box(Start 1 Relay), Smart Key Control Module |
| A/BAG | 15A | SRS Control Module, Passenger Weight Classification Sensor |
| A/BAG IND | 7.5A | Instrument Cluster |
| CLUSTER | 7.5A | ISG LDC (Audio), Cluster (ISG) |
| C/LIGHTER | 15A | Cigarette Lighter |
| BCM | 7.5A | Smart Key Control Module, BCM |
| A/CON SWITCH | 7.5A | A/C Control Module |
| MODULE 2 | 7.5A | Electro Chromic Mirror, ESC Off Switch |
| MDPS | 10A | EPS Control Module |
| MODULE 4 | 7.5A | Rear Parking Assist Sensor LH/RH (IN/OUT), A/C Control Module(Auto A/C), ATM Lever Indicator |
| IG1 | 20A | E/R Fuse & Relay Box(Fuse - TCU 1, B/UP LP, ECU 3, ABS 3) |
| PDM 3 | 7.5A | Smart Key Control Module |
| POWER OUTLET FRT | 20A | Power Outlet |
| MODULE 6 | 10A | AMP, Power Outside Mirror Switch, Audio, A/V & Navigation Head Unit, Digital Clock |

Maintenance

| Fuse Name | Fuse rating | Protected Component |
|---------------|-------------|---|
| HTD MIRR | 10A | Driver/Passenger Power Outside Mirror, A/C Control Module |
| MODULE 3 | 7.5A | Audio, Tire Pressure Monitoring Module, Digital Clock, BCM, Instrument Cluster, Driver/Passenger Seat Warmer Module |
| BRAKE SWITCH | 10A | - |
| SPARE | 15A | - |
| SUNROOF | 15A | Sunroof |
| SPARE | 15A | - |
| SPARE | 15A | - |
| BLOWER | 10A | Manual A/C - A/C Control Module, ECM/PCM, Blower Resistor |
| INTERIOR LAMP | 10A | Luggage Lamp, Vanity Lamp LH/RH, Room Lamp, Overhead Console Lamp, Ignition Key Ill. & Door Warning Switch(W/O Smart Key) |
| TRUNK | 10A | Trunk Relay |
| MODULE 1 | 7.5A | Sport Mode Switch(A/T), Key Solenoid(W/O Smart Key) |
| SPARE | 15A | - |
| S/HEATER RR | 15A | Rear Seat Warmer Switch LH/RH |
| MODULE 7 | 7.5A | Smart Key Control Module, BCM |
| MULTIMEDIA | 15A | Audio, A/V & Navigation Head Unit |

| Fuse Name | Fuse rating | Protected Component |
|------------|-------------|---|
| P/WDW RH | 25A | P/WDW RH Relay |
| PDM 2 | 7.5A | Smart Key Control Module, Start Stop Button Switch |
| SPARE | 10A | - |
| WIPER FRT | 25A | ICM Relay Box(Rain Sensor Relay), Multifunction Switch, Wiper Motor, E/R Fuse & Relay Box(Wiper Relay) |
| MODULE 5 | 7.5A | Cluster Ionizer(Auto A/C), Rain Sensor, Sunroof |
| SPARE | 7.5A | - |
| AMP | 25A | AMP |
| PDM 1 | 25A | Smart Key Control Module |
| SPARE | 20A | - |
| A/CON | 7.5A | A/C Control Module, E/R Fuse & Relay Box(Blower Relay) |
| MEMORY | 10A | Tire Pressure Monitoring Module, BCM, Auto Light & Photo Sensor, Instrument Cluster, Data Link Connector, Smart Junction Box Upgrade Connector, Electro Chromic Mirror, A/C Control Module, Digital Clock |
| P/WDW LH | 25A | P/WDW LH Relay, Driver Safety Power Window Module |
| DR LOCK | 20A | Door Lock Relay, Door Unlock Relay, ICM Relay Box(Two Turn Relay) |
| P/SEAT DRV | 30A | Driver Seat Manual Switch |

Engine compartment fuse panel

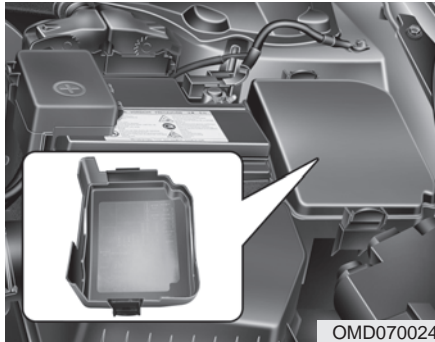

OMD070024

Inside the fuse/relay panel covers, you can find the fuse/relay label describing fuse/relay name and capacity.

*** NOTICE**

Not all fuse panel descriptions in this manual may be applicable to your vehicle. It is accurate at the time of printing. When you inspect the fuse panel in your vehicle, refer to the fuse panel label.

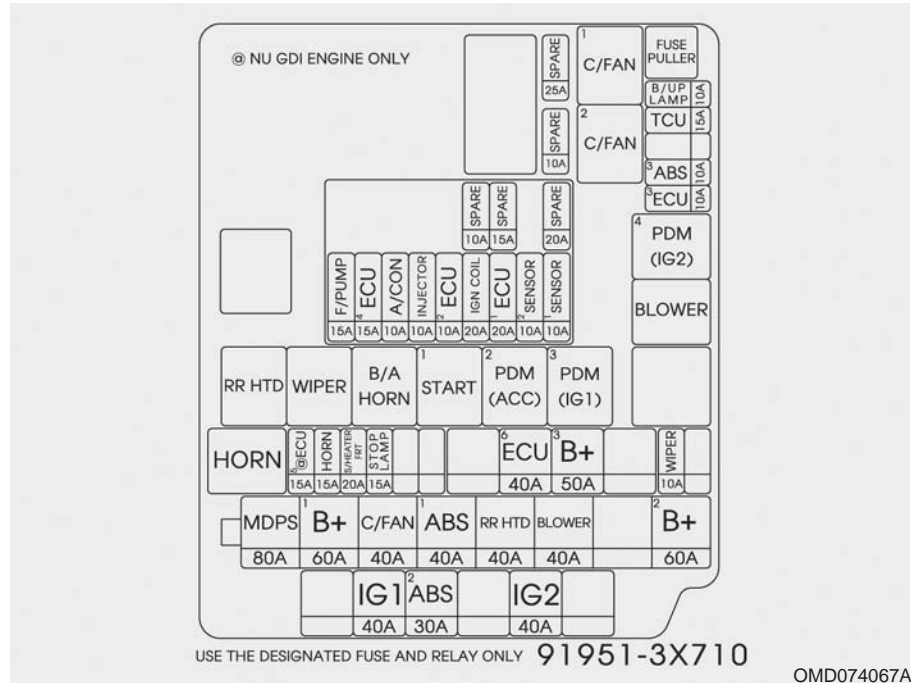

Engine compartment main fuse panel

| Description | | Fuse rating | Protected component |
|---------------|-----------|-------------|--|
| MULTI FUSE | MDPS | 80A | EPS Control Module |
| | B+1 | 60A | Smart Junction Box(ARISU 1 (4CH), IPS 1, FUSE - P/WDW LH, P/WDW RH, TRUNK, AMP 1) |
| | C/FAN | 40A | C/FAN Lo Relay, C/FAN Hi Relay |
| | ABS 1 | 40A | ESC Module, Multipurpose Check Connector |
| | RR HTD | 40A | RR HTD Relay |
| | BLOWER | 40A | Blower Relay |
| | SPARE | 40A | - |
| | B+2 | 60A | Smart Junction Box(Turn Signal Lamp Sound Relay, ARISU 2 (4CH), IPS (1CH), IPS (2CH), FUSE - P/SEAT DRV, SUNROOF) |
| FUSE | B/UP LAMP | 10A | Electro Chromic Mirror, A/V & Navigation Head Unit, Rear Combination Lamp (In) LH/RH, M/T - Back-Up Lamp Switch, BCM, Instrument Cluster |
| | TCU 1 | 15A | M/T - Vehicle Speed Sensor, A/T - Transaxle Range Switch |
| | ABS 3 | 10A | ESC Module, Multipurpose Check Connector |
| | ECU 3 | 10A | Stop Lamp Switch, M/T - ECM, A/T - PCM |
| | WIPER | 10A | Rain Sensor, M/T - ECM, A/T - PCM |
| | B+3 | 50A | Smart Junction Box (Leak Current Autocut Device, FUSE - MODULE 1, PDM 1, PDM 2, DR LOCK) |
| | EMS | 40A | EMS Box(Engine Control Relay, FUSE - ECU 4, A/CON, F/PUMP) |

| Description | | Fuse rating | Protected component |
|-------------|--------------|-------------|--|
| FUSE | ISG INVERTER | 50A | Oil Pump Inverter |
| | STOP LP | 15A | Stop Lamp Switch, Smart Key Control Module |
| | S/HEATER FRT | 20A | Driver/Passenger Seat Warmer Module |
| | HORN | 15A | Horn Relay |
| | IG 2 | 40A | W/O Smart Key : Ignition Switch, Start 1 Relay, With Smart Key : PDM 4 (IG2) Relay, Start 1 Relay |
| | ABS 2 | 30A | ESC Module, Multipurpose Check Connector |
| | IG 1 | 40A | W/O Smart Key : Ignition Switch, With Smart Key : PDM 3 (IG1) Relay, PDM 2 (ACC) Relay |
| | F/PUMP | 15A | F/PUMP Relay |
| | ECU 4 | 15A | PCM (A/T), ECM (M/T) |
| | A/CON | 10A | A/C COMP Relay |
| | INJECTOR | 10A | Injector #1 / #2 / #3 / #4, A/C COMP Relay, F/PUMP Relay |
| | ECU 2 | 10A | PCM (A/T), ECM (M/T) |
| | IGN COIL 1 | 20A | Ignition Coil #1 / #2 / #3 / #4, Condenser |
| | ECU 1 | 20A | - |
| | SENSOR 2 | 10A | Immobilizer Module, Camshaft Position Sensor #1 / #2 |

| Description | | Fuse rating | Protected component |
|-------------|----------|-------------|--|
| FUSE | SENSOR 1 | 10A | Oxygen Sensor (UP/DOWN), Canister Close Valve, Variable Intake Solenoid Valve, Oil Control Valve #1 / #2, Purge Control Solenoid Valve, C/FAN LO Relay, C/FAN HI Relay |
| | SPARE | 10A | - |
| | SPARE | 15A | - |
| | SPARE | 20A | - |

LIGHT BULBS

Consult an authorized HYUNDAI dealer to replace most vehicle light bulbs. It is difficult to replace vehicle light bulbs because other parts of the vehicle must be removed before you can get to the bulb. This is especially true for removing the headlight assembly to get to the bulb(s).

Removing/installing the headlight assembly can result in damage to the vehicle.

* NOTICE

After heavy driving, rain or washing, headlight and taillight lenses could appear frosty. This condition is caused by the temperature difference between the lamp inside and the outside temperature. This is similar to the condensation on your windows inside your vehicle during the rain and doesn't indicate a problem with your vehicle. If the water leaks into the lamp bulb circuitry, have your vehicle checked by an authorized HYUNDAI dealer.

⚠ WARNING

- Prior to replacing a light, depress the foot brake, move the shift lever into P (Park) apply the parking brake, place the ignition switch in the LOCK/OFF position, and take the key with you when leaving the vehicle to avoid sudden movement of the vehicle and to prevent possible electric shock.
- Be aware the bulbs may be hot and may burn your fingers.

Headlight, parking light, turn signal light, side marker and front fog light bulb replacement

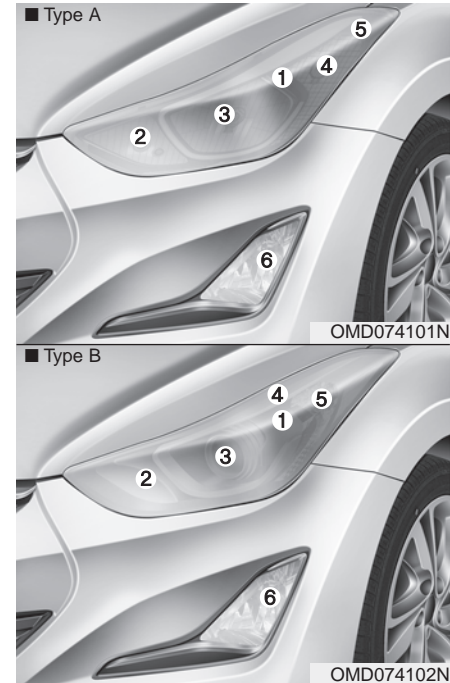

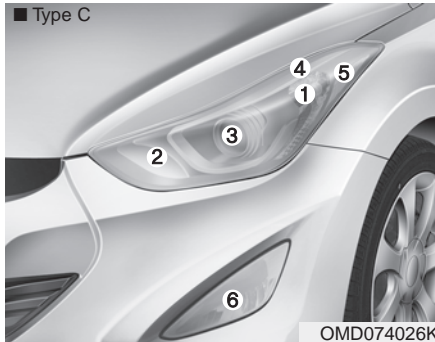

- (1) Turn signal light
- (2) Headlight (High)
- (3) Headlight (Low)
- (4) Parking (Position) light
- (5) Side marker
- (6) Fog light*

* : if equipped

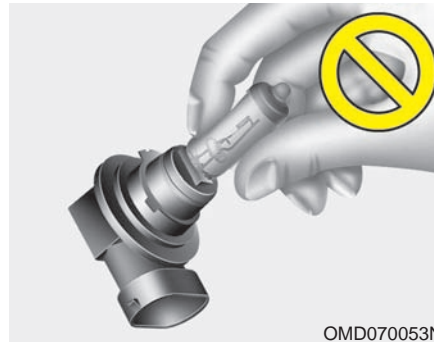

Halogen bulb

⚠ WARNING

- **Handle halogen bulbs with care. Halogen bulbs contain pressurized gas that will produce flying pieces of glass that could cause injuries if broken.**
- **Wear eye protection when changing a bulb. Allow the bulb to cool down before handling it.**

- Always handle them carefully, and avoid scratches and abrasions. If the bulbs are lit, avoid contact with liquids.
- Never touch the glass with bare hands. Residual oil may cause the bulb to overheat and burst when lit.
- A bulb should be operated only when installed in a headlamp.
- If a bulb becomes damaged or cracked, replace it immediately and carefully dispose of it.

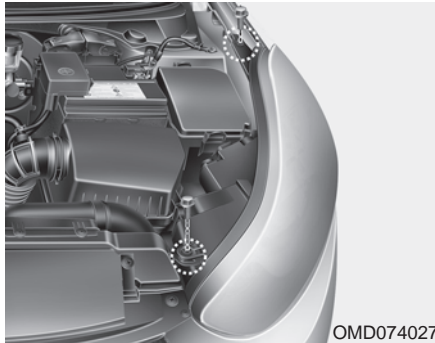

1. Open the hood.
2. Disconnect the negative battery cable.
3. Loosen the screws with a screwdriver.
4. Pull the headlight assembly out to the front of the vehicle.
5. Disconnect the power connector(s) from the back of the headlight assembly.

Headlight bulb (low, high)

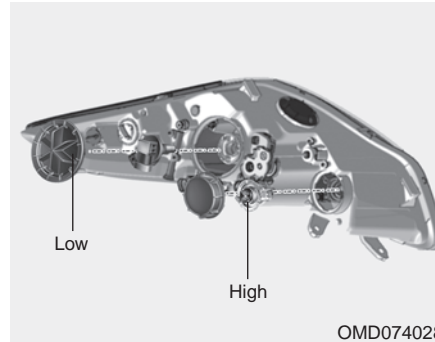

6. Remove the headlight bulb cover by turning it counterclockwise.
7. Disconnect the headlight bulb socket-connector.
8. Unsnap the headlight bulb retaining wire by depressing the end and pushing it upward.
9. Remove the bulb from the headlight assembly.
10. Install a new headlight bulb and snap the headlight bulb retaining wire into position by aligning the wire with the groove on the bulb.

11. Connect the headlight bulb socket-connector.
12. Install the headlight bulb cover by turning it clockwise.

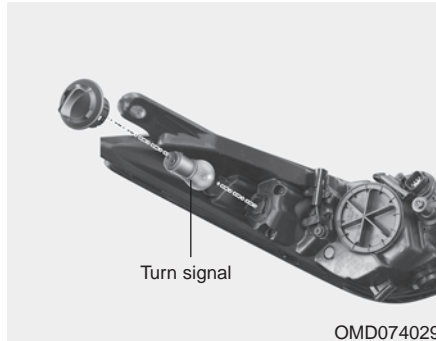
Turn signal light

Follow steps 1 to 5 from the previous page.

6. Remove the socket from the assembly by turning the socket counterclockwise until the tabs on the socket align with the slots on the assembly.
7. Remove the bulb from the socket by pressing it in and rotating it counterclockwise until the tabs on the bulb align with the slots in the socket. Pull the bulb out of the socket

8. Insert a new bulb into the socket and rotating it until it locks into place.
9. Install the socket in the assembly by aligning the tabs on the socket with the slots in the assembly. Push the socket into the assembly and turn the socket clockwise.
10. Reinstall the light assembly to the body of the vehicle.

Parking (Position) light bulbs

If the LED light does not operate, have the vehicle checked by an authorized HYUNDAI dealer.

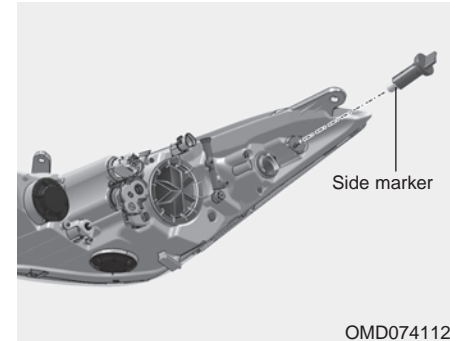
Front side marker

Follow steps 1 to 5 from the previous page.

6. Remove the socket from the assembly by turning the socket counterclockwise until the tabs on the socket align with the slots on the assembly.
7. Remove the bulb from the socket by pulling out the bulb.
8. Insert a new bulb.

9. Install the socket in the assembly by aligning the tabs on the socket with the slots in the assembly. Push the socket into the assembly and turn the socket clockwise.
10. Reinstall the light assembly to the body of the vehicle.

Fog light bulbs

1. Remove the front bumper under cover.
2. Reach your hand into the back of the front bumper.
3. Disconnect the power connector from the socket.
4. Remove the bulb-socket from the housing by turning the socket counter clockwise until the tabs on the socket align with the slots on the housing.
5. Install the new bulb-socket into the housing by aligning the tabs on the socket with the slots in the housing. Push the socket into the housing and turn the socket clockwise.
6. Connect the power connector to the socket.
7. Reinstall the front bumper under cover.

Side repeater light replacement

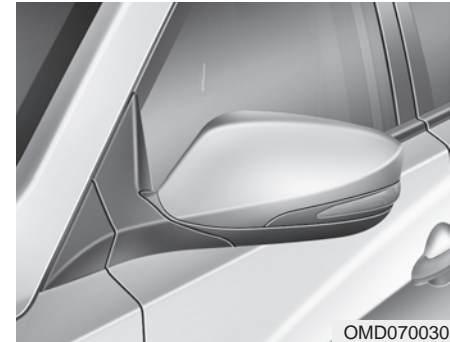

If the LED light does not operate, have the vehicle checked by an authorized HYUNDAI dealer.

Rear combination light bulb replacement

■ Type A

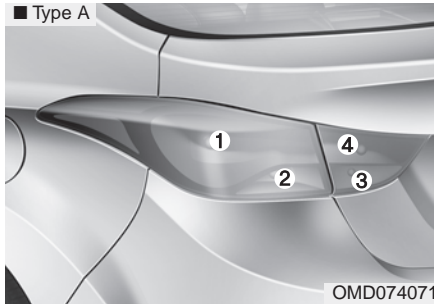

■ Type B

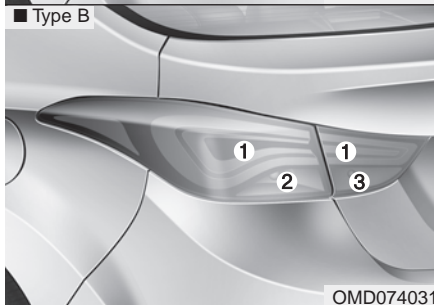

- (1) Stop/Tail light
- (2) Turn signal light
- (3) Back-up light
- (4) Tail light

Outside light

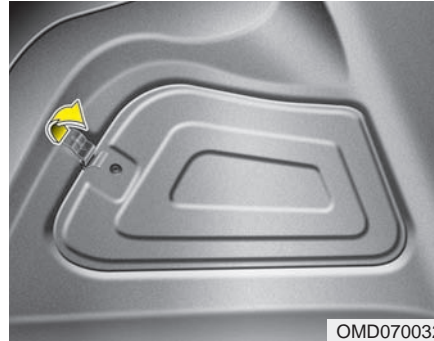

1. Open the trunk lid.
2. Remove the service cover by pulling out the service cover.

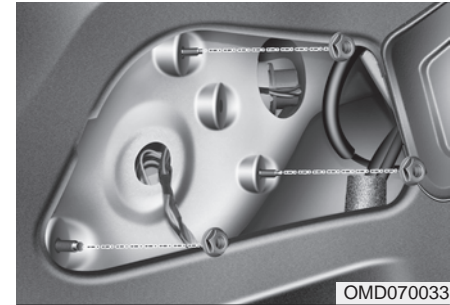

3. Loosen the assembly retaining nuts.
4. Remove the rear combination light assembly from the body of the vehicle.

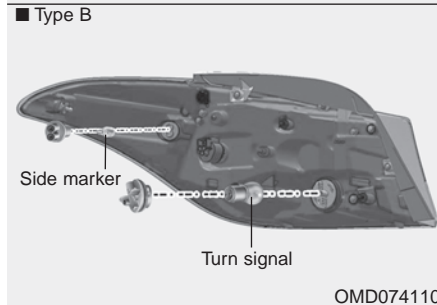
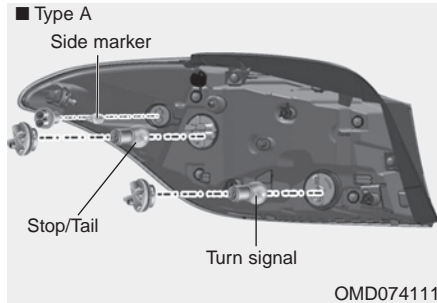

Stop/Tail light and turn signal light

5. Remove the socket from the assembly by turning the socket counterclockwise until the tabs on the socket align with the slots on the assembly.

6. Remove the bulb from the socket by pressing it in and rotating it counterclockwise until the tabs on the bulb align with the slots in the socket. Pull the bulb out of the socket.
7. Insert a new bulb by inserting it into the socket and rotating it until it locks into place.
8. Install the socket in the assembly by aligning the tabs on the socket with the slots in the assembly. Push the socket into the assembly and turn the socket clockwise.

Stop/Tail light (Type B)

If the LED light does not operate, have the vehicle checked by an authorized HYUNDAI dealer.

Side marker

5. Remove the socket from the assembly by turning the socket counterclockwise until the tabs on the socket align with the slots on the assembly.
6. Remove the bulb by pulling it out.
7. Inset a new bulb by inseting it into the socket.
8. Install the socket in the assembly by aligning the tabs on the socket with the slots in the assembly. Push the socket into the assembly and turn the socket clockwise.

Inside light

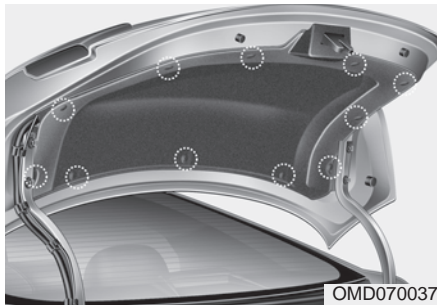

1. Open the trunk.
2. Loosen the retaining screw of the trunk lid cover and then remove the cover.

3. Disconnect the connector and then remove the nuts by turning the nuts counter clockwise.

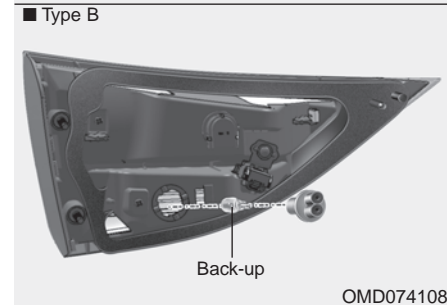
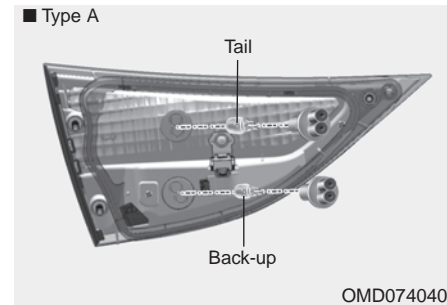

4. Take the light assembly out.
5. Remove the socket from the assembly by turning the socket counterclockwise until the tabs on the socket align with the slots on the assembly.
6. Remove the bulb by pulling it out.

7. Insert a new bulb by inserting it into the socket.
8. Install the light assembly to the trunk.
9. Reinstall the nuts and connector and then the trunk lid cover by pushing in the screw.

Stop/Tail light (Type B)

If the LED light does not operate, have the vehicle checked by an authorized HYUNDAI dealer.

High mounted stop light replacement

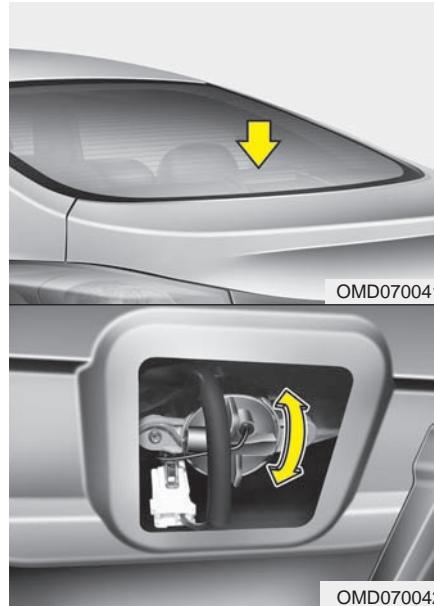

1. Open the trunk.
2. Remove the socket by turning it counterclockwise until the tabs on the socket align with the slots.

3. Remove the bulb from the socket by pressing it in and rotating it counterclockwise until the tabs on the bulb align with the slots in the socket. Pull the bulb out of the socket.
4. Insert a new bulb by inserting it into the socket and rotating it until it locks into place.
5. Install the socket in the assembly by aligning the tabs on the socket with the slots in the assembly. Push the socket into the assembly and turn the socket clockwise.

License plate light bulb replacement

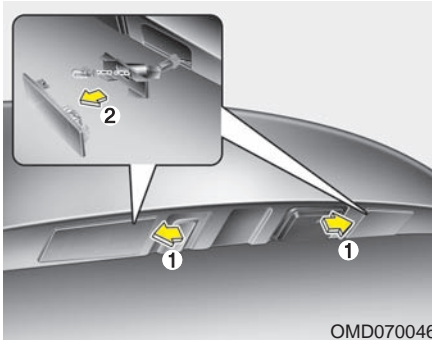

OMD070046

1. Remove the cover by pressing it as direction of the arrows.
2. Remove the bulb by pulling it straight out.
3. Install a new bulb.
4. Reinstall in the reverse order.

Interior light bulb replacement

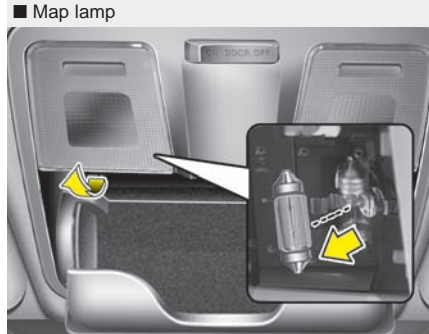

■ Map lamp

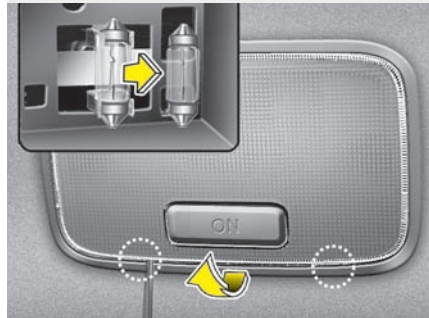

OMD070044/OMD070043

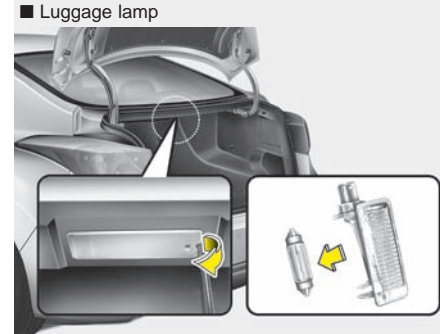

■ Luggage lamp

■ Vanity mirror lamp

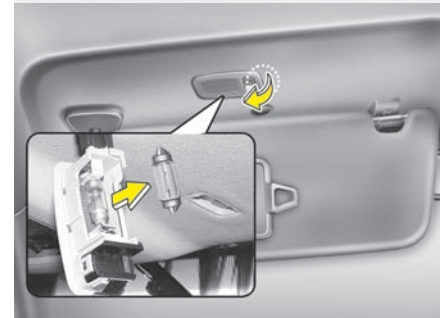

OMD070045/OTD079035

1. Using a flat-blade screwdriver, gently pry the lens from the interior lamp housing.
2. Remove the bulb by pulling it straight out.
3. Install a new bulb in the socket.
4. Align the lens tabs with the interior lamp housing notches and snap the lens into place.

⚠ WARNING

Use care not to dirty or damage lenses, lens tabs, and plastic housings.



APPEARANCE CARE

Exterior care

Exterior general caution

It is very important to follow the label directions when using any chemical cleaner or polish. Read all warning and caution statements that appear on the label.

High-pressure washing

- When using high-pressure washers, make sure to maintain sufficient distance from the vehicle. Insufficient clearance or excessive pressure can lead to component damage or water penetration.
- Do not spray the camera, sensors or its surrounding area directly with a high pressure washer. Shock applied from high pressure water may cause the device to not operate normally.
- Do not bring the nozzle tip close to boots (rubber or plastic covers) or connectors as they may be damaged if they come into contact with high pressure water.

Finish maintenance

Washing

To help protect your vehicle's finish from rust and deterioration, wash it thoroughly and frequently at least once a month with lukewarm or cold water.

If you use your vehicle for off-road driving, you should wash it after each off-road trip. Pay special attention to the removal of any accumulation of salt, dirt, mud, and other foreign materials. Make sure the drain holes in the lower edges of the doors and rocker panels are kept clear and clean.

Insects, tar, tree sap, bird droppings, industrial pollution and similar deposits can damage your vehicle's finish if not removed immediately.

Even prompt washing with plain water may not completely remove all these deposits. A mild soap, safe for use on painted surfaces, should be used.

After washing, rinse the vehicle thoroughly with lukewarm or cold water. Do not allow soap to dry on the finish.

⚠ WARNING

After washing the vehicle, test the brakes while driving slowly to see if they have been affected by water before getting on the road. If braking performance is impaired, dry the brakes by applying them lightly while maintaining a slow forward speed.

⚠ CAUTION

- *Do not use strong soap, chemical detergents or hot water, and do not wash the vehicle in direct sunlight or when the body of the vehicle is warm.*
- *Be careful when washing the side windows of your vehicle. Especially, with high-pressure water. Water may leak through the windows and wet the interior.*
- *To prevent damage to the plastic parts, do not clean with chemical solvents or strong detergents.*

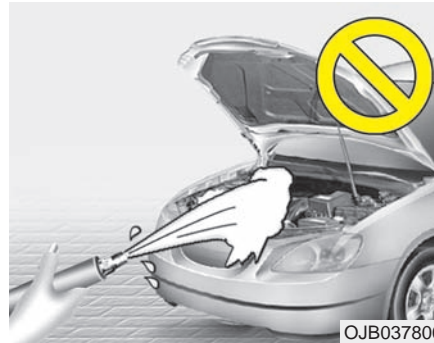

⚠ CAUTION

- *Water washing in the engine compartment including high pressure water washing may cause the failure of electrical circuits located in the engine compartment.*
- *Never allow water or other liquids to come in contact with electrical/electronic components inside the vehicle as this may damage them.*

Waxing

A good coat of wax is a barrier between your paint and contaminants. Keeping a good coat of wax on your vehicle will help protect it.

Wax the vehicle when water will no longer bead on the paint.

Always wash and dry the vehicle before waxing. Use a good quality liquid or paste wax, and follow the manufacturer's instructions. Wax all metal trim to protect it and to maintain its luster.

Removing oil, tar, and similar materials with a spot remover will usually strip the wax from the finish. Be sure to re-wax these areas even if the rest of the vehicle does not yet need waxing.

⚠ CAUTION

- *Wiping dust or dirt off the body with a dry cloth will scratch the finish.*
- *Do not use steel wool, abrasive cleaners, or strong detergents containing highly alkaline or caustic agents on chrome-plated or anodized aluminum parts. This may result in damage to the protective coating and cause discoloration or paint deterioration.*

Finish damage repair

Deep scratches or stone chips in the painted surface must be repaired promptly. Exposed metal will quickly rust and may develop into a major repair expense.

*** NOTICE**

If your vehicle is damaged and requires any metal repair or replacement, be sure the body shop applies anti-corrosion materials to the parts repaired or replaced.

Bright-metal maintenance

- To remove road tar and insects, use a tar remover, not a scraper or other sharp object.
- To protect the surfaces of bright-metal parts from corrosion, apply a coating of wax or chrome preservative and rub to a high luster.
- During winter weather or in coastal areas, cover the bright metal parts with a heavier coating of wax or preservative. If necessary, coat the parts with non-corrosive petroleum jelly or other protective compound.

Underbody maintenance

Corrosive materials used for ice and snow removal and dust control may collect on the underbody. If these materials are not removed, accelerated rusting can occur on underbody parts such as the fuel lines, frame, floor pan and exhaust system, even though they have been treated with rust protection.

Thoroughly flush the vehicle underbody and wheel openings with lukewarm or cold water once a month, after off-road driving and at the end of each winter. Pay special attention to these areas because it is difficult to see all the mud and dirt. It will do more harm than good to wet down the road grime without removing it. The lower edges of doors, rocker panels, and frame members have drain holes that should not be allowed to clog with dirt; trapped water in these areas can cause rusting.

WARNING

After washing the vehicle, test the brakes while driving slowly to see if they have been affected by water. If braking performance is impaired, dry the brakes by applying them lightly while maintaining a slow forward speed.

Aluminum wheel maintenance

The aluminum wheels are coated with a clear protective finish.

CAUTION

- *Do not use abrasive cleaner, polishing compound, solvent, or wire brushes on aluminum wheels.*
- *Clean the wheel when it has cooled.*
- *Use only a mild soap or neutral detergent, and rinse thoroughly with water. Also, clean the wheels after driving on salted roads.*
- *Do not wash the wheels with high-speed car wash brushes.*
- *Do not use any cleaners containing acid or alkaline or acid detergents.*

Corrosion protection

Protecting your vehicle from corrosion

By using the most advanced design and construction practices to combat corrosion, HYUNDAI produces cars of the highest quality. However, this is only part of the job. To achieve the long-term corrosion resistance your vehicle can deliver, the owner's cooperation and assistance is also required.

Common causes of corrosion

The most common causes of corrosion on your vehicle are:

- Road salt, dirt and moisture that is allowed to accumulate underneath the vehicle.
- Removal of paint or protective coatings by stones, gravel, abrasion or minor scrapes and dents which leave unprotected metal exposed to corrosion.

High-corrosion areas

If you live in an area where your vehicle is regularly exposed to corrosive materials, corrosion protection is particularly important. Some of the common causes of accelerated corrosion are road salts, dust control chemicals, ocean air and industrial pollution.

Moisture breeds corrosion

Moisture creates the conditions in which corrosion is most likely to occur. For example, corrosion is accelerated by high humidity, particularly when temperatures are just above freezing. In such conditions, the corrosive material is kept in contact with the car surfaces by moisture that is slow to evaporate.

Mud is particularly corrosive because it is slow to dry and holds moisture in contact with the vehicle. Although the mud appears to be dry, it can still retain the moisture and promote corrosion.

High temperatures can also accelerate corrosion of parts that are not properly ventilated so the moisture can be dispersed. For all these reasons, it is particularly important to keep your vehicle clean and free of mud or accumulations of other materials. This applies not only to the visible surfaces but particularly to the underside of the vehicle.

To help prevent corrosion

Keep your car clean

The best way to prevent corrosion is to keep your vehicle clean and free of corrosive materials. Attention to the underside of the vehicle is particularly important.

- If you live in a high-corrosion area — where road salts are used, near the ocean, areas with industrial pollution, acid rain, etc.—, you should take extra care to prevent corrosion. In winter, hose off the underside of your vehicle at least once a month and be sure to clean the underside thoroughly when winter is over.

- When cleaning underneath the vehicle, pay particular attention to the components under the fenders and other areas that are hidden from view. Do a thorough job; just dampening the accumulated mud rather than washing it away will accelerate corrosion rather than prevent it. Water under high pressure and steam are particularly effective in removing accumulated mud and corrosive materials.
- When cleaning lower door panels, rocker panels and frame members, be sure that drain holes are kept open so that moisture can escape and not be trapped inside to accelerate corrosion.

Keep your garage dry

Don't park your car in a damp, poorly ventilated garage. This creates a favorable environment for corrosion. This is particularly true if you wash your vehicle in the garage or drive it into the garage when it is still wet or covered with snow, ice or mud. Even a heated garage can contribute to corrosion unless it is well ventilated so moisture is dispersed.

Keep paint and trim in good condition

Scratches or chips in the finish should be covered with "touch-up" paint as soon as possible to reduce the possibility of corrosion. If bare metal is showing through, the attention of a qualified body and paint shop is recommended.

Bird droppings are highly corrosive and may damage painted surfaces in just a few hours. Always remove bird droppings as soon as possible.

Interior care

Interior general precautions

Prevent caustic solutions such as perfume and cosmetic oil, from contacting the interior parts because they may cause damage or discoloration. If they do contact the interior parts, wipe them off immediately. See the instructions for the proper way to clean vinyl.

CAUTION

- ***Never allow water or other liquids to come in contact with electrical/electronic components inside the vehicle as this may damage them.***
- ***When cleaning leather products (steering wheel, seats etc.), use neutral detergents or low alcohol content solutions. If you use high alcohol content solutions or acid/alkaline detergents, the color of the leather may fade or the surface may get stripped off.***

Cleaning the upholstery and interior trim

Vinyl

Remove dust and loose dirt from vinyl with a whisk broom or vacuum cleaner. Clean vinyl surfaces with a vinyl cleaner.

Fabric

Remove dust and loose dirt from fabric with a whisk broom or vacuum cleaner. Clean with a mild soap solution recommended for upholstery or carpets. Remove fresh spots immediately with a fabric spot cleaner. If fresh spots do not receive immediate attention, the fabric can be stained and its color can be affected. Also, its fire-resistant properties can be reduced if the material is not properly maintained.

CAUTION

Using anything but recommended cleaners and procedures may affect the fabric's appearance and fire-resistant properties.

Cleaning the seat belt webbing

Clean the belt webbing with any mild soap solution recommended for cleaning upholstery or carpet. Follow the instructions provided with the soap. Do not bleach or re-dye the webbing because this may weaken the seat belt.

Cleaning the interior window glass

If the interior glass surfaces of the vehicle become fogged (that is, covered with an oily, greasy or waxy film), they should be cleaned with glass cleaner. Follow the directions on the glass cleaner container.

CAUTION

Do not scrape or scratch the inside of the rear window. This may result in damage to the rear window defroster grid.

EMISSION CONTROL SYSTEM

The emission control system of your vehicle is covered by a written limited warranty. Please see the warranty information contained in the Owner's Handbook & Warranty Information booklet in your vehicle.

Your vehicle is equipped with an emission control system to meet all applicable emission regulations. There are three emission control systems, as follows.

- (1) Crankcase emission control system
- (2) Evaporative emission control system
- (3) Exhaust emission control system

In order to assure the proper function of the emission control systems, it is recommended that you have your vehicle inspected and maintained by an authorized HYUNDAI dealer in accordance with the maintenance schedule in this manual.

WARNING

- **The exhaust system and catalytic converter are very hot during and immediately after the engine has been running. To avoid SERIOUS INJURY or DEATH.**
- **Do not park, idle, or drive the vehicle over or near flammable objects, such as grass, vegetation, paper, leaves, etc. A hot exhaust system can ignite flammable items under your vehicle.**
- **Keep away from the exhaust system and catalytic converter or you may get burned.**

Also, Do not remove the heat sink around the exhaust system, do not seal the bottom of the vehicle, and do not coat the vehicle for corrosion control. It may present a fire risk under certain conditions.

1. Crankcase emission control system

The positive crankcase ventilation system is employed to prevent air pollution caused by blow-by gases being emitted from the crankcase. This system supplies fresh filtered air to the crankcase through the air intake hose. Inside the crankcase, the fresh air mixes with blow-by gases, which then pass through the PCV valve into the induction system.

2. Evaporative emission control system including Onboard Refueling Vapor Recovery (ORVR)

The Evaporative Emission Control System is designed to prevent fuel vapors from escaping into the atmosphere. The ORVR system is designed to allow the vapors from the fuel tank to be loaded into a canister while refueling at the gas station, preventing the escape of fuel vapors into the atmosphere.

Canister

Fuel vapors generated inside the fuel tank are absorbed and stored in the onboard canister. When the engine is running, the fuel vapors absorbed in the canister are drawn into the surge tank through the purge control solenoid valve.

Purge Control Solenoid Valve (PCSV)

The purge control solenoid valve is controlled by the Engine Control Module (ECM); when the engine coolant temperature is low during idling, the PCSV closes so that evaporated fuel is not taken into the engine. After the engine warms-up during ordinary driving, the PCSV opens to introduce evaporated fuel to the engine.

3. Exhaust emission control system

The Exhaust Emission Control System is a highly effective system which controls exhaust emissions while maintaining good vehicle performance.

When the engine starts or fails to start, excessive attempts to restart the engine may cause damage to the emission system.

Vehicle modifications

- This vehicle should not be modified. Modification of your vehicle could affect its performance, safety or durability and may even violate governmental safety and emissions regulations.

In addition, damage or performance problems resulting from any modification may not be covered under warranty.

- If you use unauthorized electronic devices, it may cause the vehicle to operate abnormally, wire damage, battery discharge and fire. For your safety, do not use unauthorized electronic devices.

Engine exhaust (carbon monoxide) precautions

- Carbon monoxide can be present with other exhaust fumes. If you smell exhaust fumes of any kind in your vehicle, drive with all the windows fully open. Have your vehicle checked and repaired immediately.

⚠ WARNING

Engine exhaust gases contain carbon monoxide (CO). Though colorless and odorless, it is dangerous and could be lethal if inhaled. Follow the instructions on this page to avoid CO poisoning.

⚠ WARNING - CALIFORNIA PROPOSITION 65 WARNING

Engine exhaust and a wide variety of automobile components and parts, including components found in the interior furnishings in a vehicle, contain or emit chemicals known to the State of California to cause cancer and birth defects and reproductive harm. In addition, certain fluids contained in vehicles and certain products of component wear contain or emit chemicals known to the State of California to cause cancer and birth defects or other reproductive harm.

- Do not operate the engine in confined or closed areas (such as garages) any more than what is necessary to move the vehicle in or out of the area.
- When the vehicle is stopped in an open area for more than a short time with the engine running, adjust the ventilation system (as needed) to draw outside air into the vehicle.
- Never sit in a parked or stopped vehicle for any extended time with the engine running.
- When the engine stalls or fails to start, excessive attempts to restart the engine may cause damage to the emission control system.

Operating precautions for catalytic converters (if equipped)

⚠ WARNING

- The exhaust system and catalytic converter are very hot during and immediately after the engine has been running. To avoid **SERIOUS INJURY** or **DEATH**.
- Do not park, idle, or drive the vehicle over or near flammable objects, such as grass, vegetation, paper, leaves, etc. A hot exhaust system can ignite flammable items under your vehicle.
- Keep away from the exhaust system and catalytic converter or you may get burned.

Also, Do not remove the heat sink around the exhaust system, do not seal the bottom of the vehicle, and do not coat the vehicle for corrosion control. It may present a fire risk under certain conditions.

Your vehicle is equipped with a catalytic converter emission control device.

To prevent damage to the catalytic converter and to your vehicle, take the following precautions:

 **CAUTION**

- *Use only UNLEADED FUEL for gasoline engines.*
- *Do not operate the vehicle when there are signs of engine malfunction, such as misfire or a noticeable loss of performance.*
- *Do not misuse or abuse the engine. Examples of misuse are coasting with the engine off and descending steep grades in gear with the engine off.*
- *Do not operate the engine at high idle speed for extended periods (5 minutes or more).*

(Continued)

(Continued)

- *Do not modify or tamper with any part of the engine or emission control system. All inspections and adjustments must be made by an authorized HYUNDAI dealer.*
- *Avoid driving with extremely low fuel level. If you run out of gasoline, it could cause the engine to misfire and result in excessive loading of the catalytic converter.*



CALIFORNIA PERCHLORATE NOTICE

Perchlorate Material-special handling may apply, See: www.dtsc.ca.gov/hazardouswaste/perchlorate.

Notice to California Vehicle Dismantlers:

Perchlorate containing materials, such as air bag inflators, seatbelt pretensioners and keyless remote entry batteries, must be disposed of according to Title 22 California Code of Regulations Section 67384.10 (a).

Specifications, Consumer information and Reporting safety defects

| | |
|--|-----|
| Dimensions | 8-2 |
| Bulb wattage | 8-2 |
| Tires and wheels | 8-3 |
| Capacity/Weight | 8-3 |
| Recommended lubricants and capacities | 8-4 |
| • Recommended SAE viscosity number | 8-5 |
| Vehicle identification number (VIN) | 8-6 |
| Vehicle certification label | 8-6 |
| Tire specification and pressure label | 8-7 |
| Engine number | 8-7 |
| Refrigerant label | 8-7 |
| Consumer information | 8-8 |
| Reporting safety defects | 8-9 |

DIMENSIONS

| Item | in (mm) |
|----------------|---|
| Overall length | 178.3 (4550) |
| Overall width | 69.9 (1775) |
| Overall height | 56.5 (1430) |
| Front tread | 61.5 (1563)* ¹ / 61.0 (1549)* ² / 61.1 (1551)* ³ |
| Rear tread | 62.0 (1576)* ¹ / 61.5 (1562)* ² / 61.6 (1564)* ³ |
| Wheelbase | 106.3 (2700) |

*¹ : with R15 tire

*² : with R16 tire

*³ : with R17 tire

BULB WATTAGE

| Light Bulb | Wattage | Bulb Type |
|--|-------------|-------------|
| Headlights (Low) | Standard | H11 |
| | Projection | 9005L+* |
| Headlights (High) | 55 | H7 LL |
| Front turn signal lights/ Position lights | 28/8/LED | P28/8W LED |
| Side repeater lights | LED | - |
| Front fog lights* | 27 | GE881 |
| Stop/tail lights (outside) | 28/8 or LED | 2357 or LED |
| Tail light (inside) | 5 | W5W |
| Rear turn signal lights (outside) | 27 | 1156NA |
| Back-up lights (outside) | 16 | W16W |
| High mounted stop light | 21 | W21W |
| License plate lights | 5 | W5W |
| Map lamps | 8 | FESTTON 8W |
| Room lamps | 8 | FESTTON 8W |
| Trunk lamp | 5 | FESTTON 5W |

* : if equipped

TIRES AND WHEELS

| Item | Tire size | Wheel size | Inflation pressure psi (kPa) | | | | Wheel lug nut torque lb•ft (kg•m, N•m) |
|---------------------------------------|-------------|------------|---------------------------------|-------------|--------------|-------------|---|
| | | | Normal load *1 | | Maximum load | | |
| | | | Front | Rear | Front | Rear | |
| Full size tire | P195/65 R15 | 6.0Jx15 | 33 (230) | 33 (230) | 33 (230) | 33 (230) | 65~79 (9~11, 88~107) |
| | P205/55 R16 | 6.5Jx16 | 33 (230) | 33 (230) | 33 (230) | 33 (230) | |
| | P215/45 R17 | 7.0Jx17 | 33 (230) | 33 (230) | 33 (230) | 33 (230) | |
| Compact spare tire*2 (if equipped) | T125/80D15 | 4.0Tx15 | 60 (420) | 60 (420) | 60 (420) | 60 (420) | |

*1 Normal load : Up to 3 persons

*2 If your vehicle is not equipped with a compact spare tire, you will be equipped with a Tire Mobility Kit



CAUTION

***When replacing tires, use the same size originally supplied with the vehicle.
Using tires of a different size can damage the related parts or make it work irregularly.***

CAPACITY/WEIGHT

| Item | Manual transaxle | Automatic transaxle |
|-----------------------------------|------------------|---------------------|
| Gross vehicle weight lbs. (kg) | 3836 (1739) | 3880 (1759) |
| Luggage volume cu ft (l) | 14.8 (420) | 14.8 (420) |

RECOMMENDED LUBRICANTS AND CAPACITIES

To help achieve proper engine and powertrain performance and durability, use only lubricants of the proper quality. The correct lubricants also help promote engine efficiency that results in improved fuel economy.

| Lubricant | | Volume | Classification |
|--|---------------------|----------------------------|---|
| Engine oil *1 *2 (drain and refill) Recommends  | | 4.23 US qt. (4.0 l) | API Service SM*3, ILSAC GF-4 or above |
| Manual transaxle fluid | | 2.01 US qt. (1.9 l) | API GL-4, SAE 75W/85 |
| Automatic transaxle fluid | | 7.71 US qt. (7.3 l) | MICHANG ATF SP-4, SK ATF SP-4 NOCA ATF SP-4, HYUNDAI genuine ATF SP-4 or other brands meeting the above specification approved by Hyundai Motor Co., |
| Coolant | Manual transaxle | 6.34 US qt. (6.0 l) | Mixture of antifreeze and water (Ethylene glycol base coolant for aluminum radiator) |
| | Automatic transaxle | 6.23 US qt. (5.9 l) | |
| Brake fluid | | 0.7~0.8 US qt. (0.7~0.8 l) | FMVSS116 DOT-3 or DOT-4 |
| Fuel | | 12.68 US gal. (48 l) | - |

*1 Refer to the recommended SAE viscosity numbers on the next page.

*2 Engine oils labeled Energy Conserving Oil are now available. Along with other additional benefits, they contribute to fuel economy by reducing the amount of fuel necessary to overcome engine friction. Often, these improvements are difficult to measure in everyday driving, but in a year's time, they can offer significant cost and energy savings.

*3 If the API service SM engine oil is not available in your country, you are able to use API service SL.

Recommended SAE viscosity number

⚠ CAUTION

Always be sure to clean the area around any filler plug, drain plug, or dipstick before checking or draining any lubricant. This is especially important in dusty or sandy areas and when the vehicle is used on unpaved roads. Cleaning the plug and dipstick areas will prevent dirt and grit from entering the engine and other mechanisms that could be damaged.

Engine oil viscosity (thickness) has an effect on fuel economy and cold weather operating (engine start and engine oil flowability). Lower viscosity engine oils can provide better fuel economy and cold weather performance, however, higher viscosity engine oils are required for satisfactory lubrication in hot weather.

Using oils of any viscosity other than those recommended could result in engine damage.

When choosing an oil, consider the range of temperature your vehicle will be operated in before the next oil change. Proceed to select the recommended oil viscosity from the chart.

| Temperature Range for SAE Viscosity Numbers | | | | | | | | | | |
|---|--------------|-----|-----|-----|----|----|----|-----|-----|----|
| Temperature | °C | -30 | -20 | -10 | 0 | 10 | 20 | 30 | 40 | 50 |
| | (°F) | -10 | 0 | 20 | 40 | 60 | 80 | 100 | 120 | |
| Engine Oil *1 | 10W-30 | | | | | | | | | |
| | 5W-20, 5W-30 | | | | | | | | | |

*1. For better fuel economy, it is recommended to use the engine oil of a viscosity grade SAE 5W-20 (API SM / ILSAC GF-4). However, if the engine oil is not available in your country, select the proper engine oil using the engine oil viscosity chart.



VEHICLE IDENTIFICATION NUMBER (VIN)

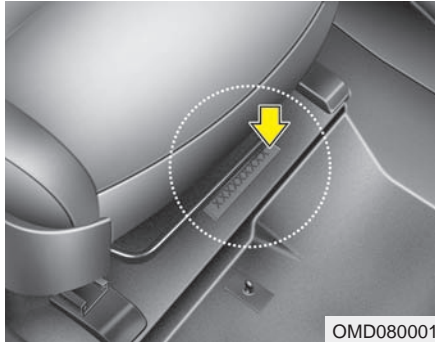

The vehicle identification number (VIN) is the number used in registering your car and in all legal matters pertaining to its ownership, etc.

The number is punched on the floor under the passenger seat. To check the number, open the cover.

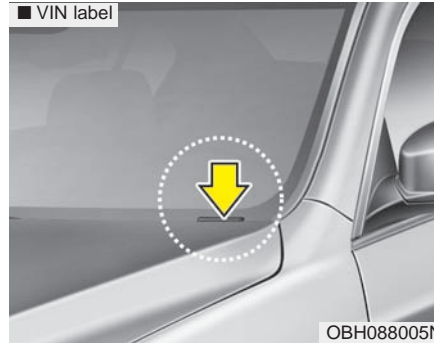

The VIN is also on a plate attached to the top of the dashboard. The number on the plate can easily be seen through the windshield from outside.

VEHICLE CERTIFICATION LABEL

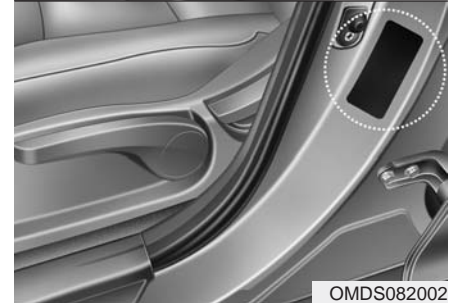
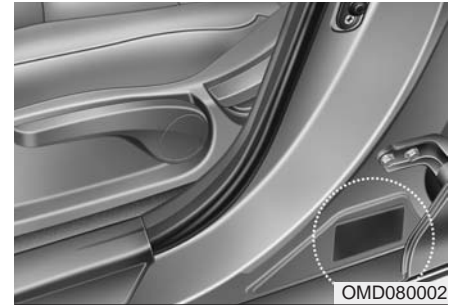

The vehicle certification label attached on the driver's side center pillar gives the Vehicle Identification Number (VIN).

TIRE SPECIFICATION AND PRESSURE LABEL

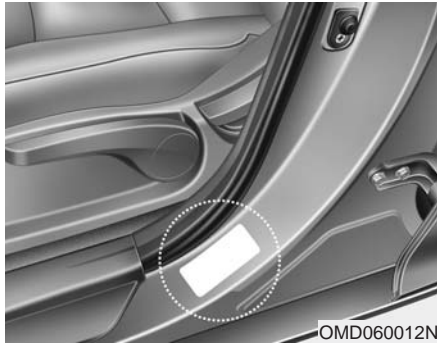

The tires supplied on your new vehicle are chosen to provide the best performance for normal driving. The tire label located on the driver's side center pillar gives the tire pressures recommended for your car.

ENGINE NUMBER

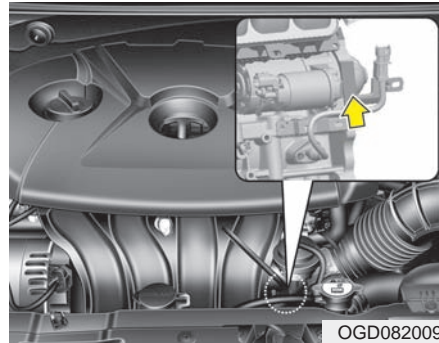

The engine number is stamped on the engine block as shown in the drawing.

REFRIGERANT LABEL (IF EQUIPPED)



The refrigerant label provides information such as refrigerant type and amount. The label is located on the underside of the hood.

CONSUMER INFORMATION

This consumer information has been prepared in accordance with regulations issued by the National Highway Traffic Safety Administration of the U.S. Department of Transportation. Your HYUNDAI dealer will help answer any questions you may have as you read this information.

HYUNDAI motor vehicles are designed and manufactured to meet or exceed all applicable safety standards.

For your safety, however, we strongly urge you to read and follow all directions in this Owner's Manual, particularly the information under the headings "**NOTICE**", "**CAUTION**" and "**WARNING**".

If, after reading this manual, you have any questions regarding the operation of your vehicle, please contact your nearest HYUNDAI Motor America Regional Office as listed in the following:

Eastern Region:

Connecticut, Delaware,
Maine, Massachusetts, New
Hampshire, New Jersey, New York,
Pennsylvania, Rhode Island,
Vermont.

Eastern Region
1122 Cranbury South River Road
Jamesburg, NJ 08831
(800) 633-5151

Southern Region:

Florida, Georgia, Maryland, North
Carolina, South Carolina, Virginia,
West Virginia.

Southern Region
3025 Chastain Meadows Parkway
Suite 100 Marietta, GA 30066
(800) 633-5151

South Central Region:

Alabama, Arkansas, Louisiana,
Mississippi, New Mexico, Oklahoma,
Tennessee, Texas.

South Central Region
1421 South Beltline Road, Suite 400
Coppell, TX 75019
(800) 633-5151

Central Region:

Illinois, Indiana, Iowa, Kentucky,
Michigan, Minnesota, Nebraska,
North Dakota, South Dakota, Ohio,
Wisconsin, Kansas, Missouri.

Central Region
1705 Sequoia Drive Aurora, Illinois
60506
(800) 633-5151

Western Region:

Alaska, Hawaii, Arizona, California,
Colorado, Idaho, Montana, Nevada,
Oregon, Utah, Washington,
Wyoming.

Western Region
10550 Talbert Avenue P.O.Box
20850 Fountain Valley, California
92728-0850
(800) 633-5151

REPORTING SAFETY DEFECTS

If you believe that your vehicle has a defect which could cause a crash or could cause injury or death, you should immediately inform the National Highway Traffic Safety Administration (NHTSA) in addition to notifying HYUNDAI MOTOR AMERICA.

If NHTSA receives similar complaints, it may open an investigation, and if it finds that a safety defect exists in a group of vehicles, it may order a recall and remedy campaign. However, NHTSA cannot become involved in individual problems between you, your dealer, or HYUNDAI MOTOR AMERICA.

To contact NHTSA, you may call the Vehicle Safety Hotline toll-free at 1-888- 327-4236 (TTY: 1-800-424-9153); go to <http://www.safercar.gov>;

or write to: Administrator, NHTSA
1200 New Jersey Ave, SE,
West Building Washington, D.C. 20590.

You can also obtain other information about motor vehicle safety from <http://www.safercar.gov>.

Index

A

| | | | |
|---|------|--|-------|
| Accessing your vehicle | 4-3 | Air cleaner | 7-37 |
| Immobilizer System | 4-12 | Air conditioning system | |
| Remote key | 4-3 | Automatic climate control system | 4-94 |
| Remote key precautions | 4-5 | Manual climate control system | 4-84 |
| Smart key | 4-7 | Antenna | 4-120 |
| Smart key precautions | 4-11 | Anti-lock brake system (ABS) | 5-32 |
| Active ECO system | 5-41 | Appearance care..... | 7-87 |
| Air bag warning labels..... | 3-67 | Exterior care | 7-87 |
| Air bags | 3-45 | Interior care | 7-93 |
| Additional safety precautions..... | 3-66 | Armrest (Rear seats) | 3-14 |
| Air bag collision sensors | 3-61 | Audio remote control..... | 4-121 |
| Air bag deployment conditions | 3-62 | Audio system | 4-120 |
| Air bag non-deployment conditions..... | 3-63 | Antenna..... | 4-120 |
| Air bag warning labels | 3-67 | Audio remote control | 4-121 |
| Curtain air bags | 3-49 | Caring for disc | 4-125 |
| Do not install a child restraint on the front | | CD player | 4-135 |
| passenger seat..... | 3-60 | How vehicle audio works | 4-122 |
| Driver's air bag..... | 3-47 | Auto defogging system | 4-108 |
| Occupant Classification System (OCS) | 3-55 | Auto door lock/unlock features | 4-18 |
| Passenger's front air bag..... | 3-47 | Auto light position | 4-73 |
| Side (impact) air bags..... | 3-48 | Automatic climate control system | 4-94 |
| SRS Care | 3-65 | Air conditioning | 4-100 |
| SRS components and functions | 3-50 | Air conditioning refrigerant label..... | 4-104 |
| What to expect after an air bag inflates | 3-54 | Air intake control | 4-99 |
| Where are the air bags? | 3-47 | Automatic heating and air conditioning..... | 4-95 |
| Why didn't my air bag go off in a collision | 3-60 | Checking the amount of air conditioner refrigerant | |
| | | and compressor lubricant | 4-104 |
| | | Fan speed control | 4-100 |

Manual heating and air conditioning4-96
 Mode selection4-96
 OFF mode.....4-101
 Temperature control4-97
 Automatic transaxle5-22
 Good driving practices5-27
 Ignition key interlock system5-27
 Parking5-27
 Shift lock system5-25
 Shift-lock release5-26
 Sports mode5-24
 Automatic turn off function4-78
 Aux, USB and iPod3-102

B

Battery7-43
 Battery recharging7-45
 Battery saver function4-77
 Before driving5-3
 Blind zone mirror.....4-49
 Blue Link® center4-42
 Brake system5-29
 Anti-lock brake system (ABS)5-32
 Disc brakes wear indicator5-30
 Electronic stability control (ESC)5-34
 Good braking practices.....5-39
 Hill-Start Assist Control (HAC)5-39
 Parking brake5-30
 Power brakes5-29
 Vehicle stability management (VSM)5-38
 Brake/clutch fluid7-35
 Bulb replacement7-76
 Front side marker7-79
 Front turn signal light.....7-79
 High mounted stop light.....7-84
 Interior light7-85
 License plate light7-85
 Rear combination light7-81
 Side repeater light7-80
 Bulb wattage8-2
 Button start/stop, see engine start/stop button.....5-9

Index

C

| | |
|---|-------|
| Capacities (Lubricants) | 3-4 |
| Capacity/Weight..... | 8-3 |
| Care | |
| Exterior care | 7-87 |
| Interior care | 7-93 |
| Tire care | 7-47 |
| CD player | 4-135 |
| Center console storage | 4-110 |
| Central door lock switch | 4-17 |
| Certification label | 8-6 |
| Chains | |
| Tire chains | 5-51 |
| Changing a Tire with TPMS | 6-14 |
| Check tire inflation pressure | 7-49 |
| Child restraint system (CRS)..... | 3-34 |
| Booster seats..... | 3-37 |
| Forward-facing child restraints | 3-37 |
| Installing a Child Restraint System (CRS) | 3-37 |
| Lower Anchors and Tether for Children (LATCH) | |
| System | 3-38 |
| Rear-facing child seats | 3-36 |
| Securing a child restraint seat with “Tether Anchor” system..... | 3-41 |
| Securing a child restraint with the LATCH anchors system..... | 3-40 |
| Selecting a Child Restraint System (CRS)..... | 3-35 |

| | |
|---|-------|
| Child-safety rear door lock | 4-19 |
| Climate control air filter | 4-92 |
| Climate control air filter (replacement)..... | 7-39 |
| Clock | 4-113 |
| Clothes hanger | 4-117 |
| Combined instrument, see instrument cluster | 4-51 |
| Compact spare tire replacement | 7-52 |
| Consumer information | 8-8 |
| Coolant..... | 7-32 |
| Cooling fluid, see engine coolant | 7-32 |
| Crankcase emission control system..... | 7-94 |
| Cruise control system | 5-43 |
| Cup holder | 4-115 |
| Curtain air bags | 3-49 |

D

| | |
|--|-------|
| Dashboard illumination, see instrument panel illumination | 4-52 |
| Dashboard, see instrument cluster..... | 4-51 |
| Day/night rearview mirror | 4-42 |
| Daytime running light | 4-78 |
| Defogging (Windshield) | 4-105 |
| Defroster (Rear window) | 4-83 |
| Defrosting (Windshield) | 4-105 |
| Dimensions | 8-2 |
| Display illumination, see instrument panel illumination .. | 4-52 |
| Displays, see instrument cluster | 4-51 |

Door locks4-14
 Auto door lock/unlock features4-18
 Central door lock switch4-17
 Child-safety rear door lock.....4-19
 Door lock button.....4-16
 Impact sensing door unlock system4-18
 Remote key4-14
 Smart key4-15
 Speed sensing door lock system.....4-18
 Drinks holders, see cup holders4-115
 Driver selectable steering mode4-39
 Driver’s air bag3-47
 Driving assist system
 Active ECO system5-41
 Driving at night5-49
 Driving in flooded areas5-50
 Driving in the rain5-50

E

Electric chromic mirror (ECM) with compass and
 HomeLink® system4-43
 Electric power steering (EPS)4-38
 Electronic stability control (ESC)5-34
 Emergency towing6-29
 Emission control system7-94
 Crankcase emission control system7-94
 Evaporative emission control system7-94
 Exhaust emission control system7-95
 Engine compartment.....2-6, 7-2
 Engine compartment panel fuse7-66
 Engine coolant7-32
 Engine coolant temperature gauge4-54
 Engine number8-7
 Engine oil7-30
 Engine Start/Stop button5-9
 Evaporative emission control system7-94
 Exhaust emission control system.....7-95
 Explanation of scheduled maintenance items7-26
 Exterior care.....7-87
 Exterior lights4-72
 Exterior overview
 Front2-2
 Rear.....2-3

Index

F

| | |
|-------------------------------------|-------|
| Flat tire | |
| Changing tires..... | 6-16 |
| Jack and tools | 6-15 |
| Spare tire..... | 6-15 |
| Tire Mobility Kit | 6-22 |
| Floor mat anchor(s) | 4-118 |
| Fluid | |
| Brake/clutch fluid | 7-35 |
| Washer fluid | 7-36 |
| Fog light (front) | 4-76 |
| Front lamps | 4-79 |
| Front seat | 3-6 |
| Fuel filler door | 4-31 |
| Fuel Gauge..... | 4-54 |
| Fuel requirements | 1-3 |
| Fuses | 7-63 |
| Engine compartment panel fuse | 7-66 |
| Fuse/relay panel description..... | 7-68 |
| Instrument panel fuse | 7-64 |
| Main fuse | 7-66 |
| Memory fuse..... | 7-65 |
| Multi fuse | 7-67 |

G

| | |
|-----------------|-------|
| Gauges | 4-53 |
| Glove box | 4-111 |

H

| | |
|---|-------|
| Hazard warning flasher | 6-2 |
| Hazardous driving conditions | 5-48 |
| Headlight bulb replacement..... | 7-76 |
| Headlight escort function..... | 4-77 |
| Headlight position | 4-73 |
| Headrest | 3-15 |
| Heater | |
| Automatic climate control system | 4-94 |
| Manual climate control system | 4-84 |
| Height adjustment | 3-23 |
| High beam operation | 4-74 |
| High mounted stop light replacement | 7-84 |
| Hill-Start Assist Control (HAC) | 5-39 |
| Hood..... | 4-29 |
| Horn | 4-41 |
| How to use this manual | 1-2 |
| How vehicle audio works | 4-122 |

I

If the engine doesn't turn over or turns over slowly6-4

If the engine overheats.....6-8

If the engine stalls at a crossroad or crossing6-3

If the engine stalls while driving6-3

If the engine turns over normally but doesn't start6-4

If the engine will not start6-4

If you have a flat tire6-15

If you have a flat tire while driving.....6-3

Ignition key interlock system5-27

Ignition switch5-5

 Engine Start/Stop button.....5-9

 Key ignition switch5-5

Immobilizer system4-12

Impact sensing door unlock system.....4-18

Important safety precautions3-2

 Air bag hazards.....3-2

 Always wear your seat belt3-2

 Control your speed3-3

 Driver distraction3-2

 Keep your vehicle in safe condition.....3-3

 Restrain all children3-2

In case of emergency while driving.....6-3

Inside rearview mirror4-42

Instrument cluster4-51

 ECO ON/OFF mode.....4-59

 Gauges4-53

 Instrument panel illumination4-52

 Manual transaxle shift indicator.....4-59

 Transaxle shift indicator.....4-56

 Trip computer4-56

 Warnings and indicators4-60

Instrument panel fuse.....7-64

Instrument panel overview2-5

Interior care7-93

Interior features4-113

 Aux, USB and iPod4-122

 Clock.....4-113

 Clothes hanger4-117

 Cup holder4-115

 Floor mat anchor(s)4-118

 Outside temperature4-114

 Power outlet4-116

 Sunvisor4-116

Interior lights4-78

Interior overview2-4

Index

J

- Jack and tools6-15
- Jump starting6-5

L

Label

- Refrigerant label8-7
- Jack label6-21
- Tire sidewall labeling7-53
- Tire specification and pressure label8-7
- Vehicle certification label8-6
- Light4-72
 - Auto light position4-73
 - Automatic turn off function4-78
 - Battery saver function4-77
 - Daytime running light4-78
 - Exterior lights4-72
 - Front fog light4-76
 - Front lamps4-79
 - Headlight escort function4-77
 - Headlight position4-73
 - High beam operation4-74
 - Lighting control4-72
 - Map lamp4-79
 - One-touch lane change function4-76
 - Parking light position4-72

- Rear room lamp4-80
- Room lamp4-80
- Trunk lamp4-80
- Turn signals4-75
- Vanity mirror lamp4-80
- Light bulbs7-76
- Lubricants and capacities8-4

M

- Main fuse7-66
- Maintenance
 - Explanation of scheduled maintenance items7-26
 - Maintenance services7-3
 - Maintenance under severe usage conditions7-24
 - Normal maintenance service7-9
 - Owner maintenance7-6
 - Scheduled maintenance service7-8
 - Tire maintenance7-53
- Maintenance services7-4
- Manual climate control system4-84
 - Air conditioning4-90
 - Air Conditioning refrigerant label4-93
 - Air intake control4-88
 - Checking the amount of air conditioner refrigerant
and compressor lubricant4-93
 - Climate control air filter4-92

Fan speed control4-89
 Heating and air conditioning4-85
 MAX A/C-Level4-87
 Mode selection4-86
 Temperature control4-87
 Manual transaxle5-18
 Downshifting5-19
 Good driving practices5-20
 Using the clutch5-19
 Map lamp4-79
 Memory fuse7-65
 Mirrors4-42
 Blind zone mirror4-49
 Blue Link® center4-42
 Day/night rearview mirror4-42
 Electric chromic mirror (ECM) with compass and
 HomeLink® system4-43
 Folding the outside rearview mirror4-50
 Inside rearview mirror4-42
 Outside rearview mirror4-48
 Outside rearview mirror remote control4-49
 Moonroof, see sunroof4-34
 Multi fuse7-67

O

Occupant Classification System (OCS)3-55
 Odometer4-55
 Oil (Engine)7-30
 Outside rearview mirror4-48
 Outside temperature4-114
 Owner maintenance7-6

P

Parking brake5-30, 7-36
 Parking light position4-72
 Passenger's front air bag3-47
 Power brakes5-29
 Power outlet4-116
 Power window lock switch4-27
 Pre-tensioner seat belt3-27

R

Rear combination light replacement7-81
 Rear seat.....3-12
 Rearview camera4-71
 Recommended cold tire inflation pressures7-48
 Recommended lubricants and capacities.....8-4
 Recommended SAE viscosity number.....8-5
 Refrigerant label8-7
 Remote key4-3
 Battery replacement4-6
 Removable towing hook6-29
 Replacement light bulb7-76
 Reporting safety defects8-9
 Rocking the vehicle5-48
 Room lamp.....4-79
 Rotation (Tire)7-50

S

Scheduled maintenance service7-8
 Seat belt warning light.....3-22
 Seat belts3-21
 Additional seat belt safety precautions3-29
 Care of seat belts3-32
 Do not lie down3-32
 Emergency Fastening Device (EFD)3-27
 Height adjustment.....3-23
 Keep belts clean and dry3-32
 One person per belt3-31
 Passenger’s 3-point system with combination
 locking retractor3-25
 Periodic inspection3-32
 Pre-tensioner seat belt3-27
 Retractor Pre-tensioner.....3-27
 Seat belt restraint system3-23
 Seat belt safety precautions3-21
 Seat belt use and children.....3-30
 Seat belt warning light3-22
 Seat Belt-Driver’s 3-point system with emergency
 locking retractor3-23
 Transporting an injured person.....3-31
 When to replace seat belts3-33
 Seat warmers3-19
 Seatback pocket3-11

| | | | |
|---------------------------------------|-------|--|-------|
| Seats | 3-4 | Speed sensing door lock system | 4-18 |
| Armrest (Rear seats) | 3-14 | Speedometer | 4-53 |
| Headrest | 3-15 | Sports mode | 5-24 |
| Manual adjustment (Front seats) | 3-7 | Starting difficulties, see engine will not start | 6-4 |
| Power adjustment (Front seats) | 3-8 | Steering wheel | 4-38 |
| Rear seats | 3-12 | Driver selectable steering mode | 4-39 |
| Safety precautions | 3-5 | Electric power steering (EPS) | 4-38 |
| Seat warmers | 3-19 | Horn | 4-41 |
| Seatback pocket | 3-11 | Tilt steering / Telescope steering | 4-39 |
| Shift lock system | 5-25 | Steering wheel audio control | 4-121 |
| Shift-lock release | 5-26 | Storage compartment | 4-110 |
| Side (impact) air bags | 3-48 | Center console storage | 4-110 |
| Sliding armrest | 4-111 | Glove box | 4-111 |
| Smart key | 4-7 | Sliding armrest | 4-111 |
| Battery replacement | 4-12 | Sunglass holder | 4-112 |
| Smooth cornering | 5-49 | Sunglass holder | 4-112 |
| Snow tires | 5-51 | Sunroof | 4-34 |
| Spare tire | | Sunvisor | 4-116 |
| Compact spare tire replacement | 7-52 | | |
| Special driving conditions | 5-48 | | |
| Driving at night | 5-49 | | |
| Driving in flooded areas | 5-50 | | |
| Driving in the rain | 5-50 | | |
| Hazardous driving conditions | 5-48 | | |
| Rocking the vehicle | 5-48 | | |
| Smooth cornering | 5-49 | | |

T

Tachometer4-53

Theft alarm system4-20

Tilt steering / Telescope steering4-39

Tire chains5-51

Tire loading information label5-56

Tire Mobility Kit (TMK)6-22

Tire pressure monitoring system (TPMS)6-10

 Changing a Tire with TPMS6-14

 Low tire pressure telltale6-11

 TPMS malfunction indicator6-13

Tire rotation7-50

Tire specification and pressure label8-7

Tires and wheels7-47

 All season tires7-60

 Check tire inflation pressure7-49

 Compact spare tire replacement7-52

 Low aspect ratio tires7-61

 Radial-ply tires7-61

 Recommended cold tire inflation pressures7-48

 Snow tires7-60

 Specification8-3

 Summer tires7-60

 Tire care7-47

 Tire maintenance7-53

 Tire replacement7-51

 Tire rotation7-50

Tire sidewall labeling7-53

Tire terminology and definitions7-57

Tire traction7-52

Wheel alignment and tire balance7-51

Wheel replacement7-52

Towing6-28

Trailer towing5-61

Transaxle shift indicator4-56

Trip computer4-56

Trunk4-21

 Emergency trunk safety release4-22

Trunk lamp4-80

Turn signals4-75

V

| | |
|---|------|
| Vanity mirror lamp..... | 4-80 |
| Vehicle break-in process | 1-5 |
| Vehicle certification label | 8-6 |
| Vehicle data collection and event data recorders..... | 1-6 |
| Vehicle identification number (VIN)..... | 8-6 |
| Vehicle load limit..... | 5-55 |
| Certification label..... | 5-60 |
| Tire loading information label | 5-56 |
| Vehicle stability management (VSM) | 5-38 |

W

| | |
|---|-------|
| Warnings and indicators..... | 4-60 |
| Washer fluid | 7-36 |
| Wheel alignment and tire balance | 7-51 |
| Wheel replacement | 7-52 |
| Windows | 4-24 |
| Auto down window | 4-26 |
| Auto up/down window | 4-26 |
| Automatic reversal | 4-27 |
| Power window lock switch | 4-27 |
| To reset the power windows..... | 4-26 |
| Windshield defrosting and defogging | 4-105 |
| Windshield washers | 4-82 |
| Windshield wipers | 4-81 |
| Winter driving | 5-51 |
| Snow tires | 5-51 |
| Tire chains | 5-51 |
| Wiper blades | 7-41 |
| Wipers and washers | 4-81 |
| Windshield washers | 4-82 |
| Windshield wipers | 4-81 |