

HYUNDAI

OWNER'S MANUAL

Operation
Maintenance
Specifications

All information in this Owner's Manual is current at the time of publication. However, HYUNDAI reserves the right to make changes at any time so that our policy of continual product improvement may be carried out.

This manual applies to all HYUNDAI models and includes descriptions and explanations of optional as well as standard equipment. As a result, you may find material in this manual that does not apply to your specific vehicle.



CAUTION: MODIFICATIONS TO YOUR HYUNDAI

Your HYUNDAI should not be modified in any way. Such modifications may adversely affect the performance, safety or durability of your HYUNDAI and may, in addition, violate conditions of the limited warranties covering the vehicle. Certain modifications may also be in violation of regulations established by the U.S. Department of Transportation and other federal or state agencies.

TWO-WAY RADIO OR CELLULAR TELEPHONE INSTALLATION

Your vehicle is equipped with electronic fuel injection and other electronic components. It is possible for an improperly installed/adjusted two-way radio or cellular telephone to adversely affect electronic systems. For this reason, we recommend that you carefully follow the radio manufacturer's instructions or consult your HYUNDAI dealer for precautionary measures or special instructions if you choose to install one of these devices.

SAFETY AND VEHICLE DAMAGE WARNING

This manual includes information titled as WARNING, CAUTION and NOTICE.
These titles indicate the following:

WARNING

This indicates that a condition may result in harm, serious injury, or death to you or other persons if the warning is not heeded. Follow the advice provided with the warning.

CAUTION

This indicates that a condition may result in damage to your vehicle or its equipment if the caution is not heeded. Follow the advice provided with the caution.

* NOTICE

This indicates that interesting or helpful information is being provided.

FOREWORD

Thank you for choosing HYUNDAI. We are pleased to welcome you to the growing number of discriminating people who drive HYUNDAI. The advanced engineering and high-quality construction of each HYUNDAI we build is something of which we're very proud.

Your Owner's Manual will introduce you to the features and operation of your new HYUNDAI. It is suggested that you read it carefully because the information it contains can contribute greatly to the satisfaction you receive from your new car.

The manufacturer also recommends that all service and maintenance on your car be performed by an authorized HYUNDAI dealer. HYUNDAI dealers are prepared to provide high-quality service, maintenance and any other assistance that may be required.

HYUNDAI MOTOR AMERICA

Note : Because future owners will also need the information included in this manual, if you sell this HYUNDAI, please leave the manual in the vehicle for their use. Thank you.

CAUTION

Severe engine and transmission damage may result from the use of poor quality fuels and lubricants that do not meet HYUNDAI specifications. You must always use high quality fuels and lubricants that meet the specifications listed on Page 8-6 in the Vehicle Specifications section of the Owner's Manual.

Copyright 2015 HYUNDAI Motor America. All rights reserved. No part of this publication may be reproduced, stored in any retrieval system or transmitted in any form or by any means without the prior written permission of HYUNDAI Motor America.

GUIDE TO HYUNDAI GENUINE PARTS

1. What are HYUNDAI Genuine Parts?

HYUNDAI Genuine Parts are the same parts used by HYUNDAI Motor Company to manufacture vehicles. They are designed and tested for the optimum safety, performance, and reliability to our customers.



2. Why should you use genuine parts?

HYUNDAI Genuine Parts are engineered and built to meet rigid manufacturing requirements. Damage caused by using imitation, counterfeit or used salvage parts is not covered under the HYUNDAI New Vehicle Limited Warranty or any other HYUNDAI warranty.

In addition, any damage to or failure of HYUNDAI Genuine Parts caused by the installation or failure of an imitation, counterfeit or used salvage part is not covered by any HYUNDAI Warranty.



3. How can you tell if you are purchasing HYUNDAI Genuine Parts?

Look for the HYUNDAI Genuine Parts Logo on the package (see below).

HYUNDAI Genuine Parts exported to the U.S. are packaged with labels written only in English.

HYUNDAI Genuine Parts are only sold through authorized HYUNDAI Dealerships.

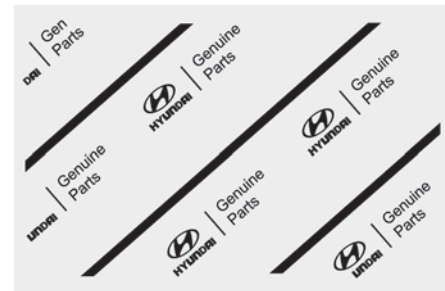

HOW TO USE THIS MANUAL

We want to help you get the greatest possible driving pleasure from your vehicle. Your Owner's Manual can assist you in many ways. We strongly recommend that you read the entire manual. In order to minimize the chance of death or injury, you must read the WARNING and CAUTION sections in this manual.

Illustrations complement the words in this manual to best explain how to enjoy your vehicle. By reading your manual, you will learn about features, important safety information, and driving tips under various road conditions.

The general layout of the manual is provided in the Table of Contents. A good place to start is the index; it has an alphabetical listing of all information in your manual.

Sections: This manual has eight chapter plus an index. Each chapter begins with a brief list of contents so you can tell at a glance if that chapter has the information you want.

You will find various WARNINGS, CAUTIONS, and NOTICES in this manual. These WARNINGS were prepared to enhance your personal safety. You should carefully read and follow ALL procedures and recommendations provided in these WARNINGS, CAUTIONS and NOTICES.

WARNING

A WARNING indicates a situation in which harm, serious bodily injury, or death could result if the warning is ignored.

CAUTION

A CAUTION indicates a situation in which damage to your vehicle could result if the caution is ignored.

* NOTICE

A NOTICE indicates interesting or helpful information is being provided.

FUEL REQUIREMENTS

Your new vehicle is designed to obtain maximum performance with UNLEADED FUEL, as well as minimize exhaust emissions and spark plug fouling.

3.8 engine

Your new vehicle is designed to use only unleaded fuel having an octane number $((R+M)/2)$ of 87 (Research Octane Number 91) or higher. (Do not use methanol blended fuels.)

5.0 engine

Your new vehicle is designed to use only unleaded fuel having an octane number $((R+M)/2)$ of 87 (Research Octane Number 91) or higher. For improved vehicle performance, premium unleaded fuel with an octane number $((R+M)/2)$ of 91 (Research Octane Number 96) or higher is recommended. (Do not use methanol blended fuels.)

⚠ CAUTION

Never add any fuel system cleaning agents to the fuel tank other than what has been specified. (Consult an authorized HYUNDAI dealer for details.)

⚠ WARNING

- Do not "top off" after the nozzle automatically shuts off when refueling.
- Tighten the cap until it clicks one time, otherwise the Check Engine  light will illuminate.
- Always check that the fuel cap is installed securely to prevent fuel spillage in the event of an accident.

Gasoline containing alcohol and methanol

Gasohol, a mixture of gasoline and ethanol (also known as grain alcohol), and gasoline or gasohol containing methanol (also known as wood alcohol) are being marketed along with or instead of leaded or unleaded gasoline.

Do not use gasohol containing more than 10% ethanol, and do not use gasoline or gasohol containing any methanol. Either of these fuels may cause drivability problems and damage to the fuel system, engine control system and emission control system.

Discontinue using gasohol of any kind if drivability problems occur.

Vehicle damage or drivability problems may not be covered by the manufacturer's warranty if they result from the use of:

1. Gasohol containing more than 10% ethanol.
2. Gasoline or gasohol containing methanol.
3. Leaded fuel or leaded gasohol.

"E85" fuel is an alternative fuel comprised of 85 percent ethanol and 15 percent gasoline, and is manufactured exclusively for use in Flexible Fuel Vehicles. "E85" is not compatible with your vehicle. Use of "E85" may result in poor engine performance and damage to your vehicle's engine and fuel system. HYUNDAI recommends that customers do not use fuel with an ethanol content exceeding 10 percent.

⚠ CAUTION

Your New Vehicle Limited Warranty does not cover damage to the fuel system or any performance problems caused by the use of "E85" fuel.

⚠ CAUTION

Never use gasohol which contains methanol. Discontinue use of any gasohol product which impairs driveability.

Other fuels

Using fuels such as;

- Silicone (Si) contained fuel,
- Ferrocene (Fe) contained fuel, and
- Other metallic additives contained fuels,

may cause vehicle and engine damage or cause plugging, misfiring, poor acceleration, engine stalling, catalyst melting, abnormal corrosion, life cycle reduction, etc.

Also, the Malfunction Indicator Lamp (MIL) may illuminate.

*** NOTICE**

Damage to the fuel system or performance problem caused by the use of these fuels may not be covered by your New Vehicle Limited Warranty.

Gasoline containing MMT

Some gasoline contains harmful manganese-based fuel additives such as MMT (Methylcyclopentadienyl Manganese Tricarbonyl).

HYUNDAI does not recommend the use of gasoline containing MMT.

This type of fuel can reduce vehicle performance and affect your emission control system.

The malfunction indicator lamp on the cluster may come on.

Do not use methanol

Fuels containing methanol (wood alcohol) should not be used in your vehicle.

This type of fuel can reduce vehicle performance and damage components of the fuel system, engine control system and emission control system.



CAUTION

Your New Vehicle Limited Warranty may not cover damage to the fuel system and any performance problems that are caused by the use of fuels containing methanol.

Fuel Additives

HYUNDAI recommends that you use good quality gasolines treated with detergent additives such as TOP TIER Detergent Gasoline, which help prevent deposit formation in the engine.

VEHICLE BREAK-IN PROCESS

These gasolines will help the engine run cleaner and enhance performance of the Emission Control System. For more information on TOP TIER Detergent Gasoline, please go to the website (www.toptiergas.com).

For customers who do not use TOP Tier Detergent Gasoline regularly, and have problems starting or the engine does not run smoothly, additives that you can buy separately may be added to the gasoline. If TOP TIER Detergent Gasoline is not available, one bottle of additive added to the fuel tank at every 7,500 miles or every engine oil change is recommended. Additives are available from your authorized HYUNDAI dealer along with information on how to use them. Do not mix other additives.

Operation in foreign countries

If you are going to drive your vehicle in another country, be sure to:

- Observe all regulations regarding registration and insurance.
- Determine that acceptable fuel is available.

No special break-in period is needed. By following a few simple precautions for the first 600 miles (1,000 km) you may add to the performance, economy and life of your vehicle.

- Do not race the engine.
- While driving, keep your engine speed (rpm, or revolutions per minute) between 2,000 rpm and 4,000 rpm.
- Do not maintain a single speed for long periods of time, either fast or slow. Varying engine speed is needed to properly break-in the engine.
- Avoid hard stops, except in emergencies, to allow the brakes to seat properly.

⚠ CALIFORNIA PROPOSITION 65 WARNING

Items contained in motor vehicles or emitted from them are known to the State of California to cause cancer and birth defects or reproductive harm. These include:

- Gasoline and its vapors
- Engine exhaust
- Used engine oil
- Interior passenger compartment components and materials
- Component parts which are subject to heat and wear

In addition, battery posts, terminals and related accessories contain lead, lead compounds and other chemicals known to the State of California to cause cancer and reproductive harm.

VEHICLE DATA COLLECTION AND EVENT DATA RECORDERS

This vehicle is equipped with an event data recorder (EDR). The main purpose of an EDR is to record, in certain crash or near crash-like situations, such as an air bag deployment or hitting a road obstacle, data that will assist in understanding how a vehicle's systems performed. The EDR is designed to record data related to vehicle dynamics and safety systems for a short period of time, typically 30 seconds or less. The EDR in this vehicle is designed to record such data as:

- How various systems in your vehicle were operating;
- Whether or not the driver and passenger safety belts were buckled/ fastened;
- How far (if at all) the driver was depressing the accelerator and/or brake pedal; and,
- How fast the vehicle was traveling.

These data can help provide a better understanding of the circumstances in which crashes and injuries occur. **NOTE:** EDR data are recorded by your vehicle only if a non-trivial crash situation occurs; no data are recorded by the EDR under normal driving conditions and no personal data (e.g., name, gender, age, and crash location) are recorded. However, other parties, such as law enforcement, could combine the EDR data with the type of personally identifying data routinely acquired during a crash investigation.

To read data recorded by an EDR, special equipment is required, and access to the vehicle or the EDR is needed. In addition to the vehicle manufacturer, other parties, such as law enforcement, that have the special equipment, can read the information if they have access to the vehicle or the EDR.

TABLE OF CONTENTS

Your vehicle at a glance	1
Safety system of your vehicle	2
Convenient features of your vehicle	3
Multimedia System	4
Driving your vehicle	5
What to do in an emergency	6
Maintenance	7
Specifications, Consumer information and Reporting safety defects	8
Index	I

1 Your vehicle at a glance

Exterior overview (I)	1-2
Exterior overview (II)	1-3
Interior overview	1-4
Instrument panel overview (I)	1-5
Instrument panel overview (II)	1-6
Engine compartment	1-7

2 Safety system of your vehicle

Important safety precautions	2-2
Always wear your seat belt	2-2
Restrain all children	2-2
Air bag hazards	2-2
Driver distraction	2-2
Control your speed	2-3
Keep your vehicle in safe condition	2-3
Seats	2-4
Safety precautions	2-5
Front seats	2-6
Rear seats	2-11
Headrest	2-14
Seat warmers and coolers	2-18

Seat belts	2-22
Seat belt safety precautions	2-22
Seat belt warning light	2-23
Seat belt restraint system	2-25
Pre-Safe Seat belt (PSB)	2-30
Additional seat belt safety precautions	2-31
Care of seat belts	2-34
Child restraint system (CRS)	2-35
Selecting a child restraint system (CRS)	2-36
Installing a child restraint system (CRS)	2-38
Air bag -	
advanced supplemental restraint system	2-46
Where are the air bags?	2-48
How does the air bags system operate?	2-51
What to expect after an air bag inflates	2-56
Occupant classification system (OCS)	2-57
Why didn't my air bag go off in a collision? (Air bags are not designed to inflate in every collision.)	2-61
SRS care	2-66
Additional safety precautions	2-67
Air bag warning labels	2-68

3 Convenient features of your vehicle

Accessing your vehicle	3-4
Smart key	3-4
Smart key precautions	3-7
Immobilizer System	3-9
Door locks	3-11
Operating door locks from outside the vehicle	3-11
Power Door Latch	3-12
Operating door locks from inside the vehicle	3-12
Auto door lock/unlock features	3-14
Child-protector rear door locks	3-14
Theft-alarm system	3-15
Driver position memory system	3-16
Storing positions into memory	3-16
Resetting the driver's seat memory system	3-17
Easy access function	3-18
Steering wheel	3-19
Electric power steering (EPS)	3-19
Tilt steering / Telescope steering	3-19
Heated steering wheel	3-20
Horn	3-21
Mirrors	3-22
Inside rearview mirror	3-22
Outside rearview mirror	3-36
Reverse parking aid function	3-39
Windows	3-40
Power windows	3-41
Panorama sunroof	3-44
Sunshade	3-44
Sliding the sunroof	3-45
Tilting the sunroof	3-45
Closing the sunroof	3-46
Resetting the sunroof	3-47
Exterior features	3-48
Hood	3-48
Trunk	3-49
Smart trunk	3-55
Fuel filler door	3-59
Instrument cluster	3-62
Instrument Cluster Control	3-63
LCD Display Control	3-63
Gauges	3-64

LCD display	3-68	Light	3-110
LCD Modes.....	3-68	Exterior lights	3-110
Trip Computer Mode.....	3-69	Smart High Beam	3-112
Turn By Turn (TBT) Mode	3-70	Welcome system	3-117
ASCC/LKAS Mode	3-70	Interior lights.....	3-118
A/V Mode.....	3-70	Wipers and washers	3-123
Information Mode	3-71	Windshield wipers	3-123
User Settings Mode.....	3-73	Windshield washers	3-125
Warning Messages.....	3-80	Driver assist system	3-126
Trip computer	3-90	Rear view camera.....	3-126
Overview.....	3-90	Parking Guide System.....	3-127
Trip A/B.....	3-91	Parking Assist System	3-128
Fuel Economy.....	3-92	Defroster	3-132
Digital Speedometer	3-94	Rear window defroster	3-132
Warning and indicator lights	3-95	Automatic climate control system	3-134
Warning lights	3-95	Automatic heating and air conditioning.....	3-135
Indicator Lights.....	3-103	Manual heating and air conditioning.....	3-136
Head Up Display (HUD)	3-107	System operation.....	3-144
Description.....	3-107	Climate control air filter	3-146
Head Up Display ON/OFF	3-108	Air conditioner refrigerant and compressor	
Head Up Display Information.....	3-108	lubricant	3-147
Head Up Display Setting	3-109	Air Conditioning refrigerant label.....	3-147
		Windshield defrosting and defogging	3-148
		Auto defogging system ON/OFF.....	3-150

Climate control additional features.....	3-151
Cluster ionizer.....	3-151
Smart ventilation.....	3-151
Rear climate system ON/OFF.....	3-152
CO2 control auto air conditioner.....	3-152
Storage compartment.....	3-153
Center console storage.....	3-153
Glove box.....	3-154
Sunglass holder.....	3-154
Interior features.....	3-155
Cup holder.....	3-155
Sunvisor.....	3-156
Power outlet.....	3-156
Clock.....	3-158
Clothes hanger.....	3-158
Bag hanger.....	3-159
Floor mat anchor(s).....	3-159
Rear curtain.....	3-160
Side curtain.....	3-161
Luggage net holder.....	3-162

4 Multimedia system

Multimedia system.....	4-2
AUX, USB and iPod® port.....	4-2
Antenna.....	4-3
Steering wheel audio control.....	4-4
Audio / Video / Navigation system (AVN).....	4-5
Bluetooth® Wireless Technology hands-free.....	4-5

5 Driving your vehicle

Before driving.....	5-4
Before entering the vehicle.....	5-4
Before starting.....	5-4
Engine Start/Stop button.....	5-6
Automatic transmission.....	5-11
Automatic transmission operation.....	5-11
Parking.....	5-17
Good driving practices.....	5-17
All Wheel Drive (AWD).....	5-19
Using All Wheel Drive (AWD).....	5-19
Emergency precautions.....	5-21

Braking system	5-23	Sensor to detect distance to the vehicle ahead.....	5-62
Power brakes	5-23	Limitations of the system	5-64
Disc brakes wear indicator	5-24	Lane Keeping Assist System (LKAS)	5-69
Foot parking brake	5-24	LKAS operation.....	5-70
Electric parking brake (EPB).....	5-26	LKAS malfunction.....	5-75
AUTO HOLD	5-31	LKAS function change	5-76
Anti-lock Brake System (ABS)	5-35	Blind Spot Detection System (BSD)	5-78
Electronic Stability Control (ESC).....	5-38	BSD (Blind Spot Detection) /	
Hill-Start Assist Control (HAC).....	5-41	LCA (Lane Change Assist).....	5-79
Good braking practices.....	5-41	RCTA (Rear Cross Traffic Alert)	5-82
Drive mode integrated control system	5-42	Special driving conditions	5-86
Electronic Control Suspension (ECS)	5-44	Hazardous driving conditions.....	5-86
ECS malfunction indicator.....	5-44	Rocking the vehicle	5-86
Autonomous Emergency Braking (AEB)	5-45	Smooth cornering	5-87
AEB operation.....	5-46	Driving at night.....	5-87
To cancel the AEB	5-47	Driving in the rain.....	5-88
Warning light and message	5-48	Driving in flooded areas.....	5-88
Cruise control	5-50	Winter driving	5-89
Cruise control operation.....	5-50	Snow or icy conditions.....	5-89
Advanced smart cruise control system	5-54	Use high quality ethylene glycol coolant	5-91
To convert to cruise control mode.....	5-55	Check battery and cables	5-91
Smart cruise control speed	5-55	Change to "winter weight" oil if necessary.....	5-92
Cancelled automatically	5-58	Check spark plugs and ignition system.....	5-92
Smart cruise control vehicle-to-vehicle distance.....	5-60	To keep locks from freezing.....	5-92

Use approved window washer anti-freeze in system.....	5-92
Don't let your parking brake freeze.....	5-92
Don't let ice and snow accumulate underneath.....	5-92
Carry emergency equipment.....	5-93
Don't place foreign objects or materials in the engine compartment.....	5-93
Vehicle load limit.....	5-93
Tire loading information label.....	5-94
Trailer towing.....	5-98

6 What to do in an emergency

Hazard warning flasher.....	6-2
In case of an emergency while driving.....	6-2
If the engine stalls while driving.....	6-2
If the engine stalls at a crossroad or crossing.....	6-2
If you have a flat tire while driving.....	6-3
If the engine will not start.....	6-3
If the engine doesn't turn over or turns over slowly.....	6-3
If the engine turns over normally but doesn't start.....	6-3

Jump starting.....	6-4
Push-starting.....	6-6
If the engine overheats.....	6-7
Tire Pressure Monitoring System (TPMS).....	6-9
Check tire pressure.....	6-9
Tire pressure monitoring system.....	6-10
Low tire pressure telltale.....	6-11
Low tire pressure position and tire pressure telltale.....	6-11
TPMS (Tire Pressure Monitoring System) malfunction indicator.....	6-12
Changing a tire with TPMS.....	6-13
If you have a flat tire.....	6-15
Jack and tools.....	6-15
Changing tires.....	6-16
Jack label.....	6-21
Towing.....	6-22
Towing service.....	6-22
Removable towing hook.....	6-23
Emergency towing.....	6-24

7 Maintenance

Engine compartment	7-3
Maintenance services	7-5
Owner's responsibility	7-5
Owner maintenance precautions	7-5
Owner maintenance.....	7-6
Owner maintenance schedule.....	7-7
Scheduled maintenance services.....	7-8
Normal maintenance schedule.....	7-9
Maintenance under severe usage conditions.....	7-22
Explanation of scheduled maintenance items.....	7-24
Engine oil	7-27
Checking the engine oil level	7-27
Checking the engine oil and filter	7-28
Engine coolant.....	7-29
Checking the engine coolant level.....	7-29
Changing engine coolant.....	7-31
Brake fluid	7-32
Checking the brake fluid level	7-32
Washer fluid	7-34
Checking the washer fluid level	7-34
Parking brake	7-34
Checking the parking brake	7-34
Air cleaner	7-35
Filter replacement.....	7-35
Climate control air filter	7-36
Filter inspection.....	7-36
Wiper blades.....	7-38
Blade inspection	7-38
Blade replacement	7-38
Battery.....	7-40
For best battery service.....	7-41
Battery recharging	7-42
Reset features	7-44
Tires and wheels.....	7-45
Tire care.....	7-45
Recommended cold tire inflation pressures.....	7-46
Check tire inflation pressure.....	7-47
Tire rotation	7-48
Wheel alignment and tire balance	7-49
Tire replacement	7-49
Wheel replacement.....	7-50
Tire traction.....	7-50
Tire maintenance	7-51
Tire sidewall labeling.....	7-51
Tire terminology and definitions.....	7-55
All season tires	7-58
Summer tires	7-58
Snow tires	7-58

Radial-ply tires	7-59
Low aspect ratio tires	7-59
Fuses	7-61
Instrument panel fuse replacement	7-62
Engine compartment panel fuse replacement.....	7-64
Fuse/Relay panel description	7-66
Light bulbs	7-79
Headlamp, position lamp, turn signal lamp, side marker and front fog lamp bulb replacement	7-79
Side repeater lamp replacement	7-83
Rear combination light bulb replacement	7-83
High mounted stop lamp	7-85
License plate light bulb replacement	7-86
Interior light bulb replacement	7-86
Appearance care	7-87
Exterior care	7-87
Interior care.....	7-92
Emission control system	7-94
California perchlorate notice	7-98

8 Specifications, Consumer information and Reporting safety defects

Dimensions	8-2
Engine	8-2
Bulb wattage	8-3
Tires and wheels	8-4
Luggage volume	8-5
Air conditioning system	8-5
Gross vehicle weight	8-5
Recommended lubricants and capacities	8-6
Recommended SAE viscosity number	8-7
Vehicle identification number (VIN).....	8-8
Vehicle certification label	8-8
Tire specification and pressure label	8-9
Engine number	8-9
Refrigerant label	8-9
Consumer information.....	8-10
Reporting safety defects.....	8-11

Your vehicle at a glance

Exterior overview (I)	1-2
Exterior overview (II)	1-3
Interior overview.....	1-4
Instrument panel overview (I).....	1-5
Instrument panel overview (II).....	1-6
Engine compartment	1-7

EXTERIOR OVERVIEW (I)

■ Front view

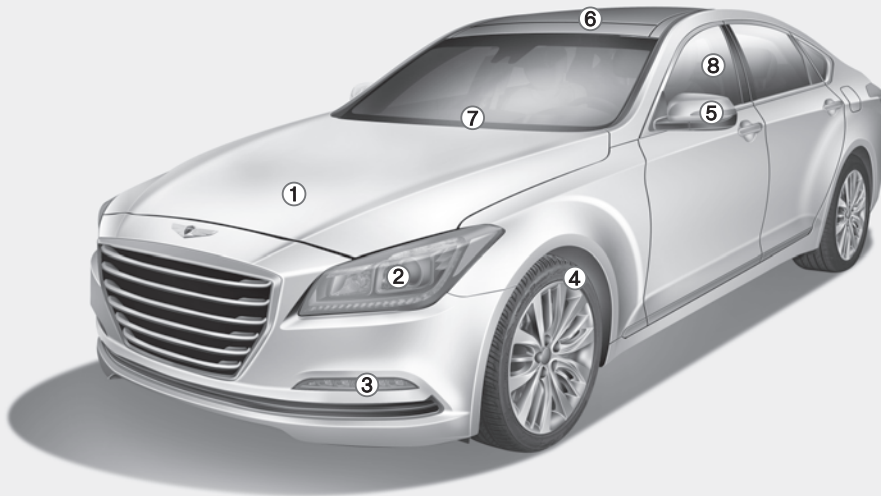

1. Hood	3-48
2. Headlamp	7-79
3. Front fog light.....	7-79
4. Tires and wheels	7-45
5. Outside rearview mirror	3-36
6. Panorama sunroof	3-44
7. Front windshield wiper blades	7-39
8. Windows	3-40

The actual shape may differ from the illustration.

ODH014001CN

EXTERIOR OVERVIEW (II)

■ Rear view

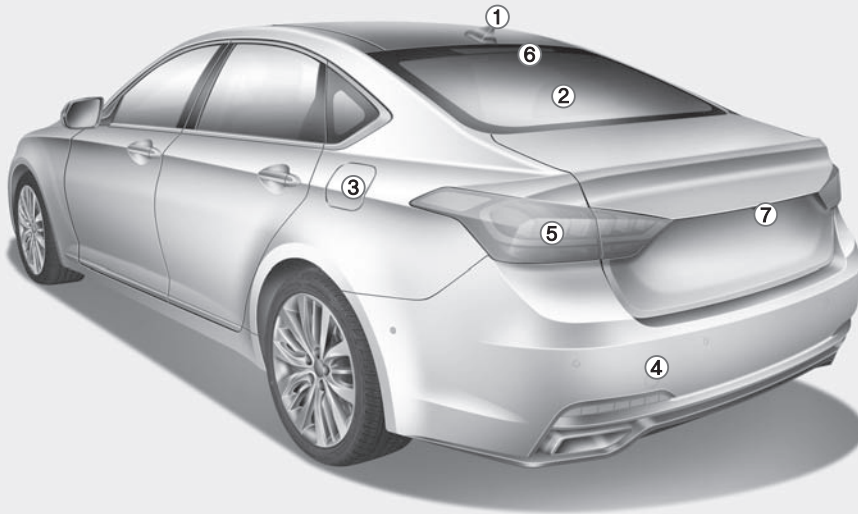

- 1. Antenna4-3
- 2. Defroster3-132
- 3. Fuel filler lid3-59
- 4. Towing hook6-23
- 5. Rear combination lamp7-83
- 6. High mounted stop lamp7-85
- 7. Rearview camera.....3-126

The actual shape may differ from the illustration.

ODH014002N

INTERIOR OVERVIEW

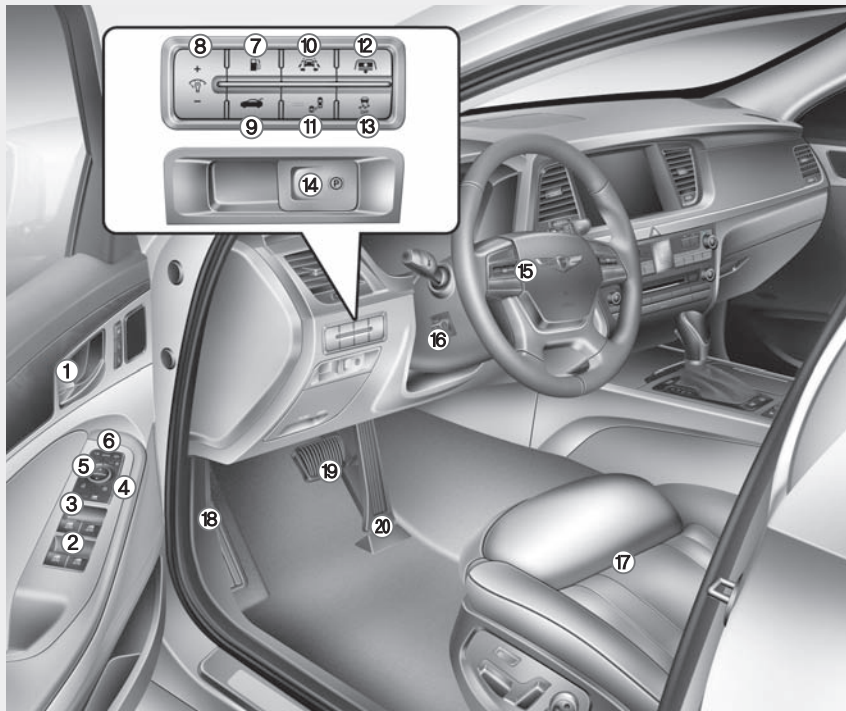

- 1. Door lock/unlock button3-12
- 2. Power window switches3-40
- 3. Power window lock switch3-43
- 4. Central door lock switch3-13
- 5. Outside rearview mirror control switch3-37
- 6. Outside rearview mirror folding button3-38
- 7. Fuel filler lid release button3-59
- 8. Instrument panel illumination control switch3-63
- 9. Trunk release button3-49
- 10. Lane keeping assist system button* ..5-69
- 11. Blind spot detection system button* ..5-78
- 12. Rear curtain button*3-160
- 13. ESC OFF button5-38
- 14. Electric parking brake switch*5-26
- 15. Steering wheel3-19
- 16. Steering wheel tilt/telescope control ..3-19
- 17. Seat2-4
- 18. Hood release lever3-48
- 19. Brake pedal5-23
- 20. Accelerator pedal

* : if equipped

The actual shape may differ from the illustration.

ODH014003N

INSTRUMENT PANEL OVERVIEW (I)

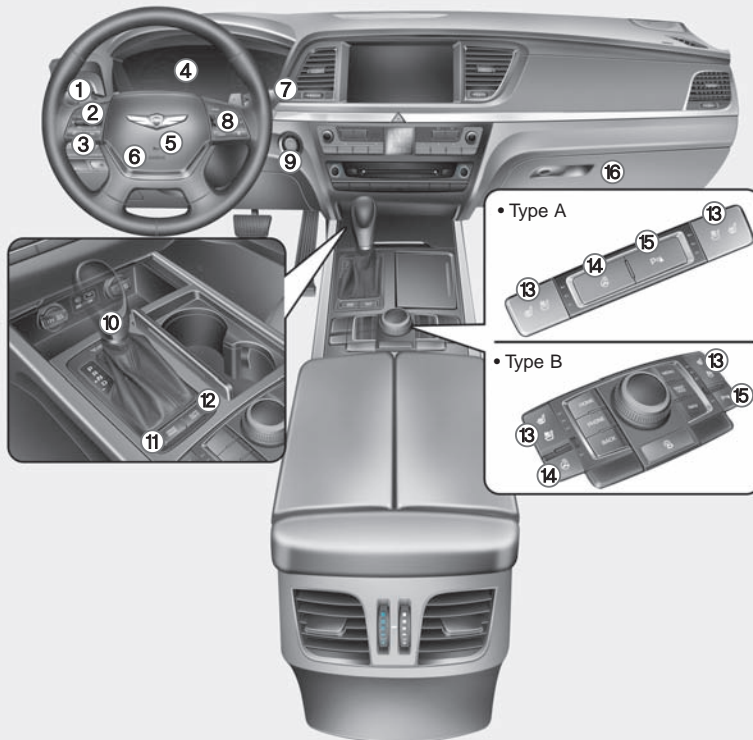

1. Light control/Turn signals..3-110 / 3-114
 2. Steering wheel audio controls*4-4
 3. *Bluetooth*[®] wireless technology hands-free controls*4-5
 4. Instrument cluster3-62
 5. Horn3-21
 6. Driver's front air bag.....2-48
 7. Wiper/Washer.....3-123
 8. Advanced smart cruise controls*5-54
 9. Engine start/stop button.....5-6
 10. Automatic transmission5-11
 11. Drive mode integrated control system5-42
 12. AUTO HOLD5-31
 13. Seat warmers and coolers.....2-18
 14. Heated steering wheel button3-20
 15. Parking assist system3-128
 16. Glove box3-154
- * : if equipped

The actual shape may differ from the illustration.

ODH014004N

INSTRUMENT PANEL OVERVIEW (II)

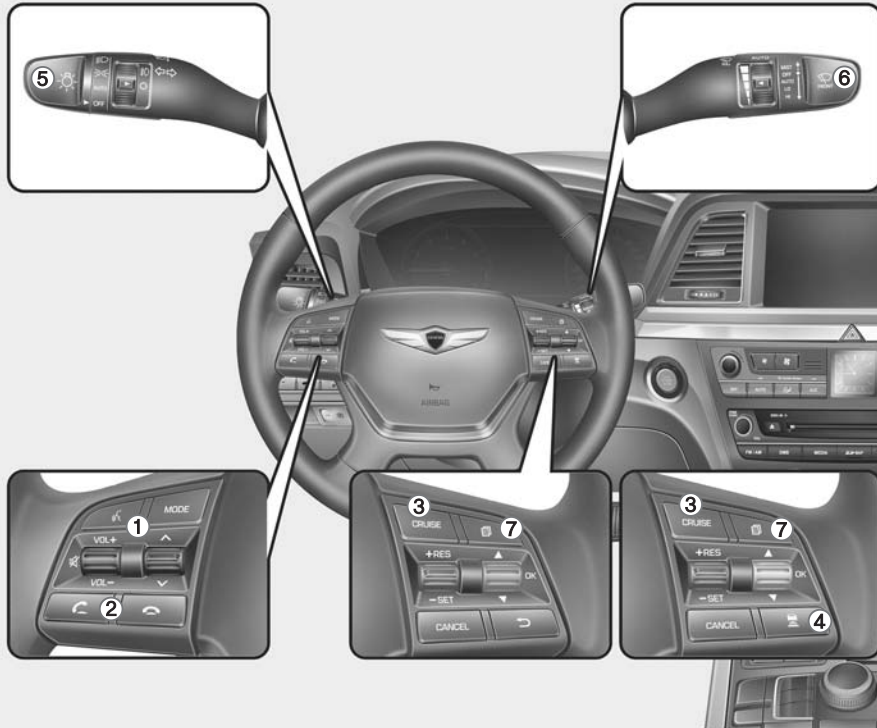

- 1. Audio remote control buttons.....4-4
- 2. *Bluetooth*[®] wireless technology hands-free button.....4-5
- 3. Cruise control button / Advanced smart cruise control button5-50 / 5-54
- 4. Smart cruise control vehicle-to-vehicle distance button5-59
- 5. Light control / Turn signals lever3-110 / 3-114
- 6. Wiper and washer control lever3-123
- 7. LCD display control.....3-63

The actual shape may differ from the illustration.

ODH014006N

ENGINE COMPARTMENT

■ Gasoline Engine (Lambda 3.8)

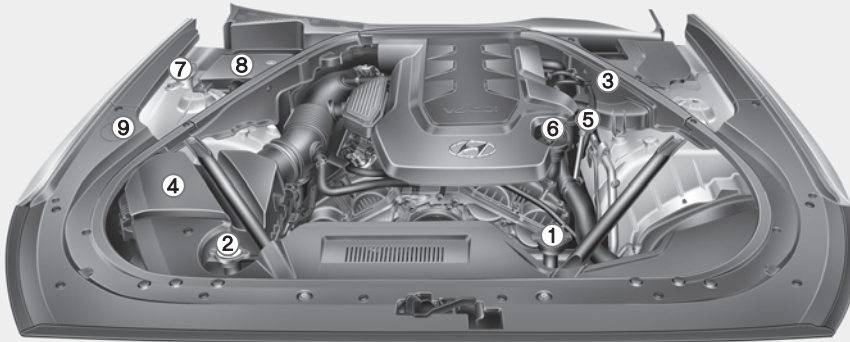

■ Gasoline Engine (Tau 5.0)

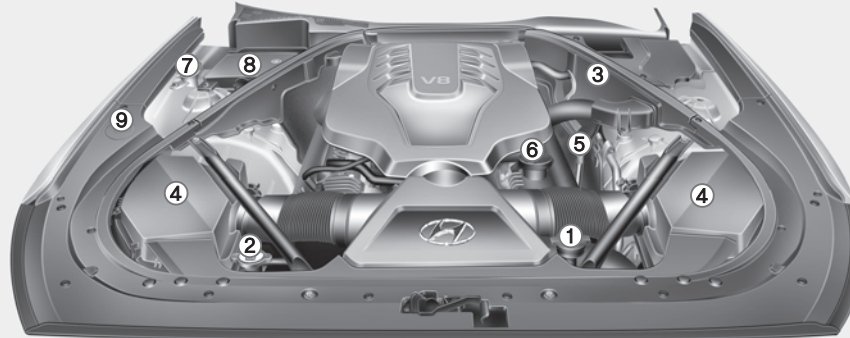

- 1. Engine coolant reservoir7-29
- 2. Radiator cap7-29
- 3. Brake fluid reservoir7-32
- 4. Air cleaner.....7-35
- 5. Engine oil dipstick7-27
- 6. Engine oil filler cap7-28
- 7. Windshield washer fluid reservoir7-34
- 8. Fuse box7-61
- 9. Jumper terminal6-5

The actual engine room in the vehicle may differ from the illustration.

ODH013005/ODH013006L

Safety system of your vehicle

- Important safety precautions.....2-2
 - Always wear your seat belt2-2
 - Restrain all children2-2
 - Air bag hazards2-2
 - Driver distraction2-2
 - Control your speed2-3
 - Keep your vehicle in safe condition2-3
- Seats2-4
 - Safety precautions2-5
 - Front seats.....2-6
 - Rear seats2-11
 - Headrest2-14
 - Seat warmers and coolers.....2-18
- Seat belts2-22
 - Seat belt safety precautions2-22
 - Seat belt warning light2-23
 - Seat belt restraint system2-25
 - Pre-Safe Seat belt (PSB).....2-30
 - Additional seat belt safety precautions2-31
 - Care of seat belts2-34
- Child restraint system (CRS)2-35
 - Selecting a child restraint system (CRS)2-36
 - Installing a child restraint system (CRS)2-38

- Air bag -
advanced supplemental restraint system2-46
 - Where are the air bags?2-48
 - How does the air bags system operate?2-51
 - What to expect after an air bag inflates.....2-56
 - Occupant classification system (OCS)2-57
 - Why didn't my air bag go off in a collision? (Air bags are not designed to inflate in every collision.)2-61
 - SRS care2-66
 - Additional safety precautions2-67
 - Air bag warning labels.....2-68

IMPORTANT SAFETY PRECAUTIONS

You will find many safety precautions and recommendations throughout this section, and throughout this manual. The safety precautions in this section are among the most important.

Always wear your seat belt

A seat belt is your best protection in all types of accidents. Air bags are designed to supplement seat belts, not replace them. So even though your vehicle is equipped with air bags, ALWAYS make sure you and your passengers wear your seat belts, and wear them properly.

Restrain all children

All children under age 13 should ride in your vehicle properly restrained in a rear seat, not the front seat. Infants and small children should be restrained in an appropriate child restraint. Larger children should use a booster seat with the lap/shoulder belt until they can use the seat belt properly without a booster seat.

Air bag hazards

While air bags can save lives, they can also cause serious or fatal injuries to occupants who sit too close to them, or who are not properly restrained. Infants, young children, and shorter adults are at the greatest risk of being injured by an inflating air bag. Follow all instructions and warnings in this manual.

Driver distraction

Driver distraction presents a serious and potentially deadly danger, especially for inexperienced drivers. Safety should be the first concern when behind the wheel and drivers need to be aware of the wide array of potential distractions, such as drowsiness, reaching for objects, eating, personal grooming, other passengers, and using cellular phones.

Drivers can become distracted when they take their eyes and attention off the road or their hands off the wheel to focus on activities other than driving. To reduce your risk of distraction or getting into an accident:

- ALWAYS set up your mobile devices (i.e., MP3 players, phones, navigation units, etc.) when your vehicle is parked or safely stopped.
- ONLY use your mobile device when allowed by laws and when conditions permit safe use. NEVER text or email while driving. Most states have laws prohibiting drivers from texting. Some states and cities also prohibit drivers from using handheld phones.

-
- NEVER let the use of a mobile device distract you from driving. You have a responsibility to your passengers and others on the road to always drive safely, with your hands on the wheel as well as your eyes and attention on the road.

Control your speed

Excessive speed is a major factor in crash injuries and deaths. Generally, the higher the speed, the greater the risk, but serious injuries can also occur at lower speeds. Never drive faster than is safe for current conditions, regardless of the maximum speed posted.

Keep your vehicle in safe condition

Having a tire blowout or a mechanical failure can be extremely hazardous. To reduce the possibility of such problems, check your tire pressures and condition frequently, and perform all regularly scheduled maintenance.

SEATS

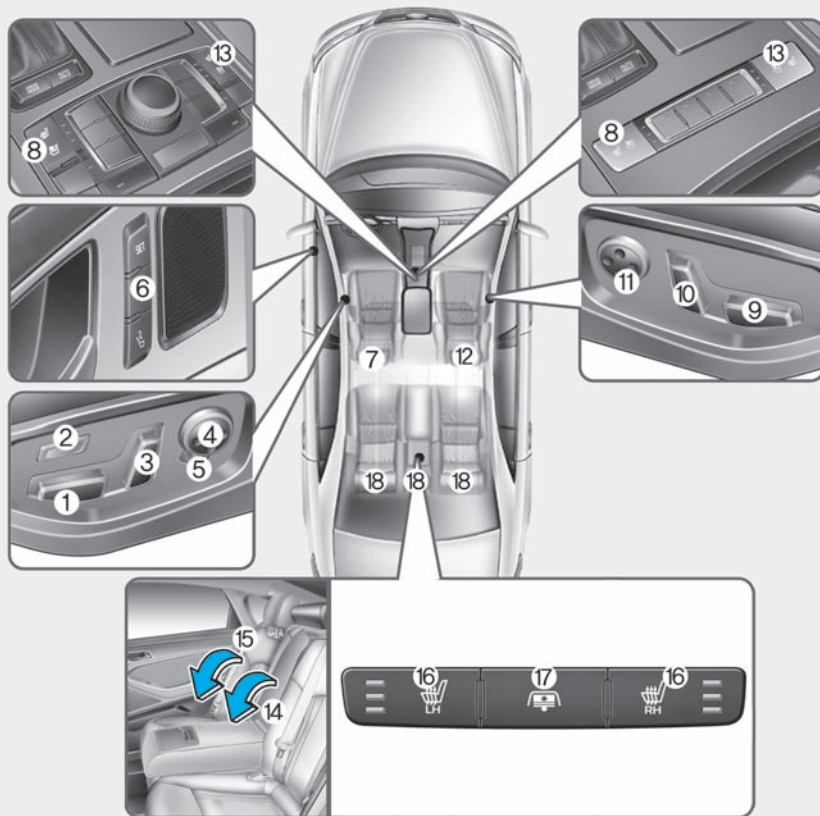

Driver's seat

- (1) Seat sliding forward or rearward/
Seat tilt/height adjustment
- (2) Seat cushion length adjustment
- (3) Seatback angle adjustment
- (4) Lumbar support adjustment
- (5) Seat bolster adjustment*
- (6) Driver position memory system*
- (7) Headrest adjustment
- (8) Seat warmer/Seat warmer and cooler (by air)*

Front passenger's seat

- (9) Seat sliding forward or rearward/
Seat tilt/height adjustment
- (10) Seatback angle adjustment
- (11) Lumbar support adjustment*
- (12) Headrest adjustment
- (13) Seat warmer/Seat warmer and cooler (by air)*

Rear seat

- (14) Ski through
- (15) Armrest
- (16) Seat warmer*
- (17) Rear curtain control*
- (18) Headrest height adjustment

* : if equipped

ODH035001N

Safety precautions

Adjusting the seats so that you are sitting in a safe, comfortable position plays an important role in driver and passenger safety together with the seat belts and air bags in an accident.

WARNING

Do not use a cushion that reduces friction between the seat and the passenger. The passenger's hips may slide under the lap portion of the seat belt during an accident or a sudden stop. Serious or fatal internal injuries could result because the seat belt cannot operate properly.

Air bags

You can take steps to reduce the risk of being injured by an inflating air bag. Sitting too close to an air bag greatly increases the risk of injury in the event the air bag inflates.

The National Highway Traffic Safety Administration (NHTSA) recommends that drivers allow at least 10 inches (25 cm) between the center of the steering wheel and their chest.

WARNING

To reduce the risk of serious injury or death from an inflating air bag, take the following precautions:

- **Adjust the driver's seat as far to the rear as possible while maintaining the ability to maintain full control of the vehicle.**
- **Adjust the front passenger seat as far to the rear as possible.**
- **Hold the steering wheel by the rim with hands at the 9 o'clock and 3 o'clock positions to minimize the risk of injuries to your hands and arms.**
- **NEVER place anything or anyone between the steering wheel and the air bag.**
- **Do not allow the front passenger to place feet or legs on the dashboard to minimize the risk of leg injuries.**

Seat belts

Always fasten your seat belt before starting any trip.

At all times, passengers should sit upright and be properly restrained. Infants and small children must be restrained in appropriate child restraint systems. Children who have outgrown a booster seat and adults must be restrained using the seat belts.

⚠ WARNING

Take the following precautions when adjusting your seat belt:

- NEVER use one seat belt for more than one occupant.
- Always position the seatback upright with the lap portion of the seat belt snug and low across the hips.
- NEVER allow children or small infants to ride in a passenger's lap.
- Do not route the seat belt across your neck, across sharp edges, or reroute the shoulder strap away from your body.
- Do not allow the seat belt to become caught or jammed.

Front seats

⚠ WARNING

Take the following precautions when adjusting your seat:

- NEVER attempt to adjust the seat while the vehicle is moving. The seat could respond with unexpected movement and may cause loss of vehicle control resulting in an accident.
- Do not place anything under the front seats. Loose objects in the driver's foot area could interfere with the operation of the foot pedals, causing an accident.
- Do not allow anything to interfere with the normal position and proper locking of the seatback.
- Do not place a cigarette lighter on the floor or seat. When you operate the seat, gas may exit out of the lighter causing a fire.

(Continued)

(Continued)

- Use extreme caution when picking small objects trapped under the seats or between the seat and the center console. Your hands might be cut or injured by the sharp edges of the seat mechanism.

⚠ WARNING

To prevent injury:

- Do not adjust your seat while wearing your seat belt. Moving the seat cushion forward may cause strong pressure on your abdomen.
- Do not allow your hands or fingers to get caught in the seat mechanisms while the seat is moving.

Power adjustment

The front seat can be adjusted by using the control switches located on the outside of the seat cushion. Before driving, adjust the seat to the proper position so that you can easily control the steering wheel, foot pedals and controls on the instrument panel.

WARNING

NEVER allow children in the vehicle unattended. The power seats are operable when the engine is turned off.

CAUTION

To prevent damage to the seats:

- **Always stop adjusting the seats when the seat has been adjusted as far forward or rearward as possible.**
- **Do not adjust the seats longer than necessary when the engine is turned off. This may result in unnecessary battery drain.**
- **Do not operate two or more seats at the same time. This may result in an electrical malfunction.**

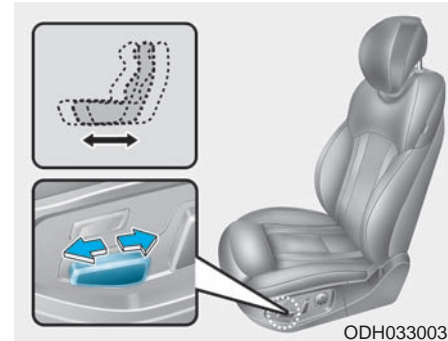

Forward and rearward adjustment

To move the seat forward or rearward:

1. Push the control switch forward or rearward.
2. Release the switch once the seat reaches the desired position.

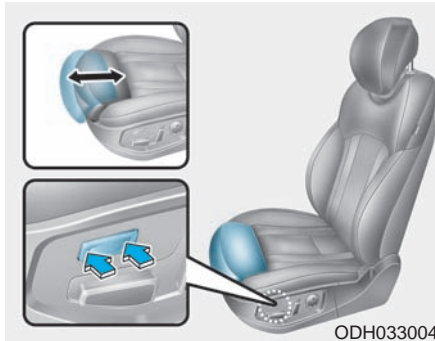

Seat cushion length adjustment (for driver's seat, if equipped)

To move the front part of cushion forward:

1. Push the front part of control switch to move the seat cushion to the desired length.
2. Release the switch once the seat cushion reaches the desired length.

To move the front part of cushion rearward:

1. Push the rear part of control switch to move the seat cushion to the desired length.
2. Release the switch once the seat cushion reaches the desired length.

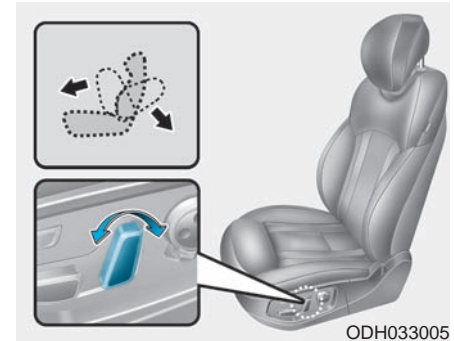

Seatback angle

To recline the seatback:

1. Push the control switch forward or rearward.
2. Release the switch once the seatback reaches the desired position.

Reclining seatback

Sitting in a reclined position when the vehicle is in motion can be dangerous. Even when buckled up, the protections of your restraint system (seat belts and air bags) is greatly reduced by reclining your seatback.

WARNING

NEVER ride with a reclined seatback when the vehicle is moving. Riding with a reclined seatback increases your chance of serious or fatal injuries in the event of a collision or sudden stop.

Driver and passengers should **ALWAYS** sit well back in their seats, properly belted, and with the seatbacks upright.

Seat belts must be snug against your hips and chest to work properly. When the seatback is reclined, the shoulder belt cannot do its job because it will not be snug against your chest. Instead, it will be in front of you. During an accident, you could be thrown into the seat belt, causing neck or other injuries.

The more the seatback is reclined, the greater chance the passenger's hips will slide under the lap belt or the passenger's neck will strike the shoulder belt.

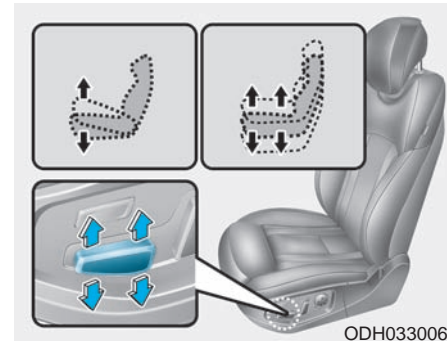

Seat cushion height

To change the height of the seat cushion:

1. Pull the front portion of the control switch up to raise or push down to lower the front part of the seat cushion. Pull the rear portion of the control switch up to raise or push down to lower the seat cushion.
2. Release the switch once the seat reaches the desired position.

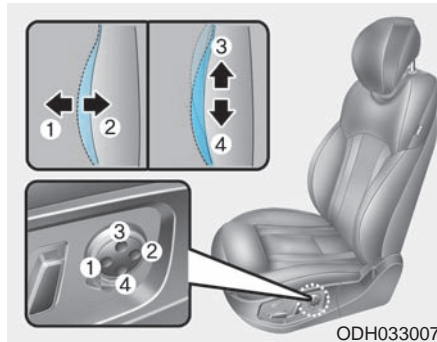

According to the equipped feature, the lumbar support does not operate up or down when the lumbar support is in the rearmost position.

In this case, to use the system, slightly increase support by pushing the front portion of the switch (1).

Lumbar support

- The lumbar support can be adjusted by pressing the lumbar support switch.
- Press the front portion of the switch (1) to increase support or the rear portion of the switch (2) to decrease support.
- To move the support position up or down, press switch (3) or (4).

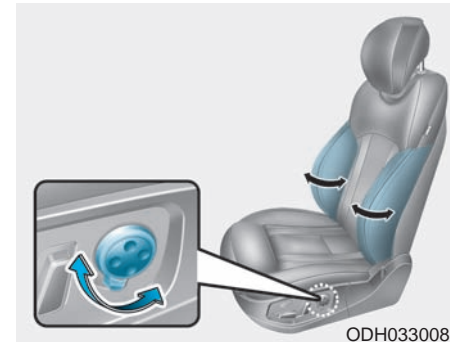

Seat bolster adjustment (for driver's seat, if equipped)

To change the height of seat bolster:

1. Pull or push the lever.
2. Release the lever once the bolster reaches the desired position.

Seatback pocket

■ Type A

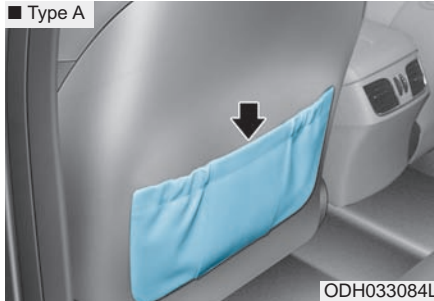

■ Type B

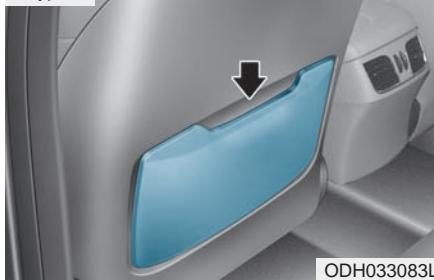

The seatback pocket is provided on the back of the front seatbacks.

⚠ WARNING

To prevent the occupant classification system from malfunctioning:

Do not hang onto the front passenger's seatback.

⚠ WARNING

Do not put heavy or sharp objects in the seatback pockets. In an accident they could come loose from the pocket and injure occupants.

Rear seats

⚠ WARNING

NEVER allow children in the car unattended. The power seats are operable when the engine is turned off.

⚠ WARNING

To prevent injury:

- Do not adjust your seat while wearing your seat belt. Moving the seat cushion forward may cause strong pressure on your abdomen.
- Do not allow your hands or fingers to get caught in the seat mechanisms while the seat is moving.

Armrest

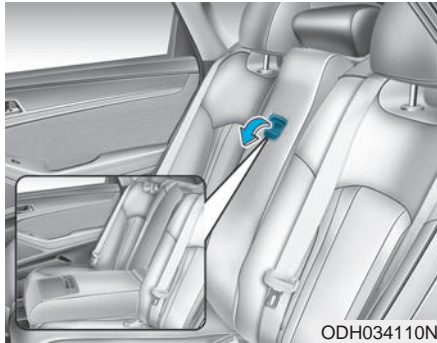

The armrest is located in the center of the rear seat. Pull the armrest down from the seatback to use it.



Cup holder

To use the cup holder, open the cover (1).

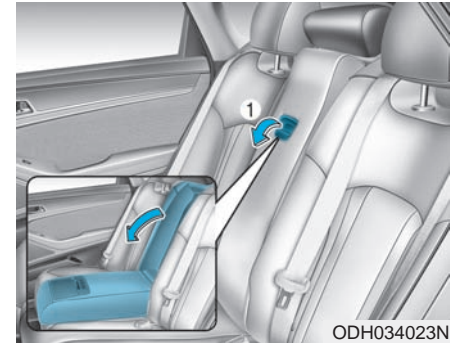

Carrying long/narrow cargo

Additional cargo space is provided to accommodate long/narrow cargo (skis, poles, etc.) not able to fit properly in the trunk when closed.

1. Pull (1) the armrest down.
2. Pull the cover down while pushing the release lever down.

⚠ CAUTION

- Make sure the engine is off, the shift lever is in P and the parking brake is applied whenever loading or unloading cargo. The Vehicle may move if the shift lever is inadvertently moved to another position.
- Be careful when loading cargo through the rear passenger seats to prevent damage to the vehicle interior.
- When cargo is loaded through the rear passenger seats, ensure the cargo is properly secured to prevent it from moving while driving.
- Unsecured cargo in the passenger compartment can cause damage to the vehicle or injury to its occupants.

⚠ WARNING**Cargo**

Cargo should always be secured to prevent it from being thrown about the vehicle in a collision and causing injury to the vehicle occupants. Do not place objects in the rear seats, since they cannot be properly secured and may hit the front seat occupants in a collision.

⚠ WARNING**Cargo loading**

Make sure the engine is off, the automatic transmission is in P (Park) and the parking brake is securely applied whenever loading or unloading cargo. Failure to take these steps may allow the vehicle to move if the shift lever is inadvertently moved to another position.

Headrest

The vehicle's front and rear seats have adjustable headrests. The headrests provide comfort for passengers, but more importantly they are designed to help protect passengers from whiplash and other neck and spinal injuries during an accident, especially in a rear impact collision.

WARNING

To reduce the risk of serious injury or death in an accident, take the following precautions when adjusting your headrests:

- **Always properly adjust the headrests for all passengers BEFORE starting the vehicle.**
- **NEVER let anyone ride in a seat with the headrest removed.**
- **Adjust the headrests so the middle of the headrests is at the same height as the height of the top of the eyes.**
- **NEVER adjust the headrest position of the driver's seat when the vehicle is in motion.**
- **Adjust the headrest as close to the passenger's head as possible. Do not use a seat cushion that holds the body away from the seatback.**
- **Make sure the headrest locks into position after adjusting it.**

CAUTION

To prevent damage, NEVER hit or pull on the headrests.

Front seat headrest

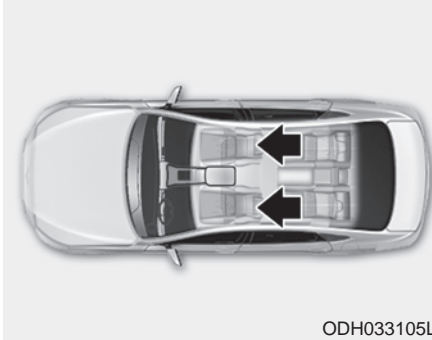

The driver's and front passenger's seats are equipped with adjustable headrests for the passengers safety and comfort.

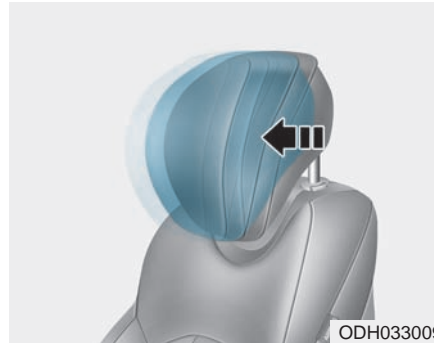

Forward and rearward adjustment

The headrest may be adjusted forward to 3 different positions by pulling the headrest forward to the desired detent. To adjust the headrest to its furthest rearwards position, pull it fully forward to the farthest position and release it.

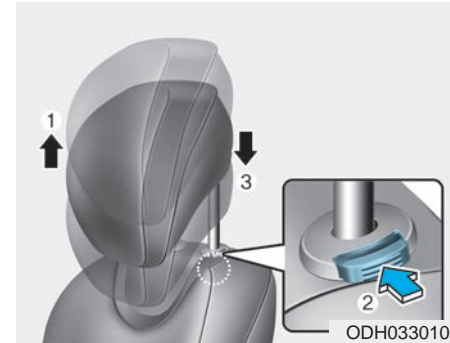

Adjusting the height up and down

To raise the headrest:

1. Pull it up to the desired position (1).

To lower the headrest:

1. Push and hold the release button (2) on the headrest support.
2. Lower the headrest to the desired position (3).

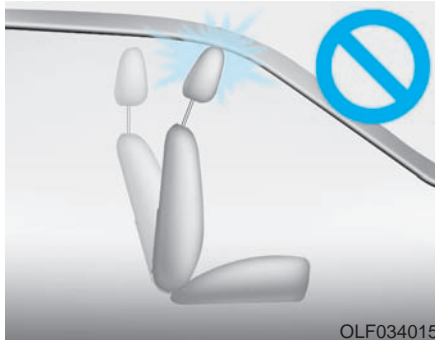

⚠ CAUTION

If you recline the seatback towards the front with the headrest and seat cushion raised, the headrest may come in contact with the sunvisor or other parts of the vehicle.

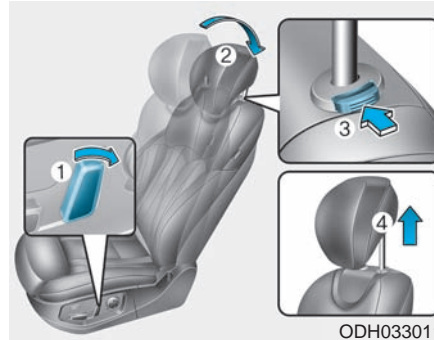

Removal/Reinstall

To remove the headrest:

1. Recline the seatback (2) with using the seatback angle switch (1).
2. Raise headrest as far as it can go.
3. Press the headrest release button (3) while pulling the headrest up (4).

⚠ WARNING

NEVER allow anyone to travel in a seat with the headrest removed.

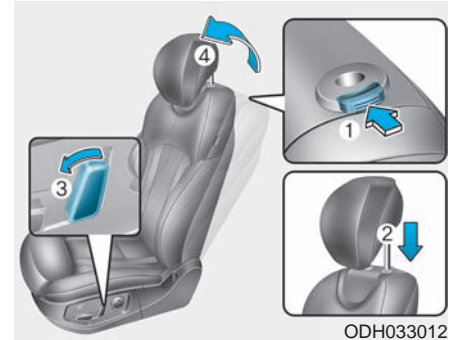

To reinstall the headrest :

1. Recline the seatback.
2. Put the headrest poles (2) into the holes while pressing the release button (1).
3. Adjust the headrest to the appropriate height.
4. Recline the seatback (4) with using the seatback angle switch (3).

⚠ WARNING

Always make sure the headrest locks into position after re-installing and adjusting it properly.

Rear seat headrests

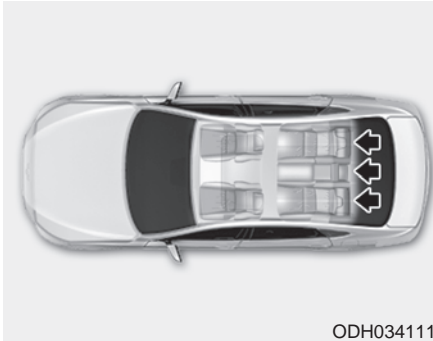

ODH034111

The rear seats are equipped with headrests in all the seating positions for the passenger's safety and comfort.

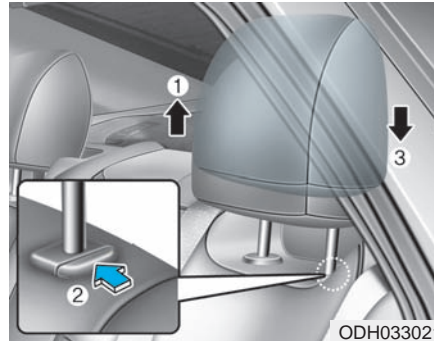

ODH033021

Adjusting the height up and down

To raise the headrest:

1. Pull it up to the desired position (1).

To lower the headrest:

1. Push and hold the release button (2) on the headrest support.
2. Lower the headrest to the desired position (3).

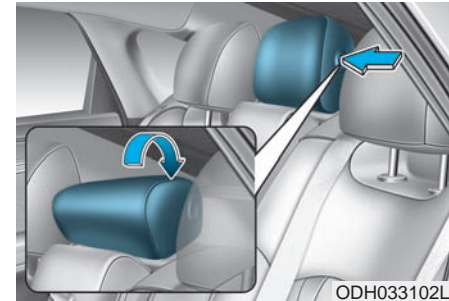

ODH033102L

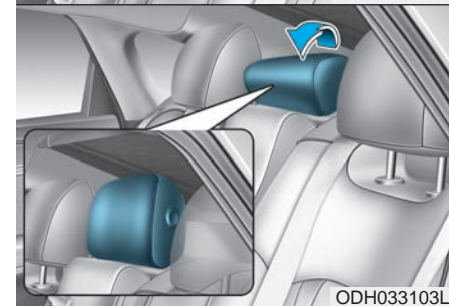

ODH033103L

Folding the center headrest

To fold the center headrest:

1. Fold the center headrest while pushing the button.

To unfold the center headrest:

1. Lift the center headrest.

Seat warmers and coolers

Seat warmers (if equipped)

Seat warmers are provided to warm the seats during cold weather.

WARNING

The seat warmers can cause a serious burn, even at low temperatures and especially if used for long periods of time.

Passengers must be able to feel if the seat is becoming too warm so they can turn it off, if needed.

People who cannot detect temperature change or pain to the skin should use extreme caution, especially the following types of passengers:

- Infants, children, elderly or disabled persons, or hospital outpatients.
- People with sensitive skin or who burn easily.

(Continued)

(Continued)

- Fatigued individuals.
- Intoxicated individuals.
- People taking medication that can cause drowsiness or sleepiness.

WARNING

NEVER place anything on the seat that insulates against heat when the seat warmer is in operation, such as a blanket or seat cushion. This may cause the seat warmer to overheat, causing a burn or damage to the seat.

CAUTION

To prevent damage to the seat warmers and seats:

- Never use a solvent such as paint thinner, benzene, alcohol or gasoline to clean the seats.
- Do not place heavy or sharp objects on seats equipped with seat warmers.
- Do not change the seat cover. It may damage the seat warmer or air ventilation system.

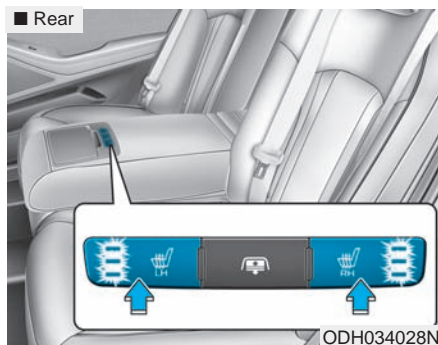
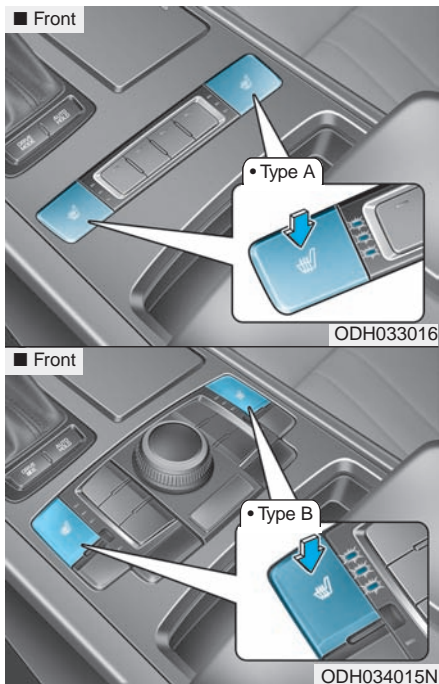

While the engine is running, push the switch to warm the seat.

During mild weather or under conditions where the operation of the seat warmer is not needed, keep the switches in the OFF position.

- Each time you push the switch, the temperature setting of the seat is changed as follows :

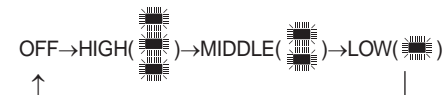

- When pressing the switch for more than 1.5 seconds with the seat warmer operating, the seat warmer will turn OFF.
- The seat warmer defaults to the OFF position whenever the Engine Start/Stop button is in the ON position.

* NOTICE

With the seat warmer switch in the ON position, the heating system in the seat automatically controls the seat temperature by designed temperature.

Seat warmers and coolers (by air) (if equipped)

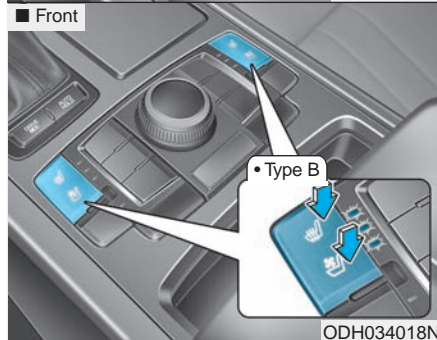
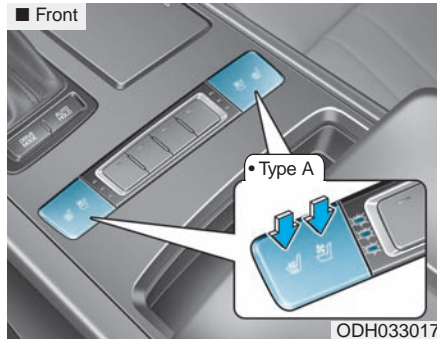

The seat warmers and coolers are provided to warm or cool the front seats by blowing air through small vent holes on the surface of the seat cushions and seatbacks.

When the operation of the seat warmers or cooler are not needed, keep the switches in the OFF position.

While the engine is running, push the switch to warm or cool the seat.

- Each time you push the switch, the air flow changes as follows:

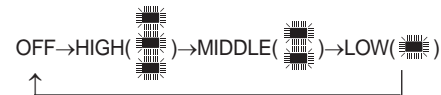

- When pressing the switch for more than 1.5 seconds with the seat warmer or cooler operating, the seat warmer will turn OFF.
- The seat warmers or coolers defaults to the OFF position whenever the Engine Start/Stop button is turned to the ON position.

* NOTICE

With the seat warmer or cooler switch in the ON position, the system in the seat automatically controls the seat temperature by designed temperature.

 **CAUTION**

To prevent damage to the seat warmer, seat cooler and seats:

- Use the seat warmer and cooler **ONLY** when the climate control system is on. Using the seat warmer and cooler for prolonged periods of time with the climate control system off could cause the seat warmer and cooler to malfunction.
- Never use a solvent such as paint thinner, benzene, alcohol or gasoline to clean the seats.
- Avoid spilling liquids on the surface of the front seats and seatbacks; this may cause the air vent holes to become blocked and not work properly.

(Continued)

(Continued)

- Do not place materials such as plastic bags or newspapers under the seats. They may block the air intake causing the air vents to not work properly.
- Do not change the seat covers. It may damage the seat warmer or cooler.
- If the air vents do not operate, restart the vehicle. If there is no change, we recommend that you have your vehicle inspected by an authorized HYUNDAI dealer.

SEAT BELTS

This section describes how to use the seat belts properly. It also describes some of the things not to do when using seat belts.

Seat belt safety precautions

Always fasten your seat belt and make sure all passengers have fastened their seat belts before starting any trip. Air bags are designed to supplement the seat belt as an additional safety device, but they are not a substitute. Most states require all occupants of a vehicle to wear seat belts.

WARNING

Seat belts must be used by ALL passengers whenever the vehicle is moving. Take the following precautions when adjusting and wearing seat belts:

- **ALWAYS** properly restrain children under age 13 in the rear seats.
- **NEVER** allow children to ride in the front passenger seat. If a child age 13 or older must be seated in the front seat, move the seat as far back as possible and properly restrain them in the seat.
- **NEVER** allow an infant or child to be carried on an occupant's lap.
- **NEVER** ride with the seatback reclined when the vehicle is moving.
- Do not allow children to share a seat or seat belt.
- Do not wear the shoulder belt under your arm or behind your back.

(Continued)

(Continued)

- Do not use the seat belt if it is twisted. A twisted seat belt will not protect you properly in an accident.
- Do not use a seat belt if the webbing or hardware is damaged.
- Do not latch the seat belt into the buckles of other seats.
- **NEVER** unfasten the seat belt while driving. This may cause loss of vehicle control resulting in an accident.
- Make sure there is nothing in the buckle interfering with the seat belt latch mechanism. This may prevent the seat belt from fastening securely.
- No modifications or additions should be made by the user which will either prevent the seat belt adjusting devices from operating to remove slack, or prevent the seat belt assembly from being adjusted to remove slack.

⚠ WARNING

Damaged seat belts and seat belt assemblies will not operate properly. Always replace:

- Frayed, contaminated, or damaged webbing
- Damaged hardware
- The entire seat belt assembly after it has been worn in an accident, even if damage to webbing or assembly is not apparent

Seat belt warning light

*Seat belt warning light
(for driver's seat)*



The driver's seat belt warning light and chime will come on according to the following table when the Engine Start/Stop button is in the ON position.

Conditions		Warning Pattern	
Seat Belt	Vehicle Speed	Light (Blink)	Chime
Unbuckled		6 seconds	
Buckled		6 seconds	None
Buckled → Unbuckled	Below 3 mph (5 km/h)	6 seconds	None
	3 mph~ 6 mph	6 seconds	
	Above 6 mph (10 km/h)	6 sec. ON / 24 sec. OFF (11 times)	
Unbuckled	Above 6 mph (10 km/h) ↓	6 seconds *1 ↓	
	Below 3 mph (5 km/h)	Stop *2	

*1 : The Warning Pattern repeats 11 times with an interval of 24 seconds. If the driver's seat belt is buckled, the light will stop within 6 seconds and chime will stop immediately.

*2 : The light will stop within 6 seconds and chime will stop immediately.

**Seat belt warning
(for front passenger's seat)**

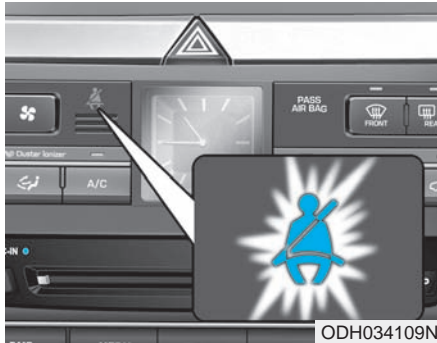

The front passenger's seat belt warning light will activate to the following table when the Engine Start/ Stop button is in "ON" position.

Conditions		Warning Pattern
Seat Belt	Vehicle Speed	Light-Blink
Unbuckled		6 seconds
Unbuckled	Above 6mph (10 km/h)	Continuously
Buckled		6 seconds
Buckled → Unbuckled	Above 6mph (10 km/h)	Continuously *1
	Below 6mph (10 km/h)	None

*1 : The seat belt warning light will go off if the vehicle speed decreases below 3 mph (5 km/h). If the vehicle speed increases above 3 mph (5 km/h), the warning light will blink again.

⚠ WARNING

Riding in an improper position adversely affects the front passenger's seat belt warning system. It is important for the driver to instruct the passenger as to the proper seating instructions as contained in this manual.

- You can find the front passenger's seat belt warning light on the center fascia panel.
- Although the front passenger seat is not occupied, the seat belt warning light will blink for 6 seconds.
- The seat belt warning light can blink when a briefcase or purse is placed on the front passenger seat.

Seat belt restraint system

Seat Belt-Driver's 3-point system with emergency locking retractor

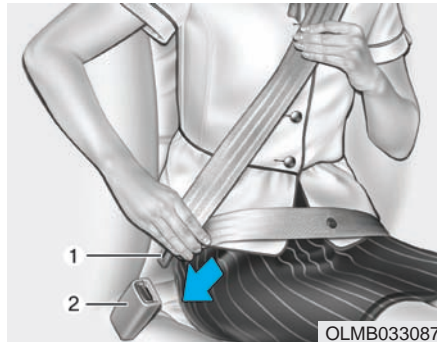

To fasten your seat belt:

Pull the seat belt out of the retractor and insert the metal tab (1) into the buckle (2). There will be an audible "click" when the tab locks into the buckle.

The seat belt automatically adjusts to the proper length after the lap belt portion is adjusted manually so that it fits snugly around your hips. If you lean forward in a slow, easy motion, the belt will extend and move with you. If there is a sudden stop or impact, the belt will lock into position. It will also lock if you try to lean forward too quickly.

*** NOTICE**

If you are not able to smoothly pull enough of the seat belt out from the retractor, firmly pull the seat belt out and release it. After release, you will be able to pull the belt out smoothly.

Height adjustment

You can adjust the height of the shoulder belt anchor to one of the four different positions for maximum comfort and safety.

The shoulder portion should be adjusted so it lies across your chest and midway over your shoulder nearest the door, not over your neck.

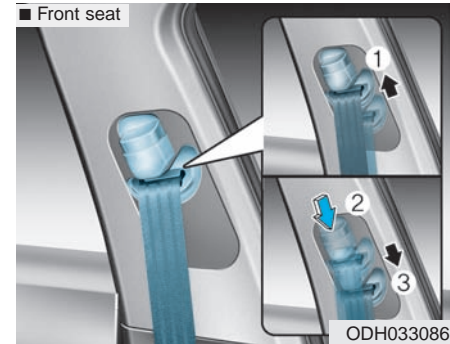

To adjust the height of the seat belt anchor, lower or raise the height adjuster into an appropriate position.

To raise the height adjuster, pull it up (1). To lower it, push it down (3) while pressing the height adjuster button (2).

Release the button to lock the anchor into position. Try sliding the height adjuster to make sure that it has locked into position.

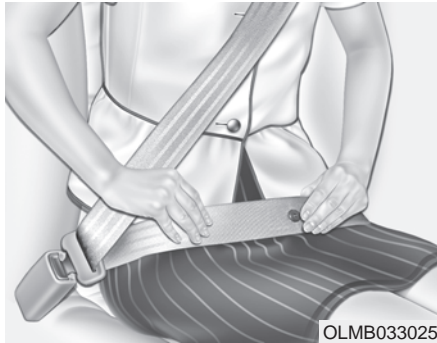

⚠ WARNING

Improperly positioned seat belts may increase the risk of serious injury in an accident. Take the following precautions when adjusting the seat belt:

- Position the lap portion of the seat belt as low as possible across your hips, not on your waist, so that it fits snugly.

(Continued)

(Continued)

- Position one arm under the shoulder belt and the other over the belt, as shown in the illustration.
- Always position the shoulder belt anchor into the locked position at the appropriate height.
- Never position the shoulder belt across your neck or face.

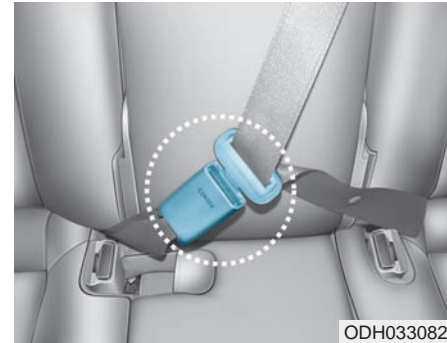

When using the rear center seat belt, the buckle with the “CENTER” mark must be used.

Seat Belt – Passenger’s 3-point system with convertible locking retractor

This type of seat belt combines the features of both an emergency locking retractor seat belt and an automatic locking retractor seat belt. Convertible retractor type seat belts are installed in the rear seat positions to help accommodate the installation of child restraint systems. Although a convertible retractor is also installed in the front passenger seat position, NEVER place any infant/child restraint system in the front seat of the vehicle.

To fasten your seat belt:

Pull the seat belt out of the retractor and insert the metal tab into the buckle. There will be an audible "click" when the tab locks into the buckle. When not securing a child restraint, the seat belt operates in the same way as the driver's seat belt (Emergency Locking Retractor Type). It automatically adjusts to the proper length only after the lap belt portion of the seat belt is adjusted manually so that it fits snugly across your hips.

When the seat belt is fully extended from the retractor to allow the installation of a child restraint system, the seat belt operation changes to allow the belt to retract, but not to extend (Automatic Locking Retractor Type). Refer to "Using a Child Restraint System" in this chapter.

*** NOTICE**

Although the seat belt retractor provides the same level of protection for seated passengers in either emergency or automatic locking modes, the emergency locking mode allows seated passengers to move freely in their seat while keeping some tension on the belt. During a collision or sudden stop, the retractor automatically locks the belt to help restrain your body. To deactivate the automatic locking mode, allow the unbuckled seat belt to fully retract.

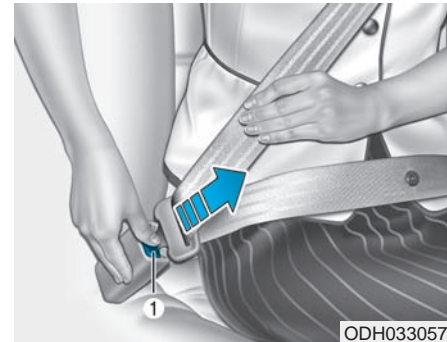

To release your seat belt:

Press the release button (1) in the locking buckle.

When it is released, the belt should automatically draw back into the retractor. If this does not happen, check the belt to be sure it is not twisted, then try again.

Pre-tensioner seat belt (Driver and front passenger)

Retractor pre-tensioner

Your vehicle is equipped with driver's and front passenger's Pre-Tensioner Seat Belts. The purpose of the pre-tensioner is to make sure the seat belts fit tightly against the occupant's body in certain frontal collisions. The pre-tensioner seat belts may be activated in crashes where the frontal collision is severe enough, together with the air bags.

If the system senses excessive tension on the driver's or passenger's seat belt when the pre-tensioner activates, the load limiter inside the pre-tensioner will release some of the pressure on the affected seat belt.

When the vehicle stops suddenly, or if the occupant tries to lean forward too quickly, the seat belt retractor will lock into position. In certain frontal collisions, the pre-tensioner will activate and pull the seat belt into tighter contact against the occupant's body.



OLMB033039

EFD system (Driver and front passenger)

The purpose of the EFD (Emergency Fastening Device) system is to make sure the lap belt fit tightly against the occupant's lower body in certain frontal collisions. The EFD (Emergency Fastening Device) may be activated in crashes where the frontal collision is severe enough.

⚠ WARNING

Pre-Tensioner Seat Belts (Retractor pre-tensioner seat belt and emergency fastening device) that malfunction may not protect you properly during an accident. Take the following precautions:

- Always wear your seat belt and sit properly in your seat.
- Do not use the seat belt if it is loose or twisted. A loose or twisted seat belt will not protect you properly in an accident.
- Do not place anything near the buckle. This may adversely affect the buckle and cause it to function improperly.
- Always replace your pre-tensioners after activation or an accident.
- NEVER inspect, service, repair or replace the pre-tensioners yourself. This must be done by an authorized HYUNDAI dealer.
- Do not hit the seat belt assemblies.

⚠ WARNING

Do not touch the pre-tensioner seat belt (Retractor pre-tensioner seat belt and emergency fastening device) assemblies for several minutes after they have been activated. When the pre-tensioner seat belt (Retractor pre-tensioner seat belt and emergency fastening device) mechanism deploy during a collision, the pre-tensioner becomes hot and can burn you.

⚠ CAUTION

Body work on the front area of the vehicle may damage the pre-tensioner seat belt (Retractor pre-tensioner seat belt and emergency fastening device) system. Therefore, we recommend that the system be serviced by an authorized HYUNDAI dealer.

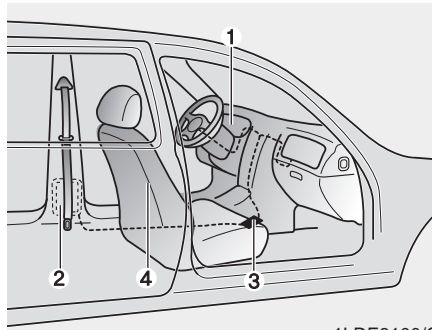

1LDE3100/Q

The Pre-Tensioner Seat Belt System consists mainly of the following components. Their locations are shown in the illustration above:

1. SRS air bag warning light
2. Retractor pre-tensioner assembly
3. SRS control module
4. Emergency fastening device (EFD)

*** NOTICE**

The sensor that activates the SRS air bag is connected with the pre-tensioner seat belts. The SRS air bag warning light on the instrument panel will illuminate for approximately 6 seconds after the Engine Start/Stop button is pressed to the ON position, and then it should turn off.

If the pre-tensioner is not working properly, the warning light will illuminate even if the SRS air bag is not malfunctioning. If the warning light does not illuminate, stays illuminated or illuminates when the vehicle is being driven, have an authorized HYUNDAI dealer inspect the pre-tensioner seat belts and SRS air bags as soon as possible.

* NOTICE

- Both the driver's and front passenger's pre-tensioner seat belts may be activated in certain frontal or side collisions or rollovers.
- The pre-tensioners will not be activated if the seat belts are not worn at the time of the collision.
- When the pre-tensioner seat belts are activated, a loud noise may be heard and fine dust, which may appear to be smoke, may be visible in the passenger compartment. These are normal operating conditions and are not hazardous.
- Although it is non-toxic, the fine dust may cause skin irritation and should not be breathed for prolonged periods. Wash all exposed skin areas thoroughly after an accident in which the pre-tensioner seat belts were activated.

Pre-Safe Seat belt (PSB) (if equipped)

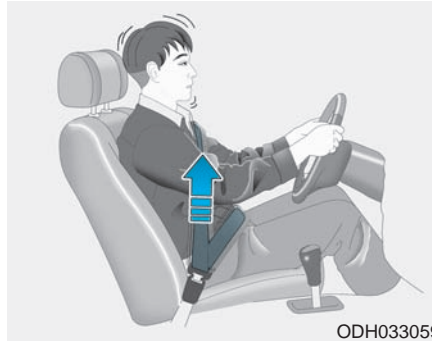

The purpose of the Pre-Safe Seat Belt is to tighten the seat belt when a collision is sensed, driving emergency braking, or when a loss of control is sensed.

⚠ CAUTION

The pre-safe seat belt is a supplementary system. The pre-safe seat belt activates only when the passenger is wearing his/her seat belt.

If the seat belt is released, the belt parking function will activate. For more detailed refer to the belt parking function.

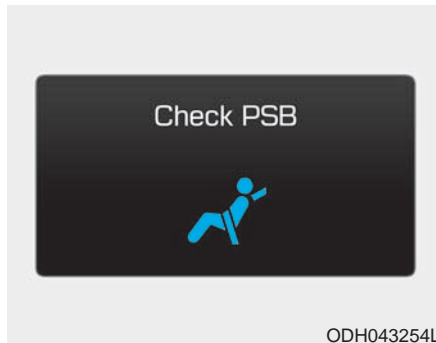

ODH043254L

The pre-safe seat belt warning will turn on if there is a problem with your pre-safe seat belt.

Have the system checked by an authorized HYUNDAI dealer if :

The warning message comes on while the vehicle is in motion. If the PSB warning message disappeared, the warning indicator (master symbol) turns on.

In order to maximize the safety of the passenger, the pre-safe seat belt system operates as below.

- Full retraction
 - The seat belt is tightened when:
 - Emergency braking situation occurs
 - Losing control of the vehicle
 - The vehicle senses the collision situation by sensor (If equipped)
- Dynamic support
 - Slippery frozen road
 - The passenger leans to one side by sudden braking or rapid turning.
- Slack removal
 - Other functions are tightening a loose seat belt after vehicle speed is over 15 km/h (9.3 mph) and winding a loose seat belt after unfastening the seat belt.
- Belt parking
 - When releasing the seat belt, if the seat belt loosens, the motor will wind up a loose seat belt to tight.

Additional seat belt safety precautions

Seat belt use during pregnancy

The seat belt should always be used during pregnancy. The best way to protect your unborn child is to protect yourself by always wearing the seat belt.

Pregnant women should always wear a lap-shoulder seat belt. Place the shoulder belt across your chest, routed between your breasts and away from your neck. Place the shoulder belt across the chest, routed away from the neck. Place the lap belt below the belt line so that it fits snugly and as low as possible across the hips, not across the abdomen.

⚠ WARNING

To reduce the risk of serious injury or death to an unborn child during an accident, pregnant women should NEVER place the lap portion of the seat belt above or over the area of the abdomen where the unborn child is located.

Seat belt use and children

Infant and small children

All 50 states have child restraint laws which require children to travel in approved child restraint devices, including booster seats. The age at which seat belts can be used instead of child restraints differs among states, so you should be aware of the specific requirements in your state, and where you are travelling. Infant and child restraints must be properly placed and installed in a rear seat. For more information refer to the “Child Restraint Systems” in this chapter.

WARNING

ALWAYS properly restrain infants and small children in a child restraint appropriate for the child’s height and weight.

To reduce the risk of serious injury or death to a child and other passengers, NEVER hold a child in your lap or arms when the vehicle is moving. The violent forces created during an accident will tear the child from your arms and throw the child against the interior of the vehicle.

Small children are best protected from injury in an accident when properly restrained in the rear seat by a child restraint system that meets the requirements of the Federal Motor Vehicle Safety Standards. Before buying any child restraint system, make sure that it has a label certifying that it meets Federal Motor Vehicle Safety Standard 213. The restraint must be appropriate for your child’s height and weight. Check the label on the child restraint for this information. Refer to “Child Restraint Systems” in this chapter.

Larger children

Children under age 13 and who are too large for a booster seat must always occupy the rear seat and use the available lap/shoulder belts. A seat belt should lie across the upper thighs and be snug across the shoulder and chest to restrain the child safely. Check belt fit periodically. A child's squirming could put the belt out of position. Always have the LATCH system inspected by your authorized HYUNDAI dealer after an accident. An accident can damage the LATCH system and may not properly secure the child restraint.

If a larger child over age 13 must be seated in the front seat, the child must be securely restrained by the available lap/shoulder belt and the seat should be placed in the rear-most position.

If the shoulder belt portion slightly touches the child's neck or face, try placing the child closer to the center of the vehicle. If the shoulder belt still touches their face or neck, they need to be returned to an appropriate booster seat in the rear seat.

WARNING

- **Always make sure children are wearing their seat belts and that they are properly adjusted before driving.**
- **NEVER allow the shoulder belt to contact the child's neck or face.**
- **Do not allow more than one child to use a single seat belt.**

Transporting an injured person

A seat belt should be used when an injured person is being transported. Consult a physician for specific recommendations.

One person per belt

Two people (including children) should never attempt to use a single seat belt. This could increase the severity of injuries in case of an accident.

Do not lie down

Sitting in a reclined position when the vehicle is in motion can be dangerous. Even when buckled up, the protections of your restraint system (seat belts and air bags) is greatly reduced by reclining your seatback.

To reduce the chance of injuries in the event of an accident and to achieve the maximum effectiveness of the restraint system, all passengers should be sitting up and the front and rear seats should be in an upright position when the car is moving. A seat belt cannot provide proper protection if the person is lying down in the rear seat or if the front or rear seats are in a reclined position.

 **WARNING**

- **NEVER ride with a reclined seatback when the vehicle is moving.**
- **Riding with a reclined seatback increases your chance of serious or fatal injuries in the event of a collision or sudden stop.**
- **Drivers and passengers should always sit well back in their seats, properly belted, and with the seatbacks upright.**

Care of seat belts

Seat belt systems should never be disassembled or modified. In addition, care should be taken to assure that seat belts and belt hardware are not damaged by seat hinges, doors or other abuse.

Periodic inspection

All seat belts should be inspected periodically for wear or damage of any kind. Any damaged parts should be replaced as soon as possible by an authorized HYUNDAI dealer.

Keep belts clean and dry

Seat belts should be kept clean and dry. If belts become dirty, they can be cleaned by using a mild soap solution and warm water. Bleach, dye, strong detergents or abrasives should not be used because they may damage and weaken the fabric.

When to replace seat belts

The entire seat belt assembly or assemblies should be replaced if the vehicle has been involved in an accident. This should be done even if no damage is visible. Additional questions concerning seat belt operation should be directed to an authorized HYUNDAI dealer.

CHILD RESTRAINT SYSTEM (CRS)

WARNING

Always properly restrain children in the rear seats of the vehicle.

Children of all ages are safer when restrained in the rear seat. A child riding in the front passenger seat can be forcefully struck by an inflating air bag resulting in SERIOUS INJURY or DEATH.

Children under age 13 must always ride in the rear seats and must always be properly restrained to minimize the risk of injury in an accident, sudden stop or sudden maneuver. According to accident statistics, children are safer when properly restrained in the rear seats than in the front seat. **Even with air bags, children can be seriously injured or killed.** Children too large for a child restraint must use the seat belts provided.

All 50 states have child restraint laws which require children to travel in approved child restraint devices. The laws governing the age or height/weight restrictions at which seat belts can be used instead of child restraints differs among states, so you should be aware of the specific requirements in your state, and where you are travelling.

Child restraint systems must be properly placed and installed in the rear seat. You must use a commercially available child restraint system that meets the requirements of the Federal Motor Vehicle Safety Standards (FMVSS).

Child restraint systems are generally designed to be secured in a vehicle seat by lap belt portion of a lap/shoulder belt, or by a LATCH system in the rear seats of the vehicle.

Child restraint system (CRS)

Infants and younger children must be restrained in an appropriate rear-facing or forward-facing CRS that has first been properly secured to the rear seat of the vehicle. Read and comply with the instructions for installation and use provided by the manufacturer of the child restraint.

⚠ WARNING

An improperly secured child restraint can increase the risk of **SERIOUS INJURY** or **DEATH** in an accident. Always take the following precautions when using a child restraint system:

- **NEVER** install a child or infant restraint in the front passenger's seat.
- Always properly secure the child restraint to a rear seat of the vehicle.

(Continued)

(Continued)

- **Always follow the child restraint system manufacturer's instructions for installation and use.**
- **Always properly restrain your child in the child restraint.**
- **Do not use an infant carrier or a child safety seat that "hooks" over a seatback, it may not provide adequate protection in an accident.**
- **After an accident, have a HYUNDAI dealer check the child restraint system, seat belts, tether anchors and lower anchors.**

Selecting a Child Restraint System (CRS)

When selecting a CRS for your child, always:

- Make sure the CRS has a label certifying that it meets applicable Federal Motor Vehicle Safety Standards (FMVSS 213).
- Select a child restraint based on your child's height and weight. The required label or the instructions for use typically provide this information.
- Select a child restraint that fits the vehicle seating position where it will be used.
- Read and comply with the warnings and instructions for installation and use provided with the child restraint system.

Child restraint system types

There are three main types of child restraint systems: rear-facing seats, forward-facing seats, and booster seats. They are classified according to the child's age, height and weight.

Rear-facing child seats

⚠ WARNING

NEVER install a child or infant restraint in the front passenger's seat.

Placing a rear-facing child restraint in the front seat can result in SERIOUS INJURY or DEATH if the child restraint is struck by an inflating air bag.

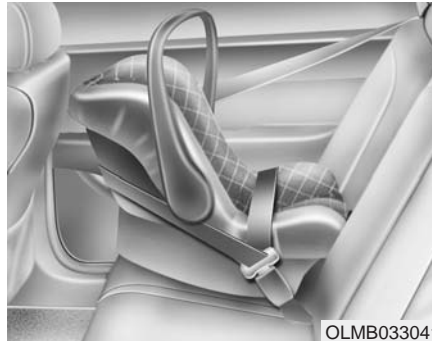

A rear-facing child seat provides restraint with the seating surface against the back of the child. The harness system holds the child in place, and in an accident, acts to keep the child positioned in the seat and reduce the stress to the neck and spinal cord.

All children under age one must always ride in a rear-facing infant child restraint.

Convertible and 3-in-1 child seats typically have higher height and weight limits for the rear-facing position, allowing you to keep your child rear-facing for a longer period of time.

Continue to use a rear-facing child seat for as long as your child will fit within the height and weight limits allowed by the child seat manufacturer. It's the best way to keep them safe. Once your child has outgrown the rear-facing child restraint, your child is ready for a forward-facing child restraint with a harness.



Forward-facing child restraints

A forward-facing child seat provides restraint for the child's body with a harness. Keep children in a forward-facing child seat with a harness until they reach the top height or weight limit allowed by your child restraint's manufacturer.

Once your child outgrows the forward-facing child restraint, your child is ready for a booster seat.

Booster seats

A booster seat is a restraint designed to improve the fit of the vehicle's seat belt system. A booster seat positions the seat belt so that it fits properly over the lap of your child. Keep your child in a booster seat until they are big enough to sit in the seat without a booster and still have the seat belt fit properly.

For a seat belt to fit properly, the lap belt must lie snugly across the upper thighs, not the stomach. The shoulder belt should lie snug across the shoulder and chest and not across the neck or face. Children under age 13 must always ride in the rear seats and must always be properly restrained to minimize the risk of injury.

Installing a Child Restraint System (CRS)

⚠ WARNING

Before installing your child restraint system always:

- Read and follow the instructions provided by the manufacturer of the child restraint.
- Read and follow the instructions regarding child restraint systems in this manual.

Failure to follow all warnings and instructions could increase the risk of the SERIOUS INJURY or DEATH if an accident occurs.

⚠ WARNING

If the vehicle headrest prevents proper installation of a child seat (as described in the child seat system manual), the headrest of the respective seating position shall be readjusted or entirely removed.

After selecting a proper child seat for your child, check to make sure it fits properly in your vehicle. Follow the instructions provided by the manufacturer when installing the child seat. Note these general steps when installing the seat to your vehicle:

- **Properly secure the child restraint to the vehicle.** All child restraints must be secured to the vehicle with the lap part of a lap/shoulder belt or with the LATCH system.
- **Make sure the child restraint is firmly secured.** After installing a child restraint to the vehicle, push and pull the seat forward and from side-to-side to verify that it is securely attached to the seat. A child restraint secured with a seat belt should be installed as firmly as possible. However, some side-to-side movement can be expected.
- **Secure the child in the child restraint.** Make sure the child is properly strapped in the child restraint according to the manufacturer instructions.

WARNING

A child restraint in a closed vehicle can become very hot. To prevent burns, check the seating surface and buckles before placing your child in the child restraint.

Lower Anchors and Tether for Children (LATCH) System

The LATCH system holds a child restraint during driving and in an accident. This system is designed to make installation of the child restraint easier and reduce the possibility of improperly installing your child restraint. The LATCH system uses anchors in the vehicle and attachments on the child restraint. The LATCH system eliminates the need to use seat belts to secure the child restraint to the rear seats.

Lower anchors are metal bars built into the vehicle. There are two lower anchors for each LATCH seating position that will accommodate a child restraint with lower attachments.

To use the LATCH system in your vehicle, you must have a child restraint with LATCH attachments.

The child seat manufacturer will provide you with instructions on how to use the child seat with its attachments for the LATCH lower anchors.

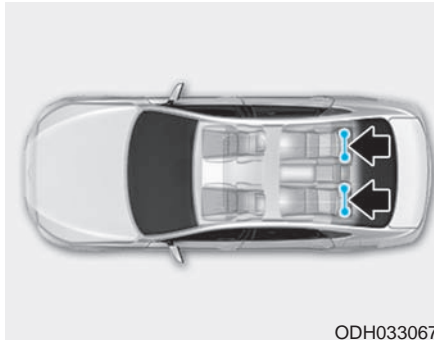

ODH033067

LATCH anchors have been provided in the left and right outboard rear seating positions. Their locations are shown in the illustration. There are no LATCH anchors provided for the center rear seating position.

⚠ WARNING

Do not attempt to install a child restraint system using LATCH anchors in the rear center seating position. There are no LATCH anchors provided for this seat. Using the outboard seat anchors can damage the anchors which may break or fail in a collision resulting in serious injury or death.

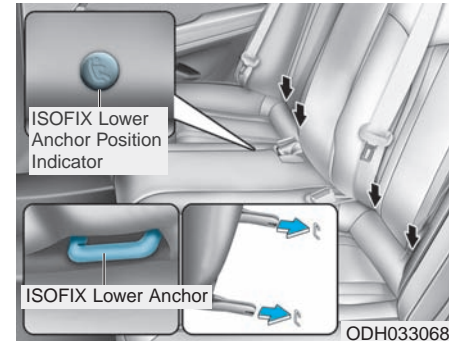

ODH033068

The lower anchor position indicator symbols are located on the left and right rear seat backs to identify the position of the lower anchors in your vehicle (see arrows in illustration).

The LATCH anchors are located between the seatback and the seat cushion of the rear seat left and right outboard seating positions.

Securing a child restraint with the LATCH anchors system

To install a LATCH-compatible child restraint in either of the rear outboard seating positions:

1. Move the seat belt buckle away from the lower anchors.
2. Move any other objects away from the anchors that could prevent a secure connection between the child restraint and the lower anchors.
3. Place the child restraint on the vehicle seat, then attach the seat to the lower anchors according to the instructions provided by the child restraint manufacturer.
4. Follow the child restraint instructions for properly adjusting and tightening the lower attachments on the child restraint to the lower anchors.

⚠ WARNING

Take the following precautions when using the LATCH system:

- **Read and follow all installation instructions provided with your child restraint system.**
- **To prevent the child from reaching and taking hold of unretracted seat belts, buckle all unused rear seat belts and retract the seat belt webbing behind the child. Children can be strangled if a shoulder belt becomes wrapped around their neck and the seat belt tightens.**
- **NEVER attach more than one child restraint to a single anchor. This could cause the anchor or attachment to come loose or break.**
- **Always have the LATCH system inspected by your authorized HYUNDAI dealer after an accident. An accident can damage the LATCH system and may not properly secure the child restraint.**

*** NOTICE**

The recommended weight for the LATCH system is under 65 lbs (30 kg).

How to calculate the child restraint weight :

Child restraint weight =
65 lbs (30 kg) - Child weight

Securing a child restraint seat with “Tether Anchor” system

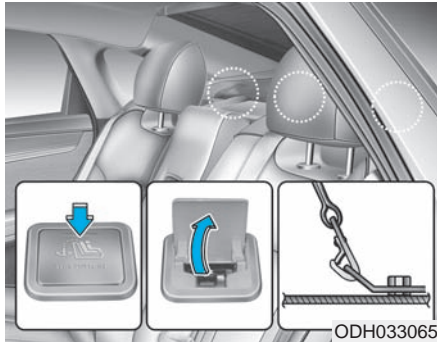

First secure the child restraint with the LATCH lower anchors or the seat belt. If the child restraint manufacturer recommends that the top tether strap be attached, attach and tighten the top tether strap to the top tether strap anchor.

Child restraint hook holders are located on the package tray.

WARNING

Take the following precautions when installing the tether strap:

- Read and follow all installation instructions provided with your child restraint system.
- **NEVER** attach more than one child restraint to a single tether anchor. This could cause the anchor or attachment to come loose or break.
- **Do not** attach the tether strap to anything other than the correct tether anchor. It may not work properly if attached to something else.
- **Do not** use the tether anchors for adult seat belts or harnesses, or for attaching other items or equipment to the vehicle.

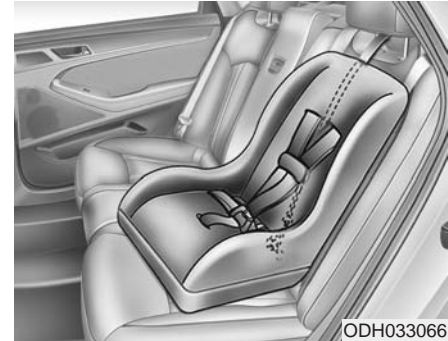

To install the tether anchor:

1. Route the child restraint tether strap over the child restraint seatback. Route the tether strap under the headrest and between the headrest posts, or route the tether strap over the top of the vehicle seatback. Make sure the strap is not twisted.
2. Connect the tether strap hook to the tether anchor, then tighten the tether strap according to the child seat manufacturer's instructions to firmly secure the child restraint to the seat.

3. Check that the child restraint is securely attached to the seat by pushing and pulling the seat forward and from side-to-side.

Securing a child restraint with a lap belt or lap/shoulder belt

When not using the LATCH system, all child restraints must be secured to a vehicle rear seat with the lap part of a lap/shoulder belt.

⚠ WARNING

ALWAYS place a rear-facing child restraint in the rear seat of the vehicle.

Placing a rear-facing child restraint in the front seat can result in serious injury or death if the child restraint is struck by an inflating air bag.

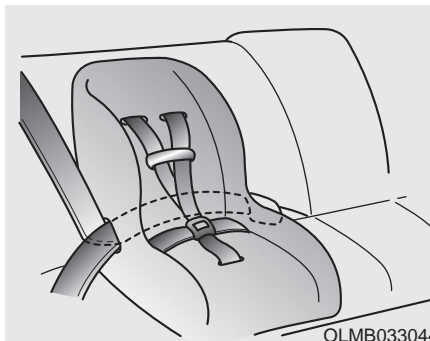

Automatic lock mode

Since all passenger seat belts move freely under normal conditions and only lock under extreme or emergency conditions (emergency locking mode), you must manually pull the seat belt all the way out to shift the retractor to the “Automatic Locking” mode to secure a child restraint.

The “Automatic Locking” mode will help prevent the normal movement of the child in the vehicle from causing the seat belt to loosen and compromise the child restraint system. To secure a child restraint system, use the following procedure.

To install a child restraint system on the rear seats, do the following:

1. Place the child restraint system on a rear seat and route the lap/shoulder belt around or through the child restraint, following the restraint manufacturer's instructions.

Be sure the seat belt webbing is not twisted.

*** NOTICE**

When using the rear center seat belt, you should also refer to the “3-point Rear Center Seat Belt” section in this chapter.

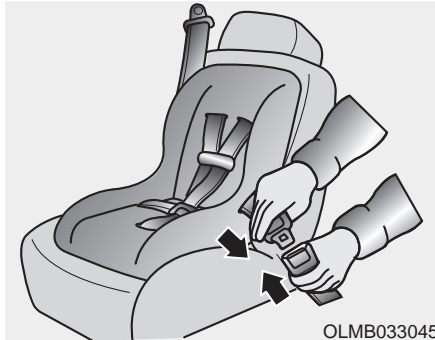

2. Fasten the lap/shoulder belt latch into the buckle. Listen for the distinct “click” sound.

* NOTICE

Position the release button so that it is easy to access in case of an emergency.



3. Pull the shoulder portion of the seat belt all the way out. When the shoulder portion of the seat belt is fully extended, it will shift the retractor to the “Automatic Locking” (child restraint) mode.

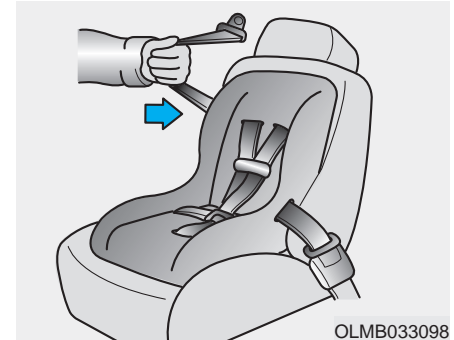

4. Slowly allow the shoulder portion of the seat belt to retract and listen for an audible “clicking” or “ratcheting” sound. This indicates that the retractor is in the “Automatic Locking” mode. If no distinct sound is heard, repeat steps 3 and 4.

5. Remove as much slack from the belt as possible by pushing down on the child restraint system while feeding the shoulder belt back into the retractor.
6. Push and pull on the child restraint system to confirm that the seat belt is holding it firmly in place. If it is not, release the seat belt and repeat steps 2 through 6.
7. Double check that the retractor is in the “Automatic Locking” mode by attempting to pull more of the seat belt out of the retractor. If you cannot, the retractor is in the “Automatic Locking” mode.

If your CRS manufacturer instructs or recommends you to use a tether anchor with the lap/shoulder belt, refer to the previous pages for more information.

* NOTICE

When the seat belt is allowed to retract to its fully stowed position, the retractor will automatically switch from the “Automatic Locking” mode to the emergency lock mode for normal adult usage.

WARNING

If the retractor is not in the “Automatic Locking” mode, the child restraint can move when your vehicle turns or stops suddenly. A child can be seriously injured or killed if the child restraint is not properly anchored in the car, including manually pulling the seat belt all the way out to shift the retractor to the “Automatic Locking” mode.

To remove the child restraint, press the release button on the buckle and then pull the lap/shoulder belt out of the restraint and allow the seat belt to retract fully.

AIR BAG – ADVANCED SUPPLEMENTAL RESTRAINT SYSTEM

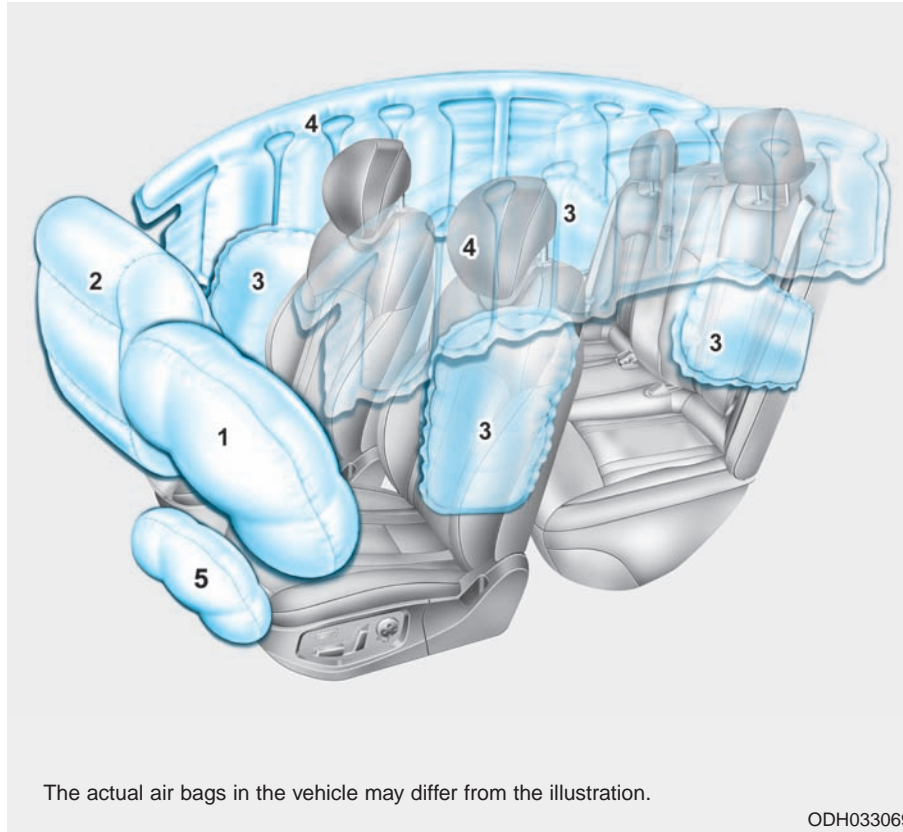

- (1) Driver's front air bag
- (2) Passenger's front air bag
- (3) Side air bag
- (4) Curtain air bag
- (5) Driver's knee air bag

The actual air bags in the vehicle may differ from the illustration.

ODH033069

This vehicle is equipped with an Advanced Supplemental Air Bag System for the driver's seat and front passenger's seats.

The front air bags are designed to supplement the three-point seat belts. For these air bags to provide protection, the seat belts must be worn at all times when driving.

You can be severely injured or killed in an accident if you are not wearing a seat belt. Air bags are designed to supplement seat belts, but do not replace them. Also, air bags are not designed to deploy in every collision. In some accidents, the seat belts are the only restraint protecting you.

WARNING

AIR BAG SAFETY PRECAUTIONS

ALWAYS use seat belts and child restraints - every trip, every time, everyone! Even with air bags, you can be seriously injured or killed in a collision if you are improperly belted or not wearing your seat belt when the air bag inflates.

NEVER place a child in any child restraint or booster seat in the front passenger seat. An inflating air bag could forcefully strike the infant or child causing serious or fatal injuries.

ABC - Always Buckle Children under age 13 in the back seat. It is the safest place for children of any age to ride. If a child age 13 or older must be seated in the front seat, he or she must be properly belted and the seat should be moved as far back as possible.

All occupants should sit upright with the seatback in an upright position, centered on the seat cushion with their seat belt on, legs comfortably extended and their feet on the floor until the vehicle is parked and the engine is turned off. If an occupant is out of position during an accident, the rapidly deploying air bag may forcefully contact the occupant causing serious or fatal injuries.

You and your passengers should never sit or lean unnecessarily close to the air bags or lean against the door or center console.

Move your seat as far back as possible from front air bags, while still maintaining control of the vehicle. NHTSA recommends that drivers allow at least 10 inches (25 cm) between the center of the steering wheel and the chest.

Where are the air bags?

Driver's and passenger's front air bags

Your vehicle is equipped with a Advanced Supplemental Restraint System (SRS) and lap/shoulder belts at both the driver and passenger seating positions.

The SRS consists of air bags which are located in the center of the steering wheel and the passenger's side front panel pad above the glove box.

The air bags are labeled with the letters "AIR BAG" embossed on the pad covers.



The purpose of the SRS is to provide the vehicle's driver and front passengers with additional protection than that offered by the seat belt system alone. The SRS uses sensors to gather information about the driver's seat position, the driver's and front passenger's seat belt usage and impact severity.

⚠ WARNING

To reduce the risk of serious injury or death from an inflating front air bags, take the following precautions:

- Seat belts must be worn at all times to help keep occupants positioned properly.
- Move your seat as far back as possible from front air bags, while still maintaining control of the vehicle.
- Never lean against the door or center console.

(Continued)

(Continued)

- Do not allow the front passenger to place their feet or legs on the dashboard.
- No objects should be placed over or near the air bag modules on the steering wheel, instrument panel, and the front passenger's panel above the glove box. Such objects could cause harm if the vehicle is in a crash severe enough to cause the air bags to deploy.

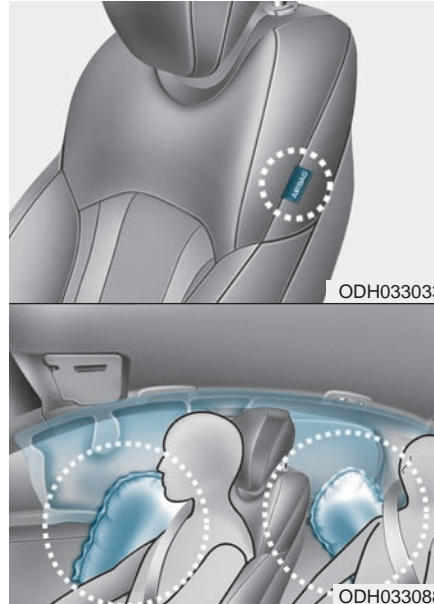
Side air bags

Your vehicle is equipped with a side air bag in each front and outboard rear seat. The purpose of the air bag is to provide the vehicle's driver and/or the front and outboard rear passenger with additional protection than that offered by the seat belt alone.

The side air bags are designed to deploy only during certain side impact collisions, depending on the crash severity, angle, speed and point of impact.

The side air bags do not only deploy on the side of the impact but also on the opposite side.

For vehicles equipped with a rollover sensor the side and curtain air bags on both sides of the vehicle may deploy if a rollover or possible rollover is detected.

The side air bags are not designed to deploy in all side impact or rollover situations.

⚠ WARNING

To reduce the risk of serious injury or death from an inflating side air bag, take the following precautions:

- Seat belts must be worn at all times to help keep occupants positioned properly.
- Do not allow passengers to lean their heads or bodies onto doors, put their arms on the doors, stretch their arms out of the window, or place objects between the doors and seats.
- Hold the steering wheel at the 9 o'clock and 3 o'clock positions, to minimize the risk of injuries to your hands and arms.
- Do not use any accessory seat covers. This could reduce or prevent the effectiveness of the system.
- Do not place any objects over the air bag or between the air bag and yourself.

(Continued)

(Continued)

- Do not place any objects between the door and the seat. They may become dangerous projectiles if the side air bag inflates.
- Do not install any accessories on the side or near the side air bags.
- Do not cause impact to the doors when the Engine Start/Stop button is in the ON position or this may cause the side air bags to inflate.
- If the seat or seat cover is damaged, have the vehicle checked and repaired by an authorized HYUNDAI dealer.

Curtain air bags

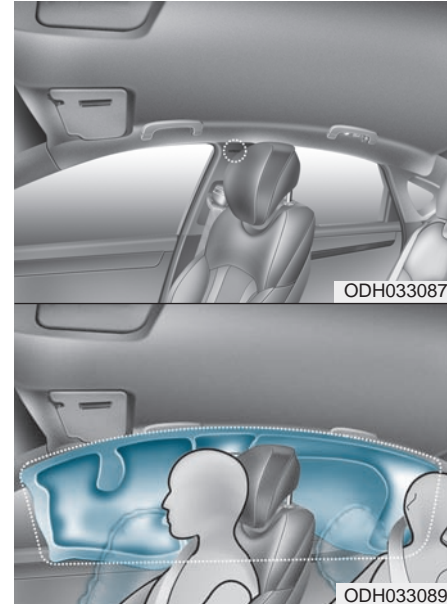

Curtain air bags are located along both sides of the roof rails above the front and rear doors.

They are designed to help protect the heads of the front seat occupants and the rear outboard seat occupants in certain side impact collisions.

The curtain air bags are designed to deploy only during certain side impact collisions, depending on the crash severity, angle, speed and impact.

The curtain air bags do not only deploy on the side of the impact but also on the opposite side.

For vehicles equipped with a rollover sensor the side and curtain air bags on both sides of the vehicle may deploy if a rollover or possible rollover is detected.

The curtain air bags are not designed to deploy in all side impact or rollover situations.

WARNING

To reduce the risk of serious injury or death from an inflating curtain air bags, take the following precautions:

- **All seat occupants must wear seat belts at all times to help keep occupants positioned properly.**
- **Properly secure child restraints as far away from the door as possible.**
- **Do not allow passengers to lean their heads or bodies onto doors, put their arms on the doors, stretch their arms out of the window, or place objects between the doors and seats.**
- **Do not open or repair the side curtain air bags.**

How does the air bags system operate?

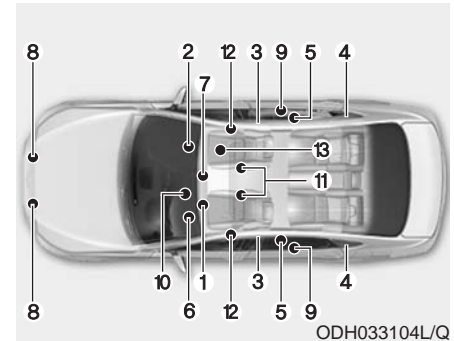

The SRS consists of the following components:

1. Driver's front air bag module
2. Passenger's front air bag module
3. Side air bag modules
4. Curtain air bag modules
5. Retractor pre-tensioner assemblies
6. Air bag warning light
7. SRS control module (SRSCM)/ Rollover sensor
8. Front impact sensors
9. Side impact sensors

10. Driver's knee air bag module
11. Driver's and front passenger's seat belt buckle sensors
12. Emergency fastening device
13. Occupant classification system

The SRSCM continually monitors all SRS components while the Engine Start/Stop button is in the ON position to determine if a crash impact is severe enough to require air bag deployment or pre-tensioner seat belt deployment.



SRS warning light

The SRS (Supplement Restraint System) air bag warning light on the instrument panel displays the air bag symbol depicted in the illustration. The system checks the air bag electrical system for malfunctions. The light indicates that there is a potential problem with your air bag system, which could include your side and curtain air bags used for rollover protection.

WARNING

If your SRS malfunctions, the air bag may not inflate properly during an accident increasing the risk of serious injury or death.

If any of the following conditions occur, your SRS is malfunctioning:

- **The light does not turn on for approximately six seconds when the Engine Start/Stop button is in the ON position.**
- **The light stays on after illuminating for approximately six seconds.**
- **The light comes on while the vehicle is in motion.**
- **The light blinks when the engine is running.**

Have an authorized HYUNDAI dealer inspect the SRS as soon as possible if any of these conditions occur.

During a moderate to severe frontal collision, sensors will detect the vehicle's rapid deceleration. If the rate of deceleration is high enough, the control unit will inflate the front air bags.

The front air bags help protect the driver and front passenger by responding to frontal impacts in which seat belts alone cannot provide adequate restraint. When needed, the side air bags help provide protection in the event of a side impact or rollover by supporting the side upper body area.

- Air bags are activated (able to inflate if necessary) only when the Engine Start/Stop button is in the ON position.
- Air bags inflate in the event of a severe frontal or side collision to help protect the occupants from serious physical injury.
- There is no single speed at which the air bags will inflate. Generally, air bags are designed to inflate based upon the severity of a collision and its direction. These two factors determine whether the sensors produce an electronic deployment/inflation signal.
- Air bag deployment depends on a number of factors including vehicle speed, angles of impact and the density and stiffness of the vehicles or objects which your vehicle impacts during a collision. The determining factors are not limited to those mentioned above.
- The front air bags will completely inflate and deflate in an instant. It is virtually impossible for you to see the air bags inflate during an accident. It is much more likely that you will simply see the deflated air bags hanging out of their storage compartments after the collision.
- In addition to inflating in serious side collisions, vehicles equipped with a rollover sensor, side and curtain air bags will inflate if the sensing system detects a rollover. When a rollover is detected, side and curtain air bags will remain inflated longer to help provide protection from ejection, especially when used in conjunction with the seat belts.
- To help provide protection, the air bags must inflate rapidly. The speed of air bag inflation is a consequence of extremely short time in which to inflate the air bag between the occupant and the vehicle structures before the occupant impacts those structures. This speed of inflation reduces the risk of serious or life-threatening injuries and is thus a necessary part of air bag design. However, the rapid air bag inflation can also cause injuries which can include facial abrasions, bruises and broken bones because the inflation speed also causes the air bags to expand with a great deal of force.
- There are even circumstances under which contact with the air bag can cause fatal injuries, especially if the occupant is positioned excessively close to the air bag.

You can take steps to reduce the risk of being injured by an inflating air bag. The greatest risk is sitting too close to the air bag. An air bag needs about 10 inches (25 cm) of space to inflate. NHTSA recommends that drivers allow at least 10 inches (25 cm) between the center of the steering wheel and the chest.

WARNING

To reduce the risk of serious injury or death from an inflating air bag, take the following precautions:

- **NEVER place a child restraint in the front passenger seat.**

Always properly restrain children under age 13 in the rear seats of the vehicle.

- **Adjust the front passenger's and driver's seats as far to the rear as possible while allowing you to maintain full control of the vehicle.**
- **Hold the steering wheel with hands at the 9 o'clock and 3 o'clock positions.**
- **Never place anything or anyone between the air bag and the seat occupant.**
- **Do not allow the front passenger to place their feet or legs on the dashboard.**



When the SRSCM detects a sufficiently severe impact to the front of the vehicle, it will automatically deploy the front air bags.

■ Driver's front air bag (2)

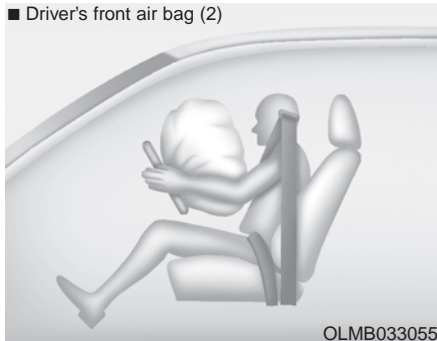

OLMB033055

Upon deployment, tear seams molded directly into the pad covers will separate under pressure from the expansion of the air bags. Further opening of the covers allows full inflation of the air bags.

A fully inflated air bag, in combination with a properly worn seat belt, slows the driver's or the passenger's forward motion, reducing the risk of head and chest injury.

■ Driver's front air bag (3)

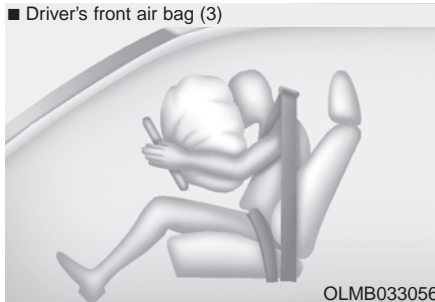

OLMB033056

■ Passenger's front air bag



OLMB033057

After complete inflation, the air bag immediately starts deflating, enabling the driver to maintain forward visibility and the ability to steer or operate other controls.

WARNING

To prevent objects from becoming dangerous projectiles when the passenger's air bag inflates:

- Do not install or place any objects (drink holder, CD holder, stickers, etc.) on the front passenger's panel above the glove box where the passenger's air bag is located.
- Do not install a container of liquid air freshener near the instrument cluster or on the instrument panel surface.

What to expect after an air bag inflates

After a frontal or side air bag inflates, it will deflate very quickly. Air bag inflation will not prevent the driver from seeing out of the windshield or being able to steer. Curtain air bags may remain partially inflated for some time after they deploy.

WARNING

After an air bag inflates, take the following precautions:

- **Open your windows and doors as soon as possible after impact to reduce prolonged exposure to the smoke and powder released by the inflating air bag.**
- **Do not touch the air bag storage area's internal components immediately after an air bag has inflated. The parts that come into contact with an inflating air bag may be very hot.**

(Continued)

(Continued)

- **Always wash exposed skin areas thoroughly with luke-warm water and mild soap.**
- **Always have an authorized HYUNDAI dealer replace the air bag immediately after deployment. Air bags are designed to be used only once.**

Noise and smoke from inflating air bag

When the air bags inflate, they make a loud noise and they leave smoke and powder in the air inside of the vehicle. This is normal and is a result of the ignition of the air bag inflator. After the air bag inflates, you may feel substantial discomfort in breathing because of the contact of your chest with both the seat belt and the air bag, as well as from breathing the smoke and powder. The powder may aggravate asthma for some people. If you experience breathing problems after an air bag deployment, seek medical attention immediately.

Though the smoke and powder are nontoxic, they may cause irritation to the skin, eyes, nose, throat, etc. If this is the case, wash and rinse with cold water immediately and seek medical attention if the symptoms persist.

Occupant Classification System (OCS)



Your vehicle is equipped with an Occupant Classification System (OCS) in the front passenger's seat. The OCS is designed to detect the presence of a properly-seated front passenger and determine if the passenger's front air bag should be enabled (may inflate) or not. The driver's front air bag is not affected or controlled by the OCS.

Main components of the Occupant Classification System

- A detection device located within the front passenger seat cushion.
- Electronic system to determine whether the passenger air bag systems should be activated or deactivated.
- An indicator light located on the instrument panel which illuminates the words "PASS AIR BAG OFF" indicating the front passenger air bag system is deactivated.
- The instrument panel air bag indicator light is interconnected with the OCS.

Front passenger seat adult occupants who are properly seated and wearing the seat belt properly, should not cause the passenger air bag to be automatically turned OFF. However, if the occupant does not sit in the seat properly (for example, by not sitting upright, by sitting on the edge of the seat, or by otherwise being out of position), this could cause the sensor to turn the air bag OFF.

You will find the "PASS AIR BAG OFF" indicator on the center facia panel. This system detects the conditions 1-4 in the following table and activates or deactivates the front passenger air bag based on these conditions.

Always be sure that you and all vehicle occupants are seated properly and wearing the seat belt properly for the most effective protection by the air bag and the seat belt.

The OCS may not function properly if the passenger takes actions which can affect the classification system. These include:

- Failing to sit in an upright position.
- Leaning against the door or center console.
- Sitting towards the sides of the front of the seat.
- Putting their legs on the dashboard or resting them on other locations which reduce the passenger weight on the front seat.
- Wearing the seat belt improperly.
- Reclining the seatback.
- Wearing a thick cloth like ski wear or hip protection wear.
- Put on the seat an additional thick cushion.

Condition and operation in the front passenger Occupant Classification System

Condition detected by the occupant classification system	Indicator/Warning light		Devices
	"PASS AIR BAG OFF" indicator light	SRS warning light	Front passenger air bag
1. Adult *1	Off	Off	Activated
2. Infant *2 or child restraint system with 12 months old *3 *4	On	Off	Deactivated
3. Unoccupied	On	Off	Deactivated
4. Malfunction in the system	Off	On	Activated

*1 The system judges a person of adult size as an adult. When a smaller adult sits in the front passenger seat, the system may recognize him/her as a child depending on his/her physique and posture.

*2 Do not allow children to ride in the front passenger seat. When a larger child who has outgrown a child restraint system sits in the front passenger seat, the system may recognize him/her as an adult depending upon his/her physique or sitting position.

*3 Never install a child restraint system on the front passenger seat.

*4 The PASSENGER AIR BAG "OFF" indicator may turn on or off when a child above 12 months to 12 years old (with or without child restraint system) sits in the front passenger seat. This is a normal condition.

WARNING

Riding in an improper position or placing weight on the front passenger's seat when it is unoccupied by a passenger adversely affects the OCS. To reduce the risk of serious injury or death:



- NEVER put a heavy load or an active electronic device in the front seat or seat-back pocket, or hang any items on the front passenger seat.



- NEVER ride with the seat-back reclined when the vehicle is moving.



- NEVER place your feet on the front passenger seat-back.



- NEVER place your feet or legs on the dashboard.



- NEVER sit with your hips shifted towards the front of the seat.



- NEVER lean on the door or center console or sit on one side of the front passenger seat.

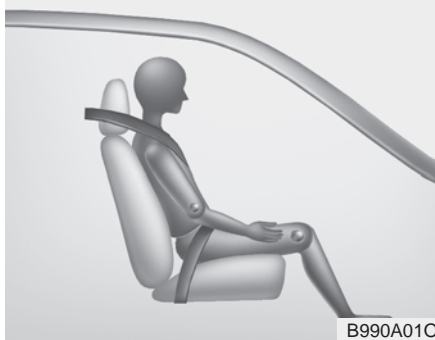

Proper seated position for OCS

If the "PASS AIR BAG OFF" indicator is on when an adult is seated in the front passenger seat, press the Engine Start/Stop button to the OFF position and ask the passenger to sit properly (sitting upright with the seat back in an upright position, centered on the seat cushion with their seat belt on, legs comfortably extended and their feet on the floor). Restart the engine and have the person remain in that position. This will allow the system to detect the person and to enable the passenger air bag. If the "PASS AIR BAG OFF" indicator is still on, ask the passenger to move to the rear seat.

WARNING

Never allow an adult passenger to ride in the front passenger seat when the "PASS AIR BAG OFF" indicator is illuminated. During a collision, the air bag will not inflate if the indicator is illuminated. Have your passenger move to the rear seat.

* NOTICE

The "PASS AIR BAG OFF" indicator illuminates for approximately 4 seconds after the Engine Start/Stop button is in the ON position or after the engine is started. If the front passenger seat is occupied, the OCS will then classify the front passenger after several more seconds.

Do Not Install a Child Restraint in the Front Passenger's Seat



Even though your vehicle is equipped with the OCS, never install a child restraint in the front passenger's seat. An inflating air bag can forcefully strike a child or child restraint resulting in serious or fatal injury.

⚠ WARNING

- NEVER place a rear-facing or front-facing child restraint in the front passenger's seat of the vehicle.
- An inflating frontal air bag could forcefully strike a child resulting in serious injury or death.
- Always properly restrain children in an appropriate child restraint in the rear seat of the vehicle.

Why Didn't My Air Bag Go Off in a Collision? (Air bags are not designed to inflate in every collision.)

There are certain types of accidents in which the air bag would not be expected to provide additional protection. These include rear impacts, second or third collisions in multiple impact accidents, as well as low speed impacts. Damage to the vehicle indicates a collision energy absorption, and is not an indicator of whether or not an air bag should have inflated.

Air bag collision sensors**⚠ WARNING**

To reduce the risk of an air bag deploying unexpectedly and causing serious injury or death:

- Do not hit or allow any objects to impact the locations where air bags or sensors are installed.

(Continued)

(Continued)

- Do not perform maintenance on or around the air bag sensors. If the location or angle of the sensors is altered, the air bags may deploy when they should not or may not deploy when they should.
- Do not install bumper guards or replace the bumper with a non-genuine HYUNDAI parts. This may adversely affect the collision and air bag deployment performance.
- Press the Engine Start/Stop button to the OFF or ACC position when the vehicle is being towed to prevent inadvertent air bag deployment.
- Have all air bag repairs conducted by an authorized HYUNDAI dealer.

Safety system of your vehicle

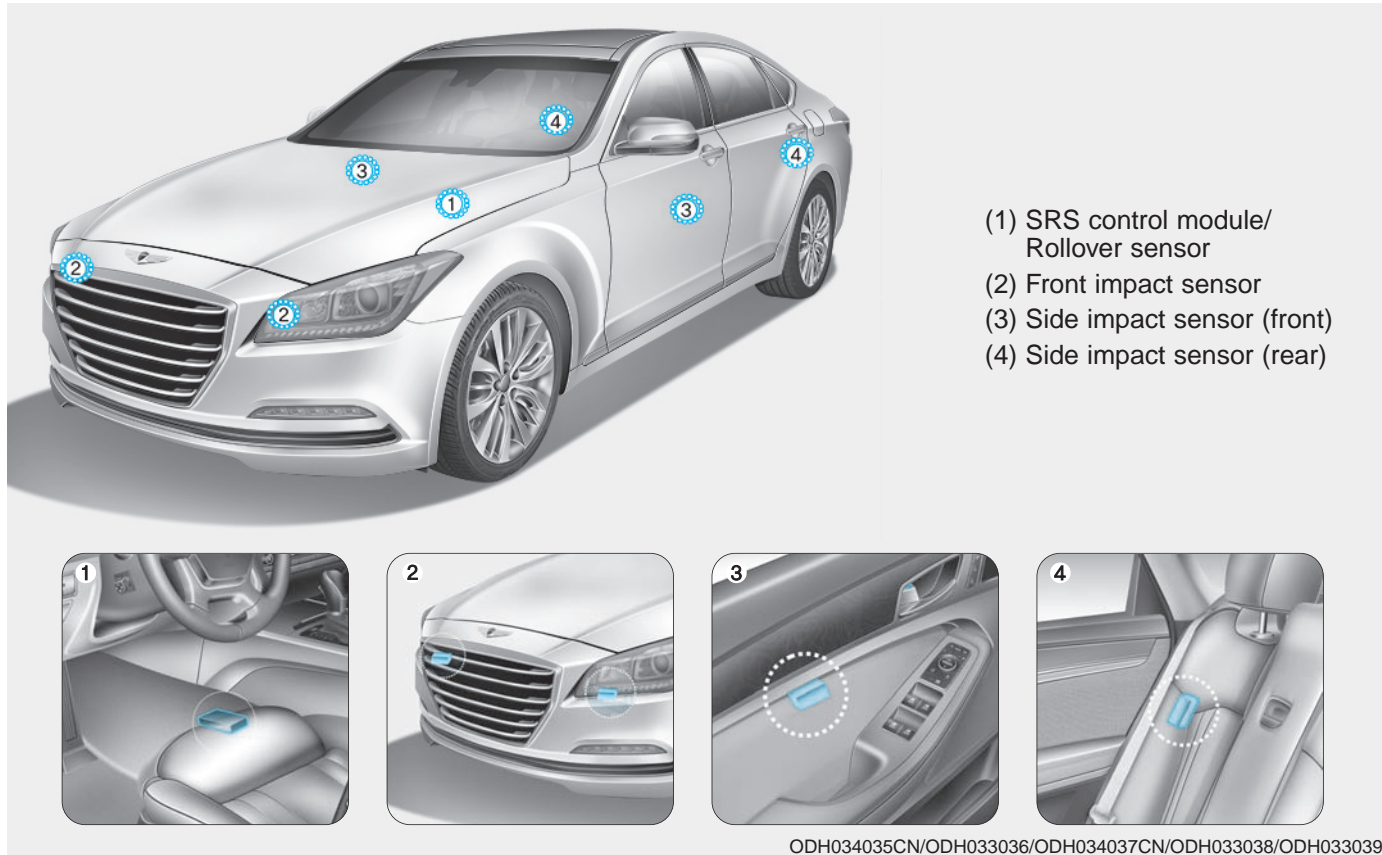

Air bag inflation conditions

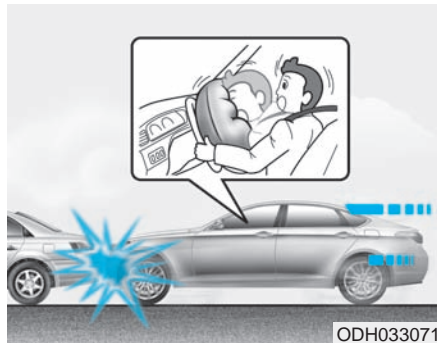

Front air bag

Front air bags are designed to inflate in a frontal collision depending on the intensity, speed, or angles of impact of the front collision.

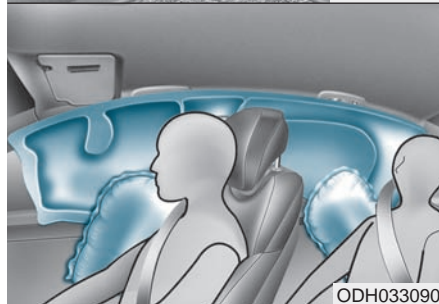
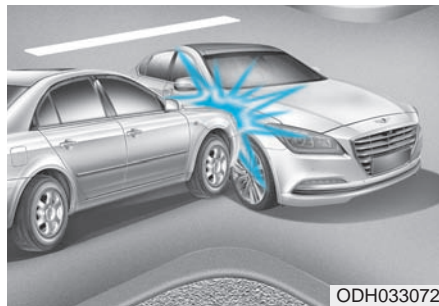

Side impact and curtain air bags

Side impact and curtain air bags are designed to inflate when an impact is detected by side collision sensors depending on the strength, speed, or angles of impact resulting from a side impact collision.

Although the driver's and front passenger's air bags are designed to inflate only in frontal collisions, they also may inflate in other types of collisions if the front impact sensors detect a sufficient impact. Side impact and curtain air bags are designed to inflate only in side impact collisions or rollover situations, but they may inflate in other collisions if the side impact sensors detect a sufficient impact.

If the vehicle chassis is impacted by bumps or objects on unimproved roads, the air bags may deploy. Drive carefully on unimproved roads or on surfaces not designed for vehicle traffic to prevent unintended air bag deployment.

Air bag non-inflation conditions



In certain low-speed collisions the air bags may not deploy. The air bags are designed not to deploy in such cases because they may not provide benefits beyond the protection of the seat belts.

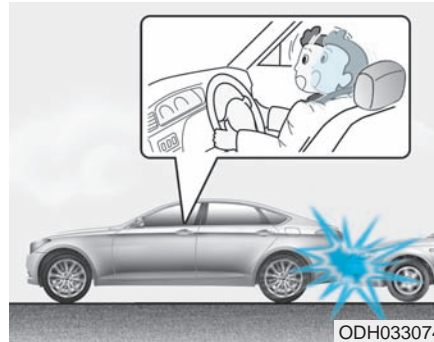

Front air bags are not designed to inflate in rear collisions, because occupants are moved backward by the force of the impact. In this case, inflated air bags would not provide any additional benefit.

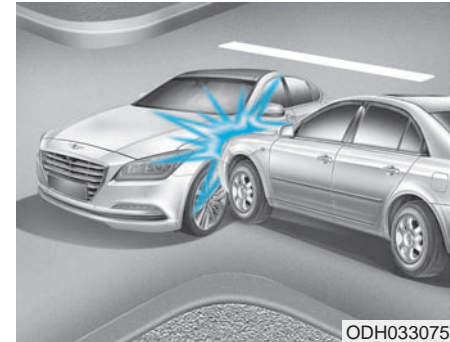

Front air bags may not inflate in side impact collisions, because occupants move in the direction of the collision, and thus in side impacts, front air bag deployment would not provide additional occupant protection.

However, side impact and curtain air bags may inflate depending on the intensity, vehicle speed and angles of impact.

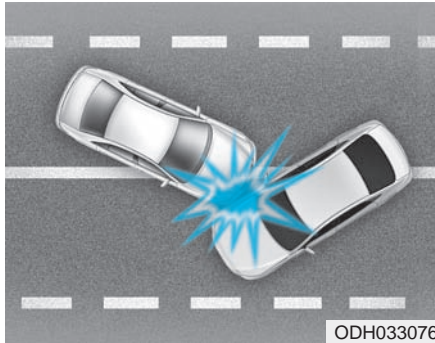

ODH033076

In an angled collision, the force of impact may direct the occupants in a direction where the air bags would not be able to provide any additional benefit, and thus the sensors may not deploy any air bags.

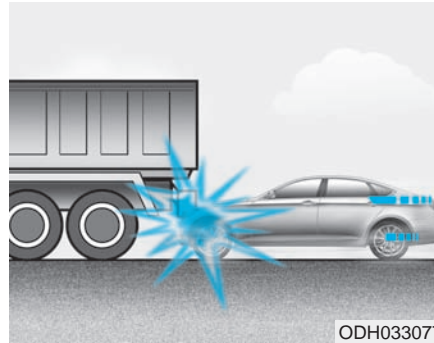

ODH033077

Just before impact, drivers often brake heavily. Such heavy braking lowers the front portion of the vehicle causing it to "ride" under a vehicle with a higher ground clearance. Air bags may not inflate in this "under-ride" situation because deceleration forces that are detected by sensors may be significantly reduced by such "underride" collisions.

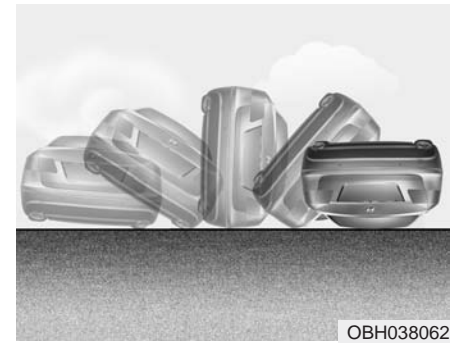

OBH038062

Front air bags may not inflate in rollover accidents because air bag deployment could not provide protection to the occupants.

However, side impact and curtain air bags may inflate when the vehicle is rolled over by a side impact collision, if the vehicle is equipped with side air bags and curtain air bags.

Also, if the vehicle is equipped with a rollover sensor, side impact and curtain air bags may inflate in a rollover.

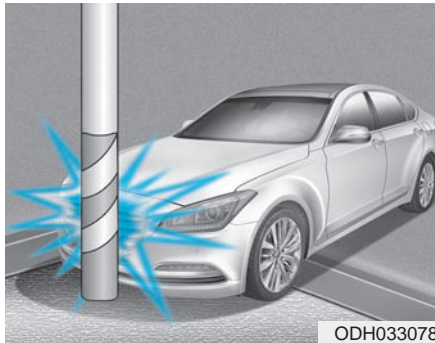

Air bags may not inflate if the vehicle collides with objects such as utility poles or trees, where the point of impact is concentrated and the collision energy is absorbed by the vehicle structure.

SRS care

The SRS is virtually maintenance-free and there are no parts you can safely service by yourself. If the SRS air bag warning light does not illuminate when the Engine Start/Stop button is in the ON position, or continuously remains on, have your vehicle immediately inspected by an authorized HYUNDAI dealer.

Any work on the SRS system, such as removing, installing, repairing, or any work on the steering wheel, the front passenger's panel, front seats and roof rails must be performed by an authorized HYUNDAI dealer. Improper handling of the SRS system may result in serious personal injury.

⚠ WARNING

To reduce the risk of serious injury or death, take the following precautions:

- **Do not attempt to modify or disconnect the SRS components or wiring, including the addition of any kind of badges to the pad covers or modifications to the body structure.**
- **Do not place objects over or near the air bag modules on the steering wheel, instrument panel, or the front passenger's panel above the glove box.**
- **Clean the air bag pad covers with a soft cloth moistened with plain water. Solvents or cleaners could adversely affect the air bag covers and proper deployment of the system.**
- **We recommend that inflated air bags be replaced by an authorized HYUNDAI dealer.**

(Continued)

(Continued)

- If components of the air bag system must be discarded, or if the vehicle must be scrapped, certain safety precautions must be observed. Consult an authorized HYUNDAI dealer for the necessary information. Failure to follow these precautions could increase the risk of personal injury.

Additional safety precautions

Passengers should not move out of or change seats while the vehicle is moving. A passenger who is not wearing a seat belt during a crash or emergency stop can be thrown against the inside of the vehicle, against other occupants, or be ejected from the vehicle.

Do not use any accessories on seat belts. Devices claiming to improve occupant comfort or reposition the seat belt can reduce the protection provided by the seat belt and increase the chance of serious injury in a crash

Do not modify the front seats.

Modification of the front seats could interfere with the operation of the supplemental restraint system sensing components or side air bags.

Do not place items under the front seats. Placing items under the front seats could interfere with the operation of the supplemental restraint system sensing components and wiring harnesses.

Do not cause impact to the doors. Impact to the doors when the Engine Start/Stop button is in the ON position may cause the air bags to inflate.

Modifications to accommodate disabilities. If you require modification to your vehicle to accommodate a disability, contact the HYUNDAI Customer Connect Center at 1-877-378-8727.

Adding equipment to or modifying your air bag equipped vehicle

If you modify your vehicle by changing your vehicle's frame, bumper system, front end or side sheet metal or ride height, this may affect the operation of your vehicle's air bag system.

Air bag warning labels

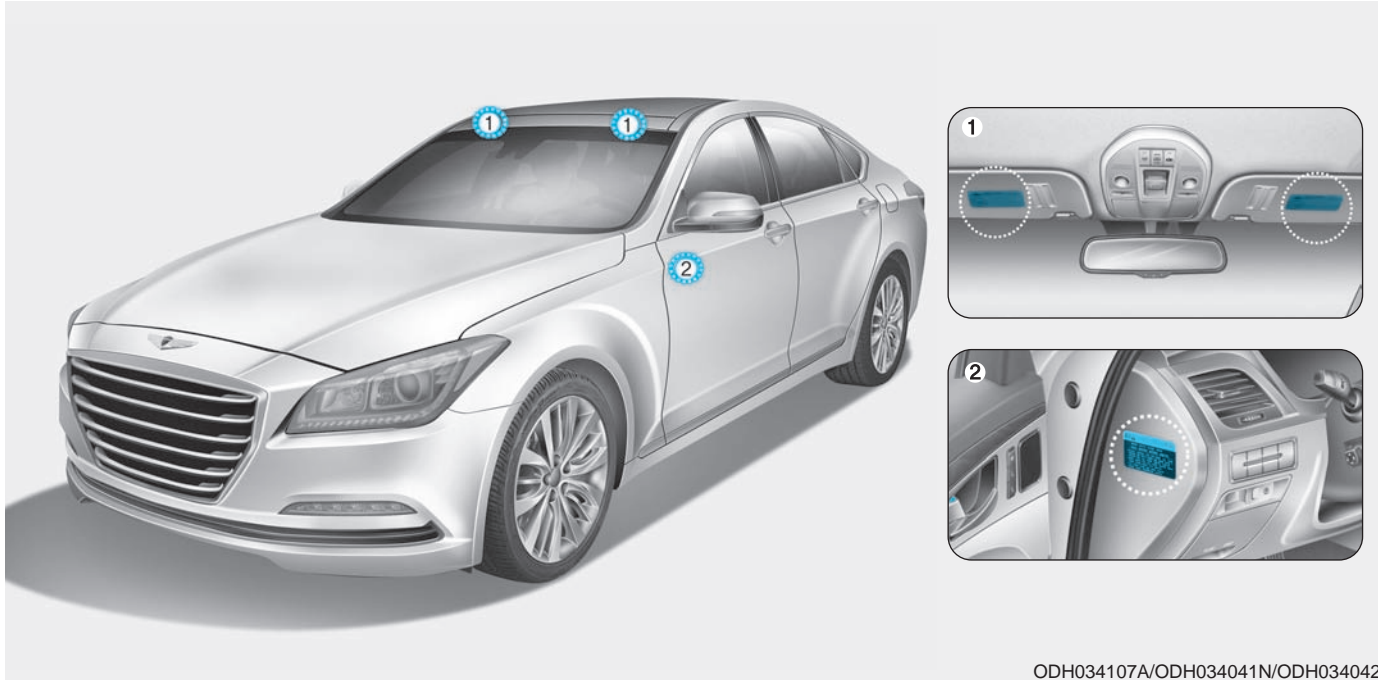

ODH034107A/ODH034041N/ODH034042

Air bag warning labels, required by the U.S. National Highway Traffic Safety Administration (NHTSA), are attached to alert the driver and passengers of potential risks of the air bag system. Be sure to read all of the information about the air bags that are installed on your vehicle in this Owners Manual.

Convenient features of your vehicle

Accessing your vehicle	3-4
Smart key	3-4
Smart key precautions.....	3-7
Immobilizer System	3-9
Door locks	3-11
Operating door locks from outside the vehicle.....	3-11
Power Door Latch.....	3-12
Operating door locks from inside the vehicle	3-12
Auto door lock/unlock features	3-14
Child-protector rear door locks.....	3-14
Theft-alarm system	3-15
Driver position memory system	3-16
Storing positions into memory	3-16
Resetting the driver's seat memory system	3-17
Easy access function	3-18
Steering wheel	3-19
Electric power steering (EPS).....	3-19
Tilt steering / Telescope steering.....	3-19
Heated steering wheel.....	3-20
Horn.....	3-21
Mirrors	3-22
Inside rearview mirror.....	3-22
Outside rearview mirror	3-36
Reverse parking aid function.....	3-39
Windows	3-40
Power windows.....	3-41
Panorama sunroof	3-44
Sunshade.....	3-44
Sliding the sunroof	3-45
Tilting the sunroof	3-45
Closing the sunroof	3-46
Resetting the sunroof.....	3-47
Exterior features	3-48
Hood	3-48
Trunk	3-49
Smart trunk.....	3-55
Fuel filler door.....	3-59
Instrument cluster	3-62
Instrument Cluster Control.....	3-63
LCD Display Control.....	3-63
Gauges	3-64

LCD display	3-68	Light	3-110
LCD Modes	3-68	Exterior lights	3-110
Trip Computer Mode	3-69	Smart High Beam	3-112
Turn By Turn (TBT) Mode	3-70	Welcome system	3-117
ASCC/LKAS Mode	3-70	Interior lights	3-118
A/V Mode	3-70	Wipers and washers	3-123
Information Mode	3-71	Windshield wipers	3-123
User Settings Mode	3-73	Windshield washers	3-125
Warning Messages	3-80	Driver assist system	3-126
Trip computer	3-90	Rear view camera	3-126
Overview	3-90	Parking Guide System	3-127
Trip A/B	3-91	Parking Assist System	3-128
Fuel Economy	3-92	Defroster	3-132
Digital Speedometer	3-94	Rear window defroster	3-132
Warning and indicator lights	3-95	Automatic climate control system	3-134
Warning lights	3-95	Automatic heating and air conditioning	3-135
Indicator Lights	3-103	Manual heating and air conditioning	3-136
Head Up Display (HUD)	3-107	System operation	3-144
Description	3-107	Climate control air filter	3-146
Head Up Display ON/OFF	3-108	Air conditioner refrigerant and compressor	
Head Up Display Information	3-108	lubricant	3-147
Head Up Display Setting	3-109	Air Conditioning refrigerant label	3-147
		Windshield defrosting and defogging	3-148
		Auto defogging system ON/OFF	3-150

- Climate control additional features.....3-151**
 - Cluster ionizer.....3-151
 - Smart ventilation.....3-151
 - Rear climate system ON/OFF.....3-152
 - CO2 control auto air conditioner.....3-152
- Storage compartment.....3-153**
 - Center console storage.....3-153
 - Glove box.....3-154
 - Sunglass holder.....3-154
- Interior features.....3-155**
 - Cup holder.....3-155
 - Sunvisor.....3-156
 - Power outlet.....3-156
 - Clock.....3-158
 - Clothes hanger.....3-158
 - Bag hanger.....3-159
 - Floor mat anchor(s).....3-159
 - Rear curtain.....3-160
 - Side curtain.....3-161
 - Luggage net holder.....3-162

ACCESSING YOUR VEHICLE

Smart key



1. Door Lock
2. Door Unlock
3. Trunk Unlock
4. Panic

Your HYUNDAI uses a Smart Key, which you can use to lock or unlock a door (and trunk) and even start the engine.

Locking

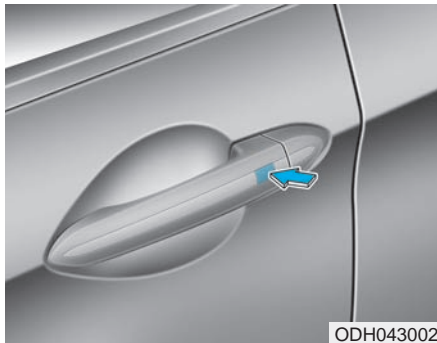

To lock :

1. Close all doors, engine hood and trunk.
2. Either press the door handle button or press the Door Lock button (1) on the smart key.
3. The hazard warning lights will blink and the chime will sound once. Also, the outside rearview mirror will fold, if the outside rearview mirror folding switch is in the AUTO position.
4. Make sure the doors are locked by checking the position of the door lock button inside the vehicle.

* NOTICE

The door handle button will only operate when the smart key is within 28~40 inches (0.7~1 m) from the outside door handle.

Even though you press the outside door handle button, the doors will not lock and the chime will sound for three seconds if any of the following occur:

- The Smart Key is in the vehicle.
- The Engine Start/Stop button is in ACC or ON position.
- Any door except the trunk is open.

⚠ WARNING

Do not leave the Smart Key in your vehicle with unsupervised children. Unattended children could press the Engine Start/Stop button and may operate power windows or other controls, or even make the vehicle move, which could result in serious injury or death.

Unlocking

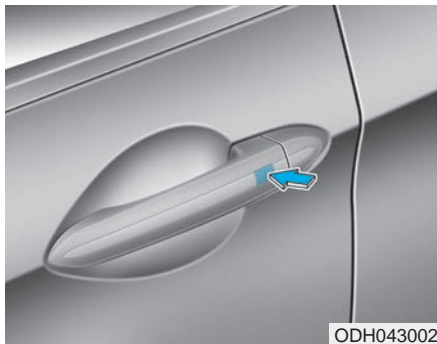

To unlock:

1. Carry the Smart Key.
2. Either press the driver's outside door handle button or press the Door Unlock button (2) on the smart key.
3. The driver's door will unlock. The hazard warning lights will blink two times. Also, the outside rearview mirror will unfold, if the outside rearview mirror folding switch is in the AUTO position.

If you press the driver's outside door handle button or Door Unlock button on the smart key again within four seconds, then all the doors will unlock.

* NOTICE

- The door handle button will only operate when the smart key is within 28~40 inches (0.7~1 m) from the outside door handle and other people can also open the doors.
- If you press the front passenger's outside door handle, while carrying the Smart Key, all doors will unlock.
- After unlocking the doors, the doors will lock automatically after 30 seconds unless a door is opened.
- You can change the system to the Central Door Unlock mode (unlock all the doors when you press the unlock button one time). To change between Two Stage Unlock mode and Central Door Unlock mode, perform the following:
Press the lock button and unlock button on the smart key at the same time for 5 seconds or more. The hazard warning lights will blink four times.

Trunk opening

To open:

1. Carry the smart key.
2. Either press the trunk handle button or press and hold the Trunk Unlock button (3) on the smart key for more than one second.
3. The hazard warning lights will blink two times.

Once the trunk is opened and then closed, the trunk will lock automatically.

* NOTICE

The trunk handle button will only operate when the smart key is within 28 inches (0.7 m) from the trunk handle.

Panic button

Press the Panic button (4) and hold for more than one second. The horn sounds and hazard warning lights blink for about 30 seconds. To cancel the panic mode, press any button on the Smart Key.

Start-up

You can start the engine without inserting the key.

For more information, refer to the **Engine Start/Stop button** in chapter 5.

CAUTION

To prevent damaging the smart key:

- Keep the smart key away from water or any liquid and fire. If the inside of the smart key gets damp (due to drinks or moisture), or is heated, internal circuit may malfunction, excluding the car from the warranty.
- Avoid dropping or throwing the smart key.
- Protect the smart key from extreme temperatures.

Mechanical key

If the Smart Key does not operate normally, you can lock or unlock the door by using the mechanical key.

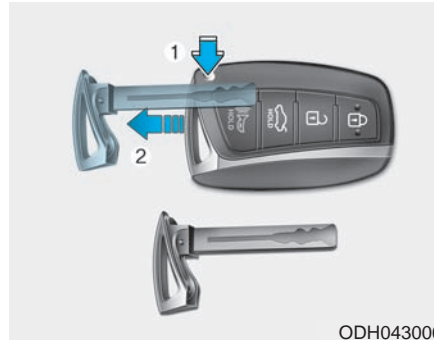

Press and hold the release button (1) and remove the mechanical key (2). Insert the mechanical key into the key hole on the door.

To reinstall the mechanical key, put the key into the hole and push it until a click sound is heard.

Loss of a smart key

A maximum of three Smart Keys including Card Type Smart Keys can be registered to a single vehicle. If you happen to lose your smart key, it is recommended that you should immediately take the vehicle and remaining keys to your authorized HYUNDAI dealer or tow the vehicle, if necessary.

Smart key precautions

The smart key will not work if any of the following occur:

- The smart key is close to a radio transmitter such as a radio station or an airport which can interfere with normal operation of the transmitter.
- The smart key is near a mobile two way radio system or a cellular phone.
- Another vehicle's smart key is being operated close to your vehicle.

When the smart key does not work correctly, open and close the door with the mechanical key. If you have a problem with the smart key, contact an authorized HYUNDAI dealer.

If the smart key is in close proximity to your mobile phone, the signal could be blocked by your mobile phones normal operational signals. This is especially important when the phone is active such as making and receiving calls, text messaging, and/or sending/receiving emails. Avoid placing the smart key and your mobile phone in the same pants or jacket pocket and always try to maintain an adequate distance between the two devices.

CAUTION

Keep the smart key away from electromagnetic materials that blocks electromagnetic waves to the key surface.

This device complies with Part 15 of the FCC rules.

Operation is subject to the following two conditions:

1. This device may not cause harmful interference, and
2. This device must accept any interference received, including interference that may cause undesired operation.

*** NOTICE**

Changes or modifications not expressly approved by the party responsible for compliance could void the user's authority to operate the device.

Restrictions in Handling Keys

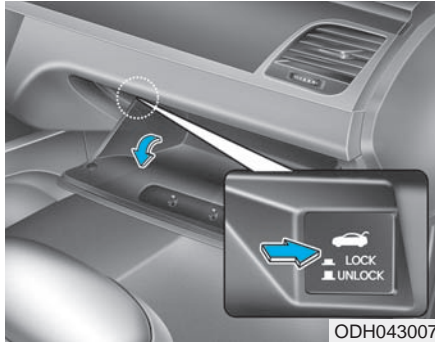

When leaving keys with parking lot and valet attendants, the following procedures will ensure your vehicle's trunk and glove box compartment can only be opened with the mechanical key.

To lock:

1. Remove the mechanical key from the Smart Key.
2. Unlock the glove box by using the mechanical key, then open it.
3. Set the Trunk Lid Control button to the LOCK position (button pressed).
4. Close and lock the glove box using the mechanical key.
5. Leave the Smart Key with the attendant and keep the mechanical key with you.

The Smart Key can only be used to start the engine and operate door locks.

To unlock:

1. Open the glove box with the mechanical key.
2. Set the Trunk Lid Control button to the UNLOCK position (button not pressed).

In this position the trunk lid will open with the Trunk Lid button or the Smart Key.

Battery replacement

If the Smart Key is not working properly, try replacing the battery with a new one.

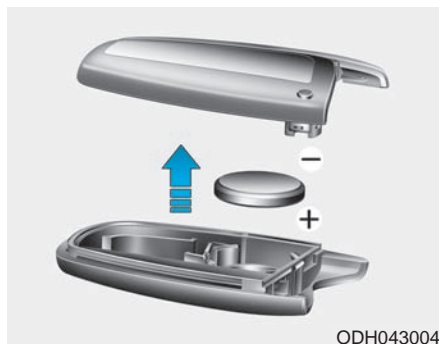

Battery Type: CR2032

To replace the battery:

1. Pry open the rear cover of the smart key.
2. Remove the old battery and insert the new battery.
3. Reinstall the rear cover of the smart key.

If you suspect your smart key might have sustained some damage, or you feel your smart key is not working correctly, contact an authorized HYUNDAI dealer.

* NOTICE



An inappropriately disposed battery can be harmful to the environment and human health. Dispose the battery according to your local law(s) and regulation(s).

Immobilizer System

The immobilizer system protects your vehicle from theft. If an improperly coded key (or other device) is used, the engine's fuel system is disabled.

When the Engine Start/Stop button is in the ON position, the immobilizer system indicator should come on briefly, then go off. If the indicator starts to blink, the system does not recognize the coding of the Smart Key.

Press the Engine Start/Stop button to the OFF position, then press the Engine Start/Stop button to the ON position again.

The system may not recognize your Smart Key's coding if another immobilizer key or other metal object (i.e., key chain) is near the Smart Key. The engine may not start because the metal may interrupt the transponder signal from transmitting normally.

If the system repeatedly does not recognize the coding of the key, contact your HYUNDAI dealer.

Do not attempt to alter this system or add other devices to it. Electrical problems could result that may make your vehicle inoperable.

WARNING

In order to prevent theft of your vehicle, do not leave spare keys anywhere in your vehicle. Your immobilizer password is a customer unique password and should be kept confidential.

CAUTION

The transponder in your key is an important part of the immobilizer system. It is designed to give years of trouble-free service, however you should avoid exposure to moisture, static electricity and rough handling. Immobilizer system malfunction could occur.

This device complies with Part 15 of the FCC rules.

Operation is subject to the following two conditions:

1. This device may not cause harmful interference, and
2. This device must accept any interference received, including interference that may cause undesired operation.

*** NOTICE**

Changes or modifications not expressly approved by the party responsible for compliance could void the user's authority to operate the device.

DOOR LOCKS

Operating door locks from outside the vehicle

Mechanical key

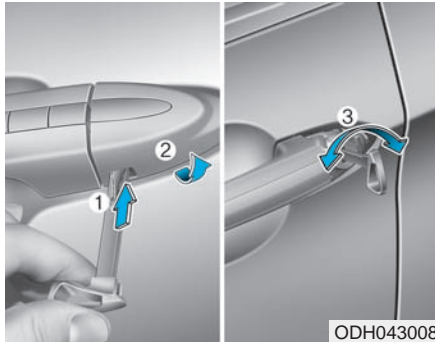

First, remove the cover (1~2), and then turn the key toward the rear of the vehicle to unlock and toward the front of the vehicle to lock (3).

If you lock the driver's door with a mechanical key, all vehicle doors will lock. If you unlock the driver's door with a mechanical key, the driver's door will unlock.

Once the doors are unlocked, they may be opened by pulling the door handle.

When closing the door, push the door by hand. Make sure that doors are closed securely.

Smart key

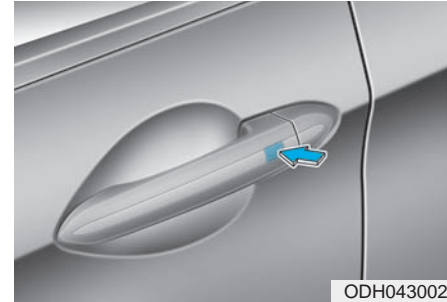

To lock the doors, press the button on the outside door handle while carrying the smart key with you or press the door lock button on the smart key.

Press the button on the driver's outside door handle while carrying the smart key with you or press the unlock button on the smart key, the driver's door will unlock. If you press the button on the front passenger's outside door, all doors will unlock.

Once the doors are unlocked, they may be opened by pulling the door handle.

When closing the door, push the door by hand. Make sure that doors are closed securely.

* NOTICE

- In cold and wet climates, door lock and door mechanisms may not work properly due to freezing conditions.
- If the door is locked/unlocked multiple times in rapid succession with either the vehicle key or door lock switch, the system may stop operating temporarily in order to protect the circuit and prevent damage to system components.

Power Door Latch (if equipped)

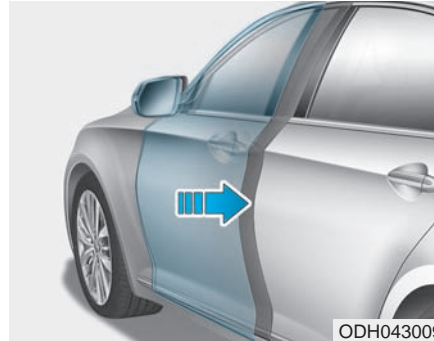

If a door isn't closed completely but is closed to the first detent position, the door will close automatically.

⚠ CAUTION

To reduce the risk of injury:

- Before closing the door, check there are no obstructions in the path of the door.
- Keep your fingers away from the edge of the door or they may become trapped when the power door latch operates.

Operating door locks from inside the vehicle

With the door lock button

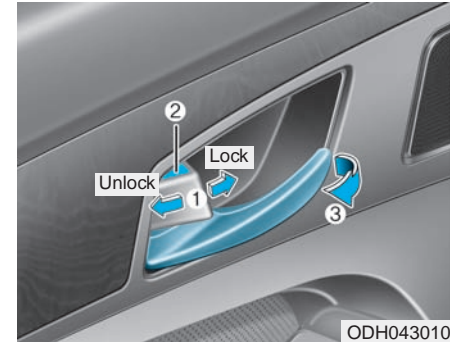

- To unlock a door, push the door lock button (1) to the "Unlock" position. The red mark (2) on the door lock button will be visible.
- To lock a door, push the door lock button (1) to the "Lock" position. If the door is locked properly, the red mark (2) on the door lock button will not be visible.
- To open a door, pull the door handle (3) outward.

- If the inner door handle of the driver's (or front passenger's) door is pulled when the door lock button is in the lock position, the button is unlocked and door opens.
- Doors cannot be locked if the smart key is in the vehicle and any door is open.

* NOTICE

If a power door lock ever fails to function while you are in the vehicle try one or more of the following techniques to exit:

Operate the door unlock feature repeatedly (both electronic and manual) while simultaneously pulling on the door handle.

Operate the other door locks and handles, front and rear.

Lower a front window and use the mechanical key to unlock the door from outside.

With the central door lock switch

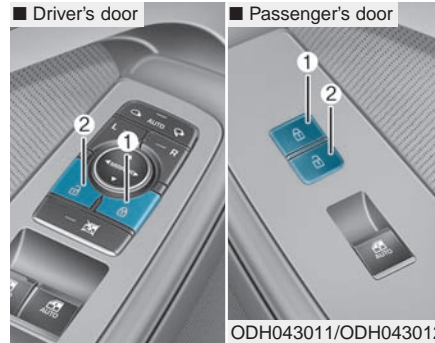

When pressing the (🔒) switch (1), all vehicle doors will lock.

When pressing the (🔓) switch (2), all vehicle doors will unlock.

If the smart key is in the vehicle and any door is opened, the doors will not lock even though the lock button (1) of the central door lock switch is pressed.

⚠ WARNING

The doors should always be fully closed and locked while the vehicle is in motion. If the doors are unlocked, the risk of being thrown from the vehicle in a crash is increased.

⚠ WARNING

Do not leave children or animals unattended in your vehicle. An enclosed vehicle can become extremely hot, causing death or serious injury to unattended children or animals who cannot escape the vehicle. Children might operate features of the vehicle that could injure them, or they could encounter other harm, possibly from someone gaining entry to the vehicle.

⚠ WARNING

Always secure your vehicle.

Leaving your vehicle unlocked increases the potential risk to you or others from someone hiding in your vehicle.

To secure your vehicle, while depressing the brake, move the shift lever to the P (Park) position, engage the parking brake, and press the Engine Start/Stop button to the OFF position, close all windows, lock all doors, and always take the Smart Key with you.

⚠ WARNING

Opening a door when something is approaching may cause damage or injury. Be careful when opening doors and watch for vehicles, motorcycles, bicycles or pedestrians approaching the vehicle in the path of the door.

Auto door lock/unlock features

Impact sensing door unlock system

All doors will be automatically unlocked when an impact causes the air bags to deploy.

Speed sensing door lock system

All doors will be automatically locked when vehicle speed exceeds 9 mph (15 km/h).

All of the doors will be automatically unlocked after the engine is turned off.

Shift lever auto door lock

All doors will be automatically locked when shifting the shift lever out of P (Park) with the engine running.

You can activate or deactivate the Auto Door Lock/Unlock features from the User Settings Mode on the LCD display.

For more details, refer to "LCD Display" in this chapter.

Child-protector rear door locks

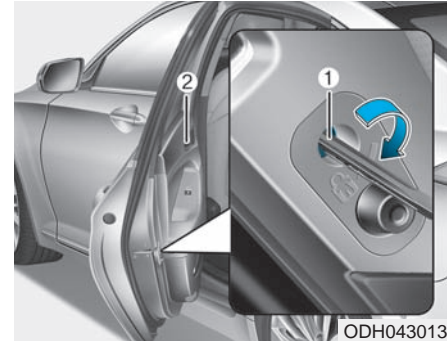

The child safety lock is provided to help prevent children seated in the rear from accidentally opening the rear doors. The rear door safety locks should be used whenever children are in the vehicle.

The child safety lock is located on the edge of each rear door. When the child safety lock is in the lock (1) position, the rear door will not open if the inner door handle (2) is pulled.

To lock the child safety lock, insert a screwdriver into the hole and turn it to the lock position.

To allow a rear door to be opened from inside the vehicle, unlock the child safety lock.

WARNING

If children accidentally open the rear doors while the vehicle is in motion, they could fall out of the vehicle. The rear door safety locks should always be used whenever children are in the vehicle.

THEFT-ALARM SYSTEM

This system helps to protect your vehicle and valuables. The horn will sound and the hazard warning lights will blink continuously if any of the following occurs:

- A door is opened without using the smart key.
- The trunk is opened without using the smart key.
- The engine hood is opened.

The alarm continues for 30 seconds, then the system resets. To turn off the alarm, unlock the doors with the smart key.

The Theft Alarm System automatically sets 30 seconds after you lock the doors and the trunk. For the system to activate, you must lock the doors and the trunk from outside the vehicle with the smart key or by pressing the button on the outside of the door handles with the smart key in your possession.

The hazard warning lights will blink and the chime will sound once to indicate the system is armed.

Once the security system is set, opening any door, the trunk, or the hood without using the smart key will cause the alarm to activate.

The Theft Alarm System will not set if the hood, the trunk, or any door is not fully closed. If the system will not set, check the hood, the trunk, or the doors are fully closed.

Do not attempt to alter this system or add other devices to it.

* NOTICE

- **Do not lock the doors until all passengers have left the vehicle. If the remaining passenger leaves the vehicle when the system is armed, the alarm will be activated.**
- **If the vehicle is not disarmed with the smart key, open the doors by using the mechanical key and start the engine.**
- **When the system is disarmed but a door or trunk is not opened within 30 seconds, the system will be rearmed.**

DRIVER POSITION MEMORY SYSTEM (IF EQUIPPED)



The Driver Position Memory System is provided to store and recall the following memory settings with a simple button operation.

- Driver's seat position
- Outside rearview mirror position
- Steering wheel position
- Instrument panel illumination intensity
- Head Up Display (HUD) position and brightness

⚠ WARNING

Never attempt to operate the driver position memory system while the vehicle is moving.

This could result in loss of control, and an accident causing death, serious injury, or property damage.

* NOTICE

- **If the battery is disconnected, the position memory will be lost and the driving positions must be stored in the system again.**
- **If the Driver Position Memory System does not operate normally, have the system checked by an authorized HYUNDAI dealer.**

Storing positions into memory

1. Check that the shift lever is in P (Park) while the Engine Start/Stop button is in the ON position.
2. Adjust the driver's seat position, outside rearview mirror position, steering wheel position, instrument panel illumination intensity and head-up display height/brightness to positions comfortable for the driver.
3. Press the SET button. The system will beep once and notify you "Press button to save settings" on the LCD display.
4. Press one of the memory buttons (1 or 2) within 5 seconds. The system will beep twice when the memory has been successfully stored.
- 5.

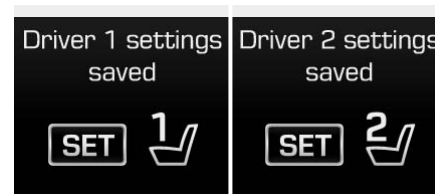

ODH043156L/ODH043157L

"Driver 1 (or 2) settings saved" will appear on the LCD display.

Recalling positions from memory

1. Check that the shift lever is in P (Park) while the Engine Start/Stop button is in the ON position.
2. Press the desired memory button (1 or 2). The system will beep once, and then the driver's seat position, outside rearview mirror position, steering wheel position, instrument panel illumination intensity and head-up display height/brightness will automatically adjust to the stored positions.
- 3.

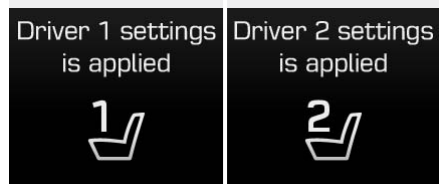

ODH043158L/ODH043159L

"Driver 1(or 2) settings is applied" will appear on the LCD display.

* NOTICE

- While recalling the "1" memory position, pressing the SET or 1 button temporarily stops the adjustment of the recalled memory position. Pressing the 2 button recalls the "2" memory position.
- While recalling the "2" memory position, pressing the SET or 2 button temporarily stops the adjustment of the recalled memory position. Pressing the 1 button recalls the "1" memory position.
- While recalling the stored positions, pressing one of the control buttons for the driver's seat, outside rearview mirror, steering wheel, instrument panel illumination or head-up display will cause the movement of that component to stop and move in the direction that the control button is pressed.

Resetting the driver's seat memory system

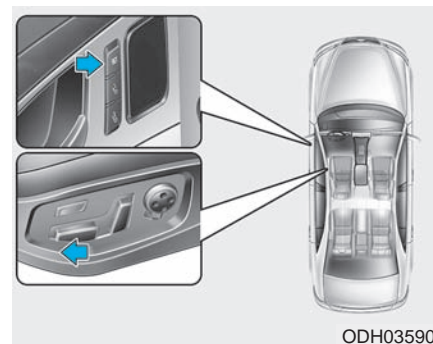

Take the following procedures to reset the driver's seat memory system, when it does not operate properly.

To reset the driver's seat memory system

1. Press the Engine Start/Stop button to the ON position, set the gear in P (Park), and open the driver's door.
2. Operate the control switch/lever to set the driver's seat and seatback to the foremost position.
3. Simultaneously press the SET button and push forward the control lever over 2 seconds.

While resetting the driver's seat memory system

1. It starts with the alarming sounds.
2. The driver's seat and seatback is adjusted to the rearward position with the alarming sounds.
3. The driver's seat and seatback is re-adjusted to the default position (central position) with the alarming sounds.

However, in the following cases, the resetting procedure and the alarming sounds may stop.

- The memory button is pressed.
- The control switch/lever is operated.
- The gear is shifted out of P (Park).
- The driving speed exceeds 3 km/h.
- The driver's door is closed.

After the resetting procedure, set the driver's seat memory system for your comfort.

CAUTION

- **Reattempt to do the resetting procedure again, when the resetting procedure or the alarming sound incompletely stops.**
- **Make sure that there is no obstacle around the driver's seat in advance of resetting the driver's seat memory system.**

Easy access function

When exiting the vehicle, the steering wheel will move away from the driver and the seat will move rearward when the engine is turned off.

When entering the vehicle, the steering wheel will move toward the driver and the seat will move forward when the Engine Start/Stop button is pressed to the ACC position.

You can activate or deactivate the Easy Access Function from the User Settings Mode on the LCD display.

For more details, refer to "LCD Display" in this chapter.

STEERING WHEEL

Electric power steering (EPS)

The system assists you with steering the vehicle. If the engine is turned off or if the power steering system becomes inoperative, you may still steer the vehicle, but it will require increased steering effort.

Should you notice any change in the effort required to steer during normal vehicle operation, we recommend that the system be checked by an authorized HYUNDAI dealer.

CAUTION

If the Electric Power Steering System does not operate normally, the warning light (⊕!) will illuminate on the instrument cluster. The steering wheel will require increase effort. Take your vehicle to an authorized HYUNDAI dealer and have the system checked as soon as possible.

* NOTICE

The following symptoms may occur during normal vehicle operation:

- The steering effort may be high immediately after placing the Engine Start/Stop button in the ON position. This happens as the system performs the EPS system diagnostics. When the diagnostics is completed, the steering wheel will return to its normal condition.
- A click noise may be heard from the EPS relay after the Engine Start/Stop button is in the ON or OFF position.
- Motor noise may be heard when the vehicle is at stop or at a low driving speed.
- When you operate the steering wheel in low temperature, abnormal noise may occur. If temperature rises, the noise will disappear. This is a normal condition.

Tilt steering / Telescope steering

Adjust the steering wheel so it points toward your chest, not toward your face. Make sure you can see the instrument panel warning lights and gauges. After adjusting, push the steering wheel both up and down to be certain it is locked in position. Always adjust the position of the steering wheel before driving.

WARNING

NEVER adjust the steering wheel while driving. This may cause loss of vehicle control resulting in an accident.

Manual type

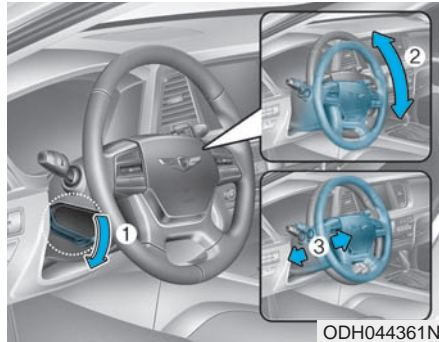

To change the steering wheel angle and height:

1. Pull down the lock-release lever (1).
2. Adjust the steering wheel to the desired angle (2) and height (3).
3. Pull up the lock-release lever to lock the steering wheel in place.

Electric type

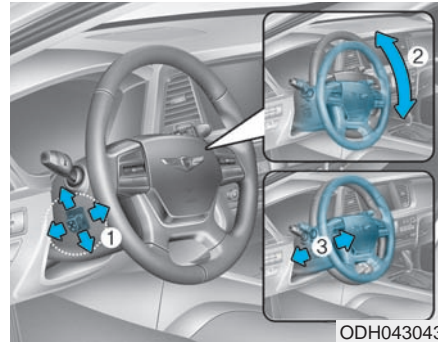

To change the steering wheel angle and height:

- Move the switch (1) up and down to adjust the angle (2).
- Move the switch forward or rearward to adjust the height (3).

CAUTION

Do not adjust the steering wheel longer than necessary when the engine is turned off. This may result in unnecessary battery drain.

Heated steering wheel (if equipped)

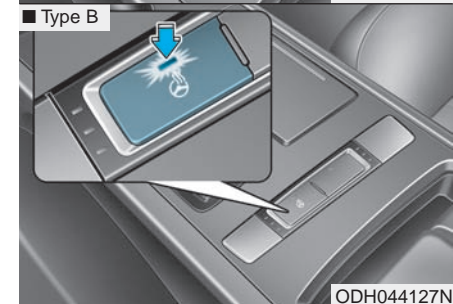
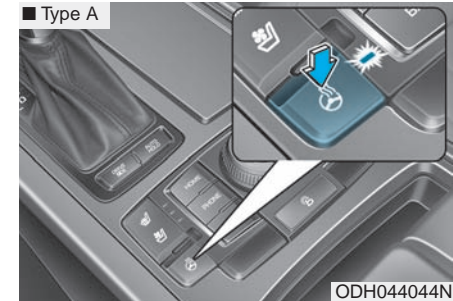

■ LCD display



ODH043224L/ODH043226L

When the Engine Start/Stop button is in the ON position, press the heated steering wheel button to warm the steering wheel. The indicator on the button will illuminate and notify you on the LCD display.

To turn the heated steering wheel off, press the button again. The indicator on the button will turn off and notify you on the LCD display.

* NOTICE

The heated steering wheel will turn off automatically approximately 30 minutes.

⚠ CAUTION

Do not install any cover or accessory on the steering wheel. This cover or accessory could cause damage to the heated steering wheel system.

Horn



ODH043045

To sound the horn, press the area indicated by the horn symbol on your steering wheel (see illustration). The horn will operate only when this area is pressed.

⚠ CAUTION

Do not strike the horn severely to operate it, or hit it with your fist. Do not press on the horn with a sharp-pointed object.

MIRRORS

Inside rearview mirror

Before you start driving, adjust the rearview mirror to the center on the view through the rear window.

WARNING

Make sure your line of sight is not obstructed. Do not place objects in the rear seat, cargo area, or behind the rear headrests which could interfere with your vision through the rear window.

WARNING

To prevent serious injury during an accident or deployment of the air bag, do not modify the rearview mirror and do not install a wide mirror.

WARNING

NEVER adjust the mirror while driving. This may cause loss of vehicle control resulting in an accident.

CAUTION

When cleaning the mirror, use a paper towel or similar material dampened with glass cleaner. Do not spray glass cleaner directly on the mirror as that may cause the liquid cleaner to enter the mirror housing.

Electric chromic mirror (ECM) with HomeLink® system, compass and Blue Link® (for U.S.A)

Your vehicle may be equipped with a Gentex Automatic-Dimming Mirror with a Z-Nav™ Electronic Compass Display and an Integrated HomeLink® Wireless Control System. During nighttime driving, this feature will automatically detect and reduce rearview mirror glare while the compass indicates the direction the vehicle is pointed. The HomeLink® Universal Transceiver allows you to activate your garage door(s), electric gate, home lighting, etc.



- (1) Telematics button
- (2) Telematics button
- (3) Telematics button
- (4) Compass control button & Dimming ON/OFF button
- (5) Status indicator LED
- (6) Channel 1 button
- (7) Channel 2 button
- (8) Channel 3 button
- (9) Compass display
- (10) Rear light sensor

Automatic-Dimming Night Vision Safety™ (NVS®) Mirror (if equipped)



CAUTION

The NVS® Mirror automatically reduces glare by monitoring light levels in the front and the rear of the vehicle. Any object that obstructs either light sensor will degrade the automatic dimming control feature.

For more information regarding NVS® mirrors and other applications, please refer to the Gentex website:

www.gentex.com

Your mirror will automatically dim upon detecting glare from the vehicles traveling behind you. The auto-dimming function can be controlled by pressing the Dimming ON/OFF button:

1. Pressing and holding the  button for 3 seconds turns the auto-dimming function OFF which is indicated by the green Status Indicator LED turning off.
2. Pressing and holding the  button for 3 seconds again turns the auto-dimming function ON which is indicated by the green Status Indicator LED turning on.



The mirror defaults to the ON position each time the vehicle is started.

Z-Nav™ Compass Display

The NVS™ Mirror in your vehicle is also equipped with a Z-Nav™ Compass that shows the vehicle Compass heading in the Display Window using the 8 basic cardinal headings (N, NE, E, SE, etc.).

Compass function

The Compass can be turned ON and OFF and will remember the last state when the ignition is cycled. To turn the display feature ON/OFF:

1. Press and release the  button within 1 second to turn the display feature OFF.
2. Press and release the  button again within 1 second to turn the display back ON.

Additional options can be set with press and hold sequences of the  button and are detailed below.

There is a difference between magnetic north and true north. To compensate for this difference you will need to adjust the Zone setting based on where you live.

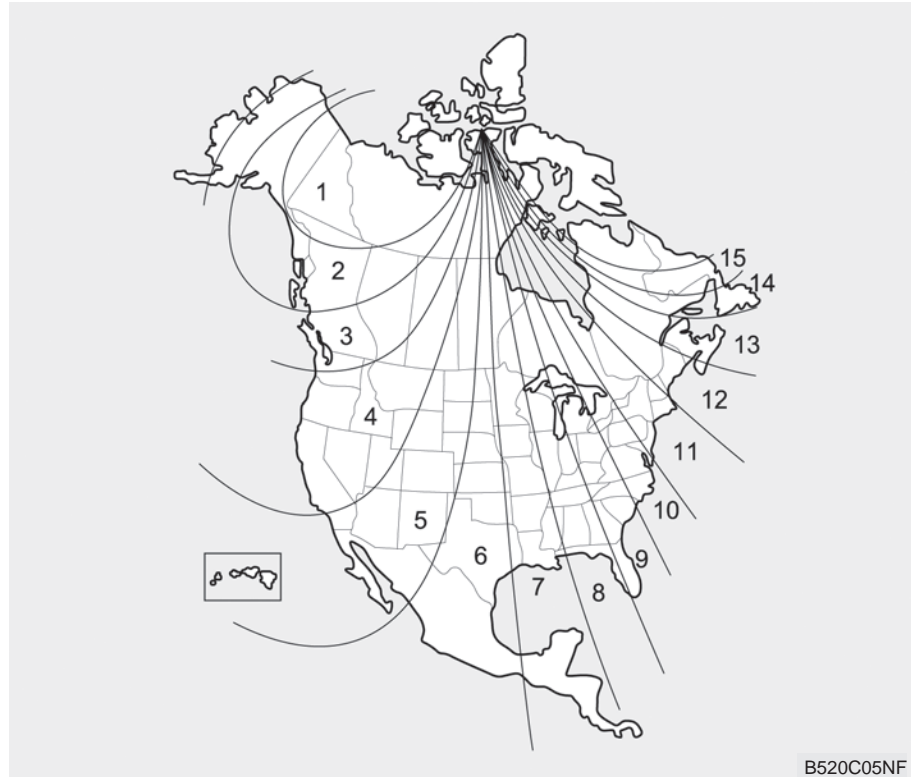

B520C05NF

To adjust the Zone setting:

1. Determine the desired Zone Number based upon your current location on the Zone Map.
2. Press and hold the \odot button for 6 seconds, the current Zone Number will appear on the display.
3. Pressing and holding the \odot button again will cause the numbers to increment (Note: they will repeat ...13, 14, 15, 1, 2, ...). Releasing the button when the desired Zone Number appears on the display will set the new Zone.
4. Within about 5 seconds the compass will start displaying a compass heading again.

There are some conditions that can cause changes to the vehicle magnets, such as installing a ski rack or a CB antenna. Body repair work on the vehicle can also cause changes to the vehicle's magnetic field. In these situations, the compass will need to be re-calibrated to quickly correct these changes.

If you need to recalibrate the compass:

1. Press and hold the \odot button for more than 9 seconds. When the compass memory is cleared a "C" will appear in the display.
2. Drive the vehicle in 2 complete circles at less than 5 mph (8 km/h).

Integrated HomeLink® Wireless Control System

The HomeLink® Wireless Control System can replace up to three hand-held radio-frequency (RF) transmitters with a single built-in device. This innovative feature will learn the radio frequency codes of most current transmitters to operate devices such as gate operators, garage door openers, entry door locks, security systems, even home lighting. Both standard and rolling code-equipped transmitters can be programmed by following the outlined procedures.

Additional HomeLink® information can be found at: www.homelink.com or by calling 1-800-355-3515.

Retain the original transmitter of the RF device you are programming for use in other vehicles as well as for future HomeLink® programming. It is also suggested that upon the sale of the vehicle, the programmed HomeLink® buttons be erased for security purposes.

WARNING

Before programming HomeLink® to a garage door opener or gate operator, make sure people and objects are out of the way of the device to prevent potential harm or damage. Do not use the HomeLink® with any garage door opener that lacks the safety stop and reverse features required by U.S. federal safety standards (this includes any garage door opener model manufactured before April 1, 1982). A garage door that cannot detect an object - signaling the door to stop and reverse - does not meet current U.S. federal safety standards. Using a garage door opener without these features increases the risk of serious injury or death.

Programming HomeLink®



Please note the following:

- When programming a garage door opener, it is advised to park the vehicle outside of the garage.
- It is recommended that a new battery be placed in the hand-held transmitter of the device being programmed to HomeLink® for quicker training and accurate transmission of the radio-frequency signal.
- Some vehicles may require the ignition switch to be placed in the ACC (or "Accessories") position for programming and/or operation of HomeLink®.
- In the event that there are still programming difficulties or questions after following the programming steps listed below, contact HomeLink® at: www.homelink.com or by calling 1-800-355-3515.

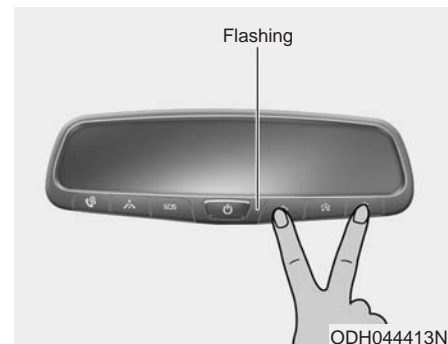
Programming



To train most devices, follow these instructions:

1. For first-time programming, press and hold the two outside buttons (, ) HomeLink® Channel 1 and Channel 3, until the indicator light begins to flash (after 10 seconds). Release both buttons. Do not hold the buttons for longer than 20 seconds.

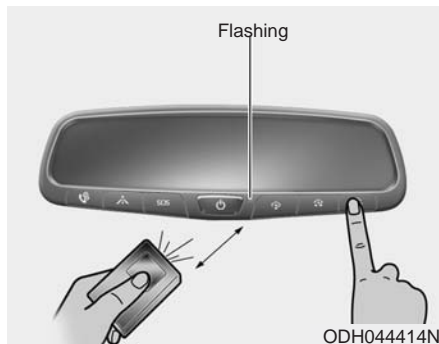

2. Position the end of your hand-held transmitter 1-3 inches (2-8 cm) away from the HomeLink® button you wish to program while keeping the indicator light in view.
3. Simultaneously press and hold both the HomeLink® and hand-held transmitter buttons until the HomeLink® indicator light changes from a slow to a rapid blinking light. Now you may release both the HomeLink® and hand-held transmitter buttons.

* NOTICE

Some devices may require you to replace this Programming step 3 with procedures noted in the "Gate Operator/Canadian Programming" chapter. If the HomeLink® indicator light does not change to a rapidly blinking light after performing these steps, contact HomeLink® at www.homelink.com.

4. Firmly press, hold for 5 seconds and release the programmed HomeLink® button up to two separate times to activate the door. If the door does not activate, press and hold the just-trained HomeLink® button and observe the indicator light.
 - If the indicator light stays on constantly, programming is complete and your device should activate when the HomeLink® button is pressed and released.
 - If the indicator light blinks rapidly for 2 seconds and then turns to a constant light, continue with "Programming" steps 5-7 to complete the programming of a rolling code equipped device (most commonly a garage door opener).

5. At the garage door opener receiver (motor-head unit) in the garage, locate the "learn" or "smart" button. This can usually be found where the hanging antenna wire is attached to the motor-head unit.
6. Firmly press and release the "learn" or "smart" button. (The name and color of the button vary by manufacturer). There are 30 seconds to initiate step 7.
7. Return to the vehicle and firmly press, hold for 2 seconds and release the programmed HomeLink® button. Repeat the "press/hold/release" sequence a second time, and, depending on the brand of the garage door opener (or other rolling code equipped device), repeat this sequence a third time to complete the programming process.

HomeLink® should now activate your rolling code equipped device.

Gate operator & Canadian programming

During programming, your handheld transmitter may automatically stop transmitting. Continue to press the Integrated HomeLink® Wireless Control System button (note steps 2 through 3 in the Programming portion of this document) while you press and re-press ("cycle") your handheld transmitter every two seconds until the frequency signal has been learned. The indicator light will flash slowly and then rapidly after several seconds upon successful training.

Operating HomeLink®

To operate, simply press and release the programmed HomeLink® button. Activation will now occur for the trained device (i.e. garage door opener, gate operator, security system, entry door lock, home/office lighting, etc.). For convenience, the hand-held transmitter of the device may also be used at any time.

Reprogramming a single HomeLink® button

To program a device to HomeLink® using a HomeLink® button previously trained, follow these steps:

1. Press and hold the desired HomeLink® button. DO NOT release the button.
2. The indicator light will begin to flash after 20 seconds. Without releasing the HomeLink® button, proceed with "Programming" step 2.

For questions or comments, contact HomeLink® at www.homelink.com or 1-800-355-3515.

Erasing HomeLink® buttons

Individual buttons cannot be erased. However, to erase all three programmed buttons:

1. Press and hold the two outer HomeLink® buttons until the indicator light begins to flash after 10 seconds.
2. Release both buttons. Do not hold for longer than 20 seconds.

The Integrated HomeLink® Wireless Control System is now in the training (learn) mode and can be programmed at any time following the appropriate steps in the Programming chapters above.

NVS® is a registered trademark and Z-Nav™ is a trademark of the Gentex Corporation, Zeeland, Michigan. HomeLink® is a registered trademark owned by Johnson Controls, Incorporated, Milwaukee, Wisconsin.

FCC ID: NZLTLMHL4
IC: 4112A-TLMHL4

This device complies with Part 15 of the FCC Rules.

Operation is subject to the following two conditions:

1. This device may not cause harmful interference, and
2. This device must accept any interference received, including interference that may cause undesired operation.

⚠ CAUTION

The transceiver has been tested and complies with FCC and Industry Canada rules. Changes or modifications not expressly approved by the party responsible for compliance could void the user's authority to operate the device.

Blue Link® center (if equipped)



For more details, please refer to the Multimedia System Manual or DIS Navigation System Manual that was supplied with your vehicle.

Electric chromic mirror (ECM) with compass and HomeLink® system (for Canada)

Your vehicle may be equipped with a Gentex Automatic-Dimming Mirror with a Z-Nav™ Electronic Compass Display and an Integrated HomeLink® Wireless Control System.

During nighttime driving, this feature will automatically detect and reduce rearview mirror glare while the compass indicates the direction the vehicle is pointed. The HomeLink® Universal Transceiver allows you to activate your garage door(s), electric gate, home lighting, etc.



- (1) Channel 1 button
- (2) Channel 2 button
- (3) Status indicator LED
- (4) Channel 3 button
- (5) Rear light sensor
- (6) Dimming ON/OFF button
- (7) Compass control button
- (8) Compass display

Automatic-Dimming Night Vision Safety™ (NVS®) Mirror (if equipped)

CAUTION

The NVS® Mirror automatically reduces glare by monitoring light levels in the front and the rear of the vehicle. Any object that obstructs either light sensor will degrade the automatic dimming control feature.

For more information regarding NVS® mirrors and other applications, please refer to the Gentex website:

www.gentex.com

The auto-dimming function can be controlled by pressing the ON/OFF button:

1. Pressing the button turns the auto-dimming function OFF which is indicated by the green Status Indicator LED turning off.
2. Pressing the button again turns the auto-dimming function ON which is indicated by the green Status Indicator LED turning on.

The mirror defaults to the ON position each time the vehicle is started.

Z-Nav™ Compass Display

The NVS™ Mirror in your vehicle is also equipped with a Z-Nav™ Compass that shows the vehicle Compass heading in the Display Window using the 8 basic cardinal headings (N, NE, E, SE, etc.).

Compass function

The Compass can be turned ON and OFF and will remember the last state when the ignition is cycled. To turn the display feature ON/OFF:



1. Press and release the \odot button to turn the display feature OFF.
2. Press and release the \odot button again to turn the display back ON.

Additional options can be set with press and hold sequences of the button and are detailed below.

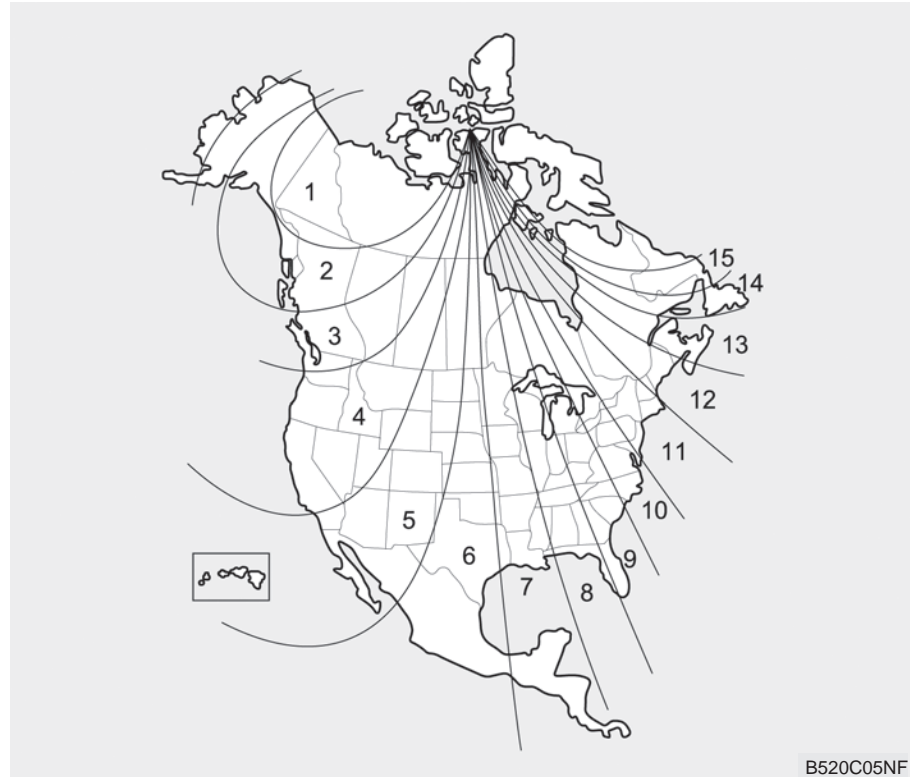
There is a difference between magnetic north and true north. To compensate for this difference you will need to adjust the Zone setting based on where you live.



To adjust the Zone setting:

1. Determine the desired Zone Number based upon your current location on the Zone Map.
2. Press and hold the  button for more than 3 but less than 6 seconds, the current Zone Number will appear on the display.
3. Pressing and holding the  button again will cause the numbers to increment (Note: they will repeat ...13, 14, 15, 1, 2, ...). Releasing the button when the desired Zone Number appears on the display will set the new Zone.
4. Within about 5 seconds the compass will start displaying a compass heading again.

There are some conditions that can cause changes to the vehicle magnets, such as installing a ski rack or a CB antenna. Body repair work on the vehicle can also cause changes to the vehicle's magnetic field. In these situations, the compass will need to be re-calibrated to quickly correct these changes.

If you need to recalibrate the compass:

1. Press and hold the  button for more than 6 seconds. When the compass memory is cleared a "C" will appear in the display.
2. Drive the vehicle in 2 complete circles at less than 5 mph (8 km/h).

Integrated HomeLink® Wireless Control System

The HomeLink® Wireless Control System can replace up to three handheld radio-frequency (RF) transmitters with a single built-in device. This innovative feature will learn the radio frequency codes of most current transmitters to operate devices such as gate operators, garage door openers, entry door locks, security systems, even home lighting. Both standard and rolling code-equipped transmitters can be programmed by following the outlined procedures.

Additional HomeLink® information can be found at: www.homelink.com or by calling 1-800-355-3515.

Retain the original transmitter of the RF device you are programming for use in other vehicles as well as for future HomeLink® programming. It is also suggested that upon the sale of the vehicle, the programmed HomeLink® buttons be erased for security purposes.

WARNING

Before programming HomeLink® to a garage door opener or gate operator, make sure people and objects are out of the way of the device to prevent potential harm or damage. Do not use the HomeLink® with any garage door opener that lacks the safety stop and reverse features required by U.S. federal safety standards (this includes any garage door opener model manufactured before April 1, 1982). A garage door that cannot detect an object - signaling the door to stop and reverse - does not meet current U.S. federal safety standards. Using a garage door opener without these features increases the risk of serious injury or death.

Programming HomeLink®

Please note the following:

- When programming a garage door opener, it is advised to park the vehicle outside of the garage.
- It is recommended that a new battery be placed in the hand-held transmitter of the device being programmed to HomeLink® for quicker training and accurate transmission of the radio-frequency signal.
- Some vehicles may require the ignition switch to be placed in the ACC (or "Accessories") position for programming and/or operation of HomeLink®.
- In the event that there are still programming difficulties or questions after following the programming steps listed below, contact HomeLink® at: www.homelink.com or by calling 1-800-355-3515.

Rolling code programming

Rolling code devices which are "code-protected" and manufactured after 1996 may be determined by the following:

- Reference the device owner's manual for verification.
- The handheld transmitter appears to program the HomeLink® Universal Transceiver but does not activate the device.
- Press and hold the trained HomeLink button. The device has the rolling code feature if the indicator light flashes rapidly and then turns solid after 2 seconds.

To train rolling code devices, follow these instructions:

1. At the garage door opener receiver (motor-head unit) in the garage, locate the "learn" or "smart" button. This can usually be found where the hanging antenna wire is attached to the motor-head unit. Exact location and color of the button may vary by garage door opener brand. If there is difficulty locating the training button, reference the device owner's manual or please visit our Web site at www.homelink.com.
2. Firmly press and release the "learn" or "smart" button (which activates the "training light"). You will have 30 seconds to initiate step 3.
3. Return to the vehicle and firmly press, hold for two seconds and then release the desired HomeLink® button. Repeat the "press/hold/release" sequence a second time to complete the programming. (Some devices may require you to repeat this sequence a third time to complete the programming.)
4. Press and hold the just-trained HomeLink® button and observe the red Status Indicator LED. If the indicator light stays on constantly, programming is complete and your device should activate.
5. To program the remaining two HomeLink® buttons, follow either steps 1 through 4 above for other Rolling Code devices or steps 2 through 5 in Standard Programming for standard devices.

Standard programming

To train most devices, follow these instructions:

1. For first-time programming, press and hold the two outside buttons, HomeLink® Channel 1 and Channel 3 Buttons, until the indicator light begins to flash (after 20 seconds). Release both buttons. Do not hold the buttons for longer than 30 seconds.
2. Position the end of your hand-held transmitter 1-3 inches (2-8 cm) away from the HomeLink® buttons while keeping the indicator light in view.
3. Simultaneously press and hold both the HomeLink® and hand-held transmitter button. DO NOT release the buttons until step 4 has been completed.
4. While continuing to hold the buttons the red Indicator Status LED will flash slowly and then rapidly after HomeLink® successfully trains to the frequency signal from the hand-held transmitter. Release both buttons.

5. Press and hold the just-trained HomeLink® button and observe the red Status Indicator LED. If the indicator light stays on constantly, programming is complete and your device should activate when the HomeLink® button is pressed and released.
6. To program the remaining two HomeLink® buttons, follow steps 2 through 5.

Gate operator & Canadian programming

During programming, your handheld transmitter may automatically stop transmitting. Continue to press the Integrated HomeLink® Wireless Control System button (note steps 2 through 4 in the Standard Programming portion of this document) while you press and re-press ("cycle") your handheld transmitter every two seconds until the frequency signal has been learned. The indicator light will flash slowly and then rapidly after several seconds upon successful training.

Operating HomeLink®

To operate, simply press and release the programmed HomeLink® button. Activation will now occur for the trained device (i.e. garage door opener, gate operator, security system, entry door lock, home/office lighting, etc.). For convenience, the hand-held transmitter of the device may also be used at any time.

Reprogramming a single HomeLink® button

To program a new device to a previously trained HomeLink® button, follow these steps:

1. Press and hold the desired HomeLink® button. Do NOT release until step 4 has been completed.
2. When the indicator light begins to flash slowly (after 20 seconds), position the handheld transmitter 1 to 3 inches away from the HomeLink® surface.
3. Press and hold the handheld transmitter button. The HomeLink® indicator light will flash, first slowly and then rapidly.
4. When the indicator light begins to flash rapidly, release both buttons.
5. Press and hold the just-trained HomeLink® button and observe the red Status Indicator LED. If the indicator light stays on constantly, programming is complete and your new device should activate.

Erasing HomeLink® buttons

Individual buttons cannot be erased. However, to erase all three programmed buttons:

1. Press and hold the two outer HomeLink® buttons until the indicator light begins to flash-after 20 seconds.
2. Release both buttons. Do not hold for longer than 30 seconds.

The Integrated HomeLink® Wireless Control System is now in the training (learn) mode and can be programmed at any time following the appropriate steps in the Programming chapters above.

NVS® is a registered trademark and Z-Nav™ is a trademark of the Gentex Corporation, Zeeland, Michigan. HomeLink® is a registered trademark owned by Johnson Controls, Incorporated, Milwaukee, Wisconsin.

FCC ID: NZLZTVHL3

IC: 4112A-ZTVHL3

This device complies with Part 15 of the FCC Rules.

Operation is subject to the following two conditions:

1. This device may not cause harmful interference, and
2. This device must accept any interference received, including interference that may cause undesired operation.

WARNING

The transceiver has been tested and complies with FCC and Industry Canada rules. Changes or modifications not expressly approved by the party responsible for compliance could void the user's authority to operate the device.

Outside rearview mirror



ODH043047

Be sure to adjust mirror angles before driving.

Your vehicle is equipped with both left-hand and right-hand outside rearview mirrors. The mirrors can be adjusted remotely with the remote switch. The mirror heads can be folded to prevent damage during an automatic car wash or when passing through a narrow street.

The right outside rearview mirror is convex. Objects seen in the mirror are closer than they appear.

Use your interior rearview mirror or direct observation to determine the actual distance of following vehicles when changing lanes.

WARNING

Do not adjust or fold the outside rearview mirrors while driving. This may cause loss of vehicle control resulting in an accident.

CAUTION

- Do not scrape ice off the mirror face; this may damage the surface of the glass.
- If the mirror is jammed with ice, do not adjust the mirror by force. Use an approved spray de-icer (not radiator antifreeze) spray, or a sponge or soft cloth with very warm water, or move the vehicle to a warm place and allow the ice to melt.

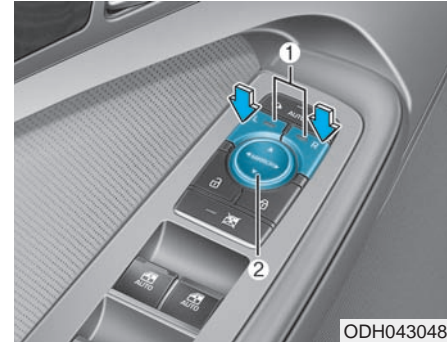

Adjusting the rearview mirrors:

1. Press either the L (driver's side) or R (passenger's side) button (1) to select the rearview mirror you would like to adjust.
2. Use the mirror adjustment control (2) to position the selected mirror up, down, left or right.
3. After adjustment, press the L or R button (1) again to prevent inadvertent adjustment.

CAUTION

- The mirrors stop moving when they reach the maximum adjusting angles, but the motor continues to operate while the switch is pressed. Do not press the switch longer than necessary, the motor may be damaged.
- Do not attempt to adjust the outside rearview mirror by hand or the motor may be damaged.

Folding/Unfolding the outside rearview mirror

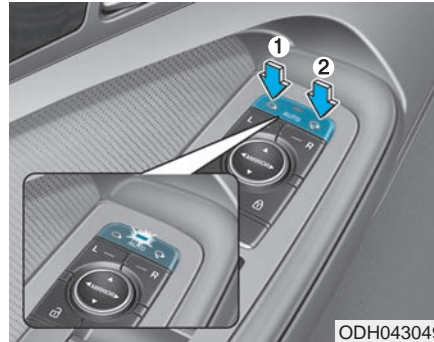

The outside rearview mirror can be folded or unfolded by pressing the switch when:

Left (1) : The mirror will unfold.

Right (2) : The mirror will fold.

Center (AUTO) :

The mirror will fold or unfold automatically as follows:

- The door is locked or unlocked by the smart key.
- The door is locked or unlocked by the button on the outside door handle.

The mirror will unfold when you approach the vehicle (all doors closed and locked) with a smart key in possession. (if equipped)

CAUTION

The electric type outside rearview mirror operates even though the Engine Start/Stop button is in the OFF position. However, to prevent unnecessary battery discharge, do not adjust the mirrors longer than necessary while the engine is not running.

CAUTION

Do not fold the electric type outside rearview mirror by hand. It could cause motor failure.

Reverse parking aid function (if equipped)



When you move the shift lever to the R (Reverse) position, the outside rearview mirror(s) will rotate downwards to aid with driving in reverse. The position of the outside rearview mirror switch (1) determines whether or not the mirrors will move:

Left/Right : When either the L (Left) or R (Right) switch is selected, both outside rearview mirrors will move.

Neutral : When neither switch is selected, the outside rearview mirrors will not move.

The outside rearview mirrors will automatically revert to their original positions if any of the following occur:

- The Engine Start/Stop button is pressed to either the OFF position or the ACC position.
- The shift lever is moved to any position except R (Reverse).
- The remote control outside rearview mirror switch is not selected.

WINDOWS

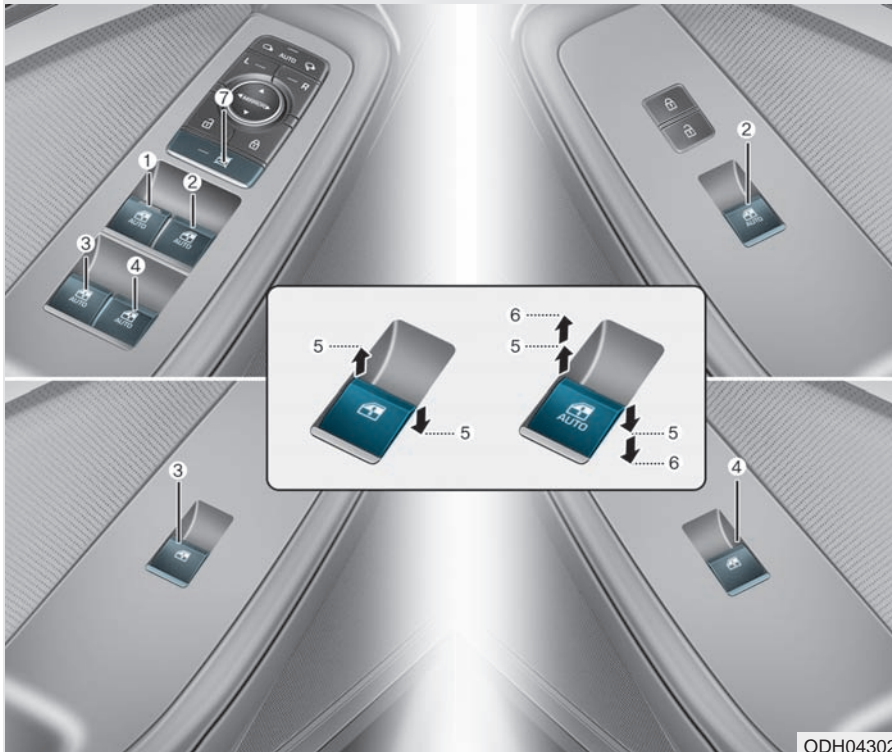

- (1) Driver's door power window switch
- (2) Front passenger's door power window switch
- (3) Rear door (left) power window switch
- (4) Rear door (right) power window switch
- (5) Window opening and closing
- (6) Automatic power window
- (7) Power window lock switch

Power windows

The Engine Start/Stop button must be in the ON position to be able to raise or lower the windows. Each door has a Power Window switch to control that door's window. The driver has a Power Window Lock switch which can block the operation of passenger windows. The power windows will operate for approximately 30 seconds after the Engine Start/Stop button is placed in the ACC or OFF position. However, if the front doors are opened, the Power Windows cannot be operated even within the 30 second period.

WARNING

To avoid serious injury or death, do not extend your head, arms or body outside the windows while driving.

* NOTICE

- In cold and wet climates, power windows may not work properly due to freezing conditions.
- While driving with the rear windows down or with the sunroof (if equipped) opened (or partially opened), your vehicle may demonstrate a wind buffeting or pulsation noise. This noise is normal and can be reduced or eliminated by taking the following actions. If the noise occurs with one or both of the rear windows down, partially lower both front windows approximately one inch. If you experience the noise with the sunroof open, slightly close the sunroof.

Window opening and closing

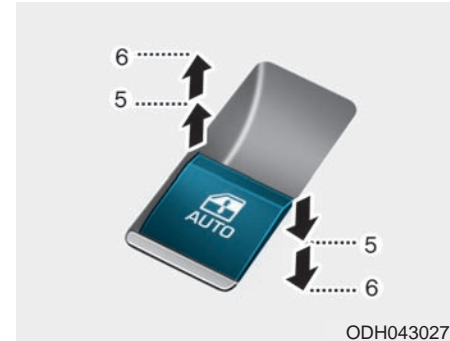

To open:

Press the window switch down to the first detent position (5). Release the switch when you want the window to stop.

To close:

Pull the window switch up to the first detent position (5). Release the window switch when you want the window to stop.

Auto up/down window

Pressing or pulling up the power window switch momentarily to the second detent position (6) completely lowers or lifts the window even when the switch is released. To stop the window at the desired position while the window is in operation, pull up or press down and release the switch.

To reset the power windows

If the power windows do not operate normally, the automatic power window system must be reset as follows:

1. Place the Engine Start/Stop button to the ON position.
2. Close the window and continue pulling up on the power window switch for at least one second.

If the power windows do not operate properly after resetting, have the system checked by an authorized HYUNDAI dealer.

Automatic reverse

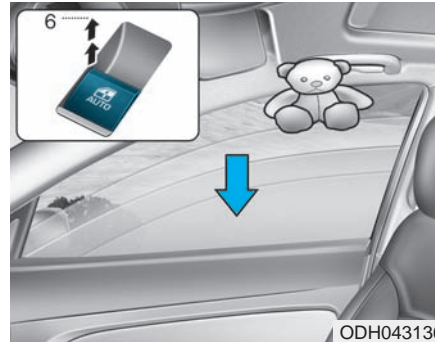

If a window senses any obstacle while it is closing automatically, it will stop and lower approximately 12 inches (30 cm) to allow the object to be cleared.

If the window detects the resistance while the power window switch is pulled up continuously, the window will stop upward movement then lower approximately 1 inch (2.5 cm).

If the power window switch is pulled up continuously again within 5 seconds after the window is lowered by the automatic window reversal feature, the automatic window reversal will not operate.

*** NOTICE**

The automatic reverse feature is only active when the “Auto Up” feature is used by fully pulling up the switch to the second detent.

⚠ WARNING

Make sure body parts or other objects are safely out of the way before closing the windows to avoid injuries or vehicle damage.

Objects less than 0.16 inch (4 mm) in diameter caught between the window glass and the upper window channel may not be detected by the automatic reverse window and the window will not stop and reverse direction.

Power window lock switch



The driver can disable the power window switches on the rear passengers' doors by pressing the power window lock switch. The indicator will be illuminated.

When the power window lock switch is pressed:

- The driver's master control can operate all the power windows.
- The front passenger's control can operate the front passenger's power window.
- The rear passenger's control cannot operate the rear passengers' power window.

WARNING

Do not allow children to play with the power windows. Keep the driver's door power window lock switch in the LOCK position. Serious injury or death can result from unintentional window operation by a child.

CAUTION

- To prevent possible damage to the power window system, do not open or close two windows or more at the same time. This will also ensure the longevity of the fuse.
- Never try to operate the main switch on the driver's door and the individual door window switch in opposite directions at the same time. If this is done, the window will stop and cannot be opened or closed.

PANORAMA SUNROOF (IF EQUIPPED)



ODH043034

The Engine Start/Stop button must be in the ON position before you can open or close the sunroof.

* NOTICE

In cold and wet climates, the sunroof may not work properly due to freezing conditions.

⚠ WARNING

Never adjust the sunroof or sunshade while driving. This could result in loss of vehicle control resulting in an accident.

⚠ CAUTION

To prevent damage to the sunroof and the motor, do not continue to press the sunroof control lever after the sunroof is in the fully open, closed or tilt position(s).

Sunshade

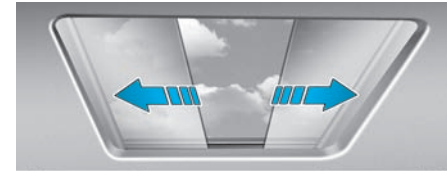

ODH043035

- To open the sunshade, press the sunshade control switch (1).
- To close the sunshade, press the sunshade control switch (2). If you press the switch when the sunroof glass is opened, the sunroof glass will close then the sunshade will close.

To stop the sliding at any point, press the sunshade control switch momentarily.

Sliding the sunroof

When the sunshade is closed



If you pull the sunroof control lever backward, the sunshade will slide all the way open then the sunroof glass will slide all the way open. To stop the sunroof movement at any point, pull or push the sunroof control lever momentarily.

When the sunshade is opened

If you pull the sunroof control lever backward, the sunroof glass will slide all the way open. To stop the sunroof movement at any point, pull or push the sunroof control lever momentarily.

*** NOTICE**

Only the front glass of the panorama sunroof opens and closes.

Tilting the sunroof

When the sunshade is closed

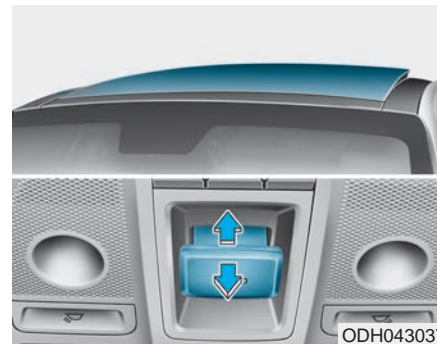

If you push the sunroof control lever upward, the sunshade will slide all the way open then the sunroof glass will tilt.

To stop the sunroof movement at any point, pull or push the sunroof control lever momentarily.

When the sunshade is opened

If you push the sunroof control lever upward, the sunroof glass will tilt.

To stop the sunroof movement at any point, pull or push the sunroof control lever momentarily.

Closing the sunroof



Press the sunshade CLOSE button. The sunroof glass will close then the sunshade will close. To stop the sunroof movement at any point, press the sunshade control switch momentarily.

Automatic reverse

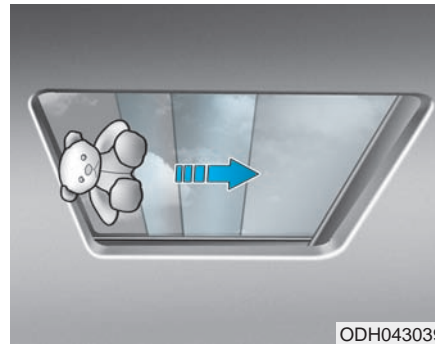

If the sunroof senses any obstacle while it is closing automatically, it will reverse direction then stop to allow the object to be cleared.

⚠ WARNING

- Make sure heads, other body parts or other objects are safely out of the way before closing the sunroof to avoid injuries or vehicle damage.

Objects less than 0.16 inch (4 mm) in diameter caught between the sunroof glass and the front glass channel may not be detected by the automatic reverse glass and the glass will not stop and reverse direction.

- To avoid serious injury or death, do not extend your head, arms or body outside the sunroof while driving.
- A panorama sunroof is made of glass, therefore it may break in an accident. If you do not have your seat belt on, you may stick out of the broken glass and get injured or killed. For all passengers safety, have an appropriate protection on (ex. seat belt, CRS, etc.).

⚠ CAUTION

- Periodically remove any dirt that may accumulate on the sunroof guide rail or between the sunroof and roof panel.
- Do not try to open the sunroof when the temperature is below freezing or when the sunroof is covered with snow or ice, the motor could be damaged.

* NOTICE

After the vehicle is washed or in a rainstorm, be sure to wipe off any water that is on the sunroof before operating it.

Resetting the sunroof



Sunroof needs to be reset if (in the followings)

- Battery is discharged or disconnected or the related fuse has been replaced or disconnected.
- The one-touch sliding function of the sunroof does not normally operate.

1. Turn the engine on and close the sunroof glass and sunshade completely.
2. Release the control lever.

3. Push the sunroof control lever forward in the direction of close (about 10 seconds) until the sunshade slides open and the sunroof glass tilts. Then, release the lever.
4. Push the sunroof control lever forward in the direction of close until the sunroof operates as follows:

Glass Tilt Close → Glass Slide Open
→ Glass Slide Close

Then, release the control lever.

When this is complete, the sunroof system is reset.

For more details, contact an authorized HYUNDAI dealer.

* NOTICE

If you do not reset the sunroof, it may not work properly.

EXTERIOR FEATURES

Hood

Opening the hood

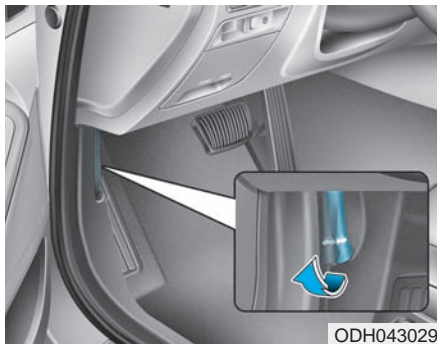

1. Park the vehicle and set the parking brake.
2. Pull the release lever to unlatch the hood. The hood should pop open slightly.

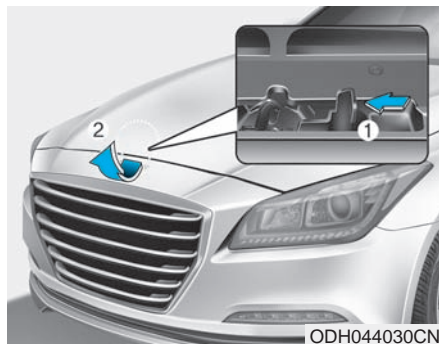

3. Raise the hood slightly, push the secondary latch up (1) inside of the hood center and lift the hood (2). After it has been raised about halfway, it will raise completely by itself.

Closing the hood

1. Before closing the hood, check the following:
 - All filler caps in engine compartment must be correctly installed.
 - Gloves, rags or any other combustible material must be removed from the engine compartment.

2. Lower the hood halfway and push down to securely lock in place. Then double check to be sure the hood is secure.

⚠ WARNING

- Before closing the hood, ensure all obstructions are removed from around hood opening.
- Always double check to be sure that the hood is firmly latched before driving away. If it is not latched, the hood could open while the vehicle is being driven, causing a total loss of visibility, which might result in an accident.
- Do not move the vehicle with the hood in the raised position, as vision is obstructed, which might result in an accident, and the hood could fall or be damaged.

Trunk

Non-Powered Trunk (if equipped)

■ Outside

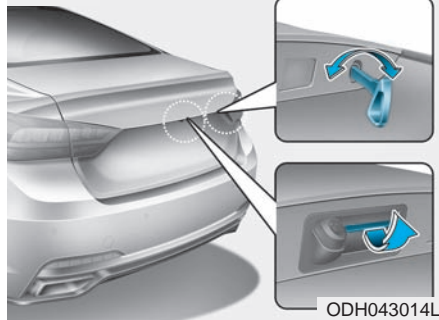

To open:

1. Make sure the shift lever is in P (Park).
2. Then do one of the following :
 - Press the Smart Key Trunk Unlock button for more than one second.
 - Press the button on the trunk itself with the Smart Key in your possession.
 - Use the mechanical key.

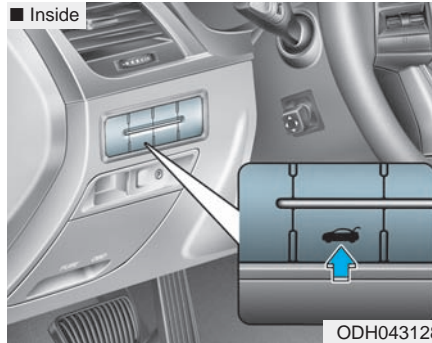

- Inside
- Use the trunk release button.
3. Lift the trunk lid up.

To close:

Lower the trunk lid and press down until it locks.

⚠ WARNING

Always keep the trunk lid completely closed while the vehicle is in motion. If it is left open or ajar, poisonous exhaust gases containing carbon monoxide (CO) may enter the vehicle and serious illness or death may result.

⚠ WARNING

Make sure there are no people or objects around the trunk before opening or closing the Power Trunk. Wait until the trunk is open fully and stopped before loading or unloading cargo from the vehicle.

⚠ CAUTION

To prevent damage to the trunk lift cylinders and the attached hardware, always close the trunk before driving.

*** NOTICE**

In cold and wet climates, trunk lock and trunk mechanisms may not work properly due to freezing conditions.

Power Trunk (if equipped)

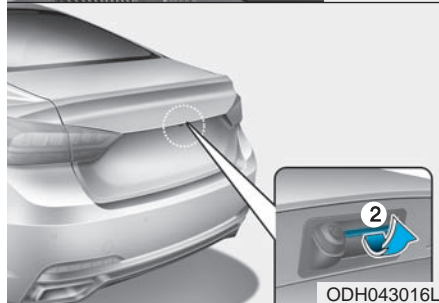
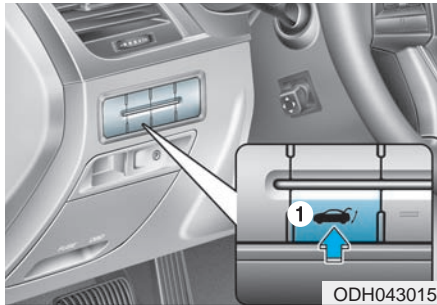

- (1) Power Trunk Main Control button
(2) Power Trunk Open button

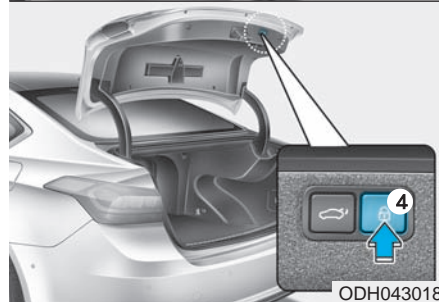
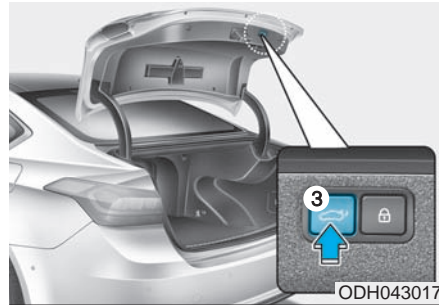

- (3) Power Trunk Close button
(4) Power Trunk Lock button

To open:

1. Make sure the shift lever is in P (Park).
2. Then do one of the following:
 - Press the Smart Key Trunk Unlock button for more than one second.
 - Press the Open button (2) on the trunk. You need the Smart Key in your possession, when all doors are locked.
 - Press the Power Trunk Main Control button (1).

To close:

Do one of the following:

- Press the Power Trunk Main Control button (1) until the Power Trunk is closed securely.
- Press the Close button (3) on the trunk.
- Press the Lock button (4) on the trunk while carrying the Smart Key with all the vehicle's doors closed. All doors will lock and arm the theft alarm system.

If you push a button or switch while the trunk is opening or closing, it could stop moving. Press any button to operate the Power Trunk again.

* NOTICE

The Power Trunk Lock button will not work if you press the button when:

- Any door is open.
- The Engine Start/Stop button is not in the OFF position.
- The Smart Key is in the vehicle.

WARNING

Never leave children or animals unattended in your vehicle. Children or animals might operate the power trunk that could result in injury to themselves or others, or damage to the vehicle.

WARNING

Always keep the trunk lid completely closed while the vehicle is in motion. If it is left open or ajar, poisonous exhaust gases containing carbon monoxide (CO) may enter the vehicle and serious illness or death may result.

WARNING

Make sure there are no people or objects around the trunk before opening or closing the Power Trunk. Wait until the trunk is open fully and stopped before loading or unloading cargo from the vehicle.

CAUTION

- Do not close or open the Power Trunk manually. This may cause damage to the Power Trunk. If it is necessary to close or open the Power Trunk manually when the battery is drained or disconnected, do not apply excessive force.
- Do not leave the Power Trunk open for a long period of time. This may drain the battery.
- To prevent damage to the trunk lift cylinders and the attached hardware, always close the trunk before driving.

* NOTICE

In cold and wet climates, trunk lock and trunk mechanisms may not work properly due to freezing conditions.

Power Trunk Non-Opening or Closing Conditions:

- The Power Trunk will not open or close automatically, when the vehicle is moving more than 1.8 mph (3 km/h).
- The Power Trunk can be operated when the engine is not running. However, the Power Trunk operation consumes large amounts of vehicle electric power. To prevent the battery from draining, do not operate it excessively (e.g., more than approximately 10 times repeatedly.)
- Do not modify or repair any part of the Power Trunk by yourself. This must be done by an authorized HYUNDAI dealer.
- Before jacking up the vehicle to change a tire or repair the vehicle, open the Power Trunk. Do not operate the Power Trunk when the vehicle is raised or this could cause the Power Trunk to operate improperly.
- If there are obstacles such as snow on the Power Trunk, it may not open automatically. After removing the obstacle, try to open it again.

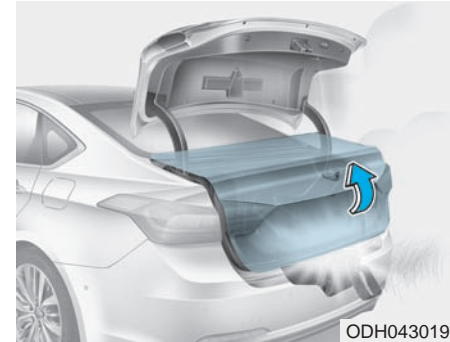

Automatic stop and reverse

If, during power opening or closing, the trunk is blocked by an object or part of someone's body, the power trunk will detect the resistance and it will stop movement or move to the full open position to allow the object to be cleared.

However, if the resistance is weak such as from an object that is thin or soft, or the trunk is near the latched position, the automatic stop and reversal may not detect the resistance and the closing operation will continue. Also, if the Power Trunk is forced by a strong impact, the automatic stop and reversal may operate.

If the automatic stop and reverse feature operates more than twice during one opening or closing operation, the Power Trunk may stop at that position. If this occurs, close the trunk manually and operate the trunk automatically again.

⚠ WARNING

To prevent serious injury and damage take the following precautions when operating the power trunk:

- Keep all faces, hands, arms, body parts and other objects away from the path of the power trunk.
- Do not intentionally place any body parts or objects in the path of the power trunk to make sure the automatic stop and reversal operates.
- Do not allow children to play with the power trunk.

To reset the power trunk

If the battery has been discharged or disconnected, or if the related fuse has been replaced or disconnected, reset the Power Trunk as follows:

1. Move the shift lever to the P (Park) position.
2. Close the trunk manually.

If the Power Trunk doesn't work properly after performing the above procedure, have the system checked by an authorized HYUNDAI dealer.

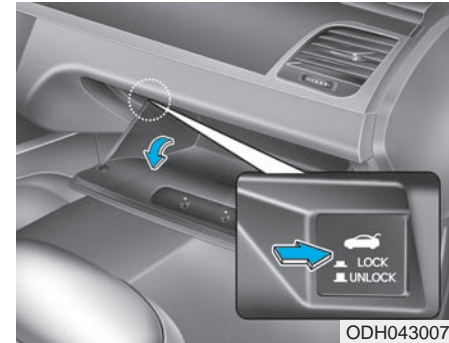

Trunk lid control button

When the trunk lid control button is UNLOCK (button not pressed), the power trunk can be controlled with the power trunk main control button, power trunk open, close button, and the smart key.

When this trunk lid control button is LOCK (button pressed), the power trunk can be controlled using the mechanical key of the smart key only.

Even though the trunk lid control button is LOCK (button pressed), the trunk will still be propelled upward by mechanical force if the trunk is manually opened more than 10 degrees beyond the fully closed position. In addition, if the trunk is manually closed to the secondary latch position, the trunk will be electrically moved to the fully latched position.

WARNING

- **Always keep the Trunk Lid Control Button in the LOCK (button pressed) position when not in use. Serious injury or death can result from unintentional operation by a child.**
- **Make sure heads, other body parts or other obstacles are safely out of the way before operating the power trunk.**

CAUTION

Close the trunk, and keep the trunk lid control button in the LOCK (button pressed) position before washing the vehicle in an automatic car wash.

Emergency trunk safety release

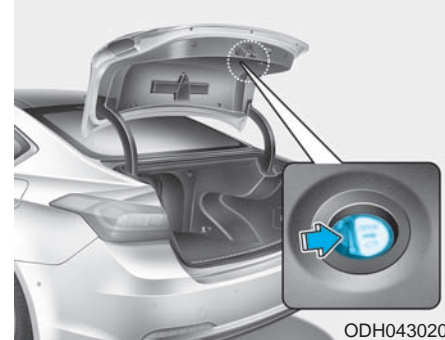

Your vehicle is equipped with an Emergency Trunk Safety Release lever located inside the trunk. When someone is inadvertently locked in the trunk, the trunk can be opened by moving the lever in the direction of the arrow and pushing the trunk open.

⚠️ WARNING

- You and your passengers must be aware of the location of the Emergency Trunk Safety Release lever in this vehicle and how to open the trunk in case you are accidentally locked in the trunk.
- NEVER allow anyone to occupy the trunk of the vehicle at any time. If the trunk is partially or totally latched and the person is unable to get out, serious injury or death could occur due to lack of ventilation, exhaust fumes and rapid heat build-up, or because of exposure to cold weather conditions. The trunk is also a highly dangerous location in the event of a crash because it is not a protected occupant space but is a part of the vehicle's crush zone.

(Continued)

(Continued)

- Your vehicle should be kept locked and the Smart Key should be kept out of the reach of children. Parents should teach their children about the dangers of playing in trunks.
- Use the release lever for emergencies only.

Smart trunk (if equipped)

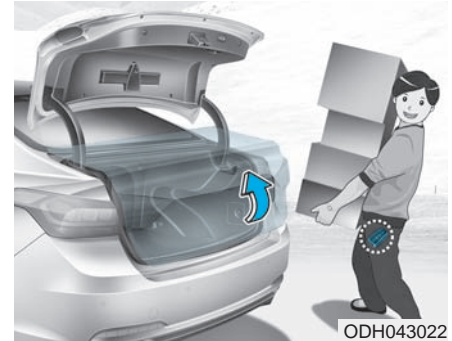

On a vehicle equipped with a smart key, the trunk can be opened with no-touch activation using the Smart Trunk system.

How to use the Smart Trunk

The trunk can be opened with no-touch activation satisfying all the conditions below.

- After 15 seconds when all doors are closed and locked
- Positioned in the detecting area for more than 3 seconds.

* NOTICE

- The Smart Trunk does not operate when:
 - The smart key is detected within 15 seconds after the doors are closed and locked, and is continuously detected.
 - The smart key is detected within 15 seconds after the doors are closed and locked, and within 60 inches (1.5 m) from the front door handles. (for vehicles equipped with Welcome Light)
 - A door is not locked or closed.
 - The smart key is in the vehicle.

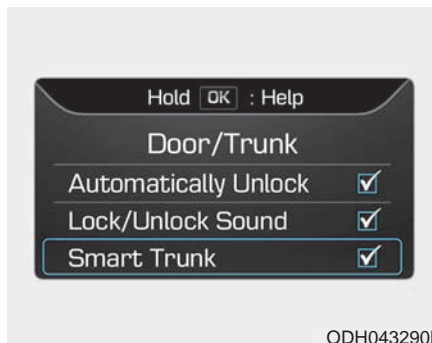

1. Setting

To activate the Smart Trunk, go to User Settings Mode and select Smart Trunk on the LCD display.

For more details, refer to "LCD Display" in this chapter.

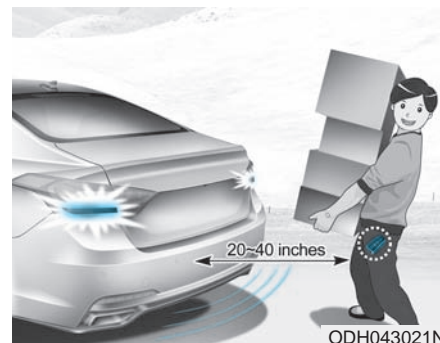

2. Detect and Alert

If you are positioned in the detecting area (20~40 inches (50 ~100 cm) behind the vehicle) carrying a smart key, the hazard warning lights will blink and chime will sound for about 3 seconds to alert you the smart key has been detected and the trunk will open.

* NOTICE

Do not approach the detecting area if you do not want the trunk to open. If you have unintentionally entered the detecting area and the hazard warning lights and chime starts to operate, leave the detecting area with the smart key. The trunk will stay closed.

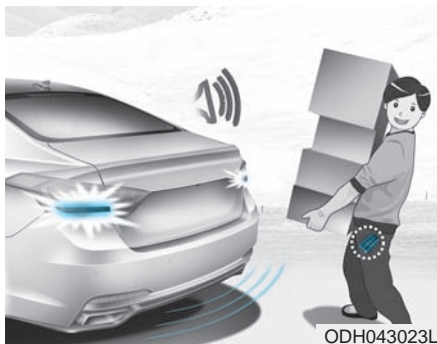

3. Automatic opening

The hazard warning lights will blink and chime will sound 2 times and then the trunk will slowly open.

WARNING

- Make sure you close the trunk before driving your vehicle.
- Make sure there are no people or objects around the trunk before opening or closing the trunk.
- Make sure objects in the trunk do not come out when opening the trunk on a slope. It may cause serious injury.
- Make sure to deactivate the Smart Trunk when washing your vehicle. Otherwise, the trunk may open inadvertently.
- The key should be kept out of reach of children. Children may inadvertently open the Smart Trunk while playing around the rear area of the vehicle.

How to deactivate the Smart Trunk function using the smart key

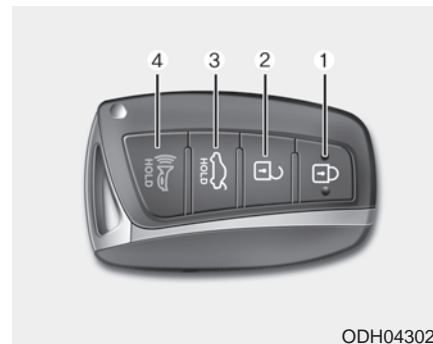

1. Door lock
2. Door unlock
3. Trunk open
4. Panic

If you press any button of the smart key during the Detect and Alert stage, the Smart Trunk function will be deactivated.

Make sure to be aware of how to deactivate the Smart Trunk function for emergency situations.

* NOTICE

- If you press the door unlock button (2), the Smart Trunk function will be deactivated temporarily. But, if you do not open any door for 30 seconds, the smart trunk function will be activated again.
- If you press the trunk open button (3) for more than 1 second, the trunk opens.
- If you press the door lock button (1) or trunk open button (3) when the Smart Trunk function is not in the Detect and Alert stage, the smart trunk function will not be deactivated.
- In case you have deactivated the Smart Trunk function by pressing the smart key button and opened a door, the smart trunk function can be activated again by closing and locking all doors.

Detecting area



- The Smart Trunk operates with a welcome alert if the smart key is detected within 20~40 inches (50~100 cm) from the trunk.
- The alert stops at once if the smart key is positioned outside the detecting area during the Detect and Alert stage.

* NOTICE

- The Smart Trunk function will not work if any of the following occurs:
 - The smart key is close to a radio transmitter such as a radio station or an airport which can interfere with normal operation of the transmitter.
 - The smart key is near a mobile two way radio system or a cellular phone.
 - Another vehicle's smart key is being operated close to your vehicle.
- The detecting range may decrease or increase when :
 - One side of the tire is raised to replace a tire or to inspect the vehicle.
 - The vehicle is slantingly parked on a slope or unpaved road, etc.

Fuel filler door

Opening the fuel filler door

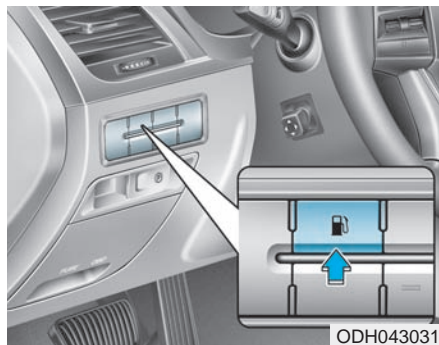

The fuel filler door must be opened from inside the vehicle by pushing the fuel filler door opener button.

1. Turn the engine off.
2. Push the fuel filler door opener button.

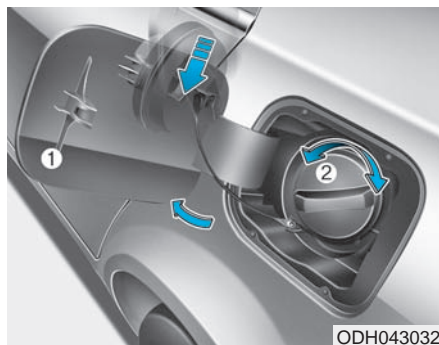

3. Pull the fuel filler door (1) out to fully open.
4. To remove the fuel tank cap (2), turn it counterclockwise. You may hear a hissing noise as the pressure inside the tank equalizes.
5. Place the cap on the fuel filler door.

* NOTICE

If the fuel filler door does not open because ice has formed around it, tap lightly or push on the door to break the ice and release the door. Do not pry on the door. If necessary, spray around the door with an approved de-icer fluid (do not use radiator anti-freeze) or move the vehicle to a warm place and allow the ice to melt.

Closing the fuel filler door

1. To install the fuel tank cap, turn it clockwise until it “clicks” one time.
2. Close the fuel filler door until it is latched securely.

⚠ WARNING

Gasoline is highly flammable and explosive. Failure to follow these guidelines may result in SERIOUS INJURY or DEATH:

- Read and follow all warnings posted at the gas station.
- Before refueling, note the location of the Emergency Gasoline Shut-Off, if available, at the gas station.
- Before touching the fuel nozzle, you should eliminate the potential build-up of static electricity by touching a metal part of the vehicle, a safe distance away from the fuel filler neck, nozzle, or other gas source, with your bare hand.

(Continued)

(Continued)

- Do not use cellular phones while refueling. Electric current and/or electronic interference from cellular phones can potentially ignite fuel vapors and cause a fire.
- Do not get back into a vehicle once you have begun refueling. You can generate a build-up of static electricity by touching, rubbing or sliding against any item or fabric capable of producing static electricity. Static electricity discharge can ignite fuel vapors causing a fire. If you must re-enter the vehicle, you should once again eliminate potentially dangerous static electricity discharge by touching a metal part of the vehicle, away from the fuel filler neck, nozzle or other gasoline source, with your bare hand.

(Continued)

(Continued)

- When using an approved portable fuel container, be sure to place the container on the ground prior to refueling. Static electricity discharge from the container can ignite fuel vapors causing a fire. Once refueling has begun, contact between your bare hand and the vehicle should be maintained until the filling is complete.
- Use only approved portable plastic fuel containers designed to carry and store gasoline.

(Continued)

(Continued)

- When refueling, always move the shift lever to the P (Park) position, set the parking brake, and press the Engine Start/Stop button to the OFF position. Sparks produced by electrical components related to the engine can ignite fuel vapors causing a fire.
- Do not use matches or a lighter and do not smoke or leave a lit cigarette in your vehicle while at a gas station, especially during refueling.
- Do not over-fill or top-off your vehicle tank, which can cause gasoline spillage.

(Continued)

(Continued)

- If a fire breaks out during refueling, leave the vicinity of the vehicle, and immediately contact the manager of the gas station and then contact the local fire department. Follow any safety instructions they provide.
- If pressurized fuel sprays out, it can cover your clothes or skin and thus subject you to the risk of fire and burns. Always remove the fuel cap carefully and slowly. If the cap is venting fuel or if you hear a hissing sound, wait until the condition stops before completely removing the cap.
- Always check that the fuel cap is installed securely to prevent fuel spillage in the event of an accident.

* NOTICE

- Make sure to refuel your vehicle according to the "Fuel Requirements" suggested in the Introduction chapter.
- Do not spill fuel on the exterior surfaces of the vehicle. Any type of fuel spilled on painted surfaces may damage the paint.

⚠ CAUTION

If the fuel filler cap requires replacement, use only a genuine HYUNDAI cap or the equivalent specified for your vehicle. An incorrect fuel filler cap can result in a serious malfunction of the fuel system or emission control system.

Emergency fuel filler door release

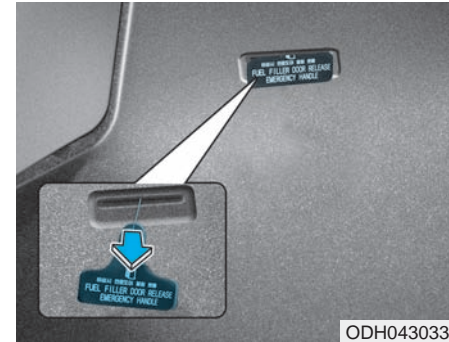

If the fuel filler door does not open using the remote fuel filler door release button, you can open it manually. Pull the handle of the release located on the left side of the luggage compartment outward slightly.

INSTRUMENT CLUSTER

■ Type A



1. Tachometer
2. Speedometer
3. Engine coolant temperature gauge
4. Fuel gauge
5. Warning and indicator lights
6. LCD display (including Trip computer)

■ Type B



For more details, refer to the "Gauges" in this chapter.

The actual cluster in the vehicle may differ from the illustration.

ODH043051N/ODH043052N

Instrument Cluster Control

Adjusting Instrument Cluster Illumination

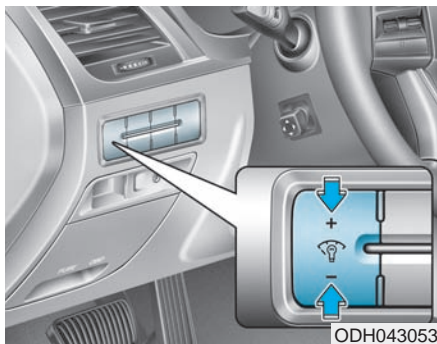

When the Engine Start Stop button is in the ON position, press the illumination control button to adjust the instrument panel illumination intensity and AVN monitor illumination intensity.

When the vehicle's parking lights or headlights are on, the interior switch illumination intensity is adjusted additionally by pressing the control button.

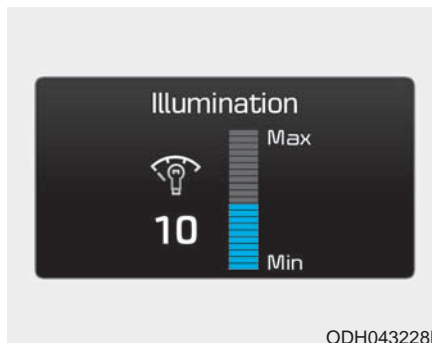



- The brightness of the instrument panel illumination is displayed.
- If the brightness reaches to the maximum or minimum level, an alarm will sound.

LCD Display Control

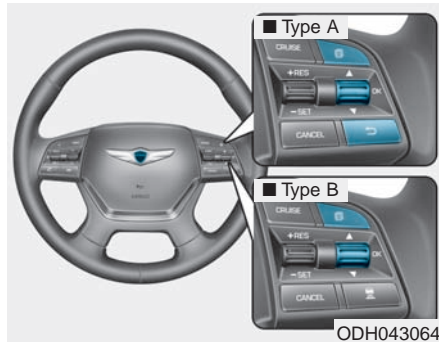
The LCD display modes can be changed by using the control buttons on the steering wheel.



- (1)  : MODE button for changing modes
- (2) ▲, ▼ : MOVE switch for changing items
- (3) OK : SELECT/RESET button for setting or resetting the selected item
- (4)  : BACK button for moving to upper level menu (if equipped)

For more information on LCD modes, refer to "LCD Display" in the next pages of this chapter.

Gauges Speedometer



The speedometer indicates the speed of the vehicle and is calibrated in miles per hour (mph) and/or kilometers per hour (km/h).

Tachometer



The tachometer indicates the approximate number of engine revolutions per minute (rpm).

Use the tachometer to select the correct shift points and to prevent lugging and/or over-revving the engine.

CAUTION

Do not operate the engine within the tachometer's RED ZONE. This may cause severe engine damage.

Engine Coolant Temperature Gauge



This gauge indicates the temperature of the engine coolant when the engine is running.

CAUTION

If the gauge pointer moves beyond the normal range area toward the "H" position, it indicates overheating that may damage the engine.

Do not continue driving with an overheated engine. If your vehicle overheats, refer to "If the Engine Overheats" in chapter 6.

WARNING

Never remove the radiator cap when the engine is hot. The engine coolant is under pressure and could severely burn. Wait until the engine is cool before adding coolant to the reservoir.

Fuel Gauge

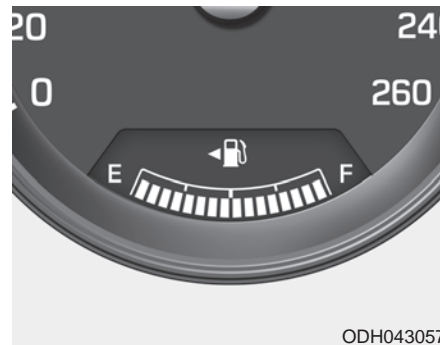

This gauge indicates the approximate amount of fuel remaining in the fuel tank.

* NOTICE

- The fuel tank capacity is given in chapter 8.
- The fuel gauge is supplemented by a low fuel warning light, which will illuminate when the fuel tank is nearly empty.
- On inclines or curves, the fuel gauge pointer may fluctuate or the low fuel warning light may come on earlier than usual due to the movement of fuel in the tank.

WARNING

Running out of fuel can expose vehicle occupants to danger. You must stop and obtain additional fuel as soon as possible after the warning light comes on or when the gauge indicator comes close to the "E (Empty)" level.

CAUTION

Avoid driving with an extremely low fuel level. Running out of fuel could cause the engine to misfire, damaging the catalytic converter.

Odometer



The odometer indicates the total distance that the vehicle has been driven and should be used to determine when periodic maintenance should be performed.

- Odometer range : 0 ~ 999999 miles or kilometers.

Outside Temperature Gauge

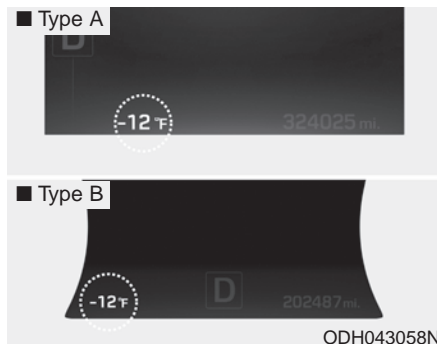

This gauge indicates the current outside air temperatures by 1°F (1°C).

- Temperature range : -40°F ~ 140°F
(-40°C ~ 60°C)

The outside temperature on the display may not change immediately like a general thermometer to prevent the driver from being inattentive. The temperature unit (from °C to °F or from °F to °C) can be changed as below procedures.

And, the temperature unit of the cluster and AVN monitor is changed at the same time.

- User Settings Mode in the Cluster : You can change the temperature unit in the “Other Features - Temperature unit” .
- Automatic climate control system : While pressing the OFF button, press the AUTO button for 3 seconds or more.

Automatic Transmission Shift Indicator

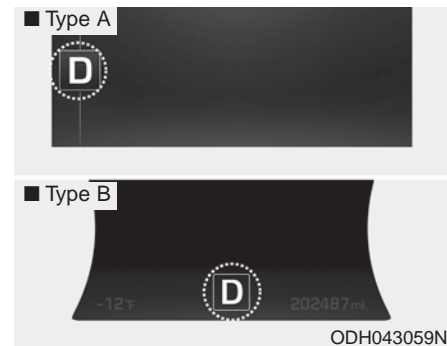







This indicator displays which automatic transmission shift lever is selected.

- Park : P
- Reverse : R
- Neutral : N
- Drive : D
- Sports Mode : 1, 2, 3, 4, 5, 6, 7, 8

LCD DISPLAY

LCD Modes

Modes	Symbol	Explanation
Trip Computer		This mode displays driving information like the tripmeter, fuel economy, and so on. For more details, refer to "Trip Computer" in this chapter.
Turn By Turn (TBT) (if equipped)		This mode displays the state of the navigation.
ASCC/LKAS (if equipped)		This mode displays the state of the Advanced Smart Cruise Control (ASCC) and Lane Keeping Assist System (LKAS). For more details, refer to "Advanced Smart Cruise Control (ASCC)" and Lane Keeping Assist System (LKAS) in chapter 5.
A/V		This mode displays the state of the A/V system.
Information		This mode informs of the tire pressure information, service interval (mileage or days) and warning messages related to the advanced smart cruise control system, pre-safe seat belt, and so on.
User Settings		On this mode, you can change settings of the doors, lamps, and so on.

For more information on controlling the LCD modes, refer to "LCD Display Control" in the previous pages of this chapter.

Cannot edit settings while driving

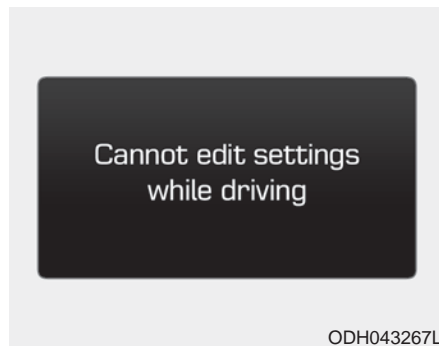

ODH043267L

This warning message illuminates if you try to select the other User Settings item except Head-up display item when driving.

For safety, change the User Settings after parking the vehicle and moving the shift lever to P (Park) position.

Quick guide (Help)

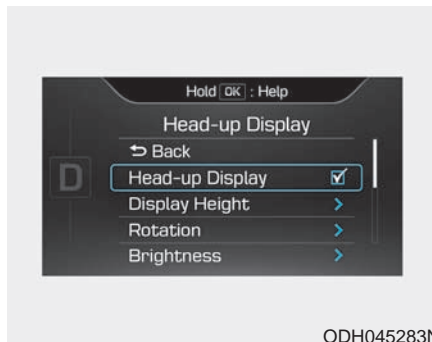

ODH045283N

If you press and hold the OK button in the User Settings Mode, explanation about the selected item is displayed in the cluster.

Trip Computer Mode

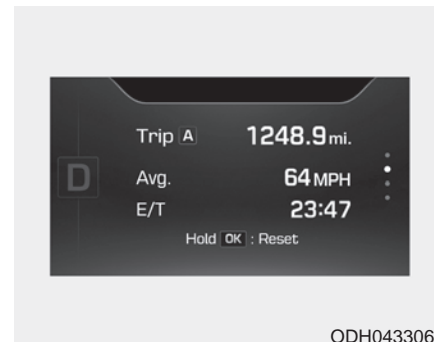

ODH043306N

This mode displays driving information like the tripmeter, fuel economy, and so on.

For more details, refer to "Trip Computer" in this chapter.

Turn By Turn (TBT) Mode (if equipped)



ODH043274N

This mode displays the state of the navigation.

ASCC/LKAS Mode (if equipped)

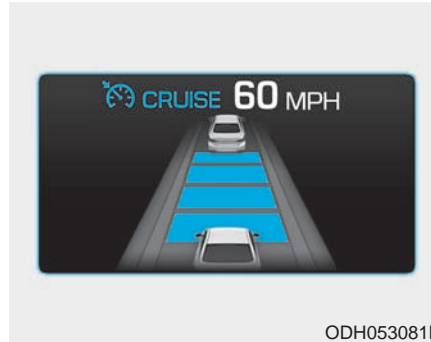

ODH053081N

This mode displays the state of the Advanced Smart Cruise Control (ASCC) and Lane Keeping Assist System (LKAS).

For more details, refer to "Advanced Smart Cruise Control (ASCC)" and "Lane Keeping Assist System (LKAS)" in chapter 5.

A/V Mode

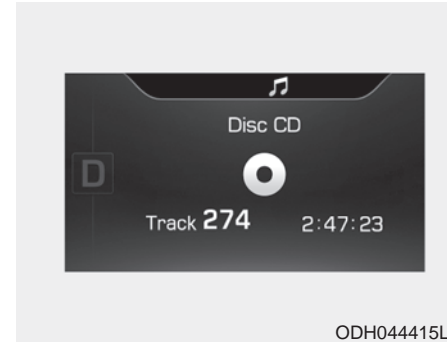

ODH044415L

This mode displays the state of the A/V system.

Information Mode

Tire pressure information



This mode informs of tire pressure information.

Service Interval

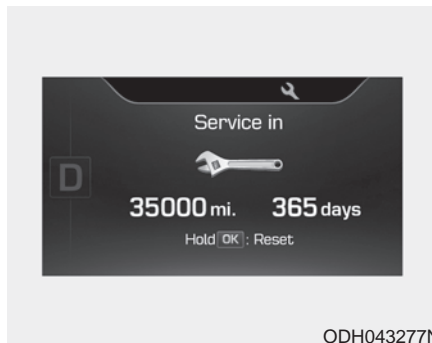

Service in

It calculates and displays when you need a scheduled maintenance service (mileage or days).

If the remaining mileage or time reaches 900 miles (1,500 km) or 30 days, "Service in" message is displayed for several seconds each time you set the Engine Start/Stop button to the ON position.

For the setting of the service interval, refer to "User Settings Mode" of the LCD display.

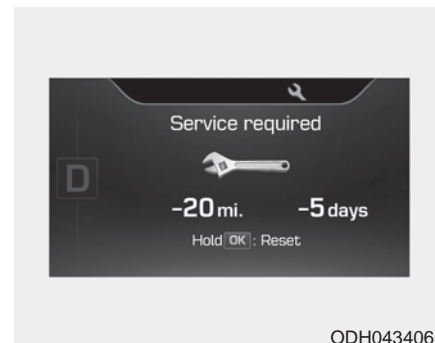

Service required

If you do not have your vehicle serviced according to the already inputted service interval, "Service required" message is displayed for several seconds each time you set the Engine Start/Stop button to the ON position.

To reset the service interval to the mileage and days you inputted before:

- Press the OK button for more than 1 second

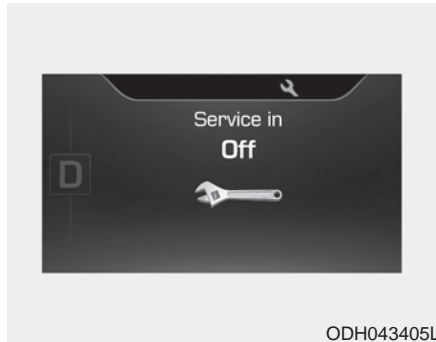

Service in OFF

If the service interval is not set, "Service in OFF" message is displayed on the LCD display.

* NOTICE

If any of the following conditions occurs, the mileage and days may be incorrect.

- The battery cable is disconnected.
- The fuse switch is turned off.
- The battery is discharged.

Warning Message

If one of followings occurs, warning messages will be displayed on the information mode for several seconds.

- Malfunction of below systems
 - Blind Spot Detection (BSD)
 - Presafe Seat Belt (PSB)
 - Electronic Control Suspension (ECS)
 - Active Hood System
 - Advanced Smart Cruise Control (ASCC)
 - Haptic Steering Wheel
 - Lane Keeping Assist System (LKAS)
 - Tire Pressure Monitoring System (TPMS)
 - Autonomous Emergency Braking
- Low washer fluid
- Low fuel etc.

User Settings Mode

On this mode, you can change setting of the Head Up display, the instrument cluster, doors, lamps, and so on.

Head Up Display (if equipped)

Items	Explanation
Head-Up Display (HUD)	<ul style="list-style-type: none">• On : Activate the Head Up Display.• Off : Deactivate the Head Up Display.
Display Height	Adjust the height of the HUD image on the windshield glass.
Brightness	Adjust the intensity of the HUD illumination.
Content Select	Activate or deactivate each contents of the HUD. <ul style="list-style-type: none">• Turn by Turn• Traffic Information• Smart Cruise control• Lane Keep Assist System• Blind Spot Detection
Speed Size	Choose the speedometer font size of the HUD. (Large, Medium, Small)
Speed Color	Choose the speedometer font color of the HUD. (White, Orange, Green)

Driving Assist

Items	Explanation
LKAS (Lane Keeping Assist System)	<ul style="list-style-type: none">• Pre-departure mode : To activate the pre-departure mode of LKAS function• Post-departure mode : To activate the post-departure mode of LKAS function For more details, refer to "Lane Keeping Assist System (LKAS)" in chapter 5.
AEB (Autonomous Emergency Braking)	To activate or deactivate the AEB system. For more details, refer to "Autonomous Emergency Braking (AEB)" in chapter 5.
RCTA (Rear Cross Traffic Alert)	To activate or deactivate the RCTA system. For more details, refer to "Rear Cross Traffic Alert (RCTA)" in chapter 5.

Door/Trunk

Items	Explanation
Automatically Lock	<ul style="list-style-type: none"> • Disable: The auto door lock operation will be deactivated. • Enable on Speed: All doors will be automatically locked when the vehicle speed exceeds 9.3mph (15km/h). • Enable on Shift: All doors will be automatically locked if the automatic transmission shift lever is shifted from the P (Park) position to the R (Reverse), N (Neutral), or D (Drive) position.
Automatically Unlock	<ul style="list-style-type: none"> • Disable: The auto door unlock operation will be canceled. • Vehicle Off: All doors will be automatically unlocked when the Engine Start/Stop button is set to the OFF position. • Driver Door Unlock: All doors will be automatically unlocked if the driver's door is unlocked. • On Shift to P: All doors will be automatically unlocked if the automatic transmission shift lever is shifted to the P (Park) position.
Lock/Unlock Sound	To activate or deactivate the lock sound when locking doors.
Smart Trunk	To activate or deactivate the Smart Trunk system. For more details, refer to "Smart Trunk" in this chapter.
Two Press Unlock	<ul style="list-style-type: none"> • OFF : The two press unlock function will be deactivated. Therefore, all doors will unlock if the door is unlocked. • ON : The driver's door will unlock if the door is unlocked. When the door is unlocked again within 4 seconds, all doors will unlock.

Lights

Items	Explanation
One Touch Turn Signal	<ul style="list-style-type: none"> • Off: The one touch turn signal function will be deactivated. • 3, 5, 7 Flashing : The lane change signals will blink 3, 5, or 7 times when the turn signal lever is moved slightly. <p>For more details, refer to "Light" in this chapter.</p>
Ambient Light	<ul style="list-style-type: none"> • Off : The ambient light of interior will turn off. • Auto : The ambient light of interior will turn automatically on or off. • On : The ambient light of interior will turn on.
Head Lamp Delay	<ul style="list-style-type: none"> • On: The head lamp delay function will be activated. • Off: The headlamp delay function will be deactivated. <p>For more details, refer to "Light" in this chapter.</p>
Welcome Light	<ul style="list-style-type: none"> • On: The welcome light function will be activated. • Off: The welcome light function will be deactivated. <p>For more details, refer to "Welcome System" in this chapter.</p>

Sound

Items	Explanation
Park Assist System vol.	<ul style="list-style-type: none">• Adjust the Park Assist System volume. (Level 1~3)
BSD (Blind Spot Detection) Sound	<ul style="list-style-type: none">• Off : The BSD sound function will be deactivated.• On : The BSD sound function will be activated.
Welcome Sound	<ul style="list-style-type: none">• Off : The welcome sound function will be deactivated.• On : The welcome sound function will be activated.

Seat/Steering

Items	Explanation
Seat Easy Access	<ul style="list-style-type: none"> • Off: The seat easy access function will be deactivated. • Normal/Extended: <ul style="list-style-type: none"> - When you turn off the engine, the driver's seat will automatically move rearward short (Normal) or long (Extended) for you to enter or exit the vehicle more comfortably. - If you change the Engine Start/Stop button from OFF position to the ACC, ON, or START position, the driver's seat will return to the original position. <p>For more details, refer to "Driver Position Memory System" in this chapter.</p>
Steering Easy Access	<ul style="list-style-type: none"> • On: The steering wheel will automatically move forward or rearward for the driver to enter or exit the vehicle comfortably. • Off: The steering easy access function will be deactivated. <p>For more details, refer to "Driver Position Memory System" in this chapter.</p>
Steering Position	<ul style="list-style-type: none"> • Off : The steering position function will be deactivated. • On : The steering position function will be activated.

Service Interval

Items	Explanation
Service Interval	<p>On this mode, you can activate the service interval function with mileage (km or mi.) and period (months).</p> <ul style="list-style-type: none"> • Off : The service interval function will be deactivated. • On : You can set the service interval (mileage and months).

Other Features

Items	Explanation
Fuel Economy Auto Reset	<ul style="list-style-type: none"> • Off : The average fuel economy will not reset automatically whenever refueling. • On (Auto Reset) : The average fuel economy will reset automatically when refueling. <p>For more details, refer to "Trip Computer" in this chapter.</p>
Traffic Information	<ul style="list-style-type: none"> • Off: The traffic information will not be displayed on the LCD display. • On: The LCD display will show traffic information.
Wiper/Lights Display	<ul style="list-style-type: none"> • Off: The wiper/lights information will not be displayed on the LCD display. • On: The LCD display will shortly show the selected wiper/lights information.
Fuel Economy Unit	Choose the fuel economy unit. (US gallon, UK gallon)
Temperature Unit	Choose the temperature unit. (°C,°F)
Tire Pressure Unit	Choose the tire pressure unit. (psi, kPa, Bar)

Warning Messages (if equipped)

Shift to "P" or "N" to start engine



- This warning message illuminates if you try to start the engine with the shift lever not in the P (Park) or N (Neutral) position.

* NOTICE

You can start the engine with the shift lever in the N (Neutral) position. But, for your safety, we recommend that you start the engine with the shift lever in the P (Park) position.

Shift to "P" position



- This message illuminates if you try to turn off the engine without the shift lever in P (Park) position.
- At this time, the Engine Start/Stop button turns to the ACC position (If you press the Engine Start/Stop button once more, it will turn to the ON position).

Press START button again



- This message illuminates if you can not operate the Engine Start/Stop button when there is a problem with the Engine Start/Stop button system.
- It means that you could start the engine by pressing the Engine Start/Stop button once more.
- If this warning illuminates each time you press the Engine Start/Stop button, have your vehicle inspected by an authorized HYUNDAI dealer.

Press brake pedal to start engine

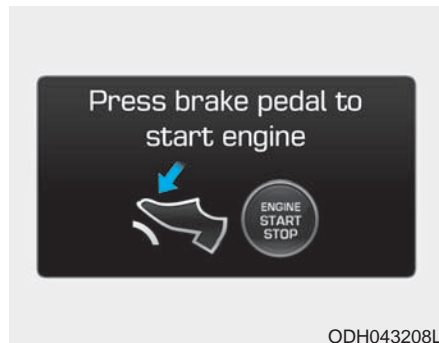

- This warning message illuminates if the Engine Start/Stop button changes to the ACC position twice by pressing the button repeatedly without depressing the brake pedal.
- It means that you should depress the brake pedal to start the engine.

Press START button with smart key



- This warning message illuminates if you press the Engine Start/Stop button while the warning message “Key not detected” is illuminating.
- At this time, the immobilizer indicator light blinks.

Low Key Battery

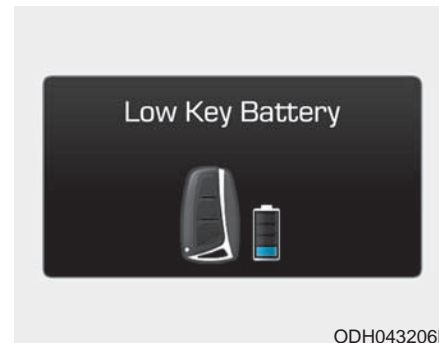

- This warning message illuminates if the battery of the smart key is discharged when the Engine Start/Stop button changes to the OFF position.

Key not detected

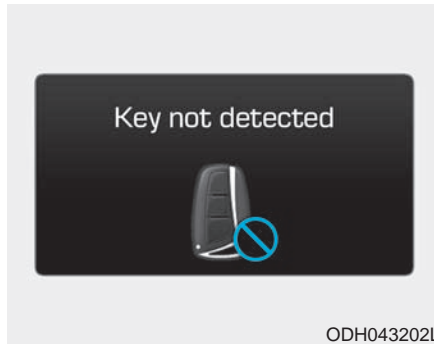

- This warning message illuminates if the smart key is not detected when you press the Engine Start/Stop button.

Key not in vehicle



- This warning message illuminates if the smart key is not in the vehicle when you press the Engine Start/Stop button.
- It means that you should always have the smart key with you.

Align steering wheel



- This warning message illuminates if you start the engine when the steering wheel is turned to more than 90 degrees to the left or right.
- It means that you should turn the steering wheel and make the angle of the steering wheel be less than 30 degrees.

Steering wheel aligning is completed

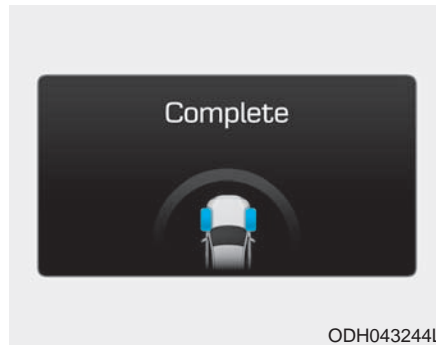

ODH043244L

- If the steering wheel aligning is completed after "Align steering wheel" warning message is displayed, this message is displayed for 2 seconds.

Heated Steering Wheel On



ODH043224L

- This warning message illuminates if you turn on the heated steering wheel.

For more details, refer to "Heated Steering Wheel" in this chapter.

Heated Steering Wheel Off



ODH043226L

- This warning message illuminates if you turn off the heated steering wheel.

For more details, refer to "Heated Steering Wheel" in this chapter.

Door / Hood / Trunk Open

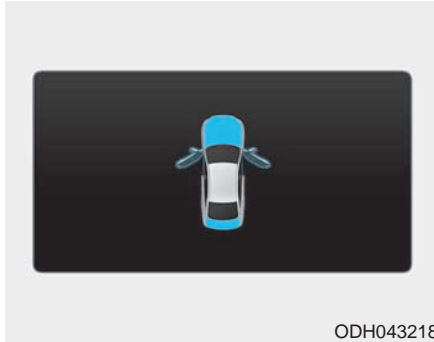

- It means that any door, hood, or trunk is open.

Sunroof Open

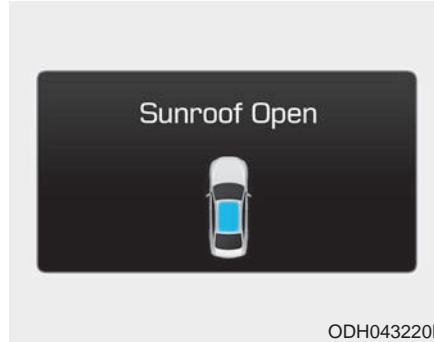

- This warning message illuminates if you turn off the engine when the sunroof is open.

Window Open

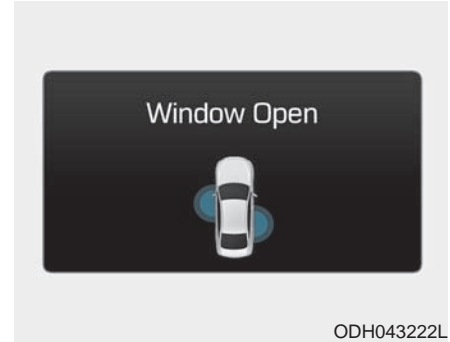

- This warning message illuminates if you turn off the engine when any window is open.

Check BRAKE SWITCH fuse

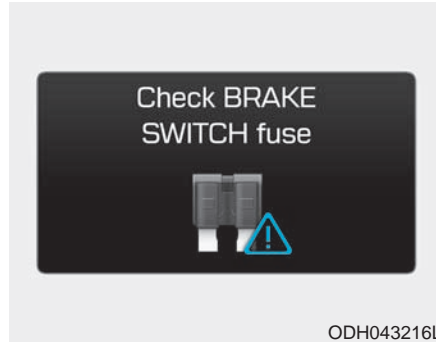

ODH043216L

- This warning message illuminates if the brake switch fuse is disconnected.
- It means that you should replace the fuse with a new one. If that is not possible, you can start the engine by pressing the Engine Start/Stop button for 10 seconds in the ACC position.

Turn on "FUZE SWITCH"



ODH043234L

- This warning message illuminates if the fuse switch under the steering wheel is OFF.
- It means that you should turn the fuse switch on.

For more details, refer to "Fuses" in chapter 7.

Low Tire Pressure

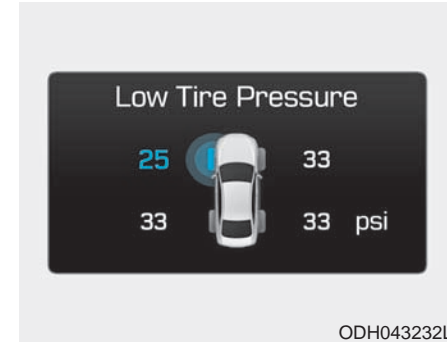

ODH043232L

- This warning message illuminates if the tire pressure is low with the Engine Start/Stop button in ON position.

For more details, refer to "Tire Pressure Monitoring System (TPMS)" in chapter 6.

Low Washer Fluid



- This warning message illuminates on the service reminder mode if the washer fluid level in the reservoir is nearly empty.
- It means that you should refill the washer fluid.

Check BSD System (if equipped)

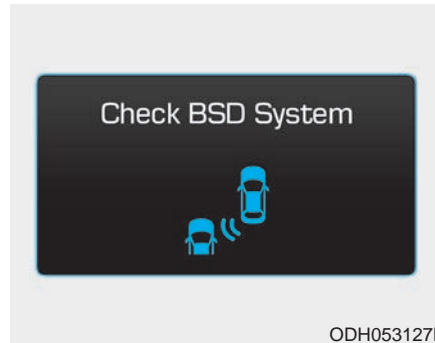

- This warning message illuminates if there is a malfunction with the Blind Spot Detection (BSD) system. And the BSD system will be automatically deactivated. In this case, have your vehicle inspected by an authorized HYUNDAI dealer.

For more details, refer to "Blind Spot Detection (BSD) System" in chapter 5.

Check PSB

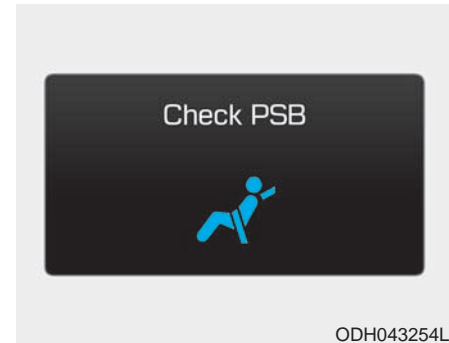

- This warning message illuminates if there is a malfunction with the Pre-safe Seat Belt (PSB) system. In this case, have your vehicle inspected by an authorized HYUNDAI dealer.

For more details, refer to "Seat Belt" in chapter 2.

Check ECS

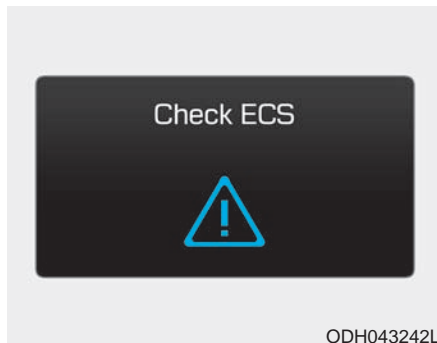

- This warning message illuminates if there is a malfunction with the Electronic Control Suspension (ECS) system. In this case, have your vehicle inspected by an authorized HYUNDAI dealer.

For more details, refer to "Electronic Control Suspension (ECS)" in chapter 5.

* NOTICE - ECS Warning Message

When there is a malfunction with the Electronic Stability Control (ESC), the Electronic Control Suspension (ECS) warning message may illuminate as well as the Electronic Stability Control (ESC) Indicator Light.

Check SCC radar

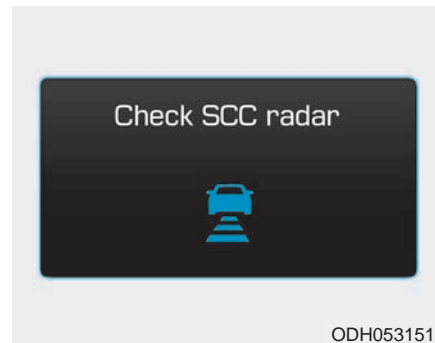

If the sensor or cover is dirty or obscured with foreign matter such as snow, the message will appear. Clean the sensor or cover by using a soft cloth.

For more details, refer to "Advanced Smart Cruise Control System" in chapter 5.

Check SCC System

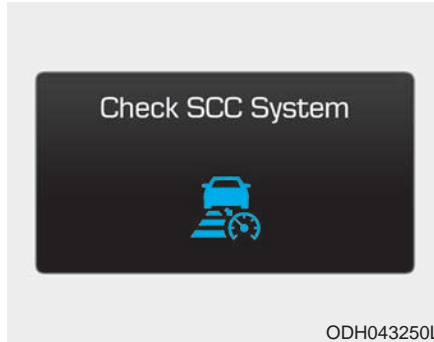

- This warning message illuminates if there is a malfunction with the advanced smart cruise control system. In this case, have your vehicle inspected by an authorized HYUNDAI dealer.

For more details, refer to "Advanced Smart Cruise Control System" in chapter 5.

Check Active Air Flap System



- This warning message illuminates if any of following conditions occurs.
 - There is a malfunction with the active air flap system.
 - A foreign substance is stuck in the air flap.
 - The air flap is frozen.

* NOTICE

The warning message "Check Active Air Flap System" may not be displayed immediately in colder climates.

Check Active Hood System

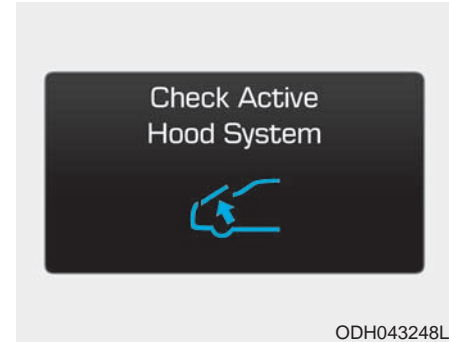

- This warning message illuminates if the active hood system has a malfunction. In this case, have your vehicle inspected by an authorized HYUNDAI dealer.

Check AEB system

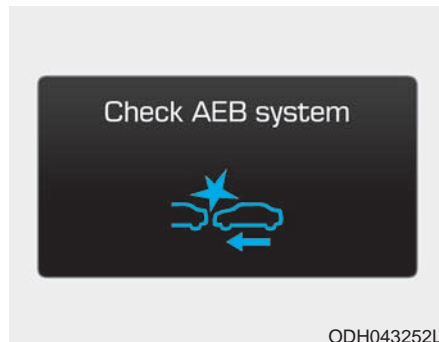

- This warning message illuminates if the sensor or cover is dirty or obscured with foreign matter such as snow. Clean the sensor or cover by using a soft cloth.
- This warning message illuminates if there is a malfunction with the Autonomous Emergency Braking (AEB) system. In this case, have your vehicle inspected by an authorized HYUNDAI dealer.

For more details, refer to "Autonomous Emergency Braking (AEB) System" in chapter 5.

Low Fuel

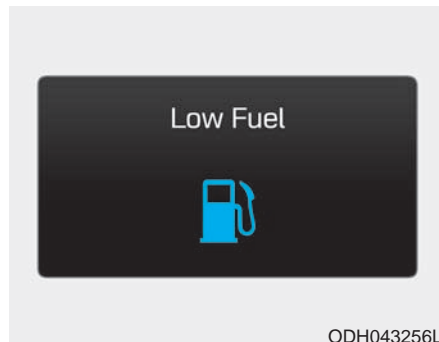

- This warning message illuminates if the fuel tank is nearly empty.
 - When the low fuel level warning light is illuminates.
 - When the trip computer displays "--- mile (or km)" as distance to empty.

Add fuel as soon as possible.

Engine has overheated

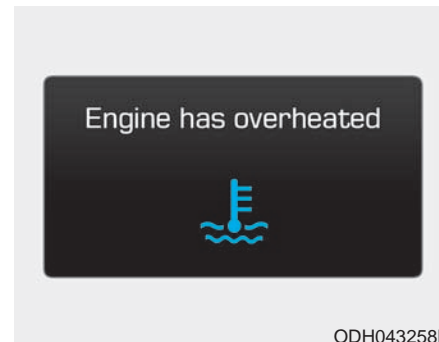

- This warning message illuminates when the engine coolant temperature is above 248°F (120°C). This means that the engine is overheated and may be damaged.

If your vehicle is overheated, refer to "Overheating" in chapter 6.

TRIP COMPUTER

Overview

Description

The trip computer is a microcomputer-controlled driver information system that displays information related to driving.

* NOTICE

Some driving information stored in the trip computer (for example Average Vehicle Speed) resets if the battery is disconnected.

Trip Modes

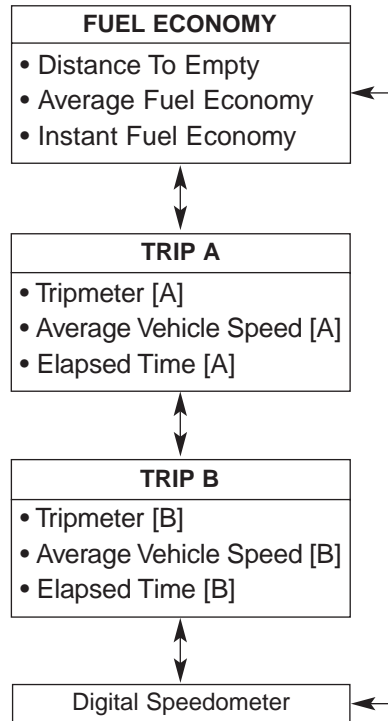

To change the trip mode, rotate the MOVE switch "▲ , ▼" on the steering wheel.

For more details, refer to "LCD Display Control" in this chapter

Trip A/B



* NOTICE

If you reset one of the tripmeter, elapsed time, and average vehicle speed, they will be reset all together.

Tripmeter (1)

- The tripmeter is the total driving distance since the last tripmeter reset.
 - Distance range:
0.0 ~ 9999.9 mi. or km
- To reset the tripmeter, press the OK button on the steering wheel for more than 1 second when the tripmeter is displayed.

Average Vehicle Speed (2)

- The average vehicle speed is calculated by the total driving distance and driving time since the last average vehicle speed reset.
 - Speed range: 0 ~ 999 MPH or km/h
- To reset the average vehicle speed, press the OK button on the steering wheel for more than 1 second when the average vehicle speed is displayed.

* NOTICE

- The average vehicle speed is not displayed if the driving distance has been less than 0.19 miles (300 meters) since the Engine Start/Stop button was turned to ON.
- Even if the vehicle is not in motion, the average vehicle speed keeps calculating while the engine is running.

Elapsed Time (3)

- The elapsed time is the total driving time since the last elapsed time reset.
 - Time range (hh:mm): 00:00 ~ 99:59
- To reset the elapsed time, press the OK button on the steering wheel for more than 1 second when the elapsed time is displayed.

*** NOTICE**

Even if the vehicle is not in motion, the elapsed time keeps calculating while the engine is running.

Fuel Economy

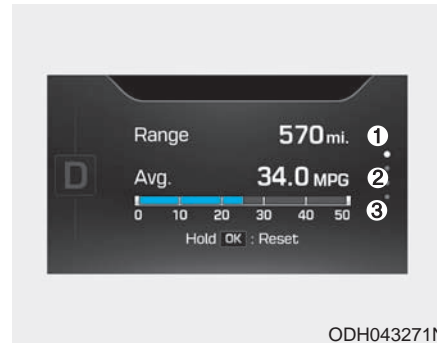

Distance To Empty (1)

- The distance to empty is the estimated distance the vehicle can be driven with the remaining fuel.
 - Distance range: 1 ~ 999 mi. or 1 ~ 999 km
- If the estimated distance is below 1 mi. (1 km), the trip computer will display “---” as distance to empty.

*** NOTICE**

- If the vehicle is not on level ground or the battery power has been interrupted, the distance to empty function may not operate correctly.
- The distance to empty may differ from the actual driving distance as it is an estimate of the available driving distance.
- The trip computer may not register additional fuel if less than 1.6 gallons (6 liters) of fuel are added to the vehicle.
- The fuel economy and distance to empty may vary significantly based on driving conditions, driving habits, and condition of the vehicle.

Average Fuel Economy (2)

- The average fuel economy is calculated by the total driving distance and fuel consumption since the last average fuel economy reset.
 - Fuel economy range:
0.0 ~ 99.9 MPG or L/100km
- The average fuel economy can be reset both manually and automatically.

Manual reset

To clear the average fuel economy manually, press the OK button on the steering wheel for more than 1 second when the average fuel economy is displayed.

For more details on the OK button, refer to the "LCD Display Control" in this chapter.

Automatic reset

To make the average fuel economy be reset automatically whenever refueling, select the "Auto Reset" mode in User Setting menu of the LCD display (**Refer to "LCD Display"**).

Under "Auto Reset" mode, the average fuel economy will be cleared to zero (---) when the vehicle speed exceeds 1 km/h after refueling more than 1.6 gallons (6 liters).

*** NOTICE**

The average fuel economy is not displayed for more accurate calculation if the vehicle does not drive more than 0.19 miles (300 meters) since the Engine Start/Stop button is turned to ON.

Instant Fuel Economy (3)

- This mode displays the instant fuel economy during the last few seconds when the vehicle speed is more than 6.2 MPH (10 km/h).
 - Fuel economy range:
0 ~ 50 MPG or 0 ~ 30 L/100km

Digital Speedometer



This message shows the speed of the vehicle (km/h, MPH).

One time driving information mode



This display shows trip distance (1), average fuel economy (2) and the vehicle can be driven with the remaining fuel (3).

This information is displayed for a few seconds when you turn off the engine and then goes off automatically. The information provided is calculated according to each trip.

If the estimated distance is below 1mi. (1km), the distance to empty (3) will display as "---" and a refuel message will appear (4).

* NOTICE

If “Window Open or Sunroof Open” warning message are displayed in the cluster, this display may not be displayed in the cluster.

WARNING AND INDICATOR LIGHTS

Warning lights

* NOTICE

Make sure that all warning lights are OFF after starting the engine. If any light is still ON, this indicates a situation that needs attention.

Supplemental Restraint System Warning Light



This warning light illuminates:

- Once you set the Engine Start/Stop button to the ON position.
 - It illuminates for approximately 6 seconds and then goes off.
- When there is a malfunction with the SRS.

In this case, have your vehicle inspected by an authorized HYUNDAI dealer.

Seat Belt Warning Light



This warning light informs the driver that the seat belt is not fastened.

For more details, refer to the "Seat Belts" in chapter 2.

Parking Brake & Brake Fluid Warning Light



This warning light illuminates:

- Once you set the Engine Start/Stop button to the ON position.
 - It illuminates for approximately 3 seconds.
 - It remains on if the parking brake is applied.
- When the parking brake is applied.
- When the brake fluid level in the reservoir is low.
 - If the warning light illuminates with the parking brake released, it indicates the brake fluid level in reservoir is low.

If the brake fluid level in the reservoir is low:

1. Drive carefully to the nearest safe location and stop your vehicle.
2. With the engine stopped, check the brake fluid level immediately and add fluid as required (**For more details, refer to "Brake Fluid" in chapter 7**). Then check all brake components for fluid leaks. If any leak on the brake system is still found, the warning light remains on, or the brakes do not operate properly, do not drive the vehicle. In this case, have your vehicle inspected by an authorized HYUNDAI dealer.

Dual-diagonal braking system

Your vehicle is equipped with dual-diagonal braking systems. This means you still have braking on two wheels even if one of the dual systems should fail.

With only one of the dual systems working, more than normal pedal travel and greater pedal pressure are required to stop the vehicle.

Also, the vehicle will not stop in as short a distance with only a portion of the brake system working.

If the brakes fail while you are driving, shift to a lower gear for additional engine braking and stop the vehicle as soon as it is safe to do so.

WARNING

Parking Brake & Brake Fluid Warning Light

Driving the vehicle with a warning light ON is dangerous. If the Parking Brake & Brake Fluid Warning Light illuminates with the parking brake released, it indicates that the brake fluid level is low.

In this case, have your vehicle inspected by an authorized HYUNDAI dealer.

Anti-lock Brake System (ABS) Warning Light



This warning light illuminates:

- Once you set the Engine Start/Stop button to the ON position.
 - It illuminates for approximately 3 seconds and then goes off.
- When there is a malfunction with the ABS (The normal braking system will still be operational without the assistance of the anti-lock brake system).

In this case, have your vehicle inspected by an authorized HYUNDAI dealer.

Electronic Brake force Distribution (EBD) System Warning Light



These two warning lights illuminate at the same time while driving:

- When the ABS and regular brake system may not work normally. In this case, have your vehicle inspected by an authorized HYUNDAI dealer.

⚠ WARNING

Electronic Brake force Distribution (EBD) System Warning Light

When both ABS and Parking Brake & Brake Fluid Warning Lights are on, the brake system will not work normally and you may experience an unexpected and dangerous situation during sudden braking.

In this case, avoid high speed driving and abrupt braking.

In this case, have your vehicle inspected by an authorized HYUNDAI dealer.

*** NOTICE - Electronic Brake force Distribution (EBD) System Warning Light**

When the ABS Warning Light is on or both ABS and Parking Brake & Brake Fluid Warning Lights are on, the speedometer, odometer, or trip-meter may not work. Also, the EPS Warning Light may illuminate and the steering effort may increase or decrease.

In this case, have your vehicle inspected by an authorized HYUNDAI dealer.

Electronic Power Steering (EPS) Warning Light (if equipped)



This warning light illuminates:

- Once you set the Engine Start/Stop button to the ON position.
 - It remains on until the engine is started.
- When there is a malfunction with the EPS.

In this case, have your vehicle inspected by an authorized HYUNDAI dealer.

Malfunction Indicator Lamp (MIL)



This warning light illuminates:

- Once you set the or Engine Start/Stop button to the ON position.
 - It remains on until the engine is started.
- When there is a malfunction with the emission control system.

In this case, have your vehicle inspected by an authorized HYUNDAI dealer.

CAUTION

Malfunction Indicator Lamp (MIL)

Driving with the Malfunction Indicator Lamp (MIL) on may cause damage to the emission control systems which could affect drivability and/or fuel economy.

CAUTION

Gasoline Engine

If the Malfunction Indicator Lamp (MIL) illuminates, potential catalytic converter damage is possible which could result in loss of engine power.

In this case, have your vehicle inspected by an authorized HYUNDAI dealer.

Charging System Warning Light



If this warning light comes on while the engine is running, the battery is not being charged. Immediately turn off all electrical accessories. Try not to use electrically operated controls, such as the power windows. Keep the engine running; starting the engine will quickly discharge the battery.

If there is a malfunction with either the alternator or electrical charging system:

1. Drive carefully to the nearest safe location and stop your vehicle.
2. Turn the engine off and check the alternator drive belt for looseness or breakage.

If the belt is adjusted properly, there may be a problem in the electrical charging system.

In this case, have your vehicle inspected by an authorized HYUNDAI dealer.

Engine Oil Pressure Warning Light



This warning light illuminates:

- Once you set the Engine Start/Stop button to the ON position.
 - It remains on until the engine is started.
- When the engine oil pressure is low.

If the engine oil pressure is low:

1. Drive carefully to the nearest safe location and stop your vehicle.
2. Turn the engine off and check the engine oil level (**For more details, refer to "Engine Oil" in chapter 7**). If the level is low, add oil as required.

If the warning light remains on after adding oil and restarting the engine or if oil is not available, turn off the engine. There is a mechanical problem that needs to be repaired before you can continue driving. In this case, have your vehicle inspected by an authorized HYUNDAI dealer.

CAUTION

Engine Oil Pressure Warning light

To prevent severe engine damage, after the Engine Oil Pressure Warning Light is illuminated and as soon as it is safe to do so, turn the engine off and check the oil level.

If the oil level is low, fill the engine oil to the proper level and start the engine again. If the light stays on with the engine running, turn the engine off immediately.

In this case, have your vehicle inspected by an authorized HYUNDAI dealer.

Low Fuel Level Warning Light



This warning light illuminates:

When the fuel tank is nearly empty.

If the fuel tank is nearly empty:

Add fuel as soon as possible.

CAUTION

Low Fuel Level

Driving with the Low Fuel Level warning light on or with the fuel level below "E" can cause the engine to misfire and damage the catalytic converter (if equipped).

Low Tire Pressure Warning Light



This warning light illuminates:

- Once you set the Engine Start/Stop button to the ON position.
 - It illuminates for approximately 3 seconds and then goes off.
- When one or more of your tires are significantly underinflated (The location of the underinflated tires are displayed on the LCD display).

For more details, refer to "Tire Pressure Monitoring System (TPMS)" in chapter 6.

This warning light remains on after blinking for approximately 60 seconds or repeats blinking and off at the intervals of approximately 3 seconds:

- When there is a malfunction with the TPMS.

In this case, have your vehicle inspected by an authorized HYUNDAI dealer.

For more details, refer to "Tire Pressure Monitoring System (TPMS)" in chapter 6.

WARNING

Safe Stopping

- The TPMS cannot alert you to severe and sudden tire damage caused by external factors.
- If you notice any vehicle instability, immediately take your foot off the accelerator pedal, apply the brakes gradually with light force, and slowly move to a safe position off the road.

Door Ajar Warning Light



This warning light illuminates:

When a door is not closed securely.

Trunk Open Warning Light



This warning light illuminates:

When the trunk lid is not closed securely.

All Wheel Drive (AWD) Warning Light (if equipped)

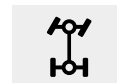

This warning light illuminates:

- Once you set the Engine Start/Stop button to the ON position.
 - It illuminates for approximately 3 seconds and then goes off.
- When there is a malfunction with the AWD system.

In this case, have your vehicle inspected by an authorized HYUNDAI dealer.

Electric Parking Brake (EPB) Warning Light (if equipped)

EPB

This warning light illuminates:

- Once you set the Engine Start/Stop button to the ON position.
 - It illuminates for approximately 3 seconds and then goes off.
- When there is a malfunction with the EPB.

In this case, have your vehicle inspected by an authorized HYUNDAI dealer.

*** NOTICE - Electric Parking Brake (EPB) Warning Light**

The Electric Parking Brake (EPB) Warning Light may illuminate when the Electronic Stability control (ESC) Indicator Light comes on to indicate that the ESC is not working properly (This does not indicate malfunction of the EPB).

Autonomous Emergency Braking (AEB) Warning light (if equipped)



This warning light illuminates :

- When the AEB system is turned off.
- When the radar or its cover is stained. Remove the stains with a soft cloth.
- When there is a malfunction with AEB. In this case, have your vehicle inspected by an authorized HYUNDAI dealer.

Master Warning Light



This indicator light illuminates

- When there is a malfunction on the pre-safe seat belt, low washer, electronic control suspension, or advanced smart cruise control. To identify the details of the warning, look at the LCD display.

Indicator Lights

Electronic Stability Control (ESC) Indicator Light



This indicator light illuminates:

- Once you set the Engine Start/Stop button to the ON position.
 - It illuminates for approximately 3 seconds and then goes off.
- When there is a malfunction with the ESC system.

In this case, have your vehicle inspected by an authorized HYUNDAI dealer.

This indicator light blinks:

While the ESC is operating.

For more details, refer to "Electronic Stability Control (ESC)" in chapter 5.

Electronic Stability Control (ESC) OFF Indicator Light



This indicator light illuminates:

- Once you set the Engine Start/Stop button to the ON position.
 - It illuminates for approximately 3 seconds and then goes off.
- When you deactivate the ESC system by pressing the ESC OFF button.

For more details, refer to "Electronic Stability Control (ESC)" in chapter 5.

Immobilizer Indicator Light



This indicator light illuminates for up to 30 seconds:

- When the vehicle detects the smart key in the vehicle properly while the Engine Start/Stop button is ACC or ON.
 - At this time, you can start the engine.
 - The indicator light goes off after starting the engine.

This indicator light blinks for a few seconds:

- When the smart key is not in the vehicle.
 - At this time, you can not start the engine.

This indicator light illuminates for 2 seconds and goes off:

- When the vehicle can not detect the smart key which is in the vehicle while the Engine Start/Stop button is ON.

In this case, have your vehicle inspected by an authorized HYUNDAI dealer.

This indicator light blinks:

- When the battery of the smart key is weak.
 - At this time, you can not start the engine. However, you can start the engine if you press the Engine Start/Stop button with the smart key. **(For more details, refer to "Starting the Engine" in chapter 5).**
- When there is a malfunction with the immobilizer system.

In this case, have your vehicle inspected by an authorized HYUNDAI dealer.

Turn Signal Indicator Light

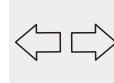

This indicator light blinks:

- When you turn the turn signal light on.

If any of the following occurs, there may a malfunction with the turn signal system. In this case, have your vehicle inspected by an authorized HYUNDAI dealer.

- The indicator light does not blink but illuminates.
- The indicator light blinks more rapidly.
- The indicator light does not illuminate at all.

Low Beam Indicator Light (if equipped)



This indicator light illuminates:

- When the headlights are on.

High Beam Indicator Light



This indicator light illuminates:

- When the headlights are on and in the high beam position.
- When the turn signal lever is pulled into the Flash-to-Pass position.

Smart High Beam indicator



This warning light illuminates :

- When the high-Beam is on with the light switch in the AUTO light position.
- If your vehicle detects oncoming or preceding vehicles, the Smart High Beam system will switch the high beam to low beam automatically.

For more details, refer to "Smart High Beam" in this chapter.

Light ON Indicator Light



This indicator light illuminates:

- When the tail lights or headlights are on.

Front Fog Indicator Light



This indicator light illuminates:

- When the front fog lights are on.

Cruise Indicator Light



This indicator light illuminates:

- When the cruise control system is enabled.

For more details, refer to "Cruise Control System" in chapter 5.

Cruise SET Indicator Light



This indicator light illuminates:

- When the cruise control speed is set.

For more details, refer to "Cruise Control System" in chapter 5.

AUTO HOLD Indicator Light (if equipped)



This indicator light illuminates:

- [White] When you activate the auto hold system by pressing the AUTO HOLD button.
- [Green] When you stop the vehicle completely by depressing the brake pedal with the auto hold system activated.
- [Yellow] When there is a malfunction with the auto hold system.

In this case, have your vehicle inspected by an authorized HYUNDAI dealer.

For more details, refer to "Auto Hold" in chapter 5.

SPORT/SNOW Mode Indicator Light

SPORT

SNOW

This indicator light illuminates:

- When you select "SPORT/SNOW" mode as drive mode.

For more details, refer to "Drive Mode Integrated Control System" in chapter 5.

ECO mode indicator Light

ECO

This indicator light illuminates :

- When you select "ECO" mode as drive mode.

For more details, refer to "LCD Display" in this chapter.

⚠ WARNING

Do not watch the ECO indicator light while driving. This will distract you and may cause an accident that results in severe personal injury.

LKAS (Lane Keeping Assistant System) indicator (if equipped)



The LKAS indicator will illuminate when you turn the lane keeping assistant system on by pressing the LKAS button.

If there is a problem with the system, the yellow LKAS indicator will illuminate.

For more details, refer to "Lane Keeping Assistant System (LKAS)" in chapter 5.

HEAD UP DISPLAY (HUD) (IF EQUIPPED)

Description

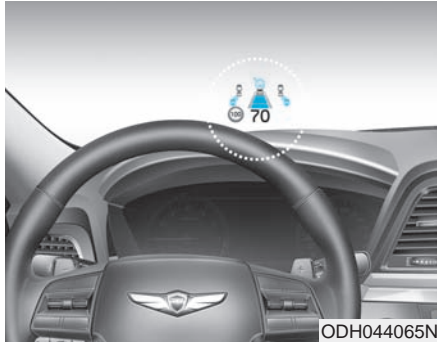

The head up display is a transparent display which projects a shadow of some information of the instrument cluster and navigation on the windshield glass.

- The head up display image on the windshield glass may be invisible when:
 - Sitting posture is bad.
 - Wearing a polarized sunglasses.
 - There is an object on the cover of the head up display.
 - Driving on a wet road.
 - An inadequate lighting is turned on inside the vehicle.
 - Any light comes from the outside.
 - Wearing glasses.
- If the head up display image is not shown well, adjust the height or illumination of the head up display in the LCD display.

For more details, refer to "LCD Display" in this chapter.

- When the head up display needs inspection or repair, have your vehicle inspected by an authorized HYUNDAI dealer.

WARNING

Head Up Display

- **Do not tint the front windshield glass or add other types of metallic coating. Otherwise, the head up display image may be invisible.**
- **Do not place any accessories on the crash pad or attach any objects on the windshield glass.**

CAUTION

When replacing the front windshield glass of the vehicles equipped with the head up display, replace it with a windshield glass designed for the head up display operation. Otherwise, duplicated images may be displayed on the windshield glass.

Head Up Display ON/OFF



To activate the head up display, select “Head-up Display” on the “User Settings Mode” in the cluster.

If you do not select “Head-up Display”, the head up display will be deactivated.

Head Up Display Information

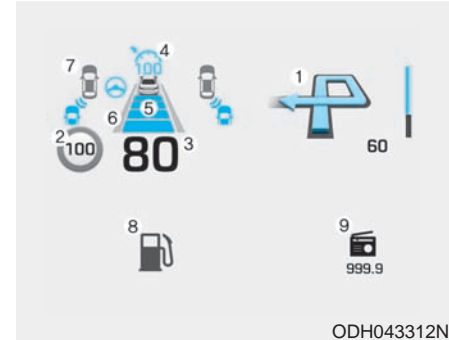

1. Turn By Turn (TBT) navigation information
2. Road signs
3. Speedometer
4. Cruise setting speed
5. Advanced Smart Cruise Control (ASCC) information (if equipped)
6. Lane Keeping Assist System (LKAS) information (if equipped)

- 7. Blind Spot Detection (BSD) system information (if equipped)
- 8. Warning lights (Low fuel)
- 9. Audio/Video information

On the "User settings Mode" of the LCD display, you can activate or deactivate the Turn By Turn (TBT) navigation, smart cruise control (scc), Lane Keeping Assist System(LKAS), and Blind Spot Detection (BSD) system information.

*** NOTICE**

If you select the Turn By Turn (TBT) navigation information as HUD contents, the Turn By Turn (TBT) navigation information will not be displayed on the LCD Display.

Head Up Display Setting

On the LCD display, you can change the head up display settings as follows.

1. Head up display ON/OFF
2. Display height
3. Rotation
4. Illumination
5. Contents setting
6. Speedometer number size
7. Speedometer number color

For more details, refer to "LCD Display" in this chapter.

LIGHT

Exterior lights

Lighting control

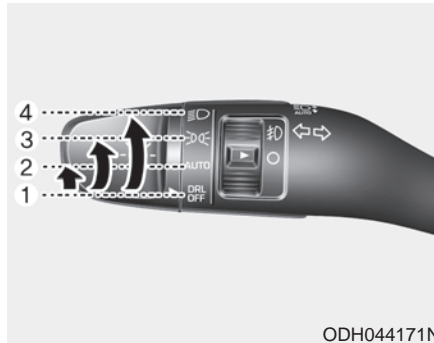

ODH044171N

To operate the lights, turn the knob at the end of the control lever to one of the following positions:

- (1) DRL OFF position
- (2) AUTO light position
- (3) Parking lamp position
- (4) Headlamp position

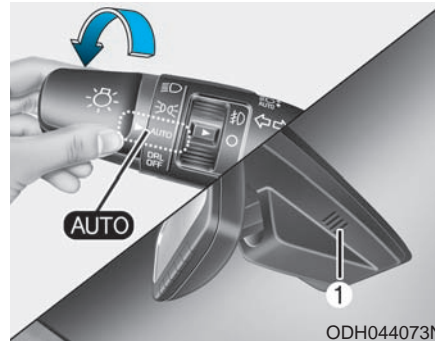

ODH044073N

AUTO light position

The parking lamp and headlamp will be turned ON or OFF automatically depending on the amount of light outside the vehicle.

Even with the AUTO light feature in operation, it is recommended to manually turn ON the lamps when driving at night or in a fog, or when you enter dark areas, such as tunnels and parking facilities.

CAUTION

- Do not cover or spill anything on the sensor (1) located on the instrument panel.
- Do not clean the sensor using a window cleaner, the cleanser may leave a light film which could interfere with sensor operation.
- If your vehicle has window tint or other types of metallic coating on the front windshield, the AUTO light system may not work properly.

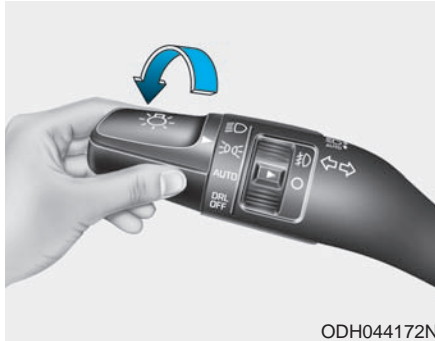

ODH044172N

Parking lamp position (⊘)

The parking lamp, license plate lamp and instrument panel lamp are turned ON.



ODH044173N

Headlamp position (⊘)

The headlamp, parking lamp, license plate lamp and instrument panel lamp are turned ON.

* NOTICE

The Engine Start/Stop button must be in the ON position to turn on the headlamp.

High beam operation

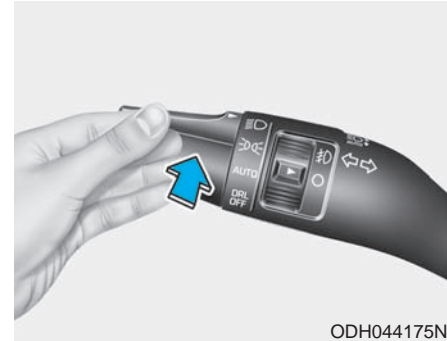

ODH044175N

To turn on the high beam headlamp, push the lever away from you. The lever will return to its original position.

The high beam indicator will light when the headlamp high beams are switched on.

To turn off the high beam headlamp, pull the lever towards you. The low beams will turn on.

⚠ WARNING

Do not use high beam when there are other vehicles approaching you. Using high beam could obstruct the other driver's vision.

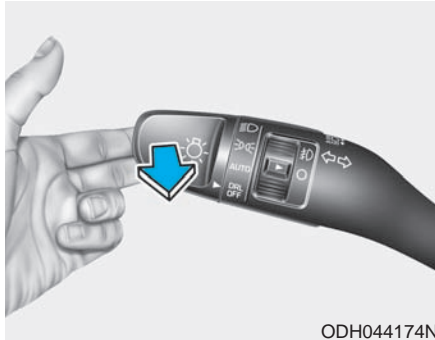

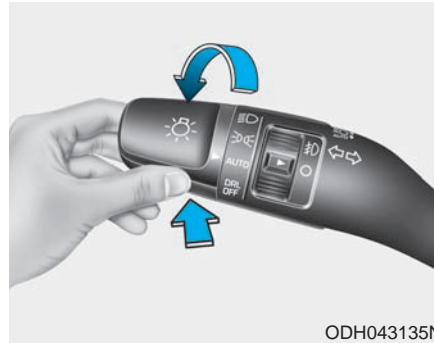

To flash the high beam headlamp, pull the lever towards you, then release the lever. The high beams will remain ON as long as you hold the lever towards you.

Smart High Beam (if equipped)



The Smart High Beam is a system that automatically adjusts the headlamp range (switches between high beam and low beam) according to the brightness of other vehicles and road conditions.

Operating condition

1. Place the light switch in the AUTO position.
2. Turn on the high beam by pushing the lever away from you.
The smart high beam () indicator will illuminate.
3. The Smart High Beam will turn on when vehicle speed is above 28 mph (45km/h).
 - If the lever is pushed away when the Smart High Beam is operating, the Smart High Beam will turn off and the high beam will be on continuously. The smart high beam () indicator will turn off.
 - If the lever is pulled towards you when the Smart High Beam is operating, the Smart High Beam will turn off.
4. If the light switch is placed to the headlamp position, the Smart High Beam will turn off and the low beam will be on continuously.

The high beam switches to low beam in the below conditions.

- When the Smart High Beam is off.
- When the light switch is not in the AUTO position.
- When the headlamp is detected from the on-coming vehicle.
- When the tail lamp is detected from the front vehicle.
- When the surrounding is bright enough high beams are not needed.
- When streetlights or other lights are detected.
- When vehicle speed is below 22 mph (35km/h).

 **CAUTION**

The system may not operate normally in the below conditions.

- **When the light from the on-coming or front vehicle is not detected because of lamp damage, hidden from sight, etc.**
- **When the lamp of the on-coming or front vehicle is covered with dust, snow or water.**
- **When the light from the on-coming or front vehicle is not detected because of exhaust fume, smoke, fog, snow, etc.**
- **When the front window is covered with foreign matters such as ice, dust, fog, or is damaged.**
- **When there is a similar shape lamp with the front vehicle's lamps.**
- **When it is hard to see because of fog, heavy rain or snow.**
- **When the headlamp is not repaired or replaced at an authorized dealer.**

(continued)

(continued)

- **When headlamp aiming is not properly adjusted.**
- **When driving on a narrow curved road or rough road.**
- **When driving downhill or uphill.**
- **When only part of the vehicle in front is visible on a cross-road or curved road.**
- **When there is a traffic light, reflecting sign, flashing sign or mirror.**
- **When the road conditions are bad such as being wet or covered with snow.**
- **When the front vehicle's headlamps are off but the fog lamps on.**
- **When a vehicle suddenly appears from a curve.**
- **When the vehicle is tilted from a flat tire or being towed.**
- **When the LKAS (Lane keeping Assist System) warning light illuminates. (if equipped)**

⚠ WARNING

- Do not place any accessories, stickers or tint the windshield.
- Have the windshield glass replaced from an authorized dealer.
- Do not remove or impact related parts of the Smart High Beam system.
- Be careful that water doesn't get into the Smart High Beam unit.
- Do not place objects on the dashboard that reflects light such as mirrors, white paper, etc. The system may malfunction if sunlight is reflected.
- At times, the Smart High Beam system may not work properly, always check the road conditions for your safety. When the system does not operate normally, manually change between the high beam and low beam.

Turn signals and lane change signals

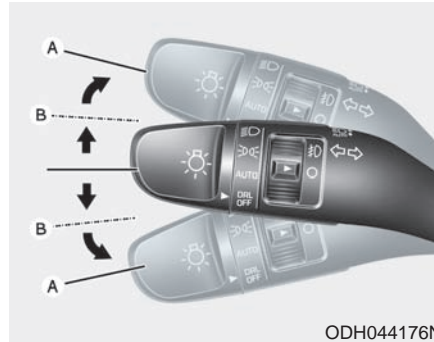

To signal a turn, push down on the lever for a left turn or up for a right turn in position (A). To signal a lane change, move the turn signal lever slightly and hold it in position (B). The lever will return to the OFF position when released or when the turn is completed.

If an indicator stays on and does not flash or if it flashes abnormally, one of the turn signal bulbs may be burned out and will require replacement.

Onetouch turn signal function (if equipped)

To activate an One Touch Turn Signal function, move the turn signal lever slightly and then release it. The lane change signals will blink 3, 5 or 7 times.

You can activate or deactivate the One Touch Turn Signal function or choose the number of blinking (3, 5, or 7) from the User Settings Mode (Light) on the LCD display.

For more details, refer to "LCD Display" in this chapter.

Front fog lamp (if equipped)



ODH043177N

Use the switch next to the headlamp switch to turn the Fog Lights ON and OFF. The fog lamps will turn on when the fog lamp switch (1) is turned to the ON position after the headlamps are turned on.

To turn off the fog lamps, turn the switch to the OFF position.

You can use the fog lamps only when the headlamps are on low beam. When the light switch is in the AUTO position, you can also use the fog lamps when the headlamps turn on automatically. The fog lamps will go OFF when the headlamps turn OFF.

* NOTICE

When in operation, the fog lamps consume large amounts of vehicle electrical power. Only use the fog lamps when visibility is poor.

Battery saver function

The purpose of this feature is to prevent the battery from being discharged. The system automatically turns off the parking lamp when the driver turns the engine off and opens the driver-side door.

With this feature, the parking lamps will turn off automatically if the driver parks on the side of road at night.

If necessary, to keep the lamps on when the engine is turned off, perform the following:

- 1) Open the driver-side door.
- 2) Turn the parking lamps OFF and ON again using the light switch on the steering column.

Headlamp delay function (if equipped)

If you place the Engine Start/Stop button in to the ACC or OFF position with the headlamps ON, the headlamps (and/or parking lamps) remain on for about 5 minutes. However, with the engine off if the driver's door is opened and closed, the headlamps (and/or parking lamps) are turned off after 15 seconds.

The headlamps (and/or parking lamps) can be turned off by pressing the lock button on the smart key twice or turning the light switch to the OFF or AUTO position. However, if you turn the light switch to the AUTO position when it is dark outside, the headlamps will not be turned off.

You can activate or deactivate the Headlamp Delay function from the User Settings Mode (Light) on the LCD display.

For more details, refer to "LCD Display" in this chapter.

*** NOTICE**

If the driver gets out of the vehicle through other doors (except driver's door), the battery saver function does not operate and the headlamp delay function does not turn off automatically. Therefore, It causes the battery to be discharged. In this case, make sure to turn off the lamp before getting out of the vehicle.

Daytime running light (DRL) (if equipped)

The Daytime Running Lights (DRL) can make it easier for others to see the front of your vehicle during the day, especially after dawn and before sunset.

for U.S.A

The DRL will turn off when:

1. The light switch is not in the AUTO position.
2. The parking brake is applied.
3. The engine is turned off.
4. The hazard warning flasher is on.
5. You turn the turn signal light on.
 - If you turn on the turn signal light, only the corresponding daytime running lights will turn off.

for Canada

The DRL will turn off when:

1. The light switch is in the headlamp position, including the operation that the headlamp is turned on automatically in the AUTO light position.
2. The parking brake is applied.
3. The engine is turned off.
4. The hazard warning flasher is on.
5. You turn the turn signal light on.
 - If you turn on the turn signal light, only the corresponding daytime running lights will turn off.
 - If you turn on turn signal light with the position light turned on, the daytime running lights will turn off but the position light remains on.

Headlamp leveling device (if equipped)

Automatically adjusts the headlamp beam level according to the number of passengers and loading weight in the luggage area.

If the Headlight Leveling Device is not working properly have your vehicle inspected by an authorized HYUNDAI dealer.

Headlamp washer (if equipped)

Washer fluid will be sprayed on the headlamps at the same time you operate the windshield washer when:

1. The Engine Start/Stop button is in the ON position.
2. The light switch is in the headlamp position (low beam).

*** NOTICE**

- Check the headlamp washers periodically to confirm that the washer fluid is being sprayed properly onto the headlamp lenses.
- The headlamp washer can be operated 15 minutes after the last operation.

Welcome system (if equipped)

Welcome light (if equipped)

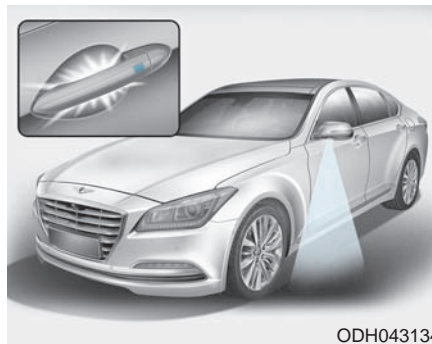

ODH043134

Puddle lamp

When all the doors (and trunk) are closed and locked, the puddle lamp will come on for about 15 seconds if any of the below is performed.

- When the door unlock button is pressed on the smart key.
- When the button of the outside door handle is pressed.
- When the vehicle is approached with the smart key in possession. (if equipped)

Also, if the outside rearview mirror folding switch is in the AUTO position, the outside rearview mirror will unfold automatically.

Door handle lamp (if equipped)

When all the doors (and trunk) are closed and locked, the door handle lamp will come on for about 15 seconds if any of the below is performed.

- When the door unlock button is pressed on the smart key.
- When the button of the outside door handle is pressed.
- When the vehicle is approached with the smart key in possession.

Headlamp and Parking lamp

When the headlamp (lamp switch in the headlamp or AUTO position) is on and all doors (and trunk) are locked and closed, the parking lamp and headlamp will come on for 15 seconds if/or any of the below is performed.

- When the door unlock button is pressed on the smart key.

At this time, if you press the door lock or unlock button on the smart key the parking lamp and headlamp will turn off immediately.

You can activate or deactivate the Welcome Light from the User Settings Mode (Light) on the LCD display.

For more details, refer to "LCD Display" in this chapter.

Interior lamp

When the interior lamp switch is in the DOOR position and all doors (and trunk) are closed and locked, the room lamp will come on for 30 seconds if any of the below is performed.

- When the door unlock button is pressed on the smart key.
- When the button of the outside door handle is pressed.

At this time, if you press the door lock or unlock button on the smart key the room lamp will turn off immediately.

Interior lights

CAUTION

Do not use the interior lights for extended periods when the engine is turned off or the battery will discharge.

WARNING

Do not use the interior lights when driving in the dark. The interior lights may obscure your view and cause an accident.

Interior lamp AUTO cut

The interior lamps will automatically go off approximately 20 minutes after the engine is turned off and the doors closed. If a door is opened, the lamp will go off 40 minutes after the engine is turned off. If the doors are locked by the smart key and the vehicle enters the armed stage of the theft alarm system, the lamps will go off five seconds later.

Front lamps

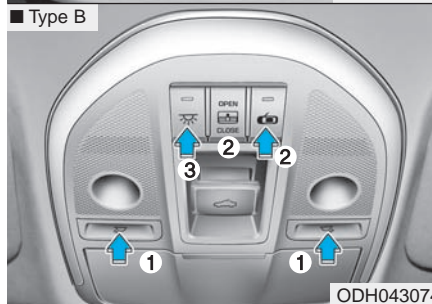
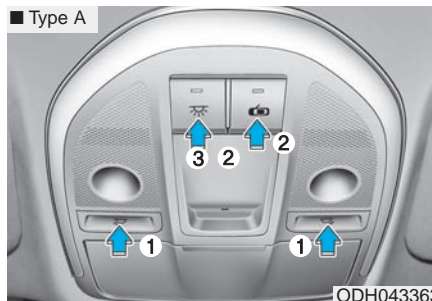

- (1) Front Map Lamp
- (2) Front Door Lamp
- (3) Front Room Lamp

Front Map Lamp (🔦 🗺️):

Press either of these buttons to turn the map lamp on or off. This light produces a spot beam for convenient use as a map lamp at night or as a personal lamp for the driver and the front passenger.

Front Door Lamp (🚪):

The front or rear room lamps come on when the front or rear doors are opened if the engine is running or not. When doors are unlocked by the Smart Key, the front and rear lamps come on for approximately 30 seconds as long as any door is not opened. The front and rear room lamps go out gradually after approximately 30 seconds if the door is closed. However, if the Engine Start/Stop button is in the ON position or all doors are locked, the front and rear lamps will turn off.

Convenient features of your vehicle

If a door is opened with the Engine Start/Stop button in the ACC position or the OFF position, the front and rear lamps stay on for about 20 minutes.

Front Room Lamp ():

Press this button to turn the front and rear room lamps on and off.

Rear lamps

■ Type A

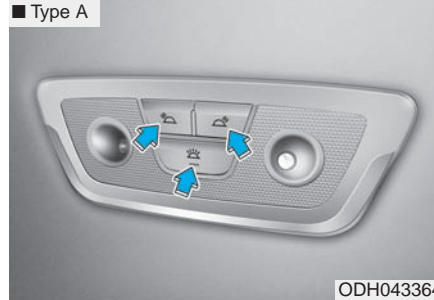

■ Type B



Rear Room Lamp ():

Press this button to turn the room lamp on and off.

Trunk room lamp (if equipped)

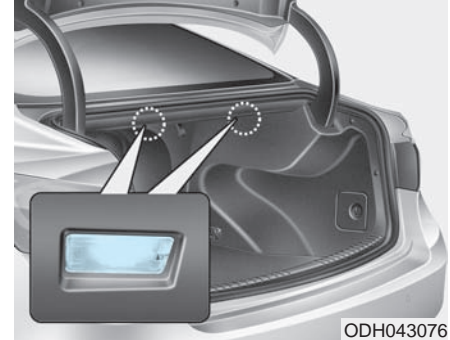

The trunk room lamp comes on when the trunk is opened.

CAUTION

The trunk lamp comes on as long as the trunk lid is open. To prevent unnecessary charging system drain, close the trunk lid securely after using the trunk.

Door courtesy lamp

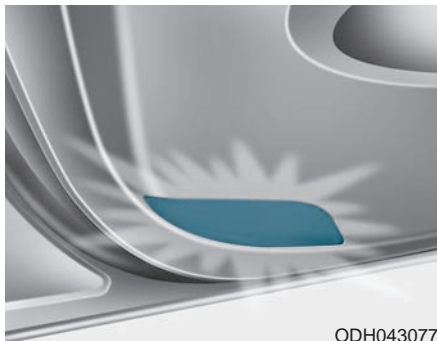

ODH043077

The door courtesy lamp comes ON when the door is opened to assist entering or exiting the vehicle. It also serves as a warning to passing vehicles that the vehicle door is open.

When the Engine Start/Stop button is in the OFF or ACC position, the door courtesy lamp turns off after 20 minutes.

Glove box lamp

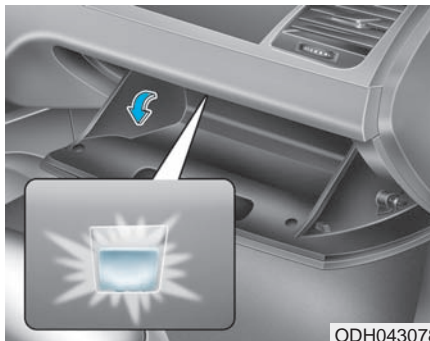

ODH043078

The glove box lamp comes on when the glove box is opened.

If the glove box is not closed, the lamp will turn off after 20 minutes.

CAUTION

To prevent unnecessary charging system drain, close the glove box securely after using the glove box.

Vanity mirror lamp

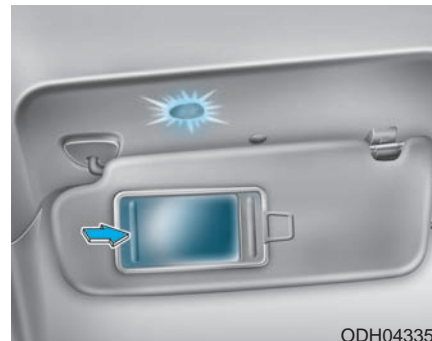

ODH043356

Opening the lid of the vanity mirror will automatically turn on the mirror light.

CAUTION

To prevent unnecessary charging system drain, close the vanity mirror cover after using the mirror.

Puddle lamp

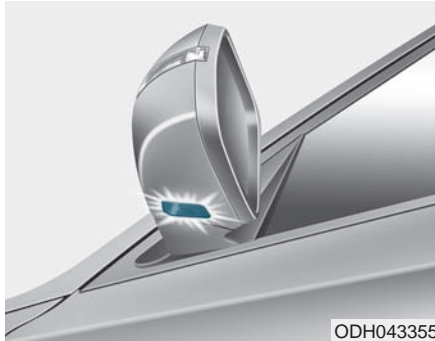

Welcome light

When all doors (and trunk) are closed and locked, the puddle lamp will come on for 15 seconds if the door is unlocked by the smart key or outside door handle button.

For more details, refer to "Welcome System" in this chapter.

Escort light

When the Engine Start/Stop button is in the OFF position and the driver's door is opened, the puddle lamp will come on for 30 seconds. If the driver's door is closed within the 30 seconds, the puddle lamp will turn off after 15 seconds. If the driver's door is closed and locked, the puddle lamp will turn off immediately.

The Puddle Lamp Escort Light will turn on only the first time the driver's door is opened after the engine is turned off.

WIPERS AND WASHERS

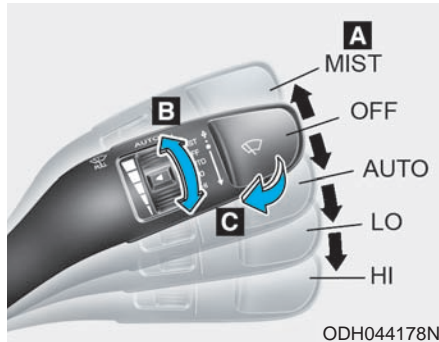

A : Wiper speed control

- MIST – Single wipe
- OFF – Off
- AUTO – Automatic control wipe
- LO – Low wiper speed
- HI – High wiper speed

B : Auto control wipe time adjustment

C : Wash with brief wipes

Windshield wipers

Operates as follows when the Engine Start/Stop button is in the ON position.

MIST : For a single wiping cycle, push the lever upward and release. The wipers will operate continuously if the lever is held in this position.

OFF : Wiper is not in operation.

AUTO : The rain sensor located on the upper end of the windshield glass senses the amount of rainfall and controls the wiping cycle for the proper interval. The more it rains, the faster the wiper operates. When the rain stops, the wiper stops. To vary the speed setting, turn the speed control knob (B).

LO : The wiper runs at a lower speed.

HI : The wiper runs at a higher speed.

* NOTICE

If there is heavy accumulation of snow or ice on the windshield, defrost the windshield for about 10 minutes, or until the snow and/or ice is removed before using the windshield wipers to ensure proper operation. If you do not remove the snow and/or ice before using the wiper and washer, it may damage the wiper and washer system.

AUTO (Automatic) control

The rain sensor located on the upper end of the windshield glass senses the amount of rainfall and controls the wiping cycle for the proper interval. The more it rains, the faster the wiper operates. When the rain stops, the wiper stops. To vary the speed setting, turn the speed control knob (B). If the wiper switch is set in AUTO mode when Engine Start/Stop button is in the ON position, the wiper will operate once to perform a self-check of the system. Set the wiper to OFF position when the wiper is not in use.

WARNING

To avoid personal injury from the windshield wipers, when the engine is running and the windshield wiper switch is placed in the AUTO mode:

- Do not touch the upper end of the windshield glass facing the rain sensor.
- Do not wipe the upper end of the windshield glass with a damp or wet cloth.
- Do not put pressure on the windshield glass.

CAUTION

- When washing the vehicle, set the wiper switch in the OFF position to stop the auto wiper operation. The wiper may operate and be damaged if the switch is set in the AUTO mode while washing the vehicle.
- Do not remove the sensor cover located on the upper end of the passenger side windshield glass. Damage to system parts could occur and may not be covered by your vehicle warranty.

Windshield washers



ODH044079N

In the OFF position, pull the lever gently toward you to spray washer fluid on the windshield and to run the wipers 1-3 cycles. The spray and wiper operation will continue until you release the lever. If the washer does not work, you may need to add washer fluid to the washer fluid reservoir.

If equipped with the Headlamp Washer, washer fluid will be sprayed on the headlamp at the same time you operate the windshield washer when:

1. The Engine Start/Stop button is in the ON position.
2. The light switch is in the headlamp position.

WARNING

When the outside temperature is below freezing, ALWAYS warm the windshield using the defroster to prevent the washer fluid from freezing on the windshield and obscuring your vision which could result in an accident and serious injury or death.

CAUTION

- To prevent possible damage to the washer pump, do not operate the washer when the fluid reservoir is empty.
- To prevent possible damage to the wipers or windshield, do not operate the wipers when the windshield is dry.
- To prevent damage to the wiper arms and other components, do not attempt to move the wipers manually.
- To prevent possible damage to the wipers and washer system, use anti-freezing washer fluids in the winter season or cold weather.

DRIVER ASSIST SYSTEM

Rear view camera

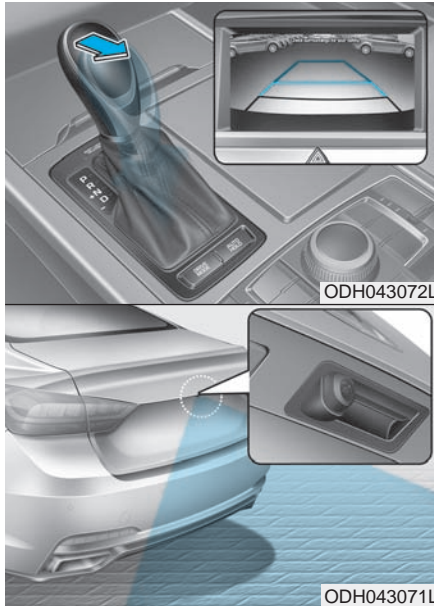

The Rear View Camera will activate when the engine is running and the shift lever is in the R (Reverse) position.

This is a supplemental system that shows behind the vehicle through the navigation display while backing-up.

⚠ WARNING

The Rear View Camera is not a safety device. It only serves to assist the driver in identifying objects directly behind the middle of the vehicle. The camera does NOT cover the complete area behind the vehicle.

⚠ WARNING

- Never rely solely on the Rear View Camera when backing-up.
- ALWAYS look around your vehicle to make sure there are no objects or obstacles before moving the vehicle in any direction to prevent a collision.
- Always pay close attention when the vehicle is driven close to objects, particularly pedestrians, and especially children.

*** NOTICE**

Always keep the camera lens clean. The camera may not work normally if the lens is covered with foreign matter.

Parking Guide System (if equipped)

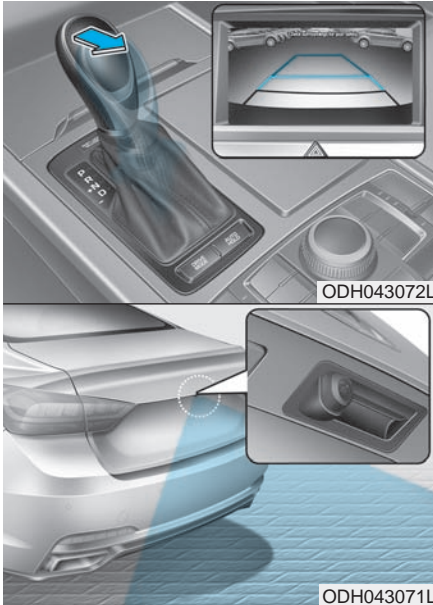

The Parking Guide System (PGS) will activate when the back-up light is ON with the Engine Start/Stop button ON and the shift lever in the R (Reverse) position.

The Parking Guide System is not a substitute for proper and safe parking procedures. The Parking Guide System may not detect every object surrounding the vehicle.

Always drive safely and use caution when parking.

WARNING

This is a supplementary system. It is the responsibility of the driver to always check the area around the vehicle when parking the vehicle.

Parking Guide System (PGS) display



1. Changing rear view angle
Changes the view angle of the rear camera. (Top View ↔ Normal View)
2. Parking guide line
According to the steering angle, the parking guide line is displayed to help parking.

Changing rear view angle

1. Top view



When Top View is selected, the rear view angle is displayed as if looking down from above.

2. Normal view

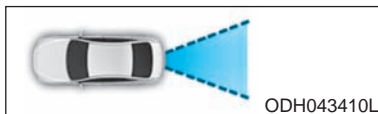

When Normal View is selected, the rear view angle is displayed in a customary view with a normal rear view perspective.

WARNING

- Never rely solely on the rear view display when backing-up.
- **ALWAYS** look around your vehicle to make sure there are no objects or obstacles before moving the vehicle in any direction to prevent a collision.
- Always pay close attention when the vehicle is driven close to objects, particularly pedestrians, and especially children.

* NOTICE

Always keep the camera lens clean. The camera may not work normally if the lens is covered with foreign matter.

Parking Assist System (if equipped)

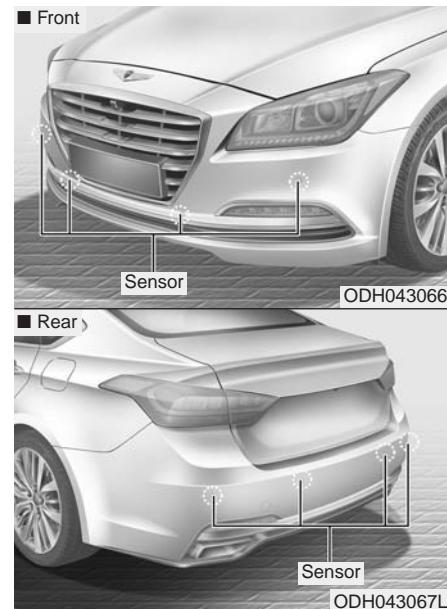

The Parking Assist System assists the driver during movement of the vehicle by chiming if any object is sensed within the distance of 39 inches (100 cm) in front and 47 inches (120 cm) behind the vehicle.

This system is a supplemental system that senses objects within the range and location of the sensors, it cannot detect objects in other areas where sensors are not installed.

WARNING

- **ALWAYS** look around your vehicle to make sure there are not any objects or obstacles before moving the vehicle in any direction to prevent a collision.
- Always pay close attention when the vehicle is driven close to objects, particularly pedestrians, and especially children.
- Be aware that some objects may not be visible on the screen or be detected by the sensors, due to the objects distance, size or material, all of which can limit the effectiveness of the sensor.

Operation of the Parking Assist System

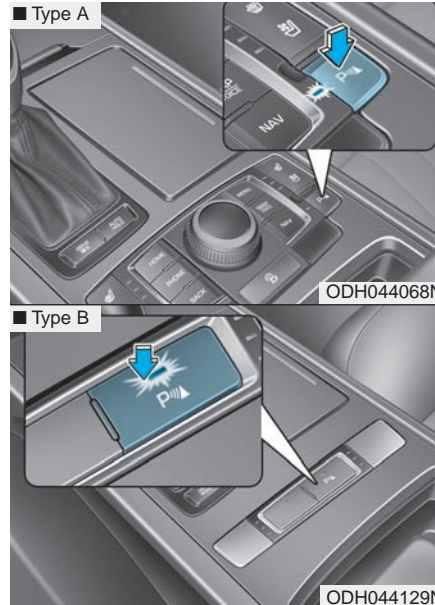

Operating condition

- When the Engine Start/Stop button is in the ON position
- When the shift lever is in D or R position
- When the vehicle speed is not over 6 mph (10 km/h)

Push the parking assist system button to the ON position to operate the parking assist system. The indicator in the button turns on.







To cancel the system, push the button again. The indicator in the button turns off.

- The system will operate automatically every time the vehicle speed is below 6 mph (10 km/h) with the system switched on.
- When you move the shift lever to R position with the system switched off, the indicator in the button will turn on and the system will operate automatically regardless of button status. However, if the vehicle speed exceeds 12 mph (20 km/h) when driving forward, the indicator in the button will turn off. The system will not automatically operate again even if vehicle speed returns to 6 mph (10 km/h).

To turn on the system, press the parking assist system button.

- When more than two objects are sensed at the same time, the closest one will be recognized first.

Types of warning sound and indicator

Distance from object		Warning indicator		Warning sound
		When driving forward	When driving rearward	
39 ~ 24 (100~61)	Front		-	Buzzer beeps intermittently
47 ~ 24 (120 ~ 61)	Rear	-		Buzzer beeps intermittently
24 ~ 12 (60 ~ 31)	Front			Buzzer beeps frequently
	Rear	-		Buzzer beeps frequently
12 (30)	Front			Buzzer sounds continuously
	Rear	-		Buzzer sounds continuously

inches (cm)

* NOTICE

- The indicator may differ from the illustration as objects or sensors status. If the indicator blinks, have your vehicle checked by an authorized HYUNDAI dealer.
- If the audible warning does not sound or if the buzzer sounds intermittently when shifting into R (Reverse) position, this may indicate a malfunction with the Parking Assist System. If this occurs, have your vehicle checked by an authorized HYUNDAI dealer as soon as possible.

Non-operational conditions of Parking Assist System

Parking Assist System may not operate normally when:

- Moisture is frozen to the sensor.
- Sensor is covered with foreign matter, such as snow or water, or the sensor cover is blocked.

There is a possibility of Parking Assist System malfunction when:

- Driving on uneven road surfaces such as unpaved roads, gravel, bumps, or gradient.
- Objects generating excessive noise such as vehicle horns, loud motorcycle engines, or truck air brakes can interfere with the sensor.
- Heavy rain or water spray is present.
- Wireless transmitters or mobile phones are present near the sensor.
- The sensor is covered with snow.
- Any non-factory equipment or accessories have been installed, or if the vehicle bumper height or sensor installation has been modified.

Detecting range may decrease when:

- Outside air temperature is extremely hot or cold.
- Undetectable objects smaller than 40 inches (1 m) and narrower than 6 inches (14 cm) in diameter.

The following objects may not be recognized by the sensor:

- Sharp or slim objects such as ropes, chains or small poles.
- Objects, which tend to absorb sensor frequency such as clothes, spongy material or snow.

*** NOTICE**

Sensor may not recognize objects less than 12 inches (30 cm) from the sensor, or it may sense an incorrect distance.

⚠ CAUTION

Do not push, scratch or strike the sensor with any hard objects that could damage the surface of the sensor. Sensor damage could occur.

⚠ WARNING

Your new vehicle warranty does not cover any accidents or damage to the vehicle or injuries to its occupants related to a Parking Assist System. Always drive safely and cautiously.

DEFROSTER

⚠ CAUTION

To prevent damage to the conductors bonded to the inside surface of the rear window, never use sharp instruments or window cleaners containing abrasives to clean the window.

If you want to defrost and defog the front windshield, refer to "Windshield Defrosting and Defogging" in this chapter.

Rear window defroster

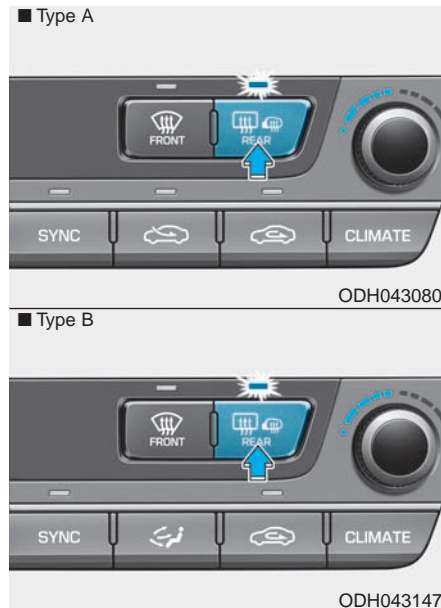

The defroster heats the window to remove frost, fog and thin ice from the interior and exterior of the rear window, while engine is running.

- To activate the rear window defroster, press the rear window defroster button located in the center facia switch panel. The indicator on the rear window defroster button illuminates when the defroster is ON.
- To turn off the defroster, press the rear window defroster button again.

* NOTICE

- If there is heavy accumulation of snow on the rear window, brush it off before operating the rear defroster.
- The rear window defroster automatically turns off after approximately 20 minutes or when the Engine Start/Stop button is in the OFF position.

Outside rearview mirror defroster

If your vehicle is equipped with the outside rearview mirror defrosters, they will operate at the same time you turn on the rear window defroster.

Front wiper deicer

If your vehicle is equipped with the wiper deicer, it will operate at the same time you turn on the rear window defroster.

AUTOMATIC CLIMATE CONTROL SYSTEM

■ Front • Type A



1. Driver's temperature control knob
2. Fan speed control button
3. OFF button

4. AUTO (automatic control) button
5. Mode selection button (Driver)
6. Air conditioning button

7. Front windshield defrost button

8. Rear window defrost button

9. Passenger's temperature control knob

10. SYNC button

11. Air intake control button (Outside air)

12. Air intake control button (Recirculated air)

13. Climate information screen selection button

14. Mode selection button (Passenger)

15. Air intake control button

16. Rear side temperature control thumbwheel

17. Rear vent ON/OFF thumbwheel

• Type B



■ Rear



ODH043081/ODH043146/ODH043082

Automatic heating and air conditioning



1. Press the AUTO button.

The modes, fan speeds, air intake and air-conditioning will be controlled automatically according to the temperature setting.



2. Turn the temperature control knob to set the desired temperature.

* NOTICE

- To turn the automatic operation off, select any button of the following:
 - Mode selection button
 - Front windshield defrost button (Press the button one more time to deselect the front windshield defroster function. The 'AUTO' sign will illuminate on the information display once again.)
 - Fan speed control buttonThe selected function will be controlled manually while other functions operate automatically.
- For your convenience, use the AUTO button and set the temperature to 73°F (23°C).

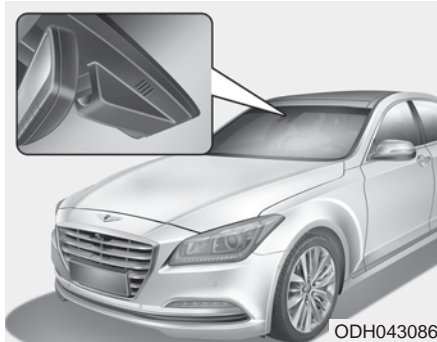

* NOTICE

Never place anything near the sensor to ensure better control of the heating and cooling system.

Manual heating and air conditioning

The heating and cooling system can be controlled manually by pushing buttons other than the AUTO button. In this case, the system works sequentially according to the order of buttons selected. When pressing any button except the AUTO button while using automatic operation, the functions not selected will be controlled automatically.

1. Start the engine.
2. Set the mode to the desired position.

For improving the effectiveness of heating and cooling;

- Heating:
- Cooling:

3. Set the temperature control to the desired position.
4. Set the air intake control to the outside (fresh) air position.
5. Set the fan speed control to the desired speed.
6. If air conditioning is desired, turn the air conditioning system on.

Press the AUTO button in order to convert to full automatic control of the system.

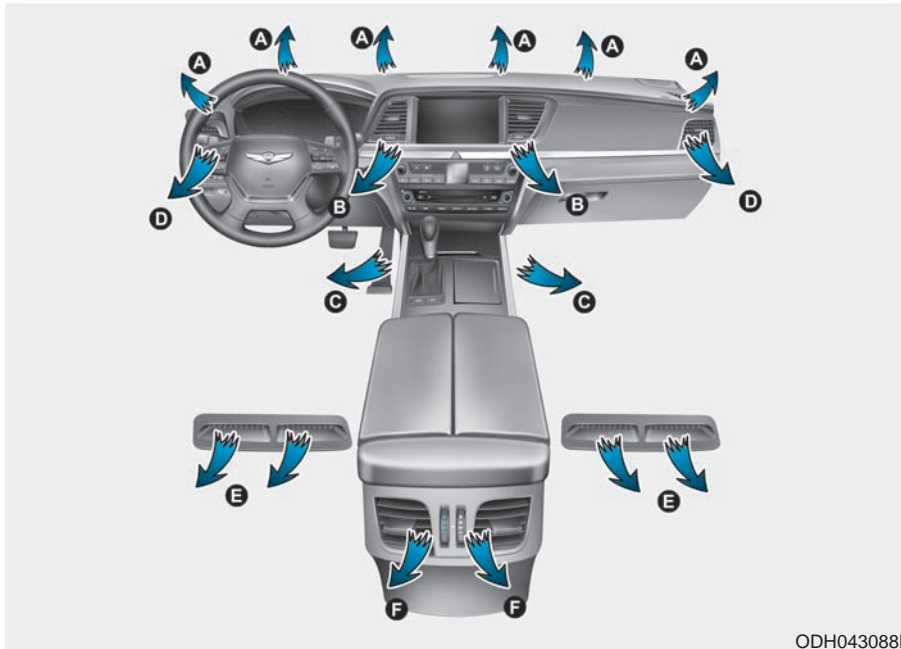

ODH043088L

Mode selection

■ Type A



ODH043087

■ Type B



ODH043148

The mode selection button controls the direction of the air flow through the ventilation system.

Convenient features of your vehicle

The air flow outlet port is converted as follows:



Air flow is directed toward the upper body and face. Additionally, each outlet can be controlled to direct the air discharged from the outlet.



Air flow is directed towards the face and the floor.



Most of the air flow is directed to the floor and the windshield with a small amount directed to the side window defrosters.



Most of the air flow is directed to the floor, with a small amount of the air being directed to the windshield and side window defrosters.

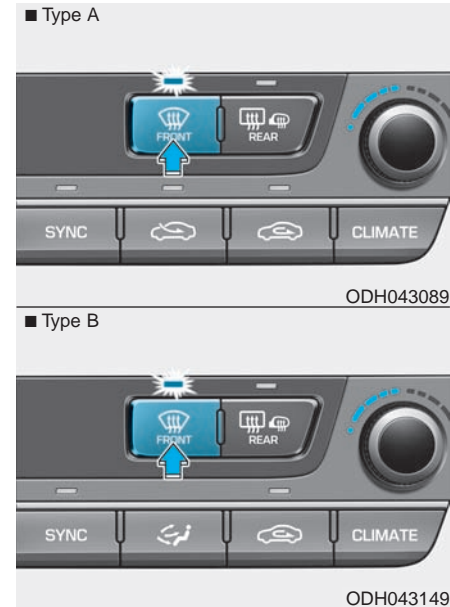

Defrost-Level (A)

Most of the air flow is directed to the windshield with a small amount of air directed to the side window defrosters.



Also, you can adjust the direction of air delivery from these vents using the vent control lever as shown.

Instrument panel vents

The outlet vents can be opened or closed separately using the thumb-wheel. To close the vent, rotate it left (Rear : down) to the maximum position. To open the vent, rotate it right (Rear : up) to the desired position.

Temperature control

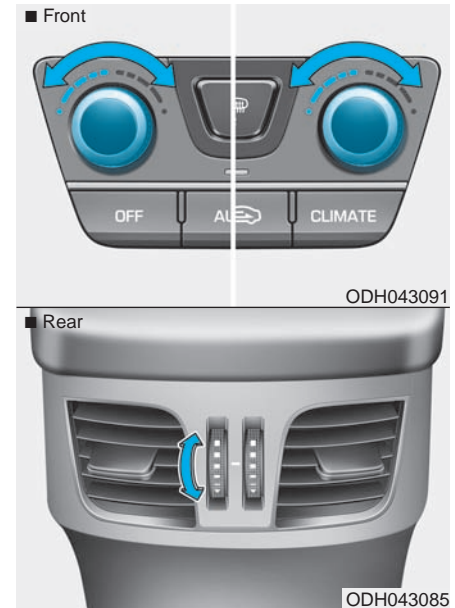

Turn the temperature control knob to set the desired temperature.

Rear temperature adjustment is independently controlled regardless of "SYNC" function.

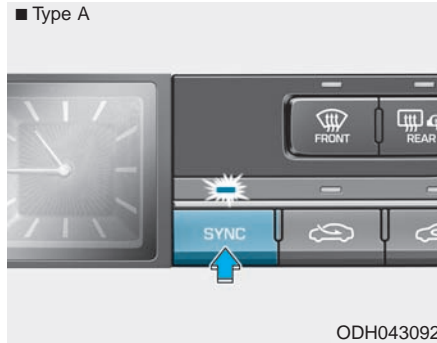

Adjusting the driver and passenger side temperature equally (Type A)

- Press the "SYNC" button to adjust the driver and passenger side temperature equally.

The passenger side temperature will be set to the same temperature as the driver side temperature.

- Turn the driver side temperature control knob. The driver and passenger side temperature will be adjusted equally.

Adjusting the driver and passenger side temperature individually (Type A)

- Press the "SYNC" button again to adjust the driver and passenger side temperature individually. The illumination of button turns off.
- Operate the driver side temperature control knob to adjust the driver side temperature.
- Operate the passenger side temperature control knob to adjust the passenger side temperature.

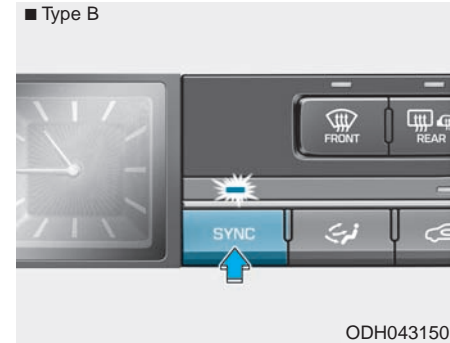

Adjusting temperature and mode of the driver & passenger side equally (Type B)

- Press the "SYNC" button to adjust the temperature and mode of the driver & passenger side equally.

The passenger side temperature and mode selection will be set to the same as the driver side.

- Turn the driver side temperature control knob. The driver and passenger side temperature will be adjusted equally.
- Press the driver side mode selection button. The driver and passenger mode will be adjusted equally.

Adjusting temperature and mode of the driver & passenger side individually (Type B)

- Press the "SYNC" button again to adjust the temperature and mode of the driver & passenger side individually. The illumination of button turns off.
- Operate the driver side temperature control knob to adjust the driver side temperature.
- Operate the driver side mode selection button to adjust the direction of the driver side air flow.
- Operate the passenger side temperature control knob to adjust the passenger side temperature.
- Operate the passenger side mode selection button to adjust the direction of the passenger side air flow.

Temperature conversion

If the battery has been discharged or disconnected, the temperature mode display will reset to Fahrenheit.

This is a normal condition. You can switch the temperature mode between Centigrade to Fahrenheit as follows;

- Automatic climate control system

While pressing the OFF button, depress the AUTO button for 3 seconds or more. The display will change from Centigrade to Fahrenheit, or from Fahrenheit to Centigrade.

- "User Setting mode" in the cluster :
You can change the temperature unit in the "Other features – Temperature unit".

Air intake control

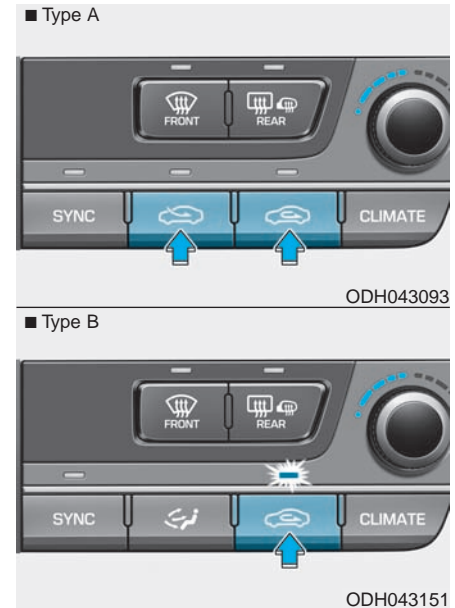

This is used to select the outside (fresh) air position or recirculated air position.

To change the air intake control position, push the control button.

Recirculated air position



With the recirculated air position selected, air from the passenger compartment will be drawn through the heating system and heated or cooled according to the function selected.

Outside (fresh) air position

■ Type A



With the outside (fresh) air position selected, air enters the vehicle from outside and is heated or cooled according to the function selected.

■ Type B



* NOTICE

Prolonged operation of the heater in the recirculated air position (without air conditioning selected) may cause fogging of the windshield and side windows and the air within the passenger compartment may become stale.

In addition, prolonged use of the air conditioning with the recirculated air position selected will result in excessively dry air in the passenger compartment.

⚠ WARNING

- Continued climate control system operation in the recirculated air position may allow humidity to increase inside the vehicle which may fog the glass and obscure visibility.
- Do not sleep in a vehicle with the air conditioning or heating system on. It may cause serious harm or death due to a drop in the oxygen level and/or body temperature.
- Continued climate control system operation in the recirculated air position can cause drowsiness or sleepiness, and loss of vehicle control. Set the air intake control to the outside (fresh) air position as much as possible while driving.

Fan speed control

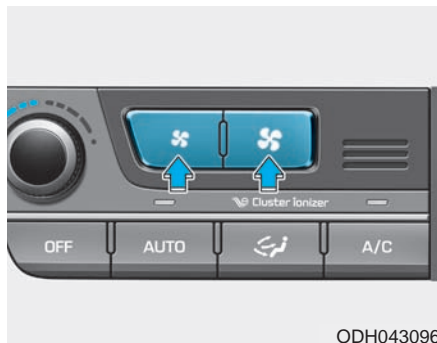

The fan speed can be set to the desired speed by pushing the fan speed control button.

The higher the fan speed is, the more air is delivered.

Pressing the OFF button turns off the fan.

* NOTICE

For better sound quality, fan speed may automatically slow down for a couple of minutes when you activate voice recognition or hands free.

Air conditioning



Push the A/C button to turn the air conditioning system on (indicator light will illuminate).

Push the button again to turn the air conditioning system off.

OFF mode



Push the OFF button of the front to turn off the air climate control system. However, you can still operate the mode and air intake buttons as long as the Engine Start/Stop button is in the ON position.

Climate information screen selection button

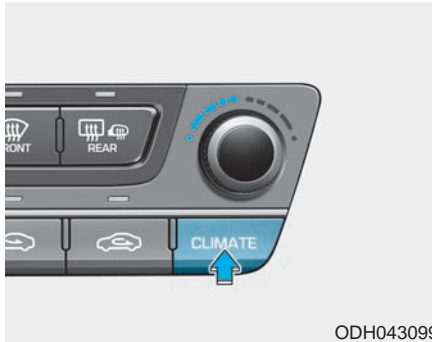

ODH043099



To change the screen into the climate information screen, press the climate information screen selection button.

System operation

Ventilation

1. Set the mode to the  position.
2. Set the air intake control to the outside (fresh) air position.
3. Set the temperature control to the desired position.
4. Set the fan speed control to the desired speed.

Heating

1. Set the mode to the  position.
 2. Set the air intake control to the outside (fresh) air position.
 3. Set the temperature control to the desired position.
 4. Set the fan speed control to the desired speed.
 5. If dehumidified heating is desired, turn the air conditioning system on.
- If the windshield fogs up, set the mode to the  or  press the front defrost button .

Operation Tips

- To keep dust or unpleasant fumes from entering the car through the ventilation system, temporarily set the air intake control to the recirculated air position. Be sure to return the control to the fresh air position when the irritation has passed to keep fresh air in the vehicle. This will help keep the driver alert and comfortable.
- Air for the heating/cooling system is drawn in through the grilles just ahead of the windshield. Care should be taken that these are not blocked by leaves, snow, ice or other obstructions.
- To prevent interior fog on the windshield, set the air intake control to the fresh air position and fan speed to the desired position, turn on the air conditioning system, and adjust the temperature control to desired temperature.

Air conditioning

1. Start the engine. Push the air conditioning button.
2. Set the mode to the  position.
3. Set the air intake control to the outside air or recirculated air position.
4. Adjust the fan speed control and temperature control to maintain maximum comfort.

*** NOTICE**

- **When using the air conditioning system, monitor the engine temperature gauge closely while driving up hills or in heavy traffic when outside temperatures are high. Air conditioning system operation may cause engine overheating. Continue to use the blower fan but turn the air conditioning system off if the engine temperature gauge indicates engine overheating.**
- **When opening the windows in humid weather air conditioning may create water droplets inside the vehicle. Since excessive water droplets may cause damage to electrical equipment, air conditioning should only be operated with the windows closed.**

Air conditioning system operation tips

- If the vehicle has been parked in direct sunlight during hot weather, open the windows for a short time to let the hot air inside the vehicle escape.
- To help reduce moisture inside of the windows on rainy or humid days, decrease the humidity inside the vehicle by operating the air conditioning system.
- During air conditioning system operation, you may occasionally notice a slight change in engine speed as the air conditioning compressor cycles. This is a normal system operation characteristic.
- Use the air conditioning system every month only for a few minutes to ensure maximum system performance.
- After sufficient cooling has been achieved, switch back from the recirculated air to the fresh outside air position.

- When using the air conditioning system, you may notice clear water dripping (or even puddling) on the ground under the passenger side of the vehicle. This is a normal system operation characteristic.
- Operating the air conditioning system in the recirculated air position provides maximum cooling, however, continual operation in this mode may cause the air inside the vehicle to become stale.
- During cooling operation, you may occasionally notice a misty air flow because of rapid cooling and humid air intake. This is a normal system operation characteristic.

Climate control air filter

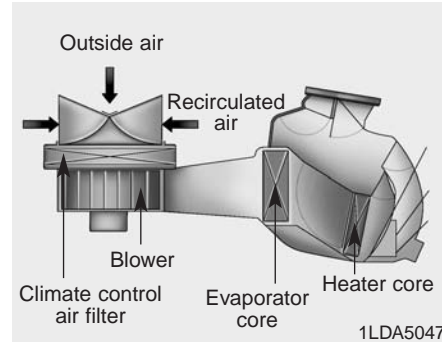

The climate control air filter installed behind the glove box filters the dust or other pollutants that come into the vehicle from the outside through the heating and air conditioning system. If dust or other pollutants accumulate in the filter over a period of time, the air flow from the air vents may decrease, resulting in moisture accumulation on the inside of the windshield even when the outside (fresh) air position is selected. If this happens, have the climate control air filter replaced by an authorized HYUNDAI dealer.

* NOTICE

- Replace the filter according to the maintenance schedule. If the car is being driven in severe conditions such as dusty or rough roads, more frequent air conditioner filter inspections and changes are required.
- When the air flow rate suddenly decreases, the system should be checked at an authorized HYUNDAI dealer.

Checking the amount of air conditioner refrigerant and compressor lubricant

When the amount of refrigerant is low, the performance of the air conditioning is reduced. Overfilling also has a negative impact on the air conditioning system.

Therefore, if abnormal operation is found, have the system inspected by an authorized HYUNDAI dealer.

* NOTICE

It is important that the correct type and amount of oil and refrigerant is used. Otherwise, damage to the compressor and abnormal system operation may occur.

WARNING

The air conditioning system should be serviced by an authorized HYUNDAI dealer. Improper service may cause serious injury to the person performing the service.

Air Conditioning refrigerant label

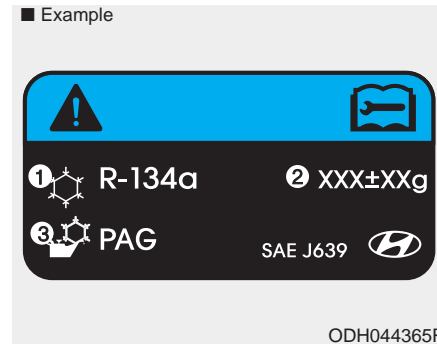

The actual Air Conditioning refrigerant label in the vehicle may differ from the illustration.

Each symbols and specification on air conditioning refrigerant label means as below ;



1. Classification of refrigerant
2. Amount of refrigerant
3. Classification of Compressor lubricant

Refer to chapter 8 for more detail location of air conditioning refrigerant label.

WINDSHIELD DEFROSTING AND DEFOGGING

⚠ WARNING

Windshield heating

Do not use the  or  position during cooling operation in extremely humid weather. The difference between the temperature of the outside air and that of the windshield could cause the outer surface of the windshield to fog up, causing loss of visibility could cause an accident resulting in serious injury or death. In this case, set the mode selection knob or button to the  position and fan speed control knob or button to a lower speed.

- For maximum defrosting, set the temperature control to the extreme right/hot position and the fan speed control to the highest speed.
- If warm air to the floor is desired while defrosting or defogging, set the mode to the floor-defrost position.
- Before driving, clear all snow and ice from the windshield, rear window, outside rear view mirrors, and all side windows.
- Clear all snow and ice from the hood and air inlet in the cowl grill to improve heater and defroster efficiency and to reduce the probability of fogging up the inside of the windshield.

* NOTICE

If the engine temperature is still cold after starting, then a brief engine warm up period may be required for the vented air flow to become warm or hot.

To defog inside windshield

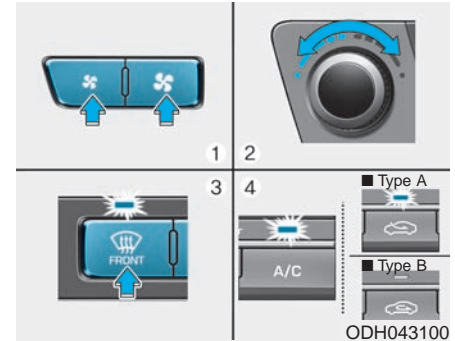



1. Select desired fan speed.
2. Select desired temperature.
3. Press the defrost button ().
4. The outside (fresh) air position will be selected automatically.

If the outside (fresh) air position is not selected automatically, adjust the corresponding button manually.

If the  position is selected, lower fan speed is adjusted to a higher fan speed.

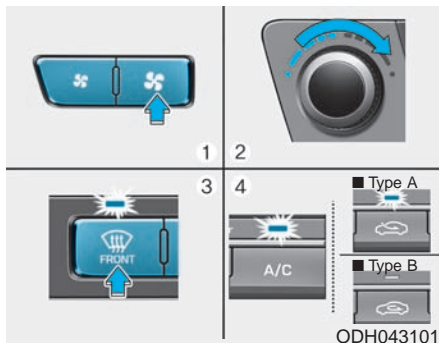
To defrost outside windshield



1. Set the fan speed to the highest (extreme right) position.
2. Set the temperature to the extreme hot (HI) position.
3. Press the defrost button ().
4. The outside (fresh) air position will be selected automatically.

If the  position is selected, lower fan speed is adjusted to a higher fan speed.

Auto defogging system

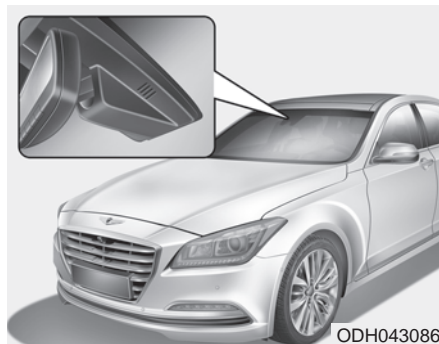

Auto defogging reduces the probability of fogging up the inside of the windshield by automatically sensing the moisture on the inside of the windshield.

The auto defogging system operates when the heater or air conditioning is on.

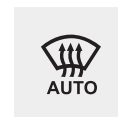

This indicator illuminates when the auto defogging system senses the moisture on the inside of the windshield and operates.

If more moisture is in the vehicle, the automated steps operate as follows:

- Step 1 : Operating the air conditioning
- Step 2 : Outside air position
- Step 3 : Blowing air toward the windshield
- Step 4 : Increasing air flow toward the windshield

Auto defogging system ON/OFF

■ Type A

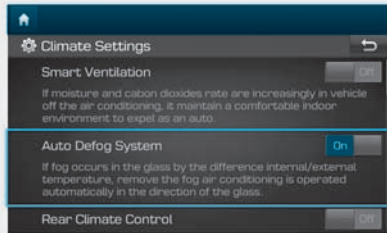

ODH043145L

■ Type B



ODH044141N

If your vehicle is equipped with the auto defogging system, it is automatically activated when the conditions are met.

However, if you would like to cancel the auto defogging system, turn off the Auto defogging function in the AVN climate monitor.

If the battery has been disconnected or discharged, it resets to the auto defogging status.

* NOTICE

When the air conditioning is turned on and the outside air position is selected by the auto defogging system, if you try to turn off the air conditioning and select the recirculated air position, the indicator will blink 3 times and the air conditioning will not be turned off and recirculated air position will not be selected.



CAUTION

Do not remove the sensor cover located on the upper end of the driver side windshield glass. Damage to system parts could occur and may not be covered by your vehicle warranty.

CLIMATE CONTROL ADDITIONAL FEATURES (IF EQUIPPED)

Cluster ionizer

When the Engine Start/Stop button is in the ON position, the clean air function turns on automatically.

Also, the clean air function turns off automatically, when the Engine Start/Stop button is in the OFF position.

Smart ventilation

When driving and the heater and air conditioning system is off, the smart ventilation system maintains pleasant indoor aerial environment by controlling the temperature, humidity and CO2 of interior.

“SMART VENTILATION ON” message is displayed on the AVN climate monitor for 5 seconds when the smart ventilation system operates.

Smart ventilation system ON/OFF

■ Type A

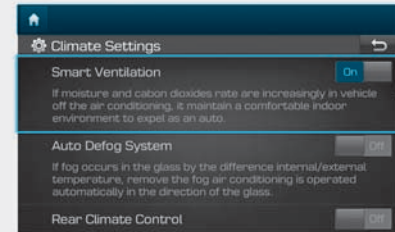

ODH043166L

■ Type B



ODH044167N

If you would like to cancel the smart ventilation system, turn off the Smart ventilation in the AVN climate monitor.

Rear climate system ON/OFF

■ Type A

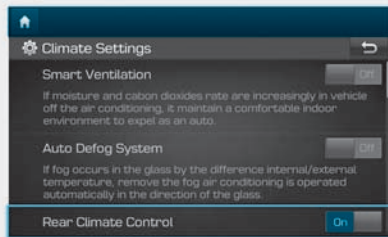

ODH043168L

■ Type B



ODH044169N

If you would like to cancel the rear climate system, turn off the rear climate in the AVN climate monitor.

CO2 control auto air conditioner (if equipped)

■ Type B



ODH044143N

When driving, the auto air conditioner controls CO2 concentration and maintains pleasant air in a vehicle.

When the system controls CO2, the symbol () displays in the AVN monitor.

You can turn on or off the CO2 control function as below.

1. Start the engine.
2. While pressing the driver mode selection button, press the air intake control button (Recirculated air) at least 4 times within 2 seconds.

STORAGE COMPARTMENT

WARNING

Never store cigarette lighters, propane cylinders, or other flammable/explosive materials in the vehicle. These items may catch fire and/or explode if the vehicle is exposed to hot temperatures for extended periods.

WARNING

ALWAYS keep the storage compartment covers closed securely while driving. Items inside your vehicle are moving as fast as the vehicle. If you have to stop or turn quickly, or if there is a crash, the items may fly out of the compartment and may cause an injury if they strike the driver or a passenger.

CAUTION

To avoid possible theft, do not leave valuables in the storage compartments.

Center console storage

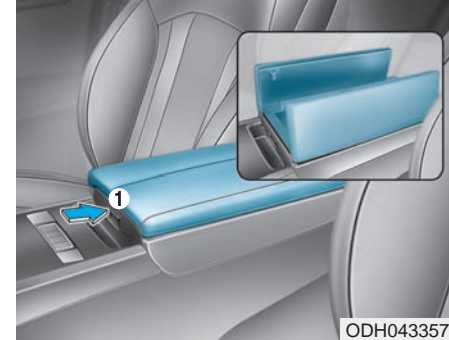

To open :
Press the button (1).

Glove box

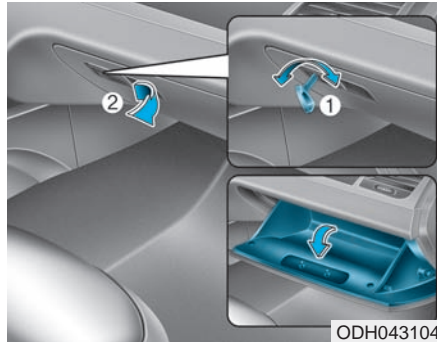

The glove box can be locked and unlocked with the mechanical key (1).

To open:
Pull the lever (2).

⚠ WARNING

ALWAYS close the glove box door after use.

An open glove box door can cause serious injury to the passenger in an accident, even if the passenger is wearing a seat belt.

Sunglass holder

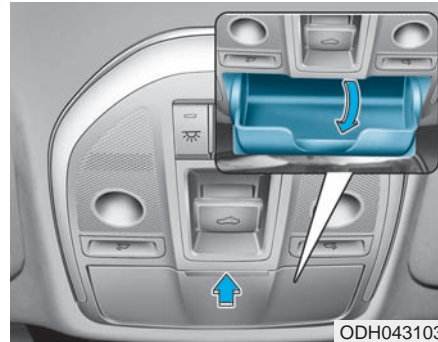

To open:

Press the cover and the holder will slowly open. Place your sunglasses in the compartment door with the lenses facing out.

To close:

Push back into position.

Make sure the sunglasses holder is closed while driving.

⚠ WARNING

- Do not keep objects except sunglasses inside the sunglasses holder. Such objects can be thrown from the holder in the event of a sudden stop or an accident, possibly injuring the passengers in the vehicle.
- Do not open the sunglasses holder while the vehicle is moving. The rear view mirror of the vehicle can be blocked by an open sunglasses holder.
- Do not put the glasses forcibly into a sunglasses holder. It may cause personal injury if you try to open it forcibly when the glasses are jammed in holder.

INTERIOR FEATURES

Cup holder

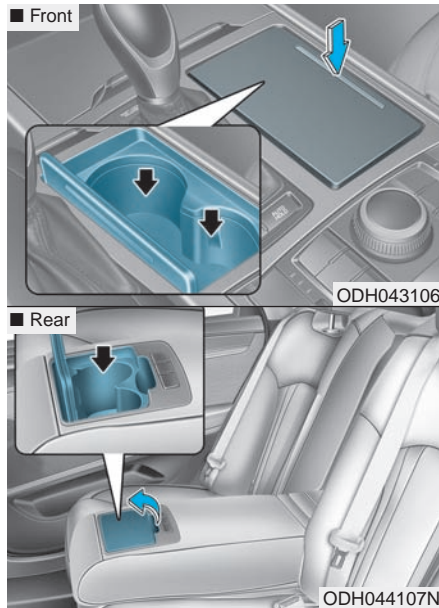

Front

To open the cover:
Press the cover and it will slowly open.

Rear

To open the cover:
Pull up the cover.

⚠ WARNING

- Avoid abrupt starting and braking when the cup holder is in use to prevent spilling your drink. If hot liquid spills, you could be burned. Such a burn to the driver could cause loss of vehicle control resulting in an accident.
- Do not place uncovered or unsecured cups, bottles, cans, etc., in the cup holder containing hot liquid while the vehicle is in motion. Injuries may result in the event of sudden stop or collision.
- Only use soft cups in the cup holders. Hard objects can injure you in an accident.

⚠ WARNING

Keep cans or bottles out of direct sun light and do not put them in a hot vehicle. It may explode.

⚠ CAUTION

- Keep your drinks sealed while driving to prevent spilling your drink. If liquid spills, it may get into the vehicle's electrical/electronic system and damage electrical/electronic parts.
- When cleaning spilled liquids, do not dry the cup holder at high temperature. This may damage the chrome part of the cup holder.

Sunvisor

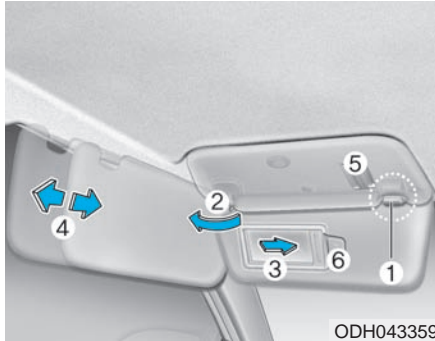

To use a sunvisor, pull it downward.
To use a sunvisor for a side window, pull it downward, unsnap it from the bracket (1) and swing it to the side (2).
To use the vanity mirror, pull down the sunvisor and slide the mirror cover (3).
Adjust the sunvisor forward or backward (4) as needed. Use the ticket holder (5 and 6) to hold tickets.

* NOTICE

Close the vanity mirror cover securely and return the sunvisor to its original position after use.

⚠ WARNING

For your safety, do not block your view when using the sunvisor.

⚠ CAUTION

- Do not put several tickets in the ticket holder at one time. This could cause damage to the ticket holder.
- Avoid putting a plastic card such as a credit card in the ticket holder located in the outside of the sunvisor. This could cause damage to the plastic card.

Power outlet (if equipped)

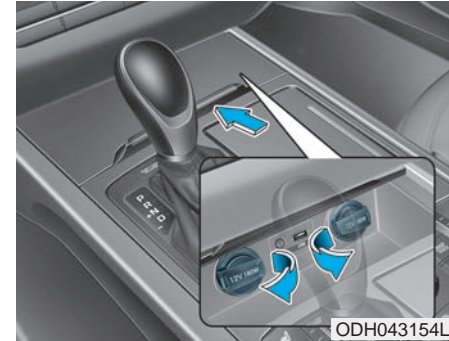

The power outlet is designed to provide power for mobile telephones or other devices designed to operate with vehicle electrical systems. The devices should draw less than 180 W(Watt) with the engine running.

To open the cover, press the cover and it will slowly open. To close the cover, press the cover and it will slowly close.

WARNING

Avoid electrical shocks. Do not place your fingers or foreign objects (pin, etc.) into a power outlet or touch the power outlet with a wet hand.

CAUTION

To prevent damage to the Power Outlets :

- Use the power outlet only when the engine is running and remove the accessory plug after use. Using the accessory plug for prolonged periods of time with the engine off could cause the battery to discharge.
- Only use 12V electric accessories which are less than 180 W(Watt) in electric capacity.
- Adjust the air-conditioner or heater to the lowest operating level when using the power outlet.
- Close the cover when not in use.

(Continued)

(Continued)

- Some electronic devices can cause electronic interference when plugged into a vehicle's power outlet. These devices may cause excessive audio static and malfunctions in other electronic systems or devices used in your vehicle.
- Push the plug in as far as it will go. If good contact is not made, the plug may overheat and the fuse may open.
- Plug in battery equipped electrical/electronic devices with reverse current protection. The current from the battery may flow into the vehicle's electrical/electronic system and cause system malfunction.

Clock



You can set the clock by using the AVN (Audio & Navigation).

For more details, please refer to the Multimedia System Manual or DIS Navigation System Manual that was supplied with your vehicle.

WARNING

Do not adjust the clock while driving. You may lose your steering control and cause an accident that results in severe personal injury or death.

Clothes hanger (if equipped)

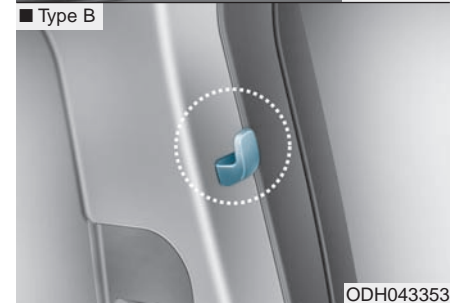
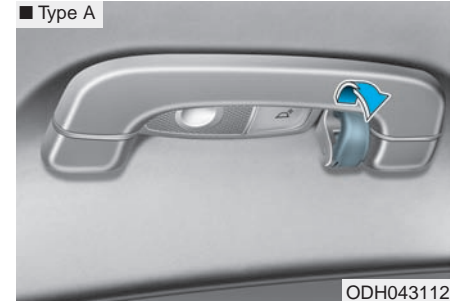

To hang items, pull the hanger down. (Type A)

These hangers are not designed to hold large or heavy items.

WARNING

Do not hang other objects except clothes. In an accident it may cause vehicle damage or personal injury.

Bag hanger (if equipped)

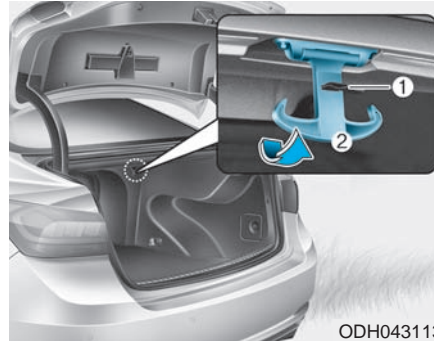

ODH043113

Pull the strap (1) to hang a bag on the hook (2). Fold the hook when not in use.

Floor mat anchor(s) (if equipped)

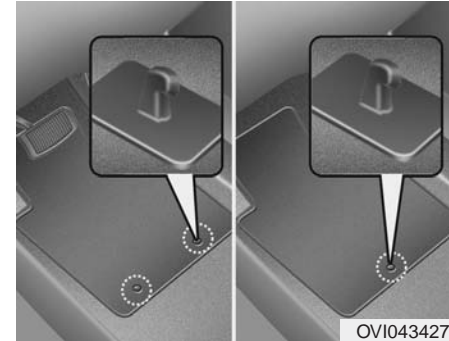

OVI043427

ALWAYS use the Floor Mat Anchors to attach the front floor mats to the vehicle. The anchors on the front floor carpet keep the floor mats from sliding forward.

⚠ WARNING

The following must be observed when installing ANY floor mat to the vehicle.

- Ensure that the floor mats are securely attached to the vehicle's floor mat anchor(s) before driving the vehicle.
- Do not use ANY floor mat that cannot be firmly attached to the vehicle's floor mat anchors.
- Do not stack floor mats on top of one another (e.g. all-weather rubber mat on top of a carpeted floor mat). Only a single floor mat should be installed in each position.

(Continued)

(Continued)

IMPORTANT - Your vehicle was manufactured with driver's side floor mat anchors that are designed to securely hold the floor mat in place. To avoid any interference with pedal operation, HYUNDAI recommends that the HYUNDAI floor mat designed for use in your vehicle be installed.

Rear curtain (if equipped)

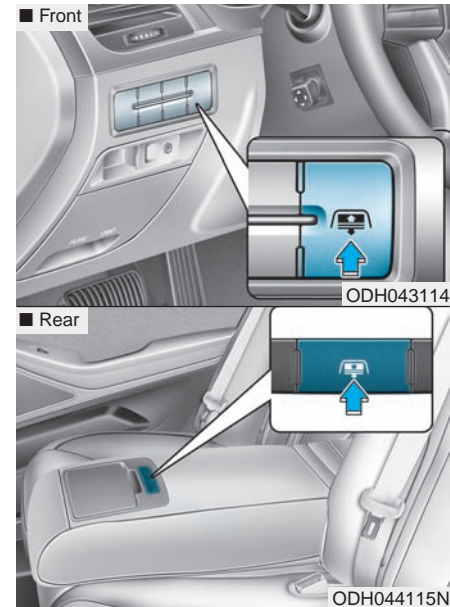

To raise and lower the rear curtain, press the button.



The rear curtain will be lowered automatically when you shift the shift lever into R (Reverse) and raised automatically when you shift the shift lever from R (Reverse) into P (Park). After the rear curtain is lowered by shifting into R (Reverse), if you drive more than 12 mph (20 km/h) with the shift lever in D (Drive), the rear curtain will be raised automatically.

CAUTION

Do not apply excessive force while operating the rear curtain. This could cause damage to the rear curtain.

Side curtain (if equipped)

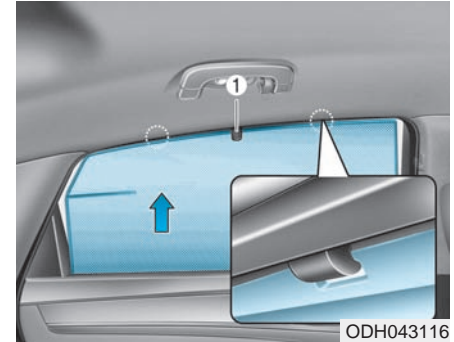

To use the side curtain:

1. Lift the curtain by the hook (1).
2. Hang the curtain on both sides of the hook.

CAUTION

- Always hang both sides of the curtain on the hook. This could cause damage to the side curtain if only one side of the curtain is hooked.
- Do not let any foreign material get in between the vehicle and side curtain. The side curtain may not be lifted up.

Luggage net holder



To keep items from shifting in the trunk, you can use the 4 holders located in the trunk to attach the luggage net.

Make sure the luggage net is securely attached to the holders in the trunk.

WARNING

Avoid eye injury. **DO NOT** overstretch the luggage net. **ALWAYS** keep your face and body out of the luggage net's recoil path. **DO NOT** use the luggage net when the strap has visible signs of wear or damage.

Multimedia System

- Multimedia system4-2
 - AUX, USB and iPod® port4-2
 - Antenna4-3
 - Steering wheel audio control4-4
 - Audio / Video / Navigation system (AVN)4-5
 - Bluetooth*® Wireless Technology hands-free.....4-5

MULTIMEDIA SYSTEM

Detailed information about the multimedia system (AV or AVN) is described in a separately supplied manual.

* NOTICE

- If you install an aftermarket HID head lamp, your vehicle's audio and electronic device may malfunction.
- Prevent chemicals such as perfume, cosmetic oil, sun cream, hand cleaner, and air freshener from contacting the interior parts because they may cause damage or discoloration.

AUX, USB and iPod® port

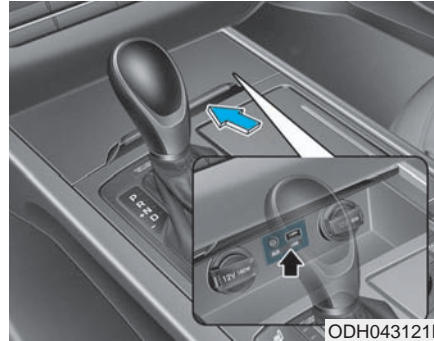

You can use an AUX port to connect audio devices and an USB port to plug in an USB and also in an iPod® port.

* NOTICE

When using a portable audio device connected to the power outlet, noise may occur during playback. If this happens, use the power source of the portable audio device.

* iPod® is a trademark of Apple Inc.

Antenna

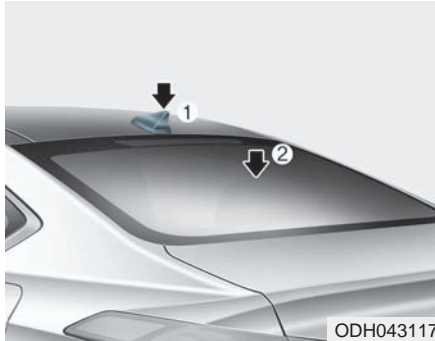

Shark fin antenna (1)

The shark fin antenna will receive the transmit data.

Glass antenna (2)

Your vehicle uses a glass antenna to receive both AM and FM signals.

⚠ CAUTION

- Do not clean the inside of the rear window glass with a cleaner or scraper to remove foreign deposits as this may cause damage to the antenna elements.
- Avoid adding metallic coatings such as Ni, Cd, and so on. These can degrade the receiving AM and FM broadcast signals.

Steering wheel audio control

■ Type A

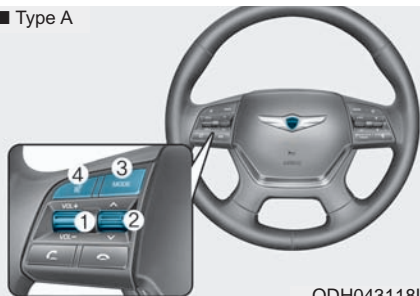

■ Type B

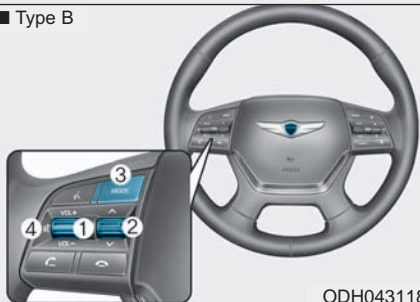

CAUTION

Do not operate audio remote control buttons simultaneously.

VOLUME (VOL + / -) (1)

- Move the VOLUME lever up to increase volume.
- Move the VOLUME lever down to decrease volume.

SEEK/PRESET (^ / v) (2)

If the SEEK/PRESET lever is moved up or down and held for 0.8 second or more, it will function in the following modes;

RADIO mode

It will function as the AUTO SEEK select button. It will SEEK until you release the button.

MEDIA mode

It will function as the FF/REW button.

If the SEEK/PRESET lever is moved up or down, it will function in the following modes;

RADIO mode

It will function as the PRESET STATION UP/DOWN button.

MEDIA mode

It will function as the TRACK UP/DOWN button.

MODE (3)

Press the MODE button to select Radio, XM, Disc, or AUX.

MUTE () (4)

- Press the MUTE button to mute the sound.
- Press the MUTE button again to activate the sound.

*** NOTICE**

Detailed information is described in a separately supplied manual.

Audio / Video / Navigation system (AVN)

■ Type A (AVN, Monitor)



■ Type B



Detailed information for the AVN system is described in a separately supplied manual.

Bluetooth® Wireless Technology hands-free

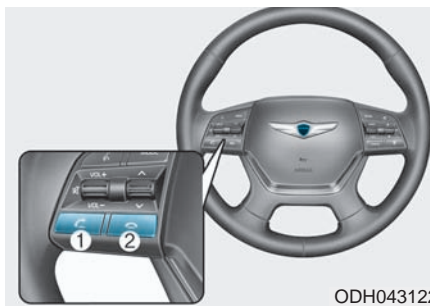

You can use the phone wirelessly by using the *Bluetooth®* Wireless Technology.

- (1) Call / Answer button
- (2) Call end button
- (3) Microphone

Detailed information for the *Bluetooth®* Wireless Technology hands-free is described in the manual supplied separately.

Driving your vehicle

Before driving	5-4	Autonomous Emergency Braking (AEB)	5-45
Before entering the vehicle	5-4	AEB operation.....	5-46
Before starting.....	5-4	To cancel the AEB	5-47
Engine Start/Stop button.....	5-6	Warning light and message	5-48
Automatic transmission	5-11	Cruise control	5-50
Automatic transmission operation	5-11	Cruise control operation.....	5-50
Parking.....	5-17	Advanced smart cruise control system	5-54
Good driving practices.....	5-17	To convert to cruise control mode.....	5-55
All Wheel Drive (AWD)	5-19	Smart cruise control speed	5-55
Using All Wheel Drive (AWD)	5-19	Cancelled automatically.....	5-58
Emergency precautions.....	5-21	Smart cruise control vehicle-to-vehicle distance.....	5-60
Braking system	5-23	Sensor to detect distance to the vehicle ahead.....	5-62
Power brakes	5-23	Limitations of the system	5-64
Disc brakes wear indicator	5-24	Lane Keeping Assist System (LKAS)	5-69
Foot parking brake	5-24	LKAS operation.....	5-70
Electric parking brake (EPB).....	5-26	LKAS malfunction.....	5-75
AUTO HOLD	5-31	LKAS function change	5-76
Anti-lock Brake System (ABS)	5-35	Blind Spot Detection System (BSD)	5-78
Electronic Stability Control (ESC).....	5-38	BSD (Blind Spot Detection) /	
Hill-Start Assist Control (HAC)	5-41	LCA (Lane Change Assist).....	5-79
Good braking practices.....	5-41	RCTA (Rear Cross Traffic Alert)	5-82
Drive mode integrated control system	5-42		
Electronic Control Suspension (ECS)	5-44		
ECS malfunction indicator.....	5-44		

Special driving conditions	5-86
Hazardous driving conditions.....	5-86
Rocking the vehicle.....	5-86
Smooth cornering.....	5-87
Driving at night.....	5-87
Driving in the rain.....	5-88
Driving in flooded areas.....	5-88
Winter driving	5-89
Snow or icy conditions.....	5-89
Winter precaution.....	5-91
Vehicle load limit	5-93
Tire loading information label.....	5-94
Trailer towing	5-98

WARNING

Carbon monoxide (CO) gas is toxic. Breathing CO can cause unconsciousness and death.

Engine exhaust contains carbon monoxide which cannot be seen or smelled.

Do not inhale engine exhaust.

If at any time you smell engine exhaust inside the vehicle, open the windows immediately. Exposure to CO can cause unconsciousness and death by asphyxiation.

Be sure the exhaust system does not leak.

The exhaust system should be checked whenever the vehicle is raised to change the oil or for any other purpose. If you hear a change in the sound of the exhaust or if you drive over something that strikes the underneath side of the vehicle, have the exhaust system checked as soon as possible by an authorized HYUNDAI dealer.

Do not run the engine in an enclosed area.

Letting the engine idle in your garage, even with the garage door open, is a hazardous practice. Run the engine only long enough to start the engine and to move the vehicle out of the garage.

Avoid idling the engine for prolonged periods with people inside the vehicle.

If it is necessary to idle the engine for a prolonged period with people inside the vehicle, be sure to do so only in an open area with the air intake set at "Fresh" and fan control set to high so fresh air is drawn into the interior.

Keep the air intakes clear.

To assure proper operation of the ventilation system, keep the ventilation air intakes located in front of the windshield clear of snow, ice, leaves, or other obstructions.

If you must drive with the trunk open:

Close all windows.

Open instrument panel air vents.

Set the air intake control at "Fresh", the air flow control at "Floor" or "Face", and the fan control set to high.

⚠ WARNING

**CALIFORNIA PROPOSITION 65
WARNING**

Engine exhaust and a wide variety of automobile components including components found in the interior furnishings in a vehicle, contain or emit harmful chemicals known to the State of California to cause cancer and birth defects and reproductive harm. In addition, certain fluids contained in vehicles and certain products of components contain or emit chemicals known to the State of California to cause cancer and birth defects or other reproductive harm.

BEFORE DRIVING

Before entering the vehicle

- Be sure all windows, outside mirror(s), and outside lights are clean and unobstructed.
- Remove frost, snow, or ice.
- Visually check the tires for uneven wear and damage.
- Check under the vehicle for any sign of leaks.
- Be sure there are no obstacles behind you if you intend to back up.

Before starting

- Make sure the hood, the trunk, and the doors are securely closed and locked.
- Adjust the position of the seat and steering wheel.
- Adjust the inside and outside rearview mirrors.
- Verify all the lights work.
- Fasten your seatbelt. Check that all passengers have fastened their seatbelts.
- Check the gauges and indicators in the instrument panel and the messages on the instrument display when the Engine Start/Stop button is in the ON position.
- Check that any items you are carrying are stored properly or fastened down securely.

WARNING

To reduce the risk of **SERIOUS INJURY** or **DEATH**, take the following precautions:

- **ALWAYS** wear your seat belt. All passengers must be properly belted whenever the vehicle is moving. For more information, refer to “Seat Belts” in chapter 2.
- Always drive defensively. Assume other drivers or pedestrians may be careless and make mistakes.
- Stay focused on the task of driving. Driver distraction can cause accidents.
- Leave plenty of space between you and the vehicle in front of you.

WARNING

NEVER drink or take drugs and drive.

Drinking or taking drugs and driving is dangerous and may result in an accident and **SERIOUS INJURY** or **DEATH**.

Drunk driving is the number one contributor to the highway death toll each year. Even a small amount of alcohol will affect your reflexes, perceptions and judgment. Just one drink can reduce your ability to respond to changing conditions and emergencies and your reaction time gets worse with each additional drink.

Driving while under the influence of drugs is as dangerous or more dangerous than driving under the influence of alcohol.

(Continued)

(Continued)

You are much more likely to have a serious accident if you drink or take drugs and drive. If you are drinking or taking drugs, don't drive. Do not ride with a driver who has been drinking or taking drugs. Choose a designated driver or call a taxi.

Engine Start/Stop button



Whenever the front door is opened, the Engine Start/Stop button will illuminate and will go off 30 seconds after the door is closed.

⚠ WARNING

To reduce risk of serious injury or death, **NEVER** allow children or any person who is unfamiliar with the vehicle to touch the Engine Start/Stop button or related parts. Unexpected and sudden vehicle movement can occur.

⚠ WARNING

To turn the engine off in an emergency:

Press and hold the Engine Start/Stop button for more than two seconds **OR** Rapidly press and release the Engine Start/Stop button three times (within three seconds).

If the vehicle is still moving, you can restart the engine without depressing the brake pedal by pressing the Engine Start/Stop button with the shift lever in the **N (Neutral)** position.

⚠ WARNING

- **NEVER** press the Engine Start/Stop button while the vehicle is in motion except in an emergency. This will result in the engine turning off and loss of power assist for the steering and brake systems.



(Continued)



(Continued)

This may lead to loss of directional control and braking function, which could cause an accident.

- Before leaving the driver's seat, always make sure the shift lever is in the P (Park) position, set the parking brake, press the Engine Start/Stop button to the OFF position, and take the Smart Key with you. Unexpected vehicle movement may occur if these precautions are not followed.
- **NEVER** reach through the steering wheel for the Engine Start/Stop button or any other control while the vehicle is in motion. The presence of your hand or arm in this area may cause a loss of vehicle control resulting in an accident.

Engine Stop/Start button positions

Button Position	Action	Notice
<p data-bbox="244 298 310 322">OFF</p>  <p>The image shows a circular button with 'OFF', 'ACC', and 'ON' markings around the perimeter. The center of the button is labeled 'ENGINE START STOP'. The 'OFF' position is highlighted in white.</p>	<p data-bbox="417 304 941 479">To turn off the engine, press the Engine Start/Stop button with shift lever in P (Park). When you press the Engine Start/Stop button without the shift lever in P (Park), the Engine Start/Stop button does not turn to the OFF position, but turns to the ACC position.</p>	
<p data-bbox="244 608 310 632">ACC</p>  <p>The image shows the same circular button as above, but the 'ACC' position is highlighted in blue.</p>	<p data-bbox="417 611 941 726">Press the Engine Start/Stop button when the button is in the OFF position without depressing the brake pedal. Electrical accessories are usable.</p>	<p data-bbox="958 611 1506 719">If you leave the Engine Start/Stop button in the ACC position for more than one hour, the battery power will turn off automatically to prevent the battery from discharging.</p>

Button Position	Action	Notice
<p style="text-align: center;">ON</p> 	<p>Press the Engine Start/Stop button while it is in the ACC position without depressing the brake pedal.</p> <p>The warning lights can be checked before the engine is started.</p>	<p>Do not leave the Engine Start/Stop button in the ON position when the engine is not running to prevent the battery from discharging.</p>
<p style="text-align: center;">START</p> 	<p>To start the engine, depress the brake pedal and press the Engine Start/Stop button with the shift lever in the P (Park) or in the N (Neutral) position.</p> <p>For your safety, start the engine with the shift lever in the P (Park) position.</p>	<p>If you press the Engine Start/Stop button without depressing the brake pedal, the engine does not start and the Engine Start/Stop button changes as follows:</p> <p>OFF → ACC → ON → OFF</p> <p>However, the engine may start if you depress the brake pedal within 0.5 second after pressing the Engine Start/Stop button when it is in the OFF position.</p>

Starting the engine

WARNING

- Always wear appropriate shoes when operating your vehicle. Unsuitable shoes, such as high heels, ski boots, sandals, flip-flops, etc., may interfere with your ability to use the brake and accelerator pedals.
- Do not start the vehicle with the accelerator pedal depressed. The vehicle can move and lead to an accident.
- Wait until the engine rpm is normal. The vehicle may suddenly move if the brake pedal is released when the rpm is high.

* NOTICE

- The engine will start by pressing the Engine Start/Stop button, only when the smart key is in the vehicle.
- Even if the smart key is in the vehicle, if it is far away from the driver, the engine may not start.
- When the Engine Start/Stop button is in the ACC or ON position, if any door is open, the system checks for the smart key. If the smart key is not in the vehicle, the warning, "Key not in vehicle" will come on and if all doors are closed, the chime will also sound for about 5 seconds. The indicator will turn off while the vehicle is moving. Keep the smart key in the vehicle when using the ACC position or if the vehicle engine is ON.

1. Always carry the smart key with you.
2. Make sure the parking brake is applied.
3. Make sure the shift lever is in P (Park).
4. Depress the brake pedal.
5. Press the Engine Start/Stop button.
6. Do not wait for the engine to warm up while the vehicle remains stationary. Start driving at moderate engine speeds. (Steep accelerating and decelerating should be avoided.)

* NOTICE

Always start the vehicle with your foot on the brake pedal. Do not depress the accelerator while starting the vehicle. Do not race the engine while warming it up.

⚠ CAUTION

To prevent damage to the vehicle:

- If the engine stalls while you are in motion, do not attempt to move the shift lever to the P (Park) position.

If traffic and road conditions permit, you may put the shift lever in the N (Neutral) position while the vehicle is still moving and press the Engine Start/Stop button in an attempt to restart the engine.

- Do not push or tow your vehicle to start the engine.

⚠ CAUTION

To prevent damage to the vehicle:

Do not press the Engine Start/Stop button for more than 10 seconds except when the stop lamp fuse is blown.

When the stop lamp fuse is blown, you can't start the engine normally. Replace the fuse with a new one. If you are not able to replace the fuse, you can start the engine by pressing and holding the Engine Start/Stop button for 10 seconds with the Engine Start/Stop button in the ACC position.

For your safety always depress the brake pedal before starting the engine.





*** NOTICE**

If the smart key battery is weak or the smart key does not work correctly, you can start the engine by pressing the Engine Start/Stop button with the smart key in the direction of the picture above.

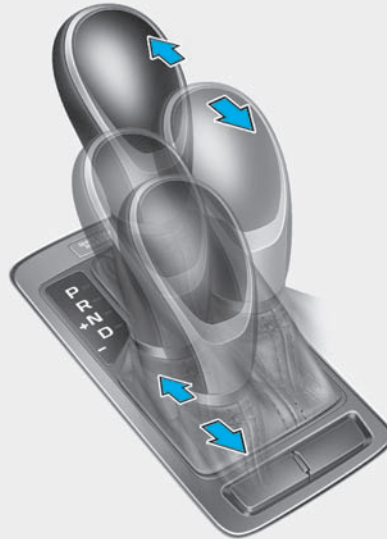
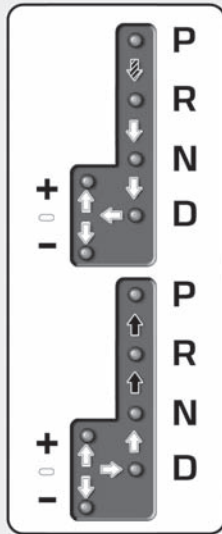
AUTOMATIC TRANSMISSION



-  Press the shift button, then move shift lever.
-  Depress the brake pedal, then move shift lever.
-  Move shift lever.

ODH053011

Automatic transmission operation

The automatic transmission has eight forward speeds and one reverse speed.

The individual speeds are selected automatically in the D (Drive) position.

⚠ WARNING

To reduce the risk of serious injury or death:

- **ALWAYS** check the surrounding areas near your vehicle for people, especially children, before shifting a vehicle into D (Drive) or R (Reverse).
- Before leaving the driver's seat, always make sure the shift lever is in the P (Park) position, then set the parking brake, and place the Engine Start/Stop button in the OFF position. Unexpected and sudden vehicle movement can occur if these precautions are not followed.
- Do not use engine braking (shifting from a high gear to lower gear) rapidly on slippery roads. The vehicle may slip causing an accident.

The indicator in the instrument cluster displays the shift lever position when the Engine Start/Stop button is in the ON position.

P (Park)

Always come to a complete stop before shifting into P (Park).

To shift from P (Park), you must depress firmly on the brake pedal and make sure your foot is off the accelerator pedal.

If you have done all of the above and still cannot shift the lever out of P (Park), see "Shift-Lock Release" on page 5-16.

The shift lever must be in P (Park) before turning the engine off.

⚠ WARNING

- **Shifting into P (Park) while the vehicle is in motion may cause you to lose control of the vehicle.**
- **After the vehicle has stopped, always make sure the shift lever is in P (Park), apply the parking brake, and turn the engine off.**
- **Do not use the P (Park) position in place of the parking brake.**

R (Reverse)

Use this position to drive the vehicle backward.

CAUTION

Always come to a complete stop before shifting into or out of R (Reverse); you may damage the transmission if you shift into R (Reverse) while the vehicle is in motion.

N (Neutral)

The wheels and transmission are not engaged.

Use N (Neutral) if you need to restart a stalled engine, or if it is necessary to stop with the engine ON. Shift into P (Park) if you need to leave your vehicle for any reason.

Always depress the brake pedal when you are shifting from N (Neutral) to another gear.

WARNING

Do not shift into gear unless your foot is firmly on the brake pedal. Shifting into gear when the engine is running at high speed can cause the vehicle to move very rapidly. You could lose control of the vehicle and hit people or objects.

D (Drive)

This is the normal driving position. The transmission will automatically shift through a 8-gear sequence, providing the best fuel economy and power.

For extra power when passing another vehicle or driving uphill depress the accelerator pedal further until you feel the transmission downshift to a lower gear.

The DRIVE MODE switch, located on the shift lever console, allows the driver to switch from NORMAL mode to SPORT, ECO or SNOW mode.

When driving in ice or snow conditions, it is recommended you switch to SNOW mode. Press the DRIVE MODE switch for 2~3 seconds until "SNOW" displays in the center of the instrument cluster. To cancel SNOW mode, press the DRIVE MODE switch one time to select NORMAL mode.

For more information, refer to "Drive Mode Integrated Control System" later in this chapter.

Sports mode

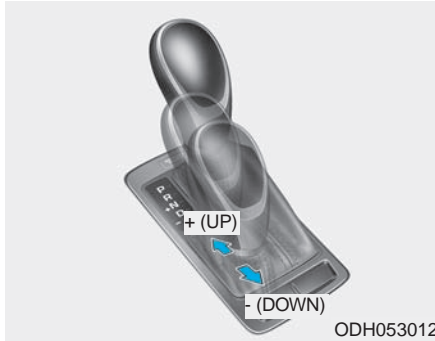

Whether the vehicle is stationary or in motion, sports mode is selected by pushing the shift lever from the D (Drive) position into the manual gate. To return to D (Drive) range operation, push the shift lever back into the main gate.

In Sports Mode, moving the shift lever backwards and forwards will allow you to select the desired range of gears for the current driving conditions.

- + (Up) : Push the lever forward once to shift up one gear.
- (Down) : Pull the lever backwards once to shift down one gear.

* NOTICE

- Only the eight forward gears can be selected. To reverse or park the vehicle, move the shift lever to the R (Reverse) or P (Park) position as required.
- Downshifts are made automatically when the vehicle slows down. When the vehicle stops, 1st gear is automatically selected.
- When the engine rpm approaches the red zone the transmission will upshift automatically.

(Continued)

(Continued)

- If the driver presses the lever to + (Up) or - (Down) position, the transmission may not make the requested gear change if the next gear is outside of the allowable engine rpm range. The driver must execute upshifts in accordance with road conditions, taking care to keep the engine rpms below the red zone.
- When accelerating from a stop on a slippery road, push the shift lever forward into the + (Up) position. This causes the transmission to shift into the 2nd gear which is better for smooth driving on a slippery road. Push the shift lever to the - (Down) side to shift back to the 1st gear.

Paddle shifter

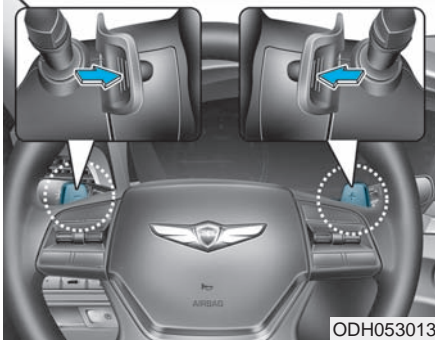

The paddle shifter is available when the shift lever is in the D (Drive) position or the sports mode.

With the shift lever in the D position

The paddle shifter will operate when the vehicle speed is more than 6 mph (10 km/h).

Pull the [+] or [-] paddle shifter once to shift up or down one gear and the system changes from automatic mode to manual mode.

When the vehicle speed is lower than 6 mph (10 km/h), if you depress the accelerator pedal for more than 5 seconds or if you move the shift lever from D (Drive) to Sports Mode and move it from Sports Mode to D (Drive) again, the system changes from manual mode to automatic mode.

With the shift lever in the sports mode

Pull the [+] or [-] paddle shifter once to shift up or down one gear.

* NOTICE

If the [+] and [-] paddle shifters are pulled at the same time, gear change may not occur.

Shift-lock system

For your safety, the automatic transmission has a shift-lock system which prevents shifting the transmission from P (Park) into R (Reverse) unless the brake pedal is depressed.

To shift the transmission from P (Park) into R (Reverse):

1. Depress and hold the brake pedal.
2. Start the engine or place the Engine Start/Stop button in the ON position.
3. Move the shift lever.

Shift-lock override

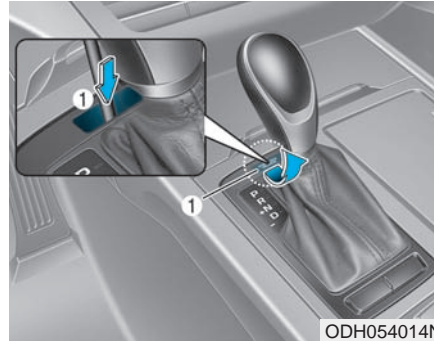

If the shift lever cannot be moved from the P (Park) position into R (Reverse) position with the brake pedal depressed, continue depressing the brake, and then do the following:

1. Place the Engine Start/Stop button in the OFF position.
2. Apply the parking brake.
3. Carefully remove the cap (1) covering the shift-lock override access hole.
4. Insert a screwdriver into the access hole and press down on the screwdriver.
5. Move the shift lever.
6. Remove the screwdriver from the shift-lock override access hole then install the cap.

If you need to use the shift-lock release, have your vehicle inspected by an authorized HYUNDAI dealer immediately.

Parking

Always come to a complete stop and continue to depress the brake pedal. Move the shift lever into the P (Park) position, apply the parking brake, and place the Engine Start/Stop button in the OFF position. Take the Key with you when exiting the vehicle.

WARNING

When you stay in the vehicle with the engine running, be careful not to depress the accelerator pedal for a long period of time. The engine or exhaust system may overheat and start a fire.

The exhaust gas and the exhaust system are very hot. Keep away from the exhaust system components.

Do not stop or park over flammable materials, such as dry grass, paper or leaves. They may ignite and cause a fire.

Good driving practices

- Never move the shift lever from P (Park) or N (Neutral) to any other position with the accelerator pedal depressed.
- Never move the shift lever into P (Park) when the vehicle is in motion.

Be sure the vehicle is completely stopped before you attempt to shift into R (Reverse) or D (Drive).

- Do not move the shift lever to N (Neutral) when driving. Doing so may result in an accident because of a loss of engine braking and the transmission could be damaged.
- Do not drive with your foot resting on the brake pedal. Even light, but consistent pedal pressure can result in the brakes overheating, brake wear and possibly even brake failure.
- Depressing both accelerator and brake pedals at the same time can trigger logic for engine power reduction to assure vehicle deceleration. Vehicle acceleration will resume after the brake pedal is released.

- When driving in Sports Mode, slow down before shifting to a lower gear. Otherwise, the lower gear may not be engaged if the engine rpms are outside of the allowable range.
- Always apply the parking brake when leaving the vehicle. Do not depend on placing the transmission in P (Park) to keep the vehicle from moving.
- Exercise extreme caution when driving on a slippery surface. Be especially careful when braking, accelerating or shifting gears. On a slippery surface, an abrupt change in vehicle speed can cause the drive wheels to lose traction and may cause loss of vehicle control resulting in an accident.
- Optimum vehicle performance and economy is obtained by smoothly depressing and releasing the accelerator.

 **WARNING**

To reduce the risk of **SERIOUS INJURY** or **DEATH**:

- **ALWAYS** wear your seatbelt. In a collision, an unbelted occupant is significantly more likely to be seriously injured or killed than a properly belted occupant.
- Avoid high speeds when cornering or turning.
- Do not make quick steering wheel movements, such as sharp lane changes or fast, sharp turns.
- The risk of rollover is greatly increased if you lose control of your vehicle at highway speeds.
- Loss of control often occurs if two or more wheels drop off the roadway and the driver over steers to reenter the roadway.

(Continued)

(Continued)

- In the event your vehicle leaves the roadway, do not steer sharply. Instead, slow down before pulling back into the travel lanes.
- **HYUNDAI** recommends you follow all posted speed limits.



ALL WHEEL DRIVE (AWD) (IF EQUIPPED)

Using All Wheel Drive (AWD)

The All Wheel Drive (AWD) System delivers engine power to all front and rear wheels for maximum traction. AWD is useful when extra traction is required, such as when driving on slippery, muddy, wet, or snow-covered roads.

If the system determines there is a need for four wheel drive, the engine's driving power is distributed to all four wheels automatically.

WARNING

If the AWD warning light () stays on the instrument cluster, your vehicle may have a malfunction with the AWD system. When the AWD warning light () illuminates have your vehicle checked by an authorized HYUNDAI dealer as soon as possible.

WARNING

To reduce the risk of **SERIOUS INJURY** or **DEATH**:

- Do not drive in conditions that exceed the vehicles intended design such as challenging off-road conditions.
- Avoid high speeds when cornering or turning.
- Do not make quick steering wheel movements, such as sharp lane changes or fast, sharp turns.
- The risk of a rollover is greatly increased if you lose control of your vehicle at highway speeds.
- Loss of control often occurs if two or more wheels drop off the roadway and the driver over steers to reenter the roadway.

(Continued)

(Continued)

- In the event your vehicle leaves the roadway, do not steer sharply. Instead, slow down before pulling back into the travel lanes.
- Always drive safely and use caution when driving an AWD vehicle.

* NOTICE

- Do not drive in water if the level is higher than the bottom of the vehicle.
- Check your brake condition once you are out of mud or water. Depress the brake pedal several times as you move slowly until you feel normal braking return.
- Shorten your scheduled maintenance interval if you drive in off-road conditions such as sand, mud or water (see “Maintenance Under Severe Usage Conditions” in chapter 7).
- Make sure that an AWD vehicle is towed by flatbed tow truck.

For safe AWD operation

Before driving

- Make sure all passengers are wearing seat belts.
- Sit upright and adjust the steering wheel to a position comfortable for you to drive.

Driving on snow-covered or icy roads

- Start off slowly by applying the accelerator pedal gently.
- Use of snow tires is recommended. For more information on Snow Tires refer to "Winter Driving" in this chapter.
- Keep sufficient distance between your vehicle and the vehicle in front of you.
- Use engine braking during deceleration.
- Avoid speeding, rapid acceleration, sudden brake applications, and sharp turns to prevent skids.

Driving in sand or mud

- Maintain slow and constant speed.
- Keep sufficient distance between your vehicle and the vehicle in front of you.
- Reduce vehicle speed and always check the road condition.
- Avoid speeding, rapid acceleration, sudden brake applications, and sharp turns to prevent getting stuck.

⚠ CAUTION

When the vehicle is stuck in snow, sand or mud, avoid running the engine continuously at high rpm, doing so may damage the tires, transmission, differential or, AWD system.

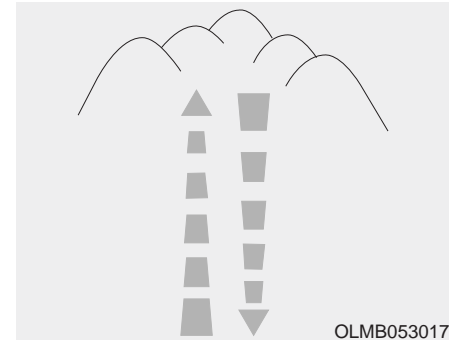

Driving up or down hills

- Driving uphill
 - Before starting off, check if it is possible to drive uphill.
 - Drive as straight as possible.
- Driving downhill
 - Do not change gear while driving downhill. Select gear before driving downhill.
 - Drive as slowly using engine braking while driving downhill.
 - Drive straight as possible.

⚠️ WARNING

Exercise extreme caution driving up or down steep hills. The vehicle may flip depending on the grade, terrain and water/mud conditions.

Emergency precautions

Tires

⚠️ WARNING

Do not use tire and wheel with different size and type from the one originally installed on your vehicle. It can affect the safety and performance of your vehicle, which could lead to steering failure or rollover causing serious injury.

When replacing the tires, be sure to equip all four tires with the tire and wheel of the same size, type, tread, brand and load-carrying capacity.

In an emergency situation, a compact spare tire may be used. But, do not use the compact spare tire continuously. Repair or replace the original tire as soon as possible to avoid failure of the differential or AWD system.

⚠️ WARNING



Never start or run the engine while an AWD vehicle is raised on a jack. The vehicle can slip or roll off of a jack causing serious injury or death to you or those nearby.

Towing

AWD vehicles must be towed with a wheel lift and dollies or flatbed equipment with all the wheels off the ground.

For more information, refer to "Towing" in chapter 6.

Vehicle inspection

- When the vehicle is on a car lift, do not operate the front and rear wheels separately. All four wheels should be operated.
- Never engage the parking brake while running the engine on a car lift. This may damage the AWD system.

Dynamometer testing

An AWD vehicle must be tested on a special four wheel chassis dynamometer.

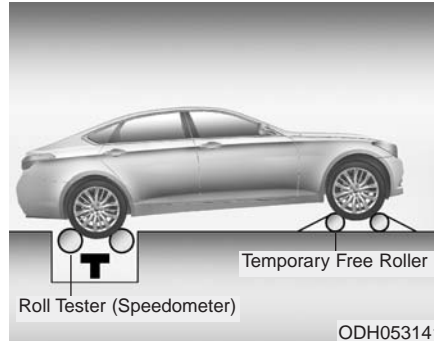

An AWD vehicle should not be tested on a 2WD roll tester. If a 2WD roll tester must be used, perform the following procedure:

1. Check the tire pressures recommended for your vehicle.
2. Place the rear wheels on the roll tester for a speedometer test as shown in the illustration.
3. Release the parking brake.
4. Place the front wheels on the temporary free roller as shown in the illustration.

WARNING

Keep away from the front of the vehicle while the vehicle is in gear on the dynamometer. The vehicle can jump forward and cause serious injury or death.

BRAKING SYSTEM

Power brakes

Your vehicle has power-assisted brakes that adjust automatically through normal usage.

If the engine is not running or is turned off while driving, the power assist for the brakes will not work. You can still stop your vehicle by applying greater force to the brake pedal than typical. The stopping distance, however, will be longer than with power brakes.

When the engine is not running, the reserve brake power is partially depleted each time the brake pedal is applied. Do not pump the brake pedal when the power assist has been interrupted.

Pump the brake pedal only when necessary to maintain steering control on slippery surfaces.

WARNING

Take the following precautions:

- **Do not drive with your foot resting on the brake pedal. This will create abnormal high brake temperatures, excessive brake lining and pad wear, and increased stopping distances.**
- **When descending a long or steep hill, shift to a lower gear and avoid continuous application of the brakes. Applying the brakes continuously will cause the brakes to overheat and could result in a temporary loss of braking performance.**

(Continued)

(Continued)

- **Wet brakes may impair the vehicle's ability to safely slow down; the vehicle may also pull to one side when the brakes are applied. Applying the brakes lightly will indicate whether they have been affected in this way. Always test your brakes in this fashion after driving through deep water. To dry the brakes, lightly tap the brake pedal to heat up the brakes while maintaining a safe forward speed until brake performance returns to normal. Avoid driving at high speeds until the brakes function correctly.**

Disc brakes wear indicator

When your brake pads are worn and new pads are required, you will hear a high pitched warning sound from your front or rear brakes. You may hear this sound come and go or it may occur whenever you depress the brake pedal.

Please remember some driving conditions or climates may cause a brake squeal when you first apply (or lightly apply) the brakes. This is normal and does not indicate a problem with your brakes.

CAUTION

To avoid costly brake repairs, do not continue to drive with worn brake pads.

* NOTICE

Always replace brake pads as complete front or rear axle sets.

Foot parking brake (if equipped)

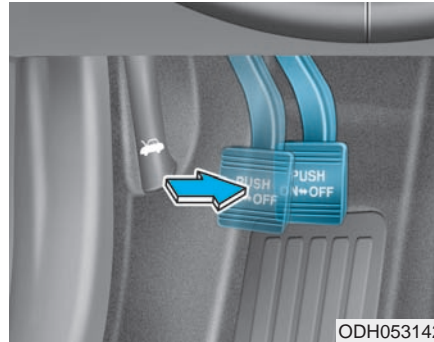

Always set the parking brake before leaving the vehicle, to apply:

Firmly depress the brake pedal.

Depress the parking brake pedal down as far as possible.

WARNING

To reduce the risk of SERIOUS INJURY or DEATH, do not operate the parking brake while the vehicle is moving except in an emergency situation. It could damage the brake system and lead to an accident.

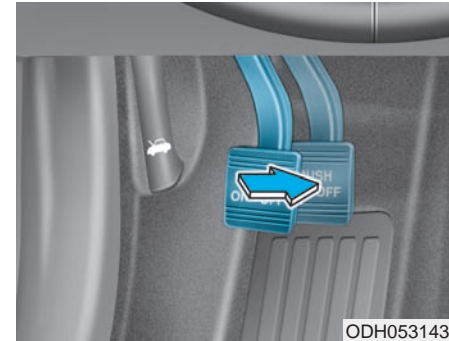

To release:

Firmly depress the brake pedal.

Depress the parking brake pedal down and it will release automatically.

If the parking brake does not release or does not release all the way, have your vehicle checked by an authorized HYUNDAI dealer.

WARNING

- Whenever leaving the vehicle or parking, always come to a complete stop and continue to depress the brake pedal. Move the shift lever into P (Park) position, then apply the parking brake, and place the Engine Start/Stop button in the OFF position.
Vehicles with the parking brake not fully engaged are at risk for moving inadvertently and causing injury to yourself or others.
- NEVER allow anyone who is unfamiliar with the vehicle to touch the parking brake. If the parking brake is released unintentionally, serious injury may occur.
- Only release the parking brake when you are seated inside the vehicle with your foot firmly on the brake pedal.

CAUTION

- Do not apply the accelerator pedal while the parking brake is engaged. If you depress the accelerator pedal with the parking brake engaged, warning will sound. Damage to the parking brake may occur.
- Driving with the parking brake on can overheat the braking system and cause premature wear or damage to brake parts. Make sure the parking brake is released and the Brake Warning Light is off before driving.



Check the Parking Brake Warning Light by placing the Engine Start/Stop button to the ON position (do not start the engine).

This light will be illuminated when the parking brake is applied with the Engine Start/Stop button in the START or ON position.

Before driving, be sure the parking brake is released and the Brake Warning Light is OFF.

If the Parking Brake Warning Light remains on after the parking brake is released while engine is running, there may be a malfunction in the brake system. Immediate attention is necessary.

If at all possible, cease driving the vehicle immediately. If that is not possible, use extreme caution while operating the vehicle and only continue to drive the vehicle until you can reach a safe location.

Electric parking brake (EPB) (if equipped)

Applying the parking brake

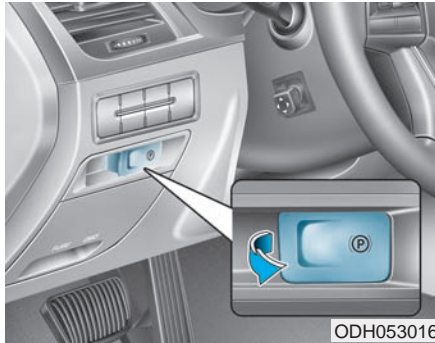

To apply the EPB (Electric Parking Brake):

1. Depress the brake pedal.
2. Pull up the EPB switch.

Make sure the Parking Brake Warning Light comes on.

Also, the EPB is applied automatically if the [AUTO HOLD] switch is on when the engine is turned off. However, if you press the EPB switch within one second after the engine is turned off, the EPB will not be applied.

WARNING

To reduce the risk of **SERIOUS INJURY or DEATH**, do not operate the EPB while the vehicle is moving except in an emergency situation. It could damage the brake system and lead to an accident.

Releasing the parking brake

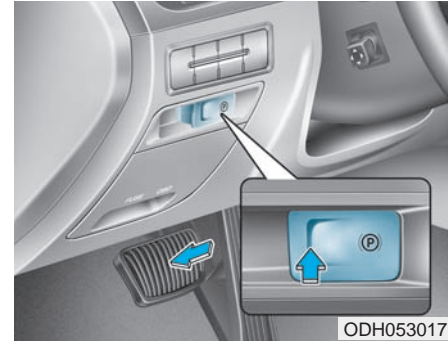

To release the EPB (Electric Parking Brake), press the EPB switch in the following condition:

- Place the Engine Start/Stop button in the ON position.
- Depress the brake pedal.

Make sure the Parking Brake Warning Light goes off.

To release EPB (Electric Parking Brake) automatically:

- Shift lever in P (Park)
With the engine running depress the brake pedal and shift out of P (Park) to R (Rear) or D (Drive).
- Shift lever in N (Neutral)
With the engine running depress the brake pedal and shift out of N (Neutral) to R (Rear) or D (Drive).
- Satisfy the following conditions
 1. Start the engine.
 2. Fasten the driver's seat belt.
 3. Close the driver's door, engine hood and trunk.
 4. Depress the accelerator pedal while the shift lever is in D (Drive) or Sports mode.

Make sure the Parking Brake Warning Light goes off.

*** NOTICE**

- For your safety, you can engage the EPB even though the Engine Stop/Start button is in the OFF position, but you cannot release it.
- For your safety, depress the brake pedal and release the parking brake manually with the EPB switch when you drive downhill or when backing up the vehicle.

 **CAUTION**

- If the Parking Brake Warning Light is still on even though the EPB has been released, have your vehicle checked by an authorized HYUNDAI dealer.
- Do not drive your vehicle with the EPB applied. It may cause excessive brake pad and brake rotor wear.

When the EPB (Electric Parking Brake) does not release:

Contact an authorized HYUNDAI dealer by loading the vehicle on a flatbed tow truck and have the system checked.

EPB (Electric Parking Brake) may be automatically applied when:

- The EPB is overheated
- Requested by other systems
- The engine is turned off with the EPB applied

* NOTICE

If the driver turns the engine off while Auto Hold is operating, EPB will be automatically applied. However, if you press the EPB switch within one second after the engine is turned off, the EPB will not be applied.

Warning messages



To disengage EPB, fasten seatbelt, close door, hood, and trunk

- If you try to drive with the EPB applied, a warning will sound and a message will appear.
- If the driver's seat belt is not fastened and the hood or trunk is opened, a warning will sound and a message will appear.
- If there is a problem with the vehicle, a warning may sound and a message may appear.

If the situation occurs, depress the brake pedal and release EPB by pressing the EPB switch.

WARNING

- Whenever leaving the vehicle or parking, always come to a complete stop and continue to depress the brake pedal. Move the shift lever into the P (Park) position, press the EPB switch, and press the Engine Start/Stop button to the OFF position. Take the Smart Key with you when exiting the vehicle.

Vehicles not fully engaged in P (Park) with the parking brake set are at risk for moving inadvertently and causing injury to yourself or others.

- NEVER allow anyone who is unfamiliar with the vehicle to touch the EPB switch. If the EPB is released unintentionally, serious injury may occur.

(Continued)

(Continued)

- Only release the EPB when you are seated inside the vehicle with your foot firmly on the brake pedal.

 **CAUTION**

- Do not apply the accelerator pedal while the parking brake is engaged. If you depress the accelerator pedal with the EPB engaged, a warning will sound and a message will appear.
Damage to the parking brake may occur.
- Driving with the parking brake on can overheat the braking system and cause premature wear or damage to brake parts. Make sure the EPB is released and the Parking Brake Warning Light is off before driving.

*** NOTICE**

- A clicking sound may be heard while operating or releasing the EPB. These conditions are normal and indicate that the EPB is functioning properly.
- When leaving your keys with a parking lot attendant or valet, make sure to inform him/her how to operate the EPB.

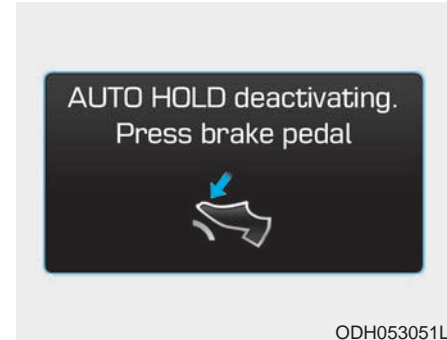

**AUTO HOLD deactivating.
Press brake pedal**

When the conversion from Auto Hold to EPB is not working properly a warning will sound and a message will appear.

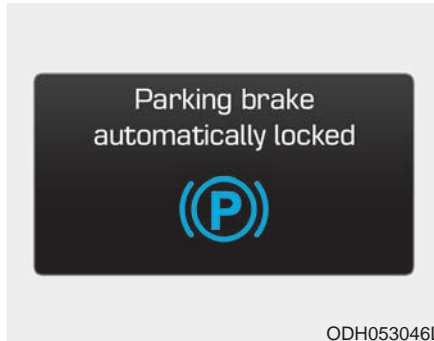

Parking brake automatically locked

If the EPB is applied while Auto Hold is activated, a warning will sound and a message will appear.

EPB malfunction indicator (if equipped)



If the EPB Malfunction Indicator remains on, comes on while driving, or does not come on when the Engine Start/Stop button is in the ON position, this indicates the EPB may have malfunctioned. Have your vehicle checked by an authorized HYUNDAI dealer as soon as possible.

The EPB Malfunction Indicator may illuminate when the ESC indicator comes on to indicate that the ESC is not working properly, but it does not indicate a malfunction of the EPB.

CAUTION

- If the EPB Malfunction Indicator is still on, have the system checked by an authorized HYUNDAI dealer.
- If the Parking Brake Warning Light does not illuminate or blinks even though the EPB switch was pulled up, the EPB may not be applied.
- If the Parking Brake Warning Light blinks when the EPB Malfunction Indicator is on, press the EPB switch, then pull it up. Once more, press the switch back to its original position and pull it back up. If the EPB Malfunction Indicator does not go off, have your vehicle checked by an authorized HYUNDAI dealer.

Emergency braking

If there is a problem with the brake pedal while driving, emergency braking is possible by pulling up and holding the EPB switch. Braking is possible only while you are holding the EPB switch. However, braking distance will be longer than normal.

WARNING

Do not operate the parking brake while the vehicle is moving except in an emergency situation. It could damage the brake system and lead to a severe accident.

* NOTICE

During emergency braking the Parking Brake Warning Light will illuminate to indicate that the system is operating.

CAUTION

If there is a noise or burning smell after using the emergency brake, have your vehicle checked by an authorized HYUNDAI dealer as soon as possible.

AUTO HOLD (if equipped)

This feature keeps the brake applied when the shift lever is in D (Drive), R (Reverse), N (Neutral) or Sports Mode with the feature enabled and when the brake pedal has been depressed to stop the vehicle.

To apply:

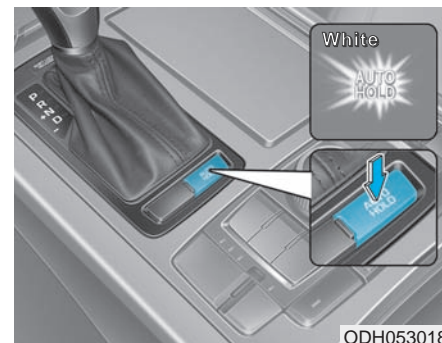

1. Press the [AUTO HOLD] switch. The AUTO HOLD indicator will illuminate white and the system will be in the standby position.

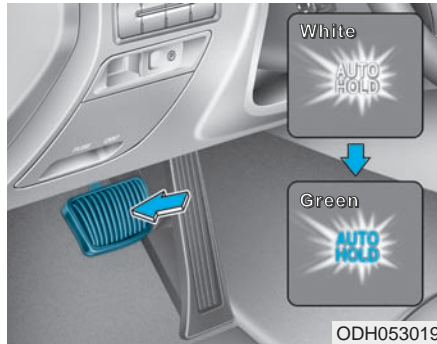

2. When you stop the vehicle completely by depressing the brake pedal, the Auto Hold maintains the brake pressure to hold the vehicle stationary. The indicator changes from white to green.
3. The vehicle will remain stationary even if you release the brake pedal.
4. If EPB is applied, Auto Hold will be released.

To release:

- Press the accelerator pedal with the shift lever in R (Reverse), D (Drive) or Sports Mode, the Auto Hold will be released automatically and the vehicle will start to move. The indicator changes from green to white.
- If the vehicle is restarted using the advanced smart cruise control lever (RES+ or SET-) while Auto Hold and advanced smart cruise control is operating (The green AUTO HOLD indicator), the Auto Hold will be released regardless of accelerator pedal operation.

To cancel:

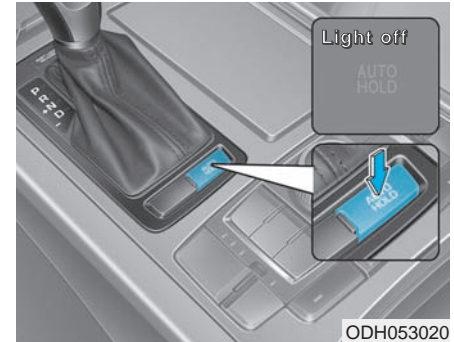

1. Depress the brake pedal.
2. Press the [AUTO HOLD] switch. The AUTO HOLD indicator will turn off.

WARNING

To prevent, unexpected and sudden vehicle movement, **ALWAYS** press your foot on the brake pedal to cancel the Auto Hold before you:

- Drive downhill.
- Drive the vehicle in R (Reverse).
- Park the vehicle.

* NOTICE

- The Auto Hold does not operate when:
 - The driver's seat belt is unbuckled and the driver's door is opened
 - The engine hood is opened
 - The trunk is opened
 - The shift lever is in P (Park)
 - The EPB is applied
 - For your safety, the Auto Hold automatically switches to EPB when:
 - The driver's seat belt is unbuckled and the driver's door is opened
 - The engine hood is opened with the shift lever in D (Drive)
 - The trunk is opened with the shift lever in R (Reverse)
 - The vehicle is in a standstill for more than 10 minutes
 - The vehicle is standing on a steep slope
 - The vehicle moved several times
- (Continued)

(Continued)

In these cases, the Parking Brake Warning Light comes on, the AUTO HOLD indicator changes from green to white, and warning sounds and a message will appear to inform you that EPB has been automatically engaged. Before driving again, depress the brake pedal, check the surrounding area near your vehicle and release the parking brake manually with the EPB switch.

- If the AUTO HOLD indicator changes to yellow, the Auto Hold is not work properly. Take your vehicle to an authorized HYUNDAI dealer and have the system checked.
- If there is a malfunction with the driver's door, hood or trunk open detection system, the Auto Hold may not work properly. Take your vehicle to an authorized HYUNDAI dealer and have the system checked.

Warning messages

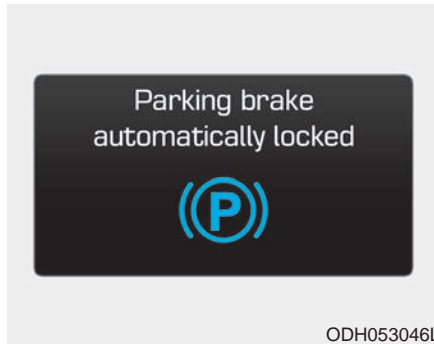

Parking brake automatically locked
When the EPB is applied from Auto Hold, a warning will sound and a message will appear.



**AUTO HOLD deactivating.
Press brake pedal**

When the conversion from Auto Hold to EPB is not working properly a warning will sound and a message will appear.

 **CAUTION**

Depress the brake pedal when the above message appears for the Auto Hold and EPB may not activate.



**Press brake pedal to deactivate
AUTO HOLD**

If you did not apply the brake pedal when you release the Auto Hold by pressing the [AUTO HOLD] switch, a warning will sound and a message will appear.

AUTO HOLD conditions
not met.
Close door, hood, trunk,
and fasten seatbelt

ODH053055L

**AUTO HOLD conditions not met.
Close door, hood, trunk, and fasten
seatbelt**

When you press the [AUTO HOLD] switch, if the driver's door, engine hood and trunk are not closed or the driver's seat belt is not fastened, a warning will sound and a message will appear on the LCD display. In that time, press the [AUTO HOLD] button after closing the driver's door, engine hood and trunk and fastening the seat belt.

Anti-lock Brake System (ABS)

WARNING

An Anti-Lock Braking System (ABS) or an Electronic Stability Control (ESC) system will not prevent accidents due to improper or dangerous driving maneuvers. Even though vehicle control is improved during emergency braking, always maintain a safe distance between you and objects ahead of you. Vehicle speeds should always be reduced during extreme road conditions. The braking distance for cars equipped with ABS or ESC may be longer than for those without these systems in the following road conditions.

(Continued)

(Continued)

- Drive your vehicle at reduced speeds during the following conditions:
- Rough, gravel or snow-covered roads.
- On roads where the road surface is pitted or has different surface height.
- Tire chains are installed on your vehicle.

The safety features of an ABS or ESC equipped vehicle should not be tested by high speed driving or cornering. This could endanger the safety of yourself or others.

ABS is an electronic braking system that helps prevent a braking skid. ABS allows the driver to steer and brake at the same time.

Using ABS

To obtain the maximum benefit from your ABS in an emergency situation, do not attempt to modulate your brake pressure and do not try to pump your brakes. Depress your brake pedal as hard as possible.

When you apply your brakes under conditions which may lock the wheels, you may hear sounds from the brakes, or feel a corresponding sensation in the brake pedal. This is normal and it means your ABS is active.

ABS does not reduce the time or distance it takes to stop the vehicle.

Always maintain a safe distance from the vehicle in front of you.

ABS will not prevent a skid that results from sudden changes in direction, such as trying to take a corner too fast or making a sudden lane change. Always drive at a safe speed for the road and weather conditions.

ABS cannot prevent a loss of stability. Always steer moderately when braking hard. Severe or sharp steering wheel movement can still cause your vehicle to veer into oncoming traffic or off the road.

On loose or uneven road surfaces, operation of the anti-lock brake system may result in a longer stopping distance than for vehicles equipped with a conventional brake system.

The ABS warning light () will stay on for several seconds after the Engine Start/Stop button is in the ON position. During that time, the ABS will go through self-diagnosis and the light will go off if everything is normal. If the light stays on, you may have a problem with your ABS. Contact an authorized HYUNDAI dealer as soon as possible

WARNING

If the ABS warning light () is on and stays on, you may have a problem with the ABS. Your power brakes will work normally. To reduce the risk of serious injury or death, contact your HYUNDAI dealer as soon as possible.

CAUTION

When you drive on a road having poor traction, such as an icy road, and apply your brakes continuously, the ABS will be active continuously and the ABS warning light () may illuminate. Pull your car over to a safe place and turn the engine off.

Restart the engine. If the ABS warning light is off, then your ABS system is normal.

Otherwise, you may have a problem with your ABS system. Contact an authorized HYUNDAI dealer as soon as possible.

* NOTICE

When you jump start your vehicle because of a drained battery, the ABS warning light () may turn on at the same time. This happens because of the low battery voltage. It does not mean your ABS is malfunctioning. Have the battery recharged before driving the vehicle.

Electronic Stability Control (ESC)

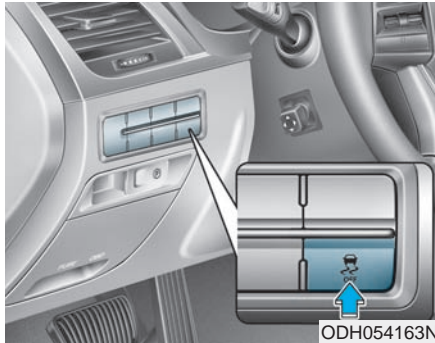

The Electronic Stability Control (ESC) system helps to stabilize the vehicle during cornering maneuvers. ESC checks where you are steering and where the vehicle is actually going. ESC applies braking pressure to any one of the vehicle's brakes and intervenes in the engine management system to assist the driver with keeping the vehicle on the intended path. It is not a substitute for safe driving practices. Always adjust your speed and driving to the road conditions.

WARNING

Never drive too fast for the road conditions or too quickly when cornering. The ESC system will not prevent accidents.

Excessive speed in turns, abrupt maneuvers, and hydroplaning on wet surfaces can result in severe accidents.

ESC operation

ESC ON condition

When the Engine Start/Stop button is in the ON position, the ESC and the ESC OFF indicator lights illuminate for approximately three seconds and go off, then the ESC is turned on.

When operating



When the ESC is in operation, the ESC indicator light blinks:

- When you apply your brakes under conditions which may lock the wheels, you may hear sounds from the brakes, or feel a corresponding sensation in the brake pedal. This is normal and it means your ESC is active.
- When the ESC activates, the engine may not respond to the accelerator as it does under routine conditions.
- If the Cruise Control was in use when the ESC activates, the Cruise Control automatically disengages. The Cruise Control can be reengaged when the road conditions allow. See "Cruise Control System" later in this chapter. (if equipped)

- When moving out of the mud or driving on a slippery road, the engine rpm (revolutions per minute) may not increase even if you press the accelerator pedal deeply. This is to maintain the stability and traction of the vehicle and does not indicate a problem.

ESC OFF condition



To cancel ESC operation :

• State 1

Press the ESC OFF button shortly (ESC OFF indicator light illuminates). At this state, the engine control function does not operate. In other words, the traction control function does not operate but only the brake control function operates.

• State 2

Press the ESC OFF button for more than 3 seconds. ESC OFF indicator light illuminates and ESC OFF warning chime will sound. At this state, the engine control function and brake control function does not operate. In other words, the vehicle stability control function does not operate any more.

If the Engine Start/Stop button is pressed to the OFF position when ESC is off, ESC remains off. Upon restarting the engine, the ESC will automatically turn on again.

Indicator lights

- ESC indicator light (blinks)



- ESC OFF indicator light (comes on)



When the Engine Start/Stop button is pressed to the ON position, the ESC indicator light illuminates, then goes off if the ESC system is operating normally.

The ESC indicator light blinks whenever the ESC is operating.

If ESC indicator light stays on, your vehicle may have a malfunction with the ESC system. When this warning light illuminates have your vehicle checked by an authorized HYUNDAI dealer as soon as possible.

The ESC OFF indicator light comes on when the ESC is turned off from the User Settings Mode.

WARNING

When the ESC is blinking, this indicates the ESC is active:

Drive slowly and NEVER attempt to accelerate. NEVER turn the ESC off while the ESC indicator light is blinking or you may lose control of the vehicle resulting in an accident.

CAUTION

Driving with varying tire or wheel sizes may cause the ESC system to malfunction. When replacing tires, make sure they are the same size as your original tires for this vehicle.

ESC OFF usage

When Driving

The ESC OFF mode should only be used briefly to help free the vehicle if stuck in snow or mud by temporarily stopping operation of the ESC to maintain wheel torque.

To turn ESC off while driving, press the ESC OFF button while driving on a flat road surface.

CAUTION

To prevent damage to the transmission:

- **Do not allow wheel(s) of one axle to spin excessively while the ESC, ABS, and brake warning lights are displayed. The repairs would not be covered by the vehicle warranty. Reduce engine power and do not spin the wheel(s) excessively while these lights are displayed.**
- **When operating the vehicle on a dynamometer, ensure the ESC is turned off (ESC OFF light illuminated).**

*** NOTICE**

Turning the ESC off does not affect ABS or standard brake system operation.

Hill-Start Assist Control (HAC)

The Hill-Start Assist Control (HAC) prevents the vehicle from rolling backwards when starting a vehicle from a stop on a hill. The system operates the brakes automatically for approximately 2 seconds and releases the brake when the accelerator pedal is depressed or after 2 seconds.

WARNING

Always be ready to depress the accelerator pedal when starting off on an incline. The HAC activates only for approximately 2 seconds.

* NOTICE

- The HAC does not operate when the shift lever is in P (Park) or N (Neutral)
- The HAC activates even though the ESC (Electronic Stability Control) is off but does not activate when the ESC has malfunctioned.

Good braking practices

WARNING

Whenever leaving the vehicle or parking, always come to a complete stop and continue to depress the brake pedal. Move the shift lever into the P (Park) position, then apply the parking brake, and place the Engine Start/Stop button in the OFF position.

Vehicles with the parking brake not fully engaged are at risk for moving inadvertently and causing injury to yourself or others.

Wet brakes can be dangerous! The brakes may get wet if the vehicle is driven through standing water or if it is washed. Your vehicle will not stop as quickly if the brakes are wet. Wet brakes may cause the vehicle to pull to one side.

To dry the brakes, apply the brakes lightly until the braking action returns to normal, taking care to keep the vehicle under control at all times. If the braking action does not return to normal, stop as soon as it is safe to do so and call an authorized HYUNDAI dealer for assistance.

DO NOT drive with your foot resting on the brake pedal. Even light, but constant pedal pressure can result in the brakes overheating, brake wear, and possibly even brake failure.

If a tire goes flat while you are driving, apply the brakes gently and keep the vehicle pointed straight ahead while you slow down. When you are moving slowly enough for it to be safe to do so, pull off the road and stop in a safe location.

Keep your foot firmly on the brake pedal when the vehicle is stopped to prevent the vehicle from rolling forward.

DRIVE MODE INTEGRATED CONTROL SYSTEM



The drive mode may be selected according to the driver's preference or road condition.

The system initializes to the NORMAL mode after the engine has been turned off and on.

* NOTICE

If there is a problem with the Electronic Stability Control (ESC) system, the drive mode will be in NORMAL mode and may not change to ECO mode, SPORT mode or SNOW mode.

- The mode changes whenever the DRIVE MODE switch is pressed.

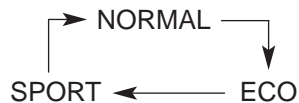

When NORMAL mode is selected, it is not displayed on the instrument cluster.

- When the DRIVE MODE switch is pressed for more than one second, the SNOW mode will operate regardless of whichever DRIVE mode (NORMAL/ECO/SPORT) is operating. If the switch is pressed once more, the DRIVE mode (NORMAL/ECO/SPORT) that was operating previously will operate.
- The selected mode is displayed on the AVN monitor.

ECO mode (Active ECO)

ECO

Active ECO helps improve fuel efficiency by controlling certain engine and transmission system operating parameters.

Fuel efficiency depends on the driver's driving habit and road condition.

- When the DRIVE MODE switch is pressed and the ECO mode is selected, the ECO indicator (green) will illuminate to show that the Active ECO is operating.
- When the Active ECO is activated, and the engine is turned off and on it will change to NORMAL mode. To turn on the ECO mode, press the DRIVE MODE switch till it is selected.

When Active ECO is activated:

- The acceleration response may be slightly reduced as the accelerator pedal is depressed moderately.
- The air conditioner performance may be limited.
- The shift pattern of the automatic transmission may change.
- The engine noise may get louder.

The above situations are normal conditions when the Active ECO system is activated to improve fuel efficiency.

Limitation of Active ECO operation:

If the following conditions occur while Active ECO is operating, the system operation is limited even though there is no change in the ECO indicator.

- When the coolant temperature is low:
The system will be limited until engine performance becomes normal.
- When driving up a hill:
The system will be limited to gain power when driving uphill because engine torque is restricted.
- When using the automatic transmission Sports mode:
The system will be limited according to the shift location.

SPORT mode**SPORT**

SPORT mode focuses on dynamic driving by automatically adjusting the steering wheel, engine and transmission system.

- When the DRIVE MODE switch is pressed and the SPORT mode is selected, the SPORT indicator (yellow) will illuminate.
- When the SPORT mode is activated, and the engine is turned off and on it will change to NORMAL mode. To turn on the SPORT mode, press the DRIVE MODE switch again.
- If the system is activated:
 - After accelerating and releasing the accelerator pedal, the gear and engine speed RPM may not drop as soon as in NORMAL mode.
 - Up-shifting is delayed.

*** NOTICE**

In SPORT mode, the fuel efficiency may decrease.

SNOW mode (if equipped)

SNOW

SNOW mode helps the driver to drive more effectively on slippery roads such as snowy or muddy roads.

- When the DRIVE MODE switch is pressed for more than one second, the SNOW mode will operate regardless of whichever drive mode (NORMAL/ECO/SPORT) is operating. If the switch is pressed once more, the drive mode (NORMAL/ECO/SPORT) that was operating previously will operate.

ELECTRONIC CONTROL SUSPENSION (ECS) (IF EQUIPPED)

The Electronic Control Suspension (ECS) controls the vehicle suspension automatically to maximize driving comfort by taking into account the driving conditions such as speed, surface of the road, cornering, stopping requirements and acceleration.

ECS (Electronic Control Suspension) malfunction indicator

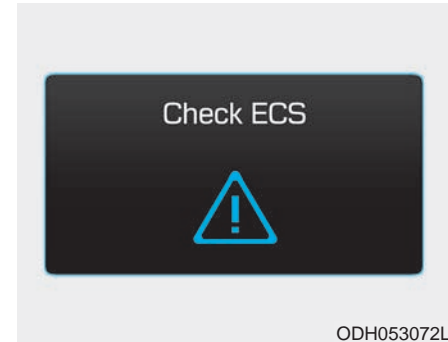

If the ECS warning message comes on, you may have a problem with the ECS system. Have your vehicle checked by an authorized HYUNDAI dealer.

AUTONOMOUS EMERGENCY BRAKING (AEB) (IF EQUIPPED)

The Autonomous Emergency Braking (AEB) helps avoid accidents by identifying critical situations early and warning the driver.

WARNING

Take the following precautions when using the Autonomous Emergency Braking (AEB):

- This system is only a supplemental system and it is not intended to, nor does it replace the need for extreme care and attention of the driver. The sensing range and objects detectable by the sensors are limited. Pay attention to the road conditions at all times.
- NEVER drive too fast for the road conditions or too quickly when cornering.
- Always drive cautiously to prevent unexpected and sudden situations from occurring. AEB does not stop the vehicle completely and does not avoid collisions.

(Continued)

(Continued)

- AEB operates according to the distance from the vehicle ahead, relative velocity, and driver's operation of the brake or accelerator pedal. Do not drive dangerously to intentionally operate the AEB.
- ALWAYS check the speed and the distance to the vehicle ahead. The AEB is not a substitute for safe driving practices.

AEB Operation

Warning message



A warning message and chime will sound when you need to use the brake pedal or steering wheel due to a sudden stop or lack of distance with the vehicle ahead. The warning messages will vary according to the severity of the situation. Immediately reduce your speed to prevent a collision.

Brake operation

In a critical situation:

- The brake assist system enters standby mode to react promptly when the driver operates the brake pedal.
- The vehicle automatically reduces speed according to the severity of the situation.
 - Rapidly reduces speed when vehicle speed is under 50 mph (80 km/h)
 - Slowly reduces speed when vehicle speed is over 50 mph (80 km/h)
- If the driver uses the brake pedal to reduce vehicle speed, the brake assist system operates to increase braking efficiency.
- If the driver presses down hard on the accelerator pedal or sharply turns the steering wheel, the brake assist system is canceled.

Seat belt operation

The driver's and passenger's seat belt may tighten if the system detects that a vehicle or object is close.

Automatic emergency mode change

In a critical situation, to help avoid collisions, the Automatic Emergency Mode automatically controls the Electronic Control Suspension (ECS) and Electronic Stability Control (ESC). When the critical situation is over, the Electronic Control Suspension (ECS) and Electronic Stability Control (ESC) returns to its previous status.

* NOTICE

- If the AEB is canceled from the User Settings Mode or there is a problem with the AEB system, the Automatic Emergency Mode will not work.
- If the ESC is off or there is a problem with the ESC system, the Automatic Emergency Mode will not work.
- The ESC must be on for the Automatic Emergency Mode to control ESC in collision situations.

⚠ WARNING

The Automatic Emergency Mode is a supplemental system to assist you and its effects may differ according to road and driving conditions. The vehicle cannot automatically avoid a collision. Do not solely rely on the system and always pay attention to prevent dangerous situations from occurring.

To cancel the AEB

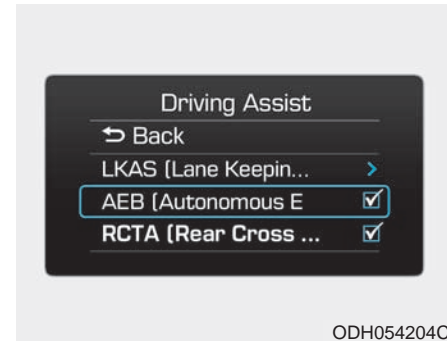

- Go to the User Settings Mode (Driving Assist) and undo the check for AEB (Autonomous Emergency Braking) on the LCD display (**For more details refer to "LCD Display" in chapter 3.**) The warning operation and automatic braking operation will not function.
- To turn on the AEB, select AEB (Autonomous Emergency Braking) from the User Settings Mode (Driving Assist) on the LCD display. The warning operation and automatic braking operation will function.

* NOTICE

When the engine is started, AEB is automatically turned on. If the system is not needed, turn the AEB system off from the User Settings Mode on the LCD display.

⚠ CAUTION

If the AEB is selected and the ESC (Electronic Stability Control) is turned off, the AEB system is automatically canceled.

Warning light and message

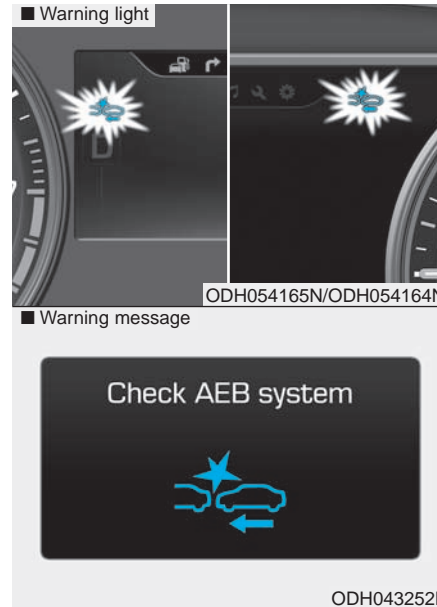

- When the AEB system is turned off, the AEB warning light turns on. (Warning message does not come on.)

- If the sensor or cover is dirty or obscured with foreign matter such as snow, the AEB warning light and message comes on. In this case, the AEB system may not function temporarily, but it does not indicate a malfunction of the AEB system. Clean the sensor or cover by using a soft cloth.
- If there is a malfunction with the AEB system, the AEB warning light and message will come on. Have your vehicle checked by an authorized HYUNDAI dealer.
- When the ESC (Electronic Stability Control) indicator or SCC (Smart Cruise Control) message comes on the AEB warning message may come on but it does not indicate a malfunction of the AEB system.

WARNING

- Even if there is a malfunction to the brake operation of the AEB, when you depress the brake pedal, the brake operates normally. AEB brake operation does not operate in certain hazardous situations.
- The AEB is designed to function above approximately 5 mph (8 km/h) and below approximately 110 mph (180 km/h).
- The AEB does not detect:
 - Persons or animals.
 - Oncoming vehicles in the opposite lane or a vehicle in an intersection.
 - Stopped objects.
- The AEB cannot detect objects, when:
 - The sensors are covered with dirt.
 - There is heavy rain or heavy snow.

(Continued)

(Continued)

- There is interference by electromagnetic waves.
- There are strong radar reflections.
- Driving in a curve.
- Driving uphill or downhill.
- Driving in areas under construction.
- An object ahead is very narrow such as motorcycles or bicycles.
- A vehicle suddenly enters your lane.
- The camera cannot secure a clear view.
- The camera cannot catch the whole vehicle.
- An unusual shape vehicle is ahead such as a trailer, special access vehicle or a truck with unique shaped cargo.

(Continued)

(Continued)

- Driving at night, the tail lamp of the vehicle ahead is missing, installed on an unusual place or installed unevenly.
- Coming in or out a tunnel, where the illumination intensity is high.

CRUISE CONTROL (IF EQUIPPED)

Cruise Control operation

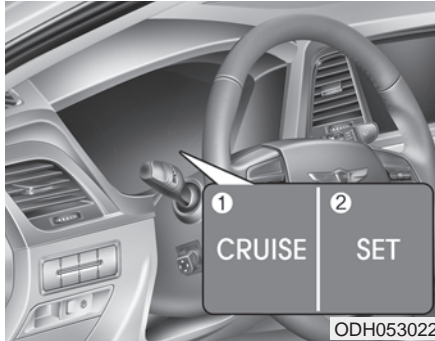

1. CRUISE indicator
2. SET indicator

The Cruise Control system allows you to drive at speeds above 20 mph (30 km/h) without depressing the accelerator pedal.

WARNING

Take the following precautions:

- If the Cruise Control is left on, (CRUISE indicator light in the instrument cluster is illuminated) the Cruise Control can be activated unintentionally. Keep the Cruise Control system off (CRUISE indicator light OFF) when the Cruise Control is not in use, to avoid inadvertently setting a speed.
- Use the Cruise Control system only when traveling on open highways in good weather.
- Do not use the Cruise Control when it may not be safe to keep the vehicle at a constant speed:
 - Driving in heavy or varying speed traffic.
 - On slippery (rainy, icy or snow covered) roads.
 - Hilly or winding roads.
 - Very windy areas.

To set Cruise Control speed

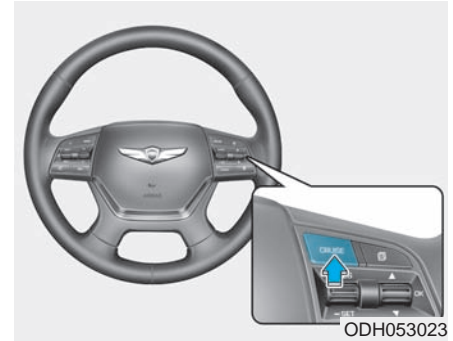

1. Push the CRUISE button on the steering wheel to turn the system on. The CRUISE indicator will illuminate.
2. Accelerate to the desired speed, which must be more than 20 mph (30 km/h).



3. Push the lever (1) down (SET-), and release it. The SET indicator light will illuminate.

4. Release the accelerator pedal.

* NOTICE

The vehicle may slow down or speed up slightly while going uphill or downhill.

To increase Cruise Control speed



- Push the lever (1) up (RES+) and hold it, while monitoring the SET speed on the instrument cluster. Release the lever when the desired speed is shown and the vehicle will accelerate to that speed.
- Push the lever (1) up (RES+) and release it immediately. The cruising speed will increase 1.0 mph (1.6 km/h) each time the lever is operated in this manner.

- Depress the accelerator pedal. When the vehicle attains the desired speed, push the lever (1) down (SET-).

To decrease Cruise Control speed



- Push the lever (1) down (SET-) and hold it. Your vehicle will gradually slow down. Release the lever at the speed you want to maintain.
- Push the lever (1) down (SET-) and release it immediately. The cruising speed will decrease 1.0 mph (1.6 km/h) each time the lever is operated in this manner.
- Lightly tap the brake pedal. When the vehicle attains the desired speed, push the lever (1) down (SET-).

To temporarily accelerate with the Cruise Control ON

Depress the accelerator pedal. When you take your foot off the accelerator, the vehicle will return to the previously set speed.

If you push the lever down (SET-) at the increased speed, the Cruise Control will maintain the increased speed.

Cruise Control will be canceled when:

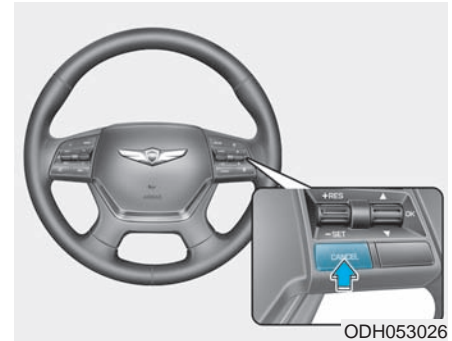

- Depressing the brake pedal.
- Pressing the CANCEL switch located on the steering wheel.
- Pushing the CRUISE button. Both the CRUISE indicator and the SET indicator will turn OFF.
- Moving the shift lever into N (Neutral).

- Decreasing the vehicle speed lower than the memory speed by 5 mph (10 km/h).
- Decreasing the vehicle speed to less than approximately 20 mph (30 km/h).
- The ESC (Electronic Stability Control) is operating.
- Downshifting to the 2nd gear in Sports Mode.

* NOTICE

Each of the above actions will cancel Cruise Control operation (the SET indicator light in the instrument cluster will go off), but only pressing the CRUISE button will turn the system off. If you wish to resume Cruise Control operation, push the lever up (RES+) located on your steering wheel. You will return to your previously preset speed, unless the system was turned off using the CRUISE button.

To resume preset Cruising speed



Push the lever (1) up (RES+). If the vehicle speed is over 20 mph (30 km/h), the vehicle will resume the preset speed.

To turn Cruise Control off



- Push the CRUISE button (the CRUISE indicator light will go off).
- Turn the engine OFF.

ADVANCED SMART CRUISE CONTROL SYSTEM (IF EQUIPPED)

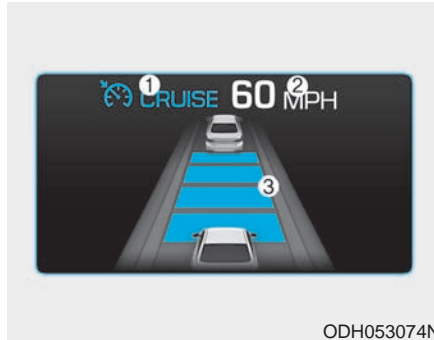

- ① Cruise Indicator
- ② Set Speed
- ③ Vehicle-to-Vehicle Distance

The Smart Cruise Control System allows you to program the vehicle to maintain constant speed and distance detecting the vehicle ahead without depressing the accelerator pedal.

⚠ WARNING

For your safety, please read the owner's manual before using the Smart Cruise Control system.

⚠ WARNING

The Smart Cruise Control System is not a substitute for safe driving practices, but a convenience function only. It is the responsibility of the driver to always check the speed and distance to the vehicle ahead.

⚠ WARNING

Take the following precautions:

- If the Smart Cruise Control is left on, (CRUISE indicator light in the instrument cluster is illuminated) the Smart Cruise Control can be activated unintentionally. Keep the Smart Cruise Control System off (CRUISE indicator light OFF) when the Smart Cruise Control is not in use, to avoid inadvertently setting a speed.
- Use the Smart Cruise Control System only when traveling on open highways in good weather.
- Do not use the Smart Cruise Control when it may not be safe to keep the vehicle at a constant speed:
 - Driving in heavy or varying speed traffic.
 - On slippery (rainy, icy or snow covered) roads.
 - Hilly or winding roads.
 - Very windy areas.

To convert to Cruise Control Mode

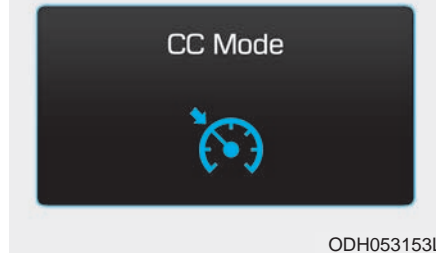
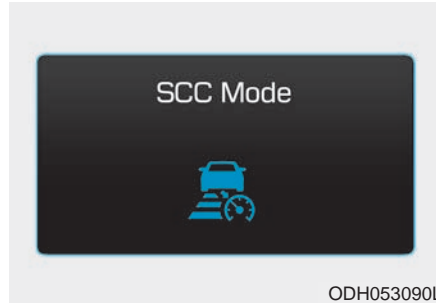

The driver may choose to only use the Cruise Control Mode (speed control function) by doing as follows:

1. Turn the Smart Cruise Control System on (the cruise indicator light will be on but the system will not be activated).
2. Push and hold the Vehicle-to-Vehicle Distance button for more than 2 seconds.
3. Choose between "Smart Cruise Control (SCC) Mode" and "Cruise Control (CC) Mode".

When the system is canceled using the CRUISE button or the CRUISE button is used after the engine is turned on, the SCC Mode will turn on.

WARNING

When using the Cruise Control Mode, you must manually adjust the distance to other vehicles by depressing the accelerator or brake pedal. The system does not automatically adjust the distance to vehicles in front of you.

Smart Cruise Control speed

To set Smart Cruise Control speed



1. Push the CRUISE button on the steering wheel to turn the system on. The CRUISE indicator will illuminate.

2. Accelerate to the desired speed.

The Smart Cruise Control speed can be set as follows:

- 20 mph (30 km/h)~110 mph (180 km/h): when there is no vehicle in front
- 0 mph (0 km/h)~110 mph (180 km/h): when there is a vehicle in front



3. Push the lever down (SET-), and release it at the desired speed. The Set Speed and Vehicle-to-Vehicle Distance on the LCD display will illuminate.

4. Release the accelerator pedal. The desired speed will automatically be maintained.

If there is a vehicle in front of you, the speed may decrease to maintain the distance to the vehicle ahead.

On a steep grade, the vehicle may slow down or speed up slightly while going uphill or downhill.

To increase Smart Cruise Control set speed



Follow either of these procedures:

- Push the lever up (RES+), and hold it. Your vehicle set speed will increase by 5 mph (10 km/h). Release the lever at the speed you want.
- Push the lever up (RES+), and release it immediately. The cruising speed will increase by 1.0 mph (1.0 km/h) each time you move the lever up in this manner.
- You can set the speed to 110 mph (180 km/h).

To decrease the Smart Cruise Control set speed



Follow either of these procedures:

- Push the lever down (SET-), and hold it. Your vehicle set speed will decrease by 5 mph (10 km/h). Release the lever at the speed you want.
- Push the lever down (SET-), and release it immediately. The cruising speed will decrease by 1.0 mph (1.0 km/h) each time you move the lever down in this manner.
- You can set the speed to 20 mph (30 km/h).

To temporarily accelerate with the Smart Cruise Control on

If you want to speed up temporarily when the Smart Cruise Control is on, depress the accelerator pedal. Increased speed will not interfere with Smart Cruise Control operation or change the set speed.

To return to the set speed, take your foot off the accelerator.

If you push the lever down (SET-) at increased speed, the cruising speed will be set again.

*** NOTICE**

Be careful when accelerating temporarily, because the speed is not controlled automatically at this time even if there is a vehicle in front of you.

Smart Cruise Control will be temporarily canceled when:

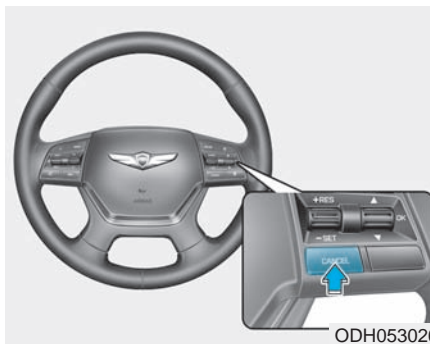

Cancelled manually

- Depressing the brake pedal.
- Pressing the CANCEL button located on the steering wheel.
- Depress the brake pedal and press the CANCEL button at the same time, when the vehicle is at a standstill.

The Advanced Smart Cruise Control turns off temporarily when the indicator on the LCD display turns off.

The CRUISE indicator is illuminated continuously.

Cancelled automatically

- The driver's door is opened.
- The shift lever is shifted to N (Neutral), R (Reverse) or P (Park).
- The EPB (Electric Parking Brake) is applied.
- The vehicle speed is over 120 mph (190 km/h)
- The vehicle stops on a steep incline.
- The ESC (Electronic Stability Control), TCS (Traction Control System) or ABS is operating.
- The ESC is turned off.
- The sensor or the cover is dirty or blocked with foreign matter.
- When the vehicle is stopped for more than 5 minutes.
- The vehicle stops and goes repeatedly for a long period of time.
- The driver starts driving by pushing the lever up (RES +) or down (SET -), approximately 3 seconds after the vehicle is stopped by the Smart Cruise Control System with no other vehicle ahead.

- The driver starts driving by pushing the lever up (RES +) or down (SET -), after stopping the vehicle with a vehicle stopped far away in front.
- The accelerator pedal is continuously depressed for more than one minute.

Each of these actions will cancel the Smart Cruise Control operation. (The Set Speed and Vehicle-to-Vehicle Distance on the LCD display will go off.)

In a condition the Smart Cruise Control is cancelled automatically, the Smart Cruise Control will not resume even though the RES+ or SET- lever is pushed. Also, the EPB will be applied when the vehicle is stopped.

* NOTICE

If the Smart Cruise Control is cancelled by other than the reasons mentioned, have your vehicle checked by an authorized HYUNDAI dealer.

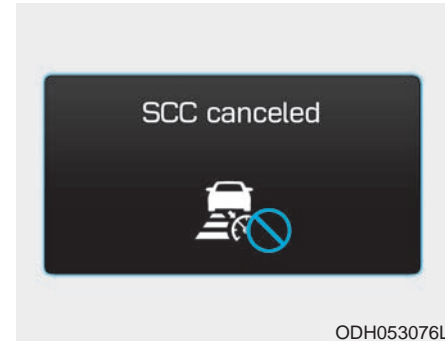

If the system is cancelled, the warning chime will sound and a message will appear for a few seconds.

You must adjust the vehicle speed by depressing the accelerator or brake pedal according to the road condition ahead and driving condition.

Always check the road conditions. Do not rely on the warning chime.

To resume Smart Cruise Control set speed



If any method other than the CRUISE lever was used to cancel cruising speed and the system is still activated, the cruising speed will automatically resume when you push the lever up (RES+) or down (SET-).

If you push the lever up (RES+), the speed will resume to the recently set speed. However, if vehicle speed has dropped below approximately 20 mph (30 km/h), it will resume when there is a vehicle in front of your vehicle.

* NOTICE

Always check the road conditions when you push the lever up (RES+) to resume speed.

To turn Cruise Control off

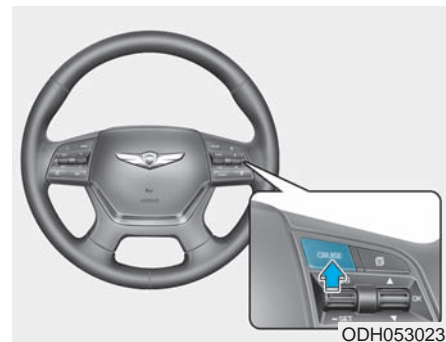

Push the CRUISE button (the CRUISE indicator light will go off).

Smart Cruise Control Vehicle-to-Vehicle Distance

To set Vehicle-to-Vehicle Distance

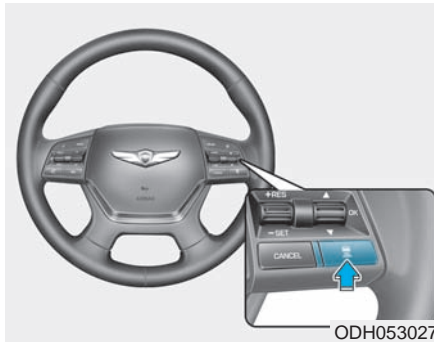

When the Smart Cruise Control System is ON, you can set and maintain the distance from the vehicle ahead of you without pressing the accelerator or brake pedal.

Each time the button is pressed, the vehicle to vehicle distance changes as follows:

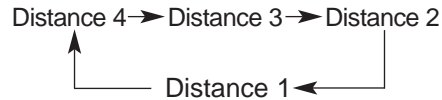

For example, if you drive at 56 mph (90 km/h), the distance maintain as follows:

- Distance 4 - approximately 172 feet (52.5 m)
- Distance 3 - approximately 130 feet (40 m)
- Distance 2 - approximately 106 feet (32.5 m)
- Distance 1 - approximately 82 feet (25 m)

* NOTICE

Distance 4 is always set when the system is used for the first time after starting the engine.

When the lane ahead is clear:

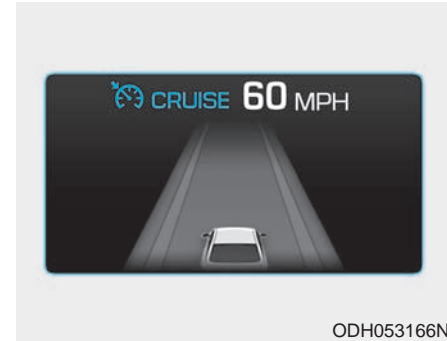

The vehicle speed will maintain the set speed.

When there is a vehicle ahead of you in your lane:



- Your vehicle speed will slow down or speed up to maintain the selected distance.

- If the vehicle ahead speeds up, your vehicle will travel at a steady cruising speed after accelerating to the set speed.

WARNING



When using the Smart Cruise Control System:

- The warning chime sounds and the Vehicle-to Vehicle Distance indicator blinks if the vehicle is unable to maintain the selected distance from the vehicle ahead.

(Continued)

(Continued)

- If the warning chime sounds, depress the accelerator or brake pedal to actively adjust the vehicle speed, and the distance to the vehicle ahead.
- Even if the warning chime is not activated, always pay attention to the driving conditions to prevent dangerous situations from occurring.



CAUTION

If the vehicle ahead (vehicle speed: less than 20 mph (30km/h)) disappears to the next lane, the warning chime will sound and a message will appear. Adjust your vehicle speed for vehicles or objects that can suddenly appear in front of you by depressing the brake pedal.

Always pay attention to the road condition ahead.

In traffic situation



- In traffic, your vehicle will stop if the vehicle ahead of you stops. Also, if the vehicle ahead of you starts moving, your vehicle will start as well. However, if the vehicle stops for more than 3 seconds, you must depress the accelerator pedal or push up the lever (RES+) to start driving.
- If you push the advanced smart cruise control lever (RES+ or SET-) while Auto Hold and advanced smart cruise control is operating (The green AUTO HOLD indicator), Auto Hold will be released regardless of accelerator pedal operation and the vehicle will start to move.

Sensor to detect distance to the vehicle ahead



The Smart Cruise Control uses a sensor to detect distance to the vehicle ahead.

Sensor warning message

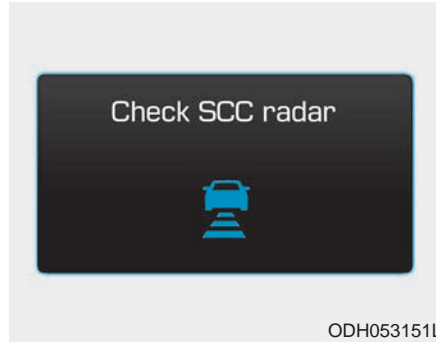

If the sensor or cover is dirty or obscured with foreign matter such as snow, this message will appear. In this case, the system may not function temporarily, but it does not indicate a malfunction of the Smart Cruise Control System. Clean the sensor or cover by using a soft cloth.

SCC (Smart Cruise Control) malfunction message

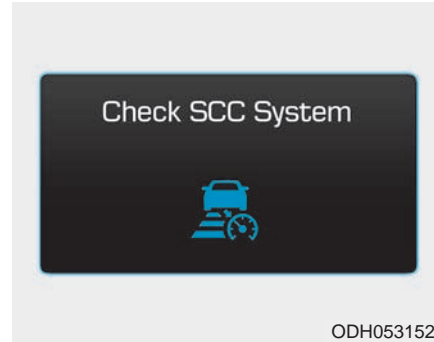

The message will appear when the vehicle to vehicle distance control system is not functioning normally. Take your vehicle to an authorized HYUNDAI dealer and have the system checked.

CAUTION

- Do not install accessories around the sensor and do not replace the bumper by yourself. It may interfere with the sensor performance.
- Always keep the sensor and bumper clean.
- To prevent sensor cover damage from occurring, wash the car with a soft cloth.
- Do not paint the sensor cover.
- Do not damage the sensor or sensor area by a strong impact. If the sensor moves slightly off position, the Smart Cruise Control System will not operate correctly. If this occurs, have your vehicle checked by an authorized HYUNDAI dealer.
- Use only a genuine HYUNDAI sensor cover for your vehicle.

Limitations of the system

The Smart Cruise Control System may have limits to its ability to detect distance to the vehicle ahead due to road and traffic conditions.

On curves

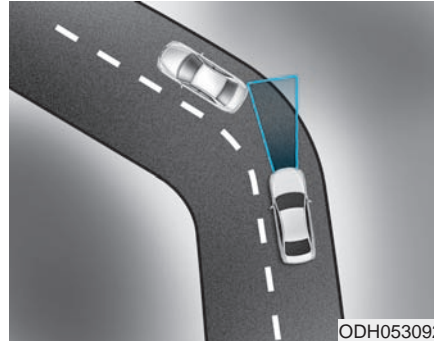

- The Smart Cruise Control System may not detect a moving vehicle in your lane, and then your vehicle could accelerate to the set speed. Also, the vehicle speed will decrease when the vehicle ahead is recognized suddenly.
- Select the appropriate set speed on curves and apply the brakes or accelerator pedal if necessary.

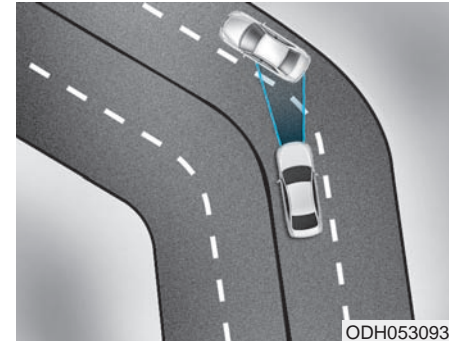

Your vehicle speed can be reduced due to a vehicle in the adjacent lane. Apply the accelerator pedal and select the appropriate set speed. Check to be sure that the road conditions permit safe operation of the Smart Cruise Control.

On inclines

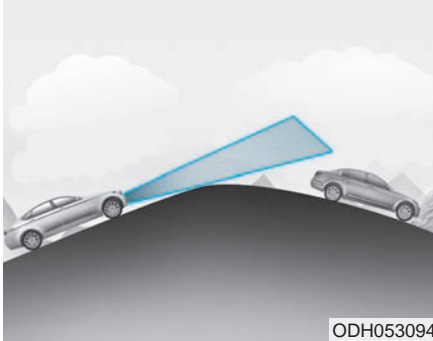

- During uphill or downhill driving, the Smart Cruise Control System may not detect a moving vehicle in your lane, and cause your vehicle to accelerate to the set speed. Also, the vehicle speed will rapidly decrease when the vehicle ahead is recognized suddenly.
- Select the appropriate set speed on inclines and apply the brake or accelerator pedal if necessary.

Lane changing

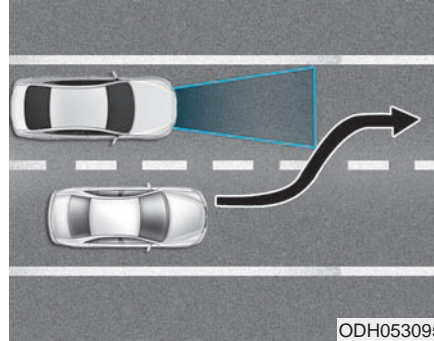

- A vehicle which moves into your lane from an adjacent lane cannot be recognized by the sensor until it is in the sensor's detection range.
- The sensor may not detect immediately when a vehicle cuts in suddenly. Always pay attention to the traffic, road and driving conditions.
- If a slower vehicle moves into your lane, your speed may decrease to maintain the distance to the vehicle ahead.
- If a faster vehicle which moves into your lane, your vehicle will accelerate to the set speed.

Vehicle recognition

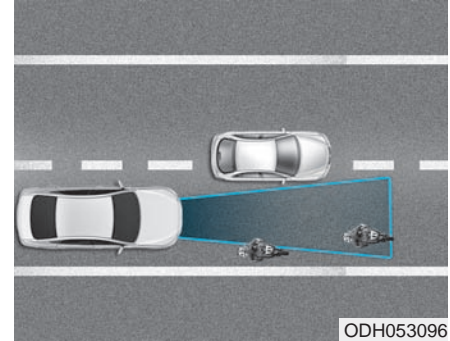

Some vehicles in your lane cannot be recognized by the sensor:

- Narrow vehicles such as motorcycles or bicycles
- Vehicles offset to one side
- Slow-moving vehicles or sudden-decelerating vehicles
- Stopped vehicles
- Vehicles with small rear profile such as trailers with no loads

Driving your vehicle

A vehicle ahead cannot be recognized correctly by the sensor if any of following occurs:

- When the vehicle is pointing upwards due to overloading in the trunk
- While the steering wheel is operating
- When driving to one side of the lane
- When driving on narrow lanes or on curves

Apply the brake or accelerator pedal if necessary.

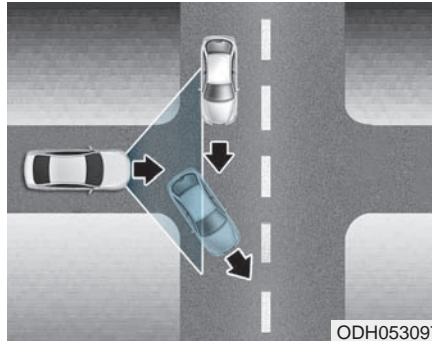

- Your vehicle may accelerate when a vehicle ahead of you disappears.
- When you are warned that the vehicle ahead of you is not detected, drive with caution.

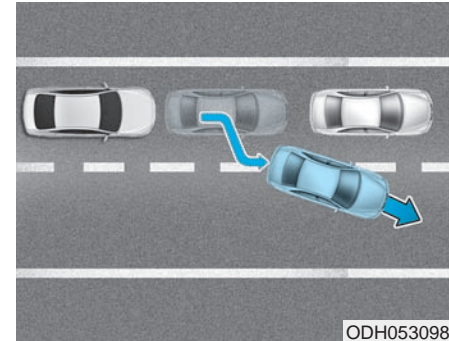

- When vehicles are at a standstill and the vehicle in front of you changes to the next lane, be careful when your vehicle starts to move because it may not recognize the stopped vehicle in front of you.

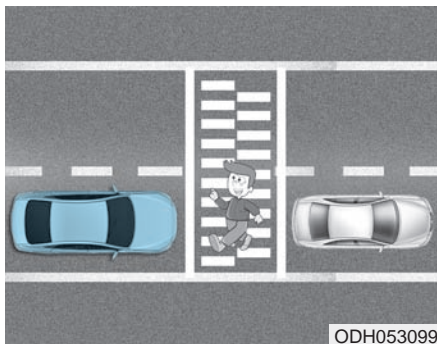

- Always look out for pedestrians when your vehicle is maintaining a distance with the vehicle ahead.

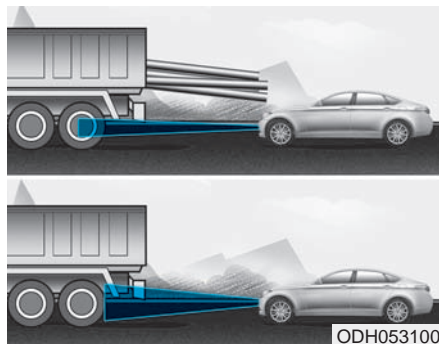

- Always be cautious for vehicles with higher height or vehicles carrying loads that sticks out from the back of the vehicle.

WARNING

When using the Smart Cruise Control take the following precautions:

- If an emergency stop is necessary, you must apply the brakes. The vehicle cannot be stopped at every emergency situation by using the Smart Cruise Control System.
- Keep a safe distance according to road conditions and vehicle speed. If the vehicle to vehicle distance is too close during a high-speed driving, a serious collision may result.
- Always maintain sufficient braking distance and decelerate your vehicle by applying the brakes if necessary.

(Continued)

(Continued)

- The Smart Cruise Control System cannot recognize a stopped vehicle, pedestrians or an oncoming vehicle. Always look ahead cautiously to prevent unexpected and sudden situations from occurring.
- Vehicles moving in front of you with a frequent lane change may cause a delay in the system's reaction or may cause the system to react to a vehicle actually in an adjacent lane. Always drive cautiously to prevent unexpected and sudden situations from occurring.
- Always be aware of the selected speed and vehicle to vehicle distance.

(Continued)

(Continued)

- The Smart Cruise Control System may not recognize complex driving situations so always pay attention to driving conditions and control your vehicle speed.

 **CAUTION**

The Smart Cruise Control System may not operate temporarily due to electrical interference.

This device complies with Part 15 of the FCC rules.

Operation is subject to the following two conditions:

1. This device may not cause harmful interference, and
2. This device must accept any interference received, including interference that may cause undesired operation.

LANE KEEPING ASSIST SYSTEM (LKAS) (IF EQUIPPED)

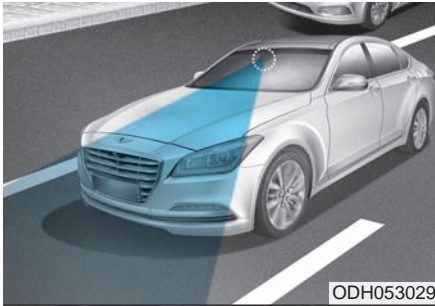

ODH053029

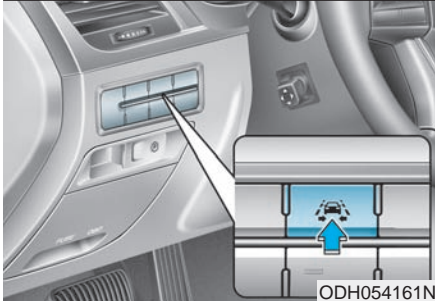

ODH054161N

The Lane Keeping Assist System detects lane markers on the road, and assists the driver's steering to help keep the vehicle between lanes.

When the system detects the vehicle straying from its lane, it alerts the driver with a visual and steering wheel vibration warning, while applying a slight counter-steering torque, trying to prevent the vehicle from moving out of its lane.

WARNING

The lane keeping assist system is not a substitute for safe driving practices, but a convenience function only. It is the responsibility of the driver to always be aware of the surrounding and steer the vehicle.

WARNING

Take the following precautions when using the Lane Keeping Assist System (LKAS):

- The steering wheel is not continuously controlled so if the vehicle speed is at a higher rate when leaving a lane the vehicle may not be controlled by the system.
- Do not steer the steering wheel suddenly when the steering wheel is being assisted by the system.
- LKAS prevents the driver from moving out of the lane unintentionally by assisting the driver's steering. However, the driver should not solely rely on the system but always pay attention on the steering wheel to stay in the lane.

(Continued)

(Continued)

- Always check the road condition and surroundings and be cautious when the system cancels, does not operate or malfunctions.
- Do not place any accessories, stickers or tint the windshield near the rearview mirror.
- The system detects lane lines and controls the steering wheel by a camera, therefore, if the lane lines are hard to detect, the system may not work properly.

Please refer to "Driver's Attention".

- Do not remove the LKAS parts and do not damage the sensor.
- Do not place objects on the dashboard that reflects light such as mirrors, white paper, etc. The system may malfunction if the sunlight is reflected.

(Continued)

(Continued)

- The operation of the LKAS can be affected by several factors (including environmental conditions). It is the responsibility of the driver to pay attention to the roadway and to maintain the vehicle in its lane at all times.
- Always have your hands on the steering wheel while the LKAS system is activated. If you continue to drive with your hands off the steering wheel after the "Keep hands on steering wheel" warning illumination, the system will turn off automatically.
- Always be cautious when using the system.

LKAS operation

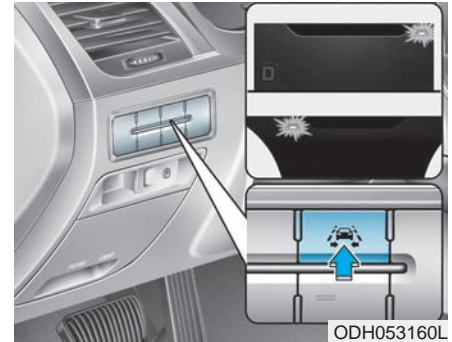

To operate:

Press the LKAS button with the Engine Start/Stop button in the ON position. The indicator (white) illuminates on the cluster.

To cancel:

Press the LKAS button again. The indicator on the cluster will go off.

LKAS activation

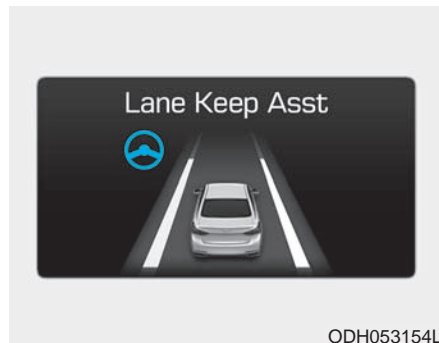

- The LKAS screen will appear on the LCD display if the system is activated.
- When both lane lines are detected and all the conditions to activate the LKAS are satisfied (green steering wheel indicator will illuminate and the LKAS indicator light will change from white to green), the steering wheel will be controlled.

WARNING

The Lane Keeping Assist System is a system to prevent the driver from leaving the lane. However, the driver should not solely rely on the system but always check the road conditions when driving.

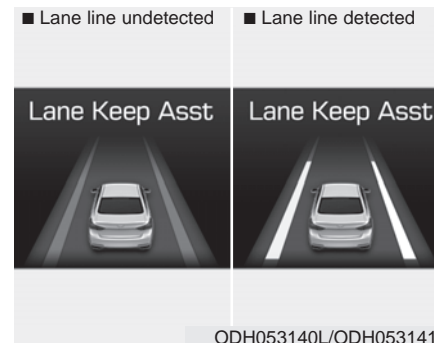

If the system detects a lane line, the color changes from gray to white.

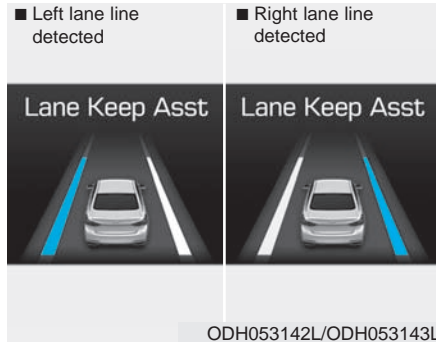

- If the system detects the left lane line, the left lane line color will change from gray to white.
- If the system detects the right lane line, the right lane line color will change from gray to white.
- Both lane lines must be detected for the system to fully activate.

Warning



- If you cross a lane line, the lane line you cross will blink (yellow) on the LCD display with steering wheel vibration warning.
- If the steering wheel appears, the system will control the vehicle's steering to prevent the vehicle from crossing the lane line.



If all the conditions to activate LKAS is not satisfied, the system will convert to LDWS and warn the driver only when the driver crosses the lane lines.



ODH053146L

If the driver takes one's hands off the steering wheel while the LKAS is activated, the system will warn the driver after several seconds with a visual and acoustic warning.

WARNING

The warning message may appear late according to road conditions. Therefore, always have your hands on the steering wheel while driving.



ODH053149L

If the driver still does not have one's hand on the steering wheel after several seconds, the system will be automatically turned off.

WARNING

- The driver is responsible for accurate steering.
- Turn off the system and drive the vehicle in below situations.
 - In bad weather
 - In bad road condition
 - When the steering wheel needs to be controlled by the driver frequently.

* NOTICE

- Even though the steering is assisted by the system, the driver may control the steering wheel.
- The steering wheel may feel heavier when the steering wheel is assisted by the system than when it is not.



A message will appear on the LCD display if the condition to activate the LKAS is not satisfied. Also, there will be an acoustic warning. The warning will disappear when the conditions are met.

The system will be cancelled when:

- Vehicle speed is below 40 mph (60 km/h) and over 110 mph (180 km/h).
- Only one lane line is detected.
- Using the turn signal to change lanes. If you change lanes without the turn signal on, the steering wheel might be controlled.
- The hazard warning flasher is on.
- The width of the lane is below 10 feet (3.1 m) and over 15 feet (4.5 m).
- ESC (Electronic Stability Control) is activated.
- When the system is on or after changing a lane, drive in the middle of the lane.
- The steering will not be assisted when you drive fast on a sharp curve.
- The steering will not be assisted when you change lanes fast.
- The steering will not be assisted when you brake suddenly.

DRIVER'S ATTENTION

The driver must be cautious in the below situations may not work properly when:

- The lane is not visible due to snow, rain, stain, a puddle or other factors.
- The brightness outside changes suddenly such as when entering or exiting a tunnel.
- The headlamps are not on at night or in a tunnel, or light level is low.
- It is difficult to distinguish the color of the lane marking from the road or the lane line is damaged or indistinct.
- Driving on a steep grade or a curve.
- Light such as street light, sunlight or oncoming vehicle light reflects from the water on the road.
- The lens or windshield is covered with foreign matter.
- The sensor cannot detect the lane because of fog, heavy rain, or heavy snow.
- The surrounding of the inside rear view mirror temperature is high due to direct sun light.

(Continued)

(Continued)

- The lane is very wide or narrow.
- The windshield is fogged by humid air in the vehicle.
- A shadow is on the lane line.
- There is a mark that looks like a lane line.
- There is a boundary structure, such as a concrete barrier.
- The distance from the vehicle ahead is very short or the vehicle ahead drives covering the lane line.
- The vehicle vibrates heavily due to road conditions.
- The number of lanes increases or decreases or the lane lines are crossing.
- Putting something on the dashboard.
- Driving with the sun in front of you.
- Driving in areas under construction.
- There are more than two lane lines.
- The lane is merged or divided.
- Driving through a toll plaza or toll gate.

LKAS malfunction

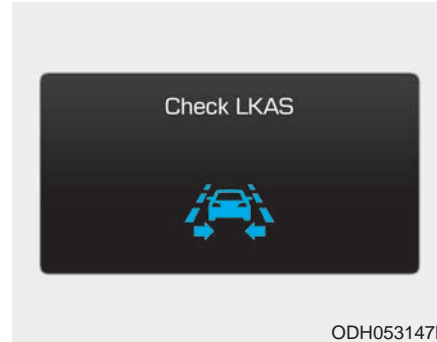

If there is a problem with the system a message will appear for 2 seconds. If the problem continues the LKAS failure indicator will illuminate.

LKAS failure indicator

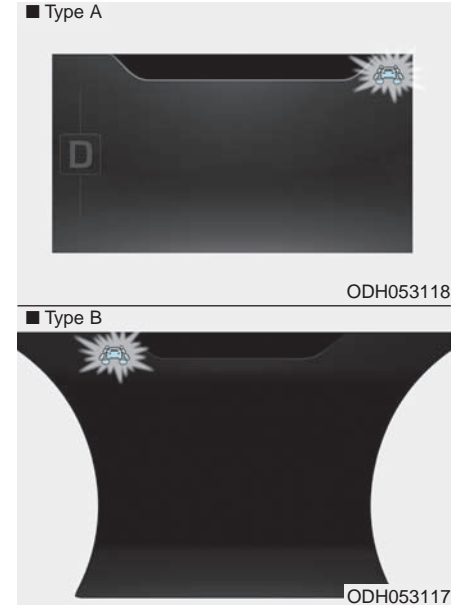

The LKAS failure indicator (yellow) will illuminate if the LKAS is not working properly. Have your vehicle checked by an authorized HYUNDAI dealer.

When there is a problem with the system do one of the following:

- Turn the system on after turning the engine off and on again.
- Check if the Engine Start/Stop button is in the ON position.
- Check if the system is affected by the weather. (ex: fog, heavy rain, etc.)
- Check if there is foreign matter on the camera lens.

If the problem is not solved, have your vehicle checked by an authorized HYUNDAI dealer.

LKAS function change

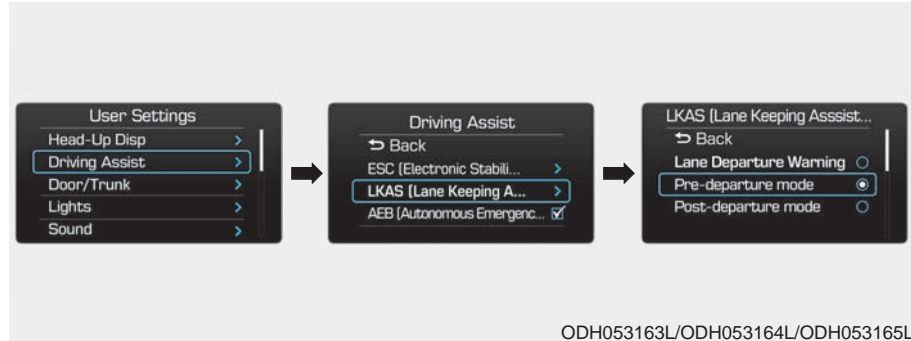

The driver can change LKAS to Lane Departure Warning System (LDWS) or change the LKAS mode between Pre-Departure Control and Post-Departure Control from the User Settings Mode on the LCD display. The system is automatically set to Pre-Departure Control if a function is not selected.

Lane Departure Warning System (LDWS)

LDWS alerts the driver with a visual warning and steering wheel vibration warning when the system detects the vehicle departing the lane. The steering wheel will not be controlled.

Pre-Departure Control

LKAS assists the driver by controlling the steering wheel before lane departure. When the vehicle is near the edge of the lane, LKAS starts controlling the steering wheel to assist the driver to stay in the lane.

Post-Departure Control

LKAS assists the driver by controlling the steering wheel when lane departure has started. When the vehicle's front wheel contacts the inside edge of lane line, LKAS starts controlling the steering wheel to assist the driver to stay in the lane.

This device complies with Part 15 of the FCC rules.

Operation is subject to the following two conditions:

1. This device may not cause harmful interference, and
2. This device must accept any interference received, including interference that may cause undesired operation.

BLIND SPOT DETECTION SYSTEM (BSD) (IF EQUIPPED)

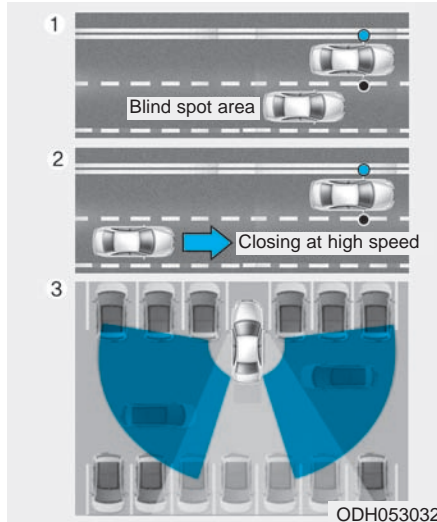

The Blind Spot Detection System (BSD) uses a radar sensor to alert the driver.

It senses the rear side territory of the vehicle and provides an indication to the driver if it detects an object approaching from these areas.

(1) BSD (Blind Spot Detection)

The warning range depends on your vehicle speed. However, if your vehicle is much faster than the other vehicle, the system will not warn you.

(2) LCA (Lane Change Assist)

If the system detects a vehicle approaching you at high speed, the system will warn you.

(3) RCTA (Rear Cross Traffic Alert)

If the sensor detects an approaching vehicle from the left and right side as your vehicle moves rearward, the system will warn you.

⚠ WARNING

- Always check the road condition while driving for unexpected situations even though the Blind Spot Detection System (BSD) is operating.
- The Blind Spot Detection System (BSD) is a supplemental system to assist you. Do not solely rely on the system and always pay attention and drive safely.
- The Blind Spot Detection System (BSD) is not a substitute for proper and safe driving. Always drive safely and use caution when changing lanes or backing the vehicle up. The Blind Spot Detection System (BSD) may not detect every object alongside the vehicle.

⚠ WARNING

As the Blind Spot Detection (BSD) system is a supplemental device for your safe driving, it may be dangerous to rely on only the BSD information of the head up display image when changing the lane. Always pay attention to drive safely.

BSD (Blind Spot Detection) / LCA (Lane Change Assist)

Operating conditions

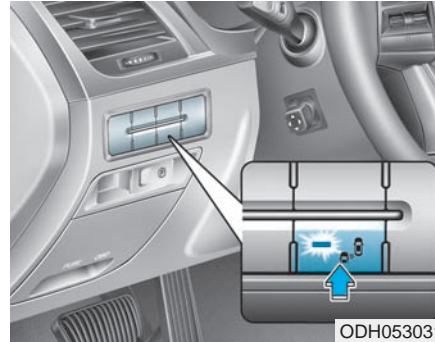

To operate:

Press the BSD switch with the Engine Start/Stop button in the ON position. The indicator illuminates on the switch. If vehicle speed exceeds 20 mph (30km/h) the system will activate.

To cancel:

Press the BSD switch again. The indicator on the switch will go off.

When the system is not used, turn the system off by turning off the switch.

*** NOTICE**

- If the engine is turned off and on, the system returns to the previous state.
- When the system is turned on, the warning light will illuminate for 3 seconds on the outside rearview mirror.

Warning type

The system will activate when:

1. The system is on.
2. Vehicle speed is above about 20 mph (30 km/h).
3. Other vehicles are detected in the rear side.

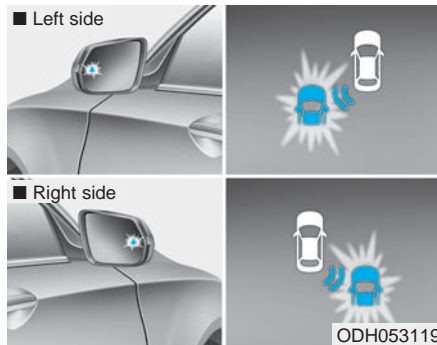

First stage alert

If a vehicle is detected within the boundary of the system, a warning light will illuminate on the outside rearview mirror and the head up display.

If the detected vehicle is not in warning range, the warning will turn off according to driving conditions.



Second stage alert

The second stage alarm will activate when:

1. The first stage alert is on.
2. The turn signal light is on to change a lane.

When the second stage alert is activated, a warning light will blink on the outside rearview mirror, the head up display and an alarm will sound. Also, a steering wheel will vibrate (if equipped with LKAS).

If you turn off the turn signal light, the second stage alert will be deactivated.

Detecting sensor



The sensors are located inside of the rear bumper.

Always keep the rear bumper clean for the system to work properly.

Warning message

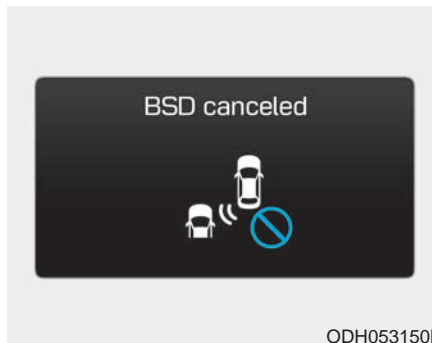

The message will appear to notify the driver if there are foreign substances on the rear bumper. The light on the switch and the system will turn off automatically.

Remove the foreign substance on the rear bumper.

After the foreign substance is removed, if you drive for approximately 10 minutes, the system will work normally.

If the system does not work normally even though the foreign substance is removed, take your vehicle to an authorized HYUNDAI dealer and have the system checked.

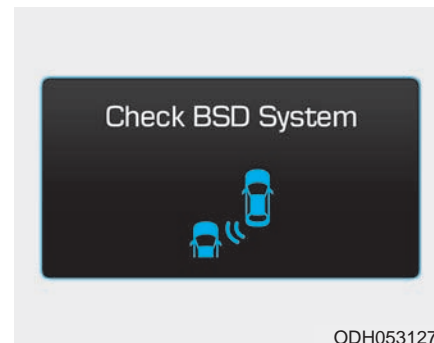

If the system does not work properly, a warning message will appear and the light on the switch will turn off. The system will turn off automatically. Have your vehicle checked by an authorized HYUNDAI dealer.

RCTA (Rear Cross Traffic Alert)

Operating conditions

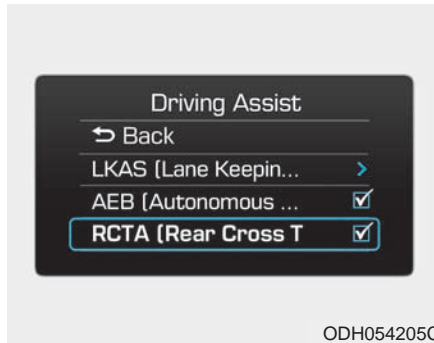

To operate:

Go to the User Settings Mode (Driving Assist) and select RCTA (Rear Cross Traffic Alert) on the LCD display (**For more details, refer to "LCD Display" in chapter 3.**). The system will turn on and standby to activate. The system will activate when vehicle speed is below 6 mph (10 km/h) with the shift lever in R (Reverse).

* NOTICE

The RCTA (Rear Cross Traffic Alert) detecting range is about 1 feet (0.5 m) ~ 65 feet (20 m). A vehicle will be detected if the vehicle speed is 2.5 mph (4 km/h) ~ 22 mph (36 km/h) within the detecting range. However, the detecting range may change under different conditions. Always pay attention to the surroundings.

Warning type



If the vehicle detected by the sensors approaches your vehicle, the warning chime will sound, the warning light on the outside rearview mirror will blink and a message will appear on the LCD display.

* NOTICE

- If the detected vehicle is out of the sensing range of your vehicle, move the vehicle away from the detected object slowly; the warning will be cancelled.
- The system may not operate properly due to other factors or circumstances. Always pay attention to your surrounding.
- If your vehicle's left or right side bumper is blinded by barrier or vehicles, the system sensing ability may be reduced.

WARNING

- The warning light on the outside rearview mirror will illuminate whenever a vehicle is detected at the rear side by the system.

To avoid accidents, do not focus only on the warning light and neglect to see the surrounding of the vehicle.

- Drive safely even though the vehicle is equipped with a Blind Spot Detection System (BSD) and Rear Cross Traffic Alert (RCTA). Do not solely rely on the system but check your surrounding before changing lanes or backing the vehicle up.

The system may not alert the driver in some conditions so always check the surroundings while driving.

(Continued)

(Continued)

- The Blind Spot Detection System (BSD) and Rear Cross Traffic Alert (RCTA) are not a substitute for proper and safe driving practices. Always drive safely and use caution when changing lanes or backing the vehicles up. The Blind Spot Detection System (BSD) may not detect every object alongside the vehicle.

 **CAUTION**

- The system may not work properly if the bumper has been replaced or if repair work has been done near the sensor.
- The detection area differs according to the roads width. If the road is narrow the system may detect other vehicles in the next lane. In addition, if the road is very wide the system may not detect other vehicles.
- The system may turn off due to strong electromagnetic waves.

Non-operating condition

Outside rearview mirror may not alert the driver when:

- The outside rearview mirror housing is damaged or covered with debris.
- The window is covered with debris.
- The windows are severely tinted.

DRIVER'S ATTENTION

The driver must be cautious in the below situations for the system may not detect other vehicles or objects in certain circumstances.

- Curved roads, tollgates, etc.
- The surrounding of the sensor is polluted with rain, snow, mud, etc
- The rear bumper near the sensor is covered or hidden with a foreign matter such as a sticker, bumper guard, bicycle stand etc.
- The rear bumper is damaged or the sensor is out of place.
- The height of the vehicle is altered such as when the trunk is loaded with heavy objects, or there is low tire pressure etc.
- Bad weather such as heavy rain or snow.
- A fixed object is near such as a guardrail, tunnel, human and animal etc.
- Metal substances are near the vehicles such as in a construction area.
- A big vehicle is near such as a bus or truck.

(Continued)

(Continued)

- A motorcycle or bicycle is near.
- A flat trailer is near.
- If the vehicle has started at the same time as the vehicle next to you and has accelerated.
- When the other vehicle passes by at a higher rate of speed.
- When changing lanes.
- When going down or up a steep road where the height of the lane is different.
- When the other vehicle drives very close.
- When a trailer or carrier is installed.
- When the temperature of the rear bumper is high.
- When the sensors are covered by a wall or a pillar of a parking lot.
- When your vehicle is backing up, if the detected vehicle also backs up.
- Small objects like shopping carts and strollers.
- If there is a vehicle with decreased ride height (lowered).

(Continued)

(Continued)

- When the vehicle is close to another vehicle.
- When the vehicle in the next lane moves two lanes away from you OR when the vehicle two lanes away moves to the next lane from you.
- When driving through a narrow road with many trees or bushes.

This device complies with Part 15 of the FCC rules.

Operation is subject to the following two conditions:

1. This device may not cause harmful interference, and
2. This device must accept any interference received, including interference that may cause undesired operation.

SPECIAL DRIVING CONDITIONS

Hazardous driving conditions

When hazardous driving conditions are encountered such as water, snow, ice, mud or sand:

Drive cautiously and allow extra distance for braking.

Avoid sudden movements in braking or steering.

If stuck in snow, mud, or sand, use second gear. Accelerate slowly to avoid spinning the drive wheels.

WARNING

Downshifting with an automatic transmission while driving on slippery surfaces can cause an accident. The sudden change in tire speed could cause the tires to skid. Be careful when downshifting on slippery surfaces.

Use sand, rock salt, or other non-slip material under the drive wheels to provide traction when stuck in ice, snow, or mud.

Rocking the vehicle

If it is necessary to rock the vehicle to free it from snow, sand, or mud, first turn the steering wheel right and left to clear the area around your front wheels. Then, shift back and forth between R (Reverse) and a forward gear.

Try to avoid spinning the wheels, and do not race the engine.

To prevent transmission wear, wait until the wheels stop spinning before shifting gears. Release the accelerator pedal while shifting, and press lightly on the accelerator pedal while the transmission is in gear. Slowly spinning the wheels in forward and reverse directions causes a rocking motion that may free the vehicle.

WARNING

If the tires spin at high speed the tires can explode, and you or others may be injured. Do not attempt this procedure if people or objects are anywhere near the vehicle.

The vehicle can overheat causing an engine compartment fire or other damage. Spin the wheels as little as possible and avoid spinning the wheels at speeds over 35 mph (56 km/h) as indicated on the speedometer.



CAUTION

If you are still stuck after rocking the vehicle a few times, have the vehicle pulled out by a tow vehicle to avoid engine overheating, possible damage to the transmission, and tire damage. See “Towing” in chapter 6.

To prevent damage to the transmission, turn OFF the ESC prior to rocking the vehicle.

Smooth cornering

Avoid braking or gear changing in corners, especially when roads are wet. Ideally, corners should always be taken under gentle acceleration.

Driving at night

Night driving presents more hazards than driving in the daylight. Here are some important tips to remember:

- Slow down and keep more distance between you and other vehicles, as it may be more difficult to see at night, especially in areas where there may not be any street lights.
- Adjust your mirrors to reduce the glare from other driver's headlamps.
- Keep your headlamps clean and properly aimed. Dirty or improperly aimed headlamps will make it much more difficult to see at night.
- Avoid staring directly at the headlamps of oncoming vehicles. You could be temporarily blinded, and it will take several seconds for your eyes to readjust to the darkness.

Driving in the rain

Rain and wet roads can make driving dangerous. Here are a few things to consider when driving in the rain or on slick pavement:

- Slow down and allow extra following distance. A heavy rainfall makes it harder to see and increases the distance needed to stop your vehicle.
- Turn OFF your Cruise Control. (if equipped)
- Replace your windshield wiper blades when they show signs of streaking or missing areas on the windshield.
- Be sure your tires have enough tread. If your tires do not have enough tread, making a quick stop on wet pavement can cause a skid and possibly lead to an accident.

Refer to "Tire Tread" in chapter 7.

- Turn on your headlamps to make it easier for others to see you.
- Driving too fast through large puddles can affect your brakes. If you must go through puddles, try to drive through them slowly.

- If you believe your brakes may be wet, apply them lightly while driving until normal braking operation returns.

Hydroplaning

If the road is wet enough and you are going fast enough, your vehicle may have little or no contact with the road surface and actually ride on the water. The best advice is SLOW DOWN when the road is wet. The risk of hydroplaning increases as the depth of tire tread decreases. **(Refer to "Tire Tread" in chapter 7.)**

Driving in flooded areas

Avoid driving through flooded areas unless you are sure the water is no higher than the bottom of the wheel hub. Drive through any water slowly. Allow adequate stopping distance because brake performance may be reduced.

After driving through water, dry the brakes by gently applying them several times while the vehicle is moving slowly.

WINTER DRIVING

Snow or icy conditions

You need to keep sufficient distance between your vehicle and the vehicle in front of you.

Apply the brakes gently. Speeding, rapid acceleration, sudden brake applications, and sharp turns are potentially very hazardous practices. During deceleration, use engine braking to the fullest extent. Sudden brake applications on snowy or icy roads may cause skids to occur.

To drive your vehicle in deep snow, it may be necessary to use snow tires or to install tire chains on your tires.

Always carry emergency equipment. Some of the items you may want to carry include tire chains, tow straps or chains, a flashlight, emergency flares, sand, a shovel, jumper cables, a window scraper, gloves, ground cloth, coveralls, a blanket, etc.

Snow tires

We recommend you use snow tires when road temperature is below 45°F (7°C). Refer to the below chart, and mount the recommended snow tire for your vehicle.

Standard tire				Recommended snow tire			
Front		Rear		Front		Rear	
Tire size	Wheel size	Tire size	Wheel size	Tire size	Wheel size	Tire size	Wheel size
245/45R18	8.0Jx18	245/45R18	8.0Jx18	245/45R18	8.0Jx18	245/45R18	8.0Jx18
				245/40R19	8.5Jx19	245/40R19 or 275/35R19	8.5Jx19 or 9.0Jx19
245/40R19	8.5Jx19	275/35R19	9.0Jx19	245/40R19	8.5Jx19	245/40R19 or 275/35R19	8.5Jx19 or 9.0Jx19

If you mount snow tires on your vehicle, make sure to use the same inflation pressure as the original tires. However, if you mount 245/40R19 size tire on the rear, the tire inflation pressure should maintain 35psi. Mount snow tires on all four wheels to balance your vehicle's handling in all weather conditions. The traction provided by snow tires on dry road may not be as high as your vehicle's original equipment tires. Check with the tire dealer for maximum speed recommendations.

* NOTICE

Do not install studded tires without first checking local, state and municipal regulations for possible restrictions against their use.

Tire chains



Since the sidewalls on some radial tires are thinner than other types of tires, they may be damaged by mounting certain types of tire chains on them. Therefore, the use of snow tires is recommended instead of tire chains. Do not mount tire chains on vehicles equipped with aluminum wheels; if unavoidable use AutoSock® (fabric snow chain). Install the tire chain after reviewing the instructions provided with the tire chains. Damage to your vehicle caused by improper tire chain use is not covered by your vehicle manufacturer's warranty.

WARNING

The use of AutoSock® (fabric snow chain) may adversely affect vehicle handling:

- Drive less than 20 mph (30 km/h) or the chain manufacturer's recommended speed limit, whichever is lower.
- Drive carefully and avoid bumps, holes, sharp turns, and other road hazards, which may cause the vehicle to bounce.
- Avoid sharp turns or locked wheel braking.

AutoSock® is a Registered trademark of AutoSock.

* NOTICE

- **Install AutoSock® (fabric snow chain) on the rear tires for 2WD vehicles or on all four tires for AWD vehicles. It should be noted that installing AutoSock® (fabric snow chain) on the tires will provide a greater driving force, but will not prevent side skids.**
- **Do not install studded tires without first checking local, state and municipal regulations for possible restrictions against their use.**

Chain Installation

When installing AutoSock® (fabric snow chain), follow the manufacturer's instructions and mount them as tightly possible. Drive slowly (less than 20 mph (30 km/h)) with chains installed. If you hear the chains contacting the body or chassis, stop and tighten them. If they still make contact, slow down until the noise stops. Remove the AutoSock® (fabric snow chain) as soon as you begin driving on cleared roads.

When mounting AutoSock® (fabric snow chain), park the vehicle on level ground away from traffic.

Turn on the vehicle Hazard Warning Flasher and place a triangular emergency warning device behind the vehicle (if available).

Always place the vehicle in P (Park), apply the parking brake and turn off the engine before installing tire chains.

CAUTION

When using AutoSock® (fabric snow chain):

- **Wrong size chains or improperly installed chains can damage your vehicle's brake lines, suspension, body and wheels.**
- **If you hear noise caused by chains contacting the body, retighten the chain to prevent contact with the vehicle body.**
- **To prevent body damage, retighten the chains after driving 0.3~0.6 miles (0.5~1.0 km).**

AutoSock® is a Registered trademark of AutoSock.

Winter precaution

Use high quality ethylene glycol coolant

Your vehicle is delivered with high quality ethylene glycol coolant in the cooling system. It is the only type of coolant that should be used because it helps prevent corrosion in the cooling system, lubricates the water pump and prevents freezing. Be sure to replace or replenish your coolant in accordance with the maintenance schedule in section 7. Before winter, have your coolant tested to assure that its freezing point is sufficient for the temperatures anticipated during the winter.

Check battery and cables

Winter puts additional burdens on the battery system. Visually inspect the battery and cables as described in section 7. The level of charge in your battery can be checked by an authorized HYUNDAI dealer or a service station.

Change to "winter weight" oil if necessary

In some climates it is recommended that a lower viscosity "winter weight" oil be used during cold weather. See section 8 for recommendations. If you aren't sure what weight oil you should use, consult an authorized HYUNDAI dealer.

Check spark plugs and ignition system

Inspect your spark plugs as described in section 7 and replace them if necessary. Also check all ignition wiring and components to be sure they are not cracked, worn or damaged in any way.

To keep locks from freezing

To keep the locks from freezing, squirt an approved de-icer fluid or glycerine into the key opening. If a lock is covered with ice, squirt it with an approved de-icing fluid to remove the ice. If the lock is frozen internally, you may be able to thaw it out by using a heated key. Handle the heated key with care to avoid injury.

Use approved window washer anti-freeze in system

To keep the water in the window washer system from freezing, add an approved window washer anti-freeze solution in accordance with instructions on the container. Window washer anti-freeze is available from an authorized HYUNDAI dealer and most auto parts outlets. Do not use engine coolant or other types of anti-freeze as these may damage the paint finish.

Don't let your parking brake freeze

Under some conditions your parking brake can freeze in the engaged position. This is most likely to happen when there is an accumulation of snow or ice around or near the rear brakes or if the brakes are wet. If there is a risk of the parking brake may freezing, apply it only temporarily while you put the shift lever in P (automatic transaxle) or in first or reverse gear (manual transaxle) and block the rear wheels so the vehicle cannot roll. Then release the parking brake.

Don't let ice and snow accumulate underneath

Under some conditions, snow and ice can build up under the fenders and interfere with the steering. When driving in severe winter conditions where this may happen, you should periodically check underneath the car to be sure the movement of the front wheels and the steering components is not obstructed.

Carry emergency equipment

Depending on the severity of the weather where you drive your car, you should carry appropriate emergency equipment. Some of the items you may want to carry include tire chains, tow straps or chains, flashlight, emergency flares, sand, a shovel, jumper cables, a window scraper, gloves, ground cloth, coveralls, a blanket, etc.

Don't place foreign objects or materials in the engine compartment

Placement of foreign objects or materials which prevent cooling of the engine, in the engine compartment, may cause a failure or combustion. The manufacturer is not responsible for the damage caused by such placement.

VEHICLE LOAD LIMIT

Two labels on your driver's door sill show how much weight your vehicle was designed to carry: the Tire and Loading Information Label and the Certification Label.

Before loading your vehicle, familiarize yourself with the following terms for determining your vehicle's weight ratings, from the vehicle's specifications and the Certification Label:

Base Curb Weight

This is the weight of the vehicle including a full tank of fuel and all standard equipment. It does not include passengers, cargo, or optional equipment.

Vehicle Curb Weight

This is the weight of your new vehicle when you picked it up from your dealer plus any aftermarket equipment.

Cargo Weight

This figure includes all weight added to the Base Curb Weight, including cargo and optional equipment.

GAW (Gross Axle Weight)

This is the total weight placed on each axle (front and rear) - including vehicle curb weight and all payload.

GAWR (Gross Axle Weight Rating)

This is the maximum allowable weight that can be carried by a single axle (front or rear). These numbers are shown on the Certification Label. The total load on each axle must never exceed its GAWR.

GVW (Gross Vehicle Weight)

This is the Base Curb Weight plus actual Cargo Weight plus passengers.

GVWR (Gross Vehicle Weight Rating)

This is the maximum allowable weight of the fully loaded vehicle (including all options, equipment, passengers and cargo). The GVWR is shown on the Certification Label located on the driver's door sill.

Tire loading information label

TIRE AND LOADING INFORMATION
RENSEIGNEMENTS SUR LES PNEUS ET LE CHARGEMENT

SEATING CAPACITY / NOMBRE DE PLACES: TOTAL 5, FRONT 2, REAR 3

The combined weight of occupants and cargo should never exceed 410 kg or 904 lbs.
Le poids total des occupants et du chargement ne doit jamais dépasser 410 kg ou 904 lb.

TIRE PNEU	SIZE DIMENSIONS	COLD TIRE PRESSURE / PRESSION DES PNEUS À FROID	SEE OWNER'S MANUAL FOR ADDITIONAL INFORMATION / VOIR LE MANUEL DE L'USAGER POUR PLUS DE RENSEIGNEMENTS
FRONT AVANT	245/40R19	230kPa, 33psi	
REAR ARRIÈRE	275/35R19	240kPa, 35psi	
SPARE DE SECOURS	T135/70R19	420kPa, 60psi	

ODH054201N

TIRE AND LOADING INFORMATION
RENSEIGNEMENTS SUR LES PNEUS ET LE CHARGEMENT

SEATING CAPACITY / NOMBRE DE PLACES: TOTAL 5, FRONT 2, REAR 3

The combined weight of occupants and cargo should never exceed 410 kg or 904 lbs.
Le poids total des occupants et du chargement ne doit jamais dépasser 410 kg ou 904 lb.

TIRE PNEU	SIZE DIMENSIONS	COLD TIRE PRESSURE / PRESSION DES PNEUS À FROID	SEE OWNER'S MANUAL FOR ADDITIONAL INFORMATION / VOIR LE MANUEL DE L'USAGER POUR PLUS DE RENSEIGNEMENTS
FRONT AVANT	245/40R19	240kPa, 35psi	
REAR ARRIÈRE	275/35R19	240kPa, 35psi	
SPARE DE SECOURS	T135/70R19	420kPa, 60psi	

ODH054203N

TIRE AND LOADING INFORMATION
RENSEIGNEMENTS SUR LES PNEUS ET LE CHARGEMENT

SEATING CAPACITY / NOMBRE DE PLACES: TOTAL 5, FRONT 2, REAR 3

The combined weight of occupants and cargo should never exceed 410 kg or 904 lbs.
Le poids total des occupants et du chargement ne doit jamais dépasser 410 kg ou 904 lb.

TIRE PNEU	SIZE DIMENSIONS	COLD TIRE PRESSURE / PRESSION DES PNEUS À FROID	SEE OWNER'S MANUAL FOR ADDITIONAL INFORMATION / VOIR LE MANUEL DE L'USAGER POUR PLUS DE RENSEIGNEMENTS
FRONT AVANT	245/45R18	230kPa, 33psi	
REAR ARRIÈRE	245/45R18	230kPa, 33psi	
SPARE DE SECOURS	T135/80R18	420kPa, 60psi	

ODH054202N

The label located on the driver's door sill gives the original tire size, cold tire pressures recommended for your vehicle, the number of people that can be in your vehicle and vehicle capacity weight.

Vehicle capacity weight

904 lbs. (410 kg)

Vehicle capacity weight is the maximum combined weight of occupants and cargo. If your vehicle is equipped with a trailer, the combined weight includes the tongue load.

Seating capacity

Total : 5 persons

(Front seat : 2 persons,
Rear seat : 3 persons)

Seating capacity is the maximum number of occupants including a driver, your vehicle may carry. However, the seating capacity may be reduced based upon the weight of all of the occupants, and the weight of the cargo being carried or towed. Do not overload the vehicle as there is a limit to the total weight, or load limit including occupants and cargo, the vehicle can carry.

Towing capacity

We do not recommend using this vehicle for trailer towing.

Cargo capacity

The cargo capacity of your vehicle will increase or decrease depending on the weight and the number of occupants and the tongue load, if your vehicle is equipped with a trailer.







Steps for determining correct load limit

1. Locate the statement "The combined weight of occupants and cargo should never exceed XXX kg or XXX lbs." on your vehicle's placard.
2. Determine the combined weight of the driver and passengers that will be riding in your vehicle.
3. Subtract the combined weight of the driver and passengers from XXX kg or XXX lbs.
4. The resulting figure equals the available amount of cargo and luggage load capacity. For example, if the "XXX" amount equals 1400 lbs. and there will be five 150 lb. passengers in your vehicle, the amount of available cargo and luggage load capacity is 650 lbs. (1400 - 750 (5 x 150) = 650 lbs.)
5. Determine the combined weight of luggage and cargo being loaded on the vehicle. That weight may not safely exceed the available cargo and luggage load capacity calculated in Step 4.

6. If your vehicle will be towing a trailer, load from your trailer will be transferred to your vehicle. Consult this manual to determine how this reduces the available cargo and luggage load capacity of your vehicle.

⚠ WARNING

Do not overload the vehicle as there is a limit to the total weight, or load limit, including occupants and cargo, the vehicle can carry. Overloading can shorten the life of the vehicle. If the GVWR or the GAWR is exceeded, parts on the vehicle can break, and it can change the handling of your vehicle. These could cause you to lose control and result in an accident.

<p>Example 1</p>	<p>Vehicle Capacity</p> <p>Maximum Load (1400 lbs.) (635 kg)</p>	<p>≥</p>	<p></p> <p>Passenger Weight (150 lbs. × 2 = 300 lbs.) (68 kg × 2 = 136 kg)</p>	<p>+</p>	<p></p> <p>Cargo Weight (1100 lbs.) (499 kg)</p>
<p>Example 2</p>	<p>Vehicle Capacity</p> <p>Maximum Load (1400 lbs.) (635 kg)</p>	<p>≥</p>	<p></p> <p>Passenger Weight (150 lbs. × 5 = 750 lbs.) (68 kg × 5 = 340 kg)</p>	<p>+</p>	<p></p> <p>Cargo Weight (650 lbs.) (295 kg)</p>
<p>Example 3</p>	<p>Vehicle Capacity</p> <p>Maximum Load (1400 lbs.) (635 kg)</p>	<p>≥</p>	<p></p> <p>Passenger Weight (172 lbs. × 5 = 860 lbs.) (78 kg × 5 = 390 kg)</p>	<p>+</p>	<p></p> <p>Cargo Weight (540 lbs.) (245 kg)</p>

Certification label

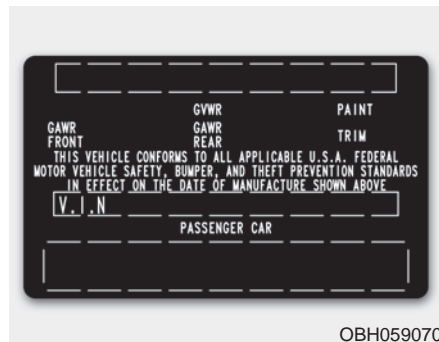

The certification label is located on the driver's door sill at the center pillar and shows the maximum allowable weight of the fully loaded vehicle. This is called the GVWR (Gross Vehicle Weight Rating). The GVWR includes the weight of the vehicle, all occupants, fuel and cargo.

This label also tells you the maximum weight that can be supported by the front and rear axles, called Gross Axle Weight Rating (GAWR).

The total weight of the vehicle, including all occupants, accessories, cargo, and trailer tongue load must not exceed the Gross Vehicle Weight Rating (GVWR) or the Gross Axle Weight Rating (GAWR). To find out the actual loads on your front and rear axles, you need to go to a weigh station and weigh your vehicle. Be sure to spread out your load equally on both sides of the centerline.

WARNING

Overloading

- Never exceed the GVWR for your vehicle, the GAWR for either the front or rear axle and vehicle capacity weight. Exceeding these ratings can affect your vehicle's handling and braking ability, and cause an accident.
- Do not overload your vehicle. Overloading your vehicle can cause heat buildup in your vehicle's tires and possible tire failure, increased stopping distances and poor vehicle handling—all of which may result in a crash.

 **CAUTION**

Overloading your vehicle may cause damage. Repairs would not be covered by your warranty. Do not overload your vehicle.

 **WARNING**

If you carry items inside your vehicle (e.g., suitcases, tools, packages, or anything else), they are moving as fast as the vehicle. If you have to stop or turn quickly, or if there is a crash, the items will keep going and can cause an injury if they strike the driver or a passenger.

- Put items in the cargo area of your vehicle. Try to spread the weight evenly.
- Do not stack items, like suitcases, inside the vehicle above the tops of the seats.
- Do not leave an unsecured child restraint in your vehicle.
- When you carry something inside the vehicle, secure it.

TRAILER TOWING

We do not recommend using this vehicle for trailer towing.

What to do in an emergency

Hazard warning flasher	6-2	If you have a flat tire.....	6-15
In case of an emergency while driving	6-2	Jack and tools	6-15
If the engine stalls while driving	6-2	Changing tires	6-16
If the engine stalls at a crossroad or crossing	6-2	Jack label.....	6-21
If you have a flat tire while driving.....	6-3	Towing	6-22
If the engine will not start	6-3	Towing service	6-22
If the engine doesn't turn over or turns over		Removable towing hook	6-23
slowly	6-3	Emergency towing	6-24
If the engine turns over normally but doesn't			
start.....	6-3		
Jump starting	6-4		
Push-starting	6-6		
If the engine overheats	6-7		
Tire Pressure Monitoring System (TPMS).....	6-9		
Check tire pressure.....	6-9		
Tire pressure monitoring system	6-10		
Low tire pressure telltale	6-11		
Low tire pressure position and tire pressure			
telltale	6-11		
TPMS (Tire Pressure Monitoring System)			
malfunction indicator	6-12		
Changing a tire with TPMS.....	6-13		

HAZARD WARNING FLASHER

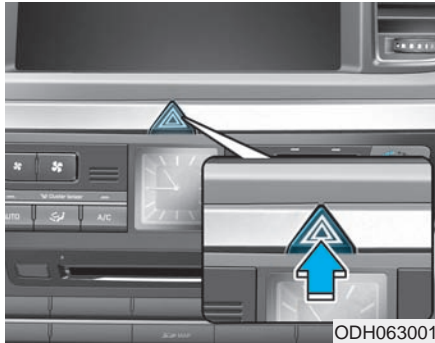

The hazard warning flasher serves as a warning to other drivers to exercise extreme caution when approaching, overtaking, or passing your vehicle.

It should be used whenever emergency repairs are being made or when the vehicle is stopped near the edge of a roadway.

To turn the hazard warning flasher on or off, press the hazard warning flasher button with the Engine Start/Stop button in any position. The button is located in the center fascia panel. All turn signal lights will flash simultaneously.

- The hazard warning flasher operates whether your vehicle is running or not.
- The turn signals do not work when the hazard flasher is on.

IN CASE OF AN EMERGENCY WHILE DRIVING

If the engine stalls while driving

- Reduce your speed gradually, keeping a straight line. Move cautiously off the road to a safe place.
- Turn on your hazard warning flasher.
- Try to start the engine again. If your vehicle will not start, contact an authorized HYUNDAI dealer or seek other qualified assistance.

If the engine stalls at a cross-road or crossing

If the engine stalls at a crossroad or crossing, if safe to do so, move the shift lever to the N (Neutral) position and then push the vehicle to a safe location.

If you have a flat tire while driving

If a tire goes flat while you are driving:

- Take your foot off the accelerator pedal and let the vehicle slow down while driving straight ahead. Do not apply the brakes immediately or attempt to pull off the road as this may cause loss of vehicle control resulting in an accident. When the vehicle has slowed to such a speed that it is safe to do so, brake carefully and pull off the road. Drive off the road as far as possible and park on firm, level ground. If you are on a divided highway, do not park in the median area between the two traffic lanes.
- When the vehicle is stopped, press the hazard warning flasher button, move the shift lever into P(Park), and apply the parking brake, and place the Engine Start/Stop button in the OFF position.
- Have all passengers get out of the vehicle. Be sure they all get out on the side of the vehicle that is away from traffic.
- When changing a flat tire, follow the instructions provided later in this chapter.

IF THE ENGINE WILL NOT START

If the engine doesn't turn over or turns over slowly

- Be sure the shift lever is in N (Neutral) or P (Park). The engine starts only when the shift lever is in N (Neutral) or P (Park).
- Check the battery connections to be sure they are clean and tight.
- Turn on the interior light. If the light dims or goes out when you operate the starter, the battery is drained.

Do not push or pull the vehicle to start it. This could cause damage to your vehicle. See instructions for "Jump Starting" provided in this chapter.

WARNING

Push or pull starting the vehicle may cause the catalytic converter to overload which can lead to damage to the emission control system.

If the engine turns over normally but doesn't start

- Check the fuel level and add fuel if necessary.

If the engine still does not start, have your vehicle checked by an authorized HYUNDAI dealer.

JUMP STARTING

Jump starting can be dangerous if done incorrectly. Follow the jump starting procedure in this section to avoid serious injury or damage to your vehicle. If in doubt about how to properly jump start your vehicle, we strongly recommend that you have a service technician or towing service do it for you.

WARNING

To prevent **SERIOUS INJURY** or **DEATH** to you or bystanders, always follow these precautions when working near or handling the battery:



Always read and follow instructions carefully when handling a battery.



Wear eye protection designed to protect the eyes from acid splashes.



Keep all flames, sparks, or smoking materials away from the battery.

(Continued)

(Continued)



Hydrogen is always present in battery cells, is highly combustible, and may explode if ignited.



Keep batteries out of reach of children.



Batteries contain sulfuric acid which is highly corrosive. Do not allow acid to contact your eyes, skin or clothing.

If acid gets into your eyes, flush your eyes with clean water for at least 15 minutes and get immediate medical attention. If acid gets on your skin, thoroughly wash the area. If you feel pain or a burning sensation, get medical attention immediately.

(Continued)

(Continued)

- When lifting a plastic-cased battery, excessive pressure on the case may cause battery acid to leak. Lift with a battery carrier or with your hands on opposite corners.
- Do not attempt to jump start your vehicle if your battery is frozen.
- NEVER attempt to recharge the battery when the vehicle's battery cables are connected to the battery.
- The electrical ignition system works with high voltage. NEVER touch these components with the engine running or when the Engine Start/Stop button is in the ON position.

* NOTICE



An inappropriately disposed battery can be harmful to the environment and human health. Dispose the battery according to your local law(s) or regulations.

! CAUTION

To prevent damage to your vehicle:

- Only use a 12-volt power supply (battery or jumper system) to jump start your vehicle.
- Do not attempt to jump start your vehicle by push-starting.

Jump starting procedure

* NOTICE

Your vehicle has a battery in the trunk compartment, but when you jump start your vehicle, use the jumper terminal in the engine compartment.

1. Position the vehicles close enough that the jumper cables will reach, but do not allow the vehicles to touch.
2. Avoid fans or any moving parts in the engine compartment at all times, even when the vehicles are turned off.
3. Turn off all electrical devices such as radios, lights, air conditioning, etc. Put the vehicles in P (Park) and set the parking brakes. Turn both vehicles OFF.

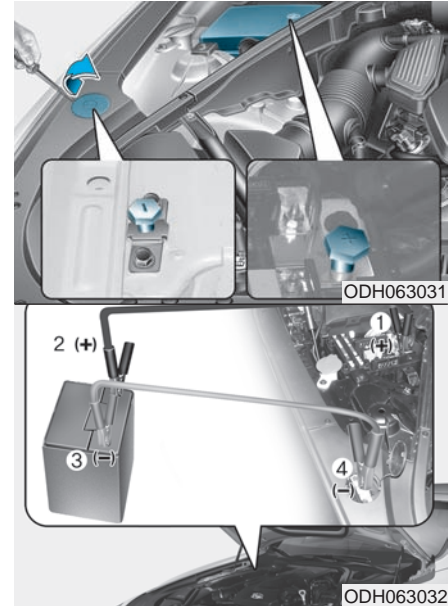

4. Open the engine hood.
5. Open the small service cover with a screwdriver.
6. Remove the engine room fuse box cover.

7. Connect the jumper cables in the exact sequence shown in the illustration. First connect one jumper cable to the red, positive (+) jumper terminal of your vehicle (1).
8. Connect the other end of the jumper cable to the red, positive (+) battery/jumper terminal of the assisting vehicle (2).
9. Connect the second jumper cable to the black, negative (-) battery/chassis ground of the assisting vehicle (3).
10. Connect the other end of the second jumper cable to the black, negative (-) chassis ground of your vehicle (4).
Do not allow the jumper cables to contact anything except the correct battery or jumper terminals or the correct ground. Do not lean over the battery when making connections.
11. Start the engine of the assisting vehicle and let it run at approximately 2,000 rpm for a few minutes. Then start your vehicle.

If your vehicle will not start after a few attempts, it probably requires servicing. In this event please seek qualified assistance. If the cause of your battery discharging is not apparent, have your vehicle checked by an authorized HYUNDAI dealer.

Disconnect the jumper cables in the exact reverse order you connected them:

1. Disconnect the jumper cable from the black, negative (-) chassis ground of your vehicle (4).
2. Disconnect the other end of the jumper cable from the black, negative (-) battery/chassis ground of the assisting vehicle (3).
3. Disconnect the second jumper cable from the red, positive (+) battery/jumper terminal of the assisting vehicle (2).
4. Disconnect the other end of the jumper cable from the red, positive (+) jumper terminal of your vehicle (1).

Push-starting

Vehicles equipped with automatic transmission cannot be push-started.

Follow the directions in this chapter for jump-starting.

IF THE ENGINE OVERHEATS

If your temperature gauge indicates overheating, you experience a loss of power, or hear loud pinging or knocking, the engine may be overheating. If this happens, you should:

1. Pull off the road and stop as soon as it is safe to do so.
2. Place the shift lever in P (Park) and set the parking brake. If the air conditioning is ON, turn it OFF.
3. If engine coolant is running out under the vehicle or steam is coming out from the hood, stop the engine. Do not open the hood until the coolant has stopped running or the steaming has stopped. If there is no visible loss of engine coolant and no steam, leave the engine running and check to be sure the engine cooling fan is operating. If the fan is not running, turn the engine off.

WARNING



While the engine is running, keep hands, clothing and tools away from the moving parts such as the cooling fan and drive belt to prevent serious injury.

4. Check for coolant leaking from the radiator, hoses or under the vehicle. (If the air conditioning had been in use, it is normal for cold water to be draining from it when you stop.)
5. If engine coolant is leaking out, stop the engine immediately and call the nearest authorized HYUNDAI dealer for assistance.

WARNING



NEVER remove the radiator cap or the drain plug while the engine and radiator are hot. Hot coolant and steam may blow out under pressure, causing serious injury.

Turn the engine off and wait until the engine cools down. Use extreme care when removing the radiator cap. Wrap a thick towel around it, and turn it counterclockwise slowly to the first stop. Step back while the pressure is released from the cooling system. When you are sure all the pressure has been released, press down on the cap, using a thick towel, and continue turning counterclockwise to remove it.

6. If you cannot find the cause of the overheating, wait until the engine temperature has returned to normal. Then, if coolant has been lost, carefully add coolant to the reservoir to bring the fluid level in the reservoir up to the halfway mark.
7. Proceed with caution, keeping alert for further signs of overheating. If overheating happens again, call an authorized HYUNDAI dealer for assistance.

CAUTION

Serious loss of coolant indicates a leak in the cooling system and should be checked as soon as possible by an authorized HYUNDAI dealer.

TIRE PRESSURE MONITORING SYSTEM (TPMS)

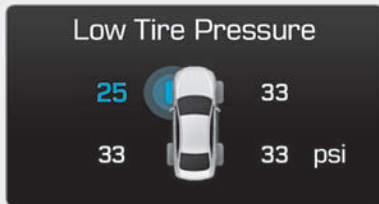

- (1) Low Tire Pressure Telltale/ TPMS Malfunction Indicator
- (2) Low Tire Pressure Position Telltale and Tire Pressure Telltale (Shown on the LCD display)

Check tire pressure



- You can check the tire pressure in the Information Mode on the cluster.

Refer to "User Settings Mode" in chapter 3.

- Tire pressure is displayed 1~2 minutes after driving.
- If tire pressure is not displayed when the vehicle is stopped, "Drive to display" message will appear. After driving, check the tire pressure.

- The displayed tire pressure values may differ from those measured with a tire pressure gauge.
- You can change the tire pressure unit in the User Settings Mode on the cluster.
 - psi, kpa, bar (**Refer to "User Settings Mode" in chapter 3**).

Tire pressure monitoring system

Each tire, including the spare (if provided), should be checked monthly when cold and inflated to the inflation pressure recommended by the vehicle manufacturer on the vehicle placard or tire inflation pressure label. (If your vehicle has tires of a different size than the size indicated on the vehicle placard or tire inflation pressure label, you should determine the proper tire inflation pressure for those tires.)

As an added safety feature, your vehicle has been equipped with a tire pressure monitoring system (TPMS) that illuminates a low tire pressure telltale when one or more of your tires is significantly under-inflated. Accordingly, when the low tire pressure telltale illuminates, you should stop and check your tires as soon as possible, and inflate them to the proper pressure. Driving on a significantly under-inflated tire causes the tire to overheat and can lead to tire failure.

Under-inflation also reduces fuel efficiency and tire tread life, and may affect the vehicle's handling and stopping ability.

Please note that the TPMS is not a substitute for proper tire maintenance, and it is the driver's responsibility to maintain correct tire pressure, even if under-inflation has not reached the level to trigger illumination of the TPMS low tire pressure telltale.

Your vehicle has also been equipped with a TPMS malfunction indicator to indicate when the system is not operating properly. The TPMS malfunction indicator is combined with the low tire pressure telltale. When the system detects a malfunction, the telltale will flash for approximately one minute and then remain continuously illuminated. This sequence will continue upon subsequent vehicle start-ups as long as the malfunction exists.

When the malfunction indicator is illuminated, the system may not be able to detect or signal low tire pressure as intended. TPMS malfunctions may occur for a variety of reasons, including the installation of replacement or alternate tires or wheels on the vehicle that prevent the TPMS from functioning properly.

Always check the TPMS malfunction telltale after replacing one or more tires or wheels on your vehicle to ensure that the replacement or alternate tires and wheels allow the TPMS to continue to function properly.

* NOTICE

If any of the below happens, have the system checked by an authorized HYUNDAI dealer.

1. The Low Tire Pressure Telltale/TPMS Malfunction Indicator does not illuminate for 3 seconds when the Engine Start/Stop button is turned to the ON position or engine is running.
2. The TPMS Malfunction Indicator remains illuminated after blinking for approximately 1 minute.
3. The Low Tire Pressure Position Telltale remains illuminated.



Low tire pressure telltale

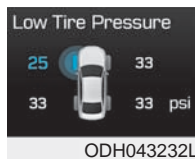

Low tire pressure position and tire pressure telltale

When the tire pressure monitoring system warning indicators are illuminated and warning message displayed on the cluster LCD display, one or more of your tires is significantly under-inflated. The Low Tire Pressure Position Telltale will indicate which tire is significantly under-inflated by illuminating the corresponding position light.

If either telltale illuminates, immediately reduce your speed, avoid hard cornering and anticipate increased stopping distances. You should stop and check your tires as soon as possible. Inflate the tires to the proper pressure as indicated on the vehicle's placard or tire inflation pressure label located on the driver's side center pillar outer panel.

If you cannot reach a service station or if the tire cannot hold the newly added air, replace the low pressure tire with the spare tire.

The Low Tire Pressure Telltale will remain on and the TPMS Malfunction Indicator may blink for one minute and then remain illuminated (when the vehicle is driven approximately 20 minutes at speed above 15.5 mph (25 km/h)) until you have the low pressure tire repaired and replaced on the vehicle.

* NOTICE

The spare tire is not equipped with a tire pressure sensor.

CAUTION

In winter or cold weather, the Low Tire Pressure Telltale may be illuminated if the tire pressure was adjusted to the recommended tire inflation pressure in warm weather. It does not mean your TPMS is malfunctioning because the decreased temperature leads to a proportional lowering of tire pressure.

When you drive your vehicle from a warm area to a cold area or from a cold area to a warm area, or the outside temperature is greatly higher or lower, you should check the tire inflation pressure and adjust the tires to the recommended tire inflation pressure.

WARNING

Low pressure damage

Significantly low tire pressure makes the vehicle unstable and can contribute to loss of vehicle control and increased braking distances.

Continued driving on low pressure tires can cause the tires to overheat and fail.



TPMS (Tire Pressure Monitoring System) malfunction indicator

The TPMS Malfunction Indicator will illuminate after it blinks for approximately one minute when there is a problem with the Tire Pressure Monitoring System.

Have the system checked by an authorized HYUNDAI dealer as soon as possible.

* NOTICE

If there is a malfunction with the TPMS, the Low Tire Pressure Position Telltale will not be displayed even though the vehicle has an under-inflated tire.

 **CAUTION**

The TPMS Malfunction Indicator may illuminate after blinking for one minute if the vehicle is near electric power supply cables or radio transmitters such as police stations, government and public offices, broadcasting stations, military installations, airports, transmitting towers, etc. Additionally, the TPMS Malfunction Indicator may illuminate if snow chains are used or electronic devices such as computers, chargers, remote starters, navigation, etc. This may interfere with normal operation of the TPMS.

Changing a tire with TPMS

If you have a flat tire, the Low Tire Pressure and Position telltales will come on. Have the flat tire repaired by an authorized HYUNDAI dealer as soon as possible or replace the flat tire with the spare tire.

 **CAUTION**

Never use a puncture-repairing agent not approved by HYUNDAI dealer to repair and/or inflate a low pressure tire. Tire sealant not approved by HYUNDAI dealer may damage the tire pressure sensor.

The spare tire (if equipped) does not come with a tire pressure monitoring sensor. When the low pressure tire or the flat tire is replaced with the spare tire, the Low Tire Pressure Telltale will remain on. Also, the TPMS Malfunction Indicator will illuminate after blinking for one minute if the vehicle is driven at speed above 15.5 mph (25 km/h) for approximately 20 minutes.

Once the original tire equipped with a tire pressure monitoring sensor is reinflated to the recommended pressure and reinstalled on the vehicle, the Low Tire Pressure Telltale and TPMS Malfunction Indicator will go off within a few minutes.

If the indicators do not extinguish after a few minutes, please visit an authorized HYUNDAI dealer.

Each wheel is equipped with a tire pressure sensor mounted inside the tire behind the valve stem (except for the spare tire). You must use TPMS specific wheels. It is recommended that you always have your tires serviced by an authorized HYUNDAI dealer as soon as possible.

You may not be able to identify a tire with low pressure by simply looking at it. Always use a good quality tire pressure gauge to measure. Please note that a tire that is hot (from being driven) will have a higher pressure measurement than a tire that is cold.

A cold tire means the vehicle has been sitting for 3 hours and driven for less than 1 mile (1.6 km) in that 3 hour period.

Allow the tire to cool before measuring the inflation pressure. Always be sure the tire is cold before inflating to the recommended pressure.

WARNING

- The TPMS cannot alert you to severe and sudden tire damage caused by external factors such as nails or road debris.
- If you feel any vehicle instability, immediately take your foot off the accelerator, apply the brakes gradually with light force, and slowly move to a safe position off the road.

WARNING

Tampering with, modifying, or disabling the Tire Pressure Monitoring System (TPMS) components may interfere with the system's ability to warn the driver of low tire pressure conditions and/or TPMS malfunctions. Tampering with, modifying, or disabling the Tire Pressure Monitoring System (TPMS) components may void the warranty for that portion of the vehicle.

This device complies with Part 15 of the FCC rules.

Operation is subject to the following two conditions:

1. This device may not cause harmful interference, and
2. This device must accept any interference received, including interference that may cause undesired operation.

*** NOTICE**

Changes or modifications not expressly approved by the party responsible for compliance could void the user's authority to operate the equipment.

IF YOU HAVE A FLAT TIRE

WARNING

Changing a tire can be dangerous. Follow the instructions in this section when changing a tire to reduce the risk of serious injury or death.

Jack and tools



- ① Jack handle
- ② Jack
- ③ Wheel nut wrench
- ④ Screw driver
- ⑤ Spanner
- ⑥ Towing hook

The jack, jack handle, and wheel lug nut wrench are stored in the luggage compartment under the luggage box cover.

The jack is provided for emergency tire changing only.



Turn the winged hold down bolt counterclockwise to remove the spare tire.

Store the spare tire in the same compartment by turning the winged hold down bolt clockwise.

To prevent the spare tire and tools from “rattling,” store them in their proper location.



If it is hard to loosen the tire hold-down wing bolt by a hand, you can loosen it easily using the Jack handle.

1. Put the Jack handle (1) into the inside of tire hold-down wing bolt.
2. Turn the tire hold-down wing bolt counterclockwise by the Jack handle to utilize the principles of the lever and fulcrum.

CAUTION

When you remove or store the spare tire, don't give a shock to the battery.

Shock to the battery may cause failure of electrical circuits.

Changing tires

WARNING

A vehicle can slip or roll off of a jack causing serious injury or death to you or those nearby. Take the following safety precautions:

- Never place any portion of your body under a vehicle that is supported by a jack.
- **NEVER** attempt to change a tire in the lane of traffic. **ALWAYS** move the vehicle completely off the road on level, firm ground away from traffic before trying to change a tire. If you cannot find a level, firm place off the road, call a towing service for assistance.
- **Be sure to use the jack provided with the vehicle.**

(Continued)

(Continued)

- **ALWAYS** place the jack on the designated jacking positions on the vehicle and **NEVER** on the bumpers or any other part of the vehicle for jacking support.
- Do not start or run the engine while the vehicle is on the jack.
- Do not allow anyone to remain in the vehicle while it is on the jack.
- **Keep children away from the road and the vehicle.**

Follow these steps to change your vehicle's tire:

1. Park on a level, firm surface.
2. Move the shift lever into P(Park), apply the parking brake, and place the Engine Start/Stop button in the OFF position.
3. Press the hazard warning flasher button.
4. Remove the wheel lug nut wrench, jack, jack handle, and spare tire from the vehicle.

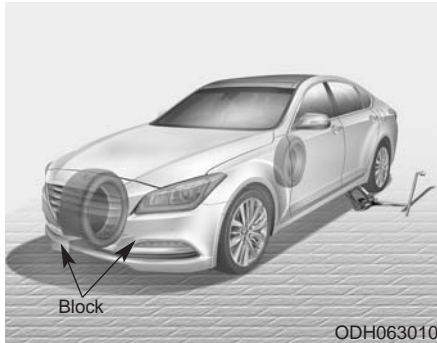

5. Block both the front and rear of the tire diagonally opposite of the tire you are changing.
6. Insert the screwdriver into the groove of the wheel cap and pry gently to remove the wheel cap (If equipped).



7. Loosen the wheel lug nuts counter-clockwise one turn each in the order shown above, but do not remove any lug nuts until the tire has been raised off of the ground.

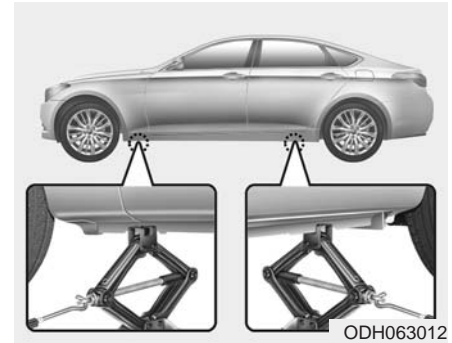

8. Place the jack at the designated jacking position under the frame closest to the tire you are changing. The jacking positions are plates welded to the frame with two tabs and a raised dot. Never jack any other position or part of the vehicle. It may damage to the side seal molding.

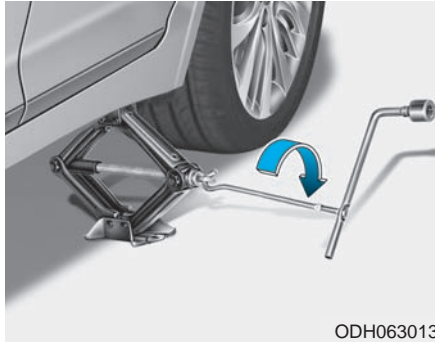

ODH063013

9. Insert the jack handle into the jack and turn it clockwise, raising the vehicle until the tire clears the ground. Make sure the vehicle is stable on the jack.

10. Loosen the lug nuts with the wheel lug nut wrench and remove them with your fingers. Remove the wheel from the studs and lay it flat on the ground out of the way. Remove any dirt or debris from the studs, mounting surfaces, and wheel.
11. Install the spare tire onto the studs of the hub.
12. Tighten the lug nuts with your fingers onto the studs with the smaller end of the lug nuts closest to the wheel.
13. Lower the vehicle to the ground by turning the jack handle counterclockwise.



ODH063014

14. Use the wheel lug nut wrench to tighten the lug nuts in the order shown. Double-check each lug nut until they are tight. After changing tires, we recommend that an authorized HYUNDAI dealer tighten the lug nuts to their proper torque as soon as possible. **The wheel lug nut should be tightened to 65~79 lb.ft (9~11 kg.m).**

If you have a tire gauge, check the tire pressure (see “Tires and Wheels” in chapter 8 for tire pressure instructions.). If the pressure is lower or higher than recommended, drive slowly to the nearest service station and adjust it to the recommended pressure. Always reinstall the valve cap after checking or adjusting tire pressure. If the cap is not replaced, air may leak from the tire. If you lose a valve cap, buy another and install it as soon as possible. After changing tires, secure the flat tire and return the jack and tools to their proper storage locations.

* NOTICE

Check the tire pressure as soon as possible after installing a spare tire. Adjust it to the recommended pressure.

CAUTION

Your vehicle has metric threads on the studs and lug nuts. Make certain during tire changing that the same nuts that were removed are reinstalled. If you have to replace your lug nuts make sure they have metric threads to avoid damaging the studs and ensure the wheel is properly secured to the hub. Consult an authorized HYUNDAI dealer for assistance.

If any of the equipment such as the jack, lug nuts, studs, or other equipment is damaged or in poor condition, do not attempt to change the tire and call for assistance.

Use of compact spare tires (if equipped)

Compact spare tires are designed for emergency use only. Drive carefully on the compact spare tire and always follow the safety precautions.

WARNING

To prevent compact spare tire failure and loss of control possibly resulting in an accident:

- Use the compact spare tire only in an emergency.
- NEVER operate your vehicle over 50 mph (80 km/h).
- Do not exceed the vehicle's maximum load rating or the load carrying capacity shown on the sidewall of the compact spare tire.
- Do not use the compact spare tire continuously. Repair or replace the original tire as soon as possible to avoid failure of the compact spare tire.

When driving with the compact spare tire mounted to your vehicle:

- Check the tire pressure after installing the compact spare tire. The compact spare tire should be inflated to 60 psi (420 kPa).
- Do not take this vehicle through an automatic car wash while the compact spare tire is installed.
- Do not use the compact spare tire on any other vehicle because this tire has been designed especially for your vehicle.
- The compact spare tire's tread life is shorter than a regular tire. Inspect your compact spare tire regularly and replace worn compact spare tires with the same size and design, mounted on the same wheel.
- Do not use more than one compact spare tire at a time.

* NOTICE

When the original tire and wheel are repaired and reinstalled on the vehicle, the lug nut torque must be set correctly. The correct lug nut tightening torque is 65-79 lb.ft (9-11 kg.m).

CAUTION

To prevent damaging the compact spare tire and your vehicle:

- Drive slowly enough for the road conditions to avoid all hazards, such as a potholes or debris.
- Avoid driving over obstacles. The compact spare tire diameter is smaller than the diameter of a conventional tire and reduces the ground clearance approximately 1 inch (25 mm).
- Do not use tire chains on the compact spare tire. Because of the smaller size, a tire chain will not fit properly.
- Do not use the compact spare tire on any other wheels, nor should standard tires, snow tires, wheel covers or trim rings be used with the compact spare wheel.

Jack label

- Example
- Type A

Model : □□□ ①

kg max. □□□ kg ②

(P) ③

④

⑤

⑥

⑦

⑧

⑨

⑩ CO., LTD.

⑪ DATE OF MANUFACTURE (YYYYMMDD)

OHYK065010

- Type B

Max. ① □□□□□□ kg ②

□□□□□□ kg ③

(P) ④

⑤

⑥

⑦

⑧

⑨

⑩ CO., LTD.

⑪ DATE OF MANUFACTURE (YYYYMMDD)

OHYK065011

- Type C

● MAX. WEIGHT □□□□kg(□□□□ lb) ②

● USE ONLY TO SPECIFIED CAR(지정 차량에만 사용함 것)

● CARGA MAXIMA □□□□kg(□□□□ lb)

● USELO SOLO PARA EL VEHICULO ESPECIFICADO

● Максимальная использовать только для грузоподъемность □□□□кг данного автомобиля

● 最大质量 □□□□kg(□□□□lb), 仅适用于指定车型

● الوزن الأقصى □□□□ كجم - رطل □□□□

● يستخدم فقط للسيارة المحددة

⑥

⑩ CO., LTD.

⑪ DATE OF MANUFACTURE (YYYYMMDD)

OHYK064002

The actual Jack label in the vehicle may differ from the illustration.
For more detailed specifications, refer to the label attached to the jack.

1. Model Name
2. Maximum allowable load
3. When using the jack, set your parking brake.
4. When using the jack, stop the engine.
5. Do not get under a vehicle that is supported by a jack.
6. The designated locations under the frame
7. When supporting the vehicle, the base plate of jack must be vertical under the lifting point.
8. Shift into Reverse gear on vehicles with manual transmission or move the shift lever to the P position on vehicles with automatic transmission.
9. The jack should be used on firm level ground.
10. Jack manufacturer
11. Production date
12. Representative company and address

TOWING

Towing service

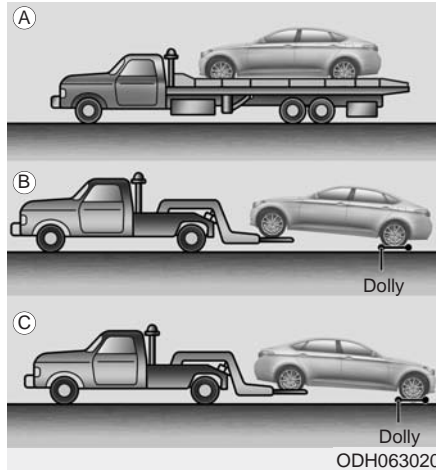

If emergency towing is necessary, we recommend having it done by an authorized HYUNDAI dealer or a commercial tow-truck service. Proper lifting and towing procedures are necessary to prevent damage to the vehicle. The use of wheel dollies or flatbed is recommended.

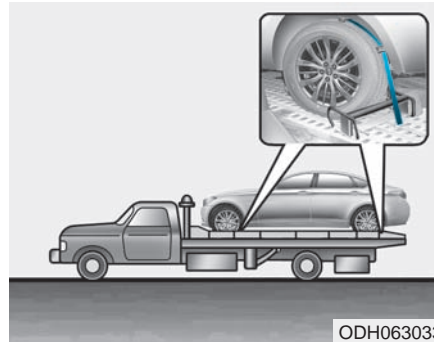

When towing the vehicle by flatbed equipment, secure wheels by using chocks and tie-down straps (or soft belts).

Do not place straps over body panels or through the wheels.

CAUTION

Do not lift the vehicle by the tow fitting or body and chassis parts. Otherwise the vehicle may be damaged.

On AWD vehicles, your vehicle must be towed with a wheel lift and dollies or flatbed equipment with all the wheels off the ground.

CAUTION

The AWD vehicle should never be towed with the wheels on the ground. This can cause serious damage to the transmission or the AWD system.

On 2WD vehicles, it is acceptable to tow the vehicle with the front wheels on the ground (without dollies) and the rear wheels off the ground.

If any of the loaded wheels or suspension components are damaged or the vehicle is being towed with the rear wheels on the ground, use a towing dolly under the rear wheels.

When being towed by a commercial tow truck and wheel dollies are not used, the rear of the vehicle should always be lifted, not the front.

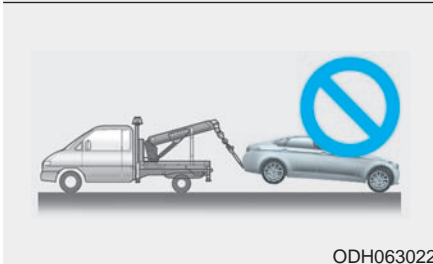
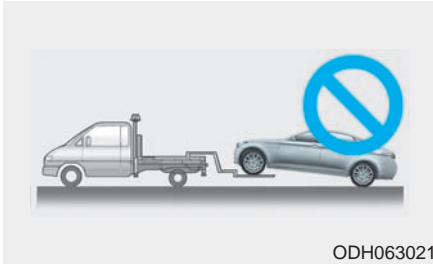

CAUTION

- Do not tow the vehicle with the rear wheels on the ground as this may cause damage to the vehicle.
- Do not tow with sling-type equipment. Use wheel lift or flatbed equipment.

When towing your vehicle in an emergency without wheel dollies :

1. Set the Engine Start/Stop button in the ACC position.
2. Place the shift lever in N (Neutral).
3. Release the parking brake.

CAUTION

Failure to place the transmission shift lever in N (Neutral) may cause internal damage to the transmission.

Removable towing hook (if equipped)

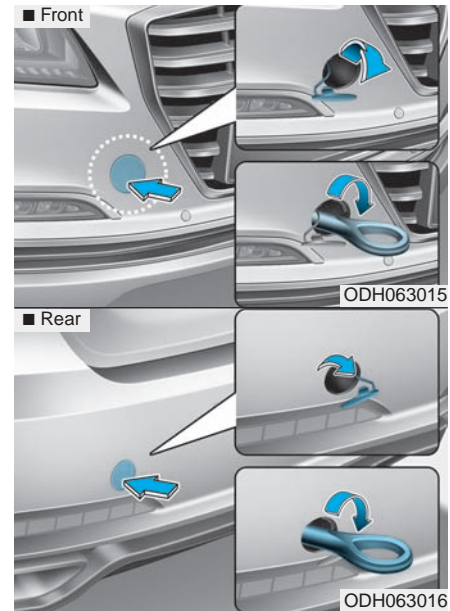

1. Open the trunk, and remove the towing hook from the tool case.
2. Remove the hole cover pressing the lower part of the cover on the bumper.

3. Install the towing hook by turning it clockwise into the hole until it is fully secured.
4. Remove the towing hook and install the cover after use.

Emergency towing (if equipped)

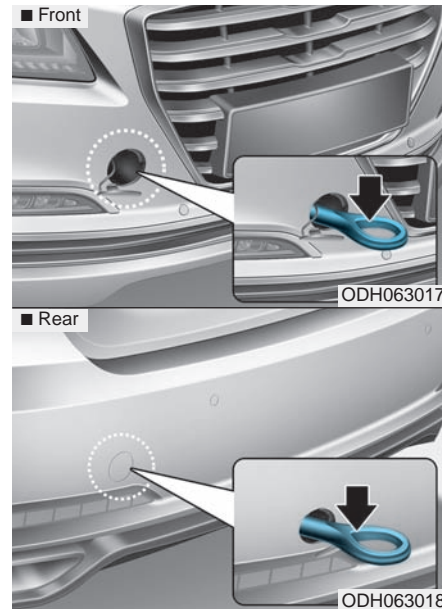

If towing is necessary, we recommend you to have it done by an authorized HYUNDAI dealer or a commercial tow truck service.

If towing service is not available in an emergency, your vehicle may be temporarily towed using a cable or chain secured to the emergency towing hook at the front (or rear) of the vehicle.

Use extreme caution when towing the vehicle with a cable or chain. A driver must be in the vehicle to steer it and operate the brakes.

Towing in this manner may be done only on hard-surfaced roads for a short distance and at low speeds. Also, the wheels, axles, power train, steering and brakes must all be in good condition.

Always follow these emergency towing precautions:

- Place the Engine Start/Stop button in the ACC position so the steering wheel is not locked.
- Place the shift lever in N (Neutral).
- Release the parking brake.
- Depress the brake pedal with more force than normal since you will have reduced braking performance.
- More steering effort will be required because the power steering system will be disabled.
- Use a vehicle heavier than your own to tow your vehicle.
- The drivers of both vehicles should communicate with each other frequently.
- Before emergency towing, check that the hook is not broken or damaged.
- Fasten the towing cable or chain securely to the hook.
- Do not jerk the hook. Apply steady and even force.

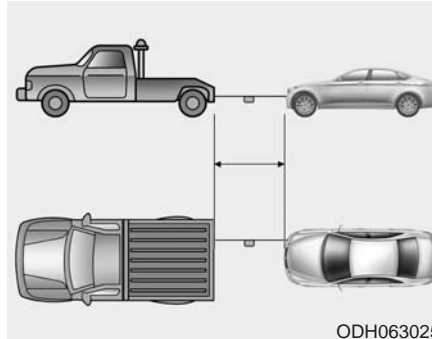

- Use a towing cable or chain less than 16 feet (5 m) long. Attach a white or red cloth (about 12 inches (30 cm) wide) in the middle of the cable or chain for easy visibility.
- Drive carefully so the towing cable or chain remains tight during towing.
- Before towing, check the automatic transmission for fluid leaks under your vehicle. If the automatic transmission fluid is leaking, flatbed equipment or a towing dolly must be used.

CAUTION

To avoid damage to your vehicle and vehicle components when towing:

- Always pull straight ahead when using the towing hooks. Do not pull from the side or at a vertical angle.
- Do not use the towing hooks to pull a vehicle out of mud, sand or other conditions from which the vehicle cannot be driven out under its own power.
- Limit the vehicle speed to 10 mph (15 km/h) and drive less than 1 mile (1.5 km) when towing to avoid serious damage to the automatic transmission.

Maintenance

Engine compartment	7-3	Air cleaner	7-35
Maintenance services	7-5	Filter replacement.....	7-35
Owner's responsibility.....	7-5	Climate control air filter	7-36
Owner maintenance precautions	7-5	Filter inspection.....	7-36
Owner maintenance.....	7-6	Wiper blades	7-38
Owner maintenance schedule.....	7-7	Blade inspection	7-38
Scheduled maintenance services.....	7-8	Blade replacement	7-38
Normal maintenance schedule.....	7-9	Battery.....	7-40
Maintenance under severe usage conditions.....	7-22	For best battery service.....	7-41
Explanation of scheduled maintenance		Battery recharging	7-42
items.....	7-24	Reset features	7-44
Engine oil	7-27	Tires and wheels	7-45
Checking the engine oil level	7-27	Tire care	7-45
Checking the engine oil and filter	7-28	Recommended cold tire inflation pressures.....	7-46
Engine coolant.....	7-29	Check tire inflation pressure.....	7-47
Checking the engine coolant level.....	7-29	Tire rotation	7-48
Changing engine coolant.....	7-31	Wheel alignment and tire balance	7-49
Brake fluid	7-32	Tire replacement	7-49
Checking the brake fluid level.....	7-32	Wheel replacement.....	7-50
Washer fluid	7-34	Tire traction.....	7-50
Checking the washer fluid level.....	7-34	Tire maintenance	7-51
Parking brake	7-34	Tire sidewall labeling.....	7-51
Checking the parking brake	7-34	Tire terminology and definitions.....	7-55
		All season tires	7-58

Summer tires	7-58
Snow tires	7-58
Radial-ply tires	7-59
Low aspect ratio tires	7-59
Fuses.....	7-61
Instrument panel fuse replacement	7-62
Engine compartment panel fuse replacement.....	7-64
Fuse/Relay panel description	7-66
Light bulbs.....	7-79
Headlamp, position lamp, turn signal lamp, side marker and front fog lamp bulb replacement	7-79
Side repeater lamp replacement	7-83
Rear combination light bulb replacement.....	7-83
High mounted stop lamp	7-85
License plate light bulb replacement	7-86
Interior light bulb replacement	7-86
Appearance care.....	7-87
Exterior care	7-87
Interior care.....	7-92
Emission control system	7-94
California perchlorate notice	7-98

ENGINE COMPARTMENT

■ Gasoline Engine (Lambda 3.8)

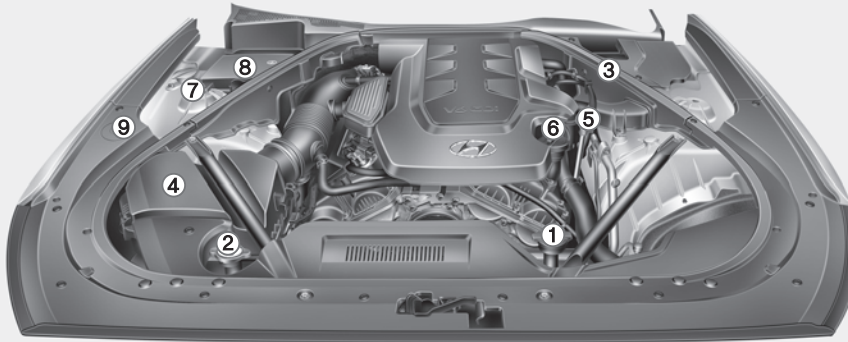

1. Engine coolant reservoir
2. Radiator cap
3. Brake fluid reservoir
4. Air cleaner
5. Engine oil dipstick
6. Engine oil filler cap
7. Windshield washer fluid reservoir
8. Fuse box
9. Jumper terminal

The actual engine compartment the vehicle may differ from the illustration.

ODH013005

■ Gasoline Engine (Tau 5.0)

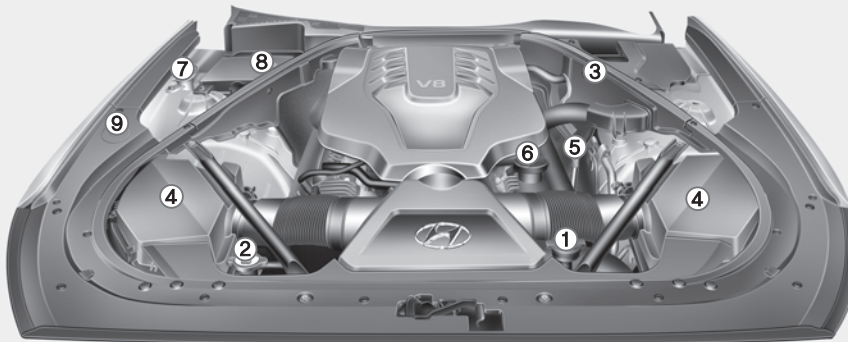

1. Engine coolant reservoir
2. Radiator cap
3. Brake fluid reservoir
4. Air cleaner
5. Engine oil dipstick
6. Engine oil filler cap
7. Windshield washer fluid reservoir
8. Fuse box
9. Jumper terminal

The actual engine compartment the vehicle may differ from the illustration.

ODH013006L

MAINTENANCE SERVICES

You should exercise the utmost care to prevent damage to your vehicle and injury to yourself whenever performing any maintenance or inspection procedures.

We recommend you have your vehicle maintained and repaired by an authorized HYUNDAI dealer. An authorized HYUNDAI dealer meets HYUNDAI's high service quality standards and receives technical support from HYUNDAI in order to provide you with a high level of service satisfaction.

Owner's responsibility

Maintenance service and record retention are the owner's responsibility.

You should retain documents that show proper maintenance has been performed on your vehicle in accordance with the scheduled maintenance service charts shown on the following pages. You need this information to establish your compliance with the servicing and maintenance requirements of your vehicle warranties.

Detailed warranty information is provided in your Owner's Handbook & Warranty Information booklet.

Repairs and adjustments required as a result of improper maintenance or a lack of required maintenance are not covered.

Owner maintenance precautions

Inadequate, incomplete or insufficient servicing may result in operational problems with your vehicle that could lead to vehicle damage, an accident, or personal injury. This chapter provides instructions only for the maintenance items that are easy to perform. Several procedures can be done only by an authorized HYUNDAI dealer with special tools.

Your vehicle should not be modified in any way. Such modifications may adversely affect the performance, safety or durability of your vehicle and may, in addition, violate conditions of the limited warranties covering the vehicle.

Certain modifications may also be in violation of regulations established by the U.S. Department of Transportation and other federal or state agencies.

* NOTICE

Improper owner maintenance during the warranty period may affect warranty coverage. For details, read the separate Owner's Handbook & Warranty Information booklet provided with the vehicle. If you're unsure about any service or maintenance procedure, have it done by an authorized HYUNDAI dealer.

OWNER MAINTENANCE

WARNING

Performing maintenance work on a vehicle can be dangerous. If you lack sufficient knowledge and experience or the proper tools and equipment to do the work, have it done by an authorized HYUNDAI dealer. ALWAYS follow these precautions for performing maintenance work:

- Park your vehicle on level ground, move the shift lever into the P (Park, for automatic transmission vehicle) position, apply the parking brake, place the Engine Start/Stop button in the OFF position.
- Block the tires (front and back) to prevent the vehicle from moving.

Remove loose clothing or jewelry that can become entangled in moving parts.

(Continued)

(Continued)

- If you must run the engine during maintenance, do so out doors or in an area with plenty of ventilation.
- Keep flames, sparks, or smoking materials away from the battery and fuel-related parts.

The following lists are vehicle checks and inspections that should be performed by the owner or an authorized HYUNDAI dealer at the frequencies indicated to help ensure safe, dependable operation of your vehicle.

Any adverse conditions should be brought to the attention of your dealer as soon as possible.

These Owner Maintenance vehicle checks are generally not covered by warranties and you may be charged for labor, parts and lubricants used.

Owner maintenance schedule

When you stop for fuel:

- Check the engine oil level.
- Check coolant level in the engine coolant reservoir.
- Check the windshield washer fluid level.
- Check for low or under-inflated tires.

WARNING

Be careful when checking your engine coolant level when the engine is hot. This may result in coolant being blown out of the opening and cause serious burns and other injuries.

While operating your vehicle:

- Note any changes in the sound of the exhaust or any smell of exhaust fumes in the vehicle.
- Check for vibrations in the steering wheel. Notice if there is any increased steering effort or looseness in the steering wheel, or change in its straight-ahead position.
- Notice if your vehicle constantly turns slightly or “pulls” to one side when traveling on smooth, level road.
- When stopping, listen and check for unusual sounds, pulling to one side, increased brake pedal travel or “hard-to-push” brake pedal.
- If any slipping or changes in the operation of your transmission occurs, check the transmission fluid level.
- Check the automatic transmission P (Park) function.

- Check the parking brake.
- Check for fluid leaks under your vehicle (water dripping from the air conditioning system during or after use is normal).

At least monthly:

- Check coolant level in the engine coolant reservoir.
- Check the operation of all exterior lights, including the stoplights, turn signals and hazard warning flashers.
- Check the inflation pressures of all tires including the spare for tires that are worn, show uneven wear, or are damaged.
- Check for loose wheel lug nuts.

At least twice a year: (i.e., every Spring and Fall):

- Check radiator, heater and air conditioning hoses for leaks or damage.
- Check windshield washer spray and wiper operation. Clean wiper blades with clean cloth dampened with washer fluid.
- Check headlight alignment.
- Check muffler, exhaust pipes, shields and clamps.
- Check the seat belts for wear and function.

At least once a year:

- Clean body and door drain holes.
- Lubricate door hinges and hood hinges.
- Lubricate door and hood locks and latches.
- Lubricate door rubber weather strips.
- Check the air conditioning system.
- Inspect and lubricate automatic transmission linkage and controls.
- Clean the battery and terminals.
- Check the brake fluid level.

SCHEDULED MAINTENANCE SERVICES

Follow Normal Maintenance Schedule if the vehicle is usually operated where none of the following conditions apply. If any of the following conditions apply, you must follow the Maintenance Under Severe Usage Conditions.

- Repeated short distance driving.
- Driving in dusty conditions or sandy areas.
- Extensive use of brakes.
- Driving in areas where salt or other corrosive materials are used.
- Driving on rough or muddy roads.
- Driving in mountainous areas.
- Extended periods of idling or low speed operation.
- Driving for a prolonged period in cold temperatures and/or extremely humid climates.
- More than 50% driving in heavy city traffic during hot weather above 90°F (32°C).

For additional information or assistance see your authorized HYUNDAI dealer.

Normal maintenance schedule

The following maintenance services must be performed to ensure good emission control and performance. Keep receipts for all vehicle emission services to protect your warranty. Where both mileage and time are shown, the frequency of service is determined by whichever occurs first.

- *1 : If TOP TIER Detergent Gasoline is not available, one bottle of additive is recommended. Additives are available from your authorized HYUNDAI dealer along with information on how to use them. Do not mix other additives.
- *2 : Fuel filter & Fuel tank air filter are considered to be maintenance free but periodic inspection is recommended for this maintenance schedule depends on fuel quality. If there are some important safety matters like fuel flow restriction, surging, loss of power, hard starting problem etc, replace the fuel filter immediately regardless of maintenance schedule and consult an authorized HYUNDAI dealer for details.
- *3 : Front/rear differential oil should be changed anytime they have been submerged in water.
- *4 : Inspect for excessive valve noise and/or engine vibration and adjust if necessary. Have an authorized HYUNDAI dealer perform the operation.
- *5 : The drive belt should be replaced when cracks occur or tension is reduced.
- * Inspect : Inspect and if necessary, adjust, correct, clean or replace.

Normal maintenance schedule

7,500 miles (12,000 km) or 6 months

- Rotate tires
- Inspect air cleaner filter
- Inspect vacuum hose
- Replace engine oil and filter
(7,500 miles (12,000 km) or 12 months)
- Add fuel additives *1
(7,500 miles (12,000 km) or 12 months)

15,000 miles (24,000 km) or 12 months

- Rotate tires
- Inspect air cleaner filter
- Inspect vacuum hose
- Inspect air conditioning refrigerant
- Inspect brake hoses and lines
- Inspect drive shafts and boots
- Inspect exhaust pipe and muffler
- Inspect front brake disc/pad, calipers
- Inspect propeller shaft
- Inspect rear brake disc/pad
- Inspect steering gear box, linkage & boots/lower arm ball joint, upper arm ball joint
- Inspect suspension mounting bolts
- Replace climate control air filter
(for evaporator and blower unit)
- Replace engine oil and filter
(15,000 miles (24,000 km) or 24 months)
- Add fuel additives *1
(15,000 miles (24,000 km) or 24 months)

Normal maintenance schedule

22,500 miles (36,000 km) or 18 months

- Rotating tires
- Inspect air cleaner filter
- Inspect vacuum hose
- Replace engine oil and filter
(22,500 miles (36,000 km) or 36 months)
- Add fuel additives *¹
(22,500 miles (36,000 km) or 36 months)

30,000 miles (48,000 km) or 24 months

- Rotate tires
- Inspect vacuum hose
- Inspect air conditioning refrigerant
- Inspect brake hoses and lines
- Inspect drive shafts and boots
- Inspect exhaust pipe and muffler
- Inspect front brake disc/pads, calipers
- Inspect propeller shaft
- Inspect rear brake disc/pads
- Inspect steering gear box, linkage & boots/lower arm ball joint, upper arm ball joint
- Inspect suspension mounting bolts
- Inspect brake fluid
- Inspect fuel filter *²
- Inspect fuel lines, fuel hoses and connections
- Inspect fuel tank air filter *²
- Inspect parking brake
- Inspect vapor hose and fuel filler cap, fuel tank
- Replace climate control air filter
(for evaporator and blower unit)
- Replace air cleaner filter
- Replace engine oil and filter
(30,000 miles (48,000 km) or 48 months)
- Add fuel additives *¹
(30,000 miles (48,000 km) or 48 months)

Normal maintenance schedule

37,500 miles (60,000 km) or 30 months

- Rotate tires
- Inspect air cleaner filter
- Inspect vacuum hose
- Inspect front(AWD)/rear differential oil *³
(Inspect 37,500 miles (60,000km) or 48months)
- Replace engine oil and filter
(37,500 miles (60,000 km) or 60 months)
- Add fuel additives *¹
(37,500 miles (60,000 km) or 60 months)

45,000 miles (72,000 km) or 36 months

- Rotate tires
- Inspect air cleaner filter
- Inspect vacuum hose
- Inspect air conditioning refrigerant
- Inspect brake hoses and lines
- Inspect drive shafts and boots
- Inspect exhaust pipe and muffler
- Inspect front brake disc/pads, calipers
- Inspect propeller shaft
- Inspect rear brake disc/pads
- Inspect steering gear box, linkage & boots/lower arm ball joint, upper arm ball joint
- Inspect suspension mounting bolts
- Replace climate control air filter
(for evaporator and blower unit)
- Replace engine oil and filter
(45,000 miles (72,000 km) or 72 months)
- Add fuel additives *¹
(45,000 miles (72,000 km) or 72 months)

Normal maintenance schedule

52,500 miles (84,000 km) or 42 months

- Rotating tires
- Inspect air cleaner filter
- Inspect vacuum hose
- Replace engine oil and filter
(52,500 miles (84,000 km) or 84 months)
- Add fuel additives ^{*1}
(52,500 miles (84,000 km) or 84 months)

60,000 miles (96,000 km) or 48 months

- Rotate tires
- Inspect vacuum hose
- Inspect air conditioning refrigerant
- Inspect brake hoses and lines
- Inspect drive shafts and boots
- Inspect exhaust pipe and muffler
- Inspect front brake disc/pads, calipers
- Inspect propeller shaft
- Inspect rear brake disc/pads
- Inspect steering gear box, linkage & boots/lower arm ball joint, upper arm ball joint
- Inspect suspension mounting bolts
- Inspect brake fluid
- Inspect fuel filter ^{*2}
- Inspect fuel lines, fuel hoses and connections
- Inspect fuel tank air filter ^{*2}
- Inspect parking brake
- Inspect vapor hose and fuel filler cap, fuel tank
- Inspect drive belts ^{*5}
(First, 60,000 miles (96,000 km) or 72 months after every 15,000 miles (24,000 km) or 24 months)
- Inspect valve clearance (Lambda Engine) ^{*4}
(Every 60,000 miles (96,000 km) or 72 months)

(Continued)

Normal maintenance schedule

(Continued)

- Replace climate control air filter
(for evaporator and blower unit)
- Replace air cleaner filter
- Replace engine oil and filter
(60,000 miles (96,000 km) or 96 months)
- Add fuel additives *¹
(60,000 miles (96,000 km) or 96 months)

67,500 miles (108,000 km) or 54 months

- Rotating tires
- Inspect air cleaner filter
- Inspect vacuum hose
- Replace engine oil and filter
(67,500 miles (108,000 km) or 108 months)
- Add fuel additives *¹
(67,500 miles (108,000 km) or 108 months)

Normal maintenance schedule

75,000 miles (120,000 km) or 60 months

- Rotate tires
- Inspect air cleaner filter
- Inspect vacuum hose
- Inspect air conditioning refrigerant
- Inspect brake hoses and lines
- Inspect drive shafts and boots
- Inspect exhaust pipe and muffler
- Inspect front brake disc/pads, calipers
- Inspect propeller shaft
- Inspect rear brake disc/pads
- Inspect steering gear box, linkage & boots/lower arm ball joint, upper arm ball joint
- Inspect suspension mounting bolts
- Inspect drive belts ^{*5}
(First, 60,000 miles (96,000 km) or 72 months
after every 15,000 miles (24,000 km) or 24 months)
- Inspect front(AWD)/rear differential oil ^{*3}
(Inspect 75,000 miles (120,000km) or 96months)
- Replace climate control air filter
(for evaporator and blower unit)
- Replace engine oil and filter
(75,000 miles (120,000 km) or 120 months)
- Add fuel additives ^{*1}
(75,000 miles (120,000 km) or 120 months)

82,500 miles (132,000 km) or 66 months

- Rotating tires
- Inspect air cleaner filter
- Inspect vacuum hose
- Replace engine oil and filter
(82,500 miles (132,000 km) or 132 months)
- Add fuel additives ^{*1}
(82,500 miles (132,000 km) or 132 months)

Normal maintenance schedule

90,000 miles (144,000 km) or 72 months

- Rotate tires
- Inspect vacuum hose
- Inspect air conditioning refrigerant
- Inspect brake hoses and lines
- Inspect drive shafts and boots
- Inspect exhaust pipe and muffler
- Inspect front brake disc/pads, calipers
- Inspect propeller shaft
- Inspect rear brake disc/pads
- Inspect steering gear box, linkage & boots/lower arm ball joint, upper arm ball joint
- Inspect suspension mounting bolts
- Inspect brake fluid
- Inspect fuel filter *2
- Inspect fuel lines, fuel hoses and connections
- Inspect fuel tank air filter *2
- Inspect parking brake
- Inspect vapor hose and fuel filler cap, fuel tank
- Inspect drive belts *5
(First, 60,000 miles (96,000 km) or 72 months
after every 15,000 miles (24,000 km) or 24 months)
- Replace climate control air filter
(for evaporator and blower unit)

(Continued)

(Continued)

- Replace air cleaner filter
- Replace engine oil and filter
(90,000 miles (144,000 km) or 144 months)
- Add fuel additives *1
(90,000 miles (144,000 km) or 144 months)

Normal maintenance schedule

97,500 miles (156,000 km) or 78 months

- Rotating tires
- Inspect air cleaner filter
- Inspect vacuum hose
- Replace engine oil and filter
(97,500 miles (156,000 km) or 156 months)
- Replace spark plugs (iridium coated)
- Add fuel additives ^{*1}
(97,500 miles (156,000 km) or 156 months)

105,000 miles (168,000 km) or 84 months

- Rotate tires
- Inspect air cleaner filter
- Inspect vacuum hose
- Inspect air conditioning refrigerant
- Inspect brake hoses and lines
- Inspect drive shafts and boots
- Inspect exhaust pipe and muffler
- Inspect front brake disc/pads, calipers
- Inspect propeller shaft
- Inspect rear brake disc/pads
- Inspect steering gear box, linkage & boots/lower arm ball joint, upper arm ball joint
- Inspect suspension mounting bolts
- Inspect drive belts ^{*5}
(First, 60,000 miles (96,000 km) or 72 months after every 15,000 miles (24,000 km) or 24 months)
- Replace climate control air filter
(for evaporator and blower unit)
- Replace engine oil and filter
(105,000 miles (168,000 km) or 168 months)
- Add fuel additives ^{*1}
(105,000 miles (168,000 km) or 168 months)

Normal maintenance schedule

112,500 miles (180,000 km) or 90 months

- Rotating tires
- Inspect air cleaner filter
- Inspect vacuum hose
- Inspect front(AWD)/rear differential oil ^{*3}
(112,500 miles (180,000km) or 144months)
- Replace engine oil and filter
(112,500 miles (180,000 km) or 180 months)
- Add fuel additives ^{*1}
(112,500 miles (180,000 km) or 180 months)

120,000 miles (192,000 km) or 96 months

- Rotate tires
- Inspect vacuum hose
- Inspect air conditioning refrigerant
- Inspect brake hoses and lines
- Inspect drive shafts and boots
- Inspect exhaust pipe and muffler
- Inspect front brake disc/pads, calipers
- Inspect propeller shaft
- Inspect rear brake disc/pads
- Inspect steering gear box, linkage & boots/lower arm ball joint, upper arm ball joint
- Inspect suspension mounting bolts
- Inspect brake fluid
- Inspect fuel filter ^{*2}
- Inspect fuel lines, fuel hoses and connections
- Inspect fuel tank air filter ^{*2}
- Inspect parking brake
- Inspect vapor hose and fuel filler cap, fuel tank
- Inspect drive belts ^{*5}
(First, 60,000 miles (96,000 km) or 72 months
after every 15,000 miles (24,000 km) or 24 months)
- Inspect valve clearance (Lambda Engine) ^{*4}
(Every 60,000 miles (96,000 km) or 72 months)

(Continued)

Normal maintenance schedule

(Continued)

- Replace climate control air filter
(for evaporator and blower unit)
- Replace air cleaner filter
- Replace engine oil and filter
(120,000 miles (192,000 km) or 192 months)
- Replace coolant
(First, 120,000 miles (210,000 km) or 120 months
after every 30,000 miles (48,000 km) or 24 months)
- Add fuel additives *1
(120,000 miles (192,000 km) or 192 months)

127,500 miles (204,000 km) or 102 months

- Rotating tires
- Inspect air cleaner filter
- Inspect vacuum hose
- Replace engine oil and filter
(127,500 miles (204,000 km) or 204 months)
- Add fuel additives *1
(127,500 miles (204,000 km) or 204 months)

Normal maintenance schedule

135,000 miles (216,000 km) or 108 months

- Rotate tires
- Inspect air cleaner filter
- Inspect vacuum hose
- Inspect air conditioning refrigerant
- Inspect brake hoses and lines
- Inspect drive shafts and boots
- Inspect exhaust pipe and muffler
- Inspect front brake disc/pads, calipers
- Inspect propeller shaft
- Inspect rear brake disc/pads
- Inspect steering gear box, linkage & boots/lower arm ball joint, upper arm ball joint
- Inspect suspension mounting bolts
- Inspect drive belts ^{*5}
(First, 60,000 miles (96,000 km) or 72 months
after every 15,000 miles (24,000 km) or 24 months)
- Replace climate control air filter
(for evaporator and blower unit)
- Replace engine oil and filter
(135,000 miles (216,000 km) or 216 months)
- Add fuel additives ^{*1}
(135,000 miles (216,000 km) or 216 months)

142,500 miles (228,000 km) or 114 months

- Rotating tires
- Inspect air cleaner filter
- Inspect vacuum hose
- Replace engine oil and filter
(142,500 miles (228,000 km) or 228 months)
- Add fuel additives ^{*1}
(142,500 miles (228,000 km) or 228 months)

Normal maintenance schedule

150,000 miles (240,000 km) or 120 months

- Rotate tires
- Inspect vacuum hose
- Inspect air conditioning refrigerant
- Inspect brake hoses and lines
- Inspect drive shafts and boots
- Inspect exhaust pipe and muffler
- Inspect front brake disc/pads, calipers
- Inspect propeller shaft
- Inspect rear brake disc/pads
- Inspect steering gear box, linkage & boots/lower arm ball joint, upper arm ball joint
- Inspect suspension mounting bolts
- Inspect brake fluid
- Inspect fuel filter *²
- Inspect fuel lines, fuel hoses and connections
- Inspect fuel tank air filter *²
- Inspect parking brake
- Inspect vapor hose and fuel filler cap, fuel tank
- Inspect drive belts *⁵
(First, 60,000 miles (96,000 km) or 72 months after every 15,000 miles (24,000 km) or 24 months)

(Continued)

(Continued)

- Inspect front(AWD)/rear differential oil *³
(150,000 miles (240,000km) or 192months)
- Replace climate control air filter
(for evaporator and blower unit)
- Replace air cleaner filter
- Replace engine oil and filter
(150,000 miles (240,000 km) or 240 months)
- Replace coolant
(First, 120,000 miles (192,000 km) or 120 months after every 30,000 miles (48,000 km) or 24 months)
- Add fuel additives *¹
(150,000 miles (240,000 km) or 240 months)

No check, No service required

- Automatic transmission fluid

* NOTICE

After 120 months or 150,000 miles (240,000 km) continue to follow the prescribed maintenance intervals.

Maintenance under severe usage conditions

The following items must be serviced more frequently on cars normally used under severe driving conditions. Refer to the chart below for the appropriate maintenance intervals.

R : Replace I : Inspect and, after inspection, clean, adjust, repair or replace if necessary

MAINTENANCE ITEM	MAINTENANCE OPERATION	MAINTENANCE INTERVALS	DRIVING CONDITION
Engine oil and filter	R	Every 3,750 miles (6,000 km) or 6 months	A, B, C, D, E, F, G, H, I, J, K
Air cleaner filter	I	More frequently	C, E
Spark plugs	R	More frequently	A, B, H, I, K
Automatic transmission fluid	R	Every 60,000 miles (96,000 km)	A, C, D, E, F, G, H, I
Front brake disc/pads, calipers	I	More frequently	C, D, G, H
Rear brake disc /pads	I	More frequently	C, D, G, H
Parking brake	I	More frequently	C, D, G, H

MAINTENANCE ITEM	MAINTENANCE OPERATION	MAINTENANCE INTERVALS	DRIVING CONDITION
Steering gear box, linkage & boots/ Lower arm ball joint, upper arm ball joint	I	More frequently	C, D, E, F, G, H, I
Drive shafts and boots	I	Every 7,500 miles (12,000 km) or 6 months	C, D, E, F, G, H, I, J
Front(AWD)/rear differential oil	R	Every 75,000 miles (120,000 km)	C, G, H, I, J
Climate control air filter (for evaporator and blower unit)	R	More frequently	C, E
Propeller shaft	I	Every 7,500 miles (12,000 km) or 6 months	C, E

Severe driving conditions

- A - Repeatedly driving short distance of less than 5 miles (8 km) in normal temperature or less than 10 miles (16 km) in freezing temperature
- B - Extensive engine idling or low speed driving for long distances
- C - Driving on rough, dusty, muddy, unpaved, graveled or salt-spread roads
- D - Driving in areas using salt or other corrosive materials or in very cold weather
- E - Driving in sandy areas
- F - Driving in heavy traffic area over 90°F (32°C)
- G - Driving on uphill, downhill, or mountain road
- H - Towing a Trailer, or using a camper, or roof rack
- I - Driving as a patrol car, taxi, other commercial use or vehicle towing
- J - Driving over 106 mph (170 km/h)
- K - Frequently driving in stop-and-go conditions

EXPLANATION OF SCHEDULED MAINTENANCE ITEMS

Engine oil and filter

The engine oil and filter should be changed at the intervals specified in the maintenance schedule. If the car is being driven in severe conditions, more frequent oil and filter changes are required.

Drive belts

Inspect all drive belts for evidence of cuts, cracks, excessive wear or oil saturation and replace if necessary. Drive belts should be checked periodically for proper tension and adjusted as necessary.

Fuel filter

A clogged filter can limit the speed at which the vehicle may be driven, damage the emission system and cause multiple issues such as hard starting. If an excessive amount of foreign matter accumulates in the fuel tank, the filter may require replacement more frequently. After installing a new filter, run the engine for several minutes, and check for leaks at the connections. Fuel filters should be installed by an authorized HYUNDAI dealer.

Fuel lines, fuel hoses and connections

Check the fuel lines, fuel hoses and connections for leakage and damage. Have an authorized HYUNDAI dealer replace any damaged or leaking parts immediately.

Vapor hose and fuel filler cap

The vapor hose and fuel filler cap should be inspected at those intervals specified in the maintenance schedule. Make sure a new vapor hose or fuel filler cap is correctly replaced.

Air cleaner filter

A genuine HYUNDAI air cleaner filter is recommended when the filter is replaced.

Spark plugs

Make sure to install new spark plugs of the correct heat range.

Valve clearance (Lambda engine)

Inspect for excessive valve noise and/or engine vibration and adjust if necessary. Have an authorized HYUNDAI dealer perform the operation.

Cooling system

Check cooling system components, such as radiator, coolant reservoir, hoses and connections for leakage and damage. Replace any damaged parts.

Engine coolant

The coolant should be changed at the intervals specified in the maintenance schedule.

Automatic transmission fluid

Automatic transmission fluid should not be checked under normal usage conditions. But in severe conditions, the fluid should be changed at an authorized HYUNDAI dealer in accordance to the scheduled maintenance at the beginning of this chapter.

* NOTICE

Automatic transmission fluid color is basically red.

As the vehicle is driven, the automatic transmission fluid will begin to look darker. This is a normal condition and you should not judge the need to replace the fluid based upon the changed color.

CAUTION

The use of a non-specified fluid could result in transmission malfunction and failure. Use only the specified automatic transmission fluid (refer to “Recommended Lubricants and Capacities” in chapter 8).

Brake hoses and lines

Visually check for proper installation, chafing, cracks, deterioration and any leakage. Replace any deteriorated or damaged parts immediately.

Brake fluid

Check brake fluid level in the brake fluid reservoir. The level should be between the MIN and the MAX marks on the side of the reservoir. Use only hydraulic brake fluid conforming to DOT 3 or DOT 4 specification.

Parking brake

Inspect the parking brake system including the parking brake pedal and cables.

Brake discs, pads, calipers and rotors

Check the pads for excessive wear, discs for run out and wear, and calipers for fluid leakage.

Exhaust pipe and muffler

Visually inspect the exhaust pipes, muffler and hangers for cracks, deterioration, or damage. Start the engine and listen carefully for any exhaust gas leakage. Tighten connections or replace parts as necessary.

Suspension mounting bolts

Check the suspension connections for looseness or damage. Retighten to the specified torque.

Steering gear box, linkage & boots/lower arm ball joint

With the vehicle stopped and the engine off, check for excessive free-play in the steering wheel. Check the linkage for bends or damage. Check the dust boots and ball joints for deterioration, cracks, or damage.

Replace any damaged parts.

Drive shafts and boots

Check the drive shafts, boots and clamps for cracks, deterioration, or damage. Replace any damaged parts and, if necessary, repack the grease.

Air conditioning refrigerant

Check the air conditioning lines and connections for leakage and damage.

ENGINE OIL

Checking the engine oil level

1. Follow all of the oil manufacturer's precautions.
2. Be sure the vehicle is on level ground in P (Park) with the parking brake set and the wheels blocked.
3. Turn the engine on and allow the engine to reach normal operating temperature.
4. Turn the engine off and wait about five minutes for the oil to return to the oil pan.
5. Pull the dipstick out, wipe it clean, and re-insert it fully.

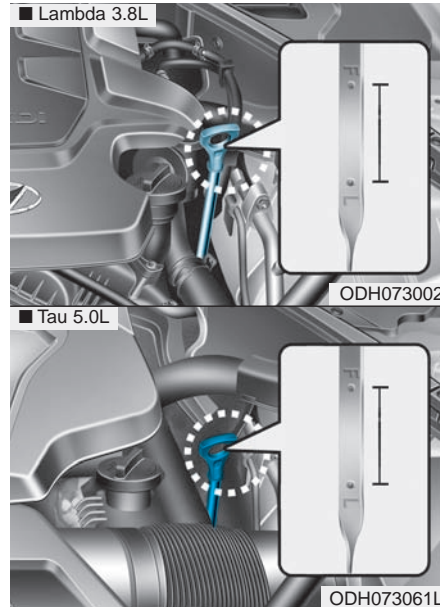

6. Pull the dipstick out again and check the level. The level should be between F and L.
7. If it is near or at L, add enough oil to bring the level to F.

* NOTICE

To prevent damage to your engine:

- Do not overfill with engine oil. Add oil in small quantities and recheck level to ensure engine is not overfilled.
- Do not spill engine oil when adding or changing engine oil. Use a funnel to help prevent oil from being spilled on engine components. Wipe off spilled oil immediately.

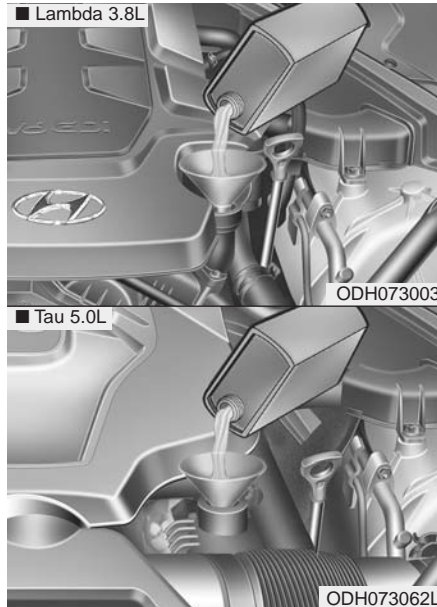

Checking the engine oil and filter



Have engine oil and filter changed by an authorized HYUNDAI dealer according to the Maintenance Schedule at the beginning of this chapter.

⚠ WARNING

CALIFORNIA PROPOSITION 65 WARNING

Engine oil contains chemicals known to the State of California to cause cancer, birth defects and reproductive harm. Used engine oil may cause irritation or cancer of the skin if left in contact with the skin for prolonged periods of time. Always protect your skin by washing your hands thoroughly with soap and warm water as soon as possible after handling used oil.

*** NOTICE**

Use only the specified engine oil (refer to “Recommended Lubricants and Capacities” in chapter 8).

ENGINE COOLANT

The high-pressure cooling system has a reservoir filled with year-round antifreeze coolant. The reservoir is filled at the factory.

Check the antifreeze protection and coolant level at least once a year, at the beginning of the winter season and before traveling to a colder climate.

Checking the engine coolant level

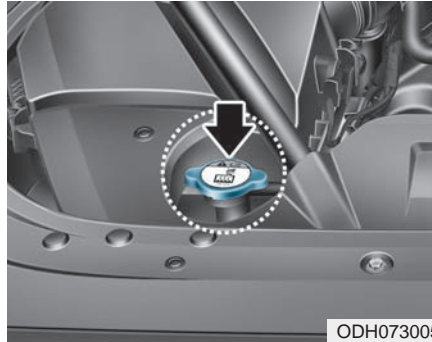

ODH073005

WARNING



Never remove the radiator cap or the drain plug while the engine and radiator are hot. Hot coolant and steam may blow out under pressure, causing serious injury.

(Continued)

(Continued)

Turn the engine off and wait until the engine cools down. Use extreme care when removing the radiator cap. Wrap a thick towel around it, and turn it counterclockwise slowly to the first stop. Step back while the pressure is released from the cooling system. When you are sure all the pressure has been released, press down on the cap, using a thick towel, and continue turning counterclockwise to remove it.

WARNING



The electric motor for the cooling fan may continue to operate or start up when the engine is not running and can cause serious injury. Keep hands, clothing and tools away from the rotating fan blades of the cooling fan.

The electric motor for the cooling fan is controlled by engine coolant temperature, refrigerant pressure and vehicle speed. As the engine coolant temperature decreases, the electric motor will automatically shut off. This is a normal condition. If your vehicle is equipped with GDI, the electric motor for the cooling fan may begin to operate at any time and continue to operate until you disconnect the negative battery cable.

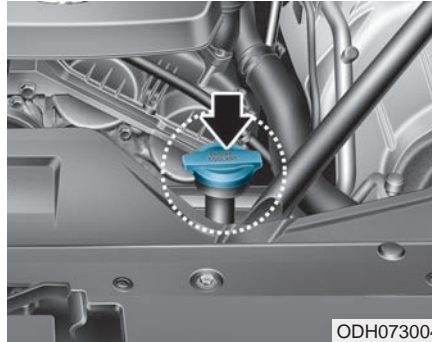

Check the condition and connections of all cooling system hoses and heater hoses. Replace any swollen or deteriorated hoses.

The coolant level should be filled between the F and the L marks on the side of the coolant reservoir when the engine is cool.

If the coolant level is low, add enough distilled (deionized) water to bring the level to the F mark, but do not overfill. If frequent additions are required, we recommend that you see an authorized HYUNDAI dealer for a cooling system inspection.

Recommended engine coolant

- When adding coolant, use only deionized water, distilled water or soft water for your vehicle and never mix hard water in the coolant filled at the factory.
- An improper coolant mixture can result in severe malfunction or engine damage.
- The engine in your vehicle has aluminum engine parts and must be protected by an ethylene-glycol-based coolant to prevent corrosion and freezing.
- Do not use alcohol or methanol coolant or mix them with the specified coolant.
- Do not use a solution that contains more than 60% antifreeze or less than 35% antifreeze, which would reduce the effectiveness of the solution.

For mixing percentage, refer to the following table:

Ambient Temperature	Mixture Percentage (volume)	
	Antifreeze	Water
5°F (-15°C)	35	65
-13°F (-25°C)	40	60
-31°F (-35°C)	50	50
-49°F (-45°C)	60	40

* NOTICE

If in doubt about the mix ratio, a 50% water and 50% antifreeze mix is the easiest to mix together as it will be the same quantity of each. It is suitable to use for most temperature ranges of -31°F and higher.

Changing engine coolant

Have coolant changed by an authorized HYUNDAI dealer according to the Maintenance Schedule at the beginning of this chapter.

WARNING

- Do not use engine coolant or antifreeze in the washer fluid reservoir.
- Engine coolant can severely obscure visibility when sprayed on the windshield and may cause loss of vehicle control resulting in an accident.
- Engine coolant may also cause damage to paint and body trim.

CAUTION

To prevent damage to engine parts, put a thick towel around the radiator cap before refilling the coolant to prevent the coolant from overflowing into engine parts, such as the generator.

BRAKE FLUID

Checking the brake fluid level

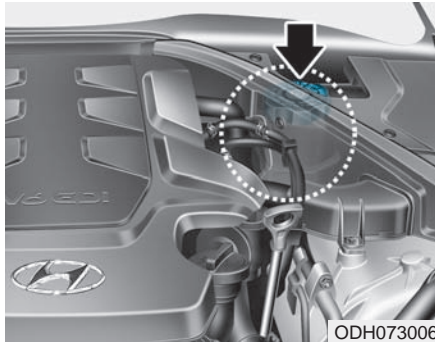

Check the fluid level in the reservoir periodically. The fluid level should be between MAX and MIN marks on the side of the reservoir.

Before removing the reservoir cap and adding brake fluid, clean the area around the reservoir cap thoroughly to prevent brake fluid contamination.

If the level is low, add the specified brake fluid to the MAX level. The level will fall with accumulated mileage. This is a normal condition associated with the wear of the brake linings. If the fluid level is excessively low, have the brake system checked by an authorized HYUNDAI dealer.

⚠ WARNING

If the brake system requires frequent additions of fluid this could indicate a leak in the brake system. Have the vehicle inspected by an authorized HYUNDAI dealer.

⚠ WARNING

Do not allow brake fluid to come in contact with your eyes. If brake fluid comes in contact with your eyes, flush your eyes with clean water for at least 15 minutes and get immediate medical attention.

⚠ CAUTION

- Do not allow brake fluid to contact the vehicle's body paint, as paint damage will result.
- Brake fluid, which has been exposed to open air for an extended time should NEVER be used as its quality cannot be guaranteed. It should be disposed of properly.
- Do not use the wrong kind of brake fluid. A few drops of mineral based oil, such as engine oil, in your brake system can damage brake system parts.

*** NOTICE**

Use only the specified brake fluid (refer to “Recommended Lubricants and Capacities” in chapter 8).

WASHER FLUID

Checking the washer fluid level

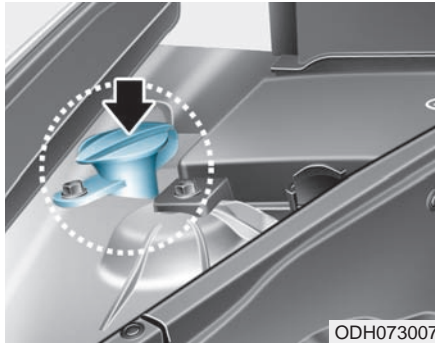

Check the fluid level in the washer fluid reservoir and add fluid if necessary. Plain water may be used if washer fluid is not available. However, use washer solvent with antifreeze characteristics in cold climates to prevent freezing.

CAUTION

To prevent serious injury or death, take the following safety precautions when using washer fluid:

- Do not use engine coolant or antifreeze in the washer fluid reservoir.

Engine coolant can severely obscure visibility when sprayed on the windshield and may cause loss of vehicle control resulting in an accident or damage to paint and body trim.

- Do not allow sparks or flame to contact the washer fluid or the washer fluid reservoir. Washer fluid may contain alcohol and can be flammable.
- Do not drink washer fluid and avoid contact with skin. Washer fluid is poisonous to humans and animals.
- Keep washer fluid away from children and animals.

PARKING BRAKE

Checking the parking brake

Foot type

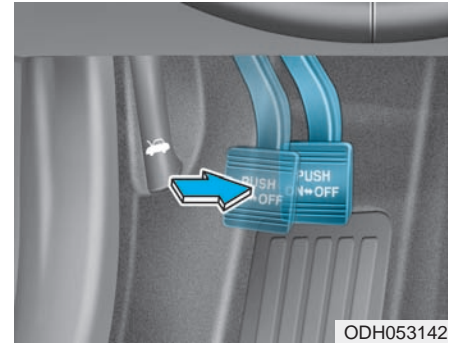

Check whether the stroke is within specification when the parking brake pedal is depressed with 44 lb (20 kg, 196 N) of force. Also, the parking brake alone should securely hold the vehicle on a fairly steep grade. If the stroke is more or less than specified, have the parking brake adjusted by an authorized HYUNDAI dealer.

Stroke : 3 notch

AIR CLEANER

Filter replacement

■ Lambda engine, Tau engine

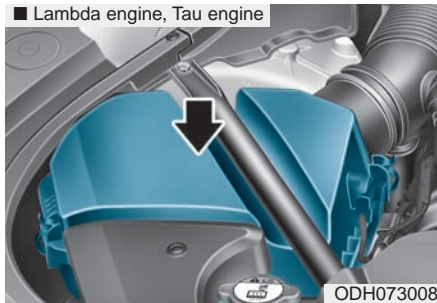

■ Tau engine

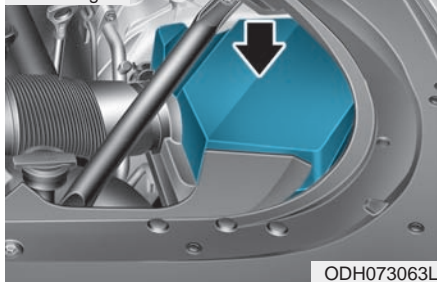

The air cleaner filter can be cleaned for inspection using compressed air. Do not attempt to wash or to rinse it, as water will damage the filter. If soiled, the air cleaner filter must be replaced.

We recommend that you visit an authorized HYUNDAI dealer to replace air cleaner filter.

Replace the filter according to the Maintenance Schedule

* NOTICE

If the vehicle is operated in extremely dusty or sandy areas, replace the element more often than the usual recommended intervals (refer to “Maintenance Under Severe Usage Conditions” in this chapter).

⚠ CAUTION

- Do not drive with the air cleaner filter removed. This will result in excessive engine wear.
- When removing the air cleaner filter, be careful that dust or dirt does not enter the air intake, or damage may result.
- Use HYUNDAI genuine parts, use of non-genuine parts could damage the air flow sensor.

CLIMATE CONTROL AIR FILTER

Filter inspection

The climate control air filter should be replaced according to the Maintenance Schedule. If the vehicle is operated in severely air-polluted cities or on dusty rough roads for a long period, it should be inspected more frequently and replaced earlier. When you replace the climate control air filter, replace it performing the following procedure, and be careful to avoid damaging other components.

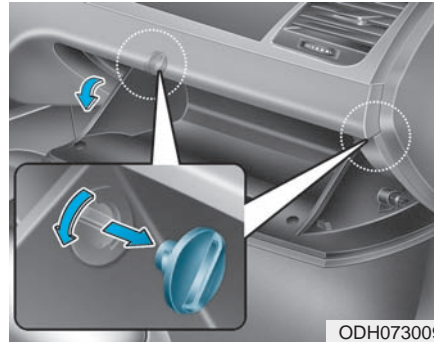

1. With the glove box open, remove the stoppers on both sides to allow the glove box to hang freely on the hinges.

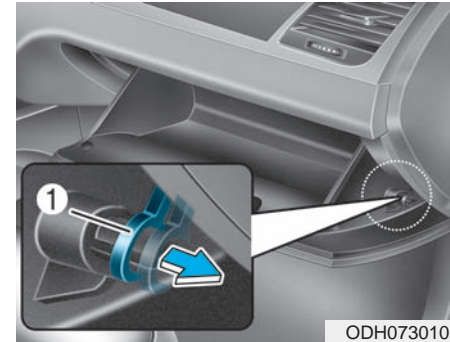

2. Remove the support rod (1).

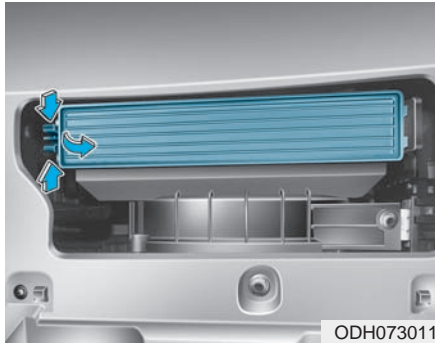

3. Remove the climate control air filter case by pulling out left sides of the cover.

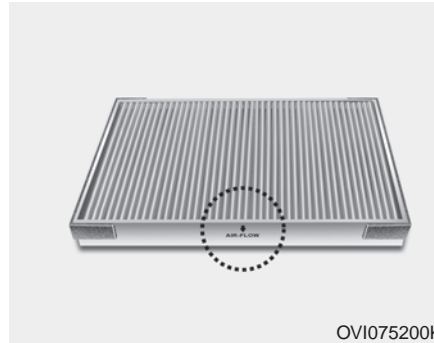

4. Replace the climate control air filter.
5. Reassemble in the reverse order of disassembly.

* NOTICE

Install a new climate control air filter in the correct direction with the arrow symbol (↓) facing downwards. Otherwise, the climate control effects may decrease, possibly with a noise.

WIPER BLADES

Blade inspection

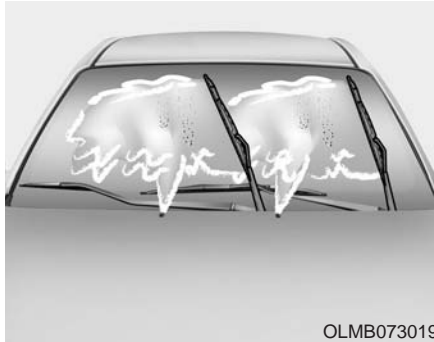

Contamination of either the windshield or the wiper blades with foreign matter can reduce the effectiveness of the windshield wipers. Common sources of contamination are insects, tree sap, and hot wax treatments used by some commercial car washes. If the blades are not wiping properly, clean both the window and the blades with a clean cloth dampened with washer fluid.

CAUTION

To prevent damage to the wiper blades, arms or other components, do not:

- Use gasoline, kerosene, paint thinner, or other solvents on or near them.
- Attempt to move the wipers manually.
- Use non-specified wiper blades.

* NOTICE

Commercial hot waxes applied by automatic car washes have been known to make the windshield difficult to clean.

Blade replacement

When the wipers no longer clean adequately, the blades may be worn or cracked, and require replacement.

CAUTION

To prevent damage to the wiper arms or other components, do not attempt to move the wipers manually.

CAUTION

The use of a non-specified wiper blade could result in wiper malfunction and failure.

Front windshield wiper blade

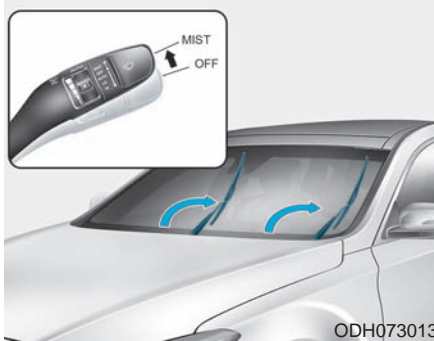

For your convenience, move the windshield wiper blades to the service position as follows;

After turning off the engine, move the wiper switch to the single wiping (MIST) position within 20 seconds and hold the switch more than 2 seconds until the wiper blade is in the fully up position.

CAUTION

Do not allow the wiper arm to fall against the windshield, since it may chip or crack the windshield.

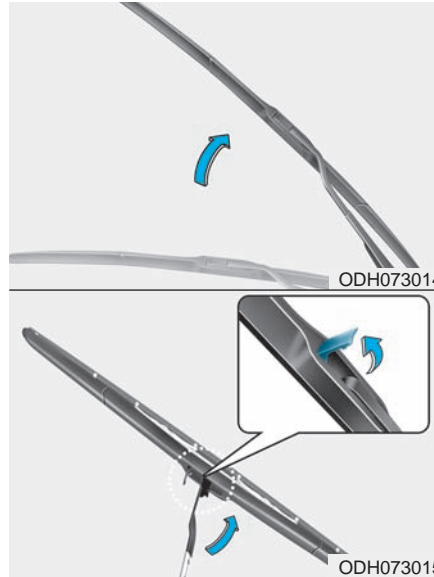

1. Raise the wiper arm.
2. Turn the wiper blade clip. Then lift up the blade clip.

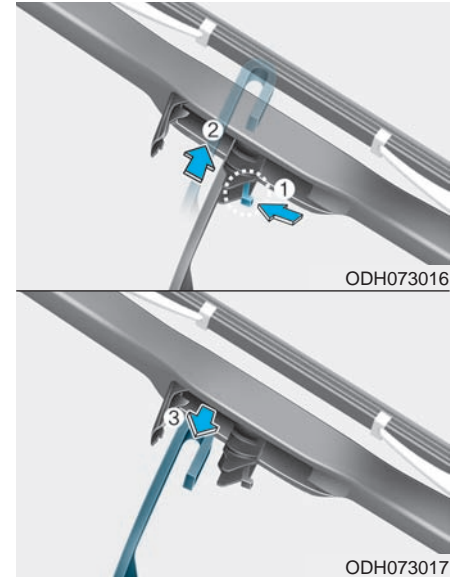

3. Push the clip (1) and push up the wiper arm (2).
4. Push down the wiper arm (3) and install the new blade assembly in the reverse order of removal.
5. Return the wiper arm on the windshield.
6. Turn ignition to the ON position and wiper arms will return to the normal operating position.

BATTERY

Jump starting can be dangerous if done incorrectly. Follow the jump starting procedure in this section to avoid serious injury or damage to your vehicle. If in doubt about how to properly jump start your vehicle, we strongly recommend that you have a service technician or towing service do it for you.

WARNING

To prevent **SERIOUS INJURY** or **DEATH** to you or bystanders, always follow these precautions when working near or handling the battery:



Always read and follow instructions carefully when handling a battery.



Wear eye protection designed to protect the eyes from acid splashes.



Keep all flames, sparks, or smoking materials away from the battery.



Hydrogen is always present in battery cells, is highly combustible, and may explode if ignited.



Keep batteries out of reach of children.

(Continued)

(Continued)



Batteries contain sulfuric acid which is highly corrosive. Do not allow acid to contact your eyes, skin or clothing.

If acid gets into your eyes, flush your eyes with clean water for at least 15 minutes and get immediate medical attention. If acid gets on your skin, thoroughly wash the area. If you feel pain or a burning sensation, get medical attention immediately.

- When lifting a plastic-cased battery, excessive pressure on the case may cause battery acid to leak. Lift with a battery carrier or with your hands on opposite corners.
- Do not attempt to jump start your vehicle if your battery is frozen.

(Continued)

(Continued)

- NEVER attempt to recharge the battery when the vehicle's battery cables are connected to the battery.
- The electrical ignition system works with high voltage. NEVER touch these components with the engine running or when the Engine Start/Stop button is in the ON position.

WARNING

CALIFORNIA PROPOSITION 65 WARNING

Battery posts, terminals, and related accessories contain lead and lead compounds, chemicals known to the State of California to cause cancer, birth defects and reproductive harm. Batteries also contain other chemicals known to the State of California to cause cancer. Wash hands after handling.

CAUTION

- When you do not use the vehicle for a long time in a low temperature area, disconnect the battery and keep it indoors.
- Always charge the battery fully to prevent battery case damage in low temperature areas.

For best battery service

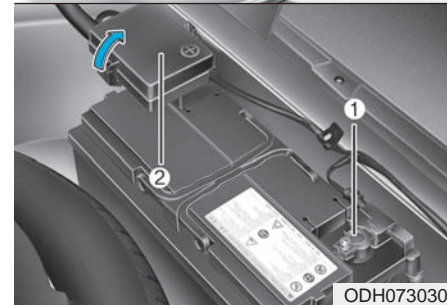

The battery is in the trunk.

When replacing the battery, disconnect the negative (-) cable (1) and remove the positive (+) battery fuse box (2).

- Keep the battery securely mounted.
- Keep the battery top clean and dry.
- Keep the terminals and connections clean, tight, and coated with petroleum jelly or terminal grease.
- Rinse any spilled acid from the battery immediately with a solution of water and baking soda.

Battery recharging

By battery charger

Your vehicle has a maintenance-free, calcium-based battery.

- If the battery becomes discharged in a short time (because, for example, the headlights or interior lights were left on while the vehicle was not in use), recharge it by slow charging (trickle) for 10 hours.
- If the battery gradually discharges because of high electric load while the vehicle is being used, recharge it at 20-30A for two hours.

CAUTION

AGM battery

- **Absorbent Glass Matt (AGM) batteries are maintenance-free and we recommend that the AGM battery be serviced by an authorized HYUNDAI dealer. For charging your AGM battery, use only fully automatic battery chargers that are specially developed for AGM batteries.**
- **When replacing the AGM battery, we recommend that you use parts for replacement from an authorized HYUNDAI dealer.**
- **Do not open or remove the cap on top of the battery. This may cause leaks of internal electrolyte that could result in severe injury.**

WARNING

Always follow these instructions when recharging your vehicle's battery to avoid the risk of **SERIOUS INJURY** or **DEATH** from explosions or acid burns:

- Before performing maintenance or recharging the battery, turn off all accessories and press the Engine Start/Stop button to the OFF position.
- Keep all flames, sparks, or smoking materials away from the battery.
- Always work outdoors or in an area with plenty of ventilation.
- Wear eye protection when checking the battery during charging.
- The battery must be removed from the vehicle and placed in a well ventilated area.

(Continued)

(Continued)

- Watch the battery during charging, and stop or reduce the charging rate if the battery cells begin boiling violently.
- The negative battery cable must be removed first and installed last when the battery is disconnected. Disconnect the battery charger in the following order:
 - (1) Turn off the battery charger main switch.
 - (2) Unhook the negative clamp from the negative battery terminal.
 - (3) Unhook the positive clamp from the positive battery terminal.
- Always use a genuine HYUNDAI approved battery when you replace the battery.

By jump starting

After a jump start from a good battery, drive the vehicle for 20-30 minutes before it is shutdown. The vehicle may not restart if you shut it off before the battery had a chance to adequately recharge. See "Jump Starting" in chapter 6 for more information on jump starting procedures.

* NOTICE



An inappropriately disposed battery can be harmful to the environment and human health. Dispose the battery according to your local law(s) or regulation.

Reset features

Some items need to be reset after the battery has been discharged or the battery has been disconnected. See chapter 3 for:

- Auto up/down window
- Sunroof
- Trip computer
- Climate control system

TIRES AND WHEELS

WARNING

Tire failure may cause loss of vehicle control resulting in an accident. To reduce risk of **SERIOUS INJURY** or **DEATH**, take the following precautions:

- Inspect your tires monthly for proper inflation as well as wear and damage.
- The recommended cold tire pressure for your vehicle can be found in this manual and on the tire label located on the driver's side center pillar. Always use a tire pressure gauge to measure tire pressure. Tires with too much or too little pressure wear unevenly causing poor handling.
- Check the pressure of the spare every time you check the pressure of the other tires on your vehicle.

(Continued)

(Continued)

- Replace tires that are worn, show uneven wear, or are damaged. Worn tires can cause loss of braking effectiveness, steering) control, or traction.
- **ALWAYS** replace tires with the same size as each tire that was originally supplied with this vehicle. Using tires and wheels other than the recommended sizes could cause unusual handling characteristics, poor vehicle control, or negatively affect your vehicle's Anti-Lock Brake System (ABS) resulting in a serious accident.

Tire care

For proper maintenance, safety, and maximum fuel economy, you must always maintain recommended tire inflation pressures and stay within the load limits and weight distribution recommended for your vehicle.



ODH083005L

All specifications (sizes and pressures) can be found on a label attached to the driver's side center pillar

Recommended cold tire inflation pressures

All tire pressures (including the spare) should be checked when the tires are cold. "Cold tires" means the vehicle has not been driven for at least three hours or driven less than one mile (1.6 km).

Warm tires normally exceed recommended cold tire pressures by 4 to 6 psi (28 to 41 kPa). Do not release air from warm tires to adjust the pressure or the tires will be under-inflated. For recommended inflation pressure, refer to "Tire and Wheels" in chapter 8.

WARNING

Recommended pressures must be maintained for the best ride, vehicle handling, and minimum tire wear.

Over-inflation or under-inflation can reduce tire life, adversely affect vehicle handling, and lead to sudden tire failure that could result in loss of vehicle control resulting in an accident.

Severe under-inflation can lead to severe heat build-up, causing blowouts, tread separation and other tire failures that can result in the loss of vehicle control resulting in an accident. This risk is much higher on hot days and when driving for long periods at high speeds.

 **CAUTION**

Under-inflation results in excessive wear, poor handling and reduced fuel economy. Wheel deformation is also possible. Keep your tire pressures at the proper levels. If a tire frequently needs refilling, have it checked by an authorized HYUNDAI dealer.

Over-inflation produces a harsh ride, excessive wear at the center of the tire tread, and a greater possibility of damage from road hazards.

Check tire inflation pressure

Check your tires, including the spare tire, once a month or more.

How to check

Use a good quality tire pressure gauge to check tire pressure. You can not tell if your tires are properly inflated simply by looking at them. Radial tires may look properly inflated when they are under-inflated.

Remove the valve cap from the tire valve stem. Press the tire gauge firmly onto the valve to get a pressure measurement. If the cold tire inflation pressure matches the recommended pressure on the tire and loading information label, no further adjustment is necessary. If the pressure is low, add air until you reach the recommended pressure. Make sure to put the valve caps back on the valve stems. Without the valve cap, dirt or moisture could get into the valve core and cause air leakage. If a valve cap is missing, install a new one as soon as possible.

If you overfill the tire, release air by pushing on the metal stem in the center of the tire valve. Recheck the tire pressure with the tire gauge. Be sure to put the valve caps back on the valve stems. Without the valve cap, dirt or moisture could get into the valve core and cause air leakage. If a valve cap is missing, install a new one as soon as possible.

Tire rotation

To equalize tread wear, HYUNDAI recommends that the tires be rotated every 7,500 miles (12,000 km) or sooner if irregular wear develops.

During rotation, check the tires for correct balance.

When rotating tires, check for uneven wear and damage. Abnormal wear is usually caused by incorrect tire pressure, improper wheel alignment, out-of-balance wheels, severe braking or severe cornering. Look for bumps or bulges in the tread or side of tire. Replace the tire if you find either of these conditions. Replace the tire if fabric or cord is visible. After rotation, be sure to bring the front and rear tire pressures to specification and check lug nut tightness (proper torque is 65-79 lb.ft [9-11 kg.m]).

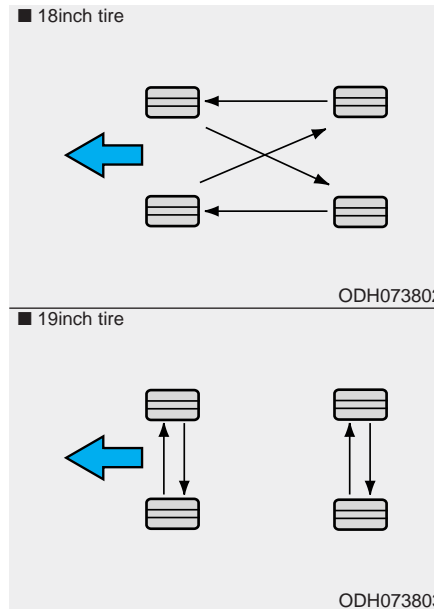

Disc brake pads should be inspected for wear whenever tires are rotated.

* NOTICE

If your tire is unsymmetrical tire, check the outside and inside marked in tire.

If the inside tire is installed on outside, the vehicle driving and wear performance may be damaged.

⚠ WARNING

- Do not use the compact spare tire for tire rotation.
- Do not mix bias ply and radial ply tires under any circumstances. This may cause unusual handling characteristics that may cause loss of vehicle control resulting in an accident.

Wheel alignment and tire balance

The wheels on your vehicle were aligned and balanced carefully at the factory to give you the longest tire life and best overall performance.

In most cases, you will not need to have your wheels aligned again. However, if you notice unusual tire wear or your vehicle pulling one way or the other, the alignment may need to be reset.

If you notice your vehicle vibrating when driving on a smooth road, your wheels may need to be rebalanced.

CAUTION

Improper wheel weights can damage your vehicle's aluminum wheels. Use only approved wheel weights.

Tire replacement



If the tire is worn evenly, a tread wear indicator will appear as a solid band across the tread. This shows there is less than 1/16 inch (1.6 mm) of tread left on the tire. Replace the tire when this happens.

Do not wait for the band to appear across the entire tread before replacing the tire.

WARNING

To reduce the risk of DEATH or SERIOUS INJURY:

Replace tires that are worn, show uneven wear, or are damaged. Worn tires can cause loss of braking effectiveness, steering control, and traction.

Always replace tires with the same size as each tire that was originally supplied with this vehicle. Using tires and wheels other than the recommended sizes could cause unusual handling characteristics, poor vehicle control, or negatively affect your vehicle's Anti-Lock Brake System (ABS) resulting in a serious accident.

Tires degrade over time, even when they are not being used. Regardless of the remaining tread, HYUNDAI recommends that tires be replaced after six (6) years of normal service.

(Continued)

(Continued)

Heat caused by hot climates or frequent high loading conditions can accelerate the aging process. Failure to follow this warning may cause sudden tire failure, which could lead to a loss of vehicle control resulting in an accident.

Compact spare tire replacement

A compact spare tire has a shorter tread life than a regular size tire. Replace it when you can see the tread wear indicator bars on the tire. The replacement compact spare tire should be the same size and design tire as the one provided with your new vehicle and should be mounted on the same compact spare tire wheel. The compact spare tire is not designed to be mounted on a regular size wheel, and the compact spare tire wheel is not designed for mounting a regular size tire.

⚠ WARNING

The original tire should be repaired or replaced as soon as possible to avoid failure of the spare and loss of vehicle control resulting in an accident. The compact spare tire is for emergency use only. Do not operate your vehicle over 50 mph (80 km/h) when using the compact spare tire.

Wheel replacement

When replacing the metal wheels for any reason, make sure the new wheels are equivalent to the original factory units in diameter, rim width and offset.

Tire traction

Tire traction can be reduced if you drive on worn tires, tires that are improperly inflated or on slippery road surfaces. Tires should be replaced when tread wear indicators appear. To reduce the possibility of losing control, slow down whenever there is rain, snow or ice on the road.

Tire maintenance

In addition to proper inflation, correct wheel alignment helps to decrease tire wear. If you find a tire is worn unevenly, have your dealer check the wheel alignment.

When you have new tires installed, make sure they are balanced. This will increase vehicle ride comfort and tire life. Additionally, a tire should always be rebalanced if it is removed from the wheel.

Tire sidewall labeling

This information identifies and describes the fundamental characteristics of the tire and also provides the tire identification number (TIN) for safety standard certification. The TIN can be used to identify the tire in case of a recall.

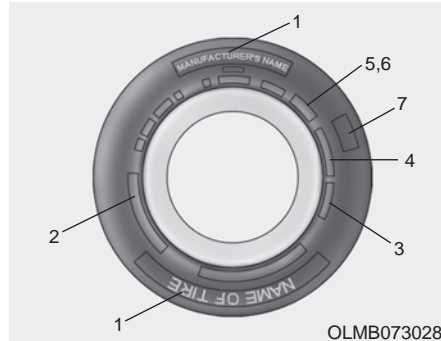

1. Manufacturer or brand name

Manufacturer or brand name is shown.

2. Tire size designation

A tire's sidewall is marked with a tire size designation. You will need this information when selecting replacement tires for your car. The following explains what the letters and numbers in the tire size designation mean.

Example tire size designation:

(These numbers are provided as an example only; your tire size designator could vary depending on your vehicle.)

225/55R18 105T

225 - Tire width in millimeters.

55 - Aspect ratio. The tire's section height as a percentage of its width.

R - Tire construction code (Radial).

18 - Rim diameter in inches.

105 - Load Index, a numerical code associated with the maximum load the tire can carry.

T - Speed Rating Symbol. See the speed rating chart in this section for additional information.

Wheel size designation

Wheels are also marked with important information that you need if you ever have to replace one. The following explains what the letters and numbers in the wheel size designation mean.

Example wheel size designation:

6.5JX18

6.5 - Rim width in inches.

J - Rim contour designation.

18 - Rim diameter in inches.

Tire speed ratings

The chart below lists many of the different speed ratings currently being used for passenger car tires. The speed rating is part of the tire size designation on the sidewall of the tire. This symbol corresponds to that tire's designed maximum safe operating speed.

Speed Rating Symbol	Maximum Speed
S	112 mph (180 km/h)
T	118 mph (190 km/h)
H	130 mph (210 km/h)
V	149 mph (240 km/h)
Z	Above 149 mph (240 km/h)

3. Checking tire life (TIN : Tire Identification Number)

Any tires that are over six years old, based on the manufacturing date, (including the spare tire) should be replaced by new ones. You can find the manufacturing date on the tire sidewall (possibly on the inside of the wheel), displaying the DOT Code. The DOT Code is a series of numbers on a tire consisting of numbers and English letters. The manufacturing date is designated by the last four digits (characters) of the DOT code.

DOT : XXXX XXXX OOOO

The front part of the DOT means a plant code number, tire size and tread pattern and the last four numbers indicate week and year manufactured.

For example:

DOT XXXX XXXX 1615 represents that the tire was produced in the 16th week of 2015.

4. Tire ply composition and material

The number of layers or plies of rubber-coated fabric in the tire. Tire manufacturers also must indicate the materials in the tire, which include steel, nylon, polyester, and others. The letter "R" means radial ply construction; the letter "D" means diagonal or bias ply construction; and the letter "B" means belted-bias ply construction.

5. Maximum permissible inflation pressure

This number is the greatest amount of air pressure that should be put in the tire. Do not exceed the maximum permissible inflation pressure. Refer to the Tire and Loading Information label for recommended inflation pressure.

6. Maximum load rating

This number indicates the maximum load in kilograms and pounds that can be carried by the tire. When replacing the tires on the vehicle, always use a tire that has the same load rating as the factory installed tire.

7. Uniform tire quality grading

Quality grades can be found where applicable on the tire sidewall between tread shoulder and maximum section width.

For example:

TREAD wear 200
TRACTION AA
TEMPERATURE A

Tread wear

The tread wear grade is a comparative rating based on the wear rate of the tire when tested under controlled conditions on a specified government test course. For example, a tire graded 150 would wear one-and-a-half times ($1\frac{1}{2}$) as well on the government course as a tire graded 100.

The relative performance of tires depends upon the actual conditions of their use, however, and may depart significantly from the norm due to variations in driving habits, service practices and differences in road characteristics and climate.

These grades are molded on the sidewalls of passenger vehicle tires. The tires available as standard or optional equipment on your vehicle may vary with respect to grade.

Traction - AA, A, B & C

The traction grades, from highest to lowest, are AA, A, B and C. Those grades represent the tire's ability to stop on wet pavement as measured under controlled conditions on specified government test surfaces of asphalt and concrete. A tire marked C may have poor traction performance.

WARNING

The traction grade assigned to this tire is based on straight-ahead braking traction tests, and does not include acceleration, cornering, hydroplaning, or peak traction characteristics.

Temperature - A, B & C

The temperature grades are A (the highest), B and C representing the tire's resistance to the generation of heat and its ability to dissipate heat when tested under controlled conditions on a specified indoor laboratory test wheel.

Sustained high temperature can cause the material of the tire to degenerate and reduce tire life, and excessive temperature can lead to sudden tire failure. Grade C responds to a level of performance which all passenger car tires must meet under the Federal Motor Vehicle Safety Standard No. 109. Grades B and A represent higher levels of performance on the laboratory test wheel than the minimum required by law.

WARNING

The temperature grade for this tire is established for a tire that is properly inflated and not overloaded. Excessive speed, under-inflation, over-inflation, or excessive loading, either separately or in combination, can cause heat build-up and possible sudden tire failure. This may cause loss of vehicle control resulting in an accident.

Tire terminology and definitions

Air Pressure

The amount of air inside the tire pressing outward on the tire. Air pressure is expressed in pounds per square inch (psi) or kilopascal (kPa).

Accessory Weight

This means the combined weight of optional accessories. Some examples of optional accessories are automatic transmission, power seats, and air conditioning.

Aspect Ratio

The relationship of a tire's height to its width.

Belt

A rubber coated layer of cords that is located between the plies and the tread. Cords may be made from steel or other reinforcing materials.

Bead

The tire bead contains steel wires wrapped by steel cords that hold the tire onto the rim.

Bias Ply Tire

A pneumatic tire in which the plies are laid at alternate angles less than 90 degrees to the centerline of the tread.

Cold Tire Pressure

The amount of air pressure in a tire, measured in pounds per square inch (psi) or kilopascals (kPa) before a tire has built up heat from driving.

Curb Weight

This means the weight of a motor vehicle with standard and optional equipment including the maximum capacity of fuel, oil and coolant, but without passengers and cargo.

DOT Markings

A code molded into the sidewall of a tire signifying that the tire is in compliance with the U.S. Department of Transportation motor vehicle safety standards. The DOT code includes the Tire Identification Number (TIN), an alphanumeric designator which can also identify the tire manufacturer, production plant, brand and date of production.

GVWR

Gross Vehicle Weight Rating

GAWR FRT

Gross Axle Weight Rating for the Front Axle.

GAWR RR

Gross Axle Weight Rating for the Rear axle.

Intended Outboard Sidewall

The side of an asymmetrical tire, that must always face outward when mounted on a vehicle.

Kilopascal (kPa)

The metric unit for air pressure.

Light Truck (LT) Tire

A tire designated by its manufacturer as primarily intended for use on light-weight trucks or multipurpose passenger vehicles.

Load Ratings

The maximum load that a tire is rated to carry for a given inflation pressure.

Load Index

An assigned number ranging from 1 to 279 that corresponds to the load carrying capacity of a tire.

Maximum Inflation Pressure

The maximum air pressure to which a cold tire may be inflated. The maximum air pressure is molded onto the sidewall.

Maximum Load Rating

The load rating for a tire at the maximum permissible inflation pressure for that tire.

Maximum Loaded Vehicle Weight

The sum of curb weight; accessory weight; vehicle capacity weight; and production options weight.

Normal Occupant Weight

The number of occupants a vehicle is designed to seat multiplied by 150 pounds (68 kg).

Occupant Distribution

Designated seating positions.

Outward Facing Sidewall

An asymmetrical tire has a particular side that faces outward when mounted on a vehicle. The outward facing sidewall bears white lettering or bears manufacturer, brand, and/or model name molding that is higher or deeper than the same moldings on the inner facing sidewall.

Passenger (P-Metric) tire

A tire used on passenger cars and some light duty trucks and multipurpose vehicles.

Ply

A layer of rubber-coated parallel cords

Pneumatic Tire

A mechanical device made of rubber, chemicals, fabric and steel or other materials, that, when mounted on an automotive wheel, provides the traction and contains the gas or fluid that sustains the load.

Production Options Weight

The combined weight of installed regular production options weighing over 5 lb.(2.3 kg) in excess of the standard items which they replace, not previously considered in curb weight or accessory weight, including heavy duty brakes, ride levelers, roof rack, heavy duty battery, and special trim.

Recommended Inflation Pressure

Vehicle manufacturer's recommended tire inflation pressure as shown on the tire placard.

Radial Ply Tire

A pneumatic tire in which the ply cords that extend to the beads are laid at 90 degrees to the centerline of the tread.

Rim

A metal support for a tire and upon which the tire beads are seated.

Sidewall

The portion of a tire between the tread and the bead.

Speed Rating

An alphanumeric code assigned to a tire indicating the maximum speed at which a tire can operate.

Traction

The friction between the tire and the road surface. The amount of grip provided.

Tread

The portion of a tire that comes into contact with the road.

Treadwear Indicators

Narrow bands, sometimes called "wear bars," that show across the tread of a tire when only 1/16 inch of tread remains.

UTQGS

Uniform Tire Quality Grading Standards is a tire information system that provides consumers with ratings for a tire's traction, temperature and treadwear. Ratings are determined by tire manufacturers using government testing procedures. The ratings are molded into the sidewall of the tire.

Vehicle Capacity Weight

The number of designated seating positions multiplied by 150 lbs. (68 kg) plus the rated cargo and luggage load.

Vehicle Maximum Load on the Tire

Load on an individual tire due to curb and accessory weight plus maximum occupant and cargo weight.

Vehicle Normal Load on the Tire

Load on an individual tire that is determined by distributing to each axle its share of the curb weight, accessory weight, and normal occupant weight and dividing by 2.

Vehicle Placard

A label permanently attached to a vehicle showing the original equipment tire size and recommended inflation pressure.

All season tires

HYUNDAI specifies all season tires on some models to provide good performance for use all year round, including snowy and icy road conditions. All season tires are identified by ALL SEASON and/or M+S (Mud and Snow) on the tire sidewall. Snow tires have better snow traction than all season tires and may be more appropriate in some areas.

Summer tires

HYUNDAI specifies summer tires on some models to provide superior performance on dry roads. Summer tire performance is substantially reduced in snow and ice. Summer tires do not have the tire traction rating M+S (Mud and Snow) on the tire side wall. If you plan to operate your vehicle in snowy or icy conditions, HYUNDAI recommends the use of snow tires or all season tires on all four wheels.

Snow tires

If you equip your car with snow tires, they should be the same size and have the same load capacity as the original tires. Snow tires should be installed on all four wheels; otherwise, poor handling may result. Snow tires should carry 4 psi (28 kPa) more air pressure than the pressure recommended for the standard tires on the tire label on the driver's side of the center pillar, or up to the maximum pressure shown on the tire sidewall, whichever is less. Do not drive faster than 75 mph (120 km/h) when your vehicle is equipped with snow tires.

Radial-ply tires

Radial-ply tires provide improved tread life, road hazard resistance and smoother high speed ride. The radial-ply tires used on this vehicle are of belted construction, and are selected to complement the ride and handling characteristics of your vehicle. Radial-ply tires have the same load carrying capacity, as bias-ply or bias belted tires of the same size, and use the same recommended inflation pressure. Mixing of radial-ply tires with bias-ply or bias belted tires is not recommended. Any combinations of radial-ply and bias-ply or bias belted tires when used on the same vehicle will seriously deteriorate vehicle handling. The best rule to follow is: Identical pairs of radial-ply tires should always be used as a set for the front tires and a set for the rear tires.

Longer wearing tires can be more susceptible to irregular tread wear. It is very important to follow the tire rotation interval in this chapter to achieve the tread life potential of these tires. Cuts and punctures in radial-ply tires are repairable only in the tread area, because of sidewall flexing. Consult your tire dealer for radial-ply tire repairs.

WARNING

Do not mix bias ply and radial ply tires under any circumstances. This may cause unusual handling characteristics that may cause loss of vehicle control resulting in an accident.

Low aspect ratio tires

Low aspect ratio tires, the aspect ratio is lower than 50, are provided for sporty looks.

Because low aspect ratio tires are optimized for handling and braking, it may be more uncomfortable to ride in and there is more noise compare with normal tires.

 **CAUTION**

Because the sidewall of the low aspect ratio tire is shorter than the normal, the wheel and tire of the low aspect ratio tire is easier to be damaged. So, follow the instructions below.

- When driving on a rough road or off road, drive cautiously because tires and wheels may be damaged. And after driving, inspect tires and wheels.
- When passing over a pothole, speed bump, manhole, or curb stone, drive slowly so that the tires and wheels are not damaged.
- If the tire is impacted, we recommend that you inspect the tire condition or contact an authorized HYUNDAI dealer.
- To prevent damage to the tire, inspect the tire condition and pressure every 1,800 miles (3,000km).

 **CAUTION**

- It is not easy to recognize tire damage with your own eyes. But if there is the slightest hint of tire damage, have the tire checked or replaced because the tire damage may cause air leakage from the tire.
- If the tire is damaged by driving on a rough road, off road, pothole, manhole, or curb stone, it will not be covered by the warranty.

FUSES

■ Blade type



Normal



Blown

■ Cartridge type



Normal



Blown

■ Multi fuse



Normal



Blown

■ Fusible link



Normal



Blown

OLMB073029/OBH072060

A vehicle's electrical system is protected from electrical overload damage by fuses.

This vehicle has 2 (or 3) fuse panels, one located in the driver's side panel bolster, the other in the engine compartment near the battery.

If any of your vehicle's lights, accessories, or controls do not work, check the appropriate circuit fuse. If a fuse has blown, the element inside the fuse will be melted or broken.

If the electrical system does not work, first check the driver's side fuse panel. Before replacing a blown fuse, disconnect the negative battery cable. Always replace a blown fuse with one of the same rating.

If the replacement fuse blows, this indicates an electrical problem. Avoid using the system involved and immediately consult an authorized HYUNDAI dealer.

* NOTICE

Three kinds of fuses are used: blade type for lower amperage rating, cartridge type, and fusible link for higher amperage ratings.

⚠ WARNING

NEVER replace a fuse with anything but another fuse of the same rating.

- A higher capacity fuse could cause damage and possibly cause a fire.
- Do not install a wire or aluminum foil instead of the proper fuse - even as a temporary repair. It may cause extensive wiring damage and possibly a fire.

CAUTION

Do not use a screwdriver or any other metal object to remove fuses because it may cause a short circuit and damage the system.

Instrument panel fuse replacement



1. Turn the engine off.
2. Turn all other switches OFF.
3. Open the fuse panel cover.
4. Refer to the label on the inside of the fuse panel cover to locate the suspected fuse location.

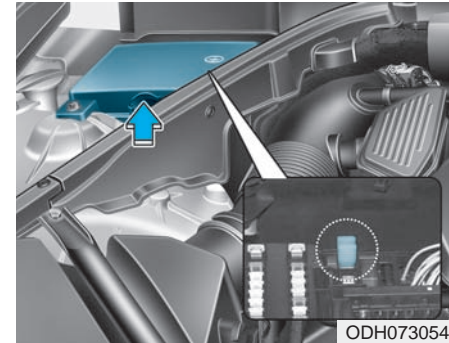

5. Pull the suspected fuse straight out. Use the removal tool provided in the engine compartment fuses panel.
6. Remove and check the suspected fuse; replace it if it is blown. Spare fuses are provided in the instrument panel fuse panels (or in the engine compartment fuse panel).
7. Push in a new fuse of the same rating, and make sure it fits tightly in the clips. If it fits loosely, consult an authorized HYUNDAI dealer.

In an emergency, if you do not have a spare fuse, use a fuse of the same rating from a circuit you may not need for operating the vehicle, such as the cigarette lighter fuse.

If the headlamps or other electrical components do not work and the fuses are OK, check the fuse panel in the engine compartment. If a fuse is blown, it must be replaced with the same rating.

Fuse switch

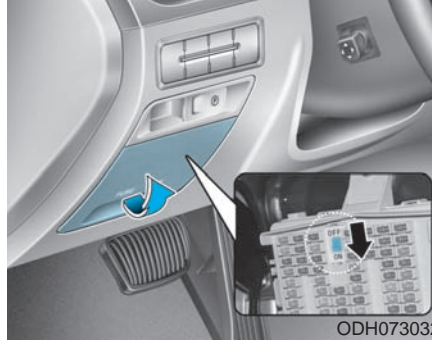

Always, place the fuse switch to the ON position.

If you move the switch to the OFF position, some items such as audio and digital clock must be reset and the smart key may not work properly.

CAUTION

- Always place the fuse switch in the ON position while driving the vehicle.
- Do not move the transportation fuse switch repeatedly. The fuse switch may be damaged.

Engine compartment panel fuse replacement

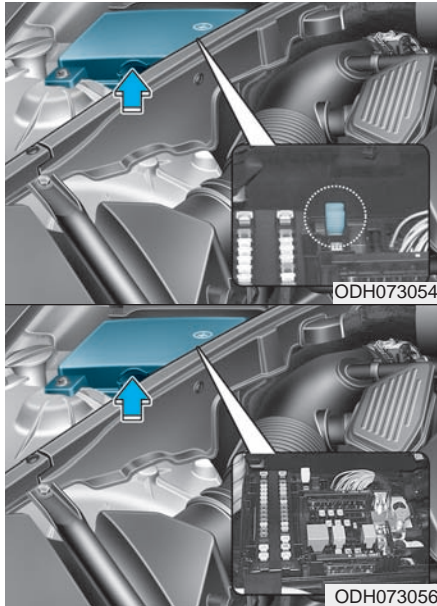

1. Turn the engine off.
2. Turn all other switches OFF.
3. Remove the fuse panel cover by pressing the tap and pulling up.

4. Remove and check the suspected fuse; replace it if it is blown. To remove or insert the fuse, use the fuse puller in the engine compartment fuse panel.
5. Push in a new fuse of the same rating, and make sure it fits tightly in the clips. If it fits loosely, consult an authorized HYUNDAI dealer.

Main fuse

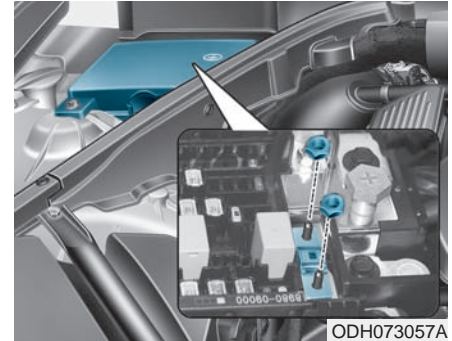

If the main fuse is blown, it must be removed as follows:

1. Turn off the engine.
2. Disconnect the negative battery cable.
3. Remove the fuse panel cover by pressing the tab and pulling it up.
4. Remove the nuts shown in the picture above.
5. Replace the fuse with a new one of the same rating.
6. Reinstall in the reverse order of removal.

* NOTICE

If the main fuse is blown, consult an authorized HYUNDAI dealer.

Multi fuse



If the multi fuse is blown, it must be removed as follows:

1. Turn off the engine.
2. Disconnect the negative battery cable.
3. Remove the fuse panel cover by pressing the tab and pulling up.
4. Remove the bolts shown in the picture above.
5. Replace the fuse with a new one of the same rating.
6. Reinstall in the reverse order of removal.

* NOTICE

If the multi fuse is blown, consult an authorized HYUNDAI dealer.

Fuse/Relay panel description

Instrument panel fuse panel

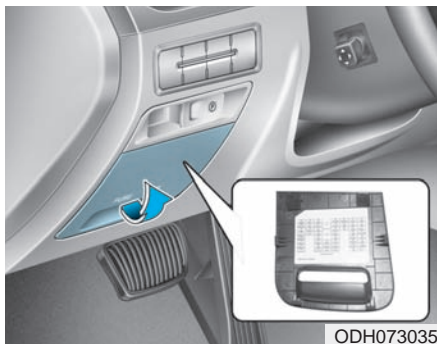

Inside the fuse/relay box cover, you can find the fuse/relay label describing fuse/relay name and capacity.

* NOTICE

Not all fuse panel descriptions in this manual may be applicable to your vehicle; the information is accurate at the time of printing. When you inspect the fuse box on your vehicle, refer to the fuse box label.

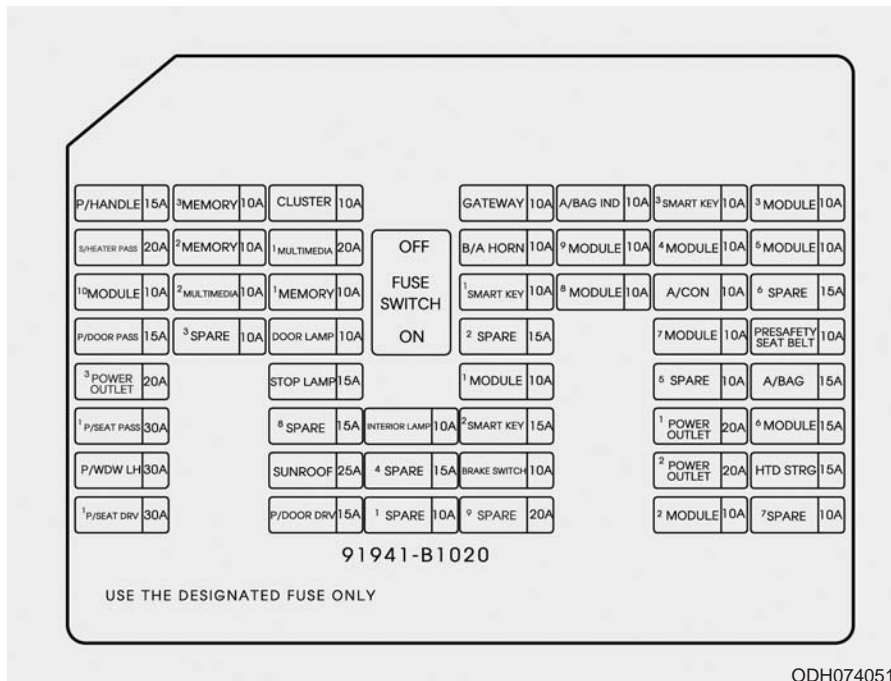

ODH074051N

Instrument panel fuse panel

Fuse Name	Fuse rating	Circuit Protected
P/HANDLE	15A	Steering Tilt & Telescopic Module
³ MEMORY	10A	Passenger Power Outside Mirror
CLUSTER	10A	Instrument Cluster, Head-Up Display
GATEWAY	10A	Gateway (IG1 (MCU))
A/BAG IND	10A	Instrument Cluster, A/C Control Module
³ SMART KEY	10A	Smart Key Control Module
³ MODULE	10A	BCM, Sport Mode Switch, Stop Lamp Switch, Driver/Passenger Door Module, Rear Door Module LH/RH
S/HEATER PASS	20A	Passenger CCS Module, Passenger Seat Warmer Control Module
² MEMORY	10A	Driver Power Outside Mirror
¹ MULTI MEDIA	20A	Fuse - MULTIMEDIA 2, A/V & Navigation Head Unit
B/A HORN	10A	Burglar Alarm Horn Relay
⁹ MODULE	10A	Multifunction Switch
⁴ MODULE	10A	Steering Tilt & Telescopic Module, Blind Spot Detection Radar LH/RH Crash Pad Switch, Tire Pressure Monitoring Module, Console Switch LH/RH, Front Parking Assist Sensor LH/RH, Front Parking Assist Sensor (Center), ECS Unit, Electric Parking Brake Switch, Rear Parking Assist Sensor LH/RH, Rear Parking Assist Sensor (Center), LKAS Module
⁵ MODULE	10A	Multipurpose Check Connector, A/V & Navigation Head Unit, Electro Chromic Mirror, A/C Control Module, I-Box, AMP, Driver/Passenger CCS Module, Driver Power Seat Switch, Driver/Passenger Seat Warmer Control Module, Rear Seat Warmer Control Module LH/RH, Driver IMS Control Module

Fuse Name	Fuse rating	Circuit Protected
¹⁰ MODULE	10A	BCM
² MULTI MEDIA	10A	Keyboard, I-Box, Front Monitor
¹ MEMORY	10A	Steering Tilt & Telescopic Module, External Buzzer, BCM, Analog Clock, A/C Control Module, Tire Pressure Monitoring Module, Security Indicator, Head-Up Display, Instrument Cluster, Driver/Passenger Door Module, Rear Door Module LH/RH, Power Trunk Lid Control Module
¹ SMART KEY	10A	Start/Stop Button Switch
⁸ MODULE	10A	BCM, Smart Key Control Module
A/CON	10A	Metal Core Block (PCB #1 - Blower Relay), Ionizer Co2 Sensor, A/C Control Module
P/DOOR PASS	15A	Passenger Door Latch
DOOR LAMP	10A	Driver/Passenger Door Module, Rear Door Module LH/RH
⁷ MODULE	10A	Parking Guide Unit, Head-Up Display Sunroof, Passenger Lumbar Support Unit, Clock Spring (Steering Wheel Remote Control Switch)
PRESAFETY SEAT BELT	10A	Pre-Safe Seat Belt Module
³ POWER OUTLET	20A	Not Used
STOP LAMP	15A	Stop Signal Electronic Module
¹ MODULE	10A	Gateway (B+ (MCU)), Rain Sensor, Hazard Switch Trunk Lid Main Switch, Electric Parking Brake Switch
A/BAG	15A	SRS Control Module
¹ P/SEAT PASS	30A	Passenger Power Seat Relay Box
INTERIOR LAMP	10A	Room Lamp, Room Lamp LH/RH, Overhead Console Lamp, Glove Box, Front Vanity Lamp LH/RH, Driver/Passenger Foot Lamp, Trunk Room Lamp LH/RH

Fuse Name	Fuse rating	Circuit Protected
² SMART KEY	15A	Smart Key Control Module
¹ POWER OUTLET	20A	Front Power Outlet & Cigarette Lighter
⁶ MODULE	15A	Head Lamp LH/RH, Auto Hold & Drive Mode Switch, Auto Head Lamp Leveling Device Module, A/T Shift Lever IND.
P/WDW LH	30A	Driver Power Window Module, Rear Door Module LH, Rear Power Window Module LH
SUNROOF	25A	Sunroof Motor
BRAKE SWITCH	10A	Stop Lamp Switch, Smart Key Control Module
² POWER OUTLET	20A	Front Power Outlet & Cigarette Lighter
HTD STRG	15A	Clock Spring (Steering Wheel Heated Module)
¹ P/SEAT DRV	30A	Driver IMS Control Module, Driver Power Seat Relay Box
P/DOOR DRV	15A	Driver Door Latch
² MODULE	10A	BCM, Smart Key Control Module, Overhead Console Lamp, Analog Clock, A/V & Navigation Head Unit, Keyboard, I-Box, Front Monitor, Parking Guide Unit

Engine compartment main fuse panel

Fuse Name	Fuse rating	Circuit Protected
ALT	200A	Alternator, Multifuse (BATT) - B+2/ B+5/ MDPS 1/ C/FAN, Fuse - P/SEAT DRV 2/ P/SEAT RR/ SEAT LUMBAR/ ESC 1/ ESC 2
¹ B+	60A	IGPM (Fuse - BRAKE SWITCH, Leak Current Autocut Device (Fuse - INTERIOR LAMP/ MULTI MEDIA 1/ MEMORY 1/ MEMORY 2/ MEMORY 3), IPS 1)
³ B+	60A	IGPM (Fuse - SMART KEY 1/ SMART KEY 2/ MODULE 1/ B/A HORN, IPS 2/IPS 3/IPS 5/IPS 7)
⁴ B+	60A	IGPM (Fuse - DOOR LAMP/ STOP LAMP, IPS 4/IPS 6)
⁶ B+	60A	Metal Core Block (PCB #1 Fuse - ECU 3/ IG2/ MODULE 1)
⁷ B+	80A	Metal Core Block (PCB #2 Fuse - HORN/ ACC/ EPB 1/ EPB 2)
² B+	60A	IGPM (Fuse - P/HANDLE/ P/WDW LH/ P/SEAT PASS 1/ S/HEATER PASS/ MODULE 10/ SUNROOF/ P/DOOR DRV/ P/DOOR PASS)
C/FAN	70A	RLY. 1 (C/Fan Relay)
⁵ B+	80A	Metal Core Block (PCB #1 Fuse - BLOWER/ DEICER/ H/LAMP WASHER)
MDPS 1	125A	MDPS Unit
B/UP LAMP	10A	TCM, Transmission Range Switch, Rear Combination Lamp (IN) LH/RH, Electro Chromic Mirror, A/V & Navigation Head Unit
P/SEAT RR	30A	Not Used
¹ ESC	40A	ESC Module, Multipurpose Check Connector
² ESC	40A	ESC Module, Multipurpose Check Connector

Fuse Name	Fuse rating	Circuit Protected
SEAT LUMBAR	10A	Driver/Passenger Power Seat Relay Box, Driver/Passenger Lumbar Support Unit
² P/SEAT DRV	25A	Driver IMS Control Module, Driver Power Seat Switch, Driver Power Seat Relay Box
ACTIVE HOOD LH	30A	Not Used
ACTIVE HOOD RH	30A	Not Used
WIPER	30A	Wiper Motor
S/HEATER DRV	25A	Driver CCS Module, Driver Seat Warmer Control Module
4WD	30A	4WD ECM
¹ PRESAFETY SEAT BELT	30A	Pre-Safe Seat Belt Module
² PRESAFETY SEAT BELT	30A	Pre-Safe Seat Belt Module
H/LAMP HI SOL	10A	Metal Core Block (PCB #2 - Head Lamp High Solenoid Relay)

Fuse Name	Fuse rating	Circuit Protected
IG2	30A	IG2 Relay
³ ECU	30A	Engine Control Relay
¹ MODULE	10A	4WD ECM, Smart Cruise Control Radar, Active Air Flap
² WIPER	10A	Metal Core Block (PCB #2 - Wiper Relay)
WASHER	20A	Washer Relay
² SENSOR	10A	ECM, Oxygen Sensor #1/#2/#3/#4
¹ SENSOR	10A	ECM, Oil Control Valve #1/#2/#3/#4, Canister Close Valve, Purge Control Solenoid Valve, Variable Intake Solenoid Valve #1/#2
³ SENSOR	10A	ECM, Rear Junction Block (Fuel Pump Relay)
⁴ SENSOR	10A	C/Fan Relay, Camshaft Position Valve (G8BE)
INJECTOR	15A	Injector Drive Box
IGN COIL	20A	G6DJ : Condenser, Ignition Coil #1/#2/#3/#4/#5/#6, G8BE : Condenser #1/#2, Ignition Coil #1/#2/#3/#4/#5/#6/#7/#8
DEICER	20A	Metal Core Block (PCB #2 - Front Deicer Relay)
H/LAMP WASHER	25A	Head Lamp Washer Relay
² A/CON	10A	A/C Control Module
BLOWER	40A	Blower Relay

Fuse Name	Fuse rating	Circuit Protected
IG1	40A	IG1 Relay
START	30A	E/R Junction Block (RLY. 2 - Start Relay)
¹ ECU	15A	ECM, Injector Drive Box
¹ TCU	20A	TCM
³ ESC	10A	ESC Module, Steering Angle Sensor
³ MODULE	10A	Smart Cruise Control Radar, Active Air Flap
² MDPS	10A	MDPS Unit
⁵ SENSOR	10A	G6DJ : Oil Pressure Solenoid Valve
HORN	20A	Horn Relay
² ECU	10A	ECM, Injector Drive Box, Alternator (G8BE)
² TCU	15A	TCM, Transmission Range Switch, 4WD ECM
² EPB	15A	Electric Parking Brake Module
¹ EPB	15A	Electric Parking Brake Module
ACC	40A	ACC Relay

Trunk fuse panel (Rear fuse box panel)



ODH073036

Inside the fuse/relay box covers, you can find the fuse/relay label describing fuse/relay name and capacity.

* NOTICE

Not all fuse panel descriptions in this manual may be applicable to your vehicle. It is accurate at the time of printing. When you inspect the fuse box on your vehicle, refer to the fuse box label.

P/DOOR RR RH	P/DOOR RR LH	¹ SPARE	F/LID	DR LOCK	TRUNK	FOG LAMP RR	S/HEATER RR LH	F/PUMP
15A	15A	10A	10A	10A	10A	10A	20A	20A
P/TRUNK	² DR LOCK	³ SPARE	² P/SEAT PASS	ECS	³ SPARE	S/HEATER RR RH	AMP	P/WDW RH
30A	15A	15A	25A	15A	15A	20A	25A	30A
RR HTD	USE THE DESIGNATED FUSE ONLY							
40A	91941-B1120							

ODH074052N

Fuse Name	Fuse rating	Circuit Protected
P/TRUNK	30A	Power Trunk Lid Control Module
P/DOOR RR RH	15A	Rear Door Latch RH
²DR LOCK	15A	Passenger Door Module
P/DOOR RR LH	15A	Rear Door Latch LH
³SPARE	15A	Spare Fuse
¹SPARE	10A	Spare Fuse
²P/SEAT PASS	25A	Passenger Power Seat Relay Box
F/LID	10A	Fuel Lid Open Relay, Crash Pad Switch
ECS	15A	ECS Unit
¹DR LOCK	10A	Driver Door Module
⁵SPARE	15A	Spare Fuse
TRUNK	10A	Trunk Lid Relay, Power Trunk Module Buzzer
S/HEATER RR RH	20A	Rear Seat Warmer Control Module RH
FOG LAMP RR	10A	Not Used
AMP	25A	AMP
S/HEATER RR LH	20A	Rear Seat Warmer Control Module LH
P/PDW RH	30A	Passenger Power Window Module, Rear Power Window Module RH
F/PUMP	20A	Fuel Pump Relay
RR HTD	40A	Rear Defogger Relay

Trunk fuse panel (Battery box fuse panel)

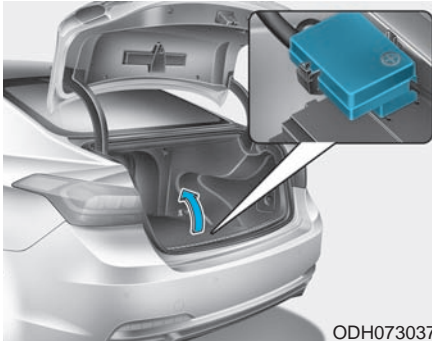

Inside the fuse/relay box covers, you can find the fuse/relay label describing fuse/relay name and capacity.

* NOTICE

Not all fuse panel descriptions in this manual may be applicable to your vehicle. It is accurate at the time of printing. When you inspect the fuse box on your vehicle, refer to the fuse box label.

• Battery box fuse panel

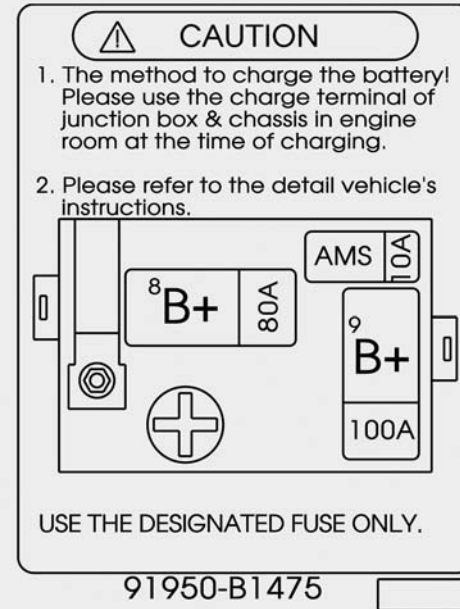

ODH074038N

Fuse Name	Fuse rating	Circuit Protected
⁹ B+	100A	Rear Junction Block (Fuse - RR HTD/ P/TRUNK/ ECS/ F/LID/ P/DOOR RR RH/ DR LOCK 2/ P/DOOR RR LH/ AMP/ P/SEAT PASS 2/ DR LOCK 1/ TRUNK/ S/HEATER RR RH/ S/HEATER RR LH/ P/WDW RH/ F/PUMP)
⁸ B+	80A	Metal Core Block (PCB #2 Fuse - TCU/ ECU 1/ START/ IG 1)
AMS	10A	Battery Sensor

LIGHT BULBS

Consult an authorized HYUNDAI dealer to replace most vehicle light bulbs. It is difficult to replace vehicle light bulbs because other parts of the vehicle must be removed before you can get to the bulb. This is especially true for removing the headlamp assembly to get to the bulb(s).

Removing/installing the headlamp assembly can result in damage to the vehicle.

* NOTICE

After heavy driving, rain or washing, headlamp and trunk lenses could appear frosty. This condition is caused by the temperature difference between the lamp inside and the outside temperature. This is similar to the condensation on your windows inside your vehicle during the rain and doesn't indicate a problem with your vehicle. If the water leaks into the lamp bulb circuitry, have your vehicle checked by an authorized HYUNDAI dealer.

⚠ WARNING

- Prior to replacing a lamp, depress the foot brake, move the shift lever into P (Park) apply the parking brake, press the Engine Start/Stop button to the OFF position, and take the key with you when leaving the vehicle to avoid sudden movement of the vehicle and to prevent possible electric shock.
- Be aware the bulbs may be hot and may burn your fingers.

Headlamp, position lamp, turn signal lamp, side marker and front fog lamp bulb replacement

Type A

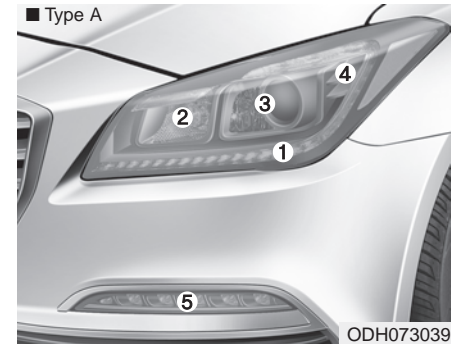

- (1) Turn signal lamp/Position lamp
- (2) Headlamp (High)/Daytime running lights
- (3) Headlamp (Low)
- (4) Side marker
- (5) Fog lamp

Type B

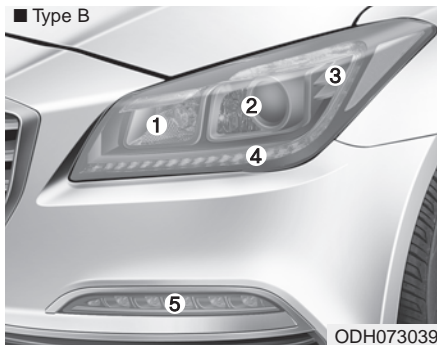

- (1) Turn signal lamp/
Daytime running lights
- (2) Headlamp (High/Low)
- (3) Side marker
- (4) Position lamp
- (5) Fog lamp

Headlight (HID type)

WARNING

HID Headlamp low beam

Do not attempt to replace or inspect the low beam (XENON bulb) due to electric shock danger. If the low beam (XENON bulb) is not working, have your vehicle checked by an authorized HYUNDAI Dealer.

CAUTION

If your vehicle is equipped with High Intensity Discharge (HID) headlights, these headlights contain mercury. So if you need to have your vehicle disposed, you should remove the HID Headlights before disposal. The removed HID headlights should be recycled, re-used or disposed as hazardous waste.

If the light bulb does not operate, have the vehicle checked by an authorized HYUNDAI dealer.

* NOTICE

HID lamps have superior performance vs. halogen bulbs. HID lamps are estimated by the manufacturer to last twice as long or longer than halogen bulbs depending on their frequency of use. They will probably require replacement at some point in the life of the vehicle. Cycling the headlamps on and off more than typical use will shorten HID lamps life. HID lamps do not fail in the same manner as halogen incandescent lamps. If a headlamp goes out after a period of operation but will immediately relight when the headlamp switch is cycled it is likely the HID lamp needs to be replaced. HID lighting components are more complex than conventional halogen bulbs thus have higher replacement cost.

* NOTICE

We recommend that the headlamp aiming be adjusted after an accident or after the headlamp assembly is reinstalled at an authorized HYUNDAI dealer.

Headlamp

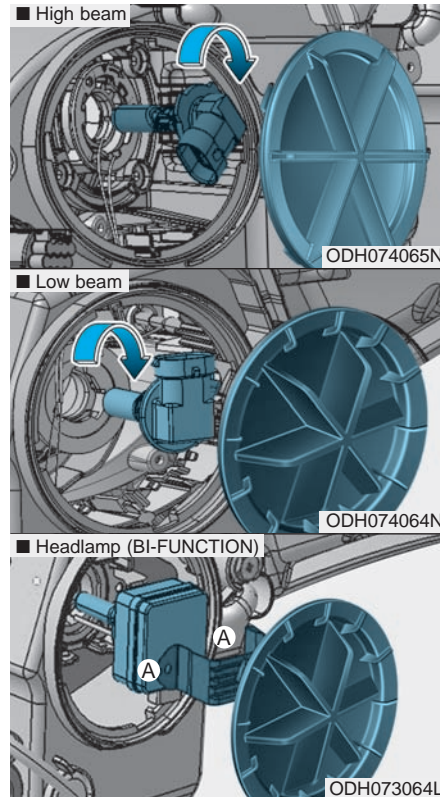

1. Turn off the engine.
2. Open the hood.
3. Remove the socket from the assembly by turning the socket counterclockwise until the tabs on the socket align with the slots on the assembly.
4. Remove the bulb from the socket by pressing it in and rotating it counterclockwise until the tabs on the bulb align with the slots in the socket. Pull the bulb out of the socket. (Bulb type)

Remove the connector (A) and pull the BI-FUNCTION lamp. (BI-FUNCTION type)

5. Insert a new bulb by inserting it into the socket and rotating it until it locks into place. (Bulb type)
Connect the BI-FUNCTION lamp to the cable and install the connector (A). (BI-FUNCTION type)
6. Install the socket in the assembly by aligning the tabs on the socket with the slots in the assembly.
Push the socket into the assembly and turn the socket clockwise.

Turn signal light

■ Bulb type

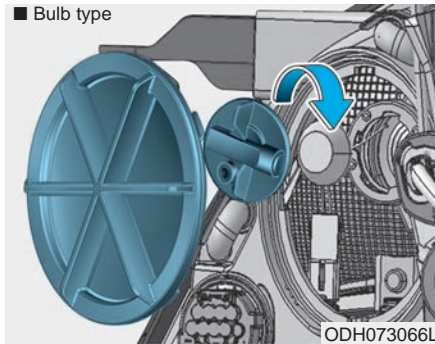

1. Turn off the engine.
2. Open the hood.
3. Remove the socket from the assembly by turning the socket counterclockwise until the tabs on the socket align with the slots on the assembly.
4. Remove the bulb from the socket by pressing it in and rotating it counterclockwise until the tabs on the bulb align with the slots in the socket. Pull the bulb out of the socket.

5. Insert a new bulb by inserting it into the socket and rotating it until it locks into place.
6. Install the socket in the assembly by aligning the tabs on the socket with the slots in the assembly.
7. Push the socket into the assembly and turn the socket clockwise.

If the turn signal light (LED) does not operate, have the vehicle checked by an authorized HYUNDAI dealer.

Position and front fog lamp/ bulbs

If the LED lamp does not operate, have the vehicle checked by an authorized HYUNDAI dealer.

Side repeater lamp replacement

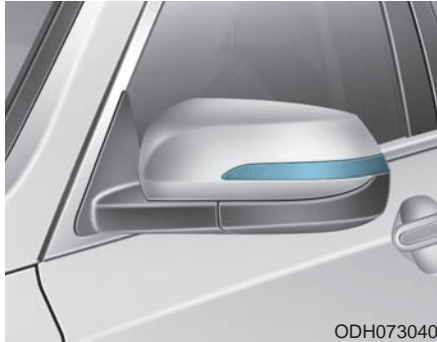

If the LED lamp does not operate, have the vehicle checked by an authorized HYUNDAI dealer.

Rear combination light bulb replacement

Type A

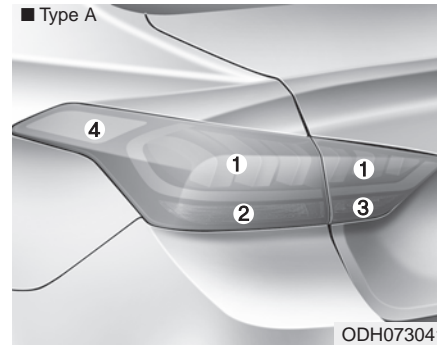

- (1) Stop/tail light
- (2) Turn signal light
- (3) Back-up light
- (4) Side marker

Type B

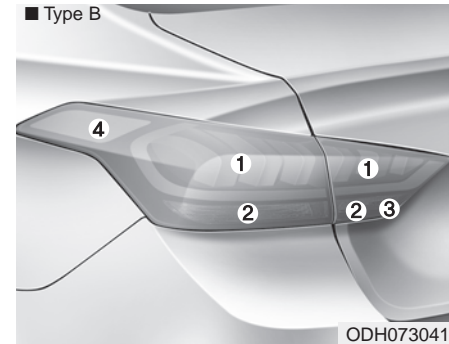

- (1) Stop/tail light
- (2) Turn signal light
- (3) Back-up light
- (4) Side marker

Rear turn signal lamp

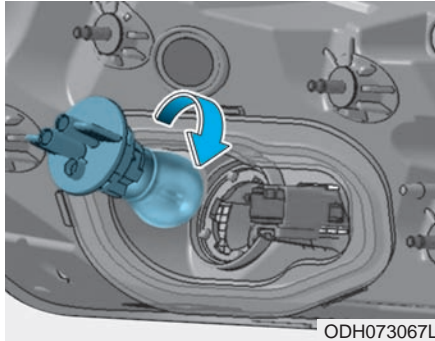

Type A

1. Open the trunk lid.
2. Open the service cover.
3. Remove the socket from the assembly by turning the socket counterclockwise until the tabs on the socket align with the slots on the assembly.
4. Remove the bulb from the socket by pressing it in and rotating it counterclockwise until the tabs on the bulb align with the slots in the socket. Pull the bulb out of the socket.

5. Insert a new bulb by inserting it into the socket and rotating it until it locks into place.
6. Install the socket in the assembly by aligning the tabs on the socket with the slots in the assembly. Push the socket into the assembly and turn the socket clockwise.
7. Install the service cover by putting it into the service hole.

Type B

If the LED lamp does not operate, have the vehicle checked by an authorized HYUNDAI dealer.

Back up lamp

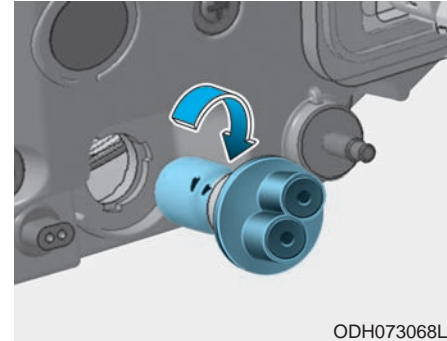

Type A

1. Open the trunk.
2. Loosen the retaining screw of the trunk lid cover and then remove the cover.
3. Remove the socket from the assembly by turning the socket counter clockwise until the tabs on the socket align with the slots on the assembly.
4. Remove the bulb by pulling it straight out.
5. Insert a new bulb by inserting it into the socket and rotating it until it locks into place.

6. Install the socket into the assembly by aligning the tabs on the socket with the slots in the assembly. Push the socket into the assembly and turn the socket clockwise.

7. Reinstall the trunk lid cover by pushing in the screw.

Type B

If the LED lamp does not operate, have the vehicle checked by an authorized HYUNDAI dealer.

Stop and tail lamp

If the lamp does not operate, have the vehicle checked by an authorized HYUNDAI dealer.

High mounted stop lamp

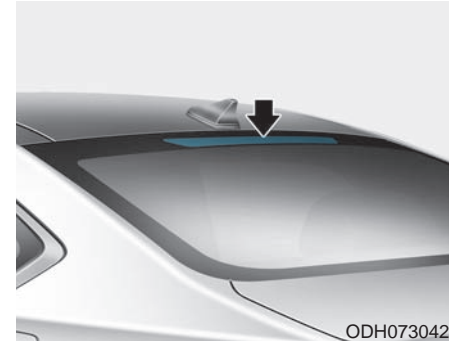

If the LED lamp does not operate, have the vehicle checked by an authorized HYUNDAI dealer.

License plate light bulb replacement

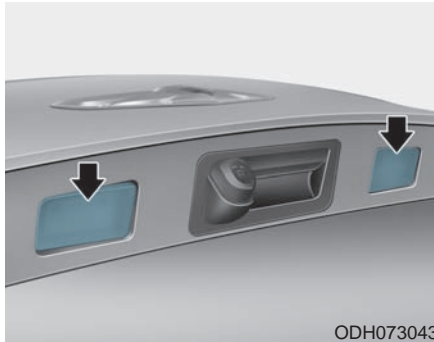

If the LED lamp does not operate, have the vehicle checked by an authorized HYUNDAI dealer.

Interior light bulb replacement

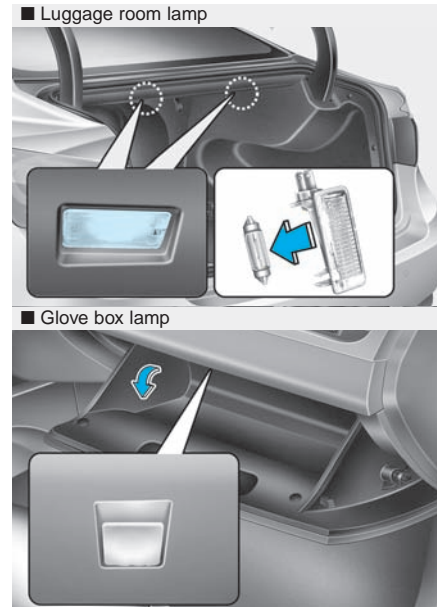

If the interior lamp does not operate, we recommend that you contact an authorized HYUNDAI dealer.

APPEARANCE CARE

Exterior care

Exterior general caution

It is very important to follow the label directions when using any chemical cleaner or polish. Read all warning and caution statements that appear on the label.

High-pressure washing

- When using high-pressure washers, make sure to maintain sufficient distance from the vehicle. Insufficient clearance or excessive pressure can lead to component damage or water penetration.
- Do not spray the camera, sensors or its surrounding area directly with a high pressure washer. Shock applied from high pressure water may cause the device to not operate normally.
- Do not bring the nozzle tip close to boots (rubber or plastic covers) or connectors as they may be damaged if they come into contact with high pressure water.

Finish maintenance

Washing

To help protect your vehicle's finish from rust and deterioration, wash it thoroughly and frequently at least once a month with lukewarm or cold water.

If you use your vehicle for off-road driving, you should wash it after each off-road trip. Pay special attention to the removal of any accumulation of salt, dirt, mud, and other foreign materials. Make sure the drain holes in the lower edges of the doors and rocker panels are kept clear and clean.

Insects, tar, tree sap, bird droppings, industrial pollution and similar deposits can damage your vehicle's finish if not removed immediately.

Even prompt washing with plain water may not completely remove all these deposits. A mild soap, safe for use on painted surfaces, should be used.

After washing, rinse the vehicle thoroughly with lukewarm or cold water. Do not allow soap to dry on the finish.

⚠ WARNING

After washing the vehicle, test the brakes while driving slowly to see if they have been affected by water before getting on the road. If braking performance is impaired, dry the brakes by applying them lightly while maintaining a slow forward speed.

CAUTION

- Do not use strong soap, chemical detergents or hot water, and do not wash the vehicle in direct sunlight or when the body of the vehicle is warm.
- Be careful when washing the side windows of your vehicle. Especially, with high-pressure water, water may leak through the windows and wet the interior.
- To prevent damage to the plastic parts, do not clean with chemical solvents or strong detergents.



CAUTION

- Water washing in the engine compartment including high pressure water washing may cause the failure of electrical circuits located in the engine compartment.
- Never allow water or other liquids to come in contact with electrical/electronic components inside the vehicle as this may damage them.

Waxing

A good coat of wax is a barrier between your paint and contaminants. Keeping a good coat of wax on your vehicle will help protect it.

Wax the vehicle when water will no longer bead on the paint.

Always wash and dry the vehicle before waxing. Use a good quality liquid or paste wax, and follow the manufacturer's instructions. Wax all metal trim to protect it and to maintain its luster.

Removing oil, tar, and similar materials with a spot remover will usually strip the wax from the finish. Be sure to re-wax these areas even if the rest of the vehicle does not yet need waxing.

⚠ CAUTION

- Wiping dust or dirt off the body with a dry cloth will scratch the finish.
- Do not use steel wool, abrasive cleaners, or strong detergents containing highly alkaline or caustic agents on chrome-plated or anodized aluminum parts. This may result in damage to the protective coating and cause discoloration or paint deterioration.

Finish damage repair

Deep scratches or stone chips in the painted surface must be repaired promptly. Exposed metal will quickly rust and may develop into a major repair expense.

*** NOTICE**

If your vehicle is damaged and requires any metal repair or replacement, be sure the body shop applies anti-corrosion materials to the parts repaired or replaced.

Bright-metal maintenance

- To remove road tar and insects, use a tar remover, not a scraper or other sharp object.
- To protect the surfaces of bright-metal parts from corrosion, apply a coating of wax or chrome preservative and rub to a high luster.
- During winter weather or in coastal areas, cover the bright metal parts with a heavier coating of wax or preservative. If necessary, coat the parts with non-corrosive petroleum jelly or other protective compound.

Underbody maintenance

Corrosive materials used for ice and snow removal and dust control may collect on the underbody. If these materials are not removed, accelerated rusting can occur on underbody parts such as the fuel lines, frame, floor pan and exhaust system, even though they have been treated with rust protection.

Thoroughly flush the vehicle underbody and wheel openings with lukewarm or cold water once a month, after off-road driving and at the end of each winter. Pay special attention to these areas because it is difficult to see all the mud and dirt. It will do more harm than good to wet down the road grime without removing it. The lower edges of doors, rocker panels, and frame members have drain holes that should not be allowed to clog with dirt; trapped water in these areas can cause rusting.

WARNING

After washing the vehicle, test the brakes while driving slowly to see if they have been affected by water. If braking performance is impaired, dry the brakes by applying them lightly while maintaining a slow forward speed.

Aluminum wheel maintenance

The aluminum wheels are coated with a clear protective finish.

CAUTION

- Do not use abrasive cleaner, polishing compound, solvent, or wire brushes on aluminum wheels.
- Clean the wheel when it has cooled.
- Use only a mild soap or neutral detergent, and rinse thoroughly with water. Also, clean the wheels after driving on salted roads.
- Do not wash the wheels with high-speed car wash brushes.
- Do not use any cleaners containing acid or alkaline detergents.

Corrosion protection

Protecting your vehicle from corrosion

By using the most advanced design and construction practices to combat corrosion, HYUNDAI produces cars of the highest quality. However, this is only part of the job. To achieve the long-term corrosion resistance your vehicle can deliver, the owner's cooperation and assistance is also required.

Common causes of corrosion

The most common causes of corrosion on your vehicle are:

- Road salt, dirt and moisture that is allowed to accumulate underneath the vehicle.
- Removal of paint or protective coatings by stones, gravel, abrasion or minor scrapes and dents which leave unprotected metal exposed to corrosion.

High-corrosion areas

If you live in an area where your vehicle is regularly exposed to corrosive materials, corrosion protection is particularly important. Some of the common causes of accelerated corrosion are road salts, dust control chemicals, ocean air and industrial pollution.

Moisture breeds corrosion

Moisture creates the conditions in which corrosion is most likely to occur. For example, corrosion is accelerated by high humidity, particularly when temperatures are just above freezing. In such conditions, the corrosive material is kept in contact with the car surfaces by moisture that is slow to evaporate.

Mud is particularly corrosive because it is slow to dry and holds moisture in contact with the vehicle. Although the mud appears to be dry, it can still retain the moisture and promote corrosion.

High temperatures can also accelerate corrosion of parts that are not properly ventilated so the moisture can be dispersed. For all these reasons, it is particularly important to keep your vehicle clean and free of mud or accumulations of other materials. This applies not only to the visible surfaces but particularly to the underside of the vehicle.

To help prevent corrosion

Keep your car clean

The best way to prevent corrosion is to keep your vehicle clean and free of corrosive materials. Attention to the underside of the vehicle is particularly important.

- If you live in a high-corrosion area — where road salts are used, near the ocean, areas with industrial pollution, acid rain, etc.—, you should take extra care to prevent corrosion. In winter, hose off the underside of your vehicle at least once a month and be sure to clean the underside thoroughly when winter is over.

- When cleaning underneath the vehicle, pay particular attention to the components under the fenders and other areas that are hidden from view. Do a thorough job; just dampening the accumulated mud rather than washing it away will accelerate corrosion rather than prevent it. Water under high pressure and steam are particularly effective in removing accumulated mud and corrosive materials.
- When cleaning lower door panels, rocker panels and frame members, be sure that drain holes are kept open so that moisture can escape and not be trapped inside to accelerate corrosion.

Keep your garage dry

Don't park your car in a damp, poorly ventilated garage. This creates a favorable environment for corrosion. This is particularly true if you wash your vehicle in the garage or drive it into the garage when it is still wet or covered with snow, ice or mud. Even a heated garage can contribute to corrosion unless it is well ventilated so moisture is dispersed.

Keep paint and trim in good condition

Scratches or chips in the finish should be covered with "touch-up" paint as soon as possible to reduce the possibility of corrosion. If bare metal is showing through, the attention of a qualified body and paint shop is recommended.

Bird droppings are highly corrosive and may damage painted surfaces in just a few hours. Always remove bird droppings as soon as possible.

Interior care

Interior general precautions

Prevent caustic solutions such as perfume and cosmetic oil, from contacting the interior parts because they may cause damage or discoloration. If they do contact the interior parts, wipe them off immediately. See the instructions for the proper way to clean vinyl.



CAUTION

- **Never allow water or other liquids to come in contact with electrical/electronic components inside the vehicle as this may damage them.**
- **When cleaning leather products (steering wheel, seats etc.), use neutral detergents or low alcohol content solutions. If you use high alcohol content solutions or acid/alkaline detergents, the color of the leather may fade or the surface may get stripped off.**

Cleaning the upholstery and interior trim

Vinyl

Remove dust and loose dirt from vinyl with a whisk broom or vacuum cleaner. Clean vinyl surfaces with a vinyl cleaner.

Fabric

Remove dust and loose dirt from fabric with a whisk broom or vacuum cleaner. Clean with a mild soap solution recommended for upholstery or carpets. Remove fresh spots immediately with a fabric spot cleaner. If fresh spots do not receive immediate attention, the fabric can be stained and its color can be affected. Also, its fire-resistant properties can be reduced if the material is not properly maintained.

CAUTION

Using anything but recommended cleaners and procedures may affect the fabric's appearance and fire-resistant properties.

Cleaning the seat belt webbing

Clean the belt webbing with any mild soap solution recommended for cleaning upholstery or carpet. Follow the instructions provided with the soap. Do not bleach or re-dye the webbing because this may weaken the seat belt.

Cleaning the interior window glass

If the interior glass surfaces of the vehicle become fogged (that is, covered with an oily, greasy or waxy film), they should be cleaned with glass cleaner. Follow the directions on the glass cleaner container.

CAUTION

Do not scrape or scratch the inside of the rear window. This may result in damage to the rear window defroster grid.

EMISSION CONTROL SYSTEM

The emission control system of your vehicle is covered by a written limited warranty. Please see the warranty information contained in the Owner's Handbook & Warranty Information booklet in your vehicle.

Your vehicle is equipped with an emission control system to meet all applicable emission regulations. There are three emission control systems, as follows.

- (1) Crankcase emission control system
- (2) Evaporative emission control system
- (3) Exhaust emission control system

In order to assure the proper function of the emission control systems, it is recommended that you have your vehicle inspected and maintained by an authorized HYUNDAI dealer in accordance with the maintenance schedule in this manual.

CAUTION

For the Inspection and Maintenance Test (With Electronic Stability Control (ESC) system)

- **To prevent the vehicle from misfiring during dynamometer testing, turn the Electronic Stability Control (ESC) system off by pressing the ESC switch (ESC OFF light illuminated).**
- **After dynamometer testing is completed, turn the ESC system back on by pressing the ESC switch again.**

1. Crankcase emission control system

The positive crankcase ventilation system is employed to prevent air pollution caused by blow-by gases being emitted from the crankcase. This system supplies fresh filtered air to the crankcase through the air intake hose. Inside the crankcase, the fresh air mixes with blow-by gases, which then pass through the PCV valve into the induction system.

2. Evaporative emission control system including Onboard Refueling Vapor Recovery (ORVR)

The Evaporative Emission Control System is designed to prevent fuel vapors from escaping into the atmosphere. The ORVR system is designed to allow the vapors from the fuel tank to be loaded into a canister while refueling at the gas station, preventing the escape of fuel vapors into the atmosphere.

Canister

Fuel vapors generated inside the fuel tank are absorbed and stored in the onboard canister. When the engine is running, the fuel vapors absorbed in the canister are drawn into the surge tank through the purge control solenoid valve.

Purge Control Solenoid Valve (PCSV)

The purge control solenoid valve is controlled by the Engine Control Module (ECM); when the engine coolant temperature is low during idling, the PCSV closes so that evaporated fuel is not taken into the engine. After the engine warms-up during ordinary driving, the PCSV opens to introduce evaporated fuel to the engine.

3. Exhaust emission control system

The Exhaust Emission Control System is a highly effective system which controls exhaust emissions while maintaining good vehicle performance.

When the engine starts or fails to start, excessive attempts to restart the engine may cause damage to the emission system.

Vehicle modifications

- This vehicle should not be modified. Modification of your vehicle could affect its performance, safety or durability and may even violate governmental safety and emissions regulations.
In addition, damage or performance problems resulting from any modification may not be covered under warranty.
- If you use unauthorized electronic devices, it may cause the vehicle to operate abnormally, wire damage, battery discharge and fire. For your safety, do not use unauthorized electronic devices.

Engine exhaust (carbon monoxide) precautions

- Carbon monoxide can be present with other exhaust fumes. If you smell exhaust fumes of any kind in your vehicle, drive with all the windows fully open. Have your vehicle checked and repaired immediately.

⚠ WARNING

Engine exhaust gases contain carbon monoxide (CO). Though colorless and odorless, it is dangerous and could be lethal if inhaled. Follow the instructions on this page to avoid CO poisoning.

⚠ WARNING

**CALIFORNIA PROPOSITION 65
WARNING**

Engine exhaust and a wide variety of automobile components and parts, including components found in the interior furnishings in a vehicle, contain or emit chemicals known to the State of California to cause cancer and birth defects and reproductive harm. In addition, certain fluids contained in vehicles and certain products of component wear contain or emit chemicals known to the State of California to cause cancer and birth defects or other reproductive harm.

- Do not operate the engine in confined or closed areas (such as garages) any more than what is necessary to move the vehicle in or out of the area.
- When the vehicle is stopped in an open area for more than a short time with the engine running, adjust the ventilation system (as needed) to draw outside air into the vehicle.
- Never sit in a parked or stopped vehicle for any extended time with the engine running.
- When the engine stalls or fails to start, excessive attempts to restart the engine may cause damage to the emission control system.

Operating precautions for catalytic converters (if equipped)

⚠ WARNING

The exhaust system and catalytic converter are very hot during and immediately after the engine has been running. To avoid **SERIOUS INJURY** or **DEATH**:

- Do not park, idle, or drive the vehicle over or near flammable objects, such as grass, vegetation, paper, leaves, etc. A hot exhaust system can ignite flammable items under your vehicle.

(Continued)

(Continued)

- **Keep away from the exhaust system and catalytic converter or you may get burned.**

Also, Do not remove the heat sink around the exhaust system, do not seal the bottom of the vehicle, and do not coat the vehicle for corrosion control. It may present a fire risk under certain conditions.

Your vehicle is equipped with a catalytic converter emission control device.

To prevent damage to the catalytic converter and to your vehicle, take the following precautions:

 **CAUTION**

- **Use only UNLEADED FUEL for gasoline engines.**
- **Do not operate the vehicle when there are signs of engine malfunction, such as misfire or a noticeable loss of performance.**
- **Do not misuse or abuse the engine. Examples of misuse are coasting with the engine off and descending steep grades in gear with the engine off.**
- **Do not operate the engine at high idle speed for extended periods (5 minutes or more).**

(Continued)

(Continued)

- **Do not modify or tamper with any part of the engine or emission control system. All inspections and adjustments must be made by an authorized HYUNDAI dealer.**
- **Avoid driving with extremely low fuel level. If you run out of gasoline, it could cause the engine to misfire and result in excessive loading of the catalytic converter.**

CALIFORNIA PERCHLORATE NOTICE

Perchlorate Material-special handling may apply, See: www.dtsc.ca.gov/hazardouswaste/perchlorate.

Notice to California Vehicle Dismantlers:

Perchlorate containing materials, such as air bag inflators, seatbelt pretensioners and keyless remote entry batteries, must be disposed of according to Title 22 California Code of Regulations Section 67384.10 (a).

Specifications, Consumer information and Reporting safety defects

Dimensions	8-2
Engine	8-2
Bulb wattage	8-3
Tires and wheels	8-4
Luggage volume	8-5
Air conditioning system	8-5
Gross vehicle weight	8-5
Recommended lubricants and capacities	8-6
Recommended SAE viscosity number	8-7
Vehicle identification number (VIN)	8-8
Vehicle certification label	8-8
Tire specification and pressure label	8-9
Engine number	8-9
Refrigerant label	8-9
Consumer information	8-10
Reporting safety defects	8-11

DIMENSIONS

Item	in (mm)
Overall length	196.5 (4,990)
Overall width	74.4 (1,890)
Overall height	58.3 (1,480)
Front tread	64.09 (1,628)* ¹ / 63.78 (1,620)* ²
Rear tread	65.31 (1,659)* ¹ / 64.29 (1,633)* ²
Wheelbase	118.5 (3,010)

*¹ : with R18 tire

*² : with R19 tire

ENGINE

Item	Lambda 3.8	Tau 5.0
Displacement cu. in (cc)	230.54 (3,778)	307.3 (5,038)
Bore x Stroke in. (mm)	3.78x3.42 (96x87)	3.78x3.42 (96x87)
Firing order	1-2-3-4-5-6	1-2-7-8-4-5-6-3
No. of cylinders	6, V-type	8, V-type

BULB WATTAGE

Light Bulb		Wattage	Bulb type (W)	
Front	Headlamp	Low	H11 / D1S	
		High	HB3 / BI-FCN	
	Turn signal lamp	LED / PY28W	LED / 28	
	Position lamp	LED	LED	
	Daytime running lights	LED	LED	
	Fog lamp	LED	LED	
	Side repeater lamps (Outside mirror)	LED	LED	
Rear	High mounted stop light	LED	LED	
	Rear combination lamp	Turn signal light	28/8W NA / LED	28 / LED
		Stop and tail lights (Outside)	LED	LED
		Stop and tail lights (Inside)	LED	LED
		Back up light	W16W / LED	16 / LED
License plate lights	LED	LED		
Interior	Luggage lamp	LED	LED	
	Map lamp	LED	LED	
	Room lamp	LED	LED	
	Vanity mirror lamp	LED	LED	

TIRES AND WHEELS

Item	Tire size	Wheel size	Inflation pressure kPa (psi)				Wheel lug nut torque kg.m (lb.ft, N.m)
			Normal load		Maximum load		
			Front	Rear	Front	Rear	
Full size tire (2WD)	245/45R18	8.0JX18	230 (33)	230 (33)	230 (33)	230 (33)	9~11 (65~79, 88~107)
	245/40R19	8.5JX19	230 (33)	-	230 (33)	-	
	275/35R19	9.0JX19	-	240 (35)	-	240 (35)	
Full size tire (AWD)	245/45R18	8.0JX18	230 (33)	230 (33)	230 (33)	230 (33)	
	245/40R19	8.5JX19	240 (35)	-	240 (35)	-	
	275/35R19	9.0JX19	-	240 (35)	-	240 (35)	
Compact spare tire (if equipped)	T135/80R18	4.0TX18	420 (60)	420 (60)	420 (60)	420 (60)	
	T135/70R19	4.0TX19	420 (60)	420 (60)	420 (60)	420 (60)	

* NOTICE

It is permissible to add 3psi (21 kPa) to the standard tire pressure specification if colder temperatures are expected. Tires typically loose 1psi for every 12°F (-11°C) temperature drop. If extreme temperature variations are expected, re-check your tire pressure as necessary to keep them properly inflated.

CAUTION

When replacing tires, use the same size originally supplied with the vehicle.
Using tires of a different size can damage the related parts or not work properly.

LUGGAGE VOLUME

Item	Lambda 3.8	Tau 5.0
SAE	15.3 cu ft (433 l)	

AIR CONDITIONING SYSTEM

Item	Weight of volume	Classification
Refrigerant	700±25g	R-134a
Compressor lubricant	120±10g	PAG (FD46XG)

We recommend that you contact an authorized HYUNDAI dealer for more details.

GROSS VEHICLE WEIGHT

lbs (kg)

Lambda 3.8		Tau 5.0	
2WD	AWD	2WD	AWD
5,379 (2,440)	5,511 (2,500)	5,556 (2,520)	-

RECOMMENDED LUBRICANTS AND CAPACITIES

To help achieve proper engine and powertrain performance and durability, use only lubricants of the proper quality. The correct lubricants also help promote engine efficiency that results in improved fuel economy.

Lubricant		Volume	Classification
Engine oil *1 *2 (drain and refill) Recommends 	Lambda 3.8	7.29 US qt. (6.9 l)	API Service SM* ³ & ILSAC GF-4 (or above), ACEA A5 or above
	Tau 5.0	8.45 US qt. (8.0 l)	API Service SM* ³ & ILSAC GF-4 (or above)
Automatic transmission fluid	Lambda 3.8	11.09 US qt. (10.5 l)	GS ATF SP-IV-RR, HYUNDAI genuine ATF SP-IV-RR
	Tau 5.0	10.46 US qt. (9.9 l)	
Coolant	Lambda 3.8	8.88 US qt. (8.4 l)	Mixture of antifreeze and water (Ethylene glycol base coolant for aluminum radiator)
	Tau 5.0	12.16 US qt. (11.5 l)	
Brake fluid		0.74~0.85 US qt. (0.7~0.8 l)	FMVSS116 DOT-3 or DOT-4
Front (AWD)/rear differential oil	Front (AWD)	0.74 US qt. (0.7 l)	Hypoid gear oil API GL-5, SAE 75W/90 (SHELL HD AXLE OIL 75W/90 or equivalent)
	Rear	1.48 US qt. (1.4 l)	
Transfer case oil (AWD)		0.65 US qt. (0.62 l)	SHELL TF0870
Fuel		20.34 US gal. (77 l)	Unleaded gasoline

*1 Refer to the recommended SAE viscosity numbers on the next page.

*2 Engine oils labeled Energy Conserving Oil are now available. Along with other additional benefits, they contribute to fuel economy by reducing the amount of fuel necessary to overcome engine friction. Often, these improvements are difficult to measure in everyday driving, but in a year's time, they can offer significant cost and energy savings.

*3 If the API service SM engine oil is not available in your country, you are able to use API service SL.

Recommended SAE viscosity number

CAUTION

Always be sure to clean the area around any filler plug, drain plug, or dipstick before checking or draining any lubricant. This is especially important in dusty or sandy areas and when the vehicle is used on unpaved roads. Cleaning the plug and dipstick areas will prevent dirt and grit from entering the engine and other mechanisms that could be damaged.

Engine oil viscosity (thickness) has an effect on fuel economy and cold weather operating (engine start and engine oil flowability). Lower viscosity engine oils can provide better fuel economy and cold weather performance, however, higher viscosity engine oils are required for satisfactory lubrication in hot weather. Using oils of any viscosity other than those recommended could result in engine damage.

When choosing an oil, consider the range of temperature your vehicle will be operated in before the next oil change. Proceed to select the recommended oil viscosity from the chart.

■ Lambda 3.8

		Temperature Range for SAE Viscosity Numbers										
Temperature	°C	-30	-20	-10	0	10	20	30	40	50		
	(°F)	-10	0	20	40	60	80	100	120			
Engine Oil *1		10W-30										
		5W-30										

*1 : For better fuel economy, it is recommended to use the engine oil of a viscosity grade SAE 5W-30 (API Service SM / ILSAC GF-4). However, if the engine oil is not available in your country, select the proper engine oil using the engine oil viscosity chart.



■ Tau 5.0

		Temperature Range for SAE Viscosity Numbers										
Temperature	°C	-30	-20	-10	0	10	20	30	40	50		
	°F	-10	0	20	40	60	80	100	120			
Engine Oil *1		10W-30										
		5W-20, 5W-30										

*1 : For better fuel economy, it is recommended to use the engine oil of a viscosity grade SAE 5W-20 (API Service SM / ILSAC GF-4). However, if the engine oil is not available in your country, select the proper engine oil using the engine oil viscosity chart.



VEHICLE IDENTIFICATION NUMBER (VIN)

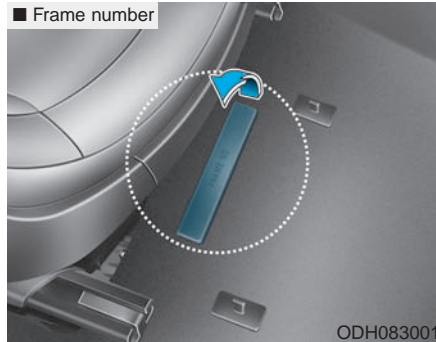

The vehicle identification number (VIN) is the number used in registering your car and in all legal matters pertaining to its ownership, etc.

The number is punched on the floor under the passenger seat. To check the number, open the cover.

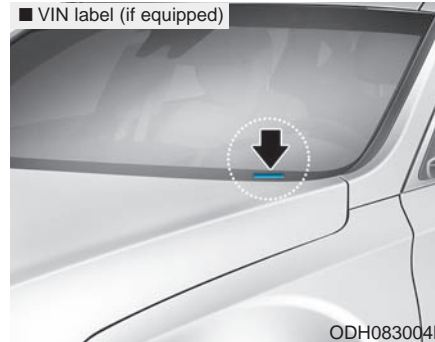

The VIN is also on a plate attached to the top of the dashboard. The number on the plate can easily be seen through the windshield from outside.

VEHICLE CERTIFICATION LABEL

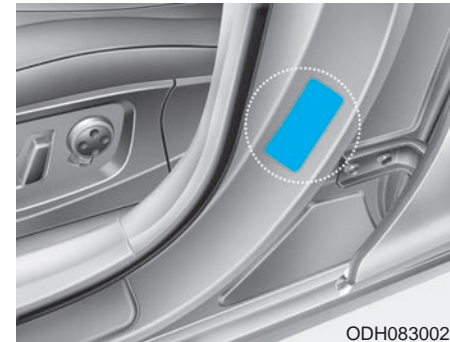

The vehicle certification label attached on the driver's side center pillar gives the Vehicle Identification Number (VIN).

TIRE SPECIFICATION AND PRESSURE LABEL



The tires supplied on your new vehicle are chosen to provide the best performance for normal driving. The tire label located on the driver's side center pillar gives the tire pressures recommended for your car.

ENGINE NUMBER

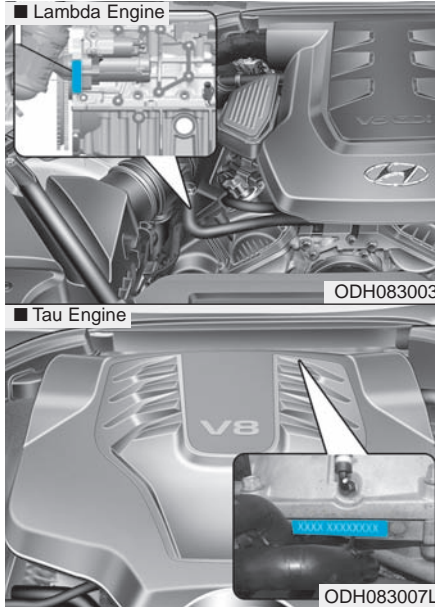

The engine number is stamped on the engine block as shown in the drawing.

REFRIGERANT LABEL (IF EQUIPPED)



The refrigerant label provides information such as refrigerant type and amount. The label is located on the underside of the hood.

CONSUMER INFORMATION

This consumer information has been prepared in accordance with regulations issued by the National Highway Traffic Safety Administration of the U.S. Department of Transportation. Your HYUNDAI dealer will help answer any questions you may have as you read this information.

HYUNDAI motor vehicles are designed and manufactured to meet or exceed all applicable safety standards.

For your safety, however, we strongly urge you to read and follow all directions in this Owner's Manual, particularly the information under the headings "**NOTICE**", "**CAUTION**" and "**WARNING**".

If, after reading this manual, you have any questions regarding the operation of your vehicle, please contact your nearest HYUNDAI Motor America Regional Office as listed in the following:

Eastern Region:

Connecticut, Delaware,
Maine, Massachusetts, New
Hampshire, New Jersey, New York,
Pennsylvania, Rhode Island,
Vermont.

Eastern Region
1122 Cranbury South River Road
Jamesburg, NJ 08831
(800) 633-5151

Southern Region:

Florida, Georgia, Maryland, North
Carolina, South Carolina, Virginia,
West Virginia.

Southern Region
3025 Chastain Meadows Parkway
Suite 100 Marietta, GA 30066
(800) 633-5151

South Central Region:

Alabama, Arkansas, Louisiana,
Mississippi, New Mexico, Oklahoma,
Tennessee, Texas.

South Central Region
1421 South Beltline Road, Suite 400
Coppell, TX 75019
(800) 633-5151

Central Region:

Illinois, Indiana, Iowa, Kentucky,
Michigan, Minnesota, Nebraska,
North Dakota, South Dakota, Ohio,
Wisconsin, Kansas, Missouri.

Central Region
1705 Sequoia Drive Aurora, Illinois
60506
(800) 633-5151

Western Region:

Alaska, Hawaii, Arizona, California,
Colorado, Idaho, Montana, Nevada,
Oregon, Utah, Washington,
Wyoming.

Western Region
10550 Talbert Avenue P.O.Box
20850 Fountain Valley, California
92728-0850
(800) 633-5151

REPORTING SAFETY DEFECTS

If you believe that your vehicle has a defect which could cause a crash or could cause injury or death, you should immediately inform the National Highway Traffic Safety Administration (NHTSA) in addition to notifying HYUNDAI MOTOR AMERICA.

If NHTSA receives similar complaints, it may open an investigation, and if it finds that a safety defect exists in a group of vehicles, it may order a recall and remedy campaign. However, NHTSA cannot become involved in individual problems between you, your dealer, or HYUNDAI MOTOR AMERICA.

To contact NHTSA, you may call the Vehicle Safety Hotline toll-free at 1-888- 327-4236 (TTY: 1-800-424-9153); go to <http://www.safercar.gov>;

or write to: Administrator, NHTSA
1200 New Jersey Ave, SE,
West Building Washington, D.C. 20590.

You can also obtain other information about motor vehicle safety from <http://www.safercar.gov>.

Index

A

Advanced smart cruise control system5-54

Air bags2-46

 Driver’s and passenger’s front air bags2-48

 Side air bags2-49

 Curtain air bags2-50

 Air bag warning light2-52

 Occupant classification system2-57

 Air bag warning labels2-68

Air cleaner7-34

Air conditioning system3-134

Alarm system3-15

All wheel drive (AWD)5-19

Antenna4-3

Anti-lock brake system (ABS)5-35

Appearance care7-87

 Exterior care7-87

 Interior care7-92

Auto Hold5-31

Automatic climate control system3-134

 Automatic heating and air conditioning3-135

 Manual heating and air conditioning3-136

Automatic transmission5-11

 Sports mode5-14

 Paddle shifter5-15

 Shift lock system5-16

Autonomous Emergency Braking (AEB)5-45

B

Bag hanger3-159

Battery7-40

Battery saver function3-115

Before driving5-4

Blind Spot Detection System (BSD)5-78

 Blind Spot Detection/Lane Change Assist5-79

 Rear Cross Traffic Alert5-82

Brake fluid7-32

Brake system5-23

 Foot parking brake5-24

 Electric parking brake (EPB)5-26

 Auto Hold5-31

 Anti-lock brake system (ABS)5-35

 Electronic Stability Control (ESC)5-38

 Hill-Start Assist Control (HAC)5-41

 Good braking practices5-41

Bulb replacement7-79

Bulb wattage8-3

Button start/stop, see engine start/stop button5-6

C

California perchlorate notice	7-98
Capacities (Lubricants)	8-6
Care	
Tire care	7-45
Exterior care	7-87
Interior care	7-92
Center console storage	3-153
Central door lock switch	3-13
Chains	
Tire chains	5-90
Changing tires	6-16
Checking tire inflation pressure	7-41
Child restraint system (CRS)	2-35
Selecting a Child Restraint System (CRS)	2-36
Installing a Child Restraint System (CRS)	2-38
Child-protector rear door lock	3-14
Climate control additional features	3-151
Cluster ionizer	3-151
Smart ventilation	3-151
Rear climate system ON/OFF	3-152
CO2 control auto air conditioner	3-152
Climate control air filter	3-146, 7-36
Climate control system (Automatic)	3-134
Automatic heating and air conditioning	3-135
Manual heating and air conditioning	3-136

Clock	3-158
Clothes hanger	3-158
Cluster ionizer	3-151
Combined instrument, see instrument cluster	3-62
Compact spare tire replacement	7-50
Consumer information	8-10
Coolant	7-29
Cooling fluid, see engine coolant	7-29
Crankcase emission control system	7-94
Cruise control system	5-50
Cup holder	3-155
Curtain air bags	2-50

D

Dashboard illumination, see instrument panel illumination	3-63
Dashboard, see instrument cluster	3-62
Daytime running lights (DRL)	3-116
Defogging (Windshield)	3-148
Defroster (Rear window)	3-132
Defrosting (Windshield)	3-148
Dimensions	8-2
Display illumination, see instrument panel illumination	3-63
Displays, see instrument cluster	3-62
Door locks	3-12
Central door lock switch	3-13
Child-protector rear door lock	3-14

Drinks holders, see cup holders.....3-155
Drive mode integrated control system.....5-42
Driver assist system3-126
 Rear view camera.....3-126
 Parking guide system3-127
 Parking assist system.....3-128
Driver position memory system3-16
Driver’s air bag2-48
Driving at night.....5-87
Driving in flooded areas5-88
Driving in the rain.....5-88

E

Electric chromic mirror.....3-22
Electric chromic mirror (ECM) with
 HomeLink® system.....3-22
Electric parking brake (EPB).....5-26
Electric power steering3-19
Electronic control suspension (ECS).....5-44
Electronic stability control (ESC).....5-38
Emergency starting
 Jump starting6-4
 Push starting6-6
Emergency towing6-24
Emergency while driving.....6-2

Emission control system7-94
 Crankcase emission control system7-94
 Evaporative emission control system.....7-94
 Exhaust emission control system7-95
Engine compartment.....1-7, 7-3
Engine coolant7-29
Engine coolant temperature gauge3-65
Engine number.....8-9
Engine oil.....7-27
Engine overheats.....6-7
Engine start/stop button5-6
Engine start/stop button positions.....5-7
Engine will not start.....6-3
Evaporative emission control system7-94
Exhaust emission control system.....7-95
Explanation of scheduled maintenance items.....7-24
Exterior care.....7-87
Exterior overview1-2, 1-3

F

Flat tire.....6-15
 Jack and tools6-15
 Changing tires6-16
 Jack label6-21
Floor mat anchor(s).....3-159
Fluid
 Brake fluid.....7-32
 Washer fluid7-34

Fog light	3-115
Front seats	2-6
Fuel filler door	3-59
Fuel gauge.....	3-65
Fuel requirements	F-6
Fuses	7-61
Fuse switch.....	7-63
Main fuse.....	7-64
Multi fuse	7-65
Fuse/relay panel description.....	7-66

G

Gauge	
Engine coolant temperature gauge	3-65
Fuel gauge	3-65
Outside Temperature Gauge.....	3-67
Glassroof, see sunroof	3-44
Glove box.....	3-154

H

Hazard warning flasher	6-2
Hazardous driving conditions	5-86
Head up display (HUD).....	3-107
Headlamp delay functionn	3-116
Headrest	2-14
Heated steering wheel.....	3-20
Heater system.....	3-134

Hill-start assist control (HAC).....	5-41
Hood.....	3-48
Horn	3-21

I

Immobilizer system.....	3-10
Indicators and warnings	3-95
Inside rearview mirror	3-22
Instrument cluster	3-62
Instrument panel illumination	3-63
LCD display control.....	3-63
Speedometer	3-64
Tachometer	3-64
Engine coolant temperature gauge.....	3-65
Fuel gauge	3-65
Odometer	3-66
Outside temperature gauge.....	3-67
Automatic transmission shift indicator	3-67
Trip computer	3-90
Warning and indicators.....	3-95
Instrument panel illumination.....	3-63
Instrument panel overview	1-5, 1-6
Interior care.....	7-92
Interior features.....	3-155
Cup holder	3-155
Sunvisor.....	3-156

Power outlet.....	3-156
Clock	3-158
Bag hanger.....	3-159
Clothes hanger.....	3-158
Floor mat anchor(s).....	3-159
Rear curtain	3-160
Side curtain.....	3-161
Luggage net holder.....	3-162
Interior light	3-118
Interior overview.....	1-4

J

Jack and tools.....	6-15
Jack label.....	6-21
Jump starting.....	6-4

L

Label	
Air bag warning label.....	2-68
Tire loading information label.....	5-94
Certification label.....	5-97
Jack label	6-21
Vehicle certification label.....	8-8
Tire specification and pressure label.....	8-9
Refrigerant label.....	8-9
Lane keeping assist system (LKAS).....	5-69

LCD display	3-68
LCD modes	3-68
Information modes	3-71
User settings mode	3-73
Warning messages	3-80
Light	3-110
Exterior lights	3-110
Smart high beam.....	3-112
Battery saver function	3-115
Headlamp delay function.....	3-115
Daytime running light	3-116
Headlamp leveling device	3-117
Headlamp washer	3-117
Welcome system	3-117
Interior lights	3-118
Light bulbs	7-79
Lubricants and capacities.....	8-6
Luggage net (holder).....	3-162
Lumbar support.....	2-10

M

Main fuse	7-64
Maintenance	
Maintenance services	7-5
Owner maintenance.....	7-6
Scheduled maintenance service.....	7-8
Normal maintenance schedule	7-9

Maintenance under severe usage conditions	7-22
Explanation of scheduled maintenance items	7-24
Tire maintenance	7-51
Maintenance schedule	
Normal maintenance schedule	7-9
Maintenance under severe usage conditions	7-22
Maintenance services	7-5
Manual heating and air conditioning	3-136
Mirrors	3-22
Inside rearview mirror	3-22
Electric chromic mirror (ECM) with HomeLink® system	3-22
Outside rearview mirror	3-36
Moonroof, see sunroof	3-44
Multi fuse	7-65
Multimedia system	4-2
AUX, USB and iPod® port	4-2
Antenna	4-3
Steering wheel audio control	4-4
Audio / Video / Navigation system (AVN)	4-5
Bluetooth® Wireless Technology hands-free	4-5

N

Neck restraints, see headrest	2-14
-------------------------------------	------

O

Odometer	3-66
Oil (Engine)	7-27
Outside rearview mirror	3-36
Overheats	6-7
Owner maintenance	7-6

P

Panorama sunroof	3-44
Parking assist system	3-128
Parking brake	5-24, 5-26
Parking brake inspect	7-34
Passenger's front air bag	2-48
Power brakes	5-23
Power outlet	3-156
Power window lock button	3-43
Push starting	6-6

R

Rear seat	2-11
Recommended cold tire inflation pressures	7-46
Recommended lubricants and capacities	8-6
Recommended SAE viscosity number	8-7
Refrigerant label	8-9
Reporting safety defects	8-11

Road warning6-2
Rocking the vehicle5-86
Rotation (Tire)7-48

S

Scheduled maintenance service7-8
 Normal maintenance schedule7-9
 Maintenance under severe usage conditions7-22
Seat belts2-22
 Seat belt safety precautions2-22
 Seat belt warning light2-23
 Seat belt restraint system2-25
 Pre-tensioner seat belt2-28
 Pre-safe seat belt (PSB)2-30
 Additional seat belt safety precautions2-31
 Care of seat belts2-34
Seat warmers and coolers2-18
 Seat warmers2-18
 Seat warmers and coolers2-20
Seatback pocket2-11
Seats2-4
 Front seats2-6
 Seatback angle2-8
 Seat cushion height2-9
 Lumbar support2-10
 Rear seats2-11
Shift lock system5-16

Side air bag2-49
Smart high beam3-112
Smart key3-4
Smart trunk3-55
Smooth cornering5-87
Snow tires5-89
Spare tire
 Compact spare tire replacement7-50
Special driving conditions5-86
 Hazardous driving conditions5-86
 Rocking the vehicle5-86
 Smooth cornering5-87
 Driving at night5-87
 Driving in the rain5-88
 Driving in flooded areas5-88
Speedometer3-64
Sports mode5-14
Starting difficulties, see engine will not start6-4
Starting the engine5-9
Steering wheel3-19
 Electric power steering (EPS)3-19
 Tilt steering / Telescope steering3-19
 Heated steering wheel3-20
 Horn3-21
Steering wheel audio control4-4

Storage compartment	3-153
Center console storage	3-153
Glove box	3-154
Sunglass holder	3-154
Sunglass holder	3-154
Sunroof.....	3-44
Sunvisor	3-156

T

Tachometer.....	3-64
Theft-alarm system	3-16
Tilt steering / Telescope steering	3-19
Tire pressure.....	7-46
Tire pressure monitoring system (TPMS)	6-9
Changing a tire with TPMS	6-14
Tire rotation	7-48
Tire specification and pressure label	8-9
Tires and wheels.....	7-45, 8-4
Tire care.....	7-45
Recommended cold tire inflation pressures	7-46
Check tire inflation pressure	7-47
Tire rotation	7-48
Wheel alignment and tire balance.....	7-49
Tire replacement.....	7-49
Compact spare tire replacement.....	7-50
Wheel replacement.....	7-50
Tire traction	7-50

Tire maintenance	7-51
Tire sidewall labeling	7-51
Tire terminology and definitions.....	7-55
All season tires	7-58
Summer tires	7-58
Snow tires	7-58
Radial-ply tires	7-59
Low aspect ratio tires	7-59
Towing	6-22
Emergency towing.....	6-24
Transmission	
Automatic transmission	5-11
Trip computer.....	3-90
Trunk	3-49
Non-powered trunk	3-49
Power trunk	3-50
Emergency trunk safety release	3-54
Smart trunk.....	3-55

V

Vehicle break-in process.....	F-9
Vehicle certification label	8-8
Vehicle data collection and event data recorders	F-10
Vehicle identification number (VIN).....	8-8

Index

Vehicle load limit	5-93
Base curb weight	5-93
Vehicle curb weight	5-93
Cargo weight	5-93
GAW (Gross axle weight)	5-93
GAWR (Gross axle weight rating)	5-93
GVW (Gross vehicle weight)	5-93
GVWR (Gross vehicle weight rating)	5-93
Tire loading information label	5-94

W

Warnings and indicators	3-95
Washer fluid	7-34
Wheel alignment and tire balance	7-49
Wheel replacement	7-50
Windows	3-40
Auto up/down window	3-42
Power window lock switch	3-43
Windshield defrosting and defogging	3-148
Winter driving	5-89
Snow tires	5-89
Tire chains	5-90
Wiper blades	7-38
Wipers and washers	3-123