



PILOT

AOG02106
31TG7G00
00X31-TG7-G000

owners.honda.com (U.S.)
myhonda.ca (Canada)

2016 Honda Pilot Owner's Guide
©2015 Honda Motor Co., Ltd. — All Rights Reserved

Information Provided by
DEAL HONDA

2016
OWNER'S GUIDE

DISCLOSURES

■ Devices That Emit Radio Waves

The following products and systems on your vehicle emit radio waves when in operation:

- Audio system
- Blind spot information system*
- Immobilizer system
- Bluetooth® Audio
- Bluetooth® HandsFreeLink®
- Collision Mitigation Braking System™ (CMBS™)
- HomeLink® Universal Transceiver*
- HondaLink®
- Remote engine starter*
- Remote transmitter
- Smart entry system*
- Tire Pressure Monitoring System

Each of the above complies with the appropriate requirements or the required standards of the FCC (Federal Communications Commission) and Industry Canada, described below:

As required by the FCC:

This device complies with Part 15 of the FCC rules. Operation is subject to the following two conditions: (1) This device may not cause harmful interference, and (2) this device must accept any interference received, including interference that may cause undesired operation.

Changes or modifications not expressly approved by the party responsible for compliance could void the user's authority to operate the equipment.

As required by Industry Canada:

This device complies with Industry Canada Standard RSS-Gen/210/310. Operation is subject to the following two conditions: (1) this device may not cause interference, and (2) this device must accept any interference, including interference that may cause undesired operation of the device.

■ California Perchlorate Contamination Prevention Act

The airbags, seat belt tensioners, and CR-type batteries in this vehicle may contain perchlorate materials—special handling may apply. See www.dtsc.ca.gov/hazardouswaste/perchlorate/ for more information.

■ California Proposition 65 Warning

WARNING: This product contains or emits chemicals known to the state of California to cause cancer and birth defects or other reproductive harm.

■ Event Data Recorders

This vehicle is equipped with an event data recorder (EDR). The main purpose of an EDR is to record, in certain crash or near crash-like situations, such as an air bag deployment or hitting a road obstacle, data that will assist in understanding how a vehicle's systems performed. **The EDR is designed to record data related to vehicle dynamics and safety systems for a short period of time, typically 30 seconds or less. The EDR in this vehicle is designed to record such data as:**

- **How various systems in your vehicle were operating;**
- **Whether or not the driver and passenger safety belts were buckled/fastened;**
- **How far (if at all) the driver was depressing the accelerator and/or brake pedal; and,**
- **How fast the vehicle was traveling.**

These data can help provide a better understanding of the circumstances in which crashes and injuries occur. NOTE: EDR data are recorded by your vehicle only if a non-trivial crash situation occurs; no data are recorded by the EDR under normal driving conditions and no personal data (e.g., name, gender, age, and crash location) are recorded. However, other parties, such as law enforcement, could combine the EDR data with the type of personally identifying data routinely acquired during a crash investigation.

To read data recorded by an EDR, special equipment is required, and access to the vehicle or the EDR is needed. In addition to the vehicle manufacturer, other parties such as law enforcement that have the special equipment can read the information if they have access to the vehicle or the EDR.

The data belong to the vehicle owner and may not be accessed by anyone else except as legally required or with the permission of the vehicle owner.

■ Service Diagnostic Recorders

This vehicle is equipped with service-related devices that record information about powertrain performance. The data can be used to verify emissions law requirements and/or help technicians diagnose and solve service problems. It may also be combined with data from other sources for research purposes, but it remains confidential.

INTRODUCTION

This Owner's Guide is intended to help you quickly get acquainted with your **2016 Honda Pilot**. It provides basic information and instructions on technology and convenience features, as well as emergency procedures and how to get assistance.

This guide is for vehicles sold in the United States and Canada. It covers all models, so you may find descriptions of features and equipment that are not in your vehicle. Images throughout this guide are from U.S. vehicles and represent features and equipment that are available on some, but not all, models.

This guide is not intended to be a substitute for the Owner's Manual. The Owner Information CD enclosed in your glove box kit includes the Owner's Manual, Navigation Manual, and vehicle and tire warranties in electronic format. This information can be viewed on a computer (PC or Mac platform) and saved or printed for your reference. You can also visit owners.honda.com (U.S.) or myhonda.ca (Canada) to view the complete and most current information.

If you are the first registered owner of your vehicle, you may request a complimentary printed copy of the Owner's Manual, Navigation Manual, or Vehicle Warranty within the first six months of vehicle purchase. To request a copy, visit owners.honda.com and create or log in to your account. In Canada, please request a copy from your Honda dealer.

American Honda Motor Company strives to be proactive in protecting our environment and natural resources. By using electronic delivery for a considerable portion of the information typically found in a vehicle owner's manual, we are further reducing our impact on the environment.

Honda Automobile Customer Service

Your authorized Honda dealer should be able to answer any questions you have about your vehicle. However, if you are dissatisfied with the information you receive, you can call Honda Automobile Customer Service (see page 162).

Call (800) 999-1009 (U.S.) or (888) 946-6329 (Canada)

Honda Roadside Assistance

24-hour emergency road service is available to you in the United States and Canada throughout your 3-year/36,000-mile warranty term. Services include jump starting, flat tire and lockout assistance, towing, and more (limitations apply).

Call (866) 864-5211 (U.S.) or (800) 465-7587 (Canada)

TABLE OF CONTENTS

VISUAL INDEX	1	Air Conditioning System*	52
Steering Wheel and Nearby Controls...	1	Climate Control System*	53
Dashboard and Ceiling Controls	2	Seat Heaters*	55
SAFETY INFORMATION	3	Customized Features	56
Important Safety Information	3	Setting the Clock	57
Seat Belts	5	AUDIO AND CONNECTIVITY	58
Airbags	9	Basic Audio Operation	58
Child Safety	15	<i>Models with color audio system</i>	
Safety Label Locations	23	Color Audio System	62
Reporting Safety Defects	23	FM/AM Radio	63
INSTRUMENT PANEL	24	iPod®	64
Malfunction Indicators	24	USB Flash Drive	65
Condition Indicators	26	Bluetooth® Audio	66
On/Off Indicators	27	<i>Models with touchscreen</i>	
Multi-Information Display (MID)	28	Touchscreen Operation	67
VEHICLE CONTROLS	29	HondaLink®	69
Using the Remote Transmitter	29	Wi-Fi Connection	70
Smart Entry System*	30	Aha™ Radio	70
Tailgate Operation	31	FM/AM Radio	71
Power Tailgate Operation*	32	SiriusXM® Radio*	72
Door Operation	33	Compact Disc (CD)*	73
Power Window Operation	34	iPod®	74
Power Moonroof Operation*	35	USB Flash Drive	75
Panoramic Glass Roof*	36	Bluetooth® Audio	76
Interior and Exterior Lights	37	Pandora®	77
One-Touch Turn Signal	38	Rear Entertainment System (RES)* ..	78
Auto High Beam System*	39	BLUETOOTH® HANDSFREELINK® ..	81
Wiper Operation	40	<i>Models with color audio system</i>	
Adjusting the Seats	42	Basic HFL Operation	81
Rear Seats	46	Pairing a Phone	82
Driving Position Memory System* ..	49	Making a Call	83
Adjusting the Steering Wheel	49	<i>Models with touchscreen</i>	
Adjusting the Mirrors	50	Basic HFL Operation	84
HomeLink® Garage Opener*	51	Pairing a Phone	86



*if equipped
COVER | C7

VISUAL INDEX

Quickly locate items in the vehicle's interior.

Steering Wheel and Nearby Controls

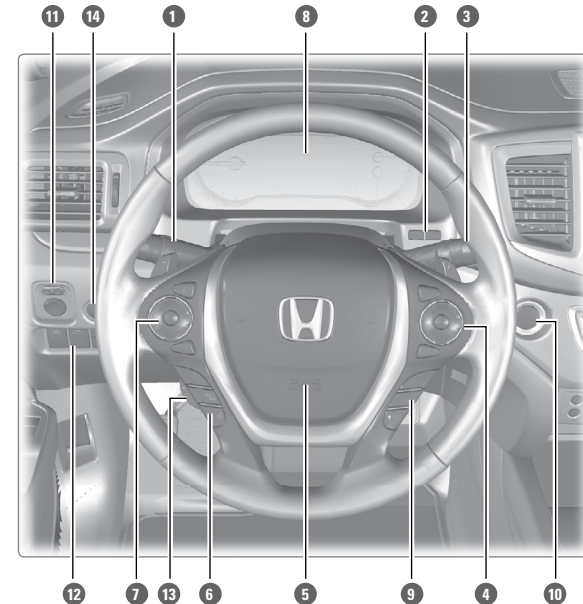

- 1 Lights/turn signals/LaneWatch button* p. 37, p. 38, p. 117
- 2 Brightness control p. 37
- 3 Wipers/washers p. 40
- 4 Cruise control*/Adaptive Cruise Control (ACC)*/Lane Keeping Assist System (LKAS) buttons* p. 114, p. 115, p. 118
- 5 Horn
- 6 Voice recognition buttons p. 81, p. 84, p. 91
- 7 Audio controls p. 60
- 8 Instrument panel p. 24
Multi-information display (MID) p. 28
- 9 INFO/RESET buttons p. 28
- 10 ENGINE START/STOP button p. 107
- 11 Door mirror controls p. 50
- 12 Vehicle Stability Assist (VSA®) OFF button p. 113
Parking sensor system button* p. 121
Collision Mitigation Braking System™ (CMBS™) OFF button* p. 120
Road Departure Mitigation (RDM) button* p. 119
Heated windshield button* p. 54
- 13 Heated steering wheel button* p. 54
- 14 ECON button p. 113

<p>Making a Call87</p> <p>HondaLink® Assist.....88</p> <p>SMS Text Messaging and E-Mail*... 89</p> <p>Siri™ Eyes Free90</p> <p>NAVIGATION*91</p> <p>Basic Navigation Operation91</p> <p>Entering a Destination93</p> <p>Routing.....96</p> <p>DRIVING.....98</p> <p>Before Driving98</p> <p>Maximum Load Limit.....100</p> <p>Towing a Trailer102</p> <p>Remote Engine Start*.....106</p> <p>Starting to Drive107</p> <p>Shifting.....108</p> <p>Braking111</p> <p>Intelligent Traction Management System*.....112</p> <p>Auto Idle Stop*112</p> <p>Eco Assist System.....113</p> <p>Vehicle Stability Assist (VSA®), aka Electronic Stability Control (ESC) System.....113</p> <p>Cruise Control.....114</p> <p>Adaptive Cruise Control (ACC)*115</p> <p>LaneWatch™*117</p> <p>Lane Keeping Assist System (LKAS)*118</p> <p>Road Departure Mitigation (RDM)*119</p> <p>Collision Mitigation Braking System™ (CMBS™)*120</p> <p>Parking Sensor System*.....121</p> <p>Blind Spot Information (BSI)*.....122</p> <p>Rear Cross Traffic Monitor*123</p> <p>Multi-View Rear Camera*.....124</p>	<p>Refueling126</p> <p>HANDLING THE UNEXPECTED127</p> <p>Smart Entry Remote Battery Strength...127</p> <p>Jump Starting127</p> <p>Shift Lever Does Not Move*128</p> <p>Overheating.....129</p> <p>Emergency Engine Stop*.....130</p> <p>Emergency Towing130</p> <p>Tire Pressure Monitoring System (TPMS)131</p> <p>Changing a Flat Tire.....133</p> <p>Fuse Locations.....137</p> <p>MAINTENANCE141</p> <p>Safety Precautions141</p> <p>Maintenance Minder™.....142</p> <p>Under the Hood.....144</p> <p>Engine Oil146</p> <p>Engine Coolant148</p> <p>Checking the Battery.....149</p> <p>Window Washer Fluid149</p> <p>Brake Fluid.....149</p> <p>Changing Wiper Blades.....150</p> <p>Tire Information.....152</p> <p>Tire Labeling155</p> <p>DOT Tire Quality Grading.....156</p> <p>Testing of Readiness Codes158</p> <p>SPECIFICATIONS.....159</p> <p>CUSTOMER INFORMATION.....161</p> <p>Frequently Asked Questions/ Troubleshooting161</p> <p>Contact Us.....162</p> <p>Honda Roadside Assistance.....163</p> <p>Warranty Coverages.....163</p> <p>VOICE COMMAND INDEX.....164</p> <p>INDEX.....166</p>
--	---



*if equipped

Dashboard and Ceiling Controls

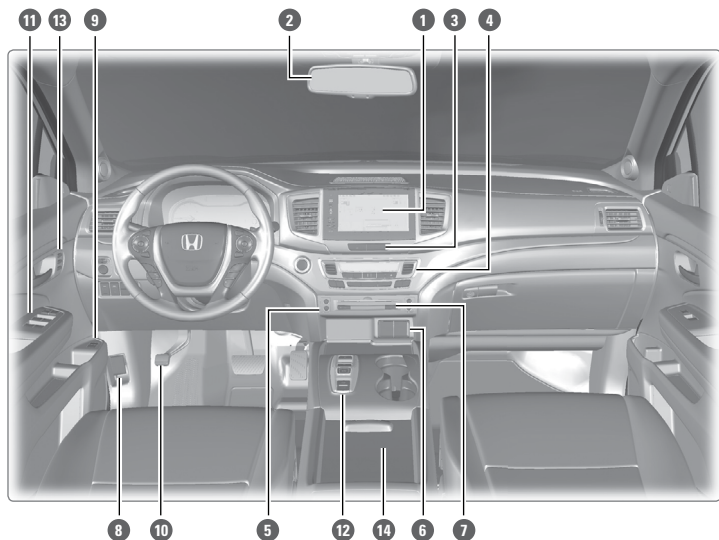

- | | |
|---|--|
| <p>1 Color audio system* p. 62
Touchscreen* p. 67
Navigation system* p. 91</p> <p>2 Rearview mirror p. 50</p> <p>3 Hazard warning button</p> <p>4 Climate control system p. 53</p> <p>5 Seat heater/ventilation buttons* p. 55</p> <p>6 USB port p. 58
Accessory power socket p. 59</p> <p>7 Rear entertainment system* p. 78</p> <p>8 Hood release handle p. 144</p> <p>9 Fuel fill door button p. 126
Power tailgate button* p. 32</p> | <p>10 Parking brake p. 111</p> <p>11 Power window switches p. 34
Door lock switches p. 33</p> <p>12 Shifting p. 108
Intelligent Traction Management button* p. 112
Auto idle stop OFF button* p. 112</p> <p>13 Driving Position Memory System* p. 49</p> <p>14 (inside center console)
USB port p. 58
Accessory power socket p. 59
Auxiliary input jack p. 59</p> |
|---|--|

SAFETY INFORMATION

Your safety—and the safety of others—is very important and operating this vehicle safely is an important responsibility. While we strive to help you make informed decisions about safety, it is not practical or possible to warn you about all the hazards associated with operating or maintaining your vehicle. Therefore, you must use your own good judgment.

Important Safety Information

This guide explains many of your vehicle's safety features and how to use them. Please read this information carefully. Following the instructions below will also help to keep you and your passengers safe.

■ Important Safety Precautions

- Always wear your seat belt.
- Secure all children in the proper restraint system.
- Be aware of airbag hazards.
- Don't drink and drive.
- Pay appropriate attention to the task of driving safely.
- Control your speed.
- Keep your vehicle in safe condition.

Engaging in cell phone conversation or other activities that keep you from paying close attention to the road, other vehicles, and pedestrians could lead to a crash. Remember, situations can change quickly, and only you can decide when it is safe to divert some attention away from driving.

■ Important Handling Information

Your vehicle has higher ground clearance than a passenger vehicle designed for use only on pavement. Higher ground clearance has many advantages for off-highway driving. It allows you to travel over bumps, obstacles, and rough terrain. It also provides good visibility so you can anticipate problems earlier.

These advantages come at some cost. Because your vehicle is taller and rides higher off the ground, it has a higher center gravity making it more susceptible to tipping or roll over if you make abrupt turns. Utility vehicles have a significantly higher rollover rate than other types of vehicles. In a rollover crash, an unbelted person is significantly more likely to die than a person wearing a seat belt. As a reminder, make sure you and your passengers always wear seat belts.

■ Safety Messages

When you see the following messages throughout this guide, pay close attention.

⚠ DANGER You **WILL** be **KILLED** or **SERIOUSLY HURT** if you don't follow instructions.

⚠ WARNING You **CAN** be **KILLED** or **SERIOUSLY HURT** if you don't follow instructions.

⚠ CAUTION You **CAN** be **HURT** if you don't follow instructions.

NOTICE This information is intended to help you avoid damage to your vehicle, other property, or the environment.

■ Carbon Monoxide Gas

The engine exhaust from this vehicle contains carbon monoxide, a colorless, odorless, and highly toxic gas. As long as you properly maintain your vehicle and follow the instructions set forth below, you will not accumulate dangerous levels of carbon monoxide gas in the vehicle interior.

Have the exhaust system inspected for leaks whenever:

- The exhaust system is making an unusual noise.
- The exhaust system may have been damaged.
- The vehicle is raised for an oil change.

When you operate a vehicle with the tailgate open, airflow can pull exhaust gas into the interior and create a hazardous condition. If you must drive with the tailgate open, open all the windows and set the climate control system as shown below.

1. Select the fresh air mode.
2. Select the  mode.
3. Set the fan speed to high.
4. Set the temperature control to a comfortable setting.

Adjust the climate control system in the same manner if you sit in your parked vehicle with the engine running.

⚠ WARNING

Carbon monoxide gas is toxic. Breathing it can cause unconsciousness and even kill you.

Avoid any enclosed areas or activities that expose you to carbon monoxide.

An enclosed area such as a garage can quickly fill up with carbon monoxide gas. Do not run the engine with the garage door closed. Even when the garage door is open, drive out of the garage immediately after starting the engine.



Information Provided by:
DEALER
E-PROCESS

Seat Belts

A seat belt is your best protection in all types of collisions. Airbags are designed to supplement seat belts, not replace them. So even though your vehicle is equipped with airbags, make sure you and your passengers always wear your seat belts and wear them properly.

■ Lap/Shoulder Seat Belts

All seven or eight seating positions are equipped with lap/shoulder seat belts with emergency locking retractors. In normal driving, the retractor lets you move freely while keeping some tension on the belt. During a collision or sudden stop, the retractor locks to restrain your body. The second- and third-row passenger's seat belts also have a lockable retractor for use with child seats.

The front seats are equipped with automatic seat belt tensioners to enhance safety. The tensioners automatically tighten the front seat belts during a moderate to severe frontal collision, sometimes even if the collision is not severe enough to inflate the front airbags.

■ Proper Use of Seat Belts

Follow these guidelines for proper use:

- All occupants should sit upright, well back in the seat, and remain in that position for the duration of the trip. Slouching and leaning reduces the effectiveness of the belt and can increase the chance of serious injury in a crash.
- Never place the shoulder part of a lap/shoulder seat belt under your arm or behind your back. This could cause very serious injuries in a crash.
- Two people should never use the same seat belt. If they do, they could be very seriously injured in a crash.
- Do not put any accessories on the seat belts. Devices intended to improve comfort or reposition the shoulder part of a seat belt can reduce the protective capability and increase the chance of serious injury in a crash.
- Regularly check the condition of your seat belts. Check for frays, cuts, burns, and wear, and that the latches work smoothly and the belts retract easily.
- No one should sit in a seat with an inoperative seat belt or one that does not appear to be working correctly. Using a seat belt that is not working properly may not protect the occupant in a crash. Have a dealer check the belt as soon as possible.

⚠ WARNING

Not wearing a seat belt properly increases the chance of a serious injury or death in a crash, even though your vehicle has airbags.

Be sure you and your passengers always wear seat belts and wear them properly.

■ Seat Belt Inspection

Regularly check the condition of your seat belts as follows:

- Pull each belt out fully, and look for frays, cuts, burns, and wear.
- Check that the latches work smoothly and the belts retract easily. If a belt does not retract easily, cleaning the belt may correct the problem. Use only mild soap and warm water. Do not use bleach or cleaning solvents. Make sure the belt is completely dry before allowing it to retract.

Any belt that is not in good condition or working properly will not provide proper protection and should be replaced as soon as possible.

A belt that has been worn during a crash may not provide the same level of protection in a subsequent crash. Have your seat belts inspected by a dealer after any collision.

⚠ WARNING

Not checking or maintaining seat belts can result in serious injury or death if the seat belts do not work properly when needed.

Check your seat belts regularly and have any problem corrected as soon as possible.

■ Fastening a Seat Belt

Adjust your seat to the proper position (see page 42), and then follow the below steps.

1. Pull the seat belt out slowly.
2. Insert the latch plate into the buckle, then tug on the belt to make sure the buckle is secure. Make sure that the belt is not twisted or caught on anything.
3. Position the lap part of the belt as low as possible across your hips, then pull up on the shoulder part of the belt so the lap part fits snugly. This lets your strong pelvic bones take the force of a crash and reduces the chance of internal injuries.
4. If necessary, pull up on the belt again to remove any slack, then make sure that the belt rests across the center of your chest and over your shoulder. This spreads the forces of a crash over the strongest bones in your upper body.

To release the belt, push the red PRESS button then guide the belt by hand until it has retracted completely.

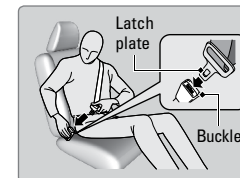
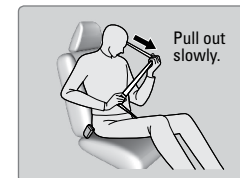

⚠ WARNING

Improperly positioning the seat belts can cause serious injury or death in a crash.

Make sure all seat belts are properly positioned before driving.

■ Adjusting the Shoulder Anchor

The front seats have adjustable shoulder anchors to accommodate taller and shorter occupants.

1. Move the anchor up and down while holding the release button.
2. Position the anchor so that the belt rests across the center of your chest and over your shoulder.

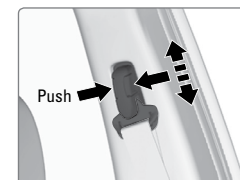

■ Seat Belt with Detachable Anchor

The seat belts for the second-row* and third-row center seat is located in the ceiling.

1. Pull out the seat belt's small latch plate and the latch plate from each holding slot in the ceiling.
2. Line up the triangle marks on the small latch plate and anchor buckle. Make sure the seat belt is not twisted. Attach the belt to the anchor buckle.
3. Insert the latch plate into the buckle. Properly fasten the seat belt the same way you fasten the lap/shoulder seat belt.

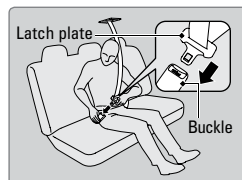
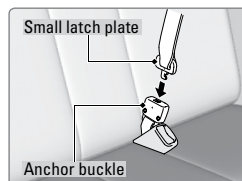
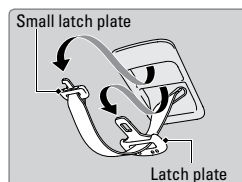

To unlatch the detachable anchor, insert a key into the slot on the side of the anchor buckle.

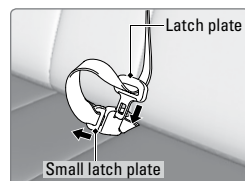

⚠ WARNING

Using the seat belt with the detachable anchor unlatched increases the chance of serious injury or death in a crash.

Before using the seat belt, make sure the detachable anchor is correctly latched.

Airbags

Your vehicle is equipped with three types of airbags: front airbags, side airbags, and side curtain airbags.

■ Front Airbags (SRS)

The front SRS airbags inflate in a moderate-to-severe frontal collision to help protect the head and chest of the driver and/or front passenger. They are housed in the center of the steering wheel for the driver, and in the dashboard for the front passenger. Both airbags are marked **SRS AIRBAG**.

SRS (Supplemental Restraint System) indicates that the airbags are designed to supplement seat belts, not replace them. Seat belts are the occupant's primary restraint system.

■ Advanced Airbags

Your front airbags have advanced features to help reduce the likelihood of airbag-related injuries to smaller occupants.

The driver's advanced front airbag system includes a seat position sensor. If the seat is too far forward, the airbag inflates with less force, regardless of the severity of the impact.

If there is a problem with the driver's seat position sensor, the SRS indicator will come on and the airbag will inflate with full (normal) force, regardless of the driver's seating position.

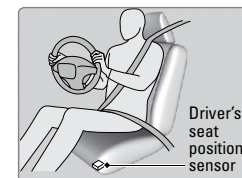

The passenger's advanced front airbag system has weight sensors. Although Honda recommends against carrying an infant or small child in front, if the sensors detect the weight of a child (up to 65 lbs or 29 kg), the system will automatically turn off the passenger's front airbag.

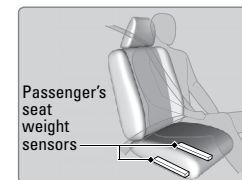

For both advanced front airbags to work properly:

- Do not spill any liquid on or under the seats.
- Do not put any object under the passenger's seat.
- Make sure any objects are positioned properly on the floor. Improperly positioned objects can interfere with the advanced airbag sensors.
- All occupants should sit upright and wear their seat belts properly.
- Do not place any cover over any part of the passenger side dashboard.

■ Side Airbags

The side airbags help protect the torso and pelvis of the driver or a front passenger during a moderate-to-severe side impact. They are housed in the outside edge of the driver's and front passenger's seat-backs. Both are marked **SIDE AIRBAG**.

■ Side Curtain Airbags

Side curtain airbags help protect the heads of the driver and passengers in outer seating positions during a moderate-to-severe side impact. The side curtain airbags equipped in this vehicle are also designed to help reduce the likelihood of partial and complete ejection of vehicle occupants through side windows in crashes, particularly rollover crashes.

The side curtain airbags are located in the ceiling above the side windows on both sides of the vehicle.

The side curtain airbags are designed to deploy in a rollover or moderate-to-severe side impact. If the SRS control unit senses that your vehicle is about to roll over, it immediately deploys both side curtain airbags and activates both front seat belt tensioners. The airbag on the passenger's side will deploy, even if there are no passengers on that side of the vehicle.

To get the best protection from the side curtain airbags, occupants should wear their seat belts properly and sit upright and well back in their seats.

When side curtain airbags deploy in a frontal collision

One or both side curtain airbags may inflate in a moderate-to-severe angled frontal collision. In this case, the side curtain airbags will deploy slightly after the front airbags.

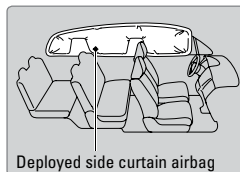
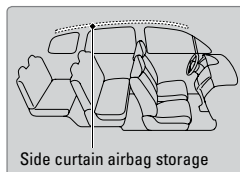

■ Important Facts About Your Airbags

Always wear your seat belt properly, and sit upright and as far back from the steering wheel as possible while allowing full control of the vehicle. A front passenger should move their seat as far back from the dashboard as possible.

Do not place hard or sharp objects between yourself and a front airbag. Carrying hard or sharp objects on your lap, or driving with a pipe or other sharp object in your mouth, can result in injuries if your front airbag inflates.

Do not attach or place objects on the front airbag covers. Objects on the covers marked **SRS AIRBAG** could interfere with the proper operation of the airbags or be propelled inside the vehicle and hurt someone if the airbags inflate.

Do not attach accessories on or near the side airbags. They can interfere with the proper operation of the airbags, or hurt someone if an airbag inflates.

Do not attach any objects to the side windows or roof pillars. They can interfere with the proper operation of the side curtain airbags.

Do not cover or replace the front seat-back covers. This can prevent your side airbags from properly deploying during a side impact.

⚠️ WARNING

An open glove box can cause serious injury to your passenger in a crash, even if the passenger is wearing the seat belt.

Always keep the glove box closed while driving.

■ Airbag System Indicators

If a problem occurs in the airbag system, the SRS indicator comes on and a message appears on the multi-information display.

SRS (Supplemental Restraint System) indicator

If the indicator comes on at any other time besides vehicle start-up, or does not come on at all, have the system checked by a dealer as soon as possible. If you don't, your airbags and seat belt tensioners may not work properly when they are needed.



⚠️ WARNING

Ignoring the SRS indicator can result in serious injury or death if the airbag systems or tensioners do not work properly.

Have your vehicle checked by a dealer as soon as possible if the SRS indicator alerts you to a possible problem.



Passenger Airbag Off indicator

The indicator comes on to alert you that the front passenger's front airbag has been turned off. This occurs when the front passenger's weight sensors detect 65 lbs (29 kg) or less, the weight of an infant or small child, on the seat.

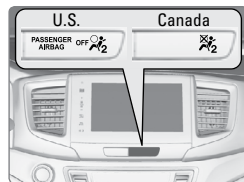

Infants and small children should always ride properly restrained in a back seat. Objects placed on the seat can also cause the indicator to come on.

If the front passenger's seat is empty, the passenger's front airbag will not deploy and the indicator will not come on.

If the indicator comes on with no occupant or objects in the front passenger's seat, something may be interfering with the weight sensors, such as:

- An object hanging on the seat or in the seat-back pocket.
- A child seat or other object pressing against the rear of the seat-back.
- A rear passenger pushing or pulling on the back of the front passenger's seat.
- The front seat or seat-back is forced against an object on the seat or floor behind it.
- An object placed under the front passenger's seat.

If none of these conditions exist, have your vehicle checked by a dealer as soon as possible.

The passenger airbag off indicator may go on and off repeatedly if the total weight on the seat is near the airbag cutoff threshold.

Airbag System Components

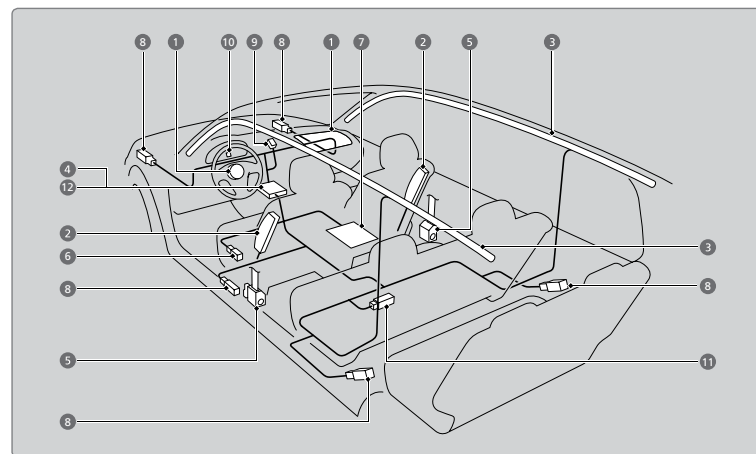

- 1 Two SRS (Supplemental Restraint System) front airbags. The driver's airbag is stored in the center of the steering wheel; the front passenger's airbag is stored in the dashboard. Both are marked **SRS AIRBAG**.
- 2 Two side airbags, one for the driver and one for the front passenger. The airbags are stored in the outer edges of the seat-backs. Both are marked **SIDE AIRBAG**.
- 3 Two side curtain airbags, one for each side of the vehicle. The airbags are stored in the ceiling, above the side windows. The front and rear pillars are marked **SIDE CURTAIN AIRBAG**.
- 4 An electronic control unit that continually monitors and can record information about the sensors, the airbag activators, the seat belt tensioners, and driver and front passenger seat belt use when the vehicle is on.
- 5 Automatic front seat belt tensioners. The driver's and front passenger's seat belts incorporate sensors that detect whether or not they are fastened.
- 6 A driver's seat position sensor. If the seat is too far forward, the airbag will inflate with less force.
- 7 Weight sensors in the front passenger's seat. The front passenger's airbag will be turned off if the weight on the seat is 65 lbs (29 kg) or less (the weight of an infant or small child).
- 8 Impact sensors that can detect a moderate-to-severe front or side impact.
- 9 An indicator on the dashboard that alerts you that the front passenger's front airbag has been turned off.
- 10 An indicator on the instrument panel that alerts you to a possible problem with the airbag system or seat belt tensioners.
- 11 Safing sensor
- 12 A rollover sensor that can detect if your vehicle is about to roll over and signal the control unit to deploy both side curtain airbags.



■ Airbag Care

You do not need to, and should not, perform any maintenance on or replace any airbag system components yourself. However, you should have your vehicle inspected by a dealer in the following situations:

When the airbags have deployed

If an airbag has inflated, the control unit and other related parts must be replaced. Similarly, once an automatic seat belt tensioner has been activated, it must be replaced.

When the vehicle has been in a moderate-to-severe collision

Even if the airbags did not inflate, have your dealer inspect the following: the driver's seat position sensor, weight sensors in the passenger's seat, front seat belt tensioners, and each seat belt that was worn during the crash.

Do not remove or modify a front seat without first consulting a dealer

This would likely disable the driver's seat position sensor or the weight sensors in the passenger's seat. If it is necessary to remove or modify a front seat to accommodate a person with disabilities, contact a Honda dealer. For U.S. vehicles, call Honda Automobile Customer Service at (800) 999-1009. For Canadian vehicles, call Honda Canada Customer Relations at (888) 946-6329.

Child Safety

Each year, many children are injured or killed in vehicle crashes because they are either unrestrained or not properly restrained. In fact, vehicle collisions are the number one cause of death of children ages 12 and under.

The National Highway Traffic Safety Administration and Transport Canada recommend that all children ages 12 and under be properly restrained in a rear seat. Some states or provinces/territories have laws restricting where children may ride.

To reduce the number of child deaths and injuries, every state, Canadian province and territory requires that infants and children be properly restrained when they ride in a vehicle.

■ Protecting Child Passengers

- An inflating front or side airbag can injure or kill a child sitting in the front seat.
- A child in the front seat is more likely to interfere with the driver's ability to safely control the vehicle.
- Statistics show that children of all sizes and ages are safer when they are properly restrained in a rear seat.
- Any child who is too small to wear a seat belt correctly must be restrained in an approved child seat that is properly secured to the vehicle using either the lap belt portion of the lap/shoulder belt or the lower anchors of the LATCH system.
- Never hold a child on your lap because it is impossible to protect them in the event of a collision.
- Never put a seat belt over yourself and a child. During a crash, the belt would likely press deep into the child and cause serious or fatal injuries.
- Never let two children use the same seat belt. Both children could be very seriously injured in a crash.
- Do not allow children to operate the doors, windows, or seat adjustments.
- Do not leave children in the vehicle unattended, especially in hot weather when the inside of the vehicle can get hot enough to kill them. They could also activate vehicle controls, causing it to move unexpectedly.

⚠ WARNING

Children who are unrestrained or improperly restrained can be seriously injured or killed in a crash.

Any child too small for a seat belt should be properly restrained in a child seat. A larger child should be properly restrained with a seat belt, using a booster seat if necessary.

⚠ WARNING

Allowing a child to play with a seat belt or wrap one around their neck can result in serious injury or death.

Instruct children not to play with any seat belt and make sure any unused seat belt a child can reach is buckled, fully retracted, and locked.

■ Protecting Infants

An infant must be properly restrained in a rear-facing, reclining child seat until the infant reaches the seat manufacturer's weight or height limit for the seat, and the infant is at least one year old. Many experts recommend use of a rear-facing seat for a child up to two years old if the child's height and weight are appropriate for a rear-facing seat.

Child seats must be placed and secured in a rear seating position. Rear-facing child seats should never be installed in a forward-facing position.

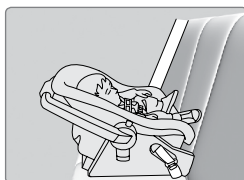

When properly installed, a rear-facing child seat may prevent the driver or a front passenger from moving their seat all the way back, or from locking their seat-back in the desired position. If this occurs, we recommend that you install the child seat directly behind the front passenger's seat, move the seat as far forward as needed, and leave it unoccupied. Or, you may wish to get a smaller rear-facing child seat.

⚠ WARNING

Placing a rear-facing child seat in the front seat can result in serious injury or death during a crash.

Always place a rear-facing child seat in the rear seat, not the front.

■ Protecting Smaller Children

If a child is at least one year old and within the weight range indicated by the child seat manufacturer, the child should be properly restrained in a firmly secured forward-facing child seat.

We strongly recommend placing a forward-facing child seat in a rear seating position.

Placing a forward-facing child seat in the front seat can be hazardous, even with advanced front airbags that automatically turn the passenger's front airbag off. A rear seat is the safest place for a child.

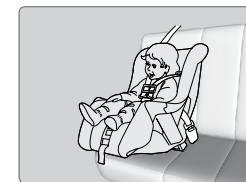
**⚠ WARNING**

Placing a forward-facing child seat in the front seat can result in serious injury or death if the front airbag inflates.

If you must place a forward-facing child seat in front, move the vehicle seat as far back as possible, and properly restrain the child.

■ Selecting a Child Seat

Most child seats are LATCH-compatible (Lower Anchors and Tethers for Children). Some have a rigid-type connector, while others have a flexible-type connector. Both are equally easy to use. Some existing and previously owned child seats can only be installed using the seat belt. Whichever type you choose, follow the child seat manufacturer's use and care instructions as well as the instructions in this manual. Proper installation is key to maximizing your child's safety.

In seating positions and vehicles not equipped with LATCH, a LATCH-compatible child seat can be installed using the seat belt and a top tether for added security. This is because all child seats are required to be designed so that they can be secured with a lap belt or the lap part of a lap/shoulder belt. In addition, the child seat manufacturer may advise that a seat belt be used to attach a LATCH-compatible seat once a child reaches a specified weight. Please read the child seat owner's manual for proper installation instructions.

Important considerations when selecting a child seat

Make sure the child seat meets the following three requirements:

- The child seat is the correct type and size for the child.
- The child seat is the correct type for the seating position.
- The child seat is compliant with Federal Motor Vehicle Safety Standard 213 or Canadian Motor Vehicle Safety Standard 213.



■ Installing a LATCH-Compatible Child Seat

A LATCH-compatible child seat can be installed in each of the second- and third-row seats. A child seat is attached to the lower anchors with either the rigid or flexible type of connectors.

1. Locate the lower anchors under the marks.

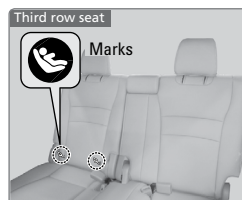
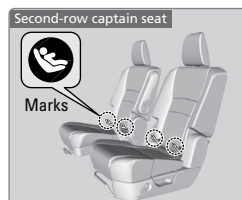
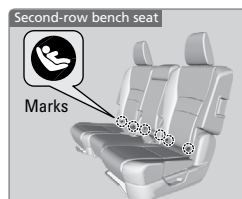

2. Place the child seat on the vehicle seat, then attach the child seat to the lower anchors according to the instructions that came with the child seat. Make sure that the lower anchors are not obstructed by the seat belt or any other object.

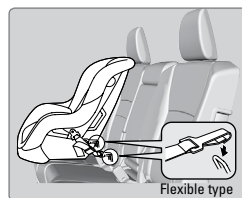
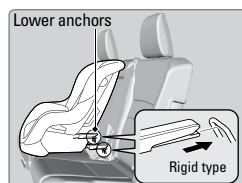

3. **For second-row outer seats:** Raise the outer head restraint to its highest position, then route the tether strap between the head restraint legs, and secure the tether strap hook onto the anchor. Make sure the strap is not twisted.

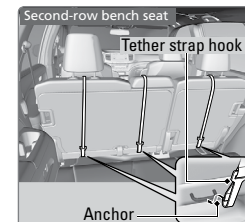

For the center seat: Lower the center head restraint to its lowest position, then route the tether strap over the top of the head restraint, and secure the tether strap hook onto the anchor. Make sure the strap is not twisted.

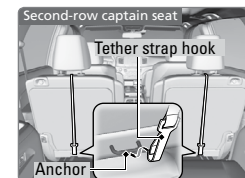

For third-row outer seats: Route the tether strap hook between the head restraint legs, and secure the tether strap hook onto the anchor. Make sure the strap is not twisted.

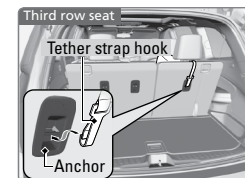

4. Tighten the tether strap according to the seat maker's instructions.
5. Make sure the child seat is firmly secured by rocking it forward and back and side to side; little movement should be felt.
6. Make sure any unused seat belt that a child can reach is buckled, the lockable retractor is activated, and the belt is fully retracted and locked.

■ Installing a Child Seat with a Lap/Shoulder Seat Belt

1. Place the child seat on the vehicle seat.
2. Route the seat belt through the child seat according to the seat manufacturer's instructions, and insert the latch plate into the buckle. Insert the latch plate fully until it clicks.
3. Slowly pull the shoulder part of the belt all the way out until it stops. This activates the lockable retractor.
4. Let the seat belt completely wind up into the retractor, then try to pull it out to make sure the retractor is locked. If you are able to pull the shoulder belt out, the lockable retractor is not activated. Pull the seat belt all the way out, and repeat steps 3 – 4.
5. Grab the shoulder part of the seat belt near the buckle, and pull up to remove any slack from the lap part of the belt. When doing this, place your weight on the child seat and push it into the vehicle seat.
6. Make sure the child seat is firmly secured by rocking it forward and back and side to side; little movement should be felt.
7. Make sure any unused seat belt that a child can reach is buckled, the lockable retractor is activated, and the belt is fully retracted and locked.

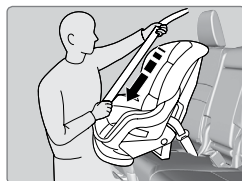

To deactivate a lockable retractor, release the buckle and allow the seat belt to wind up all the way.

■ Adding Security with a Tether

A tether anchorage point is provided behind each second- and third-row seating position. If you have a child restraint system that comes with a tether but can be installed with a seat belt, the tether may be used for additional security.

Using a second-row anchor

1. **For outer positions:** Raise the outer head restraint to its highest position, then route the tether strap between the head restraint legs, and secure the tether strap hook onto the anchor. Make sure the strap is not twisted.

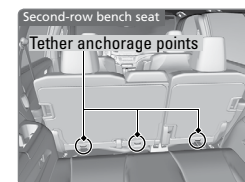

- For the center position:** Lower the center head restraint to its lowest position, then route the tether strap over the top of the head restraint, and secure the tether strap hook onto the anchor. Make sure the strap is not twisted.

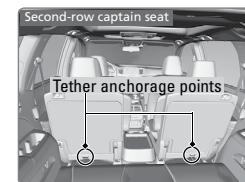

2. Tighten the tether strap as instructed by the child seat manufacturer.

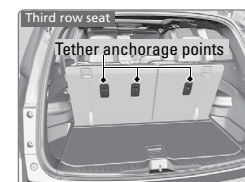

Using a third-row anchor

1. Route the tether strap hook between the head restraint legs, and secure the tether strap hook onto the anchor. Make sure the strap is not twisted.
2. Secure the tether strap hook onto the anchor.
3. Tighten the tether strap as instructed by the child seat manufacturer.

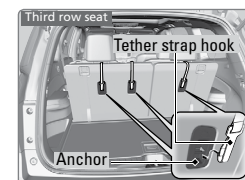
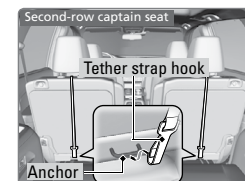
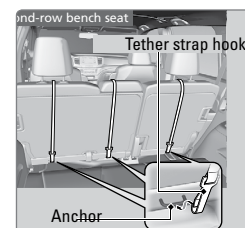

Protecting Larger Children

When a child is too big for a child seat, secure the child in a rear seat using the lap/shoulder seat belt.

Have the child sit upright and all the way back, then ensure the following:

- The child's knees bend comfortably over the edge of the seat.
- The shoulder belt crosses between the child's neck and arm.
- The lap part of the seat belt is as low as possible, touching the child's thighs.
- The child can stay seated for the whole trip.



If a lap/shoulder belt cannot be used properly, position the child in a booster seat in a rear seating position. For the child's safety, check that the child meets the booster seat manufacturer's recommendations.

Some U.S. states and Canadian provinces/territories require children to use a booster seat until they reach a given age or weight (e.g., 6 years or 60 lbs). Be sure to check current laws in the state or province/territory where you intend to drive.

WARNING

Allowing a child age 12 or under to sit in the front can result in injury or death if the passenger's front airbag inflates.

If a larger child must ride in front, move the vehicle seat as far to the rear as possible, then have the child sit up properly and wear the seat belt properly, using a booster seat if needed.

Safety Label Locations

Safety labels are in the locations shown. They warn you of potential hazards that can cause serious injury or death. Read these labels carefully.

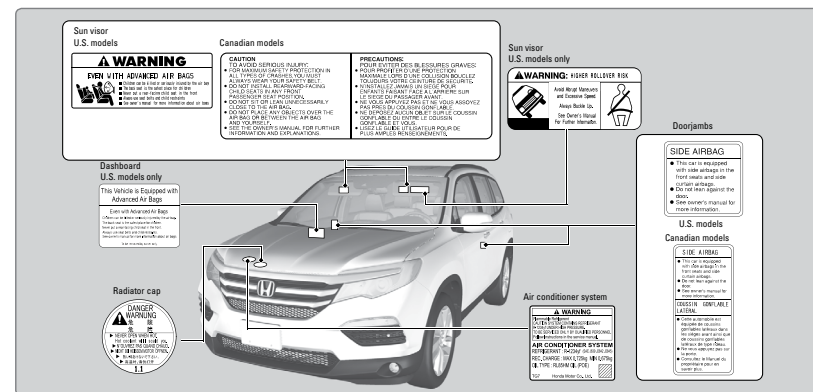

Reporting Safety Defects

In the U.S.

If you believe that your vehicle has a defect which could cause a crash or could cause injury or death, you should immediately inform the National Highway Traffic Safety Administration (NHTSA) in addition to notifying American Honda Motor Co., Inc.

If NHTSA receives similar complaints, it may open an investigation, and if it finds that a safety defect exists in a group of vehicles, it may order a recall and remedy campaign. However, NHTSA cannot become involved in individual problems between you, your dealer, or American Honda Motor Co., Inc.

To contact NHTSA, you may call the Vehicle Safety Hotline toll-free at 1-888-327-4236 (TTY: 1-800-424-9153); go to <http://www.safercar.gov>; or write to: Administrator, NHTSA, 1200 New Jersey Avenue, SE., Washington, DC 20590. You can also obtain other information about motor vehicle safety from <http://www.safercar.gov>.

In Canada

If you believe that your vehicle has a defect which could cause a crash or could cause injury or death, you should immediately inform Honda Canada, Inc., and you may also inform Transport Canada.

If Transport Canada receives similar complaints, it may open an investigation, and if it finds that a safety defect exists in a group of vehicles, it may lead to a recall and remedy campaign. However, Transport Canada cannot become involved in individual problems between you, your dealer, or Honda Canada, Inc.

To contact Transport Canada's Defect Investigations and Recalls Division, you may call 1-800-333-0510. For more information on reporting safety defects or about motor vehicle safety, go to <http://www.tc.gc.ca/roadsafety>.



INSTRUMENT PANEL

Learn about the indicators and displays related to driving the vehicle.



Indicators briefly appear with each engine start and then go out. Red and amber indicators are most critical. Blue and green indicators are used for general information.

Malfunction Indicators

These are the most critical indicators. If they come on and stay lit while driving or at any other time, there may be a problem. See your dealer if necessary.

Brake system

The brake fluid is low, or the brake system has a problem. Press the brake pedal lightly to check pedal pressure. If normal, check the brake fluid level when you stop. If abnormal, take immediate action. If necessary, downshift the transmission to slow the vehicle using engine braking. Have your vehicle repaired immediately.

Low oil pressure

Engine oil pressure is low. Stop in a safe place. Open the hood. Check the oil level, and add oil if necessary (see page 147). If the indicator does not turn off, have your vehicle repaired immediately.

Charging system

The battery is not charging. Turn off all electrical items, but do not turn off the vehicle to prevent further battery discharge. Have your vehicle repaired immediately.

Supplemental Restraint System (SRS)

There is a problem with one of the airbag systems or seat belt tensioners.

Smart Entry system*

There is a problem with the smart entry system.

Lane Keeping Assist System (LKAS)*

There is a problem with the system.

Malfunction indicator lamp (check engine light)

The emissions control system may have a problem. Avoid high speeds. Have your vehicle repaired immediately. If the indicator blinks, a misfire in the engine's cylinders is detected. Stop in a safe place, and wait for the engine to cool down.

Anti-lock Brake System (ABS)

There is a problem with the anti-lock brake system. Your vehicle still has normal braking ability, but no anti-lock function.

Tire Pressure Monitoring System (TPMS)*

There is a problem with the tire pressure monitoring system, or the vehicle is fitted with a spare tire.

Vehicle Stability Assist (VSA®) system

There is a problem with the VSA or hill start assist system.

Brake system

There is a problem with one of the braking systems.

Collision Mitigation Braking System™ (CMBS™)*

There is a problem with the system, the temperature is too high, or the camera or sensor is blocked.

Road Departure Mitigation (RDM)*

There is a problem with the system, the temperature is too high, or the camera is blocked.

Blind spot information (BSI)*

There is a problem with the system, or the radar is blocked.

Electric power steering

There is a problem with the system. Stop the vehicle in a safe place, and restart the engine.

All-Wheel Drive (AWD)*

There is a problem with the system. If the indicator blinks, the differential temperature is too high. Stop in a safe place, and let the engine idle until the indicator goes off.

Auto idle stop*

If the indicator blinks, there is a problem with the system.

Adaptive Cruise Control (ACC)*

There is a problem with the system.



Condition Indicators

These indicators may require you to perform an action.

- U.S. CANADA** **BRAKE** **Parking brake**
Release the parking brake before driving. You will hear a beep if you drive with it not fully released.
- Seat belt reminder**
Make sure seat belts are fastened for you and all passengers. The indicator blinks and beeps sound continuously if you or your front passenger has not fastened your seat belts when you begin driving. If the indicator remains on after seat belts are fastened, see your dealer.
- Low fuel**
Refuel as soon as possible. If the indicator blinks, there is a problem with the fuel gauge. See your dealer.
- Low tire pressure**
Stop in a safe place, check tire pressures, and inflate tire(s) if necessary. The indicator also appears if your vehicle is fitted with a spare tire. Have your regular tire repaired or replaced as soon as possible.
- System message**
When a condition or malfunction indicator comes on, a message also appears on the multi-information display. Check the display for more information.
- Immobilizer**
Your key or remote transmitter cannot be recognized by the vehicle. If the indicator blinks, you may not be able to start the engine. Turn the vehicle off, and then on again. If it continues to blink, there may be a problem with the system. See your dealer.

On/Off Indicators

These indicators remind you when an item is on or off.

- | | |
|----------------------|---------------------------|
| VSA off | Turn signals/hazards on |
| VSA engaged (blinks) | Fog lights* on |
| CMBS* off | High beams on |
| RDM* off | Exterior lights on |
| LKAS* on | Auto High Beam System* on |
| BSI* off | ECON mode on |
| CRUISE MAIN* on | Auto idle stop* on |
| CRUISE CONTROL* on | Auto idle stop* off |
| ACC* on | |

*if equipped

Multi-Information Display (MID)

Consists of several displays that provide you with useful information.

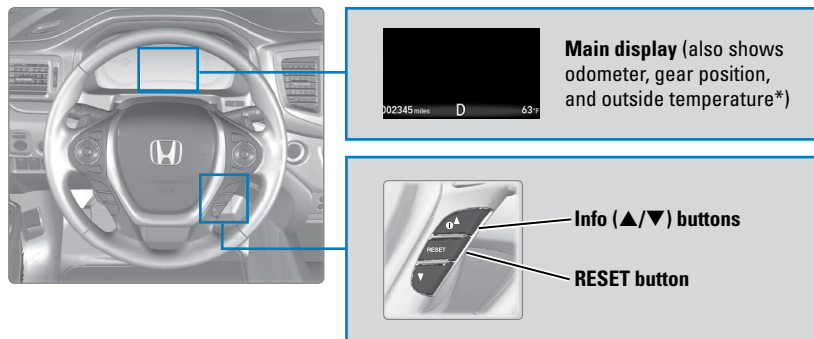

Press the Info (▲/▼) buttons on the steering wheel to change displays. Press the RESET button to enter menu selections when applicable.

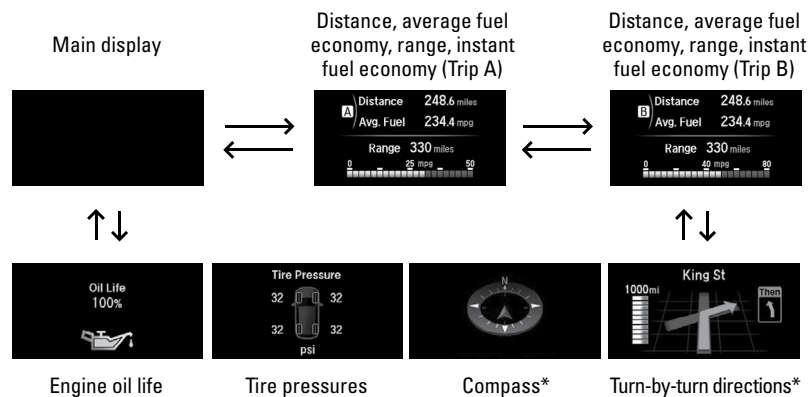

VEHICLE CONTROLS

Learn about the various controls necessary for operating and driving the vehicle.

Using the Remote Transmitter

Lock or unlock the doors and tailgate.

Models without remote engine start

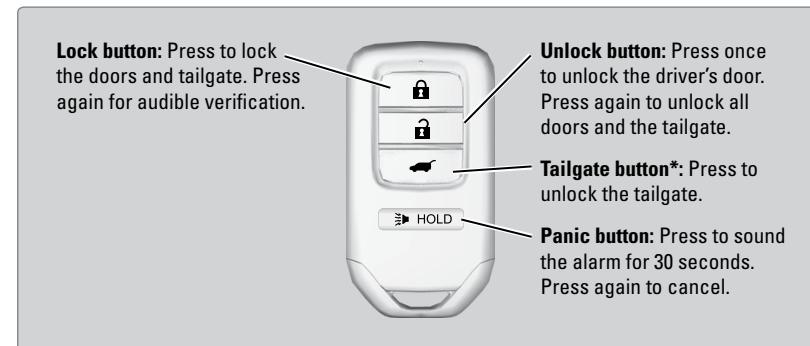

Models with remote engine start

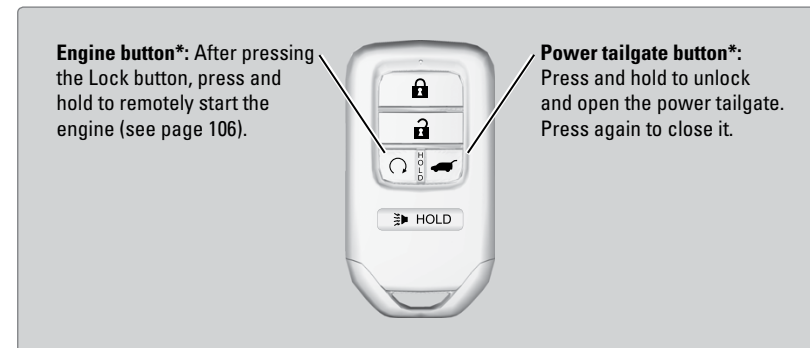

NOTICE

Leaving the key or remote transmitter in the vehicle can result in theft or accidental movement of the vehicle. Always take it with you whenever you leave the vehicle unattended.

Smart Entry System*

When you carry the remote transmitter (for example, in a pocket or purse) and it is outside the vehicle and within range (about 32 inches or 80 cm), you can lock or unlock the doors and tailgate without handling the transmitter.

■ Unlocking/Locking the Doors

To unlock: Grab the driver's door handle when the vehicle is off to unlock the driver's door. Grab the front passenger's door handle to unlock all doors.

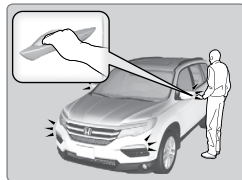

To lock: Press the door lock button on either front door handle or the tailgate when the vehicle is off. If the remote transmitter is inside the vehicle, the doors will not lock.

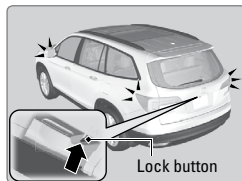
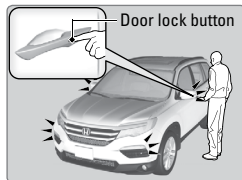

■ Walk Away Auto Lock*

When you walk away from the vehicle while carrying the remote transmitter, the doors and tailgate can automatically lock if the following conditions are met:

- The remote transmitter is within a range of 6 feet (2 m).
- All doors and the tailgate are closed.
- There is not an additional remote transmitter inside the vehicle.

When you are within the range, the system is activated and a beep sounds. When you go outside the range, the lights flash and a beep sounds again. The doors and tailgate automatically lock.

To turn on this feature, follow the steps below:

1. From the HOME screen, select Settings.
2. Select Vehicle.
3. Select Keyless Access Setup.
4. Select Walk Away Auto Lock.
5. Select Enable.
6. Select BACK to exit the menus.

Tailgate Operation

When all the doors are unlocked, the tailgate is unlocked. See page 32 for power tailgate operation.

To open the tailgate, press the tailgate release button under the tailgate handle. Lift open the tailgate.

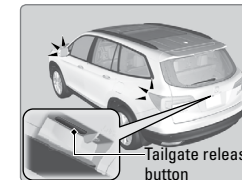

To close the tailgate, grab the inner handle, pull the tailgate down, and push it closed from the outside.

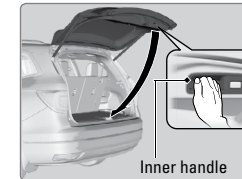

Power Tailgate Operation*

Use these methods to operate the power tailgate.

■ Power Tailgate Button

The vehicle must be in Park (P) with all doors unlocked.

Press and hold the power tailgate button on the door to open the tailgate. Press it again at any time to close it.



■ Tailgate Release Button

Press the tailgate release button. A beep sounds, and the tailgate opens and lifts automatically.

If there is not enough clearance for the power tailgate to fully open, press and hold the tailgate release button. A beep sounds, followed by two beeps. The tailgate unlatches, and you can open it manually.

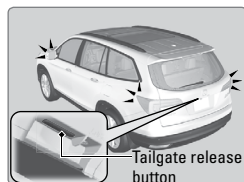

■ Power Tailgate Close Button

Press the power tailgate close button to automatically close the tailgate. Press it again at any time to reverse the tailgate direction.



⚠ WARNING

Closing the power tailgate while anyone is in the path of the tailgate can cause serious injury.

Make sure everyone is clear before closing the tailgate.

NOTICE

Do not push or pull on the power tailgate when it is being automatically opened or closed. Forcibly opening or closing the power tailgate while in operation can deform the tailgate frame.

Door Operation

Use several methods to lock or unlock the doors.

■ Using the Lock Tab

To unlock: When you unlock either front door using the lock tab, the specific door (driver's or passenger's) unlocks.

To lock: When you lock the door using the lock tab on the driver's door, all the other doors and tailgate lock at the same time. When you lock the door using the lock tab on the front passenger's door, only that door locks.

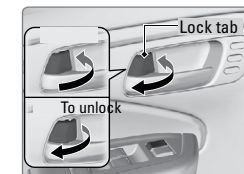

■ Using the Front Door Inner Handle

When you pull either front door inner handle, the door unlocks and opens.

Unlocking and opening the driver's door from the inner handle unlocks all the other doors.



■ Using the Master Door Lock Switch

To unlock: Press the unlock side of the switch to unlock all doors and the tailgate.

To lock: Press the lock side of the switch to lock all doors and the tailgate.

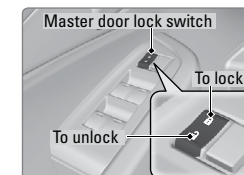

■ Childproof Door Locks

The childproof door locks prevent the rear doors from being opened from the inside regardless of the position of the lock tab.

Slide the lever in the rear door to the lock position, and close the door.

Open the door using the outer door handle.

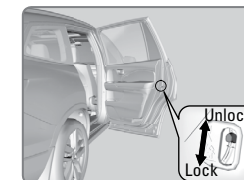

Power Window Operation

The power windows can be opened and closed when the vehicle is on by using the switches on the doors. The switches on the driver's side can be used to open and close all the windows.

Automatic Operation

To open: Push the switch down firmly.

To close: Pull the switch up firmly.

The window opens or closes completely. To stop the window at any time, push or pull the switch again briefly.

Manual Operation

To open: Push the switch down lightly.

To close: Pull the switch up lightly.

Release the switch when the windows reach the desired position.

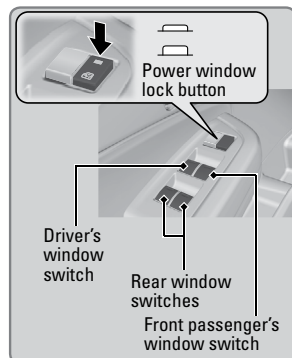

Power Window Lock

Push in the power window lock button so only the driver's window can be operated. An indicator appears in the button when window lock is on.

⚠ WARNING

Closing a power window on someone's hands or fingers can cause serious injury.

Make sure your passengers are away from the windows before closing them.

Power Moonroof Operation*

The moonroof can be opened and closed when the vehicle is on by using the switch on the ceiling.

Automatic Operation

To open: Push the switch back firmly to the second detent, then release.

To close: Push the switch forward firmly to the second detent, then release.

The moonroof opens or closes completely. To stop the moonroof at any time, push the switch briefly.

Manual Operation

To open: Push and hold the switch back lightly to the first detent until the desired position is reached.

To close: Push and hold the switch forward lightly to the first detent until the desired position is reached.

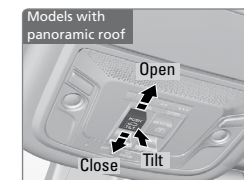
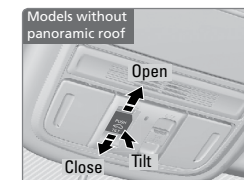

Moonroof Tilt

To tilt: Push the center of the switch.

To close: Push the switch forward firmly, then release.

NOTICE

Opening the moonroof in below freezing temperatures or when it is covered with snow or ice can damage the moonroof panel or motor.

⚠ WARNING

Closing the moonroof on someone's hands or fingers can cause serious injury.

Make sure your passengers are away from the moonroof before closing it.



Panoramic Glass Roof*

The ceiling cover in the second row can be opened and closed to reveal the glass roof when the vehicle is on by using the switch on the ceiling.

Automatic Operation

To open: Push the switch back firmly, then release.

To close: Push the switch forward firmly, then release.

The cover opens completely. To stop the cover in either direction, push the switch briefly.

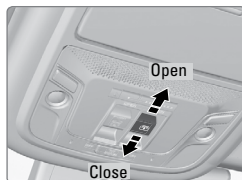

Manual Operation

To open: Push and hold the switch back lightly until the desired position is reached.

To close: Push and hold the switch forward lightly until the desired position is reached.

⚠ WARNING

Closing the roof on someone's hands or fingers can cause serious injury. Make sure your passengers are away from the roof before closing it.

Interior and Exterior Lights

Operate interior and exterior lights when the vehicle is on or off.

Brightness Control

Adjust instrument panel brightness when the vehicle is on.

To brighten: Press the + button.

To dim: Press the - button.

A beep sounds when the brightness reaches minimum or maximum.

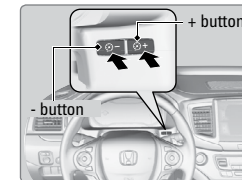

Interior Lights

Change the interior light settings using the switch on the ceiling.

ON position: Interior lights remain on.

Door-activated position: Interior lights come on when any of the doors are opened, the driver's door is unlocked, or the vehicle is turned off.

OFF position: Interior lights remain off.

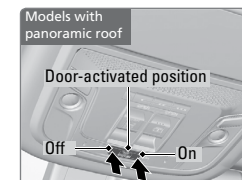
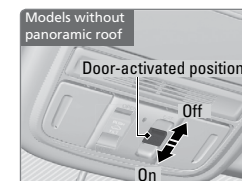

Map Lights

Press the front map lights to turn on or off.

There are also map lights located on the ceiling for the second- and third-row seats. Turn them on or off when the front interior light switch is in the door-activated position.



■ Cargo Area Lights

Located on the rear ceiling in front of the tailgate.

ON position: Cargo lights remain on.

Door-activated position: Cargo lights turn on when the tailgate is opened.

OFF position: Cargo area lights remain off.

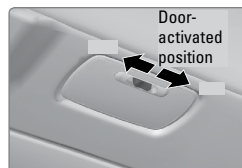

■ Exterior Lights

Rotate the switches on the headlight lever to operate the exterior lights. Push the lever forward to turn on the high beams. Return the lever to its original position for low beams.

OFF: All exterior lights are off.

☞☞: Turn on exterior lights except headlights.

AUTO: Turn on the automatic lighting feature. Headlights turn on or off depending on ambient brightness when the vehicle is on. Headlights automatically come on after the wipers are engaged for a certain time.

☰☉: Turn on all exterior lights including headlights.

☞☉: Turn fog lights* on or off.

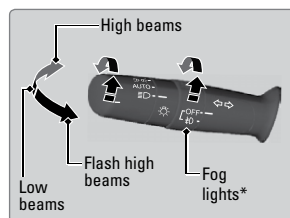

One-Touch Turn Signal

Use this quick and convenient method to signal a lane change.

Lightly push the turn signal lever up or down for a three-blink sequence.

For a continuous signal, push the lever up or down until it locks into place.

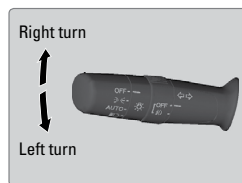

Auto High Beam System*

Automatically changes the low beam headlights to high beam headlights when necessary.

■ How It Works

When you are driving at night above 25 mph (40 km/h) and the headlight lever is in the low beam position with the switch rotated to AUTO, the system changes between low and high beams depending on the brightness of the vehicle lights ahead of you.

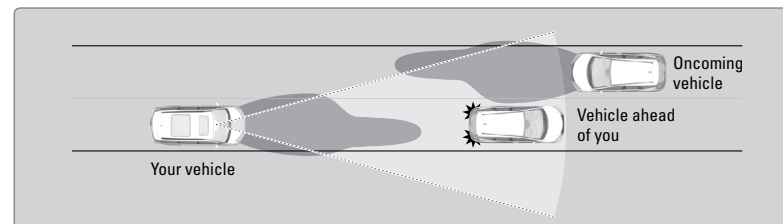

If a vehicle is detected ahead of you, the headlights stay in low beams. If the system does not detect any vehicles ahead of you, the headlights change to high beams.

Certain conditions, such as weather and brightness of other vehicles' lights, can affect system operation.

■ Turning the System On or Off

Make sure the headlight lever is in the low beam position with the switch rotated to the AUTO position. The auto high beam system indicator comes on.

To disable the system: Pull and hold the headlight lever toward you until the indicator flashes twice.

To enable the system: Pull and hold the headlight lever toward you until the indicator flashes once.

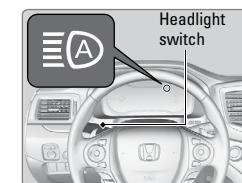

Wiper Operation

The windshield wipers and washers can be used when the vehicle is on.

Front Wipers

Move the wiper lever up or down to the desired position.

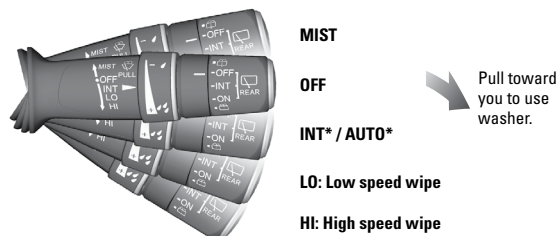

Headlight-Wiper Integration

When the headlights are in the AUTO position, they automatically turn on when the front wipers operate several times within a certain interval. The headlights turn off shortly after the wipers are turned off, or if there is enough ambient light.

Intermittent (INT) Wipers*

When you move the lever to the INT position, the wipers operate based on the delay adjustment. Rotate the adjustment ring to adjust the wiper delay.

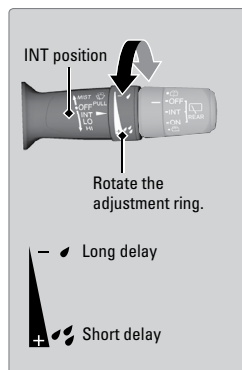

Automatic (AUTO) Rain-Sensing Wipers*

When you move the lever to the AUTO position while driving in rainy weather, the wipers operate based on the amount of detected rainfall.

Put the lever in the AUTO position only when driving in rainy weather.

Rotate the adjustment ring to adjust the rainfall sensor sensitivity.

Return the lever to the OFF position when rain stops.

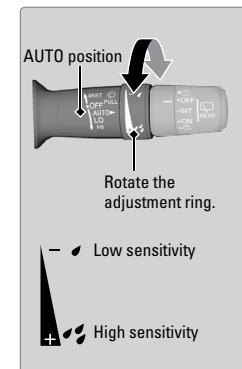

NOTICE

Always ensure the wiper lever is in the OFF position before entering a car wash to prevent severe damage to the windshield wiper system.

Rear Wiper

Rotate the end of the wiper lever to operate the rear wiper.

When you shift to Reverse (R) and the front wipers are activated, the rear wiper activates even if the switch is off.

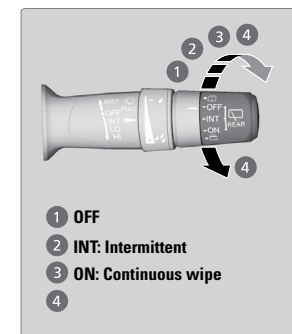

NOTICE

Do not use the wipers when the windshield is dry. The windshield will get scratched, or the rubber blades will get damaged.

In cold weather, the blades may freeze to the windshield, becoming stuck. Operating the wipers in this condition may damage the wipers. Use the defroster to warm the windshield, or manually clear the windshield of ice and snow before turning on the wipers.

Adjusting the Seats

Make seat adjustments before driving to ensure the best comfort and safety.

■ Adjusting the Front Seats

Adjust the driver's seat as far back as possible while allowing you to maintain full control of the vehicle. You should be able to sit upright and well back in the seat, adequately press the pedals without leaning forward, and grip the steering wheel comfortably. The passenger's seat should be adjusted so that it is as far back from the front airbag in the dashboard as possible.

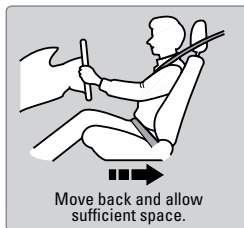

The National Highway Traffic Safety Administration and Transport Canada recommend that drivers allow at least 10 inches (25 cm) between the center of the steering wheel and the chest.

Front power seats*

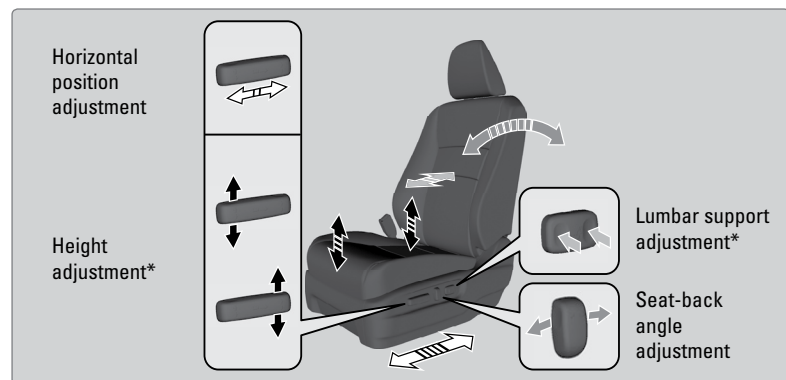

Front manual seats*

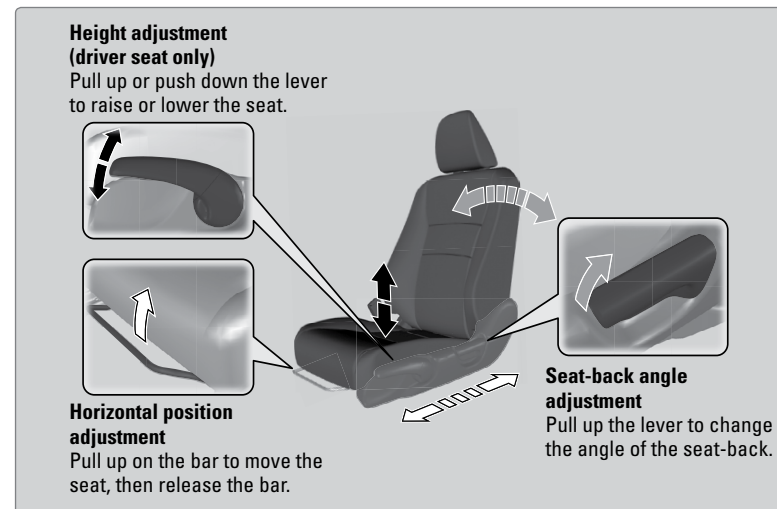

⚠ WARNING
 Reclining the seat-back too far can result in serious injury or death in a crash. Adjust the seat-back to an upright position, and sit well back in the seat.

⚠ WARNING
 Sitting too close to a front airbag can result in serious injury or death if the front airbags inflate. Always sit as far back from the front airbags as possible while maintaining control of the vehicle.

⚠ WARNING
 Sitting improperly or out of position can result in serious injury or death in a crash. Always sit upright, well back in the seat, with your feet on the floor.

TABLE OF CONTENTS
 VISUAL INDEX
 SAFETY INFORMATION
 INSTRUMENT PANEL
 VEHICLE CONTROLS
 AUDIO AND CONNECTIVITY
 BLUETOOTH® HANDSFREELINK®
 HONDALINK®

NAVIGATION
 DRIVING
 HANDLING THE UNEXPECTED
 MAINTENANCE
 SPECIFICATIONS
 CUSTOMER INFORMATION
 VOICE COMMAND INDEX
 INDEX

■ Adjusting the Head Restraints

Your vehicle is equipped with head restraints in all seating positions. Head restraints are most effective for protection against whiplash and other rear-impact crash injuries.

The center of the back of the occupant's head should rest against the center of the restraint. The tops of the occupant's ears should be level with the center height of the restraint.

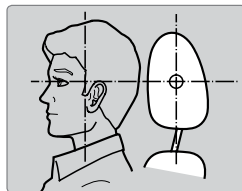

To raise the head restraint: Pull it upward.

To lower the head restraint: Push it down while pressing the release button.

Front and second-row head restraints

To remove the head restraint: Pull the restraint up as far as it will go. Then press the release button(s), and pull the restraint up and out.

To reinstall a head restraint: Insert the legs back in place, then adjust the head restraint to an appropriate height while pressing the release button(s). Pull up on the restraint to make sure it is locked in position.

Folding down the third-row head restraints

To fold down: Pull the strap.

To return to upright position: Pull up the head and push rearward until it latches.

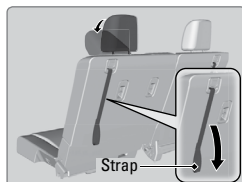
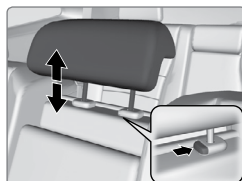
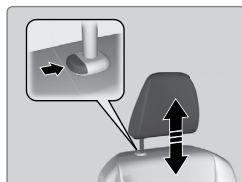

⚠️ WARNING

Improperly positioning head restraints reduces their effectiveness and increases the likelihood of serious injury in a crash.

Make sure head restraints are in place and positioned properly before driving.

⚠️ WARNING

Failure to reinstall, or correctly reinstall, the head restraints can result in severe injury during a crash.

Always replace the head restraints before driving.

For a head restraint system to work properly:

- Do not hang any items on the head restraints, or from the restraint legs.
- Do not place any object between an occupant and the seat-back.
- Install each restraint in its proper location.

■ Floor Mats

Position the front and second-row seat floor mats properly, and anchor them. If they are not properly positioned, the floor mats can interfere with the front seat functions.

Do not put additional floor mats on top of the anchored mats.

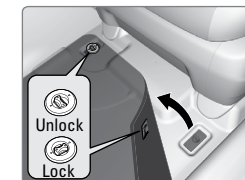

Rear Seats

Adjust second-row seats, access third-row seats, or fold down seats for carrying cargo.

■ Adjusting the Second-Row Passenger's Seats

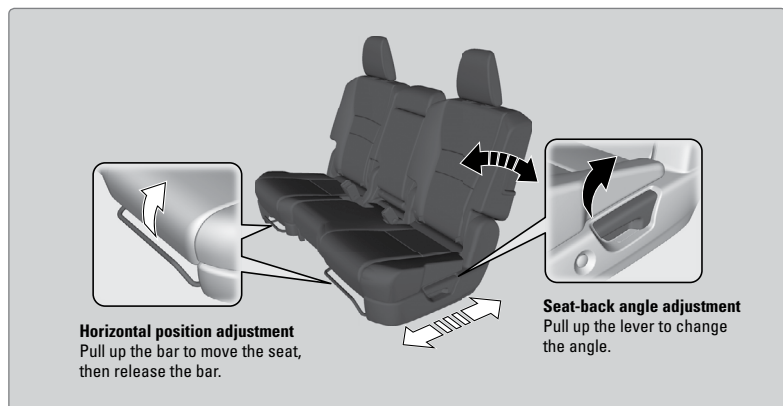

■ Folding Down the Second-Row Seat

Separately fold down the left and right halves of the second-row seat to make room for cargo.

1. Store the center seat belt first. Insert the latch plate into the slot on the side of the anchor buckle.
2. Retract the seat belt into the holder on the ceiling (see page 8).
3. Lower the center head restraint to its lowest position. Put the armrest back into the seat-back.
4. Pull up on the seat-back angle adjustment lever.

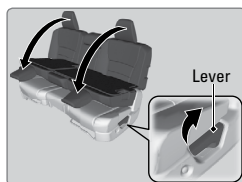

To return the seat to the original position, pull up the seat-back in the upright position.

■ Adjusting the Third-Row Passenger's Seats

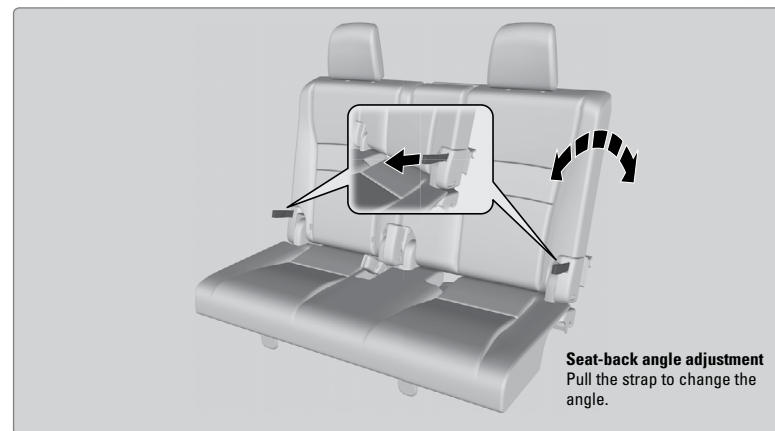

■ Third-Row Seat Access

Using the button*

Press the button on the seat-back or seat cushion when the vehicle is stopped. The whole seat slides forward.

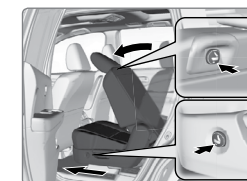

Using the lever or strap*

Pull up on the lever or strap. The whole seat slides forward.

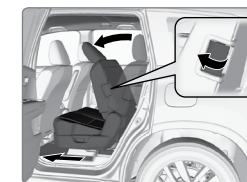

Folding Down the Third-Row Seat

Separately fold down the left and right halves of the third-row seat to make room for cargo.

To fold down the seat

1. Pull the strap on the seat-back. The head restraint tilts downward.
2. Push the seat-back forward while pulling the strap.

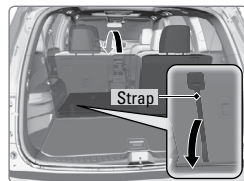

To return the seat to the original position

1. Pull up the seat-back with the strap pulled.
2. Pull the head restraint up to its original position.

Driving Position Memory System*

You can store two driver's seat and door mirror positions into memory when the vehicle is on using the buttons on the driver's door.

1. Adjust the seat and mirrors to your preferred positions.
2. Press SET.
3. Press and hold memory button 1 or 2. You will hear two beeps when the memory is set.
4. Press one of the memory buttons to recall previously stored positions.
Lumbar positions cannot be stored.

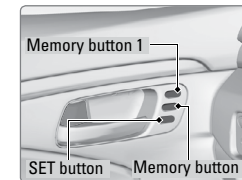

When you unlock and open the driver's door, the driver's seat slides rearward to allow for easy entry. The seat slides forward to the stored position and the other items adjust when the vehicle is turned on.

Adjusting the Steering Wheel

The steering wheel height and distance from your body can be adjusted so that you can comfortably grip the steering wheel in an appropriate driving posture.

1. Push down the steering wheel adjustment lever.
2. Move the steering wheel up or down, and in or out.
3. Pull up the steering wheel adjustment lever to lock the steering wheel in position.

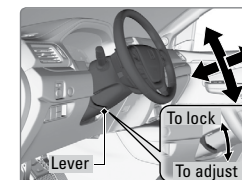

WARNING

Adjusting the steering wheel position while driving may cause you to lose control of the vehicle and be seriously injured in a crash.

Adjust the steering wheel only when the vehicle is stopped.

*if equipped

Adjusting the Mirrors

Adjust the angle of the mirrors for the best visibility when you are sitting in the correct driving position.

Rearview Mirror with Day/Night Positions*

Manually adjust the position to reduce headlight glare from vehicles behind you. Flip the tab to switch between day and night positions.

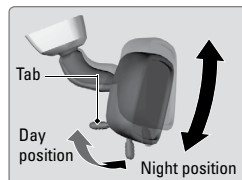

Automatic Dimming Rearview Mirror*

When driving after dark, the automatic dimming function reduces the glare from headlights behind you.

The function cancels when the shift lever is in Reverse (R).

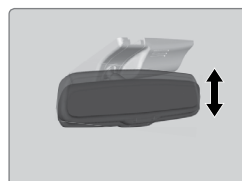

Power Door Mirrors

Adjust the power door mirrors when the vehicle is on.

L/R selector switch: Select the left or right mirror. After adjusting the mirror, return the switch to the center position.

Mirror position adjustment switch: Press the switch left, right, up, or down to move the mirror.

Folding door mirror button*: Press to fold the door mirrors in or out.

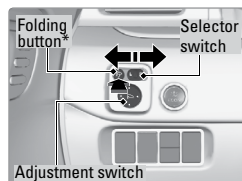

Reverse Tilt Door Mirrors*

Either side door mirror can tilt downward when you shift to Reverse (R) to improve visibility on the selected side of the vehicle when reversing. The mirror returns to its original position when you shift out of Reverse.

When in Reverse, slide the selector switch to the left or right side.

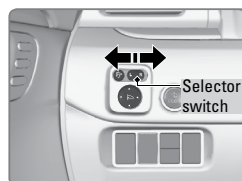

HomeLink® Garage Opener*

Program your vehicle to operate up to three remote-controlled devices around your home—such as garage doors, lighting, or home security systems—using the buttons on the ceiling.

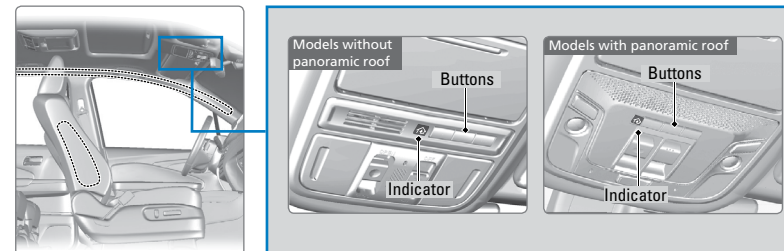

Training a Button

Park near the system you want to program, and follow the instructions in the flowchart below.

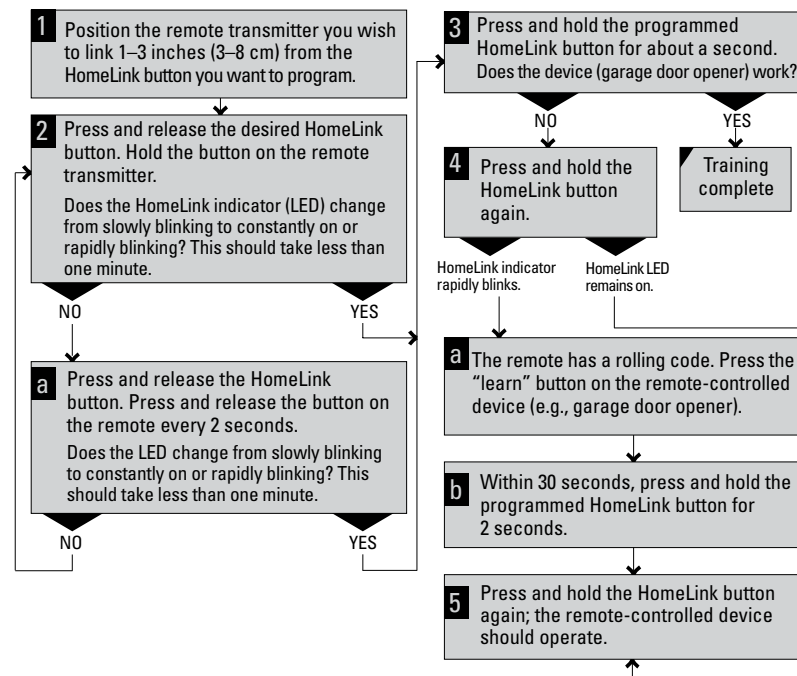

To retrain a button or erase codes, see the Owner's Manual on the Owner Information CD or at owners.honda.com (U.S.) or www.myhonda.ca (Canada). If you need help, visit www.homelink.com or call (800) 355-3515.

TABLE OF CONTENTS
 VISUAL INDEX
 SAFETY INFORMATION
 INSTRUMENT PANEL
 VEHICLE CONTROLS
 AUDIO AND CONNECTIVITY
 BLUETOOTH® HANDSFREE LINK®
 HONDALINK®

NAVIGATION
 DRIVING
 HANDLING THE UNEXPECTED
 MAINTENANCE
 SPECIFICATIONS
 CUSTOMER INFORMATION
 VOICE COMMAND INDEX
 INDEX

Air Conditioning System*

Manually control the front and rear heating and cooling in your vehicle's interior using the buttons on the dashboard.

■ Front Operation

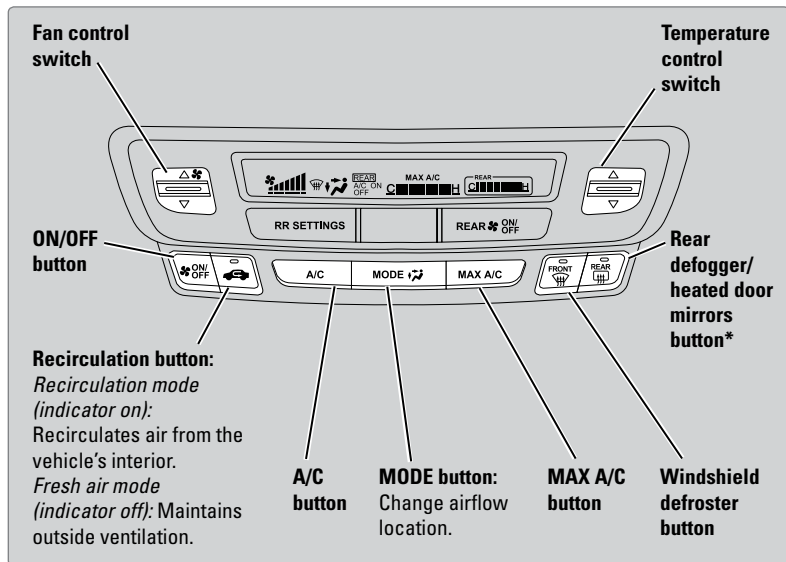

■ Rear Operation

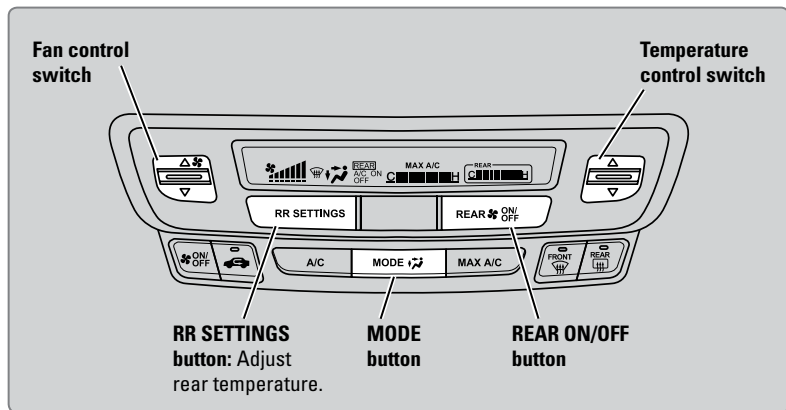

Climate Control System*

The automatic climate control system can maintain your preferred interior temperature by selecting the proper mix of heated or cooled air and fan speed. Use the buttons on the dashboard to control both front and rear operation.

Climate control is turned off during auto idle stop operation* (see page 112).

■ Front Operation

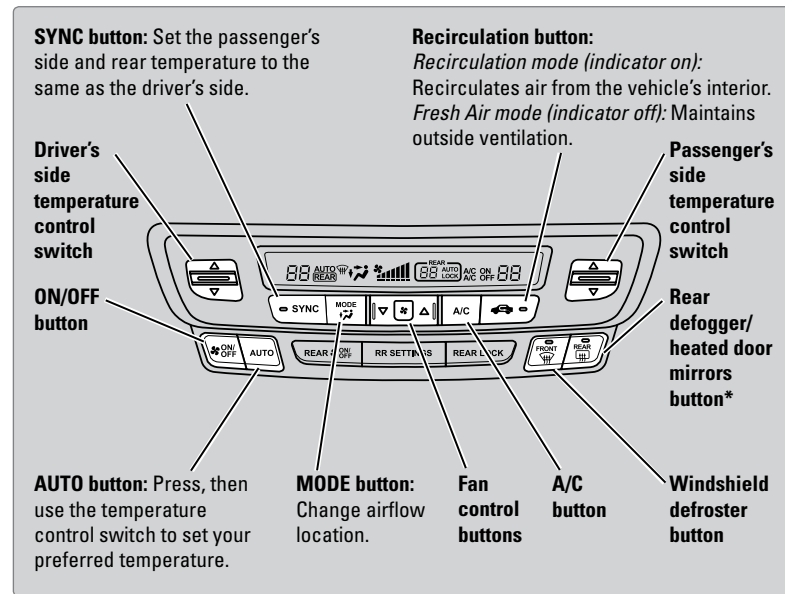

■ Rear Operation

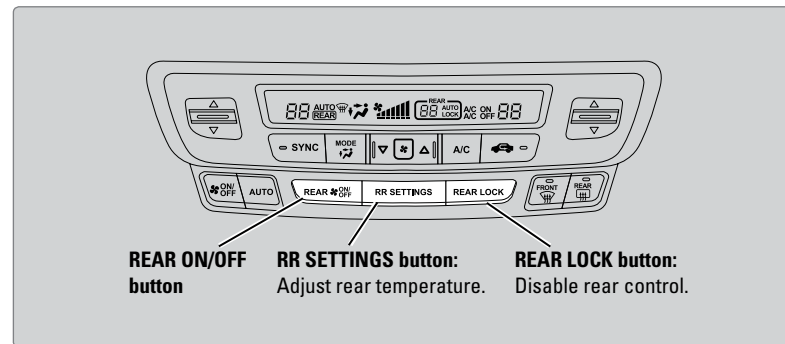

TABLE OF CONTENTS

VISUAL INDEX

SAFETY INFORMATION

INSTRUMENT PANEL

VEHICLE CONTROLS

AUDIO AND CONNECTIVITY

BLUETOOTH® HANDSFREELINK®

HONDALINK®

NAVIGATION

DRIVING

HANDLING THE UNEXPECTED

MAINTENANCE

SPECIFICATIONS

CUSTOMER INFORMATION

VOICE COMMAND INDEX

INDEX

You can also operate the rear climate control using the rear controls located on the back of the center console. Make sure the REAR LOCK button is not on in the front.

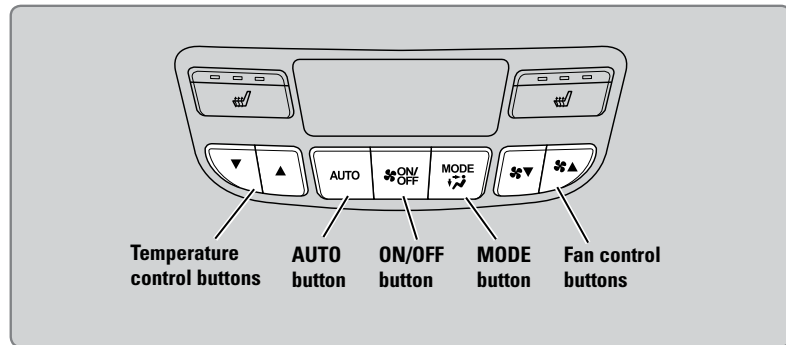

Heated Windshield Button

Canadian models

Press the heated windshield button to deice the windshield when the vehicle is on.

If the outside temperature goes below 4°C, the heated windshield automatically activates for 15 minutes.

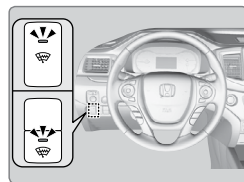

Heated Steering Wheel*

Press the button to heat the steering wheel when the vehicle is on. Press the button again to turn off heating.



Seat Heaters*

Quickly warm the front seats when the vehicle is on. The appropriate indicator appears for each setting.

Front Seat Heaters*

Press the seat heater button to cycle through high, low, and off.

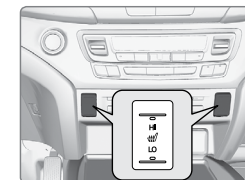

Front Seat Heaters and Ventilation*

Press the seat heater or seat ventilation button to cycle through settings. The appropriate indicator (red for heat, blue for ventilation) appears for each setting.

Once - HI setting (three indicators)

Twice - MID setting (two indicators)

Three times - LO setting (one indicator)

Four times - OFF (no indicators)



Second-Row Outer Seat Heaters*

Press the rear seat heater button to cycle through settings. The appropriate indicator appears for each setting.

Once - HI setting (three indicators)

Twice - MID setting (two indicators)

Three times - LO setting (one indicator)

Four times - OFF (no indicators)



⚠ WARNING

Heat-induced burns are possible when using seat heaters. Persons with a diminished ability to sense temperature (e.g., persons with diabetes, lower-limb nerve damage, or paralysis) or with sensitive skin should not use the seat heaters.

TABLE OF CONTENTS
VISUAL INDEX
SAFETY INFORMATION
INSTRUMENT PANEL
VEHICLE CONTROLS
AUDIO AND CONNECTIVITY
BLUETOOTH® HANDSFREELINK®
HONDALINK®

NAVIGATION
DRIVING
HANDLING THE UNEXPECTED
MAINTENANCE
SPECIFICATIONS
CUSTOMER INFORMATION
VOICE COMMAND INDEX
INDEX

Customized Features

Use the Settings menu to customize certain features when the vehicle is stopped.

■ Using the Color Audio System*

Use the selector knob to make and enter selections.

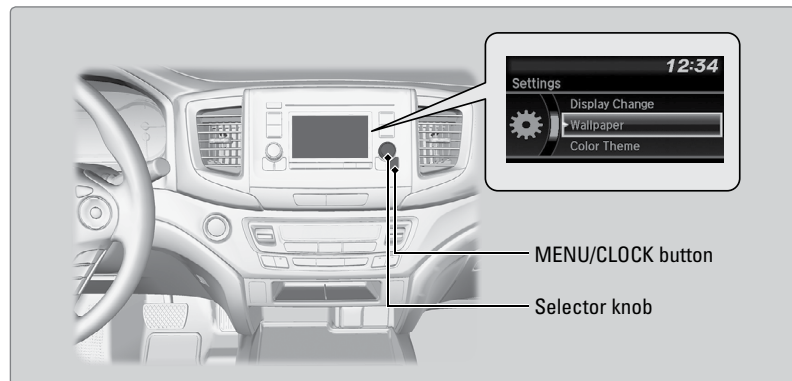

1. Press and hold the MENU/CLOCK button.
2. Select Settings.
3. Select a setting option, and make your preferred changes.
4. Press the Back button to exit the menus.

■ Using the Touchscreen*

Select items on the touchscreen to make selections.



1. From the HOME screen, select Settings.
2. Select a setting option, and make your preferred changes.
3. Press BACK to exit the menus.

Setting the Clock

Adjust the time using the steps described for your system type.

■ Using the Color Audio System*

Use the selector knob to make and enter selections.

1. Press and hold the MENU/CLOCK button.
2. Select Adjust Clock.
3. Select the hour and adjust as necessary.
4. Select the minutes and adjust as necessary.
5. Select Set when complete.
6. Press the Back button to exit the menu.



■ Using the Touchscreen*

Select items on the touchscreen to make selections.

1. From the HOME screen, select Settings.
2. Select Clock/Info.
3. Select Clock Adjustment.
4. Adjust the hour and minute values.
5. Select OK when complete.



On vehicles with navigation, the time is automatically set using GPS signals.

AUDIO AND CONNECTIVITY

Learn how to operate the vehicle's audio system.

Basic Audio Operation

Connect audio devices and operate buttons and displays for the audio system.

■ USB Port

Connect a USB flash drive or other audio device, such as an iPod® or iPhone®. Install the flash drive or cable connector to the USB port.

Models with color audio system

The USB port is located inside the center console and is for playing audio and/or charging devices.

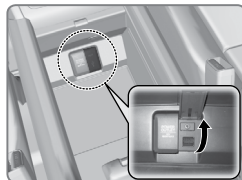

Models with touchscreen

There are two USB ports in the front console: the left port is for playing audio; the right port is for playing audio and/or charging devices.

An additional port* is located inside the center console. It can be used for playing audio and/or charging devices.

There are additional ports* on the back of the center console that can be used for charging only.

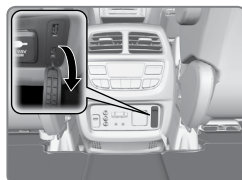
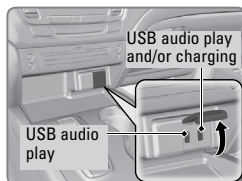

■ Auxiliary Input Jack

Connect standard audio devices with a 1/8-inch (3.5 mm) stereo miniplug.

1. Open the AUX cover.
2. Insert the miniplug attached to the audio device into the jack. The audio system switches to AUX mode. Use the device to control the audio.

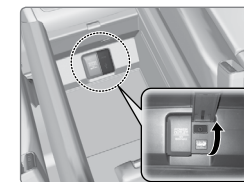

■ Accessory Power Socket

Open the socket cover to use power when the vehicle is on.

Power sockets are located in the front console, inside the center console, and the rear cargo area*.

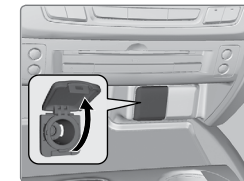

NOTICE

Do not insert an automotive type cigarette lighter element. This can overheat the power socket.

■ AC Power Outlet*

The outlet can supply power for appliances up to 115 volts that are rated 150 watts or less when the engine is running.

1. Open the socket cover on the back of the center console.
2. Slightly plug in the socket, turn it 90 degrees clockwise, then push it in all the way.

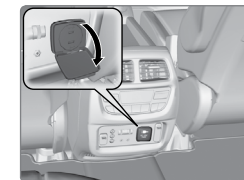

NOTICE

Do not use the AC power outlet for electric appliances that require high initial peak wattage, such as cathode-ray tube type televisions, refrigerators, electric pumps, etc. It is not suitable for devices that process precise data, such as medical equipment, and that require an extremely stable power supply, such as microcomputer-controlled electric blankets, touch sensor lamps, etc.

iPod and iPhone are trademarks of Apple, Inc.
State or local laws may prohibit the operation
of handheld electronic devices while operating a vehicle.

*if equipped



*if equipped

Steering Wheel Controls

You can operate certain functions of the audio system using the steering wheel controls.

SOURCE button: Cycle through available audio modes.

◀/▶ buttons: Change presets, tracks, albums, or folders.

+/- buttons: Adjust audio volume.

Menu button*: From the audio screen, press to choose options for the current audio mode. Use the +/- buttons and the SOURCE button to scroll and enter selections.



FM/AM/SiriusXM® Radio*

Press **◀** or **▶** for the next or previous station.

Press and hold **◀** or **▶** for the next or previous strong station.

CD/iPod®/USB/Bluetooth® Audio

Press **◀** or **▶** for the next or previous track.

Press and hold **◀** or **▶** for the next or previous folder (CD/USB).

Pandora® (U.S. only)

Press **▶** for the next song.

Press and hold **◀** or **▶** for the next or previous station.

Adjusting the Sound

Adjust various sound settings.

Models with color audio system

Use the selector knob to make and enter selections.

1. Press the Sound button.
2. Select a sound mode to change, and adjust it using the selector knob.
3. Press the Back button to exit the menu.

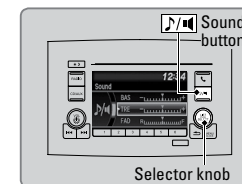

Models with touchscreen

Make selections using the touchscreen.

1. From the HOME screen, select Settings.
2. Select Audio.
3. Select Sound.
4. Select the tabs to change the sound mode and adjust the setting.
5. Select OK when complete.



Models with color audio system

Color Audio System

Use the buttons to control the display and audio system.

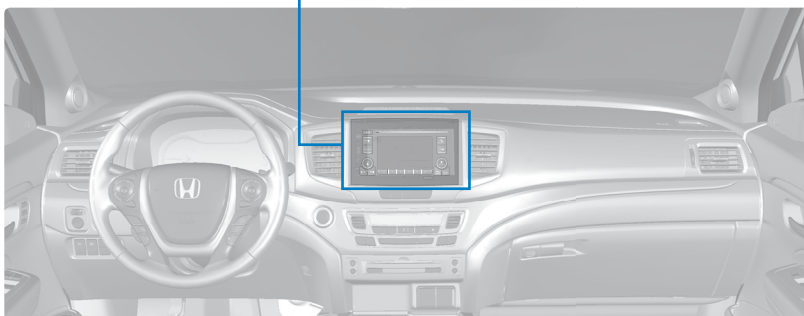
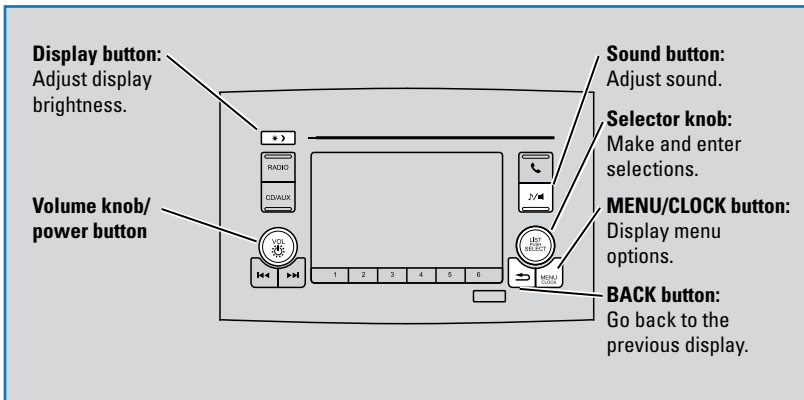

Models with color audio system

FM/AM Radio

Play FM or AM radio stations.

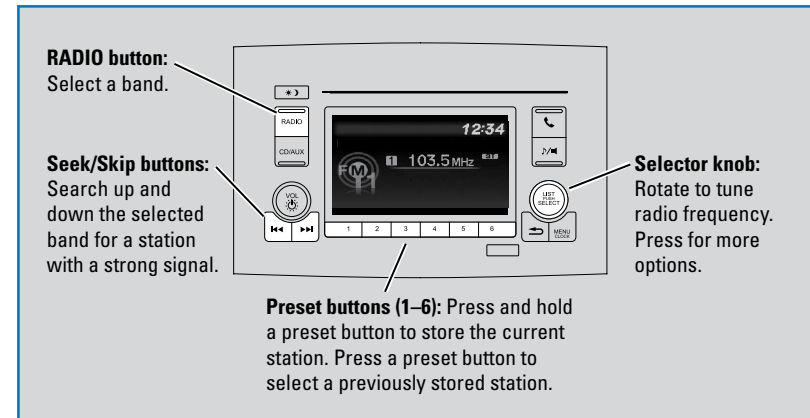

Models with color audio system

iPod®

Play and operate an iPod through the vehicle's audio system. Connect your device (see page 58).

CD/AUX button: Play a connected iPod.

Seek/Skip buttons: Press to change tracks. Press and hold to move rapidly within a track.

Selector knob: Rotate to change tracks. Press to enter the music search list.

Play mode buttons (3, 5, 6): Select a play mode, such as shuffle, repeat, etc. Corresponding icons appear above each button.



■ Searching for Music

Use the selector knob to search for tracks stored on the iPod.

1. From the audio screen, press the selector knob.
2. Select a search option.
3. Select the track you want to play.

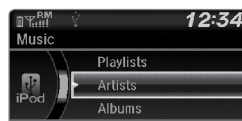

iPod is a trademark of Apple, Inc.

Models with color audio system

USB Flash Drive

Play and operate a USB flash drive through the vehicle's audio system. Connect your device (see page 58).

CD/AUX button: Play a connected USB flash drive.

Seek/Skip buttons: Press to change tracks. Press and hold to move rapidly within a track.

Selector knob: Rotate to change tracks. Press to display the folder list.

Play mode buttons (1-6): Select a play mode, such as random, repeat, etc. Corresponding icons appear above each button.



■ Searching for Music

Use the selector knob to search for tracks stored on the flash drive.

1. From the audio screen, press the selector knob.
2. Select a folder.
3. Select the track you want to play.



Models with color audio system

Bluetooth® Audio

Play streaming or stored audio from your compatible phone through the vehicle's audio system. Visit handsfreelink.com (U.S.) or handsfreelink.ca (Canada) to check phone compatibility. Standard data rates apply with your phone service provider. Connect your phone to **Bluetooth® HandsFreeLink®** (see page 82).

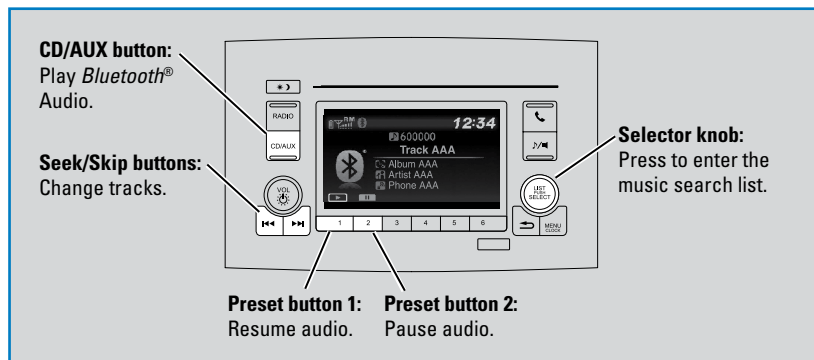

■ **Searching for Music**

Use the selector knob to search for tracks stored on the device.

1. From the audio screen, press the selector knob.
2. Select a category.
3. Select the track you want to play.

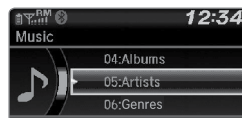

Notes:

- Make sure the volume on your phone is properly adjusted.
- You may need to enable additional settings on your phone for playback.
- The resume/pause function and remote audio controls are not supported on all phones.

State, provincial, or local laws may prohibit the operation of handheld electronic devices while operating a vehicle. Only launch streaming audio on your phone when it is safe to do so.

Models with touchscreen

Touchscreen Operation

Use simple gestures—including touching, swiping, and scrolling—to operate certain audio functions.

Some items may be grayed out during driving to reduce the potential for distraction. You can select them when the vehicle is stopped or use voice commands*.

Wearing gloves may limit or prevent touchscreen response.

You can use the microfiber cleaning cloth included in the glovebox kit to remove dust or fingerprints from the touchscreen.

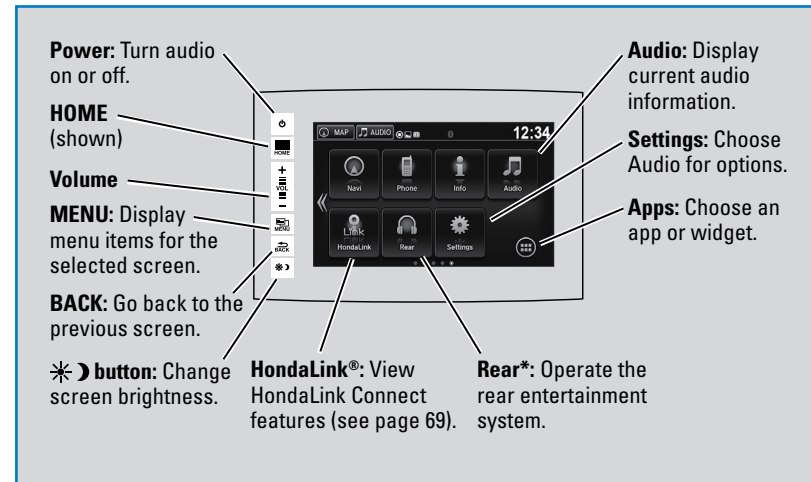

■ Changing Icon Order

You can change the order of the icons on the Home screen.

1. From the Home screen, select and hold an icon to enter the customization screen.
2. Select and hold the icon you want to move and slide it to a different position.
3. Select OK when complete.



■ Adding Apps or Widgets to the Home Screen

You can add apps or widgets to the Home screen for easy selection.

1. From the Home screen, select and hold an empty space.
2. Select Add App or Add Widget. The Apps screen appears.
3. Select and hold the app or widget you want to add to the Home screen. The customization screen appears.
4. Select and hold the app or widget and move it to where you want.
5. Select OK when complete.



Models with touchscreen

HondaLink®

Provides you with useful information about your vehicle directly from Honda.

To check phone compatibility, visit handsfreelink.com (U.S.) or handsfreelink.ca (Canada). Standard data rates may apply with your phone service provider.

To get more information on HondaLink features and to download the app, visit www.hondalink.com (U.S.) or honda.ca/hondalink (Canada).

■ HondaLink Connection

Follow the steps below to connect to HondaLink and use its features.

1. Download the HondaLink Connect app to your compatible smartphone.
2. Pair your phone to *Bluetooth®* HandsFreeLink® (see page 86).
3. From the HOME screen, select HondaLink.
4. Certain features require you to send vehicle information to Honda. Select Enable Once, Always Enable, or Cancel.

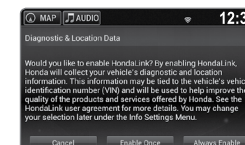

■ HondaLink Menu

Select a menu option.

Places*: Display restaurants, gas stations, and other locations. You can send a location to the navigation system and set a route.

Vehicle: Get instructional messages when your vehicle needs service.

Messages from Honda: Display helpful and important information from Honda.

Help & Support: Display tips for vehicle usage, get roadside assistance, or contact customer service.

Weather: Display a weekly five-day weather forecast for any location.

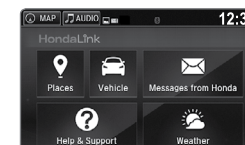

Models with touchscreen

Wi-Fi Connection

You can connect the audio system to the internet using Wi-Fi and use online services through the touchscreen. If your compatible phone has hotspot capabilities, the system can be tethered to the phone. Follow the steps below to set up Wi-Fi when the vehicle is stopped. Standard data rates apply with your phone service provider.

1. From the Home screen, select Settings.
2. Select Bluetooth/Wi-Fi. Select the Wi-Fi tab.
3. Select Wi-Fi On/Off Status, and select On.
4. Select Wi-Fi Network List. Make sure your phone's Wi-Fi setting is in access point (tethering) mode.
5. Select the phone you want to connect to the system. If the phone you want to connect does not appear, select Scan.
6. Select Connect.
7. Enter a password for your phone. Select Done. The Wi-Fi symbol is displayed on the list when connection is successful.



Aha™ Radio

Access music and information programming, location-based services, and social media through your vehicle's audio system.

Visit handsfreelink.honda.com (U.S.) or handsfreelink.ca (Canada) to check phone compatibility. Standard data rates apply. Make sure you have an active Aha account.

Bluetooth connection

Connect your compatible smartphone via *Bluetooth*® HandsFreeLink® (see page 86). Make sure the HondaLink Connect app is downloaded to your phone (see page 69). Follow steps 1 and 2 below.

Wi-Fi connection

You can also connect via Wi-Fi (see page 70) or Wi-Fi tethering with your enabled smartphone. Follow steps 1 and 2 below.

1. From the HOME screen, swipe to the second screen (if necessary). Select Aha.
2. Enter your Aha account email and password to begin using Aha.

Models with touchscreen

FM/AM Radio

Play FM or AM radio stations.

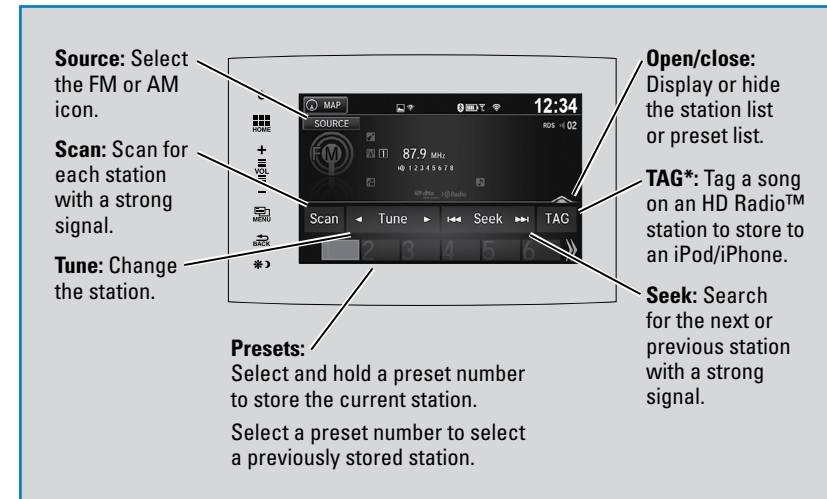

Models with touchscreen

SiriusXM® Radio*

Available on a subscription basis only. For more information or to subscribe, contact your dealer, or visit www.siriusxm.com (U.S.) or www.sirius.ca (Canada).



Source: Select the XM icon.

Scan: Scan for each station with a strong signal.

Category: Change the category.

Presets: Select and hold a preset number to store the current station. Select a preset number to select a previously stored station.

Channel: Change the channel. Press and hold to skip 10 channels at a time.

Skip: Change the selection. Press and hold to skip rapidly.

Open/close: Display or hide the channel list or preset list.

TAG*: Tag a song to store to an iPod/iPhone.



To learn about additional features—such as multi-channel preset, replay, or SportsFlash—see your Owner’s Manual on the Owner Information CD or visit owners.honda.com (U.S.) or myhonda.ca (Canada).

Models with rear entertainment system

Compact Disc (CD)*

The rear entertainment system supports audio CDs, CD-Rs, and CD-RWs in MP3, WMA, or AAC formats. Insert a CD to begin automatic playback.



Source: Select the CD icon.

Folder: Change the folder.

MENU: Display menu options, including Music Search.

Open/close: Display or hide the track list.

Track: Change the track.

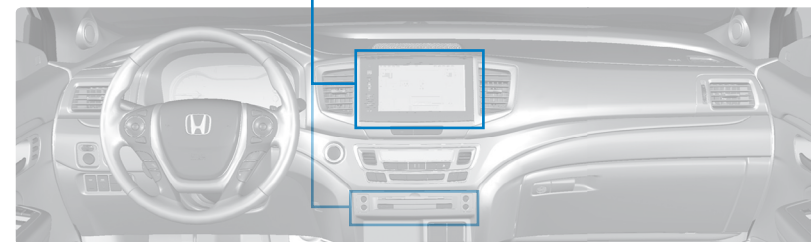
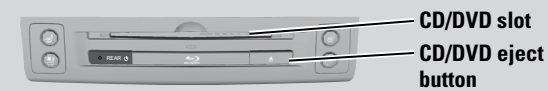

■ Searching for Music

Use the touchscreen to search for tracks stored on the CD.

1. From the audio screen, press MENU.
2. Select Music Search.
3. Select a folder.
4. Select the track you want to play.

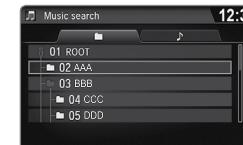

NOTICE

Do not use discs with adhesive labels or insert a damaged disc. Inserting these types of discs may cause them to get stuck or damage the audio unit.

*if equipped

Available in the U.S. and Canada, except Hawaii, Alaska, and Puerto Rico.
XM® is a registered trademark of Sirius XM Radio, Inc.
*if equipped



Models with touchscreen

iPod®

Play and operate an iPod through the vehicle's audio system. Connect your device to the USB port (see page 58).

Source: Select the iPod icon.

MENU: Display menu options, including Music Search.

Play/pause

Open/close: Display or hide the track list.

Song: Change the track. Press and hold to move rapidly within a track.



■ Searching for Music

Use the touchscreen to search for tracks stored on the iPod.

1. From the audio screen, press MENU.
2. Select Music Search.
3. Select a search option.
4. Select the track you want to play.

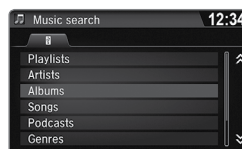

On vehicles with navigation, you can also search for and play iPod music using Song By Voice™ (see page 165).

Models with touchscreen

USB Flash Drive

Play and operate a USB flash drive through the vehicle's audio system. Connect your device to the USB port (see page 58).

Source: Select the USB icon.

MENU: Display menu options, including Music Search.

Folder: Change the folder.

Open/close: Display or hide the track list.

Track: Change the track.



■ Searching for Music

Use the touchscreen to search for tracks stored on the USB flash drive.

1. From the audio screen, press MENU.
2. Select Music Search.
3. Select a folder.
4. Select the track you want to play.

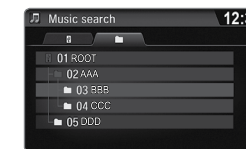

Models with touchscreen

Bluetooth® Audio

Play streaming or stored audio from your compatible phone through the vehicle's audio system. Visit handsfreelink.com (U.S.) or handsfreelink.ca (Canada) to check phone compatibility. Standard data rates apply with your phone service provider. Connect your phone to **Bluetooth® HandsFreeLink®** (see page 86).

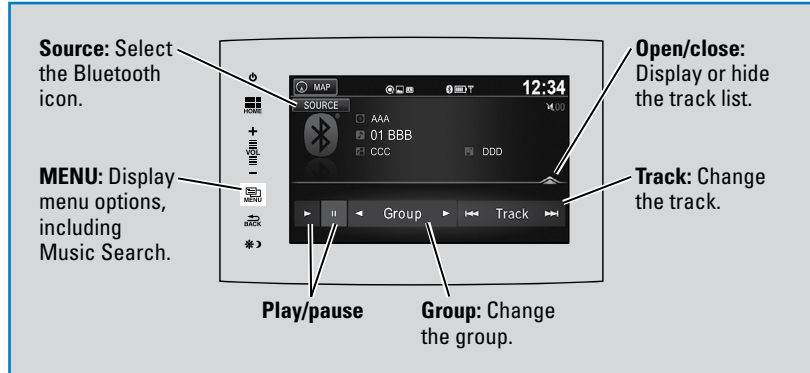

Searching for Music

Use the touchscreen to search for tracks stored on the device.

1. From the audio screen, press MENU.
2. Select Music Search.
3. Select a search category.
4. Select the track you want to play.

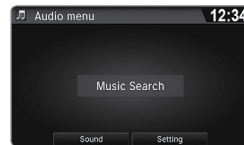

Notes:

- Make sure the volume on your phone is properly adjusted.
- You may need to enable additional settings on your phone for playback.
- The resume/pause function and remote audio controls are not supported on all phones.

State, provincial, or local laws may prohibit the operation of handheld electronic devices while operating a vehicle. Only launch streaming audio on your phone when it is safe to do so.

Models with touchscreen

Pandora®

Play and operate Pandora from your compatible phone through the vehicle's audio system. Visit handsfreelink.com to check phone compatibility. Standard data rates apply with your phone service provider. **Available in the U.S. only.**

Connect your phone when the vehicle is stopped.

For iPhone:

- Connect via **Bluetooth® HandsFreeLink®** (see page 86) or USB port (see page 58).
- A pop-up may appear on your phone requesting you to allow access for Pandora to be launched.
- If you cannot operate Pandora through the audio system, it may be streaming through **Bluetooth® Audio**. Make sure Pandora is selected on the audio system.
- If Pandora still does not operate, try rebooting the phone and reconnecting the cable if necessary.

For other compatible smartphones:

- Connect via **Bluetooth® HandsFreeLink®** (see page 86).

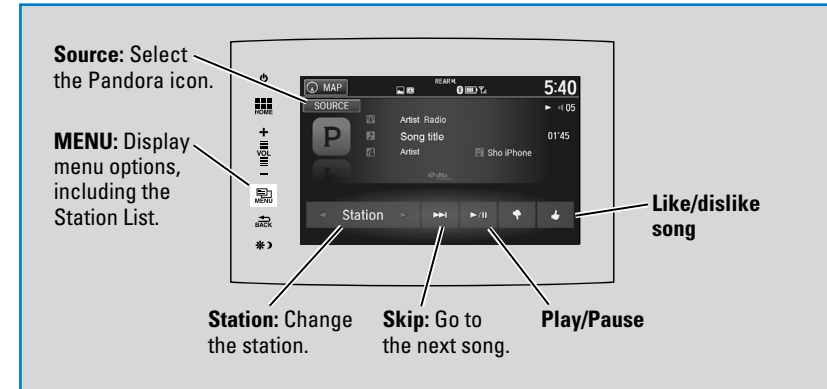

State, provincial, or local laws may prohibit the operation of handheld electronic devices while operating a vehicle. Only launch streaming audio on your phone when it is safe to do so.

Rear Entertainment System (RES)*

Rear passengers can enjoy a different audio or entertainment source than front passengers.

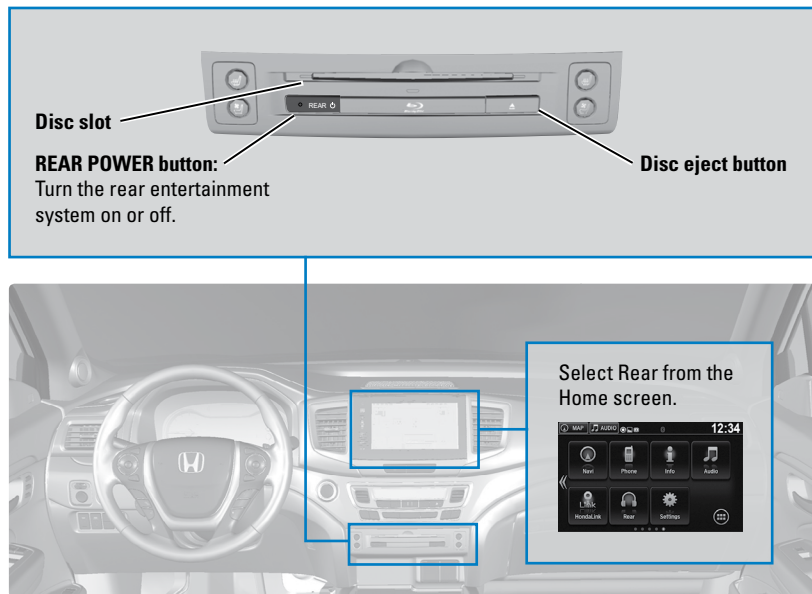

■ Operating the System from the Front

You can operate the rear entertainment system using the front audio controls.

1. Press the REAR POWER button to turn the system on.
2. From the Home screen, select Rear.
3. Choose a media source for the rear system.
4. To return to the front audio source, return to the Home screen and select Audio.

■ Playing a Disc

Insert a DVD or Blu-ray into the disc slot to begin automatic playback. Use the front or rear controls to operate the disc.

The system also supports audio CDs, CD-Rs, and CD-RWs in MP3, WMA, or AAC formats. Insert a CD to begin automatic playback (see page 73).

NOTICE

Do not use discs with adhesive labels or insert a damaged disc. Inserting these types of discs may cause them to get stuck or damage the audio unit.

■ Overhead Screen

Open the overhead screen to use the system.

Pull down the bottom edge of the screen, and extend it until it locks into place.

Fold the screen back into the ceiling when not in use.

Press the release button to detach the remote control, if desired.

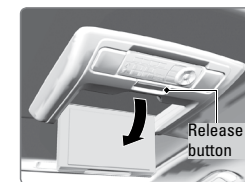

■ Wireless Headphones

Your vehicle comes with two sets of wireless headphones.

Press the power button on the right earpiece to turn on the headphones.

Turn the dial on the right earpiece to adjust the volume.

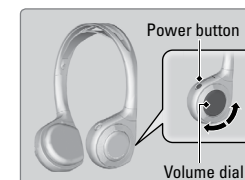

■ Auxiliary Console Panel

Multiple connection inputs are located on the back of the center console.

HDMI input jack*

The system accepts HDMI input from video game systems and other devices. Open the outlet cover and insert the cable.

Auxiliary input jacks

The system accepts auxiliary inputs from standard video game systems and other devices.

Headphone jacks

There are two headphone connectors for the rear entertainment system. Each connector has its own volume control.

AC power outlet

The outlet can supply power for appliances up to 115 volts that are rated 150 watts or less (see page 59).

USB ports*

There are two USB ports that can be used to charge a device.



■ Remote Control and Rear Operation

You can operate the system using the rear control panel.

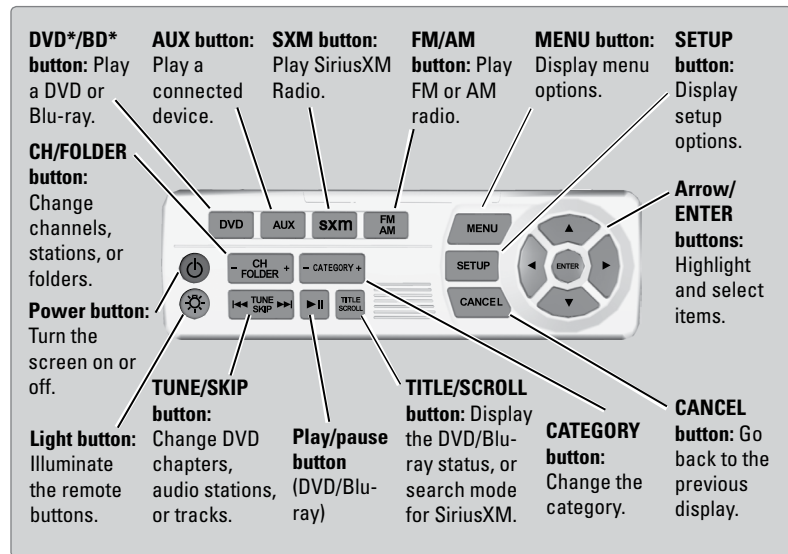

1. Make sure the REAR POWER button is turned on in the front.
2. From the rear control panel, press the desired source button (DVD, AUX, etc.).
3. Press the arrow/ENTER buttons to highlight options on the screen and select them. Use the other rear control panel buttons to operate the system.

BLUETOOTH® HANDSFREELINK® (HFL)

Learn how to operate the vehicle's hands-free calling system.

Models with color audio system

Basic HFL Operation

Make and receive phone calls using the vehicle's audio system, without handling your phone. Visit handsfreelink.com (U.S.) or handsfreelink.ca (Canada) to check phone compatibility.

To reduce the potential for driver distraction, certain manual functions may be inoperable or grayed out while the vehicle is moving. Stop or pull over to perform the function.

■ HFL Controls

Use the controls to enter information and make selections.

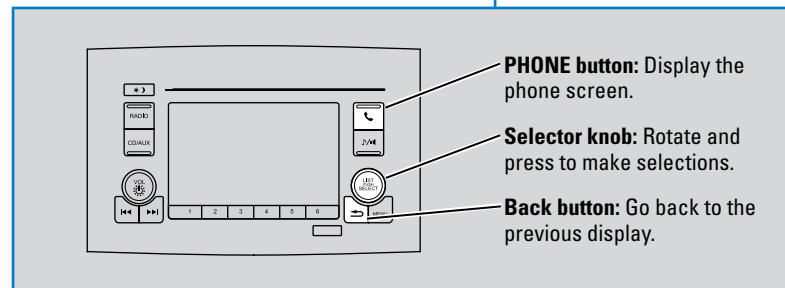
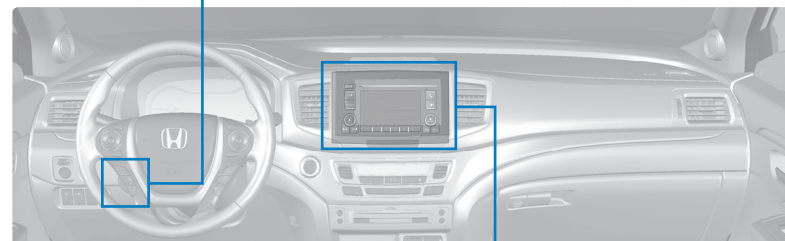
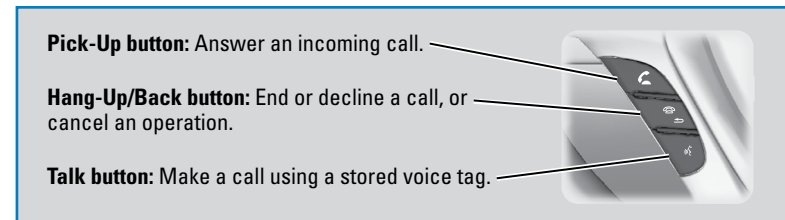

Models with color audio system

Pairing a Phone

To use hands-free phone and streaming audio functions, you must first pair your phone to the system. This can only be done when the vehicle is stopped. Use the selector knob to make and enter selections.

■ Pairing the First Phone

1. Press the Phone button to go to the Phone screen. A prompt appears. Select Yes.
2. Make sure your phone is in discovery mode. Select OK.
3. The system searches for your phone. Select your phone when it appears on the list.
If your phone does not appear: Select Phone Not Found and search for HandsFreeLink from your phone. Connect to HFL.
4. The system gives you a pairing code. Compare it to the code that appears on your phone. Connect to HFL from your phone.

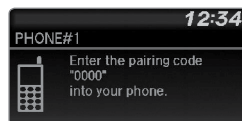

■ Pairing an Additional Phone

1. Press the Phone button to go to the Phone screen. If a prompt appears asking to connect to a phone, select No.
2. Select Phone Setup.
3. Select Bluetooth Setup.
4. Select Add New Device.
5. Make sure your phone is in discovery mode. Select OK.
6. The system searches for your phone. Select it when it appears on the list.
If your phone does not appear: Select Phone Not Found, and search for HandsFreeLink from your phone. Connect to HFL.
7. The system gives you a pairing code. Enter it on your phone when prompted.

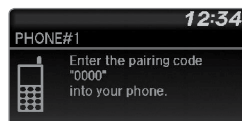

State, provincial, or local laws may prohibit the operation of handheld electronic devices while operating a vehicle.



Models with color audio system

Making a Call

You can make a call using several methods.

■ Dialing a Number

Enter a 10-digit phone number to call. Use the selector knob to make and enter selections. This method is inoperable while the vehicle is moving.

1. Press the Phone button.
2. Select Dial.
3. Enter the phone number. Select the green phone icon to call.



■ Using the Phonebook

When your phone is paired, its phonebook is automatically imported to the system. Use the selector knob to make and enter selections. This method is inoperable while the vehicle is moving.

1. Press the Phone button.
2. Select Phonebook.
3. Scroll through the list to find the name and number you want to call, and select it to call.



■ Storing Speed Dial Entries

Store up to 20 numbers for quick dialing. Use the selector knob to make and enter selections.

1. Press the Phone button.
2. Select Phone Setup.
3. Select Speed Dial, then select Add New.
4. Select an entry method.
5. If desired, you can create a voice tag for the number. Follow the prompts.



■ Using Speed Dial

Make calls quickly using stored speed dial entries. Use the selector knob to make and enter selections.

1. Press the Phone button.
2. Select Speed Dial.
3. Scroll through the list to find the entry you want to call, and select it to call.



Speed dial entries with stored voice tags can be called using the Talk button. Press the Talk button and follow the prompts.

Models with touchscreen

Basic HFL Operation

Make and receive phone calls using the vehicle's audio system, without handling your phone. Visit handsfreelink.com (U.S.) or handsfreelink.ca (Canada) to check phone compatibility.

To reduce the potential for driver distraction, certain manual functions may be inoperable or grayed out while the vehicle is moving. Stop or pull over to perform the function. Voice commands are also available.

HFL Controls

Use the controls to enter information and make selections.



Pick-Up button: Answer an incoming call.

Hang-Up/Back button: End or decline a call, or cancel an operation.

Talk button: Make a call using a stored voice tag, or say voice commands*.

+ / - buttons: Scroll the list after pressing and holding the Menu button.

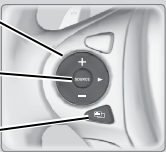

SOURCE button: Press to enter a selection after pressing and holding the Menu button.

Menu button: From the phone screen, press to display speed dial, call history, or redial.

MENU: From the phone screen, select various call options.

BACK: Go back to the previous display.

Phone: From the Home screen, display the phone screen.

Settings: Select Phone from the Settings screen for phone pairing and more.



Talk Button Tips

For a list of available phone commands, see page 164.

- When using the Talk button, wait until you hear a beep before speaking.
- To bypass the system prompts, simply press the Talk button again to say your command.*
- When the Talk button is pressed, all available voice commands are highlighted in yellow.*
- Speak in a clear, natural voice.
- Reduce all background noise.
- Adjust the dashboard vents away from the microphone on the ceiling.
- Close the windows and moonroof.

TABLE OF CONTENTS

VISUAL INDEX

SAFETY INFORMATION

INSTRUMENT PANEL

VEHICLE CONTROLS

AUDIO AND CONNECTIVITY

BLUETOOTH® HANDSFREELINK®

HONDALINK®

NAVIGATION

DRIVING

HANDLING THE UNEXPECTED

MAINTENANCE

SPECIFICATIONS

CUSTOMER INFORMATION

VOICE COMMAND INDEX

INDEX

Models with touchscreen

Pairing a Phone

To use hands-free phone and streaming audio functions, you must first pair your phone to the system. This can only be done when the vehicle is stopped. Use the touchscreen to make and enter selections.

1. From the Home screen, select Settings.
2. Select Phone.
3. Select Bluetooth Device List.
4. Select Add Bluetooth Device.
5. Make sure your phone is in discovery mode. Select Continue.
6. The system searches for your phone. Select your phone when it appears on the list.
If your phone does not appear:
Select Phone Not Found and search for HandsFreeLink from your phone. Connect to HFL.
7. The system gives you a pairing code. Compare it to the code that appears on your phone. Connect to HFL from your phone.
8. The system asks if you want to enable options:
HondaLink Assist: Select On to enable emergency collision notification (see page 88).
Phone Synchronization: Select On to automatically import contacts and call history from your phone.
9. Press BACK to exit the menu.



State, provincial, or local laws may prohibit the operation of handheld electronic devices while operating a vehicle.

Models with touchscreen

Making a Call

You can make a call using several methods.

■ Dialing a Number

Enter a 10-digit phone number to call.

Using voice commands

Press the Talk button before you say each command.

1. Say "Dial by number."
2. Say the phone number: For example, "3-1-0-5-5-1-2-3-4."
3. The system begins to dial.

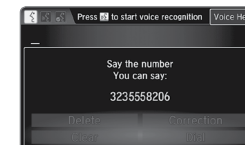

Using the touchscreen

Manual operation is limited while the vehicle is moving. Voice commands are always available.

1. From the Home screen, select Phone.
2. Select MENU.
3. Select Dial.
4. Enter the phone number. Select the green phone icon to call.



■ Using the Phonebook

When your phone is paired, its entire phonebook can be automatically imported to the system. Phone synchronization must be turned on.

Using voice commands

Press the Talk button before you say each command.

1. Say "Dial by name."
2. Say the phonebook name and phone type. For example, "John Smith mobile."

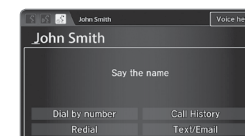

Using the touchscreen

Manual operation is limited while the vehicle is moving. Voice commands are always available.

1. From the Home screen, select Phone.
2. Select MENU.
3. Select Phonebook.
4. Scroll through the list to find the name and number you want to call, and select it to call.

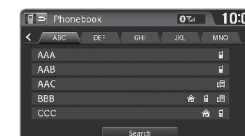

■ Storing Speed Dial Entries

Store up to 20 numbers for quick dialing.

1. From the Home screen, select Phone.
2. Select MENU.
3. Select Edit Speed Dial, then select New Entry.
4. Select an entry method.
5. If desired, you can create a voice tag for the number. Follow the prompts.



■ Using Speed Dial

Make calls quickly using stored speed dial entries.

Using voice commands

Press the Talk button before you say each command.

1. Say "Dial by name."
2. Say the stored voice tag name. For example, "John Smith."

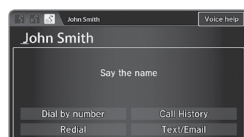

Using the touchscreen

1. From the Home screen, select Phone.
2. Scroll through the list to find the entry you want to call, and select it to call.



HondaLink® Assist

If your vehicle's airbags deploy or if the unit detects that the vehicle is severely impacted, your vehicle automatically attempts to connect to an operator. Your phone must be paired to the system and have good cellular connection. Visit www.hondalink.com (U.S.) or honda.ca/hondalinkassist (Canada) for more information.

1. Make sure your phone is on and paired to *Bluetooth*® HandsFreeLink® (see page 86).
2. Select Call Now, or the system automatically connects after 10 seconds. The vehicle information and its position are sent to the operator.
3. Select Talk Now to immediately talk to the operator.
4. When the call is complete, select Hang Up or press the Hang-Up/Back button on the steering wheel.



Models with touchscreen

SMS Text Messaging and E-Mail*

Receive and send messages from your paired and connected phone. Visit handsfreelink.com (U.S.) or handsfreelink.ca (Canada) to check phone compatibility. Standard message rates apply with your phone service provider. This feature is limited while the vehicle is moving.

■ Receiving and Responding to Messages

When you receive a new message, a pop-up appears on the touchscreen. You can view the message when the vehicle is stopped. You can also reply to it using fixed phrases or call the sender.

1. When the prompt appears, select Read.
2. The message is displayed, and the system reads it aloud.

To reply: With the message open, select Reply, and choose one of the six available responses. Select Send to send the message. You cannot create a new text message.

To call the sender: With the message open, select Call.

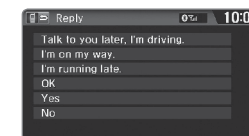
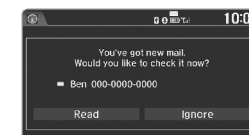

■ Selecting an Account

If your phone has both text message and e-mail accounts, you can select only one of them at a time to be active and receive notifications.

1. From the Home screen, select Settings.
2. Select Phone.
3. Select Select Account.
4. Select Text Message or an e-mail account.

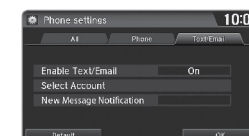

Models with touchscreen

Siri™ Eyes Free

Activate Siri through your vehicle when an iPhone® is paired to the system. Visit handsfreelink.com (U.S.) or handsfreelink.ca (Canada) to check phone compatibility.

Talk button: Press and hold to activate Siri Eyes Free mode. Say your command after you hear the Siri tone.

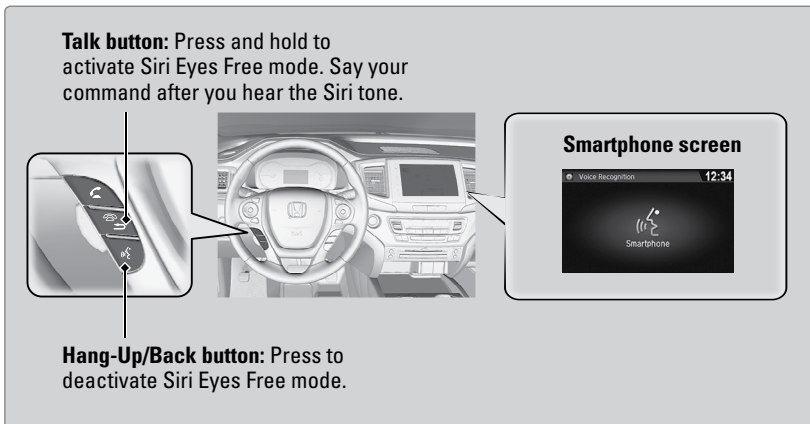

Smartphone screen

Hang-Up/Back button: Press to deactivate Siri Eyes Free mode.

Here are some examples of Siri commands:

- "Call John Smith"
- "Read my new text message"
- "Find a nearby sushi restaurant"
- "Remind me to pick up dinner"
- "Set up a meeting today at 3 p.m."
- "Play song XYZ"

Notes:

- Any requests that include visual feedback from Siri on your phone are not displayed in the vehicle.
- Certain commands rely on the iPhone's features and existing apps.
- To hear turn-by-turn directions or songs through the vehicle, set the audio source to *Bluetooth®* Audio.

Siri and iPhone are trademarks of Apple, Inc.

NAVIGATION*

Learn how to enter a destination and operate the navigation system.

Basic Navigation Operation

A real-time navigation system uses GPS and a map database to show your current location and help guide you to a desired destination. You can operate the system using voice commands or the system controls.

To reduce the potential for driver distraction, certain manual functions may be inoperable or grayed out while the vehicle is moving. Voice commands are always available.

Steering Wheel Controls

Use the steering wheel controls to say voice commands.

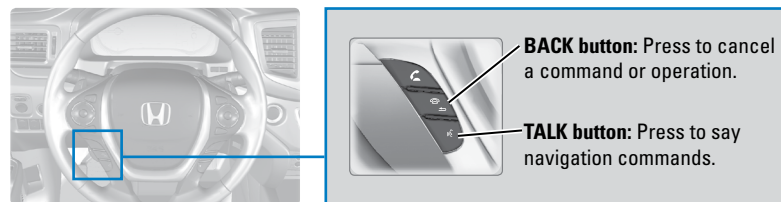

BACK button: Press to cancel a command or operation.

TALK button: Press to say navigation commands.

Talk Button Tips

- When using the Talk button, wait for a beep before saying a command.
- To bypass the system prompts, simply press the Talk button again to say your command.
- Speak in a clear, natural voice.
- Reduce all background noise.
- Adjust the dashboard vents away from the microphone in the ceiling.
- Close the windows and moonroof.

System Guidance Volume

Adjust the navigation system volume.

1. From the Home screen, select Settings.
2. Select System.
3. Select the Sound/Beep tab.
4. Adjust the Guidance Volume level.
5. Press BACK to exit the menus.

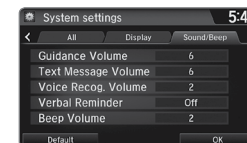

*if equipped



Navigation Display and Controls

Touch icons on the screen to enter information and make selections.

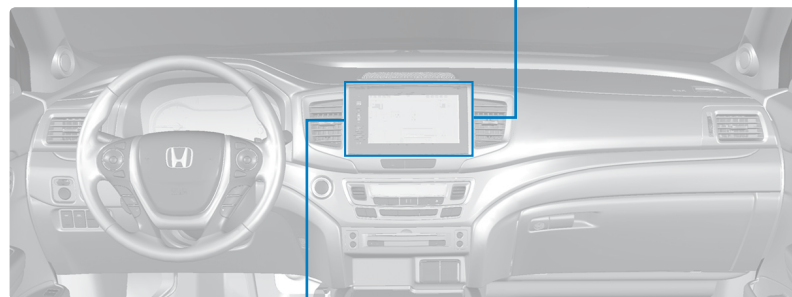
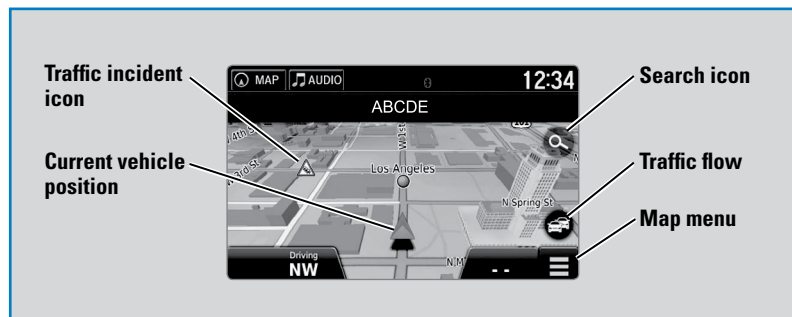

Entering a Destination

Use several methods to enter a destination.

Home Address

Store your home address in the system so you can easily route to it.

1. From the map screen, select the Search icon.
2. Select MENU.
3. Select Set Home Location.
4. Select Enter My Address.
5. Select Search All.
6. Enter the street number and select Done.
7. Enter the street name and select Done. Select the street from the list.
8. Select the address from the list. A map of the address is shown. Select Select.

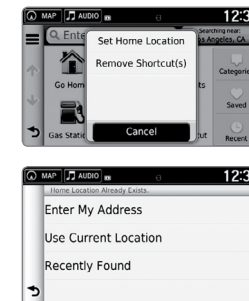

When your home address is stored, you can press the Talk button and say "Navigation" and then "Go home" at any time. You can also select Go Home from the Where To? menu.

Street Address

Enter a street address.

1. From the map screen, select the Search icon.
2. Select Address.
3. Select Search All.
4. Enter the street number and select Done.
5. Enter the street name and select Done. Select the street from the list.
6. Select the address from the list.
7. Select Go!.



You can also enter a street address using voice commands. Press the Talk button and say "Navigation" and then "Find Address." Follow the prompts.

Place Category

Enter a destination using a point of interest or landmark.

1. From the map screen, press MENU.
2. Select Where To?.
3. Select Categories.
4. Select a category (and a subcategory if necessary).
5. Select a place from the list.
6. Select Go!.

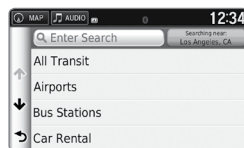
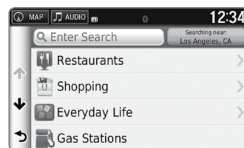

You can also enter a street address using voice commands. Press the Talk button and say "Navigation" and then "Find Place." Follow the prompts.

Recent Places

Select an address from a list of your 50 most recent destinations.

1. From the map screen, press MENU.
2. Select Where To?.
3. Select Recent.
4. Select a place from the list.
5. Select Go!.

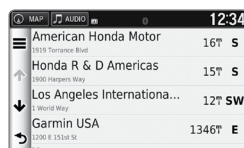

Saved Places

Save locations so you can quickly route to them.

Saving a location

1. From the map screen, press MENU.
2. Select Where To?.
3. Select Enter Search.
4. Enter the address or place name.
5. Select the destination name when it appears on the map screen.
6. Select the menu icon.
7. Select Save.
8. Select OK.

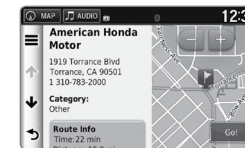

You can also save your current location. From the map screen, select the vehicle icon. Select Save. Enter a name for the location. Select Done. Select OK.

Routing to a saved location

1. From the map screen, press MENU.
2. Select Where To?.
3. Select Saved.
4. Select the destination from the list.
5. Select Go!.



Routing

After a destination is set, you can alter or cancel your route.

Map Legend

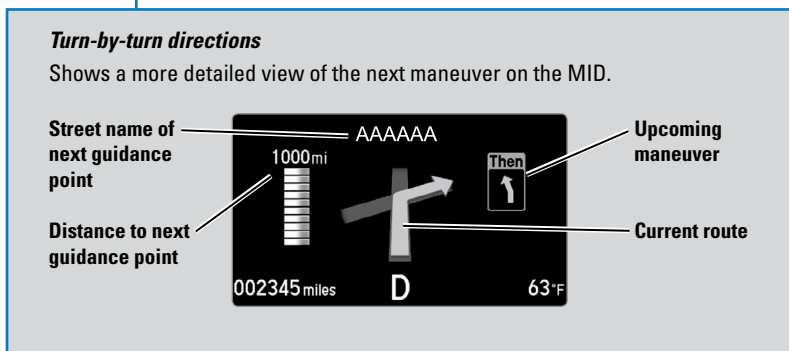
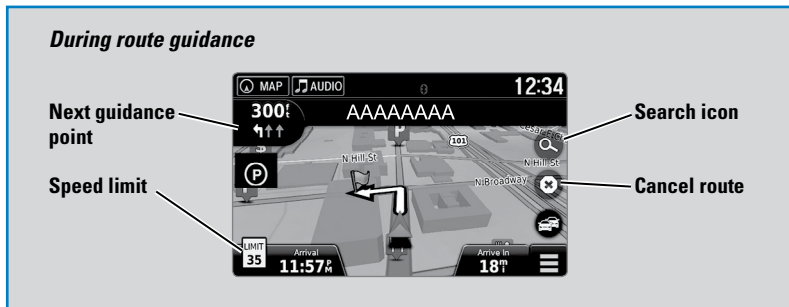

⚠ WARNING

Using the navigation system while driving can take your attention away from the road, causing a crash in which you could be seriously injured or killed.

Operate system controls only when the conditions permit you to safely do so.

Traffic

View traffic flow and incidents in major metro areas. Traffic alerts are accompanied by an audible beep. Pop-up messages and traffic information can be viewed when you are on the map screen. You can also select traffic to avoid. Traffic coverage is limited in Canada.

Viewing traffic

1. From the map screen, select the traffic icon.
2. Select Traffic Conditions.
3. Traffic icons are shown on the map. Select the magnifying glass icon to display a full list of traffic delays.

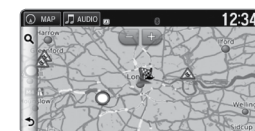

To mute traffic alerts and voice guidance: From the map screen, press MENU. Select Mute. To lower voice guidance volume, see page 91.

Avoiding traffic on your route

1. From the map screen, select the traffic icon.
2. Select Traffic on Route.
3. Select an incident to avoid from the list.
4. Select the menu icon.
5. Select Avoid.

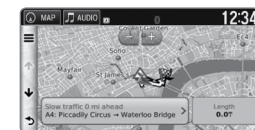

DRIVING

Learn about preparation for driving, as well as other features.

Before Driving

Check the following items before you begin driving.

■ Exterior Checks

- Make sure there are no obstructions on the windows, door mirrors, exterior lights, or other parts of the vehicle.
- Remove any frost, snow, or ice.
- Make sure the hood is securely closed.
- Heat from the engine and exhaust can ignite flammable materials left under the hood, causing a fire. If you've parked your vehicle for an extended period, inspect and remove any debris that may have collected, such as dried grass and leaves that have fallen or have been carried in for use as a nest by a small animal. Also check under the hood for leftover flammable materials after you or someone else has performed maintenance on your vehicle.
- Make sure the tires are in good condition.
- Make sure there are no people or objects behind or around the vehicle.

NOTICE

If the doors are frozen shut, use warm water around the door edges to melt any ice. Do not try to force them open, as this can damage the rubber trim around the doors. When done, wipe dry to avoid further freezing.

■ Interior Checks

- Store or secure all items on board properly.
- Do not pile items higher than the seat height.
- Do not place anything in the front seat footwells. Make sure to secure the floor mats.
- If you have any animals on board, do not let them move freely around in the vehicle.
- Securely close and lock all doors and the tailgate.
- Adjust your seating position, mirrors, and steering wheel properly.
- Make sure items placed on the floor behind the front seats cannot roll under the seats.
- Everyone in the vehicle must fasten their seat belt.
- Make sure that the indicators in the instrument panel come on when you start the vehicle, and go off soon after.

In addition:

- During the first 600 miles (1,000 km) of operation, avoid sudden acceleration or full throttle operation so as to not damage the engine or powertrain.
- Avoid hard braking for the first 200 miles (300 km). You should also follow this when the brake pads are replaced.

⚠ WARNING

Improper accessories or modifications can affect your vehicle's handling, and stability, and performance, and cause a crash in which you can be seriously hurt or killed.

Follow all instructions in the vehicle owner's manual regarding accessories and modifications.

■ Driving Guidelines for Your Utility Vehicle

Utility vehicles have a significantly higher rollover rate than other types of vehicles.

To prevent rollovers or loss of control:

- Take corners at slower speeds than you would with a passenger vehicle.
- Avoid sharp turns and abrupt maneuvers whenever possible.
- Do not modify your vehicle in any way that you would raise the center of gravity.
- Do not carry heavy cargo on the roof.
- Never carry more than 165 lbs (75 kg) of cargo on the roof rack (Honda accessory).

Your vehicle has been designed primarily for use on pavement, however, its higher ground clearance allows you to occasionally travel on unpaved roads. It is not designed for trail-blazing, or other challenging off-road activities.

If you decide to drive on unpaved roads, you will find that it requires somewhat different driving skills and that your vehicle will handle somewhat differently than it does on pavement. Pay attention to the precautions and tips in this section, and get acquainted with your vehicle before leaving the pavement.

⚠ WARNING

Improperly operating this vehicle on or off pavement can cause a crash or rollover in which you and your passengers can be seriously injured or killed.

- Follow all instructions and guidelines in this owner's guide.
- Keep your speed low, and don't drive faster than conditions permit.



Maximum Load Limit

Carrying too much cargo or improperly storing it can affect your vehicle's handling, stability, stopping distance, and tires, and make it unsafe.

■ Maximum Load for Your Vehicle

LX, EX, and EX-L with AWD

The maximum load for your vehicle is 1340 lbs (608 kg).

Touring and Elite with AWD

The maximum load for your vehicle is 1173 lbs (532 kg).

All other models

See the Tire and Loading Information label on the driver's doorjamb.

Label example

TIRE AND LOADING INFORMATION			
SEATING CAPACITY		TOTAL X FRONT X REAR X	
The combined weight of occupants and cargo should never exceed XXXkg or XXXlbs.			
TIRE	SIZE	COLD TIRE PRESSURE	SEE OWNER'S MANUAL FOR ADDITIONAL INFORMATION
FRONT	XXXX/XXXXX XXX	XXXKPA, XXPSI	
REAR	XXXX/XXXXX XXX	XXXKPA, XXPSI	
SPARE	XXXX/XXXXX XXX	XXXKPA, XXPSI	

⚠ WARNING

Overloading or improper loading can affect handling and stability and cause a crash in which you can be hurt or killed.

Follow all load limits and other loading guidelines in this guide.

The headlight aim on your vehicle was set by the factory, and does not need to be adjusted. However, if you regularly carry heavy items in the cargo area or tow a trailer, have the aiming readjusted at your dealer or by a qualified technician.

This figure includes the total weight of all occupants, cargo, and accessories, and the tongue load if you are towing a trailer. Below are the steps for determining the correct load limit:

1. Locate the statement "The combined weight of occupants and cargo should never exceed XXX kg or XXX lbs." on your vehicle's placard.
2. Determine the combined weight of the driver and passengers that will be riding in your vehicle.
3. Subtract the combined weight of the driver and passengers from XXX kg or XXX lbs.
4. The resulting figure equals the available amount of cargo and luggage load capacity. For example, if the "XXX" amount equals 1,400 lbs. and there will be five 150 lb. passengers in your vehicle, the amount of available cargo and luggage load capacity is 650 lbs. (1,400 - 750 (5 x 150) = 650 lbs.)
5. Determine the combined weight of luggage and cargo being loaded on the vehicle. That weight may not safely exceed the available cargo and luggage load capacity calculated in step 4.
6. If your vehicle will be towing a trailer, load from your trailer will be transferred to your vehicle. Consult the Owner's Manual on the Owner Information CD or at owners.honda.com (U.S.) or myhonda.ca (Canada) to determine how this reduces the available cargo and luggage load capacity of your vehicle.

In addition, the total weight of the vehicle, all occupants, accessories, cargo, and trailer tongue load must not exceed the Gross Vehicle Weight Rating (GVWR) or the Gross Axle Weight Rating (GAWR). Both are on a label on the driver's doorjamb.

Load limits example

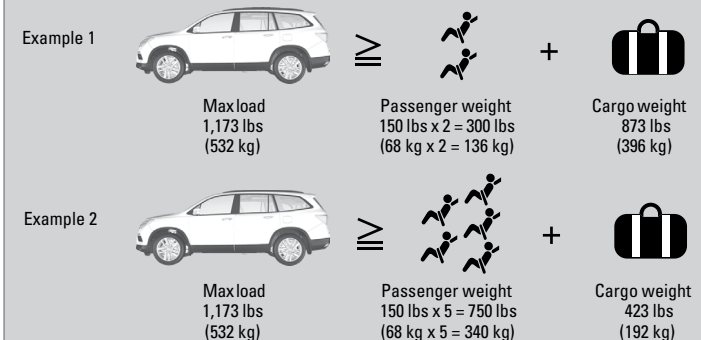

Towing a Trailer

Your vehicle can tow a trailer if you carefully observe the load limits, use the proper equipment, and follow the towing guidelines. See the Owner's Manual on the Owner Information CD or at owners.honda.com (U.S.) or www.myhonda.ca (Canada) for more information.

Towing Load Limits

Total trailer weight

Do not exceed the maximum allowable weight of the trailer, cargo, and everything in or on it shown in the table below. Towing loads in excess of this can seriously affect vehicle handling and performance and can damage the engine and drivetrain.

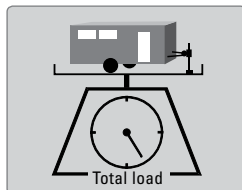

Number of occupants	AWD models with ATF cooler	AWD models without ATF cooler	2WD models
2	5,000 lbs (2,268 kg)	3,500 lbs (1,588 kg)	3,500 lbs (1,588 kg)
3	4,750 lbs (2,155 kg)	3,250 lbs (1,474 kg)	3,250 lbs (1,474 kg)
4	4,500 lbs (2,041 kg)	3,000 lbs (1,361 kg)	3,000 lbs (1,361 kg)
5	4,250 lbs (1,928 kg)	2,750 lbs (1,247 kg)	2,750 lbs (1,247 kg)
6	4,000 lbs (1,814 kg)	2,500 lbs (1,134 kg)	2,500 lbs (1,134 kg)
7	2,500 lbs (1,134 kg)	2,250 lbs (1,021 kg)	2,250 lbs (1,021 kg)
8	Towing not recommended		

Each weight limit is calculated based on the following conditions:

- Occupants fill seats from the front of the vehicle to the back.
- Each occupant weighs 150 lbs (68 kg).
- Each occupant has 15 lbs (7 kg) of cargo in the cargo area.

Any additional weight, cargo, or accessories reduce the maximum trailer weight and maximum tongue load.

Tongue load

The weight of the tongue with a fully loaded trailer on the hitch should be approximately:

- Boat trailers: 5 – 15% of the total trailer weight
- Other trailers: 10 – 15% of total trailer weight

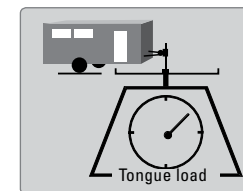

Number of occupants	AWD models with ATF cooler	2WD models
2	500 lbs (227 kg)	350 lbs (159 kg)
3	475 lbs (215 kg)	325 lbs (147 kg)
4	450 lbs (204 kg)	300 lbs (136 kg)
5	375 lbs (170 kg)	275 lbs (125 kg)
6	250 lbs (113 kg)	240 lbs (109 kg)
7	125 lbs (57 kg)	115 lbs (52 kg)
8	Towing not recommended	

To estimate the tongue load

Excessive tongue load reduces front tire traction and steering control. Too little tongue load can make the trailer unstable and cause it to sway.

You can estimate the tongue load by measuring the trailer hitch height from the ground in the following steps:

1. Park the vehicle on level ground.
2. Measure the distance between the ground and the bottom of the trailer hitch.
3. Connect the fully loaded trailer to the hitch.
4. Measure the distance between the ground and the bottom of the trailer hitch again.
5. Subtract the second measurement from the first measurement, then refer to the following table.

If the difference is	AWD models	2WD models
1 inches (2.5 cm)	150 lbs (68 kg)	
1 1/2 inches (3.8 cm)	250 lbs (114 kg)	
2 inches (5.1 cm)	350 lbs (159 kg)	
2 3/8 inches (6.0 cm)	450 lbs (205 kg)	—
2 5/8 inches (6.7 cm)	500 lbs (227 kg)	—

If the difference becomes more than indicated in the table, distribute the load or remove cargo as needed.

How to weigh the trailer loads using a public scale

Check each weight in the order indicated as shown. Refer to the table below for each weight's limit except for the tongue load.

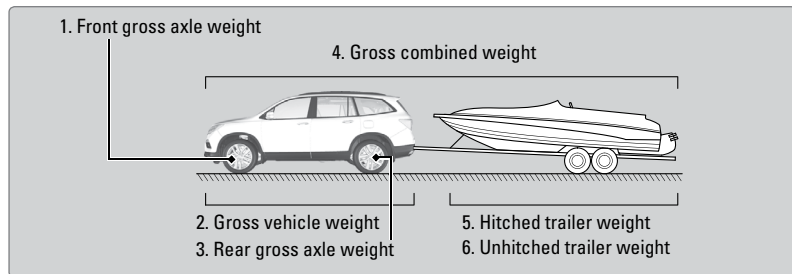

- If you cannot weigh the rear axle, subtract 1 from 2.
- The maximum gross combined weight (4) decreases by 2% for every 1,000 feet (305 m) of elevation.
- To calculate the tongue load, subtract 5 from 6.
- Refer to the trailer owner's manual for additional information.

Fully load the vehicle and trailer. An attendant who watches the scale is needed as all occupants should stay in the vehicle.

If a public scale is not available, add the estimated weight of your cargo load to the weight of your trailer (as quoted by the manufacturer), and then measure the tongue load with an appropriate scale or tongue gauge or estimate it based on cargo distribution.

Weight limit for	2WD models	AWD models
Front gross axle	2,734 lbs (1,240 kg)	2,855 lbs (1,295 kg)
Gross vehicle	5,545 lbs (2,515 kg)	5,842 lbs (2,650 kg)
Rear gross axle	2,921 lbs (1,325 kg)	3,097 lbs (1,405 kg)
Gross combined	8,025 lbs (3,640 kg)	9,755 lbs (4,425 kg)

Pre-tow checklist

When preparing to tow, and before driving away, ensure the following:

- The vehicle has been properly serviced, and the suspension and the cooling system are in good operating condition.
- Avoid towing a trailer during your vehicle's first 600 miles (1,000 km).
- The trailer has been properly serviced and is in good condition.
- All weights and loads are within limits. Never exceed the gross weight ratings.
- Check if all loads are within limits at a public scale. If a public scale is not available, add the estimated weight of your cargo load to the weight of your trailer (as quoted by the manufacturer) and the tongue load.
- The hitch, safety chains, and any other attachments are secure.
- All items in or on the trailer are properly secured and cannot shift while you drive.

⚠️ WARNING

Exceeding any load limit or improperly loading your vehicle and trailer can cause a crash in which you can be seriously hurt or killed. Check the loading of your vehicle and trailer carefully before starting to drive.

Remote Engine Start*

Start your vehicle's engine using the remote transmitter before you enter the vehicle.



Make sure the vehicle is in a safe location when using remote engine start (i.e., a well ventilated area, away from any flammable materials).

Starting the Engine

Press the Lock button, then press and hold the Engine button within 5 seconds to remotely start the engine.

The engine runs for up to 10 minutes. To extend the run time for another 10 minutes, repeat the procedure during the initial 10 minutes.

While the engine is running, the climate control system adjusts the cabin temperature, the security system remains on, and lights and accessories remain off.

Stopping the Engine

Press and hold the Engine button.

The engine will also stop if it has been running for more than 10 minutes, or if any door is opened without using the remote or smart entry.

⚠️ WARNING

Engine exhaust contains toxic carbon monoxide gas.

Breathing carbon monoxide can kill you or cause unconsciousness.

Never use the remote engine starter when the vehicle is parked in a garage or other area with limited ventilation.

Starting to Drive

Turn on the vehicle and start the engine to begin driving.

Before Starting the Engine

Check that the transmission is in Park (P), then press the brake pedal. Keep your foot firmly on the brake pedal when starting the engine.

Release the parking brake, if necessary (see page 111).

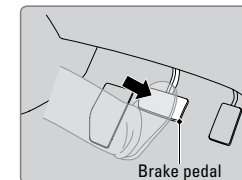

The engine is harder to start in cold weather and in thinner air found at altitudes above 8,000 feet (2,400 m). When starting the engine in cold weather, turn off all electrical accessories such as the lights, climate control system, and rear defogger in order to reduce battery drain.

Changing the Power Mode

Use the ENGINE START/STOP button to cycle through power modes or start the engine.

Accessory or On mode: Press the ENGINE START/STOP button once without pressing the brake pedal for Accessory mode. Press it again for On mode.

Starting the engine: Press and hold the brake pedal, then press the ENGINE START/STOP button. Keep your foot firmly on the brake pedal when starting the engine.

Turning the vehicle off: Shift to Park (P), then press the ENGINE START/STOP button.

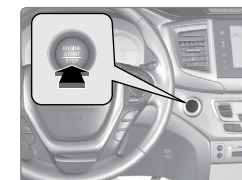

Shifting

Change the shift position based on your driving needs.

■ Shift Lever*

Park (P): Used for parking or starting/stopping the engine. Press the brake pedal, then press the release button to shift.

Reverse (R): Used for reversing.

Neutral (N): Used for idling.

Drive (D): Used for normal driving.

Low (L): Used for stronger engine power and braking when driving in hilly terrain.

D4: Press the D4 button when the shift lever is in Drive. Used for going up or down hills or towing a trailer in hilly terrain.

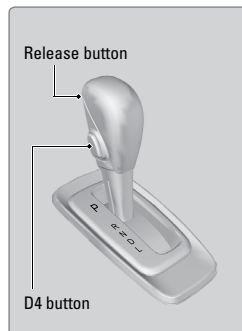

NOTICE

When you change the shift lever from D to R and vice versa, come to a complete stop and keep the brake pedal pressed. Operating the shift lever before the vehicle has come to a complete stop or while pressing the accelerator pedal can damage the transmission.

■ Electronic Gear Selector*

Park (P): Used for parking or starting or turning off the vehicle. Press P with the brake pedal pressed. A red indicator appears.

Reverse (R): Used for reversing. Pull back R. A green indicator appears.

Neutral (N): Used for idling. Press N. A red indicator appears.

Drive (D/S): Used for normal driving (D) or driving in sequential mode (S) (see page 110). Press D/S once for normal driving. Press D/S twice for sequential mode driving. A green indicator appears. Make sure the parking brake is released (see page 111).



⚠ WARNING

The vehicle can roll away if left unattended without confirming that Park is engaged. Always keep your foot on the brake pedal until you have confirmed that P is shown on the gear position indicator.

NOTICE

When you change from D to R and vice versa, press the brake pedal and come to a complete stop, then select the intended gear position while maintaining brake pressure.

Auto park mode

For your convenience, Park (P) is automatically selected when all of the following conditions are met:

- The vehicle is stopped.
- The driver's seatbelt is unbuckled.
- The driver's door is opened.

Car wash mode

If you are driving through a conveyor-style car wash where you or the attendant do not remain in the vehicle, follow these steps while the engine is on:

1. Press and hold the brake pedal.
2. Press and release N (Neutral).
3. Press and hold N again for two seconds. The engine remains on, and the transmission remains in Neutral. To turn off the engine but keep the transmission in Neutral, press the ENGINE START/STOP button.

The transmission remains in Neutral for 15 minutes. After 15 minutes, the gear position changes to Park and the vehicle turns off.



Information Provided by:
DEALER
 E-PROCESS

*if equipped

Sequential Mode*

Use the paddle shifters to change gears without removing your hands from the steering wheel.

(-) Paddle shifter:
Pull to shift down to a lower gear.

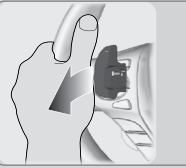

(+) Paddle shifter:
Pull to shift up to a higher gear.

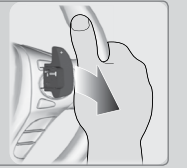

Recommended shift points

Shift up	Normal acceleration
1st to 2nd	15 mph (24 km/h)
2nd to 3rd	25 mph (40 km/h)
3rd to 4th	40 mph (64 km/h)
4th to 5th	47 mph (76 km/h)
5th to 6th	52 mph (84 km/h)
6th to 7th	57 mph (92 km/h)
7th to 8th	62 mph (100 km/h)
8th to 9th	67 mph (108 km/h)

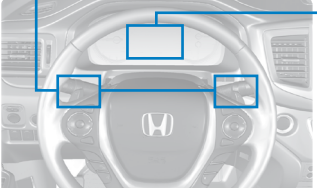
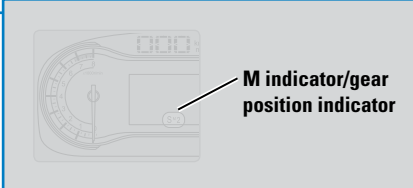
When the transmission is in D: Press D/S once. The vehicle goes into sequential shift mode momentarily, and the gear selection indicator comes on. When you start traveling at a constant speed, sequential mode and the gear position indicator automatically go off.

When the transmission is in S: Press D/S twice. The vehicle goes into sequential mode, and the M (sequential mode) indicator and gear selection indicator come on. Use the paddle shifters to change gears.

To cancel this mode, hold the + paddle shifter for two seconds or press D/S again. The M indicator and gear selection indicator go off.

Braking

Slow down or stop your vehicle, and keep it from moving when parked.

Foot Brake

Press the brake pedal to slow down or stop your vehicle from moving.

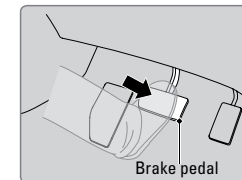

Parking Brake

Keep the vehicle from moving when it is parked.

To apply: Press the parking brake with your foot.

To release: Press the brake pedal, then press the parking brake until it releases.

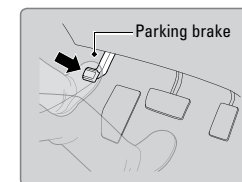

NOTICE

Release the parking brake fully before driving. The rear brakes and axle can be damaged if you drive with the parking brake applied.

Brake Assist System

During hard or emergency braking, the system increases braking force. The brake pedal may move slightly or make a noise; this is normal. Continue to hold the brake pedal firmly down.

Anti-Lock Brake System (ABS)

During hard or emergency braking, the system rapidly pumps the brakes to prevent wheel lockup and help you maintain steering control. The brake pedal may pulsate slightly during ABS operation; this is normal. Do not pump the brake pedal, and continue to hold it firmly down.

NOTICE

The ABS may not function correctly if you use an incorrect tire type and size.

Intelligent Traction Management System*

Adjusts vehicle handling performance while driving on various road surfaces.

Press the Mode button to select one of four appropriate modes. The mode you select appears on the MID.

Normal: Provides balanced driving performance on most road surfaces.

Snow: Use when driving on snowy road surfaces.

Mud*: Use when driving on muddy roads or off-road surfaces.

Sand*: Use when driving on soft, sandy road or off-road surfaces.

Cruise control/adaptive cruise control* is not available when Snow, Mud, or Sand is selected.

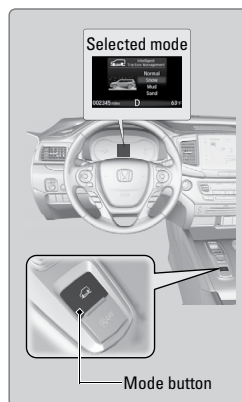

Auto Idle Stop*

Automatically stops and restarts the engine to help maximize fuel economy, depending on environmental and vehicle conditions.

■ Activating Auto Idle Stop

When the vehicle stops with the gear position in Drive (D) and the brake pedal is pressed, the engine turns off and the auto idle stop indicator appears if conditions permit.

When you release the brake pedal, turn the steering wheel, or press the accelerator pedal, the engine restarts and the vehicle begins to move.

Auto idle stop does not activate (or the engine may automatically restart) when the driver's seat belt is unfastened, the vehicle is stopped on a steep hill, the windshield defroster is on, and other conditions.

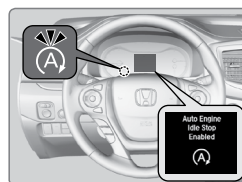

■ Turning the System On or Off

Press the Auto Idle Stop Off button to turn the system off. The amber auto idle stop indicator comes on. Press the button again to turn it on.



Eco Assist System

Can help improve your fuel economy by adjusting the performance of the engine, climate control system, and cruise control.

■ ECON Button

Press the ECON button to turn the system on or off. The ECON Mode indicator appears when the system is turned on.

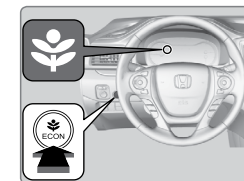

■ Ambient Meter

Color-coded bars around the speedometer change based on your driving style and brake or accelerator pedal operation.

Green: Fuel efficient driving

Light green: Moderate acceleration/deceleration

White: Aggressive acceleration/deceleration



Vehicle Stability Assist (VSA®), aka Electronic Stability Control (ESC) System

Helps to stabilize the vehicle during cornering if the vehicle turns more or less than what was intended. It assists in maintaining traction on slippery surfaces by regulating engine output and selectively applying the brakes.

■ Turning VSA On or Off

VSA is turned on every time you start the engine, even if you previously turned it off. If you turn VSA off, your vehicle has normal braking and cornering ability, but traction and stability enhancement become less effective.

Press and hold the VSA OFF button until you hear a beep to turn VSA on or off. The VSA OFF indicator appears when the system is off.

Traction control stops functioning, which may make it easier when trying to free your vehicle if it is stuck in mud or snow.

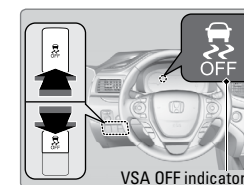

Cruise Control*

Maintain a constant vehicle speed without having to keep your foot on the accelerator pedal. Use cruise control on freeways or open roads where you can travel at a constant speed with little acceleration or deceleration.

Cruise control is not available when Snow, Mud, or Sand is selected for Intelligent Traction Management (see page 112).

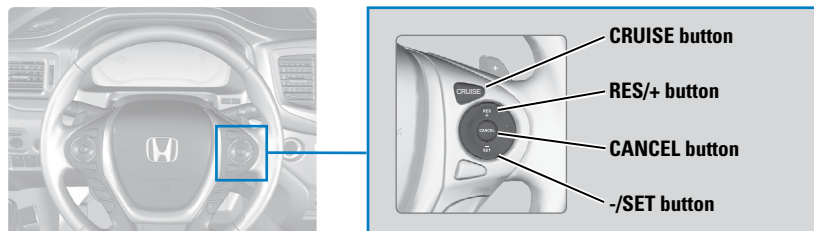

■ Activating and Setting the Vehicle Speed

1. Press the CRUISE button. The CRUISE MAIN indicator appears.
2. Accelerate to the desired speed (above 25 mph/40 km/h). Take your foot off the pedal and press the -/SET button to set the speed. The CRUISE CONTROL indicator appears.



■ Adjusting the Vehicle Speed

Press the RES/+ button to increase speed or the -/SET button to decrease speed.

Each time you press the button, the vehicle speed is increased or decreased by about 1 mph (1.6 km/h). If you keep the button pressed, the vehicle speed increases or decreases until you release it.



■ Canceling Cruise Control

Press the CANCEL button or the brake pedal. The CRUISE CONTROL indicator goes off.

After cruise control has been canceled, you can still resume the prior set speed by pressing the RES/+ button while driving at a speed of at least 25 mph (40 km/h).

Press CRUISE to turn the system off.



⚠ WARNING

Improper use of the cruise control can lead to a crash.
Use cruise control only when traveling on open highways in good weather.

Adaptive Cruise Control (ACC)*

Helps maintain a constant vehicle speed and a set following interval behind a vehicle detected ahead of yours.

Adaptive cruise control is not available when Snow, Mud, or Sand is selected for Intelligent Traction Management (see page 112).

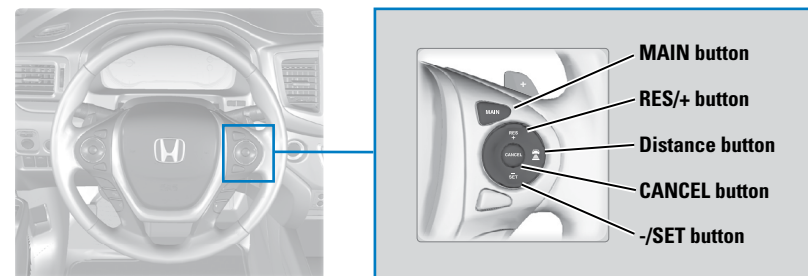

■ Activating and Setting the Vehicle Speed

1. Press the MAIN button. The ACC indicator appears in the MID.
2. Accelerate to the desired speed (above 25 mph/40 km/h). Take your foot off the pedal and press the -/SET button to set the speed.



■ Adjusting the Vehicle Speed

Press the RES/+ button to increase speed or the -/SET button to decrease speed.

Each time you press the button, the vehicle speed is increased or decreased by about 1 mph (1.6 km/h). If you keep the button pressed, the vehicle speed increases or decreases by 5 mph (5 km/h) until you release it.



■ Adjusting the Vehicle Distance

Press the Distance button to change the following interval. Each time you press the button, the setting cycles through extra long, long, middle, and short.



■ Switching to Standard Cruise Control

Press and hold the Distance button. Cruise Mode appears in the multi-information display. Press and hold the button again to switch back to ACC.

*if equipped

Information Provided by:
DEALER
E-PROCESS

*if equipped

■ During Operation

If a vehicle is detected ahead of you when ACC is turned on, the system maintains, accelerates, or decelerates your vehicle's set speed to keep the vehicle's set following interval from the vehicle ahead.

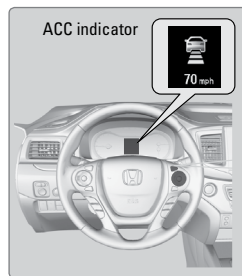

If a vehicle detected ahead of you slows down abruptly, or if another vehicle cuts in front of you, a beep sounds and BRAKE appears on the multi-information display to alert you.

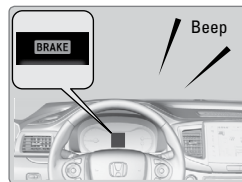

⚠ WARNING

ACC has limited braking capability. When your vehicle speed drops below 22 mph (35 km/h), ACC will automatically cancel and no longer will apply your vehicle's brakes. Always be prepared to apply the brake pedal when conditions require.

■ Canceling ACC

Press the CANCEL or MAIN button, or press the brake pedal. The ACC indicator goes off.

Certain conditions may cause ACC to cancel automatically. When this happens, the amber ACC indicator appears on the multi-information display (see page 24).

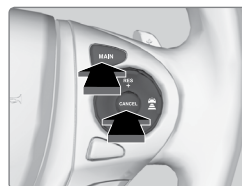

After cruise control has been canceled, you can still resume the prior set speed by pressing RES/+ when your vehicle speed is over 25 mph (40 km/h).

⚠ WARNING

Improper use of ACC can lead to a crash. Use ACC only when traveling on open highways in good weather.

LaneWatch™*

Check the passenger-side rear areas in the display when the right turn signal is activated.

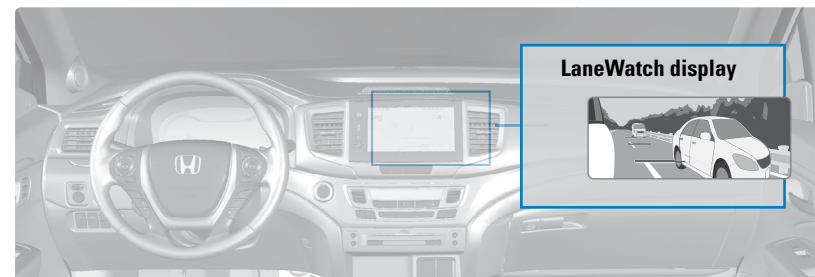

■ Activating LaneWatch

Activate the right turn signal. The LaneWatch display appears. Check the display for blind spots, and visually confirm that it is safe to change lanes.

You can also press the LaneWatch button on the end of the turn signal switch to view a constant real-time display. Press it again to turn the display off.

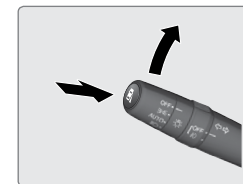

■ Changing Settings

Customize the display and how and when the display appears.

1. From the Home screen, select Settings.
2. Select Camera.
3. Select LaneWatch.
4. Select an option and make the preferred changes.
5. Press BACK to exit the menu.



⚠ WARNING

Failure to visually confirm that it is safe to change lanes before doing so may result in a crash and serious injury or death. Do not rely only on LaneWatch while driving. Always look in your mirrors, to either side of your vehicle, and behind you for other vehicles before changing lanes.

Important Safety Reminder

Like all assistance systems, LaneWatch has limitations. Over-reliance on the system may result in a collision.

**if equipped*

Lane Keeping Assist System (LKAS)*

Provides steering input to help keep the vehicle in the middle of a detected lane and visual and tactile alerts if the vehicle is detected drifting out of its lane while driving between 45–90 mph (72–145 km/h).

If your vehicle is getting too close to detected left or right side lane markings without a turn signal activated, the system provides visual and tactile alerts.

A Lane Departure message appears on the MID, and the steering wheel vibrates. Steering torque is also applied to help keep your vehicle within your driving lane. Take appropriate action to stay within your driving lane.



Turning the System On or Off

1. Press the MAIN button. LKAS appears in the MID.



2. Press the LKAS button. Lane outlines appear in the MID. Dotted lane lines turn solid when the system operates.



3. Press the MAIN button or the LKAS button to turn the system off.

Important Safety Reminder

LKAS is for your convenience only. It is not a substitute for your vehicle control. The system does not work if you take your hands off the steering wheel or fail to steer the vehicle.

Do not place an object on the top of the instrument panel. It may reflect onto the windshield and prevent the system from detecting lane lines properly.

Do not use when towing.

Road Departure Mitigation (RDM)*

Alerts and helps to assist you if the system determines a possibility of your vehicle unintentionally crossing over detected lane markings while driving between 45–90 mph (72–145 km/h).

If your vehicle is getting too close to detected lane markings without a turn signal activated, a message appears in the MID. Steering wheel torque and vibrations are applied to help your vehicle stay in the lane.

Braking may also be applied if the lane lines are solid and continuous.

If the system operates several times without detecting driver response, the system beeps to alert you.

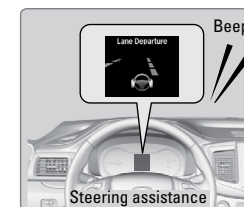

Turning the System On or Off

Press the RDM button to turn the system on or off. A green indicator appears on the button when the system is on.

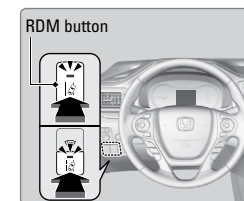

Changing Settings

Determine the warning timing.

1. From the HOME screen, select Settings.
2. Select Vehicle. The vehicle must be in Park (P).
3. Select Road Departure Mitigation Setting.
4. Select from the options.

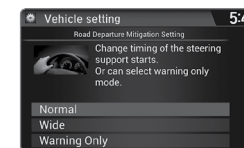

Normal (default): Steering control starts from inside the lane edge.

Wide: Steering control starts from outside the lane edge.

Warning Only: The system only provides a BRAKE message, but does not apply steering or braking.

5. Press BACK to exit the menu.

Important Safety Reminder

The RDM system has limitations. Overreliance on it may result in a collision. It is always your responsibility to keep your vehicle within the driving lane.

Collision Mitigation Braking System™ (CMBS™)*

Can assist you when there is a possibility of your vehicle colliding with a vehicle or a pedestrian detected in front of you.

The system can give you visual, audible, and tactile alerts when a potential collision is determined, and reduce your vehicle speed to help minimize collision severity when a collision is deemed unavoidable.

When a potential collision with a detected oncoming vehicle is determined, the system also alerts you with rapid vibrations on the steering wheel.

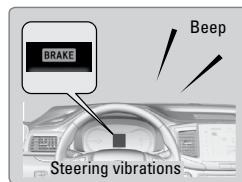

The system activates when:

- The speed difference between your vehicle and a vehicle or pedestrian detected in front of you is about 3 mph (5 km/h) and over with a chance of a collision.
- Your vehicle speed is about 62 mph (100 km/h) or less and there is a chance of a collision with an oncoming detected vehicle or a pedestrian in front of you.

Alert Stages

The system has three alert stages for a possible collision. Depending on the circumstances or CMBS settings, CMBS may not go through all of the stages before initiating the last stage.

Stage 1: Visual and audible warning, steering wheel vibrations

Stage 2: Visual and audible warning and light brake application

Stage 3: Visual and audible warning and strong brake application

Changing Settings

Determine the warning timing.

1. From the HOME screen, select Settings.
2. Select Vehicle. The vehicle must be in Park (P).
3. Select Forward Collision Warning Distance.
4. Select Long, Normal, or Short.
5. Press BACK to exit the menu.

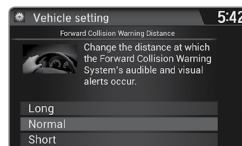

Turning CMBS On or Off

Press and hold the CMBS OFF button. A beep sounds and a message appears in the MID. The CMBS indicator appears when the system is off.

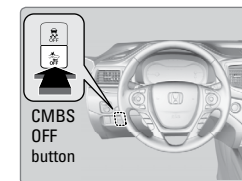

Important Safety Reminder

CMBS is designed to reduce the severity of an unavoidable collision. It does not prevent collisions nor stop the vehicle automatically. It is still your responsibility to operate the brake pedal and steering wheel appropriately according to the driving conditions.

Parking Sensor System*

When the system senses an object when you are parking or backing up, indicators appear on the display and a series of beeps will sound.

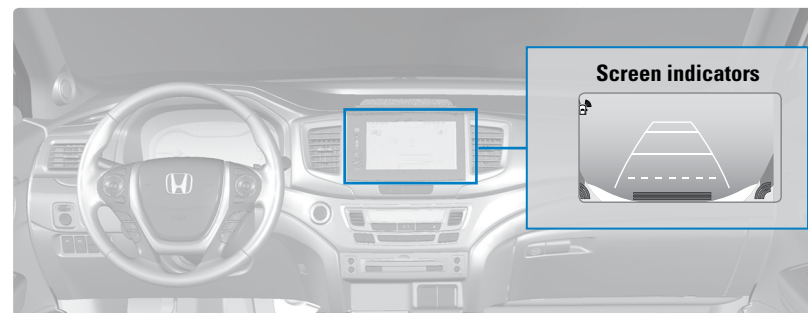

Turning the System On or Off

Press the parking sensor button to turn the system on or off. A green indicator light appears on the button when the system is on.

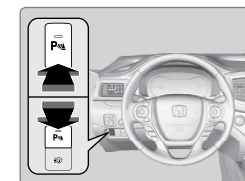

Blind Spot Information (BSI)*

Alerts you to a detected vehicle in your left or right blind spot while driving 20 mph (32 km/h) or higher.

When a vehicle is detected in your blind spot, the blind spot indicator turns on and stays lit until the area is clear.

When your turn signal is on and a vehicle is detected, the blind spot indicator blinks and a beep sounds until the area is clear or the turn signal is off.

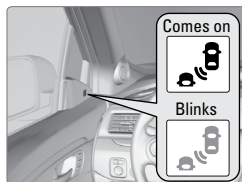

Changing Settings

Determine the warning type, or turn the system off.

1. From the Home screen, select Settings.
2. Select Vehicle. The vehicle must be in Park (P).
3. Select Driver Assist System Setup.
4. Select an alert type, or turn the system off.
5. Press BACK to exit the menu.



Important Safety Reminder

Like all assistance systems, BSI has limitations. Over-reliance on the system may result in a collision. The system is for your convenience only.

⚠ WARNING

Failure to visually confirm that it is safe to change lanes before doing so may result in a crash and serious injury or death. Do not rely only on the blind spot information system when changing lanes.

Always look in your mirrors, to either side of your vehicle, and behind you for other vehicles before changing lanes.

Rear Cross Traffic Monitor*

Alerts you if a detected vehicle is approaching from a rear corner when your vehicle is in Reverse (R) at speeds of 3 mph (5 km/h) or lower, which can be helpful when backing out of parking spaces.



The system does not provide alerts for a vehicle that is moving away from your vehicle, and it may not detect pedestrians, bicycles, or stationary objects.

Turning the System On or Off

1. From the HOME screen, select Settings.
2. Select Camera.
3. Select Cross Traffic Monitor.
4. Select On or Off.
5. Press BACK to exit the menu.



You can also select the icon in the lower right corner of the screen when the monitor is on to turn it off.

⚠ CAUTION

This system cannot detect all approaching vehicles and may not detect an approaching vehicle at all.

Failure to visually confirm that it is safe to back up the vehicle before doing so may result in a collision.

Do not solely rely on the system when reversing; always also use your mirrors, and look behind and to the sides of your vehicle before reversing.



Multi-View Rear Camera*

When you shift into Reverse (R), a real-time image of the area behind your vehicle is shown in the display, along with helpful parking guidelines.

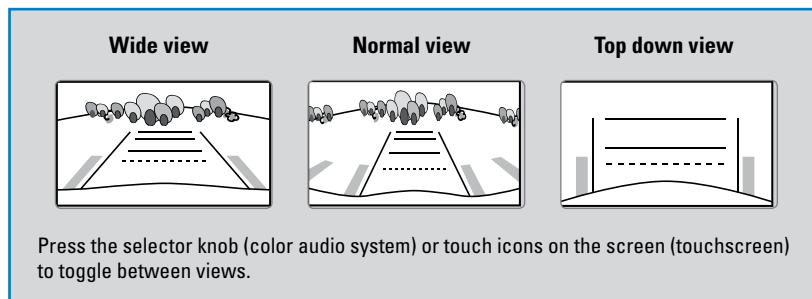

■ Changing Settings

Turn the guidelines on or off. Use the interface dial to make and enter selections.

Models with color audio system

1. Press the MENU/CLOCK button.
2. Select Settings.
3. Select Rear Camera.
4. Select Camera Guidelines.
5. Select On or Off.
6. Press the Back button to exit the menus.

Models with touchscreen

1. From the HOME screen, select Settings.
2. Select Camera.
3. Select one of the options.

Fixed Guidelines: Guidelines appear when you change the gear to Reverse. Select On or Off.

Dynamic Guidelines: Guidelines move as you turn the steering wheel. Select On or Off.

4. Press BACK to exit the menu.

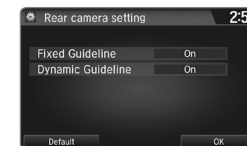

The rear camera view is restricted. You cannot see the corner ends of the bumper or what is underneath the bumper. Its unique lens also makes objects appear closer or farther than they actually are.

Visually confirm that it is safe to drive before backing up. Certain conditions (such as weather, lighting, and high temperatures) may also restrict the rear view. Do not rely on the rearview display, which does not give you all information about conditions at the rear of your vehicle.

Refueling

Use the proper fuel and refueling procedure to ensure the best performance and safety of your vehicle.

Fuel Information

Use of unleaded gasoline of 87 octane or higher is recommended.

- Honda recommends TOP TIER Detergent Gasoline where available.
- Do NOT use gasoline containing more than 15% ethanol.
- Do NOT use gasoline containing methanol.
- Do NOT use gasoline containing MMT.

NOTICE

We recommend quality gasoline containing detergent additives that help prevent fuel system and engine deposits. In addition, in order to maintain good performance, fuel economy, and emissions control, we strongly recommend the use of gasoline that does NOT contain harmful manganese-based fuel additives such as MMT, if such gasoline is available.

How to Refuel

1. The fuel fill door is located at the left rear of the vehicle. Park next to the service pump that is most accessible.
2. Turn off the engine.
3. Press the fuel fill door release button on the driver's door. The fuel fill door opens.
4. Place the end of the filler nozzle on the lower part of the filler opening, then insert it slowly and fully.
5. After filling, wait about 5 seconds before removing the filler nozzle. Close the fuel fill door by hand.

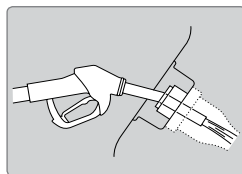
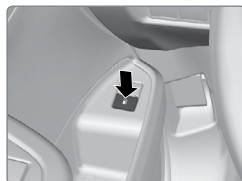

⚠ WARNING

Gasoline is highly flammable and explosive. You can be burned or seriously injured when handling fuel.

- Stop the engine, and keep heat, sparks, and flame away.
- Handle fuel only outdoors.
- Wipe up spills immediately.

HANDLING THE UNEXPECTED

Learn about what to do in critical or emergency situations.

Smart Entry Remote Battery Strength

If the battery life in your remote transmitter is weak, a message appears in the MID with information on how to start the engine.

1. Touch the back of the remote transmitter to the ENGINE START/STOP button while the indicator is flashing.
2. With the brake pedal pressed, press the ENGINE START/STOP button within 10 seconds.

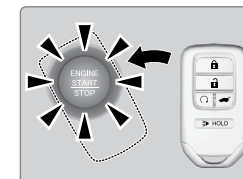

Jump Starting

Turn off the power to electric devices, such as audio and lights. Turn off the engine, then open the hood.

1. Remove the engine compartment cover (see page 145).
2. Remove the holding clips and the air intake duct.
3. Connect the first jumper cable to your vehicle's battery (+) terminal.
4. Connect the other end of the first jumper cable to the booster battery (+) terminal. Use a 12-volt booster battery only.
5. Connect the second jumper cable to the booster battery (-) terminal.
6. Connect the other end of the second jumper cable to the engine hanger as shown. Do not connect this jumper cable to any other part.
7. If your vehicle is connected to another vehicle, start the assisting vehicle's engine and increase its rpm slightly.
8. Attempt to start your vehicle's engine. If it turns over slowly, make sure that the jumper cables have good metal-to-metal contact.

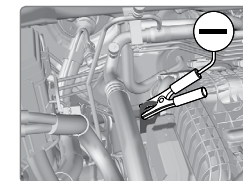
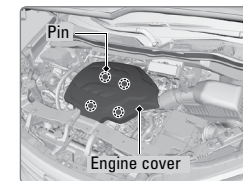
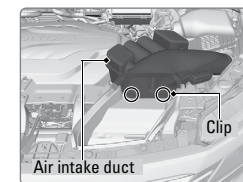

WARNING: Battery posts, terminals, and related accessories contain lead and lead compounds. **Wash your hands after handling.**



WARNING

A battery can explode if you do not follow the correct procedure, seriously injuring anyone nearby.

Keep all sparks, open flames, and smoking materials away from the battery.

After the Engine Starts

Once your vehicle's engine has started, remove the jumper cables in the following order:

1. Disconnect the jumper cable from the engine hanger.
2. Disconnect the other end of the jumper cable from the booster battery's (-) terminal.
3. Disconnect the jumper cable from your vehicle's (+) terminal.
4. Disconnect the other end of the jumper cable from the booster battery's (+) terminal.
5. Have your vehicle inspected by a nearby service station or a dealer.

Shift Lever Does Not Move*

Follow the procedure below if you cannot move the shift lever out of Park (P).

1. Set the parking brake.
2. Remove the built-in key from the remote transmitter.
3. Open the lid of the console compartment.
4. Wrap a cloth around the tip of a small flat-tip screwdriver. Put it into the shift lock release slot as shown in the image, and remove the cover.
5. Insert the key into the shift lock release slot.
6. While pushing the key down, press the shift lever release button and place the shift lever into Neutral (N). The lock is now released. Have the shift lever checked by a dealer as soon as possible.

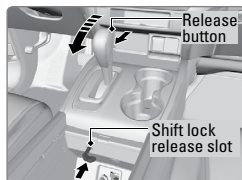
**Overheating**

If the temperature gauge needle is at the H mark, the engine suddenly loses power, or steam or spray comes out from under the hood, your engine is overheating.

1. Immediately park the vehicle in a safe place. Turn off all accessories and turn on the hazard warning lights.

2. *If steam or spray is not present:* Keep the engine running and open the hood.

If steam or spray is present: Turn off the engine and wait until it subsides. Then, open the hood.

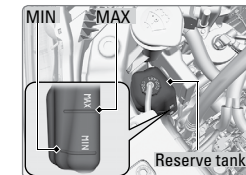

3. Check that the cooling fan is operating and stop the engine once the temperature gauge needle comes down. If the cooling fan is not operating, immediately stop the engine.
4. Once the engine has cooled down, inspect the coolant level and check the cooling system components for leaks. If the coolant level in the reserve tank is low, add coolant until it reaches the MAX mark. If there is no coolant in the reserve tank, make sure the radiator is cool, then cover the radiator cap with a heavy cloth and open the cap. If necessary, add coolant up to the base of the filler neck, and put the cap back on.

Once the engine has cooled sufficiently, restart it and check the temperature gauge. If the temperature needle has gone down, resume driving. If it has not gone down, contact a dealer for repairs.

WARNING

Steam and spray from an overheated engine can seriously scald you. Do not open the hood if steam is coming out.

WARNING

Removing the radiator cap while the engine is hot can cause the coolant to spray out, seriously scalding you.

Always let the engine and radiator cool down before removing the radiator cap.

NOTICE

Continuing to drive with the temperature gauge needle at the H mark may damage the engine.

Emergency Engine Stop*

The ENGINE START/STOP button may be used to stop the engine due to an emergency situation even while driving. If you must stop the engine, choose one of the following operations:

- Press and hold the ENGINE START/STOP button for two seconds, or
- Firmly press the ENGINE START/STOP button two times.

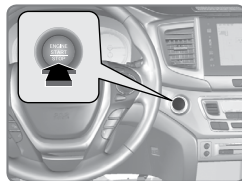

The steering wheel will not lock. Because turning off the engine also disables the power assist the engine provides to the steering and braking systems, it will require significantly more physical effort and time to steer and slow the vehicle. Use both feet on the brake pedal, if necessary, to slow the vehicle and stop immediately in a safe place.

Do not press the button while driving unless it is absolutely necessary for the engine to be switched off.

Emergency Towing

Call a professional towing service if you need to tow your vehicle.

All models

Flat bed equipment: The operator loads your vehicle on the back of a truck. **This is the best way to transport your vehicle.**

2WD models

Wheel lift equipment: The tow truck uses two pivoting arms that go under the front tires and lift them off the ground. The rear tires remain on the ground. **This is an acceptable way to tow your vehicle.**

NOTICE

Trying to lift or tow your vehicle by the bumpers will cause serious damage. The bumpers are not designed to support the vehicle's weight.

Improper towing such as towing behind a motorhome or other motor vehicle can damage the transmission.

Tire Pressure Monitoring System (TPMS)

Monitors the tire pressure while you are driving.

If your vehicle's tire pressure becomes significantly low, the low tire pressure indicator comes on and a message appears on the multi-information display. The specific tire with low pressure is displayed.



■ What to Do

Stop your vehicle in a safe place. Check the tire pressure and adjust the pressure to the specified level. The specified tire pressure is on a label on the driver's doorjamb.

■ Tire Fill Assist

Your vehicle gives you visual and audible alerts to help you adjust the tire pressure to its appropriate level when the vehicle is on.

While inflating: The system beeps and the exterior lights flash once every 5 seconds.

When the correct pressure is reached: The system beeps and the exterior lights flash continuously for 5 seconds. Stop filling the tire.

If you overinflate: The system beeps and the exterior lights flash twice every 3 seconds.

NOTICE

Driving on an extremely underinflated tire can cause it to overheat. An overheated tire can fail. Always inflate your tires to the specified pressure.

■ Tire Pressure Monitoring System (TPMS) – Required Federal Explanation

Each tire, including the spare (if provided), should be checked monthly when cold and inflated to the inflation pressure recommended by the vehicle manufacturer on the vehicle placard or tire inflation pressure label.

(If your vehicle has tires of a different size than the size indicated on the vehicle placard or tire inflation pressure label, you should determine the proper tire inflation pressure for those tires.)

As an added safety feature, your vehicle has been equipped with a tire pressure monitoring system (TPMS) that illuminates a low tire pressure telltale when one or more of your tires is significantly under-inflated.



Accordingly, when the low tire pressure telltale illuminates, you should stop and check your tires as soon as possible, and inflate them to the proper pressure.

Driving on a significantly under-inflated tire causes the tire to overheat and can lead to tire failure. Under-inflation also reduces fuel efficiency and tire tread life, and may affect the vehicle's handling and stopping ability.

Please note that the TPMS is not a substitute for proper tire maintenance, and it is the driver's responsibility to maintain correct tire pressure, even if under-inflation has not reached the level to trigger illumination of the TPMS low tire pressure telltale.

Your vehicle has also been equipped with a TPMS malfunction indicator to indicate when the system is not operating properly. The TPMS malfunction indicator is combined with the low tire pressure telltale. When the system detects a malfunction, the telltale will flash for approximately one minute and then remain continuously illuminated. This sequence will continue upon subsequent vehicle start-ups as long as the malfunction exists.

When the malfunction indicator is illuminated, the system may not be able to detect or signal low tire pressure as intended.

TPMS malfunctions may occur for a variety of reasons, including the installation of replacement or alternate tires or wheels on the vehicle that prevent the TPMS from functioning properly.

Always check the TPMS malfunction telltale after replacing one or more tires or wheels on your vehicle to ensure that the replacement or alternate tires and wheels allow the TPMS to continue to function properly.

Changing a Flat Tire

If a tire goes flat while driving, grasp the steering wheel firmly, and brake gradually to reduce speed. Then, stop in a safe place. Replace the flat tire with the compact spare tire. Go to a dealer as soon as possible to have the full-size tire repaired or replaced.

■ Getting Ready to Change the Tire

Park the vehicle on a firm, level, non-slippery surface. Apply the parking brake, shift to Park (P), and turn the vehicle off. Turn on the hazard warning lights.

1. Push the rear edge of the handle on the floor lid and open the lid.

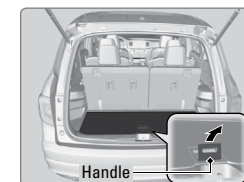

2. Pull and remove the cover. Take the wheel nut wrench and jack handle bar out of the rear side compartment.

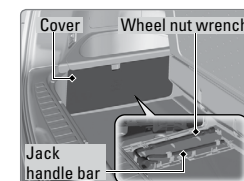

3. Loosen the strap, then take the jack out.

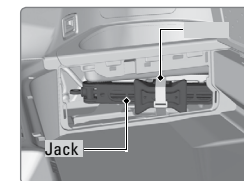

4. Remove the cover and the rubber plug on the cargo area lining to access the shaft for the spare tire hoist.

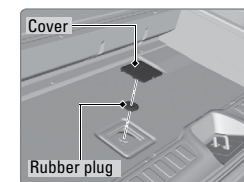

5. Put the wheel nut wrench with the jack handle bar on the hoist shaft. Turn the wrench to the left to lower the spare tire to the ground.

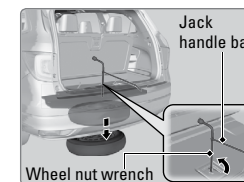

- Keep turning the wheel nut wrench to create slack in the cable.
- Remove the bracket from the spare tire.

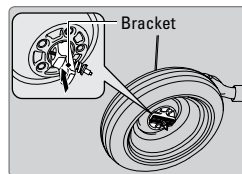

- Place the compact spare tire wheel side up under the vehicle body, near the tire that needs to be replaced.
- Loosen each wheel nut about one turn using the wheel nut wrench.



■ Setting Up the Jack

- Place the jack under the jacking point closest to the tire to be changed.
- Turn the end bracket clockwise (as shown in the image) until the top of the jack contacts the jacking point. Make sure that the jacking point tab is resting in the jack notch.
- Raise the vehicle, using the jack handle bar and the jack handle, until the tire is off the ground.

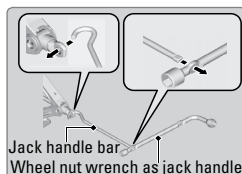
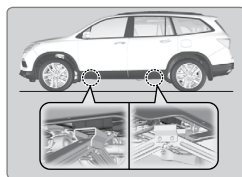

⚠ WARNING

The vehicle can easily roll off the jack, seriously injuring anyone underneath. Follow the directions for changing a tire exactly, and never get under the vehicle when it is supported only by the jack.

NOTICE

Do not use the jack if it doesn't work properly. Call your dealer or a professional towing service.

The following instructions must be followed to use the jack safely:

- Do not use the jack with people or luggage in the vehicle.
- Use the jack provided in your vehicle. Other jacks may not support the weight ("load") or fit the jacking point.
- Do not use while the engine is running.
- Use only where the ground is firm and level.
- Use only at the jacking points.
- Do not get in the vehicle while using the jack.
- Do not put anything on top of or underneath the jack.

■ Replacing the Flat Tire

- Remove the wheel nuts and flat tire.
- Mount the compact spare tire. Replace the wheel nuts, and lightly tighten them.
- Lower the vehicle and remove the jack. Tighten the wheel nuts in the order indicated in the image. Go around, tightening the nuts, two to three times in this order. Do not overtighten the wheel nuts.

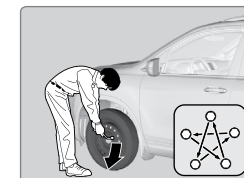
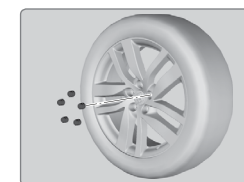

If you drive with the spare tire installed, the low tire pressure/TPMS indicator appears. The indicator stays on until a regular tire is installed.

■ Storing the Flat Tire

1. Remove the center cap and place the flat tire face up under the hoist.
2. Insert the hoist bracket into the center hole of the flat tire.
3. Turn the wheel nut wrench with the jack handle bar clockwise until the flat tire rests against the underbody of the vehicle and you hear the hoist click.
4. Securely put the jack and wheel nut wrench back in the tool case. Store the case in the cargo area.

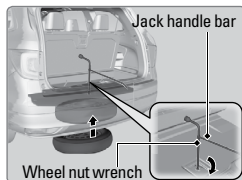
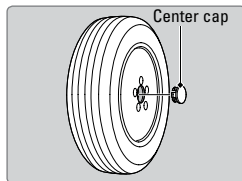

⚠ WARNING

Loose items can fly around the interior in a crash and can seriously injure the occupants.

Store the wheel, jack, and tools securely before driving.

Fuse Locations

If any electrical devices are not working, turn the vehicle off and check to see if any applicable fuse is blown. Fuse locations are shown on the fuse box cover. Locate the fuse in question by the fuse number and box cover number.

■ Engine Compartment Fuse Box Type A

Located under the hood on the passenger's side. Push the tabs to open the box.

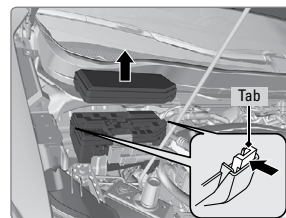

	Circuit Protected	Amps
	-	(70 A)
1	RR BLOWER	30 A
	ABS/VSA MTR	40 A
	ABS/VSA FSR	20 A
	MAIN FAN	30 A
	MAIN FUSE	150 A
	SUB FAN	30 A
	WIP MTR	30 A
	WASHER	20 A
	SUNSHADE	(20 A)
	-	(30 A)
2	FR BLOWER	40 A
	AC INVERTER	(30 A)
	AUDIO AMP	(30 A)
	RR DEF	40 A
	-	(30 A)
	-	(20 A)
3	-	-
	-	-
	-	-

	Circuit Protected	Amps
4	PARKING LIGHT	10 A
5	-	-
6	STOP LIGHT	10 A
7	-	-
8	L H/L LO	10 A
9	-	-
10	R H/L LO	10 A
11	IGPS	7.5 A
12	INJECTOR	(20 A)
13	H/L LO MAIN	20 A
14	USB CHARGER	(15 A)
15	FR FOG	(15 A)
16	HAZARD	15 A
17	AS P/SEAT (REC)	(20 A)
18	AS P/SEAT (SLIDE)	(20 A)
19	ACM	20 A
20	MG CLUTCH	7.5 A
21	MAIN RLY	15 A
22	FI SUB	15 A
23	IG COIL	15 A
24	DBW	15 A
25	SMALL/STOP MAIN	(20 A)
26	BACK UP	10 A
27	HTD STRG WHEEL	(10 A)
28	HORN	10 A
29	RADIO	(20 A)

TABLE OF CONTENTS
 VISUAL INDEX
 SAFETY INFORMATION
 INSTRUMENT PANEL
 VEHICLE CONTROLS
 AUDIO AND CONNECTIVITY
 BLUETOOTH® HANDSFREELINK®
 HONDALINK®

NAVIGATION
 DRIVING
 HANDLING THE UNEXPECTED
 MAINTENANCE
 SPECIFICATIONS
 CUSTOMER INFORMATION
 VOICE COMMAND INDEX
 INDEX

■ Engine Compartment Fuse Box Type B

Located under the hood near the brake fluid reservoir. Push the tabs to open the box.

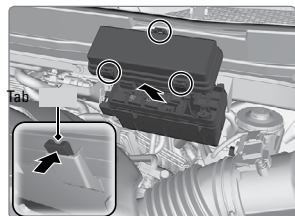

	Circuit Protected	Amps	
1	ST CUT1	(40 A)	
	4WD	(20 A)	
	IG MAIN	30 A	
	IG MAIN2	30 A	
	PTG MTR	(40 A)	
	F/B MAIN2	60 A	
	F/B MAIN	60 A	
	EPS	60 A	
	2	TRL MAIN	(30 A)
	3	TRL E-BRAKE	(20 A)
4	BMS	7.5 A	
5	H/L HI MAIN	20 A	
6	PTG CLOSER	(20 A)	
7	CTR ACC SOCKET	20 A	
8	RR ACC SOCKET	(20 A)	
9	FR DE-ICE	(15 A)	
10	ACC/IG2_MAIN	10 A	
11	TRL CHARGE	(20 A)	
12	IDLE STOP ST CUT	(30 A)	
13	IDLE STOP	(30 A)	
14	IDLE STOP	(30 A)	
15	TCU/SBW	(15 A)	
16	RR HEATED SEAT	(20 A)	
17	STRLD	7.5 A	

■ Interior Fuse Box Type A

Located under the dashboard.

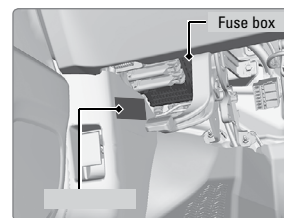

	Circuit Protected	Amps
1	DR P/W	20 A
2	DOOR LOCK	20 A
3	SMART	7.5 A
4	AS P/W	20 A
5	FR ACC SOCKET	20 A
6	FUEL PUMP	20 A
7	ACG	15 A
8	FRONT WIPER	7.5 A
9	IG1 SMART ^{*1}	7.5 A
	ABS/VSA ^{*2}	7.5 A
10	SRS	10 A
11	REAR LEFT P/W	20 A
12	-	-
13	REAR RIGHT P/W	20 A
14	FUEL LID	20 A
15	DR P/SEAT (REC)	(20 A)
16	REAR FOG	(7.5 A)
17	FR SEAT HEATER	(20 A)
18	INTR LT	7.5 A

	Circuit Protected	Amps
19	DR REAR DOOR UNLOCK	10 A
20	AS SIDE DOOR UNLOCK	10 A
21	DRL	7.5 A
22	KEY LOCK	7.5 A
23	A/C	7.5 A
24	IG1a FEED BACK	7.5 A
25	INST PANEL LIGHTS	7.5 A
26	LUMBAR SUPPORT	(10 A)
27	PARKING LIGHTS	7.5 A
28	OPTION	10 A
29	BACK LT ^{*1}	7.5 A
	METER ^{*2}	7.5 A
30	REAR WIPER	10 A
31	ST MOTOR ^{*1}	(7.5 A)
	MISS SOL ^{*2}	(7.5 A)
32	SRS	7.5 A
33	AS SIDE DOOR LOCK	10 A
34	DR DOOR LOCK	10 A
35	DR DOOR UNLOCK	10 A
36	DR P/SEAT (SLIDE)	(20 A)
37	RIGHT H/L HI	10 A
38	LEFT H/L HI	10 A
39	IG1b FEED BACK	7.5 A
40	ACC	7.5 A
41	DR REAR DOOR LOCK	10 A
42	-	-

*1: Models with auto idle stop
*2: Models without auto idle stop

■ Interior Fuse Box Type B*

Located under the dashboard.

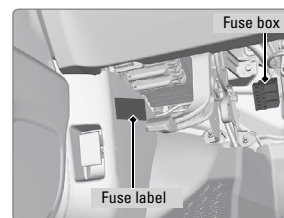

	Circuit Protected	Amps
A	METER	7.5 A
B	ABS/VSA	7.5 A
C	ACG	7.5 A
D	MICU	7.5 A
E	AUDIO	20 A
F	BACK UP	10 A
G	ACC	7.5 A

*if equipped

■ Inspecting and Changing Fuses

1. Turn the vehicle off, including all lights and accessories.
2. Remove the fuse box cover.
3. Check the large fuse in the engine compartment.

If the fuse is blown, use a Phillips-head screwdriver to remove the screws and replace the fuse with a new one. Reinstall the screws.

4. Inspect the small fuses in the engine compartment and the vehicle interior.

If there is a burned out fuse, remove it with the fuse puller and replace it with a new one.

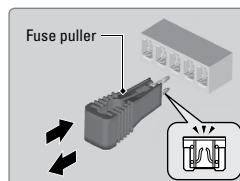
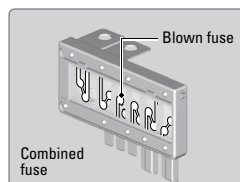

NOTICE

Replacing a fuse with one that has a higher rating greatly increases the chances of damaging the electrical system.

MAINTENANCE

Learn about basic maintenance that you can perform on the vehicle yourself, as well as information about how to best maintain the vehicle.

Safety Precautions

Some of the most important safety precautions are listed below; however, we cannot warn you of every conceivable hazard that can arise in performing maintenance. Only you can decide whether or not you should perform a given task.

■ Maintenance Safety

- To reduce the possibility of fire or explosion, keep cigarettes, sparks, and flames away from the battery and all fuel-related parts.
- Never leave rags, towels, or other flammable objects under the hood.
- To clean parts, use a commercially available degreaser or parts cleaner, not gasoline.
- Wear eye protection and protective clothing when working with the battery or compressed air.
- Do not run the engine in confined spaces where carbon monoxide gas can accumulate.

■ Vehicle Safety

- The vehicle must be stationary, and parked on level ground with the parking brake set and the engine off.
- Be aware that hot parts can burn you.
- Be aware that moving parts can injure you.
- Do not open the hood while the Auto Idle Stop function* is activated.

⚠ WARNING

Improperly maintaining this vehicle or failing to correct a problem before driving can cause a crash in which you can be seriously hurt or killed.

Always follow the inspection and maintenance recommendations according to the schedules in this guide.

⚠ WARNING

Failure to properly follow maintenance instructions and precautions can cause you to be seriously hurt or killed.

Always follow the procedures and precautions in this guide.

Maintenance Minder™

When maintenance is due, the system message indicator comes on and a message appears on the display every time you turn the vehicle on. See page 143 to check what maintenance is due indicated by the codes that appear.

Press the Info (▲/▼) button on the steering wheel to change displays.

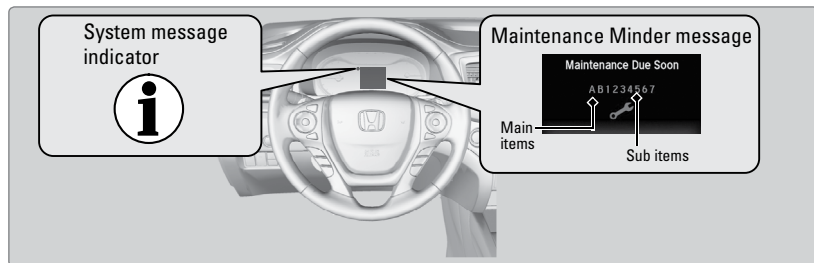

- Independent of the Maintenance Minder information, replace the brake fluid every 3 years.
- Inspect idle speed every 160,000 miles (256,000 km).
- Adjust the valves during services A, B, 1, 2, or 3 if they are noisy.

U.S. models

Maintenance, replacement, or repair of emissions control devices and systems may be done by any automotive repair establishment or individuals using parts that are certified to EPA standards.

According to state and federal regulations, failure to perform maintenance on the maintenance main items marked with # will not void your emissions warranties. However, all maintenance services should be performed in accordance with the intervals indicated by the multi-information display.

Maintenance Minder Service Codes

These codes indicate what services are due on your vehicle.

CODE	Maintenance Main Items
A	Replace engine oil*1
B	Replace engine oil*1 and oil filter Inspect front and rear brakes Check parking brake adjustment Inspect tie rod ends, steering gearbox, and boots Inspect suspension components Inspect driveshaft boots Inspect brake hoses and lines (Including ABS/VSA) Inspect all fluid levels and condition of fluids Inspect exhaust system# Inspect fuel lines and connections#

*1: If the message Maintenance Due Now does not appear more than 12 months after the display is reset, change the engine oil every year.
#: See information on maintenance and emissions warranty.
*2: If you drive in dusty conditions, replace the air cleaner element every 15,000 miles (24,000 km).
*3: If you drive primarily in urban areas that have high concentrations of soot in the air from industry and diesel-powered vehicles, replace every 15,000 miles (24,000 km).

CODE	Maintenance Sub Items
1	Rotate tires
2	Replace air cleaner element*2 Replace dust and pollen filter*3 Inspect drive belt
3	Replace transmission fluid, transfer fluid*
4	Replace spark plugs Replace timing belt and inspect water pump*4 Inspect valve clearance
5	Replace engine coolant
6	Replace rear differential fluid*,*5

*4: If you drive regularly in very high temperatures (over 110°F, 43°C), in very low temperatures (under -20°F, -29°C), or towing a trailer, replace every 60,000 miles/100,000 km.
*5: Driving in mountainous areas at very low vehicle speeds or trailer towing results in higher level of mechanical (Shear) stress to fluid. This requires differential fluid changes more frequently than recommended by the Maintenance Minder. If you regularly drive your vehicle under these conditions, have the differential fluid changed at 7,500 miles (12,000 km), then every 15,000 miles (24,000 km).

*if equipped

Under the Hood

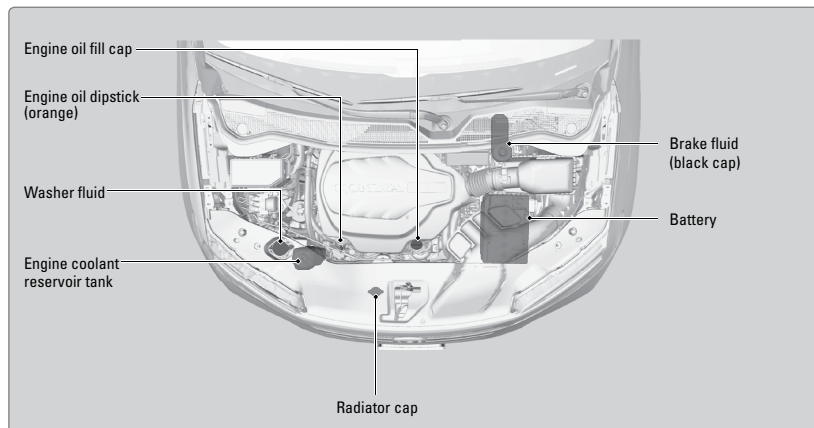

Opening the Hood

1. Park the vehicle on a level surface, and set the parking brake.
2. Pull the hood release handle under the lower left corner of the dashboard.
3. Push up the hood latch lever in the center of the hood to release the lock mechanism, and open the hood.
4. Remove the support rod from the clamp using the grip. Mount the support rod in the hood.

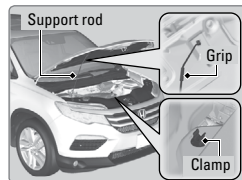
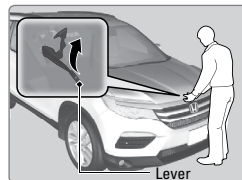
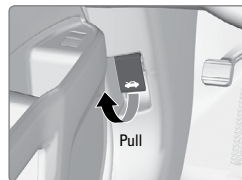

When closing, remove the support rod, and stow it in the clamp, then gently lower the hood. Remove your hand at a height of approximately 12 inches (30 cm) and let the hood close.

NOTICE

Do not open the hood when the wiper arms are raised. The hood will strike the wipers, and may damage either the hood or the wipers.

Do not open the hood while the Auto Idle Stop* function is activated.



Information Provided by:
DEALER
E-PROCESS

Engine Compartment Cover

The component parts in the engine compartment are protected by a cover. You may need to remove the cover when you perform certain maintenance work.

Starting at either side, lift the outermost edge of the engine compartment cover. Pull up on the cover, and remove it from the pins. Move towards the opposite side while applying uniform upward pressure.

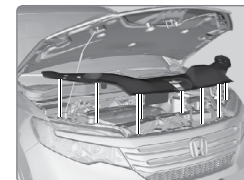

Engine Oil

Park the vehicle on level ground, and wait approximately three minutes after turning the engine off before you check the oil.

■ Checking the Oil

1. Remove the dipstick (orange).
2. Wipe the dipstick with a clean cloth or paper towel.
3. Insert the dipstick back all the way into its hole.
4. Remove the dipstick again, and check the level. It should be between the upper and lower marks. Add oil if necessary.

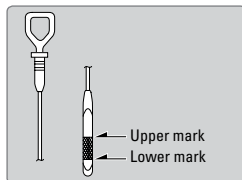
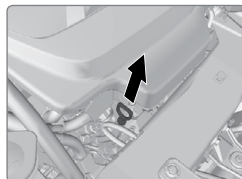

■ Recommended Engine Oil

- **Honda Genuine Motor Oil**
- **Premium-grade 0W-20 detergent oil with an API Certification Seal on the container**

This seal indicates the oil is energy conserving and that it meets the American Petroleum Institute's latest requirements.



Use Honda Genuine Motor Oil or another commercial engine oil of suitable viscosity for the ambient temperature as shown.

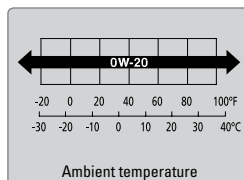

You may also use synthetic motor oil if it is labeled with the API Certification Seal and is of the specified viscosity grade.

■ Adding Oil

1. Unscrew and remove the engine oil fill cap.
2. Add oil slowly.
3. Reinstall the engine oil fill cap, and tighten it securely.
4. Wait for three minutes and recheck the engine oil dipstick.

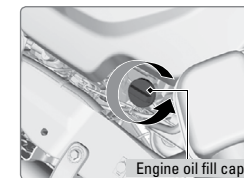

NOTICE

Do not fill the engine oil above the upper mark. Overfilling the engine oil can result in leaks and engine damage.

■ Resetting the Engine Oil Life

If you change or replace the vehicle's engine oil yourself, you must reset the engine oil life. Use the steering wheel buttons to operate the menu.

1. Use the Info (▲/▼) buttons to scroll to the Vehicle Settings menu. Press the RESET button to enter the menu.
2. Scroll to Maintenance Info, and select it.
3. Press and hold the RESET button to enter the oil life reset mode.
4. Select Reset. The maintenance codes disappear, and the engine oil life returns to 100%.

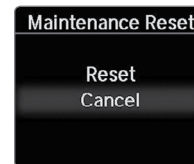

NOTICE

Failure to reset the engine oil life after a maintenance service results in the system showing incorrect maintenance intervals, which can lead to serious mechanical problems.

Engine Coolant

Park the vehicle on level ground. Check the reserve tank and the coolant level in the radiator. **We recommend Honda Long Life Antifreeze/Coolant Type 2.**

■ Checking the Reserve Tank

1. Check the amount of coolant in the reserve tank.
2. If the coolant level is below the MIN mark, add the specified coolant until it reaches the MAX mark.
3. Inspect the cooling system for leaks.

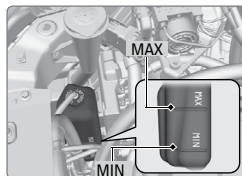

NOTICE

If temperatures consistently below -22°F (-30°C) are expected, the coolant mixture should be changed to a higher concentration. Consult a dealer for details for more information.

■ Adding Coolant

1. Make sure the engine and radiator are cool.
2. Remove the engine compartment cover.
3. Turn the radiator cap counterclockwise and relieve any pressure in the coolant system. Do not push the cap down when turning.
4. Push down and turn the radiator cap counterclockwise to remove it.
5. The coolant level should be up to the base of the filler neck. Add coolant if it is low.
6. Put the radiator cap back on, and tighten it fully.
7. Pour coolant into the reserve tank until it reaches the MAX mark. Put the cap back on the reserve tank.

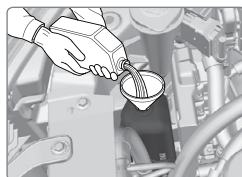
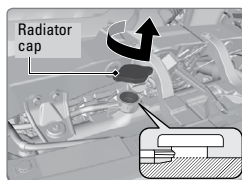

⚠ WARNING

Removing the radiator cap while the engine is hot can cause the coolant to spray out, seriously scalding you.

Always let the engine and radiator cool down before removing the radiator cap.

NOTICE

Pour the fluid slowly and carefully so you do not spill any. Clean up any spills immediately; they can damage components in the engine compartment.

Checking the Battery

The battery condition is monitored by the sensor on the negative terminal. If there is a problem with the sensor, a message appears on the multi-information display. Have your vehicle checked by a dealer.

For jump starting, see page 127.

⚠ WARNING

The battery gives off explosive hydrogen gas during normal operation.

A spark or flame can cause the battery to explode with enough force to kill or seriously hurt you.

When conducting any battery maintenance, wear protective clothing and a face shield, or have a skilled technician do it.

WARNING: Battery posts, terminals, and related accessories contain lead and lead compounds. **Wash your hands after handling.**

Window Washer Fluid

If the washer fluid level is low, fill the washer reservoir. You can check the level by looking at the reservoir, or a message* will appear on the MID.

Pour the washer fluid carefully. Do not overflow the reservoir.

NOTICE

Do not use engine antifreeze or a vinegar/water solution in the windshield washer reservoir. Antifreeze can damage your vehicle's paint. A vinegar/water solution can damage the windshield washer pump.

Brake Fluid

The fluid level should be between the MIN and MAX marks on the side of the reservoir. **We recommend using Honda Heavy Duty Brake Fluid DOT 3.**

Pour the fluid carefully.

If the fluid level is at or below the MIN mark, have a dealer inspect for leaks or worn brake pads as soon as possible.

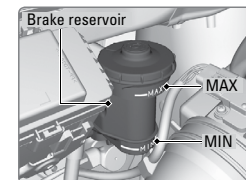

NOTICE

Brake fluid marked DOT 5 is not compatible with your vehicle's braking system and can cause extensive damage.

*if equipped

Changing Wiper Blades

If the wiper blades leave streaks across the windshield, try cleaning them first with a paper towel or soft cloth and wiper fluid. If the wiper blade rubber has deteriorated, you should change the wiper blades.

■ Changing the Front Wiper Blade Rubber

1. Lift the driver side wiper arm first, then the passenger side.
2. Place a cloth on the edge of the lock tab. Push the lock tab up with a flat-tip screwdriver.
3. Slide the blade from the wiper arm.
4. Slide the wiper blade out from its holder by pulling the tabbed end out.
5. Remove the retainers from the rubber blade that has been removed, and mount to a new rubber blade. Correctly align the rubber protrusion and the retainer grooves.
6. Slide the new wiper blade onto the holder from the bottom end. The tab on the holder should fit in the indent of the wiper blade. Slide the wiper blade onto the wiper arm until it locks
7. Slide the wiper blade onto the wiper arm, then push down the lock tab.
8. Lower the passenger side wiper arm first, then the driver side.

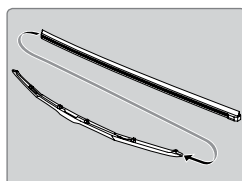
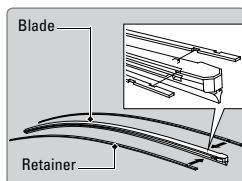
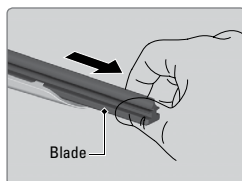
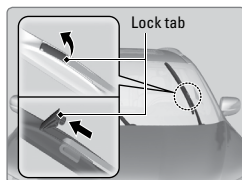
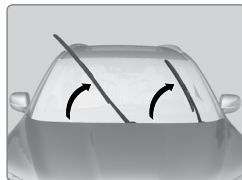

NOTICE

Avoid dropping the wiper arm, as it may damage the windshield.

■ Changing the Rear Wiper Blade Rubber

1. Raise the wiper arm off.
2. Slide the wiper blade out from the end with the indent.
3. Remove the retainers from the wiper blade, and mount to a new rubber blade.
4. Slide the new wiper blade onto the holder. Make sure it is engaged correctly, then install the wiper blade assembly onto the wiper arm.

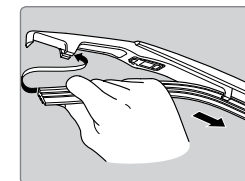
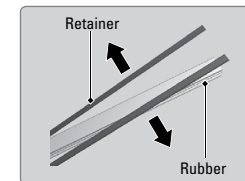
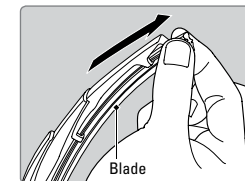

Tire Information

To safely operate your vehicle, your tires must be of the proper type and size, in good condition with adequate tread, and properly inflated.

Inflation Guidelines

- Properly inflated tires provide the best combination of handling, tread life, and comfort. Refer to the driver's doorjamb label or the specifications (see page 159) for the specified pressure.
- Underinflated tires wear unevenly, adversely affect handling and fuel economy, and are more likely to fail from overheating.
- Overinflated tires make your vehicle ride harshly, are more prone to road hazards, and wear unevenly.
- Every day before you drive, look at each of the tires. If one looks lower than the others, check the pressure with a tire gauge.
- Measure the air pressure when tires are cold. This means the vehicle has been parked for at least 3 hours, or driven less than 1 mile (1.6 km). If necessary, add or release air until the specified pressure is reached. If checked when hot, tire pressure can be as much as 4-6 psi (30-40 kPa, 0.3-0.5 kgf/cm²) higher than checked when cold.
- At least once a month or before long trips, use a gauge to measure the pressure in all tires, including the spare. Even tires in good condition can lose 1-2 psi (10-20 kPa, 0.1-0.2 kgf/cm²) per month.

Inspection Guidelines

Every time you inflate the tires, check for the following:

- Any damage to tires, including bumps, bulges, cuts, splits, or cracks in the side or tread. Remove any foreign objects and inspect for air leaks. Replace tires if you see fabric or cord.
- Uneven or excessive tread wear. Have a dealer check the wheel alignment.
- Cracks or other damage around the valve stems.

Wear Indicators

The groove where the wear indicator is located is 1/16 inch (1.6 mm) shallower than elsewhere on the tire. If the tread has worn so low that the indicator is exposed, replace the tire. **Worn out tires have poor traction on wet roads.**

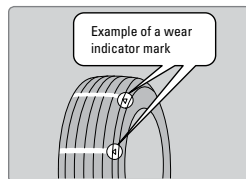

⚠ WARNING

Using tires that are excessively worn or improperly inflated can cause a crash in which you can be seriously hurt or killed.

Follow all instructions in this owner's manual regarding tire inflation and maintenance.

Tire and Loading Information Label

The label attached to the driver's doorjamb provides necessary tire and loading information.

TIRE AND LOADING INFORMATION

SEATING CAPACITY: TOTAL X FRONT X REAR X

The combined weight of occupants and cargo should never exceed XXXkg or XXXlbs.

TIRE	SIZE	COLD TIRE PRESSURE	SEE OWNER'S MANUAL FOR ADDITIONAL INFORMATION
FRONT	XXXX/XXXXX XXX	XXXKPA, XXPSI	
REAR	XXXX/XXXXX XXX	XXXKPA, XXPSI	
SPARE	XXXX/XXXXX XXX	XXXKPA, XXPSI	

Tire and Wheel Replacement

Replace your tires with radials of the same size, load range, speed rating, and maximum cold tire pressure rating (as shown on the tire's sidewall). Using tires of a different size or construction can cause certain vehicle systems to work incorrectly. It is best to replace all four tires at the same time. If that isn't possible, replace the front or rear tires in pairs.

If you change or replace a wheel, make sure that the wheel's specifications match those of the original wheels. Only use TPMS-specified wheels approved for your vehicle.

⚠ WARNING

Installing improper tires on your vehicle can affect handling and stability. This can cause a crash in which you can be seriously hurt or killed.

Always use the size and type of tires recommended in the Owner's Manual.

Tire Service Life

The life of your tires is dependent on many factors, including driving habits, road conditions, vehicle loading, inflation pressure, maintenance history, speed, and environmental conditions (even when the tires are not in use).

In addition to regular inspections and inflation pressure maintenance, it is recommended that you have annual inspections performed once the tires reach five years old. All tires, including the spare, should be removed from service after 10 years from the date of manufacture, regardless of their condition or state of wear.

Winter Tires

If driving on snowy or frozen roads, mount all season tires marked "M+S", snow tires, or tire chains; reduce speed; and maintain sufficient distance between vehicles when driving. For winter tires, select the size and load ranges that are the same as the original tires, and mount them to all four wheels.

Tire Chains

Install tire chains on the front tires only. Because your vehicle has limited tire clearance, we strongly recommend using the following chains: **Cable type: SCC Cable Chain ZT735**. Mount chains as tightly as you can, and make sure that they do not touch the brake lines or suspension.

NOTICE

Traction devices that are the wrong size or improperly installed can damage your vehicle's brake lines, suspension, body, and wheels. Stop driving if they are hitting any part of the vehicle.

WARNING

Using the wrong chains, or not properly installing chains, can damage the brake lines and cause a crash in which you can be seriously injured or killed. Follow all instructions in this guide regarding the selection and use of tire chains.

Tire Labeling

The tires that came on your vehicle have a number of markings. Those you should be aware of are described below.

Here is an example of what each marking means:

P235/60R18 102V

- P: vehicle type (P indicates passenger vehicle)
- 235: tire width in millimeters
- 60: aspect ratio (tire section height as a percentage of its width)
- R: tire construction code (radial)
- 18: rim diameter in inches
- 102: load index (code indicating maximum load tire can carry)
- V: speed symbol (code indicating maximum speed rating)

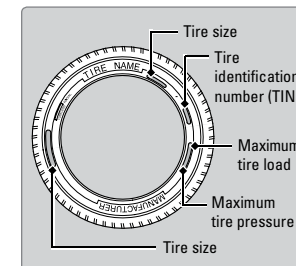

Tire Identification Number (TIN)

The tire identification number (TIN) is a group of numbers and letters that look like the example below. TIN is located on the sidewall of the tire.

DOT B97R FW6X 2209
 DOT: This indicates that the tire meets all requirements of the U.S. Department of Transportation.
 B97R: Manufacturer's identification mark
 FW6X: Tire type code
 22 09: Date of Transportation
 Year
 Week

Glossary of Tire Terminology

Cold Tire Pressure – The tire air pressure when the vehicle has been parked for at least three hours or driven less than 1 mile (1.6 km).

Load Rating – The maximum load that a tire is rated to carry for a given inflation pressure.

Maximum Inflation Pressure – The maximum tire air pressure that the tire can hold.

Maximum Load Rating – The load rating for a tire at the maximum permissible inflation pressure for that tire.

Recommended Inflation Pressure – The cold tire inflation pressure recommended by the manufacturer.

Treadwear Indicators (TWI) – The projections within the principal grooves designed to give a visual indication of the degrees of wear of the tread.



TABLE OF CONTENTS
 VISUAL INDEX
 SAFETY INFORMATION
 INSTRUMENT PANEL
 VEHICLE CONTROLS
 AUDIO AND CONNECTIVITY
 BLUETOOTH® HANDSFREELINK®
 HONDALINK®

NAVIGATION
 DRIVING
 HANDLING THE UNEXPECTED
 MAINTENANCE
 SPECIFICATIONS
 CUSTOMER INFORMATION
 VOICE COMMAND INDEX
 INDEX

DOT Tire Quality Grading

The tires on your vehicle meet all U.S. Federal Safety Requirements. All tires are also graded for treadwear, traction, and temperature performance according to Department of Transportation (DOT) standards. The following explains these gradings.

■ Uniform Tire Quality Grading

Quality grades can be found where applicable on the tire sidewall between tread shoulder and maximum section width.

For example:

Treadwear 200

Traction AA

Temperature A

All passenger car tires must conform to Federal Safety Requirements in addition to these grades.

■ Treadwear

The treadwear grade is a comparative rating based on the wear rate of the tire when tested under controlled conditions on a specified government test course. For example, a tire graded 150 would wear one and one-half (1 1/2) times as well on the government course as a tire graded 100. The relative performance of tires depends upon the actual conditions of their use, however, and may depart significantly from the norm due to variations in driving habits, service practices, and differences in road characteristics and climate.

■ Traction

The traction grades, from highest to lowest, are AA, A, B, and C. Those grades represent the tire's ability to stop on wet pavement as measured under controlled conditions on specified government test surfaces of asphalt and concrete. A tire marked C may have poor traction performance.

WARNING: The traction grade assigned to this tire is based on straight-ahead braking traction tests, and does not include acceleration, cornering, hydroplaning, or peak traction characteristics.

■ Temperature

The temperature grades are A (the highest), B, and C, representing the tire's resistance to the generation of heat and its ability to dissipate heat when tested under controlled conditions on a specified indoor laboratory test wheel. Sustained high temperature can cause the material of the tire to degenerate and reduce tire life, and excessive temperature can lead to sudden tire failure. The grade C corresponds to a level of performance which all passenger car tires must meet under the Federal Motor Vehicle Safety Standard No. 109. Grades B and A represent higher levels of performance on the laboratory test wheel than the minimum required by law.

WARNING: The temperature grade for this tire is established for a tire that is properly inflated and not overloaded. Excessive speed, underinflation, or excessive loading, either separately or in combination, can cause heat buildup and possible tire failure.

Testing of Readiness Codes

Your vehicle has “readiness codes” as part of the onboard self-diagnostic system. Some states refer to these codes as a test to see if your vehicle’s emissions components are working properly. The codes may not be read if you go through the testing just after the battery has gone dead or been disconnected.

To check if they are set, turn the vehicle on without starting the engine. The malfunction indicator lamp will come on for several seconds. If it goes off, the readiness codes are set. If it blinks five times, the readiness codes are not set.

If you are required to have your vehicle tested before the readiness codes are set, prepare the vehicle for retesting by doing the following:

1. Fill the gas tank to approximately 3/4 full.
2. Park the vehicle and leave the engine off for 6 hours or more.
3. Make sure the ambient temperature is between 40°F and 95°F (4°C and 35°C).
4. Start the engine without touching the accelerator pedal, and let it idle for 20 seconds.
5. Keep the vehicle in Park (P). Increase the engine speed to 2,000 rpm, and hold it there for about 3 minutes.
6. Let the engine idle with your foot off the accelerator for 20 seconds.
7. Select a nearby, lightly traveled major highway where you can maintain a speed of 50 to 60 mph (80 to 97 km/h) for at least 20 minutes. Drive on the highway with the vehicle in Drive. Do not use cruise control. When traffic allows, drive for 90 seconds without using the accelerator pedal. (Vehicle speed may vary slightly; this is OK.) If you cannot do this for a continuous 90 seconds because of traffic conditions, drive for at least 30 seconds, then repeat two more times (for a total of 90 seconds).
8. Drive in city/suburban traffic for at least 10 minutes. When traffic conditions allow, let the vehicle coast for several seconds without using the accelerator pedal or the brake pedal.
9. Park the vehicle and leave the engine off for 30 minutes.

The readiness codes are erased when the battery is disconnected, and set again only after several days of driving under a variety of conditions.

If a testing facility determines that the readiness codes are not set, you may be requested to return at a later date to complete the test, or see your dealer.

SPECIFICATIONS

Vehicle

Model	Honda Pilot	
No. of Passengers:		
Front	2	
Rear	2nd Row	3 (2 ^{*1})
	3rd Row	3
Total	8 (7 ^{**})	
Weights:		
Gross Vehicle	5,545 lbs (2,515 kg) ^{*2}	
Weight Rating	5,842 lbs (2,650 kg) ^{*3}	
Gross Axle Weight	2,734 lbs (1,240 kg) ^{*2}	
Rating (Front)	2,855 lbs (1,295 kg) ^{*3}	
Gross Axle Weight	2,921 lbs (1,325 kg) ^{*2}	
Rating (Rear)	3,097 lbs (1,405 kg) ^{*3}	
Gross Combined Weight	8,025 lbs (3,640 kg) ^{*2}	
Rating	9,755 lbs (4,425 kg) ^{*3}	
Air Conditioning:		
Refrigerant Type	HFO-1234yf (R-1234yf)	
Charge Quantity	23.8 – 25.6 oz (675 – 725 g)	
Lubricant Type	POE RL85HM	
Quantity	7.5 – 7.82 cu-in (123 – 143 cm ³)	

*1: ELITE and TRG grade with AWD models

*2: 2WD models

*3: AWD models

Engine and Fuel

Engine	
Displacement	211.8 cu-in (3,471 cm ³)
Spark Plugs	NGK DILZKR7B11G
Fuel	
Type	Unleaded premium gasoline, Pump octane number of 87 or higher
Fuel Tank Capacity	19.5 US gal (73.8 ℓ)

Tires

Regular	Size	245/60R18 105H ^{*1}
		245/50R20 102H ^{*2}
Compact Spare	Pressure	32 (220 [2.2]) ^{*1}
	psi (kPa [kgf/cm ²])	35 (240 [2.4]) ^{*2}
Wheel Size	Size	T165/80D17 104M
	Pressure	60 (420 [4.2])
Compact Spare	Pressure	18 x 8J ^{*1}
		20 x 8J ^{*2}
	Compact Spare	17 x 4T

*1: Model with 18-inch wheel

*2: Model with 20-inch wheel

Fluids

Engine Oil	
Recommended	-Genuine Honda Motor Oil 0W-20
	-API Premium-grade 0W-20 detergent oil
Change	5.4 US qt (5.1 ℓ)
Capacity	Change including filter
	5.7 US qt (5.4 ℓ)

Engine Coolant	
Specified	Honda Long Life Antifreeze/Coolant Type 2
Ratio	50/50 with distilled water
Capacity	1.88 US gal (7.13 ℓ) ^{*1}
	1.93 US gal (7.3 ℓ) ^{*2}
	(change including the remaining 0.19 US gal (0.72 ℓ) in the reserve tank)

*1: Automatic transmission models with shift lever
*2: Automatic transmission models with electronic gear selector

Brake Fluid	
Specified	Honda Heavy Duty Brake Fluid DOT 3

Washer Fluid	
Tank Capacity	U.S.: 4 US qt (3.8 ℓ) Canada: 5.6 US qt (5.3 ℓ)

Automatic transmission models with shift lever	
Automatic Transmission Fluid	
Specified	Honda Automatic Transmission ATF-DW-1
Capacity	Change 3.3 US qt (3.1 ℓ)

Automatic transmission models with electronic gear selector	
Automatic Transmission Fluid	
Specified	Honda Automatic Transmission Fluid ATF-TYPE 3.1 or higher
Capacity	Change 3.5 US qt (3.3 ℓ)

Rear Differential Fluid *	
Specified	Honda DPSF-II
Capacity	Change 1.92 US qt (1.82 ℓ)
Transfer Assembly Fluid *	
Specified	-Honda Hypoid Gear Oil HGO-1 Hypoid gear oil SAE 75W-85 or SAE 90 (API grade GL4 or GL5)
Capacity	Change 0.45 US qt (0.43 ℓ)

**if equipped*



Light Bulbs

Headlights (Low Beam)	LED ^{*1} 55 W ^{*2} (H11)
Headlights (High Beam)	60W (HB3)
Fog Lights [*]	35 W (H8)
Front Turn Signal/Parking Lights	28/8 W (Amber)
Front Side Marker Lights	LED
Daytime Running Lights	60 W ^{*3} LED ^{*4}
Side Turn Signal Lights (on Door Mirrors)	LED
Brake Lights	LED
Rear Side Marker Lights	LED
Taillights	LED
Back-Up Lights	21 W
Rear Turn Signal Lights	21 W
High-Mount Brake Light	LED
Rear License Plate Light	LED
Interior Lights	
Front Row Lights	LED ^{*1} 5 W ^{*2}
Second Row and Third Row Lights	5 W
Front and Rear Ambient Lights	LED
Vanity Mirror Lights	1.4 W
Door Courtesy Lights	3.8 W
Door Inner Handle Lights	LED
Door Pocket Lights	LED
Console Compartment Light	1.4 W
Glove Box Light	1.4 W
Cargo Area Lights	8 W

*1: ELITE and TRG grade with AWD models

*2: Except ELITE and TRG grade with AWD models

*3: LX grade

*4: Except LX grade

CUSTOMER INFORMATION

Learn about information specific to you as a Honda customer and how to get help.

Frequently Asked Questions/Troubleshooting

Below are some frequently asked questions and troubleshooting items that you may have about the vehicle.

Q: *How do I set the vehicle clock?*

A: See page 57. For vehicles with navigation, the time is automatically set using GPS signals.

Q: *Why doesn't the vehicle start when I press the ENGINE START/STOP button?*

A: The brake pedal must be pressed to start the engine.

Q: *What is the AUTO setting on my headlight lever?*

A: When in the AUTO position, the vehicle's exterior lights will automatically turn on or off depending on the ambient lighting.

Q: *Why won't the driver's door unlock when I grab the door handle, even though the keyless access remote is within range?*

A: If you pull the handle too quickly, the system may not have time to confirm the door is unlocked. Wait to hear a beep to confirm the door is unlocked. If you are wearing gloves, the system may be slow to respond.

Q: *After my battery was disconnected or went dead, the audio system is asking for a code. Where do I find this?*

A: In most cases, you do not need to enter a code. Turn on the vehicle, and press and hold the audio power button until the system reactivates.

Q: *Why can't I operate Pandora[®] through the audio system?*

A: Audio may be streaming through Bluetooth[®] Audio. Make sure Pandora mode is selected and the phone cable is properly connected to the USB adapter. Some phones may prompt you to "Allow" a connection.

Q: *Is my phone compatible with Bluetooth features?*

A: Visit handsfreelink.honda.com (U.S.) or www.handsfreelink.ca (Canada) to check phone compatibility for Bluetooth[®] Audio, Bluetooth[®] HandsFreeLink[®], and SMS text messaging.

Q: *Every time I press the Talk button, the system gives me voice prompts. Can I turn these off?**

A: From the HOME screen, select Settings. Select System, then the Voice Prompt tab. Select Voice Prompt, then select Off.



*if equipped

*if equipped

- Q:** Why can't I select an item using the selector knob or touchscreen?
- A:** To prevent driver distraction, certain items are limited or inoperable while the vehicle is moving. Use voice commands or pull over to select the items.
- Q:** Where can I find the vehicle identification number (VIN)?
- A:** Check the label on the driver's doorjamb.

Contact Us

Honda dealer personnel are trained professionals. They should be able to answer all your questions. If you encounter a problem that your dealership does not solve to your satisfaction, please discuss it with the dealership's service manager or general manager. If you are dissatisfied with the decision made by the dealership's management, contact Honda Automobile Customer Service.

U.S. owners

American Honda Motor Co., Inc.
Honda Automobile Customer Service
1919 Torrance Blvd.
Mail Stop 500-2N-7A
Torrance, CA 90501-2746
Tel: (800) 999-1009

In Puerto Rico and the U.S. Virgin Islands

Bella International
P.O. Box 190816
San Juan, PR 00919-0816
Tel: (787) 620-7546

Canadian owners

Honda Canada, Inc.
Customer Relations
180 Honda Blvd.
Markham, ON
L6C 0H9
Tel: (888) 946-6329
Fax: (877) 939-0909
e-mail: honda_cr@ch.honda.com

When you call or write, please give us the following information:

- Vehicle Identification Number
- Date of purchase
- Odometer reading of your vehicle
- Your name, address, and telephone number
- A detailed description of the problem
- Name of the dealer who sold the vehicle to you

Honda Roadside Assistance

24-hour emergency road service is available to you in the United States and Canada throughout your 3-year/36,000-mile warranty term. Services include jump starting, flat tire and lockout assistance, towing, and more (limitations apply).

Call (866) 864-5211 (U.S.) or (800) 465-7587 (Canada).

Warranty Coverages

Below is a brief summary of the warranties covering your new vehicle.

New Vehicle Limited Warranty: Covers your new vehicle, except for the emissions control system and accessories, against defects in materials and workmanship.

Emissions Control Systems Defects Warranty and Emissions Performance Warranty: Covers your vehicle's emissions control systems. Time, mileage, and coverage are conditional.

Seat Belt Limited Warranty: Covers seat belts that fail to function properly.

Rust Perforation Limited Warranty: Covers all exterior body panels that rust through from the inside.

Accessory Limited Warranty: Covers Honda accessories.

Replacement Parts Limited Warranty: Covers all Honda replacement parts against defects in materials and workmanship.

Replacement Battery Limited Warranty: Provides prorated coverage for a replacement battery purchased from a Honda dealer.

Replacement Muffler Lifetime Limited Warranty: Covers a replacement muffler for the duration of the ownership.

Restrictions and exclusions apply to all these warranties. See the Warranty Manual on the Owner Information CD or at owners.honda.com (U.S.) or www.myhonda.ca (Canada) for complete descriptions of each warranty, including time, mileage, and other conditional limitations.

Your vehicle's original tires are covered by their manufacturer. Tire warranty information can be found on the Owner Information CD or at owners.honda.com (U.S.) or www.myhonda.ca (Canada).

VOICE COMMAND INDEX

Learn about all available voice commands to help you operate the vehicle. Available on vehicles with touchscreen.

Press the Talk button before you say a command.

Voice Portal Commands

When you press the Talk button, the Voice Portal screen appears. Say one of the options, and follow the system prompts.

- Phone call
- Music search
- Audio
- Climate control
- Navigation*
- Voice setting
- Voice help
- What is today's date?
- What time is it?

Navigation Commands*

The system accepts these commands on most screens. You only need to press the Talk button once for navigation commands.

- View map
- Find place
- Find category
- Find intersection
- Recently found
- Go home
- Find address
- Find city
- Find saved places

Climate Control Commands

The system accepts these commands on most screens.

- Climate control on**
- Climate control off**
- Air conditioner on**
- Air conditioner off**
- Defrost on**
- Defrost off**
- Fan speed # (#: 1 to 7)
- Temperature # degrees (#: 57 to 87°F)
- Temperature max heat
- Temperature max cool

Phone Commands

The system accepts these commands on most screens.

- Call by number
- Call by name
- Call (number)
- Call (name)

**models with navigation*

***These commands toggle the function on and off, so the command may not match your intended action.*

Information Provided by:



Audio Commands*

The system accepts these commands on most screens. Audio volume levels cannot be controlled using voice commands.

FM/AM Radio Commands

- Audio on**
- Audio off**
- Radio FM
- Radio AM
- Radio tune to # FM (#: frequency, e.g., 95.5)
- Radio tune to # AM (#: frequency, e.g., 1020)
- Radio FM preset # (#: 1 to 12)
- Radio AM preset # (#: 1 to 6)

SiriusXM® Radio Commands

- Radio SXM
- SXM channel # (#: 0 to 255)
- SXM channel (channel name)
- Radio SXM preset # (#: 1 to 12)

Pandora® Commands (U.S. only)

- Pandora
- Pandora play

Song By Voice™ Commands

Available for tracks stored on an iPod® or USB device.

- Music search
- List album (specify album)
- List artist (specify artist)
- List composer (specify composer)
- List genre (specify genre)
- List playlist (specify playlist)
- Play album (specify album)
- Play artist (specify artist)
- Play composer (specify composer)
- Play genre (specify genre)
- Play playlist (specify playlist)
- Play song (specify song)
- What/Who am I listening to?
- Who is this?
- What's playing?
- Who's playing?
- What album is this?

Disc (CD) Commands

- Disc
- Disc play
- Disc play track # (#: 1 to 30)

USB Commands

- USB
- USB play
- USB play track # (#: 1 to 30)

iPod® Commands

- iPod
- iPod play
- iPod play track # (#: 1-30)

Bluetooth® Audio Commands

- Bluetooth audio play
(may not work on all phones)

AUX Commands

- Aux audio play

**models with navigation*

***These commands toggle the function on and off, so the command may not match your intended action.*

INDEX

ABS	25	AUX Commands	165
ACC	25, 27	Auxiliary input	59, 79
Accessory Power Socket	59	AWD	25
AC Power Outlet	59, 79	Battery	149
Adaptive Cruise Control (ACC)	25, 27, 115	Blind spot information (BSI)	25, 27, 122
Address	93	Bluetooth® Audio	66, 76
Aha™ Radio	70	Bluetooth® Audio Commands	165
Airbags	9	Bluetooth® HandsFreeLink® (HFL)	81
Advanced Airbags	9	E-Mail	89
Airbag Care	14	HFL Controls	81, 84
Airbag System Components	13	HondaLink® Assist	88
Airbag System Indicators	11	Making a Call	83, 87
Front Airbags (SRS)	9	Pairing a Phone	82, 86
Passenger Airbag Off Indicator	12	Phonebook	83, 87
Side Airbags	10	Siri Eyes Free	90
Side Curtain Airbags	10	SMS Text Messaging	89
SRS (Supplemental Restraint System) Indicator	11	Speed Dial	83, 88
Air Conditioning System	52	Talk Button Tips	85
All-Wheel Drive (AWD)	25	Brake Assist System	111
Ambient Meter	113	Brake Fluid	149
Anti-Lock Brake System (ABS)	25, 111	Brake system	24, 25
Apps	68	Braking	111
Audio Commands	165	Brightness Control	37
Audio Operation	58	Carbon Monoxide Gas	4
Accessory Power Socket	59	Cargo Area Lights	38
AC Power Outlet	59	Car wash mode	109
Aha™ Radio	70	Changing a Flat Tire	133
Auxiliary Input Jack	59	Changing Settings	56
Bluetooth® Audio	66, 76	Charging system	24
Color Audio System	62	Childproof Door Locks	33
Compact Disc (CD)	73	Child Safety	15
DVD	78	Childproof Door Locks	33
FM/AM Radio	63, 71	Selecting a Child Seat	17
HondaLink®	69	Child Seat	17
iPod®	64, 74	Adding Security with a Tether	21
Pandora®	77	Installing a LATCH-Compatible Child Seat	18
Rear Entertainment System	78	Selecting a Child Seat	17
SiriusXM® Radio	72	Climate Control Commands	164
Sound	61	Climate Control System	53
SOURCE button	60	Clock	57
Steering Wheel Controls	60	Collision Mitigation Braking System™ (CMBS™)	25, 27, 120
Touchscreen Operation	67	Color Audio System	62
USB Flash Drive	65, 75	Compact Disc (CD)	73
USB Port	58	Compact Disc (CD) Commands	165
Wi-Fi Connection	70	Contact Us	162
Wireless Headphones	79	Cross Traffic Monitor	123
AUTO button	53	Cruise Control	27, 114
Auto High Beam System	27, 39	Customer Information	161
Auto idle stop	25, 27, 112	Customized Features	56
Automatic Dimming Rearview Mirror	50	Dashboard and Ceiling Controls	2
Automatic Rain-Sensing Wipers	41	Destination	93
Auto park mode	109		

Dialing a Number	83, 87	Fog lights	27, 38
Door Mirrors	50	Foot Brake	111
Door Operation	30, 33	Frequently Asked Questions	161
DOT Tire Quality Grading	156	Front Airbags (SRS)	9
Driving	98	Front Door Inner Handle	33
Adaptive Cruise Control (ACC)	115	Front Seats	42
Auto Idle Stop	112	Front Wipers	40
Blind spot information (BSI)	122	Fuel Information	126
Braking	111	Fuse Locations	137
Collision Mitigation Braking System™ (CMBS™)	120	Garage Opener	51
Cruise Control	114	Hang-Up/Back button	81, 84
Eco Assist System	113	Hazards	27
Forward Collision Warning (FCW)	118, 119, 120	HDMI	79
Intelligent Traction Management System	112	Headlight-Wiper Integration	40
Lane Keeping Assist System (LKAS)	118	Headphones	79
LaneWatch™	117	Head Restraints	44
Maximum Load Limit	100	Heated Steering Wheel	54
Multi-View Rear Camera	124	Heated Windshield Button	54
Paddle shifters	110	High beams	27
Parking Sensor System	121	Home Address	93
Power Mode	107	HomeLink® Garage Opener	51
Rear Cross Traffic Monitor	123	HondaLink®	69
Refueling	126	HondaLink® Assist	88
Remote Engine Start	106	Honda Roadside Assistance	163
Road Departure Mitigation (RDM)	119	Hood	144
Shifting	108	Immobilizer	26
Starting the Engine	107	Info buttons	28
Towing a Trailer	102	Instrument Panel	24
Vehicle Stability Assist (VSA®)	113	Condition Indicators	26
Driving Position Memory System	49	Malfunction Indicators	24
DVD	78	On/Off Indicators	27
Eco Assist System	113	Intelligent Traction Management System	112
ECON Button	113	Interior Lights	37
ECON mode	27	Intermittent Wipers	40
Electric power steering	25	iPod®	64, 74
Electronic Gear Selector	109	iPod® Commands	165
Electronic Stability Control (ESC)	113	Jump Starting	127
E-Mail	89	Lane Keeping Assist System (LKAS)	24, 27, 118
Emergency Engine Stop	130	LaneWatch™	117
Emergency Towing	130	Lap/Shoulder Seat Belts	5
Engine and Fuel	159	LATCH-Compatible Child Seat	18
Engine Compartment Cover	145	Light Bulbs	160
Engine Coolant	148	Lights	37
Engine Oil	146	Locking the Doors	30
ENGINE START/STOP button	107	Lock Tab	33
Exterior lights	27, 38	Low fuel	26
Fastening a Seat Belt	7	Low oil pressure	24
Flat Tire	133	Low tire pressure	26
Floor Mats	45	Maintenance	141
Fluids	159	Brake Fluid	149
FM/AM Radio	63, 71	Changing Wiper Blades	150
FM/AM Radio Commands	165	Checking the Battery	149
		Engine Coolant	148
		Engine Oil	146

Information Provided by:



Maintenance Minder™.....142
 Safety Precautions141
 Service Codes.....143
 Under the Hood144
 Window Washer Fluid149
 Making a Call83, 87
 Malfunction indicator lamp25
 Map Legend96
 Map Lights.....37
 Master Door Lock Switch.....33
 Maximum Load Limit.....100
 Mirrors50
 Moonroof.....35
 Multi-Information Display.....28
 Multi-View Rear Camera124
 Music search.....165
 Navigation91
 Display and Controls.....92
 Entering a Destination.....93
 Home Address93
 Map Legend96
 Place Category94
 Recent Places.....94
 Routing.....96
 Saved Places.....95
 Steering Wheel Controls.....91
 Street Address.....93
 Talk Button Tips91
 Traffic97
 Turn-by-turn directions96
 Navigation Commands.....164
 One-Touch Turn Signal.....38
 Overheating.....129
 Paddle shifters.....110
 Pairing a Phone.....82, 86
 Pandora®77
 Pandora® Commands.....165
 Panoramic Glass Roof.....36
 Parking brake.....26, 111
 Parking Sensor System.....121
 Passenger Airbag Off Indicator.....12
 Phone82, 86
 Phonebook83, 87
 PHONE button.....81
 Phone Commands.....164
 Pick-Up button.....81, 84
 Place Category94
 Playing a DVD.....78
 Power Door Mirrors.....50
 Power Mode107
 Power Moonroof.....35
 Power Tailgate.....32
 Power Windows.....34
 Radio63, 71
 Rain-Sensing Wipers.....41
 Readiness Codes.....158
 Rear Camera.....124
 Rear Cross Traffic Monitor123
 Rear Entertainment System (RES).....78
 Rear Seats.....46
 Rearview Mirror50
 Rear Wiper41
 Recent Places.....94
 Refueling.....126
 Remote Battery Strength.....127
 Remote Control.....80
 Remote Engine Start.....106
 Remote Transmitter29
 Reporting Safety Defects.....23
 RESET button28
 Reverse Tilt Door Mirrors50
 Road Departure Mitigation (RDM)....25, 27, 119
 Roadside Assistance.....163
 Routing96
 Safety Information3
 Carbon Monoxide Gas.....4
 Childproof Door Locks.....33
 Child Safety.....15
 Reporting Safety Defects.....23
 Safety Label Locations.....23
 Safety Messages4
 Saved Places.....95
 Seat Belts5
 Fastening a Seat Belt7
 Lap/Shoulder Seat Belts5
 Seat Belt Inspection.....6
 Seat belt reminder26
 Seat Belt with Detachable Anchor8
 Shoulder Anchor.....7
 Seat Heaters and Ventilation55
 Seats42
 Second-Row Seat.....46
 Sequential Mode.....110
 Service Codes.....143
 Setting the Clock.....57
 Shifting108
 Shift Lever Does Not Move128
 Shoulder Anchor.....7
 Side Airbags.....10
 Side Curtain Airbags.....10
 Siri Eyes Free90
 SiriusXM® Radio.....72
 SiriusXM® Radio Commands.....165
 Smart Entry system.....24, 30
 SMS Text Messaging89
 Song By Voice™ Commands.....165
 Sound61
 SOURCE button.....60
 Specifications.....159
 Speed Dial83, 88

SRS (Supplemental Restraint System)
 Indicator.....11
 Starting the Engine107
 Steering Wheel.....49
 Steering Wheel and Nearby Controls1
 Steering Wheel Controls.....60, 91
 Street Address.....93
 Supplemental Restraint System (SRS)24
 SYNC button.....53
 System Guidance Volume.....91
 System message26
 Tailgate31, 32
 Talk button.....81, 84
 Talk Button Tips85, 91
 Text Messaging89
 Third-Row Seat.....47
 Tire Fill Assist.....131
 Tire Information152
 DOT Tire Quality Grading156
 Inflation Guidelines.....152
 Tire and Loading Information Label153
 Tire and Wheel Replacement.....153
 Tire Chains.....154
 Tire Identification Number (TIN).....155
 Tire Labeling.....155
 Tire Service Life.....154
 Tire Terminology.....155
 Wear Indicators152
 Winter Tires.....154
 Tire Pressure Monitoring System
 (TPMS)25, 131
 Tires159
 Touchscreen Operation67
 Towing a Trailer102
 Towing (emergency)130
 Traffic97
 Troubleshooting.....161
 Turn-by-turn directions96
 Turn Signal27, 38
 Under the Hood144
 Unlocking the Doors30
 USB Commands.....165
 USB Flash Drive.....65, 75
 USB Port58, 79
 Vehicle159
 Vehicle Controls29
 Vehicle Stability Assist (VSA®)25, 27, 113
 Visual Index.....1
 Voice Command Index164
 Voice Portal Commands.....164
 Walk Away Auto Lock30
 Warranty Coverages163
 Wear Indicators152
 Widgets68
 Wi-Fi Connection.....70
 Window Washer Fluid.....149
 Windows.....34
 Winter Tires.....154
 Wiper Blades.....150
 Wiper Operation.....40
 Wireless Headphones.....79



TABLE OF CONTENTS

VISUAL INDEX

SAFETY INFORMATION

INSTRUMENT PANEL

VEHICLE CONTROLS

AUDIO AND CONNECTIVITY

BLUETOOTH® HANDSFREELINK®

HONDA LINK®

NAVIGATION

DRIVING

HANDLING THE UNEXPECTED

MAINTENANCE

SPECIFICATIONS

CUSTOMER INFORMATION

VOICE COMMAND INDEX

INDEX