



2017 NAVIGATION
SYSTEM
OWNER'S MANUAL

For your safety, read carefully and keep in this vehicle.

NISSAN NAVIGATION SYSTEM HELP-DESK CONTACT INFORMATION

For assistance or inquiries about the NISSAN Navigation System, or to order updated map data, contact the NISSAN NAVIGATION SYSTEM HELPDESK at:

- ADDRESS: P.O. Box 1588,
Orem, UT 84059-992
- E-MAIL: Nissan-Navi-Info@navteq.com
- WEB SITE: www.navigation.com or
www.nissan.ca
- PHONE: 1-888-661-9995
- HOURS: 6:00 AM to 5:00 PM
(Pacific Time)

NISSAN CONSUMER AFFAIRS DEPARTMENT

For assistance or inquiries about the NISSAN warranty, service or general questions, contact the NISSAN Consumer Affairs Department at:

For U.S. customers
Nissan North America, Inc.
Consumer Affairs Department
P.O. Box 685003
Franklin, TN 37068-5003
1-800-NISSAN-1
(1-800-647-7261)

For Canadian customers
Nissan Canada Inc.
5290 Orbitor Drive
Mississauga, Ontario L4W 4Z5
1-800-387-0122

FOREWORD

Thank you for purchasing a NISSAN vehicle. This user's manual is for the navigation system only. This manual contains operating instructions for the NISSAN Navigation System offered in your NISSAN vehicle.

Please read this manual carefully to ensure safe operation of the navigation system.

- Because of possible specification changes and optional equipment, sections of this manual may not apply to your vehicle.
- All information, specifications and illustrations in this manual are those in effect at the time of printing. NISSAN reserves the right to change specifications or design at any time without notice.
- Do not remove this manual from the vehicle when selling this vehicle. The next user of this navigation system may need the manual.

Table of Contents

Introduction	1
Getting started	2
Map settings	3
Navigation	4
Other settings	5
General system information	6
Troubleshooting guide	7
Index	8

1 Introduction

How to use this manual	1-2
For safe operation	1-2
Reference symbols	1-2

Safety information	1-2
Laser product	1-3

HOW TO USE THIS MANUAL

This manual uses special words, symbols and icons that are organized by function.

Please refer to the following items to understand how to use this manual properly.

FOR SAFE OPERATION

WARNING

Indicates the presence of a hazard that could cause death or serious personal injury. To avoid or reduce the risk, the procedures must be followed precisely.

CAUTION

Indicates the presence of a hazard that could cause minor or moderate personal injury or damage to your vehicle. To avoid or reduce the risk, the procedures must be followed carefully.

NOTE:

Indicates items that help you understand and maximize the performance of your vehicle. If ignored, they may lead to a malfunction or poor performance.

REFERENCE SYMBOLS



INFO:

Indicates information that is necessary for efficient use of your vehicle or accessories.



Reference page:

Indicates the title and page that you should refer to.

NAV:

This is an example of how a button on the control panel will be shown.

“Route”:

This is an example of a key/item displayed on the screen.

SAFETY INFORMATION

This system is primarily designed to help you reach your destination, and it also performs other functions as outlined in this manual. However, you, the driver, must use the system safely and properly. Information concerning road conditions, traffic signs and the availability of services may not always be up-to-date. The system is not a substitute for safe, proper and legal driving.

Before using the navigation system, please read the following safety information. Always use the system as outlined in this manual.

WARNING

- **To operate the navigation system, first park the vehicle in a safe location and set the parking brake. Operating the system while driving can distract the driver and may result in a serious accident.**
- **Do not rely on route guidance alone. Always be sure that all driving maneuvers are legal and safe in order to avoid accidents.**
- **Do not disassemble or modify this system. If you do, it may result in accidents, fire or electrical shock.**

- If you notice any foreign objects in the system hardware, spill liquid on the system or notice smoke or a smell coming from it, stop using the system immediately and contact a **NISSAN** dealer. Ignoring such conditions may lead to accidents, fire or electrical shock.



CAUTION

- Do not use this system if you notice any malfunctions such as a frozen screen or the lack of sound. Continued use of the system may result in accidents, fire or electrical shock.
- Some states/provinces may have laws limiting the use of video screens while driving. Use this system only where it is legal to do so.
- Extreme temperature conditions [below -4 °F (-20 °C) and above 158 °F (70 °C)] could affect the performance of the system.



NOTE:

Do not keep the navigation system running with the engine stopped. Doing so may discharge the vehicle battery. When you use the navigation system, always keep the engine running.



WARNING

- Do not disassemble or modify this system. There are no user serviceable parts in this navigation system.
- If maintenance, adjustments and operations other than those specified in this manual are attempted, injury due to laser radiation and exposure could occur.



SiriusXM services require a subscription after a trial period and are sold separately or as a package. Our satellite service is available only in the 48 contiguous USA and DC. For more information visit www.siriusxm.com.



“Made for iPod” and “Made for iPhone” mean that an electronic accessory has been designed to connect specifically to iPod or iPhone, respectively, and has been certified by the developer to meet Apple performance standards. Apple is not responsible for the operation of this device or its compliance with safety and regulatory standards. Please note that the use of this accessory with iPod or iPhone may affect wireless performance.



The Bluetooth® word mark and logos are registered trademarks owned by Bluetooth SIG, Inc. and any use of such marks by DENSO CORPORATION is under license. Other trademarks and trade names are those of their respective owners.



Required SiriusXM Satellite Radio and SiriusXM Traffic monthly subscriptions are sold separately. SiriusXM Traffic are only available in select markets. For more information, see www.siriusxm.com/siriusxmtraffic



Required SiriusXM Satellite Radio and SiriusXM Travel Link monthly subscriptions are sold separately. SiriusXM Travel Link is only available in select markets. For more information, see www.siriusxm.com/travellink

App Store

Apple and the Apple logo are trademarks of Apple Inc., registered in the U.S. and other countries. App Store is a service mark of Apple Inc.

Google Play™

Google Play is a trademark of Google Inc.

Google

© 2012 Google Inc. All rights reserved.

2 Getting started

Control buttons and functions.....	2-2	Basic operation	2-5
Control panel (Type A)	2-2	Functions disabled while driving.....	2-5
Control panel (Type B)	2-3	Touch screen operation	2-5
Steering wheel switch (Type A)	2-4	Menu screen operation.....	2-7
Steering wheel switch (Type B)	2-4	How to input characters.....	2-8
Steering wheel switch (Type C)	2-5		

CONTROL BUTTONS AND FUNCTIONS

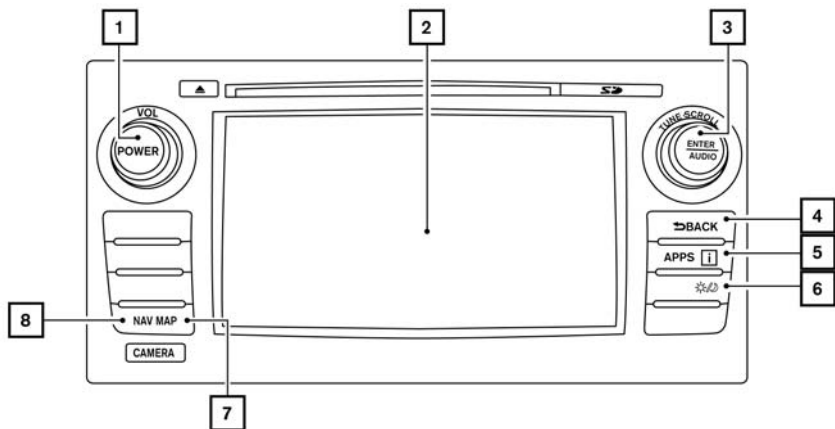

CONTROL PANEL (Type A)

- 1** VOL (volume) control knob/POWER button:
Rotate clockwise to increase the volume or counterclockwise to lower the volume.

Press to turn the audio system on or off.

- 2** Touch screen display

- 3** TUNE-SCROLL knob / ENTER/AUDIO button:
Turn to scroll through the items in a list. Press to select a menu item. When the screen is not displaying a list or menu, the knob is used to control the audio system.

Press the ENTER/AUDIO button to select a highlighted item on the screen.

- 4** ↶ BACK button:
Press to return to the previous screen or to delete the last inputted letter if a touch keyboard is displayed on the screen.

- 5** APPS  button:
Press to access the system settings.

- 6**  button:
Press to change the display brightness between day and night modes. While the mode is being displayed, the brightness can be adjusted using the TUNE-SCROLL knob.

Press and hold for more than two seconds to switch the display to a larger display of the digital clock.

 "DISPLAY SETTINGS"
(page 5-4)

- 7** MAP button:
Press to display the current location map screen.

- 8** NAV button:
Press to access the functions of the Navigation system.

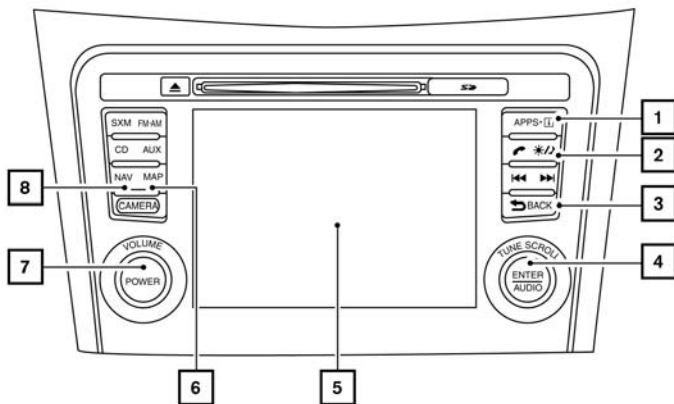

CONTROL PANEL (Type B)

1 APPS (I) button:

Press to access the system settings.

2 ☀/🌙 button:

Press to change the display brightness between day and night modes. While the mode is being displayed, the brightness can be adjusted using the TUNE-SCROLL knob.

3 ↶ BACK button:

Press to return to the previous screen or to delete the last inputted letter if a touch keyboard is displayed on the screen.

LNK2515
Press and hold for more than two seconds to switch the display to a larger display of the digital clock.



"DISPLAY SETTINGS"
(page 5-4)

4 TUNE-SCROLL knob / ENTER/AUDIO button:

Turn to scroll through the items in a list. Press to select a menu item. When the screen is not displaying a list or menu, the knob is used to control the audio system.

Press the ENTER/AUDIO button to select a highlighted item on the screen.

5 Touch screen display

6 MAP button:

Press to display the current location map screen.

7 VOL (volume) control knob/POWER button:

Rotate clockwise to increase the volume or counterclockwise to lower the volume. Press to turn the audio system on or off.

8 NAV button:

Press to access the functions of the Navigation system.

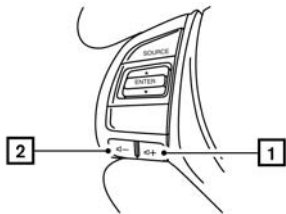

LNV2506

STEERING WHEEL SWITCH (Type A)

Volume control two-button operation

1 Volume increase button

Increases the volume of the voice guidance given by the Navigation System if pressed while the voice guidance is speaking. If the volume increase button is pressed at any other time, only the volume of the active screen (phone, SMS playback, Voice Recognition system [if so equipped], audio system) will be increased.

2 Volume decrease button

Decreases the volume of the voice guidance given by the Navigation System if pressed while the voice guidance is speaking. If the volume decrease button is pressed at any other time, only the volume of the active screen (phone, SMS playback, Voice Recognition system [if so equipped], audio system) will be decreased.

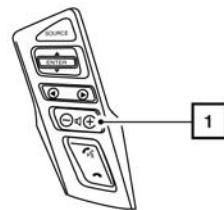

LNV3011

STEERING WHEEL SWITCH (Type B)

Volume control one-button operation

1 Volume control button

Increases or decreases the volume of the voice guidance given by the Navigation System if pressed while the voice guidance is speaking. If the volume button is pressed at any other time, only the volume of the active screen (phone, SMS playback, Voice Recognition system [if so equipped], audio system) will be adjusted.

For more information about the audio system, Bluetooth® Hands-Free Phone System and Voice Recognition system (if so equipped), see the vehicle's Owner's Manual.

BASIC OPERATION

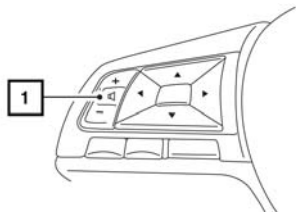

LNV4013

STEERING WHEEL SWITCH (Type C)

Volume control one-button operation

- 1** Volume control button
Increases or decreases the volume of the voice guidance given by the Navigation System if pressed while the voice guidance is speaking. If the volume button is pressed at any other time, only the volume of the active screen (phone, SMS playback, Voice Recognition system [if so equipped], audio system) will be adjusted.

For more information about the audio system, Bluetooth® Hands-Free Phone System and Voice Recognition system (if so equipped), see the vehicle's Owner's Manual.



LNV2630

FUNCTIONS DISABLED WHILE DRIVING

To promote safe driving, some functions cannot be operated or have limited operation when the vehicle driving speed is above 5 mph (8 km/h). The on-screen text and keys for these restricted functions will be "grayed out" or muted and cannot be selected while driving.



LNV3001

All text input screens are grayed out while the vehicle is moving. Other functions are locked out depending on vehicle speed, the function and the number of times a feature is selected.

When a menu selection is grayed out, the feature is locked out until the system operating conditions are met to allow the selection.

TOUCH SCREEN OPERATION

The same operations described for the scrolling knob are possible using touch screen operation.



LNV3008



LNV2440



LNV3014

Examples of touch screen operation

Selecting an item:

When any item is touched, the next screen is displayed.

Adjusting:

Touch the "+", "-", ">" or "<" key to adjust a setting.

Scrolling through a message or list:

Turn the TUNE-SCROLL knob to scroll through a message or a list. When scrolling a lengthy list, you can also touch the screen and slide your finger along the scroll bar where shown to scroll more quickly. Touching the up or down arrow will move between pages of the list.

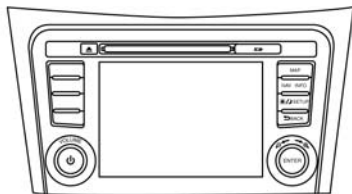
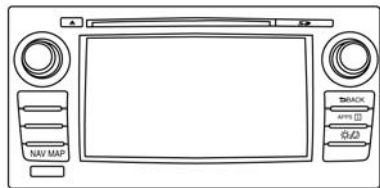

(Type A)
MENU SCREEN OPERATION

LNV2448

(Type B)
Menu screens and their purpose

LNV2509

Press one of the application buttons to activate the corresponding menu screen:

- NAV (Navigation)
- APPS: 

How to select a menu item

1. As an alternative to using the touch screen, turn the TUNE-SCROLL knob clockwise or counter-clockwise to scroll through the menu items until the preferred item is highlighted.
2. To select the preferred item, press the TUNE-SCROLL knob.

3. Press the BACK or  BACK button. The previous screen will be displayed and the changes will be saved.



LNV2415

HOW TO INPUT CHARACTERS

Alphanumeric characters are used when setting a destination, searching for an address, editing stored locations, etc.

Character (letter and number) input screen

1. Touch characters on the touch keyboard and they will appear in the field at the top of the screen. When the entry is complete, touch the "OK" key.

Alternatively, use the scrolling knob to highlight a character and press the knob to select that character.

! NOTE:

- Press the  BACK button to delete the last inputted character or to return to the previous screen if no characters have been inputted.
 - On every character entry screen, the touch keyboard will display only the letters that are possible to enter after the current letter.
 - Symbol and number keys are available when the "123/ABC" key is touched.
 - Touch the "123/ABC" key to toggle the display between the touch keyboard for letters and the touch keyboard for numbers and symbols.
2. To delete the last entry, touch the "Delete" key or hold it to delete all entries at once.
 3. After finalizing the entries, touch the "OK" key or touch the "List" key for the completed list screen.

! NOTE:

- If a phrase is being entered that has been previously entered into the system, the matched text may appear in light gray. Touch "OK" to search for the matched text. Touch "List" to search for both the matched text and entered text.

3 Map settings

Screen information	3-2	Looking at information on the map	3-7
Map types	3-3	Map symbols	3-7
2-Dimensional (2D) view	3-3	Map settings for the map screen	3-9
2-Dimensional North Up (2DN) view	3-4	Lane information	3-11
3-Dimensional (3D) view	3-4	Map SD-card	3-11
Moving a map	3-4	How to handle the SD-card	3-12
Returning to the current vehicle location	3-5	SD-card replacement	3-12
Map options menu screen	3-5	How to order map data updates	3-12
Changing the map scale	3-6	About the map data	3-12
Map scale	3-6	End-user terms	3-14

SCREEN INFORMATION

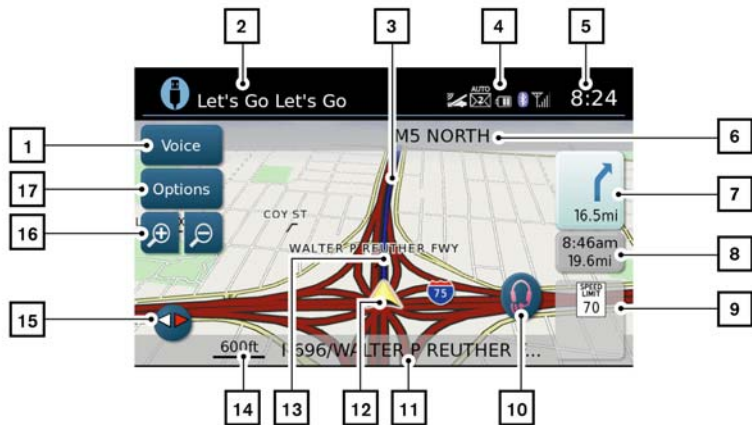

1 “Voice” key:

Touch to repeat the voice guidance while a route is active. Touch and hold for two seconds to toggle the voice guidance on or off (button will be grayed out when voice guidance is turned off). This option is available only when a route is set.

2 Audio information:

Indicates the radio station, CD track number or other audio information currently playing.

3 Current route:

A blue line indicates the path to follow.

4 Satellite and Bluetooth connection information:

This area shows satellite and/or Bluetooth connections, indicates unread text messages and illustrates a connected cell phone's battery and signal strength.

5 Clock:

Indicates the current time.

6 Next maneuver road name:

Indicates the name of the next road in the route guidance. This is only shown if route guidance is active.

7 Direction indicator and distance to next maneuver on the route:

When route guidance is active but you have deviated from the route, this area displays a compass icon with an arrow indicating the destination direction.

When route guidance is active and you are on the route, this area indicates the distance (in miles or kilometers) to the next point and the turning direction at that point.

When the “Voice” key is not shown on the screen (such as when an audio screen is displayed on the screen), touch the direction indicator to repeat the voice guidance while a route is active. Touch and hold for two seconds to toggle the voice guidance on or off.

8 Estimated time of arrival and distance to destination or remaining time of travel and distance to destination:

Touch this button to switch the indicator between estimated arrival time and remaining travel time. This indicator only appears once the destination is set and the route guidance is initiated. The estimated arrival time may not switch to the estimated arrival time for the destination's time zone if a time zone line is crossed as part of the route.

LNV3010

- 9** Posted speed limit:
When available, the posted speed limit for the current road is displayed.
- 10** NissanConnectSM Services (if so equipped):
Touch the headset icon to connect to NissanConnectSM Services.

 "NISSANCONNECT SERVICES" (page 6-4)
- 11** Current road indicator:
This displays the name of the road upon which the vehicle is currently traveling.
- 12** Vehicle icon:
Indicates the current location and direction of the vehicle.
- 13** Suggested route:
Appears as a bold blue line during route guidance.
- 14** Scale indicator:
Indicates the scale of the map.
- 15** Compass icon:
Indicates the direction of the map. Touch this icon to switch the map view between the North Up, Heading Up (or actual direction) and 3D modes.

- 16** Zoom in and zoom out keys:
Touch to zoom the map perspective in or out.
- 17** "Options" key:
Touch this key to access the map options menu screen.



"MAP OPTIONS MENU SCREEN" (page 3-5)

MAP TYPES

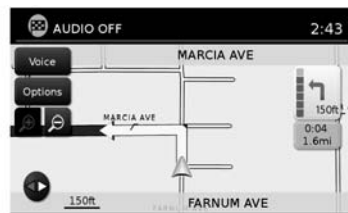

2D

LNV2455

2-DIMENSIONAL (2D) VIEW

The 2D map is a two-dimensional (flat) representation of the map data, similar to a road map, focused on the vehicle's position (vehicle icon).

Touch the compass icon to switch map to another view.



"SCREEN INFORMATION (2D, 2DN or 3D)" (page 3-2)



"MAP SETTINGS FOR THE MAP SCREEN" (page 3-7)



2DN LNV2454

2-DIMENSIONAL NORTH UP (2DN) VIEW

The 2DN map is a two-dimensional (flat) representation of the map data, similar to a road map, focused on the vehicle's position (vehicle icon) with the top of the map aligned North.

Touch the compass icon to switch map to another view.

3D LNV2456

3-DIMENSIONAL (3D) VIEW

The 3D map displays the map from an elevated perspective, providing a panoramic view over a long distance.

The map in 3D view always appears with the current forward direction facing up (heading up).

Touch the compass icon to switch map to another view.

MOVING A MAP

To scroll the map in either direction:

1. Touch and release the screen anywhere on the map.
2. Touch the screen again and move your finger along the screen in the direction you wish to scroll.

After releasing and touching the map again, a marker will be displayed at the point touched and, if possible, the position determined.

NOTE:

When the current location of the vehicle is recognized, the street name will be displayed at the bottom of the screen. When scrolling a map and an area that is not a road, city or POI is touched, coordinates corresponding to the marker's position are displayed at the bottom of the screen.

MAP OPTIONS MENU SCREEN

RETURNING TO THE CURRENT VEHICLE LOCATION

The basic map screen displays the current location of the vehicle. The current location can be displayed again even after the map is moved, or after the menu screen is displayed.

Press the MAP button or the BACK or  BACK button and the current location will be displayed on the map.



LNV3002

The Map Options menu allows you to quickly store the current position, show position information or destination information, and adjust the map settings.

1. Touch the “Options” key while the route guidance map is displayed.
2. The following options are available for selection:
 - Enter Destination
Select to open the navigation screen for entering an address.
 - Turn List
Select to display all of the turns and waypoints along the route.
 - Cancel Route
Select to cancel entire route or waypoints along route.

- POIs Along Route
Select to choose the types of points of interest to display along the active route. Available options are gas stations, restaurants, ATMs, parking, rest areas, hotels, dealerships and airports.



NOTE:

Some places of interest on divided high-ways may show the equivalent place of interest on the opposite side of the road (such as a rest area) as being closer than the place in your traveling direction. Confirm location of the place before following the route.

- SiriusXM Traffic
Select to display all traffic events on route and options to avoid roads along route.
- Show Route On Map
Select to display the entire route on the screen. The view will zoom to the necessary level in order to show both the starting point and destination on the screen.

CHANGING THE MAP SCALE

- **Routing Options**
Select to view options available to customize route. Avoiding specific roads, dynamic guidance, route type and minimizing freeways, types of roads and ferries can all be adjusted.
- **Show Position Information**
Select to display the latitude, longitude and altitude for the current position of the vehicle. Location can also be stored to the Address Book.
- **Show Waypoints**
Select to add or show list of waypoints along route.
- **Guidance & Map Settings**
Select to toggle guidance information and map settings options.



"MAP SETTINGS FOR THE MAP SCREEN" (page 3-7)



LNV2462

When using the "+" or "-" for zooming in or out, the scale on the bottom left side of the screen changes to indicate the new scale level.

MAP SCALE

The following scales are available depending on the map view:





Per approximately 1/2 inch (1 cm)
150 ft (50 m)
300 ft (100 m)
600 ft (200 m)
1/4 mile (500 m)
1/2 mile (1 km)
1 mile (2 km)
2.5 mi (5 km)
5 mi (10 km)
10 mi (20 km)
25 mi (50 km)
50 mi (100 km)
100 mi (200 km)
250 mi (500 km)

LOOKING AT INFORMATION ON THE MAP

Icons of various categories of locations can be displayed on the map.

MAP SYMBOLS

This navigation system uses symbols to display various types of facilities. The following icons (if so equipped) may be used on the map screen.

	Danger		Default		Airport		Hotel
	Accident		Caution/Radio On		Bus Station		Campground
	Traffic Jam		Hospital		Train Station		Rest Area
	Heavy/Congested Traffic		Infiniti Dealership		Gas Station		Parking
	Construction		Nissan Dealership		Aral Gas Station		Garage Parking
	Merging		Auto Repair		BP Gas Station		Park & Ride
	Slippery Road		ATM and Bank		Esso Gas Station		Park & Ride/Car Rental
	Bad Road		Restaurant		Exxon Gas Station		Car Rental/Parking
	Fog/Snow/Storm		Traffic Control Camera		Shell Gas Station		Car Rental
	Road Closed						

LNV2467

MAP SETTINGS FOR THE MAP SCREEN



LNV3000



LNV3006

Other settings are available for the map screen, such as switching the map view or changing the map direction.

1. Press the **APPS**  button.
2. Touch the “Settings” key.

3. Touch the “Navigation” key.
4. Touch the “Guidance & Map Settings” key.

When selected, the system will offer the following map setting options:

Menu Item	Options
Voice Guidance	Select to toggle on or off the voice guidance on map screen.
Volume	Select “+” or “-” to increase or decrease voice guidance volume.
Map View	Touch the “Map View” key to toggle between 2D and 3D map view.
2D-North/Heading Up	Touch to toggle display between “Head” and “North” for 2D mode. When “Head” is selected, the screen always shows the map in the driving direction. When “North” is selected, the top of the map is always orientated north. This option can only be selected when the “Map View” is set to 2D.
Auto Zoom	Touch the “Auto Zoom” key to choose a setting for automatic zooming. Available settings are “Never”, “Always” and “Only with a route”.
Show Points of Interest On Map	Select to toggle various map icons on and off including gas stations, restaurants, banks and parking.

Menu Item	Options
My Points of Interest Alert	Select to control alert options. Choose "Off" to disable the alert. Choose "Show Only" to have the alert displayed on the screen. Choose "Show & Beep" to have an audible beep in addition to the alert displayed on the screen.
Show Presets On Map	Select to toggle on or off the preset radio station buttons on the map screen.
Split Map for Freeway Exits	Select to toggle on or off the split view map when approaching a freeway exit.
Show Lane Information	Select to toggle on or off lane information when available.
Show Speed Limit	Select to toggle on or off the display of speed limit information when available.
Show Estimated Time	Select to control display of estimated time of arrival or trip time remaining.
Customize Travel Speed	Select to customize travel speeds on local roads and freeways along route.
Speed Limit Warning	Select to control the speed limit alert that activates when the vehicle speed is greater than the speed limit information for the current location. Choose "Off" to disable the alert. Choose "Show Only" to have the alert displayed on the screen. Choose "Show & Beep" to have an audible beep in addition to the alert displayed on the screen.
Speed Limit Sensitivity	Select the sensitivity level for the speed limit warning. Choose a value between zero and 30
Speed Warning for Curves	Select to control the alert that activates depending on vehicle speed and a curve in the road ahead. Choose "Off" to disable the alert. Choose "Show Only" to have the alert displayed on the screen. Choose "Show & Beep" to have an audible beep in addition to the alert displayed on the screen.
Distance Units	Select to toggle "US" or "Metric" for the distance units on the map screen.

LANE INFORMATION



LNV2464

When the vehicle is approaching a junction or interchange, the screen switches to a split view. Lane information is graphically displayed on the left side of the split screen and icons showing the proper lanes for upcoming maneuvers are shown in the upper right corner below the clock.

The highlighted lanes are those from which the next maneuver on the route will be made. Lanes displayed in gray are those that do not follow the route at the upcoming junction or interchange. The icons in the upper right corner also indicate direction and may change as the junction or interchange approaches (for example, straight ahead, to straight and then right).

Once the vehicle passes through the junction or interchange, the screen returns to the previous view. Touching the screen also returns to the previous view.



LNV2465

! NOTE:

Lane information is not available for all areas. It will only be displayed in areas where the necessary map data is available.

! NOTE:

The number of lane icons in the upper right corner may change as the junction or interchange approaches due to a difference in the number of available lanes.

MAP SD-CARD

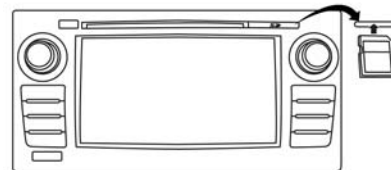

LNV3016

Type A

The SD-card slot is located on the front of the unit. When you purchase this system, an SD-card with map data is provided.

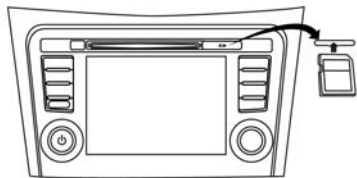

LNV3017

Type B

NOTE:

- Before inserting the map SD-card confirm that there is no SD-card already in the slot.
- The SD-card slot can only read the SD-card with map data provided specifically for use with the vehicle's navigation system. The system will not read other SD-cards.
- If an SD-card with something other than map data (such as music, pictures or movies) is inserted into the slot, the Navigation System will not function. A message will appear prompting for the map SD-card to be reinserted. This message will not appear if the SD-card is removed while in audio mode. The audio mode is not affected by the SD-card.

HOW TO HANDLE THE SD-CARD

When handling the SD-card, please be careful and adhere to the following instructions:



CAUTION

- **Handle the SD-card with care. Never touch the metal contacts.**
- **Do not use any conventional cleaner, benzene, thinner, or antistatic spray.**
- **If you need to clean the SD-card use a soft cloth.**
- **Never attempt to use an SD-card that has been cracked, deformed or repaired using adhesive. Doing so may damage the equipment.**
- **Do not try to bend the SD-card. Do not use any SD-card that is bent or cracked.**
- **Do not put on any sticker or write anything on the SD card.**
- **Handle the SD-card carefully to avoid contamination or flaws. Otherwise, the data may not be read properly.**

- **Do not store the SD-card in locations exposed to direct sunlight, or in high temperatures or humidity.**
- **Always place the SD-card in its storage case when not in use.**

SD-CARD REPLACEMENT

For additional SD-cards with map data, contact the NISSAN Navigation Helpdesk.

HOW TO ORDER MAP DATA UPDATES

To order updated map data and voice commands, contact the NISSAN Navigation Helpdesk. See the contact information on the inside front cover of this manual.

ABOUT THE MAP DATA

- Bosch has compiled the digitized map data into a usable format. © 2011 Robert Bosch GmbH all rights in compilation software reserved. Due to the production timing of the map data, some new roads may not be included, or some names and roads may be different from those in use at the time this map data is used.

- Traffic control and regulation data used in this map data may be different from those in use at the time this map data is used. When driving, follow the actual traffic control signs and notices on the roads.
- Reproducing or copying this map software is strictly prohibited by law.



WARNING

- **This navigation system should not be used to replace your own judgement. No itinerary suggested by this navigation system should ever override any freeway regulations, your own judgement, or a knowledge of safe driving practices. Do not follow the navigation system's suggested itinerary if it would cause you to perform a dangerous or illegal act, place you in a dangerous situation, or take you into an area you consider unsafe.**

- **The advice provided by the navigation system is to be regarded as a suggestion only. There may be times when the navigation system displays the vehicle's location incorrectly, fails to suggest the shortest route, or fails to direct you to your desired destination. In such instances, rely on your own judgement taking into account the driving conditions at the time.**
- **Do not use the navigation system to locate emergency services. The database does not contain a complete listing of emergency services such as police stations, fire stations, hospitals and walk-in clinics. Please show discretion and ask for directions in such instances.**
- **As the driver, you alone are responsible for your driving safety.**
 - In order to avoid a traffic accident, do not operate the system while driving.

- In order to avoid a traffic accident, operate the system only when the vehicle is stopped at a safe place and the parking brake is on.
- In order to avoid a traffic accident or traffic offence, remember that actual road conditions and traffic regulations take precedence over the information contained on the navigation system.
- The software may contain inaccurate or incomplete information due to the passage of time, changing circumstances, and the sources of information used. Please respect current traffic conditions and regulations at all times while driving.
- Where actual road conditions and highway regulations differ from the information contained on the navigation system, abide by the highway regulations.
- Keep the amount of time spent viewing the screen while driving to a strict minimum.

The navigation system does not provide, nor represent in any way information on: traffic and highway regulations; technical aspects of the vehicle including weight, height, width, load and speed limits; road conditions including grade, percentage of incline and surface conditions; obstacles such as the height and width of bridges and tunnels; and other current driving or road conditions. Always rely on your own judgment when driving a car, taking into account current driving conditions.

The company trademarks used in this product to identify locations and business offices are the trademarks of their respective owners. Their use does not represent sponsorship, approval or recommendation of this product by these companies.

END-USER TERMS

The data ("Data") is provided for your personal, internal use only and not for resale. It is protected by copyright, and is subject to the following terms and conditions which are agreed to by you, on the one hand, and NISSAN and its licensors (including their licensors and suppliers) on the other hand.

© 2011 NAVTEQ. All rights reserved.

The Data for areas of Canada includes information taken with permission from Canadian authorities, including: © Her Majesty the Queen in Right of Canada, © Queen's Printer for Ontario, © Canada Post Corporation, GeoBase®, © Department of Natural Resources Canada.

NAVTEQ holds a non-exclusive license from the United States Postal Service® to publish and sell ZIP+4® information.

©United States Postal Service® 2009. Prices are not established, controlled or approved by the United States Postal Service®. The following trademarks and registrations are owned by the USPS: United States Postal Service, USPS, and ZIP+4.

The Data may include or reflect data of licensors, including Her Majesty the Queen in the Right of Canada ("Her Majesty"), Canada Post Corporation ("Canada Post") and the Department of Natural Resources Canada ("NRCan"). Such data is licensed on an "as is" basis. The licensors, including Her Majesty, Canada Post and NRCan, make no guarantees, representations or warranties respecting such data, either express or implied, arising by law or otherwise, including but not limited to, effectiveness, completeness, accuracy or fitness for a particular purpose.

The licensors, including Her Majesty, Canada Post and NRCan, shall not be liable in respect of any claim, demand or action, irrespective of the nature of the cause of the claim, demand or action alleging any loss, injury or damages, direct or indirect, which may result from the use or possession of the data or the Data. The licensors, including Her Majesty, Canada Post and NRCan, shall not be liable in any way for loss of revenues or contracts, or any other consequential loss of any kind resulting from any defect in the data or the Data.

End User shall indemnify and save harmless the licensors, including Her Majesty, Canada Post and NRCan, and their officers, employees and agents from and against any claim, demand or action, irrespective of the nature of the cause of the claim, demand or action, alleging loss, costs, expenses, damages or injuries (including injuries resulting in death) arising out of the use or possession of the data or the Data.

Terms and conditions

Personal Use Only:

You agree to use this Data together with NISSAN Automotive Products for the solely personal, non-commercial purposes for which you were licensed, and not for service bureau, timesharing or other similar purposes. Accordingly, but subject to the restrictions set forth in the following paragraphs, you may copy this Data only as necessary for your personal use to view it, and save it, provided that you do not remove any copyright notices that appear and do not modify the Data in any way. You agree not to otherwise reproduce, copy, modify, decompile, disassemble or reverse engineer any portion of this Data, and may not transfer or distribute it in any form, for any purpose, except to the extent such restrictions are expressly prohibited or limited by applicable law.

Restrictions:

Except where you have been specifically licensed to do so by NISSAN and without limiting the preceding paragraph, you may not:

- a. use this Data with any products, systems, or applications installed or otherwise connected to or in communication with vehicles, capable of vehicle navigation positioning, dispatch, real time route guidance, fleet management or similar applications;

- b. use this Data with or in communication with any positioning devices or any mobile or wireless-connected electronic or computer devices, including without limitation mobile phones, palmtop and handheld computers, pagers, and personal digital assistants or PDAs.

Warnings:

The Data may contain inaccurate or incomplete information due to the passage of time, changing circumstances, sources used and the nature of collecting comprehensive geographic data, any of which may lead to incorrect results.

No Warranty:

This Data is provided to you “as is,” and you agree to use it at your own risk. NISSAN and its licensors (and their licensors and suppliers) make no guarantees, representations or warranties of any kind, express or implied, arising by law or otherwise, including but not limited to, content, quality, accuracy, completeness, effectiveness, reliability, fitness for a particular purpose, usefulness, use or results to be obtained from this Data, or that the Data or server will be uninterrupted or error-free.

Disclaimer of Warranty:

NISSAN AND ITS LICENSORS (INCLUDING THEIR LICENSORS AND SUPPLIERS) DISCLAIM ANY WARRANTIES, EXPRESS OR

IMPLIED, OF QUALITY, PERFORMANCE, MERCHANTABILITY FITNESS FOR A PARTICULAR PURPOSE OR NON-INFRINGEMENT.

Some countries, local laws and territories do not allow certain warranty exclusions, so that extent the above exclusion may not apply to you.

Disclaimer of Liability:

NISSAN AND ITS LICENSORS (INCLUDING THEIR LICENSORS AND SUPPLIERS) SHALL NOT BE LIABLE TO YOU: IN RESPECT OF ANY CLAIM, DEMAND OR ACTION, IRRESPECTIVE OF THE NATURE OF THE CAUSE OF THE CLAIM, DEMAND OR ACTION ALLEGING ANY LOSS, INJURY OR DAMAGES, DIRECT OR INDIRECT, WHICH MAY RESULT FROM THE USE OR POSSESSION OF THE INFORMATION; OR FOR ANY LOSS OF PROFIT, REVENUE, CONTRACTS OR SAVINGS, OR ANY OTHER DIRECT, INDIRECT, INCIDENTAL, SPECIAL OR CONSEQUENTIAL DAMAGES ARISING OUT OF YOUR USE OF OR INABILITY TO USE THIS INFORMATION, ANY DEFECT IN THE INFORMATION, OR THE BREACH OF THESE TERMS OR CONDITIONS, WHETHER IN AN ACTION IN CONTRACT OR TORT OR BASED ON A WARRANTY, EVEN IF NISSAN OR ITS LICENSORS (OR THEIR LICENSORS OR SUPPLIERS) HAVE BEEN ADVISED OF THE POSSIBILITY OF SUCH DAMAGES.

Some countries or local laws do not allow certain liability exclusions or damages limitations, so to that extent the above may not apply to you.

Export control:

You agree not to export from anywhere any part of the Data provided to you or any direct product thereof except in compliance with, and with all licenses and approvals required under, applicable export laws, rules and regulations.

Entire Agreement:

These terms and conditions constitute the entire agreement between NISSAN (and its licensors, including their licensors and suppliers) and you pertaining to the subject matter hereof, and supersedes in their entirety any and all written or oral agreements previously existing between us with respect to such subject matter.

4 Navigation

About route guidance	4-2	Setting a destination from the address book	4-17
Voice guidance during route guidance	4-2	Setting a new entry to the address book	4-17
Navigation screen	4-3	Setting an entry as a destination.	4-17
Basic operation	4-3	Setting a destination from the address book using Voice Recognition (if so equipped)	4-18
Available setting items	4-3	Setting an intersection as a destination	4-18
Setting a destination	4-5	Setting a city center as a destination.	4-19
Available destination setting methods	4-5	Traffic feature	4-19
Setting a destination from a street address	4-5	Displaying traffic events along route	4-20
Setting a destination from points of interest.	4-9	Traffic flow feature	4-20
Searching for places near current location.	4-9	Traffic settings	4-21
Searching for nearby restaurants or gas stations	4-11	Fuel prices.	4-21
Searching for points of interest in another city	4-12	Weather	4-22
Searching for places using Voice Recognition (if so equipped)	4-13	Displaying weather information on the screen	4-22
My points of interest/User-defined points of interest (POIs)	4-13	Stocks	4-24
		Sports	4-24
		Movie Listings.	4-25

ABOUT ROUTE GUIDANCE

After setting the destination, select “Start” to begin route guidance.

During route guidance, the system navigates you through the guide points using visual and voice guidance.



CAUTION

- The navigation system visual and voice guidance is for reference purposes only. The contents of the guidance may be inappropriate depending on the situation.
- When driving along the suggested route, follow all traffic regulations (for example, one-way traffic).



“Route guidance” (page 6-2)

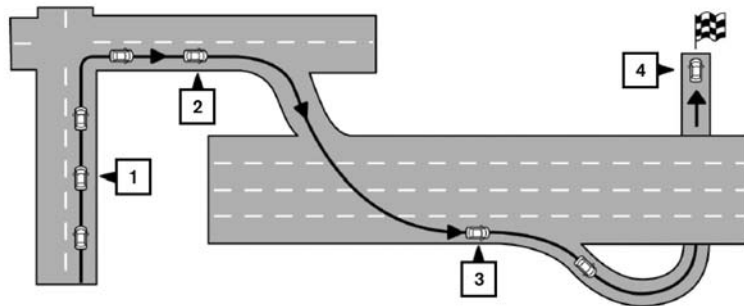

VOICE GUIDANCE DURING ROUTE GUIDANCE

When approaching a guide point (intersection or corner), destination, etc., during route guidance, voice guidance announces the remaining distance and/or turning direction.

Touch “Voice” on the upper left of the screen to repeat the voice guidance.

Example of voice guidance:

- 1 “In about one quarter mile (400 meters), right (or left) turn.” “Right (or left) turn ahead.”

- LNV0943
- 2 “In about one quarter mile (400 meters) freeway entrance on your right onto (road number and direction).” “Freeway entrance on your right onto (road number and direction).”
- 3 “In about one mile (1.6 kilometers), exit on your right.” “Take the second exit on your right.”
- 4 “You have reached your destination. Ending route guidance.”

NAVIGATION SCREEN



LNV3003



LNV3004

BASIC OPERATION

1. Press the NAV button.
2. Select the appropriate destination setting method by touching the screen or scrolling with the tune-scroll knob.

AVAILABLE SETTING ITEMS

- Street Address:
Set a destination address.

Several methods are available to set your destination.



“SETTING A DESTINATION”
(page 4-5)

- Points of Interest:
The system features a database of places such as restaurants, hotels, banks and more to assist you in navigation. These points of interest can be set as destinations and the system can then calculate a route.

- Cancel Route:
Touch “Cancel Route” to cancel the route guidance.



NOTE:

If route guidance is not active, “Cancel Route” cannot be operated.



- Previous Destinations:
Searches for a destination from the previous destinations in the destination memory.

Up to 50 previous destinations will be automatically stored. If the number of previous destinations exceeds 50, the oldest one will be removed from the list and the newest one will be added.

To manually delete a previous destination entry, select an entry from the list and then touch the “Delete” key.

Touch the “Save” key to add a previous destination to the address book.

Previous destinations can also be selected using the NISSAN Voice Recognition System (if so equipped):

1. Press the  or  button on the steering wheel. The system provides prompts and waits for voice commands.
2. Say “Navigation”.

3. Say "Previous destinations".
4. Speak the number of an entry on the displayed list to choose that destination or say "Next Page" to view more entries (if available).

If no route is set, route guidance is calculated automatically. If a route is set, say "Replace Destination" to use the chosen previous destination in Step 4 as the new destination. Say "Set as Waypoint" to add the chosen previous destination as a waypoint on the current route. Say "Show on Map" to show the chosen previous destination on the map.



For more information about the NISSAN Voice Recognition System, refer to the vehicle Owner's Manual.

 **NOTE:**

It is not possible to retrieve deleted previous destination entries.

- Home:
Your home address can be entered as a destination.

Home can also be set as a destination using the NISSAN Voice Recognition System (if so equipped):

1. Press the  or  button on the steering wheel. The system provides prompts and waits for voice commands.
2. Say "Navigation".
3. Say "Home".

If a home location is set, route guidance to the home location is calculated automatically.

For more information about the NISSAN Voice Recognition System, see the vehicle Owner's Manual.

- Address Book:
Touch "Address Book" to access stored addresses.
- City Center:
Select "City Center" to designate a city as a destination.
- Connected Search (if so equipped):
Touch "Connected Search" to use Nissan-Connect Services to search for a destination.

- Intersection:
Select "Intersection" to designate an intersection of two roads as a destination.
- My Points of Interest:
My Points of Interest are locations entered into the system via the vehicle's USB port.



"MY POINTS OF INTEREST/USER-DEFINED POINTS OF INTEREST (POIs)"
(page 4-13)

SETTING A DESTINATION

Press the NAV button. The methods for setting a destination are shown.

If route guidance is active, you can choose how to use the new destination. Select "Add as Waypoint" to keep the current destination and to add the current destination as a waypoint along the route. Select "Replace" to cancel the current route and replace the current destination with the new destination.

AVAILABLE DESTINATION SETTING METHODS

- Street Address



"SETTING A DESTINATION FROM A STREET ADDRESS"
(page 4-5)

- Points of Interest



"SETTING A DESTINATION FROM POINTS OF INTEREST"
(page 4-9)

- My Points of Interest



"MY POINTS OF INTEREST/USER-DEFINED MY POINTS OF INTEREST"
(page 4-13)

- Address Book



"SETTING A DESTINATION FROM THE ADDRESS BOOK"
(page 4-17)

- City Center



"SETTING A CITY CENTER AS A DESTINATION"
(page 4-19)

- Intersection



"SETTING AN INTERSECTION AS A DESTINATION"
(page 4-18)

SETTING A DESTINATION FROM A STREET ADDRESS



LNV2426

1. Press the NAV button.
2. Touch "Street Address".
3. If the state or province shown on the screen is correct, proceed to step 5. If the state or province shown on the screen is not correct, touch "Change State/Province".



LNV2415

4. Enter the name of the state or province. The display shows the touch keyboard.



“HOW TO INPUT CHARACTERS” (page 2-8)

The keyboard has an intelligent spelling setting, so it excludes non-existing combinations. On the top right of the screen, the number of matches is shown. At any time, touch the “List” key to display a list of possible names based on the letters currently entered. When the number of matches is reduced to six or less, a list will be shown automatically.

5. Touch “City”



NOTE:

It is possible to choose “House Number & Street” at this step if you want to manually enter the street name. However, the system can automatically narrow down the street in most cases when you enter the city name first. Entering by city can also be useful if you are unsure of the street’s correct spelling.



LNV2406

6. The display shows a touch keyboard to enter the city of the destination. Enter the name of the city. At any time, touch the “List” key to display a list of possible city names based on the letters currently entered. When the number of matches is reduced to six or less, the city list will be shown automatically.



LNV3013

7. Touch the city name on the list.



LNV2411

8. The display shows a touch keyboard to enter the house number of the destination. If the house number is not known, touch “Skip” and a default location on the street will be used.



NOTE:

If you choose “Skip”, a default location is chosen by the system and you will have a chance to change the position once the map is displayed. See step 12 for more instructions on changed the default location.



LNV2412

9. The display shows a touch keyboard to enter the street name. Enter the name of the street. At any time, touch the “List” key to display a list of possible street names based on the letters currently entered. When the number of matches is reduced to six or less, the street list will be shown automatically.

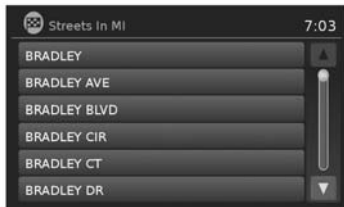

LNV2413

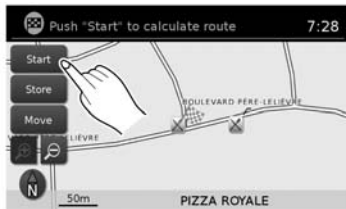

LNV2438

10. Touch the street name on the list.
11. If the house number entered in step 8 does not exist on the street in the chosen city, "The house number is not available" will be displayed. Select "Show Map" or "Change Number".

! NOTE:

You will have a chance to change the position from the default location once the map is displayed. See step 12 for more instructions on changing the default location.

12. A map of the destination is displayed on the screen. Touch "Start" to calculate the route.

The map of the destination is always displayed in 2D North Up. Once the "Start" key is touched, the system returns to the current map settings.

! NOTE:



If you did not enter an exact street address earlier in the process, the system will have chosen a default location, either along the street or within a range of addresses on that street. To move the map from that default position, touch the "Move" key. A message will be displayed asking if you want to touch a new location for the destination. Touch "OK" when complete.

Touch "Store" to store the location in the address book.



"SETTING A NEW ENTRY TO THE ADDRESS BOOK" (page 4-17)

A destination can also be set from a street address using the NISSAN Voice Recognition System (if so equipped):

1. Press the  or  button on the steering wheel. The system provides prompts and waits for voice commands.
2. Say "Navigation".
3. Say "Enter address in steps".
4. When prompted, say the name of the state or province. If the system cannot clearly interpret the name of the state or province, a list is provided with possible matches. Speak the number of the state or province displayed on the screen or say "Spell State" to spell the name of the state.
5. When prompted, say the name of the city. If the system cannot clearly interpret the name of the city, a list is provided with possible matches. Speak the number of the city displayed on the screen or say "Spell City" to spell the name of the city.

SETTING A DESTINATION FROM POINTS OF INTEREST

- When prompted, say the name of the street. If the system cannot clearly interpret the name of the street, a list is provided with possible matches. Speak the number of the street displayed on the screen or say "Spell Street" to spell the name of the street.
- When prompted, say the house number or say "No House Number" to display a default location on the chosen street within the chosen city. If the house number spoken is not on the chosen street, the system will notify you that the number is out of range and to restate the number or say "No House Number".

If a route is active, say "Replace Destination" to replace the current destination with the new street address or say "Set as Waypoint" to set the new street address as a waypoint on the current route.

If a route is not set, say "Set as Destination" to set the new street address as the destination and begin route guidance.

Say "Show on Map" to display the new street address on the map.

For more information about the NISSAN Voice Recognition System, see the vehicle Owner's Manual.

The system features a database of points of interest such as restaurants, hotels, banks and more to assist you in navigation. These points of interest can be set as destinations and the system can then calculate a route.



"MY POINTS OF INTEREST/USER-DEFINED POINTS OF INTEREST (POIs)" (page 4-13)



LNV3003

SEARCHING FOR PLACES NEAR CURRENT LOCATION

- Press the NAV button.
- Touch "Points of Interest".



LNV3005

3. Touch "Search by Category".
4. Touch "Near Current Location".

When searching by category, you can browse destinations from a variety of categories and subcategories, including:

- All POI
- Automotive
- Banking & Business
- Emergency
- Hotel/Motel
- Leisure
- Public Places
- Restaurant
- Shopping

4-10 Navigation

- Town Centre
- Travel

If you choose "By Name", you can search for places using a specific name. The touch keyboard is shown.



"HOW TO INPUT CHARACTERS"
(page 2-8)



NOTE:

- When using "Search By Category", the system will search for up to 200 matches within 50 miles (80 km) of the current position.
- When using "Search By Name", the system will search for up to 30 matches within 50 miles (80 km) of the current position.
- If the destination is not found within the 50 mile (80 km) search radius, you can search for places around a specific city name.



"SEARCHING FOR POINTS OF INTEREST IN ANOTHER CITY"
(page 4-12)

5. Destinations are shown based on the distance to the selected position. The arrow on the right shows the direction of the destination. The distance shown is a straight line distance.

Touch the desired destination from the list.

6. A detailed description of the destination is provided.

Press the BACK or ↩ BACK button to go back and pick another destination or touch "Start" to have the system calculate the route to the destination.



LNV3003



LNV3005



LNV2407

SEARCHING FOR NEARBY RESTAURANTS OR GAS STATIONS

While a wide variety of places can be searched in the system, shortcut buttons are available for restaurants and gas stations.

1. Press the NAV button.
2. Touch “Points of Interest”.

3. Touch “Nearby Restaurants”, “Nearby Gas Stations”, “Nearby Parking” or “Nearby ATMs”.
4. The system searches for destinations within 50 miles (80 km) of the current position.

5. Places are shown based on the straight line distance to the current position. The arrow on the right shows the direction of the destination. Touch the desired destination on the list.



NOTE:

A maximum of 200 destinations will be listed when searching with this method.

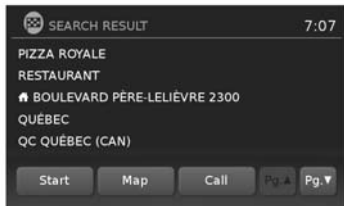

LNV2408

- A detailed description of the destination is provided.

- Press the BACK or ↩ BACK button to go back and pick another destination.
- Touch “Call” to call the destination (if a phone number is available) using the Bluetooth® Hands-Free Phone System. See the vehicle Owner’s Manual for more information about the Bluetooth® Hands-Free Phone System.
- Touch “Map” to show a map of the destination.
- Touch “Start” to calculate the route to the destination.

SEARCHING FOR POINTS OF INTEREST IN ANOTHER CITY

1. Press the NAV button.
2. Touch “Points of Interest”.
3. Touch “Search By Category” or “Search By Name”.
4. Touch “In Another City”.
5. Touch “Change State/Province” if the state or province shown is not correct.
6. If necessary, enter the name of the state or province.

The display shows the touch keyboard.



“HOW TO INPUT CHARACTERS” (page 2-8)

The keyboard has an intelligent spelling setting, so it excludes non-existing combinations. On the top right of the screen, the number of matches is shown.

7. Touch “City”.
8. A touch keyboard is displayed. Enter the name of the desired city.

Press “List” at any time to display a list of remaining cities. Touch the desired city.

9. If you chose “Search By Category” in Step 4, you can browse destinations from a list of categories and subcategories.

If you choose “Search By Name” in Step 4, you can search for places using a specific name. The touch keyboard is shown.



NOTE:

- When using “Search By Category”, the system will search for up to 200 matches within 50 miles (80 km) of the chosen city.
- When using “Search By Name”, the system will search for up to 30 matches within 50 miles (80 km) of the chosen city. If no matches are found, touch “Change Name” to search for another name.

10. Destinations are shown based on the distance from the selected position. The arrow on the right shows the direction of the destination. The distance shown is a straight line distance from the city center.



Touch the desired destination from the list.

11. A detailed description of the destination is provided.

Press the BACK or ↩ BACK button to go back and pick another destination or touch “Start” to have the system calculate the route to the destination.

SEARCHING FOR PLACES USING VOICE RECOGNITION (if so equipped)

Places can be set as destinations using the NISSAN Voice Recognition System:

1. Press the  or  button on the steering wheel. The system provides prompts and waits for voice commands.
2. Say "Navigation".
3. Say "Points of Interest" followed by a brand name.
4. Say number of the point of interest from the available list on the screen.
5. There are up to four options to search for a point of interest:
 - Say "Along Route" to search for the desired places along the current route.
 - Say "Nearby" to search for the desired places close to the vehicle's current location.
 - Say "Near Destination" to search for the desired places near the route's destination.
 - Say "In another city" so search for the desired places in another city. Selecting this option will lead to a series of other steps.

6. The system displays a list of results fitting the search criteria. Say the number of the desired entry on the list.

If a route is active, say "Replace Destination" to replace the current destination with the new street address or say "Set as Waypoint" to set the new street address as a waypoint on the current route.

If a route is not set, say "Set as Destination" to set the new street address as the destination and begin route guidance.

Say "Show on Map" to display the new street address on the map.

For more information about the NISSAN Voice Recognition System, see the vehicle Owner's Manual.

MY POINTS OF INTEREST/USER-DEFINED POINTS OF INTEREST (POIs)

A point of interest (POI) in the My Points of Interest database is a specific location of interest such as a gas station or bank. The POI consists of a longitude value, a latitude value and a name.

Additional POIs can be added to the system using the vehicle's USB port. For more information about using the USB port, see your vehicle's owner's manual.

The POIs can be set as a destination or be setup to activate POI warnings that display a pop-up message when the vehicle approaches certain areas such as hazard spot warnings.



NOTE:

- In order to save the user-defined points of interest data, a USB mass storage device is required. The user-defined points of interest data cannot be saved on the SD-card which contains the navigation data.
- User-defined points of interest are not shown in the map representation.
- The system recognizes the user-defined points of interest (POI) data and then asks the user via a pop-up message if the data needs to be downloaded into the system.
- If you confirm the download, the available user Points of Interest in the system internal memory will be deleted and the new ones in the USB mass storage device will be downloaded into the internal memory of the system.
- The progress of the download is shown by a progress-bar. When the download is finished, the user is notified that the USB mass storage device can be removed.

	A	B	C	D	E	F
1	-4.06494	53.600651	(Silverstone) Silverstone			
2						
3						
4						
5						
6						
7						
8						

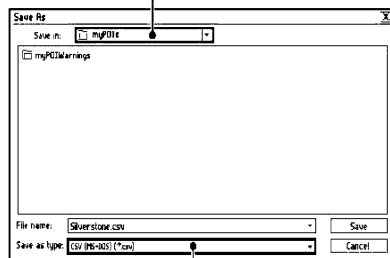

LNV1017

Creating user-defined points of interest (POIs)

- 1 Longitude
- 2 Latitude
- 3 Name
- 4 Location/Folder to save
- 5 File name

POI data can be downloaded from the Internet or created in a simple text editor in CSV (Comma Separated Values) file format.

There are two kinds of POI data supported by the system:

- User POIs – user-defined points of interest (POI) that can later be set as a destination and found using route guidance.
- POI-warnings – user-supplied areas such as hazard spots that the system displays in a pop-up window when the vehicle is approaching the designated area.

Perform the following procedure to create your own User POIs:

1. Connect a USB mass storage device to your personal computer.
2. Use a standard software program to create a list of POIs. Make sure the software can support the CSV file format.
3. In the first column, enter the longitude value of the position of the POI.
4. In the second column, enter the latitude value of the position of the POI.
5. In the third column, enter the name of the POI. Information entered in the fourth column, such as address or phone number, will be appended to the name of the POI.
6. Add more rows if necessary.
7. Save the file with the extension .csv (for example, myplacesfile.csv).



NOTE:

The name of the .CSV file will be used to create a My Points of Interest category in the system. Create separate .CSV files with different names to create other My Points of Interest categories.

8. Make sure to select the USB mass storage device as the location to save, using the exact folder name “/myPOIs” for User POIs or “/myPOIs/myPOIwarnings” for POI-warnings.

For example, if the USB mass storage device's root folder is represented by f:/, save the file to the folder “f:/myPOIs” for User POIs or to the folder “f:/myPOIs/myPOIwarnings” for POI-warnings.

9. Connect the USB mass storage device to the vehicle's USB port. For more information about the USB port, see your vehicle's Owner's Manual.



LNV3004

Adding user-defined points of interest (POIs)

Perform the following procedure to add your User POIs to the system:

1. Press the NAV button.
2. Touch “Next Page”.
3. Touch “My Points of Interest”.
4. If a USB mass storage device with the new POI data is connected, the system will automatically ask if you want to transfer the POI data. Touch “Download” to begin the transfer or “Cancel” to cancel the procedure.



NOTE:

New POI data will overwrite POI data already in the internal memory.

5. The POI data on the USB mass storage device is transferred to the vehicle.



NOTE:

A maximum of 8 MB of POI data can be added to the system.

6. Once the download process is complete, the available POIs are displayed in a list on the screen.
7. Touch the name of a POI on the list to set it as the destination.
8. Touch “Start” to calculate the route.

A user-defined POI in the My Points of Interest database can also be set as the destination by following the procedure below:

1. Press the NAV button.
2. Touch “Next Page”.
3. Touch “My Points of Interest”
4. Touch the name of the user-defined Point of Interest to set that entry as a destination.



LNV3000



LNV3006

Deleting user-defined points of interest (POIs)

Perform the following procedure to delete the user-defined POIs stored in the My Points of Interest memory:

1. Press the **APPS** button.
2. Touch "Settings".

3. Touch "Navigation".
4. Touch "My Points of Interest Settings"
5. Touch "Remove My Points of Interest From System".
6. A pop-up is displayed to confirm that you want to delete all User POIs (My Points of Interest) from the system. Touch "Yes" to delete the User POIs or "No" to cancel.

Other options are available on the "My Points of Interest Settings" screen:

- **My Points of Interest Alert:**
Select to adjust how alerts are provided when approaching a destination set by My Points of Interest. Choose "OFF" to disable the alert. Choose "Show Only" to display the alert on the screen. Choose "Show & Beep" to display the alert on the screen and play an audible sound.

- **Points of Interest Alert Distance:**
Select to choose from the available list a distance away from the My Points of Interest destination at which to activate the alert.

SETTING A DESTINATION FROM THE ADDRESS BOOK



LNV3004

SETTING A NEW ENTRY TO THE ADDRESS BOOK

1. Press the NAV button.
2. Touch "Next Page".
3. Touch "Address Book".
4. Touch "Add New Entry".

There are four possibilities shown:

NOTE:

Up to 50 address book entries can be stored. If the number of address book entries exceeds 50, one must be deleted before the new one can be added.

 "SETTING AN ENTRY AS A DESTINATION" (page 4-17)

● Street Address

This option allows you to save a new entry by selecting the address.

 "SETTING A DESTINATION FROM A STREET ADDRESS" (page 4-5)

● Previous Destination

This option allows you to save a destination in the address book from a location stored in the previous destination memory.

Touch the destination you would like to save into the address book.

The touch keyboard gives the option to change the name of the selected destination.

Touch "OK". The system confirms the entry and adds it to the address book.

● Current Destination

This option allows you to store the currently set destination in the address book when a route is active. This option is only available when a route is active.

Touch "Current Destination".

The touch keyboard gives the option to change the name of the destination.

Touch "OK". The system confirms the entry and adds it to the address book.

● Current Position

This option allows you to set the current position as a destination in the address book.

Touch "Current Position".

The touch keyboard gives the option to change the name of the destination.

Touch "OK". The system confirms the entry and adds it to the address book.

SETTING AN ENTRY AS A DESTINATION

Instead of touching "Add New Entry", you can touch any previously saved address.

The detailed description of the entry is shown. If information for the destination is not available, latitude and longitude coordinates will be shown.

You can rename or delete the entry. Touch "OK" to set the entry as a destination.

The system will calculate the route to the address chosen.

SETTING AN INTERSECTION AS A DESTINATION



SETTING A DESTINATION FROM THE ADDRESS BOOK USING VOICE RECOGNITION (if so equipped)

Entries in the address book can be set as destinations using the NISSAN Voice Recognition System:

1. Press the or button on the steering wheel. The system provides prompts and waits for voice commands.
2. Say "Navigation".
3. Say "Address Book".
4. Say the number of the entry in the address book displayed on the screen.

If a route is active, say "Replace Destination" to replace the current destination with the address book entry or say "Set as Waypoint" to set address book entry as a waypoint on the current route.

If a route is not set, route guidance is calculated to the address book entry.

Say "Show on Map" to display the location of the address book entry on the map.

For more information about the NISSAN Voice Recognition System, see the vehicle Owner's Manual.

LNV3004

An intersection of two streets can be set as a destination. To set an intersection as the destination:

1. Press the NAV button.
2. Touch "Next Page".
3. Touch "Intersection".
4. Touch "Change State/Province" if the state or province displayed is not correct.
5. If necessary, enter the name of the state or province.

The display shows the touch keyboard.



"HOW TO INPUT CHARACTERS"
(page 2-8)

6. Press "List" at any time and a list of remaining cities will be shown. Touch the desired city.

7. Touch "Street".

The display shows the touch keyboard.

8. Touch the name of the desired street.

9. A list of intersecting streets will be shown if six or less exist. Otherwise, the touch keyboard will be displayed again so that the name of the second street in the intersection can be entered. Enter the second street name.

10. Select the intersecting street.

11. Touch "Start".

The route to the intersection will be calculated.

SETTING A CITY CENTER AS A DESTINATION



LNV3004

The center of a city can be set as a destination. To set a city center as a destination:

1. Press the NAV button.
2. Touch “Next Page”.
3. Touch “City Center”.
4. If the state shown is not correct, touch “Change State or Province”. Otherwise, proceed to step 7.
5. Enter the name of the state or province. The display shows the touch keyboard.



“HOW TO INPUT CHARACTERS” (page 2-8)

The keyboard has an intelligent spelling setting, so it excludes non-existing combinations. On the top right of the screen, the number of matches is shown.

TRAFFIC FEATURE

6. Touch “City”
7. Enter the name of the first street. The display shows the touch keyboard.
8. Touch “Start” to calculate the route to the city center.

The Navigation System receives traffic information from SiriusXM Traffic to inform you of traffic events and guide you to an alternate route. Traffic events include accidents, road construction, heavy traffic and other factors that affect the route ahead.





LNV3000

DISPLAYING TRAFFIC EVENTS ALONG ROUTE

When a route is active, press the **APPS** button and then touch "SiriusXM Traffic" to display the traffic event nearest the current vehicle location. The location and nature of the traffic event is displayed on the screen. Three menu options are available on the screen.

! NOTE:

This feature can also be accessed using the NISSAN Voice Recognition System (if so equipped) by pressing the  or  button on the steering wheel and when prompted, saying "Information" then "Traffic".

- "Avoid Road On Route."

Touch the "Avoid Road On Route." key to direct the navigation system to avoid the area impacted by the listed traffic event. The next screen lists multiple options.

Touch the "Detour by Distance" key to avoid the road listed on the traffic event. You can choose the distance over which the system avoids the affected road. Touch the "+" or "-" key to set the distance and then touch "Recalculate Route" to calculate the new route.

Touch the "Avoid Segment of Route List" key to avoid a series of roads on the route list due to the traffic event. The route list is displayed on the screen. Touch the names of two streets on the list to avoid that portion of the route and then touch "Recalculate Route" to calculate the new route.

- "List All Traffic Events"

Touch the "List All Traffic Events" key to display a list of all traffic events in the area, including those which are not directly along the current route. Touch the line of a specific event on the screen to see more details about that item.

TRAFFIC FLOW FEATURE

Using information received from SiriusXM Traffic, the system informs you of traffic levels on certain highways and roads in the area along the route. Press the MAP button to display the map of the current vehicle location. Any roads with traffic flow information will appear colored as follows:

- Green: traffic is light and moving at normal speeds. (>45 mph)
- Yellow: traffic is heavy and moving slowly. (10-45 mph)
- Red: traffic is gridlocked and not moving. (<10 mph)



LNV3000



LNV3006

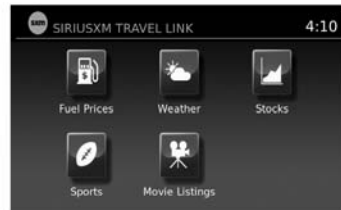

LNV3007

TRAFFIC SETTINGS

To access the settings for the traffic feature:

1. Press the **APPS+I** button.
2. Touch the “Settings” key.

3. Touch the “Traffic Messages” key.

The following settings can be adjusted:

- Dynamic Guidance
- Show Traffic Incidents
- Show Traffic Flow
- Announce Traffic Alerts

FUEL PRICES

To display fuel prices at gas stations in the surrounding area on the screen:

1. Press the **APPS+I** button.
2. Touch “SiriusXM Travel Link”.
3. Touch “Fuel Prices”.
4. Determine an area for the fuel search.

A menu will be presented to determine a location for the fuel price search.

- “Favorites”
Select to view fuel prices at stations near pre-determined favorite locations.
- “Nearby”
Select to view fuel prices at stations nearby.



WEATHER

- “Near Destination”
Select to view fuel prices at stations nearby the destination of the current route. Route guidance must be active for this option to be available.

Additional filtering options are available to narrow the search for specific fuel type and brand.

5. A list of gas stations is displayed with the distance and direction to each entry. Touch an entry on the screen to view information about that gas station.
6. The name, address and phone number of the gas station are displayed. If available, the prices for each grade of gasoline are also displayed. Touch “Go Here” to plot the location through the navigation system. Touch “Save” to store the gas station location.

! NOTE:

This feature can also be accessed using the NISSAN Voice Recognition System (if so equipped) by pressing the  or  button on the steering wheel and when prompted, saying “Information” then “Fuel Prices”.

NavWeatherXM information is a subscription service offered by SiriusXM Satellite Radio.

This service provides real-time information regarding current weather and forecasts where available. The weather information is broadcast to the vehicle by the SiriusXM satellites.

WARNING

NavWeatherXM information is not a substitute for attentive driving. Weather conditions change constantly and emergency situations can arise without warning. Relying only on NavWeatherXM information could result in serious personal injury.

XM NavWeather information is available in limited markets. To subscribe to or check if this service is available in the area, call 1-866-635-2349 or access www.siriusxm.com/navweather.

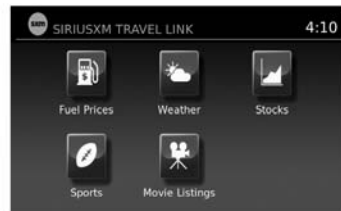

LNV3007

DISPLAYING WEATHER INFORMATION ON THE SCREEN

1. Press the **APPS**  button.
2. Touch “SiriusXM Travel Link”.
3. Touch “Weather”.



LNV2702

The weather conditions for the current location are displayed on the screen.

! **NOTE:**

In some areas, the location name at the top of the screen may not match the location shown for “Weather Station” due to differences in where weather information is collected.

Touch “Location” to view weather information for a different location:

- “Favorites”
Select to view weather information for pre-determined favorite locations.
- “Nearby”
Select to view weather information for the current location.

- “Near Destination”
Select to view weather information near the destination of the current route. Route guidance must be active for this option to be available.
- “In Another City”
Select to view weather information for a different city. Follow the on screen prompts and character input screens to select the desired location.



! **NOTE:**

When the weather function is accessed for the first time of the day, the GPS location may not be used. If this occurs, touch the “Location” key to update the location.

When a location has been determined, the current weather will be displayed. Touch “Forecast” and select either “6–Hour Forecast” or “5–Day Forecast” for the appropriate forecast.

Touch “Map” to display a radar map of weather conditions.

! **NOTE:**

This feature can also be accessed using the NISSAN Voice Recognition System (if so equipped) by pressing the  or  button on the steering wheel and, when prompted, saying “Information” then “Current Weather”, “Weather Map”, “6–hour Forecast” or “5–day Forecast”.

STOCKS



LNV3007

To display stock prices on the display screen:



1. Press the **APPS** button.
2. Touch "SiriusXM Travel Link".
3. Touch "Stocks".

Stocks to follow can be added by touching the "Add" button and entering the appropriate stock market symbol. Once the symbol is stored, the stock information will be available and updated when SiriusXM Travel Link is active.

Selections can be erased by touching "Remove" and choosing the appropriate stock to discard.



NOTE:

This feature can also be accessed using the **NISSAN Voice Recognition System** (if so equipped) by pressing the  or  button on the steering wheel and when prompted, saying "Information" then "Stocks".

SPORTS

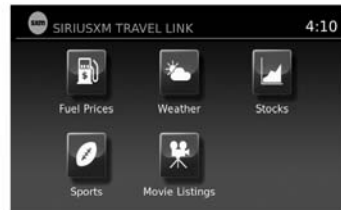

LNV3007



To display sports information the display screen:

1. Press the **APPS** button.
2. Touch "SiriusXM Travel Link".
3. Touch "Sports".

Various sports and individual teams can be followed using the Sports feature. Choose from the list of sports to display information such as news, select a specific team, view scores from previous games or view times for upcoming games.



NOTE:

This feature can also be accessed using the **NISSAN Voice Recognition System** (if so equipped) by pressing the  or  button on the steering wheel and when prompted, saying "Information" then "Sports".

MOVIE LISTINGS

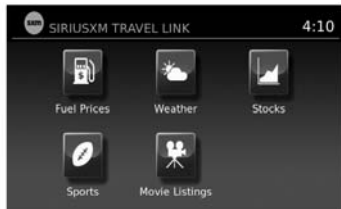

LNV3007

To display movie listings and theaters in the surrounding area on the screen:

1. Press the **APPS** button.
2. Touch "SiriusXM Travel Link".
3. Touch "Movie Listings".



Multiple options will be presented for searching for theater locations or specific movie titles. Select the appropriate search method.

- "Favorite Theaters"
Select to view a list of previously-stored movie theaters.
- "List Theaters"
Select to view of list of nearby movie theaters.
- "List Movies"
Select to view a list of current movies showing in theaters. When a movie title is selected, theater locations will be displayed.

- "Search for a Theater"
Select to manually enter the name of a theater.
 - "Search for a Movie"
Select to manually enter the name of a movie. When a movie is selected, theater locations will be displayed.
4. Once a location is determined, touch "Go Here" to plot the route through the navigation system. Touching "Call" will contact the theater via phone. "Save" will store the theater location.



NOTE:

This feature can also be accessed using the NISSAN Voice Recognition System (if so equipped) by pressing the  or  button on the steering wheel and, when prompted, saying "Information" then "Movie Listings".

MEMO

5 Other settings

System settings	5-2
Touchscreen click	5-3
System Beeps	5-3
Return to factory settings.....	5-3
Software licenses	5-3
Minimize Voice Feedback.....	5-3
System software version	5-3
Display settings	5-4

Display.....	5-4
Brightness.....	5-4
Rear View Camera Settings	5-4
Temperature Unit Settings.....	5-4
Clock settings.....	5-5
Set clock manually.....	5-5
Language settings.....	5-6
NissanConnect SM Services Settings.....	5-6

SYSTEM SETTINGS



LNV3000



LNV3006

The system can be customized according to your preference.

1. Press the **APPS** button.
2. Touch "Settings".

3. Touch "System".

4. Select the preferred setting item on the screen and the next screen will be shown. You may need to use the TUNE-SCROLL knob or the touch screen to scroll if more than one screen of options is available.

The following settings are available:

- Display

 "DISPLAY SETTINGS"
(page 5-4)

- Clock/Date

 "CLOCK SETTINGS" (page 5-5)

- Language

 "LANGUAGE SETTINGS"
(page 5-6)

- NissanConnectSM Services Settings

 "NISSANCONNECT SERVICES SETTINGS" (page 5-6)

- Camera Settings

 "REAR VIEW CAMERA SETTINGS" (page 5-4)

- Temperature Unit

 "TEMPERATURE UNIT SETTINGS" (page 5-4)

- Touchscreen Click

 "TOUCHSCREEN CLICK"
(page 5-3)

- System Beeps

 "SYSTEM BEEPS" (page 5-3)

- Return to Factory Settings/Clear Memory

 "FACTORY SETTINGS"
(page 5-3)

- Software Licenses

 "SOFTWARE LICENSES"
(page 5-3)

- Minimize Voice Feedback



“MINIMIZE VOICE FEEDBACK”
(page 5-3)

- System Software Version



“SYSTEM SOFTWARE VER-
SION” (page 5-3)

5. Select the button of the preferred item and adjust the setting. Alternatively, use the TUNE-SCROLL knob or steering wheel scrolling switch (if so equipped).
6. Press the BACK or  BACK button to return to the previous screen or press the NAV button to return to the current location map screen.

TOUCHSCREEN CLICK

Use this setting to change the audible confirmation between the on or off position when a screen button is touched.

Select the “Touchscreen Click” key to toggle between On and Off.

SYSTEM BEEPS

Use this setting to change the audible confirmation when:

- a button on the unit is pressed and held for about two seconds, such as the  button.
- a pop-up message appears on the screen.

Select the “System Beeps” key to toggle between ON and OFF.

RETURN TO FACTORY SETTINGS

Use this setting to restore the factory default settings.

Touch the “Return to Factory Settings/Clear Memory” key and then confirm the message. If you choose “Yes”, the system will reset the settings to the default settings. If you choose “No”, the default settings will not be restored and the display returns to the system settings screen.

SOFTWARE LICENSES

Select this option to view the license agreements associated with this software version.

Use the scroll bar to navigate through the menu.

MINIMIZE VOICE FEEDBACK

Use this function to minimize the amount of prompts spoken by the system in Alternate Command Mode.

SYSTEM SOFTWARE VERSION

This displays the software version your navigation system is currently running.

DISPLAY SETTINGS

DISPLAY

Switching the display on or off

This setting allows you to turn the display on or off. When the display is turned off, the clock will still be displayed.

To turn off the display, press and hold the  button.

The display will switch on when:

- the  button is pressed.
- any other button is pressed.
- receiving incoming calls or during a phone call. When the call is ended, the display returns to clock display.

Voice guidance (if active) continues even when the display is turned off.

Press and hold the  button for more than two seconds to switch the display to a larger display of the digital clock.

Changing day-night brightness

Press the  button for less than two seconds to toggle:

- between day and auto (night) when headlights are on.



- between night and auto (day) when headlights are off.

While the display is showing the current brightness mode, turn the TUNE/SCROLL knob to adjust the brightness.

The day or night mode can also be toggled from the Display Settings menu.

BRIGHTNESS

This menu allows you to adjust the brightness of the screen.

1. Press the **APPS**  button.
2. Touch the “Settings” key.
3. Touch the “System” key.
4. Touch the “Display” key.
5. Adjust the brightness using the “+” and “-” keys.
6. To save the setting, press the **BACK** or  **BACK** button to return to the previous screen.

REAR VIEW CAMERA SETTINGS

Use this setting to change the display mode (automatic/day/night) for the rear view camera. Brightness, contrast and color can also be adjusted.

1. Press the **APPS**  button.
2. Touch the “Settings” key.
3. Touch the “System” key.
4. Scroll down and touch the “Camera Settings” key.

Toggle display mode and use the “+” and “-” keys to adjust brightness, contrast and color for rear camera display.

TEMPERATURE UNIT SETTINGS

Use this setting to change the temperature units (Fahrenheit/Celsius).

1. Press the **APPS**  button.
2. Touch the “Settings” key.
3. Touch the “System” key.
4. Scroll down and touch the “Temperature Unit” key.

CLOCK SETTINGS

This setting allows you to make clock adjustments.

1. Press the **APPS** .
2. Touch the "Settings" key.
3. Touch the "System" key.
4. Touch the "Clock/Date" key.
5. Select the preferred setting item and make an adjustment.

- Time Format

Touch the "Time Format" key to change the clock format between 12-hour and 24-hour.

- Date Format

Touch the "Date Format" key to choose one of five available date formats.

- Clock Mode

Select "Manual" to manually set the clock with the "Set Clock Manually" key. Select "Auto" to have the clock automatically adjusted by the GPS system. Select "Time Zone" to have the time set to a specific time zone.

- Set Clock Manually

Allows you to set the clock manually. This feature is only available if "Manual" is selected for "Clock Mode".



"SET CLOCK MANUALLY"

(page 5-5)

- Daylight Savings Time

Touch the "Daylight Savings Time" key to toggle daylight savings time on or off. This feature is unavailable if "Clock Mode" is set to "Auto".

- Time Zone

Select and touch an appropriate time zone of the current vehicle location to bypass the GPS satellite. This feature is only available if "Time Zone" is selected for "Clock Mode".



NOTE:

If "Daylight Savings Time" is set to "ON" and a time zone is chosen for an area that does not observe Daylight Savings Time, the "Daylight Savings Time" setting remains "On" and must be turned off manually.

6. After adjusting the desired settings, press the BACK or  BACK button to return to the previous screen. You can also press the MAP button to return to the current location map screen or the FM, AM, CD or AUX button to return to the audio screen.

SET CLOCK MANUALLY

Adjust the hour, minute, day, month and year using the "+" and "-" keys.

1. Press the **APPS**  button.
2. Touch the "Settings" key.
3. Touch the "System" key.
4. Touch the "Clock/Date" key.
5. Toggle "Clock Mode" key to "Manual".
6. Toggle "MODE" to "AM" or "PM", then use "+" and "-" keys to adjust hour, minute, day, month and year.

After adjusting the desired settings, press the BACK or  BACK button to return to the previous screen.

LANGUAGE SETTINGS

This setting allows you to change the language used by the system.

1. Press the **APPS** button.
2. Touch the “Settings” key.
3. Touch the “System” key.
4. Touch the “Language” key.
5. Select the appropriate language. The available languages are:
 - English
 - Français
 - Español

NISSANCONNECTSM SERVICES SETTINGS

This option allows you to change the NissanConnectSM Services settings.

1. Press the **APPS** button.
2. Touch the “Settings” key.
3. Touch the “System” key.
4. Touch the “NissanConnect Services Settings” key.
5. Select one of the following options:
 - **Sync All Information Feeds**
Select to update all the feeds received from the NissanConnectSM Services center.
 - **Share Driver Information**
Toggle “ON” or “OFF” to share vehicle information with Nissan.
 - **Delete History**
Select to delete message history.
 - **Unit ID Information**
Use this option to display the Unit ID, TCU (Telematics Control Unit) ID, SIM ID and VIN information required for user registration.

- **Vehicle Data Transmission Setting**
When active, data transmission to the NissanConnectSM Data Center is enabled. Turning this option off disables NissanConnectSM Services functions.

6 General system information

Safety information	6-2	Display of current vehicle location	6-12
Features of this navigation system	6-2	What is GPS (Global Positioning System)?	6-12
Route guidance	6-2	Detailed map coverage (MCA) for the navigation system	6-12
Points of Interest directory	6-3	When a gray road is displayed on the map	6-13
Address book	6-3	Route calculation	6-13
SiriusXM Traffic information	6-3	Route guidance	6-14
Voice guidance	6-3	Basics of voice guidance	6-14
NissanConnect SM Services (if so equipped)	6-4	Directions provided and the distances to guide points	6-15
Subscription to NissanConnect SM Services	6-4	Repeating voice guidance	6-15
Legal Disclaimer	6-4	Notes on voice guidance	6-15
NissanConnect SM Services Features	6-4	How to handle the display	6-16
NissanConnect SM Services menus	6-9	Characteristics of a liquid crystal display	6-16
Emergency support information (if so equipped)	6-10	Maintenance of the display	6-16
Current vehicle location	6-12		

SAFETY INFORMATION

This system is primarily designed to help you reach your destination, and it performs other functions as outlined in this manual. However the driver must use the system safely and properly. Information concerning road conditions, traffic signs and the availability of services may not always be up-to-date. The system is not a substitute for safe, proper and legal driving.

Before using the navigation system, please read the following safety information. Always use the system as outlined in this manual.

WARNING

- **When the driver wants to operate the navigation system, first park the vehicle in a safe location and set the parking brake. Operating the system while driving can distract the driver and may result in a serious accident.**
- **Do not rely on route guidance alone. Always be sure that all driving maneuvers are legal and safe in order to avoid accidents.**
- **Do not disassemble or modify this system. If you do, it may result in accidents, fire or electrical shock.**

- **Do not use this system if you notice any malfunctions such as a frozen screen or lack of sound. Continued use of the system may result in accidents, fire or electrical shock.**
- **If you notice any foreign objects in the system hardware, spill liquid on the system or notice smoke or a smell, stop using the system immediately and contact a NISSAN dealer. Ignoring such conditions may lead to accidents, fire or electrical shock.**

CAUTION

- **Some states or provinces may have laws limiting the use of video screens while driving. Use this system only where it is legal to do so.**

NOTE:

Do not keep the navigation system running with the engine stopped. Doing so may discharge the vehicle battery. When you use the navigation system, always keep the engine running.

FEATURES OF THIS NAVIGATION SYSTEM

ROUTE GUIDANCE

The main features of the NISSAN Navigation System are visual guidance and voice guidance in selected map coverage areas. Utilizing a network of GPS (Global Positioning System) satellites, the NISSAN Navigation System tracks the location on the map and navigates to a preferred location.

Once you set the destination in a map coverage area, the NISSAN Navigation System will calculate a route from your current location to your destination. The real-time map display and turn-by-turn voice guidance leads the driver along the route. These features can be especially helpful when driving to unfamiliar locations.

The system may be unable to set a destination and/or calculate a route when the destination is outside the map coverage area. Additionally, voice guidance may not be available if the destination is outside the map coverage area. For more information on how to set a destination, refer to Section 4.

POINTS OF INTEREST DIRECTORY

The NISSAN Navigation System offers an extensive Points of Interest directory in map coverage areas. This directory includes a wide variety of destinations. By accessing the Points of Interest directory, you can search for addresses for a destination, and just by pushing a button, the NISSAN Navigation System will calculate a route to the destination.

The Points of Interest directory has many uses. For example, the directory can be sorted by the various types of restaurants near your current location. If you need a bank or a gas station, the NISSAN Navigation System can navigate you to the closest preferred location using the Points of Interest entered in the system.



“SETTING A DESTINATION FROM POINTS OF INTEREST” (page 4-9)

ADDRESS BOOK

The address book can store up to 50 locations from map coverage areas into a personal directory. This is especially useful for frequently visited locations, such as clients, relatives and friends. The address book function allows easy access to frequently visited locations when setting them as your destination.



“SETTING A DESTINATION FROM THE ADDRESS BOOK” (page 4-17)

SIRIUSXM TRAFFIC INFORMATION

When available, the SiriusXM Traffic Information broadcast may help to avoid delays due to traffic incidents. Traffic jams, roadwork, closed roads around the current location, etc. are represented graphically on the map by icons depicting the nature of the event. Incidents on the route are automatically displayed when they are approached.

The SiriusXM Traffic Information feature, via the guidance mode, may help to detour around traffic problems. For more information on the SiriusXM Traffic Information feature, refer to section 4.



LN2026

VOICE GUIDANCE

Route guidance is provided through voice and visual instructions. Voice guidance announces the appropriate directions when approaching an intersection at which you need to turn. To repeat the voice guidance, touch the “Voice” key.

The voice guidance can be alternately enabled or disabled by touching and holding the “Voice” key on the screen for about two seconds. When the voice guidance is disabled, the “Voice” key on the screen will appear grayed out.

NISSANCONNECTSM SERVICES (if so equipped)

NissanConnectSM Services website:

For U.S. customers
www.nissanusa.com/connect

For Canadian customers
www.nissan.ca/nissanconnect (English)
www.nissan.ca/nissanconnect/fr (French)

NissanConnectSM Services support line: 1-855-426-6628

SUBSCRIPTION TO NISSANCONNECTSM SERVICES

Except for services received under Demonstration Mode, it is necessary to subscribe to NissanConnectSM Services in order to use the NissanConnectSM Services. To activate NissanConnectSM Services, you can enroll via the NissanConnectSM Services Companion App, NissanConnectSM portal website, or contact a NISSAN dealer.

NissanConnectSM Services are offered by SiriusXM or other third-party vendors in accordance with the terms and conditions and privacy policies outlined in a Subscription Agreement.

LEGAL DISCLAIMER

Driving is serious business. Only use NissanConnectSM Services powered by SiriusXM[®] when safe to do so. Late availability for some features. Services, including automatic crash notification and SOS, are dependent upon the telematics device being in operative condition, its ability to connect to a wireless network, compatible wireless network availability, navigation map data, and GPS satellite signal receptions, the absence of which can limit or prevent the ability to reach NissanConnect Customer Care or receive support. Never program while driving. GPS mapping may not be detailed in all areas or reflect current road status. You are responsible for using Remote Engine Start and Remote Horn features in accordance with any laws, rules or ordinances in effect in your vehicle's location. Cellular network not available in all areas and/or at all times. Cellular technology is evolving, and changes to cellular networks provided by independent companies are not within Nissan's or Sirius XM Radio Inc.'s control. Neither Nissan nor Sirius XM are responsible for associated costs that may be required for continued operation due to cellular network termination (including equipment upgrades, if available, or roaming charges on alternative networks). Should cellular provider terminate/restrict service, service may be terminated without notice and with no liability

to Nissan, Sirius XM and/or their respective agents or affiliates. Certain services require a PIN for activation. www.NissanUSA.com/connect for details. Enrollment and Subscription Agreement is required to receive full suite of services. Terms and conditions of Subscription Agreement apply. Six (6) month trial period begins on your date of vehicle purchase or lease of a new Nissan; subsequently a paid subscription is required at the then current rate to continue to receive services. Text rates and/or data usage may apply.

NISSANCONNECTSM SERVICES FEATURES

NissanConnectSM Services provides various types of information and services by connecting your vehicle to the NissanConnectSM Services Data Center and NissanConnectSM Services Response Center using the TCU (Telematics Control Unit) installed in your vehicle.

WARNING

- Please note that the Automatic Collision Notification service and Emergency Call function cannot be used in the following conditions:
 - Emergency functions and services will not be available without a paid subscription to NissanConnectSM Services.
 - The NissanConnectSM Services network system is disabled.
 - The vehicle moves outside the service area where the TCU (Telematics Control Unit) is connected to the system.
 - The vehicle is outside the area where the cellular network service is receivable.
 - The vehicle is in a location with poor signal reception such as tunnels, underground parking garages, behind buildings or in mountainous areas.
 - The line is busy.

- The TCU (Telematics Control Unit) or other systems of your vehicle are not working properly.
- It may not be possible to make an emergency call depending on the severity of a collision and/or emergency.
- Radio waves could adversely affect electric medical equipment. Individuals who use a pacemaker should contact the device manufacturer regarding any possible effects before using the system.
- The TCU (Telematics Control Unit) antenna is installed inside the upper central part of the instrument panel. An occupant should not get any closer to the antenna than specified by the pacemaker manufacturer. The radio waves from the TCU antenna may adversely affect the operation of the pacemaker while using the NissanConnectSM Services.



INFO:

- NissanConnectSM Services features are dependent upon subscription enrollment and the telematics device being in operative

condition, cellular connectivity, navigation map data and GPS satellite signal reception. Terms and conditions of the NissanConnectSM Services Subscription Agreement apply.

- Enrollment is required in order to receive NissanConnectSM Services. The services that can be received vary depending on the plan in which you are enrolled.
- A six-month trial is included beginning on the date of purchase, however you must still be enrolled and activated to use services.
- After the trial period, you must enroll in a paid subscription for NissanConnectSM Services to continue using the features. The services that can be received vary depending on the plan to which you subscribe.
- Laws in some jurisdictions may restrict the use of "Text-to-Speech." Check local regulations before using this feature.

NissanConnectSM Services may be updated. The latest detailed information is available on the following websites or from the support line.

NissanConnectSM Services website:

For U.S. customers
www.nissanusa.com/connect

For Canadian customers
www.nissan.ca/nissanconnect (English)
www.nissan.ca/nissanconnect/fr (French)

NissanConnectSM Services support line:
1-855-426-6628

Roadside Assistance Service

Enhanced Roadside Assistance allows you to receive assistance from the Roadside Response Specialist for a non-emergency incident that requires a towing or third-party response service. The service is accessed by touching the Voice Menu button on the navigation screen. Roadside Assistance may also be used in conjunction with the Emergency Assistance service, if warranted.

 (page 6-10)

Emergency Calling (E-Call)

The Emergency Calling (E-Call) feature provides emergency assistance by connecting to a Response Specialist. In the event of an emergency, by pressing the in-vehicle SOS button to use this feature. The Response Specialist provides various assistance depending on the situation.

 (page 6-10)

Automatic Collision Notification (ACN)

The TCU (Telematics Control Unit) generates a signal automatically to the NissanConnectSM Services Response Center in the case of an accident severe enough to trigger one of the vehi-

cle's air bags. Upon the signal, a Response Specialist receives the vehicle location and customer information and notifies the proper authorities in accordance with established policies and procedures.

Curfew Alert

Customers can set time interval for acceptable and unacceptable operation of the vehicle via NissanConnectSM Portal Website and NissanConnectSM Services Companion App. If the time restrictions are violated, the customer will be automatically notified (email, text message, or phone call).

Remote Door Lock/Unlock

The Remote Door Lock/Unlock feature allows the customer to access the vehicle remotely from the NissanConnectSM Services website or Companion App to send lock or unlock commands to the vehicle.

Remote Sound Horn and Flash Lights

Customers can activate the vehicle's headlights and horn via the NissanConnectSM Services website or Companion App.

Remote Engine Start

If the vehicle is equipped with TCU (Telematics Control Unit), Remote Start and via the Intelligent Key, customers can remotely start the vehicle via the NissanConnectSM Services website or Companion App.

Alarm Notification

Customers can set an area for the vehicle to stay in or out of via the NissanConnectSM Services website or Companion App. Customers will be notified when vehicle is out-of-bounds based on their notification preferences (e-mail, text, phone call).

Maintenance Alert/Reminder

The center sends maintenance and other relevant info. to registered e-mail address (PC/Mobile) based on the vehicle information (e.g. driving mileage and etc.) sent at the center access timing. Details of vehicle information are separately examined.

GoogleTM Send-To-Car

Customers can access turn-by-turn navigation provided by Google maps and sent directly to the NissanConnectSM vehicle.

Journey Planner

Customers can create a multiple way-point route via Journey Planner on the NissanConnectSM Services website and send the details directly to their vehicle.

Destination Send-To-Car

Customers can search for different locations via the NissanConnectSM Services website and send them directly to their vehicle.

Connected Search

Customers can access Internet search engines directly from the vehicle to find exact destinations to navigate to.

Assisted Search

Customers can use Assisted Search to get further destination assistance via operator service or live Response Specialist for more detailed information.

Stolen Vehicle Locator

In the event that the customer's vehicle is stolen, after filing a police report the customer can contact NissanConnectSM Services via phone and report the vehicle stolen. At that point, NissanConnectSM Services emergency support staff will work with authorities to attempt to recover the vehicle.

Valet Alert

Customers will be notified if their vehicle is driven more than 0.2 miles once they activate Valet Alert via the NissanConnectSM Services website or Companion App.

Notice to Bluetooth® Hands-free phone users

This is to avoid various services by NissanConnectSM Services Response Specialists (such as Assisted Search) and NissanConnectSM Services emergency support staff being interrupted

by incoming calls. Incoming phone calls received while the vehicle is connected to the Service Center will not be listed in the call history of the Bluetooth® Hands-free phone system. However those incoming calls may be listed in the call history of your mobile phone, depending on its capabilities. After disconnecting communication with the NissanConnectSM Services Response Specialist or NissanConnectSM Services emergency support staff, check the incoming call history on your mobile phone when it is safe to do so.

Service application

A separately purchased NissanConnectSM Services subscription is required. For more details, refer to the NissanConnectSM Services website or contact the NissanConnectSM Services support line.

NissanConnectSM Services website:

For U.S. customers
www.nissanusa.com/connect

For Canadian customers
www.nissan.ca/nissanconnect (English)
www.nissan.ca/nissanconnect/fr (French)

NissanConnectSM Services support line: 1-855-426-6628



INFO:

If the vehicle is owned by another person and is resold, the subscription for this service must be canceled and all data stored on the device must be deleted.

Operating tips



WARNING

- **Use NissanConnectSM Services after stopping your vehicle in a safe location. If you have to use NissanConnectSM Services while driving, exercise extreme caution at all times so full attention may be given to vehicle operation.**
- **If you are unable to devote full attention to vehicle operation while talking with NissanConnectSM Services, pull off the road to a safe location and stop your vehicle.**
- Do not use NissanConnectSM Services with the engine stopped. Doing so may discharge the vehicle battery.

- NissanConnectSM Services cannot be used under the following conditions:
 - NissanConnectSM Services subscription has expired.
 - The vehicle is outside the area where the cellular network service is receivable.
 - The vehicle is in a location with poor signal reception such as tunnels, underground parking garages, behind buildings or in mountainous areas.
 - The line is busy.
 - The TCU (Telematics Control Unit) or other systems of your vehicle are not working properly.
 - The NissanConnectSM Services network system is disabled.
- Information Feeds download cannot be used when the vehicle is connected to the NissanConnectSM Services Data Center and NissanConnectSM Services Response Center.
- Communication with the NissanConnectSM Services Data Center is related to the data communication mode and may cause occasional difficulty in receiving signals, and the signal receivable area may be limited compared to regular mobile phones.
- You may hear clicks or experience interruptions while speaking with the NissanConnectSM Services Response Specialists. This is due to a shift in the connection zone and is not a malfunction.
- Depending on the line used, the sound volume may decrease. Adjust the volume as necessary.
- Received sounds may be distorted or ambient noise may sound like voices of a crowd. This is due to the use of the digital line and is not a malfunction.
- You may hear your own voice from the speaker when talking with the NissanConnectSM Services Response Specialists due to a network disturbance. When this occurs, reconnect the line after a few minutes or at a different location.
- This vehicle incorporates a communication device that is called a TCU (Telematics Control Unit). The communication connection between this unit and the NissanConnectSM Data Center allows for various services. When the system connects to the NissanConnectSM Data Center, an antenna icon will appear in the upper right corner of the screen. Use the service in a location where the symbol representing good signal reception appears on the screen.



: When the signal reception is good.

: When the signal reception is bad.

- NissanConnectSM Services uses the TCU (Telematics Control Unit). Even if the signal strength bar of the in-vehicle data communication module indicates good reception, connection to the NissanConnectSM Data Center may be disabled. This does not indicate a malfunction. Operate the system again after a few minutes.

6-8 General system information



LNV3000

NISSANCONNECTSM SERVICES MENU

To access the NissanConnectSM Services features:

1. Press the **APPS** button.
2. Touch "NissanConnectSM Services".

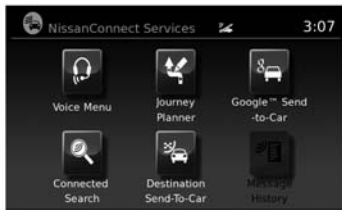

LNV3012

The NissanConnectSM Services menu allows you to access the following options:

- **Voice Menu**
When selected, this menu offers a choice of Assisted Search, Account Management or Roadside Assistance all through a live NissanConnectSM Services representative.
- **GoogleTM Send-To-Car**
Customers can access turn-by-turn navigation provided by Google Maps and sent directly to the NissanConnectSM vehicle.
- **Destination Send-To-Car**
Customers can search for different locations via the NissanConnectSM Services website and send them directly to their vehicle.

- **Journey Planner**
Customers can create a multiple way-point route via Journey Planner on the NissanConnectSM Services website and send the details directly to their vehicle.
- **Connected Search**
Customers can access Internet search engines directly from the vehicle to find exact destinations to navigate to.
- **Message History**
Customers can review previous messages sent to the vehicle.

Voice Menu

When selected, the system offers three options:

- Assisted Search
- Account Management
- Roadside Assistance

If you begin speaking before the options are offered, you will be immediately connected with a NissanConnectSM Services representative.

Google™ Send-To-Car

Use your favorite connected device to send an address to your NissanConnectSM system via the Send-To-Car website. When you start your vehicle, select the 'Sent To Car' button. The address will be delivered and loaded into the system. Obtain the specific address for your vehicle by registering here:

For U.S. customers
www.nissanusa.com/connect

For Canadian customers
www.nissan.ca/nissanconnect (English)
www.nissan.ca/nissanconnect/fr (French)

Destination Send-To-Car

Use the NissanConnectSM website to search and send destinations directly to your vehicle. Obtain the specific address for your vehicle by registering here:

For U.S. customers
www.nissanusa.com/connect

For Canadian customers
www.nissan.ca/nissanconnect (English)
www.nissan.ca/nissanconnect/fr (French)

Journey Planner

Before you travel, use the NissanConnectSM Services Web Portal to help you plan your itiner-

ary and simplify your trip. Just enter your starting point and end destination plus locations you'd like to stop at along the way. Journey Planner will determine your route, calculate driving distance and time, and send your journey plan to your vehicle. Learn more about this feature here:

For U.S. customers
www.nissanusa.com/connect

For Canadian customers
www.nissan.ca/nissanconnect (English)
www.nissan.ca/nissanconnect/fr (French)

Connected Search

Use Google™ to search for a destination without knowing the specific name or category. Simply type in the name of a destination and a list of options will be presented. Choose an item from the list to view details such as its address and phone number. Options to save the item, plot the navigation or calling the location are also available.

Message History

This option displays in-vehicle messaging notifying customers about scheduled maintenance appointments and important information about their vehicle like warranty alerts. Vehicle owners can also opt-in to receive promotional offers in their vehicle.

EMERGENCY SUPPORT INFORMATION (if so equipped)

NissanConnectSM Services provides various services to support dealing with emergencies of the subscribed vehicle and the driver.

For example, in case of an illness or serious injury, you can seek support by pressing the in-vehicle SOS button and connecting to NissanConnectSM Services. NissanConnectSM Services can specify the location of the vehicle via GPS, and the information will be sent to the police or other agencies as needed.

For information about other NissanConnectSM Services emergency support related services, refer to the NissanConnectSM Services website or contact the NissanConnectSM Services support line.

NissanConnectSM Services website:

For U.S. customers
www.nissanusa.com/connect

For Canadian customers
www.nissan.ca/nissanconnect (English)
www.nissan.ca/nissanconnect/fr (French)

**NissanConnectSM Services support line:
1-855-426-6628**

WARNING

- Please note that the Automatic Collision Notification service and Emergency Call function cannot be used in the following conditions:
 - Emergency functions and services will not be available without a paid subscription to NissanConnectSM Services.
 - The NissanConnectSM Services network system is disabled.
 - The vehicle moves outside the service area where the TCU (Telematics Control Unit) is connected to the system.
 - The vehicle is outside the area where the cellular network service is receivable.
 - The vehicle is in a location with poor signal reception such as tunnels, underground parking garages, behind buildings or in mountainous areas.
 - The line is busy.

- The TCU (Telematics Control Unit) or other systems of your vehicle are not working properly.
- It may not be possible to make an emergency call depending on the severity of a collision and/or emergency.
- Park the vehicle in a safe location and set the parking brake before operating SOS button.
- Only use this service in case of an emergency. There may be a penalty for inappropriate use of the service.
- Radio waves could adversely affect electric medical equipment. Individuals who use a pacemaker should contact the device manufacturer regarding any possible effects before using the system.

- The TCU (Telematics Control Unit) antenna is installed inside the upper central part of the instrument panel. An occupant should not get any closer to the antenna than specified by the pacemaker manufacturer. The radio waves from the TCU antenna may adversely affect the operation of the pacemaker while using the NissanConnectSM Services.

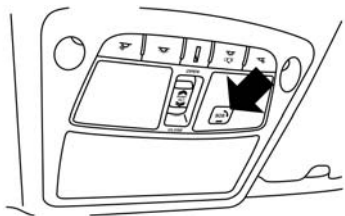

LNV2706

Making an emergency call

1. Press the SOS button.
2. When the line is connected, speak to the Response Specialist.



INFO:

- After the SOS button is pushed, it may take some time until the system initiates connection, depending on the technical environment and whether the TCU (Telematics Control Unit) is being used by other services.

- An indicator light on the SOS button shows the readiness of the emergency support system. If the indicator light is not illuminated, pressing SOS button does not connect your vehicle to the Response Specialist.

The indicator light blinks while connected to the NissanConnectSM Services Response Center.

- Even when the indicator light is illuminated, connection to the NissanConnectSM Services Response Center may not be possible. If this occurs in an emergency situation, contact the authorities by other means.
- To avoid disconnecting the line, do not turn off the engine.

CURRENT VEHICLE LOCATION

DISPLAY OF CURRENT VEHICLE LOCATION

This navigation system combines the data obtained from the vehicle (by gyro sensor) and from GPS (Global Positioning System) satellites to calculate the current location of the vehicle. This position is then displayed throughout route guidance to a destination.

WHAT IS GPS (Global Positioning System)?

GPS is a position detecting system that uses satellites deployed by the U.S. government. This navigation system receives radio signals from three or more different satellites that orbit 13,049 miles (21,000 km) above the earth in space, and detects the position of the vehicle by utilizing the principle of triangulation.

DETAILED MAP COVERAGE (MCA) FOR THE NAVIGATION SYSTEM

This system is designed to help you reach your destination, and also performs other functions as outlined in this manual. However, you, the driver, must use the system safely and properly. Information concerning road conditions, traffic signs and the availability of services may not always be up-to-date. The system is not a substitute for safe, proper, and legal driving.

ROUTE CALCULATION

Map data is available on the provided SD-card. For information about the map SD-card, contact a NISSAN dealer or call the NISSAN NAVIGATION SYSTEM HELPDESK. See the contact information on the inside front cover of this manual.

Map data includes 2 types of areas: "Detailed coverage areas" providing all detailed road data and other areas showing "Main roads only".



NOTE:

Detailed map data is not available in many areas and is generally limited to select major metropolitan areas.

WHEN A GRAY ROAD IS DISPLAYED ON THE MAP

- Route calculation may not be possible when a destination or the current vehicle location is near a gray road.
- Route guidance (enlarged view and voice guidance) may not be available at the intersection where the road your vehicle is driving on and a gray road intersect.
- Places information and street names near gray roads are not contained in the map data.

- The NISSAN Navigation System may not calculate a route if the current vehicle location is too far away from the destination. In this case, please divide your trip by selecting one or two intermediate destinations.
- To reach your destination, refer to the map screen. Always follow actual roads and regulations and drive safely.
- The suggested route may not be the shortest, nor are other circumstances such as traffic jams considered unless the SiriusXM Traffic is active.
- Because of the inevitable difference in road conditions and circumstances between the time you use this system and the time the information was produced for the map data, there may be discrepancies in roads and regulations. In such cases, follow the actual information available.
- During route calculation, the map will not scroll, however the vehicle icon will move with the actual vehicle's movement.
- In some cases, after the calculation is complete, the calculated route may not be immediately displayed.
- If you scroll the map while the suggested route is being drawn, it may take more time to finish drawing.
- If waypoints are set, the system calculates multiple routes between waypoints simultaneously, and the following may result.
 - If one section between waypoints cannot be calculated, none of the route will be displayed.
 - The route may not connect completely at some waypoints.
 - The route may require a U-turn close to some waypoints.
- Route calculation may not be completed in the following cases.
 - If there is no main road within a range of 1.5 miles (2.5 km) from the vehicle, a message will then appear on the screen. Try recalculating when the vehicle is closer to a main road.
 - If the vehicle is too close to the destination or if there are no roads to the destination, a message will then appear on the screen.
 - If it is impossible to reach the destination or waypoints because of traffic regulations, etc.
 - If the only target route to the destination or waypoints is extremely complicated.

ROUTE GUIDANCE

- The following may occur when the route is displayed.
 - If you calculate a route on a main road, the starting point of the route may not exactly match the current vehicle location.
 - The endpoint of the route may not exactly match the destination.
 - If you calculate a route on a main road, the system may display a route from another main road. This may be because the position of the vehicle icon is not accurate. In this case, park the vehicle in a safe location and reset the vehicle icon, or continue driving to see if the position of the vehicle icon is automatically adjusted before recalculating the route.



“VEHICLE ICON” (page 7-3)

- In some cases, the system shows an indirect route to the destination or waypoints if you set them from stored or places information. In order to correct, you must be careful about the traffic direction, especially when lanes with different travel directions are shown separately, such as interchanges and service areas.

- Even if the freeway preference is set to OFF, a route that uses the freeway may be suggested.
- Even if the preference is set to OFF, a route that uses a ferry line may be suggested.
- Ferry lines, excluding those that are only for pedestrians, bicycles and motorcycles, are stored in this system. Take into consideration the travel time required and operational condition before deciding whether to use the route.

BASICS OF VOICE GUIDANCE

The voice guidance announces which direction to follow when approaching an intersection where a turn is required.

After setting the route, select “Start” to begin route guidance.

During route guidance, the system navigates you through the guide points using visual and voice guidance.



NOTE:

- The navigation system visual and voice guidance is for reference purposes only. The contents of the guidance may be inappropriate depending on the situation.
- There may be some cases in which voice guidance and actual road conditions do not correspond. This may occur because of discrepancies between the actual road and the information on the map data, or due to the vehicle’s speed.
- In case voice guidance does not correspond to the actual road conditions, follow the information obtained from traffic signs or noticed on the road.
- Route guidance provided by the navigation system does not take carpool lane driving into consideration, especially when carpool lanes are separated from other road lanes.

DIRECTIONS PROVIDED AND THE DISTANCES TO GUIDE POINTS

Directions will differ, depending on the road type.



INFO:

Distances may vary, depending on the vehicle speed.

Notification when approaching the destination

Ordinary road:

The voice guidance will warn you when approaching your destination. To reach your destination precisely, refer to the map screen.

REPEATING VOICE GUIDANCE

This function is available throughout route guidance, from the time after the route calculation is completed until the vehicle arrives at the destination.

Touch the "Voice" key.

Voice guidance will be repeated.



INFO:

- If you touch the "Voice" key when you have deviated from the suggested route, voice guidance will announce, "Proceed to the highlighted route."

- If you touch the "Voice" key when you are going in the wrong direction, voice guidance will announce: "Please make a legal U-turn if possible."

NOTES ON VOICE GUIDANCE

- Voice guidance in this system should be regarded as a supplementary function. When driving your vehicle, check the route on the map and follow the actual roads and traffic regulations.
- Voice guidance is activated only for intersections with certain conditions.
- There may be cases where the vehicle has to turn, but voice guidance is not provided.
- Voice guidance contents may vary, depending on the direction of the turn and the type of intersection.
- The voice guidance timing will vary depending on the situation.
- When the vehicle has deviated from the suggested route, voice guidance is not available. The system will not announce this to you. Refer to the map and recalculate the route.
- Voice guidance may not accurately correspond with road numbers and directions at freeway junctions.
- Voice guidance may not accurately correspond to street names at freeway exits.
- The displayed street names may sometimes differ from the actual names, or "UNKNOWN STREET NAME" may be displayed.
- Voice guidance is not available when the feature is disabled in the SETTINGS menu.
- Voice guidance will start when the vehicle enters the suggested route. Refer to the map for directions to the starting point of the route.
- When approaching a waypoint, voice guidance will announce, "You have reached your intermediate destination on the (left/right) side." Voice guidance will switch to the next section of the route. When voice guidance is not available, refer to the map for directions.
- In some cases, voice guidance ends before arrival at the destination. Refer to the destination icon on the map to reach the destination.
- If the system recognizes on which side the destination (waypoint) is located, voice guidance will announce "on the right/left" after announcing the arrival at the destination.
- Voice guidance may be partially operational or inoperative due to the angle of roads at an intersection.

HOW TO HANDLE THE DISPLAY

- Because it is not possible to consider data concerning roads that are seasonally available or unavailable, a route may be displayed that does not match the actual traffic restrictions. Be sure to follow the actual traffic restrictions while driving.
- Canada and Alaska contain many roads with incomplete map data. As a result, when searching for a route, the route may include roads with incomplete data. In regions where road data is not complete, voice guidance may stop for long periods of time. Be sure to follow the actual traffic restrictions while driving.

The display is a liquid crystal display and should be handled with care.

WARNING

Never disassemble the display. Some parts utilize extremely high voltage. Touching them may result in serious personal injury.

CHARACTERISTICS OF A LIQUID CRYSTAL DISPLAY

- If the temperature inside the vehicle is especially low, the display will stay relatively dim or the movement of the images may be slow. These conditions are normal. The display will function normally when the interior of the vehicle has warmed up.
- Some pixels in the display are darker or brighter than others. This condition is an inherent characteristic of liquid crystal displays, and it is not a malfunction.
- A remnant of the previous display image may remain on the screen. This screen burn is inherent in displays, and it is not a malfunction.



INFO:

The screen may become distorted by strong magnetic fields.

MAINTENANCE OF THE DISPLAY



CAUTION

- **To clean the display, never use a rough cloth, alcohol, benzene, thinner, any kind of solvent, or paper tissues with chemical cleaning agent. They would scratch or deteriorate the panel.**
- **Do not splash any liquid such as water or car fragrance on the display. Contact with liquid will cause the system to malfunction and damage the hardware.**

For cleaning, use a dry soft cloth. If additional cleaning is necessary, use a small amount of neutral detergent with a soft cloth. Never spray the screen with water or detergent. Dampen the cloth first, then wipe the screen.

7 Troubleshooting guide

Basic operations 7-2
Vehicle icon 7-3

Map SD-card route calculation and visual guidance ... 7-5
Voice guidance 7-6



BASIC OPERATIONS

Symptom	Possible cause	Possible solution
No image is displayed.	The brightness is at the lowest setting.	Adjust the brightness of the display.
	The display is turned off.	Press the  button to turn on the display.
	The system is in overheat mode due to excessive high temperature.	Wait until the system cools down.
No voice guidance is available. or The volume is too high or too low.	The volume is not set correctly, or it is turned off.	Adjust the volume of voice guidance or turn voice guidance on.
No map is displayed on the screen.	The map SD-card is not inserted.	Insert the map SD-card correctly.
	A screen other than map screen is displayed.	Press MAP.
The screen is too dim. The movement is slow.	The temperature in the interior of the vehicle is low.	Wait until the interior of the vehicle has warmed up.
Some pixels in the display are darker or brighter than others.	This condition is an inherent characteristic of liquid crystal displays.	This is not a malfunction.
Some menu items cannot be selected.	Some menu items become unavailable while the vehicle is driven.	Park the vehicle in a safe location, and then operate the navigation system.



NOTE:

Locations stored in the Address Book and other memory functions may be lost if the vehicle's battery is disconnected or is discharged. If this occurs, service the vehicle's battery as necessary and re-enter the information in the Address Book.

VEHICLE ICON

Symptom	Possible cause	Possible solution
Names of roads and locations differ between 2D and 3D mode.	This is because the quantity of the displayed information is reduced so that the screen does not become difficult to read. There is also a chance that names of the roads or locations may be displayed several times, and the names appearing on the screen may be different because of a processing procedure.	This is not a malfunction.
The vehicle icon is not displayed in the correct position.	The vehicle was transported after the ignition switch was turned off by a ferry or car transporter, for example.	Drive the vehicle for a while on a road where GPS signals can be received.
	The position and direction of the vehicle icon may be incorrect depending on the driving environments and the levels of positioning accuracy of the navigation system.	This is not a malfunction. Drive the vehicle for a while to automatically correct the position and direction of the vehicle icon.  "CURRENT VEHICLE LOCATION" (page 6-12)
When the vehicle is traveling on a new road, the vehicle icon is located on another road nearby.	The system automatically places the vehicle icon on the nearest available road, because the new road is not stored in the map data.	Updated road information will be included in the next version of the map SD-card.
The map does not scroll even when the vehicle is moving.	The current location map screen is not displayed.	Press the MAP button.
The vehicle icon is not displayed.	The current location map screen is not displayed.	Press the MAP button.
The GPS indicator on the screen remains gray.	GPS signals cannot be received under certain conditions, such as in a parking garage, on a road with many tall buildings, etc.	Drive on an open, straight road for a while.
	A sufficient number of GPS satellites is not available.	Wait for the satellites to move to locations available for the navigation system.

Symptom	Possible cause	Possible solution
The location of the vehicle icon is misaligned from the actual position.	When using tire chains or replacing the tires, speed calculations based on the speed sensor may be incorrect.	Drive the vehicle for a while (at approximately 19 mph [30 km/h] for about 30 minutes) to automatically correct the vehicle icon position. If this does not correct the vehicle icon position, contact a NISSAN dealer.
	The map data has a mistake or is incomplete (the vehicle icon position is always misaligned in the same area).	Updated road information will be included in the next version of the map data.

MAP SD-CARD ROUTE CALCULATION AND VISUAL GUIDANCE

Symptom	Possible cause	Possible solution
The message "Error" appears.	The SD-card is not recognized by the system.	Replace the map SD-card if you see any damage.
In the automatic reroute calculation, the waypoint is not included.	A waypoint that you have already passed is not included in the automatic reroute calculation.	If you want to go to that waypoint again, you need to add it back to the route.
Route information is not displayed.	Route calculation has not yet been performed.	Set the destination and perform route calculation.
	The vehicle is not on the suggested route.	Drive on the suggested route.
	Route guidance is cancelled.	Turn on route guidance.
The automatic reroute calculation (or detour calculation) suggests the same route as the one previously suggested.	Route calculations took priority conditions into consideration, but the same route was calculated.	This is not a malfunction.
The suggested route is not displayed.	Roads near the destination cannot be calculated.	Reset the destination to a main or ordinary road, and recalculate the route.
	The starting point and destination are too close.	Set a more distant destination.
	The starting point and destination are too far away.	Divide the trip by selecting one or two intermediate destinations, and perform route calculations multiple times.
An indirect route is suggested.	If there are restrictions (such as one-way streets) on roads close to the starting point or destination, the system may suggest an indirect route.	Adjust the location of the starting point or destination.
	The system may suggest an indirect route because route calculation does not take into consideration some areas such as narrow streets (gray roads).	Reset the destination to a main or ordinary road, and recalculate the route.
The landmark information does not correspond to the actual information.	This may be caused by insufficient or incorrect data on the map SD-card.	Updated information will be included in the next version of the map SD-card.
The suggested route does not exactly connect to the starting point or destination.	There is no data for route calculation closer to these locations.	Set the starting point and destination on a main road, and perform route calculation.

VOICE GUIDANCE

Symptom	Possible cause	Possible solution
Voice guidance is not available.	In some cases, voice guidance is not available even when the vehicle should make a turn.	This is not a malfunction.
	The vehicle has deviated from the suggested route.	Go back to the suggested route or request route calculation again.
	Voice guidance is set to off.	Turn on voice guidance.
The guidance content does not correspond to the actual condition.	The content of voice guidance may vary, depending on the types of intersections at which turns are made.	Follow all traffic rules and regulations.

8 Index

2D map3-3
3D map3-4

A

Address book.6-3

B

Basic operations2-5, 7-2
Basics of voice guidance.6-14

C

Characteristics of a liquid crystal display . . .6-16
Character (letter and number) input screen . .2-8
Clock settings5-5
Connected Search6-10
Control buttons and functions.2-2
Current vehicle location6-12

D

Destination-To-Car6-10
Directions provided and the distances to guide points6-15
Display of current vehicle location.6-12
Display settings.5-4

E

Emergency support information6-10

F

Features of this navigation system6-2
For safe operation1-2
Functions disabled while driving2-5

G

Google Send-to-Car6-10

H

How to handle the display6-16
How to use this manual1-2

I

Incorrect display of vehicle position.7-3

J

Journey Planner6-10

L

Language settings5-6
Laser product.1-3

M

Maintenance of the display.6-16
Map screen information3-2
Map types.3-3
Message History6-10
Moving a map.3-4
My Places4-13

N

NissanConnectSM Services . .6-10, 6-9, 5-6, 6-4
Notes on voice guidance.6-15

P

Points Of Interest (POI) directory6-3

R

Reference symbols1-2
Repeating voice guidance6-15
Returning to the current vehicle location3-5
Route calculation6-13
Route calculation and visual guidance7-5
Route guidance.6-2

S

Safety information1-2
SiriusXM Traffic information6-3
Steering wheel switch2-5, 2-4

T

Touch screen operation examples.2-6
Traffic features4-19

U

User-defined points of interest (POIs).4-13
---	-------

V

Vehicle icon7-3
Voice guidance7-6, 6-3
Voice Menu6-9
Voice recognition.4-9, 4-18, 4-20, 4-24, 4-13, 4-5

W

What is GPS (Global Positioning System)?6-12
When a gray road is displayed on the map6-13

X

XM NavWeather™4-22, 4-22
--------------------------	-------------



Printing : March 2017 (03)
Publication No.: N17E LKEUU2
Printed in U.S.A.

LKE