



GIULIA

2017

OWNER'S MANUAL

GIULIA



VEHICLES SOLD IN CANADA

With respect to any Vehicles Sold in Canada, the name FCA US LLC shall be deemed to be deleted and the name FCA Canada Inc. used in substitution therefore.

DRIVING AND ALCOHOL

Drunken driving is one of the most frequent causes of accidents.

Your driving ability can be seriously impaired with blood alcohol levels far below the legal minimum. If you are drinking, don't drive. Ride with a designated non-drinking driver, call a cab, a friend, or use public transportation.

WARNING!

Driving after drinking can lead to an accident. Your perceptions are less sharp, your reflexes are slower, and your judgment is impaired when you have been drinking. Never drink and then drive.

This manual illustrates and describes the operation of features and equipment that are either standard or optional on this vehicle. This manual may also include a description of features and equipment that are no longer available or were not ordered on this vehicle. Please disregard any features and equipment described in this manual that are not on this vehicle.

FCA US LLC reserves the right to make changes in design and specifications, and/or make additions to or improvements to its products without imposing any obligation upon itself to install them on products previously manufactured.

Copyright © 2016 FCA US LLC



DEAR CUSTOMER

Dear Customer,

We would like to congratulate and thank you for choosing Alfa Romeo.

We have written this Owner's Manual to help you get to know all of the features of your vehicle and use it in the best possible way. Please take the necessary time to familiarize yourself with all the dynamic features of your vehicle.

Here you will find important information and warnings regarding the use of your vehicle, and how to achieve the best performance from the technical features of your Alfa Romeo.

You are advised to read through the Owner's Manual before taking it on the road for the first time. It is important to become familiar with the controls of your vehicle, especially with sections concerning the brakes, handling, transmission, and vehicle behavior on different road surfaces.

This Owner's Manual also provides a description of special features and tips, as well as essential information for the safe driving, care, and maintenance of your Alfa Romeo over time.

In the provided Warranty Booklet, you will also find a description of the services that Alfa Romeo offers to its customers. The New Vehicle Limited Warranty will detail the terms and conditions for maintaining its validity.

We are sure that these will help you to get in touch with and appreciate both your new vehicle and the service provided by the people at Alfa Romeo.

For questions or comments pertaining to your vehicle, please contact the Alfa Romeo Customer Care Center:

P.O. Box 21-8004 Auburn Hills, MI

48321-8004 Phone: 1-844-Alfa-USA

(1-844-253-2872)



READ THIS CAREFULLY

Refueling



Do not use fuel containing methanol or ethanol E85. Using these mixtures may cause misfiring and driving issues, as well as damage vital components of the supply system. For further details on the use of the correct fuel, see the "Fuel Requirements" paragraph in the "Technical Specifications" chapter.

Starting The Engine



Make sure that the electric park brake is engaged and that the transmission is in PARK (P) or NEUTRAL (N). Next, press the brake pedal, and then push the engine START/STOP button.

Parking On Flammable Material



The catalytic converter develops high temperatures during operation. Do not park the vehicle on grass, dry leaves, pine needles or other flammable material: fire hazard.

Respecting The Environment



The vehicle is fitted with a system that carries out a continuous diagnosis of the emission-related components in order to help protect the environment.

Electrical Accessories



If you decide to add electrical accessories after purchasing the vehicle, (with the risk of gradually draining the battery), contact your authorized dealer. They can calculate the overall electrical requirement and check that the vehicle's electric system can support the required load.

Scheduled Servicing



Correctly performed maintenance procedures are essential for ensuring that your vehicle continuously maintains its quality in performance and safety features, environmental friendliness, and low running costs.

VEHICLE CHANGES / ALTERATIONS

Accessories Purchased By The Owner



Warning!

Any change or alteration of the vehicle might seriously affect its safety and road handling, thus causing accidents, in which the occupants could even be fatally injured.

If you decide to install electrical accessories that require a permanent electrical supply (e.g. radio, satellite anti-theft system, etc.) or accessories that in any case drain the electrical supply after purchasing the vehicle, contact your authorized dealer. Dealer personnel will check whether the vehicles's electrical system is able to withstand the load required or whether it needs to be integrated with a more powerful battery.

Note: Use caution when adding additional spoilers, alloy wheel rims, or non-standard wheel hubs: they could reduce the ventilation of the brakes and affect efficiency under sharp and repeated braking, or on long descents. Make sure that nothing obstructs the pedals (mats, etc.).

FCA US LLC shall not be liable for damage caused by the installation of accessories either not supplied or recommended by FCA US LLC and/or not installed in compliance with the provided instructions.

Installing Electrical/Electronic Devices

FCA US LLC authorizes the installation of transceivers provided that installation is carried out at a specialized center, in compliance with manufacturer's specifications.

Note: Local authorities may not allow the vehicle on the road if devices that modify the features of the vehicle have been installed. This also may void the warranty in relation to faults caused by the change either directly or indirectly related to it.

FCA US LLC shall not be liable for damage caused by the installation of accessories either not supplied or recommended by FCA US LLC and/or not installed in compliance with the provided instructions.

Radio Transmitters And Mobile Phones

Radio transmitter equipment (vehicle mobile phones, CB radios, amateur radio etc.) cannot be used inside the vehicle unless a separate antenna is mounted externally.

Transmission and reception of these devices may be affected by the shielding effect of the vehicle body. As far as the use of approved mobile phones is concerned, follow the usage instructions provided by the mobile phone Manufacturer.



Caution!

- The use of these devices inside the passenger compartment (without an external antenna) may cause the electrical systems to malfunction. This could compromise the safety of the vehicle in addition to constituting a potential hazard for passengers' health.*
- If mobile phones/laptops/smartphones/tablets are inside the vehicle and/or close to the electronic key, a reduced performance of the Passive Entry/Keyless Start system may occur.*

HOW TO USE THIS MANUAL

Operating Instructions

Each time an instruction is given that concerns direction (left/right or forward/backward), it is written to be read from the perspective of an occupant in the driver's seat. If a direction is written from a different perspective, it will be specified as such in the text as appropriate.

The figures in the manual are only examples: this might imply that some details of the image do not correspond to the actual arrangement of your vehicle.

To identify the chapter with the information necessary, you can consult the index at the end of this manual.

Chapters can be rapidly identified with dedicated graphic tabs, located at the side of each odd page. There is also a key for getting to know the chapter order and the relevant symbols in the tabs. Additionally, there is a textual indication of each current chapter at the side of each even page.

Warnings And Cautions

While reading this Owner's Manual you will find a series of **WARNINGS** that must be carefully followed to prevent incorrect use of the components of the vehicle, which could cause accidents or injuries.

There are also **CAUTIONS** to prevent procedures that could damage your vehicle.

Therefore all **WARNINGS** and **CAUTIONS** must always be carefully followed.

WARNINGS and **CAUTIONS** are recalled in the text with the following symbols:

Personal Safety: 

Vehicle Safety: 

Note: This Owner's Manual describes all vehicle models. Optional contents, equipment meant for specific Markets or particular models are not identified as such in the text: you need to consider only the information related to the model you own. Any content introduced throughout the production of the model, outside the specific request of options at the time of purchase, will be identified by the indicator: — if equipped.

The data contained in this publication is intended to help you use your vehicle in the best possible way. FCA US LLC aims for constant improvement of the vehicles produced. For this reason, it reserves the right to make changes to the model described for technical and/or commercial reasons.

For further information, contact your authorized dealer.

Symbols

Some car components have colored labels with symbols indicating precautions to be observed when using this component. It is important to follow all warnings when operating your vehicle. See below for a brief description of each symbol.



READ THE OWNER HANDBOOK



DO NOT TOUCH WITH HANDS



IT CAN START AUTOMATICALLY ALSO WITH ENGINE OFF



PROTECT YOUR EYES



DO NOT OPEN THE CAP WHEN THE ENGINE IS HOT



DO NOT OPEN: HIGH PRESSURE GAS



KEEP CHILDREN AT A DISTANCE



BURSTING

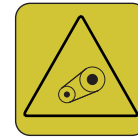

MOVING PARTS KEEP PARTS OF YOUR BODY AND CLOTHES AWAY









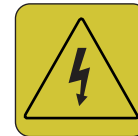



DO NOT APPROACH FLAMES



CORROSIVE LIQUID



HIGH VOLTAGE

GRAPHICAL TABLE OF CONTENTS	
GETTING TO KNOW YOUR VEHICLE	
GETTING TO KNOW YOUR INSTRUMENT PANEL	
SAFETY	
STARTING AND OPERATING	
IN CASE OF EMERGENCY	
SERVICING AND MAINTENANCE	
TECHNICAL SPECIFICATIONS	
CUSTOMER ASSISTANCE	
INDEX	

GRAPHICAL TABLE OF CONTENTS

FRONT VIEW

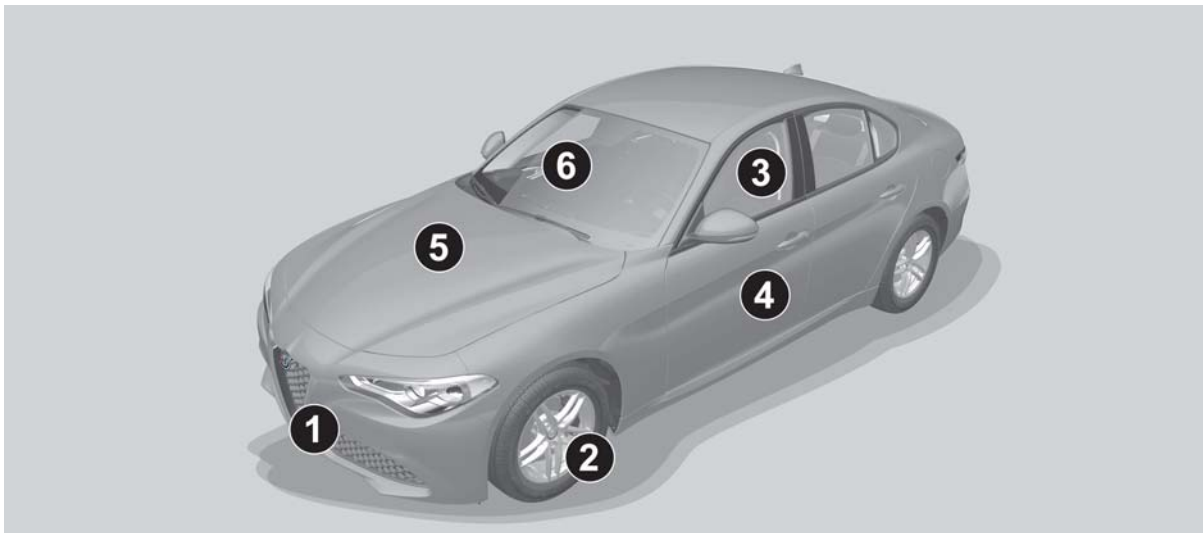

Front View

03016S0001EM

- 1 — Headlights
- 2 — Tires And Wheels
- 3 — Power Windows

- 4 — Doors
- 5 — Engine Compartment
- 6 — Windshield Wipers



REAR VIEW

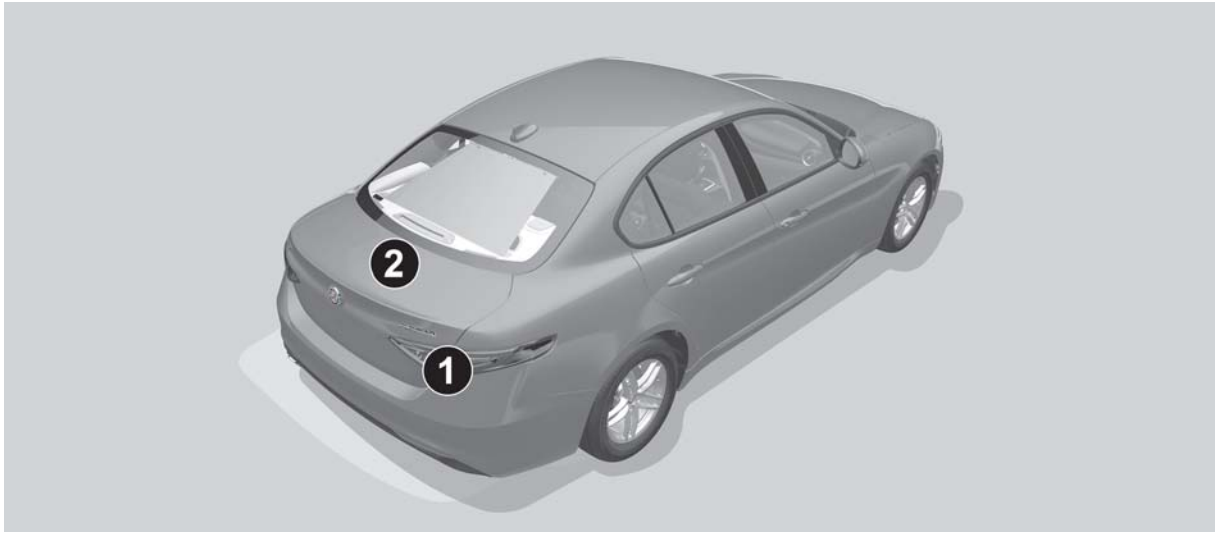

Rear View

03026S0001EM

- 1 — Tail Lights
 - 2 — Trunk Lid
-

INSTRUMENT PANEL

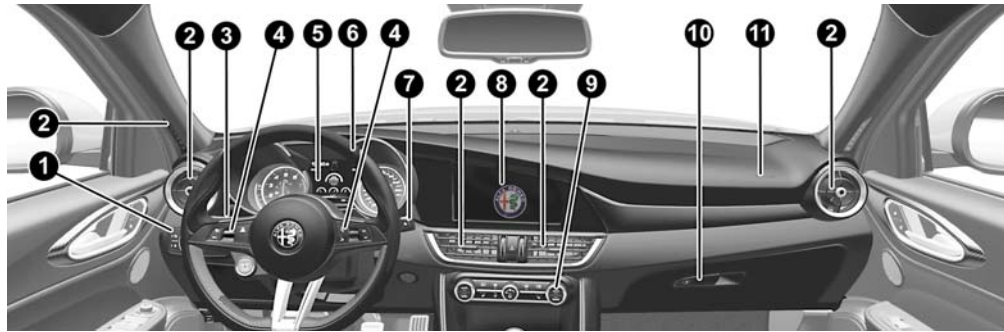

Instrument Panel

03036S0050EM

- 1 — Headlight Switch
- 2 — Air Vents
- 3 — Multifunction Stalk
- 4 — Controls On Steering Wheel

- 5 — Instrument Cluster
- 6 — Steering Wheel
- 7 — Windshield Wiper Stalk
- 8 — Audio System

- 9 — Climate Control System
- 10 — Glove Compartment
- 11 — Passenger-Side Air Bag



VEHICLE INTERIOR



03046S0001EM

Vehicle Interior

- | | |
|--|---------------------------|
| 1 — Driver Seat | 4 — Hazard Warning Lights |
| 2 — Power Windows/Power Mirrors Controls | 5 — Alfa DNA System |
| 3 — Gear Selector/Paddle Shifter | |

GETTING TO KNOW YOUR VEHICLE

In this section, you will find important information to help you become familiar with the features needed to operate your vehicle, and how they function.

KEYS	14
IGNITION SYSTEM	16
ENGINE IMMOBILIZER	18
SECURITY ALARM SYSTEM — IF EQUIPPED	19
DOORS	20
SEATS	26
HEAD RESTRAINTS	30
STEERING WHEEL	32
MIRRORS	34
EXTERIOR LIGHTS	35
INTERIOR LIGHTS	38
WINDSHIELD WIPERS	41
CLIMATE CONTROL	44
POWER WINDOWS	51
POWER SUNROOF — IF EQUIPPED	52
HOOD	54
TRUNK	55
INTERNAL EQUIPMENT	57
ENVIRONMENTAL PROTECTION SYSTEMS	61
ACTIVE AERODYNAMICS	61



KEYS

Key Fob

Your vehicle uses a keyless ignition system. This system includes a key fob and a keyless push button ignition.

The Remote Keyless Entry key fob allows you to lock or unlock the doors and trunk or activate the Panic Alarm from distances. The key fob does not need to be pointed at the vehicle to activate the system.



04016S0001EM

Key Fob

PANIC Function

The key fob contains a PANIC button. Should you ever feel threatened, push this button and the vehicle security alarm will sound.

To activate the PANIC function, push and hold the PANIC button for at least one second. When the panic alarm is active, the headlights turn on, the turn signals flash, the horn honks intermittently, and all internal adjustable

lights turn on. The panic alarm will remain active for three minutes, and can be deactivated:

- By pushing the PANIC button again.
- Automatically if the vehicle speed exceeds 5 mph (8 km/h).

In both cases, the panic alarm is immediately deactivated.



Warning!

Before exiting a vehicle, always shift the automatic transmission into PARK, apply the parking brake, turn the engine OFF, remove the key fob from the vehicle and lock your vehicle.

Never leave children alone in a vehicle, or with access to an unlocked vehicle.

Allowing children to be in a vehicle unattended is dangerous for a number of reasons. A child or others could be seriously or fatally injured. Children should be warned not to touch the parking brake, brake pedal or the gear selector.

Do not leave the key fob in or near the vehicle, or in a location accessible to children. A child could operate power windows, other controls, or move the vehicle.

Do not leave children or animals inside parked vehicles in hot weather. Interior heat build-up may cause serious injury or death.

Operation

Door And Trunk Lid Unlock

Briefly pushing the unlock button on the key fob will unlock the doors and trunk lid, turn on the interior lights, and flash the turn signals once (if activated from the Information and Entertainment System).

Push and release the unlock button on the key fob once to unlock the driver side front door or twice within one second to unlock all doors and the trunk lid.

The current unlock setting can be changed through the Information and Entertainment System menu, so that the system unlocks:

All doors unlock on the first push of the key fob unlock button.

Unlock the driver door on the first push of the key fob unlock button.

Flashing of the turn signals upon locking/unlocking the doors and activation of the courtesy light upon unlocking the doors can be activated or deactivated through the Information and Entertainment System. For further information, refer to the Information and Entertainment System Owner's Manual Supplement.

The doors can also be unlocked by using the emergency key, located inside the key fob.

Door And Trunk Lid Lock

Briefly pushing the lock button on the key fob will lock the doors and trunk lid, turn off the internal lights, and flash the turn signals (if activated in the Information and Entertainment System).

If one or more doors are open, these doors will also lock, and this is indicated by a rapid flashing of the turn signals. The doors prepare for locking, which becomes active from the moment they are closed. The doors will unlock again only if the key fob is detected inside the passenger compartment.

The doors can be locked by using the emergency key in the driver's side door lock.

Trunk Lid Opening

Rapidly push the trunk lid key fob button twice to open the trunk lid. The turn signals will flash to indicate that the trunk lid has been opened.

Remote Start

The remote start button on the key fob enables engine starting (push the button twice to start the engine).

Car Finder

Push the lock or unlock button to remotely and temporarily turn on turn signals and headlights.

This is useful for finding the vehicle easily in a crowded area like a parking garage, for example.

Pushing the lock or unlock button again will restart the lights turn on timer (if the parking lights functions was already active, it will remain active).

This function is available only if the doors are closed.

Replacing The Electronic Key Fob Battery

To replace the battery, proceed as follows:

1. Push the sides of the key fob inward and extract the cover pulling downwards.



04016S0002EM

Key Fob Cover Removal

2. Remove the emergency key from its housing.

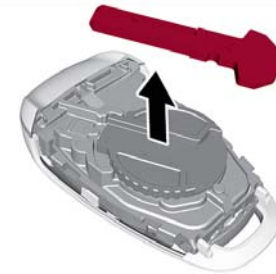

04016S0003EM

Removing Emergency Key

3. Remove the battery plug by rotating it counter clockwise.



04016S0004EM

Removing Battery Plug

4. Remove the battery from its slot and replace it with a new one of the same type.





04016S0005EM

Battery Location

Proceed in reverse order to reassemble the key.



Caution!

The battery replacement operation must be done with care, in order not to damage the electronic key.

Request For Additional Keys

The system can recognize up to eight key fobs with remote control.

To guarantee that the engine starts and the vehicle operates correctly, use only electronic key fobs specifically coded for the vehicle's electronics.

If an electronic key fob is coded for a vehicle, it cannot be used on any other vehicle.

Duplicating Keys

If you need a replacement key fob, go to an authorized dealer.

General Information

The following regulatory statement applies to all Radio Frequency (RF) devices equipped in this vehicle:

This device complies with Part 15 of the FCC Rules and with Industry Canada license-exempt RSS standard(s). Operation is subject to the following two conditions:

1. This device may not cause harmful interference, and
2. This device must accept any interference received, including interference that may cause undesired operation.

Note: Changes or modifications not expressly approved by the party responsible for compliance could void the user's authority to operate the equipment.

IGNITION SYSTEM

Operation

To activate the keyless ignition, the key fob must be inside the passenger compartment.



04026S0001EM

Keyless Ignition START/STOP Button

The keyless ignition has the following modes:

- STOP: engine off, steering locked. Some electrical devices (e.g. central door locking system, alarm, etc.) are still available.
- ON: all electrical devices are available. This state can be entered by pushing the ignition button once, without pressing the brake pedal.
- AVV: engine starting. This state can be entered by pushing the ignition button once while pressing the brake pedal.

Note:

❑ With the keyless ignition in the ON position: if 30 minutes pass with the gear selector in P (Park) and the engine stopped, the keyless ignition will automatically reset to the STOP position.

❑ With the engine started, it is possible to remove the key fob from the vehicle. The engine will remain running and the instrument cluster will indicate the absence of the key fob when the door is closed.

For more information on the engine start-up, refer to "Starting The Engine" in "Starting And Operating."



Warning!

❑ Never use the PARK position as a substitute for the parking brake. Always apply the parking brake fully when parked to guard against vehicle movement and possible injury or damage.

❑ When leaving the vehicle, always make sure the ignition is in the OFF mode, remove the key fob from the vehicle, and lock your vehicle.

❑ Never leave children alone in a vehicle, or with access to an unlocked vehicle. Allowing children to be in a vehicle

unattended is dangerous for a number of reasons. A child or others could be seriously or fatally injured. Children should be warned not to touch the parking brake, brake pedal or the transmission gear selector.

❑ Do not leave the key fob in or near the vehicle, (or in a location accessible to children), and do not leave the ignition in the AVV or ON/RUN mode. A child could operate power windows, other controls, or move the vehicle.

❑ Be sure the parking brake is fully disengaged before driving; failure to do so can lead to brake failure and a collision.

❑ Always fully apply the parking brake when leaving your vehicle, or it may roll and cause damage or injury. Also be certain to leave the transmission in PARK. Failure to do so may allow the vehicle to roll and cause damage or injury.

❑ Driving the vehicle with the parking brake engaged, or repeated use of the parking brake to slow the vehicle may cause serious damage to the brake system.



Caution!

If the Brake System Warning Light remains on with the parking brake released, a brake system malfunction is indicated. Have the brake system serviced by an authorized dealer immediately.

Starting With A Discharged Key Fob Battery

If the key fob battery is discharged, proceed as follows to start the vehicle:

1. Lift the front armrest.
2. Lay the key fob on the key fob outline found on the floor of the armrest compartment while pushing the START/STOP button to start the ignition.



04026S0002EM

Key Fob Placement Location



General Information

The following regulatory statement applies to all Radio Frequency (RF) devices equipped in this vehicle:

This device complies with Part 15 of the FCC Rules and with Industry Canada license-exempt RSS standard(s). Operation is subject to the following two conditions:

1. This device may not cause harmful interference, and
2. This device must accept any interference received, including interference that may cause undesired operation.

Note: Changes or modifications not expressly approved by the party responsible for compliance could void the user's authority to operate the equipment.

ENGINE IMMOBILIZER

Engine Immobilizer Operation

The Engine Immobilizer system prevents unauthorized use of the vehicle by disabling engine starting.

The system does not need to be enabled or activated. Operation of the immobilizer is automatic whether the vehicle's doors are locked or unlocked.

When the ignition is set to ON, the Engine Immobilizer system identifies the code transmitted by the key. If the code is recognized as valid, the Engine Immobilizer system enables engine starting.

When the ignition is brought back to STOP, the Engine Immobilizer system deactivates the control unit controlling the engine, disabling engine starting.

For the correct engine starting procedures, refer to "Starting The Engine" in "Starting And Operating."

Irregular Operation

If the key code is not correctly recognized during starting, the Engine Immobilizer Failure/Break-in Attempt  icon is displayed on the instrument panel (refer to "Warning Lights And Messages" in "Getting To Know Your Instrument Panel"). This condition leads to the engine turning off after two seconds. In this case, switch the ignition to STOP and then to ON; if it is

still blocked, try with the other keys provided. If it is still not possible to start the engine, contact an authorized dealer.

If the Engine Immobilizer Failure/Break-in Attempt  icon is displayed while driving, this means that the system is running a self-diagnosis (e.g. due to a voltage drop). If the display persists, contact an authorized dealer.

Note:

- Do not tamper with the Engine Immobilizer system. Any modifications or alterations could cause the protection function to be deactivated.
- The Engine Immobilizer system is not compatible with certain aftermarket remote starting systems. The use of these devices could cause problems when starting, as well as the deactivation of the protection function.
- All keys provided with the vehicle have been programmed in accordance with the electronics on the vehicle itself.
- Each key has its own code which must be stored by the system's control unit. Contact an authorized dealer to have new keys (up to eight) stored with a code.

SECURITY ALARM SYSTEM — IF EQUIPPED

Alarm Activation

While armed, the alarm will sound in the following scenarios:

- Opening of doors/hood/deck lid (perimeter protection)
- Operation of ignition with a key which is not validated
- Cutting of the battery cables
- Movement inside the passenger compartment (volumetric protection — if equipped)
- Unexpected lifting/tilting of the vehicle (anti-lift protection — if equipped)

Activation of the alarm triggers the acoustic warning and the turn signals.

Note: The alarm system is activated by the Engine Immobilizer system, which is automatically activated when you get out of the vehicle with the key fob and lock the doors.

To Arm The Alarm

With the doors, hood, and trunk lid closed and the keyless ignition system placed in the STOP position, push and release the lock button on the key fob. The alarm can also be armed by pushing the Passive Entry door handle button, located on the door external

handle. For further information, refer to "Passive Entry" in "Doors."

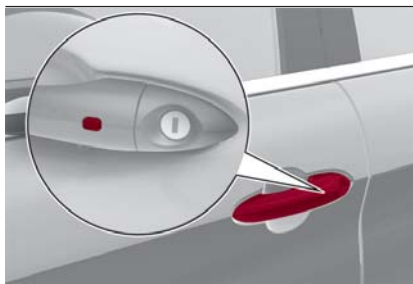

04056S0003EM

Passive Entry Door Handle Button

When the alarm is armed, the warning lights on the panels of the interior front door handles will flash.

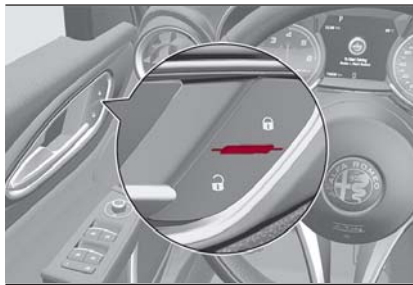

04046S0001EM

Lock/Unlock Buttons

The activation of the alarm is preceded by a self-diagnosis stage: if a fault is detected, the system emits a further acoustic signal.

If a second acoustic signal is emitted after the alarm is already armed, wait about four seconds and disarm the alarm by pushing the unlock button. Verify that the doors, hood, and trunk lid are closed correctly and then rearm the system by pushing the lock button on the key fob.

If the alarm emits an acoustic signal even when the doors, hood, and trunk lid are correctly closed, a fault has occurred in system operation. In this case, contact an authorized dealer.

To Disarm The Alarm

Push the unlock button to disarm the alarm. While disarming, the following operations are performed:

- Two brief flashes of the turn signals (if programmed)
- Two brief acoustic signals (if programmed)
- Doors are unlocked

The alarm can also be disarmed using the Passive Entry System, by grasping one of the Passive Entry front door handles with a valid key fob in hand to unlock. For further information refer to "Passive Entry" in "Doors."



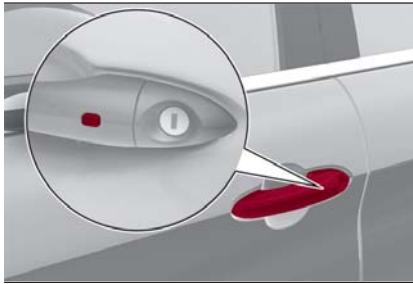

04056S0003EM

Passive Entry Door Handle Button

Note: The alarm does not disarm when the doors are unlocked by inserting the blade of the emergency key, found inside the key fob, into the door handle lock cylinder.

Volumetric/Anti-Lift Protection — If Equipped

To ensure the correct operation of the Volumetric/Anti-Lift Protection system, completely close the side windows.

To disable the function, push the Volumetric/Anti-Lift Protection button before activating the alarm.

When the function is disabled, this is indicated by the light on the Volumetric/Anti-Lift Protection button flashing for several seconds.



04046S0002EM

Volumetric/Anti-Lift Protection Button

Any disabling of the Volumetric/Anti-Lift Protection must be repeated each time the instrument panel is switched off.

To Disarm The Alarm Using Passive Entry

To completely deactivate the alarm (e.g. during a long period of vehicle inactivity), insert the blade of the emergency key, found inside the key fob, into the door handle lock cylinder and turn the emergency key to the right (clockwise) to lock the door(s).

DOORS

Locking And Unlocking Doors From The Inside

If all doors are closed properly, they will automatically lock once the vehicle has exceeded approximately 12 mph (20 km/h) ("Auto Relock" function active).

Push the interior lock button on the driver or passenger side door panel trim to lock the doors.

With doors locked, push the unlock button on the interior trim panel to unlock the doors.

Note: The key fob may not be found if it is located next to a mobile phone, laptop or other electronic device; these devices may block the key fob's wireless signal.



04056S0001EM

Door Lock And Unlock Switch Panel



Warning!

- ❑ Do not leave children or animals inside parked vehicles in hot weather. Interior heat build-up may cause serious injury or death.
- ❑ For personal security and safety in the event of a collision, lock the vehicle doors as you drive as well as when you park and leave the vehicle.
- ❑ Before exiting a vehicle, always shift the automatic transmission into PARK, apply the parking brake, turn the engine OFF, remove the key fob from the vehicle and lock your vehicle.
- ❑ Never leave children alone in a vehicle, or with access to an unlocked vehicle.
- ❑ Allowing children to be in a vehicle unattended is dangerous for a number of reasons. A child or others could be seriously or fatally injured. Children should be warned not to touch the parking brake, brake pedal or the gear selector.
- ❑ Do not leave the key fob in or near the vehicle, or in a location accessible to children. A child could operate power windows, other controls, or move the vehicle.



Caution!

An unlocked vehicle is an invitation. Always remove the key from the ignition and lock all of the doors when leaving the vehicle unattended.

Locking/Unlocking Doors From The Outside

When locking the doors from the outside with the doors closed, push the lock button on the key fob.

The door lock can be activated with all doors locked and the trunk lid open. When the lock button on the key fob is pushed, all locks are activated, including the open trunk lid. The trunk lid will be locked when it is closed.

When unlocking the doors from the outside, push the unlock button on the key fob.

Locking/Unlocking Doors From The Outside In An Emergency

If the battery is discharged or the key fob is inoperable, you can lock or unlock the doors from the outside by inserting the blade of the emergency key, found inside the key fob, into the door handle lock cylinder and turn the emergency key as follows.

- ❑ Lock — Turn the emergency key to the right (clockwise)

- ❑ Unlock — Turn the emergency key to the left (counter clockwise)

Passive Entry — If Equipped

The Passive Entry system can identify the presence of a key fob near the doors and trunk lid.

The system enables the doors and trunk lid to be locked or unlocked without pushing any button on the key fob.

The key fob is detected only after the system recognizes the presence of a hand on one of the front door handles. If the detected key fob is valid, the doors and the trunk lid are unlocked (refer to the Information and Entertainment System Owner's Manual Supplement for Passive Entry Settings).

Note: The key fob may not be able to be detected by the vehicle keyless-go system if it is located next to a mobile phone, laptop or other electronic device; these devices may block the key fob's wireless signal and prevent the keyless-go system from starting the vehicle.

Grasping the handle of the driver's door unlocks the driver's side door, or all doors depending on the mode set using the Information and Entertainment System (refer to the Information and Entertainment System Owner's Manual Supplement for Passive Entry Settings).



Note: If wearing gloves, or if it has rained and the door handle is wet, the activation sensitivity of the Passive Entry function may be reduced, resulting in a longer reaction time.

Door Locking

To lock the doors, proceed as follows:

1. Make sure that you have the key fob and are close to the driver's or passenger's side door handle.
2. Push the Passive Entry door handle button or the Passive Entry trunk lid button, which is located next to the external trunk lid release button. This will lock all doors and the trunk lid. Door locking will activate the alarm as well.

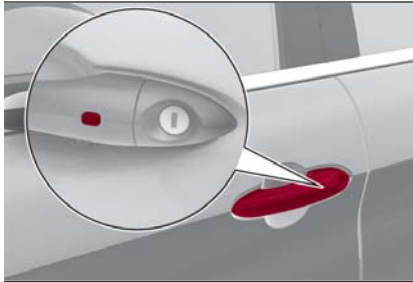

04056S0003EM

Passive Entry Door Handle Button



04056S0006EM

Passive Entry Trunk Lid Button

Note: After pushing the Passive Entry door handle button, you must wait two seconds before the doors can be unlocked again using the passive entry door handle button. This feature makes it possible to check whether the vehicle has been locked correctly by pulling the door handle within two seconds. The doors will not be unlocked again.

The vehicle doors and trunk lid can be locked by pushing the lock button on the key fob or on the interior door lock.

Driver Side Door Emergency Opening

If the key fob does not work, e.g. because its battery is discharged or the vehicle battery is discharged, the emergency key can be used to unlock the driver side door.

To remove the emergency key from the key fob, proceed as follows:

1. Push the sides of the key fob inward and extract the cover pulling downwards.
2. Remove the emergency key from the key fob housing.
3. Insert the emergency key in the driver side door lock cylinder and turn it to the left (counter clockwise) to unlock the door.



04016S0002EM

Emergency Key Release Buttons

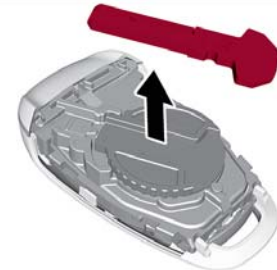

04016S0003EM

Emergency Key

Note:

- ❑ The emergency key blade is not directional and can be inserted indifferently into the lock.
- ❑ To avoid leaving the key fob inside the vehicle accidentally, the Passive Entry function features an automatic door unlocking function.
- ❑ If one of the vehicle doors is open and the "door locking" button on the front door handles or lock button in the interior door lock switch panel is pushed, a check of the inside and outside of the vehicle for the presence of the key fob is made once all the open doors are closed.

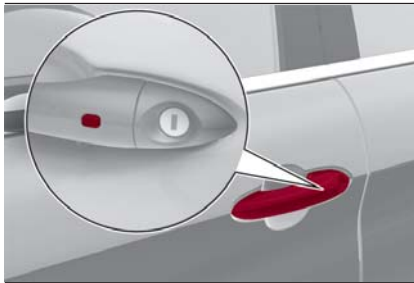

04056S0003EM

Passive Entry Door Handle Button



04056S0001EM

Interior Lock Switch Panel

While pulling the handle, do not push the door lock/unlock button on the handle.

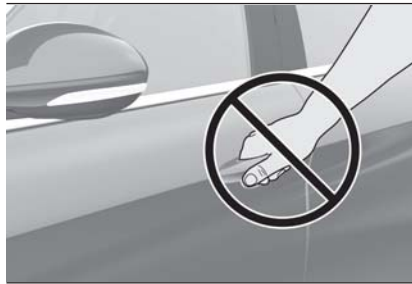

04056S0004EM

Do NOT Grab The Door Handle When Locking

If the key fob is detected inside the vehicle, the Passive Entry function automatically unlocks all the vehicle doors and flashes the turn signals.

If one or more key fobs are inside the passenger compartment, the lock button on the key fob inside the passenger compartment is temporarily disabled.

The vehicle will **not unlock** the doors if an unauthorized key fob has been detected close to the outside of the vehicle.

If the Passive Entry function is disabled using the Information and Entertainment System, the protections to avoid accidentally leaving the key fob inside the vehicle are deactivated.

Trunk Lid Access

Approaching the trunk lid with a valid key fob, push the opening button to access the trunk lid.



04056S0005EM

External Trunk Lid Release Button



Note:

- If the key fob is inadvertently forgotten inside of the trunk, and an attempt is made to close it from outside, the trunk lid will not lock. With the doors locked, the trunk lid unlocked, and the key fob detected inside the vehicle, the trunk lid will unlock again and the lights flash twice.
- Before driving, make sure the trunk lid is closed correctly.

Trunk Lid Lock

The trunk lid of the vehicle may still be locked by pushing the lock button on the key fob, pushing the door lock button on the door handles, or pushing the lock button on the interior door panel of the vehicle.

On vehicles equipped with Passive Entry, the trunk lid and the doors can be locked by pushing the button located near the opening button of the trunk lid.



04056S0006EM

Passive Entry Trunk Lid Button**System Activation/Deactivation**

The Passive entry system can be activated or deactivated using the Information and Entertainment System.

General Information

The following regulatory statement applies to all radio frequency (RF) devices equipped in this vehicle:

This device complies with Part 15 of the FCC Rules and with Industry Canada license-exempt RSS standard(s). Operation is subject to the following two conditions:

1. This device may not cause harmful interference, and
2. This device must accept any interference received, including interference that may cause undesired operation.

Note: Changes or modifications not expressly approved by the party responsible for compliance could void the user's authority to operate the equipment.

Power Lock – If Equipped

The Power Lock is a safety device that prevents the operation of the interior door handles and the door locking and unlocking buttons. The Power Lock also prevent opening of the doors from inside the passenger compartment.

It is recommended to lock the vehicle doors each time the vehicle is parked.

Activating The Power Lock

The Power Lock is enabled on all the doors by quickly pushing the lock button on the key fob twice.

The turn signals will flash to let you know that the Power Lock is active.

If one or more of the doors are not closed correctly, the Power Lock will not activate, preventing a person from getting stuck inside the passenger compartment by entering the vehicle, and then closing, the open door.

Deactivating The Power Lock

The Power Lock disengages automatically:

- When the doors are unlocked, pushing the unlock button on the key fob.
- When the keyless ignition is placed in the ON position.

Child Safety Locks

To provide a safer environment for small children riding in the rear seats, the rear doors are equipped with Child-Protection Door Lock system.

This device can be engaged only with the doors open.



Child Safety Lock Positions

- Lock position: device locked (door opened from exterior only)
 - Unlock position: device unlocked (door may be opened from the inside)
- The Child Safety Locks remain locked even if the doors are unlocked.

Note: The rear doors cannot be opened from the inside when the Child Safety Lock is engaged.

Unlocking The Doors With A Discharged Battery

Proceed as follows to unlock the doors if the vehicle battery is discharged.

Rear Doors And Passenger Door

1. With the doors unlocked insert the emergency key from the key fob or a flat bladed screwdriver into the door lock manual release lock cylinder.



Door Lock Manual Release Lock Cylinder

2. Turn the manual release lock cylinder clockwise for the right door locks or counterclockwise for the left door locks.

3. Remove the key/screwdriver from the manual release lock.

Proceed as follows to realign the door lock device (only when the battery charge has been restored):

- Push the lock button on the electronic key

- Push the unlock button on the door panel

- Unlock driver's door lock with the emergency key

- Operate the internal door handle

Note: For the rear doors, if the Child Safety Locks are engaged, and the previously described locking procedure is carried out, operating the internal handle will not open the door. Instead, it will only realign the lock release device. To open the door, the outside handle must be used. The door central locking/unlocking buttons are not deactivated when the emergency lock is engaged.



SEATS

The front seats can be adjusted to ensure maximum comfort for the occupants. When adjusting the driver's seat, keep the shoulders resting firmly against the backrest, and the wrists within reach of the top of the steering wheel. The driver must also be able to fully press the brake pedal.



Warning!

- ❑ *It is dangerous to ride in a cargo area, inside or outside of a vehicle. In a collision, people riding in these areas are more likely to be seriously injured or killed.*
- ❑ *Do not allow people to ride in any area of your vehicle that is not equipped with seats and seat belts. In a collision, people riding in these areas are more likely to be seriously injured or killed.*
- ❑ *Be sure everyone in your vehicle is in a seat and using a seat belt properly.*

Sparco Racing Seats — If Equipped

Forward/Rearward Adjustment

The adjustment lever is at the front of the seat, near the floor. Pull the bar upward to move the seat forward or rearward. Release the bar once the seat is in the position desired. Using body pressure, move forward and rearward on the seat to be sure that the seat adjusters have latched.

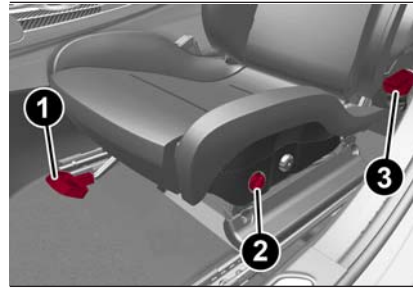

Manual Seat Adjustment

- 1 — Adjustment Lever
- 2 — Height Adjustment Button
- 3 — Recline Lever

Height Adjustment

Push the height adjustment button upwards or downwards to obtain your desired height.

Seatback Recline

To adjust the seatback, lift the recline lever located on the outboard side of the seat, lean back to the desired position and release the lever. To return the seatback, lift the lever, lean forward and release the lever.

Power Seats — If Equipped

On models equipped with power seats, the switch is located on the outboard side of the seat near the floor. Use this switch to move the driver's seat up, down, forward, and rearward, or to recline the seatback.

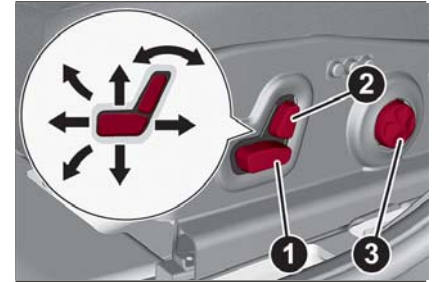

Power Seat Adjustment

- 1 — Seat Switch (For/Rear/Height Adjustment)
- 2 — Seatback Switch
- 3 — Lumbar Adjustment



Caution!

Do not place any article under a power seat or impede its ability to move as it may cause damage to the seat controls. Seat travel may become limited if movement is stopped by an obstruction in the seat's path.

Forward/Rearward Adjustment

Push the seat switch forward or rearward to adjust to your desired position.

Seatback Recline

The angle of the seatback can be adjusted forward or rearward. Push the seatback switch forward or rearward, and the seat will move in the direction of the switch. Release the switch when the desired position is reached.

Power Lumbar — If Equipped

Vehicles equipped with power driver or passenger seats may also be equipped with power lumbar. The power lumbar switch is located on the outboard side of the power seat. Push the switch forward or rearward to increase or decrease the lumbar support. Push the switch upward or downward to raise or lower the lumbar support.

Height Adjustment

The height of the seats can be adjusted up or down. Pull upward or push downward on the seat switch, and the seat will move in the direction of the switch. Release the switch when the desired position is reached.

Seat Angle Adjustment (Tilting)

The seat angle can be adjusted in four directions. Lift or push the front part of the seat switch to move the front part of the seat in the corresponding direction. Release the seat switch when the seat has reached the desired position.

Power Bolster Adjustment

Push the power bolster adjustment buttons to regulate the width of the backrest through the lateral padding.

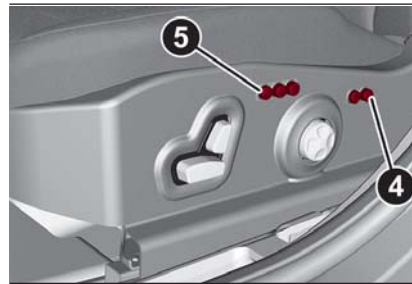

04066S0015EM

Seatback Width Adjustment

- 4 — Power Adjustable Bolster Buttons
- 5 — Driver Memory Seat Buttons

Driver Memory Seat

The driver memory seat buttons can store and recall three different driver's seat positions as well as outside power mirror positions. Storing and recalling is possible with the ignition in the ON or STOP positions and the driver's side door closed, or for three minutes after having opened the driver's side door. The performed position memory is confirmed by a beep. To set a memory profile, first adjust your seat (and power mirror position if desired) with the various controls until you are in the desired position. Then, push the specific button you want to assign the set position to for 1.5 seconds. When a new seat position is memorized, the previously memorized position on the same button is automatically overwritten. Recalling a memorized position is also possible for approximately three minutes after the doors are opened and approximately one minute after the engine is stopped. To recall a memorized position, push the relevant button briefly.



**Warning!**

Adjusting a seat while driving may be dangerous. Moving a seat while driving could result in loss of control which could cause a collision and serious injury or death.

Seats should be adjusted before fastening the seat belts and while the vehicle is parked. Serious injury or death could result from a poorly adjusted seat belt.

Do not ride with the seatback reclined so that the shoulder belt is no longer resting against your chest. In a collision you could slide under the seat belt, which could result in serious injury or death.

Heated Seats – If Equipped

With the engine in the ON position, push the driver or passenger heated seat button  located on the instrument panel.

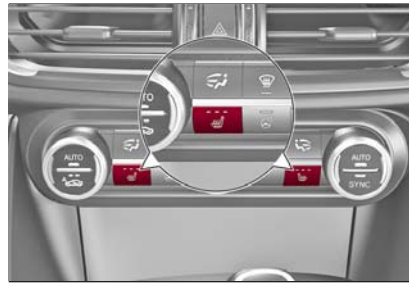

04066S0004EM

Heated Seat Buttons

You can select three heating levels:

Minimum — one orange indicator illuminated on the buttons

Average — two orange indicator illuminated on the buttons

Maximum — three orange indicator illuminated on the buttons

After selecting a heating level, heat will be felt within a few minutes.

A quick push of the heated seat button will select the heat levels in order of lowest to highest. Or, holding the switch down from either “off” or the minimum level for 1–2 seconds will automatically select the maximum heat level.

When the heated seat function is not active, pushing and holding the desired heated seat button for 1–2 seconds will activate the “fast maximum heating” function. The heater produces a boosted heat level for the first few minutes of operation. After this, the

heat automatically lowers to reach the normal temperature level for the “maximum” setting.

The “minimum” setting is automatically deactivated once a certain period of time has elapsed. This varies on a case-by-case basis, in accordance with the specific operating conditions.

To lower the heat level, each quick push of the switch will decrease by one level until it is off. Holding the switch down at any of the three levels for 1-2 seconds will deactivate the heated seat.

Note: To preserve the battery charge, this function cannot be activated when the engine is off.

**Warning!**

Persons who are unable to feel pain to the skin because of advanced age, chronic illness, diabetes, spinal cord injury, medication, alcohol use, exhaustion or other physical condition must exercise care when using the seat heater. It may cause burns even at low temperatures, especially if used for long periods of time

Do not place anything on the seat or seatback that insulates against heat, such as a blanket or cushion. This may cause the seat heater to overheat. Sitting in a seat that has been overheated could cause serious burns due to the increased surface temperature of the seat.

Rear Seats

The rear seats allow for three passengers.

Note: Middle Seat: The rear seat is designed as a 4+1 seat vehicle. The middle seat is of limited use. It is recommended that this seat only be used by a person who can use the backrest as a substitute for the head restraint.



04066S0005EM

Rear Seat

The seats and the seatbelts are considered as components of the protection system for the vehicle's occupants.

Note: Refer to the "Seatbelts" in "Safety" for further information.

Split Folding Rear Seat – If Equipped

The rear seatbacks can be folded forward to provide an additional storage area.



04066S0005EM

Rear Seat

Partial Extension Of The Luggage Compartment (1/3 Or 2/3)

Extending the right side of the trunk allows you to carry two passengers on the left part of the rear seat, while extending the left side allows you to carry one passenger.

Proceed as follows:

1. Completely lower the rear seat head restraints.
2. Place the seatbelt so that it doesn't impede the movement of the backrest while tilting it.
3. Operate lever 1 to tilt the left part or lever 2 to tilt the right part of the backrest: it will automatically tilt forward. If necessary, assist the backrest during the initial stage of tilting.

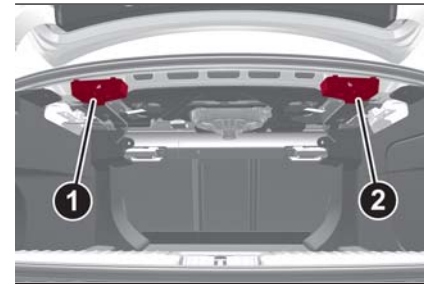

04066S0007EM

Seat Release Levers

- 1 – Left Side Seat Release Lever
- 2 – Right Side Seat Release Lever

Full Expansion Of The Trunk

Tilting the rear seat completely forwards allows maximum loading volume.

Proceed as follows:

1. Completely lower the rear seat head restraints.
2. Place the seatbelts so that they don't impede the movement of the backrest while tilting it.
3. Use levers 1 and 2 to fold down the backrests: these will fold down forwards automatically. If necessary, accompany the backrests during the initial stage of tilting.



Repositioning The Backrests

Move the seatbelts to the side, making sure that they are correctly extended and not twisted, and that they are not trapped behind the backrests of the seats. Then, lift the backrests pushing them back until you hear the locking click on both attachment mechanisms.



Warning!

Be certain that the seatback is securely locked into position. If the seatback is not securely locked into position the seat will not provide the proper stability for child seats and/or passengers. An improperly latched seat could cause serious injury.

Center Backrest Section Tilting

Before tilting the backrest, make sure that the rear center seatbelt is not fastened and that there aren't any objects in the middle part of the cushion (if there are any, remove them). Using the release strap, release the center part of the backrest from its housing and tilt it using the head restraint.

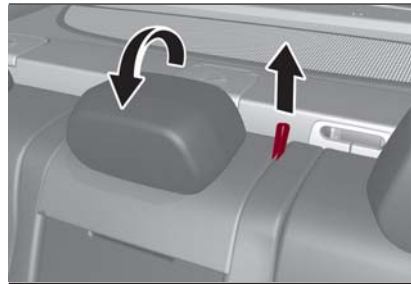

04066S0008EM

Center Backrest Section Tilting

Center Backrest Section Repositioning

Using the head restraint, lift the center portion upwards, accompanying it during its movement, lightly push to make sure that it is properly attached. Make sure that the armrest is properly attached by trying to move it, if it is not attached, repeat the operation.

HEAD RESTRAINTS

Head restraints are designed to reduce the risk of injury by restricting head movement in the event of a rear impact. Head restraints should be adjusted so that the top of the head restraint is located above the top of your ear.



Warning!

- A loose head restraint thrown forward in a collision or hard stop could cause serious injury or death to occupants of the vehicle. Always securely stow removed head restraints in a location outside the occupant compartment.
- ALL the head restraints MUST be reinstalled in the vehicle to properly protect the occupants. Follow the re-installation instructions above prior to operating the vehicle or occupying a seat.
- Do not place items over the top of the Reactive Head Restraint, such as coats, seat covers or portable DVD players. These items may interfere with the operation of the Reactive Head Restraint in the event of a collision and could result in serious injury or death.

Racing Seat Head Restraints

Your vehicle may be equipped with non-adjustable head restraints on the driver's and passenger's seatbacks.

The non-adjustable head restraints consist of a trimmed foam covering over the upper structure of the seatbacks and are intended to help protect you and the passenger from neck injury.

Adjust the seatbacks to their upright, on-road positions so that the head restraint is positioned as close as possible to the back of your head.

Front Head Restraints (Adjustments) – If Equipped

The front head restraints may be height-adjustable. To adjust them, operate as follows:

- Upward adjustment: Raise the head restraint until it clicks into place.
- Downward adjustment: Push button and lower the head restraint.



Warning!

All occupants, including the driver, should not operate a vehicle or sit in a vehicle's seat until the head restraints are placed in their proper positions in order to minimize the risk of neck injury in the event of a crash.

Head restraints should never be adjusted while the vehicle is in motion. Driving a vehicle with the head restraints improperly adjusted or removed could cause serious injury or death in the event of a collision.

Note: To allow maximum visibility for the driver, if the head restraints are not used, lower the head restraints to the fully down position.

Rear Head Restraints (Adjustments)



Warning!

All occupants, including the driver, should not operate a vehicle or sit in a vehicle's seat until the head restraints are placed in their proper positions in order to minimize the risk of neck injury in the event of a crash.

Head restraints should never be adjusted while the vehicle is in motion. Driving a vehicle with the head restraints

improperly adjusted or removed could cause serious injury or death in the event of a collision.

The height of the outboard head restraints can be adjusted. The head restraint of the center seat, if equipped, cannot be adjusted, only removed.

For upward adjustment, pull up on the head restraint until it clicks into place.

For downward adjustment, push in the adjustment button and lower the head restraint while holding the button to the desired height.

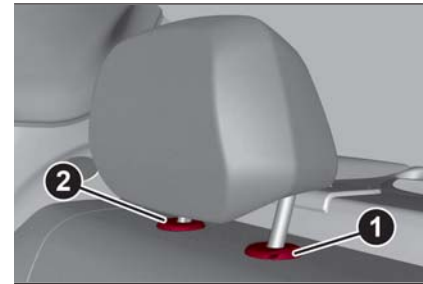

04076S0002EM

Rear Head Restraint

- 1 — Adjustment Button
- 2 — Release Button

Note: To allow maximum visibility for the driver, if the head restraints are not in use, lower the head restraints to the fully down position.



Head Restraints (Removal)

To remove the head restraints, proceed as follows:

1. Raise the head restraints to their maximum height.
2. Push the adjustment button and the release button at the side of the two supports.
3. Remove the head restraints by pulling them upwards.

To reinstall the head restraints, proceed as follows:

1. Hold down both the adjustment button and release button while placing the head restraint post into the holes.
2. Then, reposition the head restraint to the appropriate height for the passengers.



Warning!

❑ A loose head restraint thrown forward in a collision or hard stop could cause serious injury or death to occupants of the vehicle. Always securely stow removed head restraints in a location outside the occupant compartment.

❑ ALL the head restraints MUST be reinstalled in the vehicle to properly protect the occupants. Follow the re-installation instructions above prior to operating the vehicle or occupying a seat.

STEERING WHEEL

Adjustments

This feature allows you to tilt the steering column upward or downward. It also allows you to lengthen or shorten the steering column. The tilt/telescoping lever is located below the steering wheel at the end of the steering column.

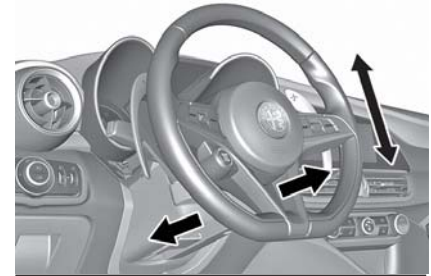
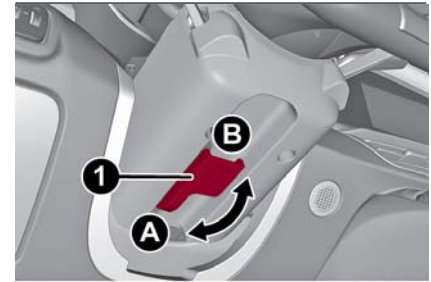

04086S0001EM

Steering Wheel Adjustment

- 1 — Tilt/Telescoping Control Handle
 A — Open
 B — Closed



Warning!

Do not adjust the steering column while driving. Adjusting the steering column while driving or driving with the steering column unlocked, could cause the driver to lose control of the vehicle. Failure to follow this warning may result in serious injury or death.

To Adjust The Position:

1. Pull the Tilt/Telescoping Control Handle down to the open position.
2. Adjust the steering wheel to the desired position.
3. Lock the desired position by pushing the Tilt/Telescoping Control Handle to the closed position.



Warning!

*It is absolutely forbidden to carry out any after-market operation involving steering system or steering column modifications (e.g. installation of anti-theft device) that could adversely affect performance, invalidate the New Vehicle Limited Warranty, cause **SERIOUS SAFETY PROBLEMS** and also result in the vehicle not meeting type-approval requirements.*

Heated Steering Wheel – If Equipped

With the ignition in the ON position, push the heated steering wheel  button on the instrument panel.



04086S0002EM

Heated Steering Wheel Button

When the function is enabled, the indicator on the button will illuminate.

Note: If this function is activated with the engine stopped, the battery may run down.



Warning!

Persons who are unable to feel pain to the skin because of advanced age, chronic illness, diabetes, spinal cord injury, medication, alcohol use, exhaustion, or other physical conditions must exercise care when using the steering wheel heater. It may cause burns even at low temperatures, especially if used for long periods.

Do not place anything on the steering wheel that insulates against heat, such as a blanket or steering wheel covers of any type and material. This may cause the steering wheel heater to overheat.



MIRRORS

Electrochromic Mirror

This mirror automatically adjusts for headlight glare from vehicles behind you.

The electrochromic mirror has a power button to activate/deactivate the automatic dimming/anti-glaring function.



04106S0002EM

Electrochromic Mirror Power Button

When the vehicle is in REVERSE, the automatic dimming feature is deactivated.

Outside Power Mirrors

Power Adjustment

The power mirrors can only be adjusted with the ignition ON.

Select the desired mirror using the power mirror control.



04106S0004EM

Power Mirror Control

- 1 — Power Mirror Control Knob
- A — Left
- B — Right
- C — Power Folding Position
- D — Neutral

To adjust the selected mirror, push the knob in the direction desired.

Note: Once adjustment is complete, rotate the knob to the neutral position to prevent accidental movements.

Power Folding

With the power mirror control knob in the neutral position, move it to the power folding position. Move the knob again to return the mirrors to the driving position.

If the power mirror control knob is moved again during door mirror folding (from closed to open position and vice versa), the movement direction is reversed.

Automatic Activation

Activating the central door locking system from outside the vehicle automatically folds the mirrors. The mirrors return to the driving position when the ignition is cycled to the ON position.

If the door mirrors were folded using the power mirror control knob, they can only be returned to the driving position by rotating the knob again.

Note: The power folding operation can be enabled only when the vehicle speed is lower than 31 mph (50 km/h), they can only be manually controlled up to that speed.

Automatic Dimming Mirrors — If Equipped

Like the electrochromic mirror, an automatic dimming feature is also available on the outside rear view mirrors to prevent glare. The automatic dimming button is the same for all rear view mirrors.



Warning!

Vehicles and other objects seen in an outside convex mirror will look smaller and farther away than they really are. Relying too much on side convex mirrors could cause you to collide with another vehicle or other object. Use your inside mirror when judging the size or distance of a vehicle seen in a side convex mirror.

Heated Mirrors

Push the rear defrost  button in the climate controls to activate the heated mirrors.

EXTERIOR LIGHTS

Headlight Switch

The headlight switch is located to the left of the steering wheel on the instrument panel. This switch controls the operation of the headlights, parking lights, instrument panel lights, instrument panel light dimming, interior lights and rear fog lights.

In addition, there are buttons for parking sensors deactivation and stop/start. Refer to "Starting And Operating" for further information.

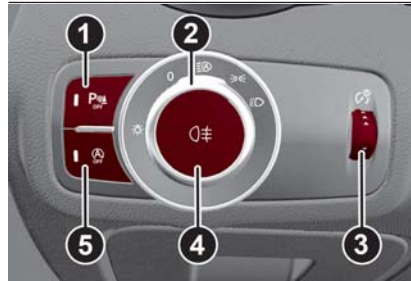

04126S0001NA

Headlight Switch

- 1 — Parking Sensors Deactivation Button
- 2 — Parking Light, Daylight Running Lights, Headlight Switch
- 3 — Instrument Panel Dimmer
- 4 — Rear Fog Light Button
- 5 — Stop/Start Button

The exterior lights can be activated only when the ignition is in the ON position, except for the parking lights. Refer to "Parking Lights" in this section for more information.

The instrument panel and the various controls on the dashboard will be illuminated when the exterior lights are turned on.

Automatic Headlights

This system automatically turns the headlights on or off according to ambient light levels.

Function Activation

From the O (OFF) position, turn the light switch to the  (AUTO) position

Note: The function can only be activated with the ignition position cycled to ON.

Function Deactivation

To deactivate the function, turn the light switch to a position other than the  (AUTO) position.



Daytime Running Lights (DRL)

With the ignition in the ON mode and the light switch turned to the  position, if the dusk sensor detects sufficient external light, the Daytime Running Lights will turn on automatically while the other lights remain off.

If the turn signals are operated, the brightness of the corresponding Daytime Running Lights will be decreased as long as the turn signals are on.

Non-Canadian Markets

If equipped, the DRL can be activated/deactivated from the Information and Entertainment System, by selecting the following functions in sequence on the main MENU: "Settings", "Lights" and "Daytime Lights".

Rear Fog Light

The rear fog light switch is integrated with the headlight switch.

Push the  button to turn the rear fog lights on/off.

The rear fog lights turn on only when the headlights or parking lights are turned on. The lights can be turned off by pushing the  button again or by turning the headlight switch to the O (off) position.

When the engine is stopped with the rear fog lights on, they will remain off the next time the engine is started.

Parking Lights

With the ignition in the STOP position, turn the headlight switch to the  position to turn the parking lights on. All of the parking lights will turn on for eight minutes, and opening the door activates an audible warning.

To leave only the lights on one side (right/left) illuminated, you must move the multifunction lever (located on the left side of the steering wheel) to the side that you want to remain on. With the parking lights on, the  warning light on the instrument panel will come on.

Note: Placing the ignition to ON turns off the parking lights, which were only illuminated on one side.

Headlight Off Delay

The "Headlight Off Delay" function delays the switching off of the headlights after the vehicle has been stopped.

The function can be activated from the Information and Entertainment System by selecting the following functions in sequence on the main menu: "Settings", "Lights" and "Headlight Off Delay".

The side lights and the headlights stay on for a time that can be set between 30, 60, and 90 seconds.

Function Activation



With the headlights on, place the ignition to the STOP position and the timer will then start.

Note: To activate this function, the headlights must be deactivated within two minutes after the ignition has been cycled to the STOP position.

Function Deactivation

This function is deactivated by turning on the headlights, the side lights, or by cycling the ignition to ON.

High Beam Headlights

To activate the fixed high beam headlights, push the turn multifunction lever, located on the left side of the steering wheel, towards the instrument panel. The headlight switch must be turned to the  (AUTO) or  (ON) position.

With high beam headlights on, the  High Beam Indicator on the instrument panel will illuminate.

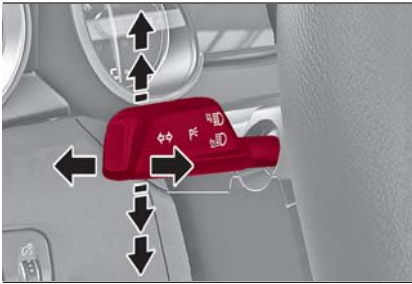

04126S0020EM

Multifunction Lever

The high beam headlights are turned off by pulling the lever to its original position. The warning light/icon  will turn off in the instrument panel when the headlights are turned off.

Flashing The Headlights

Pulling the multifunction lever toward the steering wheel will activate the high beam headlights manually. The lights will remain on as long as the lever is held. Once the lever is released, the lights will resume the previous position.

Automatic High Beam Headlights – If Equipped

The Automatic High Beam Headlights system provides increased forward lighting at night by automating high beam control through the use of a digital camera mounted on the

windshield. This camera detects vehicle specific light and automatically switches from high beams to low beams until the approaching vehicle is out of view.

This function is enabled with the Information and Entertainment System, and can only be activated with the light switch turned to  (AUTO).

If the high beam headlights are on, the blue icon/warning light  will illuminate in the instrument panel.

When the speed is higher than 37 mph (60 km/h) and the function is active, the lights will turn off if the multifunction lever is pushed again.

When the speed is lower than 15 mph (25 km/h) and the function is active, the function switches the high beam headlights off.

If the high beam headlights are operated quickly again (pushing the multifunction lever towards the instrument panel), the warning light/icon  will illuminate in the instrument panel, and the main beam headlights will be turn on constantly until the speed exceeds 37 mph (60 km/h).

When the speed of 37 mph (60 km/h) is exceeded again, the automatic functioning is reactivated.

If the multifunction lever is pushed again with the Automatic High Beam Headlights activated, the Automatic

High Beam Headlights function deactivates.

To deactivate the automatic headlight function, rotate the headlight switch to the  position.

Note: If the system recognizes heavy traffic areas, the automatic functions remain disabled independently of the vehicle's speed.

Turn Signals

To activate the turn signals function, move the multifunction lever, located on the left side of the steering wheel, up or down until it reaches the detent. Moving the lever upward flashes the right turn signal and moving the lever downward will flash the left turn signal.

The  or  turn signal will blink on the instrument panel.

The turn signals turn off automatically when the vehicle is brought back onto a straight course.



“Lane Change” Function

Tap the lever up or down once, without moving beyond the detent, and the turn signal (right or left) will flash five times. Then, the turn signal (right or left) will automatically turn off.

To turn off the flashing before the end of the cycle, move the lever in the opposite direction until the first click (about half way).



Static Bending Light Function (SBL) – If Equipped

The SBL function utilizes Light Emitting Diodes (LEDs) in order to better illuminate the street and increase the light angle while turning. This function is enabled by rotating the light switch to position  or  (AUTO). The SBL LEDs activate when the speed is below 25 mph (40 km/h).

This function can be activated/deactivated on the Information and Entertainment System by selecting the following functions in sequence on the main menu: “Settings”, “Lights” and “Cornering Lights”.

INTERIOR LIGHTS

Front Map Reading Lights

The front map/reading and overhead lights are mounted in the overhead console. Each light can be turned on by pushing the corresponding switch on the console. These switches are backlit for night time visibility. To turn the lights off, push the switch a second time.

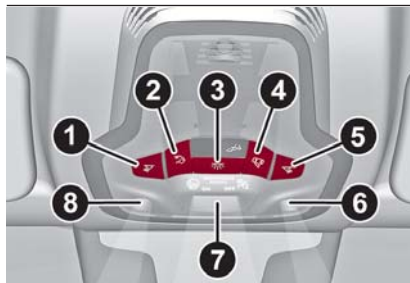

04136S0001EM

Overhead Console

- 1 – Driver’s Reading/Map Light Switch
- 2 – Rear Overhead Lights Switch
- 3 – Overhead Lights Switch
- 4 – Front Map Reading Lights Switch
- 5 – Passenger’s Reading/Map Light Switch
- 6 – Passenger’s Reading/Map Light
- 7 – Center Reading/Map Light
- 8 – Driver’s Reading/Map Light

Note: Before getting out of the vehicle, ensure that the overhead lights are off. This will prevent the battery level from being drained once the doors are closed. If a light is left on accidentally, the overhead lights turn off automatically approximately 15 minutes after the engine has been turned OFF.

Overhead Light Timing – If Equipped

On certain models, to assist getting in and out of the vehicle at night or in poorly-lit areas, two timed modes have been provided.

Timing While Getting Into The Vehicle

— The overhead lights turn on according to the following modes:

- Will illuminate for a few seconds when the doors are unlocked.
 - Will illuminate for approximately three minutes when one of the doors is opened.
 - Will illuminate for a few seconds when the doors are locked.
- Timing is interrupted when the ignition is cycled to ON.

Three Modes Are Provided For Switching Off:

❑ When all doors are closed after entering the vehicle, the three-minute timer will stop and a seconds timer will start for the interior lights. This timing will stop when the ignition is cycled to ON.

❑ When doors are locked (either with key fob or with key inserted on driver side door), the overhead light turns off.

❑ The interior lights will turn off after 15 minutes to preserve the battery.

Timing While Getting Out Of The Vehicle — After cycling the ignition to STOP, the overhead lights will turn on as follows:

❑ For a few seconds after the engine stops.

❑ For approximately three minutes when one of the doors is opened.

❑ For a few seconds when the last door is closed.

The timing stops automatically when the doors are locked.

Courtesy Lights — If Equipped

On the driver and passenger sun visor, there is a light which illuminates the sun visor mirror when folded down.



04136S0002EM

Sun Visor Mirror

1 — Sun Visor Mirror Cover

The courtesy light turns on automatically by lifting the cover.

Glove Compartment Light

This light turns on automatically when the glove compartment is opened and turns off when it is closed.

The light turns on and off regardless of the ignition status.



04136S0003EM

Glove Compartment Light

Interior Ambient Lighting

The brightness of the interior passenger compartment lights can be adjusted via the Information and Entertainment System.

To access the adjustment function, on the main menu select the following items in sequence:

1. "Settings"
2. "Interior Ambient Lighting"
3. "Lights"

The lights can be adjusted to seven different levels of brightness.



Door Light

This vehicle is equipped with door courtesy lamps that illuminate the entry way for the driver or passenger when the door is opened, and turns off when it is closed.

The light turns on and off regardless of the ignition status.

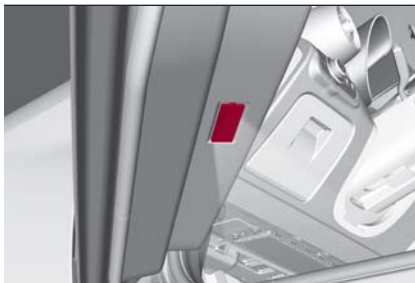

04136S0007EM

Door Light

On vehicles equipped with a "Passive Entry" system, another light can be found under each exterior door handle.

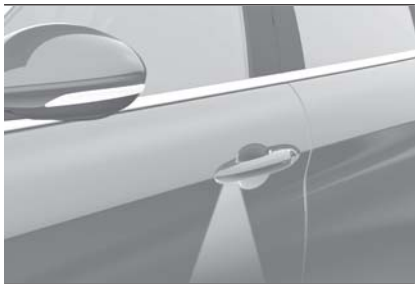

04136S0005EM

Exterior Door Handle Light

Rear Overhead Light

The rear overhead light buttons are activated or deactivated by two on/off switches on the front map reading lights.

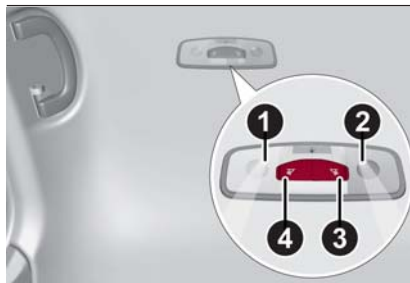

04136S0004EM

Rear Overhead Light

- 1 – Passenger Rear Overhead Light
- 2 – Driver Rear Overhead Light
- 3 – Driver Rear Overhead Light Switch
- 4 – Passenger Rear Overhead Light Switch

The lights turn on when a door is opened.

Note: The light will turn off automatically after a few minutes if a door is left open. To turn it on again, open another door or close and reopen the same door.

Luggage Compartment Courtesy Lights

The luggage compartment features two courtesy lights.

These courtesy lights turn on automatically when the trunk is opened and turn off when it is closed.

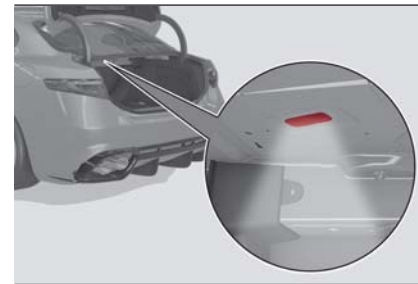

04136S0006EM

Luggage Compartment Courtesy Lights

The courtesy lights will turn on and off regardless of the position of the ignition switch.

Note: If the trunk is left open, the lights will automatically turn off after 15 minutes to preserve battery life.

Instrument Panel Dimmer Control

With the daytime running lights or headlights on, rotate the dimmer control upward to increase the instrument panel brightness and the control button icons. Rotate the dimmer control downward to decrease brightness.



04126S0055EM

Dimmer Control

WINDSHIELD WIPERS

Windshield Wiper Stalk

The windshield wiper stalk is located on the right side of the steering wheel.

The windshield wipers will only operate with the ignition cycled to ON.



Turn the windshield wipers off when driving through an automatic car wash. Damage to the windshield wipers may result if the wiper control is left in any position other than off.

In cold weather, always turn off the wiper switch and allow the wipers to return to the "Park" position before turning off the engine. If the wiper switch is left on and the wipers freeze to the windshield, damage to the wiper motor may occur when the vehicle is restarted.

Always remove any buildup of snow that prevents the windshield wiper blades from returning to the off position. If the windshield wiper control is turned off and the blades cannot return to the off position, damage to the wiper motor may occur.

Windshield Wiper/Washers



04146S0001EM

Windshield Wiper Switch

Operation: The switch on the wiper stalk can be set to the following positions:

- 0 Windshield Wiper Off.
- A Low Sensitivity Rain Sensing.
- A High Sensitivity Rain Sensing.
- ... Low Continuous Wiper Speed.
- ... High Continuous Wiper Speed.

Windshield Wiper Operation

Rotating the switch to the ... position activates the first (low) level continuous speed of the windshield wipers in manual mode.

Rotating the switch to the ... position activates the second (high) level continuous speed of the windshield wipers in manual mode.



Rain Sensors

Rotating the switch to the **A** position, activates the first, less sensitive level of the Rain Sensing function.

Rotating the switch to the **..A** position, activates the second, more sensitive level of the Rain Sensing function. Refer to “Rain Sensor” in this section for more information on how this system functions.

Windshield Washer Operation

Pull the stalk toward the steering wheel to operate the windshield washer.

Keep the stalk pulled to activate both the windshield washer jet and the windshield wiper with a single movement. The wipers and washers will continue to operate until you let go of the stalk.

The windshield wiper stops working three strokes after the stalk is released, followed by a final stroke six seconds later to complete the cycle.

Mist

Use this feature when weather conditions make occasional usage of the wipers necessary. Push the stalk upward to the MIST position and release for a single wiping cycle. This function is useful to remove small deposits of dust from the windshield or morning dew.

Note: This function does not activate the windshield washer. To spray windshield washer fluid onto the windshield, the washing function must be used.



Warning!

Sudden loss of visibility through the windshield could lead to a collision. You might not see other vehicles or other obstacles. To avoid sudden icing of the windshield during freezing weather, warm the windshield with the defroster before and during windshield washer use.

Rain Sensor

The Rain Sensor is located behind the interior rear view mirror. This feature senses moisture on the windshield and automatically activates the wipers for the driver.

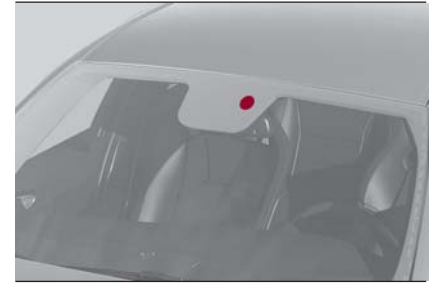

04146S0002EM

Rain Sensor

The feature is especially useful for road splash or over spray from the windshield washers of the vehicle ahead. Rotate the end of the multifunction lever to one of four settings to activate this feature.

The sensor has an adjustment range that varies progressively from wiper still (no stroke) when the windshield is dry, to wiper at continuous speed (fast operation) with intense rain.

Activation

Rotating the wiper switch to position **•A** or **•A** activates the rain sensor.

The activation of the rain sensor system is done by tapping the wiper stalk upwards while the switch is in the **•A** or **•A** position.

The variation in sensitivity during rain sensor operation is also signaled by a stroke of the wiper (command acquired and implemented). This stroke is also executed with the windshield dry.

If the windshield washer is used with the rain sensor activated, the normal washing cycle is performed, after which the rain sensor resumes its normal automatic operation.

Note: Keep the glass in the sensor area clean.

Deactivation

Use the wiper switch or cycle the ignition to STOP.

If the ignition is cycled to the STOP position and the wiper switch is left in **•A** or **•A** position, no wiping cycle will occur even if it rains when the vehicle is next started (ignition at ON).

This prevents accidental activation of the rain sensor when the engine is started (e.g. when the windshield is being washed by hand or the wipers are stuck to the windshield by ice).

You can restore the automatic functioning of the rain sensor by tapping the wiper stalk upwards once the vehicle has been restarted.

When the rain sensor is reactivated using any of the functions described above, reactivation is indicated by a single tap of the windshield wipers, regardless of the condition of the windshield.

In the event of malfunction of the rain sensor while it is active, the windshield wiper operates intermittently at a speed

consistent with the sensitivity setting of the rain sensor, whether or not there is rain on the glass for as long as the sensor failure is indicated on the display.

The sensor continues to operate and it is possible to set the windshield wiper to continuous mode **•** or **•**. The failure indication remains on for as long as the sensor is active.

The rain sensor is able to recognize and automatically adjust itself in the presence of the following conditions:

- Presence of dirt on the controlled surface (e.g. salt, dirt, etc.).
- Presence of streaks of water caused by the worn window wiper blades.
- Difference between day and night.



CLIMATE CONTROL

Passenger Compartment Air Vents

Side Air Vents

- To adjust the position of the Side Air Vents, move the Side Air Vent Adjuster (2) in any direction.
- Rotate the Side Air Vent Adjuster (2) to adjust the air flow. Rotating the Side Air Vent Adjuster (2) clockwise will close the vent. Rotating it counterclockwise will open the vent.

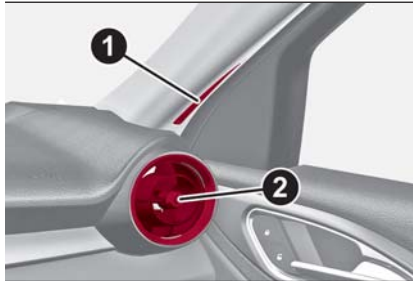

04156S0002EM

Side Air Vents

- 1 — Demister Air Vents
- 2 — Side Air Vent Adjuster

Central Air Vents

- To adjust the position of the Central Air Vents, move the Central Air Vent Adjuster (2) up or down.
- Rotate the Central Air Vent Air Flow Adjuster (3) to adjust the air flow. Rotating Central Air Vent Air Flow Adjuster (3) up will open the vents, allowing for maximum airflow. Rotating it down will close the vents.

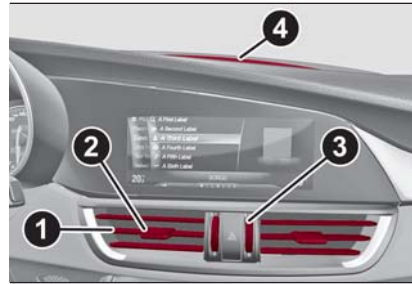

04156S0003EM

Central Air Vents

- 1 — Adjustable Central Air Vents
- 2 — Central Air Vent Adjuster
- 3 — Central Air Vent Air Flow Adjuster
- 4 — Windshield Front Defroster Vent

Rear Air Vents

- To adjust the position of the Rear Air Vents, move the Rear Air Vent Adjuster (2) in any direction.
- Rotate the Rear Air Vent Adjuster (2) to adjust the air flow. Rotating the Rear Air Vent Adjuster (2) clockwise will close the vent. Rotating it counterclockwise will open the vent.

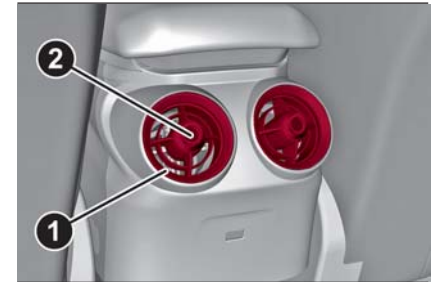

04156S0004EM

Rear Air Vents

- 1 — Adjustable Rear Air Vents
- 2 — Rear Air Vent Adjuster

Automatic Dual-Zone Climate Control System

Controls

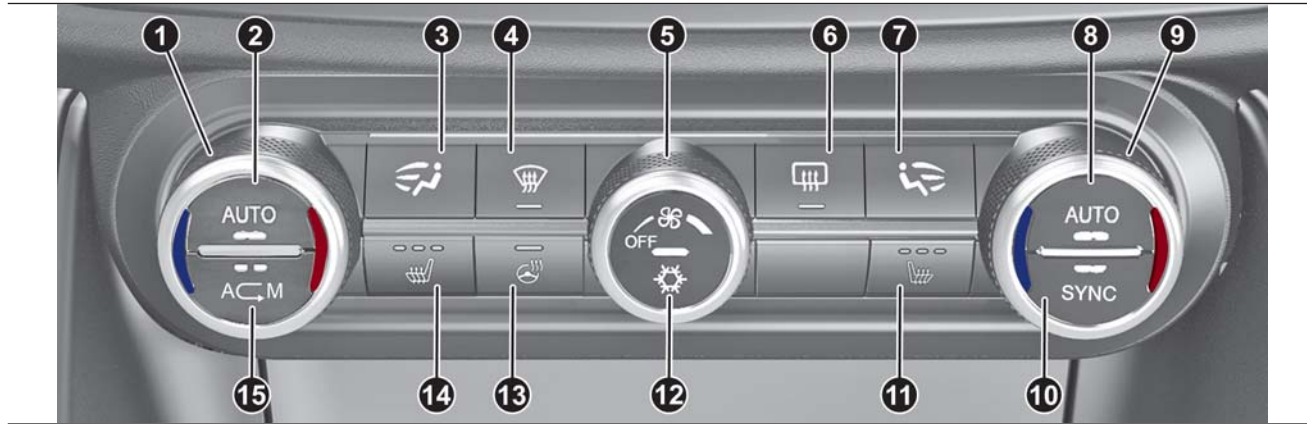

04156S0005EM

Automatic Climate Control System

- | | | |
|--|--|--|
| 1. Driver Temperature Adjustment Knob | 6. Rear Defrost Button | 11. Passenger Heated Seat Button — If Equipped |
| 2. Driver Side AUTO Button (Automatic Operation) | 7. Passenger Side Air Distribution Selection Button | 12. Air Conditioning On/Off Button |
| 3. Driver Side Air Distribution Selection Button | 8. Passenger Side AUTO Button (Automatic Operation) | 13. Steering Wheel Heater Button — If Equipped |
| 4. Front Defrost Button (Rapid Defrosting) | 9. Passenger Temperature Adjustment Knob | 14. Driver Side Heated Seat Button — If Equipped |
| 5. Blower Speed Adjustment Knob | 10. SYNC Button – Sets Temperature Alignment Between Driver & Passenger Side | 15. Air Recirculation Button |

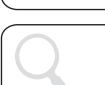

**Caution!**

The system uses R1234yf refrigerant, which does not pollute the environment in the event of accidental leakage. Under no circumstances, use R134a and R12 fluids, which are incompatible with the components of this system.

Description

The Automatic Dual Zone Climate Control System adjusts the temperature and air distribution independently between the driver and passenger.

The system maintains the set temperature inside the passenger compartment and compensates for outside temperature change.

Note: The reference temperature is 72 °F (22 °C) for optimal comfort management.

The automatic setting will adjust the following to maintain comfort within the passenger compartment:

- Air temperature from the driver/front passenger side vents
- Air distribution from the driver/front passenger side vents
- Fan speed (continuous variation of the air flow)
- Compressor variations (for cooling/dehumidifying the air)
- Air recirculation

The Climate Control System can also be operated manually by using the buttons and knobs on the faceplate.

Manual selections will override the automatic settings, which are stored until the AUTO button is pushed. If the system intervenes for safety reasons, the automatic setting will take control of the system.

The below operations will not deactivate the automatic (AUTO) function:

- Air Recirculation activation/deactivation
- A/C activation/deactivation
- SYNC function activation
- Rear Window Defrost activation/deactivation

When in AUTO mode, the vehicle's internal temperature is controlled according to the set temperature.

The following can be manually set or adjusted:

- Driver/passenger air temperature
- Blower speed (continuous variation)
- Air distribution (seven positions for driver and passenger)
- A/C activation
- Front Defroster
- Air recirculation
- Rear Defroster
- System deactivation

Operating Mode

The Climate Control system can be activated in different ways. It is recommended to use the automatic function. Push the AUTO button and set the desired temperatures.

The automatic system adjusts the temperature, quantity, and distribution of air introduced into the passenger compartment. It also controls air recirculation and the activation of the air conditioner.

At any time during automatic operation, you can change the temperature, activate or deactivate the Rear Defroster, activate SYNC, activate or deactivate the air conditioner, and activate or deactivate air recirculation. The system will automatically adjust to the new settings.

Climate Control Display Settings

The Climate Control settings are visible on the Information and Entertainment System radio screen.

The display on the Information and Entertainment System is a pop up window (1), which is activated by pushing the buttons or turning the knobs on the Climate Control system. The indicator lights located on the number of buttons and knobs indicate that the selected feature is on/off. If no operation is performed for a

predetermined time, the pop-up will close on the display.



04156S0006EM

1 – Climate Control Pop-up Display

Air Temperature Adjustment

Rotate the driver or passenger Temperature Adjustment Knob clockwise for warmer temperatures or counterclockwise for cooler temperatures. The set temperatures are shown on the Information and Entertainment System.





Push the SYNC button to sync the driver and passenger air temperatures. Rotate the passenger Temperature Adjustment Knob to cancel the SYNC function. This will set a new passenger side temperature.

Rotate the Temperature Adjustment Knob fully clockwise to engage the HI (maximum heating) setting or fully counterclockwise to engage the LO (maximum cooling) setting. To deactivate these functions, rotate the Temperature Adjustment Knob to the desired temperature.

Rear passengers' temperature is linked to driver side selection.

Air Distribution Selection

Push the Air Distribution Selection button on the faceplate to change the mode of air distribution.

-  Air flow to the windshield and demister window vents to demist/defrost them.
-  Air flow at the central and side dashboard vents to ventilate the chest and the face.
-  Air flow to the front and rear floor vents. This setting heats the passenger compartment the quickest.
-  Air flow distributed between the floor vents (hotter air) and the central and side dashboard vents (cooler air). This air distribution setting is useful on sunny days during spring and autumn.

 Air flow distributed between the floor vents, windshield, and front side window defrosting/demisting vents. This distribution setting warms the passenger compartment while preventing the windows from fogging up.

 Air flow distribution between the windshield demisting/defrosting vents, and side/central dashboard vents. This distribution setting sends air to the windshield in sunny conditions.

 Air flow distribution to all vents on the vehicle.

In AUTO mode, the Climate Controls automatically manage the air distribution. When set manually, the respective symbols on the Information and Entertainment System indicate the air distribution setting.

Fan Speed Adjustment

Turn the Blower Speed Knob to increase or decrease the blower speed. The speed is displayed with lighted indicators in the Information and Entertainment System display.

Maximum fan speed = all indicators illuminated on the Information and Entertainment System display



Minimum fan speed = one indicator illuminated on the Information and Entertainment System display

The fan can be turned off by rotating the Blower Speed Knob counterclockwise to position O (all segments on the Information and Entertainment System display are turned off).

Note: To restore automatic control of the fan speed, push the AUTO button.

AUTO Button

When the AUTO button is pushed (indicator illuminated), the Climate Control system automatically adjusts the following settings:

- Quantity and distribution of air flow in the passenger compartment
- The air conditioner
- Air recirculation
- Cancels any manual settings

Selecting the AUTO function illuminates the indicator on the A/C button .

If air distribution or the fan speed is manual adjusted, the AUTO button indicator will turn off to indicate that the Climate Control system is no longer in AUTO mode.

After a manual adjustment, push the AUTO button to resume the automatic system.

SYNC Button

Push the SYNC button (indicator illuminated) to sync the passenger side air temperature with the driver side air temperature.

This function makes temperature regulation easier when the driver is traveling alone.

Turn the passenger Temperature Adjustment Knob or push the passenger side Air Distribution Selection Button to change the passenger side air temperature and return to separate air temperature management.

Air Recirculation And Air Quality System (AQS)

Air Recirculation is managed according to the following operating mode:

- Automatic engagement: indicator is illuminated above the “A” on the Air Recirculation Button
- Forced activation (air circulation always activated): indicator illuminated above the  icon on the Air Recirculation Button
- Forced deactivation (air recirculation always off with intake of outside air): both indicators not illuminated on the Air Recirculation Button

The three operating conditions are obtained by pushing the Air Recirculation Button  in sequence.

Enabling The Air Quality System (AQS) Function – If Equipped

When the automatic recirculation function is selected, the AQS function automatically activates internal air recirculation when the outside air is polluted (e.g. in heavy traffic and tunnels).

At low external temperatures or in high humidity, the automatic function turns off to avoid fogging up the windows. The user can select the function again by pushing the Air Recirculation Button. In automatic operation, air recirculation will be controlled by the system according to outside environmental conditions.

Note:

With the AQS function active and after the internal air recirculation system has been functioning for a set amount of time, the Climate Control System enables air intake to cycle the air in the passenger compartment for a set time. The AQS function is disabled during the air changes.

The engagement of the recirculation system makes it possible to reach the required heating or cooling conditions faster. It is, however, inadvisable to use it on rainy/cold days as it can increase the possibility of the windows fogging. When the outside temperature is low, recirculation is forced off to prevent the windows from fogging up.

A/C Compressor

Push the A/C button  to activate or deactivate the A/C compressor (indicator illuminated when activated). The A/C compressor will remain off even after the engine has stopped.

When the A/C compressor is turned off, the system deactivates air recirculation to prevent the windows from fogging up. If the climate control system can maintain the temperature, with the A/C turned off, the AUTO feature will remain on and the AUTO button indicator light will not switch off.

To restore automatic control of the A/C compressor, push the A/C button  or the AUTO button. With the A/C compressor off, the air speed can be set manually using the Air Speed Adjustment Knob.

When the A/C compressor is on, and the engine is running, air speed cannot be lower than the minimum speed (only one indicator light is lit).

Note: When the A/C is off the Climate Control system can not produce air that is colder than the current outside temperature. Under certain environmental conditions, windows could fog up rapidly, since the air is not dehumidified.

Front Defroster And MAX-DEF Function

Push the Front Defroster button  (indicator illuminated) to defrost the windshield and side windows.

While in MAX-DEF function, the air conditioner will:

- Activate the air conditioner compressor when the weather allows
- Turn air recirculation off
- Set the maximum air temperature (HI) on both the driver and passenger side
- Activate a blower speed based on the temperature of the engine coolant
- Adjust the air flow towards the windshield and front side windows
- Activate the Rear Window Defroster
- Display the fan speed (indicators illuminated) and current air distribution setting

Note: The MAX-DEF function remains active for approximately three minutes once the engine coolant reaches the proper temperature.

When the function is on, AUTO mode will deactivate. The only manual operations possible are adjusting blower speed and turning off the Rear Window Defroster.

Pushing the  button switches off the MAX-DEF function.

Rear Defroster

Push the Rear Defroster button  to activate (indicators illuminated) the Rear Defroster.

The Rear Defroster will turn off after 20 minutes or once the engine is turned off. To reactive the Rear Defroster, push the Rear Defroster  button.

Note: To avoid damage, do not apply stickers over the interior heating filaments of the Rear Defroster.

Humidity Sensor

The Humidity Sensor helps to prevent the windows from fogging up. The AUTO function (indicator illuminated) must be on for the Humidity Sensor to function.

When outside temperature is low, the system may turn the compressor on and turn air recirculation off for safer driving.

Switching Off/On The Climate Control System

Switching Off The Climate Control System

Rotate the Air Speed Adjustment Knob completely counterclockwise to turn off the Climate Control System.

With the air conditioner off:

- Air recirculation is on
- The A/C compressor is off



- ❑ The fan is off
- ❑ The heated rear window can be activated/deactivated

Note: The climate control system stores the previously set temperatures and resumes operation when any button on the system is pushed.

Switching On The Climate Control System

To switch the climate control system on in automatic mode, push the AUTO button.

Stop/Start

The climate control system manages the Stop/Start system. Stop/Start has the engine shut off when vehicle speed is 0 mph (0 km/h) to maintain comfort within the vehicle.

Stop/Start will deactivate in the following scenarios:

- ❑ The climate control system is in AUTO mode (indicator illuminated), and the vehicle has yet to reach the set temperature
- ❑ The climate control system is in LO maximum cooling
- ❑ The climate control system is in HI maximum heating
- ❑ The climate control system is in the MAX-DEF status

When the Stop/Start system is active, the engine will restart if the inside temperature changes significantly, or if the LO setting, or MAX-DEF setting, is activated.

With Stop/Start system on, air flow is reduced to keep the compartment comfort conditions for longer.

Until the temperature drastically changes within the cabin, the climate control system will continue to maintain the temperature while the engine is off. By deactivating the Stop/Start system with the (A) button located on the dashboard, the climate control system will take priority over the engine shutting off.

Note:

- ❑ In harsh climate conditions, limit the use of the Stop/Start system to prevent the compressor from continuously switching on and off. This will cause rapid misting of the windows and the accumulation of humidity in the passenger compartment.
- ❑ When the Stop/Start system is on, the climate control system will always take air in from outside, reducing the probability of the windows fogging up.

Additional Heater – If Equipped

Note: The additional heater automatically operates if the outside temperature and engine coolant temperature are low. The heater will not operate if battery voltage is low.

System Maintenance

In winter, the Climate Control System must be turned on at least once a month for approximately ten minutes. Have the system inspected at an authorized dealer before the summer.

POWER WINDOWS

Power Window Switches

The power window switches work with the ignition in the ON position and for three minutes after the ignition has been placed in the STOP position. When one of the front doors is opened, this operation is disabled.

Driver Side Front Door Controls

The switches are located on the door panel trim. All windows can be controlled from the driver side door panel.

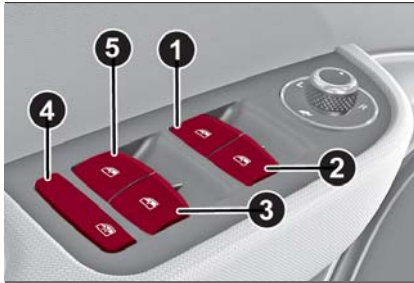

04166S0001EM

Power Window Switches

- | | |
|-------------------------------|-----------------------------|
| 1 — Front Left Window Switch | 4 — Window Lockout Switch |
| 2 — Front Right Window Switch | 5 — Rear Left Window Switch |
| 3 — Rear Right Window Switch | |

Window Opening

Briefly push the window switch once to move the window downward.

Push the switch a second time to activate the automatic operation.

Pushing the switch a third time will stop the window in the desired position.

Window Closing

Pull the window switch up to move the window upward. Hold the switch for at least half of a second and the window will go up automatically.

To stop the window during Auto-Up operation, push or pull the window switch again.

Passenger Side Front Door/Rear Door Controls

There are single window controls on the passenger and rear door trim panels which operate the door windows.

Auto-Up Feature With Anti-Pinch Protection

The vehicle may be equipped with an anti-pinch safety device for closing the windows.

If the safety system senses any obstacle while the window is closing, it will stop the window's movement and reverse it, depending on its position.

This device is also useful if the windows are activated accidentally by children on board the vehicle.

The anti-pinch safety function is activated both during the manual and the automatic operation of the window.

When the anti-pinch system is activated, the window closing is immediately interrupted. Then the window closing is automatically reversed and the window lowers by about eight inches (20 cm) in relation to the first stop position. The window cannot be operated during this time.

Note: In the event of an error, or if the anti-pinch protection is activated three consecutive times, the automatic closing operation of the window will be deactivated. In order to restore the correct operation of the system, the window must be lowered.



Power Window System Initialization

If power supply is interrupted, the electric window automatic operation must be initialized once more.

The initialization procedure described below must be carried out for each door (with the doors closed):

1. Fully close the window to be initialized, with manual operation.
2. After the window has been closed, hold the up switch for at least three seconds.



Warning!

Never leave children unattended in a vehicle, and do not let children play with power windows. Do not leave the key fob in or near the vehicle, or in a location accessible to children. Occupants, particularly unattended children, can become entrapped by the windows while operating the power window switches. Such entrapment may result in serious injury or death.

POWER SUNROOF — IF EQUIPPED

Power Sunroof

The power sunroof consists of two glass panels (the front one is power and the rear one fixed) and is fitted with a power sunshade in the front, as well as a manually operated sunshade in the rear.

Operation of the sunroof is only possible with the ignition at ON. Refer to “Ignition” in this chapter for further information.



Warning!

Never leave children unattended in a vehicle, or with access to an unlocked vehicle. Never leave the key fob in or near the vehicle, or in a location accessible to children. Do not leave the ignition of a vehicle equipped with keyless ignition in the ON mode. Occupants, particularly unattended children, can become entrapped by the power sunroof while operating the power sunroof switch. Such entrapment may result in serious injury or death.

In a collision, there is a greater risk of being thrown from a vehicle with an open sunroof. You could also be seriously injured or killed. Always fasten your seat belt properly and make sure all passengers are also properly secured.

Do not allow small children to operate the sunroof. Never allow your fingers, other body parts, or any object, to project through the sunroof opening. Injury may result.

Opening

To open the sunroof's front panel, push the open/close button toward the rear of the vehicle to open completely.

The automatic motion can be interrupted in any position by pushing the open/close button again.

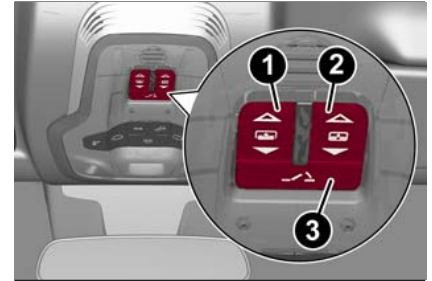

04186S0001EM

Sunroof And Power Shade Buttons

- 1 — Open/Close Button
- 2 — Vent Open/Close
- 3 — Power Shade Open/Close



Caution!

Do not open the sun roof if a roof rack or crossbars are fitted. Do not open the sun roof if there is snow or ice on it: you may damage it.

Closing

From the complete open position, push the open/close button toward the front of the vehicle. The roof will close completely.

The automatic motion can be interrupted in any position by pushing the open/close button again.

Vent Opening

To bring the roof into vent position, push and release the vent button.

This type of vent opening can be activated regardless of the position of the sunroof. When starting with the roof in the closed position, pushing the vent button automatically causes the sunroof to open to the vent position. If the roof is already open, the button must be held until the roof reaches the vent-opening position.

Pushing vent button again during automatic movement of the roof will stop it.

Sun Shade Movement

The front sunshade is power operated. Push the Power Shade open/close button toward the rear of the vehicle to open the front sun shade.

Push the Power Shade open/close button toward the front of the vehicle to close the sun shade.

The automatic motion can be interrupted in any position by pushing the Power Shade on/off button again.

To open the rear sunshade, pull sunshade manually toward the rear of the vehicle.

Pinch Protect Feature

The sunroof has an anti-pinch safety system capable of detecting the presence of an obstacle during the closing movement. If an obstacle is detected, the system intervenes and the movement of the sunroof is immediately reversed into opening.

Initialization Procedure

Automatic operation of the sunroof must be initialized again in case of faulty sunroof operation.

Proceed as follows:

1. Push the open/close button to bring the roof into the completely closed position.

2. Cycle the ignition to the STOP position and wait at least ten seconds.

3. Cycle the ignition to the AVV position. Refer to "Ignition" in this chapter for further information.

4. Hold the open/close button down for at least ten seconds. You should then hear the mechanical stop of the roof motor.

5. Within five seconds, hold the open/close button down. The roof will perform a complete automatic opening and closing cycle (to indicate that the initialization procedure has been successful). If this does not occur, the procedure must be restarted from the beginning.



HOOD

Opening

To open the hood, proceed as follows:

1. Pull the release lever located on the driver's side kick panel.

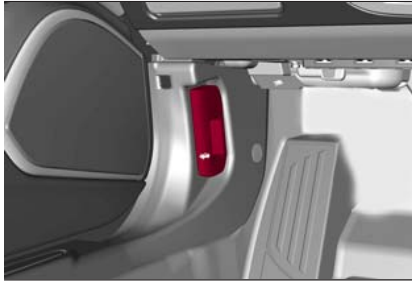

04196S0001EM

Hood Release Lever

2. Go to the outside of the vehicle and position yourself in front of the grille.
3. Lift the hood slightly.
4. Move the under-hood latch from right to left to release the hood.

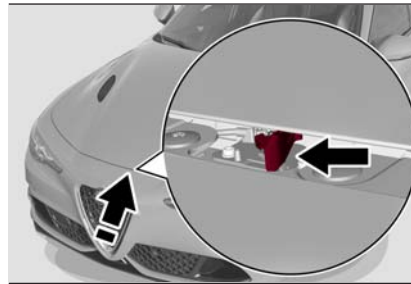

04196S0002EM

Lift Under Hood Latch Up Then Left

5. Raise the hood completely. The operation is assisted by the addition of two gas props which hold it in the open position.

Note:

- Do not tamper with the props and assist the hood while lifting it.
- Use both hands to lift the hood. Before lifting, check that the windshield wiper arms are not raised from the windshield or in operation, that the vehicle is stationary and that the electric park brake is engaged.

Closing

To close, lower the hood to approximately 16 inches (40 cm) from the engine compartment then let it drop. Make sure that the hood is completely closed and fully latched. Do this by trying to open it. If it is not perfectly closed, do not try to push the hood lid down, but open it and repeat the procedure.

Note: Always check that the hood is closed correctly to prevent it from opening while the vehicle is travelling. Since the hood is equipped with a double locking system, one for each side, you must check that it is closed on both its side ends.



Warning!

Be sure the hood is fully latched before driving your vehicle. If the hood is not fully latched, it could open when the vehicle is in motion and block your vision. Failure to follow this warning could result in serious injury or death.

TRUNK

The trunk unlocking is electrically operated and is deactivated when the vehicle is in motion.

Opening

Opening From The Outside

When unlocked, the trunk lid can be opened from outside the vehicle using the external trunk lid release button located between the plate lights. Push the button until you hear a “click.” The trunk lid can also be opened by quickly pushing the external trunk lid release button on the key fob twice.



04056S0005EM

External Trunk Lid Release Button

The turn signal indicators will blink and the internal lights will turn on when the trunk lid is opened. They turn off automatically when the trunk lid is closed.

The lights turn off automatically after a few minutes if the trunk lid is left open.

Opening From The Inside

When unlocked, the trunk lid can be opened from inside the vehicle using the internal trunk lid release button, located under the dashboard near the engine hood opening lever. Push the trunk lid release button until you hear a “click.”

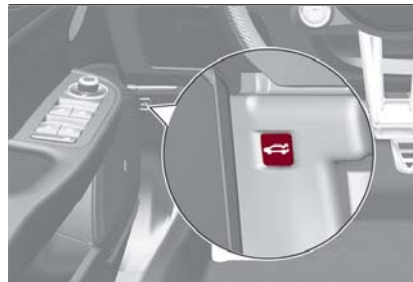

04206S0002EM

Internal Trunk Lid Release Button

Trunk Lid Emergency Opening

A lever can be found in the trunk lid over the lock to allow opening from the inside.

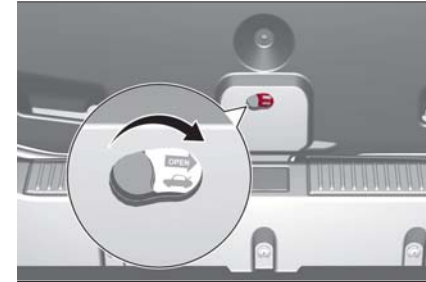

04206S0006EM

Emergency Release Button

Pull the lever in the direction indicated by the arrow to open the trunk lid. The lever can be seen in the dark.



Closing

Grip one of the handles and lower the trunk lid until it clicks.



04206S0003EM

Trunk Lid Internal Handles

Note:

❑ It will not be possible to open the trunk lid with a key or by pushing the button in the passenger compartment when the battery is disconnected. So, always position the manual trunk lid opening strap on the trunk lid lock before disconnecting the battery. Refer to “Storing The Vehicle” in “Servicing And Maintenance” for the procedure.

Trunk Initialization

Note: If the battery is disconnected or the protection fuse blows, the trunk lid opening/closing mechanism must be re-initialized as follows:

1. Close all the doors and the trunk lid.
2. Push the lock button on the remote control.
3. Push the unlock button on the remote control.

Luggage Compartment Specifications

Access To The Tire Service Kit

To access the Tire Service Kit, lift the carpet in the luggage compartment. For its use, refer to “Tire Service Kit” in “In Case Of Emergency” for further information.



04206S0004EM

Cargo Area

Rear Cargo Tie-Downs – If Equipped

There are four hooks inside the luggage compartment for attaching the cargo net or cables which can secure the cargo be carried.

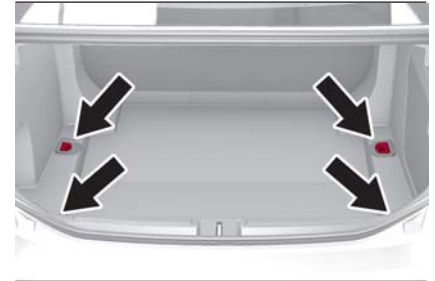

04206S0005EM

Rear Cargo Tie-Downs

Note: Do not apply a load greater than 22 lbs (10 kg) on a single hook.

Cargo Net – If Equipped

This is useful for correctly arranging the cargo and/or for transporting light materials.

The cargo net is available from an authorized dealer.

INTERNAL EQUIPMENT

Glove Compartment

To open the glove compartment proceed as follows:

1. If equipped with a lock, unlock the glove compartment by placing the emergency key in the lock on the handle.
2. Pull handle to open the glove compartment.

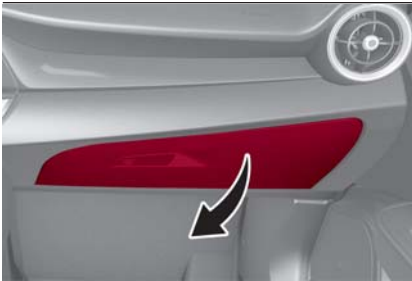

04246S0001EM

Opening The Glove Compartment

When the glove compartment is opened, a light turns on to illuminate the inside of the compartment.

Note: Do not insert objects of such a size that the compartment cannot be completely closed. Always make sure that the glove compartment is completely closed when driving.

Sun Visors

The sun visors are located at the sides of the interior rear view mirror. They can be adjusted forward and sideways.

To direct the visor toward the passenger side window, detach the visor from the interior rear view mirror side hook and turn it towards the side window.

From this position, the sun visor can also be extended toward to rear of the vehicle for additional blockage of sunlight.

Courtesy mirrors with lights are fitted on the back of the sun visors and can be used even in poor light conditions.

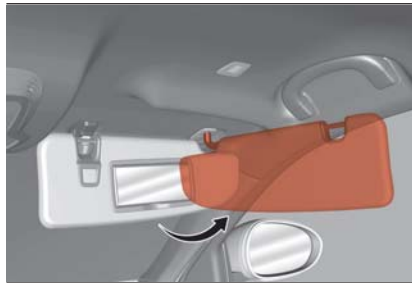

04246S0002EM

Rotate Sun Visor Toward Passenger Window

Note: A rear facing child restraint system should never be fitted in the front passenger seat. Always comply with the instructions on the sun visor. Refer to "Child Restraints" in "Safety" for more information.



Homelink — If Equipped

Description

Homelink is a fixed system installed on the vehicle. It can sync up to three different devices that activate garage doors, gates, lighting systems, and home or office alarm systems.

Programming



Warning!

❑ Vehicle exhaust contains carbon monoxide, a dangerous gas. Do not run your vehicle in the garage while programming the transceiver. Exhaust gas can cause serious injury or death.

❑ Your motorized door or gate will open and close while you are programming the universal transceiver. Do not program the transceiver if people, pets or other objects are in the path of the door or gate. Only use this transceiver with a garage door opener that has a "stop and reverse" feature as required by Federal safety standards. This includes most garage door opener models manufactured after 1982. Do not use a garage door opener without these safety features. Call toll-free 1-800-355-3515 or, on the Internet at HomeLink.com for safety information or assistance.

Note: Without starting the engine, activate the handbrake and place the ignition in the ON position.



The following operation will delete the manufacture's standard codes and does not need to be repeated during the subsequent button programming:

- ❑ Push and hold the outer buttons (1 and 3). After about ten seconds, the lighted indicators will start to flash. Release both buttons.

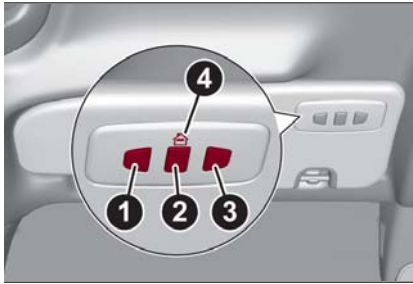

04246S0006NA

Garage Door Opener (Homelink) Buttons

- 1 — Homelink Button 1
- 2 — Homelink Button 2
- 3 — Homelink Button 3
- 4 — Homelink Indicator

Note: Follow the steps below to begin programming your remote control to one of the Homelink buttons:

1. Push and hold the desired Homelink button (1, 2 or 3). When the Homelink indicator begins to flash slowly, move the portable remote control one to three inches from the

Homelink system (keeping the programmable button pushed down).

2. If the indicator does not begin to flash quickly, change the distance between the Homelink and the portable remote control and try the procedure again.
3. The Homelink indicator flashes, first slowly and then quickly. When the indicator starts to flash quickly, release both buttons.

Using The Homelink System

The Homelink system activates the garage door or gate motor, just like the portable remote control. The car must be within the range of the garage door and the ignition must be in the ON position.

Push the programmed button (1, 2 or 3). While the signal is being transmitted, the indicator is lit and the system (garage door, gate, etc.) will respond. If the Homelink system does not operate, the original portable remote control may be equipped with an alternative code (refer to "Alternative Code Synchronization").

If necessary, the original remote control can still be used to operate the system.

Alternative Code Synchronization

To check whether the garage door or gate motor has an alternative code, proceed as follows:

1. Read the garage door or gate motor manufacturer manual.
2. The portable remote control seems to have programmed to the Homelink system, but the garage door or gate can be neither opened or closed.
3. Push the programmed button and keep it pushed (1, 2 or 3). With an alternative code system, the indicator flashes briefly, and then remains off for two seconds. This sequence is repeated for 20 seconds.



Warning!

❑ Vehicle exhaust contains carbon monoxide, a dangerous gas. Do not run your vehicle in the garage while programming the transceiver. Exhaust gas can cause serious injury or death.

❑ Your motorized door or gate will open and close while you are programming the universal transceiver. Do not program the transceiver if people, pets or other objects are in the path of the door or gate. Only use this transceiver with a garage door opener that has a "stop and reverse" feature as required by Federal safety standards. This includes most garage door opener models manufactured after 1982. Do not use a garage door opener without these safety features. Call toll-free 1-800-355-3515 or, on the Internet at HomeLink.com for safety information or assistance.

Note: To program Homelink using an Alternative Code, the car must be within range of the garage door. Activate the handbrake and turn the ignition to ON, without starting the engine.

Proceed as follows:

1. Locate the “Learn” or “Train” button on the garage door or gate motor. The color and position may vary depending on the manufacturer (consult the garage door or gate manual). Push the “Learn” or “Train” button (this normally activates the setting warning light).

2. Push the desired HomeLink button (1, 2 or 3). When the HomeLink indicator begins to flash slowly, move the portable remote control one to three inches from the HomeLink system (keeping the programmable button pushed down).

3. Within 30 seconds, push the programmed key (1, 2 or 3) and release it. Push the programmed button a second time and release it to conclude the operation. For some motors, the operation will probably have to be repeated a third time to end the setting.

The motor should now be capable of recognizing the signal transmitted by HomeLink and then open/close the door or gate.

Programming A Single Key

It is possible to program another original remote control on an already programmed HomeLink key by canceling the previously stored frequency.



Warning!

Vehicle exhaust contains carbon monoxide, a dangerous gas. Do not run your vehicle in the garage while programming the transceiver. Exhaust gas can cause serious injury or death.

Your motorized door or gate will open and close while you are programming the universal transceiver. Do not program the transceiver if people, pets or other objects are in the path of the door or gate. Only use this transceiver with a garage door opener that has a “stop and reverse” feature as required by Federal safety standards. This includes most garage door opener models manufactured after 1982. Do not use a garage door opener without these safety features. Call toll-free 1-800-355-3515 or, on the Internet at HomeLink.com for safety information or assistance.

Note: Activate the handbrake and place the ignition to ON without starting the engine.

Proceed as follows:

1. Push the desired HomeLink button and keep it pushed (1, 2 or 3). Do not release the button until the last operation has been performed.

2. When the HomeLink indicator begins to flash slowly, move the portable remote control 1 to 3 inches from the system (keeping the programmable button pressed down). If the indicator does not begin to flash quickly, change the distance between the HomeLink and the portable remote control and try the procedure again.

The HomeLink indicator flashes, first slowly and then quickly. When the indicator starts to flash quickly, release both buttons on the remote control.

The system previously programmed to HomeLink has now been deleted and the new system is ready to use. This does not affect the other two HomeLink buttons in any way.

Deleting Programmed Keys

It is recommended to delete HomeLink programming before selling the car.

All three keys are deleted simultaneously.

Proceed as follows:

1. Push and hold the outer buttons (1 and 3). After about ten seconds, the indicator will start to flash.

2. Release both keys.



Technical Information For After Sales Service

If you are unable to set up HomeLink successfully after following the above instructions, contact After Sales Service (HomeLink free hotline number 1-800-355-3515) with the following information:

- ❑ Vehicle make and model, including manufacturing year and country of purchase;
- ❑ Make, model, age and frequency of use of the original portable remote control (if known).

Note: For US:

- ❑ FCC ID: M3N-82135300

For Canada:

- ❑ IC: 7812A-82135300

For Mexico:

- ❑ RLVC-A213-0334

This device complies with Part 15 of the FCC Rules. Operation is subject to the following two conditions:

(1) this device may not cause harmful interference, and (2) this device must accept any interference received, including interference that may cause undesired operation.

Note: Changes or modifications not expressly approved by the party responsible for compliance could void the user's authority to operate the equipment.

Center Console

The center console storage compartment is located between the front seats.

To access the center console storage, lift the upper part of the center console as shown below.



Center Console

04246S0004EM



Warning!

Do not operate this vehicle with a console compartment lid in the open position. Driving with the console compartment lid open may result in injury in a collision.

Cupholder

Two cupholders are available in the center console.



04246S0005EM

Cupholders In Center Console

1 – Cover

To access the cupholders, slide the cover forward. To close the compartment, push the cover and it will close automatically.

Fire Extinguisher – If Equipped

If equipped, there is a fire extinguisher located in the cargo area.

ENVIRONMENTAL PROTECTION SYSTEMS

The following systems are used for reducing engine emissions:

- Catalytic Converter
- Oxygen Sensors
- Evaporation Control System

ACTIVE AERODYNAMICS

Front Mobile Spoiler (Alfa Active Aero)

This is an automatic device, working at the vehicle speed, which allows higher reactivity at average speeds and higher vehicle stability at high speeds, regulating the air flow into the lower part of the vehicle.

Note: The system is not active in temperatures near or below zero, or when the Alfa DNA selector is in the "Natural" or "Advanced Efficiency" positions.



04296S0001EM

Front Fascia

If there is a fault, a generic failure icon will light up on the instrument panel display, along with a message that will identify the type of malfunction. See your authorized dealer if a fault occurs.



GETTING TO KNOW YOUR INSTRUMENT PANEL

This section gives you all the information you need to understand and use the instrument panel correctly.

INSTRUMENT PANEL FEATURES63
INSTRUMENT CLUSTER	
DISPLAY65
WARNING LIGHTS AND MESSAGES	
ON THE INSTRUMENT PANEL70
ONBOARD DIAGNOSTIC SYSTEM. .	.94



INSTRUMENT PANEL FEATURES

Instrument Cluster



Instrument Cluster

05026S0005EM

1. Tachometer
2. Digital Engine Oil Temperature Gauge With Overheating Warning Light
3. Instrument Cluster Display
4. Digital Fuel Level Gauge (The Triangle On The Left Side Of The Symbol Indicates The Side Of The Vehicle With The Fuel Door)
5. Speedometer (Speed Indicator)



Tachometer

The Tachometer indicates the engine Revolutions Per Minute (RPM).

Adjusting Instrument Panel Lighting (Brightness Sensor)

Inside the Tachometer there is a light sensor capable of detecting light and adjusting the brightness of the instrument panel and the Information and Entertainment System display.

Engine Oil Temperature Gauge

The digital indicator monitors the temperature of the engine oil and starts supplying indications when the oil temperature reaches approximately 122° F (50°C).

Under normal usage, the temperature should remain around the middle of the digital scale according to the working conditions.

The  warning light will turn on to signal the excessive increase of the engine oil temperature.

In the event of excessive engine oil temperature, stop the engine immediately and contact an authorized dealer.

Fuel Level Gauge

The digital fuel gauge monitors the amount of fuel in the tank.

When the  warning light turns on, a message is displayed, and a chime is sound when 2.38 Gallons (9.0 L) of fuel are left in the tank.

Note: If the low fuel warning light turns on, refuel the vehicle at your nearest fuel station.



Caution!

Do not travel with the fuel tank almost empty: any gaps in fuel supply could damage the catalytic converter.

Speedometer

The speedometer shows the vehicle speed in miles per hour and/or kilometers per hour (mph/km/h).

INSTRUMENT CLUSTER DISPLAY

Instrument Cluster Display Description

The vehicle is equipped with a driver-interactive display that is located in the instrument cluster.

When one or more of the doors have been opened or closed and the ignition is in the OFF position, the instrument cluster will display the vehicle mileage for a few seconds.

Reconfigurable Instrument Cluster Display

During operation, the instrument cluster display is divided into multiple sections which show driving data, warnings and failure indications.



Premium Instrument Cluster Display

05036S0001QV



Reconfigurable Display Items

1. Headlight Warning Lights

Displays the headlight warning light for either of the following active modes:

- Headlights
- Automatic Headlights

2. Gear Selector Information

Displays the following information controlled by the gear selector function:

- P** = PARK
- R** = REVERSE
- N** = NEUTRAL
- D** = DRIVE, (automatic forward speed)

AutoStick: + shifting to higher gear in manual (sequential) driving mode – shifting to lower gear in sequential driving mode

3. Forward Collision, Lane Departure, Cruise Control

Displays operations for the following modes:

- Forward Collision Warning (FCW)
- Lane Departure Warning (LDW)
- Cruise Control (CC) or Active Cruise Control (ACC) (if equipped)

4. Speed Limit Warning Light

Shows information regarding the Speed Limiter function.

5. Compass

6. Reconfigurable Main Area

Can display the following screens:

- Home
- Trip A
- Trip B (can be activated/deactivated through the Information and Entertainment System)
- Performance

The screens can be selected, on rotation, by pushing the MENU selection button on the windshield wiper stalk.



05036S0002EM

MENU Selection Button

Depending on the driving mode chosen using the Alfa DNA (Dynamic, Natural, and Advanced Efficiency), the screens

can be graphically different. Navigation instructions and call information can be set and displayed in the Information and Entertainment System.

Home

The parameters shown on the display, for the modes: Dynamic, Natural and Advanced Efficiency are:

- Time
- Outside Temperature
- Current Speed (shown if the repeat modes of the Phone and Navigation functions are not active)
- Range



05036S0004NA

Premium Instrument Cluster Display



05036S0055NA

Premium Instrument Cluster Display

Trip A And B

For all driving modes (Dynamic, Natural, and Advanced Efficiency) and with the ignition device ON, the "Trip computer" can be used to display the measurements regarding the operating state of the vehicle. This function is characterized by two separate records, called "Trip A" and "Trip B" (the latter can be deactivated by Information and Entertainment System), where the "complete missions" (journeys) are recorded in a reciprocally independent manner.

"Trip A" and "Trip B" are used to display the values relating to:

- Distance travelled
- Average fuel consumption
- Average speed

- Active trip
- Fuel consumption indicator



05036S0007NA

Premium Instrument Cluster Display

To reset the values, press and hold down the button on the windshield wiper stalk.



05036S0002EM

Reset Button

Performance

The displayed parameters differ according to the active mode. The

modes which can be selected using the Alfa DNA system are:

- Natural

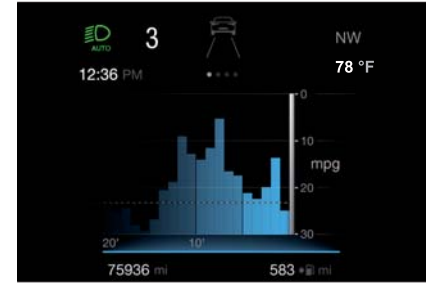

05036S0009NA

Efficiency Consumption Graph

The screen graphically reproduces some parameters closely linked to the efficiency of the driving style, with a view to limiting consumption.

- Advanced Efficiency



05036S0011NA

Dynamic Driving Style

The three central icons on the screen indicate the effectiveness of the driving



style, linked to the following parameters: acceleration, deceleration and gear shifts, with a view to limiting consumption. The bar below the icons shows current consumption and the green line represents the optimal area. The globe lights up gradually according to lower consumption.

Dynamic



05036S0013NA

Acceleration Gauge

The displayed parameters are related to vehicle stability, the graphs illustrate the trend of the longitudinal/lateral accelerations (G-meter information), considering gravity acceleration as a reference unit.

Lateral acceleration peaks are also indicated.



05036S0014NA

Acceleration Stability Gauge

The displayed parameters are related to vehicle stability, the graphs illustrate the trend of the longitudinal/lateral accelerations (G-meter information), considering gravity acceleration as a reference unit.

Lateral acceleration peaks are also indicated.

7. Vehicle Range

Indicates the miles left before the fuel tank is empty.

Displays the position by indicating the cardinal direction.

8. Failure Warning Lights

Area dedicated to displaying failures, the following symbols could be displayed on rotation:

- Low criticality symbols (yellow amber)
- High criticality symbols (red)

9. Odometer

Indicates the total miles travelled.

U.S. Federal regulations require that upon transfer of vehicle ownership, the seller certify to the purchaser the correct mileage that the vehicle has been driven. If your odometer needs to be repaired or serviced, the repair technician should leave the odometer reading the same as it was before the repair or service. If s/he cannot do so, then the odometer must be set at zero, and a sticker must be placed in the door jamb stating what the mileage was before the repair or service. It is a good idea for you to make a record of the odometer reading before the repair/service, so that you can be sure that it is properly reset, or that the door jamb sticker is accurate if the odometer must be reset at zero.

PARAMETERS SET BY USER



05036S0015EM

Information and Entertainment System

Multiple settings can be programmed by the user using the Information and Entertainment System. This section describes only the basic settings:

- Units & Language
- Time & Date
- Cluster

To access the settings list in the Information and Entertainment System, proceed as follows:

1. Press the MENU button to access the main menu.

Select “Settings” from the main menu using the Rotary Knob.



05036S0040EM

MENU button

Units & Language



05036S0016EM

Units & Language Selectable Menu Options

The following settings can be modified under the “Units & Language” menu:

- Measure Units: select US, metric, or custom. The custom option allows for individual selection of the unit measures
- Language: change the language of the system
- Restore Settings: restores the factory settings

To access and change the setting, turn and push the Rotary Pad.



Clock & Date



05036S0017EM

Clock & Date Selectable Menu Options

The following settings can be modified under the “Clock & Date” menu:

- Sync With GPS Time: activates or deactivates the clock synchronization through the GPS. If the function is deactivated, the options Set Time and Set Date are enabled
- Set Time: set the time manually
- Time Format: set the time format to either a 12-hour and a 24-hour clock)
- Set Date: set the date manually
- Restore Settings: restores the factory settings

To access and the change the setting, turn and push the Rotary Pad.

Cluster



05036S0018EM

Instrument Cluster Display Selectable Menu Options

The following settings can be modified under the “Cluster” menu:

- Warning buzzer volume: set the volume of the warning buzzer
- Trip B: activate or deactivate the Trip function
- Phone repeat: activate or deactivate repeating the Phone function screens on the instrument cluster display
- Restore Settings: restores the factory settings

To access and the change the setting, turn and push the Rotary Pad.

WARNING LIGHTS AND MESSAGES ON THE INSTRUMENT PANEL



The following pages consist of warning lights and messages.

Note:



The warning light turns on together with a dedicated message and/or chime when applicable. These indications are precautionary and as such must not be considered as exhaustive and/or alternative to the information contained in the Owner's Manual, which you are advised to read carefully in all cases. Always refer to the information in this section in the event of a failure indication.

The failure indicators appearing on the display are divided into two categories: very serious and less serious faults. Serious faults are indicated by a repeated and prolonged warning "cycle." Less serious faults are indicated by a warning "cycle" with a shorter duration. You can stop the warning cycle in both cases by pushing the button located on the windshield wiper stalk. The instrument panel warning light will stay on until the cause of the failure is eliminated.

Red Warning Lights

Warning Light	What It Means	What To Do
<p>BRAKE</p>	<p>INSUFFICIENT BRAKE FLUID/ELECTRIC PARK BRAKE ON</p> <p>This light monitors various brake functions, including brake fluid level and parking brake application. If the brake light turns on it may indicate that the parking brake is applied, that the brake fluid level is low, or that there is a problem with the anti-lock brake system reservoir.</p> <p>If the light remains on when the parking brake has been disengaged, and the fluid level is at the full mark on the master cylinder reservoir, it indicates a possible brake hydraulic system malfunction or that a problem with the Brake Booster has been detected by the Anti-Lock Brake System (ABS) / Electronic Stability Control (ESC) system. In this case, the light will remain on until the condition has been corrected. If the problem is related to the Brake Booster, the ABS pump will run when applying the brake, and a brake pedal pulsation may be felt during each stop.</p>	<p>For low brake fluid level, go to an authorized dealer to have the system checked as soon as possible. Release the electric park brake, then check that the warning light has turned off.</p> <p>If the warning light stays on, contact an authorized dealer.</p>
<p>BRAKE</p> <p></p>	<p>ELECTRONIC BRAKING FORCE DISTRIBUTION (EBD) FAILURE</p> <p>The simultaneous turning on of the BRAKE (red) and  (amber) warning lights with the engine on indicates either a failure of the EBD system or that the system is not available. In this case, the rear wheels may suddenly lock and the vehicle may swerve when braking abruptly.</p>	<p>Drive very carefully to the nearest authorized dealer to have the system inspected immediately.</p>



Warning Light	What It Means	What To Do
	<p>AIR BAG WARNING LIGHT This light will turn on for four to eight seconds as a bulb check when the ignition is placed in the ON/RUN position. If the light is either not on during startup, stays on, or turns on while driving, have the system inspected at an authorized dealer as soon as possible. This light will illuminate with a single chime when a fault with the Air Bag Warning Light has been detected, it will stay on until the fault is cleared. If the light comes on intermittently or remains on while driving, have an authorized dealer service the vehicle immediately.</p>	<p>If the problem persists, contact an authorized dealer.</p>
	<p>SEAT BELT REMINDER WARNING LIGHT When the ignition is first placed in the ON/RUN position, if the driver's seat belt is unbuckled, a chime will sound and the light will turn on. When driving, if the driver or front passenger seat belt remains unbuckled, the Seat Belt Reminder Light will flash or remain on continuously and a chime will sound. Refer to "Occupant Restraints" in "Safety" for further information.</p>	
	<p>OIL TEMPERATURE WARNING LIGHT This telltale indicates engine oil temperature is high.</p>	<p>Stop the vehicle and shut off the engine as soon as possible. If the problem persists, contact an authorized dealer.</p>



Warning!

- The fault of the warning light is signaled by the turning on of the icon on the instrument panel. In this case, the warning light may not indicate any faults with the restraint systems. Before proceeding, contact an authorized dealer to have the system checked immediately.
- If the warning light does not turn on when the ignition device is moved to ON or if it stays on when driving (together with the message on the display), there might be a fault in the restraint systems; in this case, the air bags or pretensioners may not deploy in the event of an accident or, in a lower number of cases, they could deploy erroneously. Before proceeding, contact an authorized dealer to have the system checked immediately.





Caution!

If the symbol turns on when driving, stop the vehicle and the engine immediately.



Amber Warning Lights

Warning Light	What It Means	What To Do
	<p>ANTI-LOCK BRAKE (ABS) INDICATOR LIGHT</p> <p>This light monitors the Anti-Lock Brake System (ABS). The light will turn on when the ignition is placed in the ON/RUN position and may stay on for as long as four seconds.</p> <p>If the ABS light remains on or turns on while driving, then the Anti-Lock portion of the brake system is not functioning and service is required. However, the conventional brake system will continue to operate normally if the brake indicator light is not on.</p> <p>If the ABS light is on, the brake system should be serviced as soon as possible to restore the benefits of Anti-Lock Brakes.</p> <p>If the ABS light does not turn on when the ignition is placed in the ON/RUN position, have the light inspected by an authorized dealer.</p>	<p>Drive carefully and contact an authorized dealer as soon as possible.</p>

Warning Light	What It Means	What To Do
	<p>TIRE PRESSURE MONITORING INDICATOR LIGHT</p> <p>The indicator light illuminates and a message is displayed to indicate that the tire pressure is lower than the recommended value and/or that slow pressure loss is occurring. In these cases, optimal tire duration and fuel consumption may not be guaranteed.</p> <p>Should one or more tires be in the condition mentioned above, the display will show the indications corresponding to each tire in sequence.</p> <p>Note:</p> <p>Do not continue driving with one or more flat tires as handling may be compromised. Stop the vehicle, avoiding sudden braking and steering. Repair immediately using the dedicated tire repair kit and contact your authorized dealer as soon as possible.</p> <p>Each tire, including the spare (if provided), should be checked monthly when cold and inflated to the inflation pressure recommended by the vehicle manufacturer on the vehicle placard or tire inflation pressure label. If your vehicle has tires of a different size than the size indicated on the vehicle placard or tire inflation pressure label, you should determine the proper tire inflation pressure for those tires.</p> <p>As an added safety feature, your vehicle has been equipped with a Tire Pressure Monitoring System (TPMS) that illuminates a low tire pressure telltale when one or more of your tires is significantly under-inflated. Accordingly, when the low tire pressure telltale illuminates, you should stop and check your tires as soon as possible and inflate them to the proper pressure. Driving on a significantly under-inflated tire causes the tire to overheat and can lead to tire failure. Under-inflation also reduces fuel efficiency and tire tread life, and may affect the vehicle's handling and stopping ability.</p>	<p>Do not continue driving with one or more flat tires as handling may be compromised. Stop the vehicle, avoiding sharp braking and steering. Immediately restore the correct inflation pressure using the Tire Repair Kit (refer to "Tire Repair Kit" in "In Case Of Emergency") and contact an authorized dealer as soon as possible.</p>



Warning Light	What It Means	What To Do
	<p>Please note that the TPMS is not a substitute for proper tire maintenance, and it is the driver's responsibility to maintain correct tire pressure, even if under-inflation has not reached the level to trigger illumination of the TPMS low tire pressure telltale. Your vehicle has also been equipped with a TPMS malfunction indicator to indicate when the system is not operating properly. The TPMS malfunction indicator is combined with the low tire pressure telltale. When the system detects a malfunction, the telltale will flash for approximately one minute and then remain continuously illuminated. This sequence will continue upon subsequent vehicle start-ups as long as the malfunction exists. When the malfunction indicator is illuminated, the system may not be able to detect or signal low tire pressure as intended. TPMS malfunctions may occur for a variety of reasons, including the installation of replacement or alternate tires or wheels on the vehicle that prevent the TPMS from functioning properly. Always check the TPMS malfunction telltale after replacing one or more tires or wheels on your vehicle, to ensure that the replacement or alternate tires and wheels allow the TPMS to continue to function properly.</p>	





Caution!

The TPMS has been optimized for the original equipment tires and wheels. TPMS pressures and warning have been established for the tire size equipped on your vehicle. Undesirable system operation or sensor damage may result when using replacement equipment that is not of the same size, type, and/or style. Aftermarket wheels can cause sensor damage. Using aftermarket tire sealants may cause the Tire Pressure Monitoring System (TPMS) sensor to become inoperable. After using an aftermarket tire sealant it is recommended that you take your vehicle to an authorized dealership to have your sensor function checked.

Warning Light	What It Means	What To Do
	<p>Tire Pressure Low</p> <p>The indicator light will illuminate to indicate that the tire pressure is lower than the recommended value and/or that slow pressure loss is occurring. In these cases, optimal tire duration and fuel consumption may not be guaranteed.</p>	<p>In any situation in which the message on the display is "See Manual", it is ESSENTIAL to refer to "Driving Assistance Systems" in "Safety," strictly complying with the indications that you find there.</p>
<p>ESC</p>	<p>ELECTRONIC STABILITY CONTROL (ESC) INDICATOR LIGHT</p> <p>When the ignition is cycled to ON, the indicator light illuminates, but should turn off as soon as the engine is started.</p> <p>ESC System Intervention: Intervention by the system is indicated by the flashing of the indicator light: it indicates that the vehicle is in critical stability and grip conditions.</p> <hr/> <p>ESC System Failure: If the indicator light does not turn off, or if it stays on with the engine running, a failure was found in the ESC system.</p> <hr/> <p>Hill Start Assist System Failure: The illumination of the indicator light indicates a Hill Start Assist system failure.</p>	<p>In these cases, contact an authorized dealer as soon as possible.</p>





Warning Light	What It Means	What To Do
	<p>ELECTRONIC STABILITY CONTROL (ESC) OFF INDICATOR LIGHT — IF EQUIPPED</p> <p>When the ignition is cycled to ON, the indicator light illuminates, but should turn off as soon as the engine is started.</p> <p>The indicator light illuminates to indicate that some active safety systems have been partially or totally deactivated.</p> <p>For further details about the active safety systems, refer to “Active Safety Systems” in “Safety.” When the active safety systems are reactivated, the indicator light turns off.</p>	
	<p>REAR FOG LIGHT</p> <p>The indicator illuminates when the rear fog light is activated.</p>	
	<p>ENGINE CHECK/MALFUNCTION INDICATOR LIGHT (MIL)</p> <p>In normal conditions, when the ignition is cycled to ON, the indicator light illuminates, but it should turn off as soon as the engine is started.</p> <p>The operation of the indicator light may be checked by the traffic police using specific devices. Comply with the laws and regulations of the country where you are driving.</p>	<p>Under these conditions, the vehicle can continue travelling at moderate speed but without demanding excessive effort from the engine or high speed. Prolonged use of the vehicle with the indicator light on constantly may cause damage. Contact an authorized dealer as soon as possible.</p>



Caution!

If, turning the ignition device to ON, the warning light  does not turn on or if it turns on steadily or flashing when travelling (on some versions together with the message on the display), contact an authorized dealer as soon as possible.





Warning Light	What It Means	What To Do
	<p>FORWARD COLLISION WARNING SYSTEM (FCW) – IF EQUIPPED</p> <p>This indicator light informs the driver that the frontal collision alarm function is not enabled.</p>	
	<p>FUEL RESERVE / LIMITED RANGE</p> <p>The indicator light (or the symbol in the display) illuminates when about 2.4 gallons (9 liters) of fuel is left in the tank.</p>	

 **Warning!**

If the warning light (or the icon on the display) flashes while driving, contact an authorized dealer.



Green Telltale Indicator Lights

Warning light	What It Means	What To Do
	<p>PARK/HEADLIGHT ON INDICATOR LIGHT This indicator will illuminate when the park lights or headlights are turned on.</p> <p>Headlight Off Delay This function allows the headlights to remain on for 30, 60 or 90 seconds after the ignition was placed in the STOP position.</p>	
	<p>LEFT TURN SIGNAL The instrument cluster directional arrow will flash independently for the left turn signal as selected, as well as the exterior turn signal lamp(s) (front and rear) as selected when the multifunction lever is moved down (left). This directional arrow will flash in conjunction with the right directional arrow when the hazard warning light button is pushed.</p>	
	<p>RIGHT TURN SIGNAL The instrument cluster directional arrow will flash independently for the right turn signal as selected, as well as the exterior turn signal lamp(s) (front and rear) as selected when the multifunction lever is moved up (right). This directional arrow will flash in conjunction with the left directional arrow when the hazard warning light button is pushed.</p>	
	<p>AUTOMATIC HIGH BEAM HEADLIGHTS (On Base Instrument Cluster Display) This indicator light will illuminate when the automatic high beam headlights are activated.</p>	

Blue Telltale Indicator Light

Warning Light	What It Means	What To Do
	<p>HIGH BEAM HEADLIGHTS (On Base Instrument Cluster Display)</p> <p>This indicator shows that the high beam headlights are on. Push the multifunction control lever away from you to switch the headlights to high beam. Push the lever a second time to switch the headlights back to low beam. Pull the lever toward you for a temporary high beam on, “flash to pass” scenario.</p>	





Red Symbols

Symbol	What It Means	What To Do
	<p>LOW ENGINE OIL PRESSURE</p> <p>This telltale indicates low engine oil pressure. If the telltale turns on while driving, stop the vehicle and shut off the engine as soon as possible. A chime will sound when this telltale turns on. Do not operate the vehicle until the cause is corrected. This telltale does not indicate how much oil is in the engine. The engine oil level must be checked under the hood.</p> <p>Note:</p> <p>Do not use the vehicle until the failure has been solved. The turning on of the telltale does not indicate the amount of oil in the engine: the oil level can be checked on the display upon entering the vehicle and also by activating the "Oil level" function on the Information and Entertainment System.</p>	<p>Contact an authorized dealer as soon as possible.</p>





Caution!

If the LOW ENGINE OIL PRESSURE symbol switches on when driving, stop the engine immediately and contact an authorized dealer.

Symbol	What It Means	What To Do
	<p>ENGINE COOLANT TEMPERATURE TOO HIGH The telltale lights up when the engine has overheated.</p>	<p><i>In normal driving conditions:</i> stop the car, switch off the engine and check that the coolant level in the reservoir is not below the MIN mark. In this case, wait for the engine to cool down, then slowly and carefully open the cap, top up with coolant and check that the level is between the MIN and MAX marks on the reservoir itself. Also check visually for any fluid leaks. Contact an authorized dealer if the telltale comes on when the engine is started again.</p> <p><i>If the vehicle is used under demanding conditions (e.g. in high-performance driving):</i> slow down and, if the warning light stays on, stop the vehicle. Stop for 2 or 3 minutes with the engine running and slightly accelerated to facilitate better coolant circulation, then turn the engine off. Check that the coolant level is correct as described above.</p>
	<p>POWER STEERING FAILURE If the telltale remains on, you could not have steering assistance and the effort required to operate the steering wheel could be increased; steering is, however, possible.</p>	<p>Contact an authorized dealer as soon as possible.</p>
	<p>DOOR OPEN The telltale turns on when one or more doors are not completely shut. An acoustic signal is activated with the doors open and the car moving.</p>	<p>Close the doors properly.</p>









Symbol	What It Means	What To Do
	<p>HOOD CAP NOT PROPERLY SHUT</p> <p>The telltale turns on when the hood cap is not properly closed, along with the icon, an image of the vehicle with an open hood cap appears on the display.</p> <p>A buzzer is heard when the hood cap is open and the vehicle is moving.</p>	Close the hood properly.
	<p>TRUNK LID NOT PROPERLY SHUT</p> <p>The telltale turns on when the trunk lid is not properly closed, along with the icon, an image of the vehicle with an open trunk lid appears on the display.</p> <p>A buzzer is heard when the trunk lid is open and the vehicle is moving.</p>	Close the trunk lid properly.
	<p>AUTOMATIC TRANSMISSION FAILURE</p> <p>The telltale turns on, together with a buzzer warning, to indicate that the automatic transmission is faulty.</p>	Contact an authorized dealer as soon as possible.





Caution!



Driving the vehicle with this symbol on may severely damage the gearbox, with resulting breakage. The oil may also overheat: contact with hot engine or with exhaust components at high temperature could cause fires.

Symbol	What It Means	What To Do
	ELECTRONIC THROTTLE CONTROL (ETC) WARNING LIGHTS This warning light, along with the related message, signals a failure in the electronic throttle control system (ETC).	Contact an authorized dealer as soon as possible.
	If a failure is detected, the warning light turns on while the engine is running.	Place the ignition in the off position and the shift selector in the P (Park) position: the warning light should switch off. If the warning light stays on with engine running the vehicle can still be driven. Contact an authorized dealer as soon as possible to have the failure eliminated.
	If the warning light flashes with the engine running, immediate intervention is required. A loss of performance, irregular/high idling speed or engine stopping might take place and the vehicle may need to be towed.	Contact an authorized dealer as soon as possible to have the failure eliminated.
	INSUFFICIENT ENGINE OIL LEVEL The telltale turns on, along with the related message on the display, to indicate low engine oil level.	Contact an authorized dealer to have the system checked.
	ALFA STEERING TORQUE (AST) FAILURE The switching on of the telltale signals a failure in the automatic steering correction system.	Contact an authorized dealer to have the system checked.
	ALTERNATOR FAILURE The switching on of the telltale with engine on corresponds to an alternator failure.	Contact an authorized dealer as soon as possible.



Amber Symbols

Symbol	What It Means	What To Do
	<p>ENGINE IMMOBILIZER FAILURE / BREAK-IN ATTEMPT</p> <p>Engine Immobilizer System Failure The telltale will illuminate to report a failure of the Engine Immobilizer system.</p>	<p>Contact an authorized dealer as soon as possible.</p>
	<p>Break-In Attempt</p> <p>The telltale will illuminate when the ignition is cycled to ON position, to indicate a possible break-in attempt detected by the alarm system.</p>	
	<p>Electronic Key Not Recognized</p> <p>The telltale will illuminate when the engine is started and the electronic key is not recognized by the system.</p> <p>Alarm System Failure</p> <p>The telltale will illuminate to report an alarm system failure.</p>	
	<p>FUEL CUT-OFF INDICATOR LIGHT</p> <p>The telltale will illuminate after an accident has occurred and the system has shut the fuel off.</p>	<p>For reactivating the fuel cut-off system, refer to "Enhanced Accident Response System" in "Occupant Restraint Systems" in "Safety" for further information. If it is not possible to restore the fuel supply, contact an authorized dealer.</p>
	<p>PARK SENSORS SYSTEM FAILURE</p> <p>The telltale will illuminate when the system has failed or is not available.</p>	<p>Contact an authorized dealer to have the system checked.</p>









Symbol	What It Means	What To Do
	<p>POSSIBLE ICE ON ROAD The telltale will illuminate when the outside temperature falls to or below 37°F (3°C).</p>	
	<p>ENGINE OIL CHANGE REQUIRED — IF EQUIPPED The telltale is illuminated only for a limited time.</p> <p>Note: After the first indication, each time the engine is started the symbol will continue to illuminate as described above until the oil is changed.</p> <p>If the telltale flashes, this does not mean that there is a fault on the vehicle, rather it simply reports that it is now necessary to change the oil as a result of regular use of the vehicle. The deterioration of engine oil is accelerated by using the vehicle for short drives, preventing the engine from reaching operating temperature.</p>	<p>Contact an authorized dealer as soon as possible.</p>







Caution!





Deteriorated engine oil should be replaced as soon as possible after the symbol is switched on, and never more than 310 miles (500 km) after it first switches on. Failure to observe the above may result in severe damage to the engine and invalidate the New Vehicle Limited Warranty. When this symbol comes on, it does not mean that the level of engine oil is low, so if it flashes you do not need to top up the engine oil.



Symbol	What It Means	What To Do
	ENGINE OIL PRESSURE SENSOR FAILURE The telltale will illuminate in the event of engine oil pressure sensor failure.	Contact an authorized dealer as soon as possible.
	ENGINE OIL LEVEL SENSOR FAILURE The telltale will illuminate in the event of engine oil level sensor failure.	Contact an authorized dealer as soon as possible.
	FORWARD COLLISION WARNING (FCW) SYSTEM FAILURE The telltale will illuminate in the case of failure of the Forward Collision Warning system.	Contact an authorized dealer as soon as possible.
	START & STOP SYSTEM FAILURE This telltale will illuminate to report a Stop & Start system failure.	Contact an authorized dealer as soon as possible to have the failure eliminated.
	RAIN SENSOR FAILURE The telltale will illuminate in the case of failure of the automatic windshield wiper.	Contact an authorized dealer as soon as possible.
	DUSK SENSOR FAILURE The telltale will illuminate in the case of failure of the automatic low beam alignment.	Contact an authorized dealer as soon as possible.
	BLIND SPOT MONITORING SYSTEM FAILURE The telltale will illuminate in the event of a Blind Spot Monitoring system failure.	Contact an authorized dealer as soon as possible.
	FUEL LEVEL SENSOR FAILURE The telltale will illuminate in the event of fuel level sensor failure.	Contact an authorized dealer as soon as possible.

Symbol	What It Means	What To Do
	<p>EXTERIOR LIGHTS FAILURE</p> <p>The telltale will illuminate to indicate a failure on the following lights: daytime running lights (DRLs) / parking lights / trailer turn signal indicators (if present) / trailer lights (if present) / side lights / turn signal indicators / rear fog light / reversing light / brake lights / license plate lights.</p>	<p>The failure may be caused by a blown bulb, a blown protection fuse, or an interruption of the electrical connection.</p> <p>Replace the bulb or the relevant fuse. Contact an authorized dealer.</p>
	<p>KEYLESS SYSTEM FAILURE</p> <p>The telltale will illuminate in the event of keyless system failure.</p>	<p>Contact an authorized dealer as soon as possible.</p>
	<p>FUEL CUT-OFF SYSTEM FAILURE</p> <p>The telltale will illuminate in the event of fuel cut-off system failure.</p>	<p>Contact an authorized dealer as soon as possible.</p>
	<p>LANE DEPARTURE WARNING (LDW) SYSTEM FAILURE</p> <p>The telltale will illuminate in the event of a fault in the Lane Departure Warning system.</p>	<p>Contact an authorized dealer as soon as possible.</p>
	<p>AUTOMATIC HIGH BEAM HEADLIGHTS FAILURE — IF EQUIPPED</p> <p>The telltale will illuminate to report a failure of the automatic high beam headlights.</p>	<p>Contact an authorized dealer as soon as possible to have the failure eliminated.</p>







Symbol	What It Means	What To Do
	AUTOMATIC TRANSMISSION FLUID OVERHEATING The telltale will illuminate in the case of transmission overheating, after a particularly demanding use. In this case an engine performance limitation is carried out.	Wait for the telltale to turn off with the engine off or idling.
	AUDIO SYSTEM FAILURE The telltale will illuminate to report a failure of the audio system.	Contact an authorized dealer as soon as possible to have the failure eliminated.
	SPEED LIMITER SYSTEM FAILURE While driving, the telltale will illuminate to signal a Speed Limiter system failure.	Contact an authorized dealer as soon as possible to have the failure eliminated.
	LOOSE FUEL FILLER CAP Lights up if the fuel tank cap is open or not properly closed.	Tighten the cap properly.
	ELECTRIC PARK BRAKE FAILURE The telltale will illuminate and a message will display to signal a failure in the electric park brake system. This failure may partially or completely block the vehicle because the park brake could remain activated even if automatically or manually disengaged using the relevant controls. In these circumstances, you can disengage the park brake following the emergency disengagement procedure described in "In Case Of Emergency."	If you are still able to drive the vehicle (park brake is not engaged), drive to the nearest authorized dealer and remember, when executing any maneuvers/commands, that the electric park brake is not operational.



Warning!

If a failure is present with sharp braking, the rear wheels may lock and the vehicle may swerve.







Symbol	What It Means	What To Do
	<p>LOW COOLANT LEVEL — IF EQUIPPED</p> <p>This telltale will illuminate to indicate that the vehicle coolant level is low.</p>	Top up, as described in "Servicing And Maintenance."
	<p>SERVICE ADAPTIVE CRUISE CONTROL SYSTEM</p> <p>This light will illuminate when the Adaptive Cruise Control (ACC) is not operating and needs service.</p>	Contact an authorized dealer to have the system checked.
	<p>WEAR ON BRAKE PADS</p> <p>This light will illuminate when the brake pads have reached their wear limit.</p>	<p>Contact an authorized dealer as soon as possible.</p> <p>Note: Always use genuine parts or similar because the Integrated Brake System (IBS) system could detect anomalies.</p>
	<p>WEAR ON CCB BRAKE DISCS — IF EQUIPPED</p> <p>This light will illuminate when the carbon ceramic brake discs have reached their wear limit.</p>	Contact an authorized dealer as soon as possible.

 **Warning!**





It is recommended to use only original or equivalent, bench-tested spare pads in order to ensure the original performance of the braking system.

Symbol	What It Means	What To Do
	<p>DYNAMIC DRIVE CONTROL SYSTEM FAILURE</p> <p>The telltale will illuminate to signal a failure in the dynamic drive control system.</p>	





Symbol	What It Means	What To Do
	WINDSHIELD WIPER FAILURE Signals a windshield wiper failure.	Contact an authorized dealer.
	GENERIC INDICATION Signals information and failures. The accompanying messages describe the failure.	
	FOUR WHEEL DRIVE FAILURE This telltale will illuminate to report a four wheel drive system failure.	Contact an authorized dealer as soon as possible to have the failure eliminated.
	AFS SYSTEM FAILURE The telltale will illuminate to indicate the automatic directional light system failure.	Go to an authorized dealer to have the system checked.
	SOFT SUSPENSION CALIBRATION INSERTION — IF EQUIPPED The telltale will illuminate when the most comfortable suspension setting is activated.	
	SHOCK ABSORBERS FAILURE (ADC) — IF EQUIPPED While driving, if the telltale illuminates, it signals a failure in the suspension system.	Contact an authorized dealer to have the system checked.
	WINDSHIELD WASHER LIQUID LEVEL The telltale will illuminate to indicate that the level of the windshield and headlight washing fluid (if any) is low.	To refill the liquid, refer to “Engine Compartment” in “Servicing And Maintenance.” Always use liquid with the features indicated in the “Fluids And Lubricants” section in “Technical Specifications.”

Green Symbols

Symbol	What It Means
	<p>HEADLIGHTS</p> <p>The telltale will illuminate when the headlights are turned on.</p>
	<p>AUTOMATIC HEADLIGHTS</p> <p>The symbol lights up when the automatic headlights are on.</p>
	<p>START & STOP OPERATION</p> <p>The telltale will illuminate in the case of Start & Stop system intervention (stopping the engine). When the engine is restarted, the telltale will shut off (for the engine restarting modes refer to “Stop/Start” in “Starting And Operating”).</p>
	<p>SPEED CONTROL ACTIVATED</p> <p>The telltale will illuminate when the Speed Control system is activated.</p>
	<p>ADAPTIVE CRUISE CONTROL SYSTEM</p> <p>The symbol comes on when the Adaptive Cruise Control system is activated.</p>

Blue Symbols

Symbol	What it means
	<p>AUTOMATIC HIGH BEAM HEADLIGHTS</p> <p>The telltale will illuminate when the automatic high beam headlights are activated.</p>
	<p>HIGH BEAM HEADLIGHTS</p> <p>The telltale will illuminate when the high beam headlights are activated.</p>



ONBOARD DIAGNOSTIC SYSTEM

Operation

The OBD (Onboard Diagnostic system) carries out a continuous diagnosis of the components of the vehicle related to emissions.

It also alerts the driver of when these components are no longer in peak condition by switching on the  warning light on the instrument panel (see “Warning Lights And Messages” paragraph in this chapter).

The aim of the OBD system (Onboard Diagnostic) is to:

- Monitor the efficiency of the system
- Indicate an increase in emissions
- Indicate the need to replace damaged components

The vehicle also has a connector, which can interface with appropriate tools, that makes it possible to read the error codes stored in the electronic control units together with a series of specific parameters for engine operation and diagnosis. This check can be carried out by your authorized dealer.

Note: After eliminating a fault, to check the system completely, your authorized dealer is obliged to run tests and, if necessary certain road tests.

Onboard Diagnostic System (OBD II) Cybersecurity

Your vehicle is required to have an Onboard Diagnostic system (OBD II) and a connection port to allow access to information related to the performance of your emissions controls. Authorized service technicians may need to access this information to assist with the diagnosis and service of your vehicle and emissions system.



Warning!

- ONLY an authorized service technician should connect equipment to the OBD II connection port in order to diagnose or service your vehicle.*
- If unauthorized equipment is connected to the OBD II connection port, such as a driver-behavior tracking device, it may:*
 - Be possible that vehicle systems, including safety related systems, could be impaired or a loss of vehicle control could occur that may result in an accident involving serious injury or death.*
 - Access, or allow others to access, information stored in your vehicle systems, including personal information.*

SAFETY

This very important section describes the safety systems that your vehicle may be equipped with, and provides instructions on how to use them correctly.

ACTIVE SAFETY SYSTEMS96
AUXILIARY DRIVING SYSTEMS99
OCCUPANT RESTRAINT SYSTEMS108
SAFETY TIPS133



ACTIVE SAFETY SYSTEMS

The vehicle may be equipped with the following active safety devices:

- Anti-Lock Braking (ABS) System
- Drive Train Control (DTC) System
- Electronic Stability Control (ESC) System
- Traction Control System (TCS)
- Panic Brake Assist (PBA) System
- Hill Start Assist (HSA) System
- Dynamic Steering Torque (DST) System

For the operation of the systems, see the following pages.

Anti-Lock Braking (ABS) System

An integral part of the braking system, the ABS prevents one or more wheels from locking and slipping in all road surface conditions, regardless of the intensity of the braking action. The system ensures that the vehicle can be controlled even during emergency braking, allowing the driver to optimize stopping distances.

The system intervenes during braking when the wheels are about to lock, typically in emergency braking or low-grip conditions where locking may be more frequent.

The system also improves control and stability of the vehicle when braking on a surface where the grip of the left and right wheels varies, such as in a corner.

The Electronic Braking Force Distribution (EBD) system works with the ABS, allowing the brake force to be distributed between the front and rear wheels.

System Intervention

The ABS equipped on this vehicle is provided with the "Brake-by-wire" (Integrated Brake System - IBS) function. With this system, the command given by pressing the brake pedal is not transmitted hydraulically, but electrically. Therefore, the light pulsation that is felt on the pedal with the traditional system is no longer noticeable.



Warning!

The ABS contains sophisticated electronic equipment that may be susceptible to interference caused by improperly installed or high output radio transmitting equipment. This interference can cause possible loss of anti-lock braking capability. Installation of such equipment should be performed by qualified professionals.

Pumping of the Anti-Lock Brakes will diminish their effectiveness and may lead to a collision. Pumping makes the stopping distance longer. Just press firmly on your brake pedal when you need to slow down or stop.

The ABS cannot prevent the natural laws of physics from acting on the vehicle, nor can it increase braking or steering efficiency beyond that afforded by the condition of the vehicle brakes and tires or the traction afforded.

The ABS cannot prevent collisions, including those resulting from excessive speed in turns, following another vehicle too closely, or hydroplaning.

The capabilities of an ABS equipped vehicle must never be exploited in a reckless or dangerous manner that could jeopardize the user's safety or the safety of others.

Drive Train Control (DTC) System – If Equipped

Some models of this vehicle are equipped with an All-Wheel Drive system (AWD), which offers an optimal drive for countless driving conditions and road surfaces. The system reduces the slipping of the tires to a minimum, automatically redistributing the torque to the front and rear wheels as needed.

To maximize fuel savings, the vehicle with AWD automatically passes to rear-wheel drive (RWD) when the road and environmental conditions are such that they wouldn't cause the tires to slip. When the road and environmental conditions require better traction, the vehicle automatically goes to AWD mode.

The driving mode, RWD or AWD, is shown on the instrument cluster display.

Note: If the system failure symbol switches on, after starting the engine or while driving, it means that the AWD system is not working properly. If the warning message activates frequently, it is recommended to carry out the maintenance operations.

Electronic Stability Control (ESC) System

The ESC system improves the directional control and stability of the vehicle in various driving conditions.

The ESC system corrects the vehicle's understeer and oversteer, distributing the brake force on the appropriate wheels. The torque supplied by the engine can also be reduced in order to maintain control of the vehicle.

The ESC system uses sensors installed on the vehicle to determine the path that the driver intends to follow and compares it with the vehicle's effective path. When the real path deviates from the desired path, the ESC system intervenes to counter the vehicle's understeer or oversteer.

□ **Oversteer** occurs when the vehicle is turning more than it should according to the angle of the steering wheel.

□ **Understeer** occurs when the vehicle is turning less than it should according to the angle of the steering wheel.

System Intervention

The intervention of the system is indicated by the flashing of the ESC warning light on the instrument panel, to inform the driver that the vehicle stability and grip are critical.



Warning!

□ *Electronic Stability Control (ESC) cannot prevent the natural laws of physics from acting on the vehicle, nor can it increase the traction afforded by prevailing road conditions. ESC cannot prevent accidents, including those resulting from excessive speed in turns, driving on very slippery surfaces, or hydroplaning. ESC also cannot prevent accidents resulting from loss of vehicle control due to inappropriate driver input for the conditions. Only a safe, attentive, and skillful driver can prevent accidents. The capabilities of an ESC equipped vehicle must never be exploited in a reckless or dangerous manner which could jeopardize the user's safety or the safety of others.*

□ *Vehicle modifications, or failure to properly maintain your vehicle, may change the handling characteristics of your vehicle, and may negatively affect the performance of the ESC system. Changes to the steering system, suspension, braking system, tire type and size or wheel size may adversely affect ESC performance. Improperly inflated and unevenly worn tires may also degrade ESC performance. Any vehicle modification or poor vehicle*

maintenance that reduces the effectiveness of the ESC system can increase the risk of loss of vehicle control, vehicle rollover, personal injury and death.

Traction Control System (TCS)

The system automatically operates in the event of slipping, loss of grip on wet roads (hydroplaning), and acceleration on one or both drive wheels on roads that are slippery, snowy, icy, etc. Depending on the slipping conditions, two different control systems are activated:

□ If the slipping involves both drive wheels, the system intervenes, reducing the power transmitted by the engine.

□ If the slipping only involves one of the drive wheels, the Brake Limited Differential (BLD) function is activated, automatically braking the wheel which is slipping (the behavior of a self-locking differential is simulated). This will increase the engine torque transferred to the wheel which isn't slipping.

System Intervention

The intervention of the system is indicated by the flashing of the ESC warning light on the instrument panel, to inform the driver that the vehicle stability and grip are critical.



Panic Brake Assist (PBA) System

The PBA system is designed to improve the vehicle's braking capacity during emergency braking.

The system detects emergency braking by monitoring the speed and force with which the brake pedal is pressed, and consequently applies the optimal brake pressure. This can reduce the braking distance: the PBA system therefore complements the ABS.

Maximum assistance from the PBA system is obtained by pressing the brake pedal very quickly. In addition, the brake pedal should be pressed continuously during braking, avoiding intermittent presses, to get the most out of the system. Do not reduce pressure on the brake pedal until braking is no longer necessary.

The PBA system is deactivated when the brake pedal is released.



Warning!

The Panic Brake Assist (PBA) cannot prevent the natural laws of physics from acting on the vehicle, nor can it increase the traction afforded by prevailing road conditions. PBA cannot prevent collisions, including those resulting from excessive speed in turns, driving on very slippery surfaces, or hydroplaning. The capabilities of a PBA-equipped vehicle must never be exploited in a reckless or dangerous manner, which could jeopardize the user's safety or the safety of others.

Hill Start Assist (HSA) System

This is an integral part of the ESC system and facilitates starting on slopes, activating automatically in the following cases:

- Uphill: vehicle stationary on a road with a gradient higher than 5%, engine running, brake pressed and transmission in NEUTRAL (N) or gear other than REVERSE (R) engaged.
- Downhill: vehicle stationary on a road with a gradient higher than 5%, engine running, brake pressed and reverse gear engaged.

When setting off, the ESC system control unit maintains the braking pressure on the wheels until the engine torque necessary for starting is reached, or in any case for a maximum of two seconds, allowing your right foot to be moved easily from the brake pedal to the accelerator.

The system will automatically deactivate after two seconds without starting, gradually releasing the braking pressure. During this release stage, it is possible to hear a typical mechanical brake release noise, indicating the imminent movement of the vehicle.



Warning!

There may be situations where the Hill Start Assist (HSA) will not activate and slight rolling may occur, such as on minor hills or with a loaded vehicle, or while pulling a trailer. HSA is not a substitute for active driving involvement. It is always the driver's responsibility to be attentive to distance to other vehicles, people, and objects, and most importantly brake operation to ensure safe operation of the vehicle under all road conditions. Your complete attention is always required while driving to maintain safe control of your vehicle. Failure to follow these warnings can result in a collision or serious personal injury.

Dynamic Steering Torque (DST) System

The DST function uses the integration of the ESC system with the electric power steering to increase the safety level of the whole vehicle.

In critical situations (braking on surfaces with different grip conditions), the ESC system controls the steering through the DST function to implement an additional torque contribution on the steering wheel in order to suggest the most correct maneuver to the driver.

The coordinated action of the brakes and steering increases the sensation of safety and control of the vehicle.

Note: The DST feature is only meant to help the driver realize the correct course of action through small torques on the steering wheel, which means the effectiveness of the DST feature is highly dependent on the driver's sensitivity and overall reaction to the applied torque. It is very important to realize that this feature will not steer the vehicle, meaning the driver is still responsible for steering the vehicle.

AUXILIARY DRIVING SYSTEMS

The following auxiliary driving systems are available in this vehicle:

- Blind Spot Monitoring (BSM)
- Forward Collision Warning (FCW)
- Tire Pressure Monitoring System (TPMS)

Blind Spot Monitoring (BSM) System

The Blind Spot Monitoring (BSM) system uses two radar sensors, located in the rear bumper (one for each side), to detect the presence of other vehicles in the rear side blind spots of your vehicle.



06016S0001EM

Rear Sensor Location

The system warns the driver about the presence of other vehicles in the detection area by illuminating the warning light located within the door

mirror on the side in which the other vehicle was detected.

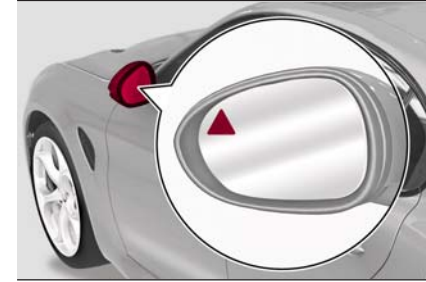

06016S0002EM

BSM Indicator Light

When the engine is started the warning light turns on to signal the driver that the system is active.

Sensors

The sensors are activated when any forward gear is engaged at a speed higher than approximately 6 mph (10 km/h) or when REVERSE is engaged.

The sensors are temporarily deactivated when the vehicle is stationary and in PARK (P).

The detection area of the system covers approximately a lane on both sides of the vehicle which is around 9 ft (3 m).

This area begins from the door mirror and extends for approximately 19 ft (6 m) towards the rear part of the vehicle.



When the sensors are active, the system monitors the detection areas on both sides of the vehicle and warns the driver about the possible presence of vehicles in these areas.

While driving, the system monitors the detection area from three different input points (side, rear and front) to check whether an alert needs to be sent to the driver. The system can detect the presence of a vehicle in one of these three areas.

Note:

- The system does not alert the driver for the presence of fixed object (e.g. safety barriers, poles, walls, etc.). However, in some circumstances, the system may activate in the presence of these objects. This is normal and does not indicate a system malfunction.
- The system does not alert the driver about the presence of vehicles coming from the opposite direction, in the adjacent lanes.



Warning!

The Blind Spot Monitoring system is only an aid to help detect objects in the blind spot zones. The BSM system is not designed to detect pedestrians, bicyclists, or animals. Even if your vehicle is equipped with the BSM system, always check your vehicle's mirrors, glance over your shoulder, and use your turn signal before changing lanes. Failure to do so can result in serious injury or death.

Note:

- For the system to operate correctly, the rear bumper area where the radar sensors are located must stay free from snow, ice and dirt gathered from the road surface.
- Do not cover the rear bumper area where the radar sensors are located with any object (e.g. adhesives, bike rack, etc.).
- If you wish to install the tow hook after purchasing the vehicle, you need to deactivate the system via the Information and Entertainment System. To access the function, select the following items in sequence on the main menu: "Settings", "Safety", and "Blind Spot Alert".

Rear View

The system detects vehicles coming from the rear part of your vehicle on both sides and entering the rear detection area with a difference in speed of less than 31 mph (50 km/h) with relation to your vehicle.

Overtaking Vehicles

If another vehicle is overtaken slowly, with a difference in speed of less than approximately 15 mph (25 km/h) and the vehicle stays in the blind spot for approximately 1.5 seconds, the warning light on the door mirror of the corresponding side illuminates.

If the difference in speed between the two vehicles is greater than approximately 15 mph (25 km/h), the warning light does not illuminate.

Rear Cross Path Detection (RCP) System

This system helps the driver during reverse maneuvers in the case of reduced visibility.

The RCP system monitors the rear detection areas on both sides of the vehicle to detect objects moving towards the sides of the vehicle, with a minimum speed between approximately 1 mph (1 km/h) and 2 mph (3 km/h) and objects moving at a maximum speed of 21 mph (35 km/h), in areas such as parking lots.

The system activation is signaled to the driver by an acoustic warning.

Note: If the sensors are covered by objects or vehicles, the system will not warn the driver.



Rear Cross Path Detection (RCP) is not a back up aid system. It is intended to be used to help a driver detect an oncoming vehicle in a parking lot situation. Drivers must be careful when backing up, even when using RCP. Always check carefully behind your vehicle, look behind you, and be sure to check for pedestrians, animals, other vehicles, obstructions, and blind spots before backing up. Failure to do so can result in serious injury or death.

Operating Mode

The system may be activated/deactivated via the Information and Entertainment System. To access the function, select the following items on the main menu in sequence: "Settings", "Safety" and "Blind Spot Alert".

"Blind Spot Alert", "Visual" Mode

When the system is enabled, the warning light within the door mirror on the side of the detected object illuminates.

The visual warning on the mirror will blink if the driver activates the turn

signals, thus indicating the intention to change lane.

The warning will be fixed if the driver stays in the same lane.

"Blind Spot Alert" Function Deactivation

When the system is deactivated ("Blind Spot Alert" mode off), the BSM or RCP systems will not emit neither an acoustic nor visual warnings.

The BSM system will store the operating mode running when the engine was stopped. Each time the engine is started, the operating mode stored previously will be recalled and used.

General Information

This vehicle has systems that operate on radio frequency that comply with Part 15 of the Federal Communications Commission (FCC) rules and with Industry Canada Standards RSS-GEN/210/220/310.

Operation is subject to the following two conditions:

1. The device may not cause harmful interference.
2. The device must accept any interference received, including interference that may cause undesired operation of the device.

Changes or modifications to any of these systems by other than an

authorized service facility could void authorization to use this equipment.

Forward Collision Warning (FCW) System

This is a driving assistance system which comprises a radar located behind the front bumper and a camera located in the central part of the windshield.



06016S0003EM

Front Bumper Radar Location

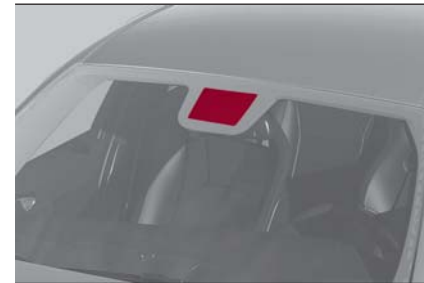

06016S0004EM

Windshield Camera Location



In the event of an imminent collision, the system intervenes by automatically braking the vehicle to prevent the crash or reduce its effects.

The system provides the driver with audible and visual signals through specific messages on the instrument cluster display.

The system may lightly brake to warn the driver if a possible frontal accident is detected (limited braking). Signals and limited braking are intended to allow the driver to react promptly, in order to prevent or reduce the effects of a potential accident.

In situations with the risk of collision, if the system detects no intervention by the driver, it provides automatic braking to help slow the vehicle and mitigate the potential frontal collision (automatic braking). If intervention by the driver on the brake pedal is detected, but not deemed sufficient, the system may intervene in order to improve the reaction of the braking system, therefore reducing vehicle speed further (additional assistance in braking stage).

The system will intervene automatically in case of imminent collision or impact against a pedestrian crossing the road (speed under 31 mph (50 km/h)).

Note: For safety reasons, when the vehicle has stopped, the brake calipers may remain blocked for about two seconds. Make sure you press the

brake pedal if the vehicle moves slightly forward.



Warning!

Forward Collision Warning (FCW) is not intended to avoid a collision on its own, nor can FCW detect every type of potential collision. The driver has the responsibility to avoid a collision by controlling the vehicle via braking and steering. Failure to follow this warning could lead to serious injury or death.

Engagement/Disengagement

The following functions can be selected in sequence using the Information and Entertainment System: "Settings", "Safety", "Forward Collision Warning" and "Mode". Select from among three operating modes:

Warning And Brake: the system (if active), in addition to the visual and audible warnings, provides limited braking, automatic braking and additional assistance in braking stage, where the driver does not brake sufficiently in the event of a potential frontal impact.

Only Warning: the system (if active), does not provide limited braking, but guarantees automatic braking or additional assistance in braking stage, where the driver does not brake at all or

not sufficiently in the event of a potential frontal impact.

Disable: the system does not provide visual and audible warnings, limited braking, automatic braking or additional assistance in braking stage. The system will therefore provide no indication of a possible accident.

Activation/Deactivation

The Forward Collision Warning system is activated whenever the engine is started regardless of what is shown on the Information and Entertainment System.

Following a deactivation, the system will not warn the driver about the possible collision with the preceding vehicle, regardless of the setting selected with the Information and Entertainment System.

Note: Each time the engine is started, the system is activated regardless of what setting was selected when the engine was turned OFF

This function is not active at a speed lower than 4 mph (7 km/h) or higher than 124 mph (200 km/h).

The system is active:

- Each time the engine is started.
- In the Information and Entertainment System.
- When the ignition is in the ON position.

❑ The vehicle speed is between 4 mph (7 km/h) and 124 mph (200 km/h).

❑ When the front seat belts are fastened.

Changing The System Sensitivity

The sensitivity of the system can be changed through the Information and Entertainment System menu, choosing from one of the following three options: "Near", "Med" or "Far". Refer to the description in the "Information and Entertainment System Supplement" for how to change the settings.

The default setting is "Med". With this setting, the system warns the driver of a possible collision with the vehicle in front when that vehicle is at a standard distance, between that of the other two settings.

With the system sensitivity set to "Far", the system will warn the driver of a possible collision with the vehicle in front when that vehicle is at a greater distance, thus providing the possibility of acting on the brakes more lightly and gradually. This setting provides the drivers with the maximum possible reaction time to prevent a potential accident.

With the option set to "Near", the system will alert the driver of a possible collision with the vehicle in front when that vehicle is close. This setting offers the driver a lower reaction time compared to the "Med" and "Far" settings, in the event of a potential

collision, but permits more dynamic driving of the vehicle.

The system sensitivity setting is kept in the memory when the engine is turned OFF.

System Limited Operation Signal

If a dedicated message is displayed, a condition limiting the system operation may have occurred. The possible reasons of this limitation are something blocking the camera view or a fault.

If an obstruction is signaled, clean the area of the windshield indicated in.

Although the vehicle can still be driven in normal conditions, the system may be not completely available.

When the conditions limiting the system functions end, this will go back to normal and complete operation. Should the fault persist, contact an authorized dealer.

System Failure Signaling

If the system turns off and a dedicated message is shown on the display, it means that there is a fault with the system.

In this case, it is still possible to drive the vehicle, but you are advised to contact an authorized dealer as soon as possible.

Radar Indication Not Available

If conditions are such that the radar cannot detect obstacles correctly, the system is deactivated and a dedicated message appears on the display. This

generally occurs in the event of poor visibility, such as when it is snowing or raining heavily.

The function of this system can also be temporarily reduced due to obstructions such as mud, dirt or ice on the bumper. In such cases, a dedicated message will be shown on the display and the system will be deactivated. This message can sometimes appear in conditions of high reflectivity (e.g. tunnels with reflective tiles or ice or snow). When the conditions limiting the system functions end, it will go back to normal and complete operation.

In certain cases, this dedicated message could be displayed when the radar is not detecting any vehicles or objects within its view range.

If atmospheric conditions are not the reason behind this message, check if the sensor is dirty. It could be necessary to clean or remove any obstructions in the area.

If the message appears frequently, even in the absence of atmospheric conditions such as snow, rain, mud or other obstructions, contact an authorized dealer for a sensor alignment check.

In the absence of visible obstructions, manually removing the decorative cover trim and cleaning the radar surface could be required. Have this operation performed at an authorized dealer.



Note: It is recommended that you do not install devices, accessories or aerodynamic attachments in front of the sensor or darken it in any way, as this can compromise the correct functioning of the system.

Frontal Collision Alarm With Active Braking — If Equipped

If this function is selected, the brakes are operated to reduce the speed of the vehicle in the event of potential frontal impact.

This function applies an additional braking pressure if the braking pressure applied by the driver does not suffice to prevent potential frontal impact.

The function is active with speed above 4 mph (7 km/h).

Driving In Special Conditions

In certain driving conditions, system intervention might be unexpected or delayed. The driver must therefore be very careful, keeping control of the vehicle to drive in complete safety.

- Driving close to a bend.
- The vehicle ahead is leaving a roundabout.
- Vehicles with small dimensions and/or not aligned in the driving lane.
- Lane change by other vehicles.
- Vehicles traveling at right angles to the vehicle.

System intervention might be unexpected or delayed. The driver must therefore be very careful, keeping control of the vehicle to drive in complete safety.

Note: In particularly complex traffic conditions, the driver can deactivate the system manually through the Information and Entertainment System.

Driving Close To A Bend

When entering or leaving a wide bend, the system may detect a vehicle in front you, but not driving on the same driving lane. In cases such as these, the system may intervene.

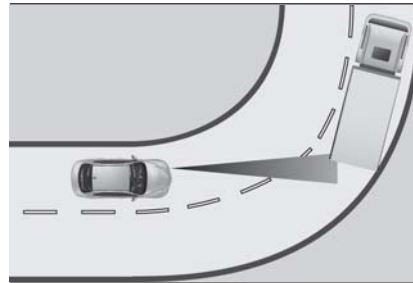

06016S0005EM

Driving Around Wide Curves

The Vehicle Ahead Is Leaving A Roundabout

On a roundabout, the system could intervene if it detects a vehicle ahead which is leaving the roundabout.

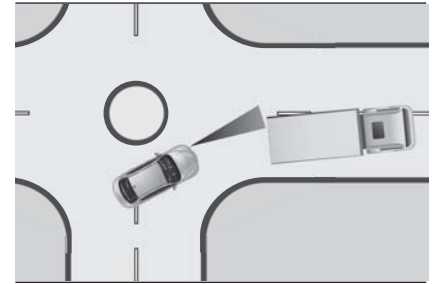

06016S0010EM

Driving In Roundabouts

Vehicles With Small Dimensions And/Or Not Aligned In The Driving Lane

The system cannot detect vehicles in front of you but outside the range of the radar sensor and may therefore not react in the presence of small vehicles, such as bicycles or motorcycles.

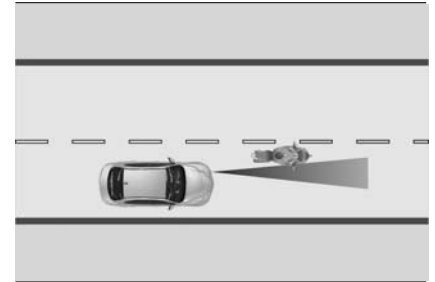

06016S0006EM

Driving Near Small Vehicles

Lane Change By Other Vehicles

Vehicles suddenly changing lanes to enter the same lane as your vehicle within the operating range of the radar sensor, may cause the system to intervene.

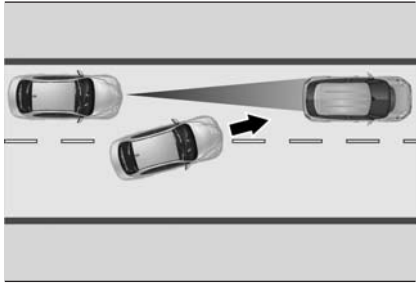

06016S0007EM

Other Vehicles Changing Lanes

Vehicles Traveling At Right Angles To The Vehicle

The system may temporarily react to a vehicle that is passing through the radar sensor's operating range at right angles.

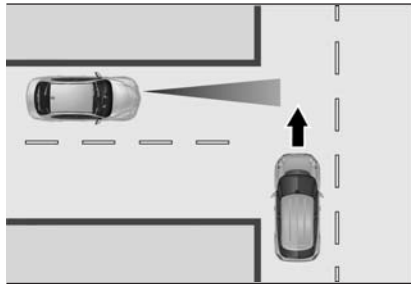

06016S0008EM

Other Vehicle Passing Through Radar Range



Warning!

The system has not been designed to prevent impacts and cannot detect possible conditions leading to an accident in advance. Failure to take into account this warning may lead to serious or fatal injuries.

The system may activate, assessing the trajectory of the vehicle, for the presence of reflecting metal objects different from other vehicles, such as safety barriers, road signs, barriers before parking lots, tollgates, level crossings, gates, railways, objects near road constructions sites or higher than the vehicle (e.g. a fly-over). In the same way, the system may intervene inside multi-story parking lots or tunnels, or due to a glare on the road surface. These possible activations are a consequence of

the real driving scenario coverage by the system and must not be regarded as faults.

The system has been designed for road use only. If the vehicle is driven on a track, the system must be deactivated to avoid unnecessary warnings. Automatic deactivation is signaled by the dedicated warning light/symbol switching on in the instrument panel (refer to the instructions in the "Warning Lights And Messages On The Instrument Panel" in "Getting To Know Your Instrument Panel" for further information).

Tire Pressure Monitoring System (TPMS)

This vehicle is equipped with a Tire Pressure Monitoring System (TPMS) that sends the inflation pressure information of each tire to the control unit, and will signal the driver in the event of insufficient tire pressure.

Tire pressure will vary with temperature by approximately 1 psi (7 kPa) for every 12°F (6.5°C). This means that when the outside temperature decreases, the tire pressure will also decrease. Tire pressure should always be set based on cold inflation tire pressure. This is defined as the tire pressure after the vehicle has not been driven for at least three hours, or driven less than 1 mile (1.6 km) after a three hour period. The cold tire inflation pressure must not exceed the maximum inflation pressure molded into the tire sidewall. Refer to



“Tires” in “Servicing And Maintenance” for information on how to properly inflate the vehicle’s tires. The tire pressure will also increase as the vehicle is driven. This is normal, and there should be no adjustment for this increased pressure.

The TPMS will signal the driver if pressure falls below the warning limit for any reason, including the effects of low temperature and normal loss of pressure from the tire.

The TPMS will stop indicating insufficient tire pressure when pressure is equal to or greater than the prescribed cold inflation level. Therefore, if insufficient tire pressure is indicated by the () warning light displaying in the instrument cluster, increase the inflation pressure up to the prescribed cold inflation value.

The system will automatically update, and the “Tire Pressure Monitoring Telltale Light” will turn off once the system receives the updated tire pressures. The vehicle may need to be driven for up to 20 minutes above 15 mph (24 km/h) in order for the TPMS to receive this information.

Operating Example

For example, your vehicle may have a recommended cold (parked for more than three hours) placard pressure of 33 psi (227 kPa). If the ambient temperature is 68°F (20°C), and the measured tire pressure is 28 psi (193 kPa), a temperature drop to 20°F (-7°C) will decrease the tire pressure to approximately 24 psi (165 kPa). This tire pressure is low enough to turn on the “Tire Pressure Monitoring Warning Light.” Driving the vehicle may cause the tire pressure to rise to approximately 28 psi (193 kPa), but the “Tire Pressure Monitoring Telltale Light” will still be on. In this situation, the “Tire Pressure Monitoring Warning Light” will turn off only after the tires are inflated to the vehicle’s recommended cold placard pressure value.



Caution!

❑ The TPMS has been optimized for the original equipment tires and wheels. TPMS pressures and warning have been established for the tire size equipped on your vehicle. Undesirable system operation or sensor damage may result when using replacement equipment that is not of the same size, type, and/or style. The TPM sensor is not designed for use on aftermarket wheels and may contribute to a poor overall system performance or sensor damage. Customers are encouraged to use OEM wheels to assure proper TPM feature operation.

❑ Using aftermarket tire sealants may cause the Tire Pressure Monitoring System (TPMS) sensor to become inoperable. After using an aftermarket tire sealant it is recommended that you take your vehicle to an authorized dealer to have your sensor function checked.

❑ After inspecting or adjusting the tire pressure always reinstall the valve stem cap. This will prevent moisture and dirt from entering the valve stem, which could damage the TPMS sensor.

INSUFFICIENT TIRE PRESSURE INDICATION

If an insufficient pressure value is detected on one or more tires, the (⚠) warning light in the instrument cluster will display alongside the dedicated messages, the system will highlight the tire or tires with insufficient pressure graphically, and an acoustic signal will be emitted.

In this case, stop the vehicle, check the inflation pressure of each tire, and inflate the necessary tire or tires to the correct cold inflation pressure value, shown on the display or in the dedicated TPMS menu.

TPMS TEMPORARILY DISABLED

TPMS Check Message

When a system fault is detected, the "Tire Pressure Monitoring Telltale Light" will flash on and off for 75 seconds, and then remain on solid. The system fault will also sound a chime. If the ignition is cycled, this sequence will repeat, provided that the system fault still exists. The "Tire Pressure Monitoring Telltale Light" will turn off when the fault condition no longer exists. A system fault can occur due to any of the following:

- ❑ Jamming due to electronic devices or driving next to facilities emitting the same radio frequencies as the TPMS sensors.

- ❑ Installing some form of aftermarket window tinting that affects radio wave signals.

- ❑ Accumulation of snow or ice around the wheels or wheel housings.

- ❑ Using tire chains on the vehicle.

- ❑ Using wheels/tires not equipped with TPMS sensors.

After the punctured tire has been repaired with the original tire sealant contained in the Tire Repair Kit, the previous condition must be restored so that the (⚠) warning light is off during normal driving.

TPMS Deactivation

The TPMS can be deactivated by replacing all four wheel and tire assemblies (road tires) with wheel and tire assemblies that do not have TPMS Sensors, such as when installing winter wheel and tire assemblies on your vehicle.

To deactivate the TPMS, first replace all four wheel and tire assemblies (road tires) with tires not equipped with Tire Pressure Monitoring (TPM) Sensors. Then, drive the vehicle for 20 minutes above 15 mph (24 km/h). The TPMS will chime, the "TPM Telltale Light" will flash on and off for 75 seconds and then remain on. The instrument cluster will display the "SERVICE TPM SYSTEM" message and then display dashes (-) in place of the pressure values.

Beginning with the next ignition switch cycle, the TPMS will no longer chime or display the "SERVICE TPM SYSTEM" message in the instrument cluster. Instead, dashes (-) will remain in place of the pressure values.

To reactivate the TPMS, replace all four wheel and tire assemblies (road tires) with tires equipped with TPM sensors. Then, drive the vehicle for up to 20 minutes above 15 mph (24 km/h). The TPMS will chime, the "TPM Telltale Light" will flash on and off for 75 seconds and then turn off. The instrument cluster will display the "SERVICE TPM SYSTEM" message and then display pressure values in place of the dashes. On the next ignition switch cycle the "SERVICE TPM SYSTEM" message will no longer be displayed, as long as no system fault exists.



Note:

- The TPMS is not intended to replace normal tire care and maintenance, or to provide warning of a tire failure or condition.
- The TPMS should not be used as a tire pressure gauge while adjusting your tire pressure.
- Driving on a significantly underinflated tire will cause the tire to overheat, and can lead to tire failure. Underinflation also reduces fuel efficiency and tire tread life, and may affect the vehicle's handling and stopping ability.
- The TPMS is not a substitute for proper tire maintenance, and it is the driver's responsibility to maintain correct tire pressure using an accurate tire pressure gauge, even if underinflation has not reached the level to trigger illumination of the "Tire Pressure Monitoring Telltale Light".
- Seasonal temperature changes will affect tire pressure, and the TPMS will monitor the actual tire pressure in the tire.

General Information

The following regulatory statement applies to all radio frequency (RF) devices equipped in this vehicle:

This device complies with Part 15 of the FCC rules and RSS-210 of Industry Canada. Operation is subject to the following two conditions:

- (1) This device may not cause harmful interference.
- (2) This device must accept any interference received, including interference that may cause undesired operation.

Note: Changes or modifications not expressly approved by the party responsible for compliance could void the user's authority to operate the equipment.

OCCUPANT RESTRAINT SYSTEMS

Some of the most important safety features in your vehicle are the restraint systems:

Occupant Restraint Systems Features

- Seat Belt Systems
- Supplemental Restraint Systems (SRS) Air Bags
- Child Restraints

Some of the safety features described in this section may be standard equipment on some models, or may be optional equipment on others. If you are not sure, ask your authorized dealer.

Important Safety Precautions

Please pay close attention to the information in this section. It tells you how to use your restraint system properly, to keep you and your passengers as safe as possible.

Here are some simple steps you can take to minimize the risk of harm from a deploying air bag:

1. Children 12 years old and under should always ride buckled up in a vehicle with a rear seat.

2. If a child from 2 to 12 years old (not in a rear-facing child restraint) must ride in the front passenger seat, move the seat as far back as possible and use the proper child restraint (refer to “Child Restraints” in this section for further information).

3. Children that are not big enough to wear the vehicle seat belt properly (refer to “Child Restraints” in this section for further information) should be secured in a vehicle with a rear seat in child restraints or belt-positioning booster seats. Older children who do not use child restraints or belt-positioning booster seats should ride properly buckled up in a vehicle with a rear seat.

4. Never allow children to slide the shoulder belt behind them or under their arm.

5. You should read the instructions provided with your child restraint to make sure that you are using it properly.

6. All occupants should always wear their lap and shoulder belts properly.

7. The driver and front passenger seats should be moved back as far as practical to allow the front air bags room to inflate.

8. Do not lean against the door or window. If your vehicle has side air bags, and deployment occurs, the side air bags will inflate forcefully into the space between occupants and the door and occupants could be injured.

9. If the air bag system in this vehicle needs to be modified to accommodate a disabled person, refer to the “Customer Assistance” section for customer service contact information.



Warning!

Never place a rear-facing child restraint in front of an air bag. A deploying passenger front air bag can cause death or serious injury to a child 12 years or younger, including a child in a rear-facing child restraint.

Only use a rear-facing child restraint in a vehicle with a rear seat.

Seat Belt Systems

Buckle up even though you are an excellent driver, even on short trips. Someone on the road may be a poor driver and could cause a collision that includes you. This can happen far away from home or on your own street.

Research has shown that seat belts save lives, and they can reduce the seriousness of injuries in a collision. Some of the worst injuries happen

when people are thrown from the vehicle. Seat belts reduce the possibility of ejection and the risk of injury caused by striking the inside of the vehicle. Everyone in a motor vehicle should be belted at all times.

Enhanced Seat Belt Use Reminder System (BeltAlert)

Driver And Passenger BeltAlert — If Equipped

 BeltAlert is a feature intended to remind the driver and outboard front seat passenger (if equipped with outboard front passenger seat BeltAlert) to buckle their seat belts. The Belt Alert feature is active whenever the ignition switch is in the START or ON/RUN position.

Initial Indication

If the driver is unbuckled when the ignition switch is first in the START or ON/RUN position, a chime will signal for a few seconds. If the driver or outboard front seat passenger (if equipped with outboard front passenger seat BeltAlert) is unbuckled when the ignition switch is first in the START or ON/RUN position the Seat Belt Reminder Light will turn on and remain on until both outboard front seat belts are buckled. The outboard front passenger seat BeltAlert is not active when an outboard front passenger seat is unoccupied.



BeltAlert Warning Sequence

The BeltAlert warning sequence is activated when the vehicle is moving above a specified vehicle speed range and the driver or outboard front seat passenger is unbuckled (if equipped with outboard front passenger seat BeltAlert) (the outboard front passenger seat BeltAlert is not active when the outboard front passenger seat is unoccupied). The BeltAlert warning sequence starts by blinking the Seat Belt Reminder Light and sounding an intermittent chime. Once the BeltAlert warning sequence has completed, the Seat Belt Reminder Light will remain on until the seat belts are buckled. The BeltAlert warning sequence may repeat based on vehicle speed until the driver and occupied outboard front seat passenger seat belts are buckled. The driver should instruct all occupants to buckle their seat belts.

Change Of Status

If the driver or outboard front seat passenger (if equipped with outboard front passenger seat BeltAlert) unbuckles their seat belt while the vehicle is traveling, the BeltAlert warning sequence will begin until the seat belts are buckled again. The outboard front passenger seat BeltAlert is not active when the outboard front passenger seat is unoccupied. BeltAlert may be triggered when an animal or other items are

placed on the outboard front passenger seat or when the seat is folded flat (if equipped). It is recommended that pets be restrained in the rear seat (if equipped) in pet harnesses or pet carriers that are secured by seat belts, and cargo is properly stowed.

BeltAlert can be activated or deactivated by your authorized dealer. FCA US LLC does not recommend deactivating BeltAlert.

Note: If BeltAlert has been deactivated and the driver or outboard front seat passenger (if equipped with outboard front passenger seat BeltAlert) is unbuckled the Seat Belt Reminder Light will turn on and remain on until the driver and outboard front seat passenger seat belts are buckled.

Lap/Shoulder Belts

All seating positions in your vehicle are equipped with lap/shoulder belts. The seat belt webbing retractor will lock only during very sudden stops or collisions. This feature allows the shoulder part of the seat belt to move freely with you under normal conditions. However, in a collision the seat belt will lock and reduce your risk of striking the inside of the vehicle or being thrown out of the vehicle.



Warning!

- Relying on the air bags alone could lead to more severe injuries in a collision. The air bags work with your seat belt to restrain you properly. In some collisions, the air bags won't deploy at all. Always wear your seat belt even though you have air bags.*
- In a collision, you and your passengers can suffer much greater injuries if you are not properly buckled up. You can strike the interior of your vehicle or other passengers, or you can be thrown out of the vehicle. Always be sure you and others in your vehicle are buckled up properly.*
- It is dangerous to ride in a cargo area, inside or outside of a vehicle. In a collision, people riding in these areas are more likely to be seriously injured or killed.*
- Do not allow people to ride in any area of your vehicle that is not equipped with seats and seat belts.*
- Be sure everyone in your vehicle is in a seat and using a seat belt properly. Occupants, including the driver, should always wear their seat belts whether or not an air bag is also provided at their seating position to minimize the risk of severe injury or death in the event of a crash.*
- Wearing your seat belt incorrectly could make your injuries in a collision much worse. You might suffer internal injuries, or you could even slide out of the seat belt. Follow these instructions to wear your seat belt safely and to keep your passengers safe, too.*

❑ *Two people should never be belted into a single seat belt. People belted together can crash into one another in a collision, hurting one another badly. Never use a lap/shoulder belt or a lap belt for more than one person, no matter what their size.*



Warning!

❑ *A lap belt worn too high can increase the risk of injury in a collision. The seat belt forces won't be at the strong hip and pelvic bones, but across your abdomen. Always wear the lap part of your seat belt as low as possible and keep it snug.*

❑ *A twisted seat belt may not protect you properly. In a collision, it could even cut into you. Be sure the seat belt is flat against your body, without twists. If you can't straighten a seat belt in your vehicle, take it to your authorized dealer immediately and have it fixed.*

❑ *A seat belt that is buckled into the wrong buckle will not protect you properly. The lap portion could ride too high on your body, possibly causing internal injuries. Always buckle your seat belt into the buckle nearest you.*

❑ *A seat belt that is too loose will not protect you properly. In a sudden stop, you could move too far forward, increasing the possibility of injury. Wear your seat belt snugly.*

❑ *A seat belt that is worn under your arm is dangerous. Your body could strike the inside surfaces of the vehicle in a collision, increasing head and neck injury. A seat belt worn under the arm can cause internal injuries. Ribs aren't as strong as shoulder bones. Wear the seat belt over your shoulder so that your strongest bones will take the force in a collision.*

❑ *A shoulder belt placed behind you will not protect you from injury during a collision. You are more likely to hit your head in a collision if you do not wear your shoulder belt. The lap and shoulder belt are meant to be used together.*

❑ *A frayed or torn seat belt could rip apart in a collision and leave you with no protection. Inspect the seat belt system periodically, checking for cuts, frays, or loose parts. Damaged parts must be replaced immediately. Do not disassemble or modify the seat belt system. Seat belt assemblies must be replaced after a collision.*

Lap/Shoulder Belt Operating Instructions

1. Enter the vehicle and close the door. Sit back and adjust the seat.
2. The seat belt latch plate is above the back of the front seat, and next to your arm in the rear seat (for vehicles equipped with a rear seat). Grasp the latch plate and pull out the seat belt.

Slide the latch plate up the webbing as far as necessary to allow the seat belt to go around your lap.

3. When the seat belt is long enough to fit, insert the latch plate into the buckle until you hear a "click."



06046S0001NA

Seat Belt Latch Plate Inserted Into Seat Belt Buckle

4. Position the lap belt so that it is snug and lies low across your hips, below your abdomen. To remove slack in the lap belt portion, pull up on the shoulder belt. To loosen the lap belt if it is too tight, tilt the latch plate and pull on the lap belt. A snug seat belt reduces the risk of sliding under the seat belt in a collision.
5. Position the shoulder belt across the shoulder and chest with minimal, if any slack so that it is comfortable and not resting on your neck. The retractor will withdraw any slack in the shoulder belt.



6. To release the seat belt, push the red button on the buckle. The seat belt will automatically retract to its stowed position. If necessary, slide the latch plate down the webbing to allow the seat belt to retract fully.

Lap/Shoulder Belt Untwisting Procedure

Use the following procedure to untwist a twisted lap/shoulder belt.

1. Position the latch plate as close as possible to the anchor point.
2. At about 6 to 12 inches (15 to 30 cm) above the latch plate, grasp and twist the seat belt webbing 180 degrees to create a fold that begins immediately above the latch plate.
3. Slide the latch plate upward over the folded webbing. The folded webbing must enter the slot at the top of the latch plate.
4. Continue to slide the latch plate up until it clears the folded webbing and the seat belt is no longer twisted.

Second Row Center Seat Belt Operating Instructions

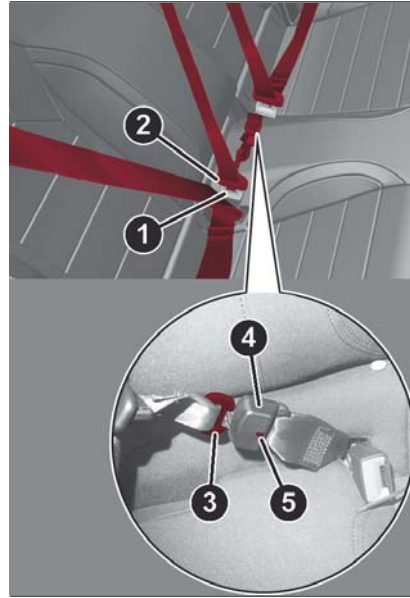

06056S0002EM

Second Row Seat Belts

- | | | |
|---------------------------|---------------------------|-------------------------|
| 1 — Seat Belt Buckle | 3 — Mini Latch Plate | 5 — Mini Buckle Release |
| 2 — Seat Belt Latch Plate | 4 — Mini Seat Belt Buckle | |

The second row center seat belt features a seat belt with a mini-latch plate and buckle, which allows the seat belt to detach from the lower anchor when the seat is folded. The mini-latch plate and regular latch plate can then be stored out of the way in the parcel tray for added convenience to open up utilization of the storage areas behind the front seats when the seat is not occupied.

1. Remove the mini-latch plate and regular latch plate from its stowed position in the right rear side trim panel.
2. Grasp the mini-latch plate and pull the seat belt over the seat.
3. Route the shoulder belt to the inside of the right head restraint.
4. When the seat belt is long enough to fit, insert the mini-latch plate into the mini-buckle until you hear a “click.”
5. Sit back in seat. Slide the regular latch plate up the webbing as far as necessary to allow the seat belt to go around your lap.
6. When the seat belt is long enough to fit, insert the latch plate into the buckle until you hear a “click.”

7. Position the lap belt so that it is snug and lies low across your hips, below your abdomen. To remove slack in the lap belt portion, pull up on the shoulder belt. To loosen the lap belt if it is too tight, pull on the lap belt. A snug seat belt reduces the risk of sliding under the seat belt in a collision.

8. Position the shoulder belt on your chest so that it is comfortable and not resting on your neck. The retractor will withdraw any slack in the seat belt.

9. To release the seat belt, push the red button on the buckle.

10. To disengage the mini-latch plate from the mini-buckle for storage, insert the regular latch plate into the black button on the top of the mini-buckle. The seat belt will automatically retract to its stowed position. If necessary, slide the latch plate down the webbing to allow the seat belt to retract fully. Insert the mini-latch plate and regular latch plate into its stowed position.



Warning!

If the mini-latch plate and mini-buckle are not properly connected when the seat belt is used by an occupant, the seat belt will not be able to provide proper restraint and will increase the risk of injury in a collision.

When reattaching the mini-latch plate and mini-buckle, ensure the seat belt webbing is not twisted. If the webbing is twisted, follow the preceding procedure to detach the mini-latch plate and mini-buckle, untwist the webbing, and reattach the mini-latch plate and mini-buckle.

Seat Belts And Pregnant Women

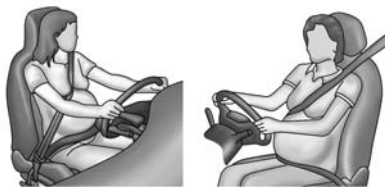

0226075266

0226075266

Pregnant Women And Seat Belts

Seat belts must be worn by all occupants including pregnant women: the risk of injury in the event of an

accident is reduced for the mother and the unborn child if they are wearing a seat belt.

Position the lap belt snug and low below the abdomen and across the strong bones of the hips. Place the shoulder belt across the chest and away from the neck. Never place the shoulder belt behind the back or under the arm.

Seat Belt Pretensioner

The front seat belt system is equipped with pretensioning devices that are designed to remove slack from the seat belt in the event of a collision. These devices may improve the performance of the seat belt by removing slack from the seat belt early in a collision. Pretensioners work for all size occupants, including those in child restraints.

Note: These devices are not a substitute for proper seat belt placement by the occupant. The seat belt still must be worn snugly and positioned properly.

The pretensioners are triggered by the Occupant Restraint Controller (ORC). Like the air bags, the pretensioners are single use items. A deployed pretensioner or a deployed air bag must be replaced immediately.



Energy Management Feature

This vehicle has a seat belt system with an Energy Management feature in the front seating positions that may help further reduce the risk of injury in the event of a collision. The seat belt system has a retractor assembly that is designed to release webbing in a controlled manner.

Switchable Automatic Locking Retractors (ALR)

The seat belts in the passenger seating positions are equipped with a Switchable Automatic Locking Retractor (ALR) which is used to secure a child restraint system. For additional information, refer to “Installing Child Restraints Using The Vehicle Seat Belt” under the “Child Restraints” section of this manual. The figure below illustrates the locking feature for each seating position.

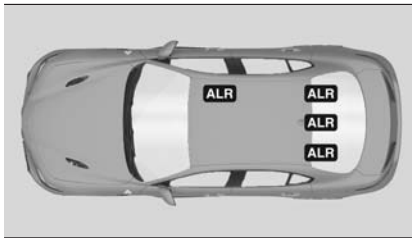

06086S0102NA

ALR – Switchable Automatic Locking Retractor

If the passenger seating position is equipped with an ALR and is being used for normal usage, only pull the seat belt webbing out far enough to comfortably wrap around the occupant’s mid-section so as to not activate the ALR. If the ALR is activated, you will hear a clicking sound as the seat belt retracts. Allow the webbing to retract completely in this case and then carefully pull out only the amount of webbing necessary to comfortably wrap around the occupant’s mid-section. Slide the latch plate into the buckle until you hear a “click.”

In Automatic Locking Mode, the shoulder belt is automatically pre-locked. The seat belt will still retract to remove any slack in the shoulder belt. Use the Automatic Locking Mode anytime a child restraint is installed in a seating position that has a seat belt with this feature. Children 12 years old and under should always be properly restrained in a vehicle with a rear seat.



Warning!

Never place a rear-facing child restraint in front of an air bag. A deploying passenger front air bag can cause death or serious injury to a child 12 years or younger, including a child in a rear-facing child restraint.

Only use a rear-facing child restraint in a vehicle with a rear seat.

How To Engage The Automatic Locking Mode

1. Buckle the combination lap and shoulder belt.
2. Grasp the shoulder portion and pull downward until the entire seat belt is extracted.
3. Allow the seat belt to retract. As the seat belt retracts, you will hear a clicking sound. This indicates the seat belt is now in the Automatic Locking Mode.

How To Disengage The Automatic Locking Mode

Unbuckle the combination lap/shoulder belt and allow it to retract completely to disengage the Automatic Locking Mode and activate the vehicle sensitive (emergency) locking mode.



Warning!

- The seat belt assembly must be replaced if the switchable Automatic Locking Retractor (ALR) feature or any other seat belt function is not working properly when checked according to the procedures in the Service Manual.
- Failure to replace the seat belt assembly could increase the risk of injury in collisions.
- Do not use the Automatic Locking Mode to restrain occupants who are wearing the seat belt or children who are using booster seats. The locked mode is only used to install rear-facing or forward-facing child restraints that have a harness for restraining the child.

Supplemental Restraint Systems (SRS)

Some of the safety features described in this section may be standard equipment on some models, or may be optional equipment on others. If you are not sure, ask your authorized dealer.

The air bag system must be ready to protect you in a collision. The Occupant Restraint Controller (ORC) monitors the internal circuits and interconnecting wiring associated with the electrical Air Bag System Components. Your vehicle may be equipped with the following Air Bag System Components:

Air Bag System Components

- Occupant Restraint Controller (ORC)
- Air Bag Warning Light
- Steering Wheel and Column
- Instrument Panel
- Knee Impact Bolsters
- Driver and Front Passenger Air Bags
- Supplemental Side Air Bags
- Supplemental Knee Air Bags
- Front and Side Impact Sensors
- Seat Belt Pretensioners
- Seat Track Position Sensors
- Seat Belt Buckle Switch

Air Bag Warning Light



The ORC monitors the readiness of the electronic parts of the air bag system whenever the ignition switch is in the START or ON/RUN position. If the ignition switch is in the OFF position or in the ACC position, the air bag system is not on and the air bags will not inflate.

The ORC contains a backup power supply system that may deploy the air bag system even if the battery loses power or it becomes disconnected prior to deployment.

The ORC turns on the Air Bag Warning Light in the instrument panel for approximately four to eight seconds for a self-check when the ignition switch is first in the ON/RUN position. After the self-check, the Air Bag Warning Light will turn off. If the ORC detects a malfunction in any part of the system, it turns on the Air Bag Warning Light, either momentarily or continuously. A single chime will sound to alert you if the light comes on again after initial startup.

The ORC also includes diagnostics that will illuminate the instrument panel Air Bag Warning Light if a malfunction is detected that could affect the air bag system. The diagnostics also record the nature of the malfunction. While the air bag system is designed to be maintenance free, if any of the following occurs, have an authorized dealer service the air bag system immediately.

- The Air Bag Warning Light does not come on during the four to eight seconds when the ignition switch is first in the ON/RUN position.
- The Air Bag Warning Light remains on after the four to eight-second interval.
- The Air Bag Warning Light comes on intermittently or remains on while driving.

Note: If the speedometer, tachometer, or any engine related gauges are not



working, the Occupant Restraint Controller (ORC) may also be disabled. In this condition the air bags may not be ready to inflate for your protection. Have an authorized dealer service the air bag system immediately.



Warning!

Ignoring the Air Bag Warning Light in your instrument panel could mean you won't have the air bag system to protect you in a collision. If the light does not come on as a bulb check when the ignition is first turned on, stays on after you start the vehicle, or if it comes on as you drive, have an authorized dealer service the air bag system immediately.

Redundant Air Bag Warning Light



If a fault with the Air Bag Warning Light is detected, which could affect the Supplemental Restraint System (SRS), the Redundant Air Bag Warning Light will illuminate on the instrument panel. The Redundant Air Bag Warning Light will stay on until the fault is cleared. In addition, a single chime will sound to alert you that the Redundant Air Bag Warning Light has come on and a fault has been detected. If the Redundant Air Bag Warning Light comes on intermittently or remains on while driving

have an authorized dealer service the vehicle immediately. For additional information regarding the Redundant Air Bag Warning Light, refer to “Warning Lights And Messages” in the “Getting To Know Your Instrument Panel” section of this manual.

Front Air Bags

This vehicle has front air bags and lap/shoulder belts for both the driver and front passenger. The front air bags are a supplement to the seat belt restraint systems. The driver front air bag is mounted in the center of the steering wheel. The passenger front air bag is mounted in the instrument panel, above the glove compartment. The words “SRS AIRBAG” or “AIRBAG” are embossed on the air bag covers.



Driver Air Bag

06106S0001EM



Passenger Air Bag

06106S0002EM



Warning!

- Being too close to the steering wheel or instrument panel during front air bag deployment could cause serious injury, including death. Air bags need room to inflate. Sit back, comfortably extending your arms to reach the steering wheel or instrument panel.*
- Never place a rear-facing child restraint in front of an air bag. A deploying passenger front air bag can cause death or serious injury to a child 12 years or younger, including a child in a rear-facing child restraint.*
- Only use a rear-facing child restraint in a vehicle with a rear seat.*

Driver And Passenger Front Air Bag Features

The Advanced Front Air Bag system has multistage driver and front passenger air bags. This system provides output appropriate to the severity and type of collision as determined by the Occupant Restraint Controller (ORC), which may receive information from the front impact sensors (if equipped) or other system components.

The first stage inflator is triggered immediately during an impact that requires air bag deployment. A low energy output is used in less severe collisions. A higher energy output is used for more severe collisions.

This vehicle may be equipped with a driver and/or front passenger seat belt buckle switch that detects whether the driver or front passenger seat belt is buckled. The seat belt buckle switch may adjust the inflation rate of the Advanced Front Air Bags.

This vehicle may be equipped with driver and/or front passenger seat track position sensors that may adjust the inflation rate of the Advanced Front Air Bags based upon seat position.



Warning!

- No objects should be placed over or near the air bag on the instrument panel or steering wheel because any such objects could cause harm if the vehicle is in a collision severe enough to cause the air bag to inflate.
- Do not put anything on or around the air bag covers or attempt to open them manually. You may damage the air bags and you could be injured because the air bags may no longer be functional. The protective covers for the air bag cushions are designed to open only when the air bags are inflating.
- Relying on the air bags alone could lead to more severe injuries in a collision. The air bags work with your seat belt to restrain you properly. In some collisions, air bags won't deploy at all. Always wear your seat belts even though you have air bags.

Front Air Bag Operation

Front Air Bags are designed to provide additional protection by supplementing the seat belts. Front air bags are not expected to reduce the risk of injury in rear, side, or rollover collisions. The front air bags will not deploy in all frontal collisions, including some that may produce substantial vehicle damage — for example, some pole collisions, truck underrides, and angle offset collisions.

On the other hand, depending on the type and location of impact, front air bags may deploy in crashes with little vehicle front-end damage but that produce a severe initial deceleration.

Because air bag sensors measure vehicle deceleration over time, vehicle speed and damage by themselves are not good indicators of whether or not an air bag should have deployed.

Seat belts are necessary for your protection in all collisions, and also are needed to help keep you in position, away from an inflating air bag.

When the ORC detects a collision requiring the front air bags, it signals the inflator units. A large quantity of non-toxic gas is generated to inflate the front air bags.

The steering wheel hub trim cover and the upper right side of the instrument panel separate and fold out of the way as the air bags inflate to their full size. The front air bags fully inflate in less time than it takes to blink your eyes. The front air bags then quickly deflate while helping to restrain the driver and front passenger.

Knee Impact Bolsters

The Knee Impact Bolsters help protect the knees of the driver and front passenger, and position the front occupants for improved interaction with the front air bags.





Warning!

- ❑ Do not drill, cut, or tamper with the knee impact bolsters in any way.
- ❑ Do not mount any accessories to the knee impact bolsters such as alarm lights, stereos, citizen band radios, etc.

Supplemental Driver And Front Passenger Knee Air Bags

This vehicle is equipped with a Supplemental Driver Knee Air Bag mounted in the instrument panel below the steering column and a Supplemental Passenger Knee Air Bag mounted in the instrument panel below the glove compartment. The Supplemental Knee Air Bags provide enhanced protection during a frontal impact by working together with the seat belts, pretensioners, and front air bags.



06096S0102NA

Driver Knee Air Bag



06096S0103NA

Front Passenger Knee Air Bag

Supplemental Side Air Bags

Your vehicle is equipped with two types of side air bags:

1. Supplemental Seat-Mounted Side Air Bags (SABs): Located in the outboard side of the front seats. The SABs are marked with a “SRS AIRBAG” or “AIRBAG” label sewn into the outboard side of the seats.



06106S0004EM

Front Supplemental Seat-Mounted Side Air Bag

The SABs may help to reduce the risk of occupant injury during certain side impacts and/or vehicle rollover events, in addition to the injury reduction potential provided by the seat belts and body structure.

When the SAB deploys, it opens the seam on the outboard side of the seatback's trim cover. The inflating SAB deploys through the seat seam into the space between the occupant and the door. The SAB moves at a very high speed and with such a high force that it could injure occupants if they are not seated properly, or if items are positioned in the area where the SAB inflates. Children are at an even greater risk of injury from a deploying air bag.



Warning!

Do not use accessory seat covers or place objects between you and the Side Air Bags; the performance could be adversely affected and/or objects could be pushed into you, causing serious injury.

2. Supplemental Side Air Bag Inflatable Curtains (SABICs): Located above the side windows. The trim covering the SABICs is labeled “SRS AIRBAG” or “AIRBAG.”



06106S0005EM

Supplemental Side Air Bag Inflatable Curtain (SABIC) Label Location

SABICs may help reduce the risk of head or other injuries to front and rear seat outboard occupants in certain side impacts and/or vehicle rollover events, in addition to the injury reduction potential provided by the seat belts and body structure.

The SABICs deploy downward, covering the side windows. An inflating SABIC pushes the outside edge of the trim out of the way and covers the window. The SABICs inflate with enough force to injure occupants if they are not belted and seated properly, or if items are positioned in the area where the SABICs inflate. Children are at an even greater risk of injury from a deploying air bag.



Warning!

Do not stack luggage or other cargo up high enough to block the deployment of the SABICs. The trim covering above the side windows where the SABIC and its deployment path are located should remain free from any obstructions.

In order for the SABICs to work as intended, do not install any accessory items in your vehicle which could alter the roof. Do not add an aftermarket sunroof to your vehicle. Do not add roof racks that require permanent attachments (bolts or screws) for installation on the vehicle roof. Do not drill into the roof of the vehicle for any reason.

The SABICs and SABs (Side Air Bags) are designed to activate in certain side impacts and certain rollover events. The Occupant Restraint Controller (ORC) determines whether the deployment of the Side Air Bags in a particular side impact or rollover event is appropriate,



based on the severity and type of collision. Vehicle damage by itself is not a good indicator of whether or not Side Air Bags should have deployed.

Side Air Bags are a supplement to the seat belt restraint system. Side Air Bags deploy in less time than it takes to blink your eyes.



Warning!

Occupants, including children, who are up against or very close to Side Air Bags can be seriously injured or killed. Occupants, including children, should never lean on or sleep against the door, side windows, or area where the side air bags inflate, even if they are in an infant or child restraint.

Seat belts (and child restraints where appropriate) are necessary for your protection in all collisions. They also help keep you in position, away from an inflating Side Air Bag. To get the best protection from the Side Air Bags, occupants must wear their seat belts properly and sit upright with their backs against the seats. Children must be properly restrained in a child restraint or booster seat that is appropriate for the size of the child.



**Warning!**

- Side Air Bags need room to inflate. Do not lean against the door or window. Sit upright in the center of the seat.
- Being too close to the Side Air Bags during deployment could cause you to be severely injured or killed.
- Relying on the Side Air Bags alone could lead to more severe injuries in a collision. The Side Air Bags work with your seat belt to restrain you properly. In some collisions, Side Air Bags won't deploy at all. Always wear your seat belt even though you have Side Air Bags.

Note: Air bag covers may not be obvious in the interior trim, but they will open during air bag deployment.

Side Impacts

In side impacts, the side impact sensors aid the ORC in determining the appropriate response to impact events. The system is calibrated to deploy the Side Air Bags on the impact side of the vehicle during impacts that require Side Air Bag occupant protection. In side impacts, the Side Air Bags deploy independently; a left side impact deploys the left Side Air Bags only and a right side impact deploys the right Side Air Bags only.

The Side Air Bags will not deploy in all side collisions, including some collisions at certain angles, or some side collisions that do not impact the area of the passenger compartment. The Side Air Bags may deploy during angled or offset frontal collisions where the front air bags deploy.

Rollover Events

Side Air Bags are designed to activate in certain rollover events. The ORC determines whether the deployment of the Side Air Bags in a particular rollover event is appropriate, based on the severity and type of collision. Vehicle damage by itself is not a good indicator of whether or not Side Air Bags should have deployed.

The Side Air Bags will not deploy in all rollover events. The rollover sensing system determines if a rollover event may be in progress and whether deployment is appropriate. In the event the vehicle experiences a rollover or near rollover event, and deployment of the Side Air Bags is appropriate, the rollover sensing system will also deploy the seat belt pretensioners on both sides of the vehicle.

The SABICs may help reduce the risk of partial or complete ejection of vehicle occupants through side windows in certain rollover or side impact events.

The Occupant Restraint Controller (ORC) monitors the internal circuits and interconnecting wiring associated with electrical Air Bag System Components listed below:

Air Bag System Components

- Occupant Restraint Controller (ORC)
- Air Bag Warning Light
- Steering Wheel and Column
- Instrument Panel
- Knee Impact Bolsters
- Driver and Front Passenger Air Bags
- Supplemental Side Air Bags
- Supplemental Knee Air Bags
- Front and Side Impact Sensors
- Seat Belt Pretensioners
- Seat Track Position Sensors
- Seat Belt Buckle Switch

If A Deployment Occurs

The front air bags are designed to deflate immediately after deployment.

Note: Front and/or side air bags will not deploy in all collisions. This does not mean something is wrong with the air bag system.

If you do have a collision which deploys the air bags, any or all of the following may occur:

The air bag material may sometimes cause abrasions and/or skin reddening to the occupants as the air bags deploy and unfold. The abrasions are similar to friction rope burns or those you might get sliding along a carpet or gymnasium floor. They are not caused by contact with chemicals. They are not permanent and normally heal quickly. However, if you haven't healed significantly within a few days, or if you have any blistering, see your doctor immediately.

As the air bags deflate, you may see some smoke-like particles. The particles are a normal by-product of the process that generates the non-toxic gas used for air bag inflation. These airborne particles may irritate the skin, eyes, nose, or throat. If you have skin or eye irritation, rinse the area with cool water. For nose or throat irritation, move to fresh air. If the irritation continues, see your doctor. If these particles settle on your clothing, follow the garment manufacturer's instructions for cleaning. Do not drive your vehicle after the air bags have deployed. If you are involved in another collision, the air bags will not be in place to protect you.

 **Warning!**

Deployed air bags and seat belt pretensioners cannot protect you in another collision. Have the air bags, seat belt pretensioners, and the seat belt retractor assemblies replaced by an authorized dealer immediately. Also, have the Occupant Restraint Controller System serviced as well.

Note:

Air bag covers may not be obvious in the interior trim, but they will open during air bag deployment.

After any collision, the vehicle should be taken to an authorized dealer immediately.

Enhanced Accident Response System

In the event of an impact, if the communication network remains intact, and the power remains intact, depending on the nature of the event, the ORC will determine whether to have the Enhanced Accident Response System perform the following functions:

Cut off fuel to the engine.

Flash hazard lights as long as the battery has power or until the hazard light button is pressed. The hazard lights can be deactivated by pressing the hazard light button.

Turn on the interior lights, which remain on as long as the battery has power or for 15 minutes from the intervention of the Enhanced Accident Response System.

Unlock the power door locks.

Turn off the Fuel Pump Heater (if equipped).

Turn off the HVAC Blower Motor.

Cut off battery power to the:

- Engine
- Electric power steering
- Brake booster
- Electric park brake
- Automatic transmission gear selector
- Horn
- Front wiper
- Headlamp washer pump



Enhanced Accident Response System Reset Procedure

After the event occurs, when the system is active, a message regarding fuel cutoff is displayed. Turn the ignition switch from ignition AVV/START or MAR/ACC/ON/RUN to ignition STOP/OFF/LOCK. Carefully check the vehicle for fuel leaks in the engine compartment and on the ground near the engine compartment and fuel tank before resetting the system and starting the engine.

Depending on the nature of the event the left and right turn signal lights, located in the instrument panel, may both be blinking and will continue to blink. In order to move your vehicle to the side of the road, you must follow the system reset procedure.

Customer Action	Customer Will See
Note: Each step MUST BE held for at least two seconds	
1. Turn ignition STOP/OFF/LOCK. (Turn Signal Must be placed in Neutral State).	
2. Turn ignition MAR/ACC/ON/RUN.	Right turn light BLINKS. Left turn light is OFF.

Customer Action	Customer Will See
Note: Each step MUST BE held for at least two seconds	
3. Turn right turn signal switch ON.	Right turn light is ON SOLID. Left turn light BLINKS.
4. Place turn signal in neutral state.	Right turn light is OFF. Left turn light BLINKS.
5. Turn left turn signal switch ON.	Right turn light BLINKS. Left turn light is ON SOLID.
6. Place turn signal in neutral state.	Right turn light BLINKS. Left turn light is OFF.
7. Turn right turn signal switch ON.	Right turn light is ON SOLID. Left turn light BLINKS.
8. Place turn signal in neutral state.	Right turn light is OFF. Left turn light BLINKS.
9. Turn left turn signal switch ON.	Right turn light is ON SOLID. Left turn light is ON SOLID.

Customer Action	Customer Will See
Note: Each step MUST BE held for at least two seconds	
10. Turn left turn signal switch OFF. (Turn Signal Switch Must be placed in Neutral State).	Right turn light is OFF. Left turn light is OFF.
11. Turn ignition STOP/OFF/LOCK.	
12. Turn ignition MAR/ACC/ON/RUN. (Entire sequence needs to be completed within one minute or sequence will need to be repeated).	System is now reset and the engine may be started.
Turn hazard flashers OFF (Manually).	
If a reset procedure step is not completed within 60 seconds, then the turn signal lights will blink and the reset procedure must be performed again in order to be successful.	

Maintaining Your Air Bag System



Warning!

- Modifications to any part of the air bag system could cause it to fail when you need it. You could be injured if the air bag system is not there to protect you. Do not modify the components or wiring, including adding any kind of badges or stickers to the steering wheel hub trim cover or the upper right side of the instrument panel. Do not modify the front bumper, vehicle body structure, or add aftermarket side steps or running boards.
- It is dangerous to try to repair any part of the air bag system yourself. Be sure to tell anyone who works on your vehicle that it has an air bag system.
- Do not attempt to modify any part of your air bag system. The air bag may inflate accidentally or may not function properly if modifications are made. Take your vehicle to an authorized dealer for any air bag system service. If your seat, including your trim cover and cushion, needs to be serviced in any way (including removal or loosening/tightening of seat attachment bolts), take the vehicle to your authorized dealer. Only manufacturer approved seat accessories may be used. If it is necessary to modify the air bag system for persons with disabilities, contact your authorized dealer.

Event Data Recorder (EDR)

This vehicle is equipped with an event data recorder (EDR). The main purpose of an EDR is to record, in certain crash or near crash-like situations, such as an air bag deployment or hitting a road obstacle, data that will assist in understanding how a vehicle's systems performed. The EDR is designed to record data related to vehicle dynamics and safety systems for a short period of time, typically 30 seconds or less. The EDR in this vehicle is designed to record such data as:

- How various systems in your vehicle were operating;
- Whether or not the driver and passenger safety belts were buckled/fastened;
- How far (if at all) the driver was depressing the accelerator and/or brake pedal; and,
- How fast the vehicle was traveling.
- These data can help provide a better understanding of the circumstances in which crashes and injuries occur.

Note: EDR data are recorded by your vehicle only if a non-trivial crash situation occurs; no data are recorded by the EDR under normal driving conditions and no personal data (e.g., name, gender, age, and crash location) are recorded. However, other parties, such as law enforcement, could

combine the EDR data with the type of personally identifying data routinely acquired during a crash investigation.

To read data recorded by an EDR, special equipment is required, and access to the vehicle or the EDR is needed. In addition to the vehicle manufacturer, other parties, such as law enforcement, that have the special equipment, can read the information if they have access to the vehicle or the EDR.

Child Restraints

Everyone in your vehicle needs to be buckled up at all times, including babies and children. Every state in the United States, and every Canadian province, requires that small children ride in proper restraint systems. This is the law, and you can be prosecuted for ignoring it.

Children 12 years or younger should ride properly buckled up in a rear seat, if available. According to crash statistics, children are safer when properly restrained in the rear seats rather than in the front.



**Warning!**

In a collision, an unrestrained child can become a projectile inside the vehicle. The force required to hold even an infant on your lap could become so great that you could not hold the child, no matter how strong you are. The child and others could be badly injured. Any child riding in your vehicle should be in a proper restraint for the child's size.

There are different sizes and types of restraints for children from newborn size

to the child almost large enough for an adult safety belt. Always check the child seat Owner's Manual to make sure you have the correct seat for your child. Carefully read and follow all the instructions and warnings in the child restraint Owner's Manual and on all the labels attached to the child restraint. Before buying any restraint system, make sure that it has a label certifying that it meets all applicable Safety Standards. You should also make sure that you can install it in the vehicle where you will use it.

Note:

For additional information, refer to www.safercar.gov/parents/index.htm or call:

1-888-327-4236

Canadian residents should refer to Transport Canada's website for additional information: <http://www.tc.gc.ca/eng/motorvehiclesafety/safedrivers-childsafety-index-53.htm>

Summary Of Recommendations For Restraining Children In Vehicles

	Child Size, Height, Weight or Age	Recommended Type of Child Restraint
Infants and Toddlers	Children who are two years old or younger and who have not reached the height or weight limits of their child restraint	Either an Infant Carrier or a Convertible Child Restraint, facing rearward in the rear seat of the vehicle
Small Children	Children who are at least two years old or who have out-grown the height or weight limit of their rear-facing child restraint	Forward-Facing Child Restraint with a five-point Harness, facing forward in the rear seat of the vehicle
Larger Children	Children who have out-grown their forward-facing child restraint, but are too small to properly fit the vehicle's seat belt	Belt Positioning Booster Seat and the vehicle seat belt, seated in the rear seat of the vehicle
Children Too Large for Child Restraints	Children 12 years old or younger, who have out-grown the height or weight limit of their booster seat	Vehicle Seat Belt, seated in the rear seat of the vehicle

Infant And Child Restraints

Safety experts recommend that children ride rear-facing in the vehicle until they are two years old or until they reach either the height or weight limit of their rear-facing child restraint. Two types of child restraints can be used rear-facing: infant carriers and convertible child seats.

The infant carrier is only used rear-facing in the vehicle. It is recommended for children from birth until they reach the weight or height limit of the infant carrier. Convertible child seats can be used either rear-facing or forward-facing in the vehicle. Convertible child seats often have a higher weight limit in the rear-facing direction than infant carriers do, so they can be used rear-facing by children who have outgrown their infant carrier but are still less than at least two years old. Children should remain rear-facing until they reach the highest weight or height allowed by their convertible child seat.



Warning!

- Never place a rear-facing child restraint in front of an air bag. A deploying passenger front air bag can cause death or serious injury to a child 12 years or younger, including a child in a rear-facing child restraint.
- Only use a rear-facing child restraint in a vehicle with a rear seat.

Older Children And Child Restraints

Children who are two years old or who have outgrown their rear-facing convertible child seat can ride forward-facing in the vehicle. Forward-facing child seats and convertible child seats used in the forward-facing direction are for children who are over two years old or who have outgrown the rear-facing weight or height limit of their rear-facing convertible child seat. Children should remain in a forward-facing child seat with a harness for as long as possible, up to the highest weight or height allowed by the child seat.

All children whose weight or height is above the forward-facing limit for the child seat should use a belt-positioning

booster seat until the vehicle's seat belts fit properly. If the child cannot sit with knees bent over the vehicle's seat cushion while the child's back is against the seatback, they should use a belt-positioning booster seat. The child and belt-positioning booster seat are held in the vehicle by the seat belt.



Warning!

- Improper installation can lead to failure of an infant or child restraint. It could come loose in a collision. The child could be badly injured or killed. Follow the child restraint manufacturer's directions exactly when installing an infant or child restraint.
- After a child restraint is installed in the vehicle, do not move the vehicle seat forward or rearward because it can loosen the child restraint attachments. Remove the child restraint before adjusting the vehicle seat position. When the vehicle seat has been adjusted, reinstall the child restraint.
- When your child restraint is not in use, secure it in the vehicle with a seat belt or LATCH anchorages, or remove it from the vehicle. Do not leave it loose in the vehicle. In a sudden stop or accident, it could strike the occupants or seatbacks and cause serious personal injury.



Children Too Large For Booster Seats

Children who are large enough to wear the shoulder belt comfortably, and whose legs are long enough to bend over the front of the seat when their back is against the seatback, should use the seat belt in a rear seat. Use this simple 5-step test to decide whether the child can use the vehicle's seat belt alone:

1. Can the child sit all the way back against the back of the vehicle seat?

2. Do the child's knees bend comfortably over the front of the vehicle seat – while they are still sitting all the way back?

3. Does the shoulder belt cross the child's shoulder between their neck and arm?

4. Is the lap part of the belt as low as possible, touching the child's thighs and not their stomach?

5. Can the child stay seated like this for the whole trip?

If the answer to any of these questions was "no," then the child still needs to use a booster seat in this vehicle. If the child is using the lap/shoulder belt, check seat belt fit periodically and make

sure the seat belt buckle is latched. A child's squirming or slouching can move the belt out of position. If the shoulder belt contacts the face or neck, move the child closer to the center of the vehicle, or use a booster seat to position the seat belt on the child correctly.



Warning!

Never allow a child to put the shoulder belt under an arm or behind their back. In a crash, the shoulder belt will not protect a child properly, which may result in serious injury or death. A child must always wear both the lap and shoulder portions of the seat belt correctly.

Recommendations For Attaching Child Restraints

Restraint Type	Combined Weight of the Child + Child Restraint	Use Any Attachment Method Shown With An "X" Below			
		LATCH – Lower Anchors Only	Seat Belt Only	LATCH – Lower Anchors + Top Tether Anchor	Seat Belt + Top Tether Anchor
Rear-Facing Child Restraint	Up to 65 lbs (29.5 kg)	X	X		
Rear-Facing Child Restraint	More than 65 lbs (29.5 kg)		X		
Forward-Facing Child Restraint	Up to 65 lbs (29.5 kg)			X	X
Forward-Facing Child Restraint	More than 65 lbs (29.5 kg)				X

Lower Anchors And Tethers For Children (LATCH) Restraint System



022668173

022668173

LATCH Label

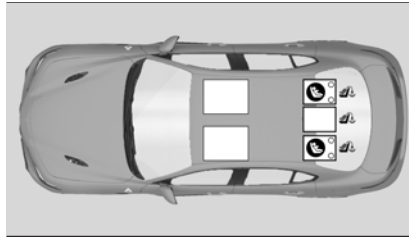

Your vehicle is equipped with the child restraint anchorage system called LATCH, which stands for Lower Anchors and Tethers for Children. The LATCH system has three vehicle anchor points for installing LATCH-equipped child seats. There are two lower anchorages located at the back of the seat cushion where it meets the seatback and one top tether anchorage located behind the seating position. These anchorages are used to install LATCH-equipped child seats without using the vehicle's seat belts. Some seating positions may have a top tether anchorage but no lower anchorages. In these seating positions, the seat belt must be used with the top tether anchorage to install the child restraint. Please see the following table for more information.

LATCH Positions For Installing Child Restraints In This Vehicle



06086S0101NA

LATCH Positions

-  Lower Anchorage Symbol
(2 Anchorages Per Seating Position)
-  Top Tether Anchorage Symbol



Frequently Asked Questions About Installing Child Restraints With LATCH

What is the weight limit (child's weight + weight of the child restraint) for using the LATCH anchorage system to attach the child restraint?	65 lbs (29.5 kg)	Use the LATCH anchorage system until the combined weight of the child and the child restraint is 65 lbs (29.5 kg). Use the seat belt and tether anchor instead of the LATCH system once the combined weight is more than 65 lbs (29.5 kg).
Can the LATCH anchorages and the seat belt be used together to attach a rear-facing or forward-facing child restraint?	No	Do not use the seat belt when you use the LATCH anchorage system to attach a rear-facing or forward-facing child restraint. Booster seats may be attached to the LATCH anchorages if allowed by the booster seat manufacturer. See your booster seat owner's manual for more information.
Can a child seat be installed in the center position using the inner LATCH lower anchorage?	No	Use the seat belt and tether anchor to install a child seat in the center seating position.
Can two child restraints be attached using a common lower LATCH anchorage?	No	Never "share" a LATCH anchorage with two or more child restraints. If the center position does not have dedicated LATCH lower anchorages, use the seat belt to install a child seat in the center position next to a child seat using the LATCH anchorages in an outboard position.
Can the rear-facing child restraint touch the back of the front passenger seat?	Yes	The child seat may touch the back of the front passenger seat if the child restraint manufacturer also allows contact. See your child restraint owner's manual for more information.
Can the head restraints be removed?	Yes	The rear outboard head restraints can be removed.

Locating The LATCH Anchorages



The lower anchorages are round bars that are found at the rear of the seat cushion where it meets the seatback, below the anchorage symbols on the

seatback. They are just visible when you lean into the rear seat to install the child restraint. You will easily feel them if you run your finger along the gap between the seatback and seat cushion.

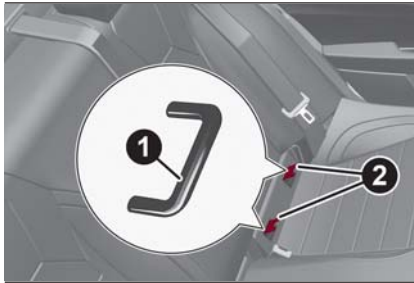

06086S0009EM

LATCH Anchorage Locations

- 1 — LATCH Anchorage Bar
- 2 — LATCH Anchorage Locations

Locating The Upper Tether Anchorages



There are tether strap anchorages behind each rear seating position located in the panel between the rear seatback and the rear window. They are

found under a plastic cover with the tether anchorage symbol on it.

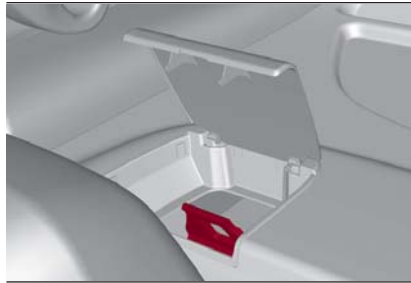

06086S0104NA

Upper Tether Anchorage Location

LATCH-compatible child restraint systems will be equipped with a rigid bar or a flexible strap on each side. Each will have a hook or connector to attach to the lower anchorage and a way to tighten the connection to the anchorage. Forward-facing child restraints and some rear-facing child restraints will also be equipped with a tether strap. The tether strap will have a hook at the end to attach to the top tether anchorage and a way to tighten

the strap after it is attached to the anchorage.

Center Seat LATCH



Warning!

Do not install a child restraint in the center position using the LATCH system. This position is not approved for installing child seats using the LATCH attachments. You must use the seat belt and tether anchor to install a child seat in the center seating position.

Never use the same lower anchorage to attach more than one child restraint. Please refer to "Installing The LATCH-Compatible Child Restraint System" for typical installation instructions.

Always follow the directions of the child restraint manufacturer when installing your child restraint. Not all child restraint systems will be installed as described here.

To Install A LATCH-Compatible Child Restraint

If the selected seating position has a Switchable Automatic Locking Retractor (ALR) seat belt, stow the seat belt, following the instructions below. See the section "Installing Child Restraints Using The Vehicle Seat Belt" to check what type of seat belt each seating position has.



1. Loosen the adjusters on the lower straps and on the tether strap of the child seat so that you can more easily attach the hooks or connectors to the vehicle anchorages.
2. Place the child seat between the lower anchorages for that seating position. For some second row seats, you may need to recline the seat and/or raise the head restraint to get a better fit. If the rear seat can be moved forward and rearward in the vehicle, you may wish to move it to its rear-most position to make room for the child seat. You may also move the front seat forward to allow more room for the child seat.
3. Attach the lower hooks or connectors of the child restraint to the lower anchorages in the selected seating position.
4. If the child restraint has a tether strap, connect it to the top tether anchorage. See the section "Installing Child Restraints Using The Top Tether Anchorage" for directions to attach a tether anchor.
5. Tighten all of the straps as you push the child restraint rearward and downward into the seat. Remove slack in the straps according to the child restraint manufacturer's instructions.

6. Test that the child restraint is installed tightly by pulling back and forth on the child seat at the belt path. It should not move more than 1 inch (25.4 mm) in any direction.

How To Stow An Unused Switchable-ALR (ALR) Seat Belt

When using the LATCH attaching system to install a child restraint, stow all ALR seat belts that are not being used by other occupants or being used to secure child restraints. An unused belt could injure a child if they play with it and accidentally lock the seat belt retractor. Before installing a child restraint using the LATCH system, buckle the seat belt behind the child restraint and out of the child's reach. If the buckled seat belt interferes with the child restraint installation, instead of buckling it behind the child restraint, route the seat belt through the child restraint belt path and then buckle it. Do not lock the seat belt. Remind all children in the vehicle that the seat belts are not toys and that they should not play with them.



Warning!

- Improper installation of a child restraint to the LATCH anchorages can lead to failure of the restraint. The child could be badly injured or killed. Follow the child restraint manufacturer's directions exactly when installing an infant or child restraint.*
- Child restraint anchorages are designed to withstand only those loads imposed by correctly-fitted child restraints. Under no circumstances are they to be used for adult seat belts, harnesses, or for attaching other items or equipment to the vehicle.*

Installing Child Restraints Using The Vehicle Seat Belt

Child restraint systems are designed to be secured in vehicle seats by lap belts or the lap belt portion of a lap/shoulder belt.



Warning!

- Improper installation or failure to properly secure a child restraint can lead to failure of the restraint. The child could be badly injured or killed.*
- Follow the child restraint manufacturer's directions exactly when installing an infant or child restraint.*

The seat belts in the passenger seating positions are equipped with a Switchable Automatic Locking Retractor (ALR) that is designed to keep the lap portion of the seat belt tight around the child restraint so that it is not necessary to use a locking clip. The ALR retractor can be “switched” into a locked mode by pulling all of the webbing out of the retractor and then letting the webbing retract back into the retractor. If it is locked, the ALR will make a clicking noise while the webbing is pulled back into the retractor. Refer to the “Automatic

Locking Mode” description in “Switchable Automatic Locking Retractors (ALR)” under “Occupant Restraint Systems” for additional information on ALR.

Please see the table below and the following sections for more information.

Lap/Shoulder Belt Systems For Installing Child Restraints In This Vehicle

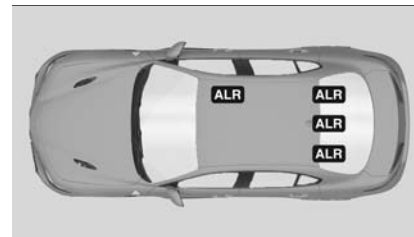

06086S0102NA

Automatic Locking Retractor (ALR) Locations

- ALR = Switchable Automatic Locking Retractor
-  Top Tether Anchorage Symbol

Frequently Asked Questions About Installing Child Restraints With Seat Belts

What is the weight limit (child's weight + weight of the child restraint) for using the Tether Anchor with the seat belt to attach a forward facing child restraint?	Weight limit of the Child Restraint	Always use the tether anchor when using the seat belt to install a forward facing child restraint, up to the recommended weight limit of the child restraint.
Can the rear-facing child restraint touch the back of the front passenger seat?	Yes	Contact between the front passenger seat and the child restraint is allowed, if the child restraint manufacturer also allows contact.
Can the head restraints be removed?	Yes	The rear outboard head restraints can be removed.
Can the buckle stalk be twisted to tighten the seat belt against the belt path of the child restraint?	No	Do not twist the buckle stalk in a seating position with an ALR retractor.



Installing A Child Restraint With A Switchable Automatic Locking Retractor (ALR):

Child restraint systems are designed to be secured in vehicle seats by lap belts or the lap belt portion of a lap/shoulder belt.



Warning!

Improper installation or failure to properly secure a child restraint can lead to failure of the restraint. The child could be badly injured or killed.

Follow the child restraint manufacturer's directions exactly when installing an infant or child restraint.

1. Place the child seat in the center of the seating position. For some second row seats, you may need to recline the seat and/or raise the head restraint to get a better fit. If the rear seat can be moved forward and rearward in the vehicle, you may wish to move it to its rear-most position to make room for the child seat. You may also move the front seat forward to allow more room for the child seat.

2. Pull enough of the seat belt webbing from the retractor to pass it through the belt path of the child restraint. Do not twist the belt webbing in the belt path.

3. Slide the latch plate into the buckle until you hear a "click."
4. Pull on the webbing to make the lap portion tight against the child seat.
5. To lock the seat belt, pull down on the shoulder part of the belt until you have pulled all the seat belt webbing out of the retractor. Then, allow the webbing to retract back into the retractor. As the webbing retracts, you will hear a clicking sound. This means the seat belt is now in the Automatic Locking mode.
6. Try to pull the webbing out of the retractor. If it is locked, you should not be able to pull out any webbing. If the retractor is not locked, repeat step 5.
7. Finally, pull up on any excess webbing to tighten the lap portion around the child restraint while you push the child restraint rearward and downward into the vehicle seat.
8. If the child restraint has a top tether strap and the seating position has a top tether anchorage, connect the tether strap to the anchorage and tighten the tether strap. See the section "Installing Child Restraints Using the Top Tether Anchorage" for directions to attach a tether anchor.

9. Test that the child restraint is installed tightly by pulling back and forth on the child seat at the belt path. It should not move more than 1 inch (25.4 mm) in any direction. Any seat belt system will loosen with time, so check the belt occasionally, and pull it tight if necessary.

Installing Child Restraints Using The Top Tether Anchorage:



Warning!

Do not attach a tether strap for a rear-facing car seat to any location in front of the car seat, including the seat frame or a tether anchorage. Only attach the tether strap of a rear-facing car seat to the tether anchorage that is approved for that seating position, located behind the top of the vehicle seat. See the section "Lower Anchors and Tethers for CHildren (LATCH) Restraint System" for the location of approved tether anchorages in your vehicle.



1. Look behind the seating position where you plan to install the child restraint to find the tether anchorage. You may need to move the seat forward to provide better access to the tether anchorage. If there is no top tether anchorage for that seating position, move the child restraint to another position in the vehicle if one is available.

2. Rotate or lift the cover to access the anchor directly behind the seat where you are placing the child restraint.

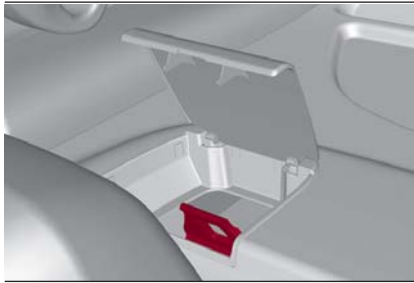

06086S0104NA

Upper Tether Anchorage Location

3. Route the tether strap to provide the most direct path for the strap between the anchor and the child seat. If your vehicle is equipped with adjustable rear head restraints, raise the head restraint, and where possible, route the tether strap under the head restraint and between the two posts. If not possible, lower the head restraint and pass the tether strap around the outboard side of the head restraint.

4. Attach the tether strap hook of the child restraint to the top tether anchorage as shown in the diagram.

5. Remove slack in the tether strap according to the child restraint manufacturer's instructions.



Warning!

An incorrectly anchored tether strap could lead to increased head motion and possible injury to the child. Use only the anchorage position directly behind the child seat to secure a child restraint top tether strap.

If your vehicle is equipped with a split rear seat, make sure the tether strap does not slip into the opening between the seatbacks as you remove slack in the strap.

Transporting Pets

Air Bags deploying in the front seat could harm your pet. An unrestrained pet will be thrown about and possibly injured, or injure a passenger during panic braking or in a collision.

Pets should be restrained in the rear seat in pet harnesses or pet carriers that are secured by seat belts.

SAFETY TIPS

Transporting Passengers

NEVER TRANSPORT PASSENGERS IN THE CARGO AREA.



Warning!

Do not leave children or animals inside parked vehicles in hot weather. Interior heat build-up may cause serious injury or death.

It is extremely dangerous to ride in a cargo area, inside or outside of a vehicle. In a collision, people riding in these areas are more likely to be seriously injured or killed.

Do not allow people to ride in any area of your vehicle that is not equipped with seats and seat belts.

Be sure everyone in your vehicle is in a seat and using a seat belt properly.



Exhaust Gas



Warning!

Exhaust gases can injure or kill. They contain carbon monoxide (CO), which is colorless and odorless. Breathing it can make you unconscious and can eventually poison you. To avoid breathing (CO), follow these safety tips:

- Do not run the engine in a closed garage or in confined areas any longer than needed to move your vehicle in or out of the area.*
- If you are required to drive with the trunk/liftgate/rear doors open, make sure that all windows are closed and the climate control BLOWER switch is set at high speed. DO NOT use the recirculation mode.*
- If it is necessary to sit in a parked vehicle with the engine running, adjust your heating or cooling controls to force outside air into the vehicle. Set the blower at high speed.*

The best protection against carbon monoxide entry into the vehicle body is a properly maintained engine exhaust system.

Whenever a change is noticed in the sound of the exhaust system, when exhaust fumes can be detected inside the vehicle, or when the underside or rear of the vehicle is damaged, have a competent mechanic inspect the

complete exhaust system and adjacent body areas for broken, damaged, deteriorated, or mispositioned parts. Open seams or loose connections could permit exhaust fumes to seep into the passenger compartment. In addition, inspect the exhaust system each time the vehicle is raised for lubrication or oil change. Replace as required.

Safety Checks You Should Make Inside The Vehicle

Seat Belts

Inspect the seat belt system periodically, checking for cuts, frays, and loose parts. Damaged parts must be replaced immediately. Do not disassemble or modify the system.

Front seat belt assemblies must be replaced after a collision. Rear seat belt assemblies must be replaced after a collision if they have been damaged (i.e., bent retractor, torn webbing, etc.). If there is any question regarding seat belt or retractor condition, replace the seat belt.

Air Bag Warning Light

The Air Bag warning light  will turn on for four to eight seconds as a bulb check when the ignition switch is first turned to ON/RUN. If the light is either not on during starting, stays on, or turns on while driving, have the system

inspected at an authorized dealer as soon as possible. This light will illuminate with a single chime when a fault with the Air Bag Warning Light has been detected, it will stay on until the fault is cleared. If the light comes on intermittently or remains on while driving, have an authorized dealer service the vehicle immediately. Refer to “Occupant Restraint Systems” in “Safety” for further information.

Defroster

Check operation by selecting the defrost mode and place the blower control on high speed. You should be able to feel the air directed against the windshield. See your authorized dealer for service if your defroster is inoperable.

Floor Mat Safety Information

Always use floor mats designed to fit your vehicle. Only use a floor mat that does not interfere with the operation of the pedal assemblies. Only use a floor mat that is securely attached using the floor mat fasteners so it cannot slip out of position and interfere with the pedal assemblies or impair safe operation of your vehicle in other ways.



Warning!

An improperly attached, damaged, folded, or stacked floor mat, or damaged floor mat fasteners may cause your floor mat to interfere with the accelerator, brake, or clutch pedals and cause a loss of vehicle control. To prevent **SERIOUS INJURY or DEATH**:

ALWAYS securely attach  your floor mat using the floor mat fasteners. DO NOT install your floor mat upside down or turn your floor mat over. Lightly pull to confirm mat is secured using the floor mat fasteners on a regular basis.

ALWAYS REMOVE THE EXISTING FLOOR MAT FROM THE VEHICLE  before installing any other floor mat. NEVER install or stack an additional floor mat on top of an existing floor mat.

ONLY install floor mats designed to fit your vehicle. NEVER install a floor mat that cannot be properly attached and secured to your vehicle. If a floor mat needs to be replaced, only use a FCA approved floor mat for the specific make, model, and year of your vehicle.

ONLY use the driver's side floor mat on the driver's side floor area. To check for interference, with the vehicle properly parked with the engine off, fully depress the accelerator, the brake, and the clutch pedal (if present) to check for interference. If your floor mat interferes with the operation of any pedal, or is not secure to the floor, remove the floor mat from the vehicle and place the floor mat in your trunk.

ONLY use the passenger's side floor mat on the passenger's side floor area.

ALWAYS make sure objects cannot fall or slide into the driver's side floor area when the vehicle is moving. Objects can become trapped under accelerator, brake, or clutch pedals and could cause a loss of vehicle control.

NEVER place any objects under the floor mat (e.g., towels, keys, etc.). These objects could change the position of the floor mat and may cause interference with the accelerator, brake, or clutch pedals.

If the vehicle carpet has been removed and re-installed, always properly attach carpet to the floor and check the floor mat fasteners are secure to the vehicle carpet. Fully depress each pedal to check for interference with the accelerator, brake, or clutch pedals then re-install the floor mats.

It is recommended to only use mild soap and water to clean your floor mats. After cleaning, always check your floor mat has been properly installed and is secured to your vehicle using the floor mat fasteners by lightly pulling mat.

Periodic Safety Checks You Should Make Outside The Vehicle

Tires

Examine tires for excessive tread wear and uneven wear patterns. Check for stones, nails, glass, or other objects lodged in the tread or sidewall. Inspect the tread for cuts and cracks. Inspect

sidewalls for cuts, cracks, and bulges. Check the wheel nuts for tightness. Check the tires (including spare) for proper cold inflation pressure.

Lights

Have someone observe the operation of brake lights and exterior lights while you work the controls. Check turn signal and high beam indicator lights on the instrument panel.

Door Latches

Check for proper closing, latching, and locking.

Fluid Leaks

Check area under vehicle after overnight parking for fuel, coolant, oil, or other fluid leaks. Also, if gasoline fumes are detected or if fuel, or brake fluid leaks are suspected. The cause should be located and corrected immediately.



STARTING AND OPERATING

Let's get to the core of the vehicle, and see how you can explore its fullest potential. We'll look at how to drive safely in any situation, making it a welcome companion with our comfort and wallets in mind.

STARTING THE ENGINE	137
ENGINE BLOCK HEATER — IF EQUIPPED	140
ELECTRIC PARK BRAKE	141
AUTOMATIC TRANSMISSION	143
ALFA DNA SELECTOR	149
ALFA ACTIVE SUSPENSION (AAS) — IF EQUIPPED	152
STOP/START SYSTEM	152
SPEED LIMITER	154
ELECTRONIC SPEED CONTROL (CRUISE CONTROL)	156
ADAPTIVE CRUISE CONTROL (ACC) — IF EQUIPPED	158
PARK SENSORS SYSTEM	165
LANE DEPARTURE WARNING (LDW) SYSTEM	170
REAR BACK-UP CAMERA/DYNAMIC GRIDLINES	173
REFUELING THE VEHICLE	175
VEHICLE LOADING	176
TRAILER TOWING	177
SUGGESTIONS FOR DRIVING	178

STARTING THE ENGINE

Before starting the engine, be sure to adjust the seat, the interior rear view mirrors, and the door mirrors, and fasten the seat belt correctly.

Never press the accelerator pedal before starting the engine.

If necessary, messages indicating the starting procedure can be shown in the display.



Warning!

- When leaving the vehicle, always remove the key fob from the vehicle and lock your vehicle.
- Never leave children alone in a vehicle, or with access to an unlocked vehicle.
- Allowing children to be in a vehicle unattended is dangerous for a number of reasons. A child or others could be seriously or fatally injured. Children should be warned not to touch the parking brake, brake pedal or the transmission gear selector.
- Do not leave the key fob in or near the vehicle, or in a location accessible to children. A child could operate power windows, other controls, or move the vehicle.
- Do not leave children or animals inside parked vehicles in hot weather. Interior heat build-up may cause serious injury or death.

Starting Procedure

Proceed as follows:

1. Apply the electric park brake and set the gear selector to PARK (P) or NEUTRAL (N).
2. Fully depress the brake pedal without touching the accelerator.
3. Briefly push the ignition button.
4. If the engine doesn't start within a few seconds, you need to repeat the procedure.

If the problem persists, contact an authorized dealer.



Warning!

- Never pour fuel or other flammable liquid into the throttle body air inlet opening in an attempt to start the vehicle. This could result in flash fire causing serious personal injury.
- Do not attempt to push or tow your vehicle to get it started. Vehicles equipped with an automatic transmission cannot be started this way. Unburned fuel could enter the catalytic converter and once the engine has started, ignite and damage the converter and vehicle.
- If the vehicle has a discharged battery, booster cables may be used to obtain a start from a booster battery or the battery in another vehicle. This type of start can be

dangerous if done improperly. Refer to "Emergency Starting" in "In Case Of Emergency" for further information.



Caution!

To prevent damage to the starter, do not continuously crank the engine for more than 25 seconds at a time. Wait 60 seconds before trying again.

Remote Starting System – If Equipped

This system uses the key fob to start the engine conveniently from outside the vehicle while still maintaining security. The system has a range of at least 300 feet (91 meters).

The remote starting system also activates the climate control (if equipped), the heated seats (if equipped), and the heated steering wheel (if equipped), depending on temperatures outside and inside of the vehicle.

Note:

- The vehicle must be equipped with an automatic transmission in order to include remote start.
- Obstructions between the vehicle and key fob may reduce this range.



How to use Remote Start

All of the following conditions must be met before the engine will remote start:

- Gear selector in PARK (P).
- Doors closed.
- Hood closed.
- Trunk closed.
- Hazard switch off.
- Brake switch inactive (brake pedal not pressed).
- Battery at an acceptable charge level.
- PANIC button not pushed.
- System not disabled from previous remote start event.
- Vehicle alarm system indicator flashing.
- Ignition in the OFF mode (if equipped with keyless ignition system).
- Fuel level meets minimum requirement.

Remote Start Comfort Systems — If Equipped

When Remote Start is activated, the heated steering wheel and driver heated seat features will automatically turn on in cold weather.

These features will stay on through the duration of remote start also until the ignition is cycled to the ON/RUN mode.

Remote Start Windshield Wiper De-Icer Activation — If Equipped

When remote start is active and the outside ambient temperature is less than 39°F (4°C), the Windshield Wiper De-Icer will be enabled. Exiting remote start will resume previous operation, except if the Windshield Wiper De-Icer is active.

The Windshield Wiper De-Icer timer and operation will continue.

Cold Weather Operation

To prevent possible engine damage while starting at low temperatures, this vehicle will inhibit engine cranking when the ambient temperature is less than -22° F (-30° C) and the oil temperature sensor reading indicates an engine block heater has not been used. An externally-powered electric engine block heater is available as optional equipment or from your authorized dealer.

The message “plug in engine heater” will be displayed in the instrument cluster when the ambient temperature is below 5° F (-15° C) at the time the engine is shut off as a reminder to avoid possible crank delays at the next cold start.



Caution!

Use of the recommended oil and adhering to the prescribed oil change intervals is important to prevent engine damage and ensure satisfactory starting in cold conditions.

Extended Park Starting

If the vehicle has not been started or driven for at least 35 days, it is advisable to follow the indications below.

To start the engine, proceed as follows:

1. Briefly push the ignition button
2. If the engine does not start, wait five seconds and let the starter cool down and then repeat the starting procedure
3. If the engine does not start after eight attempts, let the starter cool down for at least 10 seconds, and then repeat the starting procedure

If the problem persists, contact your authorized dealer.

Note: After prolonged vehicle inactivity, very difficult starting, that can be noticed through rapid fatigue of the starter, might also be due to a discharged battery. In this case, see the "Emergency Starting" section in the "In Case Of Emergency" chapter.

If Engine Fails To Start

Starting the Engine with Key Fob Battery Run Down or Drained

If the ignition does not respond when the button is pushed, the key fob battery might be run down or drained. Therefore, the system does not detect the presence of the key fob in the vehicle, and will display a dedicated message.

In this case, follow the instructions outlined in "Starting With A Discharged Key Fob Battery" in the "Getting To Know Your Vehicle" chapter, and start the engine normally.



Warning!

❑ Never pour fuel or other flammable liquid into the throttle body air inlet opening in an attempt to start the vehicle. This could result in flash fire causing serious personal injury.

❑ Do not attempt to push or tow your vehicle to get it started. Vehicles equipped with an automatic transmission cannot be started this way. Unburned fuel could enter the catalytic converter and once the engine has started, ignite and damage the converter and vehicle.

❑ If the vehicle has a discharged battery, booster cables may be used to obtain a start from a booster battery or the battery in another vehicle. This type of start can be dangerous if done improperly. Refer to "Emergency Starting" in "In Case Of Emergency" for further information.



Caution!

To prevent damage to the starter, do not continuously crank the engine for more than 25 seconds at a time. Wait 60 seconds before trying again.

After Starting — Warming Up The Engine

Proceed as follows:

- ❑ Travel slowly, letting the engine run at a reduced RPM, without accelerating suddenly.
- ❑ It is recommended to wait until the digital engine coolant temperature indicator starts to rise for maximum performance.

Stopping The Engine

To stop the engine, proceed as follows:

1. Park the vehicle in a position that is not dangerous for oncoming traffic.

2. Engage the PARK (P) mode.

3. With engine idling, push the START/STOP button on the steering wheel to STOP the engine.

Note: Do not leave the ignition in ON mode when the engine is off.

To shut off the engine with vehicle speed greater than 5 mph (8 km/h), you must push and hold the ignition or push the START/STOP button three times consecutively within a few seconds. The engine will shut down, and the ignition will be placed in the ON mode. With the keyless ignition system, it is possible to go away from the vehicle taking the key fob with you, without the engine switching off. The vehicle will inform about the absence of the key on board, only if the doors are closed.

Stopping the engine (cycling from the ON to the STOP position) the accessories are still powered for about three minutes, or until a door is opened. When the ignition is in the STOP/OFF mode, the window switches remain active for three minutes. Opening a front door will cancel this function.

After severe driving, idle the engine to allow the temperature inside the engine compartment to cool before shutting off the engine.



Turbocharger Cool Down

Before switching the engine off, keep it idling for a few minutes so that the turbocharger can be suitably lubricated. This procedure is particularly recommended after severe driving.

After a full load operation, keep the engine idling for three to five minutes before switching it off.

This time allows the lubricating oil and the engine coolant to eliminate the excessive heat from combustion chamber, bearings, inner components and turbocharger.

ENGINE BLOCK HEATER – IF EQUIPPED

The engine block heater warms the engine and permits quicker starts in cold weather.

Connect the cord to a 110-115 Volt AC electrical outlet with a grounded, three-wire extension cord.

For ambient temperatures below 0°F (-18°C), the engine block heater is recommended. For ambient temperatures below -20°F (-29°C), the engine block heater is required.

The engine block heater cord is routed under the hood, behind to the driver's side headlamp. Follow the steps below to properly use the engine block heater:

1. Locate the engine block heater cord (access door on the passenger side wiper cowl).
2. Pull the cord to the front of the vehicle and plug it into a grounded, three-wire extension cord.
3. After the vehicle is running, properly stow away behind access door on the passenger side wiper cowl.

Note:

- The engine block heater cord is a factory installed option. If your vehicle is not equipped, heater cords are available from your authorized dealer.
- The engine block heater will require 110 Volts AC and 6.5 Amps to activate the heater element.
- The engine block heater must be plugged in at least one hour to have an adequate warming effect on the engine.



Warning!

Remember to disconnect the engine block heater cord before driving. Damage to the 110-115 Volt electrical cord could cause electrocution.

ELECTRIC PARK BRAKE

The vehicle is equipped with electric park brake to guarantee better use and optimal performance compared to a manually operated park brake.

The electric parking brake features a switch located on the center console, a motor with caliper for each rear wheel, and an electronic control module.



07046S0001EM

Electric Park Brake Switch

The electric parking brake can be engaged in two ways:

- Manually, by pulling the switch on the center console.
- Automatically, in "Safe Hold" or "Auto Park Brake" conditions.

Note: Normally, the electric parking brake is engaged automatically when the engine is stopped. This function can be deactivated/activated on the Information and Entertainment system by selecting the following items in sequence on the main menu: "Settings", "Driver Assistance" and "Automatic Parking Brake".

In addition to engaging the electric park brake, along with steering and positioning chocks in front of the wheels (when on a steep slope), you must always place the vehicle in the PARK (P) mode before leaving.

Should the vehicle battery be faulty, the battery must be replaced in order to unlock the electric park brake.

Engaging The Park Brake Manually

Briefly pull the switch located on the center console to manually engage the electric park brake when the vehicle is stationary.

Noise may be heard from the rear of the vehicle when engaging the electric parking brake.

A slight movement of the brake pedal may be detected when engaging the electric parking brake with the brake pedal pressed.

With the electric parking brake engaged, the BRAKE warning light on the instrument panel and the switch will illuminate.



Caution!

With the Electronic Parking Brake failure warning light on, some functions of the electric parking brake are deactivated. In this case the driver is responsible for brake activation and vehicle parking in complete safety conditions.

If, under exceptional circumstances, the use of the brake is required with the vehicle in motion, keep the switch on the center console pulled as long as the brake action is necessary.

The BRAKE warning light may turn on with the hydraulic system temporarily unavailable, in this case braking is controlled by the motors.

The brake lights will also automatically turn on in the same way as for normal braking with the use of the brake pedal.

Release the switch on the center console to stop the braking action with the vehicle in motion.

If, through this procedure, the vehicle is braked until a speed below 1.9 mph (3 km/h) is reached and the switch is kept pulled, the park brake will definitively engage.

Note: Driving the vehicle with the electric parking brake engaged, or using it several times to slow down the vehicle, may cause severe damage to the braking system.



Disengaging The Electric Park Brake Manually

In order to manually release the park brake, the ignition should be in the ON mode. Press the brake pedal, and then push the switch on the center console briefly.

Noise may be heard from the rear of the vehicle, and a slight movement of the brake pedal may be detected during disengagement.

After disengaging the electric parking brake, the BRAKE warning light on the instrument panel and the light on the switch will turn off.

If the BRAKE warning light on the instrument panel remains on with the electric parking brake disengaged, this indicates a fault: in this case, contact an authorized dealer.



Warning!

- Never leave children alone in a vehicle, or with access to an unlocked vehicle.
- Allowing children to be in a vehicle unattended is dangerous for a number of reasons. A child or others could be seriously or fatally injured. Children should be warned not to touch the park brake, brake pedal or the gear selector.
- Do not leave the key fob in or near the vehicle or in a location accessible to

children. A child could operate power windows, other controls, or move the vehicle.

- Be sure the park brake is fully disengaged before driving; failure to do so can lead to brake failure and a collision.
- Always fully apply the park brake when leaving your vehicle, or it may roll and cause damage or injury.



Caution!

Never use gear position PARK (P) instead of the electric parking brake. Always engage the electric parking brake when parking the vehicle to prevent injury or damage caused by the unexpected movement of the vehicle.

Electric Park Brake Operating Modes

The electric park brake may operate as follows:

- "Dynamic Operating Mode": this mode is activated by pulling the switch repeatedly while driving.
- "Static Engagement and Release Mode": with the vehicle stationary, the electric park brake can be activated by pulling the switch on the center console once. On the other hand, push the switch and the brake pedal at the same time to disengage the brake.

- "Drive Away Release" — if equipped: the electric park brake will automatically disengage with the driver side seat belt fastened and the detection of an action performed by the driver to move the vehicle (forward gear or reverse gear).
- "Safe Hold": if the vehicle speed is lower than 1.9 mph (3 km/h), the gear selector is not in PARK (P) position and the driver's intention of leaving the vehicle is detected, the electric park brake will automatically engage to hold the vehicle in safety conditions.
- "Auto Park Brake": if the vehicle speed is below 1.9 mph (3 km/h), the electric park brake will automatically engage when the gear selector is in PARK (P) position. The light on the switch located on the center console switches on together with the BRAKE warning light on the instrument panel when the park brake is engaged and applied to the wheels. Each automatic park brake engagement can be cancelled by pressing the switch on the center console and at the same time moving the gear selector for the transmission to position PARK (P).

Safe Hold

Safe Hold is a safety function that automatically engages the electric park brake in the event of a dangerous condition for the vehicle.

The electric park brake engages automatically to prevent vehicle movement if:

- ❑ The vehicle speed is below 2 mph (3 km/h).
- ❑ A transmission operating mode different from PARK (P) is activated.
- ❑ The driver's seat belt is not fastened.
- ❑ The driver side door is open.
- ❑ No attempts to apply pressure on the brake pedal have been detected.

The "Safe Hold" function can be temporarily disabled by pressing the switch located on the center console and the brake pedal at the same time, with the vehicle stationary and the driver side door open.

Once disabled, the function will activate again when the vehicle speed reaches 12 mph (20 km/h) or the ignition is cycled to STOP and then to ON.

AUTOMATIC TRANSMISSION

The vehicle can be equipped with an electronically controlled 8-speed automatic transmission where gear shifting automatically takes place, depending on the vehicle usage instantaneous parameters (vehicle speed, grade, and accelerator pedal position).

The new transmission is an absolute innovation, as it can match the Stop/Start system with the traditional automatic transmissions with built-in torque converter. For further information, refer to the "Stop/Start" section within this chapter.

Manual gear shifting can still occur thanks to the "sequential mode" position for the gear selector.



Warning!

❑ It is dangerous to shift out of PARK or NEUTRAL if the engine speed is higher than idle speed. If your foot is not firmly pressing the brake pedal, the vehicle could accelerate quickly forward or in reverse. You could lose control of the vehicle and hit someone or something. Only shift into gear when the engine is idling normally and your foot is firmly pressing the brake pedal.

❑ Unintended movement of a vehicle could injure those in or near the vehicle. As with all vehicles, you should never exit a vehicle while the engine is running. Before exiting a vehicle, always apply the park brake, shift the transmission into PARK, and turn the ignition STOP/OFF. When the ignition is in the STOP/OFF mode, the transmission is locked in PARK, securing the vehicle against unwanted movement.

❑ When leaving the vehicle, always make sure the ignition is in the STOP/OFF mode, remove the key fob from the vehicle, and lock the vehicle.

❑ Never leave children alone in a vehicle, or with access to an unlocked vehicle. Allowing children to be in a vehicle unattended is dangerous for a number of reasons. A child or others could be seriously or fatally injured. Children should be warned not to touch the parking brake, brake pedal or the transmission gear selector.

❑ Do not leave the key fob in or near the vehicle (or in a location accessible to children), and do not leave the ignition in the AVV or ON mode. A child could operate power windows, other controls, or move the vehicle.





Damage to the transmission may occur if the following precautions are not observed:

- Shift into or out of PARK or REVERSE only after the vehicle has come to a complete stop.
- Do not shift between PARK, REVERSE, NEUTRAL, or DRIVE when the engine is above idle speed.
- Before shifting into any gear, make sure your foot is firmly pressing the brake pedal.

Display

The following information is shown on the dedicated area of the display:

- In Automatic Mode:** the active mode (P, R, N, D) and with "D" the current gear number.
- In Manual Drive Mode (Sequential):** the mode (M), the current gear and the double or single gear shift request, both up and down (single or double arrow).



07076S0001EM

Gear Display

Gear Selector

The gear functioning is controlled by the gear selector, which can assume the following positions:

- P** = PARK
- R** = REVERSE
- N** = NEUTRAL
- D** = DRIVE, (automatic forward speed)
- AutoStick:** + manually shift to higher gear; – manually shift to lower gear

The positions diagram is illustrated on the top of the gear selector.

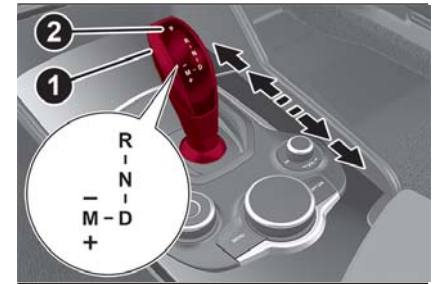

07076S0002EM

Gear Selector Center Console

- 1 – Gear Selector
- 2 – PARK (P) Button

The letter corresponding to the mode selected on the gear selector lights up and appears on the instrument cluster display.

To select a mode, move the gear selector forward or backwards, together with pressing the brake pedal and button to engage REVERSE (R).

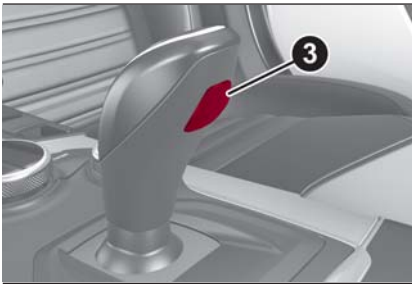

07076S0005EM

Gear Selector

3 — Gear Selector Button

The gear selector is a joystick style shifting mechanism which returns to the center position automatically. It can be pushed forward twice and rearward twice, based on the starting condition.

The PARK (P) mode can be enabled/disabled by pushing the PARK (P) button.

To transition the vehicle into REVERSE (R) mode from DRIVE (D) mode, or into DRIVE (D) mode from REVERSE (R) mode, it is necessary to move the gear selector by pushing the gear selector button.

When using AutoStick, activate it by moving the gear selector from DRIVE (D) to the left and then forward toward the - symbol or backward toward the + symbol and the gear is changed.

To shift out of PARK (P), or to pass from position NEUTRAL (N) to position

DRIVE (D) or REVERSE (R), the vehicle must be moving at a low speed or stopped, and the brake pedal must also be pressed.

Note:

- ❑ DO NOT accelerate while shifting from position PARK (P) or NEUTRAL (N) to another position.
- ❑ After selecting a gear, wait a few seconds before accelerating. This precaution is particularly important with engine cold.

Transmission Operating Modes

PARK (P)

The transmission is locked in this mode. The engine can be started in this mode.

Note: Never try to engage PARK (P) mode when the vehicle is moving. Before leaving the vehicle, make sure this mode is engaged (letter P shown on the display and gear selector) and that the park brake is engaged.

When parking on a flat surface, first engage the PARK (P) mode and then engage the electric park brake.

When parking uphill, before activating the PARK (P) mode, engage the electric park brake. Otherwise, it could be difficult to engage the (P) mode.

To check that the PARK (P) mode is actually engaged, make sure (P) is illuminated on the display and on the gear selector.



Warning!

❑ Never use the PARK position as a substitute for the park brake. Always apply the park brake fully when parked to guard against vehicle movement and possible injury or damage.

❑ Your vehicle could move and injure you and others if it is not in PARK. Check by trying to move the gear selector out of PARK with the brake pedal released. Make sure the transmission is in PARK before leaving the vehicle.

❑ It is dangerous to shift out of PARK or NEUTRAL if the engine speed is higher than idle speed. If your foot is not firmly pressing the brake pedal, the vehicle could accelerate quickly forward or in reverse. You could lose control of the vehicle and hit someone or something. Only shift into gear when the engine is idling normally and your foot is firmly pressing the brake pedal.

❑ Unintended movement of a vehicle could injure those in or near the vehicle. As with all vehicles, you should never exit a vehicle while the engine is running. Before exiting a vehicle, always apply the park brake, shift the transmission into PARK, and turn the ignition STOP/OFF. When the ignition is in the STOP/OFF mode, the transmission is locked in PARK, securing the vehicle against unwanted movement.

❑ When leaving the vehicle, always make sure the ignition is in the STOP/OFF mode, remove the key fob from the vehicle, and lock the vehicle.

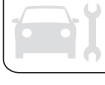

Never leave children alone in a vehicle, or with access to an unlocked vehicle. Allowing children to be in a vehicle unattended is dangerous for a number of reasons. A child or others could be seriously or fatally injured. Children should be warned not to touch the park brake, brake pedal or the transmission gear selector.

Do not leave the key fob in or near the vehicle (or in a location accessible to children), and do not leave the ignition in the ON mode. A child could operate power windows, other controls, or move the vehicle.



Caution!

Before moving the transmission gear selector out of PARK, you must push the ignition button to cycle from STOP/OFF mode to the ON mode, and also press the brake pedal. Otherwise, damage to the gear selector could result.

DO NOT race the engine when shifting from PARK or NEUTRAL into another gear range, as this can damage the drivetrain.

REVERSE (R)

Select this mode only with the vehicle at a standstill.

NEUTRAL (N)

Use this range when the vehicle is standing for prolonged periods with the engine running. The engine may be started in this range. Apply the electric park brake and shift the transmission into PARK (P) if you must leave the vehicle.



Warning!

Do not coast in NEUTRAL and never turn off the ignition to coast down a hill. These are unsafe practices that limit your response to changing traffic or road conditions. You might lose control of the vehicle and have a collision.

DRIVE (D)

Use this mode in normal driving conditions.

Shifting from DRIVE (D) to PARK (P) or REVERSE (R) modes must take place only after releasing the accelerator pedal, with vehicle at a standstill and brake pedal pressed.

This mode ensures automatic engagement of the most suitable gears for driving needs and maximum fuel economy in terms of consumption.

In this position, the transmission shifts the gears automatically, selecting the most suitable for forward driving among those available as you go. In this way the vehicle's optimal driving

characteristics are provided for all conditions.

AutoStick

In the case of frequent shifting (e.g. for sport driving, when the vehicle is driven with a heavy load, on slopes, when towing heavy trailers), it is recommended to use the Autostick (sequential shifting) mode to select and keep a lower fixed ratio.

In these conditions, the use of a lower gear improves vehicle performance, preventing overheating.

It is possible to shift from DRIVE (D) mode to sequential mode regardless of vehicle speed.

Activation

Starting from DRIVE (D), move the selector to the left (- and + indication of the trim) to activate the sequential drive mode. The gear engaged will be shown on the display.

Shifting is made by moving the gear selector forwards, towards symbol - or backwards, towards symbol +.

Steering Wheel Shift Paddles – If Equipped

The gear can also be manually shifted by using the paddles behind the steering wheel. Pull the right paddle (+) toward the steering wheel and release it to engage a higher gear, and perform the same operation with the left paddle (-) to engage a lower gear.



07076S0006EM

Steering Wheel Shift Paddles

Note: If only one manual shift is necessary, the letter (D) will remain on the display with the engaged gear next to it.

Deactivation

To deactivate the sequential driving mode, bring the gear selector back in position DRIVE (D) ("automatic" driving mode).



Warning!

Do not downshift for additional engine braking on a slippery surface. The drive wheels could lose their grip and the vehicle could skid, causing a collision or personal injury.

Note:

- To select the correct gear for maximum deceleration (engine brake), just keep the gear paddle pulled (-): the transmission goes to an operating mode in which the vehicle can slow down easily.
- The vehicle will keep the gear selected by the driver until the safety conditions allow it.
- This means, for example, that the system will try to prevent the engine from switching off, automatically downshifting if the engine speed is too low.

Automatic Transmission Limp Home Mode

Transmission function is monitored electronically for abnormal conditions. If a condition is detected that could result in transmission damage, Transmission Limp Home Mode is activated.

In this condition, the transmission stays in fourth gear, regardless of the selected gear. Positions PARK (P), REVERSE (R) and NEUTRAL (N) still work.

The  symbol might light up in the instrument cluster.

Temporary failure

In the event of a momentary problem, the transmission can be reset to regain all forward gears by performing the following steps:

1. Stop the vehicle.
2. Shift the transmission into PARK (P), if possible. If not, shift the transmission to NEUTRAL (N).
3. Push and hold the ignition until the engine turns OFF.
4. Wait for about 10 seconds, then restart the engine.
5. Shift into the desired gear range. If the problem is no longer detected, the transmission will return to normal operation.

Note: Even if the transmission can be reset, we recommend that you visit your authorized dealer at your earliest possible convenience. Your authorized dealer has diagnostic equipment to determine if the problem could reoccur. If the transmission cannot be reset, service is required at your authorized dealer.



Brake/Transmission Shift Interlock System

This vehicle is equipped with a Brake Transmission Shift Interlock system (BTSI) that holds the gear selector in PARK (P) unless the brakes are applied.

This system prevents you from moving the gear selector from position PARK (P) unless the brakes are applied.

To shift the transmission out of PARK (P), the ignition must be cycled to the AVV mode (engine running or not) and the brake pedal must be pressed.

Brake/Transmission Shift Interlock Disabling

Only if strictly necessary (e.g. pushing the vehicle, conveyor vehicle washing systems) inhibit the automatic activation of PARK (P) mode when stopping the engine, or proceed as described below:

1. Vehicle at a standstill.
2. NEUTRAL (N) mode activated.
3. Push the ignition button for at least three seconds.

The automatic park brake engagement function when the engine is stopped can also be deactivated on the Information and Entertainment system by selecting the following functions on the main menu: "Settings", "Driver Assistance" and "Automatic Parking Brake".

Important Notes

Failure to comply with what is reported below may damage the transmission:

- Shift into PARK (P) mode only with the vehicle at a standstill.
- Select REVERSE (R) mode, or pass from REVERSE to another mode only with the vehicle at a standstill and engine idling.
- Do not change between PARK (P), REVERSE (R), NEUTRAL (N) or DRIVE (D) modes with engine running at a speed above idling.
- Before activating any transmission operating mode, fully depress the brake pedal.

Note: The unexpected movement of the vehicle can injure the occupants or people nearby. Do not leave the vehicle with engine running: before getting out of the passenger compartment always engage the electric park brake, select the PARK (P) mode, stop the engine.



Warning!

It is dangerous to shift out of PARK or NEUTRAL if the engine speed is higher than idle speed. If your foot is not firmly pressing the brake pedal, the vehicle could accelerate quickly forward or in reverse. You could lose control of the vehicle and hit someone or something. Only shift into gear when the engine is idling normally and your foot is firmly pressing the brake pedal.

Unintended movement of a vehicle could injure those in or near the vehicle. As with all vehicles, you should never exit a vehicle while the engine is running. Before exiting a vehicle, always apply the park brake, shift the transmission into PARK, and turn the ignition STOP/OFF. When the ignition is in the STOP/OFF mode, the transmission is locked in PARK, securing the vehicle against unwanted movement.

When leaving the vehicle, always make sure the ignition is in the STOP/OFF mode, remove the key fob from the vehicle, and lock the vehicle.

Never leave children alone in a vehicle, or with access to an unlocked vehicle. Allowing children to be in a vehicle unattended is dangerous for a number of reasons. A child or others could be seriously or fatally injured. Children should be warned not to touch the parking brake, brake pedal or the transmission gear selector.

Do not leave the key fob in or near the vehicle (or in a location accessible to children), and do not leave the ignition in the AVV or ON mode. A child could operate power windows, other controls, or move the vehicle.



Caution!

Only engage the gear with engine at idling while fully depressing the brake pedal. If the transmission temperature exceeds the normal operating limits, the transmission control unit may change the gear engagement order and reduce the drive torque. If the transmission overheats, it could operate incorrectly until it cools down.

When using the vehicle with extremely low external temperatures, the transmission operation may change depending on the engine and transmission temperature, as well as vehicle speed. Activation of the torque converter clutch and of the eighth gear is inhibited until the transmission oil is correctly warmed up. Complete operation of the transmission will be enabled as soon as the fluid temperature reaches the predefined value.

ALFA DNA SELECTOR

Alfa DNA System

This vehicle is equipped with an Alfa DNA system selector (located on the center console). There are four modes of operation to be selected according to driving style and road conditions:



07076S0004BASE

Alfa DNA System Selector

- d = Dynamic (sports driving mode).
- n = Natural (mode for driving in normal conditions).
- a = Advanced Efficiency (ECO driving mode for maximum fuel savings).
- = Adjusts the calibration of the active suspension (if equipped).

The symbol of the active mode lights up in red on the selector.

On the instrument panel display, the different modes are characterized by different colors:

- Natural - Blue
- Dynamic - Red
- Advanced Efficiency - Green

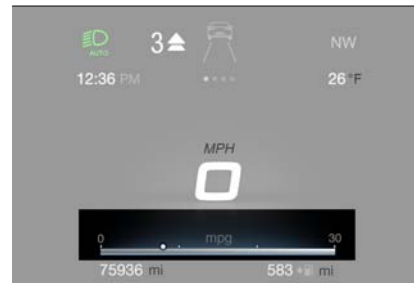

07076S0003EM

Mode Display

Each driving mode is graphically different in frame color and contents of each individual "performance" screen.

Driving Modes

"Natural" Mode

"Natural" Mode is characterized by reduced engine performance and ECO shifting strategy for the automatic transmission.

Activation

It is activated by rotating the selector to the letter "n", the displays light up in blue.



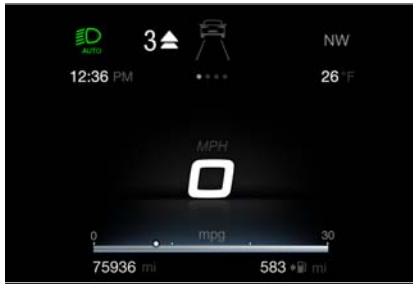

07116S0002EM

Natural Mode

The "Performance" screen graphically reproduces some parameters closely linked to the efficiency of the driving style, with a view to limiting consumption.



07116S0001EM

Natural Mode Performance Display

"Dynamic" Mode

Activation

It is activated by rotating the selector to the letter "d", the displays light up in red.



07116S0003EM

Dynamic Mode

ESC and ASR systems: intervention thresholds that ensure more enjoyable, sportier driving while guaranteeing the stability of the vehicle.

Engine and transmission: adoption of sports mapping.



Warning!

In "Dynamic", the sensitivity of the accelerator pedal increases considerably. Consequently, driving is less fluid and comfortable.



07116S0006EM

Dynamic Mode Performance Display

The "Performance" screen displays parameters related to vehicle stability, the graphs illustrate the trend of the longitudinal/lateral accelerations (G-meter information), considering gravity acceleration as a reference unit. Lateral acceleration peaks are displayed on the right.

"Advanced Efficiency" Mode

Activation

It is activated by rotating the selector to the letter "a", the displays light up in green.



07116S0005EM

Advanced Efficiency Mode

ESC and ASR systems: intervention thresholds aimed at ensuring maximum safety in low-grip driving conditions. It is advisable to select "Advanced Efficiency" mode in the presence of low-grip road surfaces.

Engine and transmission: standard response.

The "Performance" screen graphically displays some parameters closely related to the vehicle consumption.



07116S0008EM

Advanced Efficiency Mode Performance Display

Driving Mode Deactivation

To deactivate any driving mode, simply move the selector to any other mode.

Note:

- ❑ When the engine is next started, the "Advanced Efficiency", "Dynamic" and "Natural" mode selected previously is retained. The system will reactivate in "Advanced Efficiency", "Dynamic" or "Natural" mode, depending on which mode was selected before the engine was stopped.
- ❑ When the engine is next started, the "Race" mode selected previously is not retained. The system will reactivate in "Dynamic" mode.
- ❑ It is not possible to go directly from "Dynamic" mode to "Advanced Efficiency" mode and vice versa. You must always activate the "Natural" mode first and then select the other mode.



ALFA ACTIVE SUSPENSION (AAS) – IF EQUIPPED

The vehicle's electronic suspensions management system is the result of a sophisticated elaboration of the various board sensors, aimed at optimizing the vehicle's performance.

The system continuously monitors the damping of the suspensions through the actuator installed on each shock absorber. This way, the calibration of the shock absorbers can be adjusted to the conditions of the road surface and to the dynamic conditions of the vehicle, improving its comfort and road holding.

The driver can choose, even while driving, (only in "Dynamic" mode), between two types of suspension calibration: a more sporty or a more comfortable one.

By pressing the button, the system prepares to work with a shock absorber calibration which favours driving comfort.



04306S0001BASE

"Alfa DNA" System Selector

In case of a system failure, the symbol ⚡ and a dedicated message will be shown on the instrument panel display.

STOP/START SYSTEM

Stop/Start System

The Stop/Start system automatically shuts off the engine during a vehicle stop if the required conditions are met. Releasing the brake pedal or accelerator pedal will automatically restart the engine.

The function was developed to increase vehicle efficiency by reducing fuel consumption, gas emissions, and sound pollution.

Operating Mode

Stopping the Engine

With vehicle at a standstill and brake pedal pressed, the engine switches off if the gear selector is in a position other than REVERSE (R).

The system does not operate when the gear selector is in REVERSE (R), in order to making parking maneuvers easier.

In the event of stops uphill, engine switching off is disabled to make the "Hill Start Assist" function available (works only with running engine).

NOTE: The engine can only be automatically stopped after having run at about 6 mph (10 km/h). After an automatic restart, the vehicle only needs to exceed a speed of 0.3 mph (0.5 km/h) to stop the engine.

Engine stopping is signaled by the (A) symbol lighting up on the instrument cluster display.

Restarting the Engine

To restart the engine, release the brake pedal.

With brake pressed, if the gear selector is in automatic mode - DRIVE (D) - the engine can be restarted by moving the gear selector to REVERSE (R) or NEUTRAL (N) or "AutoStick".

With brake pressed, if the gear selector is in "AutoStick" mode, the engine can be restarted by moving the gear selector to "+" or "-", or REVERSE (R) or NEUTRAL (N).

When the engine has been stopped automatically, keeping the brake pedal pressed, the brake can be released keeping the engine off by quickly shifting the gear selector to PARK (P).

To restart the engine, just move the gear selector out of a position other than PARK (P).

System Manual Activation/Deactivation

To manually activate/deactivate the system, push the button located in the control panel on the left of the steering wheel.



Stop/Start Button

System Activation

The activation of the system is indicated by the (A) symbol lighting up on the display. In this condition, the light on the button is off.

System Deactivation

A message will appear on the display when the system is deactivated. In this condition, the light on the button is on.

Note: Each time the engine is started, the system is activated regardless of where was when it was previously switched off.

Possible Reasons The Engine Does Not Autostop

For higher comfort and increased safety, and to reduce emissions, there are certain conditions where the engine will not autostop despite the system being active, such as:

- Engine still cold.

- Especially cold outside temperature.
- Battery not sufficiently charged.
- Driver's door not shut.
- Driver's seat belt not fastened.
- Reverse gear engaged (e.g. for parking maneuvers).
- With the automatic climate control active, an adequate cabin heating or cooling comfort has not been reached or with MAX-DEF function active.
- During the first period of use, to initialize the system.
- Steering angle beyond threshold.

Engine Restarting Conditions

Due to comfort, emission control and safety reasons, the engine can restart automatically without any action by the driver, under special conditions, such as:

- Battery not sufficiently charged.
- Reduced braking system vacuum (e.g. if the brake pedal is pressed repeatedly).
- Vehicle moving (e.g. when driving on roads with a grade).
- Engine stopping by the Stop/Start system for more than approx. three minutes.
- With the automatic climate control active, an adjustment in cabin heating or cooling is made or with MAX-DEF function active.



Safety Functions

When the engine is stopped through the Stop/Start system, if the driver releases their seat belt, opens the driver's or passenger's door, or opens the hood from inside the vehicle, the engine can be restarted only by using the ignition.

This condition is indicated to the driver both through a buzzer and a message on the instrument cluster display.

Irregular Operation

In the event of malfunction, the Stop/Start system is deactivated.

For failure indications, see the "Warning Lights and Messages" paragraph, "Getting To Know Your Instrument Panel" chapter.

Vehicle Inactivity

In the event of vehicle inactivity (or if the battery is replaced), special attention must be paid to the disconnection of the battery power supply.

Proceed as follows:

Remove connector from socket to disconnect sensor (battery status monitoring) installed on the negative pole of the battery. This sensor should never be disconnected from the pole except if the battery is replaced.

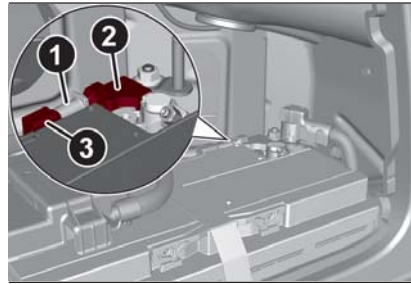

07126S0002EM

Battery Power Supply

- 1 – Socket
- 2 – Sensor
- 3 – Connector

Note: After setting the ignition to STOP and having closed the driver side door, wait at least one minute before disconnecting the electrical supply from the battery. When reconnecting the electrical supply to the battery, make sure that the ignition is in the STOP mode and the driver side door is closed.

SPEED LIMITER

Description

This feature allows the speed of the vehicle to be limited to speeds, which can be set by the driver.

The maximum speed can be set with the vehicle stationary or in motion. The minimum speed that can be set is 18 mph (30mk/h).

When this feature is active, the vehicle speed depends on the pressing of the accelerator pedal until the programmed speed limit is reached (see "Speed Limit Programming" paragraph).

Activating The Device

The feature can be activated/deactivated through the Information and Entertainment System.

Activating The Device

To access this feature on the main menu, select the following items in sequence: "Settings", "Safety", "Speed Limiter" and "on".

The activation of this feature is signaled by the displaying of the green symbol along with the last speed set. The Speed Limiter feature can remain active concurrently with the Speed Control system. If a speed limit below the one indicated in the Speed Control is selected, the Speed Control speed will be lowered to that of the Speed Limiter. This function remains available in RACE mode.

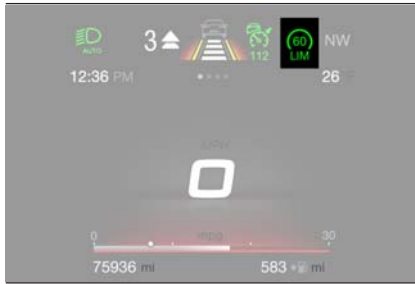

Speed Limiter Display

Speed Limit Programming

The speed limit can be programmed through the Information and Entertainment System.

To access the function on the main menu, select the following items in sequence: "Settings", "Safety" and "Speed Limiter Set Speed".

By turning the Rotary Pad, the speed increases by 3 mph (5 km/h), from a minimum of 18 mph (30 km/h) to a maximum of 112 mph (180 km/h).

Exceeding The Programmed Speed

By fully pressing the accelerator pedal, the programmed speed can be exceeded even with the device active (e.g. in the event of overtaking).

The device is disabled until the speed drops below the set limit, after which it reactivates automatically.

Programmed Speed Icon Flashing

The programmed speed will flash in the following scenarios:

- When the accelerator pedal has been fully pressed and the vehicle has exceeded the programmed speed.
- Activating the system after setting a limit below the effective speed of the vehicle.
- In the event of overtake acceleration.

Deactivating The Device

The feature can be activated/deactivated through the Information and Entertainment System.

Deactivating The Device

To access this feature on the main menu, select the following items in sequence: "Settings", "Safety", "Speed Limiter" and "OFF".

Automatic Deactivation Of The Device

The device deactivates automatically in the event of fault in the system. In this case, contact an authorized dealer.

Temporary Signal Loss

When the device loses the signal, the white symbol without the speed indication illuminates on the display.

System Failure

If there is a system failure, the amber symbol  illuminates on the display.



ELECTRONIC SPEED CONTROL (CRUISE CONTROL)

Electronic Speed Control Description

This is an electronically controlled driving assistance feature that allows the desired vehicle speed to be maintained, without having to press the accelerator pedal. This feature can be used at a speed above 25 mph (40 km/h) on long stretches of dry, straight roads with few variations (highways).

The speed control buttons are located on the left side of the steering wheel.

Note:

❑ To ensure correct operation, the speed control is designed to deactivate if more than one function is operated simultaneously. In this case, the system can be reactivated by pushing the on/off button  and setting the desired speed.

❑ It is not recommended to use this feature in city traffic.

While driving downhill, the system could brake the vehicle to keep the set speed the same.



Warning!

Speed Control can be dangerous where the system cannot maintain a constant speed. Your vehicle could go too fast for the conditions, and you could lose control and have an accident. Do not use Speed Control in heavy traffic or on roads that are winding, icy, snow-covered or slippery.

Activating

To activate the Electronic Speed Control System, push the on/off button location on the left side of the steering wheel.



07146S0001EM

Electronic Speed Control On/Off Switch

The activation of the system is signaled by the white warning light  illuminating in the instrument cluster display.

The Electronic Speed Control function can remain active at the same time as the Speed Limiter System. If a speed limit below the one indicated in the set speed control, the speed control speed will be lowered to that of the Speed Limiter.

Note: The system cannot be engaged in FIRST or REVERSE gear. It is advisable to engage it in THIRD gear or higher if using the Autostick feature.



Warning!

Leaving the Speed Control system on when not in use is dangerous. You could accidentally set the system or cause it to go faster than you want. You could lose control and have an accident. Always leave the system OFF when you are not using it.

Setting The Desired Speed

To set a desired speed, proceed as follows:

1. Turn the Electronic Speed Control on.
2. When the vehicle has reached the desired speed, push the SET switch up or down and release to activate. When the accelerator is released, the vehicle will keep the selected speed automatically.



07146S0002EM

Set Switch Location

If needed (when overtaking for instance), you can accelerate beyond the set speed by pressing the accelerator. When you release the pedal, the vehicle goes back to the previously set speed.

When traveling downhill with the system active, the vehicle speed may slightly exceed the set one.

Note: Before pushing the SET switch, the vehicle must be traveling at a constant speed on a flat surface.

Increasing/Decreasing Speed

Increasing Speed

Once the Electronic Speed Control has been activated, the speed can be increased by pushing the SET switch upward.

By keeping the button pushed, the set speed will increase until the button is released. The new speed will then be set.

At every movement of the SET switch, the set speed can be adjusted.

Decreasing Speed

When the feature is active, to reduce the speed, push the SET switch downward.

By keeping the button pushed, the set speed will decrease until the button is released. The new speed will then be set.

At every movement of the SET switch, the set speed can be adjusted.

Note: Moving the SET switch allows to adjust the speed according to the selected unit of measurement set on the Information and Entertainment System (see dedicated supplement).

Accelerating When Overtaking

Press the accelerator as you would normally. When the pedal is released, the vehicle will return to the set speed.

Use Of The Feature On Hilly Routes

The feature can automatically downshift to keep the set speed when driving on hilly routes.

On steep grades, the loss or gain in speed may be considerable and is advisable to deactivate the Electronic Speed Control.

Note: The feature keeps the speed set even uphill and downhill. A slight variation in the speed on slight rises is completely normal.

Recalling The Speed

Note: Before returning to the previously set speed, you must accelerate to a speed close to that speed, then push the RES button and release it.

While in DRIVE (D), push and release the RES button to recall the previously set speed.



07146S0003EM

Resume Button Location

In Autostick (sequential) mode, before recalling the previously set speed, you should accelerate until you are close to that speed. Then, push and release the RES button.



Deactivating

Lightly pressing the brake pedal deactivates the speed control without deleting the set speed.

The speed control may also be deactivated by applying the electric park brake or when the braking system is operated (e.g. operation of the ESC system).

The set speed is deleted in the following cases:

- Pushing the on/off button twice.
- The ignition is cycled to the STOP position
- If there is a malfunction with the Electronic Speed Control.

ADAPTIVE CRUISE CONTROL (ACC) – IF EQUIPPED

System Description

The Adaptive Cruise Control (ACC) is a driver assist system that combines the speed control functions for controlling the distance from the vehicle ahead.

The system allows to set and hold the vehicle at the desired speed without needing to press the accelerator. It also allows to set and hold a distance from the vehicle ahead (these settings are set by the driver).

The Adaptive Cruise Control (ACC) uses a radar sensor located behind the front bumper and a camera located in the center/upper part of the windshield, to detect the presence of a vehicle close ahead.



06016S0003EM

Front Bumper Radar Location

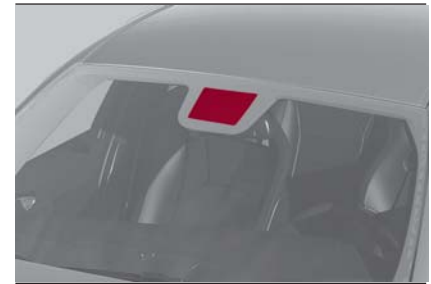

06016S0004EM

Windshield Camera Location

This system enhances driving comfort while on the highway or out of town with light traffic.

If the sensor does not detect a vehicle ahead, the system will maintain a fixed set speed.

If the sensor detects a vehicle ahead, the device automatically intervenes by braking (or accelerating) slightly in order not to exceed the original set speed, so that the vehicle keeps the preset distance, seeking to adapt to the speed of the vehicle ahead.

Note: Adaptive Cruise Control performance is not guaranteed under the following circumstances, and it is

recommended to turn the system off when:

- Driving in fog, heavy rain, or snow
- Driving in heavy traffic or construction zones
- Driving on icy, snowy, slippery roads, roads with steep climbs and descents, or roads with numerous turns and bends
- Entering a turn lane
- Towing a trailer
- When circumstances do not allow safe driving at a constant speed



Warning!

Adaptive Cruise Control (ACC) is a convenience system. It is not a substitute for active driving involvement. It is always the driver's responsibility to be attentive of road, traffic, and weather conditions, vehicle speed, distance to the vehicle ahead; and, most importantly, brake operation to ensure safe operation of the vehicle under all road conditions. Your complete attention is always required while driving to maintain safe control of your vehicle. Failure to follow these warnings can result in a collision and death or serious personal injury.

- The ACC system:
 - Does not react to pedestrians, oncoming vehicles, and stationary objects

(e.g., a stopped vehicle in a traffic jam or a disabled vehicle).

- Cannot take street, traffic, and weather conditions into account, and may be limited upon adverse sight distance conditions.
 - Does not always fully recognize complex driving conditions, which can result in wrong or missing distance warnings.
 - Will bring the vehicle to a complete stop while following a target vehicle and hold the vehicle for approximately 3 minutes in the stop position. If the target vehicle does not start moving within 3 minutes the parking brake will be activated, and the ACC system will be canceled.
- You should switch off the ACC system:

- When driving in fog, heavy rain, heavy snow, sleet, heavy traffic, and complex driving situations (i.e., in highway construction zones).
- When entering a turn lane or highway off ramp; when driving on roads that are winding, icy, snow-covered, slippery, or have steep uphill or downhill slopes.
- When circumstances do not allow safe driving at a constant speed.

Activation/Deactivation

The system has four operating states:

- Enabled (speed not set)
- Activated (speed set)
- Paused
- Deactivated



Enabling/Activating

To enable the system, push and release the  button located on the left side on the steering wheel.



07146S0010EM

On/Off Button

When the system is enabled and ready to operate, the display shows the white icon above dashes in place of the speed.

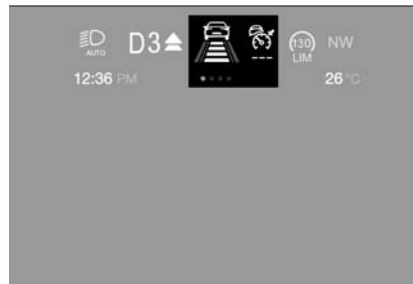

07146S0016EM

Enabled Icons



Setting a speed activates the system. The display shows the icon in green with the set speed.





Warning!

Leaving the Adaptive Cruise Control (ACC) system on when not in use is dangerous. You could accidentally set the system or cause it to go faster than you want. You could lose control and have a collision. Always leave the system off when you are not using it.

Pausing/Deactivating

With the feature enabled (speed not set), push the  (on/off) button to disable.

With the feature active (speed set), push the  (on/off) button to pause. The display will show the icon in white with the speed in brackets. To then deactivate the feature, push the  (on/off) button again.

Setting The Desired Speed

The speed can be set from a minimum of 20 mph (30 km/h) to a maximum of 110 mph (180 km/h).

When the vehicle reaches the desired speed, push the SET switch upward or downward and release it to activate the system. When the accelerator is

released, the vehicle will maintain the set speed automatically.



07146S0017EM

SET Switch

While the accelerator pedal is pressed, the system will not be able to control the distance between the vehicle and the one ahead. In this case, the speed will be determined only by the position of the accelerator pedal.

The system will return to normal operation as soon as the accelerator pedal is released.

The system **cannot** be set:

- When pressing the brake pedal.
- When the brakes are overheated.
- When the electric park brake has been operated.
- When either PARK (P), REVERSE (R) or NEUTRAL (N) is engaged
- When the engine rpm is above a maximum threshold.

When the vehicle speed is not within the operational speed range.

When the ESC (or ABS or other stability control systems) are operating or have just operated.

When the ESC system is off.

When the Forward Collision Warning system (if equipped) is braking automatically.

In the event of system failure.

When the engine is OFF.

In case of obstruction of the radar sensor (in this case the bumper area where it is located must be cleaned).

If the system is set, the conditions described above also cause a cancellation or deactivation of the system. These situations may vary according to the conditions.

Note: The system will not be deactivated when speeds higher than those set are reached by pressing the accelerator pedal above 110 mph (180 km/h). In these situations, the system may not work correctly and it is recommended to deactivate it.

To Vary The Speed Setting

Increasing Speed

Once the system has been activated, you can increase the speed by lifting the SET switch. Each time it is operated, the speed increases by 1 mph.

By holding the button up, the set speed will increase in increments of 5 mph until the button is released. Then, the new speed will be set.

Decreasing Speed

Once the system has been activated, you can decrease the speed by lowering the SET switch. Each time it is operated, the speed decreases by 1 mph.

By holding the button down, the set speed will decrease in increments of 5 mph until the button is released. Then, the new speed will be set.

Note:

❑ Moving the SET switch allows you to adjust the speed according to the selected unit of measurement ("US" or "metric") set on the Information and Entertainment System (see dedicated supplement)

❑ When the unit of measurement is set to metric, holding the SET switch the speed will change in 10 km/h increments

❑ By keeping the accelerator pedal depressed, the vehicle can continue to accelerate beyond the set speed. In this case, use the SET switch to set the speed to the vehicle's current speed

❑ When you push the SET button to reduce the speed, the braking system intervenes automatically if the engine brake does not slow the vehicle down sufficiently to reach the set speed. The device holds the set speed uphill and downhill; however a slight variation is entirely normal, particularly on slight inclines

❑ The transmission could change to a lower gear when driving downhill, or when accelerating. This is normal and necessary to maintain the set speed

❑ The system will disable while driving if the brakes overheat

Accelerating When Overtaking

When driving with ACC activated and following a vehicle, the system will provide an additional acceleration up to the ACC set speed to assist in passing the vehicle. This additional acceleration is triggered when the driver utilizes the left turn signal and will only be active when passing on the left hand side.

The system detects the direction of traffic automatically when the vehicle passes from left-hand traffic to right-hand traffic. In this case, the overtaking assist function is only active when the reference vehicle is overtaken on the right. The additional acceleration is deactivated when the driver uses the right direction indicator and returns to the original lane.

Resuming The Speed

Once the system has been canceled but not deactivated, to resume a previously set speed, simply push the RES button and remove your foot from the accelerator to recall it.

The system will be set to the last stored speed.





07146S0018EM

RES (Resume) Button

Before returning to the previously set speed, bring the speed close to that value, then push the RES button and release it.



Warning!

The Resume function should only be used if traffic and road conditions permit. Resuming a set speed that is too high or too low for prevailing traffic and road conditions could cause the vehicle to accelerate or decelerate too sharply for safe operation. Failure to follow these warnings can result in a collision and death or serious personal injury.

Setting The Distance Between Vehicles

The distance between your vehicle and the vehicle ahead may be set to one bar (short), two bars (medium), three bars (long), or four bars (maximum).

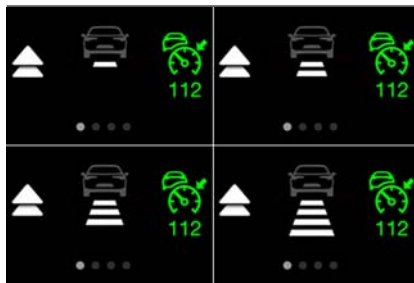

07146S0019EM

Distance Icons

The distances from the vehicle ahead are proportional to speed.

The interval of time with relation to the vehicle ahead remains constant and varies from one second (for the short distance one-bar setting) to two seconds (for the maximum distance four-bar setting).

The set distance is shown on the display by a dedicated icon.

The setting is four (maximum) the first time the system is used. After the distance has been modified by the driver, the new distance will be stored also after the system is deactivated and reactivated.

To Decrease The Distance

Push and release the distance button to decrease the distance setting. The distance setting decreases by one bar (shorter) every time the button is pushed.



07146S0015EM

Distance Button

The set speed is held if there are no vehicles ahead. Once the shortest distance has been selected, the next push of the button will set the maximum distance.

If a slower vehicle is detected in the same lane, the vehicle icon on the display illuminates from grey to white. The system automatically adjusts the vehicle's speed to keep the set speed, independently of the set speed.

The vehicle holds the set distance until:

- The vehicle ahead accelerates to a speed higher than the set speed.
- The vehicle ahead leaves the lane or the detection field of the Adaptive Cruise Control system sensor.
- The distance setting is changed.
- The Adaptive Cruise Control system is deactivated/paused.



Warning!

- The maximum braking applied by the system is limited. The driver may apply the brakes in all cases if needed.
- If the system predicts that the braking level is insufficient to hold the set distance, either "BRAKE!" or a dedicated message is displayed to warn the driver of approaching the vehicle ahead. An acoustic signal is also emitted. In this case, it is advised to brake immediately as necessary to hold a safe distance from the vehicle ahead.
- The driver is responsible for ensuring that there are no pedestrians, other vehicles or objectives along the direction of the vehicle. Failure to comply with these precautions may cause serious accidents and injuries.
- The driver is fully responsible for holding a safe distance from the vehicle ahead respecting the highway code in force in the respective country.

“Stop And Go” Function

The “Stop and Go” operating strategy allows you to maintain a safe distance from the vehicle ahead until the vehicle has completely stopped. It will also restart the vehicle automatically if the vehicle ahead drives away within two seconds, otherwise it is necessary to press the accelerator pedal or push the RES button to restart.



Warning!

When the ACC system is resumed, the driver must ensure that there are no pedestrians, vehicles or objects in the path of the vehicle. Failure to follow these warnings can result in a collision and death or serious personal injury.

Deactivation

The system is deactivated and the set speed is canceled if:

- The  (on/off) button is pushed (when the system is on or paused).
- The ignition is cycled to STOP.

The system is canceled (the set speed and distance are stored):

- When the system is paused (Refer to the “Activation / Deactivation” section).
- When the conditions shown in the “Setting The Desired Speed” section occur.

Limited Operation Warning

If the dedicated message is shown on the display, a condition limiting the Adaptive Cruise Control operation may have occurred.

This could be due to an obstruction of the vehicles sensor or camera. It could also be due to a fault in the system. If an obstruction is detected, clean the



area of the windshield opposite the interior rear view mirror, where the camera is located, as well as the area of the front bumper where the sensor is located. Then check that the message has disappeared.

When the conditions limiting the system functions end, normal operation will resume.

Should the fault persist, contact an authorized dealer.

Precautions While Driving

The system may not work correctly in some driving conditions (see below). The driver must control the vehicle at all times.

Vehicle Not Aligned

The system may not detect a vehicle traveling in the same lane, in the same direction, but is not aligned. It also may not detect a vehicle which is cutting in from a side lane. Sufficient distance from the vehicles ahead may not be guaranteed in these cases.

The non-aligned vehicle can weave in and out of the driving lane causing the vehicle to brake or accelerate unexpectedly.

Steering And Curves

Driving on curves with the system set could limit speed and acceleration to guarantee vehicle stability, even if no vehicles are detected ahead.



When leaving the curve, the system resets the previously set speed.

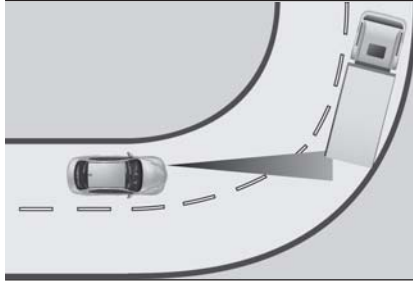

07146S0011EM

Steering And Curves

Note:

- In cases of narrow curves, the performance of the system could be limited. In this case, it is advisable to deactivate the system.
- The system only limits the speed DURING a bend and not BEFORE it.

Using The System On Slopes

When driving on roads with a variable incline, the system may not detect the presence of a vehicle in the lane. System performance could be limited according to speed, load, traffic conditions and steep slopes.

Lane Change

The system may not detect the presence of a vehicle until it is fully in your lane.

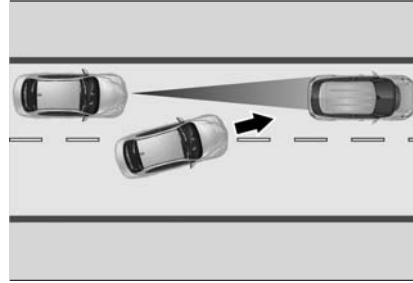

07146S0012EM

Lane Change

In this case, sufficient distance from the vehicle which is changing lanes may not be guaranteed. It is advisable to pay the utmost attention at all times and be always ready to apply the brakes if needed.

Small Vehicles

Some narrow vehicles (e.g. bicycles and motorcycles) traveling near the outer edges of the lane or which enter the lane from curb side are not detected until they are fully in the lane.

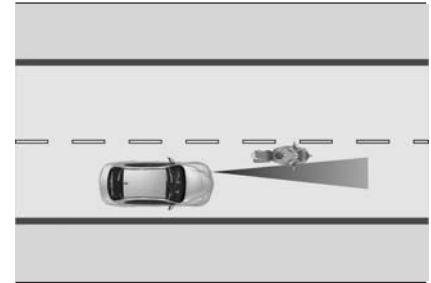

07146S0013EM

Small Vehicles

Sufficient distance from the vehicles ahead may not be guaranteed in these cases.

Stationary Objects And Vehicles

The system cannot detect the presence of stationary vehicles or objects. For example, the system will not operate if the vehicle ahead leaves the lane and a vehicle ahead of that one is stationary in that lane. Pay the utmost attention at all times and be always ready to apply the brakes if needed.

Objects And Vehicles Moving In Opposite Or Crosswise Direction

The system cannot detect the presence of objects or vehicles traveling in opposite or crosswise directions and consequently will not activate.

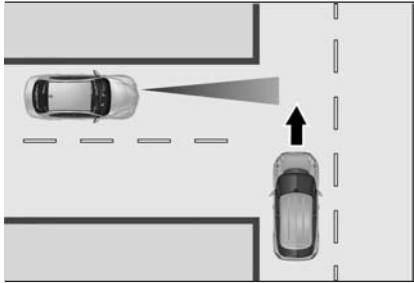

07146S0014EM

Objects And Vehicles Moving In Opposite Or Crosswise Direction

General Information

This vehicle has systems that operate on radio frequency that comply with Part 15 of the Federal Communications Commission (FCC) rules and with Industry Canada Standards RSS-GEN/210/220/310.

Operation is subject to the following two conditions:

1. The device may not cause harmful interference.
2. The device must accept any interference received, including interference that may cause undesired operation of the device.

Changes or modifications to any of these systems by other than an authorized service facility could void authorization to use this equipment.

PARK SENSORS SYSTEM

Vehicles With Rear Sensors Only

The parking sensors, located in the rear bumper, detect obstacles while the vehicle is in REVERSE. When an obstacle is detected, an acoustic alert will sound and visual indications will be displayed on the instrument cluster.



07176S0001EM

Rear Sensor Location

Engagement/Disengagement

To turn the system off, push the Park Sensors System button located to the left of the headlight switch. The indicator light within the button will illuminate when the system is turned off. Pushing the button a second time will turn the system back on, and the indicator light will turn off.





07176S0052EM

Park Sensors System On/Off Switch

The indicator light within the Park Sensors System switch will also be on in case of system failure. If the switch is pushed with a system failure, the indicator light will flash for approximately five seconds. The light will then stay on constantly.

Note: When the ignition is cycled to ON, the Park Sensors System keeps the last state when the engine was stopped (activated or deactivated) in its memory.

System Activation/Deactivation

The system, when engaged, is automatically activated by engaging the REVERSE gear. It is deactivated by engaging another gear.

Acoustic Signal

When REVERSE is engaged and there is an obstacle behind the vehicle, an acoustic signal with variable frequency will sound.

- The acoustic signal increases in frequency as the distance between the vehicle and the obstacle decreases.
- The acoustic signal becomes continuous when the distance between the vehicle and the obstacle is less than 11 inches (30 cm), and stops if the distance increases.
- The acoustic signal is constant if the distance between the vehicle and the obstacle is unchanged.

Note: If several obstacles are detected by the sensors, only the nearest one is considered.

Indication On Display

The driver can select the type of warning they would like to be displayed through the Information and Entertainment System. To access the function on the main menu, select in the following order:

1. "Settings"
2. "Driver Assistance"
3. "ParkSense"
4. "Mode"
5. "Sound-Display"

Visual Indications

The system indicates the presence of an obstacle by displaying a single red arc in the detected area, in relation to the distance of the object and the position of the vehicle.

If the obstacle is detected in the rear central area, a single red arc will be displayed as the obstacle approaches, first constant, then flashing, in addition to an acoustic signal.

If the obstacle is detected in the rear left and/or right area, a single red flashing arc will be shown in the corresponding area on the display and the system will emit an acoustic signal, either at frequent intervals or constantly.

In general, the vehicle is closer to the obstacle when a single red flashing arc is shown on the display and the acoustic signal becomes continuous.

If several obstacles are detected simultaneously in the rear area, the display will show all of them, regardless of the area in which they were detected. It is not possible to exit from the display screen while the vehicle is in REVERSE.

Fault Indication

Parking sensor faults, if any, will be indicated when REVERSE is engaged by a message on the instrument cluster display. Refer to "Warning Lights And Messages" in "Getting To Know Your Instrument Panel" for further information.

Messages On The Display

In case of system failure, a dedicated message appears on the instrument cluster for about five seconds.

❑ Cleaning The Front Sensors: If the display shows a message requiring the sensors to be cleaned, make sure that the outer surface and the underside of the rear bumper is free of debris (e.g. snow, mud, ice, etc.). Once these areas are clear, cycle the ignition to the STOP position. Then, return it to ON position. If the message is still displayed, contact an authorized dealer.

❑ Audio System Not Available: If the display shows a message that the audio system is not available, it means that the acoustic signal will be emitted by the instrument panel, and not through the vehicles speakers.

Note: Some conditions may influence the performance of the Park Sensors System:

- ❑ Reduced sensor sensitivity could be due to the presence of ice, snow, mud, or thick paint on the surface of the sensor.
- ❑ The sensors may detect a false obstacle (echo interference) due to mechanical interference, for example when washing the vehicle or in extreme weather.

❑ The signals sent by the sensors can be altered by the presence of ultrasonic systems (e.g. pneumatic brake systems of trucks or pneumatic drills) near the vehicle.

❑ System performance can be influenced by the position of the sensors. For example, due to a change in the ride setting (caused by wear to the shock absorbers or suspension), by changing tires, overloading the vehicle or operations that require the vehicle to be lowered.

❑ Be sure not to place bumper stickers or other adhesives over the sensors as this will affect system performance.



Warning!

Drivers must be careful when backing up even when using the Parking Sensor system. Always check carefully behind your vehicle, and be sure to check for pedestrians, animals, other vehicles, obstructions, or blind spots before backing up. You are responsible for the safety of your surroundings and must continue to pay attention while backing up. Failure to do so can result in serious injury or death.



Caution!

- ❑ *The Parking Sensor system is only a parking aid and it is unable to recognize every obstacle, including small obstacles. Parking curbs might be temporarily detected or not detected at all. Obstacles located above or below the sensors will not be detected when they are in close proximity*
- ❑ *The vehicle must be driven slowly when using the Parking Sensor system in order to be able to stop in time when an obstacle is detected. It is recommended that the driver looks over his/her shoulder when using the Parking Sensor system.*



Vehicles With Front And Rear Sensors

The parking sensors, located in the front and rear bumpers, detect the presence of any obstacles and warn the driver through an acoustic signal and visual indications will be displayed on the instrument cluster.



07176S0003EM

Front Sensor Location



07176S0001EM

Rear Sensor Location

Engagement/Disengagement

To turn the system off, push the Park Sensors System switch located to the left of the headlight switch. The indicator light within the switch will illuminate when the system is turned off. Pushing the switch a second time will turn the system back on, and the indicator light will turn off.

The indicator light within the Park Sensors System switch will also be on in case of system failure. If the switch is pushed with a system failure, the indicator light will flash for approximately five seconds. The light will then stay on constantly.

Note: When the ignition is cycled to ON the Park Sensors system keeps the last state when the engine was stopped (activated or deactivated) in its memory.

System Activation/Deactivation

When the REVERSE gear is engaged and the system is on, the front and rear sensors are activated. If the vehicle moves from REVERSE to a forward gear, the rear sensors are deactivated, while the front sensors remain active until the speed of 9 mph (15 km/h) is exceeded.

Note: In certain operating conditions, the system could start detecting an obstacle only after the vehicle has moved slightly (a few inches).

Acoustic Signal

In the presence of an obstacle at the front or the rear of the vehicle, an acoustic signal with variable frequency will sound:

- The acoustic signal increases in frequency as the distance between the vehicle and the obstacle decreases.
- The acoustic signal becomes continuous when the distance between the vehicle and the obstacle is less than 11 in (30 cm), and stops if the distance increases.
- The acoustic signal is constant if the distance between the vehicle and the obstacle is unchanged.

Note: If the sensors detect several front and rear obstacles, the closest obstacle is considered. An intermittent signal will sound if the obstacles are at the same distance (front and rear).

When the system emits an acoustic signal, the volume of the Information and Entertainment System, if activated, is automatically lowered.

Indication On Display

The driver can select the type of warning they would like to be displayed through the Information and Entertainment System. To access the function on the main menu, select in the following order:

1. "Settings"
2. "Driver assistance"
3. "ParkSense"
4. "Mode"
5. "Sound-Display"

Visual Indications

The system indicates the presence of an obstacle by displaying a single red arc in the detected areas, in relation to the distance of the object and the position of the vehicle.

If the obstacle is detected in the front or rear central area, a single red arc will be displayed as the obstacle approaches, first constant, then flashing, in addition to an acoustic signal.

If the obstacle is detected in the front or rear left and/or right area, a single red flashing arc will be shown in the corresponding area on the display and the system will emit an acoustic signal, either at frequent intervals or constantly.

If several obstacles are detected simultaneously in the front and rear area, the display will show all of them,

regardless of the area in which they were detected.

In general, the vehicle is closer to the obstacle when a single or several flashing arcs are shown on the display and the acoustic signal becomes continuous.

It is not possible to exit from the display screen while the vehicle is in REVERSE.

Fault Indication

Parking sensor faults, if any, will be indicated by a message on the display on the instrument cluster. Refer to "Warning Lights And Messages" in "Getting To Know Your Instrument Panel" for further information.

Messages On The Display

In case of system failure, a dedicated message appears on the instrument cluster for about five seconds.

□ Cleaning the front or rear sensors: If the display shows a message requiring the sensors to be cleaned, make sure that the outer surface and the underside of the front and rear bumpers are free of debris (e.g. snow, mud, ice, etc.). Once these areas are clear, place the ignition in STOP mode. Then, return it to ON mode. If the message is still displayed, contact an authorized dealer.

□ Audio system not available: If the display shows a message that the audio system is not available, it means

that the acoustic signal will be emitted by the instrument panel, and not through the vehicles speakers.

Note: Some conditions may influence the performance of the Park Sensors System:

- Reduced sensor sensitivity could be due to the presence of ice, snow, mud, or thick paint on the surface of the sensor.
- The sensors may detect a false obstacle (echo interference) due to mechanical interference, for example when washing the vehicle or in extreme weather.
- The signals sent by the sensors can be altered by the presence of ultrasonic systems (e.g. pneumatic brake systems of trucks or pneumatic drills) near the vehicle.
- System performance can be influenced by the position of the sensors. For example, due to a change in the ride setting (caused by wear to the shock absorbers or suspension), by changing tires, overloading the vehicle or operations that require the vehicle to be lowered.

□ Be sure not to place bumper stickers or other adhesives over the sensors as this will affect system performance.



**Warning!**

Drivers must be careful when backing up even when using the Parking Sensor system. Always check carefully behind your vehicle, and be sure to check for pedestrians, animals, other vehicles, obstructions, or blind spots before backing up. You are responsible for the safety of your surroundings and must continue to pay attention while backing up. Failure to do so can result in serious injury or death.

**Caution!**

The Parking Sensor system is only a parking aid and it is unable to recognize every obstacle, including small obstacles. Parking curbs might be temporarily detected or not detected at all. Obstacles located above or below the sensors will not be detected when they are in close proximity

The vehicle must be driven slowly when using the Parking Sensor system in order to be able to stop in time when an obstacle is detected. It is recommended that the driver looks over his/her shoulder when using the Parking Sensor system.

LANE DEPARTURE WARNING (LDW) SYSTEM

Description

The Lane Departure Warning system uses a forward looking camera located on the windshield to detect lane markings and measure vehicle position within the lane boundaries.

When one or both lane limits are detected and the vehicle passes over one without the an activated turn signal, the system emits a visual as well as an acoustic signal.

If the vehicle continues to go beyond the line of the lane without any intervention from the driver, the surpassed line will light up on the display (left or right) to urge the driver to bring the vehicle back into the limits of the lane.

**Caution!**

Do not tamper with nor operate on the camera. Do not close the openings in the aesthetic cover located under the interior rear view mirror. In the event of a failure of the camera, contact an authorized dealer.

The camera may have limited or absent operation due to weather conditions such as: heavy rain, hail, thick fog, heavy snow, formation of ice layers on the windshield.

Camera operation may also be compromised by the presence of dust, condensation, dirt or ice on the windshield, by traffic conditions (e.g. vehicles that are driving not aligned with yours, vehicle driving in a transverse or opposite way on the same lane, bend with a small radius of curvature), by road surface conditions and by driving conditions (e.g. off-road driving). Make sure the windshield is always clean. Use specific detergents and clean cloths to avoid scratching the windshield. The camera operation may also be limited or absent in some driving, traffic and road surface conditions.

If the windshield must be replaced due to scratches, chipping or breakage, contact exclusively an authorized dealer. Do not replace the windshield on your own. It is advisable to replace the windshield if it is damaged in the area of the camera.

System Activation/ Deactivation

The system is activated/deactivated by pushing the button located on the end of the multifunction lever.

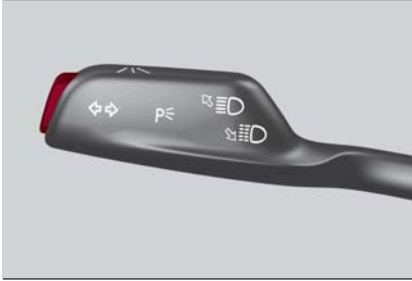

07226S0001EM

Lane Departure Warning System Activation/Deactivation Button

Note: When the engine is started, the system maintains the operating mode that was selected when it was turned OFF.

Activation Conditions

Once turned on, the system becomes active only if the following conditions are met:

- The vehicle speed is above 37 mph (60 km/h).
- The lane limit lines are visible at least on one side.

- There are suitable visibility conditions.
- The road is straight or with wide radius bends.
- A suitable distance is kept from the vehicle in front.
- The turn signal is not active.

Symbols And Messages On The Display

The Lane Departure Warning system advises the driver when the vehicle leaves the driving lane by showing symbols and messages on the instrument cluster display.

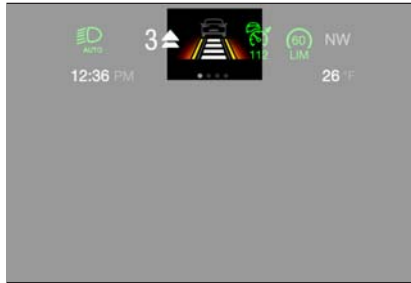

Vehicle Changing Lanes

When the system is active and the lane limits have not been detected, the display shows a grey vehicle icon with two grey lines

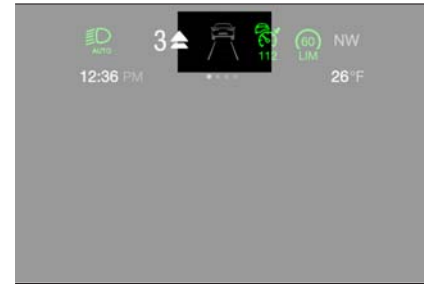

Lane Limits Not Detected

Exiting a lane with detection of a single limit

When the system is active and only, for example, the left lane limit has been detected, the detected lane illuminates in white on the display; the system is ready to provide visual warnings on the display in the event of unintentional exiting of the lane (turn signal not activated) to the left.

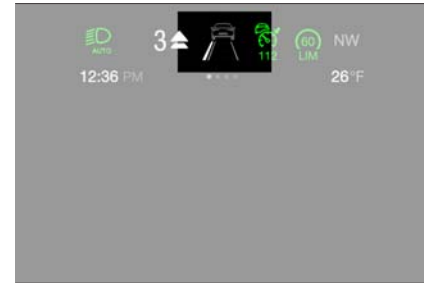

Left Lane Limit Detected



When the system detects that the vehicle has approached the lane line and is about to pass it, the left line on the display illuminates in yellow.

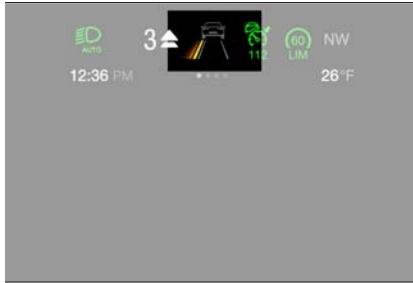

07226S0004EM

Left Lane Limit Approached

The system operates in the same way, but mirrored, in the event of exiting the right lane when only the right lane limit has been detected.

Exiting a lane with detection of both limits

When the system is active, both lane lines on the display illuminate in white to indicate the successful detection of both limits.



07226S0005EM

Both Lane Limits Detected

When lane limits are detected, the system is ready to provide indications in case the driver unintentionally leaves the lane (turn signal not activated).

As the Lane Departure Warning system detects the lane limits while the vehicle is in motion, it will adjust the display accordingly (from white to yellow and vice versa, and increase their thickness).

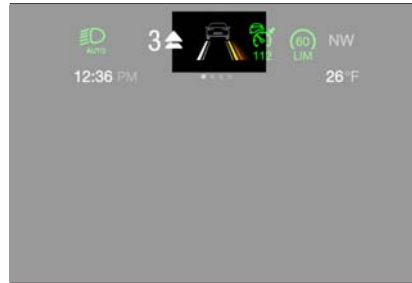

07226S0006EM

Right Lane Limit Approached

If a line is crossed, the driver is alerted by an audible signal as well as the visual indication in the instrument cluster. The signal is emitted through the speakers on the side of the lane limit which is being crossed (eg. if the vehicle is exceeding the left line of the lane, the audible signal will come from the speakers on the left of the vehicle).

Changing The System Settings

The system's sensitivity can be set through the Information and Entertainment System. Sensitivity "High" or "Low" can be selected.

To access the function, from the main menu select the following in order:

1. "Settings"
2. "Safety"
3. "Lane Departure Warning"
4. "Sensitivity"

Limited Operation Warning

If a message appears on the display, a condition limiting the Lane Departure Warning system operation may have occurred. This could be an obstruction of the camera view, or a fault in the system.

If an obstruction is detected, clean the area of the windshield by the interior rear view mirror.

Although the vehicle can still be driven in normal conditions, the system may not function properly.

When the conditions limiting the system are corrected, it will go back to normal operation. Should a fault persist, contact an authorized dealer.

System Failure Warning

If the system turns off and  appears on the display, it means that there is a system fault.

In this case, it is still possible to drive the vehicle, but you are advised to contact an authorized dealer as soon as possible.

REAR BACK-UP CAMERA / DYNAMIC GRIDLINES

Description

The Rear Back-Up Camera is located just under the vehicle's trunk lid, above the rear license plate.



07186S0001EM

Rear Back-Up Camera Location

When the vehicle is in REVERSE, the Information and Entertainment System display will show the area behind the vehicle, as seen by the Rear Back-up Camera, along with a warning message.



07186S0002EM

Rear Back-Up Camera Display

Rear Back-Up Camera Features

To activate the Rear Back-Up Camera features, select "Settings" from the Main Menu of the Information and Entertainment System. Under "Driver Assistance", Rear Back-Up Camera features can be selected:

- View
- Camera Delay
- Camera Guidelines

Selecting "View" will activate the camera view on the display.

Selecting "Camera Delay" will allow the camera view to remain on the display shortly after the vehicle is no longer in REVERSE, followed by the previously active screen.



Selecting “Camera Guidelines” will activate the display of the dynamic guidelines that indicate the route of the vehicle.



Warning!

Drivers must be careful when backing up even when using the Rear Back Up Camera. Always check carefully behind your vehicle, and be sure to check for pedestrians, animals, other vehicles, obstructions, or blind spots before backing up. You are responsible for the safety of your surroundings and must continue to pay attention while backing up. Failure to do so can result in serious injury or death.



Caution!

To avoid vehicle damage, Rear Back Up Camera should only be used as a parking aid. The Rear Back Up Camera is unable to view every obstacle or object in your drive path.

To avoid vehicle damage, the vehicle must be driven slowly when using the Rear Back Up Camera to be able to stop in time when an obstacle is seen. It is recommended that the driver look frequently over his/her shoulder when using the Rear Back Up Camera.

Symbols And Messages On The Display

Indications On The Display

Through the Information and Entertainment System settings, by activating the “Camera Guidelines” feature, guidelines can be seen on the rear camera display. If activated, the guidelines are positioned on the image to highlight the width of the vehicle and the expected reverse path based on the steering wheel position.

A superimposed central line indicates the center of the vehicle to assist in rear parking maneuvers. The various colored areas indicate the distance from the rear of the vehicle.

The table below shows the approximate distances for each area:

Area	Distance from the rear of the vehicle
Red	0–11.8 inches (0–30 cm)
Yellow	11.8 inches to 3.3 feet (30 cm–1 m)
Green	3.3 feet or more (1 m or more)

Messages On The Display

If the trunk lid is lifted, the camera will not detect any obstacle behind the vehicle. The display will show a dedicated warning message.

Make sure the trunk lid is closed by pushing next to the lock until it clicks.

Important Notes

- Ice, snow or mud on the surface of the camera may reduce its sensitivity. It is important to keep the camera surface clean, and free from debris.
- When parking, be aware of obstacles that may be above or under the camera range.

REFUELING THE VEHICLE

Refueling The Vehicle

Before refueling, make sure that the fuel type is correct.

Also, stop the engine before refueling.

Note: An inefficient catalytic converter leads to harmful exhaust emissions, thus contributing to air pollution.



Caution!

Never introduce leaded fuel to the tank, even in small amounts in an emergency, as this would damage the catalytic converter beyond repair.

Refueling Capacity

To ensure that you fill the tank completely, top off twice after the first click of the fuel nozzle.

Further top-off could cause faults in the fuel feeding system.

Refueling Procedure

The fuel filler door is unlocked when the central door locking system is unlocked. It is automatically locked when the central locking system is applied.

Opening The Fuel Filler Door

To refuel proceed as follows:

1. Open fuel filler door by pressing on the point shown by the arrow.



Fuel Door

07206S0001EM

2. Remove the fuel filler cap.
 3. Insert the fuel nozzle fully into the filler pipe.
 4. When the fuel nozzle “clicks” or shuts off, before removing the nozzle, wait for at least 10 seconds in order for the fuel to flow inside the tank.
 5. Remove the fuel filler nozzle, tighten the gas cap about ¼ turn until you hear one click. This is an indication that cap is properly tightened.
- The label indicates the fuel type (UNLEADED FUEL = gasoline).

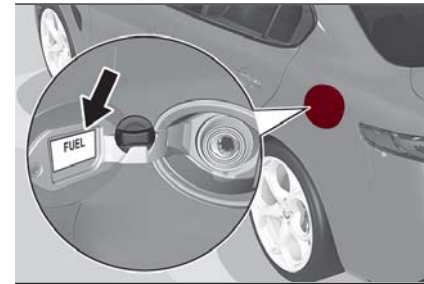

07206S0002EM

Fuel Door Label

Emergency Fuel Door Opening

In the event of an emergency the fuel filler door can be opened by operating from inside the trunk.

Proceed as follows:

1. Open the trunk and locate the emergency fuel filler release cap on the inside lining.
2. Open the cap, and pull the cord inside to unlock the fuel filler door.
3. Open the fuel filler door by pressing on it (see the previous instructions).



**Warning!**

- Never have any smoking materials lit in or near the vehicle when the fuel door is open or the tank is being filled.
- Never add fuel when the engine is running. This is in violation of most state and federal fire regulations and may cause the MIL to turn on.
- A fire may result if gasoline is pumped into a portable container that is inside of a vehicle. You could be burned. Always place gas containers on the ground while filling.

Note: If the filler compartment is washed with a pressure washer, keep it at a distance of at least 8 inches (20 cm).

VEHICLE LOADING**Certification Label**

As required by National Highway Traffic Safety Administration regulations, your vehicle has a certification label affixed to the driver's side door or pillar.

This label contains the month and year of manufacture, Gross Vehicle Weight Rating (GVWR), Gross Axle Weight Rating (GAWR) front and rear, and Vehicle Identification Number (VIN). A Month-Day-Hour (MDH) number is included on this label and indicates the Month, Day and Hour of manufacture. The bar code that appears on the bottom of the label is your VIN.

Gross Vehicle Weight Rating (GVWR)

The GVWR is the total permissible weight of your vehicle including driver, passengers, vehicle, options and cargo. The label also specifies maximum capacities of front and rear axle systems (GAWR). Total load must be limited so GVWR and front and rear GAWR are not exceeded.

Payload

The payload of a vehicle is defined as the allowable load weight a truck can carry, including the weight of the driver, all passengers, options and cargo.

Gross Axle Weight Rating (GAWR)

The GAWR is the maximum permissible load on the front and rear axles. The load must be distributed in the cargo area so that the GAWR of each axle is not exceeded.

Each axle GAWR is determined by the components in the system with the lowest load carrying capacity (axle, springs, tires or wheels). Heavier axles or suspension components sometimes specified by purchasers for increased durability does not necessarily increase the vehicle's GVWR.

Tire Size

The tire size on the Vehicle Certification Label represents the actual tire size on your vehicle. Replacement tires must be equal to the load capacity of this tire size.

Rim Size

This is the rim size that is appropriate for the tire size listed.

Inflation Pressure

This is the cold tire inflation pressure for your vehicle for all loading conditions up to full GAWR.

Curb Weight

The curb weight of a vehicle is defined as the total weight of the vehicle with all fluids, including vehicle fuel, at full capacity conditions, and with no occupants or cargo loaded into the vehicle. The front and rear curb weight values are determined by weighing your vehicle on a commercial scale before any occupants or cargo are added.

Loading

The actual total weight and the weight of the front and rear of your vehicle at the ground can best be determined by weighing it when it is loaded and ready for operation.

The entire vehicle should first be weighed on a commercial scale to insure that the GVWR has not been exceeded. The weight on the front and rear of the vehicle should then be determined separately to be sure that the load is properly distributed over the front and rear axle. Weighing the vehicle may show that the GAWR of either the front or rear axles has been exceeded but the total load is within the specified GVWR. If so, weight must be shifted from front to rear or rear to front as appropriate until the specified weight limitations are met. Store the heavier items down low and be sure that the weight is distributed equally. Stow all loose items securely before driving.

Improper weight distributions can have an adverse effect on the way your vehicle steers and handles and the way the brakes operate.



Caution!

Do not load your vehicle any heavier than the GVWR or the maximum front and rear GAWR. If you do, parts on your vehicle can break, or it can change the way your vehicle handles. This could cause you to lose control. Also overloading can shorten the life of your vehicle.

TRAILER TOWING

Trailer towing is not recommended for this vehicle.



SUGGESTIONS FOR DRIVING

Saving Fuel

Below are some suggestions which may help you save fuel and lower the amount of harmful emissions released into the atmosphere.

Vehicle Maintenance

Checks and operations should be carried out in accordance with the Maintenance Plan. Refer to "Scheduled Servicing" in "Servicing And Maintenance" for further information.

Tires

Check the tire pressures at least once every four weeks: if the pressure is too low, consumption levels increase as resistance to rolling is higher.

Unnecessary Loads

Do not travel with an overloaded trunk. The weight of the vehicle and its arrangement greatly affect fuel consumption and stability.

Electric Devices

Use electrical systems only for the amount of time needed. The rear window defroster, additional headlights, windshield wipers and heater blower fan require a considerable amount of energy; increasing the current uptake increases fuel consumption (by up to +25% when city driving).

Climate Control System

Using the climate control system will increase consumption: use standard ventilation when the temperature outside permits.

Devices for Aerodynamic Control

The use of non-certified devices for aerodynamic control may adversely affect air drag and consumption levels.

Driving Style

Starting

Do not warm up the engine at low or high revs when the vehicle is stationary; this causes the engine to warm up more slowly, thereby increasing fuel consumption and emissions. It is therefore advisable to drive off immediately, slowly, avoiding high speeds: by doing this the engine will warm up more quickly.

Unnecessary Actions

Avoid revving up when starting at traffic lights or before stopping the engine. This action is unnecessary and causes increased fuel consumption and pollution.

Gear Selection

Use a high gear when traffic and road conditions allow it. Using a low gear for faster acceleration will increase fuel consumption. Improper use of a high gear increases consumption, emissions and engine wear.

Max. Speed

Fuel consumption considerably increases as speed increases. Maintain a constant speed, avoiding unnecessary braking and acceleration, which cost in terms of both fuel consumption and emissions.

Acceleration

Accelerating violently severely affects consumption and emissions: acceleration should be gradual and should not exceed the maximum torque.

Conditions Of Use

Cold Starting

Short trips and frequent cold starts will not allow the engine to reach optimum operating temperature. This results in a significant increase in consumption levels (from +15 to +30% in city driving) and emissions.

Traffic And Road Conditions

High fuel consumption is caused by heavy traffic, for instance when travelling in traffic with frequent use of low gears or in cities with many traffic lights. Winding mountain roads and rough road surfaces also adversely affect consumption.

Stops In Traffic

During prolonged stops (e.g. railway crossings) turn off the engine.

Transporting Passengers



Warning!

- It is extremely dangerous to leave children in a parked vehicle when the temperature outside is very high. The heat inside the passenger compartment may have serious, or even fatal, consequences.
- Never travel in the trunk of the vehicle. In the event of an accident, anyone inside the trunk would be at greater risk of serious or even fatal injury.
- Ensure that all the occupants of the vehicle wear their seat belts correctly and that any children are positioned correctly on the dedicated child restraint systems.

Transporting Animals

The intervention of the airbags may be dangerous for an animal on the front seat. It is therefore advised to arrange animals on the rear seat inside dedicated cages restrained by the vehicle's seat belts.

Keep in mind that, in the event of a sudden braking or an accident, an inadequately restrained animal may be projected within the passenger compartment, risking injury to the animal itself and the other occupants of the vehicle.

Exhaust Gas

Exhaust emissions are very dangerous, and may be lethal. They contain carbon monoxide, a colorless, odorless gas which can cause fainting and poisoning if inhaled.

To avoid inhaling carbon monoxide, take the following measures:

- Do not keep the engine running in closed spaces.
- If, for some reason (e.g. transporting bulky loads), it is necessary to drive with the trunk open, close all the windows and run the climate control fan at maximum speed. DO NOT activate air recirculation mode.
- Should it be necessary to stay in the stationary vehicle with engine running, adjust the ventilation/heating system and operate the fan in such a way that outside air will enter the passenger compartment. Activate the maximum fan speed.

Maintenance of the exhaust system provides the best protection against leaks of carbon monoxide into the passenger compartment.

Should an unusual noise from the exhaust system or the presence of exhaust gas in the passenger compartment be identified, or if the underbody or rear section of the vehicle is damaged, have the entire exhaust system and bodywork areas checked to identify any components which are

broken, damaged, worn or have moved from their correct fitting position. If any of these things occur, contact your authorized dealer.

Open welding or loose connections may permit exhaust gas to enter the passenger compartment.

Check the exhaust system each time the vehicle is raised for lubrication or oil change operations. Replace the components if necessary, contact your authorized dealer.



IN CASE OF EMERGENCY

Have a flat tire or a burnt-out bulb?

At times, a problem such as these may interfere with your driving experience.

The section on emergencies can help you to deal with critical situations independently.

In an emergency, we recommend that you call the phone number found in the Warranty Book.

You may also consider contacting your nearest authorized dealer.

HAZARD WARNING LIGHTS	181
BULB REPLACEMENT.	181
FUSES.	186
TIRE SERVICE KIT — IF EQUIPPED	191
JUMP STARTING	194
REFUELING IN EMERGENCY	197
ENGINE OVERHEATING	197
TOWING A DISABLED VEHICLE . .	198
TOW EYES	199
ENHANCED ACCIDENT RESPONSE SYSTEM (EARS)	201
EVENT DATA RECORDER (EDR) . .	201

HAZARD WARNING LIGHTS

The Hazard Warning flasher switch is located in the switch bank below the radio screen.



Push the switch once to turn the hazard warning flasher on. When the switch is activated, all directional turn signals will flash on and off to warn oncoming traffic of an emergency. Push the switch a second time to turn the hazard warning flashers off.

This is an emergency warning system and it should not be used when the vehicle is in motion. Use it when your vehicle is disabled and is creating a safety hazard for other motorists.

When you must leave the vehicle to seek assistance, the hazard warning flashers will continue to operate even though the ignition is placed in the STOP position.

Note: With extended use the hazard warning flashers may discharge your battery.



Hazard Warning Switch

08016S0001EM



Caution!

Prolonged use of the hazard warning flashers may discharge the vehicle's battery.

BULB REPLACEMENT

General Instructions

- Before replacing a bulb, check the contacts for oxidation.
- Replace blown bulbs with others of the same type and power.
- After replacing a headlight bulb, always check its alignment.
- When a light is not working, check that the corresponding fuse is intact before changing the bulb. For the location of fuses, refer to “Fuses” in this chapter.

Note: In some particular climate conditions, such as low temperature, humidity, or after washing the car, a thin condensation layer may form on the internal surfaces of the front and rear headlights. This condensation will disappear after switching on the headlights.



Types Of Bulbs

The vehicle may be equipped with the following bulbs

Glass Bulbs (Type A): They are press-fitted. Pull to extract.

Bayonet-Type Bulbs (Type B): To remove them from their holder, press the bulb and turn it counterclockwise, then extract it.

Tubular Bulbs (Type C): Release them from their contacts to remove.

Halogen Bulbs (Type D): To remove the bulb, turn the connector to the side and pull it out.

Halogen Bulbs (Type E): To remove the bulb, turn it counterclockwise.

Xenon Gas Discharge Bulb (Type F): to remove the bulb, contact an authorized dealer.

A



B



C

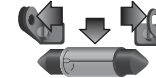

D

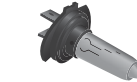

E



F



Replacement Bulbs

Light bulbs	Type	Power
Front direction indicators	PY24W	24 W
Rear Fog lights	H11	55 W
Main beam headlights (Xenon gas discharge)	D5S	25 W
Main beam headlights (Xenon gas discharge)	D3S	35 W
Sun visor light	1.5CP	2.1 W
Glove compartment light	W5W	4 W
Deck lid light	W5W	5 W
Puddle lights (under door panel)	W5W	5 W



Replacing Exterior Bulbs

Note: Only replace the bulb when the engine is off. Also ensure that the engine is cold, to prevent the risk of burns.

Direction Indicators

To change the bulb of these lights, proceed as follows:

1. Operating inside the engine compartment, remove the protective cover.

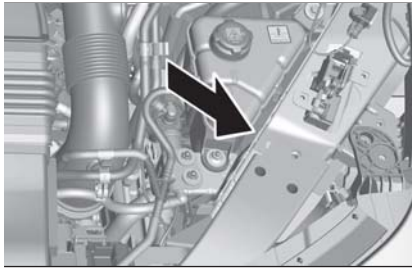

08026S0023EM

Protective Cover Location

2. Remove protective cover.

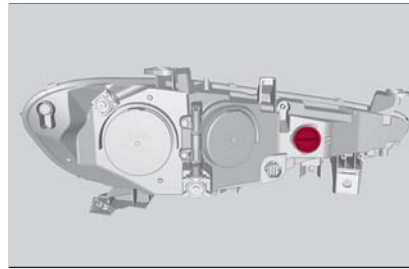

08026S0006EM

Protective Cover

3. Turn the bulb/connector assembly counterclockwise, and then slide it off the headlight body.

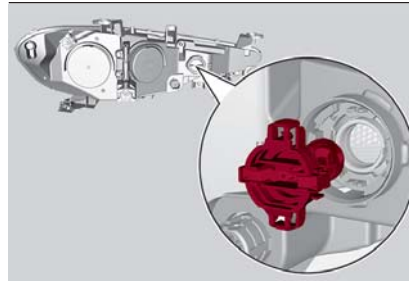

08026S0007EM

Bulb/Connector

4. Remove the bulb by sliding it off the bulb holder.
5. Install the new bulb, making sure it is correctly inserted in the bulb holder.

6. Insert the bulb/connector assembly in the housing on the headlight body and turn it clockwise, making sure that it is locked correctly.

7. Install the protective cover.

Front Light Cluster with Main Beam Xenon Gas Discharge Headlights

To replace the bulbs of the main beam headlights, contact your authorized dealer.



Caution!

Do not touch the new bulb with your fingers. Oil contamination will severely shorten bulb life. If the bulb comes in contact with any oily surface, clean the bulb with rubbing alcohol.

Replacing Interior Bulbs

Courtesy Mirror Light

To replace the bulbs, proceed as follows:

1. Lift the mirror cover and remove the lens, using a suitable tool.

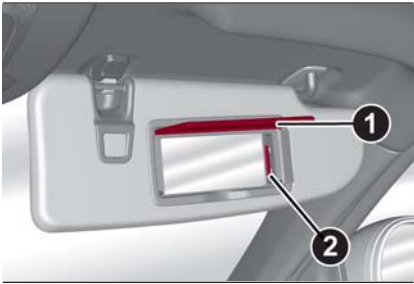

08026S0008EM

Sun Visor

- 1 — Mirror Cover
- 2 — Lens

2. Change the bulb, releasing it from the side contacts, then insert the new bulb, making sure that it is correctly fastened between the contacts.

3. Install the lens, inserting it firstly on one side and then pressing on the other side until it clicks into place.

Glove Compartment Light

To replace the bulb, proceed as follows:

1. Open the glove compartment.
2. Remove the courtesy light assembly, using a suitable tool.

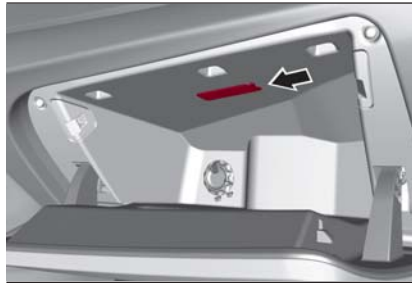

08026S0009EM

Courtesy Lamp Indent

3. Open protective cover up and remove the bulb pulling out of the connector.

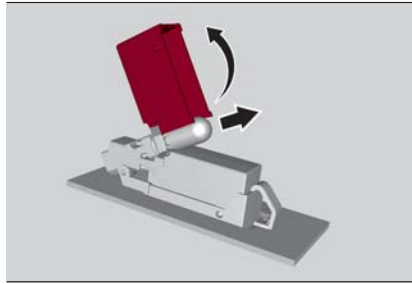

08026S0011EM

Cover And Bulb Removal Direction

4. Install bulb, making sure that it is correctly inserted fully.
5. Close the protective cover on the lens.
6. Install courtesy light, inserting it first on one side and then pressing on the other side until it clicks into place.

Luggage Compartment Courtesy Lights

To replace the bulbs, proceed as follows:

1. Open the trunk, and remove the trunk lamp assembly using a suitable tool.

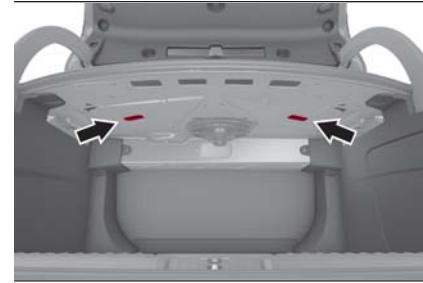

08026S0010EM

Ceiling Light Indent

2. Open protective cover up and remove the bulb pulling out of the connector.

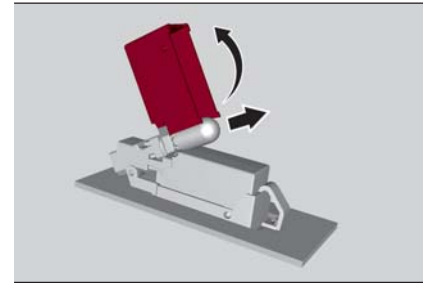

08026S0011EM

Cover And Bulb Removal Direction



3. Install bulb, making sure that it is correctly inserted fully.
4. Close the protective cover on the lens.
5. Install trunk lamp in the correct position, inserting it firstly on one side, and then pressing on the other side until it clicks into place.

Puddle Lights On Door Panel

To replace the bulb, proceed as follows:

1. Open the door and remove the puddle light assembly, using a suitable tool.

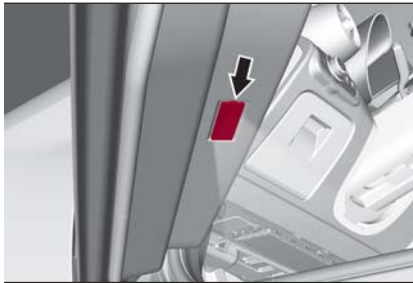

08026S0012EM

Puddle Light Indent

2. Open protective cover up and remove the bulb pulling out of the connector.

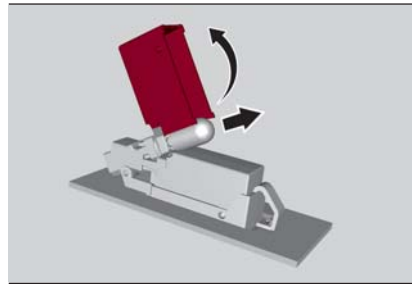

08026S0011EM

Cover And Bulb Removal Direction

3. Install bulb, making sure that it is correctly inserted fully.
4. Close the protective cover on the lens.
5. Install puddle light in the correct position, inserting it firstly on one side and then pressing on the other side until it clicks into place.

FUSES

General Information

The fuses protect electrical systems against excessive current.

When a device does not work, you must check the electrical circuit inside of the fuse for a break/melt.

Also, please be aware that using power outlets for extended periods of time with the engine off may result in vehicle battery discharge.

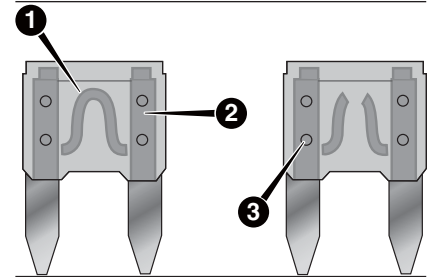

0726067916

Blade Fuses

- 1 — Electrical Circuit
- 2 — Blade Fuse With Good Electrical Circuit
- 3 — Blade Fuse With Bad Electrical Circuit

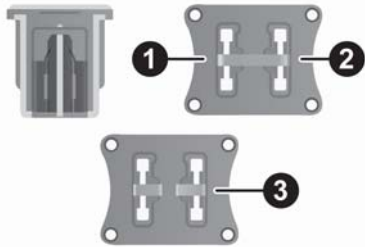

08036S0002EM

J-CASE Fuse

- 1 — Electrical Circuit
- 2 — Case Fuse With Good Electrical Circuit
- 3 — Case Fuse With Bad Electrical Circuit

Fuse Extracting Pliers

To replace a fuse, use the pliers hooked to the fuse box.

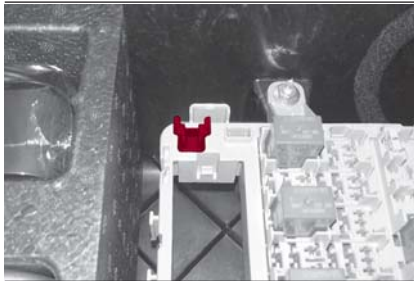

08036S00053EM

Fuse Box

Grab the pliers from the upper tabs, press them, and extract the pliers pulling upwards.

The pliers have two different ends, both of which are specifically designed to remove the different types of fuses present in the vehicle:

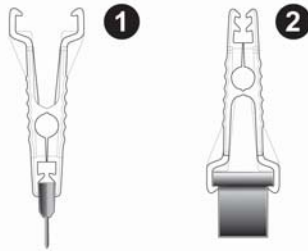

08036S0005EM

Fuse Extracting Pliers

- 1 — MINI fuse
- 2 — J-CASE fuse

After use, return the pliers to their proper position by following the below procedures:

- Grasp the pliers from the upper tabs and insert them into their housing.
- Push downward on the pliers into their housing until they click into place.



Warning!

When replacing a blown fuse, always use an appropriate replacement fuse with the same amp rating as the original fuse. Never replace a fuse with another fuse of higher amp rating. Never replace a blown fuse with metal wires or any other material. Failure to use proper fuses may result in serious personal injury, fire and/or property damage.

Before replacing a fuse, make sure that the ignition is off and that all the other services are switched off and/or disengaged.

If the replaced fuse blows again, contact an authorized dealer.

If a general protection fuse for safety systems (air bag system, braking system), power unit systems (engine system, transmission system) or steering system blows, contact an authorized dealer.

Fuse Location

The fuses, which can be replaced by the user, are grouped in two boxes below the passenger side foot board and inside the trunk.



Control Unit Under Passenger Side Footboard

To access the fuses, proceed as follows:

1. Lift the upper end of the footboard on the passenger side, pulling to release the two buttons.



08036S0010EM

Release Buttons On Footboard

1 — Footboard

2. Unscrewing the two hooks, remove the panel pulling downward.



08036S0011EM

Release Hooks On Footboard

2 — Panel

The fuses are freely accessible on the control unit.

After replacing the fuse, make sure that panel and footboard are correctly locked.

Luggage Compartment Fuse Box

To access the fuses, proceed as follows:

1. Lift the luggage compartment cover.
2. Remove the control unit cover.

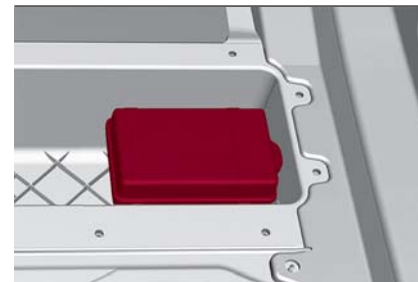

08036S0014EM

Control Unit

The fuses are freely accessible on the control unit.

The number identifying the electrical component corresponding to each fuse is shown on the cover.

After replacing a fuse, make sure that you have closed cover correctly.

Control Unit Under Passenger Side Footboard

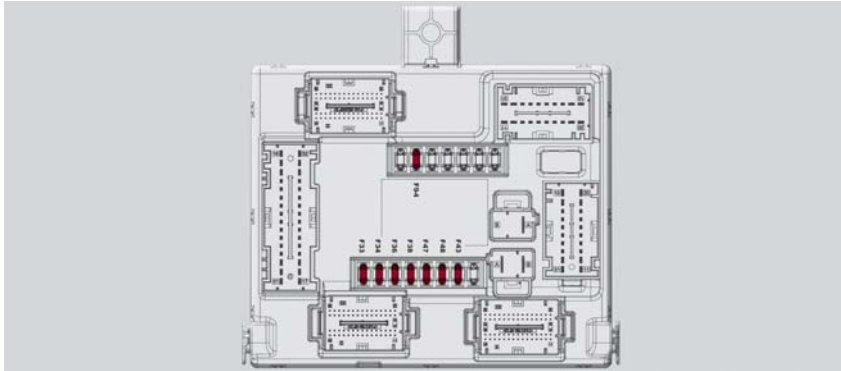

Passenger Side Control Unit

08036S0013EM

FUNCTION	FUSE	AMPERAGE
Front power window (driver side)	F33	25
Front power window (passenger side)	F34	25
Supply for Information and Entertainment system, Climate Control system, Alarm, Power door mirror folding, EOBD system, USB port	F36	15
Safe Lock device (driver side door unlock – if equipped), Doors unlock, Central lock	F38	20
Windshield washer pump	F43	20
Rear left power window	F47	25
Rear right power window	F48	25
Heater rear window coil	F94	15



Luggage Compartment Fuse Box

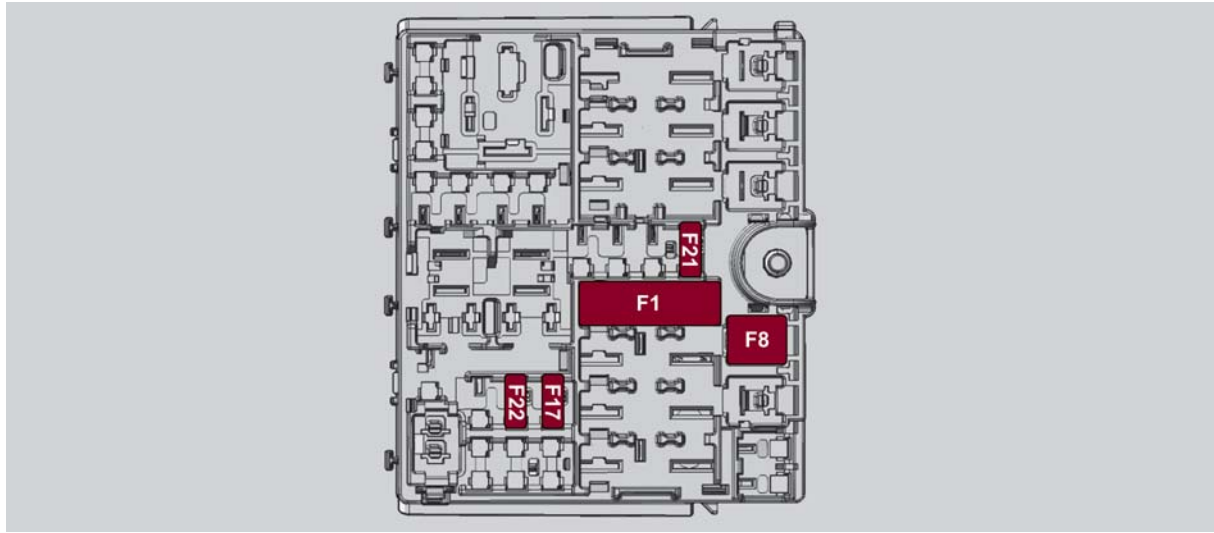

Luggage Compartment Control Unit

0803650015EM

FUNCTION	FUSE	AMPERAGE
Tow hook module (TTM)	F1	40
Hi-Fi system	F8	30
KL15/a USB Recharge (C070)	F17	7.5
I-Drive / USB / AUX port	F21	10
KL15/a 12V Power outlet (R053)	F22	20

TIRE SERVICE KIT — IF EQUIPPED

Description

If a tire is punctured, you can make a first emergency repair using the Tire Service Kit located in the rear storage area under the load floor.

Note: Vehicles equipped with Run Flat Tires will not be equipped with a Tire Service Kit.

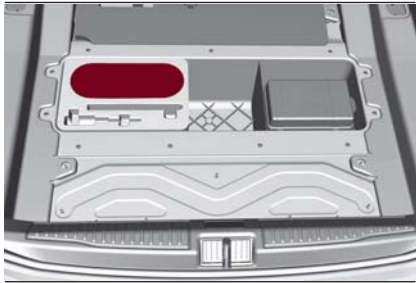

08066S0001EM

Tire Service Kit Location

The Tire Service Kit includes:

- Sealant cartridge containing the sealing fluid.
- Filler tube.
- Adhesive label with the writing "Max. 50 mph (80 km/h)", to be attached in a position easily visible to the driver (eg. on the dashboard) after repairing the tire.
- Air compressor, complete with pressure gauge and connectors.

An instruction pamphlet for reference in prompt and correct use of the Tire Service Kit, which must be then given to the personnel dealing with the sealant-treated tire.

A pair of protective gloves.

Some adaptors, for inflating different elements.

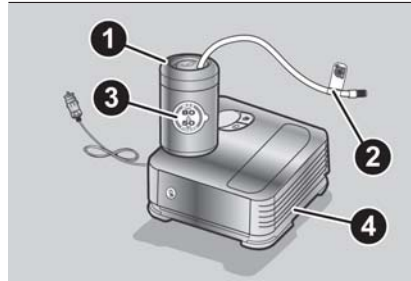

08066S0002EM

Tire Service Kit Components

- 1 — Sealant Cartridge
- 2 — Filler Tube
- 3 — Adhesive Label
- 4 — Air Compressor

Note: The sealing fluid is effective with external temperatures of between -40°F (-40°C) and 122°F (50°C). The sealing fluid has an expiration date.

To use the Tire Service Kit, proceed as follows:

1. Stop the vehicle in a position where you can repair the tire safely. You should be as far as possible from the side of the road, and in a position that is not dangerous for oncoming traffic. Engage the hazard warning flashers, remove the safety triangle from the luggage compartment, and place it at a suitable distance from the vehicle to make other drivers aware of your presence.

2. Verify that the valve stem (on the wheel with the deflated tire) is in a position that is near to the ground. This will allow the tire service kit hoses to reach the valve stem and keep the tire repair kit flat on the ground.

3. Shift the gear selector to PARK (P).

4. Apply the electric park brake and turn the engine OFF.

Inflation Procedure



Warning!

Do not attempt to seal a tire on the side of the vehicle closest to traffic. Pull far enough off the road to avoid the danger of being hit when using the Tire Service Kit.

Do not use Tire Service Kit or drive the vehicle under the following circumstances:

If the puncture in the tire tread is approximately 1/4 inch (6 mm) or larger.

If the tire has any sidewall damage.



- ❑ If the tire has any damage from driving with extremely low tire pressure.
- ❑ If the tire has any damage from driving on a flat tire.
- ❑ If the wheel has any damage.
- ❑ If you are unsure of the condition of the tire or the wheel.
- ❑ Keep Tire Service Kit away from open flames or heat sources.
- ❑ A loose Tire Service Kit thrown forward in a collision or hard stop could endanger the occupants of the vehicle. Always stow the Tire Service Kit in the place provided. Failure to follow these warnings can result in injuries that are serious or fatal to you, your passengers, and others around you.
- ❑ Take care not to allow the contents of Tire Service Kit to come in contact with hair, eyes, or clothing. Tire Service Kit sealant is harmful if inhaled, swallowed, or absorbed through the skin. It causes skin, eye, and respiratory irritation. Flush immediately with plenty of water if there is any contact with eyes or skin. Change clothing as soon as possible, if there is any contact with clothing.
- ❑ Tire Service Kit Sealant solution contains latex. In case of an allergic reaction or rash, consult a physician immediately. Keep Tire Service Kit out of reach of children. If swallowed, rinse mouth immediately with plenty of water and drink plenty of water. Do not induce vomiting! Consult a physician immediately.

To use your Tire Service Kit, proceed as follows:

1. Engage the electric park brake.
2. Insert the sealant cartridge in the proper compressor holder, pushing down hard. Unscrew the tire valve cap, take out the filler tube and tighten the fitting on the tire valve.

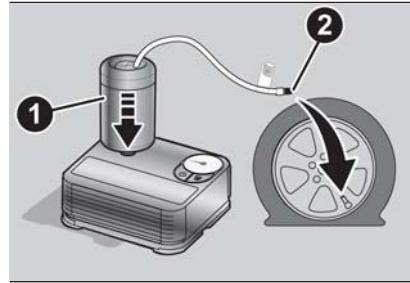

Attaching Filler Tube To Deflated Tire

- 1 – Sealant Cartridge
- 2 – Filler Tube

3. Make sure the power switch of the compressor is in the off position (O).
4. Insert the plug into the power outlet in the center console, then start the engine.

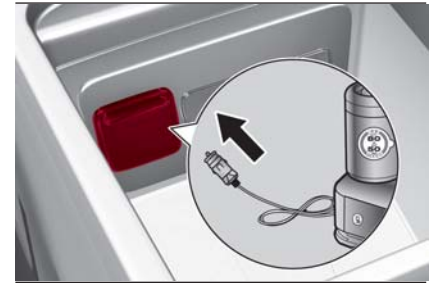

08066S0006EM

Center Console Power Outlet

5. Start the compressor by placing the power switch in the on position (I).
6. Inflate the tire to the pressure indicated on the tire placard, located on the driver's side B-Pillar or the rear edge of the driver's side door. Refer to "Tires" in "Servicing And Maintenance" for more information. In order to obtain a more precise reading, check the pressure value on pressure gauge with the compressor off.

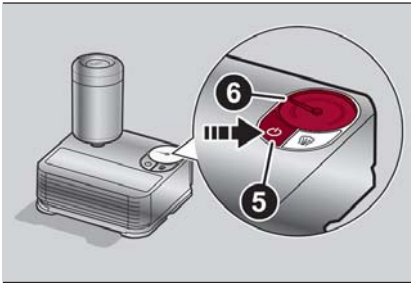

08066S0005EM

Air Compressor

- 5— Power Switch
- 6— Pressure Gauge

7. If the pressure is not at least 26.1 psi (1.8 bar) after 15 minutes, disengage the compressor from the valve and power outlet. Then, move the vehicle forwards approximately five tire turns in order to distribute the sealing fluid inside the tire evenly, and then repeat the inflation operation.

8. If you still cannot obtain a pressure of at least 26 psi (1.8 bar) within 15 minutes from the compressor switching on, do not drive the vehicle, and contact an authorized dealer.

9. Drive the vehicle for about 5 miles (8 km), stop, engage the electric park brake, and recheck the tire pressure.

10. If the pressure is less than 26 psi (1.8 bar), **DO NOT** drive the vehicle, and see an authorized dealer.

11. If a pressure value of at least 26 psi (1.8 bar) is detected, restore the correct pressure (with engine running and electric park brake engaged), and drive immediately with great care to an authorized dealer.



Warning!

Tire Service Kit is not a permanent flat tire repair. Have the tire inspected and repaired or replaced after using Tire Service Kit. Do not exceed 50 mph (80 km/h) until the tire is repaired or replaced. Failure to follow this warning can result in injuries that are serious or fatal to you, your passengers, and others around you. Have the tire checked as soon as possible at an authorized dealer.

12. Apply the adhesive label from the sealant bottle where it can be easily seen by the driver as a reminder that the tire has been treated with a Tire Service Kit, as well as not to exceed the speed restriction for the treated tire.



Warning!

Do not adhere the speed restriction sticker to the padded area on the steering wheel. Adhering the speed restriction sticker to the padded area on the steering wheel is dangerous because the air bag may not operate (deploy) normally resulting in serious injury. In addition, do not adhere the sticker to areas where warning lights or the speedometer cannot be viewed.

Checking And Restoring Tire Pressure

The compressor can also be used to check and, if necessary, restore the tire pressure.

Proceed as follows:

1. Release the quick connector and connect it directly to the valve of the tire to be inflated.



2. Push the air release button.

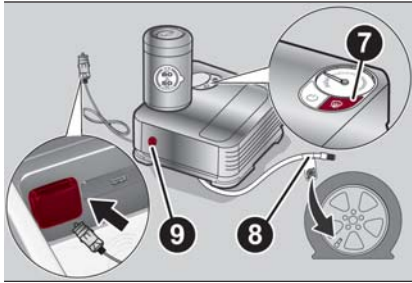

08066S0008EM

Air Compressor Components

- 7— Air Release Button
- 8— Quick Connector
- 9— Release Button

Sealant Cartridge Replacement

Note: Only use original cartridges, which can be purchased at an authorized dealer.

Proceed as follows:

1. Remove the sealant cartridge by pushing the release button located on the side of the compressor.
2. Insert the new sealant cartridge by pushing downward firmly.

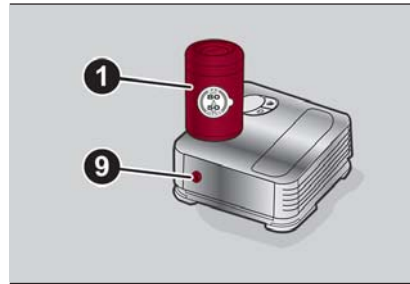

08066S0009EM

Sealant Cartridge Replacement

- 1— Sealant Cartridge
- 9— Release Button

JUMP STARTING

If your vehicle has a discharged battery, it can be jump-started using a set of jumper cables and a battery in another vehicle, or by using a portable battery booster pack. Jump-starting can be dangerous if done improperly, so please follow the procedures in this section carefully.

Note: When using a portable battery booster pack, follow the manufacturer's operating instructions and precautions.



Warning!

Do not attempt jump-starting if the battery is frozen. It could rupture or explode and cause personal injury.



Caution!

Do not use a portable battery booster pack or any other booster source with a system voltage greater than 12 Volts or damage to the battery, starter motor, alternator or electrical system may occur.

Remote Battery Connection Posts

The remote posts of the battery for jump starting can be found inside the engine compartment. The battery itself is located in the luggage compartment. The negative terminal (-) is positioned next to the passenger side hood lock.

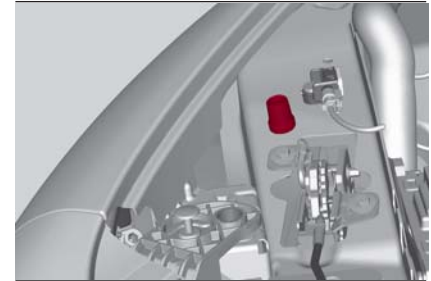

08076S0006EM

Remote Negative Post Location



Warning!

Do not connect the jumper cable to the negative (-) post of the discharged battery. The resulting electrical spark could cause the battery to explode and could result in serious injury. Only use the specific ground point, do not use any other exposed metal parts.

The positive post (+) can be accessed by removing the cover, and opening the protective flap.



08076S0007EM

Protective Flap

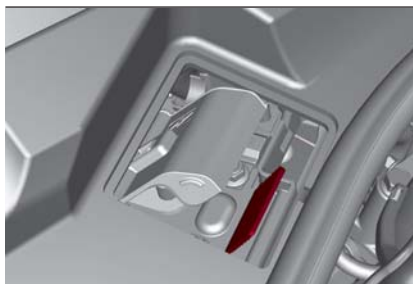

08076S0001EM

Remote Positive Post Location

To carry out the operation, you need to have the correct cables to connect to the battery of another vehicle or a portable battery booster pack to the remote posts of the discharged battery. Usually, these cables have terminals at the ends and are identified by different sheath colors (red = positive, black = negative).

Jump Starting



Warning!

Failure to follow this jump-starting procedure could result in personal injury or property damage due to battery explosion.



Caution!

Failure to follow these procedures could result in damage to the charging system of the booster vehicle or the discharged vehicle.

Preparation For Jump Starting:

1. Firmly apply the parking brake, and turn the ignition to the STOP position.
2. Switch off all electrical features in the vehicle.
3. If using another vehicle to jump-start the battery, park the vehicle within the jumper cables reach, set the parking brake and make sure the ignition is in STOP position.



Warning!

Do not allow vehicles to touch each other as this could establish a ground connection and personal injury could result.



Cable Connection

Proceed as follows to perform a jump starting procedure:

1. Connect the positive (+) end of the jumper cable to the positive (+) post of the vehicle with the discharged battery
2. Connect the opposite end of the positive (+) jumper cable to the positive (+) post of the booster battery.
3. Connect the negative end (-) of the jumper cable to the negative (-) post of the booster battery.
4. Connect the opposite end of the negative (-) jumper cable to a good engine ground of the vehicle with the discharged battery (exposed metal part of the engine) away from the battery and the fuel injection system.



Warning!

Do not connect the jumper cable to the negative (-) post of the discharged battery. The resulting electrical spark could cause the battery to explode and could result in serious injury. Only use the specific ground point, do not use any other exposed metal parts.

5. Start the engine in the vehicle that has the booster battery, let the engine idle a few minutes, and then start the engine in the vehicle with the discharged battery. If using a portable battery booster pack, before starting the vehicle, wait a few seconds after completing the connection.

Cable Disconnection

Once the engine is started, remove the connection cables in reverse sequence, as described below:

1. Disconnect the negative (-) jumper cable from the engine (-) ground of the vehicle with the discharged battery.
 2. Disconnect the negative end (-) of the jumper cable from the negative (-) post of the booster battery.
 3. Disconnect the opposite end of the positive (+) jumper cable from the positive (+) post of the booster battery.
 4. Disconnect the positive (+) end of the jumper cable from the positive (+) post of the vehicle with the discharged battery.
- If frequent jump-starting is required to start your vehicle, you should have the battery and charging system inspected at your authorized dealer.



Caution!

Accessories plugged into the vehicle power outlets draw power from the vehicle's battery, even when not in use (i.e., cellular phones, etc.). Eventually, if plugged in long enough without engine operation, the vehicle's battery will discharge sufficiently to degrade battery life and/or prevent the engine from starting.

Bump Starting

Never jump start the engine by pushing, towing or coasting downhill.

Note: You cannot start a vehicle with an automatic transmission by pushing it.



Caution!

Accessories plugged into the vehicle power outlets draw power from the vehicle's battery, even when not in use (i.e., cellular phones, etc.). Eventually, if plugged in long enough without engine operation, the vehicle's battery will discharge sufficiently to degrade battery life and/or prevent the engine from starting.

REFUELING IN EMERGENCY

Refueling in an emergency is described in "Refueling The Vehicle" in "Starting And Operating".

ENGINE OVERHEATING

Engine overheating may occur in situations of extreme environmental temperatures, frequent engine stops/starts, or driving in heavy traffic. If the engine becomes overheated, the Engine Temperature Warning Light in the instrument cluster will illuminate along with a dedicated message. Refer to "Warning Lights And Messages" in the "Getting To Know Your Instrument Panel" for more information.

In any of the following situations, you can reduce the potential for overheating by taking the appropriate action.

- On the highways — slow down.
- In city traffic — while stopped, place the transmission in NEUTRAL, but do not increase engine idle speed.

Note: There are steps that you can take to slow down an impending overheat condition:

- If your air conditioner (A/C) is on, turn it off. The A/C system adds heat to the engine cooling system and turning the A/C off can help remove this heat.

- You can also turn the temperature control to maximum heat, the mode control to floor and the blower control to high. This allows the heater core to act as a supplement to the radiator and aids in removing heat from the engine cooling system.



Warning!

You or others can be badly burned by hot engine coolant (antifreeze) or steam from your radiator. If you see or hear steam coming from under the hood, do not open the hood until the radiator has had time to cool. Never try to open a cooling system pressure cap when the radiator or coolant bottle is hot.



Caution!

Driving with a hot cooling system could damage your vehicle. If temperature gauge reads "H", pull over and stop the vehicle. Idle the vehicle with the air conditioner turned off until the pointer drops back into the normal range. If the pointer remains on the "H", turn the engine off immediately, and call for service.



If Steam Is Coming From The Engine Compartment

Do not go near the front of the vehicle. Stop the engine. Wait until the steam dissipates. Then, open the hood and start the engine.

If Neither Coolant Nor Steam Is Escaping

Open the hood and idle the engine until it cools.

Note:

- If the cooling fan does not operate while the engine is running, the engine temperature will increase. Stop the engine and contact your authorized dealer.
- If the engine continues to overheat or frequently overheats, have the cooling system inspected. The engine could be seriously damaged unless repairs are made. Contact your authorized dealer.

TOWING A DISABLED VEHICLE

This section describes procedures for towing a disabled vehicle using a commercial towing service.



Caution!

- The vehicle should be transported with all four wheels OFF the ground on the flatbed of a roadside assistance vehicle. Avoid towing with only the front (or rear) wheels lifted. When towing with only the front (or rear) wheels lifted, in addition to damaging the body, it could damage the transmission.
- Do not use sling-type equipment when towing. Vehicle damage may occur.
- When securing the vehicle to a flatbed truck, do not attach to front or rear suspension components. Damage to your vehicle may result from improper towing.
- Ensure that the Electric Park Brake is released, and remain released, while being towed.
- Damage from improper towing is not covered under the New Vehicle Limited Warranty.

The operators of the assistance vehicle must be informed with regard to the vehicle's minimum height from ground in order to avoid contact between the ends of the bumpers with the equipment of the breakdown truck.

The following image illustrates the front and rear attachment corners of the vehicle, to be taken into consideration when loading the vehicle on the assistance vehicle.

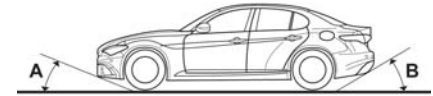

08126S0001EM

Front And Rear Loading Angles

	RWD Models	AWD Models
A	12.880°	15.160°
B	17.105°	18.400°

Rear Wheel Drive (RWD) Models

It is recommended to tow the vehicle with all four wheels OFF the ground on the flatbed of a roadside assistance vehicle.



Caution!

- Do not use sling type equipment when towing. Vehicle damage may occur.
- When securing the vehicle to a flat bed truck, do not attach to front or rear suspension components. Damage to your vehicle may result from improper towing.
- Ensure that the Electric Park Brake is released, and remains released, while being towed.

If an assistance vehicle with a flatbed is not available, the vehicle must be towed with the rear wheels lifted from the ground using a trailer or special equipment allowing lifting of the rear wheels.

Four-Wheel Drive (AWD) Models

It is recommended to tow the vehicle with all four wheels OFF the ground on the flatbed of a roadside assistance vehicle.



Caution!

- DO NOT flat tow this vehicle. Damage to the drivetrain will result.
- DO NOT dolly tow this vehicle. Use of a towing dolly can cause significant damage to your vehicle. Towing this vehicle in violation of the above requirements can cause severe transmission damage. Damage from improper towing is not covered under the New Vehicle Limited Warranty.

TOW EYES

If the vehicle has been in an accident or has broken down, a tow eye is provided in the tools container located inside the luggage compartment for vehicle towing. Towing is meant only for short distances on a paved road surface.

Proceed as follows to use the tow eye:

1. Unhook the cap on the front or rear bumper (if equipped), pushing on the upper part.



08136S0001EM

Front Tow Eye Cap



08136S0003EM

Rear Tow Eye Cap



2. Remove the tow eye from its housing in the trunk and carefully clean the threaded housing on the vehicle before using it.

3. Tighten the vehicle's tow eye in place (about 11 turns).

Note: The largest work angle of a tow cable to fix on the tow hook must not exceed 15°.

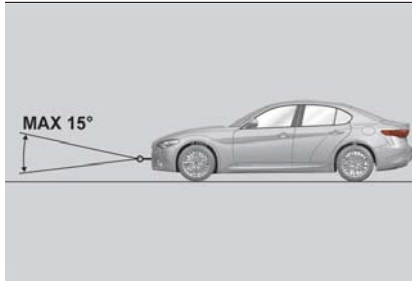

08136S0002EM

Work Angle Of Tow Cable



Warning!

Stand clear of vehicles when pulling with tow eyes.

- Do not use a chain with a tow eye. Chains may break, causing serious injury or death.
- Do not use a tow strap with a tow eye. Tow straps may break or become disengaged, causing serious injury or death.
- Failure to follow proper tow eye usage may cause components to break resulting in serious injury or death.



Caution!

- The tow eye must be used exclusively for roadside assistance operations. Only use the tow eye with an appropriate device in accordance with the highway code (a rigid bar or rope) to flat tow the vehicle for a short distance to the nearest service location.
- Tow eyes **MUST NOT** be used to tow vehicles off the road or where there are obstacles.
- In compliance with the above conditions, towing with a tow eye must take place with two vehicles (one towing, the other towed) aligned as much as possible along the same center line. Damage to your vehicle may occur if these guidelines are not followed.
- When towing, only use a facility that can tow vehicles with low ground clearances as extensive damage can result by using a standard tow truck platform.

ENHANCED ACCIDENT RESPONSE SYSTEM (EARS)

This vehicle is equipped with an Enhanced Accident Response System. Please refer to “Occupant Restraint Systems” in “Safety” for further information on the Enhanced Accident Response System (EARS) function.

EVENT DATA RECORDER (EDR)

This vehicle is equipped with an Event Data Recorder (EDR). The main purpose of an EDR is to record data that will assist in understanding how a vehicle’s systems performed under certain crash or near crash-like situations, such as an air bag deployment or hitting a road obstacle.

Please refer to “Occupant Restraint Systems” in “Safety” for further information on the Event Data Recorder (EDR).



SERVICING AND MAINTENANCE

Correct servicing permits the performance of the vehicle to be maintained over time, as well as limited running costs and safeguarding the efficiency of the safety systems.

This chapter explains how.

SCHEDULED SERVICING.203
ENGINE COMPARTMENT207
BATTERY RECHARGING210
DEALER SERVICE212
RAISING THE VEHICLE218
TIRES218
DEPARTMENT OF5	
TRANSPORTATION UNIFORM	
TIRE QUALITY GRADES235
STORING THE VEHICLE236
BODYWORK237
INTERIORS239

SCHEDULED SERVICING

Correct servicing is crucial for guaranteeing a long life for the vehicle under the best conditions.

For this reason, Alfa Romeo has planned a series of checks and services for your vehicle at fixed intervals based on distance and time, as described in the Scheduled Servicing Plan.

Before each service, it is always necessary to carefully follow the instructions in the Scheduled Servicing Plan (e.g. periodically check level of fluids, tire pressure, etc.).

Scheduled Servicing is offered by an authorized dealer according to a set time schedule. If, during each operation, in addition to the ones scheduled, the need arises for further replacements or repairs, these may be carried out with the owner's explicit consent only.

Note: Scheduled Servicing intervals are required by the Manufacturer. Failure to have them carried out may invalidate the New Vehicle Limited Warranty.

You are advised to inform your authorized dealer of any small operating irregularities without waiting for the next service.

Periodic Checks

Every month or every **600** miles (**1,000** km) or before long trips check and, if necessary, top off:

- Engine coolant level.
- Brake fluid level (if insufficient, see your authorized dealer as soon as possible).
- Windshield washer fluid level.
- Tire inflation pressure and condition.
- Operation of lighting system (headlights, direction indicators, hazard warning lights, etc.).
- Operation of windshield washing/wiping system and positioning/wear of wiper blades.

Every **2,000** miles (**3,000** km), check and top off if required:

- Engine oil level.

Heavy Usage Of The Vehicle

If the vehicle is used under one of the following conditions:

- Dusty roads.
- Short, repeated journeys less than 4 miles (7-8 km) at sub-zero outside temperatures.
- Engine often idling or driving long distances at low speeds or long periods of inactivity.
- In the event of a long period of inactivity.

The following checks must be carried out more often than indicated in the Scheduled Servicing Plan:

- Check cleanliness of hood and trunk locks, cleanliness and lubrication of linkage.
- Visually inspect conditions of: engine, transmission, pipes and hoses (exhaust/fuel system/brakes) and rubber elements (sleeves/bushes, etc.).
- Check battery charge and battery fluid level (electrolyte).
- Visually inspect conditions of the accessory drive belts.
- Check and, if necessary, change engine oil and replace oil filter.
- Check and, if necessary, replace cabin air filter.
- Check and, if necessary, replace air cleaner.

Severe Duty All Models

Change Engine Oil at 4,000 miles (6,500 km) if the vehicle is operated in a dusty and off-road environment or is operated predominately at idle or only very low engine RPM's. This type of vehicle use is considered Severe Duty.



Maintenance Plan (2.0 T4 MAir Engine)

Thousands of miles	10	20	30	40	50	60	70	80	90	100	110	120	130	140	150
Years	1	2	3	4	5	6	7	8	9	10	11	12	13	14	15
Thousands of kilometers	16	32	48	64	80	96	112	128	144	160	176	192	208	224	240
Check battery charge status with the proper instrument	•	•	•	•	•	•	•	•	•	•	•	•	•	•	•
Check tire condition/wear and adjust pressure, if necessary. Check the tire repair kit recharge condition and expire date	•	•	•	•	•	•	•	•	•	•	•	•	•	•	•
Check operation of lighting system (headlights, direction indicators, hazard warning lights, deck lid, passenger compartment, glove compartment, instrument panel warning lights, etc.)	•	•	•	•	•	•	•	•	•	•	•	•	•	•	•
Check and, if necessary, top up fluid levels (1)	•	•	•	•	•	•	•	•	•	•	•	•	•	•	•
Check engine control system operation (via diagnostic tool) and, if equipped, engine oil degradation (2)	•	•	•	•	•	•	•	•	•	•	•	•	•	•	•
Visually inspect conditions of: exterior bodywork, underbody protection, pipes and hoses (exhaust, fuel system, brakes), rubber elements (sleeves, bushes, etc.)		•		•		•		•		•		•		•	
Check position/wear of front windshield wiper blade	•		•		•		•		•		•		•		•
Check operation of the windshield wiper/washer system and adjust nozzles, if necessary	•		•		•		•		•		•		•		•

(1) Top up using the fluids indicated in the “Fluids And Lubricants” section of the “Technical Specifications” chapter only after checking that the system is intact.

(2) If oil degradation ratio (data collectable from diagnostic device) is more than 80% (oil quality less than 20%) engine oil and filter replacement is recommended.

Thousands of miles	10	20	30	40	50	60	70	80	90	100	110	120	130	140	150
Years	1	2	3	4	5	6	7	8	9	10	11	12	13	14	15
Thousands of kilometers	16	32	48	64	80	96	112	128	144	160	176	192	208	224	240
Check cleanliness of hood and luggage compartment locks, cleanliness and lubrication of linkage		•		•		•		•		•		•		•	
Visually inspect conditions and wear of front/rear disc brake pads and operation of pad wear indicators	•	•	•	•	•	•	•	•	•	•	•	•	•	•	•
Visually inspect the condition and tensioning of the accessory drive belt(s)	•	•	•		•	•	•		•	•	•		•	•	•
Change engine coolant															•
Change engine oil and replace oil filter								(3)							
Replace transfer case oil (AWD models only)								•							
Replace accessory drive belt/s								(4)							
Replace air cleaner cartridge (5)			•			•			•			•			•
Replace the additional fuel filter (if equipped)	•	•	•	•	•	•	•	•	•	•	•	•	•	•	•
Change the brake fluid								(6)							
Replace the passenger compartment cleaner (5)	○	•	○	•	○	•	○	•	○	•	○	•	○	•	○

(3) The actual interval for changing engine oil and replacing the engine oil filter depends on the vehicle usage conditions and is signaled by the warning light or message in the instrument panel. In all cases, never exceed 1 year/10,000 miles.

(4) Areas that are not dusty: recommended maximum mileage 36,000 miles (60,000 km). Regardless of the mileage, the belt must be replaced every 4 years. Dusty areas and/or demanding use of the vehicle (cold climates, town use, long periods of idling): advised maximum mileage 18,000 miles (30,000 km). Regardless of the mileage, the belt must be replaced every 2 years.

(5) If the vehicle is used in dusty areas, this cleaner must be replaced every 10,000 miles (16,000 km).

(6) The brake fluid replacement has to be done every two years, irrespective of the mileage.



Thousands of miles	10	20	30	40	50	60	70	80	90	100	110	120	130	140	150
Years	1	2	3	4	5	6	7	8	9	10	11	12	13	14	15
Thousands of kilometers	16	32	48	64	80	96	112	128	144	160	176	192	208	224	240
Spark plug replacement *			●			●			●			●			●

*The spark plug change interval is mileage-based only. Yearly intervals do not apply.

(o) Recommended operations

(●) Mandatory operations



Warning!

- You can be badly injured working on or around a motor vehicle. Do only service work for which you have the knowledge and the right equipment. If you have any doubt about your ability to perform a service job, take your vehicle to a competent mechanic.
- Failure to properly inspect and maintain your vehicle could result in a component malfunction and effect vehicle handling and performance. This could cause an accident.

ENGINE COMPARTMENT

Checking Levels

2.0 T4 MAir engine

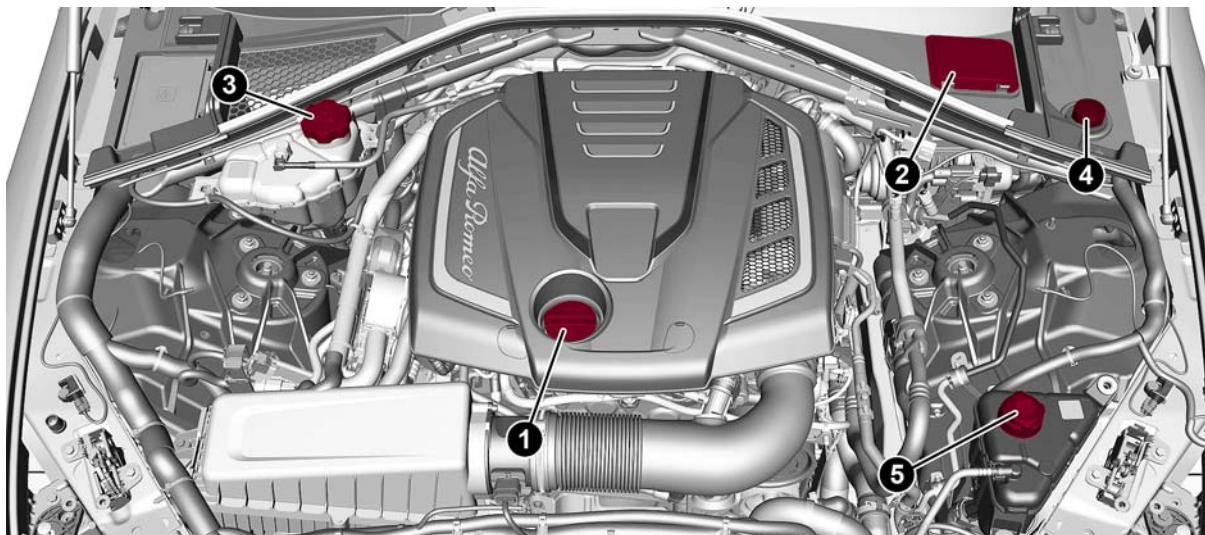

09026S0002EM

- 1 – Engine Oil Filler Cap
- 2 – Brake Fluid Reservoir Access Cover
- 3 – Engine Coolant Reservoir Cap

- 4 – Windshield/Headlights Washer Fluid Reservoir Cap
- 5 – Intercooler Coolant Reservoir Cap



Engine Oil

The engine oil level can be seen on the instrument cluster display every time the engine is started, or on the Information and Entertainment system display by activating on the main menu (MENU button) the following functions in sequence: “Apps”; “My Car” and “Oil Level”.

Check on the display using the 6 notches that the oil level is between the MIN and MAX level: 1 notch MIN level, 6 notches MAX level.

If the oil level is close to or below the MIN mark, add oil gradually through the filler, (refer to “Top-Up And Oil Level Indication Update On Display” in this section) considering that each notch shown on the display corresponds to approximately 8.8 fl oz (250 ml).



Caution!

Make sure not to add too much oil when topping off the engine. Engine oil in excess may damage the engine. Have the vehicle checked. Never exceed the MAX level when topping off engine oil.



Caution!

The oil level is not refreshed immediately on the display after topping off. Consequently, wait for the oil level to be refreshed on the display and follow the procedure below.

Note: Always reinstall the oil cap and tighten to proper torque whenever it is removed to add oil to engine. Never run the engine with cap removed this could cause oil to leak from engine.

Top-Up And Oil Level Indication Update On Display

If an engine oil top-off is needed, in order to ensure the correct indication of the oil level on the display, leave the vehicle on flat ground with the engine running for approximately 5 minutes (temperature higher than 176°F (80°C)) and shut the engine off then proceed with the process below:

- Start the engine again and idle it for about five minutes.

Note: If you have added the specified amount of oil and the indicator is not reading “Full”, please contact your authorized dealer.



Warning!

If the engine oil is being topped up, wait for the engine to cool down before loosening the filler cap, particularly for vehicles with aluminium cap (if equipped). WARNING: risk of burns!



Caution!

- The oil level must never exceed the MAX mark.

- If the MAX mark is exceeded MAX (last notch on the right turns red) after the fill-up, go to your authorized dealer as soon as possible to have the oil in excess removed.

- Do not add oil with specifications different from those of the oil already in the engine.

- Used engine oil and oil filters contain substances which are harmful to the environment. To change the oil and filters, we advise you to contact your authorized dealer.

Engine Coolant Fluid

If the level is too low, unscrew the cap of reservoir and add the fluid described in the "Technical Specifications" chapter.

Washer Fluid For Windshield/Headlights

The windshield and headlights washer fluid reservoir (if equipped) has a telescopic filler.

If the level is too low, remove reservoir cap and lift the filler. Then, add the fluid described in the "Technical Specifications" chapter.

Note: The headlight washing system will not work if the liquid level is low (as indicated by the symbol on the instrument cluster display). The windshield washer will keep working. On vehicles equipped with headlight washers, if equipped, there is a reference notch on the dipstick: **ONLY** the windshield/rear window washer operates with the level below this reference.

Brake Fluid

Check that the fluid is at the maximum level. If the fluid level in the tank is low, contact your authorized dealer to have the system checked.

Automatic Transmission Activation System Oil

The transmission control oil level should only be checked at your authorized dealer.

Useful Advice For Extending The Life Of Your Battery

To avoid draining your battery and make it last longer, observe the following instructions:

- When you park the car, ensure that the doors and trunk are closed properly to prevent any lights from remaining on inside the passenger's compartment.
- Do not keep accessories (e.g. radio, hazard warning lights, etc.) switched on for a long time when the engine is not running.
- Before performing any operation on the electrical system, disconnect the negative battery cable.

If you wish to install electrical accessories after purchasing the car that require permanent electrical supply (e.g. alarm, etc.), or accessories which influence the electrical supply requirements, contact your authorized dealer, whose qualified staff will evaluate the overall electrical consumption.



Caution!

If the charge level remains under 50% for a long time, the battery may be damaged by sulphation, reducing its capacity and efficiency at start the vehicle. The battery is also more prone to the risk of freezing (at temperatures as high as 14°F (-10°C)).

Note: After the battery is disconnected, the steering must be initialized. The  warning light on the instrument panel switches on to indicate this. To carry out this procedure, simply turn the steering wheel all the way from one end to the other, and then turn it back to the central position.



Battery

The battery does not require the electrolyte to be topped up with distilled water. A periodic check carried out at an authorized dealer, however, is necessary to check efficiency.

Follow the battery manufacturer's instructions for maintenance.

Replacing The Battery

If necessary, replace the battery with another original battery with the same specifications. Follow the battery manufacturer's instructions for maintenance.



Warning!

Battery acid is a corrosive solution and can burn or even blind you. Do not allow battery acid to contact your eyes, skin, or clothing. Do not lean over a battery when attaching clamps. If acid splashes in eyes or on skin, flush the area immediately with large amounts of water. Refer to "Jump Starting" in "In Case Of Emergency" for further information.

Battery gas is flammable and explosive. Keep flame or sparks away from the battery. Do not use a booster battery or any other booster source with an output greater than 12 Volts. Do not allow cable clamps to touch each other.

Battery posts, terminals, and related accessories contain lead and lead compounds. Wash hands after handling.

Note: It will not be possible to open the trunk with a key or by pressing the button in the passenger compartment when the battery is disconnected. So, always position the manual trunk opening strap on the trunk lock before disconnecting the battery. The procedure is described in the "Storing The Vehicle" paragraph in this chapter.

BATTERY RECHARGING

Important Notes



Warning!

- Never charge or recharge a frozen battery: it may explode because of the nitrogen trapped inside the ice crystals.
- At all times while charging or recharging the battery, make sure that any sparks or open flames are kept sufficiently far away from the battery.

Note:

- Before using the charging device, always make sure that it is appropriate for the installed battery, with constant voltage (below 14.8 V) and low amperage (maximum 15 A).
- Recharge the battery in a well ventilated environment.
- Before using any devices to charge or to maintain the charge of the battery, carefully follow the instructions provided with the device in order to properly and safely connect it to the car battery.

You can recharge the battery without disconnecting the wires of the vehicle's electrical system.

- ❑ To reach the battery, remove the access panel inside the trunk.



09036S0001EM

Battery Access Panel

- ❑ Remove the protective cover and connect the positive cable terminal of the charger (usually red) to the positive terminal (+) of the battery.
- ❑ Connect the negative terminal of the charger (usually black) to nut next to the negative terminal (-) of the battery.

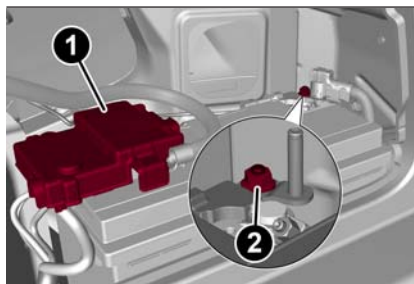

09036S0002EM

Battery

- 1 — Protective Cover
- 2 — Negative Post (Nut)

The vehicle is equipped with an IBS (Intelligent Battery Sensor), which is able to measure the charge and discharge voltage and calculate the charge level and the general condition of the battery. The sensor is placed next to the negative terminal (-) of the battery.

For a correct charge/discharge procedure, the charge voltage must go through the IBS sensor.

1. Turn the charger on and follow the instructions on the user's manual to completely recharge the battery.
2. When the battery is charged, turn the charger off before disconnecting it from the battery.
3. Disconnect the black cable terminal of the battery charger and then the red cable terminal.
4. Refit the protective cover of the positive terminal of the battery and the access cover to the battery compartment.

Note: If a "quick-type" battery charger is used with the battery fitted on the vehicle, before connecting it disconnect both cables of the battery itself. Do not use a "quick-type" battery charger to provide the starting voltage.



DEALER SERVICE

The following pages contain instructions on the required maintenance from the technical personnel who designed the vehicle.

In addition to these specific maintenance instructions specified for routine scheduled servicing, there are other components which may require periodic maintenance or replacement over the vehicle's life cycle.

Engine Oil

Engine Oil Level Check

To ensure correct engine lubrication, the oil must always be kept at the prescribed level (see "Engine Compartment" in this chapter).

Check the oil level at regular intervals, for example every 1864 miles (3000 km).

It must be checked about five minutes after stopping the engine, once full operating temperature is reached. The vehicle must also be parked on as level a surface as possible.

The engine oil level can be checked using the Information and Entertainment system. To access the function, activate the main menu (MENU button) and select the following options in sequence: "Applications"; "My Car"; "Oil level".

Changing The Engine Oil

See the "Maintenance Plan" for the correct servicing intervals.

Choice Of Engine Oil Type

To ensure optimal performance and maximum protection in all operating conditions, it is advisable to use solely certified engine oils (see description in "Fluid And Lubricants" in the "Technical Specifications" chapter).

Additives For Engine Oil

It is strongly recommended not to use additives (other than leak detection dyes) with the engine oil.

The engine oil is a product designed specially for the vehicle and its performance may be deteriorated through the use of further additives.

Disposal Of Used Engine Oil And Filters

For the disposal of the engine oil and filters, contact the appropriate body to determine local regulations.

Note: Used engine oil disposed of incorrectly may seriously harm the environment.

Engine Oil Filter

Replacing The Engine Oil Filter

The engine oil filter must be replaced each time the engine oil is changed. It is advised to replace it with a genuine spare part, specifically designed for this vehicle.

Air Filter

Replacing The Air Cleaner

See the "Maintenance Plan" for the correct servicing intervals. It is advised to replace it with a genuine spare part, specifically designed for this vehicle.

Air Conditioning System Maintenance

To ensure the best possible performance, the air conditioning system must be checked and undergo maintenance at an authorized dealer at the beginning of the summer.



Caution!

Do not use chemicals to clean the air conditioning system, since the internal components may be damaged. This kind of damage is not covered by warranty.

Replace The Cabin Air Filter

See the "Maintenance Plan" for the correct servicing intervals. For cleaner replacement, contact an authorized dealer.



Warning!

Use only refrigerants and compressor lubricants approved by the manufacturer for your air conditioning system. Some unapproved refrigerants are flammable and can explode, injuring you. Other unapproved refrigerants or lubricants can cause the system to fail, requiring costly repairs. Refer to Warranty Information Book, located in your owner's information kit, for further warranty information.

Lubricating Moving Parts Of The Bodywork

Ensure that the locks and bodywork junction points, including components such as the seat guides, door hinges (and rollers), trunk and hood are periodically lubricated with lithium-based grease to ensure correct, silent operation and to protect them from rust and wear.

Thoroughly clean the components, eliminating every trace of dirt and dust. After lubricating, eliminate excess oil and grease. Also pay particular attention to the hood closing devices, to ensure correct operation. During operations on the hood, to be carried out with the engine cold, also remember to check, clean and lubricate the locking, release and safety devices.

Lubricate the external lock barrels twice a year. Apply a small amount of high-quality lubricant directly into the lock barrel.

If necessary, contact your authorized dealer as soon as possible.

Windshield Wiper

Periodically clean the windshield and rear window and rubber profile of the windshield wiper blades, using a sponge or a soft cloth and a non-abrasive detergent. This eliminates the salt or impurities accumulated when driving.

Prolonged operation of the windshield window wipers with dry glass may cause the deterioration of the blades, in addition to abrasion of the surface of the glass. To eliminate the impurities on the dry glass, always operate the windshield washers.

In the event of very low outdoor temperatures, below zero degrees, ensure that the movement of the rubber part in contact with the glass is not obstructed. Use a suitable deicing product to release it if required.

Avoid using the windshield wipers to remove frost or ice.

Also avoid contact of the rubber profile of the blades with petroleum derivatives such as engine oil, gas, etc.



Warning!

Driving with worn windshield wiper blades is a serious hazard, because visibility is reduced in bad weather conditions.

Note: The life of the windshield wiper blades varies according to the usage frequency. In any case, it is advised to replace the blades approximately once a year. When the blades are worn, noise, marks on the glass or streaks of water may be noticed. In the presence of these conditions, clean the windshield wiper blades or, if necessary, replace them.

Raising The Windshield Wiper Blades ("Service Position" Function)

The "service position" function allows the driver to replace the windshield wiper blades more easily. It is also recommended to activate this function when it is snowing and to make it easier to remove any dirt deposits in the area where the blades are normally positioned, when washing.

Activation Of The Function

To activate this function, disable the windshield wiper before setting the ignition device to STOP.



This function can only be activated within two minutes of cycling the ignition to STOP.

To activate this function, move the lever upward for at least three seconds.



09046S0001EM

Multifunction Lever

Function Deactivation

The function is deactivated if:

- ❑ More than two minutes passes before cycling the ignition to the STOP position after having raised the lever and putting the wipers into service position.
- ❑ The ignition is cycled to the ON position and the windshield wiper control is used.

If, after using the function, the ignition is set back to ON with the blades in a position other than rest position (at the base of the windshield), they will only return to rest position following a command given using the stalk (stalk upwards, into unstable position) or

when a speed of 3 mph (5 km/h) is exceeded.

Replacing The Windshield Wiper Blades

Proceed as follows:

1. Raise the wiper arm, press tab of the attachment spring and remove the blade from the arm.

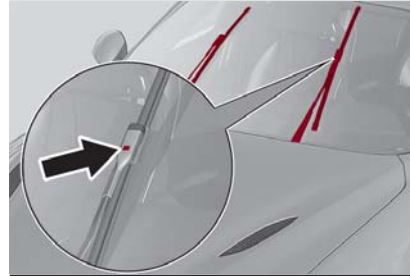

09046S0002EM

Wiper Release Tab

2. Fit the new blade, inserting the tab in the dedicated housing in the arm and checking that it is locked.
 3. Lower the wiper arm onto the windshield.
- Note:** Do not operate the windshield wiper with the blades lifted from the windshield.

Windshield Washer

The window washer nozzles are fixed. If there is no jet of fluid, first check that there is fluid in the reservoir (see paragraph “Engine Compartment” in this chapter).

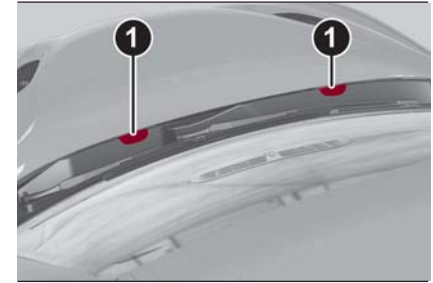

09046S0003EM

Windshield Washers

- 1 — Washer Nozzles

Then, check that the nozzle holes are not clogged; use a needle to unblock them if necessary.

Exhaust System

Adequate maintenance of the engine exhaust system represents the best protection against leaks of carbon monoxide into the passenger compartment.

If an unusual noise from the exhaust or the presence of smoke in the passenger compartment is identified, or if the underbody or rear section of the vehicle have been damaged, have the

entire exhaust system and adjoining bodywork areas checked at your authorized dealer to identify any components which are broken, damaged, worn or have moved from their correct fitting position.

Open welding or loose connections may permit exhaust gas to enter the passenger compartment.

Have the exhaust system checked every time the vehicle is raised. Replace the components where necessary (for these operations, contact an authorized dealer).

In normal operating conditions, the catalytic converter does not require maintenance. To ensure that it operates correctly, however, and prevent it from getting damaged, it is extremely important that the engine operates perfectly.

To minimize the risk of damaging the catalytic converter, proceed as follows:

- ❑ Do not stop the engine or deactivate the ignition with gear engaged and vehicle in motion.
- ❑ Do not attempt to start the engine by bump starting.
- ❑ Do not persist in using the vehicle if idling is very irregular or the operating conditions are very notably irregular.



Warning!

- ❑ Exhaust gases can injure or kill. They contain carbon monoxide (CO), which is colorless and odorless. Breathing it can make you unconscious and can eventually poison you.
- ❑ A hot exhaust system can start a fire if you park over materials that can burn. Such materials might be grass or leaves coming into contact with your exhaust system. Do not park or operate your vehicle in areas where your exhaust system can contact anything that can burn.

Cooling System



Warning!

- ❑ Turn vehicle off and disconnect the fan motor lead before working near the radiator cooling fan.
- ❑ You or others can be badly burned by hot engine coolant (antifreeze) or steam from your radiator. If you see or hear steam coming from under the hood, do not open the hood until the radiator has had time to cool. Never open a cooling system pressure cap when the radiator or coolant bottle is hot.
- ❑ Keep hands, tools, clothing, and jewelry away from the radiator cooling fan when the hood is raised. The fan starts

automatically and may start at any time, whether the engine is running or not.

- ❑ When working near the radiator cooling fan, disconnect the fan motor lead or turn the ignition to the OFF mode. The fan is temperature controlled and can start at any time the ignition is in the ON mode.
- ❑ You or others can be badly burned by hot engine coolant (antifreeze) or steam from your radiator. If you see or hear steam coming from under the hood, do not open the hood until the radiator has had time to cool. Never try to open a cooling system pressure cap when the radiator is hot.

Coolant Check

Your vehicle has two cooling systems and they both need to be checked to ensure they are at proper fill levels. Refer to the “Engine Compartment” section for the locations.

Check the engine coolant and intercooler coolant level every oil change or before long trips.

If there are impurities in the engine coolant, the system must be drained, flushed and refilled: contact an authorized dealer.

Check the front part of the condenser to check for any build-up of insects, leaves or other debris. Should it be dirty, clean it by spraying delicately with water.



Check the hoses of the engine/intercooler cooling system to ensure that the rubber has not deteriorated and that there are no cracks, tears, cuts or obstructions in the expansion tank side and radiator side connectors. Should there be any doubt regarding leaks from the system (e.g. if frequent top ups are required), have the seal checked at an authorized dealer. With the engine off and at normal operating temperature, check that the cooling system radiator cap is closed properly.



Warning!

Do not open hot engine cooling system. Never add engine coolant (antifreeze) when the engine is overheated. Do not loosen or remove the cap to cool an overheated engine. Heat causes pressure to build up in the cooling system. To prevent scalding or injury, do not remove the pressure cap while the system is hot or under pressure.

Do not use a pressure cap other than the one specified for your vehicle. Personal injury or engine damage may result.

Note: Before removing the coolant reservoir cap, wait for the system to cool down.

Topping Up / Draining / Flushing The Engine/Intercooler Coolant

If the engine coolant (antifreeze) is dirty, have cleaning and flushing carried out at an authorized dealer.

See the "Maintenance Plan" for the correct servicing intervals.

Note:

- For topping up, use a fluid with the same characteristics as those indicated in the "Fluids And Lubricants" table (see "Technical Specifications" chapter).
- Do not use pure water, alcohol-based coolants, corrosion inhibitors or additional anti-rust products because they may be incompatible with the engine coolant and cause the clogging of the radiator. The use of propylene glycol-based coolant is also not recommended.

Engine Cooling/Intercooler System Cap

To prevent loss of engine coolant, make sure that the expansion tank cap is closed. If it is open, screw it completely until you reach/hear the click.

Periodically check the cap and clean it from any foreign bodies that may have deposited on the external surface.



Warning!

- Never add coolant with the engine hot or overheated.
- Do not attempt to cool an overheated engine by loosening or removing the cap. The heat causes a considerable increase in pressure in the cooling system.
- To prevent damage to the engine, only use the engine cooling circuit caps provided.

Disposal of Used Coolant

Disposal of engine/intercooler coolant is subject to legal requirements: contact the appropriate body to determine local regulations.

Note:

- ❑ To prevent the fluid from being ingested by children or animals, do not keep it in open containers or pour it on the ground. If ingested, contact a doctor immediately. Eliminate any traces of fluid from the ground immediately.
- ❑ When the vehicle stops after a short trip, steam may be seen coming out from front of the hood. This is a normal phenomenon which is due to the presence of rain, snow or a lot of moisture on the surface of the radiator.
- ❑ With engine and system cold, do not top up with coolant beyond the maximum level indicated on the reservoir in the engine compartment.

Braking System

In order to guarantee the efficiency of the braking system, periodically check its components; for this operation, contact an authorized dealer. See the "Maintenance Plan" for the correct servicing intervals.

Note: Driving with your foot resting on the brake pedal may compromise its efficiency, increasing the risk of accidents. When driving, never keep your foot on the brake pedal and don't put unnecessary strain on it to prevent the brakes from overheating: excess

pad wear may cause damage to the braking system.

- ❑ When an insufficient oil level is detected, contact an authorized dealer to have the system checked.
- ❑ Always keep the cap of the brake fluid reservoir (in the engine compartment) completely closed.



Warning!

❑ Use only manufacturer's recommended brake fluid. Refer to "Fluids And Lubricants" in "Technical Specifications" for further information. Using the wrong type of brake fluid can severely damage your brake system and/or impair its performance. The proper type of brake fluid for your vehicle is also identified on the original factory installed hydraulic master cylinder reservoir.

❑ To avoid contamination from foreign matter or moisture, use only new brake fluid or fluid that has been in a tightly closed container. Keep the master cylinder reservoir cap secured at all times. Brake fluid in an open container absorbs moisture from the air resulting in a lower boiling point. This may cause it to boil unexpectedly during hard or prolonged braking, resulting in sudden brake failure. This could result in a collision.

❑ Overfilling the brake fluid reservoir can result in spilling brake fluid on hot engine parts, causing the brake fluid to catch fire. Brake fluid can also damage painted and vinyl surfaces, care should be taken to avoid its contact with these surfaces.

❑ Do not allow petroleum based fluid to contaminate the brake fluid. Brake seal components could be damaged, causing partial or complete brake failure. This could result in a collision.

Automatic Transmission

Use only a transmission oil with the same characteristics as those indicated in the "Fluids and Lubricants" table (see "Technical Specifications" chapter).

Special Additives

Do not use any type of additive with the automatic transmission oil. The automatic transmission oil is a product designed specially for this vehicle and its performance may be compromised through the use of further additives.



Caution!

Do not use chemical flushes in your transmission as the chemicals can damage your transmission components. Such damage is not covered by the New Vehicle Limited Warranty.



Frequency of Oil Changes

In normal vehicle operating conditions, it is not necessary to change the transmission oil.



Caution!

If a transmission fluid leak occurs, visit your authorized dealer immediately. Severe transmission damage may occur. Your authorized dealer has the proper tools to adjust the fluid level accurately.

Replacing The Battery

If necessary, replace the battery with another battery with the same specifications. It is advised to contact an authorized dealer for replacement. Follow the battery manufacturer's instructions for maintenance.

Note: It will not be possible to open the trunk with a key or by pressing the button in the passenger compartment when the battery is disconnected. So, always position the manual trunk opening strap on the trunk lock before disconnecting the battery. The procedure is described in the "Storing The Vehicle" section in this chapter.

RAISING THE VEHICLE

If the vehicle requires lifting, visit an authorized dealer which is equipped with shop jacks or jack arms.

The vehicle lifting points are marked on the side skirts with the ▽ symbols.

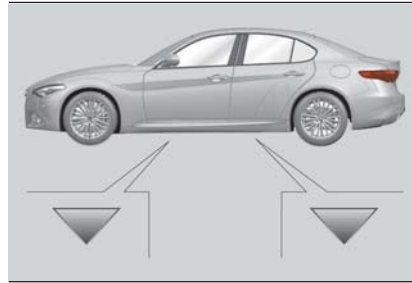

09056S0001EM

Vehicle Lift Point Locations

TIRES

Tire Safety Information

Tire safety information will cover aspects of the following information: Tire Markings, Tire Identification Numbers, Tire Terminology and Definitions, Tire Pressures, and Tire Loading.

Tire Markings

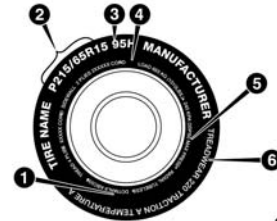

0601085395US

0601085395US

Tire Markings

- | | |
|--|--|
| 1 — U.S. DOT Safety Standards Code (TIN) | 4 — Maximum Load |
| 2 — Size Designation | 5 — Maximum Pressure |
| 3 — Service Description | 6 — Treadwear, Traction and Temperature Grades |

Note:

P (Passenger) — Metric tire sizing is based on U.S. design standards. P-Metric tires have the letter “P” molded into the sidewall preceding the size designation. Example: P215/65R15 95H.

European — Metric tire sizing is based on European design standards. Tires designed to this standard have the tire size molded into the sidewall beginning with the section width. The letter “P” is absent from this tire size designation. Example: 215/65R15 96H.

LT (Light Truck) — Metric tire sizing is based on U.S. design standards. The size designation for LT-Metric tires is the same as for P-Metric tires except for the letters “LT” that are molded into the sidewall preceding the size designation. Example: LT235/85R16.

Temporary spare tires are designed for temporary emergency use only. Temporary high pressure compact spare tires have the letter “T” or “S” molded into the sidewall preceding the size designation. Example: T145/80D18 103M.

High flotation tire sizing is based on U.S. design standards and it begins with the tire diameter molded into the sidewall. Example: 31x10.5 R15 LT.

Tire Sizing Chart

EXAMPLE:

Example Size Designation: P215/65R15XL 95H, 215/65R15 96H, LT235/85R16C, T145/80D18 103M, 31x10.5 R15 LT

P = Passenger car tire size based on U.S. design standards, or

"....**blank**...." = Passenger car tire based on European design standards, or

LT = Light truck tire based on U.S. design standards, or

T or S = Temporary spare tire or

31 = Overall diameter in inches (in)

215, 235, 145 = Section width in millimeters (mm)

65, 85, 80 = Aspect ratio in percent (%)

Ratio of section height to section width of tire, or

10.5 = Section width in inches (in)



EXAMPLE:

R = Construction code

- "R" means radial construction, or
- "D" means diagonal or bias construction

15, 16, 18 = Rim diameter in inches (in)

Service Description:

95 = Load Index

- A numerical code associated with the maximum load a tire can carry

H = Speed Symbol

- A symbol indicating the range of speeds at which a tire can carry a load corresponding to its load index under certain operating conditions
- The maximum speed corresponding to the speed symbol should only be achieved under specified operating conditions (i.e., tire pressure, vehicle loading, road conditions, and posted speed limits)

Load Identification:

Absence of the following load identification symbols on the sidewall of the tire indicates a Standard Load (SL) tire:

- XL** = Extra load (or reinforced) tire, or
- LL** = Light load tire or
- C, D, E, F, G** = Load range associated with the maximum load a tire can carry at a specified pressure

Maximum Load – Maximum load indicates the maximum load this tire is designed to carry

Maximum Pressure – Maximum pressure indicates the maximum permissible cold tire inflation pressure for this tire

Tire Identification Number (TIN)

The TIN may be found on one or both sides of the tire; however, the date code may only be on one side. Tires with

white sidewalls will have the full TIN, including the date code, located on the white sidewall side of the tire. Look for the TIN on the outboard side of black sidewall tires as mounted on the

vehicle. If the TIN is not found on the outboard side, then you will find it on the inboard side of the tire.

EXAMPLE:

DOT MA L9 ABCD 0301

DOT = Department of Transportation

- This symbol certifies that the tire is in compliance with the U.S. Department of Transportation tire safety standards and is approved for highway use

MA = Code representing the tire manufacturing location (two digits)

L9 = Code representing the tire size (two digits)

ABCD = Code used by the tire manufacturer (one to four digits)

03 = Number representing the week in which the tire was manufactured (two digits)

- 03 means the 3rd week

01 = Number representing the year in which the tire was manufactured (two digits)

- 01 means the year 2001

- Prior to July 2000, tire manufacturers were only required to have one number to represent the year in which the tire was manufactured. Example: 031 could represent the 3rd week of 1981 or 1991



Tire Terminology And Definitions

Term	Definition
B-Pillar	The vehicle B-Pillar is the structural member of the body located behind the front door.
Cold Tire Inflation Pressure	Cold tire inflation pressure is defined as the tire pressure after the vehicle has not been driven for at least three hours, or driven less than 1 mile (1.6 km) after sitting for a minimum of three hours. Inflation pressure is measured in units of PSI (pounds per square inch) or kPa (kilopascals).
Maximum Inflation Pressure	The maximum inflation pressure is the maximum permissible cold tire inflation pressure for this tire. The maximum inflation pressure is molded into the sidewall.
Recommended Cold Tire Inflation Pressure	Vehicle manufacturer's recommended cold tire inflation pressure as shown on the tire placard.
Tire Placard	A label permanently attached to the vehicle describing the vehicle's loading capacity, the original equipment tire sizes and the recommended cold tire inflation pressures.

Tire Loading And Tire Pressure

Note: The proper cold tire inflation pressure is listed on the driver's side B-Pillar or the rear edge of the driver's side door.

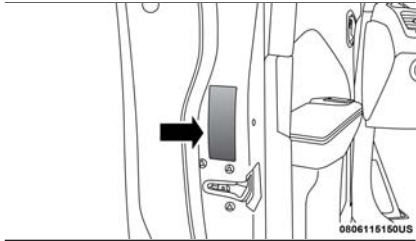

0806115150US

**Example Tire Placard Location
(Door)**

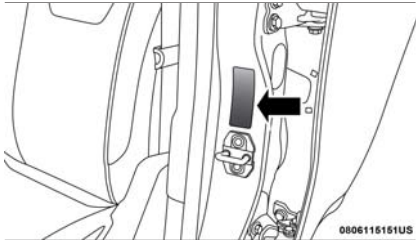

0806115151US

0806115151US

**Example Tire Placard Location
(B-Pillar)**

Tire And Loading Information Placard

TIRE AND LOADING INFORMATION			
SEATING CAPACITY - TOTAL 5 FRONT 2 REAR 3			
THE COMBINED WEIGHT OF OCCUPANTS AND CARGO SHOULD NEVER EXCEED XXX KG OR XXX LBS.			
TIRE	FRONT	REAR	SPARE
ORIGINAL TIRE SIZE	P195/70R14	P195/70R14	T125/70D15
COLD TIRE INFLATION PRESSURE	200kPa, 29PSI	200kPa, 29PSI	420kPa, 60PSI
SEE OWNER'S MANUAL FOR ADDITIONAL INFORMATION			4N109268

811b5a9a

GUID-054900418-high.tif

Tire And Loading Information Placard

This placard tells you important information about the:

1. Number of people that can be carried in the vehicle.
2. Total weight your vehicle can carry.
3. Tire size designed for your vehicle.
4. Cold tire inflation pressures for the front, rear, and spare tires.

Loading

The vehicle maximum load on the tire must not exceed the load carrying capacity of the tire on your vehicle. You will not exceed the tire's load carrying capacity if you adhere to the loading conditions, tire size, and cold tire inflation pressures specified on the Tire and Loading Information placard in "Vehicle Loading" in the "Starting And Operating" section of this manual.

Note: Under a maximum loaded vehicle condition, gross axle weight ratings (GAWRs) for the front and rear axles must not be exceeded. For further information on GAWRs, vehicle loading, and trailer towing, refer to "Vehicle Loading" in the "Starting And Operating" section of this manual.

To determine the maximum loading conditions of your vehicle, locate the statement "The combined weight of occupants and cargo should never exceed XXX kg or XXX lbs" on the Tire and Loading Information placard. The combined weight of occupants, cargo/luggage and trailer tongue weight (if applicable) should never exceed the weight referenced here.



Steps For Determining Correct Load Limit—

- (1) Locate the statement “The combined weight of occupants and cargo should never exceed XXX kg or XXX lbs.” on your vehicle’s placard.
- (2) Determine the combined weight of the driver and passengers that will be riding in your vehicle.
- (3) Subtract the combined weight of the driver and passengers from XXX kg or XXX lbs.
- (4) The resulting figure equals the available amount of cargo and luggage load capacity. For example, if “XXX” amount equals 1400 lbs. and there will be five 150 lb passengers in your vehicle, the amount of available cargo and luggage load capacity is 650 lbs. $(1400 - 750 (5 \times 150) = 650 \text{ lbs.})$

(5) Determine the combined weight of luggage and cargo being loaded on the vehicle. That weight may not safely exceed the available cargo and luggage load capacity calculated in Step 4.

(6) If your vehicle will be towing a trailer, load from your trailer will be transferred to your vehicle. Consult this manual to determine how this reduces the available cargo and luggage load capacity of your vehicle.

Metric Example For Load Limit

For example, if “XXX” amount equals 635 kg and there will be five 68 kg passengers in your vehicle, the amount of available cargo and luggage load capacity is 295 kg $(635 - 340 (5 \times 68) = 295 \text{ kg})$ as shown in step 4.

Note:

- If your vehicle will be towing a trailer, load from your trailer will be transferred to your vehicle. The following table shows examples on how to calculate total load, cargo/luggage, and towing capacities of your vehicle with varying seating configurations and number and size of occupants. This table is for illustration purposes only and may not be accurate for the seating and load carry capacity of your vehicle.
- For the following example, the combined weight of occupants and cargo should never exceed 865 lbs (392 kg).

Occupants			Combined weight of occupants and cargo from Tire Placard	MINUS	Combined Occupant's weight	=	AVAILABLE Cargo/Luggage and Trailer Tongue Weight
TOTAL	FRONT	REAR					
EXAMPLE 1			865 lbs	minus	670 lbs	=	195 lbs
5	2	3					
EXAMPLE 2			865 lbs	minus	540 lbs	=	325 lbs
3	2	1					
EXAMPLE 3			865 lbs	minus	400 lbs	=	465 lbs
2	2	0					

Occupant 1: 200 lbs
 Occupant 2: 130 lbs
 Occupant 3: 160 lbs
 Occupant 4: 100 lbs
 Occupant 5: 80 lbs
 TOTAL WEIGHT: 670 lbs

Occupant 1: 210 lbs
 Occupant 2: 180 lbs
 Occupant 3: 150 lbs
 TOTAL WEIGHT: 540 lbs

Occupant 1: 200 lbs
 Occupant 2: 200 lbs
 TOTAL WEIGHT: 400 lbs

811a4d11

GUID-054900419-high.tif

Warning!

Overloading of your tires is dangerous. Overloading can cause tire failure, affect vehicle handling, and increase your stopping distance. Use tires of the recommended load capacity for your vehicle. Never overload them.



Tires — General Information

Tire Pressure

Proper tire inflation pressure is essential to the safe and satisfactory operation of your vehicle. Four primary areas are affected by improper tire pressure:

- Safety and Vehicle Stability
- Economy
- Tread Wear
- Ride Comfort

Safety



Warning!

- Improperly inflated tires are dangerous and can cause collisions.*
- Underinflation increases tire flexing and can result in overheating and tire failure.*
- Overinflation reduces a tire's ability to cushion shock. Objects on the road and chuckholes can cause damage that result in tire failure.*
- Overinflated or underinflated tires can affect vehicle handling and can fail suddenly, resulting in loss of vehicle control.*
- Unequal tire pressures can cause steering problems. You could lose control of your vehicle.*

- Unequal tire pressures from one side of the vehicle to the other can cause the vehicle to drift to the right or left.*
- Always drive with each tire inflated to the recommended cold tire inflation pressure.*

Both under-inflation and over-inflation affect the stability of the vehicle and can produce a feeling of sluggish response or over responsiveness in the steering.

Note:

- Unequal tire pressures from side to side may cause erratic and unpredictable steering response.
- Unequal tire pressure from side to side may cause the vehicle to drift left or right.

Fuel Economy

Underinflated tires will increase tire rolling resistance resulting in higher fuel consumption.

Tread Wear

Improper cold tire inflation pressures can cause abnormal wear patterns and reduced tread life, resulting in the need for earlier tire replacement.

Ride Comfort And Vehicle Stability

Proper tire inflation contributes to a comfortable ride. Over-inflation produces a jarring and uncomfortable ride.

Tire Inflation Pressures

The proper cold tire inflation pressure is listed on the driver's side B-Pillar or rear edge of the driver's side door.

At least once a month:

- Check and adjust tire pressure with a good quality pocket-type pressure gauge. Do not make a visual judgement when determining proper inflation. Tires may look properly inflated even when they are under-inflated.
- Inspect tires for signs of tire wear or visible damage.



Caution!

After inspecting or adjusting the tire pressure, always reinstall the valve stem cap. This will prevent moisture and dirt from entering the valve stem, which could damage the valve stem.

Inflation pressures specified on the placard are always "cold tire inflation pressure". Cold tire inflation pressure is defined as the tire pressure after the vehicle has not been driven for at least three hours, or driven less than 1 mile (1.6 km) after sitting for a minimum of three hours. The cold tire inflation pressure must not exceed the maximum inflation pressure molded into the tire sidewall.

Check tire pressures more often if subject to a wide range of outdoor temperatures, as tire pressures vary with temperature changes.

Tire pressures change by approximately 1 psi (7 kPa) per 12°F (7°C) of air temperature change. Keep this in mind when checking tire pressure inside a garage, especially in the Winter.

Example: If garage temperature = 68°F (20°C) and the outside temperature = 32°F (0°C) then the cold tire inflation pressure should be increased by 3 psi (21 kPa), which equals 1 psi (7 kPa) for every 12°F (7°C) for this outside temperature condition.

Tire pressure may increase from 2 to 6 psi (13 to 40 kPa) during operation. DO NOT reduce this normal pressure build up or your tire pressure will be too low.

Tire Pressures For High Speed Operation

The manufacturer advocates driving at safe speeds and within posted speed limits. Where speed limits or conditions are such that the vehicle can be driven at high speeds, maintaining correct tire inflation pressure is very important.

Increased tire pressure and reduced vehicle loading may be required for high-speed vehicle operation. Refer to your authorized tire dealer or original equipment vehicle dealer for recommended safe operating speeds, loading and cold tire inflation pressures.



Warning!

High speed driving with your vehicle under maximum load is dangerous. The added strain on your tires could cause them to fail. You could have a serious collision. Do not drive a vehicle loaded to the maximum capacity at continuous speeds above 75 mph (120 km/h).

Recommended Cold Tire Inflation Pressures

For vehicle speeds below 100 mph (160 km/h), recommended cold tire inflation pressures are listed on the Tire And Loading Information Placard located on driver's side B-Pillar or the rear edge of the driver's side door.

When driving at speeds 100 mph (160 km/h) and above, increased tire pressures and reduced vehicle loading are required for high-speed vehicle operation.

For driving speeds above 100 mph (160 km/h) recommended cold tire inflation pressures are listed below under "High Speed Tire Inflation Pressure". Vehicle loading condition must not exceed 688 lbs. (312 kg) (driver + three passengers + 88 lbs. (40kg) luggage).



Warning!

High speed driving with your vehicle under maximum load is dangerous. The added strain on your tires could cause them to fail. You could have a serious collision.



	Tires	Wheel	Recommended Cold Tire Inflation Pressure		High Speed Tire Inflation Pressure	
			Front	Rear	Front	Rear
Original Equipment	225/50R17 94V M+S Runflat	17x7.5J	32 psi/ 220kpa	35 psi/ 240kpa	39 psi/ 270kpa	44 psi/ 300kpa
	225/45R18 91V M+S Runflat	18x8J	32 psi/ 220kpa	35 psi/ 240kpa	39 psi/ 270kpa	44 psi/ 300kpa
	225/40R19 93V XL M+S Runflat	19x8J	35 psi/ 240kpa	38 psi/ 260kpa	39 psi/ 270kpa	42 psi/ 290kpa
	225/40R19 89W Runflat	19x8J	35 psi/ 240kpa	–	39 psi/ 270kpa	–
	255/35R19 92W Runflat	19x9J	–	34 psi/ 230kpa	–	42 psi/ 290kpa
Snow Tires	225/50R17 94V M+S Runflat	17x7.5J	32 psi/ 220kpa	35 psi/ 240kpa	39 psi/ 270kpa	44 psi/ 300kpa
	225/45R18 91V M+S Runflat	18x8J	32 psi/ 220kpa	35 psi/ 240kpa	39 psi/ 270kpa	44 psi/ 300kpa

Radial Ply Tires



Warning!

Combining radial ply tires with other types of tires on your vehicle will cause your vehicle to handle poorly. The instability could cause a collision. Always use radial ply tires in sets of four. Never combine them with other types of tires.

Tire Repair

If your tire becomes damaged, it may be repaired if it meets the following criteria:

- The tire has not been driven on when flat.
- The damage is only on the tread section of your tire (sidewall damage is not repairable).
- The puncture is no greater than a ¼ of an inch (6 mm).

Consult an authorized tire dealer for tire repairs and additional information.

Damaged Run Flat tires, or Run Flat tires that have experienced a loss of pressure should be replaced immediately with another Run Flat tire of identical size and service description (Load Index and Speed Symbol).

Run Flat Tires — If Equipped

Run Flat tires allow you the capability to drive 50 miles (80 km) at 50 mph (80 km/h) after a rapid loss of inflation pressure. This rapid loss of inflation is referred to as the Run Flat mode. A Run Flat mode occurs when the tire inflation pressure is of/or below 14 psi (96 kPa). Once a Run Flat tire reaches the run flat mode it has limited driving capabilities and needs to be replaced immediately. A Run Flat tire is not repairable.

It is not recommended driving a vehicle loaded at full capacity or to tow a trailer while a tire is in the run flat mode.

See the tire pressure monitoring section for more information.

Tire Spinning

When stuck in mud, sand, snow, or ice conditions, do not spin your vehicle's wheels above 30 mph (48 km/h) or for longer than 30 seconds continuously without stopping.



Warning!

Fast spinning tires can be dangerous. Forces generated by excessive wheel speeds may cause tire damage or failure. A tire could explode and injure someone. Do not spin your vehicle's wheels faster than 30 mph (48 km/h) for more than 30 seconds continuously when you are stuck, and do not let anyone near a spinning wheel, no matter what the speed.

Tread Wear Indicators

Tread wear indicators are in the original equipment tires to help you in determining when your tires should be replaced.

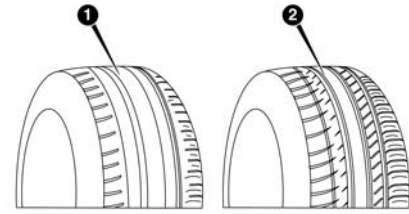

Tire Tread

- 1 — Worn Tire
- 2 — New Tire

These indicators are molded into the bottom of the tread grooves. They will appear as bands when the tread depth becomes a 1/16 of an inch (1.6 mm). When the tread is worn to the tread wear indicators, the tire should be replaced. Refer to “Replacement Tires” in this section for further information.

Life Of Tire

The service life of a tire is dependent upon varying factors including, but not limited to:

- Driving style.
- Tire pressure - Improper cold tire inflation pressures can cause uneven wear patterns to develop across the tire tread. These abnormal wear patterns will reduce tread life, resulting in the need for earlier tire replacement.



- ☐ Distance driven.
- ☐ Performance tires, tires with a speed rating of V or higher, and Summer tires typically have a reduced tread life. Rotation of these tires per the vehicle maintenance schedule is highly recommended.



Warning!

Tires and the spare tire should be replaced after six years, regardless of the remaining tread. Failure to follow this warning can result in sudden tire failure. You could lose control and have a collision resulting in serious injury or death.

Keep dismantled tires in a cool, dry place with as little exposure to light as possible. Protect tires from contact with oil, grease, and gasoline.

Replacement Tires

The tires on your new vehicle provide a balance of many characteristics. They should be inspected regularly for wear and correct cold tire inflation pressures. The manufacturer strongly recommends that you use tires equivalent to the originals in size, quality and performance when replacement is needed. Refer to the paragraph on “Tread Wear Indicators” in this section. Refer to the Tire and Loading Information placard or the Vehicle

Certification Label for the size designation of your tire. The Load Index and Speed Symbol for your tire will be found on the original equipment tire sidewall.

See the Tire Sizing Chart example found in the “Tire Safety Information” section of this manual for more information relating to the Load Index and Speed Symbol of a tire.

It is recommended to replace the two front tires or two rear tires as a pair. Replacing just one tire can seriously affect your vehicle’s handling. If you ever replace a wheel, make sure that the wheel’s specifications match those of the original wheels.

It is recommended you contact your authorized tire dealer or original equipment dealer with any questions you may have on tire specifications or capability. Failure to use equivalent replacement tires may adversely affect the safety, handling, and ride of your vehicle.



Warning!

☐ Do not use a tire, wheel size, load rating, or speed rating other than that specified for your vehicle. Some combinations of unapproved tires and wheels may change suspension dimensions and performance characteristics, resulting in changes to steering, handling, and braking of your vehicle. This can cause unpredictable handling and stress to steering and suspension components. You could lose control and have a collision resulting in serious injury or death. Use only the tire and wheel sizes with load ratings approved for your vehicle.

☐ Never use a tire with a smaller load index or capacity, other than what was originally equipped on your vehicle. Using a tire with a smaller load index could result in tire overloading and failure. You could lose control and have a collision.

☐ Failure to equip your vehicle with tires having adequate speed capability can result in sudden tire failure and loss of vehicle control.



Caution!

Replacing original tires with tires of a different size may result in false speedometer and odometer readings.

Spare Tires — If Equipped

Note: For vehicles equipped with Tire Repair Kit instead of a spare tire, please refer to “Tire Repair Kit” in “In Case Of Emergency” for further information.



Caution!

Because of the reduced ground clearance, do not take your vehicle through an automatic car wash with a compact or limited use temporary spare installed. Damage to the vehicle may result.

Spare Tire Matching Original Equipped Tire And Wheel — If Equipped

Your vehicle may be equipped with a spare tire and wheel equivalent in look and function to the original equipment tire and wheel found on the front or rear axle of your vehicle. This spare tire may be used in the tire rotation for your vehicle. If your vehicle has this option, refer to an authorized tire dealer for the recommended tire rotation pattern.

Compact Spare Tire — If Equipped

The compact spare is for temporary emergency use only. You can identify if your vehicle is equipped with a compact spare by looking at the spare

tire description on the Tire and Loading Information Placard located on the driver's side door opening or on the sidewall of the tire. Compact spare tire descriptions begin with the letter “T” or “S” preceding the size designation. Example: T145/80D18 103M.

T, S = Temporary Spare Tire
Since this tire has limited tread life, the original equipment tire should be repaired (or replaced) and reinstalled on your vehicle at the first opportunity. Do not install a wheel cover or attempt to mount a conventional tire on the compact spare wheel, since the wheel is designed specifically for the compact spare tire. Do not install more than one compact spare tire and wheel on the vehicle at any given time.



Warning!

Compact and collapsible spares are for temporary emergency use only. With these spares, do not drive more than 50 mph (80 km/h). Temporary use spares have limited tread life. When the tread is worn to the tread wear indicators, the temporary use spare tire needs to be replaced. Be sure to follow the warnings, which apply to your spare. Failure to do so could result in spare tire failure and loss of vehicle control.

Full Size Spare — If Equipped

The full size spare is for temporary emergency use only. This tire may look like the originally equipped tire on the front or rear axle of your vehicle, but it is not. This spare tire may have limited tread life. When the tread is worn to the tread wear indicators, the temporary use full size spare tire needs to be replaced. Since it is not the same as your original equipment tire, replace (or repair) the original equipment tire and reinstall on the vehicle at the first opportunity.

Limited Use Spare — If Equipped

The limited use spare tire is for temporary emergency use only. This tire is identified by a label located on the limited use spare wheel. This label contains the driving limitations for this spare. This tire may look like the original equipped tire on the front or rear axle of your vehicle, but it is not. Installation of this limited use spare tire affects vehicle handling. Since it is not the same as your original equipment tire, replace (or repair) the original equipment tire and reinstall on the vehicle at the first opportunity.



**Warning!**

Limited use spares are for emergency use only. Installation of this limited use spare tire affects vehicle handling. With this tire, do not drive more than the speed listed on the limited use spare wheel. Keep inflated to the cold tire inflation pressures listed on your Tire and Loading Information Placard located on the driver's side B-Pillar or the rear edge of the driver's side door. Replace (or repair) the original equipment tire at the first opportunity and reinstall it on your vehicle. Failure to do so could result in loss of vehicle control.

Wheel And Wheel Trim Care

All wheels and wheel trim, especially aluminum and chrome plated wheels, should be cleaned regularly using mild (neutral Ph) soap and water to maintain their luster and to prevent corrosion. Wash wheels with the same soap solution recommended for the body of the vehicle.

Your wheels are susceptible to deterioration caused by salt, sodium chloride, magnesium chloride, calcium chloride, etc., and other road chemicals used to melt ice or control dust on dirt roads. Use a soft cloth or sponge and mild soap to wipe away promptly. Do not use harsh chemicals or a stiff brush. They can damage the wheel's

protective coating that helps keep them from corroding and tarnishing.

Note: Many aftermarket wheel cleaners contain strong acids or strong alkaline additives that can harm the wheel surface.

**Caution!**

Avoid products or automatic car washes that use acidic solutions or strong alkaline additives or harsh brushes. These products and automatic car washes may damage the wheel's protective finish. Such damage is not covered by the New Vehicle Limited Warranty. Only car wash soap, Mopar Wheel Cleaner or equivalent is recommended.

When cleaning extremely dirty wheels including excessive brake dust, care must be taken in the selection of tire and wheel cleaning chemicals and equipment to prevent damage to the wheels. Mopar Wheel Treatment or Mopar Chrome Cleaner or their equivalent is recommended or select a non-abrasive, non-acidic cleaner for aluminum or chrome wheels. Do not use any products on Dark Vapor or Black Satin Chrome Wheels. They will permanently damage this finish and such damage is not covered by the New Vehicle Limited Warranty.

**Caution!**

Do not use scouring pads, steel wool, a bristle brush, metal polishes or oven cleaner. These products may damage the wheel's protective finish. Such damage is not covered by the New Vehicle Limited Warranty. Only car wash soap, Mopar Wheel Cleaner or equivalent is recommended.

Note: If you intend parking or storing your vehicle for an extended period after cleaning the wheels with wheel cleaner, drive your vehicle for a few minutes before doing so. Driving the vehicle and applying the brakes when stopping will reduce the risk of brake rotor corrosion.

Dark Vapor Or Black Satin Chrome Wheels**Caution!**

If your vehicle is equipped with Dark Vapor or Black Satin Chrome wheels DO NOT USE wheel cleaners, abrasives or polishing compounds. They will permanently damage this finish and such damage is not covered by the New Vehicle Limited Warranty. USE ONLY MILD SOAP AND WATER WITH A SOFT CLOTH. Used on a regular basis; this is all that is required to maintain this finish.

Tire Types

All Season Tires – If Equipped

All Season tires provide traction for all seasons (Spring, Summer, Fall, and Winter). Traction levels may vary between different all season tires. All season tires can be identified by the M+S, M&S, M/S or MS designation on the tire sidewall. Use all season tires only in sets of four; failure to do so may adversely affect the safety and handling of your vehicle.

Summer Or Three Season Tires – If Equipped

Summer tires provide traction in both wet and dry conditions, and are not intended to be driven in snow or on ice. If your vehicle is equipped with Summer tires, be aware these tires are not designed for Winter or cold driving conditions. Install Winter tires on your vehicle when ambient temperatures are less than 40°F (5°C) or if roads are covered with ice or snow. For more information, contact an authorized dealer.

Summer tires do not contain the all season designation or mountain/snowflake symbol on the tire sidewall. Use Summer tires only in sets of four; failure to do so may adversely affect the safety and handling of your vehicle.



Warning!

Do not use Summer tires in snow/ice conditions. You could lose vehicle control, resulting in severe injury or death. Driving too fast for conditions also creates the possibility of loss of vehicle control.

Snow Tires

Some areas of the country require the use of snow tires during the Winter. Snow tires can be identified by a “mountain/snowflake” symbol on the tire sidewall.



If you need snow tires, select tires equivalent in size and type to the original equipment tires. Use snow tires only in sets of four; failure to do so may

adversely affect the safety and handling of your vehicle.

Snow tires generally have lower speed ratings than what was originally equipped with your vehicle and should not be operated at sustained speeds over 75 mph (120 km/h). For speeds above 75 mph (120 km/h) refer to original equipment or an authorized tire dealer for recommended safe operating speeds, loading and cold tire inflation pressures.



While studded tires improve performance on ice, skid and traction capability on wet or dry surfaces may be poorer than that of non-studded tires. Some states prohibit studded tires; therefore, local laws should be checked before using these tire types.

Tire Chains (Traction Devices)

Use of traction devices require sufficient tire-to-body clearance. Follow these recommendations to guard against damage.

Note:

- Traction device must be of proper size for the tire, as recommended by the traction device manufacturer
- Use on Rear Tires Only
- Due to limited clearance, the following traction devices are recommended:
 - For a 255/35R19 tire, use of a snow traction device with a maximum projection of 7 mm beyond the tire profile is recommended.
 - For 225/50R17, 225/45R18 or 225/40R19 tires, use of a snow traction device with a maximum projection of 9 mm beyond the tire profile is recommended.





Caution!

To avoid damage to your vehicle or tires, observe the following precautions:

Because of restricted traction device clearance between tires and other suspension components, it is important that only traction devices in good condition are used. Broken devices can cause serious damage. Stop the vehicle immediately if noise occurs that could indicate device breakage. Remove the damaged parts of the device before further use.

Install device as tightly as possible and then retighten after driving about 1/2 mile (0.8 km).

Do not exceed 30 mph (48 km/h).

Drive cautiously and avoid severe turns and large bumps, especially with a loaded vehicle.

Do not drive for a prolonged period on dry pavement.

Observe the traction device manufacturer's instructions on the method of installation, operating speed, and conditions for use. Always use the suggested operating speed of the device manufacturer's if it is less than 30 mph (48 km/h).

Do not use traction devices on a compact spare tire.

Tire Rotation Recommendations

Tires on the front and rear axles of vehicles operate at different loads and perform different steering, driving, and braking functions. For these reasons, they wear at unequal rates. These effects can be reduced by timely rotation of tires. Rotation will increase tread life, maintain traction levels and contribute to a smooth, quiet ride.

To resolve this problem, tires should be rotated at each service interval (approximately every 10,000 miles [16,000km]). More frequent rotation is permissible if desired. The reasons for any rapid or unusual wear should be corrected prior to rotation being performed.

Tire Rotations Not Recommended – If Equipped

Due to different size tires and wheels on front and rear axles tire rotation is not possible for:

2.0T GME Engine Equipped with a 225/40R19 front and 255/35R19 rear tires.



Caution!

Damage to the vehicle may occur if 225/40R19 front and 255/35R19 rear tires are rotated

Tire rotation contributes to the preservation of the grip and traction performance on wet, muddy or snowy roads, guaranteeing optimal driveability of the vehicle.

In the case of irregular wear of the tires identify the cause and correct it as soon as possible, by contacting an authorized dealer.

Tire Rotation for Directional Tires – If Equipped

Directional tires are equipped on the following:

2.0T GME Engine equipped with same size tires and wheels on front and rear axles

The rotational direction of the tire must be taken into consideration when rotating the tires. The recommended rotation pattern for directional tires is shown below.

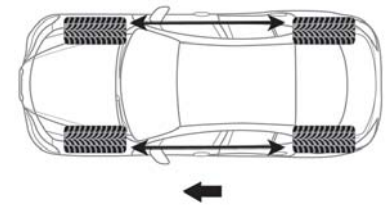

Tire Rotation

09066S0002EM

All Wheel Drive (AWD) Models

It is recommended to avoid situations with a large difference in wear between the front and rear tires and to strictly use winter tires of the sizes given on the tire placard.

The AWD system and the original tires are developed together to ensure the vehicle's best performance. When changing the tires, it is recommended to use the same "AR" marked tires, to maintain the same level of performance and component life.

DEPARTMENT OF TRANSPORTATION UNIFORM TIRE QUALITY GRADES

The following tire grading categories were established by the National Highway Traffic Safety Administration. The specific grade rating assigned by the tire's manufacturer in each category is shown on the sidewall of the tires on your vehicle.

All passenger vehicle tires must conform to Federal safety requirements in addition to these grades.

Treadwear

The Treadwear grade is a comparative rating, based on the wear rate of the tire when tested under controlled conditions on a specified government test course. For example, a tire graded 150 would wear one and one-half times as well on the government course as a tire graded 100. The relative performance of tires depends upon the actual conditions of their use, however, and may depart significantly from

the norm due to variations in driving habits, service practices, and differences in road characteristics and climate.

Traction Grades

The Traction grades, from highest to lowest, are AA, A, B, and C. These grades represent the tire's ability to stop on wet pavement, as measured under controlled conditions on specified government test surfaces of asphalt and concrete. A tire marked C may have poor traction performance.



Warning!

The traction grade assigned to this tire is based on straight-ahead braking traction tests, and does not include acceleration, cornering, hydroplaning, or peak traction characteristics.

Temperature Grades

The temperature grades are A (the highest), B, and C, representing the tire's resistance to the generation of heat and its ability to dissipate heat,



when tested under controlled conditions on a specified indoor laboratory test wheel. Sustained high temperature can cause the material of the tire to degenerate and reduce tire life, and excessive temperature can lead to sudden tire failure. The grade C corresponds to a level of performance, which all passenger vehicle tires must meet under the Federal Motor Vehicle Safety Standard No. 109. Grades B and A represent higher levels of performance on the laboratory test wheel, than the minimum required by law.



Warning!

The temperature grade for this tire is established for a tire that is properly inflated and not overloaded. Excessive speed, under-inflation, or excessive loading, either separately or in combination, can cause heat buildup and possible tire failure.

STORING THE VEHICLE

If the vehicle is left inactive for longer than a month, the following precautions should be observed:

- Park the vehicle in an area that is covered and dry, and well-ventilated if possible. Slightly open the windows.
- Check that the electric park brake is not activated.
- Carry out the procedure: “manual trunk opening device” procedure described in this paragraph.
- Disconnect the negative battery terminal and check the battery charge. Repeat this check once every three months during storage.
- If the battery is not disconnected from the electrical system, check its state of charge every thirty days.
- Clean and protect the painted parts using protective wax.
- Clean and protect the shiny metal parts using special compounds available commercially.
- Sprinkle talcum powder on the windshield wiper rubber blades, and lift them off the glass.
- Cover the vehicle with a fabric or perforated plastic sheet, paying particular care not to damage the painted surface by dragging any dust that may have accumulated on it. Do not use compact plastic sheets, as they

do not allow humidity to evaporate from the surface of the vehicle.

- Inflate tires to +7.25 psi (+0.5 bar) above the standard prescribed pressure and check it periodically.
- Do not drain the engine cooling system.
- Any time the vehicle is left inactive for two weeks or more, operate the air conditioning system with engine idling for at least five minutes, setting external air and with fan set to maximum speed. This operation will ensure appropriate lubrication for the system, thus minimizing the possibility of damage to the compressor when the system is operated again.

Note: After cycling the ignition to STOP and having closed the driver side door, wait at least one minute before disconnecting the electrical supply from the battery. When reconnecting the electrical supply to the battery, make sure that the ignition is in the STOP position and the driver side door is closed.

Manual Trunk Opening Device

Proceed as follows if the battery needs to be disconnected:

1. From the trunk interior covering, rotate the plug to the left of the lock and extract the strap connected to it.

2. Make sure the free end of the strap remains outside the deck lid when closing the deck lid.



09086S0001EM

Trunk Compartment

3. The trunk can now be opened manually by pulling the strap.

Note: This procedure must be carried out exclusively in safe places because it allows to open the trunk unconditionally.

BODYWORK

Protection Against Atmospheric Agents

The vehicle is equipped with the best available technological solutions to protect the bodywork against corrosion.

These include:

- Painting products and systems which give the vehicle resistance to corrosion and abrasion.
- Use of galvanized (or pre-treated) steel sheets, with high resistance to corrosion.
- Spraying of plastic parts, with a protective function in the more exposed points: underdoor, inner wing, edges, etc.
- Use of “open” boxed sections to prevent condensation and pockets of moisture which could favor the formation of rust inside.
- Use of special films to protect against abrasion in exposed areas (e.g. rear wing, doors, etc.).

Corrosion Warranty

Your vehicle is covered by Corrosion Warranty against perforation due to rust of any original element of the structure or bodywork. For the general terms of this warranty, refer to the Warranty Booklet.

Preserving The Bodywork

Paint

Touch up abrasions and scratches immediately to prevent the formation of rust.

Maintenance of paintwork consists of washing the car: the frequency depends on the conditions and environment where the car is used. For example, it is advisable to wash the vehicle more often in areas with high levels of atmospheric pollution or salted roads.

Some parts of the vehicle may be covered with a matte paint which, in order to be maintained intact, requires special care.

To correctly wash the vehicle, follow these instructions:

- If high pressure jets or cleaners are used to wash the vehicle, keep a distance of at least 15 inches (40 cm) from the bodywork to avoid damage or alteration. Build up of water could cause damage to the vehicle in the long term.



☐ To make it easier to remove any dirt deposits in the area where the blades are normally located it is recommended to position the windshield wipers vertically (service position), for more information, refer to “Dealer Service” in this chapter.

☐ Wash the bodywork using a low pressure jet of water if possible.

☐ Wipe a sponge with a slightly soapy solution over the bodywork, frequently rinsing the sponge.

☐ Rinse well with water and dry with a leather chamois.

Dry the less visible parts (e.g. door frames, hood, headlight frames, etc.) with special care, as water may stagnate more easily in these areas. Do not wash the car after it has been left in the sun or with the hood hot: this may alter the shine of the paintwork.

Exterior plastic parts must be cleaned in the same way as the rest of the vehicle.

If washing the car in a service that moves the car, for cars with automatic transmissions, PARK (P) must be cut out. You have to shut off the engine in the following conditions: car stopped, transmission in NEUTRAL (N), push the starter button for at least three seconds.

Note: Avoid parking under trees; the resin dropped by trees makes the paintwork go opaque and increases the possibility of corrosion.

Windows

Use specific detergents and clean cloths to prevent scratching or altering the transparency.



Caution!

Wipe the rear window inside gently with a cloth following the direction of the filaments to avoid damaging the heating device.

Front Headlights

Use a soft cloth soaked in water and detergent for washing cars.

Note:

☐ Never use aromatic substances (e.g. gasoline) or ketones (e.g. acetone) for cleaning the plastic lenses of the headlights.

☐ When cleaning with a pressure washer, keep the pressure washer at least eight inches (20 cm) away from the headlights.

Engine Compartment

At the end of every winter, wash the engine compartment thoroughly, taking care not to aim the jet of water directly at the electronic control units or at the windshield wiper motors. Have this operation performed at a specialized workshop.

Note: The washing should take place with the engine cold and the ignition device in the STOP position. After the washing operation, make sure that the various protections (e.g. rubber caps and guards) have not been removed or damaged.

INTERIORS

Periodically check the cleanliness of the interior, beneath the mats, which could cause oxidation of the sheet metal.

Seats And Fabric Parts

Remove dust with a soft brush or a vacuum cleaner. It is advised to use a moist brush on velvet upholstery. Rub the seats with a sponge moistened with a solution of water and neutral detergent.

Leather Seats – If Equipped

Remove the dry dirt with a chamois or slightly damp cloth, without exerting too much pressure.

Remove any liquid or grease stains using an absorbent dry cloth, without rubbing. Then clean with a soft cloth or buckskin cloth dampened with water and mild soap. If the stain persists, use specific products and observe the instructions carefully.

Note: Never use alcohol. Make sure that the cleaning products used contain no alcohol or alcohol derivatives, even in small quantities.

Plastic And Coated Parts

Clean interior plastic parts with a damp cloth (if possible made from microfiber), and a solution of water and neutral, non-abrasive detergent.

To clean oily or persistent stains, use specific products free from solvents and designed to maintain the original appearance and color of the components.

Remove any dust using a microfiber cloth, if necessary moistened with water. The use of paper tissues is not recommended as these may leave residues.

Genuine Leather Parts – If Equipped

Use only water and mild soap to clean these parts. Never use alcohol or alcohol-based products.

Before using a specific product for cleaning interiors, make sure that it does not contain alcohol and/or alcohol based substances.

Carbon Fiber Parts

To eliminate small scratches and marks on the carbon, contact your authorized dealer. An improperly performed operation may irreparably damage the carbon.



TECHNICAL SPECIFICATIONS

Everything you may find useful for understanding how your vehicle is made and works is contained in this chapter and illustrated with data, tables and graphics. For the enthusiasts and the technician, but also just for those who want to know every detail of their vehicle.

IDENTIFICATION DATA.241
ENGINE242
POWER SUPPLY243
TRANSMISSION.244
BRAKES.245
SUSPENSION246
STEERING SYSTEM247
DIMENSIONS248
WEIGHTS.249
FUEL REQUIREMENTS250
FLUID CAPACITIES.252
FLUIDS AND LUBRICANTS.253
PERFORMANCE255

IDENTIFICATION DATA

Vehicle Identification Number

The Vehicle Identification Number (VIN) is stamped on a plate on the front left corner of the dashboard cover, which can be seen from outside the vehicle, through the windshield.

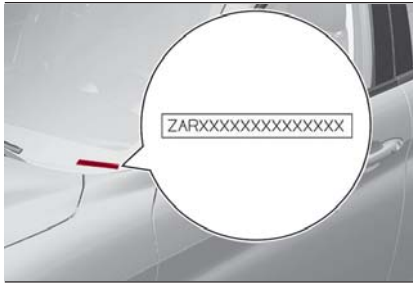

10016S0001EM

Vehicle Identification Number

This number is also printed on the chassis at the front left shock absorber and can be seen by opening the engine compartment hood.

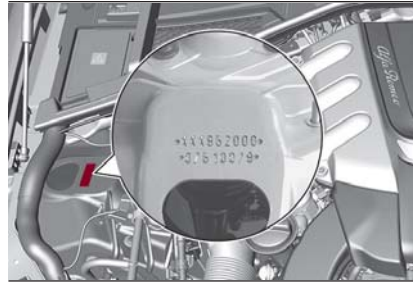

10016S0002EM

Vehicle Identification Number

Vehicle Identification Number (VIN) Plate

The plates are located on the left side A pillar and contain the data about:

- Chassis number (VIN).
- Vehicle type (USA and Canada only).
- Color code.
- Place of manufacturing of the vehicle (USA and Mexico only).
- Vehicle manufacturing date.
- Maximum permitted weights.
- Permitted tire inflation pressure (USA and Canada only).



ENGINE

2.0 T4 MAir Engine	280 HP
Cycle	Four
Number and position of cylinders	4 in line
Piston bore and stroke (mm)	84 / 89.9
Total displacement (cm ³)	1,993
Compression ratio	10:1
Maximum power (SAE) (HP)	280
Maximum power (kW)	209
Corresponding engine speed (rpm)	5200
Maximum torque (SAE) (ft-lb)	306
Maximum torque (Nm)	415
Corresponding engine speed (rpm)	2,000 – 4,800
Fuel	Gasoline with an octane number (A.K.I.) 91, ethanol percentage is 0–15%.

POWER SUPPLY



Power Supply

2.0L T4 MAir Engine

Electronic timed sequential injection with knock control



TRANSMISSION

Model	Transmission	Traction
2.0L T4 MAir Engine	Eight forward gears plus reverse	Rear or All-wheel drive

BRAKES

Model	Front brakes	Rear brakes	Parking brake
2.0 T4 MAir Engine	Disc	Disc	Electric



Caution!

- Water, ice and salt spread on the roads may deposit on the brake discs, reducing braking efficiency the first time the brakes are applied.
- To obtain the maximum efficiency of the braking system, a bedding-in period of about 300 miles (500 km) is needed: during this period it is better to avoid sharp, repeated and prolonged braking.



SUSPENSION

Model	Front	Rear
2.0L T4 MAir Engine	Independent wheel double-wishbone suspension	Independent wheel with multilink system

STEERING SYSTEM

Model	Curb-to-curb turning circle	Type
2.0L T4 MAir Engine	35.50 ft (10.80 m)	Rack and pinion with electric power steering



DIMENSIONS

Dimensions

Dimensions are expressed in inches and refer to the vehicle equipped with its standard-supplied tires. Height is measured with vehicle unladen.

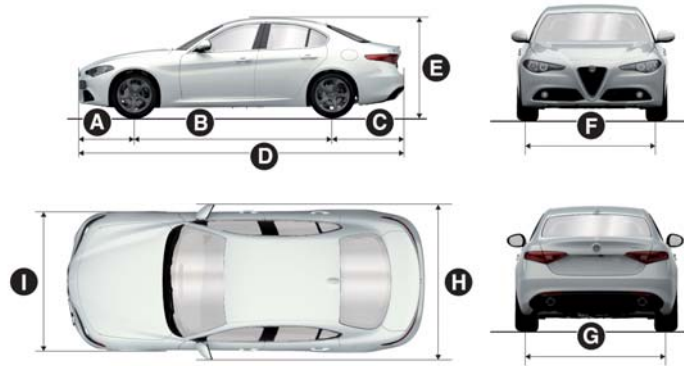

10106S0001EM

A	B	C	D	E	F	G	H	I
31.30	111.02	40.47	182.80	56.54(+) 57.09(*)	61.30(+) 61.38(*)	63.98(+) 63.15(*)	79.69	73.23

(+) RWD models

(*) AWD models

Small variations with respect to the reported values are possible depending on the dimensions of the rims.

Luggage Compartment Volume

Capacity (V.D.A. standards)

Rear seats not folded

Vehicle unladen: 16.96 cubic feet

WEIGHTS

Weights (lbs)	2.0 T4 MAir Engine With AWD	2.0 T4 MAir Engine With RWD
Unladen weight (with all fluids, fuel tank filled to 90% and without optional equipment)	3632	3521
Payload including the driver (*)	905	905
Maximum permitted loads (**)	155	155
– front axle	2205	2205
– rear axle	2646	2646
– total	4723	4612
Towable loads	–	–

(*) If special equipment is fitted (trailer towing equipment, etc.) the empty weight will increase and consequently the payload will decrease in relation to the maximum permitted loads.

(**) Loads not to be exceeded. The user is responsible for arranging goods in the luggage compartment and/or on the load platform within the maximum permitted loads.



FUEL REQUIREMENTS



This engine is designed to meet all emission regulations, and provide satisfactory fuel economy and performance, when

using high-quality unleaded "Regular" gasoline having a posted octane number of 91 as specified by the (R+M)/2 method. For optimum performance and fuel economy the use of "Premium" 91 octane gasoline or higher is recommended.

While operating on gasoline with the required octane number, hearing a light knocking sound from the engine is not a cause for concern. However, if the engine is heard making a heavy knocking sound, see your dealer immediately. Use of gasoline with a lower than recommended octane number can cause engine failure and may void or not be covered by the New Vehicle Limited Warranty.

Poor quality gasoline can cause problems such as hard starting, stalling, and hesitations. If you experience these symptoms, try another brand of gasoline before considering service for the vehicle.

Reformulated Gasoline

Many areas of the country require the use of cleaner burning gasoline referred to as "Reformulated Gasoline". Reformulated gasoline contains oxygenates and are specifically blended to reduce vehicle emissions and improve air quality.

The use of reformulated gasoline is recommended. Properly blended reformulated gasoline will provide improved performance and durability of engine and fuel system components.

Gasoline/Oxygenate Blends

Some fuel suppliers blend unleaded gasoline with oxygenates such as ethanol.



Caution!

DO NOT use gasoline containing methanol or gasoline containing more than 15% ethanol (E-15). Use of these blends may result in starting and drivability problems, damage critical fuel system components, cause emissions to exceed the applicable standard, and/or cause the "Malfunction Indicator Light" to illuminate. Please observe pump labels as they should clearly communicate if a fuel contains greater than 15% ethanol (E-15).

Problems that result from using gasoline containing more than 15% ethanol (E-15) or gasoline containing methanol are not the responsibility of the manufacturer and may void or not be covered under New Vehicle Limited Warranty.

CNG And LP Fuel System Modifications

Modifications that allow the engine to run on compressed natural gas (CNG) or liquid propane (LP) may result in damage to the engine, emissions, and fuel system components. Problems that result from running CNG or LP are not the responsibility of the manufacturer and may void or not be covered under the New Vehicle Limited Warranty.

MMT In Gasoline

Methylcyclopentadienyl Manganese Tricarbonyl (MMT) is a manganese-containing metallic additive that is blended into some gasoline to increase octane. Gasoline blended with MMT provides no performance advantage beyond gasoline of the same octane number without MMT. Gasoline blended with MMT reduces spark plug life and reduces emissions system performance in some vehicles. The manufacturer recommends that gasoline without MMT be used in your vehicle. The MMT content of gasoline may not be indicated on the gasoline pump; therefore, you should ask your gasoline retailer whether the gasoline contains MMT. MMT is prohibited in Federal and California reformulated gasoline.

Materials Added To Fuel

Besides using unleaded gasoline with the proper octane rating, gasolines that contain detergents, corrosion and stability additives are recommended. Using gasolines that have these additives will help improve fuel economy, reduce emissions, and maintain vehicle performance.



Designated TOP TIER Detergent Gasoline contains a higher level of detergents to further aide in minimizing engine and fuel system deposits. When

available, the usage of Top Tier Detergent gasoline is recommended. Visit www.toptiergas.com for a list of TOP TIER Detergent Gasoline Retailers. Indiscriminate use of fuel system cleaning agents should be avoided. Many of these materials intended for gum and varnish removal may contain active solvents or similar ingredients. These can harm fuel system gasket and diaphragm materials.

Fuel System Cautions



Caution!

Follow these guidelines to maintain your vehicle's performance:

The use of leaded gasoline is prohibited by Federal law. Using leaded gasoline can impair engine performance and damage the emissions control system.

An out-of-tune engine or certain fuel or ignition malfunctions can cause the catalytic converter to overheat. If you notice a pungent burning odor or some light smoke, your engine may be out of tune or malfunctioning and may require immediate service. Contact your authorized dealer for service assistance.

The use of fuel additives, which are now being sold as octane enhancers, is not recommended. Most of these products contain high concentrations of methanol. Fuel system damage or vehicle performance problems resulting from the use of such fuels or additives is not the responsibility of the manufacturer and may void or not be covered under the New Vehicle Limited Warranty.

Note: Intentional tampering with the emissions control system can result in civil penalties being assessed against you.



FLUID CAPACITIES

2.0 T4 MAir Engine

	U.S.	Metric
Fuel tank	15.3 Gallons	58 Liters
Fuel tank reserve	2.3 Gallons	9 Liters
Engine cooling system	2.2 Gallons	8.6 Liters
Intercooler cooling system	1.1 Gallons	4.3 Liters
Engine sump and filter	5.5 Quarts	5.2 Liters
Hydraulic brake circuit	0.9 Quarts	0.9 Liters
Windshield washer fluid reservoir	1.1 Gallons	4.2 Liters
Automatic transmission, 2.0 T4 MAir engine	9.9 Quarts (RWD Model) / 9.8 Quarts (AWD Model)	9.4 Liters (RWD Model) / 9.3 Liters (AWD Model)
Differentials and reduction gears RDU 195	0.9 Quarts	0.9 Liters
Differentials and reduction gears RDU 230-TV	-	-
RDU 230-LSD differential	0.9 Quarts	0.9 Liters
RDU 210-eLSD differential (if equipped)	1.4 Quarts	1.4 Liters
RDU 210/215-LSD differential	1.1 Quarts	1.1 Liters
AWD System FAD transfer case	0.5 Quarts	0.5 Liters
AWD System TRANSFER CASE	0.7 Quarts	0.7 Liters

FLUIDS AND LUBRICANTS

Your vehicle is equipped with an engine oil that has been thoroughly developed and tested in order to meet the requirements of the Scheduled Servicing Plan. Constant use of the prescribed lubricants guarantees the fuel consumption and emission specifications. Lubricant quality is crucial for engine operation and duration.

Engine Lubrication

Use	Features	Specification	Replacement interval
Lubricant for engines 2.0 T4 MAir	SAE 0W-30 API SN	MS-13340 9.55535-GS1	According to the Maintenance Plan

If lubricants conforming to the specific request are not available, products that meet the indicated specifications can be used to top up; in this case optimal performance of the engine is not guaranteed.



Chassis Lubrication

Use	Features	Specification	Applications
	ZF 8HP 50 - Synthetic ATF	-	Automatic transmission
Lubricants and greases	SAE 75W-85 synthetic lubricant	FPW9.55550-DA9	Differential RDU 195; RDU 230-LSD; RDU 210-eLSD; RDU 210/215-LSD / 2.0 T4 MAir engine
	SAE 75W-80 APL GL-5 synthetic lubricant	FPW9.55550-DA10	AWD System FAD transfer case
	SAE 75W synthetic lubricant	FPW9.55550-DA11	AWD System TRANSFER CASE
Brake fluid	DOT 4	MS.90039	Hydraulic brakes
Engine coolant	CUNA NC 956-16 ASTMD3306	MS.90032	Use rate 50% Not mixable with different formulation products. (*)
Windshield washer fluid	CUNA NC 956-11	MS.90043	To be used diluted or undiluted in windshield washer/wiper systems
HVAC	R1234yf or R134yf (depending on market)	-	-

(*) For particularly harsh climate conditions, a mixture of 60% product and 40% distilled water is recommended.

PERFORMANCE

Top performance after the initial period of vehicle usage.

Models	Maximum speed mph	Acceleration from 0–60 mph/0-100 km/h sec.
2.0 T4 MAir 280 HP RWD engine	149	5.5
2.0 T4 MAir 280 HP AWD engine	149	5.1



CUSTOMER ASSISTANCE

SUGGESTIONS FOR OBTAINING
SERVICE FOR YOUR VEHICLE257
IF YOU NEED ASSISTANCE257
WARRANTY INFORMATION258
REPORTING SAFETY DEFECTS . .259
PUBLICATION ORDER FORMS . . .259



SUGGESTIONS FOR OBTAINING SERVICE FOR YOUR VEHICLE

Prepare For The Appointment

If you are having warranty work done, be sure to bring the right papers with you, as well as your warranty folder. All work to be performed may not be covered by the warranty. Discuss additional charges with the service manager. Keep a maintenance log of your vehicle's service history, as this can often provide a clue to the current problem.

Prepare A List

Make a written list of your vehicle's problems or the specific work you want done. If you've had an accident or work done that is not on your maintenance log, let the service advisor know.

Be Reasonable With Requests

If you list a number of items and you must have your vehicle by the end of the day, discuss the situation with the service advisor and list the items in order of priority. At many authorized dealers, you may obtain a rental vehicle at a minimal daily charge. If you need a rental, it is advisable to make these arrangements when you call for an appointment.

IF YOU NEED ASSISTANCE

The manufacturer and its authorized dealer are vitally interested in your satisfaction. We want you to be happy with our products and services.

Warranty service must be done by an authorized dealer. We strongly recommend that you take the vehicle to an authorized dealer. They know your vehicle the best, and are most concerned that you get prompt and high quality service. The manufacturer's authorized dealer have the facilities, factory-trained technicians, special tools, and the latest information to ensure the vehicle is fixed correctly and in a timely manner.

This is why you should always talk to an authorized dealer service manager first. Most matters can be resolved with this process.

If for some reason you are still not satisfied, talk to the general manager or owner of the authorized dealer. They want to know if you need assistance.

If an authorized dealer is unable to resolve the concern, you may contact the manufacturer's customer center.

Any communication to the manufacturer's customer center should include the following information:

Owner's name and address

Owner's telephone number (home and office)

Authorized dealer name

Vehicle Identification Number (VIN)

Vehicle delivery date and mileage

Alfa Romeo Customer Center

P.O. Box 21-8004 Auburn Hills, MI 48321-8004 Phone: 1-844-Alfa-USA (1-844-253-2872)

Alfa Romeo Customer Center (Canada)

P.O. Box 1621 Windsor, Ontario N9A 4H6 Phone: 1-800-465-2001 (English) Phone: 1-800-387-9983 (French)

Customer Assistance For The Hearing Or Speech Impaired (TDD/TTY)

To assist customers who have hearing difficulties, the manufacturer has installed special TDD (Telecommunication Devices for the Deaf) equipment at its customer center. Any hearing or speech impaired customer, who has access to a TDD or a conventional teletypewriter (TTY) in the United States, can communicate with the manufacturer by dialing 1-800-380-CHRY.



Canadian residents with hearing difficulties that require assistance can use the special needs relay service offered by Bell Canada. For TTY teletypewriter users, dial 711 and for Voice callers, dial 1-800-855-0511 to connect with a Bell Relay Service operator.

Service Contract

You may have purchased a service contract for a vehicle to help protect you from the high cost of unexpected repairs after the manufacturer's New Vehicle Limited Warranty expires. The manufacturer stands behind only the manufacturer's service contracts. If you purchased a manufacturer's service contract, you will receive Plan Provisions and an Owner Identification Card in the mail within three weeks of the vehicle delivery date. If you have any questions about the service contract, call the manufacturer's Service Contract National Customer Hotline at 1-800-521-9922 (Canadian residents, call (800) 465-2001 English / (800) 387-9983 French).

The manufacturer will not stand behind any service contract that is not the manufacturer's service contract. It is not responsible for any service contract other than the manufacturer's service contract. If you purchased a service contract that is not a manufacturer's service contract, and you require service after the manufacturer's New

Vehicle Limited Warranty expires, please refer to the contract documents, and contact the person listed in those documents.

We appreciate that you have made a major investment when you purchased the vehicle. An authorized dealer has also made a major investment in facilities, tools, and training to assure that you are absolutely delighted with the ownership experience. You will be pleased with their sincere efforts to resolve any warranty issues or related concerns.



Warning!

Engine exhaust (internal combustion engines only), some of its constituents, and certain vehicle components contain, or emit, chemicals known to the State of California to cause cancer and birth defects, or other reproductive harm. In addition, certain fluids contained in vehicles and certain products of component wear contain, or emit, chemicals known to the State of California to cause cancer and birth defects, or other reproductive harm.

WARRANTY INFORMATION

See the Warranty Information Booklet, for the terms and provisions of FCA US LLC warranties applicable to this vehicle and market.

REPORTING SAFETY DEFECTS

In The 50 United States And Washington, D.C.

If you believe that your vehicle has a defect that could cause a crash or cause injury or death, you should immediately inform the National Highway Traffic Safety Administration (NHTSA) in addition to notifying FCA US LLC.

If NHTSA receives similar complaints, it may open an investigation, and if it finds that a safety defect exists in a group of vehicles, it may order a recall and remedy campaign. However, NHTSA cannot become involved in individual problems between you, your authorized dealer or FCA US LLC.

To contact NHTSA, you may call the Vehicle Safety Hotline toll free at 1-888-327-4236 (TTY: 1-800-424-9153); or go to <http://www.safercar.gov> ; or write to: Administrator, NHTSA, 1200 New Jersey Avenue, SE., West Building, Washington, D.C. 20590. You can also obtain other information about motor vehicle safety from <http://www.safercar.gov> .

In Canada

If you believe that your vehicle has a safety defect, you should contact the Customer Service Department immediately. Canadian customers who wish to report a safety defect to the Canadian government should contact Transport Canada, Motor Vehicle Defect Investigations and Recalls at 1-800-333-0510 or go to <http://www.tc.gc.ca/roadsafety/> .

PUBLICATION ORDER FORMS

To order the following manuals, you may use either the website or the phone numbers listed below. Visa, Mastercard, American Express, and Discover orders are accepted.

Service Manuals

These comprehensive Service Manuals provide the information that students and professional technicians need in diagnosing/troubleshooting, problem solving, maintaining, servicing, and repairing FCA US LLC vehicles. A complete working knowledge of the vehicle, system, and/or components is written in straightforward language with illustrations, diagrams, and charts.



Diagnostic Procedure Manuals

Diagnostic Procedure Manuals are filled with diagrams, charts and detailed illustrations. These practical manuals make it easy for students and technicians to find and fix problems on computer-controlled vehicle systems and features. They show exactly how to find and correct problems the first time, using step-by-step troubleshooting and drivability procedures, proven diagnostic tests, and a complete list of all tools and equipment.

Owner's Manuals

These Owner's Manuals have been prepared with the assistance of service and engineering specialists to acquaint you with specific FCA US LLC vehicles. Included are starting, operating, emergency and maintenance procedures as well as specifications, capabilities and safety tips.

Call toll free at:

☐ **1-800-890-4038 (U.S.)**

☐ **1-800-387-1143 (Canada)**

Or

Visit us on the Worldwide Web at:

☐ www.techauthority.com

INDEX

Accessories Purchased By The Owner3
Active Aerodynamics61
Active Safety Systems96
Adaptive Cruise Control158
Adaptive Cruise Control (ACC) (Cruise Control)158
Additional Heaters50
Additives, Fuel251
Air Bag116
Air Bag Components115,120
Air Bag Operation117
Air Bag Warning Light115
Driver Knee Air Bag118
Enhanced Accident Response201
Event Data Recorder (EDR)201
Front Air Bag116
If A Deployment Occurs120
Knee Impact Bolsters117
Maintaining Your Air Bag System123
Redundant Air Bag Warning Light116
Side Air Bags118
Transporting Pets133
Air Bag Light115,134
Air Bag Maintenance123
Air Pressure, Tires226
Alarm (Security Alarm)19

Alfa Active Suspension (AAS)152
Alfa DNA System.149
Anti-Lock Braking (ABS) System.96
Automatic Dimming Mirror.34
Automatic Headlights.35
Automatic Temperature Control (ATC)45
Automatic Transmission143
Auxiliary Driving Systems99
B-Pillar Location223
Battery210
Battery Recharging210
Belts, Seat.134
Blind Spot Monitoring99
Bodywork (Cleaning And Maintenance)237
Brakes245
Brake Fluid Level209
Brightness, Interior Lights41
Bulbs, Light135
Camera, Rear.173
Carbon Monoxide Warning134
Cargo Tie-Downs56
Certification Label176
Changing A Flat Tire.218
Chart, Tire Sizing.219
Checking Levels207

Checking Your Vehicle For Safety . . .133	
Checks, Safety133
Child Restraint123
Child Restraints	
Booster Seats126
Child Restraints123
Child Seat Installation132
How To Stow An Unused ALR Seat Belt130
Infants And Child Restraints125
LATCH Positions127
Lower Anchors And Tethers For Children127
Older Children And Child Restraints125
Seating Positions126
Using The Top Tether Anchorage132
Clean Air Gasoline250
Cleaning	
Wheels232
Climate Control44,46
Close The Hood54
Compact Spare Tire.231
Contract, Service258
Courtesy Mirror Light (Bulb Replacement)184
Cruise Control (Speed Control)158
Cupholder.60
Cupholders60



Customer Assistance257	Hazard Warning Flasher181	Fire Extinguisher60
Daytime Running Lights36	Jacking218	Flashers	
Daytime Running Lights (DRL)36	Jump Starting194,195	Hazard Warning181
Defroster, Windshield134	Overheating197	Turn Signal37,135
Dimensions248	Tow Hooks199	Fluid Leaks135
Direction Indicators (Changing A Bulb).184	Towing198	Fluids And Lubricants.253
Disabled Vehicle Towing198	Engine242	Forward Collision Warning.101
Door Locks		Block Heater140	Front Light Cluster With Main Beam Xenon Gas Discharge Headlights (Bulb Replacement)184
Child-Protection Door Lock — Rear Doors24	Engine Coolant Level209	Front Mobile Spoiler (Alfa Active Aero)61
Power Door Locks24	Exhaust Gas Caution134	Front Seat Electric Heating28
Doors.20	Fuel Requirements250	Front Seats (Power Seats).26
Drive Train Control (DTC) System96	Jump Starting194,195	Front Wipers	
Driving Modes149	Overheating197	Wiper Operation41
Dynamic Steering Torque (DST) System99	Starting196	Fuel	
Electric Park Brake141	Temperature Gauge64	Additives251
Electric Remote Mirrors34	Engine Compartment207	Clean Air250
Electric Steering Wheel Heating33	Engine Compartment (Washing)238	Ethanol250
Electronic Speed Control.156	Engine Oil		Gauge64
Electronic Speed Control (Cruise Control)156,158	Level Check208	Materials Added251
Electronic Stability Control (ESC) System97	Engine Overheating197	Methanol250
Emergency Refuelling197	Enhanced Accident Response Feature201	Fuse Boxes187
Emergency Starting194	Environmental Protection Systems61	Fuses (Replacement)186
Emergency, In Case Of191	Ethanol.250	Garage Door Opener (HomeLink)57
		Exhaust Gas Caution134	Gasoline, Clean Air250
		Exhaust System134	Gasoline, Reformulated250
		Exterior Lighting35,36		
		Exterior Lights35,135		
		External Lights35		

Electric Powered34	Radial Ply Tires228	Safety, Exhaust Gas.134
Electric Remote34	Radio Frequency		Saving Fuel178
Heated35	General Information16,18,24	SBL Function.38
OBD System94	Radio Transmitters And Mobile		Scheduled Servicing203
Occupant Restraints108	Phones.4	Scheduled Servicing Program	
Overheating, Engine.197	Rear Camera173	(2.0 T4 MAir Engine Versions)204
Owner's Manual		Rear Cross Path99	Seat Belt	
(Operator Manual)259	Rear Seats29	Energy Management Feature114
Paintwork (Cleaning And		Rear View Mirrors34	Lap/Shoulder Belt Untwisting112
Maintenance)237	Reformulated Gasoline250	Lap/Shoulder Belts110
Panic Brake Assist (PBA) System98	Refueling Procedure.175	Pregnant Women113
Park Sensors System.165	Refueling The Vehicle175	Seat Belt Pretensioner113
Passive Entry (system)21	Refuelling252	Seat Belt Reminder109
Performance (Top Speed)255	Reminder, Seat Belt109	Seat Belt Reminder109
Pets133	Remote Starting System137	Seat Belts109,134
Placard, Tire And Loading		Replacement Tires.230	Child Restraint123
Information.223	Replacing A Bulb181	Front Seat109,110
Power		Replacing An External Bulb184	Inspection134
Mirrors34	Replacing An Internal Bulb.184	Pregnant Women113
Seats26	Reporting Safety Defects259	Pretensioners113
Sunroof52	Restraint, Head30	Rear Seat110
Power Sunroof.52	Restraints, Child123	Untwisting Procedure112
Power Supply.243	Rims And Tires218	Seats26
Power Windows51	Safety Checks Inside Vehicle134	Adjustment26
Pregnant Women And Seat Belts . .	.113	Safety Checks Outside Vehicle135	Head Restraints30
Pretensioners		Safety Defects, Reporting259	Height Adjustment26
Seat Belts113	Safety Information, Tire.218	Power26
Prolonged Vehicle Inactivity236	Safety Tips133	Tilting26
				Service Assistance257

Service Contract	258	Stop/Start System	152	Load Capacity	223
Service Manuals	259	Storage	60	Quality Grading	235
Servicing Procedures	212	Suggestions For Driving	178	Radial	228
Shoulder Belts	110	Sun Roof	52	Replacement	230
Signals, Turn	37,135	Sun Visors.	57	Safety	218,226
Snow Chains	233	Supplemental Restraint System - Air Bag	116	Sizes	219
Snow Tires	233	Suspension	246	Snow Tires	233
Spare Tire	231	Symbols.	6	Spare Tire	231
Speed Control		Telescoping Steering Column	32	Spinning	229
Accel/Decel	157	Tie Down Hooks, Cargo	56	Tread Wear Indicators	229
Cancel	158	Tilt Steering Column	32	To Open Hood	54
Resume	157	Tire And Loading Information Placard	223	Tow Hooks, Emergency	199
Set	156	Tire Markings	218	Towing	
Speed Control (Cruise Control)	156,158	Tire Safety Information	218	Disabled Vehicle	198
Speed Limiter.	154	Tire Service Kit	191	Towing Trailers	177
Split Folding Rear Seat	29	Tires	135,226,231,235	TPMS (Tire Pressure Monitoring System).	105
Starting.	196	Aging (Life Of Tires)	229	Traction Control System (TCS)	97
Cold Weather	138	Air Pressure	226	Transmission	244
Starting And Operating	196	Changing	218	Transporting Animals	179
Starting Procedures	196	Compact Spare	231	Transporting Passengers.	179
Starting The Engine	137	Flat Changing	191	Transporting Pets	133
Steering		General Information	226,231	Tread Wear Indicators.	229
Tilt Column	32	High Speed	227	Turn Signals.	37
Wheel, Heated	33	Inflation Pressures	226	Uniform Tire Quality Grades	235
Wheel, Tilt	32	Jacking	218	Untwisting Procedure, Seat Belt	112
Steering System	247	Life Of Tires	229	Use Of The Owner's Manual	5
Steering Wheel.	32				



Vehicle Changes/Alterations3
Vehicle Identification Number241
Vehicle Loading.176,223
Vent Operation44

Warning Flasher, Hazard181
Warranty Information258
Washer Fluid For
 Windshield/Headlights.209
Washers, Windshield41
Weights249
Wheel And Wheel Trim232
Wheel And Wheel Trim Care.232
Wheels And Tires218
Windows (Cleaning)238
Windshield Defroster134
Windshield Wiper41
 Replacing Blades214
Windshield Wiper/Washer
 Smart Washing Function42
Windshield Wipers41
Wrecker Towing198

INSTALLATION OF RADIO TRANSMITTING EQUIPMENT

Special design considerations are incorporated into this vehicle's electronic system to provide immunity to radio frequency signals. Mobile two-way radios and telephone equipment must be installed properly by trained personnel. The following must be observed during installation.

The positive power connection should be made directly to the battery and fused as close to the battery as possible. The negative power connection should be made to body sheet metal adjacent to the negative battery connection. This connection should not be fused.

Antennas for two-way radios should be mounted on the roof or the rear area of the vehicle. Care should be used in mounting antennas with magnet bases. Magnets may affect the accuracy or operation of the compass on vehicles so equipped.

The antenna cable should be as short as practical and routed away from the vehicle wiring when possible. Use only fully shielded coaxial cable.

Carefully match the antenna and cable to the radio to ensure a low Standing Wave Ratio (SWR).

Mobile radio equipment with output power greater than normal may require special precautions.

All installations should be checked for possible interference between the communications equipment and the vehicle's electronic systems.



GIULIA



17GABASE-126-AB

©2016 FCA US LLC. All Rights Reserved.

ALFA ROMEO is a registered trademark of
FCA Group Marketing S.p.A., used with permission.



Second Edition Rev 1
Printed in U.S.A.