

California Proposition 65 Warning

WARNING: This product contains or emits chemicals known to the state of California to cause cancer and birth defects or other reproductive harm.

Event Data Recorders

This vehicle is equipped with an event data recorder (EDR).

The main purpose of an EDR is to record, in certain crash or near crash-like situations, such as an air bag deployment or hitting a road obstacle, data that will assist in understanding how a vehicle's systems performed. **The EDR is designed to record data related to vehicle dynamics and safety systems for a short period of time, typically 30 seconds or less. The EDR in this vehicle is designed to record such data as:**

- **How various systems in your vehicle were operating;**
- **Whether or not the driver and passenger safety belts were buckled/fastened;**
- **How far (if at all) the driver was depressing the accelerator and/or brake pedal; and,**
- **How fast the vehicle was traveling.**

These data can help provide a better understanding of the circumstances in which crashes and injuries occur. NOTE: EDR data are recorded by your vehicle only if a non-trivial crash situation occurs; no data are recorded by the EDR under normal driving conditions and no personal data (e.g., name, gender, age, and crash location) are recorded. However, other parties, such as law enforcement, could combine the EDR data with the type of personally identifying data routinely acquired during a crash investigation.

To read data recorded by an EDR, special equipment is required, and access to the vehicle or the EDR is needed. In addition to the vehicle manufacturer, other parties, such as law enforcement, that have the special equipment, can read the information if they have access to the vehicle or the EDR.

The data belongs to the vehicle owner and may not be accessed by anyone else except as legally required or with the permission of the vehicle owner.

Service Diagnostic Recorders

This vehicle is equipped with service-related devices that record information about powertrain performance. The data can be used to verify emissions law requirements and/or help technicians diagnose and solve service problems. It may also be combined with data from other sources for research purposes, but it remains confidential.

California Perchlorate Contamination Prevention Act

The airbags, seat belt tensioners, and CR type batteries in this vehicle may contain perchlorate materials - special handling may apply. See www.dtsc.ca.gov/hazardouswaste/perchlorate/

As you read this manual, you will find information that is preceded by a **NOTICE** symbol. This information is intended to help you avoid damage to your vehicle, other property, or the environment.

A Few Words About Safety

Your safety, and the safety of others, is very important. And operating this vehicle safely is an important responsibility.

To help you make informed decisions about safety, we have provided operating procedures and other information on labels and in this manual. This information alerts you to potential hazards that could hurt you or others.

Of course, it is not practical or possible to warn you about all the hazards associated with operating or maintaining your vehicle. You must use your own good judgment.

You will find this important safety information in a variety of forms, including:

- **Safety Labels** - on the vehicle.
- **Safety Messages** - preceded by a safety alert symbol  and one of three signal words: **DANGER**, **WARNING**, or **CAUTION**. These signal words mean:

 **DANGER**

You WILL be KILLED or SERIOUSLY HURT if you don't follow instructions.

 **WARNING**

You CAN be KILLED or SERIOUSLY HURT if you don't follow instructions.

 **CAUTION**

You CAN be HURT if you don't follow instructions.

- **Safety Headings** - such as Important Safety Precautions.
- **Safety Section** - such as Safe Driving.
- **Instructions** - how to use this vehicle correctly and safely.

This entire book is filled with important safety information - please read it carefully.

This owner's manual should be considered a permanent part of the vehicle and should remain with the vehicle when it is sold.

This owner's manual covers all models of your vehicle. You may find descriptions of equipment and features that are not on your particular model.

Images throughout this owner's manual (including the front cover) represent features and equipment that are available on some, but not all, models. Your particular model may not have some of these features.

This owner's manual is for vehicles sold in the United States and Canada.

The information and specifications included in this publication were in effect at the time of approval for printing. Honda Motor Co., Ltd. reserves the right, however, to discontinue or change specifications or design at any time without notice and without incurring any obligation.

➤ **Safe Driving P. 25**

For Safe Driving P. 26 Seat Belts P. 30 Airbags P. 37

➤ **Instrument Panel P. 67**

Indicators P. 68 Gauges and Multi-Information Display P. 97

➤ **Controls P. 113**

Clock P. 114 Locking and Unlocking the Doors P. 115
Opening and Closing the Moonroof P. 136
Adjusting the Seats P. 156

➤ **Features P. 191**

Audio System P. 192 Audio System Basic Operation P. 196
Customized Features P. 262 HomeLink® Universal Transceiver P. 288

➤ **Driving P. 337**

Before Driving P. 338 Towing a Trailer P. 343
Multi-View Rear Camera* P. 426 Surround View Camera System* P. 427

➤ **Maintenance P. 441**

Before Performing Maintenance P. 442 Maintenance Minder™ P. 445
Checking and Maintaining Wiper Blades P. 468
Climate Control System Maintenance P. 483

➤ **Handling the Unexpected P. 489**

Tools P. 490 If a Tire Goes Flat P. 491
Overheating P. 516 Indicator, Coming On/Blinking P. 518
When You Cannot Open the Trunk P. 529

➤ **Information P. 531**

Specifications P. 532 Identification Numbers P. 534
Emissions Testing P. 537 Warranty Coverages P. 539

Contents

Child Safety P. 52

Exhaust Gas Hazard P. 64

Safety Labels P. 65

Opening and Closing the Trunk P. 128

Security System P. 131

Opening and Closing the Windows P. 134

Operating the Switches Around the Steering Wheel P. 137

Adjusting the Mirrors P. 153

Interior Lights/Interior Convenience Items P. 163

Climate Control System P. 181

Audio Error Messages P. 253

General Information on the Audio System P. 258

Bluetooth® HandsFreeLink® P. 290

AcuraLink® P. 330

When Driving P. 344

Braking P. 402

Parking Your Vehicle P. 417

Refueling P. 437

Fuel Economy and CO₂ Emissions P. 439

Maintenance Under the Hood P. 450

Replacing Light Bulbs P. 462

Checking and Maintaining Tires P. 471

Battery P. 480

Remote Transmitter Care P. 481

Cleaning P. 484

Accessories and Modifications P. 488

Engine Does Not Start P. 509

Jump Starting P. 512

Shift Lever Does Not Move P. 515

Fuses P. 522

Emergency Towing P. 527

When You Cannot Unlock the Fuel Fill Door P. 528

Refueling P. 530

Devices that Emit Radio Waves P. 535

Reporting Safety Defects P. 536

Authorized Manuals P. 541

Client Service Information P. 542

Quick Reference Guide P. 4

Safe Driving P. 25

Instrument Panel P. 67

Controls P. 113

Features P. 191

Driving P. 337

Maintenance P. 441

Handling the Unexpected P. 489

Information P. 531

Index P. 546



Visual Index

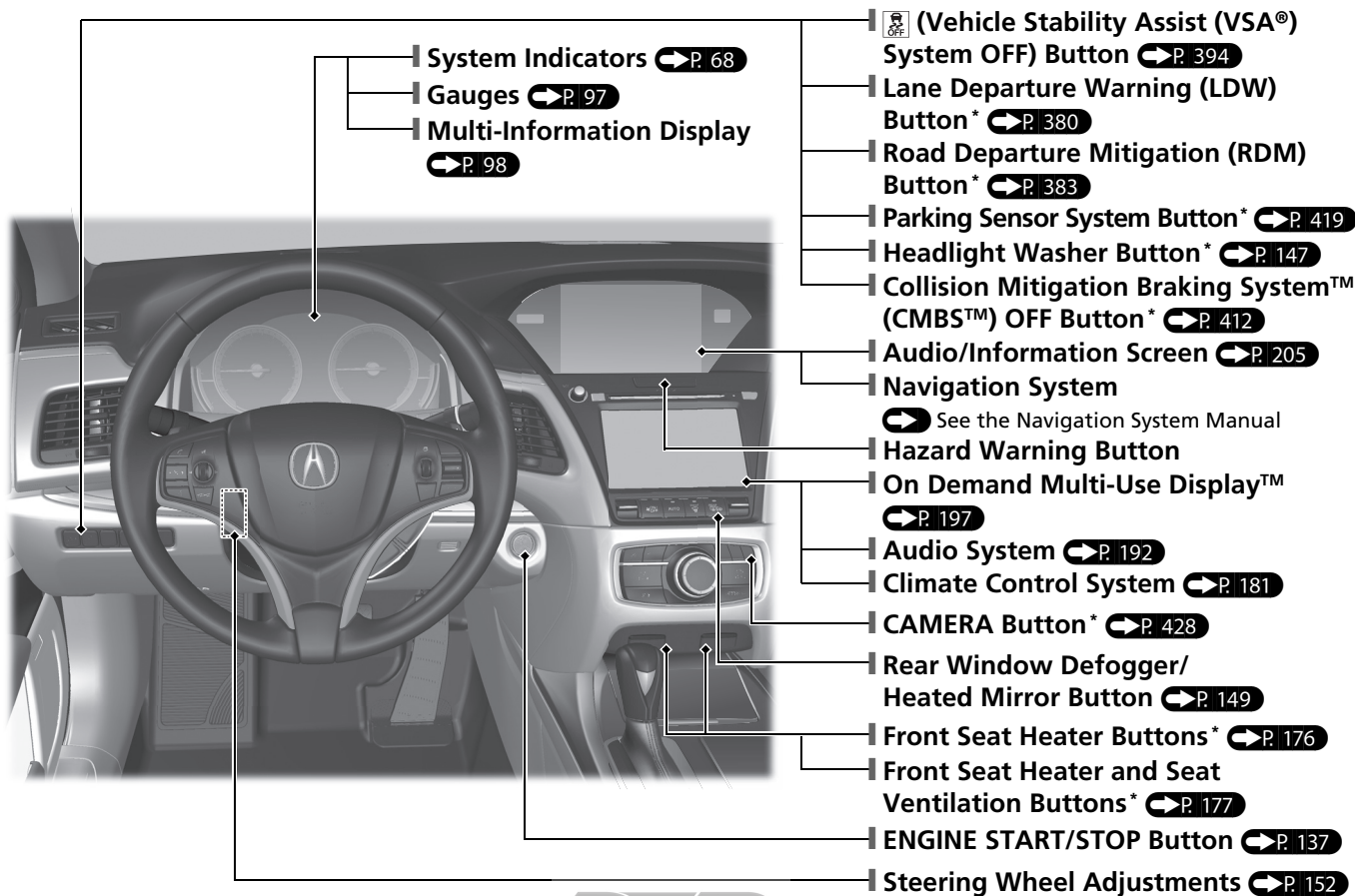

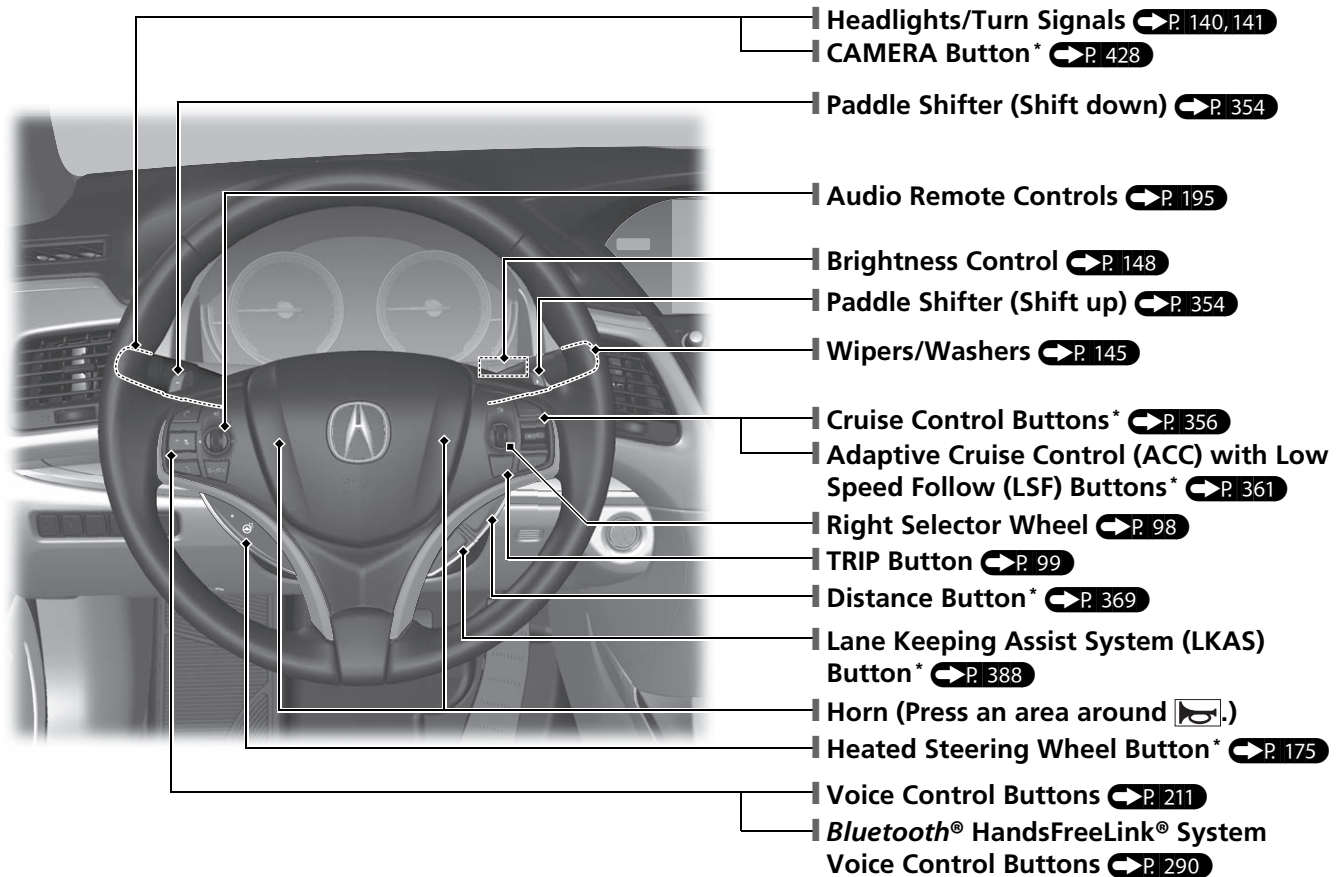

Visual Index

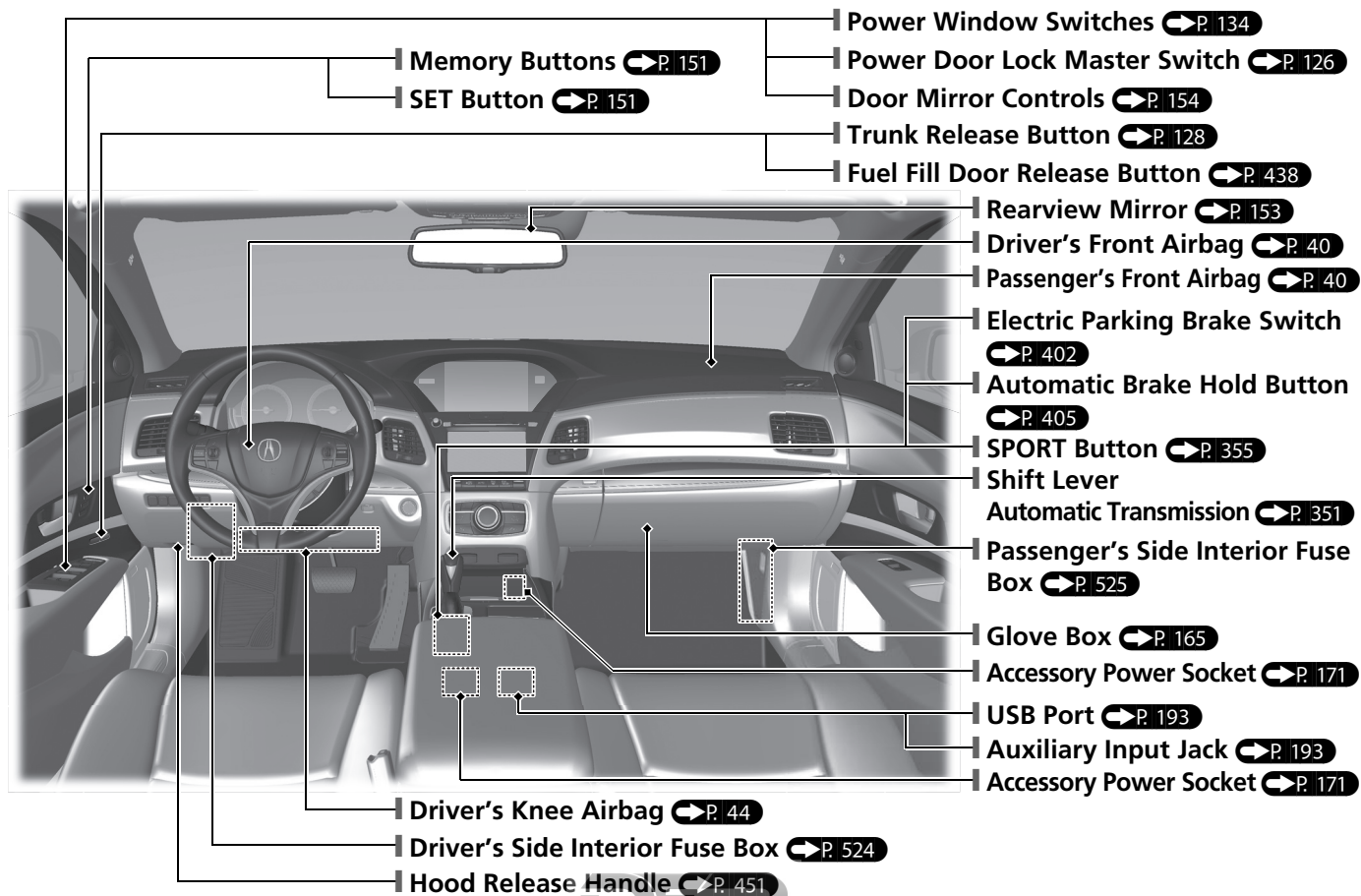

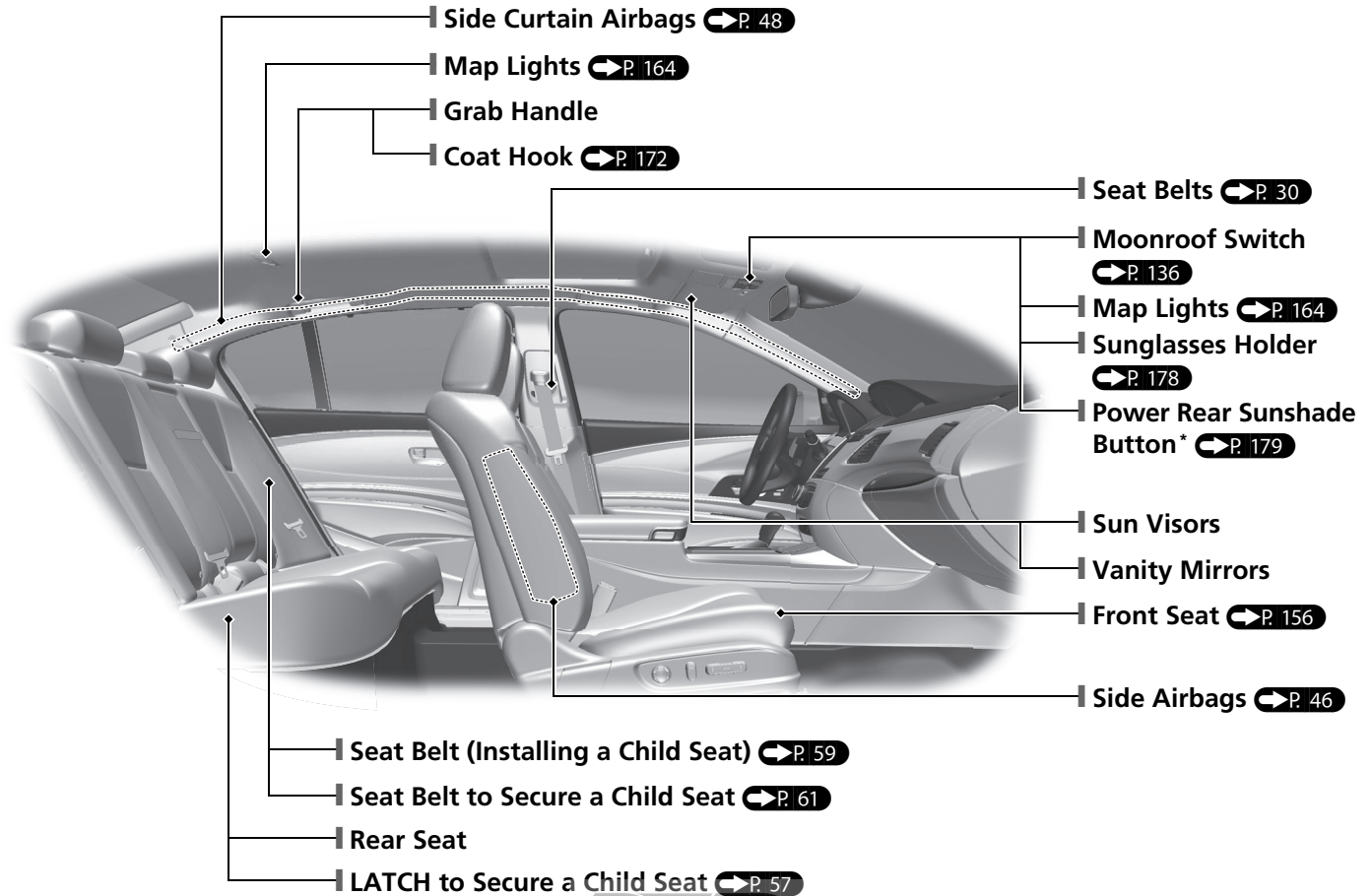

* Not available on all models

Visual Index

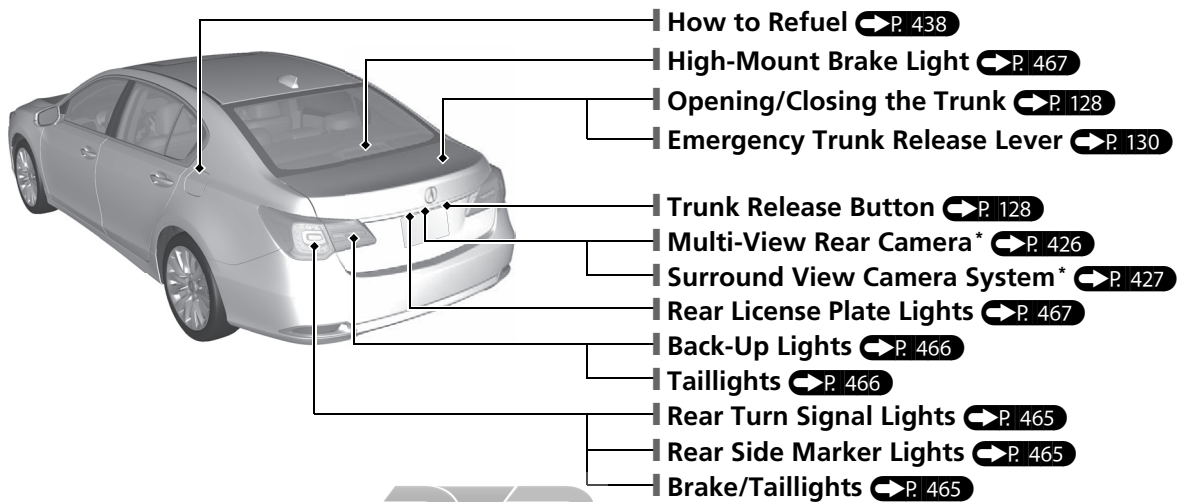
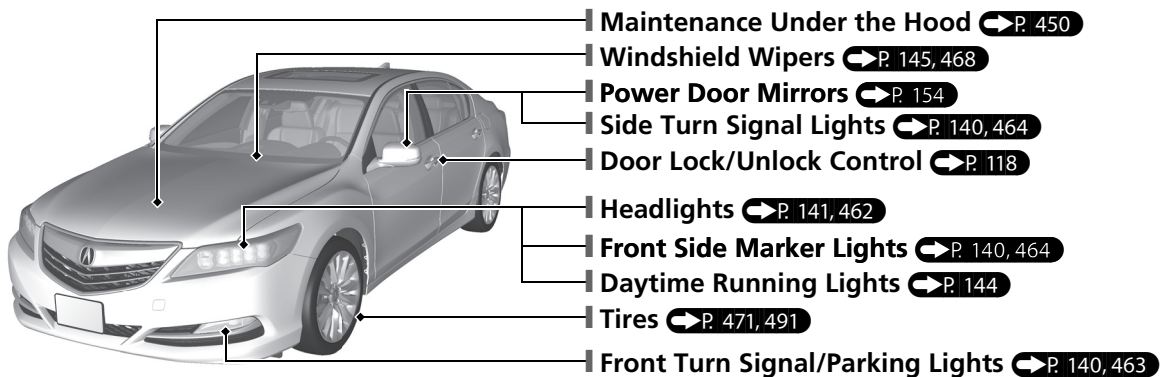

Safe Driving P. 25

Airbags P. 37

- Your vehicle is fitted with airbags to help protect you and your passengers during a moderate-to-severe collision.

Child Safety P. 52

- All children 12 and younger should be seated in the rear seat.
- Smaller children should be properly restrained in a forward-facing child seat.
- Infants must be properly restrained in a rear-facing child seat.

Exhaust Gas Hazard P. 64

- Your vehicle emits dangerous exhaust gases that contain carbon monoxide. Do not run the engine in confined spaces where carbon monoxide gas can accumulate.

Seat Belts P. 30

- Fasten your seat belt and sit upright well back in the seat.
- Check that your passengers are wearing their seat belts correctly.

Before Driving Checklist P. 29

- Before driving, check that the front seats, head restraints, steering wheel, and mirrors have been properly adjusted.



















Fasten your lap belt as low as possible.

Instrument Panel P. 67

Gauges P. 97 / Multi-Information Display P. 98 / System Indicators P. 68

System Indicators

-  Blind Spot Information (BSI) Indicator*
-  Electric Power Steering (EPS) System Indicator
-  Malfunction Indicator Lamp
-  Low Oil Pressure Indicator
- SPORT**  SPORT Mode Indicator
-  Vehicle Stability Assist (VSA®) System Indicator
-  VSA® OFF Indicator
-  Immobilizer System Indicator
-  Keyless Access System Indicator
-  Charging System Indicator
-  Automatic Brake Hold System Indicator
- U.S.**  Automatic Brake Hold Indicator
- Canada**  Automatic Brake Hold Indicator
- P**  Electric Parking Brake System Indicator
- U.S.**  Electric Parking Brake Indicator
- Canada**  Electric Parking Brake Indicator

Multi-Information Display

CRUISE MAIN Indicator*



CRUISE CONTROL Indicator*

Adaptive Cruise Control (ACC) with Low Speed Follow (LSF) Indicator*

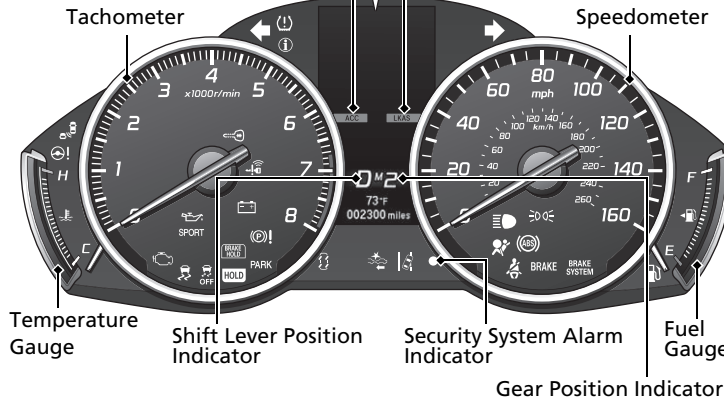

Lane Keeping Assist System (LKAS) Indicator*















System Indicators

-  Low Tire Pressure/TPMS Indicator
-  System Message Indicator

Lights Indicators

-  Lights On Indicator
-  High Beam Indicator

System Indicators

-  Turn Signal and Hazard Warning Indicators
-  Supplemental Restraint System Indicator
-  Anti-lock Brake System (ABS) Indicator
- U.S.**  Brake System Indicator (Red)
- Canada**  Brake System Indicator (Amber)
- U.S.**  Brake System Indicator (Amber)
- Canada**  Brake System Indicator (Amber)
-  Lane Departure Warning (LDW) Indicator/Road Departure Mitigation (RDM) Indicator*
-  Forward Collision Warning (FCW) Indicator/Collision Mitigation Braking System™ (CMBS™) Indicator*
-  Low Fuel Indicator
-  Precision All-Wheel Steer™ (P-AWS®) System Indicator
-  Seat Belt Reminder Indicator







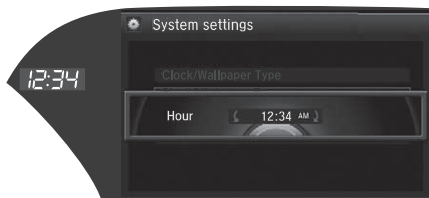

Controls P. 113

Clock P. 114

The navigation system receives signals from GPS satellites, updating the clock automatically.

You can also adjust the time manually.



- 1** Enter the **Clock Adjustment** screen.
 **Clock**  P. 114
- 2** Rotate  to change hour, then press .
- 3** Rotate  to change minute, then press .

ENGINE START/STOP Button P. 137

Press the button to changes the vehicle's power mode.

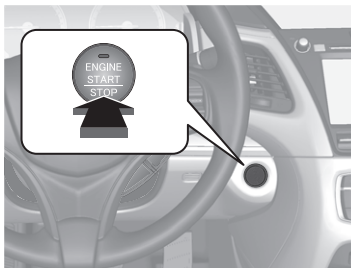

Turn Signals P. 140

Turn Signal Control Lever

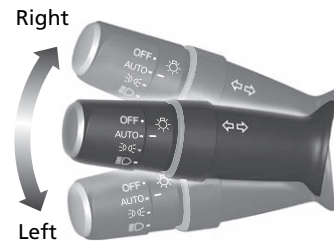

Lights P. 141

Light Control Switches

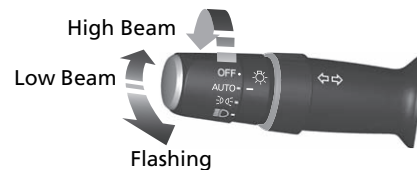

Wipers and Washers

➔ P. 145

Wiper/Washer Control Lever

Adjustment Ring

- ☂: Low sensitivity^{*1}
: Lower speed, fewer sweeps^{*2}
- ☂: High sensitivity^{*1}
: Higher speed, more sweeps^{*2}

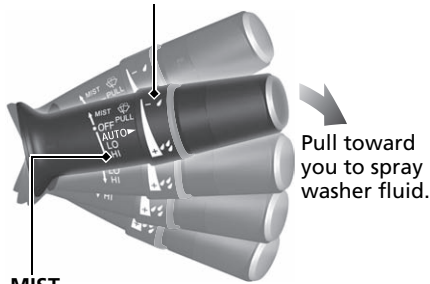

MIST
OFF

AUTO^{*1}: Wiper speed varies automatically
INT^{*2}: Low speed with intermittent
LO: Low speed wipe
HI: High speed wipe

- *1: Models with auto wiper
- *2: Models without auto wiper

Steering Wheel ➔ P. 152

- To adjust, push and hold the adjustment switch to move the steering wheel to the desired position.

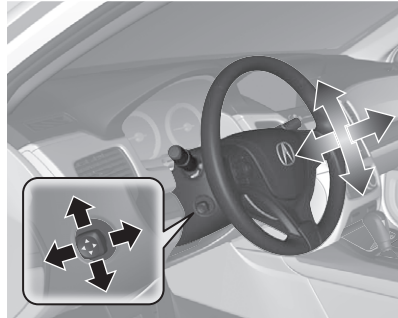

Unlocking the Front Doors from the Inside

➔ P. 124

- Pull either front door inner handle to unlock and open it in one motion.



- Unlocking and opening the driver's door from the inner handle unlocks all the other doors.

Trunk ➔ P. 128

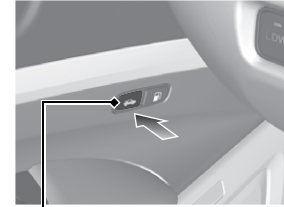

Trunk Release Button

- To unlock and open the trunk:
 - Press the trunk release button on the driver's door.
 - Press the trunk release button on the keyless access remote.
 - Press the trunk release button on the trunk lid.

Power Door Mirrors

← P. 154

- With the power mode in ON, move the selector switch to L or R.
- Push the appropriate edge of the adjustment switch to adjust the mirror.
- Press the folding button* to fold in and out the door mirrors.

Folding Button* Selector Switch

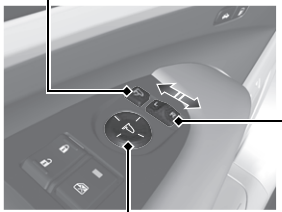

Adjustment Switch

Power Windows → P. 134

- With the power mode in ON, open and close the power windows.
- If the power window lock button is in the off position, each passenger's window can be opened and closed with its own switch.
- If the power window lock button is in the on position (indicator on), each passenger's window switch is disabled.

Power Window Lock Button Indicator

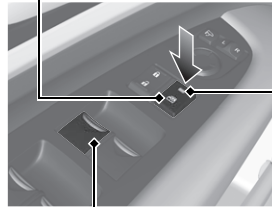

Window Switch

Climate Control System P. 181

- Press the **AUTO** button to activate the climate control system.
- Press the button to turn the system on or off.
- Press the button to defrost the windshield.

The climate control system is voice operable. P. 211

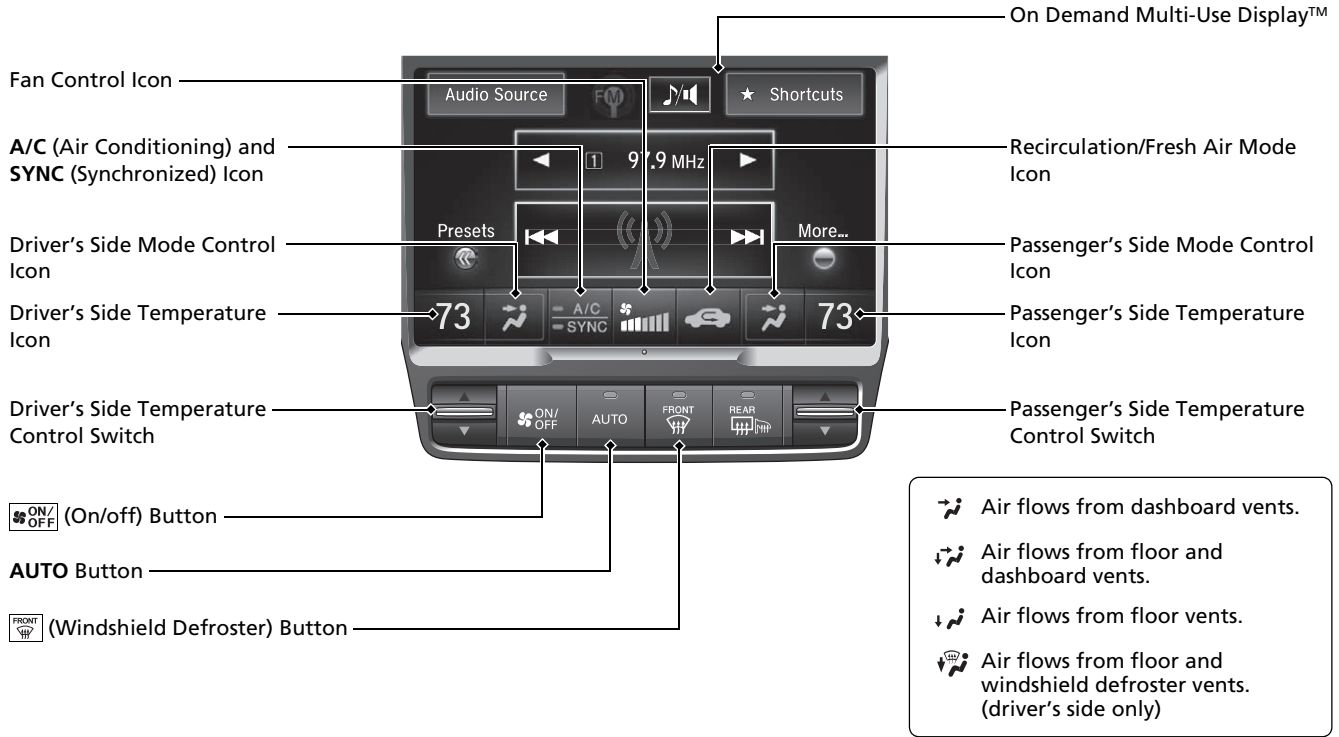

Features P. 191

Audio system P. 196

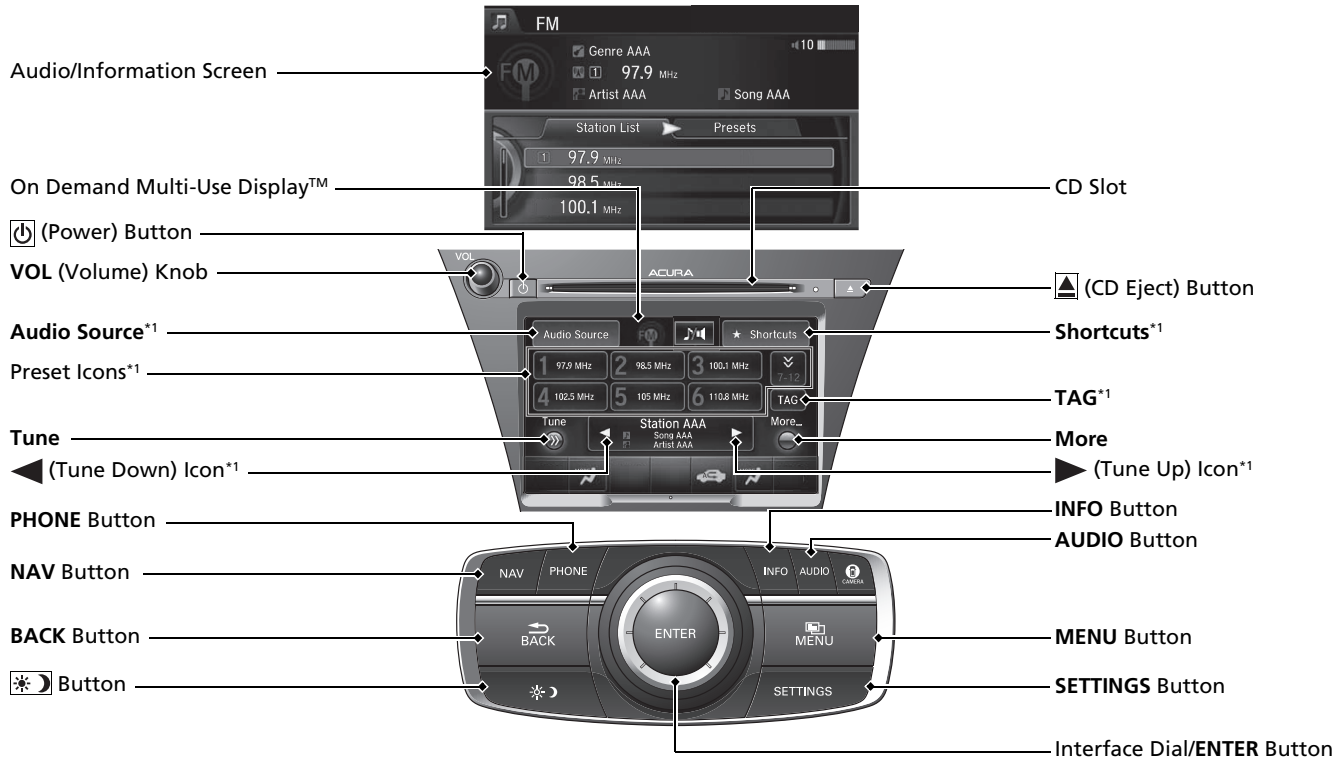

*1: Icons that appear on the screen vary by the source selected.

● **Audio Remote Controls**  P. 195

Left Selector Wheel

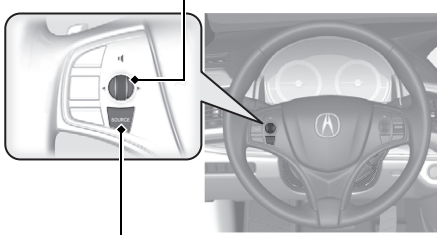

SOURCE Button

● **SOURCE** Button

Press to change the audio mode: FM/AM/CD/SiriusXM®/HDD/USB/iPod/Bluetooth® Audio/Pandora®*/Aha™/AUX.

● **Left Selector Wheel**

Roll to adjust the volume up/down.

Radio: Shift to change the preset station.
Shift and hold to select the next or previous strong station.

CD/HDD/USB device:

Shift to skip to the beginning of the next song or return to the beginning of the current song.
Shift and hold to change a folder.

Driving ➔ P. 337

Automatic Transmission ➔ P. 351

- Shift to **P** and depress the brake pedal when starting the engine.

● Shifting

- P** **Park**
Turn off or start the engine. Transmission is locked.
- R** **Reverse**
Used when reversing.
- N** **Neutral**
Transmission is not locked.
- D** **Drive**
Normal driving. The sequential shift mode can be used.

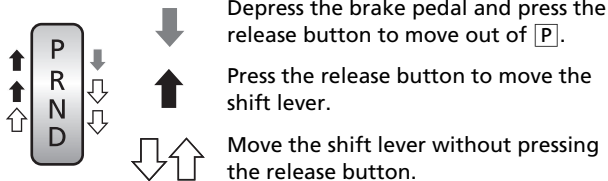

Paddle Shifters ➔ P. 354

- Paddle shifters allow you to shift gears much like a manual transmission (1st through 6th). This is useful for engine braking.

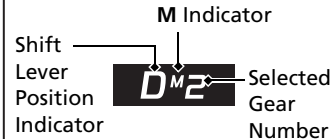

Shift Down **-** Paddle Shifter Shift Up **+** Paddle Shifter



- D-paddle shift mode: The transmission will shift back to automatic mode once the system detects that the vehicle is cruising.
- Sequential shift mode: Holds the selected gear, and the **M** indicator comes on, when the SPORT mode is on.
- The selected gear position is shown in the instrument panel.

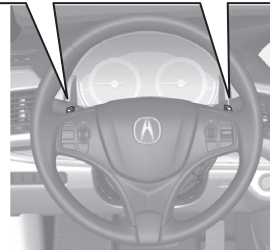

VSA® OFF Button P. 394

- The vehicle stability assist (VSA®) system helps stabilize the vehicle during cornering, and helps maintain traction while accelerating on loose or slippery road surfaces.
- VSA® comes on automatically every time you start the engine.
- To turn VSA® on or off, press and hold the button until you hear a beep.

Cruise Control* P. 356

- Cruise control allows you to maintain a set speed without keeping your foot on the accelerator pedal.
- To use cruise control, press the **CRUISE** button, then press the **RES/+SET/-** switch down once you have achieved the desired speed (above 25 mph or 40 km/h).

Collision Mitigation Braking System™ (CMBS™) OFF Button* P. 412

- When a possible collision is likely unavoidable, the CMBS™ can help you to reduce the vehicle speed and the severity of the collision.
- To turn the CMBS™ on or off, press and hold the button until you hear a beep.

Tire Pressure Monitoring System (TPMS) P. 398

- The TPMS monitors tire pressure.
- The TPMS is turned on automatically every time you start the engine.

Refueling P. 437

Fuel recommendation: Unleaded premium gasoline with a pump octane number 91 or higher

Fuel tank capacity: 18.5 US gal (70 L)

- 1 Press the fuel fill door release button.



- 2 After refueling, wait for about five seconds before removing the filler nozzle.

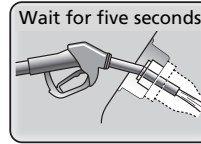

Maintenance [↔ P. 441](#)

Under the Hood [↔ P. 450](#)

- Check engine oil and engine coolant. Add when necessary.
- Check brake fluid.
- Check the battery condition monthly.

- 1** Pull the hood release handle under the corner of the dashboard.

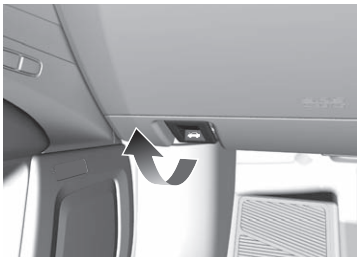

- 2** Locate the hood latch lever, push up the lever and lift the hood.



- 3** When finished, close the hood and make sure it is firmly locked in place.

Wiper Blades [↔ P. 468](#)

- Replace blades if they leave streaks across the windshield.

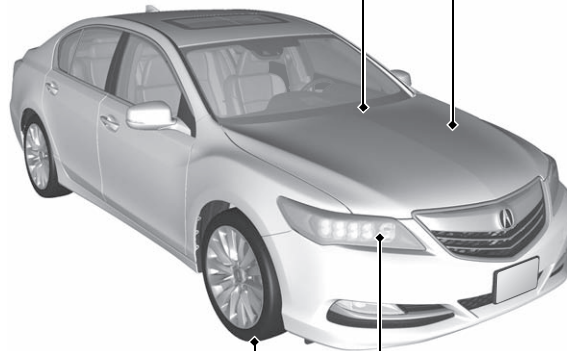

Tires [↔ P. 471](#)

- Inspect tires and wheels regularly.
- Check tire pressures regularly.
- Install snow tires for winter driving.

Lights [↔ P. 462](#)

- Inspect all lights regularly.

Handling the Unexpected ➔ P. 489

Flat Tire ➔ P. 491

- Park in a safe location and repair the flat tire using the temporary tire repair kit.

Vehicles with optional spare tire kit

Park in a safe location and replace the flat tire with the compact spare tire in the trunk.



Engine Won't Start ➔ P. 509

- If the battery is dead, jump start using a booster battery.



Overheating ➔ P. 516

- Park in a safe location. If you do not see steam under the hood, open the hood, and let the engine cool down.



Indicators Come On ➔ P. 518

➔ P. 518

- Identify the indicator and consult the owner's manual.

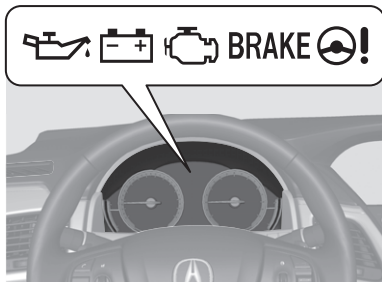

Blown Fuse ➔ P. 522

➔ P. 522

- Check for a blown fuse if an electrical device does not operate.

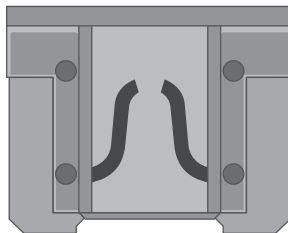

Emergency Towing ➔ P. 527

➔ P. 527

- Call a professional towing service if you need to tow your vehicle.



What to Do If

Q The power mode does not change from ON to VEHICLE OFF (LOCK). Why?

A The shift lever should be moved to **P**.



Q Why does the brake pedal pulsate slightly when applying the brakes?

A This can occur when the ABS activates, and does not indicate a problem. Apply firm, steady pressure on the brake pedal. Never pump the brake pedal.

Q The rear door cannot be opened from inside the vehicle. Why?

A Check if the childproof lock is in the LOCK position. If so, open the rear door with the outside door handle. To cancel this function, push the lever to the UNLOCK position.



Q Why do the doors lock after I unlocked the doors using a remote transmitter?

A If you do not open the doors within 30 seconds, the doors are relocked automatically for security.

Q Why does the beeper sound when I open the driver's door?

A The beeper sounds when:

- The power mode is in ACCESSORY.
- The exterior lights are left on.

Q Why does the beeper sound when I start driving?

A The beeper sounds when the driver and/or front passenger are not wearing their seat belts.

Q Why does the beeper sound when I turn the engine off?

A The beeper sounds when you turn off the engine with the driver's door open.

Q Why do I hear a screeching sound when I apply the brake pedal?

A The brake pads may need to be replaced. Have your vehicle inspected by a dealer.

Q Pressing the electric parking brake switch does not release the parking brake. Why?

A Press the electric parking brake switch with the brake pedal depressed.

Q Depressing the accelerator pedal does not release the parking brake automatically. Why?

A

- Fasten the driver's seat belt.
- Check if the shift lever is in **P** or **N**. If so, move the lever to any other position.

Q Is it possible to use unleaded gasoline with a Pump Octane Number (PON) of 87 or lower on this vehicle?

A Unleaded gasoline with a Pump Octane Number (PON) of 91 or higher is recommended.
Use of lower octane gasoline can cause occasional metallic knocking noise in the engine and will result in decreased engine performance.
Use of gasoline with a pump octane less than 87 can lead to engine damage.

Safe Driving

You can find many safety recommendations throughout this chapter, and throughout this manual.

For Safe Driving

Important Safety Precautions.....	26
Your Vehicle's Safety Features.....	28
Safety Checklist	29

Seat Belts

About Your Seat Belts.....	30
Fastening a Seat Belt.....	33
Seat Belt Inspection.....	36

Airbags

Airbag System Components.....	37
Types of Airbags.....	40
Front Airbags (SRS)	40

Driver's Knee Airbag.....	44
Side Airbags.....	46
Side Curtain Airbags.....	48
Airbag System Indicators.....	49
Airbag Care	51

Child Safety

Protecting Child Passengers	52
Safety of Infants and Small Children.....	54
Safety of Larger Children	62

Exhaust Gas Hazard

Carbon Monoxide Gas.....	64
--------------------------	----

Safety Labels

Label Locations	65
-----------------------	----

The following pages explain your vehicle's safety features and how to use them properly. The safety precautions below are ones that we consider to be among the most important.

Important Safety Precautions

■ Always wear your seat belt

A seat belt is your best protection in all types of collisions. Airbags are designed to supplement seat belts, not replace them. So even though your vehicle is equipped with airbags, make sure you and your passengers always wear your seat belts, and wear them properly.

■ Restrain all children

Children ages 12 and under should ride properly restrained in a back seat, not the front seat. Infants and small children should be restrained in a child seat. Larger children should use a booster seat and a lap/shoulder seat belt until they can use the belt properly without a booster seat.

■ Be aware of airbag hazards

While airbags can save lives, they can cause serious or fatal injuries to occupants who sit too close to them, or are not properly restrained. Infants, young children, and short adults are at the greatest risk. Be sure to follow all instructions and warnings in this manual.

■ Don't drink and drive

Alcohol and driving don't mix. Even one drink can reduce your ability to respond to changing conditions, and your reaction time gets worse with every additional drink. So don't drink and drive, and don't let your friends drink and drive, either.

» Important Safety Precautions

Some states, provinces and territories prohibit the use of cell phones other than hands-free devices by the driver while driving.

■ Pay appropriate attention to the task of driving safely

Engaging in cell phone conversation or other activities that keep you from paying close attention to the road, other vehicles, and pedestrians could lead to a crash. Remember, situations can change quickly, and only you can decide when it is safe to divert some attention away from driving.

■ Control your speed

Excessive speed is a major factor in crash injuries and deaths. Generally, the higher the speed, the greater the risk, but serious injuries can also occur at lower speeds. Never drive faster than is safe for current conditions, regardless of the maximum speed posted.

■ Keep your vehicle in safe condition

Having a tire blowout or a mechanical failure can be extremely hazardous. To reduce the possibility of such problems, check your tire pressures and condition frequently, and perform all regularly scheduled maintenance.

Your Vehicle's Safety Features

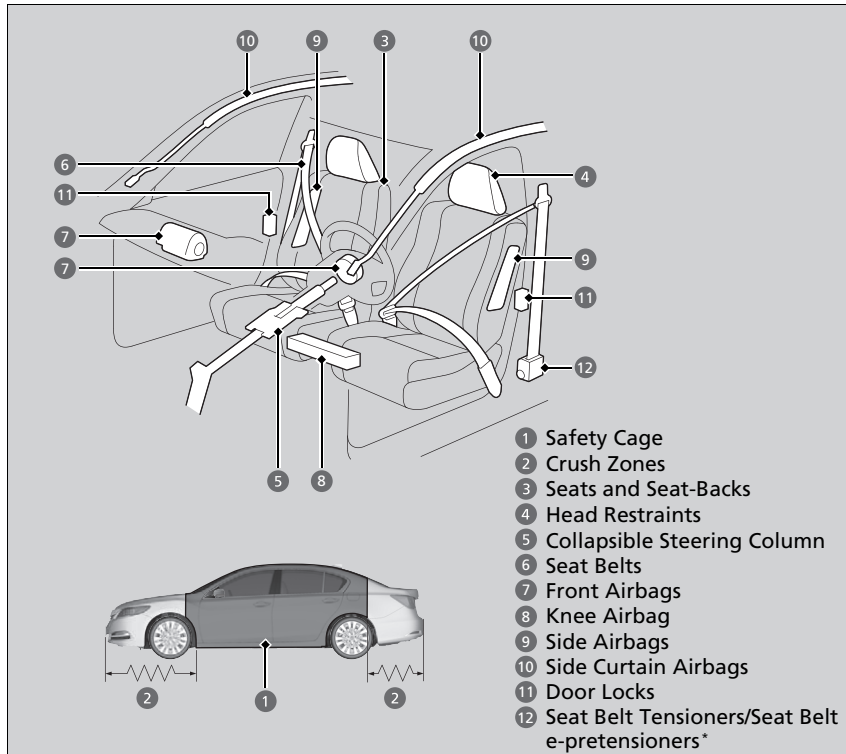

The following checklist will help you take an active role in protecting yourself and your passengers.

Your Vehicle's Safety Features

Your vehicle is equipped with many features that work together to help protect you and your passengers during a crash.

Some features do not require any action on your part. These include a strong steel framework that forms a safety cage around the passenger compartment, front and rear crush zones, a collapsible steering column, and tensioners that tighten the front seat belts in a sufficient crash.

However, you and your passengers cannot take full advantage of these features unless you remain seated in the correct position and always wear your seat belts. In fact, some safety features can contribute to injuries if they are not used properly.

Safety Checklist

For the safety of you and your passengers, make a habit of checking these items each time before you drive.

- After everyone has entered the vehicle, be sure all doors are closed and locked. Locking the doors helps prevent an occupant from being ejected and an outsider from unexpectedly opening a door.
 - **Locking/Unlocking the Doors from the Inside** P. 124
- Adjust your seat to a position suitable for driving. Be sure the front seats are adjusted as far to the rear as possible while allowing the driver to control the vehicle. Sitting too close to a front airbag can result in serious or fatal injury in a crash.
 - **Adjusting the Seats** P. 156
- Adjust head restraints to the proper position. Head restraints are most effective when the center of the head restraint aligns with the center of your head. Taller persons should adjust their head restraint to the highest position.
 - **Adjusting the Head Restraints** P. 159
- Always wear your seat belt, and make sure you wear it properly. Confirm that any passengers are properly belted as well.
 - **Fastening a Seat Belt** P. 33
- Protect children by using seat belts or child seats according to a child's age, height and weight.
 - **Child Safety** P. 52

☒ Safety Checklist

If the door and/or trunk open message appears on the multi-information display, a door and/or the trunk is not completely closed. Close all doors and the trunk tightly until the message disappears.

➤ **Multi-Information Display Warning and Information Messages** P. 86

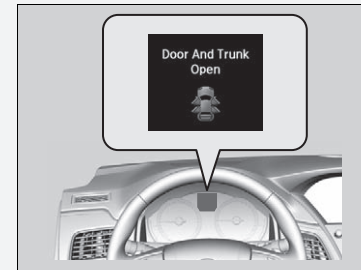

About Your Seat Belts

Seat belts are the single most effective safety device because they keep you connected to the vehicle so that you can take advantage of many built-in safety features. They also help keep you from being thrown against the inside of the vehicle, against any passengers, or out of the vehicle. When worn properly, seat belts also keep your body properly positioned in a crash so that you can take full advantage of the additional protection provided by the airbags.

In addition, seat belts help protect you in almost every type of crash, including:

- frontal impacts
- side impacts
- rear impacts
- rollovers

■ Lap/shoulder seat belts

All five seating positions are equipped with lap/shoulder seat belts with emergency locking retractors. In normal driving the retractor lets you move freely while keeping some tension on the belt. During a collision or sudden stop the retractor locks to restrain your body. The front passenger's and rear seat belts also have a lockable retractor for use with child seats.

➤ **Installing a Child Seat with a Lap/Shoulder Seat Belt** P. 59

➤ About Your Seat Belts

WARNING

Not wearing a seat belt properly increases the chance of serious injury or death in a crash, even though your vehicle has airbags.

Be sure you and your passengers always wear seat belts and wear them properly.

Seat belts cannot completely protect you in every crash. But in most cases, seat belts can reduce your risk of serious injury.

Most states and all Canadian provinces and territories require you to wear seat belts.

The emergency locking retractor may lock if you lean forward too quickly. Slower movements will allow the belt to extend fully without locking.

■ Proper use of seat belts

Follow these guidelines for proper use:

- All occupants should sit upright, well back in the seat, and remain in that position for the duration of the trip. Slouching and leaning reduce the effectiveness of the belt and can increase the chance of serious injury in a crash.
- Never place the shoulder part of a lap/shoulder seat belt under your arm or behind your back. This could cause very serious injuries in a crash.
- Two people should never use the same seat belt. If they do, they could be very seriously injured in a crash.
- Do not put any accessories on the seat belts. Devices intended to improve comfort or reposition the shoulder part of a seat belt can reduce the protective capability and increase the chance of serious injury in a crash.

■ Seat Belt Reminder



Your vehicle monitors front seat belt use. If the power mode is set to ON before the driver's seat belt is fastened, the beeper will sound and the indicator will blink. If the driver does not fasten the belt before the beeper stops, the indicator will remain on.

The beeper will periodically sound and the indicator will blink while driving until the driver's and/or front passenger's seat belt is fastened.

▶▶ About Your Seat Belts

If a rear seat passenger moves around and extends the seat belt, the lockable retractor may activate. If this happens, release the retractor by unfastening the seat belt and allow the belt to retract completely. Then refasten the belt.

▶▶ Seat Belt Reminder

The indicator will also come on if a front passenger does not fasten their seat belt within six seconds after the power mode is set to ON.

When no one is sitting in the front passenger's seat, the indicator will not come on and the beeper will not sound.

The indicator also may not come on and the beeper may not sound when the occupant is not heavy enough to trigger the weight sensor. Such occupants (e.g., infants and smaller children) should be moved to the rear seat as a deploying front airbag likely will injure or kill them.

▶▶ **Protecting Child Passengers** P. 52

Automatic Seat Belt Tensioners

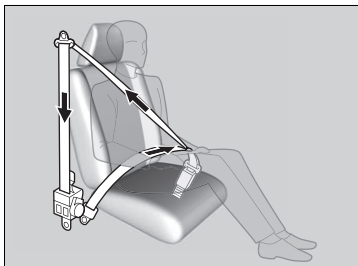

The front seats are equipped with automatic seat belt tensioners to enhance safety.

The tensioners automatically tighten the front seat belts during a moderate-to-severe frontal collision, sometimes even if the collision is not severe enough to inflate the front airbags or the driver's knee airbag.

Seat Belt e-pretensioners*

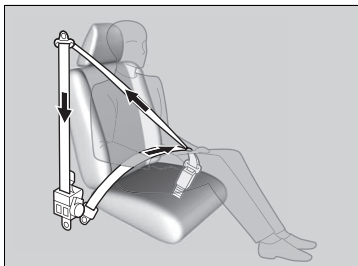

Are the motor-powered pretensioners that start to retract the front seat belts when the CMBS™, brake assist system, or VSA® system is in operation. They may also activate when you steer the vehicle hard, or the vehicle is impacted. After being retracted, the seat belts are slackened to their original positions. As convenient features, the e-pretensioners slightly retract the seat belts when you latch the seat belt buckle, depress the brake pedal more aggressively than you normally do, or make a sharp turn, and fully retract when you release the seat belt buckle.

Automatic Seat Belt Tensioners

The seat belt tensioners can only operate once. If a tensioner is activated, the SRS indicator will come on. Have a dealer replace the tensioner and thoroughly inspect the seat belt system as it may not offer protection in a subsequent crash.

During a moderate-to-severe side impact, the tensioner on that side of the vehicle also activates.

Seat Belt e-pretensioners*

If only the e-pretensioners were activated, no components need to be replaced.

The e-pretensioners may not work if:

- Supplemental Restraint System Indicator is on.
- Vehicle Stability Assist (VSA®) System Indicator is on.
- A warning message for e-pretensioners appears on multi-information display.

Fastening a Seat Belt

After adjusting a front seat to the proper position, and while sitting upright and well back in the seat:

➤ **Adjusting the Seats** P. 156

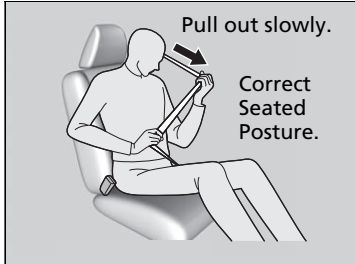

1. Pull the seat belt out slowly.

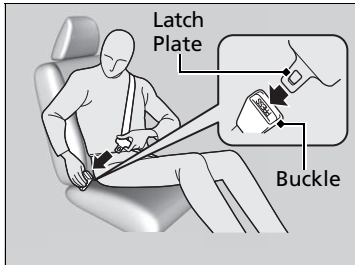

2. Insert the latch plate into the buckle, then tug on the belt to make sure the buckle is secure.

▶ Make sure that the belt is not twisted or caught on anything.

Models with CMBS™

When you or the front passenger insert the latch plate into the buckle, the front seat belt retracts automatically.

➤ **Seat Belt e-pretensioners*** P. 32

Fastening a Seat Belt

No one should sit in a seat with an inoperative seat belt or one that does not appear to be working correctly. Using a seat belt that is not working properly may not protect the occupant in a crash. Have a dealer check the belt as soon as possible.

Never insert any foreign objects into the buckle or retractor mechanism.

* Not available on all models

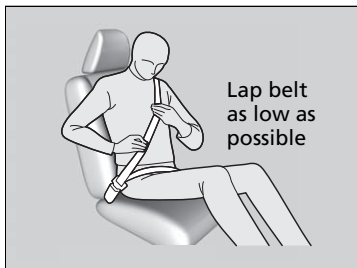

3. Position the lap part of the belt as low as possible across your hips, then pull up on the shoulder part of the belt so the lap part fits snugly. This lets your strong pelvic bones take the force of a crash and reduces the chance of internal injuries.
4. If necessary, pull up on the belt again to remove any slack, then check that the belt rests across the center of your chest and over your shoulder. This spreads the forces of a crash over the strongest bones in your upper body.

Adjusting the Shoulder Anchor

The front seats have adjustable shoulder anchors to accommodate taller and shorter occupants.

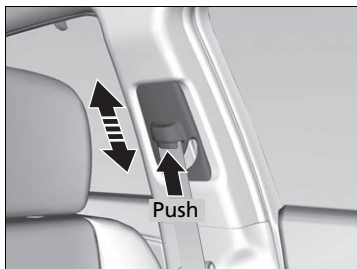

1. Move the anchor up and down while holding the release button.
2. Position the anchor so that the belt rests across the center of your chest and over your shoulder.

Fastening a Seat Belt

WARNING

Improperly positioning the seat belts can cause serious injury or death in a crash.

Make sure all seat belts are properly positioned before driving.

To release the belt, push the red **PRESS** button then guide the belt by hand until it has retracted completely.

When exiting the vehicle, be sure the belt is out of the way and will not get caught by closing the door.

Adjusting the Shoulder Anchor

The shoulder anchor height can be adjusted to four levels. If the belt contacts your neck, lower the height one level at a time.

After an adjustment, make sure that the shoulder anchor position is secure.

Advice for Pregnant Women

If you are pregnant, the best way to protect yourself and your unborn child when driving or riding in a vehicle is to always wear a seat belt and keep the lap part of the belt as low as possible across the hips.

Wear the shoulder belt across the chest avoiding the abdomen.



Wear the lap part of the belt as low as possible across the hips.

Advice for Pregnant Women

Each time you have a checkup, ask your doctor if it is okay for you to drive.

To reduce the risk of injuries to both you and your unborn child that can be caused by an inflating front airbag:

- When driving, sit upright and adjust the seat as far back as possible while allowing full control of the vehicle.
- When sitting in the front passenger's seat, adjust the seat as far back as possible.

Seat Belt Inspection

Regularly check the condition of your seat belts as follows:

- Pull each belt out fully, and look for frays, cuts, burns, and wear.
- Check that the latch plates and buckles work smoothly and the belts retract easily.
 - ▶ If a belt does not retract easily, cleaning the belt may correct the problem. Only use a mild soap and warm water. Do not use bleach or cleaning solvents. Make sure the belt is completely dry before allowing it to retract.

Any belt that is not in good condition or working properly will not provide proper protection and should be replaced as soon as possible.

A belt that has been worn during a crash may not provide the same level of protection in a subsequent crash. Have your seat belts inspected by a dealer after any collision.

Seat Belt Inspection

WARNING

Not checking or maintaining seat belts can result in serious injury or death if the seat belts do not work properly when needed.

Check your seat belts regularly and have any problem corrected as soon as possible.

Airbag System Components

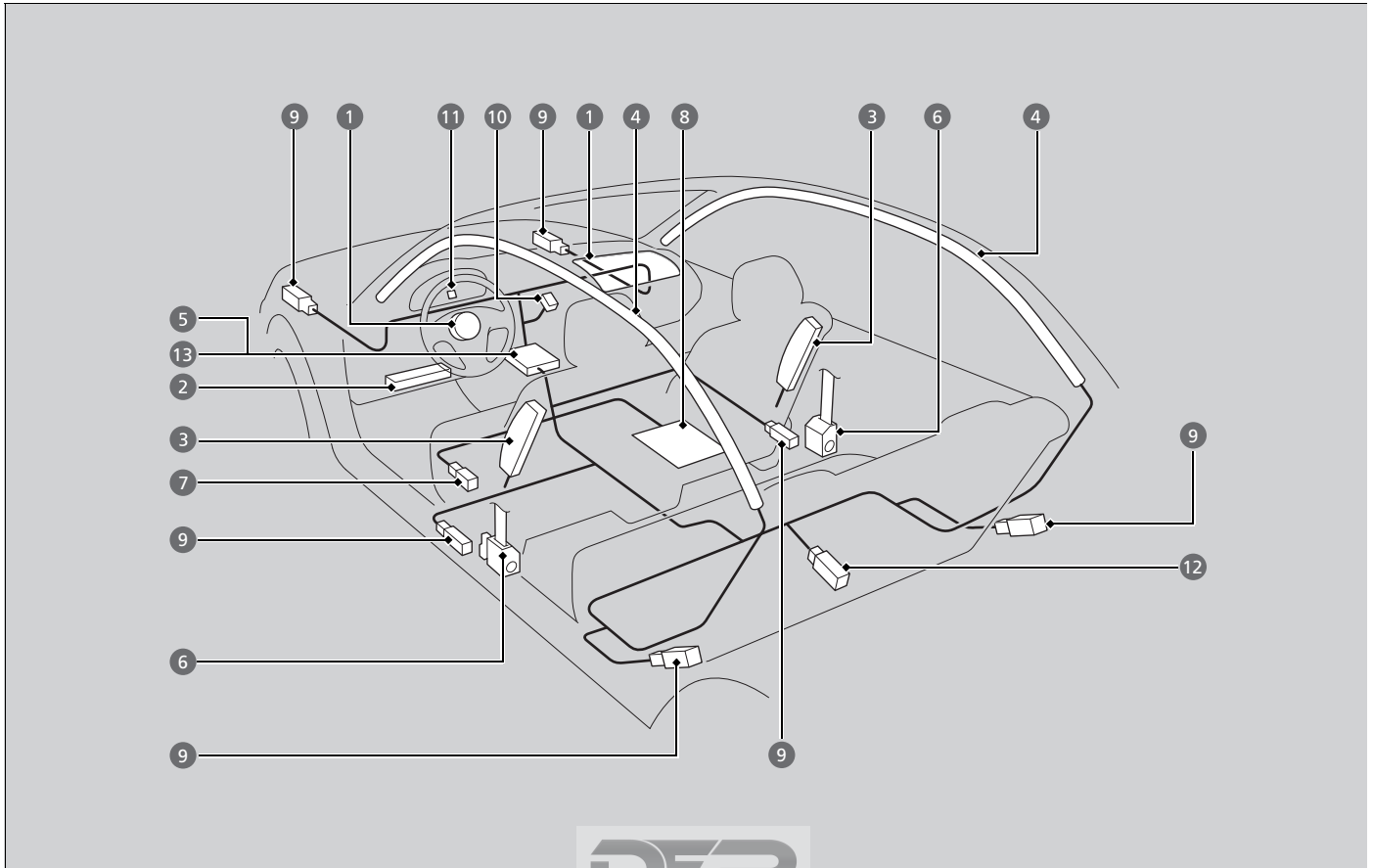

The front, driver's knee, front side, and side curtain airbags are deployed according to the direction and severity of impact. Both side curtain airbags are deployed in a rollover. The airbag system includes:

- 1 Two SRS (Supplemental Restraint System) front airbags. The driver's airbag is stored in the center of the steering wheel; the front passenger's airbag is stored in the dashboard. Both are marked **SRS AIRBAG**.
- 2 Driver's knee airbag. The knee airbag is stored under the steering column. It is marked **SRS AIRBAG**.
- 3 Two side airbags, one for the driver and one for a front passenger. The airbags are stored in the outer edges of the seat-backs. Both are marked **SIDE AIRBAG**.
- 4 Two side curtain airbags, one for each side of the vehicle. The airbags are stored in the ceiling, above the side windows. The front and rear pillars are marked **SIDE CURTAIN AIRBAG**.
- 5 An electronic control unit that, when the vehicle is on, continually monitors information about the various impact sensors, seat and buckle sensors, rollover sensor, airbag activators, seat belt tensioners, and other vehicle information. During a crash event the unit records such information.
- 6 Automatic front seat belt tensioners. In addition, the driver's and front passenger's seat belt buckles incorporate sensors that detect whether or not the belts are fastened.
Models with CMBS™
The front seat belt tensioners also include the e-pretensioners.
- 7 A driver's seat position sensor. If the seat is too far forward, the airbag will inflate with less force.
- 8 Weight sensors in the front passenger's seat. The front passenger's airbag will be turned off if the weight on the seat is approximately 65 lbs (29 kg) or less (the weight of an infant or small child).
- 9 Impact sensors that can detect a moderate-to-severe front or side impact.
- 10 An indicator on the dashboard that alerts you that the front passenger's front airbag has been turned off.
- 11 An indicator on the instrument panel that alerts you to a possible problem with your airbag system or seat belt tensioners.
- 12 Safing Sensor
- 13 A rollover sensor that can detect if your vehicle is about to roll over and signal the control unit to deploy both side curtain airbags.

Important Facts About Your Airbags

Airbags can pose serious hazards. To do their job, airbags must inflate with tremendous force. So, while airbags help save lives, they can cause burns, bruises, and other minor injuries, sometimes even fatal ones if occupants are not wearing their seat belts properly and sitting correctly.

What you should do: Always wear your seat belt properly, and sit upright and as far back from the steering wheel as possible while allowing full control of the vehicle. A front passenger should move their seat as far back from the dashboard as possible.

Remember, however, that no safety system can prevent all injuries or deaths that can occur in a severe crash, even when seat belts are properly worn and the airbags deploy.

Do not place hard or sharp objects between yourself and a front airbag.

Carrying hard or sharp objects on your lap, or driving with a pipe or other sharp object in your mouth, can result in injuries if your front airbag inflates.

Do not attach or place objects on the front and driver's knee airbag covers.

Objects on the covers marked **SRS AIRBAG** could interfere with the proper operation of the airbags or be propelled inside the vehicle and hurt someone if the airbags inflate.

Important Facts About Your Airbags

Do not attempt to deactivate your airbags. Together, airbags and seat belts provide the best protection.

When driving, keep hands and arms out of the deployment path of the front airbag by holding each side of the steering wheel. Do not cross an arm over the airbag cover.

Types of Airbags

Your vehicle is equipped with four types of airbags:

- **Front airbags:** Airbags in front of the driver's and front passenger's seats.
- **Driver's knee airbag:** Airbag under the steering column.
- **Side airbags:** Airbags in the driver's and front passenger's seat-backs.
- **Side curtain airbags:** Airbags above the side windows.

Each is discussed in the following pages.

Front Airbags (SRS)

The front SRS airbags inflate in a moderate-to-severe frontal collision to help protect the head and chest of the driver and/or front passenger.

SRS (Supplemental Restraint System) indicates that the airbags are designed to supplement seat belts, not replace them. Seat belts are the occupant's primary restraint system.

Housing Locations

The front airbags are housed in the center of the steering wheel for the driver, and in the dashboard for the front passenger. Both airbags are marked **SRS AIRBAG**.

Types of Airbags

The airbags can inflate whenever the power mode is in ON.

After an airbag inflates in a crash, you may see a small amount of smoke. This is from the combustion process of the inflator material and is not harmful. People with respiratory problems may experience some temporary discomfort. If this occurs, get out of the vehicle as soon as it is safe to do so.

Front Airbags (SRS)

Dual-Stage, Multiple-Threshold Front Airbags (SRS)

Your vehicle is equipped with dual-stage, multiple-threshold front airbags (SRS).

During a frontal crash severe enough to cause one or both front airbags to deploy, the airbags can inflate at different rates, depending on the severity of the crash, whether the seat belts are latched, and/or other factors. Frontal airbags are designed to supplement the seat belts to help reduce the likelihood of head and chest injuries in frontal crashes.

■ Operation

Front airbags are designed to inflate during moderate-to-severe frontal collisions. When the vehicle decelerates suddenly, the sensors send information to the control unit which signals one or both front airbags to inflate.

A frontal collision can be either head-on or angled between two vehicles, or when a vehicle crashes into a stationary object, such as a concrete wall.

■ How the Front Airbags Work

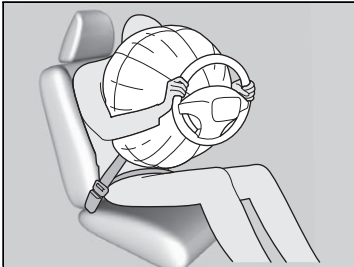

While your seat belt restrains your torso, the front airbag provides supplemental protection for your head and chest.

The front airbags deflate immediately so that they won't interfere with the driver's visibility or the ability to steer or operate other controls.

The total time for inflation and deflation is so fast that most occupants are not aware that the airbags deployed until they see them lying in front of them.

▣ How the Front Airbags Work

Although the driver's and front passenger's airbags normally inflate within a split second of each other, it is possible for only one airbag to deploy. This can happen if the severity of a collision is at the margin, or threshold, that determines whether or not the airbags will deploy. In such cases, the seat belt will provide sufficient protection, and the supplemental protection offered by the airbag would be minimal.

■ When front airbags should not deploy

Minor frontal crashes: Front airbags were designed to supplement seat belts and help to save lives, not to prevent minor scrapes, or even broken bones that might occur during a less than moderate-to-severe frontal crash.

Side impacts: Front airbags can provide protection when a sudden deceleration causes a driver or front passenger to move towards the front of the vehicle. Side airbags and side curtain airbags have been specifically designed to help to reduce the severity of injuries that can occur during a moderate-to-severe side impact which can cause the driver or passenger to move towards the side of the vehicle.

Rear impacts: Head restraints and seat belts are your best protection during a rear impact. Front airbags cannot provide any significant protection and are not designed to deploy in such collisions.

Rollovers: Seat belts, and in vehicles equipped with a rollover sensor, side curtain airbags offer the best protection in a rollover. Because front airbags could provide little if any protection, they are not designed to deploy during a rollover.

■ When front airbags deploy with little or no visible damage

Because the airbag system senses sudden deceleration, a strong impact to the vehicle framework or suspension might cause one or more of the airbags to deploy. Examples include running into a curb, the edge of a hole, or other low fixed object that causes a sudden deceleration in the vehicle chassis. Since the impact is underneath the vehicle, damage may not be readily apparent.

■ When front airbags may not deploy, even though exterior damage appears severe

Since crushable body parts absorb crash energy during an impact, the amount of visible damage does not always indicate proper airbag operation. In fact, some collisions can result in severe damage but no airbag deployment because the airbags would not have been needed or would not have provided protection even if they had deployed.

Advanced Airbags

Your front airbags have advanced features to help reduce the likelihood of airbag related injuries to smaller occupants.

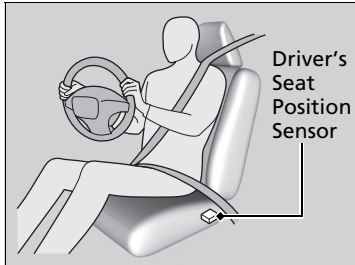

The driver's advanced front airbag system includes a seat position sensor.

Based on information from this sensor and the severity of the impact, the advanced airbag system determines the optimal deployment of the driver's airbag.

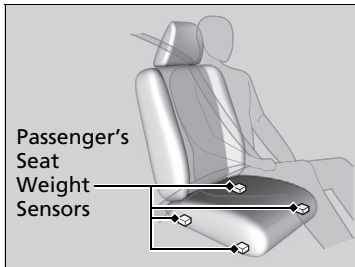

The passenger's advanced front airbag system has weight sensors.

Although we recommend against letting children under the age of 12 sit in passenger seat, if the sensors detect the weight of a child (up to about 65 lbs or 29 kg), the system will automatically turn off the passenger's front airbag.

Advanced Airbags

If there is a problem with the driver's seat position sensor, the SRS indicator will come on and the airbag will inflate with full (normal) force, regardless of the driver's seating position.

For both advanced front airbags to work properly:

- Do not spill any liquid on or under the seats.
- Do not put any object under the passenger's seat.
- Make sure any objects are positioned properly on the floor. Improperly positioned objects can interfere with the advanced airbag sensors.
- All occupants should sit upright and wear their seat belts properly.
- Do not place any cover over the passenger side dashboard.

▶ **Passenger Airbag Off Indicator** P. 50

Make sure the floor mat behind the front passenger's seat is hooked to the floor mat anchor. An improperly placed mat can interfere with the advanced airbag sensors.

▶ **Floor Mats** P. 485

Driver's Knee Airbag

The driver's knee SRS airbag inflates in a moderate-to-severe frontal collision to help keep the driver in the proper position and to help maximize the benefit provided by the vehicle's other safety features.

SRS (Supplemental Restraint System) indicates that the airbag is designed to supplement seat belts, not replace them. Seat belts are the occupant's primary restraint system.

Housing Locations

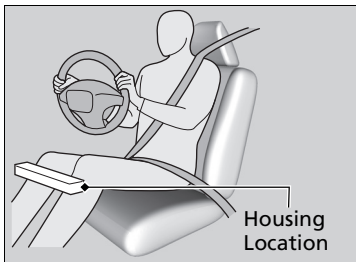

The driver's knee airbag is housed under the steering column.

The airbag is marked **SRS AIRBAG**.

Operation

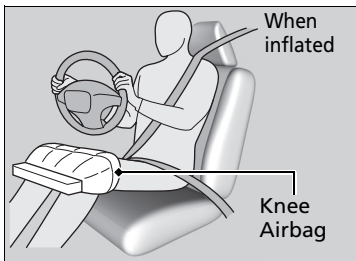

When the driver's front airbag inflates, the driver's knee airbag also inflates.

Even if the collision is not severe enough to deploy the front airbag, the knee airbag may inflate alone.

Driver's Knee Airbag

Do not attach accessories on or near the driver's knee airbag. They can interfere with the proper operation of the airbag, or hurt someone if an airbag inflates.

■ When driver's knee airbag deploys with little or no visible damage

Because the airbag system senses sudden deceleration, a strong impact to the vehicle framework or suspension might cause one or more of the airbags to deploy. Examples include running into a curb, the edge of a hole, or other low fixed object that causes a sudden deceleration in the vehicle chassis. Since the impact is underneath the vehicle, damage may not be readily apparent.

■ When driver's knee airbag may not deploy, even though exterior damage appears severe

Since crushable body parts absorb crash energy during an impact, the amount of visible damage does not always indicate proper airbag operation. In fact, some collisions can result in severe damage but no airbag deployment because the airbags would not have been needed or would not have provided protection even if they had deployed.

Side Airbags

The side airbags help protect the torso and pelvis of the driver or a front passenger during a moderate-to-severe side impact.

Housing Locations

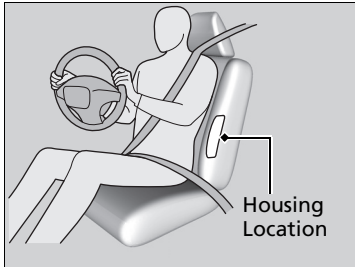

The side airbags are housed in the outside edge of the driver's and passenger's seat-backs.

Both are marked **SIDE AIRBAG**.

Operation

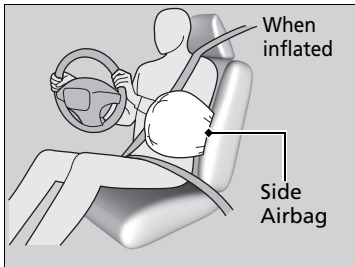

When the sensors detect a moderate-to-severe side impact, the control unit signals the side airbag on the impact side to immediately inflate.

Side Airbags

Make sure you and your front seat passenger always sit upright. Leaning into the path of a side airbag can prevent the airbag from deploying properly and increases your risk of serious injury.

Do not attach accessories on or near the side airbags. They can interfere with the proper operation of the airbags, or hurt someone if an airbag inflates.

Do not cover or replace the front seat-back covers without consulting a dealer. Improperly replacing or covering front seat-back covers can prevent your side airbags from properly deploying during a side impact.

■ When a side airbag deploys with little or no visible damage

Because the airbag system senses sudden acceleration, a strong impact to the side of the vehicle's framework can cause a side airbag to deploy. In such cases, there may be little or no damage, but the side impact sensors detected a severe enough impact to deploy the airbag.

■ When a side airbag may not deploy, even though visible damage appears severe

It is possible for a side airbag to not deploy during an impact that results in apparently severe damage. This can occur when the point of impact was toward the far front or rear of the vehicle, or when the vehicle's crushable body parts absorbed most of the crash energy. In either case, the side airbag would not have been needed nor provided protection even if it had deployed.

Side Curtain Airbags

The side curtain airbags help protect the heads of the driver and passengers in outer seating positions during a moderate-to-severe side impact. The side curtain airbags equipped in this vehicle are also designed to help reduce the likelihood of partial and complete ejection of vehicle occupants through side windows in crashes, particularly rollover crashes.

Housing Locations

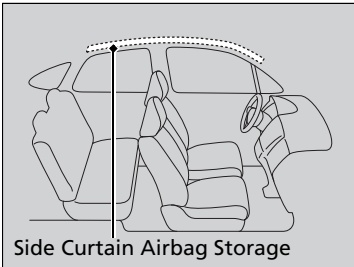

The side curtain airbags are located in the ceiling above the side windows on both sides of the vehicle.

Operation

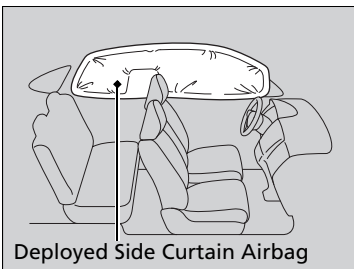

The side curtain airbag is designed to deploy in a rollover or a moderate-to-severe side impact.

Side Curtain Airbags

If the SRS control unit senses that your vehicle is about to rollover, it immediately deploys both side curtain airbags and activates both front seat belt tensioners.

If the impact is on the passenger's side, the passenger's side curtain airbag deploys even if there is no passenger in the passenger seat.

To get the best protection from the side curtain airbags, occupants should wear their seat belts properly and sit upright and well back in their seats.

Do not attach any objects to the side windows or roof pillars as they can interfere with the proper operation of the side curtain airbags.

■ When side curtain airbags deploy in a frontal collision

One or both side curtain airbags may also inflate in a moderate-to-severe angled frontal collision.

Airbag System Indicators

If a problem occurs in the airbag system, the SRS indicator will come on and a message appears on the multi-information display.

■ Supplemental Restraint System (SRS) Indicator

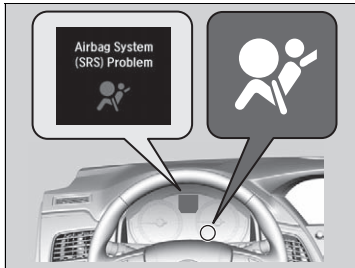

■ When the power mode is set to ON

The indicator comes on for a few seconds, then goes off. This tells you the system is working properly.

If the indicator comes on at any other time, or does not come on at all, have the system checked by a dealer as soon as possible. If you don't, your airbags and seat belt tensioners may not work properly when they are needed.

⊠ Supplemental Restraint System (SRS) Indicator

⚠ WARNING

Ignoring the SRS indicator can result in serious injury or death if the airbag systems or tensioners do not work properly.

Have your vehicle checked by a dealer as soon as possible if the SRS indicator alerts you to a possible problem.

■ Passenger Airbag Off Indicator

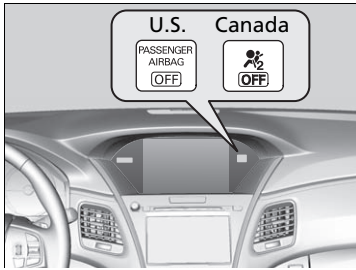

■ When the passenger airbag off indicator comes on

The indicator comes on to alert you that the passenger's front airbag has been turned off. This occurs when the weight sensors detect about 65 lbs (29 kg) or less, the weight of an infant or small child, on the seat.

Children under the age of 12 should always ride properly restrained in a back seat.

▶ **Child Safety** P. 52

Objects placed on the seat can also cause the indicator to come on.

If the front passenger seat is empty, the passenger's front airbag will not deploy and the indicator will not come on.

▶▶ Passenger Airbag Off Indicator

If the indicator comes on with no front passenger and no objects on the passenger's seat, or with an adult riding there, something may be interfering with the weight sensor, such as:

- An object hanging on the seat or in the seat-back pocket.
- A child seat or other object pressing against the rear of the seat-back.
- A rear passenger pushing or pulling on the back of the front passenger's seat.
- The front seat or seat-back is forced back against an object on the seat or floor behind it.
- An object placed under the front passenger's seat.

If none of these conditions exist, have your vehicle checked by a dealer as soon as possible.

The passenger airbag off indicator may come on and goes off repeatedly if the total weight on the seat is near the airbag cutoff threshold.

Airbag Care

You do not need to, and should not, perform any maintenance on or replace any airbag system components yourself. However, you should have your vehicle inspected by a dealer in the following situations:

■ When the airbags have deployed

If an airbag has inflated, the control unit and other related parts must be replaced. Similarly, once an automatic seat belt tensioner has been activated, it must be replaced.

■ When the vehicle has been in a moderate-to-severe collision

Even if the airbags did not inflate, have your dealer inspect the following: the driver's seat position sensor, weight sensors in the passenger's seat, front seat belt tensioners, and each seat belt that was worn during the crash.

■ Do not remove or modify a front seat without consulting a dealer

This would likely disable or affect the proper operation of the driver's seat position sensor or the weight sensors in the passenger's seat. If it is necessary to remove or modify a front seat to accommodate a person with disabilities, contact an Acura dealer, or for U.S. vehicles, Acura Client Service at 1-800-382-2238 and for Canadian vehicles, Acura Client Services at 1-866-78-ACURA.

✕ Airbag Care

We recommend against the use of salvaged airbag system components, including the airbag, tensioners, sensors, and control unit.

Protecting Child Passengers

Each year, many children are injured or killed in vehicle crashes because they are either unrestrained or not properly restrained. In fact, vehicle crashes are the number one cause of death of children ages 12 and under.

To reduce the number of child deaths and injuries, every state, Canadian province and territory requires that infants and children be properly restrained when they ride in a vehicle.

Children should sit properly restrained in a rear seat. This is because:

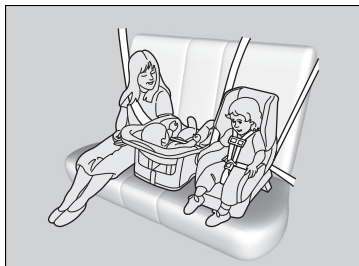

- An inflating front or side airbag can injure or kill a child sitting in the front seat.
- A child in the front seat is more likely to interfere with the driver's ability to safely control the vehicle.
- Statistics show that children of all sizes and ages are safer when they are properly restrained in a rear seat.

Protecting Child Passengers

⚠ WARNING

Children who are unrestrained or improperly restrained can be seriously injured or killed in a crash.

Any child too small for a seat belt should be properly restrained in a child seat. A larger child should be properly restrained with a seat belt, using a booster seat if necessary.

The National Highway Traffic Safety Administration and Transport Canada recommend that all children ages 12 and under be properly restrained in a rear seat. Some states or provinces/territories have laws restricting where children may ride.

- Any child who is too small to wear a seat belt correctly must be restrained in an approved child seat that is properly secured to the vehicle using either the seat belt or the lower anchors of the LATCH system.
- Never hold a child on your lap because it is impossible to protect them in the event of a collision.
- Never put a seat belt over yourself and a child. During a crash, the belt would likely press deep into the child and cause serious or fatal injuries.
- Never let two children use the same seat belt. Both children could be very seriously injured in a crash.
- Do not allow children to operate the doors, windows or seat adjustments.
- Do not leave children in the vehicle unattended, especially in hot weather when the inside of the vehicle can get hot enough to kill them. They could also activate vehicle controls causing it to move unexpectedly.

▶▶ Protecting Child Passengers

⚠ WARNING

Allowing a child to play with a seat belt or wrap one around their neck can result in serious injury or death.

Instruct children not to play with any seat belt and make sure any unused seat belt a child can reach is buckled, fully retracted, and locked.

To deactivate a lockable retractor, release the buckle and allow the seat belt to wind up all the way.

To remind you of the passenger's front airbag hazards and child safety, your vehicle has warning labels on the dashboard (U.S. models) and on the front visors. Please read and follow the instructions on these labels.

▶ **Safety Labels** P. 65

Safety of Infants and Small Children

■ Protecting Infants

An infant must be properly restrained in a rear-facing, reclining child seat until the infant reaches the seat manufacturer's weight or height limit for the seat, and the infant is at least one year old. Many experts recommend use of a rear-facing seat for a child up to two years old if the child's height and weight are appropriate for a rear-facing seat.

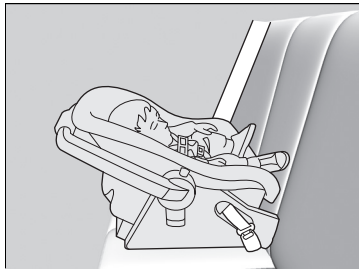

■ Positioning a rear-facing child seat

Child seats must be placed and secured in a rear seating position.

When properly installed, a rear-facing child seat may prevent the driver or a front passenger from moving their seat all the way back, or from locking their seat-back in the desired position.

It can also interfere with proper operation of the passenger's advanced front airbag system.

➤ **Airbags** P. 37

If this occurs, we recommend that you install the child seat directly behind the front passenger's seat, move the seat as far forward as needed, and leave it unoccupied. Or, you may wish to get a smaller rear-facing child seat.

⌘ Protecting Infants

⚠ WARNING

Placing a rear-facing child seat in the front seat can result in serious injury or death during a crash.

Always place a rear-facing child seat in the rear seat, not the front.

Rear-facing child seats should never be installed in a forward facing position.

Always refer to the child seat manufacturer's instructions before installation.

■ Protecting Smaller Children

If a child is at least one year old and has exceeded the weight and height limitations of a rear-facing child seat, the child should be properly restrained in a firmly secured forward-facing child seat until they exceed the weight and height limitations for the forward-facing child seat.

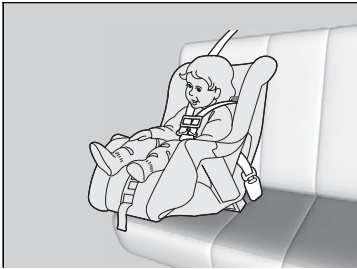

■ Forward-facing child seat placement

We strongly recommend placing a forward-facing child seat in a rear seating position.

Placing a forward-facing child seat in the front seat can be hazardous, even with advanced front airbags that automatically turn the passenger's front airbag off. A rear seat is the safest place for a child.

⊠ Protecting Smaller Children

⚠ WARNING

Placing a forward-facing child seat in the front seat can result in serious injury or death if the front airbag inflates.

If you must place a forward-facing child seat in front, move the vehicle seat as far back as possible, and properly restrain the child.

Educate yourself about the laws and regulations regarding child seat use where you are driving, and follow the child seat manufacturer's instructions.

Many experts recommend use of a rear-facing seat for a child up to two years old if the child's height and weight are appropriate for a rear-facing seat.

■ Selecting a Child Seat

Most child seats are LATCH-compatible (Lower Anchors and Tethers for Children). Some have a rigid-type connector, while others have a flexible-type connector. Both are equally easy to use. Some existing and previously owned child seats can only be installed using the seat belt. Whichever type you choose, follow the child seat manufacturer's use and care instructions including recommended expiration dates as well as the instructions in this manual. Proper installation is key to maximizing your child's safety.

In seating positions and vehicles not equipped with LATCH, a LATCH compatible child seat can be installed using the seat belt and a top tether for added security. This is because all child seats are required to be designed so that they can be secured with the seat belt. In addition, the child seat manufacturer may advise that a seat belt be used to attach a LATCH-compatible seat once a child reaches a specified weight. Please read the child seat owner's manual for proper installation instructions.

■ Important consideration when selecting a child seat

Make sure the child seat meets the following three requirements:

- The child seat is the correct type and size for the child.
- The child seat is the correct type for the seating position.
- The child seat is compliant with Federal Motor Vehicle Safety Standard 213 or Canadian Motor Vehicle Safety Standard 213.

►► Selecting a Child Seat

Installation of a LATCH-compatible child seat is simple.

LATCH-compatible child seats have been developed to simplify the installation process and reduce the likelihood of injuries caused by incorrect installation.

■ Installing a LATCH-Compatible Child Seat

A LATCH-compatible child seat can be installed in either of the two outer rear seats. A child seat is attached to the lower anchors with either the rigid or flexible type of connectors.

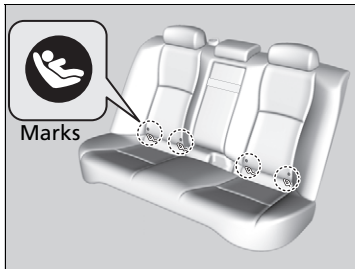

1. Locate the lower anchors under the marks.

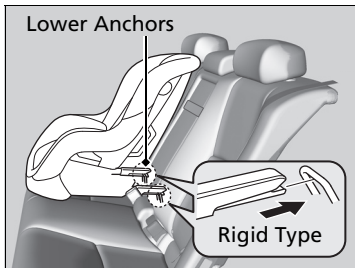

2. Place the child seat on the vehicle seat then attach the child seat to the lower anchors according to the instructions that came with the child seat.

▶ When installing the child seat, make sure that the lower anchors are not obstructed by the seat belt or any other object.

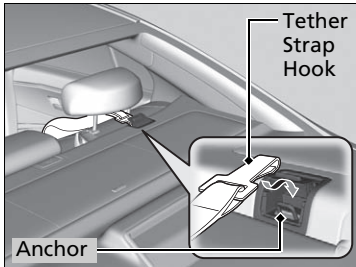
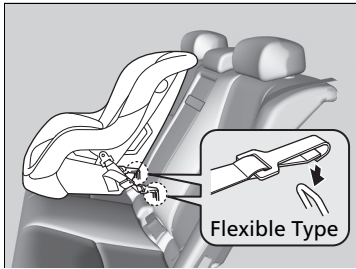

3. Open the tether anchor cover behind the head restraint.
4. Raise the head restraint to its highest position, then route the tether strap between the head restraint legs, and secure the tether strap hook to the anchor.
5. Tighten the tether strap as instructed by the child seat manufacturer.
6. Make sure the child seat is firmly secured by rocking it forward and back and side to side; little movement should be felt.
7. Make sure any unused seat belt that a child can reach is buckled, the lockable retractor is activated, and the belt is fully retracted and locked.

►► Installing a LATCH-Compatible Child Seat

For your child's safety, when using a child seat installed using the LATCH system, make sure that the child seat is properly secured to the vehicle. A child seat that is not properly secured will not adequately protect a child in a crash and may cause injury to the child or other vehicle occupants.

■ Installing a Child Seat with a Lap/Shoulder Seat Belt

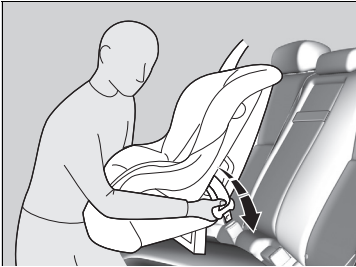

1. Place the child seat on the vehicle seat.
2. Route the seat belt through the child seat according to the seat manufacturer's instructions, and insert the latch plate into the buckle.
 - Insert the latch plate fully until it clicks.

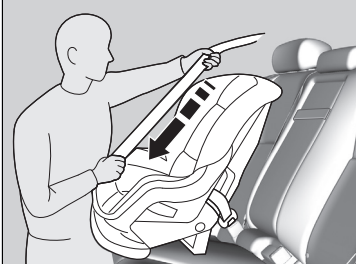

3. Slowly pull the shoulder part of the belt all the way out until it stops. This activates the lockable retractor.
4. Let the seat belt retract a few inches and check that the retractor has switched modes by pulling on the webbing. It should not pull out again until it is reset by removing the latch plate from the buckle.
 - If you are able to pull the shoulder belt out, the lockable retractor is not activated. Slowly pull the seat belt all the way out, and repeat steps 3 – 4.

▣ Installing a Child Seat with a Lap/Shoulder Seat Belt

A child seat that is not properly secured will not adequately protect a child in a crash and may cause injury to the child or other vehicle occupants.

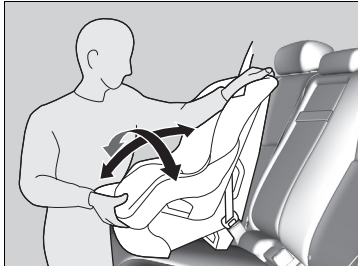
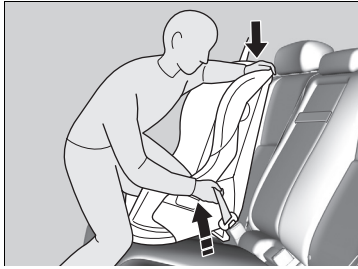

5. Grab the shoulder part of the seat belt near the buckle, and pull up to remove any slack from the lap part of the belt.
 - ▶ When doing this, place your weight on the child seat and push it into the vehicle seat.
6. Make sure the child seat is firmly secured by rocking it forward and back and side to side; little movement should be felt.
7. Make sure any unused seat belt that a child can reach is buckled, the lockable retractor is activated, and the belt is fully retracted and locked.

▶▶ Installing a Child Seat with a Lap/Shoulder Seat Belt

To deactivate a lockable retractor, release the buckle and allow the seat belt to wind up all the way.

■ Adding Security with a Tether

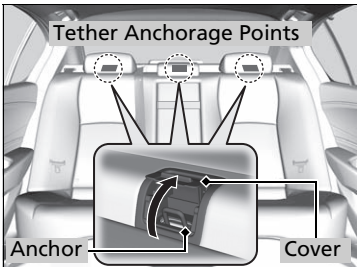

A tether anchorage point is provided behind each rear seating position. If you have a child restraint system that comes with a tether but can be installed with a seat belt, the tether may be used for additional security.

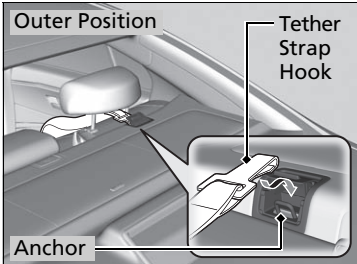

1. Locate the appropriate tether anchorage point and lift the cover.
2. Raise the head restraint to its highest position, then route the tether strap through the head restraint legs. Make sure the strap is not twisted.

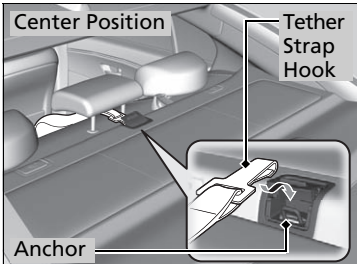

3. Secure the tether strap hook to the anchor.
4. Tighten the tether strap as instructed by the child seat manufacturer.

▣ Adding Security with a Tether

Always use a tether for forward-facing child seats when using the seat belt or lower anchors.

Safety of Larger Children

■ Protecting Larger Children

The following pages give instructions on how to check proper seat belt fit, what kind of booster seat to use if one is needed, and important precautions for a child who must sit in front.

■ Checking Seat Belt Fit

When a child is too big for a child seat, secure the child in a rear seat using the lap/shoulder seat belt. Have the child sit upright and all the way back, then answer the following questions.



■ Checklist

- Do the child's knees bend comfortably over the edge of the seat?
- Does the shoulder belt cross between the child's neck and arm?
- Is the lap part of the seat belt as low as possible, touching the child's thighs?
- Will the child be able to stay seated like this for the whole trip?

If you answer yes to all these questions, the child is ready to wear the lap/shoulder seat belt correctly. If you answer no to any question, the child needs to ride on a booster seat until the seat belt fits properly without a booster seat.

▶ Safety of Larger Children

⚠ WARNING

Allowing a child age 12 or under to sit in front can result in injury or death if the passenger's front airbag inflates.

If a larger child must ride in front, move the vehicle seat as far to the rear as possible, have the child sit up properly and wear the seat belt properly, using a booster seat if needed.

Booster Seats



If a lap/shoulder seat belt cannot be used properly, position the child in a booster seat in a rear seat. For the child's safety, check that the child meets the booster seat manufacturer's recommendations.

Protecting Larger Children-Final Checks

Your vehicle has a rear seat where children can be properly restrained. If you ever have to carry a group of children, and a child must ride in front:

- Make sure you read and fully understand the instructions and safety information in this manual.
- Move the front passenger seat as far back as possible.
- Have the child sit upright and well back in the seat.
- Check that the seat belt is properly positioned so that the child is secure in the seat.

Monitoring child passengers

We strongly recommend that you keep an eye on child passengers. Even older, more mature children sometimes need to be reminded to fasten their seat belts and sit up properly.

Booster Seats

When installing a booster seat, make sure to read the instructions that came with it, and install the seat accordingly.

There are high- and low-type booster seats. Choose a booster seat that allows the child to wear the seat belt correctly.

Some U.S. states, and Canadian provinces and territories require children to use a booster seat until they reach a given age or weight (e.g. six years or 60 lbs). Be sure to check current laws in the state or province, or territory where you intend to drive.

Carbon Monoxide Gas

The engine exhaust from this vehicle contains carbon monoxide, a colorless, odorless, and highly toxic gas. As long as you properly maintain your vehicle, carbon monoxide gas will not get into the interior.

■ Have the exhaust system inspected for leaks whenever

- The exhaust system is making an unusual noise.
- The exhaust system may have been damaged.
- The vehicle is raised for an oil change.

When you operate a vehicle with the trunk open, airflow can pull exhaust gas into the interior and create a hazardous condition. If you must drive with the trunk open, open all the windows and set the climate control system as shown below.

1. Select the fresh air mode.
2. Select the  mode.
3. Set the fan speed to high.
4. Set the temperature control to a comfortable setting.

Adjust the climate control system in the same manner if you sit in your parked vehicle with the engine running.

Carbon Monoxide Gas

WARNING

Carbon monoxide gas is toxic. Breathing it can cause unconsciousness and even kill you.

Avoid any enclosed areas or activities that expose you to carbon monoxide.

An enclosed area such as a garage can quickly fill up with carbon monoxide gas. Do not run the engine with the garage door closed. Even when the garage door is open, drive out of the garage immediately after starting the engine.

Label Locations

These labels are in the locations shown. They warn you of potential hazards that can cause serious injury or death. Read these labels carefully.

If a label comes off or becomes hard to read (except for the U.S. dashboard label which may be removed by the owner), contact a dealer for a replacement.

Sun Visors

U.S. models

WARNING

EVEN WITH ADVANCED AIR BAGS

- Children can be killed or seriously injured by the air bag.
- The back seat is the safest place for children.
- Never sit a child in a child seat in the front.
- Always use seat belt and child restraints.
- See owner's manual for more information about air bags.



Canadian models

CAUTION
TO AVOID SERIOUS INJURY:

- FOR MAXIMUM SAFETY PROTECTION IN ALL TYPES OF CRASHES, YOU MUST ALWAYS WEAR YOUR SAFETY BELT.
- DO NOT INSTALL REARWARD-FACING CHILD SEATS IN ANY FRONT PASSENGER SEAT POSITION.
- DO NOT SIT OR LEAN UNNECESSARILY CLOSE TO THE AIR BAG.
- DO NOT PLACE ANY OBJECTS OVER THE AIR BAG OR BETWEEN THE AIR BAG AND YOURSELF.
- SEE THE OWNER'S MANUAL FOR FURTHER INFORMATION AND EXPLANATIONS.

PRECAUTIONS:
POUR EVITER DES BLESSURES GRAVES:

- POUR PROFITER D'UNE PROTECTION MAXIMALE LORS D'UNE COLLISION BOUCLEZ TOUJOURS VOTRE CEINTURE DE SECURITE.
- N'INSTALLEZ JAMAIS UN SIEGE POUR ENFANTS FASANT FACE A L'ARRIERE SUR LE SIEGE DU PASSAGER AVANT.
- NE VOUS APPUYEZ PAS ET NE VOUS ASSOYEZ PAS PRES DU COUSSIN GONFLABLE.
- NE DEPOSEZ AUCUN OBJET SUR LE COUSSIN GONFLABLE OU ENTRE LE COUSSIN GONFLABLE ET VOUS.
- LISEZ LE GUIDE UTILISATEUR POUR DE PLUS AMPLES RENSEIGNEMENTS.

Dashboard U.S. models only

This Vehicle is Equipped with Advanced Air Bags

Even with Advanced Air Bags

Children can be killed or seriously injured by the air bags. The back seat is the safest place for children. Never sit a child in a child seat in the front. Always use seat belts and child restraints. See owner's manual for more information about air bags.

To be removed by owner only.

Radiator Cap

DANGER
WARNING
危險

NEVER OPEN WHEN HOT. Hot coolant will scald you.
N'OUVREZ PAS QUAND CHAUD. Le liquide refroidissant peut vous brûler.

NEVER REMOVE MOTOR OFFENLY.
NE JAMAIS ENLEVER LE CAPOT.

1.1

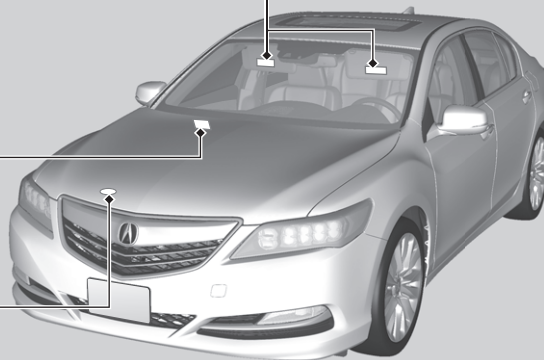









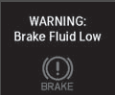
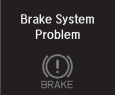

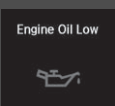
Instrument Panel



This chapter describes the buttons, indicators, and gauges that are used while driving.





Indicators	68
Multi-Information Display Warning and Information Messages.....	86
Gauges and Multi-Information Display	97
Gauges.....	97
Multi-Information Display	98





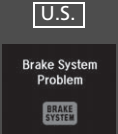

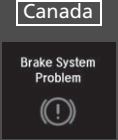
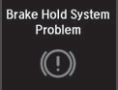
Indicator	Name	On/Blinking	Explanation	Message
	Brake System Indicator (Red)	<ul style="list-style-type: none"> Comes on for a few seconds when you set the power mode to ON, then goes off. Comes on when the brake fluid level is low. Comes on if there is a problem with the brake system. 	<ul style="list-style-type: none"> Comes on while driving - Check the brake fluid level. <ul style="list-style-type: none"> ➤ What to do when the indicator comes on while driving P. 519 Comes on along with the ABS indicator - Have your vehicle checked by a dealer. <ul style="list-style-type: none"> ➤ If the Brake System Indicator (Red) Comes On P. 519 	 
	Low Oil Pressure Indicator	<ul style="list-style-type: none"> Comes on when you set the power mode to ON, and goes off when the engine starts. Comes on when the engine oil pressure is low. 	<ul style="list-style-type: none"> Comes on while driving - Immediately stop in a safe place. <ul style="list-style-type: none"> ➤ If the Low Oil Pressure Indicator Comes On P. 518 	









Indicator	Name	On/Blinking	Explanation	Message
	Electric Parking Brake Indicator	<ul style="list-style-type: none"> • Comes on for a few seconds when you set the power mode to ON, then goes off. • Comes on when the parking brake is applied, and goes off when it is released. • Comes on for about 15 seconds then goes off when you pull the electric parking brake switch with the power mode in OFF. • Comes on for about 15 seconds then goes off when you set the power mode to OFF with the parking brake applied. 	<ul style="list-style-type: none"> • Blinks and the electric parking brake system indicator comes on at the same time - There is a problem with the electric parking brake system. The parking brake may not be set. 	
	Electric Parking Brake System Indicator	<ul style="list-style-type: none"> • Comes on when you press the electric parking brake switch without depressing the brake pedal. 	<ul style="list-style-type: none"> • Depress the brake pedal to release the parking brake.  Parking Brake P. 402 	
	Electric Parking Brake System Indicator	<ul style="list-style-type: none"> • Comes on for a few seconds when you set the power mode to ON, then goes off. • Comes on if there is a problem with the electric parking brake system. 	<ul style="list-style-type: none"> • Comes on while driving - Avoid using the parking brake and have your vehicle checked by a dealer immediately.  If the Electric Parking Brake System Indicator Comes On P. 520 	





Indicator	Name	On/Blinking	Explanation	Message
	Automatic Brake Hold System Indicator	<ul style="list-style-type: none"> • Comes on for a few seconds when you set the power mode to ON, then goes off. • Comes on when the automatic brake hold system is on. 	<p>➤ Automatic Brake Hold P. 405</p>	
	Automatic Brake Hold Indicator	<ul style="list-style-type: none"> • Comes on for a few seconds when you set the power mode to ON, then goes off. • Comes on when the automatic brake hold is activated. 	<p>➤ Automatic Brake Hold P. 405</p>	<p>—</p>



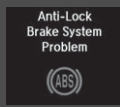

Indicator	Name	On/Blinking	Explanation	Message
 <p>U.S. BRAKE SYSTEM Canada (Amber)</p>	<p>Brake System Indicator (Amber)</p>	<ul style="list-style-type: none"> • Comes on for a few seconds when you set the power mode to ON, then goes off. • Comes on if there is a problem with a system related to braking other than the conventional brake system. • Comes on if there is a problem with hydraulic brake boost system. 	<ul style="list-style-type: none"> • Comes on while driving - Have your vehicle checked by a dealer. • With this indicator on, your vehicle still has normal braking ability. 	 <p>U.S. Brake System Problem BRAKE SYSTEM</p>  <p>Brake Hold System Problem BRAKE SYSTEM</p>  <p>Canada Brake System Problem (Amber)</p>  <p>Brake Hold System Problem (Amber)</p>

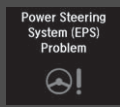

Instrument Panel





Indicator	Name	On/Blinking	Explanation	Message
	Malfunction Indicator Lamp	<ul style="list-style-type: none"> Comes on when you set the power mode to ON, and goes off either when the engine starts or after several seconds if the engine did not start. If “readiness codes” have not been set, it blinks five times before it goes off. Comes on if there is a problem with the emissions control system. Blinks when a misfire in the engine’s cylinders is detected. 	<ul style="list-style-type: none"> Readiness codes are part of the on board diagnostics for the emissions control systems. <ul style="list-style-type: none"> ► Testing of Readiness Codes P. 537 Comes on while driving - Have your vehicle checked by a dealer. Blinks while driving - Stop in a safe place where there are no flammable objects. Stop the engine for 10 minutes or more, and wait for it to cool down. Then, take the vehicle to a dealer. <ul style="list-style-type: none"> ► If the Malfunction Indicator Lamp Comes On or Blinks P. 519 	
	Charging System Indicator	<ul style="list-style-type: none"> Comes on when you set the power mode to ON, and goes off when the engine starts. Comes on when the battery is not charging. 	<ul style="list-style-type: none"> Comes on while driving - Turn off the climate control system and rear defogger in order to reduce electricity consumption. <ul style="list-style-type: none"> ► If the Charging System Indicator Comes On P. 518 	
	Shift Lever Position Indicator	<ul style="list-style-type: none"> Indicates the current shift lever position. 	<ul style="list-style-type: none"> ► Shifting P. 351 	—
	Transmission Indicator	<ul style="list-style-type: none"> Blinks if the transmission system has a problem. 	<ul style="list-style-type: none"> Blinks while driving - Avoid sudden starts and acceleration and have your vehicle checked by a dealer immediately. 	

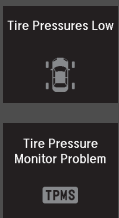







Indicator	Name	On/Blinking	Explanation	Message
	M (sequential shift mode) Indicator/Gear Position Indicator	<ul style="list-style-type: none"> Comes on when the manual sequential shift mode is applied. 	<ul style="list-style-type: none">  Sequential Shift Mode P. 353 	<p>—</p>
	Seat Belt Reminder Indicator	<ul style="list-style-type: none"> Comes on and the beeper sounds if you are not wearing a seat belt when you set the power mode to ON. If the front passenger is not wearing a seat belt, the indicator comes on about a few seconds later. Blinks while driving if either you or the front passenger has not fastened a seat belt. The beeper sounds and the indicator blinks at regular intervals. 	<ul style="list-style-type: none"> The beeper stops and the indicator goes off when you and the front passenger fasten their seat belts. Stays on after you or the front passenger has fastened the seat belt - A detection error may have occurred in the sensor. Have your vehicle checked by a dealer. <ul style="list-style-type: none">  Seat Belt Reminder P. 31 	<div data-bbox="1355 407 1469 505"> <p>Fasten Seat Belt</p>  </div> <div data-bbox="1355 530 1469 622"> <p>Fasten Passenger's Seat Belt</p>  </div>
	Low Fuel Indicator	<ul style="list-style-type: none"> Comes on when the fuel reserve is running low (approximately 2.8 U.S. gal/10.5 Liter left). Blinks if there is a problem with the fuel gauge. 	<ul style="list-style-type: none"> Comes on - Refuel your vehicle as soon as possible. Blinks - Have your vehicle checked by a dealer. 	<div data-bbox="1355 710 1469 807"> <p>Fuel Low</p>  </div> <div data-bbox="1355 822 1469 913"> <p>Fuel Gauge System Problem</p>  </div>

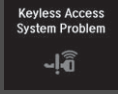



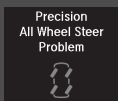

Indicator	Name	On/Blinking	Explanation	Message
	Anti-lock Brake System (ABS) Indicator	<ul style="list-style-type: none"> • Comes on for a few seconds when you set the power mode to ON, then goes off. • If it comes on at any other time, there is a problem with the ABS. 	<ul style="list-style-type: none"> • Stays on constantly - Have your vehicle checked by a dealer. With this indicator on, your vehicle still has normal braking ability but no anti-lock function. ► Anti-lock Brake System (ABS) P. 407 	
	Supplemental Restraint System Indicator	<ul style="list-style-type: none"> • Comes on for a few seconds when you set the power mode to ON, then goes off. • Comes on if a problem with any of the following is detected: <ul style="list-style-type: none"> - Supplemental restraint system - Side airbag system - Side curtain airbag system - Seat belt tensioner 	<ul style="list-style-type: none"> • Stays on constantly or does not come on at all - Have your vehicle checked by a dealer. 	
	Electric Power Steering (EPS) System Indicator	<ul style="list-style-type: none"> • Comes on when you set the power mode to ON, and goes off when the engine starts. • Comes on if there is a problem with the EPS system. 	<ul style="list-style-type: none"> • Stays on constantly or does not come on at all - Have your vehicle checked by a dealer. ► If the Electric Power Steering (EPS) System Indicator Comes On P. 520 	

Indicator	Name	On/Blinking	Explanation	Message
	Vehicle Stability Assist (VSA®) System Indicator	<ul style="list-style-type: none"> • Comes on for a few seconds when you set the power mode to ON, then goes off. • Blinks when VSA® is active. • Comes on if there is a problem with the VSA® system or hill start assist system. 	<ul style="list-style-type: none"> • Stays on constantly - Have your vehicle checked by a dealer. <ul style="list-style-type: none"> ➤ Vehicle Stability Assist (VSA®), aka Electronic Stability Control (ESC), System P. 393 	<div style="border: 1px solid black; padding: 5px; margin-bottom: 5px;"> Vehicle Stability Assist (VSA) Problem  </div> <div style="border: 1px solid black; padding: 5px;"> Hill Start Assist Problem  </div>
	Vehicle Stability Assist (VSA®) OFF Indicator	<ul style="list-style-type: none"> • Comes on for a few seconds when you set the power mode to ON, then goes off. • Comes on when you deactivate VSA®. 	<ul style="list-style-type: none"> ➤ VSA® OFF Button P. 394 	—



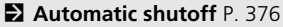

Indicator	Name	On/Blinking	Explanation	Message
	<p>Low Tire Pressure/TPMS Indicator</p>	<ul style="list-style-type: none"> • Comes on for a few seconds when you set the power mode to ON. • Comes on if the tire pressure of any of the tires becomes significantly low. • Blinks for about one minute, and then stays on if there is a problem with the TPMS, or when a compact spare tire* is temporarily installed. 	<ul style="list-style-type: none"> • Comes on while driving - Stop in a safe place, check tire pressures, and inflate the tire(s) if necessary. • Blinks and remains on - Have your vehicle checked by a dealer. If the vehicle is fitted with a compact spare*, get your regular tire repaired or replaced and put back on your vehicle as soon as you can. 	
	<p>System Message Indicator</p>	<ul style="list-style-type: none"> • Comes on for a few seconds when you set the power mode to ON, then goes off. • Comes on along with a beep when a problem is detected. A system message on the multi-information display appears at the same time. 	<ul style="list-style-type: none"> • While the indicator is on, roll the right selector wheel to see the message again. • Refer to the Indicators information in this chapter when a system message appears on the multi-information display. Take the appropriate action for the message. • The multi-information display does not return to the normal screen unless the warning is canceled, or the right selector wheel is rolled. 	





Indicator	Name	On/Blinking	Explanation	Message
	Turn Signal Indicators	<ul style="list-style-type: none"> • Blinks when you operate the turn signal lever. • Blink along with all turn signals when you press the hazard warning button. 	<ul style="list-style-type: none"> • Does not blink or blinks rapidly - A turn signal light bulb has blown. Change the bulb immediately. <ul style="list-style-type: none"> ► Replacing Light Bulbs P. 463, 464, 465 	—
	High Beam Indicator	<ul style="list-style-type: none"> • Comes on when the high beam headlights are on. 	—	—
	Lights On Indicator	<ul style="list-style-type: none"> • Comes on whenever the light switch is on, or in AUTO when the exterior lights are on. 	<ul style="list-style-type: none"> • If you set the power mode to ACCESSORY or VEHICLE OFF (LOCK) while the exterior lights are on, a chime sounds when the driver's door is opened. 	—
	Immobilizer System Indicator	<ul style="list-style-type: none"> • Comes on briefly when you set the power mode to ON, then goes off. • Comes on if the immobilizer system cannot recognize the key information. 	<ul style="list-style-type: none"> • Blinks - You cannot start the engine. Set the power mode to VEHICLE OFF (LOCK), then select the ON mode again. • Repeatedly blinks - The system may be malfunctioning. Have your vehicle checked by a dealer. • Do not attempt to alter this system or add other devices to it. Electrical problems can occur. 	—
 Indicator	Security System Alarm Indicator	<ul style="list-style-type: none"> • Blinks when the security system alarm has been set. 	<ul style="list-style-type: none"> ► Security System Alarm P. 131 	—

Indicator	Name	On/Blinking	Explanation	Message
	Keyless Access System Indicator	<ul style="list-style-type: none"> • Comes on for a few seconds when you set the power mode to ON, then goes off. • Comes on as soon as a problem is detected in the keyless access system or keyless starting system. 	<ul style="list-style-type: none"> • Have your vehicle checked by a dealer. 	 
	CRUISE MAIN Indicator*	<ul style="list-style-type: none"> • Comes on when you press the CRUISE button. 	 Cruise Control* P. 356	—
	CRUISE CONTROL Indicator*	<ul style="list-style-type: none"> • Comes on if you have set a speed for cruise control. 	 Cruise Control* P. 356	—
	Precision All-Wheel Steer™ (P-AWS®) System Indicator	<ul style="list-style-type: none"> • Comes on for a few seconds when you set the power mode to ON, then goes off. • If it comes on at any other time, there is a problem with the Precision All-Wheel Steer™ (P-AWS®) system. 	<ul style="list-style-type: none"> • Comes on while driving - Have your vehicle checked by a dealer. • The system may limit the vehicle speed to 50 mph (80 km/h) or less. 	
	SPORT Mode Indicator	<ul style="list-style-type: none"> • Comes on for a few seconds when you set the power mode to ON, then goes off. • Comes on when you press the SPORT button. 	 SPORT Mode P. 355	—

Indicator	Name	On/Blinking	Explanation	Message
	Forward Collision Warning (FCW) Indicator*	<ul style="list-style-type: none"> • Comes on for a few seconds when you change the power mode to ON, then goes off. • Comes on when you have customized FCW to turn off. • Comes on if there is a problem with the FCW system. 	<ul style="list-style-type: none"> • Stays on constantly without FCW off - Have your vehicle checked by a dealer. 	 
		<ul style="list-style-type: none"> • Comes on when the FCW system shuts itself off. 	<ul style="list-style-type: none"> • Stays on - The temperature inside the FCW system is too high. The system activates when the temperature inside the system cools down.  	
			<ul style="list-style-type: none"> • Stays on - The area around the camera is blocked by dirt, mud, etc. Stop your vehicle in a safe place, and wipe it off with a soft cloth. • Have your vehicle checked by a dealer if the indicator and message come back on after you cleaned the area around the camera.  	





* Not available on all models

Indicator	Name	On/Blinking	Explanation	Message
	Lane Departure Warning (LDW) Indicator*	<ul style="list-style-type: none"> • Comes on for a few seconds when you change the power mode to ON, then goes off. • Comes on if there is a problem with the LDW system. 	<ul style="list-style-type: none"> • Stays on constantly - Have your vehicle checked by a dealer. 	
		<ul style="list-style-type: none"> • Comes on when the LDW system shuts itself off. 	<ul style="list-style-type: none"> • Stays on - The temperature inside the LDW camera is too high. Use the climate control system to cool down the camera. The system activates when the temperature inside the camera cools down. ❏ Lane Departure Warning Camera (LDW Camera) P. 379 	
			<ul style="list-style-type: none"> • Stays on - The area around the camera is blocked by dirt, mud, etc. Stop your vehicle in a safe place, and wipe it off with a soft cloth. • Have your vehicle checked by a dealer if the indicator and message come back on after you cleaned the area around the camera. ❏ Lane Departure Warning Camera (LDW Camera) P. 379 	



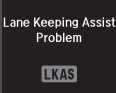
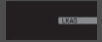



Indicator	Name	On/Blinking	Explanation	Message
	Road Departure Mitigation (RDM) Indicator*	<ul style="list-style-type: none"> • Comes on for a few seconds when you change the power mode to ON, then goes off. • Comes on if there is a problem with the RDM system. 	<ul style="list-style-type: none"> • Stays on constantly - Have your vehicle checked by a dealer. 	
		<ul style="list-style-type: none"> • Comes on when the RDM system shuts itself off. 	<ul style="list-style-type: none"> • Stays on - The temperature inside the camera is too high. Use the climate control system to cool down the camera. The system activates when the temperature inside the camera cools down. ➤ Front Sensor Camera* P. 359 	
			<ul style="list-style-type: none"> • Stays on - The area around the camera is blocked by dirt, mud, etc. Stop your vehicle in a safe place, and wipe it off with a soft cloth. • Have your vehicle checked by a dealer if the indicator and message come back on after you cleaned the area around the camera. ➤ Front Sensor Camera* P. 359 	







* Not available on all models

Indicator	Name	On/Blinking	Explanation	Message
	Adaptive Cruise Control (ACC) with Low Speed Follow (LSF) Indicator (Amber)*	<ul style="list-style-type: none"> Comes on for a few seconds when you change the power mode to ON, then goes off. Comes on if there is a problem with ACC with LSF. Comes on if anything covers the radar sensor cover and prevents the sensor from detecting a vehicle in front. May come on when driving in bad weather (rain, snow, fog, etc.) ACC with LSF has been automatically canceled. 	<ul style="list-style-type: none"> Comes on while driving - Have your vehicle checked by a dealer. When the radar sensor gets dirty, stop your vehicle in a safe place, and wipe off dirt using a soft cloth. Have your vehicle checked by a dealer if the indicator does not go off even after you clean the sensor cover. 	
	Adaptive Cruise Control (ACC) with Low Speed Follow (LSF) Indicator (Green)*	<ul style="list-style-type: none"> Comes on when you press the MAIN button. Comes on if the temperature inside the camera is too high. ACC with LSF has been automatically canceled. 	<ul style="list-style-type: none"> Use the climate control system to cool down the camera. Goes off - The camera has been cooled down. Pressing the MAIN button can resume the system. ➤ Front Sensor Camera* P. 359 ➤ Adaptive Cruise Control (ACC) with Low Speed Follow (LSF)* P. 361 	

Indicator	Name	On/Blinking	Explanation	Message
	Lane Keeping Assist System (LKAS) Indicator (Amber)*	<ul style="list-style-type: none"> Comes on for a few seconds when you change the power mode to ON, then goes off. Comes on if there is a problem with the LKAS. 	<ul style="list-style-type: none"> Stays on constantly - Have your vehicle checked by a dealer. 	
	Lane Keeping Assist System (LKAS) Indicator (Green)*	<ul style="list-style-type: none"> Comes on when you press the MAIN button. 	<ul style="list-style-type: none"> ➤ Lane Keeping Assist System (LKAS)* P. 386 	
		<ul style="list-style-type: none"> Comes on if the temperature inside the camera is too high. The LKAS has been automatically canceled. 	<ul style="list-style-type: none"> Use the climate control system to cool down the camera. Goes off - The camera has been cooled down. Pressing the LKAS button can resume the system. ➤ Front Sensor Camera* P. 359 ➤ Lane Keeping Assist System (LKAS)* P. 386 	
		<ul style="list-style-type: none"> Comes on when the area around the camera is blocked by dirt, mud, etc. Stop your vehicle in a safe place, and wipe it off with a soft cloth. May come on when driving in bad weather (rain, snow, fog, etc.) 	<ul style="list-style-type: none"> Have your vehicle checked by a dealer if the indicator and message come back on after you cleaned the area around the camera. 	

* Not available on all models



Indicator	Name	On/Blinking	Explanation	Message
	Blind Spot Information (BSI) Indicator*	<ul style="list-style-type: none"> • Comes on for a few seconds when you change the power mode to ON, then goes off. • Stays on while BSI is turned off. 	—	
		<ul style="list-style-type: none"> • Comes on when mud, snow, or ice accumulates in the vicinity of sensor. 	<ul style="list-style-type: none"> • Comes on while driving - Remove the obstacle in the vicinity of sensor. ➤ Blind Spot Information (BSI) System* P. 396 	
		<ul style="list-style-type: none"> • Comes on if there is a problem with the system. 	<ul style="list-style-type: none"> • Comes on while driving - Have your vehicle checked by a dealer. 	
	Collision Mitigation Braking System™ (CMBS™) Indicator*	<ul style="list-style-type: none"> • Comes on for a few seconds when you change the power mode to ON, then goes off. • Comes on when you deactivate the CMBS™. A multi-information display message appears for five seconds. • Comes on if there is a problem with the CMBS™. 	<ul style="list-style-type: none"> • Stays on constantly without the CMBS™ off - Have your vehicle checked by a dealer. ➤ Collision Mitigation Braking System™ (CMBS™)* P. 409 	 





Indicator	Name	On/Blinking	Explanation	Message
	Collision Mitigation Braking System™ (CMBS™) Indicator*	<ul style="list-style-type: none"> Comes on when the CMBS™ system shuts itself off. 	<ul style="list-style-type: none"> Stays on - The area around the camera is blocked by dirt, mud, etc. Stop your vehicle in a safe place, and wipe it off with a soft cloth.  Front Sensor Camera* P. 359 	
			<ul style="list-style-type: none"> When the radar sensor gets dirty, stop your vehicle in a safe place, and wipe off dirt using a soft cloth. Have your vehicle checked by a dealer if the message does not disappear even after you clean the sensor cover.  Collision Mitigation Braking System™ (CMBS™)* P. 409 	
			<ul style="list-style-type: none"> Stays on - The temperature inside the camera is too high. Use the climate control system to cool down the camera. The system activates when the temperature inside the camera cools down.  Front Sensor Camera* P. 359 	

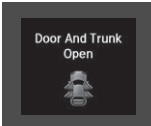
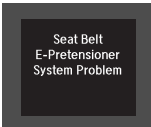

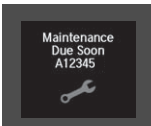
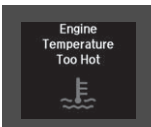
* Not available on all models



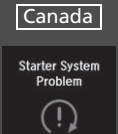

Multi-Information Display Warning and Information Messages

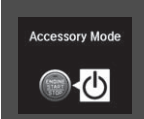
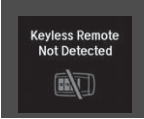
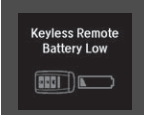

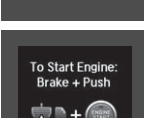

The following messages appear only on the multi-information display. Roll the right selector wheel to see the message again with the system message indicator on.

Message	Condition	Explanation
 <p>Door And Trunk Open</p>	<ul style="list-style-type: none"> • Appears if any door or the trunk is not completely closed. • Appears if any door or the trunk is opened while driving. The beeper sounds. 	<ul style="list-style-type: none"> • Goes off when all doors and the trunk are closed.
 <p>Seat Belt E-Pretensioner System Problem</p>	<ul style="list-style-type: none"> • Appears if there is a problem a problem with the e-pretensioner system*. 	<ul style="list-style-type: none"> • Have your vehicle checked by a dealer.
 <p>Washer Fluid Low</p>	<ul style="list-style-type: none"> • Appears when the washer fluid is low. 	<ul style="list-style-type: none"> • Refill the washer fluid. ► Refilling Window Washer Fluid P. 461
 <p>Maintenance Due Soon A12345</p>	<ul style="list-style-type: none"> • Appears when the scheduled maintenance is due soon. • Consequently, Maintenance Due Now and Maintenance Past Due follow. 	<ul style="list-style-type: none"> ► Maintenance Minder Messages on the Multi-Information Display P. 447
 <p>Engine Temperature Too Hot</p>	<ul style="list-style-type: none"> • Appears when the engine coolant temperature gets abnormally high. 	<ul style="list-style-type: none"> ► Overheating P. 516

Message	Condition	Explanation
 <p>Transmission Temperature Too Hot</p>	<ul style="list-style-type: none"> • Appears when the transmission fluid temperature is too high. 	<ul style="list-style-type: none"> • Stop in a safe place in P. Let the engine idle until the message disappears.
 <p>Charging System Problem</p>	<ul style="list-style-type: none"> • Appears when there is a problem with the sensor on the battery. • Appears along with the battery charging system indicator when the battery is not charging. 	<ul style="list-style-type: none"> • Have your vehicle checked by a dealer. <ul style="list-style-type: none"> ► Checking the Battery P. 480 • Turn off the climate control system and rear defogger to reduce electricity consumption. <ul style="list-style-type: none"> ► If the Charging System Indicator Comes On P. 518
<div style="border: 1px solid black; padding: 2px; width: fit-content; margin-bottom: 5px;">U.S.</div>  <p>Starter System Problem</p> <div style="border: 1px solid black; padding: 2px; width: fit-content; margin-bottom: 5px;">Canada</div>  <p>Starter System Problem</p>	<ul style="list-style-type: none"> • Appears when the starter system has a problem. 	<ul style="list-style-type: none"> • As a temporary measure, press and hold the ENGINE START/STOP button for up to 15 seconds while depressing the brake pedal and manually start the engine. Have your vehicle checked by a dealer.
 <p>To Start, Hold Remote Near Start Button</p>	<ul style="list-style-type: none"> • Appears if the keyless access remote battery is too weak to start the engine or the key is not within operating range to start the engine. A beeper sounds six times. 	<ul style="list-style-type: none"> • Bring the keyless access remote in front of the ENGINE START/STOP button to be touched with. <ul style="list-style-type: none"> ► If the Keyless Access Remote Battery is Weak P. 510

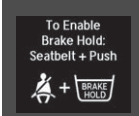
Message	Condition	Explanation
 <p>To Switch Vehicle Off: Push Twice</p>	<ul style="list-style-type: none"> Appears after the driver's door is opened when the power mode is in ACCESSORY. 	<ul style="list-style-type: none"> Press the ENGINE START/STOP button twice with your foot off the brake pedal to change the power mode to VEHICLE OFF (LOCK).
 <p>Accessory Mode</p>	<ul style="list-style-type: none"> Appears when the power mode is in ACCESSORY. 	—
 <p>Keyless Remote Not Detected</p>	<ul style="list-style-type: none"> Appears when you close the door with the power mode in ON without the keyless access remote inside the vehicle. 	<ul style="list-style-type: none"> Disappears when you bring the keyless access remote back inside the vehicle and close the door. <ul style="list-style-type: none"> ➤ Keyless Access Remote Reminder P. 139
 <p>Keyless Remote Battery Low</p>	<ul style="list-style-type: none"> Appears when the keyless access remote battery becomes weak. 	<ul style="list-style-type: none"> Replace the battery as soon as possible. <ul style="list-style-type: none"> ➤ Replacing the Button Battery P. 481
 <p>To Switch Accessory On: Push</p>	<ul style="list-style-type: none"> Appears three seconds after you bring the keyless access remote in front of the ENGINE START/STOP button when To Start, Hold Remote Near Start Button appears. To Start Engine: Brake + Push appears sequentially. 	<ul style="list-style-type: none"> Unless you bring the keyless access remote in front of the ENGINE START/STOP button, this message does not appear. <ul style="list-style-type: none"> ➤ If the Keyless Access Remote Battery is Weak P. 510
 <p>To Start Engine: Brake + Push</p>	<ul style="list-style-type: none"> Appears when you set the power mode to ACCESSORY or ON. 	<ul style="list-style-type: none"> ➤ Starting the Engine P. 344

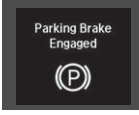
Message	Condition	Explanation
 <p>Shift To Park</p>	<ul style="list-style-type: none"> Appears if you press the ENGINE START/STOP button to turn the engine off without the shift lever in P. 	<ul style="list-style-type: none"> Move the shift lever to P. The power mode changes to VEHICLE OFF.
 <p>Engine Cooling Problem</p>	<ul style="list-style-type: none"> Appears if there is a problem with the radiator system. 	<ul style="list-style-type: none"> Drive slowly to prevent overheating and have your vehicle checked by a dealer as soon as possible.
 <p>Headlight Problem</p>	<ul style="list-style-type: none"> Appears when there is a problem with the headlights. 	<ul style="list-style-type: none"> Appears while driving - The low beam headlights may not be on. When conditions allow you to drive safely, have your vehicle checked by a dealer as soon as possible.
 <p>Brake Hold Disabled Apply Brake Pedal</p>	<ul style="list-style-type: none"> Appears if the automatic brake hold is automatically canceled while it is in operation. 	<ul style="list-style-type: none"> Immediately depress the brake pedal.
 <p>Brake Hold System Off</p>	<ul style="list-style-type: none"> Appears when the automatic brake hold system is turned off. 	<p>➤ Automatic Brake Hold P. 405</p>

Message	Condition	Explanation
	<ul style="list-style-type: none"> • Appears when the automatic brake hold button is pressed without wearing the driver's seat belt. 	<ul style="list-style-type: none"> • Fasten the driver's seat belt. <ul style="list-style-type: none"> ➤ Automatic Brake Hold P. 405
	<ul style="list-style-type: none"> • Appears when the automatic brake hold button is pressed without depressing the brake pedal while the automatic brake hold is in operation. 	<ul style="list-style-type: none"> • Press the automatic brake hold button with the brake pedal depressed. <ul style="list-style-type: none"> ➤ Automatic Brake Hold P. 405
	<ul style="list-style-type: none"> • Appears when the parking brake is applied automatically while it is in operation. 	<ul style="list-style-type: none"> ➤ Automatic Brake Hold P. 405 ➤ Parking Brake P. 402
	<ul style="list-style-type: none"> • Flashes when the system senses a likely collision with a vehicle in front of you. 	<ul style="list-style-type: none"> • Take the appropriate means to prevent a collision (apply the brakes, change lanes, etc.) <ul style="list-style-type: none"> ➤ Collision Mitigation Braking System™ (CMBS™)* P. 409 ➤ Forward Collision Warning (FCW) P. 375 ➤ Adaptive Cruise Control (ACC) with Low Speed Follow (LSF)* P. 361



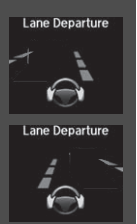

Models with parking sensor system

Message	Condition	Explanation
	<ul style="list-style-type: none"> Appears if there is a problem with the parking sensor system. 	<ul style="list-style-type: none"> Check if the area around the sensor(s) is covered with mud, ice, snow, etc. If the indicator(s) stays on even after you clean the area, have the system checked by a dealer.







Models with lane departure warning system

Message	Condition	Explanation
	<ul style="list-style-type: none"> Appears when your vehicle is too close to the traffic lane lines. The beeper sounds. 	<ul style="list-style-type: none"> Take appropriate action to keep your vehicle within the lane lines. <ul style="list-style-type: none"> ▶ Lane Departure Warning (LDW) P. 378

Models with ACC with LSF



Message	Condition	Explanation
	<ul style="list-style-type: none"> Appears when ACC with LSF has been automatically canceled. 	<ul style="list-style-type: none"> You can resume the set speed after the condition that caused ACC with LSF to cancel improves. Press the RES/+ /SET/- switch up. <ul style="list-style-type: none"> ➤ Adaptive Cruise Control (ACC) with Low Speed Follow (LSF)* P. 361
	<ul style="list-style-type: none"> Appears when the distance between your vehicle and the vehicle ahead of you is too close while ACC with LSF is in operation. 	<ul style="list-style-type: none"> ACC with LSF has been automatically canceled. <ul style="list-style-type: none"> ➤ Adaptive Cruise Control (ACC) with Low Speed Follow (LSF)* P. 361
	<ul style="list-style-type: none"> Appears when pressing the RES/+ /SET/- switch down while the distance between your vehicle and the vehicle ahead of you is too close. 	<ul style="list-style-type: none"> ACC with LSF cannot be set. <ul style="list-style-type: none"> ➤ Adaptive Cruise Control (ACC) with Low Speed Follow (LSF)* P. 361
	<ul style="list-style-type: none"> Appears when the driver's seat belt is unfastened while your vehicle is automatically stopped by ACC with LSF. 	<ul style="list-style-type: none"> ACC with LSF has been automatically canceled. <ul style="list-style-type: none"> ➤ Adaptive Cruise Control (ACC) with Low Speed Follow (LSF)* P. 361
	<ul style="list-style-type: none"> Appears when pressing the RES/+ /SET/- switch down while the driver's seat belt is unfastened. 	<ul style="list-style-type: none"> ACC with LSF cannot be set. <ul style="list-style-type: none"> ➤ Adaptive Cruise Control (ACC) with Low Speed Follow (LSF)* P. 361

Models with ACC with LSF



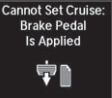
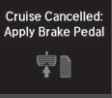

Message	Condition	Explanation
 <p>Cruise Cancelled: Shift To Drive</p>	<ul style="list-style-type: none"> Appears when the shift lever is moved into any position other than D while ACC with LSF is in operation. 	<ul style="list-style-type: none"> ACC with LSF has been automatically canceled. <ul style="list-style-type: none"> ➤ Adaptive Cruise Control (ACC) with Low Speed Follow (LSF)* P. 361
 <p>Cannot Set Cruise: Shift To Drive</p>	<ul style="list-style-type: none"> Appears when pressing the RES/+ / SET/- switch down while the shift lever is in any position other than D. 	<ul style="list-style-type: none"> ACC with LSF cannot be set. <ul style="list-style-type: none"> ➤ Adaptive Cruise Control (ACC) with Low Speed Follow (LSF)* P. 361
 <p>Cruise Cancelled: Slope Too Steep</p>  <p>Cannot Set Cruise: Slope Too Steep</p>	<ul style="list-style-type: none"> Appears when the vehicle is stopped on a very steep slope while ACC with LSF is in operation. 	<ul style="list-style-type: none"> ACC with LSF has been automatically canceled. <ul style="list-style-type: none"> ➤ Adaptive Cruise Control (ACC) with Low Speed Follow (LSF)* P. 361
 <p>Cannot Set Cruise: Slope Too Steep</p>  <p>Cannot Set Cruise: Slope Too Steep</p>	<ul style="list-style-type: none"> Appears when pressing the RES/+ / SET/- switch down while the vehicle is stopped on a very steep slope. 	<ul style="list-style-type: none"> ACC with LSF cannot be set. <ul style="list-style-type: none"> ➤ Adaptive Cruise Control (ACC) with Low Speed Follow (LSF)* P. 361

* Not available on all models

Models with ACC with LSF

Message	Condition	Explanation
	<ul style="list-style-type: none"> Appears when the parking brake is applied automatically while ACC with LSF is in operation. 	<ul style="list-style-type: none"> ACC with LSF has been automatically canceled. <ul style="list-style-type: none"> ➤ Adaptive Cruise Control (ACC) with Low Speed Follow (LSF)* P. 361 ➤ Parking Brake P. 402
	<ul style="list-style-type: none"> Appears when pressing the RES/+ / SET/- switch down while the parking brake is applied. 	<ul style="list-style-type: none"> ACC with LSF cannot be set. <ul style="list-style-type: none"> ➤ Adaptive Cruise Control (ACC) with Low Speed Follow (LSF)* P. 361 ➤ Parking Brake P. 402
	<ul style="list-style-type: none"> Appears when pressing the RES/+ / SET/- switch down while the vehicle is moving and the brake pedal is depressed. 	<ul style="list-style-type: none"> ACC with LSF cannot be set. <ul style="list-style-type: none"> ➤ Adaptive Cruise Control (ACC) with Low Speed Follow (LSF)* P. 361
	<ul style="list-style-type: none"> Appears if ACC with LSF is canceled while your vehicle is automatically stopped by ACC with LSF. 	<ul style="list-style-type: none"> Immediately depress the brake pedal.

Models with LKAS

Message	Condition	Explanation
 	<p>Lane Keeping Assist System (LKAS)</p> <ul style="list-style-type: none"> • Appears when the vehicle is driving out of a detected line. The steering wheel vibrates rapidly. 	<ul style="list-style-type: none"> • Keep the vehicle within the lane you are driving. • The color of either line changes from white to amber as the vehicle gets closer to that side of the lane line. <ul style="list-style-type: none"> ► Lane Keeping Assist System (LKAS)* P. 386
	<p>Road Departure Mitigation (RDM) System</p> <ul style="list-style-type: none"> • Appears when the vehicle is driving out of a detected line. 	<ul style="list-style-type: none"> • Keep the vehicle within the lane you are driving. • The color of either line changes from white to amber as the vehicle gets closer to that side of the lane line. <ul style="list-style-type: none"> ► Road Departure Mitigation (RDM) System* P. 382 • You can change the setting for the road departure mitigation system. Normal, Wide, and Warning Only can be selected. <ul style="list-style-type: none"> ► Customized Features P. 103, 262
	<p>When you selected Warning Only</p> <ul style="list-style-type: none"> - The steering wheel vibrates rapidly when the vehicle is drifting out of a detected line. <p>When you selected Normal or Wide</p> <ul style="list-style-type: none"> - The steering wheel vibrates rapidly when the vehicle is drifting out of a detected line. The system also steers the vehicle to help you remain within your driving lane. 	
	<ul style="list-style-type: none"> • Blinks when you fail to steer the vehicle. The beeper sounds simultaneously. 	<ul style="list-style-type: none"> • Operate the steering wheel to resume the LKAS.
	<ul style="list-style-type: none"> • Appears when the LKAS is in operation, or the LKAS button is pressed, but there is a problem with a system related to the LKAS. The LKAS cancels automatically. The beeper sounds simultaneously. 	<ul style="list-style-type: none"> • If any other system indicators come on, such as the VSA®, ABS and brake system, take appropriate action. <ul style="list-style-type: none"> ► Indicators P. 68

* Not available on all models

Models with two-way keyless access remote

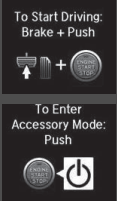
Message	Condition	Explanation
 <p>The image shows two messages on a dark instrument panel background. The top message reads "To Start Driving: Brake + Push" and includes icons for a brake pedal and a power button. The bottom message reads "To Enter Accessory Mode: Push" and includes an icon for a power button.</p>	<ul style="list-style-type: none"> • Appears when you unlock and open the driver's door while the engine is running by two-way keyless access remote. 	<p>➤ Remote Engine Start with Vehicle Feedback* P. 346</p>

Gauges

Gauges include the speedometer, tachometer, fuel gauge, and related indicators. They are displayed when the power mode is in ON.

■ Speedometer

Displays your driving speed in mph or km/h.

■ Tachometer

Shows the number of engine revolutions per minute.

■ Fuel Gauge

Displays the amount of fuel left in the fuel tank.

■ Temperature Gauge

Displays the temperature of the engine coolant.

» Fuel Gauge

NOTICE

You should refuel when the needle approaches **E**. Running out of fuel can cause the engine to misfire, damaging the catalytic converter.

The actual amount of remaining fuel may differ from the fuel gauge reading.

» Temperature Gauge

NOTICE

Driving with the temperature gauge pointer in the upper zone can cause serious engine damage. Pull safely to the side of the road and allow engine temperature to return to normal.

» **Overheating** P. 516

Multi-Information Display

The multi-information display shows the odometer, trip meter, outside temperature indicator, and other gauges. It also displays important messages such as warnings and other helpful information.

Switching the Display

Main displays

Roll the right selector wheel to change the display.

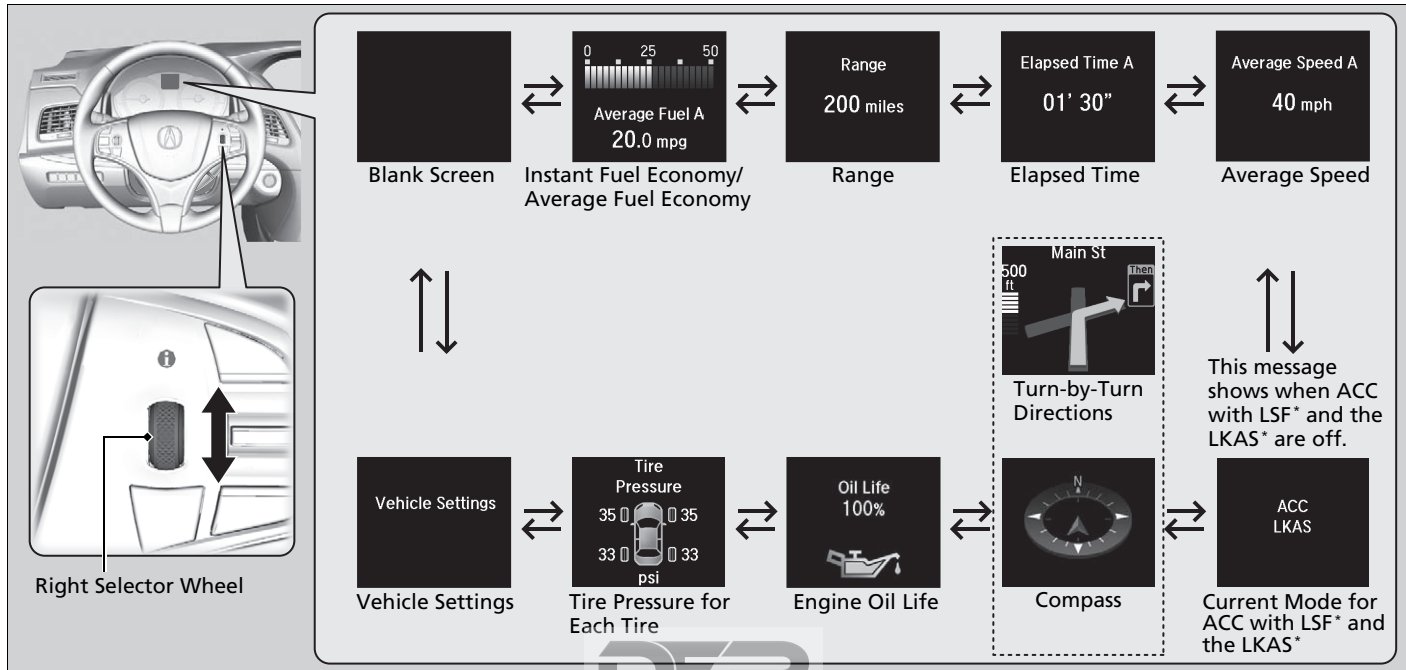

■ Lower displays

Press the **TRIP** button to change the display.

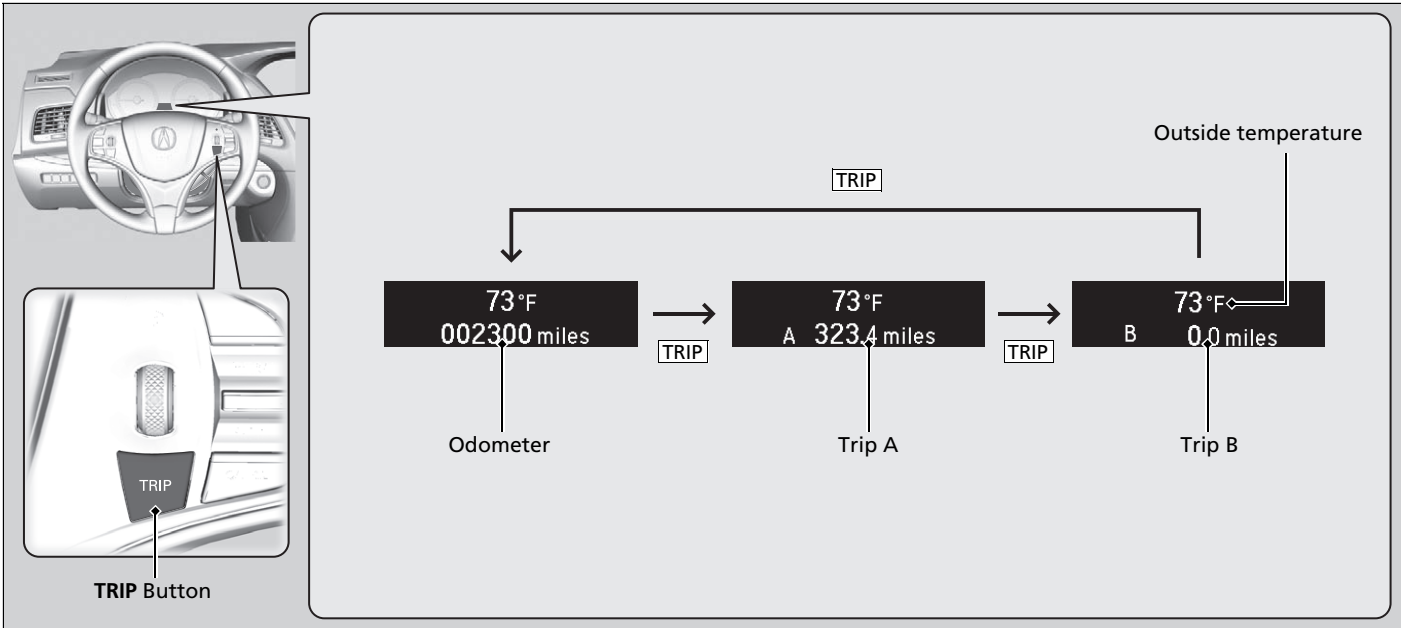

Instrument Panel

■ Odometer

Shows the total number of miles or kilometers that your vehicle has accumulated.

■ Trip Meter

Shows the total number of miles or kilometers driven since the last reset. Meters A and B can be used to measure two separate trips.

■ Resetting a trip meter

To reset a trip meter, display it, then press and hold the **TRIP** button. The trip meter is reset to **0.0**.

■ Outside Temperature

Shows the outside temperature in Fahrenheit (U.S.) or Celsius (Canada).

■ Adjusting the outside temperature display

Adjust the temperature reading up to $\pm 5^{\circ}\text{F}$ (U.S.) or $\pm 3^{\circ}\text{C}$ (Canada) if the temperature reading seems incorrect.

■ Average Fuel Economy

Shows the estimated average fuel economy of each trip meter in mpg (U.S.) or l/100 km (Canada). The display is updated at set intervals. When a trip meter is reset, the average fuel economy is also reset.

▶▶ Trip Meter

Switch between trip meter A and trip meter B by pressing the **TRIP** button.

▶▶ Outside Temperature

The temperature sensor is in the front bumper. Road heat and exhaust from another vehicle can affect the temperature reading when your vehicle speed is less than 19 mph (30 km/h).

It may take several minutes for the display to be updated after the temperature reading has stabilized.

Use the multi-information display's customized features to correct the temperature.

▶▶ **Customized Features** P. 103, 262

▶▶ Average Fuel Economy

You can change when to reset the average fuel economy.

▶▶ **Customized Features** P. 103, 262

■ Instant Fuel Economy

Shows the instant fuel economy as a bar graph in mpg (U.S.) or l/100 km (Canada).

■ Range

Shows the estimated distance you can travel on the remaining fuel. This distance is estimated from the fuel economy of your previous trips.

■ Elapsed Time

Shows the time elapsed since Trip A or Trip B was reset.

■ Average Speed

Shows the average speed in mph (U.S.) or km/h (Canada) since Trip A or Trip B was reset.

■ Current Mode for ACC with LSF

Models with ACC with LSF

Shows the current mode for ACC with LSF.

➤ **To Switch ACC with LSF to Cruise Control** P. 373

■ Turn-by-Turn Directions

Shows you turn-by-turn driving directions to your destination linked with the navigation system.

➤ **Refer to the Navigation System Manual**

⌘ Elapsed Time

You can change when to reset the elapsed time.

➤ **Customized Features** P. 103, 262

⌘ Average Speed

You can change when to reset the average speed.

➤ **Customized Features** P. 103, 262

⌘ Turn-by-Turn Directions

You can select whether the turn-by-turn display comes on during the route guidance.

➤ **Customized Features** P. 103, 262

■ Engine Oil Life

Shows the remaining oil life and Maintenance Minder™.

➤ **Maintenance Minder™** P. 445

■ Tire Pressure Monitor

Shows each tire's pressure.

➤ **Tire Pressure Monitoring System (TPMS)** P. 398

■ Customized Features

Use the multi-information display to customize certain features.

■ How to customize

Select the **Vehicle Settings** screen by rolling the right selector wheel while the power mode is in ON, and the vehicle is at a complete stop.
Push the right selector wheel.

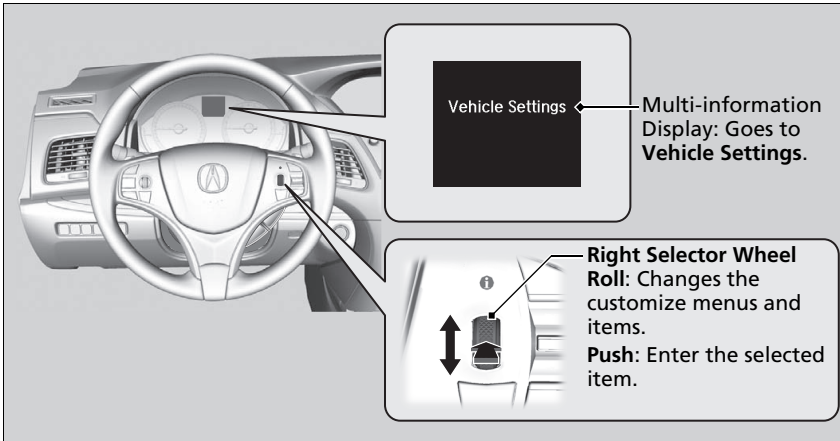

☒ Customized Features

To customize other features, roll the right selector wheel.

☒ **List of customizable options** P. 106

☒ **Example of customization settings** P. 111

Customization is possible when you see the driver's ID (**Driver 1** or **Driver 2**) on the screen. The driver's ID indicates which remote transmitter you have used to unlock the driver's door. The customized settings are recalled every time you unlock the driver's door with that remote.

When you customize settings: Shift to **[P]**.

Customizing is also available from the audio/information screen.

You cannot have **Vehicle Settings** displayed on the multi-information display while the audio/information screen shows the same menu.

☒ **Customized Features** P. 262

■ Customization flow

Roll the right selector wheel to select **Vehicle Settings** and push the right selector wheel.

Instrument Panel

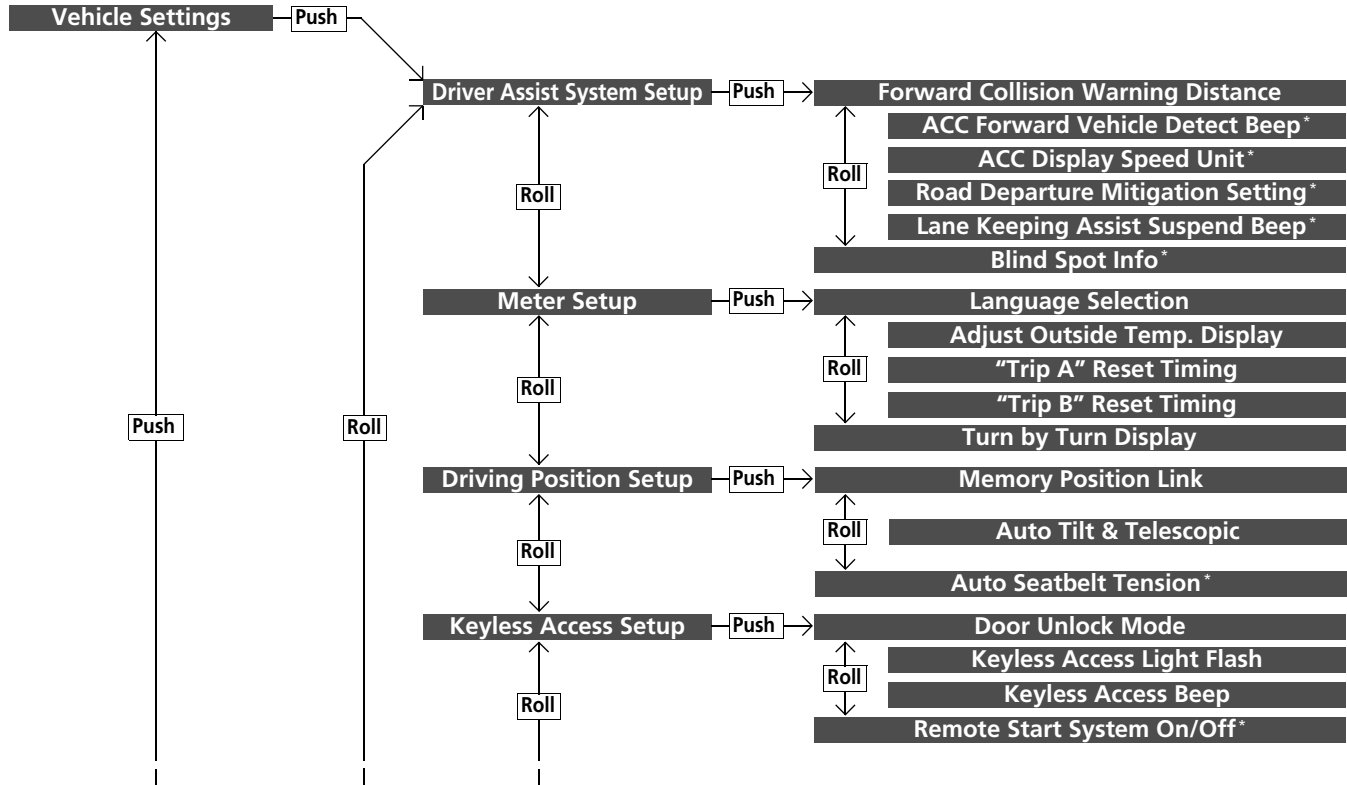

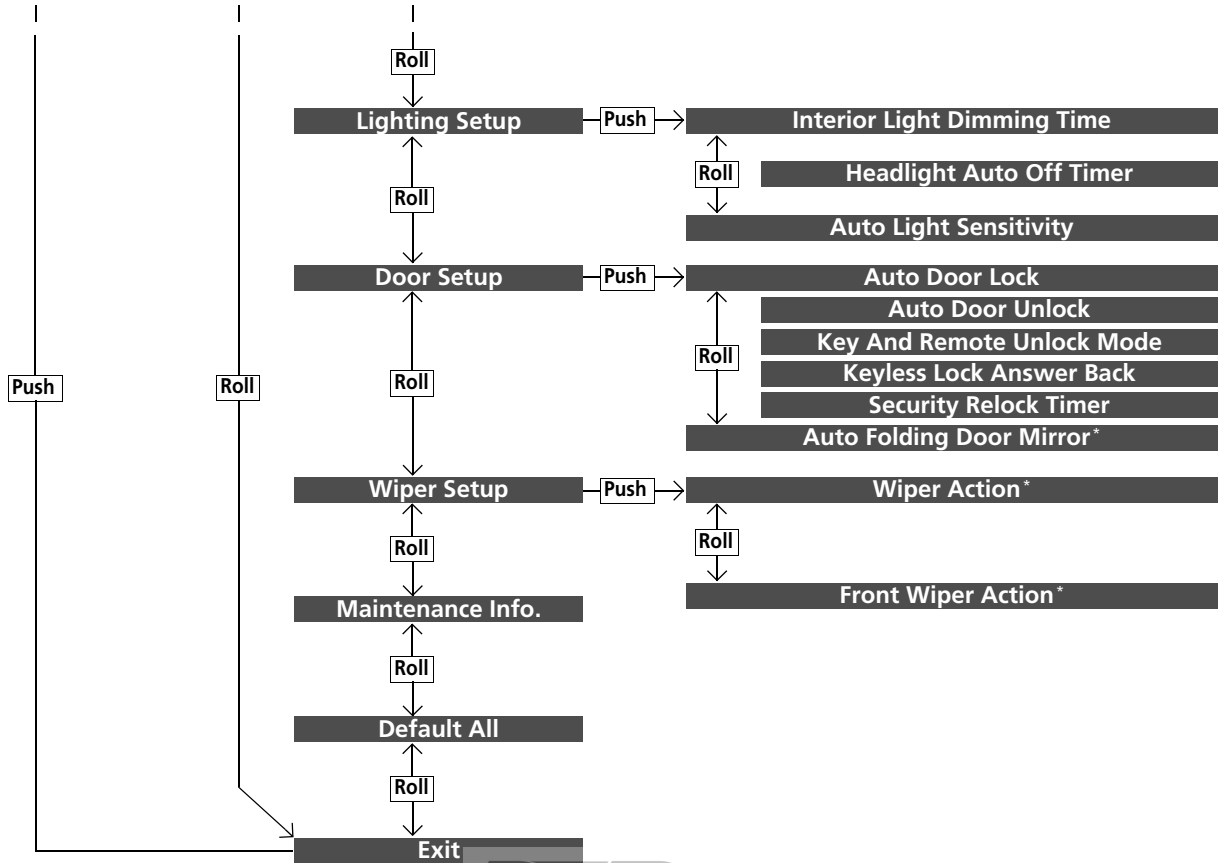

Instrument Panel

* Not available on all models



■ List of customizable options

Setup Group	Customizable Features	Description	Selectable Settings
Driver Assist System Setup	Forward Collision Warning Distance	Changes at which distance FCW* or CMBS™* alerts, or turns FCW* on and off.	Long/Normal*¹/Short/Off
	ACC Forward Vehicle Detect Beep*	Causes the system to beep when the system detects a vehicle, or when the vehicle goes out of the ACC with LSF range.	On/Off*¹
	ACC Display Speed Unit*	Changes the speed unit for ACC with LSF on the multi-information display.	mph*¹/km/h (U.S.) mph/km/h*¹ (Canada)
	Road Departure Mitigation Setting*	Changes the setting for the road departure mitigation system.	Normal*¹/Wide/Warning Only
	Lane Keeping Assist Suspend Beep*	Causes the system to beep when the LKAS is suspended.	On/Off*¹
	Blind Spot Info*	Changes the setting for the blind spot information.	Audible And Visual Alert*¹/Visual Alert/Off

*1:Default Setting

Setup Group	Customizable Features	Description	Selectable Settings
Meter Setup	Language Selection	Changes the displayed language.	English^{*1}/French/Spanish
	Adjust Outside Temp. Display	Adjusts the temperature reading by a few degrees.	-5°F ~ ±0°F^{*1} ~ +5°F (U.S.) -3°C ~ ±0°C^{*1} ~ +3°C (Canada)
	“Trip A” Reset Timing	Changes the setting of how to reset trip meter A, average fuel economy A, average speed A, and elapsed time A.	When Refueled/IGN Off/Manually Reset^{*1}
	“Trip B” Reset Timing	Changes the setting of how to reset trip meter B, average fuel economy B, average speed B, and elapsed time B.	When Refueled/IGN Off/Manually Reset^{*1}
	Turn by Turn Display	Selects whether the turn-by-turn display comes on during the route guidance.	On^{*1}/Off

*1:Default Setting

Setup Group	Customizable Features	Description	Selectable Settings
Driving Position Setup	Memory Position Link	Turns the driving position memory system on and off.	On*¹/Off
	Auto Tilt and Telescopic	Moves the steering wheel fully up when you get in/get out of the vehicle.	On*¹/Off
	Auto Seatbelt Tension*	Turns the auto seatbelt tension setting for the seat belt e-pretensioner on and off.	On*¹/Off
Keyless Access Setup	Door Unlock Mode	Changes which doors unlock when you grab the driver's door handle.	Driver Door Only*¹/All Doors
	Keyless Access Light Flash	Causes some exterior lights to flash when you unlock/lock the doors.	On*¹/Off
	Keyless Access Beep	Causes the beeper to sound when you unlock/lock the doors.	On*¹/Off
	Remote Start System On/Off*	Turns the remote engine start feature on and off.	On*¹/Off
Lighting Setup	Interior Light Dimming Time	Changes the length of time the interior lights stay on after you close the doors.	60sec/30sec*¹/15sec
	Headlight Auto Off Timer	Changes the length of time the exterior lights stay on after you close the driver's door.	60sec/30sec/15sec*¹/0sec
	Auto Light Sensitivity	Changes the timing for the headlights to come on.	Max/High/Mid*¹/Low/Min

*1:Default Setting

Setup Group	Customizable Features	Description	Selectable Settings
Door Setup	Auto Door Lock	Changes the setting for when the doors automatically lock.	With Vehicle Speed^{*1}/Shift from P/Off
	Auto Door Unlock	Changes the setting for when the doors automatically unlock.	All Doors When Driver's Door Opens^{*1}/All Doors When Shifted To Park/All Doors When Ignition Switched Off/Off
	Key And Remote Unlock Mode	Sets up either the driver's door or all doors to unlock on the first operation of the remote or built-in key.	Driver Door^{*1}/ All Doors
	Keyless Lock Answer Back	LOCK/UNLOCK- The exterior lights flash. LOCK (2nd push)- The beeper sounds.	On^{*1}/Off
	Security Relock Timer	Changes the time it takes for the doors to relock and the security system to set after you unlock the vehicle without opening any door.	90sec/60sec/30sec^{*1}
	Auto Folding Door Mirror*	Changes how you can fold the door mirrors.	Auto Fold With Keyless^{*1}/ Manual Only

*1:Default Setting

* Not available on all models



Setup Group	Customizable Features	Description	Selectable Settings
Wiper Setup	Wiper Action *	Changes the setting for the automatic intermittent wipers in the AUTO position.	Rain Sensing*¹/Intermittent/Speed Sensitive
	Front Wiper Action *	Changes the setting for the wipers in the INT position.	Speed Sensitive*¹/Intermittent
Maintenance Info.	Maintenance Reset	Resets/Cancel the engine oil life display when you have performed the maintenance service.	Cancel/Reset
Default All	—	Cancel/Resets all the customized settings as default.	Cancel/Set

*1:Default Setting

■ Example of customization settings

The steps for changing the **“Trip A” Reset Timing** setting to **When Refueled** are shown below. The default setting for **“Trip A” Reset Timing** is **Manually Reset**.

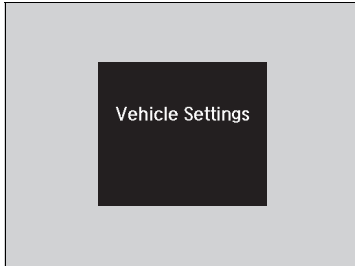

1. Roll the right selector wheel to select **Vehicle Settings**, then push the right selector wheel.
2. Roll the right selector wheel until **Meter Setup** appears on the display.
3. Push the right selector wheel.
 - ▶ **Language Selection** appears first on the display.

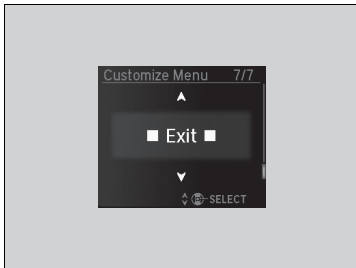

4. Roll the right selector wheel until **"Trip A" Reset Timing** appears on the display, then push the right selector wheel.
 - The display switches to the customization setup screen, where you can select **When Refueled, IGN Off, Manually Reset,** or **Exit.**
5. Roll the right selector wheel and select **When Refueled**, then push the right selector wheel.
 - The **When Refueled Setup** screen appears, then the display returns to the customization menu screen.
6. Roll the right selector wheel until **Exit** appears on the display, then push the right selector wheel.
7. Repeat Step 6 until you return to the normal screen.

Controls

This chapter explains how to operate the various controls necessary for driving.



Clock	114
Locking and Unlocking the Doors	
Key Types and Functions	115
Low Keyless Access Remote Signal Strength	117
Locking/Unlocking the Doors from the Outside	118
Locking/Unlocking the Doors from the Inside	124
Childproof Door Locks	126
Auto Door Locking/Unlocking	127
Opening and Closing the Trunk	128
Security System	131
Immobilizer System	131

Security System Alarm.....	131
Opening and Closing the Windows	134
Opening and Closing the Moonroof	136
Operating the Switches Around the Steering Wheel	
ENGINE START/STOP Button.....	137
Turn Signals	140
Light Switches.....	141
Daytime Running Lights	144
Wipers and Washers	145
Brightness Control	148
Rear Defogger/Heated Door Mirror Button...	149
Driving Position Memory System	150
Adjusting the Steering Wheel.....	152

Adjusting the Mirrors	153
Interior Rearview Mirror	153
Power Door Mirrors	154
Adjusting the Seats	156
Front Seats	156
Interior Lights/Interior Convenience Items	163
Interior Lights	163
Interior Convenience Items	165
Climate Control System	181
Using Automatic Climate Control	181
Automatic Climate Control Sensors.....	190

Adjusting the Clock

The clock is automatically updated through the navigation system, so the time does not need to be adjusted.







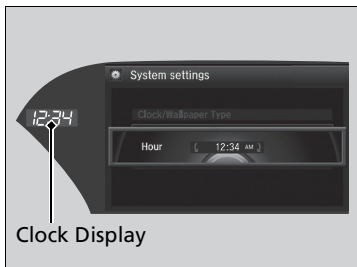



You can also adjust the time manually in the audio/information screen, with the power mode in ON.

Adjusting the Time

Using the Settings menu on the audio/information screen



Clock Display

1. Press the **SETTINGS** button.
2. Rotate  to select **System Settings**, then press .
3. Move  or  to select the **Clock** tab.
4. Rotate  to select **Clock Adjustment**, then press .
5. Rotate  to change hour, then press .
6. Rotate  to change minute, then press .

Adjusting the Clock

These indications are used to show how to operate the interface dial.

Rotate  to select.

Press  to enter.

You can customize the clock display to show the 12 hour clock or 24 hour clock.

 **Customized Features** P. 262

Key Types and Functions

This vehicle comes with the following keys:

Keys

Keyless access remote

Models without two-way keyless access remote



Models with two-way keyless access remote



Use the keyless access remote to start and stop the engine, to lock and unlock the doors and to open the trunk. You can also use the keyless access system to lock and unlock the doors and trunk.

* Not available on all models

Key Types and Functions

All the keys have an immobilizer system. The immobilizer system helps to protect against vehicle theft.

Immobilizer System P. 131

The keys contain precision electronics. Adhere to the following advice to prevent damage to the electronics:

- Do not leave the keys in direct sunlight, or in locations with high temperature or high humidity.
- Do not drop the keys or set heavy objects on them.
- Keep the keys away from liquids.
- Do not take the keys apart except for replacing the battery.

If the circuits in the keys are damaged, the engine may not start, and the keyless access system may not work.

If the keys do not work properly, have them inspected by a dealer.

Models with two-way keyless access remote

You can remotely start the engine using the two-way keyless access remote.

Remote Engine Start with Vehicle Feedback* P. 346

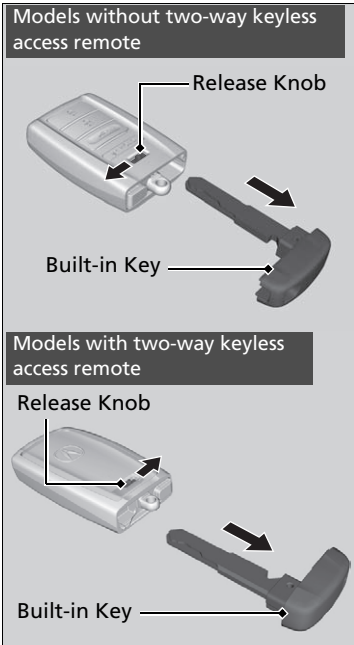

The built-in key can be used to lock/unlock the doors when the keyless access remote battery becomes weak and the power door lock/unlock operation is disabled.

To remove the built-in key, pull it out while sliding the release knob. To reinstall the built-in key, push the built-in key into the keyless access remote until it clicks.

■ Key Number Tag

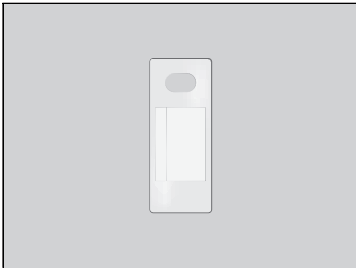

Contains a number that you will need if you purchase a replacement key.

Low Keyless Access Remote Signal Strength

The vehicle transmits radio waves to locate the keyless access remote when locking/unlocking the doors, opening the trunk, or to start the engine.

In the following cases, locking/unlocking the doors, opening the trunk, or starting the engine may be inhibited or operation may be unstable:

- Strong radio waves are being transmitted by nearby equipment.
- You are carrying the keyless access remote together with telecommunications equipment, laptop computers, cell phones, or wireless devices.
- A metallic object is touching or covering the keyless access remote.

☒ Key Number Tag

Keep the key number tag separate from the key in a safe place outside of your vehicle. If you wish to purchase an additional key, contact a dealer.

If you lose your key and you cannot start the engine, contact a dealer.

☒ Low Keyless Access Remote Signal Strength

Communication between the keyless access remote and the vehicle consumes the keyless access remote's battery.

The keyless access remote battery lasts about two years. This changes by how often you use the remote. The battery is consumed whenever the keyless access remote is receiving strong radio waves. Avoid placing it near electrical appliances such as televisions and personal computers.

Locking/Unlocking the Doors from the Outside

■ Using the Keyless Access System

Models with door lock buttons on all doors

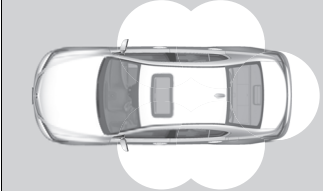

Models with door lock buttons on the front doors

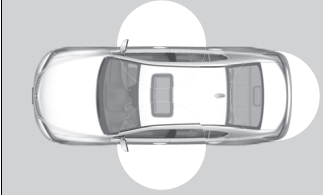

When you carry the keyless access remote, you can lock/unlock the doors and open the trunk.

You can lock/unlock the doors within a radius of about 32 inches (80 cm) of the outside door handle. You can open the trunk within about 32 inches (80 cm) radius from the trunk release button.

► Locking/Unlocking the Doors from the Outside

You can lock or unlock doors using the remote transmitter or keyless access system only when the power mode is in VEHICLE OFF.

► Using the Keyless Access System

- Do not leave the keyless access remote in the vehicle when you get out. Carry it with you.
- Even if you are not carrying the keyless access remote, you can lock/unlock the doors while someone else with the remote is within range.
- The door may be unlocked if the door handle is covered with water in heavy rain or in a car wash if the keyless access remote is within range.
- If you grip a front or rear* door handle wearing gloves, the door sensor may be slow to respond or may not respond by unlocking the doors.
- The door may not open if you pull it immediately after gripping the door handle. Grip the handle again and confirm that the door is unlocked before pulling the handle.
- Even within the 32 inches (80 cm) radius, you may not be able to lock/unlock the doors with the keyless access remote if it is above or below the outside handle.
- The keyless access remote may not operate if it is too close to the door and door glass.

■ Locking the vehicle

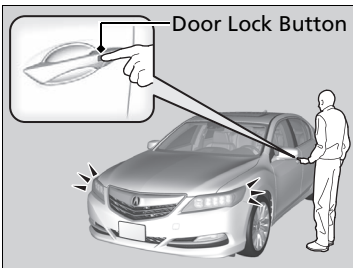

Press the door lock button on the front or rear* door.

- Some exterior lights flash; the beeper sounds; all the doors lock; and the security system sets.

■ Unlocking the vehicle

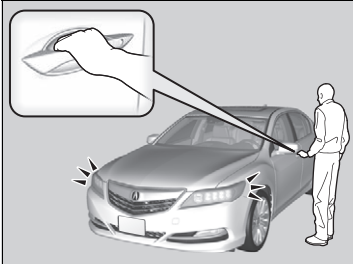

Grab the driver's door handle:

- ▶ The driver's door unlocks.
- ▶ Some exterior lights flash twice and the beeper sounds twice.

Grab the front passenger's or rear* door handle:

- ▶ All the doors unlock.
- ▶ Some exterior lights flash twice and the beeper sounds twice.

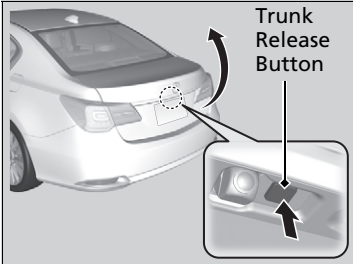

Press the trunk release button:

- ▶ The trunk unlocks and opens.
- ▶ The beeper sounds.

➤ **Using the Trunk Release Button** P. 128

➤ Using the Keyless Access System

If the distance at which the remote transmitter works varies, the battery is probably low.
If the LED does not come on when you press a button, the battery is dead.

➤ **Replacing the Button Battery** P. 481

You can customize the door lock mode and keyless lock acknowledgement setting.

➤ **Customized Features** P. 103, 262

If you do not open a door within 30 seconds of unlocking the vehicle, the doors will automatically relock.

When you go into the front side of the keyless access system working range with all the doors locked, the front and rear* door outer handle ambient lights come on for 30 seconds.

The lights do not come on if you have previously stayed within the range for more than five minutes, or the doors have been locked for a few days. The feature activates again after you drive the vehicle, then lock the doors.

The light flash, beep and unlock settings can be customized using the audio/information screen or multi-information display.

➤ **Customized Features** P. 103, 262

* Not available on all models

■ Using the Remote Transmitter

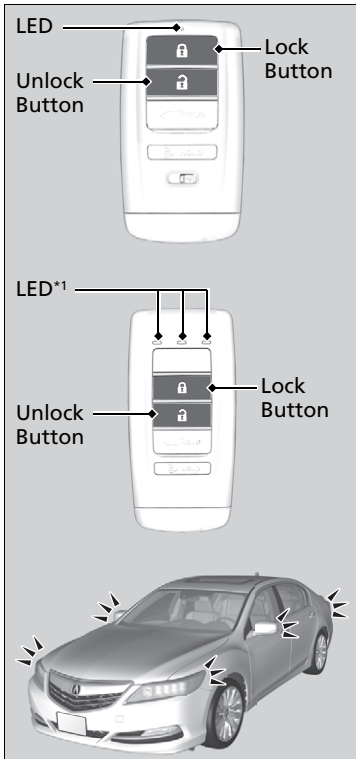

■ Locking the doors

Press the lock button.

Once:

- ▶ Some exterior lights flash, all the doors lock, and the security system sets.

Twice (within five seconds after the first push):

- ▶ The beeper sounds and verifies the security system is set.

☒ Using the Remote Transmitter

If you do not open a door within 30 seconds of unlocking the vehicle with the remote transmitter, the doors will automatically relock.

You can change the relock timer setting.

☒ **Customized Features** P. 103, 262

If the interior light switch is in the door activated position, the interior lights come on when you press the unlock button.

No doors opened: The lights fade out after 30 seconds.

Doors relocked with the remote: The lights go off immediately.

☒ **Interior Lights** P. 163

The remote transmitter uses low-power signals, so the operating range may vary depending on the surroundings.

The remote will not lock the vehicle when a door is open.

1: Checking Door Lock Status P. 123

■ Unlocking the doors

Press the unlock button.

Once:

- ▶ Some exterior lights flash twice, and the driver's door unlocks.

Twice:

- ▶ The remaining doors unlock.

✎ Using the Remote Transmitter

If the distance at which the remote transmitter works varies, the battery is probably low.

If the LED does not come on when you press a button, the battery is dead.

- ▶ **Replacing the Button Battery** P. 481

You can customize the door unlock mode setting.

- ▶ **Customized Features** P. 103, 262

■ Locking/Unlocking the Doors Using a Key

If the keyless remote battery or the vehicle battery is dead, use the key instead of the keyless remote.

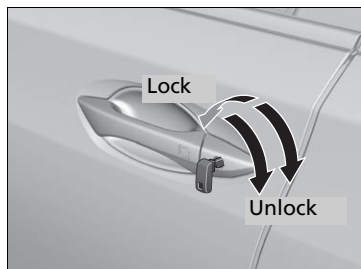

Fully insert the key and turn it.

■ Locking a Door Without Using a Key

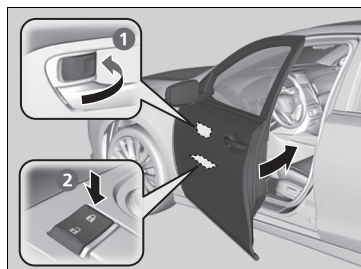

■ Locking the front doors

Push the lock tab forward ① or push the master door lock switch in the lock direction ②, and close the door.

■ Locking the rear doors

Push the lock tab forward and close the door.

■ Lockout prevention system

The doors cannot be locked when the keyless access remote is inside the vehicle, and any door is open.

⌘ Locking/Unlocking the Doors Using a Key

When you lock the driver's door with a key, all the other doors lock at the same time. When unlocking, the driver's door unlocks first. Turn the key a second time within a few seconds to unlock the remaining doors.

If you unlock the doors with the key, the alarm goes off when you open the hood or move the shift lever out of [P] before the power mode is set to ON.

You can customize the door unlock mode setting.

➤ **Customized Features** P. 103, 262

⌘ Locking a Door Without Using a Key

When you lock the driver's door, all the other doors lock at the same time.

Make sure you have the key in your hand before locking the door to prevent it from being locked in the vehicle.

■ Checking Door Lock Status*

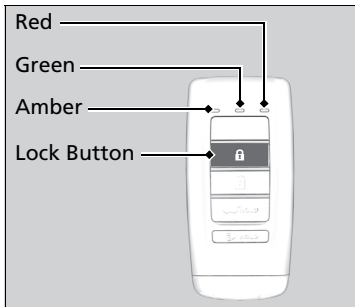

You can remotely check if your vehicle's doors are all locked or any are unlocked using the keyless access remote from extended distances.

Press the lock button, the Amber (LEFT) LED blinks once. Then after three seconds one of the following feedback will come:

- Green (center) comes on: Acknowledges that the doors are locked.
- Red (right) comes on: Acknowledges that doors are not locked, or any door is not completely closed.
- Red (right) blinks three times: The remote does not receive the door lock status from the vehicle.

▣ Checking Door Lock Status*

Operate the remote in an open space. If there are buildings or other obstacles between your vehicle and the remote, the remote may not work even within the operable range. However, the range of unlock, all doors, and panic functions are the same as the standard keyless access remote.

➤ **Using the Remote Transmitter** P. 120

When checking the door lock status, you can also start or stop the engine.

➤ **Remote Engine Start with Vehicle Feedback*** P. 346

* Not available on all models

Locking/Unlocking the Doors from the Inside

■ Using the Lock Tab

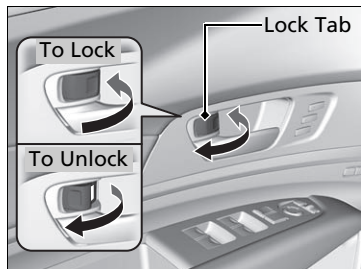

■ **Locking a door**
Push the lock tab forward.

■ **Unlocking a door**
Pull the lock tab rearward.

☒ Using the Lock Tab

When you lock the door using the lock tab on the driver's door, all the other doors lock at the same time.

When you unlock the door using the lock tab on the driver's door, only the driver's door will unlock.

■ Unlocking Using the Front Door Inner Handle

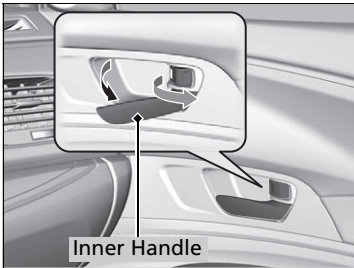

Pull the front door inner handle.

- ▶ The door unlocks and opens in one motion.

Unlocking and opening the driver's door from the inner handle unlocks all the other doors.

To avoid all the doors to be unlocked, use the lock tab on the driver's door to unlock, then lock again before opening the door.

- ▶ This setting works for one time only. If you do not want all the doors to be unlocked all the time, customize the **Auto Door Unlock** setting to **Off** using the multi-information display or audio/information screen.

☒ Unlocking Using the Front Door Inner Handle

The inner front door handles are designed to allow front seat occupants to open the door in one motion. However this feature requires that front seat occupants never pull a front door inner handle while the vehicle is in motion.

Children should always ride in a rear seat where childproof door locks are provided.

☒ **Childproof Door Locks** P. 126

■ Using the Master Door Lock Switch

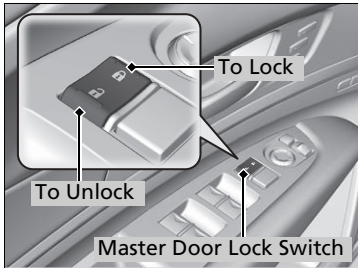

Press the master door lock switch in as shown to lock or unlock all doors.

Childproof Door Locks

The childproof door locks prevent the rear doors from being opened from the inside regardless of the position of the lock tab.

■ Setting the Childproof Door Locks

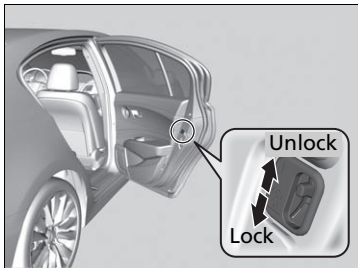

Slide the lever in the rear door to the lock position, and close the door.

■ When opening the door

Open the door using the outside door handle.

☒ Using the Master Door Lock Switch

When you lock/unlock either front door using the master door lock switch, all the other doors lock/unlock at the same time.

☒ Childproof Door Locks

To open the door from the inside when the childproof door lock is on, put the lock tab in the unlock position, lower the rear window, put your hand out of the window, and pull the outside door handle.

Auto Door Locking/Unlocking

Your vehicle locks all doors and unlocks the driver's door automatically when a certain condition is met.

■ Auto Door Locking

■ Drive lock mode

All doors lock when the vehicle's speed reaches about 10 mph (15 km/h).

■ Auto Door Unlocking

■ Driver's door open mode

All doors unlock when the driver's door is opened.

☒ Auto Door Locking/Unlocking

You can turn off or change to another auto door locking/unlocking setting using the audio/information screen or multi-information display.

☒ **Customized Features** P. 103, 262

Precautions for Opening/Closing the Trunk

■ Opening the trunk

Open the trunk all the way.

- ▶ If it is not fully opened, the trunk lid may begin to close under its own weight.

■ Closing the trunk

Keep the trunk lid closed while driving to:

- ▶ Avoid possible damage.
- ▶ Prevent exhaust gas from leaking into the vehicle.

➤ **Exhaust Gas Hazard** P. 64

Using the Trunk Release Button

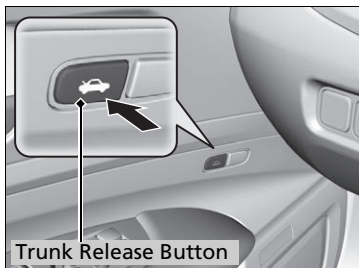

Pressing the trunk release button on the driver's door.

➤ **When You Cannot Open the Trunk** P. 529

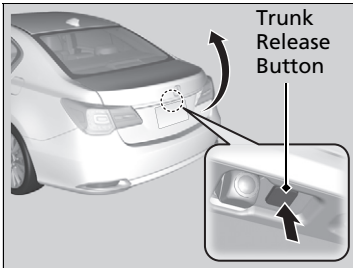

Push up the release button on the trunk lid after the doors are unlocked.

❏ **When You Cannot Open the Trunk** P. 529

Even if the trunk is locked, you can open the trunk if you carry the keyless access remote.

▶ The beeper sounds.

Using the Remote Transmitter

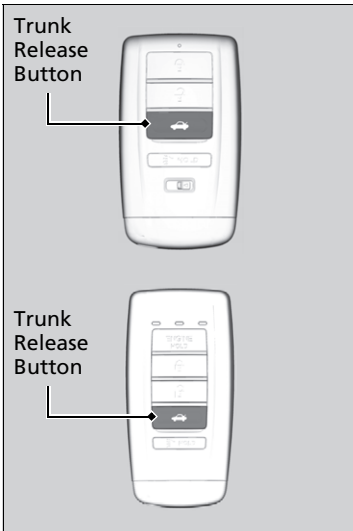

Press the trunk release button for approximately one second to unlock and open the trunk.

⌘ Using the Trunk Release Button

- Do not leave the keyless access remote in the vehicle when you get out. Carry it with you.
- Even if you are not carrying the keyless access remote, you can unlock the trunk while someone else with the remote is within range.
- Do not leave the keyless access remote inside the trunk and close the lid. The beeper sounds and the trunk cannot be closed.

Emergency Trunk Opener

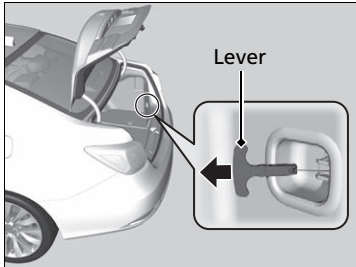

The trunk release lever allows you to open the trunk from inside for your safety.

Pull the release lever in the direction of the arrow.

Emergency Trunk Opener

Parents should decide if their children should be shown how to use this feature.

Immobilizer System

The immobilizer system prevents a key that has not been pre-registered from starting the engine. Each key contains electronic transmitters that use electronic signals to verify the key.

Pay attention to the following when pressing the **ENGINE START/STOP** button:

- Do not allow objects that emit strong radio waves near the **ENGINE START/STOP** button.
- Make sure the key is not covered by or touching a metal object.
- Do not bring a key from another vehicle's immobilizer system with the keyless access remote.

Security System Alarm

The security system alarm activates when the trunk, hood or doors are forcibly opened. The alarm does not go off if the trunk or doors are opened with the key, remote transmitter or keyless access system.

However, the alarm goes off when a door is opened with the key, then the shift lever is moved out of **[P]** or the hood is opened before the power mode is set to ON.

■ When the security system alarm activates

The horn sounds intermittently and all of the exterior lights flash.

■ To deactivate the security system alarm

Unlock the vehicle using the remote transmitter or keyless access system. The system, along with the horn and flashing lights, is deactivated.

☒ Immobilizer System

NOTICE

Leaving the keyless access remote in the vehicle can result in theft or accidental movement of the vehicle. Always take the key with you whenever you leave the vehicle unattended.

Do not alter the system or add other devices to it. Doing so may damage the system and make your vehicle inoperable.

☒ Security System Alarm

The security alarm continues for a maximum of two minutes until the security system deactivates.

■ Setting the security system alarm

The security system alarm automatically sets when the following conditions have been met:

- The power mode is set to VEHICLE OFF (LOCK).
- The hood and trunk are closed.
- All doors are locked from outside with the key, remote transmitter or keyless access system.

■ When the security system alarm sets

The security system indicator in the instrument panel blinks. When the blinking interval changes after about 15 seconds, the security system is set.

■ To cancel the security system alarm

The security system is canceled when the vehicle is unlocked using the remote transmitter, or you grab either front door* or any door* handle while carrying the keyless access remote, or the power mode is set to ON. The security system indicator goes off at the same time.

ⓘ Security System Alarm

Do not set the security system alarm when someone is in the vehicle or a window is open. The system can accidentally activate when:

- Unlocking the door with the lock tab.
- Opening the trunk with the trunk release button on the driver's door or the emergency trunk opener.
- Moving the shift lever out of **[P]**.
- Opening the hood with the hood release.

If the battery goes dead after you have set the security system alarm, the security alarm may go off once the battery is recharged or replaced.

If this occurs, deactivate the security system alarm by unlocking a door using the remote transmitter or keyless access system.

Do not attempt to alter this system or add another device to it.

■ Panic Mode

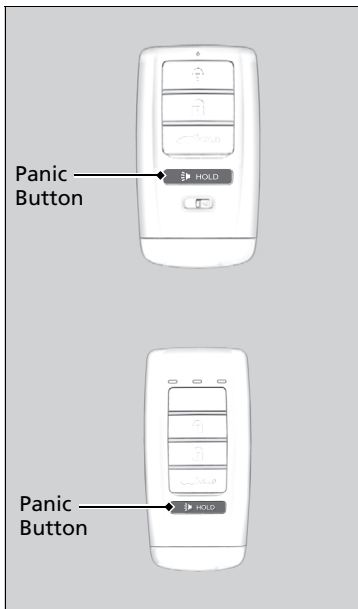

■ The panic button on the remote transmitter

If you press the panic button for approximately one second, the following will occur for about 30 seconds:

- The horn sounds.
- Some exterior lights flash.

■ Canceling panic mode

Press any button on the remote transmitter, or set the power mode to ON.

Opening/Closing the Power Windows

The power windows can be opened and closed when the power mode is in ON, using the switches on the doors. The driver's side switches can be used to open and close all of the windows.

The power window lock button on the driver's side must be switched off (not pushed in, indicator off) to open and close the windows from anywhere other than the driver's seat.

When the power window lock button is pushed in, you can only operate the driver's window. Turn the power window lock button on when children are in the vehicle.

Opening/Closing the Windows with Auto-Open/Close Function

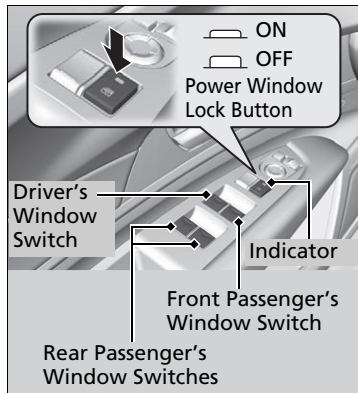

Automatic operation

To open: Push the switch down firmly.

To close: Pull the switch up firmly.

The window opens or closes completely. To stop the window at any time, push or pull the switch briefly.

Manual operation

To open: Push the switch down lightly, and hold it until the desired position is reached.

To close: Pull the switch up lightly, and hold it until the desired position is reached.

Opening/Closing the Power Windows

WARNING

Closing a power window on someone's hands or fingers can cause serious injury.

Make sure your passengers are away from the windows before closing them.

The power windows can be operated for up to 10 minutes after you set the power mode to VEHICLE OFF (LOCK).

Opening either front door cancels this function.

Auto Reverse

If a power window senses resistance when closing automatically, it stops closing and reverse direction.

The driver's window auto reverse function is disabled when you continuously pull up the switch.

The auto reverse function stops sensing when the window is almost closed to ensure that it fully closes.

■ Opening the Windows and Moonroof with the Remote

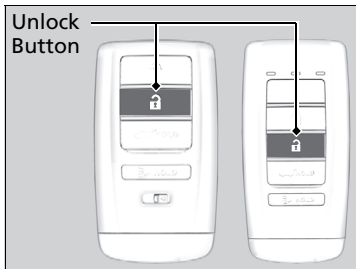

To open: Press the unlock button twice within 10 seconds and hold it down the second time. If the windows stop midway, repeat the procedure.

■ Opening/Closing the Windows/Moonroof with the Key

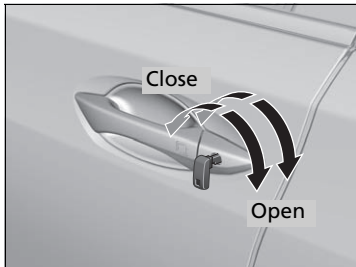

To open: Unlock the driver's door with the key. Within 10 seconds of returning the key to the central position, turn the key in the unlock direction and hold it there.

To close: Lock the driver's door with the key. Within 10 seconds of returning the key to the central position, turn the key in the lock direction and hold it there.

Release the key to stop the windows/moonroof at the desired position. If you want further adjustment, repeat the same operation.

■ Opening/Closing the Moonroof

You can only operate the moonroof when the power mode is in ON. Use the switch in the front of the ceiling to open and close the moonroof.

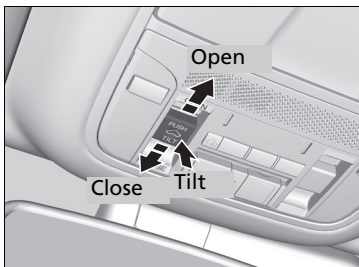

■ Automatic operation

To open: Pull the switch back firmly.

To close: Push the switch forward firmly.

The moonroof will automatically open or close all the way. To stop the moonroof midway, touch the switch briefly.

■ Manual operation

To open: Pull the switch back lightly, and hold it until the desired position is reached.

To close: Push the switch forward lightly, and hold it until the desired position is reached.

■ Tilting the moonroof up

To tilt: Push on the center of the moonroof switch.

To close: Push the switch forward firmly, then release.

» Opening/Closing the Moonroof

⚠ WARNING

Opening or closing the moonroof on someone's hands or fingers can cause serious injury.

Make sure all hands and fingers are clear of the moonroof before opening or closing it.

NOTICE

Opening the moonroof in below freezing temperature or when it is covered with snow or ice can damage the moonroof panel or motor.

The power moonroof can be operated for up to 10 minutes after you set the power mode to VEHICLE OFF (LOCK).

Opening either front door cancels this function.

When resistance is detected, the auto reverse function causes the moonroof to change directions, then stop. Auto reverse stops sensing when the moonroof is almost closed to ensure that it fully closes. Make sure that all objects, including fingers, are clear of the moonroof.

ENGINE START/STOP Button

Changing the Power Mode

Indicator

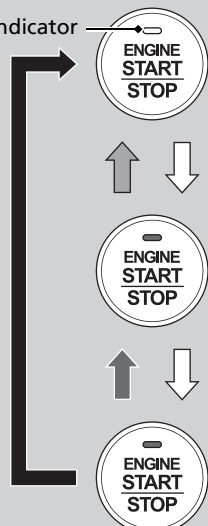

VEHICLE OFF (LOCK)
Indicator in the button is off. The power to all electrical components is turned off.

ACCESSORY
Indicator in the button is on. Indicator in the button blinks (from ON to ACCESSORY). Operate the audio system and other accessories in this position.

ON
Indicator in the button is on. All electrical components can be used.

Without depressing the brake pedal

- ➡ Press the button.
- ➡ Press the button without the shift lever in **P**.
- ➡ Shift to **P** then press the button.
- ➡ Shift to **P**.

ENGINE START/STOP Button

ENGINE START/STOP Button Operating Range

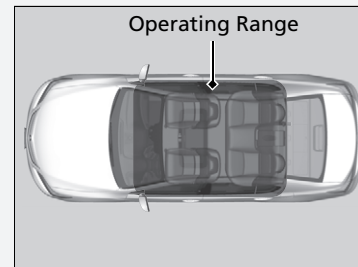

You can start the engine when the keyless access remote is inside the vehicle.

The engine may also run if the keyless access remote is close to the door or window, even if it is outside the vehicle.

ON mode:

Indicator in the button is off, if the engine is running.

If the keyless access remote battery is weak, beeper sounds and the **To Start, Hold Remote Near Start Button** message appears on the multi-information display.

➡ **If the Keyless Access Remote Battery is Weak** P. 510

■ Automatic Power Off

If you leave the vehicle for 30 to 60 minutes with the shift lever in **P** and the power mode in ACCESSORY, the vehicle automatically goes into the mode similar to VEHICLE OFF (LOCK) to avoid the battery drain.

When in this mode, you cannot lock or unlock doors with the remote transmitter or the keyless access system.

Press the **ENGINE START/STOP** button to switch the mode to VEHICLE OFF (LOCK).

■ Power Mode Reminder

If you open the driver's door when the power mode is set to ACCESSORY, a warning buzzer sounds.

■ Keyless Access Remote Reminder

Keyless Remote
Not Detected



Warning buzzers may sound from inside or/ and outside the vehicle to remind you that the keyless access remote is out of the vehicle. If the buzzer continues even after the remote is put back inside, place it to be within its operational range.

■ When the power mode is in ON

If the keyless access remote is taken out of the vehicle, and the driver's door is closed, warning buzzers sound from both inside and outside the vehicle. A warning message on the multi-information display notifies the driver inside that the remote is out.

■ When the power mode is in ACCESSORY

If the keyless access remote is taken out of the vehicle, and the driver's door is closed, a warning buzzer sounds from outside the vehicle.

⊠ Keyless Access Remote Reminder

When the keyless access remote is within the system's operational range, and the driver's door is closed, the warning function cancels.

If the keyless access remote is taken out of the vehicle after the engine has been started, you can no longer change the **ENGINE START/STOP** button mode or restart the engine. Always make sure if the remote is in your vehicle when you operate the **ENGINE START/STOP** button.

Removing the keyless access remote from the vehicle through a window does not activate the warning buzzer.

Do not put the keyless access remote on the dashboard or in the glove box. It may cause the warning buzzer to go off. Under some other conditions that can prevent the vehicle from locating the remote, the warning buzzer may also go off even if the remote is within the system's operational range.

Turn Signals

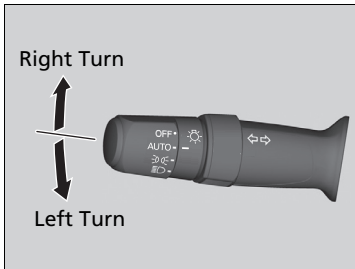

The turn signals can be used when the power mode is in ON.

■ One-touch turn signal

When you lightly push up or down and release the turn signal lever, the exterior turn signals and turn signal indicator blink three times.

This feature can be used when signaling for a lane change.

Light Switches

Manual Operation

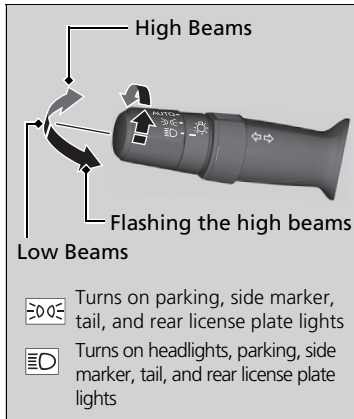

Rotating the light switch turns the lights on and off, regardless of the power mode setting.

High beams

Push the lever forward until you hear a click.

Low beams

When in high beams, pull the lever back to return to low beams.

Flashing the high beams

Pull the lever back, and release it.

Lights off

Turn the lever to OFF either when:

- The shift lever is in **[P]**.
- The parking brake is applied.

To turn the lights on again, turn the lever to OFF to cancel the lights off mode. Even if you do not cancel the lights off mode, the lights come on automatically when:

- The shift lever is moved out of **[P]**.
- The parking brake is released.
- The vehicle starts to move.

Light Switches

If you leave the power mode in VEHICLE OFF (LOCK) with the lights on, a light on reminder chime will sound when you open the driver's door.

When the lights are on, the lights on indicator in the instrument panel will be on.

➤ **Lights On Indicator** P. 77

If you sense that the level of the headlights is abnormal, have the vehicle inspected by a dealer.

Do not leave the lights on when the engine is off because it will cause the battery to discharge.

Your vehicle is equipped with the automatic headlight adjusting system that automatically adjusts the vertical angle of the headlights. If you find a significant change in the vertical angle of the headlights, there may be a problem with the system. Have your vehicle checked by a dealer.

■ Automatic Lighting Control



Automatic lighting control can be used when the power mode is in ON.

When the light switch is in **AUTO**, the headlights and other exterior lights will switch on and off automatically depending on the ambient brightness.

You can change the auto light sensitivity setting.

▶ **Customized Features** P. 103, 262

▶ Automatic Lighting Control

We recommend that you turn on the lights manually when driving at night, in a dense fog, or in dark areas such as long tunnels or parking facilities.

The light sensor is in the location shown below. Do not cover this light sensor with anything; otherwise, the automatic lighting system may not work properly.

Models with automatic intermittent wipers

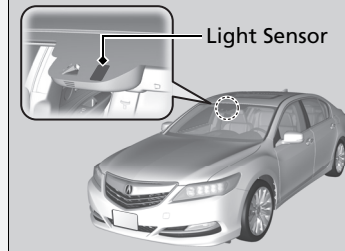

Models without automatic intermittent wipers

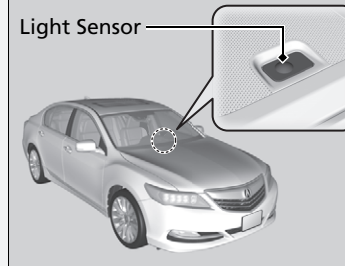

■ Headlight Integration with Wipers*

The headlights automatically come on when the wipers are used several times within a certain intervals with the headlight switch in **AUTO**.

The headlights automatically go off a few minutes later if the wipers are stopped.

■ Automatic Lighting Off Feature

The headlights, all other exterior lights, and the instrument panel lights turn off 15 seconds after you set the power mode to VEHICLE OFF (LOCK), take the remote with you, and close the driver's door.

If you set the power mode to VEHICLE OFF (LOCK) with the headlight switch on, but do not open the door, the lights turn off after 10 minutes (three minutes, if the switch is in the **AUTO** position).

The lights turn on again when you unlock or open the driver's door. If you unlock the door, but do not open it within 15 seconds, the lights go off. If you open the driver's door, you will hear a lights on reminder chime.

⌘ Automatic Lighting Control

Adjust the auto light sensitivity as follows:

Setting	The exterior lights come on when the ambient light is at
MAX	 Bright
HIGH	
MID	
LOW	
MIN	

➤ **Customized Features** P. 103, 262

⌘ Headlight Integration with Wipers*

This feature activates during the headlights are off in **AUTO**.

The instrument panel brightness does not change when the headlights come on.

At dark ambient light levels, the automatic lighting control feature turns on the headlights, regardless of the number of wiper sweeps.

⌘ Automatic Lighting Off Feature

You can change the headlight auto off timer setting.

➤ **Customized Features** P. 103, 262

* Not available on all models

Daytime Running Lights

The low beam headlights come on slightly dimmer than normal when the following conditions have been met:

- The power mode is in ON.
- The headlight switch is **AUTO**, or in .
- The parking brake is released.

The low beam headlights return to the original brightness once the headlight switch is turned on, or when the head light switch is in **AUTO** and it is getting darker outside.

▶▶ Daytime Running Lights

U.S. models

The daytime running lights come on dimmer when the headlight switch is in  than when it is in **AUTO**. In **AUTO**, if the ambient brightness is dark, the low beam headlights come on.

Wipers and Washers

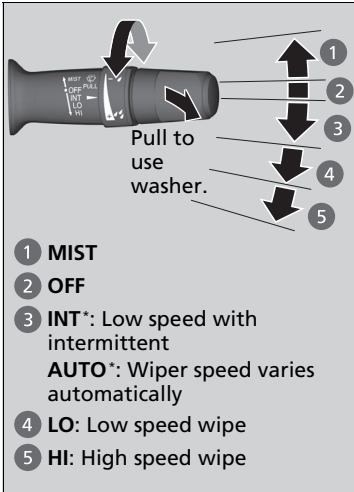

The windshield wipers and washers can be used when the power mode is in ON.

■ MIST

The wipers run at high speed until you release the lever.

■ Wiper switch (OFF, INT*, LO, HI)

Change the wiper switch setting according to the amount of rain.

■ AUTO*

➤ Automatic Intermittent Wipers* P. 146

■ Adjusting wiper operation

Turn the adjustment ring to adjust the wiper delay.



Lower speed, fewer sweeps

Higher speed, more sweeps

■ Washer

Sprays while you pull the lever toward you. When you release the lever, the wipers make two or three more sweeps before stopping.

Wipers and Washers

NOTICE

Do not use the wipers when the windshield is dry. The windshield will get scratched, or the rubber blades will get damaged.

NOTICE

In cold weather, the blades may freeze to the windshield, becoming stuck. Operating the wipers in this condition may damage them. Use the defroster to warm the windshield, then turn the wipers on.

Models without automatic intermittent wipers

If the vehicle speeds up while the wipers are operating intermittently, the length of the wipe interval shortens. When the vehicle starts moving, the wipers make a single sweep. When the vehicle speeds up, the wiper operation's shortest delay setting (👆) and the LO setting become the same.

All models

Turn the washers off if no washer fluid comes out. The pump may get damaged.

The wiper motor may stop motor operation temporarily to prevent an overload. Wiper operation will return to normal within a few minutes, once the circuit has returned to normal.

* Not available on all models

■ Automatic Intermittent Wipers*

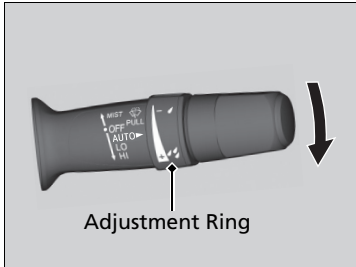

When you push the lever down to **AUTO**, the windshield wipers sweep once, and go into the automatic mode.

The wipers operate intermittently, at low speed, or at high speed and stops in accordance with the amount of rainfall the rainfall sensor detects.

■ AUTO sensitivity adjustment

When in **AUTO**, you can also adjust the rainfall sensor sensitivity using the adjustment ring.

Sensor sensitivity



Low sensitivity:
Lower speed, fewer sweeps

High sensitivity:
Higher speed, more sweeps

⌘ Wipers and Washers

If the wipers stop operating due to any obstacle such as the build-up of snow, park the vehicle in a safe place.

Rotate the wiper switch to **OFF**, and set the power mode to **ACCESSORY** or **VEHICLE OFF (LOCK)**, then remove the obstacle.

⌘ Automatic Intermittent Wipers*

The rainfall sensor is in the location shown below.

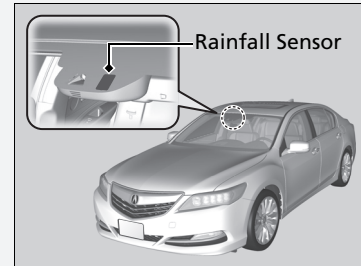

Do not put the wiper lever in **AUTO** when cleaning the windshield or driving through a car wash. If the wiper lever is in **AUTO**, and the power mode is in **ON**, the rainfall sensor may respond to your hand or car wash liquids, and the wipers may operate automatically.

■ Headlight Washers*

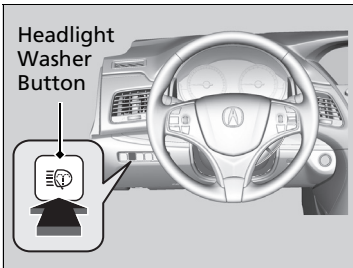

Turn the headlights on and press the headlight washer button to operate. The headlight washers also operate when you turn the windshield washers for the first time after the power mode sets to ON.

▣ Headlight Washers*

The headlight washers use the same fluid reservoir as the windshield washers.

* Not available on all models

Brightness Control

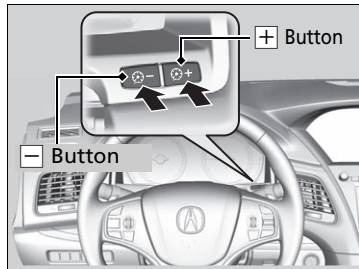

When the power mode is in ON, you can use the **+** or **-** button to adjust instrument panel brightness.

To brighten: Press the **+** button.

To dim: Press the **-** button.

You will hear a beep when the brightness reaches minimum or maximum. The multi-information display will return to its original state several seconds after you adjust the brightness.

■ Brightness level indicator

The brightness level is shown on the multi-information display while you are adjusting it.

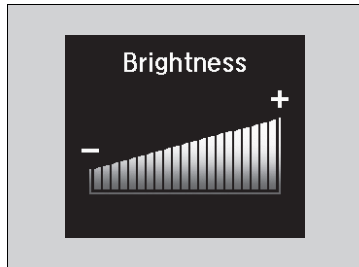

▶▶ Brightness Control

Instrument panel brightness varies, depending on whether the exterior lights are on or off. The instrument panel dims to reduce glare when they are on.

When it is bright outside and the headlight integration with the wiper is activated, the instrument panel brightness does not change.

Pushing or rolling the right selector wheel changes to a different display.

If you press the **+** button until the brightness display is up to max, the beeper sounds. This cancels the reduced instrument panel brightness when the parking lights are on.

The brightness can be set differently for when the exterior lights are on, and when they are off.

Rear Defogger/Heated Door Mirror Button

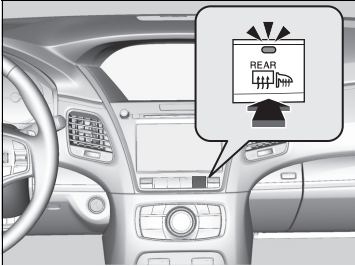

Press the rear defogger and heated door mirror button to defog the rear window and mirrors when the power mode is in ON.

The rear defogger and heated door mirrors automatically switch off after 10-30 minutes depending on the outside temperature.

However, if the outside temperature is 32°F (0°C) or below, they do not automatically switch off.

⊠ Rear Defogger/Heated Door Mirror Button

NOTICE

When cleaning the inside of the rear window, be careful not to damage the heating wires and antenna line.

It is critical to wipe the window from side to side along the defogger heating wires and antenna line.

This system consumes a lot of power, so turn it off when the window has been defogged.

Also, do not use the system for a long period when the engine is idling. This may weaken the battery, making it difficult to start the engine.

Driving Position Memory System

You can store two driver's seat (except for power lumbar), steering wheel and door mirror positions with the driving position memory system.

When you unlock and open the driver's door with a remote transmitter, or keyless access system, the seat and door mirrors adjust automatically to one of the two preset positions.

The steering wheel will move to the stored position when you set the power mode to ACCESSORY.

The multi-information display shows you which remote transmitter you used to unlock the vehicle when you enter.

- **DRIVER 1** transmitter is linked to memory button 1.
- **DRIVER 2** transmitter is linked to memory button 2.



▶▶ Driving Position Memory System

Using the audio/information screen or multi-information display, you can disable the automatic seat, steering wheel and door mirrors adjustment function.

▶ **Customized Features** P. 103, 262

■ Storing a Position in Memory

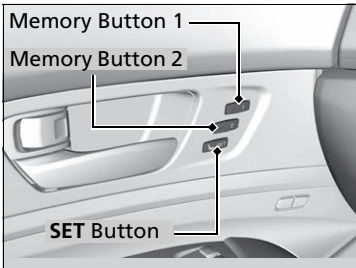

1. Set the power mode to ON. Adjust the driver's seat, the steering wheel and the door mirrors to the desired position.
2. Press the **SET** button.
 - ▶ You will hear the beep, and the memory button indicator light will blink.
3. Press memory button **1** or **2** within five seconds of pressing the **SET** button.
 - ▶ Once the seat, the steering wheel and the outside mirror positions have been memorized, the indicator light on the button you pressed stays on.

■ Recalling the Stored Position

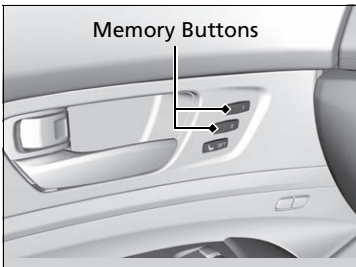

1. Move the shift lever to **P**.
2. Apply the parking brake.
3. Press a memory button (**1** or **2**).
 - ▶ You will hear the beep, and the indicator light will blink.

The seat, the steering wheel and the door mirrors will automatically move to the memorized positions. When it has finished moving, you will hear the beep, and the indicator light stays on.

☒ Storing a Position in Memory

After you press the **SET** button, the storing operation will be canceled when:

- You do not press the memory button within five seconds.
- You readjust the seat, the steering wheel or the outside mirror position before the double-beep.
- You set the power mode to any position except ON.

☒ Recalling the Stored Position

The seat will stop moving if you:

- Press the **SET** button, or a memory button (**1** or **2**).
- Adjust the seat, the steering wheel or the door mirror position.
- Shift into any position except **P**.

Adjusting the Steering Wheel

The steering wheel height and distance from your body can be adjusted so that you can comfortably grip the steering wheel in an appropriate driving posture.

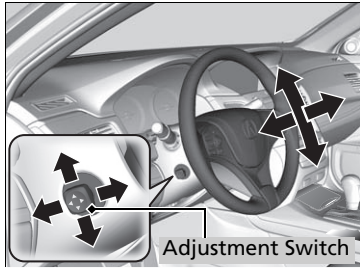

Push and hold the adjustment switch to move the steering wheel in, out, up or down.

Make sure you can see the instrument panel gauges and indicators.

▶▶ Adjusting the Steering Wheel

⚠ WARNING

Adjusting the steering wheel position while driving may cause you to lose control of the vehicle and be seriously injured in a crash.

Adjust the steering wheel only when the vehicle is stopped.

Make any steering wheel adjustments before you start driving.

Interior Rearview Mirror

Adjust the angle of the rearview mirror when you are sitting in the correct driving position.

Automatic Dimming Rearview Mirror and Power Door Mirrors*

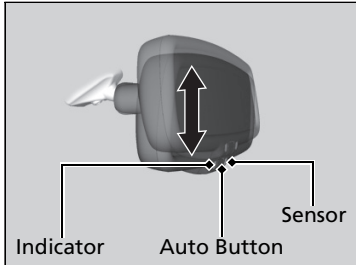

When driving after dark, the automatic dimming rearview mirror and power door mirrors* reduce the glare from headlights behind you. Press the auto button to turn this function on and off. When activated, the auto indicator comes on.

* Not available on all models

Adjusting the Mirrors

Keep the inside and outside mirrors clean and adjusted for best visibility.

Adjust the mirrors before you start driving.

➤ **Front Seats** P. 156

Automatic Dimming Rearview Mirror and Power Door Mirrors*

The auto dimming function cancels when the shift position is in **R**.

Power Door Mirrors

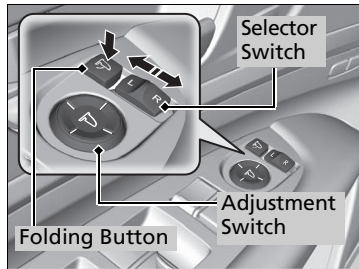

You can adjust the door mirrors when the power mode is in ON.

■ Mirror position adjustment

L/R selector switch: Select the left or right mirror. After adjusting the mirror, return the switch to the center position.

Mirror position adjustment switch: Press the switch left, right, up, or down to move the mirror.

■ Folding door mirrors*

Press the folding button to fold in and out the door mirrors.

■ Reverse Tilt Door Mirror

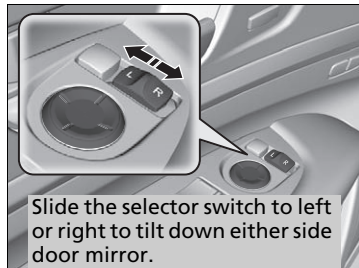

If activated, either side door mirror automatically tilts downward when you put the shift lever in **R**; this improves close-in visibility on the selected side of the vehicle when backing up. The mirror automatically returns to its original position when you shift out of **R**.

To activate this feature, set the power mode to ON and slide the selector switch to the left or right side.

■ Automatic Folding Door Mirror Function *

■ Folding in the door mirrors

Press the lock button on the keyless access remote, or press the door lock button on any door.

- ▶ The mirrors start folding in automatically.

■ Folding out the door mirrors

Press the unlock button on the keyless access remote, or grab the door handle on any door.

- ▶ The mirrors start folding out automatically.

■ Expanded View Driver's Mirror

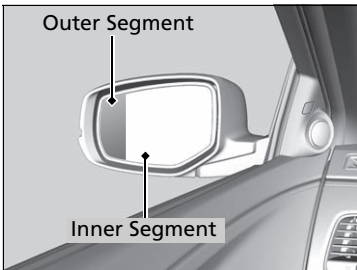

The driver's side door mirror has outer and inner segments. The outer segment is slightly curved to provide a wider angle view than a standard flat mirror. This wider view may help you check areas that are not visible using a standard door mirror.

☒ Automatic Folding Door Mirror Function *

You can turn the automatic folding door mirror function on and off.

- ☒ **Customized Features** P. 103, 262

☒ Folding out the door mirrors

The door mirrors do not fold out automatically if they have been folded in using the folding button.

☒ Expanded View Driver's Mirror

Objects visible in the outer segment of the driver's side door mirror appear smaller than objects in the rest of the mirror. But in fact, they are closer than they appear.

Do not rely on your mirrors. Always look to the side and behind your vehicle before changing lanes.

* Not available on all models

Front Seats

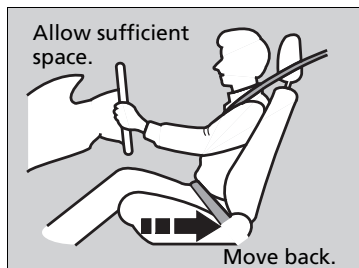

Adjust the driver's seat as far back as possible while allowing you to maintain full control of the vehicle. You should be able to sit upright, well back in the seat and be able to adequately depress the pedals without leaning forward, and grip the steering wheel comfortably. The passenger's seat should be adjusted in a similar manner, so that it is as far back from the front airbag in the dashboard as possible.

■ Adjusting the front power seats

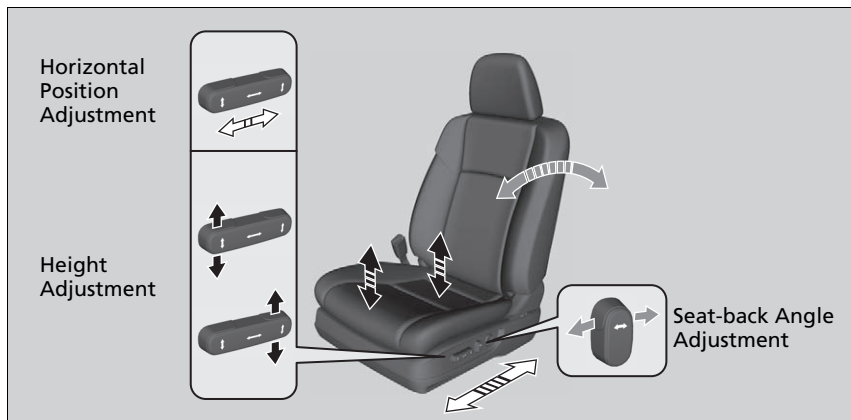

Adjusting the Seats

⚠ WARNING

Sitting too close to a front airbag can result in serious injury or death if the front airbags inflate.

Always sit as far back from the front airbags as possible while maintaining control of the vehicle.

The National Highway Traffic Safety Administration and Transport Canada recommend that drivers allow at least 10 inches (25 cm) between the center of the steering wheel and the chest.

Always make seat adjustments before driving.

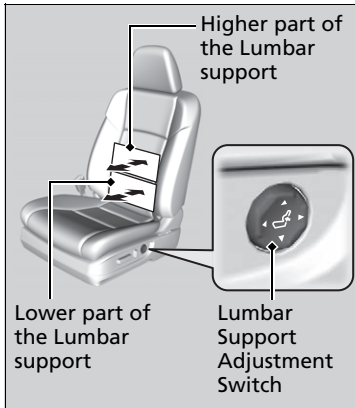

■ Lumbar Support Adjustment Switch

Press the top: To increase the higher part of the lumbar support.

Press the bottom: To increase the lower part of the lumbar support. (The higher part support is decreased.)

Press the front: To increase the entire lumbar support.

Press the rear: To decrease the entire lumbar support.

■ Adjusting the Seat-Backs

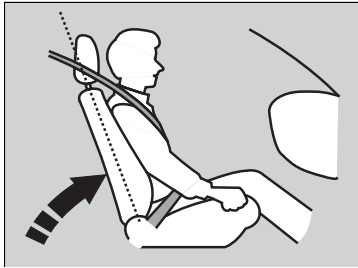

Adjust the driver's seat-back to a comfortable, upright position, leaving ample space between your chest and the airbag cover in the center of the steering wheel.

The front seat passenger should also adjust their seat-back to a comfortable, upright position.

Reclining a seat-back so that the shoulder part of the belt no longer rests against the occupant's chest reduces the protective capability of the belt. It also increases the chance of sliding under the belt in a crash and being seriously injured. The farther a seat-back is reclined, the greater the risk of injury.

► Adjusting the Seat-Backs

⚠ WARNING

Reclining the seat-back too far can result in serious injury or death in a crash.

Adjust the seat-back to an upright position, and sit well back in the seat.

Do not put a cushion, or other object, between the seat-back and your back. Doing so may interfere with proper seat belt or airbag operation.

If you cannot get far enough away from the steering wheel and still reach the controls, we recommend that you investigate whether some type of adaptive equipment may help.

Head Restraints

■ Adjusting the Head Restraints

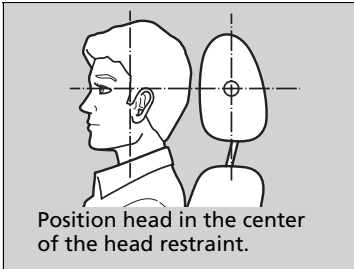

Your vehicle is equipped with head restraints in all seating positions.

Head restraints are most effective for protection against whiplash and other rear-impact crash injuries when the center of the back of the occupant's head rests against the center of the restraint. The tops of the occupant's ears should be level with the center height of the restraint.

■ Adjusting the front and rear outer head restraint positions

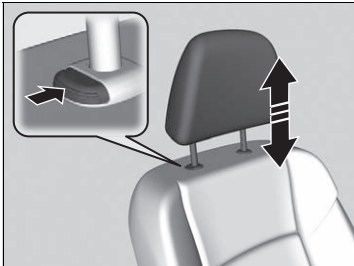

To raise the head restraint:

Pull it upward.

To lower the head restraint:

Push it down while pressing the release button.

▶▶ Adjusting the Head Restraints

⚠ WARNING

Improperly positioning head restraints reduces their effectiveness and increases the likelihood of serious injury in a crash.

Make sure head restraints are in place and positioned properly before driving.

In order for the head restraint system to work properly:

- Do not hang any items on the head restraints, or from the restraint legs.
- Do not place any object between an occupant and the seat-back.
- Install each restraint in its proper location.

■ Changing the Rear Center Seat Head Restraint Positions

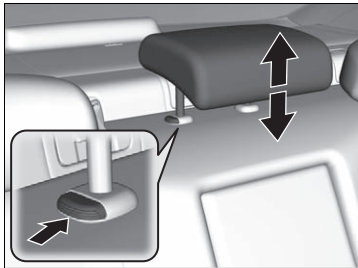

A passenger sitting in the center back seating position should adjust the height of their head restraint to an appropriate position before the vehicle begins moving.

To raise the head restraint:

Pull it upward.

To lower the head restraint:

Push it down while pressing the release button.

■ Removing and Reinstalling the Head Restraints

Head restraints can be removed for cleaning or repair.

To remove a head restraint:

Pull the restraint up as far as it will go. Then push the release button, and pull the restraint up and out.

To reinstall a head restraint:

Insert the legs back in place, then adjust the head restraint to an appropriate height while pressing the release button. Pull up on the restraint to make sure it is locked in position.

►► Removing and Reinstalling the Head Restraints

⚠ WARNING

Failure to reinstall, or correctly reinstall, the head restraints can result in severe injury during a crash.

Always replace the head restraints before driving.

Maintain a Proper Sitting Position

After all occupants have adjusted their seats and head restraints, and put on their seat belts, it is very important that they continue to sit upright, well back in their seats, with their feet on the floor, until the vehicle is safely parked and the engine is off.

Sitting improperly can increase the chance of injury during a crash. For example, if an occupant slouches, lies down, turns sideways, sits forward, leans forward or sideways, or puts one or both feet up, the chance of injury during a crash is greatly increased.

In addition, an occupant who is out of position in the front seat can be seriously or fatally injured in a crash by striking interior parts of the vehicle or being struck by an inflating front airbag.

▶ Maintain a Proper Sitting Position

⚠ WARNING

Sitting improperly or out of position can result in serious injury or death in a crash.

Always sit upright, well back in the seat, with your feet on the floor.

Armrest

■ Using the Rear Seat Armrest

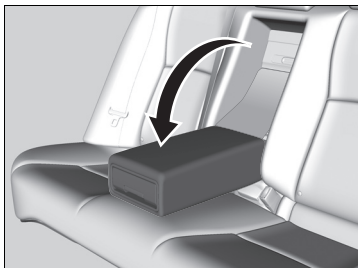

Pull down the armrest in the center seat-back.

Interior Lights

Interior Light Switches

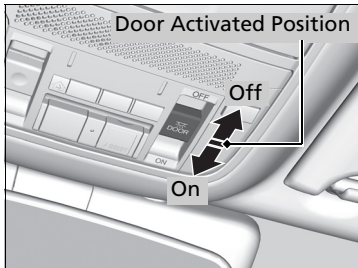

■ ON

The interior lights come on regardless whether the doors are open or closed.

■ Door activated

The interior lights come on in the following situations:

- When any doors are opened.
- You unlock the driver's door.
- When the power mode is set to VEHICLE OFF (LOCK).

■ OFF

The interior lights remain off regardless whether the doors are open or closed.

Interior Light Switches

In the door activated position, the interior lights fade out and go off about 30 seconds after the doors are closed.

The lights go off after 30 seconds in the following situations:

- When you unlock the driver's door but do not open it.
- When you set the power mode to VEHICLE OFF (LOCK) but do not open a door.

You can change the interior lights dimming time.

➤ **Customized Features** P. 103, 262

The interior lights go off immediately in the following situations:

- When you lock the driver's door.
- When you close the driver's door in ACCESSORY mode.
- When you set the power mode to ON.

If you leave any doors open, the interior lights go off after about 15 minutes.

■ Map Lights

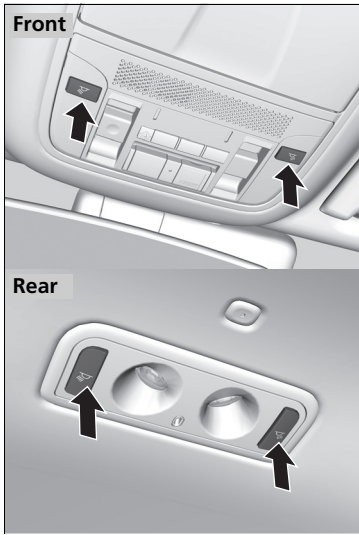

The map lights can be turned on and off by pressing the  (map light) button.

▣ Map Lights

When the ceiling light switch is in the door activated position and any door is open, the map light will not go off when you press the  (map light) button.

Interior Convenience Items

■ Glove Box

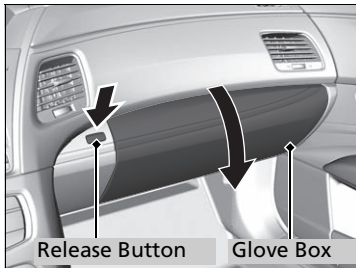

Press the release button to open the glove box.

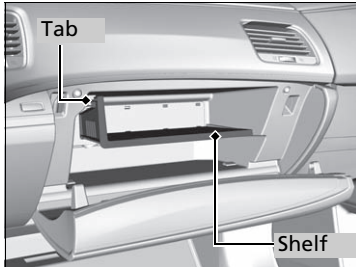

■ Removable shelf

The shelf in the glove box is detachable. To remove it, disengage the tabs.



The removable shelf can be stored upside down in the glove box.

» Glove Box

⚠ WARNING

An open glove box can cause serious injury to your passenger in a crash, even if the passenger is wearing the seat belt.

Always keep the glove box closed while driving.

Valet Mode

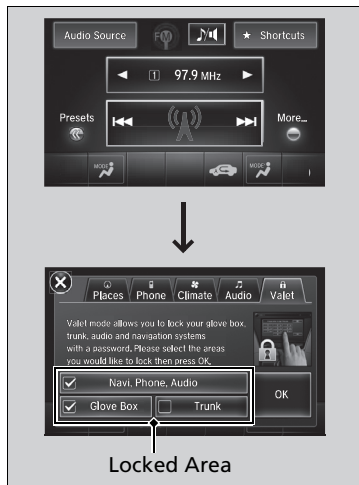

You can lock the glove box, trunk, and/or navigation system, entering a PIN code from the On Demand Multi-Use Display™.

To lock:

1. Select **Shortcuts**.
2. Select **Valet**.
3. Select the item you want to be PIN-protected from the locked area, then select **OK**.

Valet Mode

If you need to give the key to someone else, lock the trunk pass-through cover first, and give the keyless access remote without a built-in key as a valet key.

► **Trunk Pass-through Cover** P. 174



4. The previous code is displayed. Select **OK**.
 - You will receive a confirmation message on the display. Select **OK**.

When you enter the PIN code for the first time or if you want to change the code:

1. Select **Shortcuts**.
2. Select **Valet**.
3. Select the item you want to be PIN-protected from the locked area, then select **OK**.
4. Enter your selected four-digit PIN code, then select **OK**.
5. You will be asked to enter the same four-digit PIN code again. Enter, then select **OK**.
 - You will receive a confirmation message on the display. Select **OK**.

To unlock:

1. Select **Valet**.
2. Select **Unlock**.
3. Enter the four-digit PIN code you have previously selected, then select **OK**.

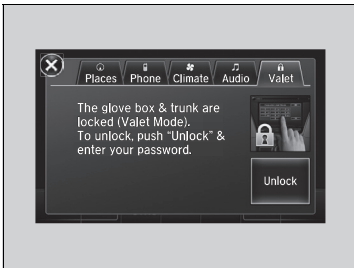

☒ Valet Mode

The PIN code entering screen also appears when you press:

- The glove box open button
 - The trunk release button on the driver's door, on the trunk, or on the remote
- While the glove box or the trunk is PIN-protected.

If you have locked all the items of the locked area, the PIN code entering screen appears with the power mode in ACCESSORY.

You can cancel the valet mode when you manually open the trunk.

☒ **When You Cannot Open the Trunk** P. 529

If you have only set **Navi, Phone, Audio** PIN-protected but forgot your four-digit PIN code, you need to go to a dealer to have the set valet mode reset.

■ Console Compartment

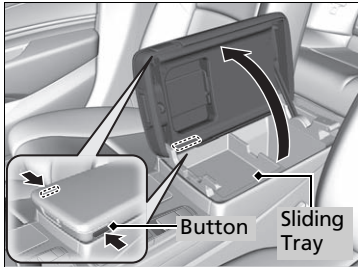

Your vehicle has a multi-function center console. It includes a storage compartment, an armrest, and a sliding tray.

Push the button on either side of the console compartment to open the console compartment.

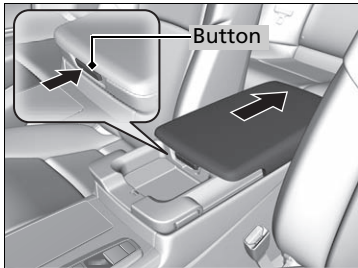

You can put small items in the sliding tray located in the console compartment lid. To use the tray, push the button, then slide the console compartment lid out fully. To close the lid, push the button. It is automatically slid back.

☒ Console Compartment

The console compartment light comes on when the parking lights are on.

■ Center Pocket

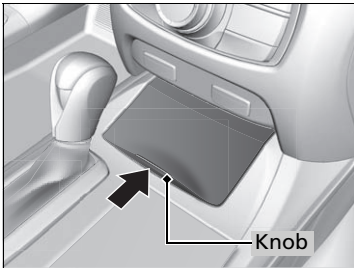

Slide the lid using release knob to use the center pocket.
To close it, push the release knob. It is automatically slid back.

■ Beverage Holders

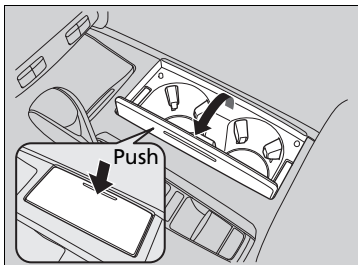

■ Front seat beverage holders

Press the raised detent to open the lid. To close the lid, push it down until it latches.

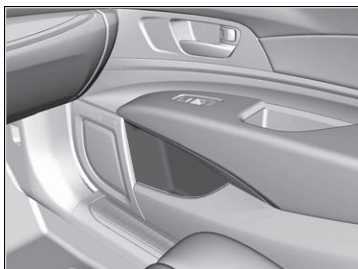

■ Front door beverage holders

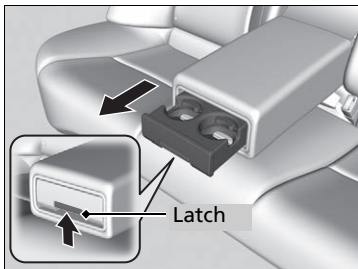

■ Rear seat beverage holders

The rear beverage holders are in the rear seat armrest. Open the beverage holders by pulling the latch up on the front.

» Beverage Holders

NOTICE

Spilled liquids damage the upholstery, carpeting, and electrical components in the interior.

Be careful when you are using the beverage holders. Hot liquid can scald you.

■ Accessory Power Sockets

The accessory power sockets can be used when the power mode is in ACCESSORY or ON.

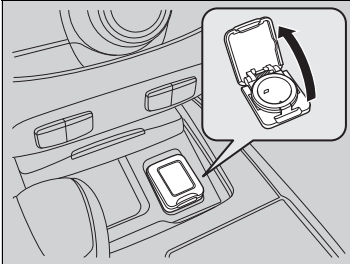

■ Accessory power socket (center pocket)

Open the lid and the cover to use it.



■ Accessory power socket (console compartment)

Open the console lid and the cover to use it.

» Accessory Power Sockets

NOTICE

Do not insert an automotive type cigarette lighter element.

This can overheat the power socket.

The accessory power sockets are designed to supply power for 12-volt DC accessories that are rated 180 watts (15 amps) or less.

To prevent battery drain, only use the power socket with the engine running.

When both sockets are being used, the combined power rating of the accessories should not exceed 180 watts (15 amps).

■ Coat Hooks

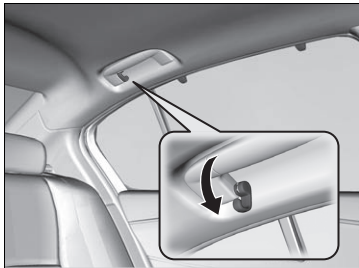

There is a coat hook on the rear grab handle of both sides. Pull it down to use it.

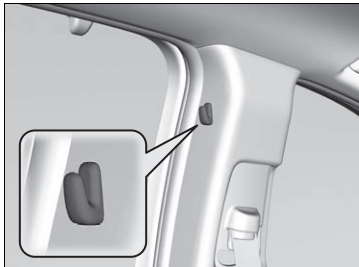

There is a coat hook on the door pillar of both sides.

☒ Coat Hooks

The coat hooks are not designed for large or heavy items.

■ Tie-down Anchors

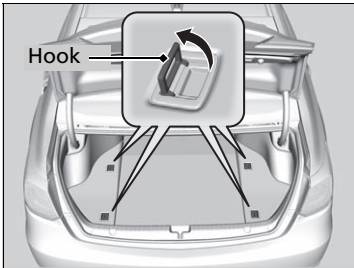

The tie-down anchors on the trunk floor can be used to install a net for securing items.

■ Cargo Hooks

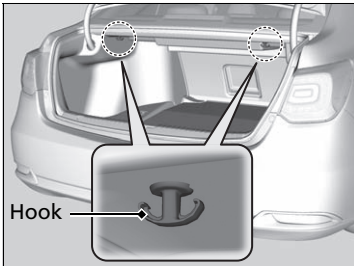

The cargo hooks in the trunk can be used to install a net for securing items.

☒ Tie-down Anchors

Distribute cargo evenly on the floor of the trunk, placing the heaviest items on the bottom and as far forward as possible.

➤ **Maximum Load Limit** P. 341

☒ Cargo Hooks

Distribute cargo evenly on the floor of the trunk, placing the heaviest items on the bottom and as far forward as possible.

➤ **Maximum Load Limit** P. 341

■ Trunk Pass-through Cover

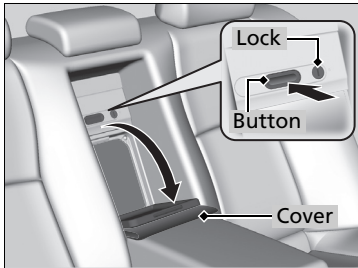

Pull the rear seat armrest down and push the button to open the cover.

You have access to the trunk from this opening in the rear seat-back.

The cover latches when you push it back to the original position.

You can lock and unlock this cover using the built-in key.

■ Heated Steering Wheel*

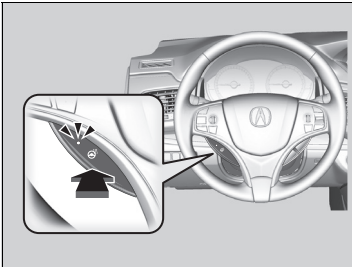

The power mode must be in ON to use the heated steering wheel.

Press the button on the left side of the steering wheel.

When a comfortable temperature is reached, press the button again to turn it off.

The heated steering wheel is turned off every time you start the engine, even if you turned it on the last time you drove the vehicle.

▣ Heated Steering Wheel*

Do not use the heated steering wheel continuously when the engine is off. Under such conditions, the battery may be weakened, making the engine difficult to start.

* Not available on all models

■ Front Seat Heaters *

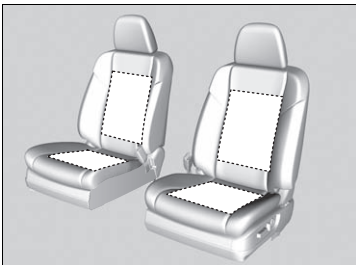

The power mode must be in ON to use the seat heaters.

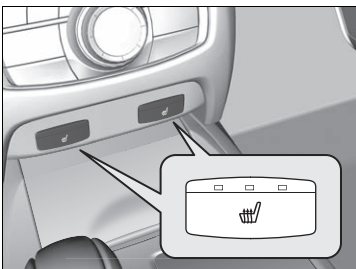

Press the seat heater button:

Once - The HI setting (three indicators on)

Twice - The MID setting (two indicators on)

Three times - The LO setting

Four times - The OFF setting (no indicators on)

▣ Front Seat Heaters *

⚠ WARNING

Heat induced burns are possible when using seat heaters.

Persons with a diminished ability to sense temperature (e.g., persons with diabetes, lower-limb nerve damage, or paralysis) or with sensitive skin should not use seat heaters.

Do not use the seat heaters even in LO when the engine is off. Under such conditions, the battery may be weakened, making the engine difficult to start.

■ Front Seat Heaters and Seat Ventilation*

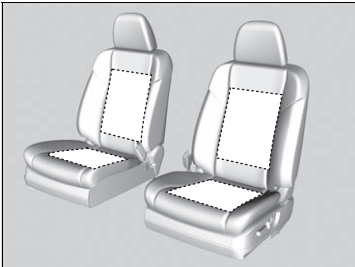

The power mode must be in ON to use the seat heaters and ventilation.

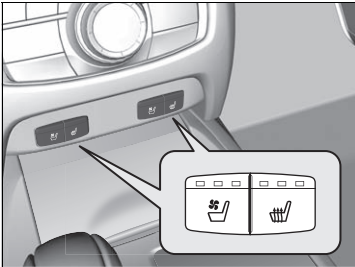

Press the seat heater or the seat ventilation button:

- Once - The HI setting (three indicators on)
- Twice - The MID setting (two indicators on)
- Three times - The LO setting
- Four times - The OFF setting (no indicators on)

▣ Front Seat Heaters and Seat Ventilation*

⚠ WARNING

Heat induced burns are possible when using seat heaters.

Persons with a diminished ability to sense temperature (e.g., persons with diabetes, lower-limb nerve damage, or paralysis) or with sensitive skin should not use seat heaters.

Do not use the seat heaters and the seat ventilation even in LO when the engine is OFF. Under such conditions, the battery may be weakened, making the engine difficult to start.

* Not available on all models

Rear Seat Heaters*

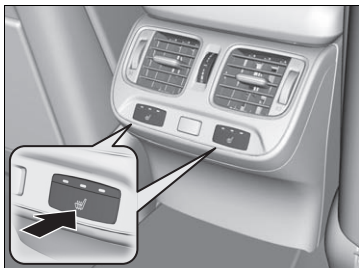

The power mode must be in ON to use the seat heaters.

There is no heater in the rear center seating position.

Press the seat heater button:

Once - The HI setting (three indicators on)

Twice - The MID setting (two indicators on)

Three times - The LO setting

Four times - The OFF setting (no indicators on)

⌘ Rear Seat Heaters*

⚠ WARNING

Heat induced burns are possible when using seat heaters.

Persons with a diminished ability to sense temperature (e.g., persons with diabetes, lower-limb nerve damage, or paralysis) or with sensitive skin should not use seat heaters.

Do not use the seat heaters even in LO when the engine is off. Under such conditions, the battery may be weakened, making the engine difficult to start.

Sunglasses Holder

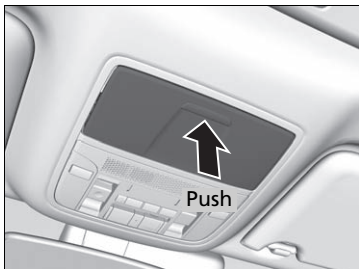

To open the sunglasses holder, push and release the indent. To close, push it again until it latches.

You can store eyeglasses and other small items in this holder.

⌘ Sunglasses Holder

Keep the holder closed while driving except when accessing stored items.

Power Rear Sunshade*

The power rear sunshade can be operated with the power mode in ON.

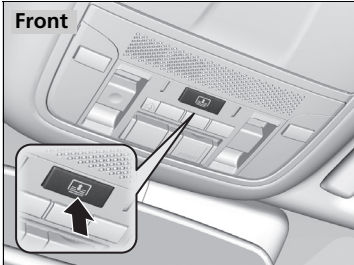

To raise: Press the button.

To lower: Press the button again.

If the sunshade stops while moving, check for and clear any obstacles, then push the button again.

Power Rear Sunshade*

⚠ WARNING

Opening or closing the sunshade on someone's hands or fingers can cause serious injury.

Make sure all hands and fingers are clear of the sunshade before opening or closing it.

* Not available on all models

■ Expanded Rear Door Sunshades*

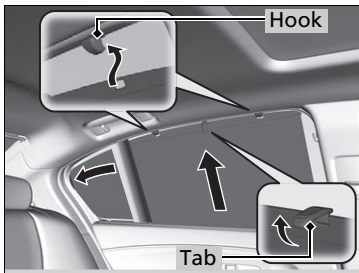

Pull the tab and roll up the sunshade all the way. Use the hooks to hang it.

☒ Expanded Rear Door Sunshades*

Use the sunshades only when the windows are fully closed. Using the shade while a window is open can unhook and blow off the shade, hitting and possibly hurting anyone sitting near the window.

Using Automatic Climate Control

The automatic climate control system maintains the interior temperature you select. The system also selects the proper mix of heated or cooled air that raises or lowers the interior temperature to your preference as quickly as possible.

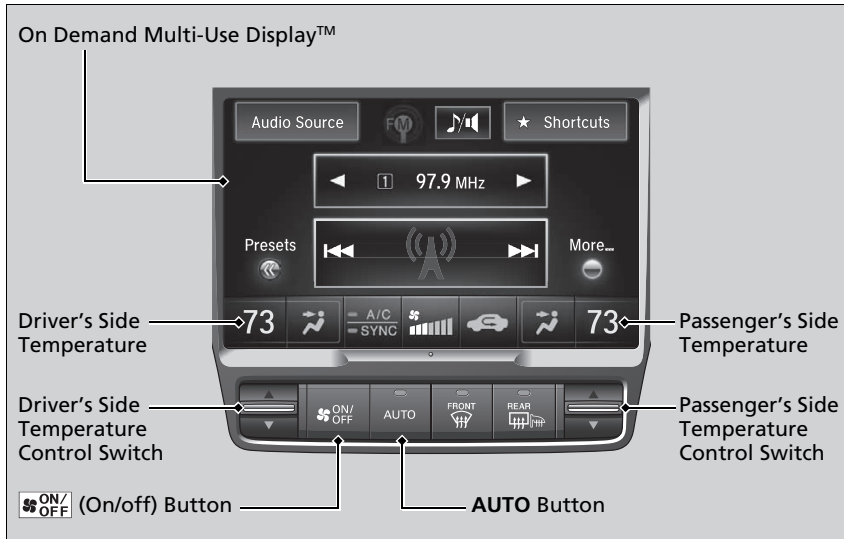

Use the system when the engine is running.

1. Press the **AUTO** button.
2. Adjust the interior temperature using the driver's side or passenger's side temperature control switch.
3. Press the **ON/OFF** (on/off) button to cancel.

In addition to the button/switch operations, you can control the climate control system from the On Demand Multi-Use Display™ touch screen.

Using Automatic Climate Control

If any buttons/icons on the touch screen are pressed while using the climate control system in **AUTO**, the function of the button/icon that was pressed will take priority.

The **AUTO** indicator will go off, but functions unrelated to the button/icon that was pressed will be controlled automatically.

To prevent cold air from blowing in from outside, the fan may operate at low speed for a while after the **AUTO** button has been pressed.

If the interior is very warm, you can cool it down more rapidly by partially opening the windows, turning the system on auto, and setting the temperature to low. Change the fresh mode to recirculation mode until the temperature cools down.

When you set the temperature to the lower or upper limit, **Lo** or **Hi** is displayed.

Pressing the **ON/OFF** button switches the climate control system between on and off. When turned on, the system returns to your last selection.

When you unlock the doors with your remote, the driver's ID (**Driver 1** or **Driver 2**) is detected, and the climate control settings are turned to the respective mode automatically when you set the power mode to **ON**.

■ Operating from the On Demand Multi-Use Display™

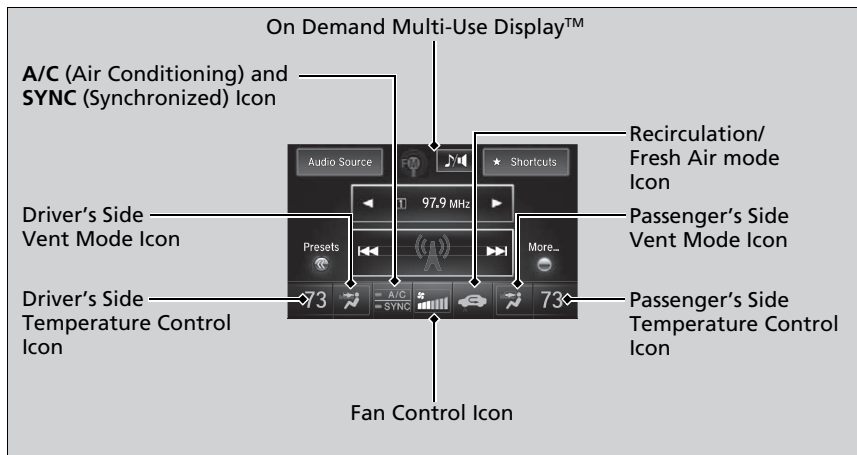

►► Using Automatic Climate Control

You can store two customized climate control settings to the system and recall them from the On Demand Multi-Use Display™.

► **Shortcuts** P. 198

■ Changing the interior temperature setting

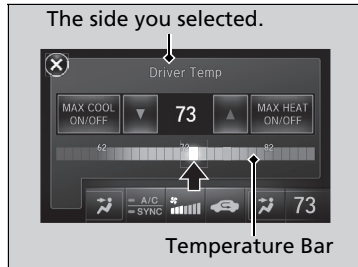

1. Select the driver's or passenger's side temperature control.
2. Change the temperature setting from the following:

Temperature bar: Select a point where your desired temperature setting is. Farther to the left is for a lower, and to the right for a higher setting.

▲/▼: To raise or lower the temperature setting one degree at a time.

While you select and hold **▲/▼**, the temperature decreases or increases.

MAX COOL ON/OFF: To rapidly cool down the interior.

- The AUTO indicator comes on. The setting returns to the previously selected value when you select it again.

MAX HEAT ON/OFF: To rapidly warm up the interior.

- The AUTO indicator comes on. The setting returns to the previously selected value when you select it again.

✎ Using Automatic Climate Control

When you set the temperature to the lower or upper limit, **Lo** or **Hi** is displayed.

When you set the **MAX COOL** or **MAX HEAT**, **MAX COOL** or **MAX HEAT** is displayed.

■ Switching the vent mode

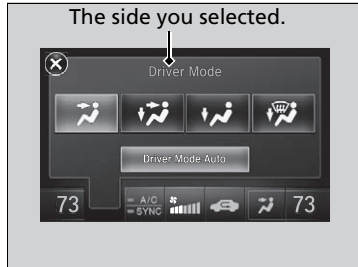

1. Select the driver's or passenger's side vent mode.
2. Select a desired vent mode icon, or **Driver Mode Auto** (driver's side)/**Passenger Mode Auto** (passenger's side): The system automatically selects the vent mode most suitable to the ambient environment.

Vent mode

- Dashboard vents and back of the center console
- Dashboard and floor vents, and back of the center console
- Floor vents
- Floor and defroster vents (driver's side only)

■ A/C on and off

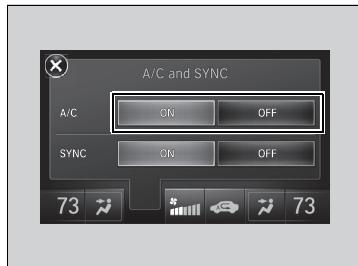

1. Select **A/C**.
2. Select **ON** or **OFF**.

► Switching the vent mode

While the climate control system is in AUTO, **Driver Mode Auto** or **Passenger Mode Auto** is highlighted.

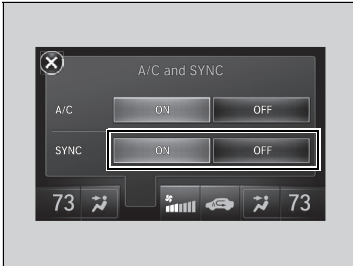

■ SYNC on and off

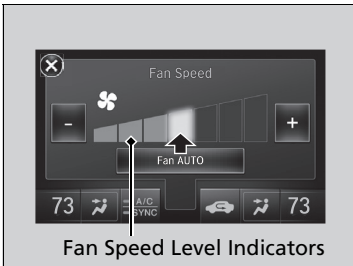

1. Select **SYNC**.
2. Select **ON** for synchronized mode, and **OFF** for dual mode.
 - When in synchronized mode, the passenger's side temperature and vent mode become the same as the driver's side settings.
3. Adjust the temperature or change the mode from the driver's side.

■ Changing the fan speed



1. Select .
 2. Change the fan speed with one of the following:
 - The fan speed level indicators: Select your desired speed level. The smaller indicator is for a slower speed, and the larger for a faster speed.
 - : To go up or down one level at a time.
- Fan AUTO:** The system automatically selects the fan speed most suitable to the ambient environment.

☒ SYNC on and off

When you press the  button, the system changes to synchronized mode.

When the system is in dual mode, the driver's side temperature and vent mode, and the passenger's side temperature and vent mode can be set separately.

You can also return to dual mode by changing the passenger's side temperature or switching the vent mode.



The system adjusts each temperature based on the information of the sunlight sensor and the sun position updated by the navigation system's GPS.

☒ Changing the fan speed

While the climate control system is in AUTO, **Fan AUTO** is highlighted.

■ Switching between the recirculation and fresh air modes



1. Select ,  or  currently shown.
2. Switch the mode depending on environmental conditions to the following:

 (recirculation mode): Recirculates air from the vehicle's interior through the system.

 (auto mode): Automatically switch between the recirculation and fresh air modes most suitable to environmental conditions. If the ambient temperature is low, the mode may not change to recirculation to keep the windows from fogging up.

 (fresh air mode): Maintains outside ventilation. Keep the system in fresh air mode in normal situations.

» Switching between the recirculation and fresh air modes

While the climate control system is in AUTO,  is highlighted.

■ Shortcuts

You can store two sets of your preferred temperature, fan speed, and vent mode settings to the climate control system.

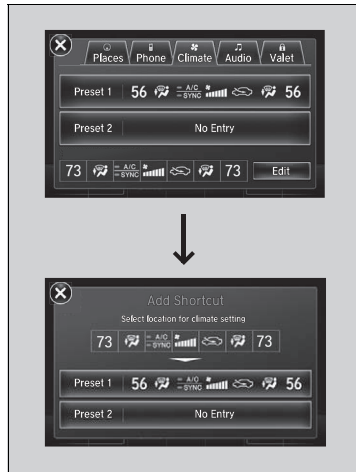

To store a set of the climate control settings:

1. Select **Shortcuts**.
2. Adjust the climate control system to your preference.
 ► **Climate Control System** P. 181
3. Select **Climate**.
4. Select **Edit**.
5. Select **Add**.
6. Select **Preset 1** or **Preset 2** you want to store your settings to.

To recall one of the settings:

1. Select **Shortcuts**.
2. Select **Climate**.
3. Select **Preset 1** or **Preset 2**.

To delete a preset:

1. Select **Shortcuts**.
2. Select **Climate**.
3. Select **Edit**.
4. Select **Delete**.
5. Select **Preset 1** or **Preset 2** you want to delete.

» Shortcuts

You can also store a set by pressing and holding the preset number you want to store that setting after step 3.

■ Defrosting the Windshield and Windows

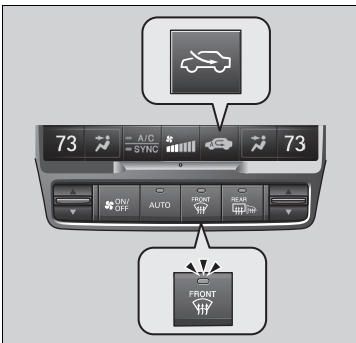

Pressing the  button turns the air conditioning system on and automatically switches the system to fresh air mode.

Press the  button again to turn off, the system returns to the previous settings.

■ To rapidly defrost the windows

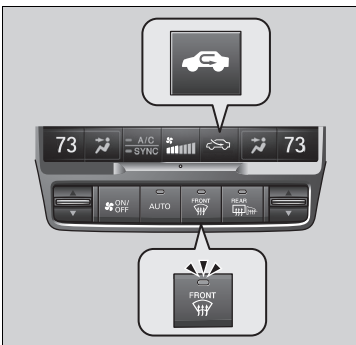

1. Press the  button.
2. Select the recirculation mode.
 - **Switching between the recirculation and fresh air modes** P. 186

►► Defrosting the Windshield and Windows

For your safety, make sure you have a clear view through all the windows before driving.

Do not set the temperature near the upper or lower limit.

When cold air hits the windshield, the outside of the windshield may fog up.

If the side windows fog up, adjust the vents so that the air hits the side windows.

►► To rapidly defrost the windows

After defrosting the windows, switch over to fresh air mode.

If you keep the system in recirculation mode, the windows may fog up from humidity. This impedes visibility.

Rear Temperature Control Dial

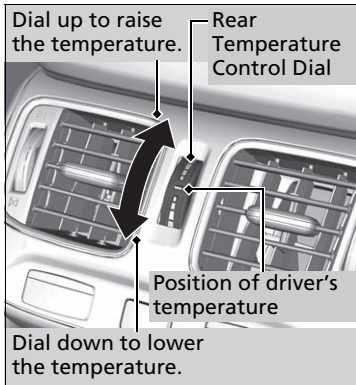

You can set the rear passenger compartment temperature different than the driver's, using the rear temperature control dial.

⌘ Rear Temperature Control Dial

The rear temperature can be adjusted when the climate control system is on.

Automatic Climate Control Sensors

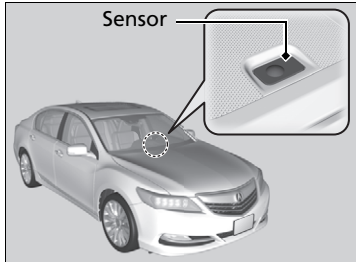

The automatic climate control system is equipped with sensors. Do not cover or spill any liquid on them.

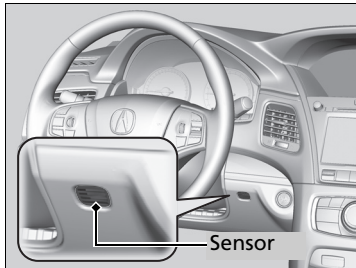

Features

This chapter describes how to operate technology features.

Audio System

About Your Audio System	192
USB Port	193
Auxiliary Input Jack	193
Audio System Theft Protection	194
Audio Remote Controls.....	195
Audio System Basic Operation	196
On Demand Multi-Use Display™.....	197
Audio/Information Screen	205
Adjusting the Sound	209
Display Setup	210
Voice Control Operation	211
Playing AM/FM Radio.....	216

Playing SiriusXM® Radio	221
Playing a CD	224
Playing Hard Disk Drive (HDD) Audio.....	227
Playing an iPod	237
Song By Voice™ (SBV)	241
Playing Internet Radio	245
Playing a USB Flash Drive	248
Playing <i>Bluetooth</i> ® Audio.....	251
Audio Error Messages	
CD Player.....	253
Hard Disk Drive (HDD) Audio.....	254
iPod/USB Flash Drive	255
Pandora®	256
Aha™ Radio	257

General Information on the Audio System

SiriusXM® Radio Service	258
Recommended CDs	259
Compatible iPod, iPhone, and USB Flash Drives	261
Customized Features	262
Defaulting All the Settings.....	286
Deleting all HDD Data	287
HomeLink® Universal Transceiver	288
<i>Bluetooth</i>® HandsFreeLink®	
Using HFL	290
HFL Menus	292
AcuraLink®	330



About Your Audio System

See the Navigation System Manual for information on the navigation system.

The audio system features AM/FM radio and the SiriusXM® Radio service. It can also play audio CDs, WMA/MP3/AAC files, Hard Disk Drive (HDD) audio, USB flash drives, and iPod, iPhone and *Bluetooth*® devices.

You can operate the audio system from the buttons and switches on the panel, the icons on the touchscreen interface.

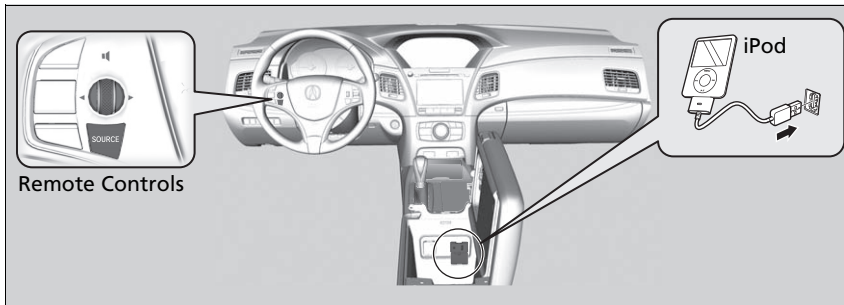

Remote Controls

iPod

About Your Audio System

SiriusXM® Radio is available on a subscription basis only. For more information on SiriusXM® Radio, contact a dealer.

General Information on the Audio System P. 258

SiriusXM® Radio is available in the United States and Canada, except Hawaii, Alaska, and Puerto Rico.

SiriusXM® is a registered trademark of Sirius XM Radio, Inc.

Video CDs, DVDs, and 3-inch (8-cm) mini CDs are not supported.

iPod, iPhone and iTunes are trademarks of Apple Inc.

State or local laws may prohibit the operation of handheld electronic devices while operating a vehicle.

When the screen is viewed through polarized sunglasses, a rainbow pattern may appear on the screen due to optical characteristics of the screen. If this is disturbing, please operate the screen without polarized sunglasses.

USB Port

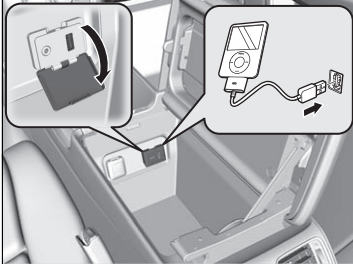

Install the iPod dock connector or the USB flash drive to the USB port.

USB Port

- Do not leave the iPod or USB flash drive in the vehicle. Direct sunlight and high temperatures may damage it.
- We recommend using an extension cable with the USB port.
- Do not connect the iPod or USB flash drive using a hub.
- Do not use a device such as a card reader or hard disk drive, as the device or your files may be damaged.
- We recommend your data backed up before using the device in your vehicle.
- Displayed messages may vary depending on the device model and software version.

If the audio system does not recognize the iPod, try reconnecting it a few times or reboot the device. To reboot, follow the manufacturer's instructions provided with the iPod or visit www.apple.com/ipod.

Auxiliary Input Jack

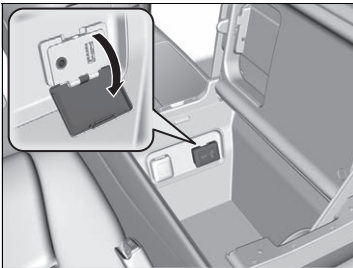

Use the jack to connect standard audio devices.

1. Open the **AUX** cover.
2. Connect a standard audio device to the input jack using a 1/8 inch (3.5 mm) stereo miniplug.

▶ The audio system automatically switches to the AUX mode.

Auxiliary Input Jack

You can return to the AUX mode by selecting **Change Source** on the **Audio menu** screen or **Audio Source** on the On Demand Multi-Use Display™.

Audio System Theft Protection

The audio system is disabled when it is disconnected from the power source, such as when the battery is disconnected or goes dead. In certain conditions, the system may display **Enter code**. If this occurs, reactivate the audio system.

■ Reactivating the audio system

1. Set the power mode to ON.
2. Turn on the audio system.
3. Press and hold the audio system power button for more than two seconds.
 - ▶ The audio system is reactivated when the audio control unit establishes a connection with the vehicle control unit. If the control unit fails to recognize the audio unit, you must go to a dealer and have the audio unit checked.

Audio Remote Controls

Allows you to operate the audio system while driving.

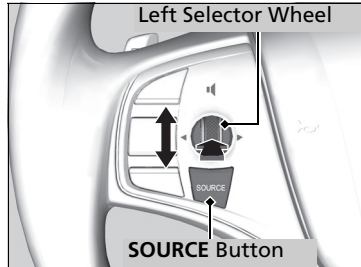

SOURCE Button

Cycles through the audio modes as follows:
 FM→AM→SiriusXM®→CD→HDD→USB→
 iPod→Bluetooth® Audio→Pandora®*→Aha™
 →AUX

Left Selector Wheel

Roll Up: To increase the volume.

Roll Down: To decrease the volume.

Push: To mute. Push again to unmute.

- When listening to the radio
 - Move to the right:** To select the next preset radio station.
 - Move to the left:** To select the previous preset radio station.
 - Move to the right and hold:** To select the next strong station.
 - Move to the left and hold:** To select the previous strong station.
- When listening to a CD, HDD, iPod, USB flash drive, or Bluetooth® Audio
 - Move to the right:** To skip to the next song.
 - Move to the left:** To go back to the beginning of the current or previous song.
 - Move to the right and hold:** To go the group up. (Bluetooth® Audio only)
 - Move to the left and hold:** To go the group down. (Bluetooth® Audio only)
- When listening to a CD, HDD or USB flash drive
 - Move to the right and hold:** To skip to the next folder.
 - Move to the left and hold:** To go back to the previous folder.
- When listening to Pandora®*
 - Move to the right:** To skip to the next song.
 - Move to the right and hold:** To select the next station.
 - Move to the left and hold:** To select the previous station.

* Not available on all models

Audio Remote Controls

Some mode appears only when an appropriate device or medium is used.

To select audio mode, press the **SOURCE** button, then move the left selector wheel to the right or left.

Audio System Basic Operation

To use the audio system function, the power mode must be in ACCESSORY or ON.

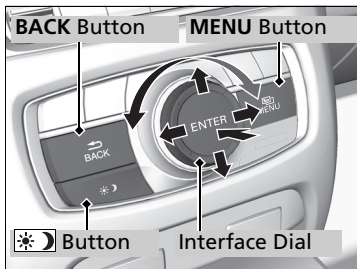

Use the interface dial or **MENU** button to access some audio functions.

Press to switch between the normal and extended display for some functions.

Interface dial: Rotate left or right to scroll through the available choices. Press to set your selection. Move right, left, up or down to select secondary menu.

MENU button: Press to select any mode. The available mode includes **Sound, Change Source, Refresh Station List, Save Preset, Radio Text, Music Search,** and play modes. Play modes can be also selected from **Scan, Random/Repeat,** and so on.

BACK button: Press to go back to the previous display.

button: Press to change the audio/information screen brightness.

Press once and make an adjustment.

- ▶ Each time you press , the mode switches between the daytime mode, nighttime mode and off mode.



Audio System Basic Operation

Voice Control System

The navigation system is voice operable.

- ▶ **Voice Control Operation** P. 211

These indications are used to show how to operate the interface dial.

Rotate to select.

Press to enter.

Move , , or to select secondary menu.

Audio Menu Items

- ▶ **Sound** P. 209
- ▶ **Refresh Station List** P. 218
- ▶ **Save Preset** P. 217, 223
- ▶ **Radio Text** P. 219
- ▶ **Music Search** P. 225, 229, 239, 249
- ▶ **Scan** P. 226, 230, 250
- ▶ **Random/Repeat** P. 226, 230, 240, 250

When you unlock the doors with your remote, the driver's ID (**Driver 1** or **Driver 2**) is detected, and the audio system settings and preset memory are turned to the respective mode automatically when you set the power mode to ON.

On Demand Multi-Use Display™

Use the On Demand Multi-Use Display™ to operate the audio system.

Selecting an Audio Source

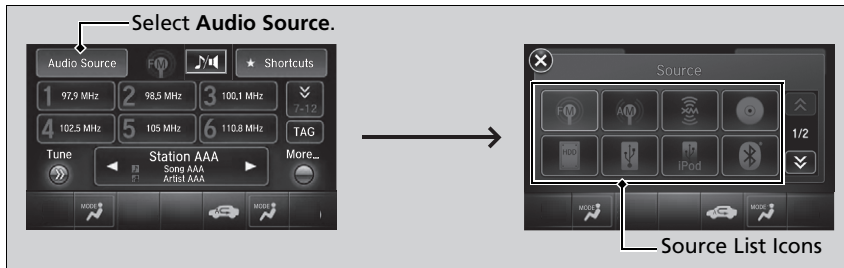

Select **Audio Source**, then select an icon on the source list to switch the audio source.

Displaying the Menu Items

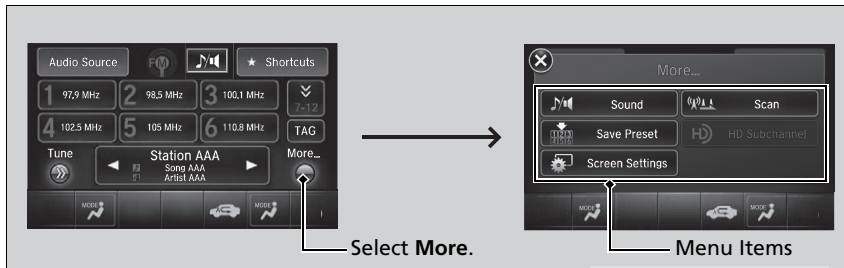

Select **More** to display the menu items.

On Demand Multi-Use Display™

Icons that appear on the screen vary by the source selected.

Select to go back to the previous screen.

Use the icons to turn the page.

Selecting an Audio Source

You can change the order of source icons displayed.



1. Select **Audio Source**, , then **Edit Order**.
 2. Select two icons, then select **Done**.
- The locations of these icons are switched.
To go back to the original display order, select **Default**.

Shortcuts

Shortcuts

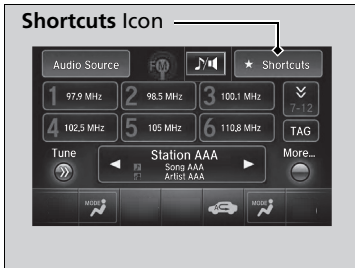

You can preset the settings of four or three categories (**Places**, **Phone**, **Climate**, **Audio**) from **Shortcuts**.

The preset memory is cleared when it is disconnected from the power source, such as when the battery is disconnected or goes dead.

■ Places

You can store up to six addresses, and the home address for your preset destinations.

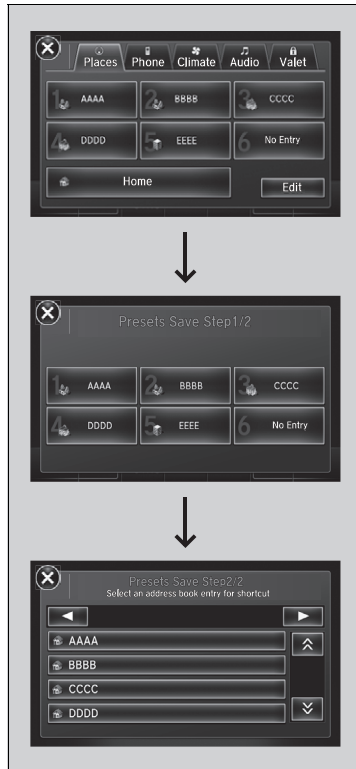

To store an address on the selected preset number:

1. Select **Shortcuts**.
2. Select **Places**.
3. Select **Edit** or **No Entry**.
 - ▶ If you select **No Entry**, go to step 6.
4. Select **Add**.
 - ▶ All the six preset icons appear.
5. Select the preset number to which you want to store an address.
6. The screen changes to a list of addresses stored in your address book.
7. Select an address you want to store as a preset.

To enter one of the preset addresses, or **Home** as your destination:

1. Select **Shortcuts**.
2. Select **Places**.
3. Select a preset number or **Home**.
 - ▶ The system starts to calculate the route to your selected destination.

» Places

See the Navigation System Manual for how to store address book entries, and enter your home address.

To delete a preset address:

1. Select **Shortcuts**.
2. Select **Places**.
3. Select **Edit**.
4. Select **Delete**.
5. Select the preset number with the destination you want to delete.

■ Phone

You can preset five speed dial entries, and make a call from one of the preset numbers, or call history when the phone is paired and connected to the vehicle's *Bluetooth*® HandsFreeLink® (HFL) system. ▶ **Phone Setup** P. 296

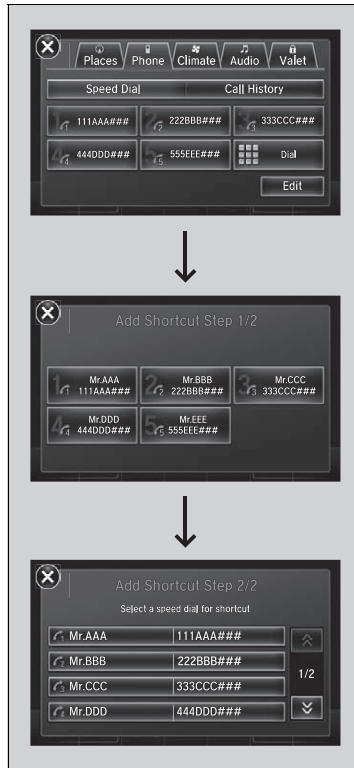

To preset a speed dial:

1. Select **Shortcuts**.
2. Select **Phone**.
3. Select **Speed Dial**.
4. Select **Edit** or **No Entry**.
 - ▶ If you select **No Entry**, go to step 6.
5. Select **Add**.
 - ▶ Five presets appear. Select a **No Entry** preset or an existing preset.
 - ▶ The screen changes to a list of previously stored speed dial entries.
6. Select a number you want to store as a shortcut.

To make a call from a speed dial entry:

1. Select **Shortcuts**.
2. Select **Phone**.
3. Select **Speed Dial**.
4. Select a preset number.
 - ▶ Dialing starts automatically.

☒ Phone

Dial icon

You can make a call using the keyboard on the On Demand Multi-Use Display™ to input numbers.

- ▶ **To make a call using a phone number**
P. 318



To delete a speed dial:

1. Select **Shortcuts**.
2. Select **Phone**.
3. Select **Speed Dial**.
4. Select **Edit**.
5. Select **Delete**.
6. Select the preset number with the phone number you want to delete.

To make a call from call history:

1. Select **Shortcuts**.
2. Select **Phone**.
3. Select **Call History**.
4. Select a phone number.
 - ▶ Dialing starts automatically.

Phone

The call history displays the last six dialed, received, or missed calls.

■ Audio

You can store up to six radio stations, and HDD audio album/play lists when playing AM, FM, or SiriusXM® radio, or HDD audio.

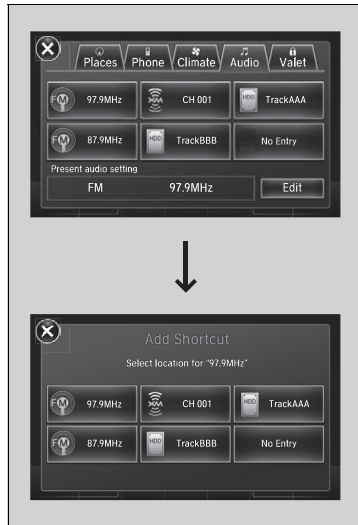

To preset a station or song:

1. Select **Shortcuts**.
2. Tune to a radio station or select a song from HDD audio.
 - ▶ **Playing AM/FM Radio** P. 216
 - ▶ **Playing SiriusXM® Radio** P. 221
 - ▶ **Playing Hard Disk Drive (HDD) Audio** P. 227

3. Select **Audio**.
4. Select **Edit** or **No Entry**.
 - ▶ If you select **No Entry**, go to step 6.
5. Select **Add**.
6. Select the preset icon you want to store the station or song to.

To play a preset station or song:

1. Select **Shortcuts**.
2. Select **Audio**.
3. Select a preset icon.

To delete a preset station or song:

1. Select **Shortcuts**.
2. Select **Audio**.
3. Select **Edit**.
4. Select **Delete**.
5. Select the preset icon with the radio station or a song you want to delete.

▶▶ Audio

You can also preset a station or song by pressing and holding the preset icon you want to store that station or song after step 3.

■ Adjusting the Sound

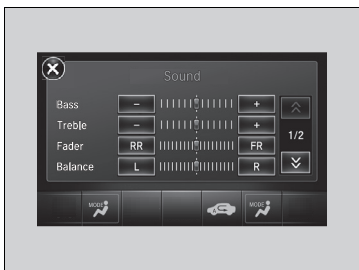

1. Select **More**, then **Sound**.
2. Use **+**, **-** or other icons to adjust the setting.

■ Changing the Screen Settings

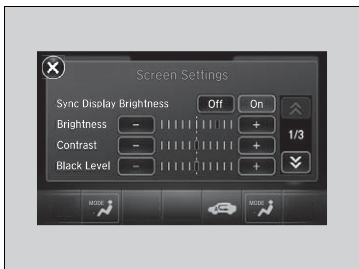

1. Select **More**, then **Screen Settings**.
2. Use **+**, **-** or other icons to adjust the setting.

▶▶ Adjusting the Sound

Select **Off**, **Low**, **Mid** or **High** for the SVC setting.
▶▶ Adjusting the Sound P. 209

Instead of using **+**, **-** or icons, you can also touch the point where your desired setting is.

▶▶ Changing the Screen Settings

The followings are adjustable screen settings:

- **Sync Display Brightness**
Selects whether the screen brightness synchronizes with the instruments panel brightness.
- **Brightness**
- **Contrast**
- **Black Level**
- **Display**
Changes between the daytime or nighttime modes.
- **Beep**
Mutes a beep that sounds every time you touch the screen.
- **Keyboard**
Changes the on-screen keyboard from the alphabetical order to the qwerty type.
- **Vibration**
Turns on and off the vibration when you touch the screen.
- **Fade Timer**
Sets the screen black out timing.

Instead of using **+**, **-** or icons, you can also touch the point where your desired setting is.



Audio/Information Screen

Displays the audio status and wallpaper. From this screen, you can go to various setup options.

Switching the Display

Press the **NAV**, **PHONE**, **INFO** and **AUDIO** buttons to go to the corresponding display.

Navigation

Phone

Info

Audio

NAV Button **PHONE Button** **INFO Button** **AUDIO Button**

Models with surround view camera system

NAV Button **PHONE Button** **INFO Button** **AUDIO Button**

Models without surround view camera system

Features

■ Audio

Shows the current audio information.

■ Navigation

Shows the navigation screen.  **Refer to the Navigation System Manual**

■ Phone

Shows the HFL information.  **Bluetooth® HandsFreeLink®** P. 290

■ Info

Shows the **Trip Computer** or **Clock/Wallpaper** and other information. Rotate  to select an item, then press .





■ Trip computer (Current Drive)

Shows the range, and instant and average fuel economy of the current trip, as well as the average fuel economy from your last trip.

■ Trip computer (History of Trip A)

Shows the range, average fuel economy and distances traveled for the current trip, as well as the average fuel economy and distances traveled during the last three driving cycles. Each time you reset the trip meter A, the information on the display updates. The history of the previous three driving cycles is kept.

■ Deleting the history manually

1. Move  on the **History of Trip A** screen to select **Delete History**, then press .
2. You will receive a confirmation message on the screen. Rotate  to select **Yes**, then press .

■ Clock/Wallpaper

Shows a clock screen or an image you import.



Wallpaper Setup

You can change, store, and delete the wallpaper on the audio/information screen.

Import wallpaper

You can import up to three images, one at a time, for wallpaper from a USB flash drive.

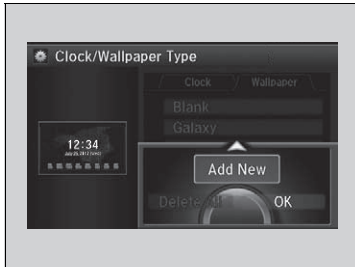



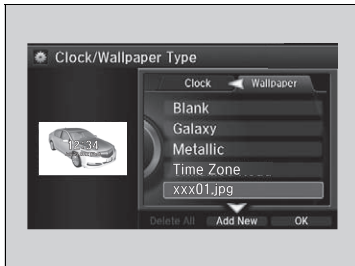







1. Connect the USB flash drive to the USB port.
▶ **USB Port** P. 193
2. Press the **SETTINGS** button.
3. Rotate to select **System Settings**, then press .
4. Move or to select the **Clock** tab.
5. Rotate to select **Clock/Wallpaper Type**, then press .
6. Move to select **Wallpaper**.
▶ The screen will change to the wallpaper list.
7. Move to select **Add New**, then press .
8. Rotate to select a desired picture.
▶ The preview is displayed on the left side on the screen.
9. Press , then move to select **Start Import**.
▶ The confirmation message will appear. Then the display will return to the wallpaper list.

















Wallpaper Setup

- When importing wallpaper files, the image must be in the USB flash drive's root directory. Images in a folder cannot be imported.
- The file name must be fewer than 64 characters.
- The file format of the image that can be imported is BMP (bmp) or JPEG (jpg).
- The individual file size limit is 6 MB.
- The maximum image size is 1,680 x 936 pixels. If the image size is less than 420 x 234 pixels, the image is displayed in the middle of the screen with the extra area appearing in black.
- Up to 255 files can be selected.
- If the USB flash drive does not have any pictures, the **No files detected** message appears.



■ Select wallpaper

1. Press the **SETTINGS** button.
2. Rotate  to select **System Settings**, then press .
3. Move  or  to select the **Clock** tab.
4. Rotate  to select **Clock/Wallpaper Type**, then press .
5. Move  to select **Wallpaper**.
 - ▶ The screen changes to the wallpaper list.
6. Rotate  to select a desired wallpaper.
 - ▶ The preview is displayed on the left side on the screen.
7. Press .
- ▶ The pop-up menu appears on the screen.
8. Rotate  to select **Set**, then press .
- ▶ The display will return to the wallpaper list.

■ Delete wallpaper

1. Press the **SETTINGS** button.
2. Rotate  to select **System Settings**, then press .
3. Move  or  to select the **Clock** tab.
4. Rotate  to select **Clock/Wallpaper Type**, then press .
5. Move  to select **Wallpaper**.
 - ▶ The screen changes to the wallpaper list.
6. Rotate  to select a wallpaper that you want to delete, then press .
 - ▶ The preview is displayed on the left side on the screen.
7. Press .
- ▶ The pop-up menu appears on the screen.
8. Rotate  to select **Delete**, then press .
 - ▶ The confirmation message will appear.
9. Rotate  to select **Yes**, then press  to delete completely.
 - ▶ The display will return to the wallpaper list.

▶▶ Wallpaper Setup

From the pop-up menu, rotate  to select **Preview** and press  to see a preview at full-size screen.

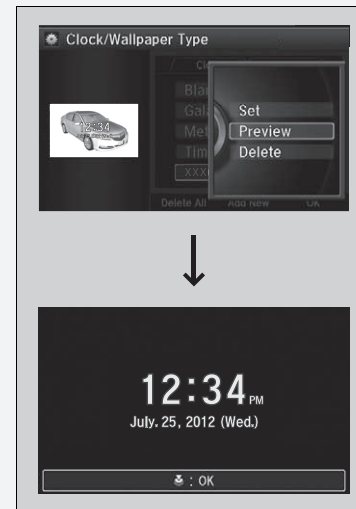

To go back to the previous screen, press  to select **OK**, or press the **BACK** button.

When the file size is large, it takes a while to be previewed.

Adjusting the Sound

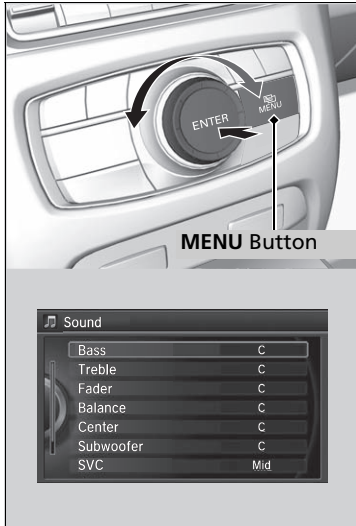

1. Press the **MENU** button.
2. Rotate to select **Sound**, then press .

Rotate to scroll through the following choices:

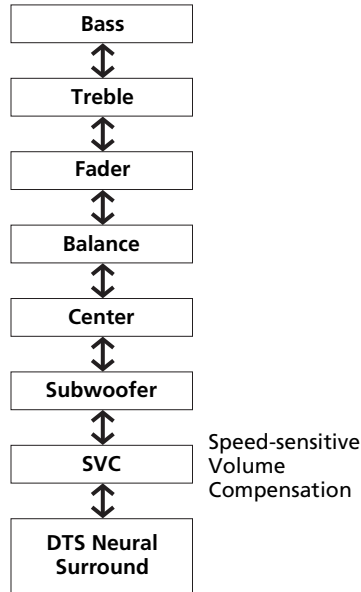

▶▶ Adjusting the Sound

The SVC has four modes: **Off**, **Low**, **Mid**, and **High**. SVC adjusts the volume level based on the vehicle speed. As you go faster, audio volume increases. As you slow down, audio volume decreases.

DTS Neural Surround is a trademark of DTS, Inc.

On Demand Multi-Use Display™

▶ Adjusting the Sound P. 204

Display Setup

You can change the brightness or color theme of the audio/information screen.

■ Changing the Screen Brightness



1. Press the **SETTINGS** button.
2. Rotate to select **System Settings**, then press .
3. Move or to select the **Display** tab.
4. Rotate to select **Brightness**, then press .
5. Rotate to adjust the setting.

■ Changing the Screen's Color Theme





1. Press the **SETTINGS** button.
2. Rotate to select **System Settings**, then press .
3. Move or to select the **Others** tab.
4. Rotate to select **Background Color**, then press .
5. Rotate to select the setting you want, then press .

☒ Changing the Screen Brightness

You can change the **Contrast** and **Black Level** settings in the same manner.

Voice Control Operation

Your vehicle has a voice control system that allows hands-free operation of most of the navigation system functions.

The voice control system uses the  (Talk) and  (hang-up/back) buttons on the steering wheel and a microphone near the map lights on the ceiling.



Voice Recognition

To achieve optimum voice recognition when using the voice control system:

- Make sure the correct screen is displayed for the voice command that you are using.
- Close the windows and moonroof.
- Adjust the dashboard and side vents so air does not blow onto the microphone on the ceiling.
- Speak clearly in a clear, natural speaking voice without pausing between words.
- Reduce any background noise if possible. The system may misinterpret your command if more than one person is speaking at the same time.
- Refer to the Voice Help feature.

 **Refer to the Navigation System Manual**

Voice Control Operation

When you press the  button, a helpful prompt asks what you would like to do. Press and release the  button again to bypass this prompt and give a command.

Voice Recognition

The voice control system can only be used from the driver's seat because the microphone unit removes noises from the front passenger's side.

■ Voice Portal Screen

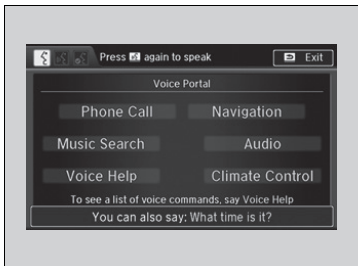

When the  (Talk) button is pressed, available voice commands appear on the screen.

For a complete list of commands, say “Voice Help” after the beep or select **Voice Help**.

You can see the list of commands in **Voice Info** on the Info menu screen. Select **Info**, then select .

■ Phone Call

This can be only used when the phone is connected. When the system recognizes the *Phone call* command, the screen will change the dedicated screen for the voice recognition of the phone.

- Call <Your Contact Name>
- Call <Phone Number>

■ Music Search

This can be only used when the iPod or HDD device is connected.

■ Voice Help

You can see a list of the available commands on the screen.

- *Navigation Commands*
- *Useful Commands*
- *Phone Commands*
- *Audio Commands*
- *On Screen Commands*
- *Music Search Commands*
- *General Commands*
- *Climate Control Commands*
- *All Commands*
- *Voice Settings*
- *Getting Started*

■ Navigation

The screen changes the navigation screen.

- ▶ **Refer to the Navigation System Manual**

■ Audio

When the system recognizes the *Audio* command, the screen will change the dedicated screen for the voice recognition of the audio.

- *Audio On**¹
- *Audio off**¹
- *FM*
- *AM*
- *SXM*
- *Disc*
- *HDD*
- *USB*
- *iPod*
- *Bluetooth® Audio*
- *Pandora**
- *Aha*
- *AUX*

📖 **Audio Commands** P. 214

*1: These commands toggle the function on and off, so the command may not match your intended action.

■ Climate Control

The screen changes the climate control screen.

📖 **Climate Control Commands** P. 215

* Not available on all models

■ Useful Commands

The system accepts these commands on the voice portal top screen.

- *Call <Your Contact Name>*
- *Call <Phone Number>*
- *What time is it?*
- *What is today's date?*

■ Phone Commands

The system accepts these commands on the dedicated screen for the voice recognition of the phone.

- *Call <Your Contact Name>*
- *Call <Phone Number>*

■ Audio Commands

The system accepts these commands on the dedicated screen for the voice recognition of the audio.

■ Radio FM Commands

- *Radio tune to <87.7-107.9> FM*
- *Radio FM preset <1-12>*

■ Radio AM Commands

- *Radio tune to <530-1710> AM*
- *Radio AM preset <1-6>*

■ Radio SXM Commands

- *SXM channel <1-999>*
- *Radio SXM preset <1-12>*

■ Disc Commands

- *Disc play*
- *Disc play track <1-30>*

■ HDD Commands

- *HDD play*
- *HDD play track <1-30>*
- *Music Search*
- *What album is this?*
- *What am I listening to?*

■ iPod Commands

- *iPod play*
- *iPod play track <1-30>*
- *Music Search*
- *What album is this?*
- *What am I listening to?*

■ USB Commands

- *USB play*
- *USB play track <1-30>*

■ Bluetooth® Audio Commands

- *Bluetooth® Audio play*

NOTE:

Bluetooth® Audio commands may not work on some phones or *Bluetooth®* Audio devices.

■ Pandora Commands*

- *Pandora play*

■ Aha Commands

- *Aha radio play*

■ AUX Commands

- *AUX play*

■ On Screen Commands

The system accepts the the voice command operation of the voice recognition screen.

■ Music Search Commands

The system accepts these commands on the **Music Search** screen.

■ Using Song By Voice

Song By Voice™ is a feature that allows you to select music from your iPod or HDD device using Voice Commands. To activate this mode, you must press the  (Talk) button and say: "Music Search".

■ Song By Voice Commands

- *Music Search*
- *What am I listening to?*
- *Who am I listening to?*
- *Who is this?*
- *What's playing?*
- *Who's playing?*
- *What album is this?*

■ Play Commands

- *Play artist <Name>*
- *Play album <Name>*
- *Play song <Name>*
- *Play composer <Name>*
- *Play genre <Name>*
- *Play playlist <Name>*

■ List Commands

- *List artist <Name>*
- *List album <Name>*
- *List composer <Name>*
- *List genre <Name>*
- *List playlist <Name>*

■ General Commands

- *What time is it?*
- *What is today's date?*

■ Climate Control Commands

The system accepts these commands on the **Climate control** screen.

- *Climate Control Automatic*
- *Climate Control On*¹*
- *Climate Control Off*¹*
- *Air conditioner On*¹*
- *Air conditioner Off*¹*
- *Defrost On*¹*
- *Defrost Off*¹*
- *Vent*
- *Dash and Floor*
- *Floor Vents*
- *Floor and Defrost*
- *Fan Speed Up*
- *Fan Speed Down*
- *Fan Speed <1-7>*
- *Temperature Up*
- *Temperature Down*
- *Temperature Max Heat*
- *Temperature Max Cool*
- *Temperature <57-87> Degrees (U.S.)*
- *Temperature <18-32> Degrees (Canada)*

*1: These commands toggle the function on and off, so the command may not match your intended action.

Playing AM/FM Radio

Features

Audio/Information Screen —>

Audio Source —>
Select to change a band or change an audio source.

(Power) Button —>
Press to turn the audio system on and off.

VOL (Volume) Knob (Pushed out) —>
Turn to adjust the volume.

Tune —>
Select to switch to tune mode.

Skip/Seek Icons —>
Select ◀◀ or ▶▶ to search up and down the selected band for a station with a strong signal.

Scan —>
Select to sample each of the strongest stations on the selected band for 10 seconds.

BACK Button —>
Press to go back to the previous display.

On Demand Multi-Use Display™ —>

Preset Icons —>
Select to store a station. To listen to a stored channel, select 1-6 (AM) or 1-12 (FM).

Models with HD Radio™ feature iPod/iPhone —>

TAG —>
Select to tag the song if it is played on an HD Radio™ station. The iPod/iPhone should be connected to the audio system to store the tagged song information on your device.

More —>
Select to display the menu items.

Tune Up/Down Icons —>
Select ◀ or ▶ to tune the radio frequency.

MENU Button —>
Press to display the menu items.





Interface Dial/ENTER Button —>
Press and turn to select preset radio stations. Move up, down, right and left to select secondary menu.





Preset Memory

To store a station:

Interface Dial

1. Tune to the selected station.
2. Press the **MENU** button.
3. Rotate  to select **Save Preset**, then press .
4. Rotate  to select the preset number you want to store that station, then press .

You can also store that station by the following procedure.

1. Tune to the selected station.
2. Rotate  to select the preset number you want to store the station.
3. Press and hold  for a few seconds.

On Demand Multi-Use Display™

1. Tune to the selected station.
2. Select **More**.
3. Select **Save Preset**.
4. Select the preset number you want to store that station.

You can also store that station by the following procedure.

1. Tune to the selected station.
2. Change the display to the preset screen.
3. Select and hold the preset number you want to store that station.

▶▶ Playing AM/FM Radio

You can control the AM/FM radio using voice commands.

▶ **Voice Control Operation** P. 211

The **ST** indicator appears on the display indicating stereo FM broadcasts.
Stereo reproduction in AM is not available.

Switching the Audio Mode

Press the **SOURCE** button on the steering wheel.

▶ **Audio Remote Controls** P. 195

You can also switch the mode by pressing the **MENU** button and selecting **Change Source** on the **Audio menu** screen.

You can store 6 AM stations and 12 FM stations into the preset memory.

Models with HD Radio™ feature

HD Radio Technology manufactured under license from iBiquity Digital Corporation. U.S. and Foreign Patents. HD Radio™ and the HD, HD Radio, and "Arc" logos are proprietary trademarks of iBiquity Digital Corp.



Radio Data System (RDS)

Provides text data information related to your selected RDS-capable FM station.

To find an RDS station from Station List



1. Move ◀ or ▶ to select the **Station List** tab.
2. Rotate to select the station, then press .

Manual update

Updates your available station list at any time.

1. Press the **MENU** button while listening to an FM station.
2. Rotate to select **Refresh Station List**, then press .

▶▶ Playing AM/FM Radio

Models with HD Radio™ feature

iTunes Tagging

“iTunes” in “iTunes Tagging” is a trademark of Apple Inc. When an HD Radio™ station is selected, the **HD** indicator appears on the audio/information screen and On Demand Multi-Use Display™.

If you want to have the information on the song played from the HD Radio™ station, select **TAG** in On Demand Multi-Use Display™ or select **Tag Song** in the menu with Interface dial.

If iPod/iPhone is connected, the tag is transferred to the connected device immediately, otherwise the tag will be transferred when the device will be connected and select **Tag Song** in the menu with Interface dial.

■ Radio text

Display the radio text information of the selected RDS station.

1. Press the **MENU** button.
2. Rotate  to select **Radio Text**, then press .

■ Scan

Samples each of the strongest stations on the selected band for 10 seconds.

Interface Dial

1. Press the **MENU** button.
2. Rotate  to select **Scan**, then press .

To turn off scan, press  to select **Cancel Scan**, or press the **BACK** button.

On Demand Multi-Use Display™

 **Playing AM/FM Radio** P. 216



To turn off scan, select **Stop Scan**.

Models with HD Radio™ feature**■ Tag song to device**

You can store the TAG information in the connected iPod/iPhone.

If the iPod/iPhone is not connected to the audio system, the information is stored in the audio unit temporarily, then once the device is connected to the system, data is transferred to the iPod/iPhone.

To store the TAG information to the iPod/iPhone, or the audio system:

1. Press the **MENU** button.
2. Rotate  to select **Tag Song**, then press .
3. Select the song you want to save the information.

▶▶ Radio text

The text indicator comes on when you received a text message. The indicator stays on until you read the message.

■ Tagged song list





Displays the TAG information saved to the audio system.

1. Press the **MENU** button.
2. Rotate  to select **Tagged Song List**, then press .



■ HD subchannel

Displays the subchannel list when an HD Radio™ station is selected.

Interface Dial

1. Press the **MENU** button.
2. Rotate  to select **HD Subchannel**, then press .
3. Rotate  to select a channel from a list, then press .

On Demand Multi-Use Display™

Select the  or  when the subchannel number is displayed.

You can also select the channel by the following procedure.

1. Select **More**.
2. Select **HD Subchannel**.
3. Select the channel number.

Playing SiriusXM® Radio

Audio/Information Screen —>

Audio Source —>
Select to change an audio source.

(Power) Button —>
Press to turn the audio system on and off.

VOL (Volume) Knob (Pushed out) —>
Turn to adjust the volume.

Tune
Select to switch to tune mode.

Skip/Seek Icons
Select **◀◀** or **▶▶** to the previous or next channel.
In channel mode, select and hold to change the channel rapidly.

Scan
Select to sample each of the strongest stations on the selected band for 10 seconds.

BACK Button —>
Press to go back to the previous display.

On Demand Multi-Use Display™ —>

Preset Icons
Select to store a station.
To listen to a stored channel, select 1-12.

More
Select to display the menu items.

Category Up/Down Icons
Select **◀** or **▶** to display and select an SiriusXM® Radio category.

MENU Button —>
Press to display the menu items.





Interface Dial/ENTER Button —>
Press and turn to select preset radio stations.
Move up, down, right and left to select secondary menu.

Features

■ To Play the SiriusXM® Radio

1. Select the SiriusXM® mode.
 - ▶ **Audio Remote Controls** P. 195
 - ▶ **On Demand Multi-Use Display™** P. 197

Interface Dial





2. Press the **MENU** button.
3. Rotate  to select **Channel List**, then press .
4. Rotate  to select a channel from a list, then press .

On Demand Multi-Use Display™

2. Select a channel using the , , ,  icons on the tune mode screen or the preset numbers (1-12) on the preset mode screen.

To change the tune mode:

Interface Dial

1. Press the **MENU** button.
2. Rotate  to select **XM Tune Mode**, then press .
3. Rotate  to select **Channel Mode** or **Category Mode**, then press .

On Demand Multi-Use Display™

1. Select **More**.
2. Select **XM Tune Mode**.
3. Select **Channel Mode** or **Category Mode**.

▶▶ Playing SiriusXM® Radio

You can control the SiriusXM® radio using voice commands.

- ▶ **Voice Control Operation** P. 211

In the channel mode, all available channels are selectable. In the category mode, you can select a channel within a category (Jazz, Rock, Classical, etc.).





There may be instances when SiriusXM® Radio does not broadcast all the data fields (artist name, title). This does not indicate a problem with your audio system.

SiriusXM® Radio stations load in ascending order, which can take about a minute. Once they have loaded you will be able to scroll up or down to make your selections.



■ Preset Memory

To store a station:

Interface Dial

1. Tune to the selected station.
2. Press the **MENU** button.
3. Rotate  to select **Save Preset**, then press .
4. Rotate  to select the preset number you want to store that station, then press .

You can also store that station by the following procedure.

1. Tune to the selected station.
2. Rotate  to select the preset number you want to store the station.
3. Press and hold  for a few seconds.

On Demand Multi-Use Display™

1. Tune to the selected station.
2. Select **More**.
3. Select **Save Preset**.
4. Select the preset number you want to store that station.

You can also store that station by the following procedure.

1. Tune to the selected station.
2. Change the display to the preset screen.
3. Select and hold the preset number you want to store that station.

▶▶ Playing SiriusXM® Radio

You can store 12 SiriusXM® stations into the preset memory.

Playing a CD

Your audio system supports audio CDs, CD-Rs and CD-RWs in either MP3, WMA, or AAC*1 format. With the CD loaded, select the CD mode.

Audio/Information Screen — Points to the top display area showing CD mode, track list, and album information.

Audio Source — Select to change an audio source.

(Power) Button — Press to turn the audio system on and off.

VOL (Volume) Knob (Pushed out) — Turn to adjust the volume.

Scan — Select to use a scan feature.

Random — Select to use a random feature.

Interface Dial/ENTER Button — Press and turn to select an item, then press to set your selection. Move up, down, right and left to select secondary menu.

BACK Button — Press to go back to the previous display.

On Demand Multi-Use Display™ — Points to the top right of the screen.

CD Slot — Insert a CD about halfway into the CD slot.

(CD Eject) Button — Press to eject a CD.

Folder Up/Down Icons — Select ▶ to skip to the next folder, and ◀ to skip to the beginning of the previous folder in MP3, WMA, or AAC.

Repeat — Select to use a repeat feature.

More — Select to display the menu items.

Skip/Seek Icons — Select ◀◀ or ▶▶ to change tracks (files in MP3, WMA, or AAC). Select and hold to move rapidly within a track/file.

MENU Button — Press to display the menu items.

*1: Only AAC format files recorded with iTunes are playable on this unit.



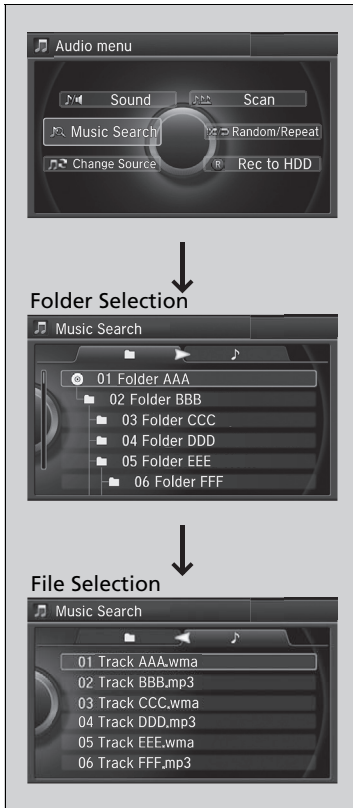



How to Select a File from the Music Search List (MP3/WMA/AAC)



1. Press the **MENU** button.
2. Rotate  to select **Music Search**, then press .

3. Rotate , move  or , then press  to select a file from the **Music Search** list.

You can also select a file by the following procedure.

1. Rotate  or press  to display the song list.
2. Rotate , move  or , then press  to select a file from the list.

▶▶ Playing a CD

NOTICE

Do not use CDs with adhesive labels. The label can cause the CD to jam in the unit.

WMA and AAC files protected by digital rights management (DRM) cannot be played. The audio system displays **Unplayable File**, then skips to the next file.

Text data appears on the display under the following circumstances:

- When you select a new folder, file, or track.
- When you change the audio mode to CD.
- When you insert a CD.

If you eject the CD but do not remove it from the slot, the system reloads the CD automatically after several seconds.

You can control a CD audio using voice commands.

▶ **Voice Control Operation** P. 211

■ How to Select a Play Mode

You can select scan, repeat, and random modes when playing a track or file.



Interface Dial

1. Press the **MENU** button.
2. Rotate to select **Scan** or **Random/Repeat**, then press .
3. Rotate to select a mode, then press .

On Demand Multi-Use Display™

1. Select **Scan**, **Random**, or **Repeat**.
Playing a CD P. 224
2. Select a mode.

■ To turn off a play mode

Interface Dial

1. Press the **MENU** button.
2. Rotate to select the mode you want to turn off, then press .

On Demand Multi-Use Display™

1. Select **Scan**, **Random**, or **Repeat**.
Playing a CD P. 224
2. Select the mode you want to turn off.

▶▶ How to Select a Play Mode

Play Mode Menu Items

Scan

Scan Folders (MP3/WMA/AAC): Provides 10-second sampling of the first file in each of the main folders.

Scan Tracks: Provides 10-second sampling of all tracks on the CD (all files in the current folder in MP3, WMA, or AAC).

Random/Repeat

Repeat Folder (MP3/WMA/AAC): Repeats all files in the current folder.

Repeat Track: Repeats the current track/file.

Random in Folder (MP3/WMA/AAC): Plays all files in the current folder in random order.

Random All Tracks: Plays all tracks/files in random order.

Playing Hard Disk Drive (HDD) Audio

The Hard Disk Drive (HDD) Audio function plays tracks from music CDs that have been recorded onto the built-in HDD. You can arrange the tracks in playlists or play the tracks using various search methods.

Audio/Information Screen — Points to the top display showing 'HDD' and track information.

Audio Source — Select to change an audio source.

(Power) Button — Press to turn the audio system on and off.

VOL (Volume) Knob (Pushed out) — Turn to adjust the volume.

Scan — Select to use a scan feature.

Random — Select to use a random feature.

Interface Dial/ENTER Button — Press and turn to select an item, then press to set your selection. Move up, down, right and left to select secondary menu.

BACK Button — Press to go back to the previous display or cancel a setting.

On Demand Multi-Use Display™ — Points to the top display showing track details.

CD Slot — Insert a CD about halfway into the CD slot.

(CD Eject) Button — Press to eject a CD.

Playlist/Album Up/Down Icons — Select ▶ to skip to the next playlist/album, and ◀ to skip to the beginning of the previous playlist/album.

Repeat — Select to use a repeat feature.

More — Select to display the menu items.

Skip/Seek Icons — Select ◀◀ or ▶▶ to change tracks. Select and hold to move rapidly within a track.

MENU Button — Press to display the menu items.

SETTINGS Button — Press to go the Setting menu screen.

■ Recording a Music CD to HDD

The songs on music CDs are automatically recorded by factory default to the HDD the first time you play each disc. You can then play the songs directly from the HDD.

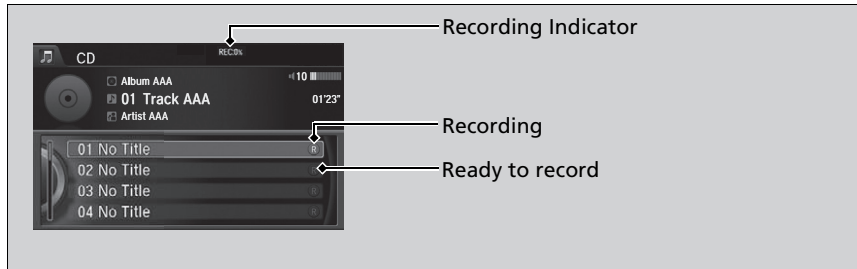

■ Stop Recording

1. Press the **MENU** button.
2. Rotate to select **Cancel Record to HDD**, then press .

■ Recording a CD Manually

1. Press the **MENU** button.
2. Rotate to select **Rec to HDD**, then press .

▶▶ Recording a Music CD to HDD

You can add tracks to user playlists, where you can mix and match tracks from other CDs recorded on the HDD.

- ▶▶ **Editing an Album or Playlist** P. 231
- ▶▶ **Editing Track Information** P. 234

If you stop the engine or the power system is turned off while recording a CD, there may be pauses between songs when you play back from the HDD.

Repeat, random, and scan functions are not available during recording.

You can play music from other sources (e.g., SiriusXM®, HDD, etc.) while recording.

Please note that there is no compensation offered in the case of unsuccessful recording of audio data or the loss of audio data due to any cause whatsoever.

Clearing the HDD
Any music tracks stored on the HDD can be deleted.

- ▶▶ **Deleting all HDD Data** P. 287

How to Select a Track from the Music Search List

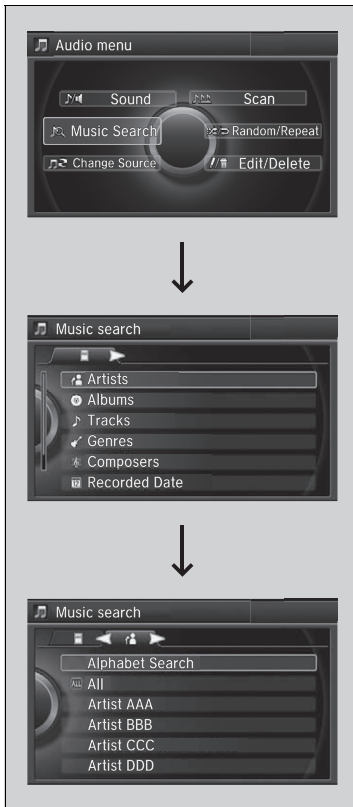

1. Press the **MENU** button.
2. Rotate to select **Music Search**, then press .
3. Rotate , move or , then press to select a track from the **Music Search** list.
 - ▶ Title information is displayed if found in the Gracenote® Album Info (Gracenote® Media Database) stored on the HDD.
 - ▶ The HDD has two types of playlists: original playlists and user playlists. An original playlist is automatically created for each album when a music CD is recorded. You can customize up to six user playlists provided on the HDD by adding tracks from your original playlists.

You can also select a track by the following procedure.

1. Rotate or press to display the song list.
2. Rotate , move or , then press to select a track from the list.

How to Select a Track from the Music Search List

You can control the HDD audio using voice commands.

- ▶ **Voice Control Operation** P. 211
- ▶ **Song By Voice™ (SBV)** P. 241

Music tracks recorded on HDD cannot be recorded onto CDs or other devices.

Tracks are recorded at four times the playback speed using ultra-efficient compression technology; therefore, sound quality may vary slightly from the original.

If the HDD is ever replaced, all music data is lost and cannot be recovered.

If there is a problem, you may see an error message on the display.





- ▶ **Hard Disk Drive (HDD) Audio** P. 254

How to Select a Play Mode

You can select scan, repeat, and random modes when playing a track.



Interface Dial



1. Press the **MENU** button.
2. Rotate  to select **Scan** or **Random/Repeat**, then press .
3. Rotate  to select a mode, then press .

On Demand Multi-Use Display™

1. Select **Scan**, **Random**, or **Repeat**.
 **Playing Hard Disk Drive (HDD) Audio**
P. 227
2. Select a mode.

To turn off a play mode

Interface Dial

1. Press the **MENU** button.
2. Rotate  to select the mode you want to turn off, then press .

On Demand Multi-Use Display™

1. Select **Scan**, **Random**, or **Repeat**.
 **Playing Hard Disk Drive (HDD) Audio** P. 227
2. Select the mode you want to turn off.

How to Select a Play Mode

Play Mode Menu Items

Scan

Scan Albums: Provides 10-second sampling of the first track in each album.

Scan Tracks: Provides 10-second sampling of all tracks on HDD.

Random/Repeat

The following menu items vary depending on the category you selected by the **Music Search** list.

Repeat Artist: Repeats all tracks in the current artist.

Repeat Album: Repeats all tracks in the current album.

Repeat Track: Repeats the current track.

Random in Artist: Plays all tracks in the current artist in random order.

Random in Album: Plays all tracks in the current album in random order.

Random All Tracks: Plays all tracks in random order.

Editing an Album or Playlist

Change the playlist name, album name, genre, and track order of the current playlist. You can also delete tracks, playlists, and albums.



Editing an album

1. Press the **MENU** button.
2. Rotate to select **Edit/Delete**, then press .
3. Rotate to select **Albums**, then press .
 - ▶ The pop-up menu appears on the screen.
4. Rotate to select an album that you want to edit or delete, then press .
5. To edit an album name:
 - Rotate to select **Edit Name**, then press .
 - ▶ Enter the name using the interface dial or the On Demand Multi-Use Display™.

To delete an album:

Rotate to select **Delete**, then press .

To edit track information or delete a track:

Rotate to select **List Tracks**, then press .

▶ **Editing Track Information** P. 234

Editing an Album or Playlist

The maximum number of songs in each of the six user playlists is 999. Adding new songs overwrites the oldest songs.

The maximum number of original playlists is 999 with a maximum of 99 songs in each playlist.

Each album CD counts as an original playlist. Adding a track from a user playlist into the same user playlist will cause the track to appear twice in the playlist.

Deleting an album (original playlist) also deletes the album tracks you have stored in any user playlists.

Deleting a user playlist or deleting all tracks from a user playlist does not remove the playlist folder. The folder retains the playlist name and artist information.

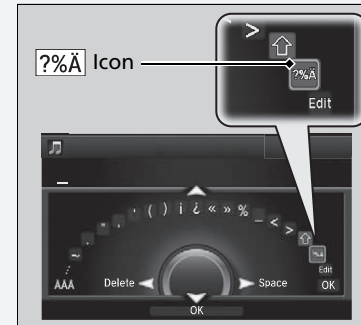

Select **?%A** to enter symbols.

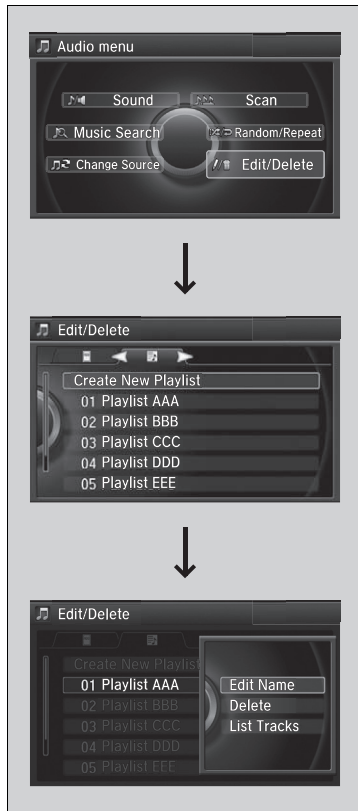

■ Editing a playlist

1. Press the **MENU** button.
2. Rotate to select **Edit/Delete**, then press .
3. Rotate to select **Playlists**, then press .
 - ▶ The pop-up menu appears on the screen.
4. Rotate to select a playlist that you want to edit or delete, then press .
5. To edit a playlist name:
 - Rotate to select **Edit Name**, then press .
 - ▶ Enter the name using the interface dial or the On Demand Multi-Use Display™.

To delete a playlist:

Rotate to select **Delete**, then press .





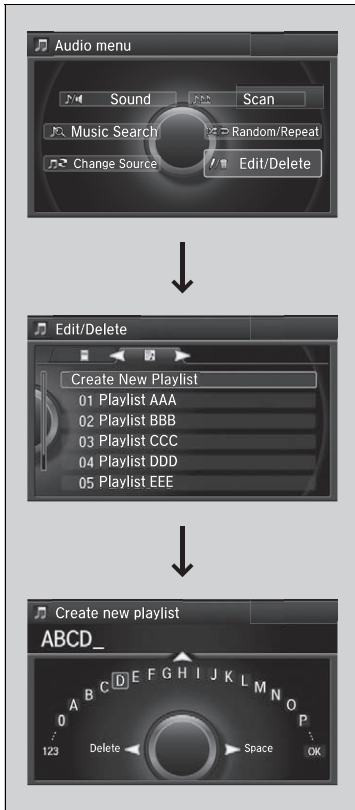

To edit track information or delete a track:

Rotate to select **List Tracks**, then press .

▶ **Editing Track Information** P. 234











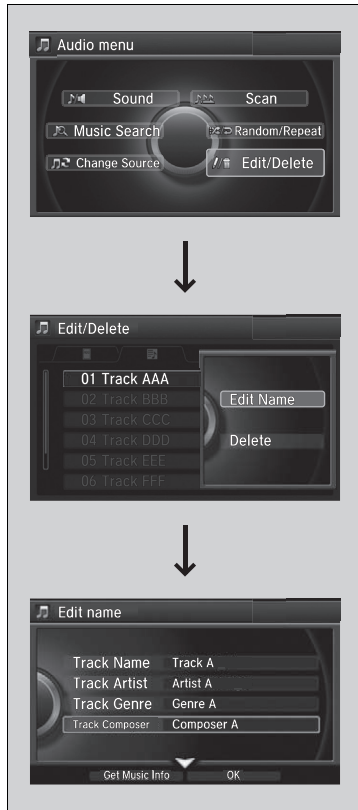



■ Creating a new playlist

1. Press the **MENU** button.
2. Rotate  to select **Edit/Delete**, then press .
3. Rotate  to select **Playlists**, then press .
4. Rotate  to select **Create New Playlist**, then press .
 - ▶ Enter the name using the interface dial or the On Demand Multi-Use Display™, then select tracks from the **Music Search** list.

■ Editing Track Information

Change the track title, artist name, genre and composer. You can also delete tracks.



1. Press the **MENU** button.
2. Rotate  to select **Edit/Delete**, then press .
3. Rotate  to select **Tracks**, then press .
4. Rotate  to select a track you want to edit or delete, then press .
▶ The pop-up menu appears on the screen.
5. To edit track information:
Rotate  to select **Edit Name**, then press .
▶ Enter the track name, track artist, etc. using the interface dial or the On Demand Multi-Use Display™. Move , rotate  to select **OK**, then press .











To delete a track:

Rotate  to select **Delete**, then press .

■ Displaying Music Information

Music information (album name, artist name, genre) can be acquired by accessing the Gracenote® Album Info.



1. Press the **MENU** button.
2. Rotate  to select **Edit/Delete**, then press .
3. Rotate  to select **Albums**, then press .
4. Rotate  to select an album you want to edit, then press .
 - ▶ The pop-up menu appears on the screen.
5. Rotate  to select **Edit Name**, then press .
6. Move  to select **Get Music Info**, then press .
 - ▶ The system starts to access the Gracenote® Album Info.

■ Updating Gracenote® Album Info

Update the Gracenote® Album Info (Gracenote® Media Database) that is included with the navigation system.

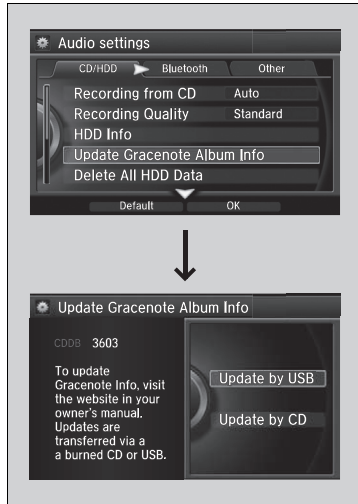

1. Insert the update disc into the disc slot or connect the USB flash drive that includes the update.
2. Press the **SETTINGS** button in the HDD mode.
3. Move ◀ or ▶ to select the **CD/HDD** tab.
4. Rotate to select **Update Gracenote Album Info**, then press .
5. Rotate to select **Update by USB** or **Update by CD**, then press .
 - ▶ The system starts updating and the confirmation message appears on the screen. Press to finish.

▶▶ Updating Gracenote® Album Info

To acquire updated files:

- Consult a dealer.
- U.S.: Visit www.acura.com.
- Canada: Visit www.acura.ca.

Once you perform an update, any information you edited before will be overwritten or erased.

Playing an iPod

Connect the iPod using your dock connector to the USB port, then select the iPod mode.

 **USB Port** P. 193

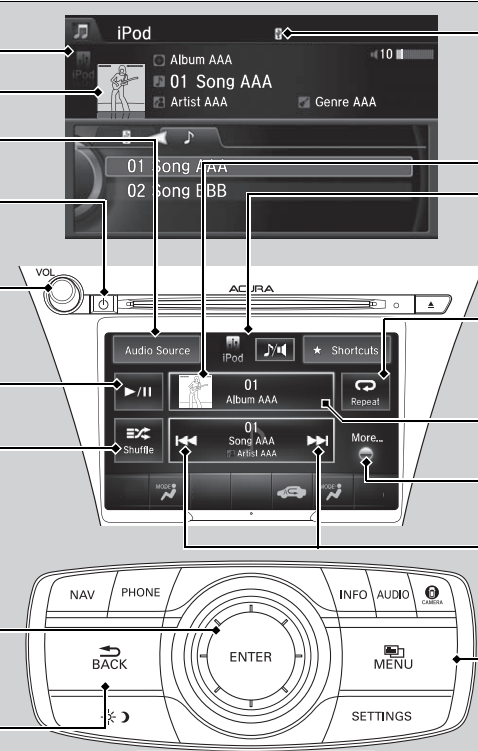

Audio/Information Screen — Points to the top section of the iPod screen.

Album Art — Points to the album art icon on the iPod screen.

Audio Source — Select to change an audio source.

(Power) Button — Press to turn the audio system on and off.

VOL (Volume) Knob (Pushed out) — Turn to adjust the volume.

Play/Pause Icon — Select to resume or play a song.

Shuffle — Select to use a shuffle feature.

Interface Dial/ENTER Button — Press and turn to select an item, then press to set your selection. Move up, down, right and left to select secondary menu.

BACK Button — Press to go back to the previous display.

USB Indicator — Appears when an iPod is connected.

Album Art Icon — Points to the album art icon on the iPod screen.

On Demand Multi-Use Display™ — Points to the iPod screen.

Repeat — Select to use a repeat feature.

Album Bar — Select to search for an album.

More — Select to display the menu items.

Skip/Seek Icons — Select **⏮** or **⏭** to change songs. Select and hold to move rapidly within a song.

MENU Button — Press to display the menu items.

Features

■ How to Select an Album

You can select albums in the category you selected by the **Music Search** list.

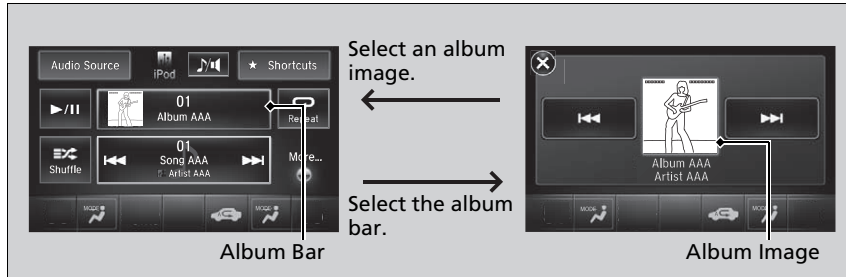

1. Select the album bar.
 - ▶ The image of the current album is displayed.
2. Select **◀◀** or **▶▶** icon to search for an album.
 - ▶ When the album image you are looking for appears, select it to play.

▶▶ How to Select an Album

This function may not be available depending on models or versions.

Select **[X]** to go back to the previous screen.

How to Select a Song from the Music Search List

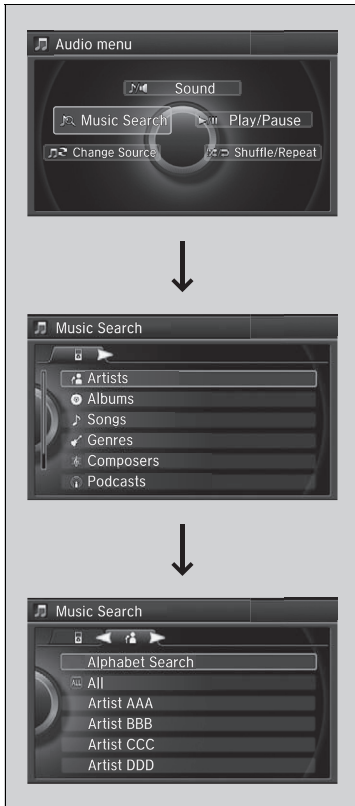

1. Press the **MENU** button.
2. Rotate to select **Music Search**, then press .

3. Rotate , move or , then press to select a song from the **Music Search** list.

You can also select a song by the following procedure.

1. Rotate or press to display the song list.
2. Rotate , move or , then press to select a song from the list.

How to Select a Song from the Music Search List

You can control an iPod using voice commands.

- ▶ **Voice Control Operation** P. 211
- ▶ **Song By Voice™ (SBV)** P. 241

Available operating functions vary on models or versions. Some functions may not be available on the vehicle's audio system.

If there is a problem, you may see an error message on the audio/information screen.

- ▶ **iPod/USB Flash Drive** P. 255

How to Select a Play Mode

You can select repeat and shuffle modes when playing a file.



Interface Dial

1. Press the **MENU** button.
2. Rotate to select **Shuffle/Repeat**, then press .
3. Rotate to select a mode, then press .

On Demand Multi-Use Display™

1. Select **Shuffle** or **Repeat**.
 Playing an iPod P. 237
2. Select a mode.

To turn off a play mode

Interface Dial

1. Press the **MENU** button.
2. Rotate to select the mode you want to turn off, then press .

On Demand Multi-Use Display™

1. Select **Shuffle** or **Repeat**.
 Playing an iPod P. 237
2. Select the mode you want to turn off.

How to Select a Play Mode

Play Mode Menu Items

Repeat Song: Repeats the current track.

Shuffle Albums: Plays all available albums in a selected list (playlists, artists, albums, songs, genres, or composers) in random order.

Shuffle All Songs: Plays all available files in a selected list (playlists, artists, albums, songs, genres, or composers) in random order.

Song By Voice™ (SBV)

Use SBV to search for and play music from your HDD or iPod using voice commands.

■ To enable SBV

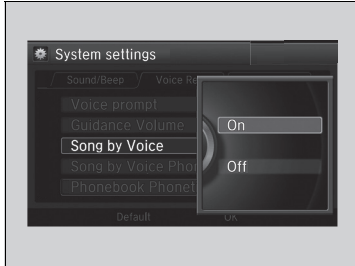

1. Press the **SETTINGS** button.
2. Rotate to select **System Settings**, then press .
3. Move or to select the **Voice Reco** tab.
4. Rotate to select **Song by Voice**, then press .
5. Rotate to select **On** or **Off**, then press .



☒ Song By Voice™ (SBV)

Setting options:

- **On** (factory default): Song By Voice™ commands are available.
- **Off**: Disable the feature.

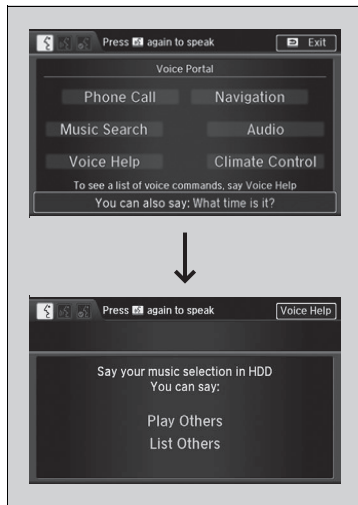
■ Searching for music using SBV



1. Set the **Song by Voice** setting to **On**.
2. Press the  (Talk) button and say "Music Search" to activate the SBV feature for the HDD and iPod.
3. Press the  button and say a command.
 - ▶ Example 1: Say "(List) 'Artist A'" to view a list of songs by that artist. Select the desired song to start playing.
 - ▶ Example 2: Say "Play 'Artist A'" to start playing songs by that artist.
4. To cancel SBV, press the  (hang-up/back) button on the steering wheel. The selected song continues playing.

Once you have canceled this mode, you need to press the  button and say "Music Search" again to re-activate this mode.

▶▶ Searching for music using SBV

Song By Voice™ Commands List

▶ **Song By Voice Commands** P. 215

NOTE:

Song By Voice™ commands are available for tracks stored on the HDD or iPod.

You can add phonetic modifications of difficult words so that it is easier for SBV to recognize artists, songs, albums, and composers in voice commands.

▶ **Phonetic Modification** P. 243

Phonetic Modification

Add phonetic modifications of difficult or foreign words so that it is easier for SBV to recognize artists, songs, albums, and composers in voice commands when searching for music on the HDD or iPod.



1. Press the **SETTINGS** button.
2. Rotate to select **System Settings**, then press .
3. Move or to select the **Voice Reco** tab.
4. Rotate to select **Song by Voice Phonetic Modification**, then press .
5. Move and rotate to select **New Modification**, then press .
6. Rotate to select **HDD** or **iPod**, then press .

Phonetic Modification

Phonetic Modification is grayed out when **Song By Voice** is set to **Off**.

You can store up to 2,000 phonetic modification items.

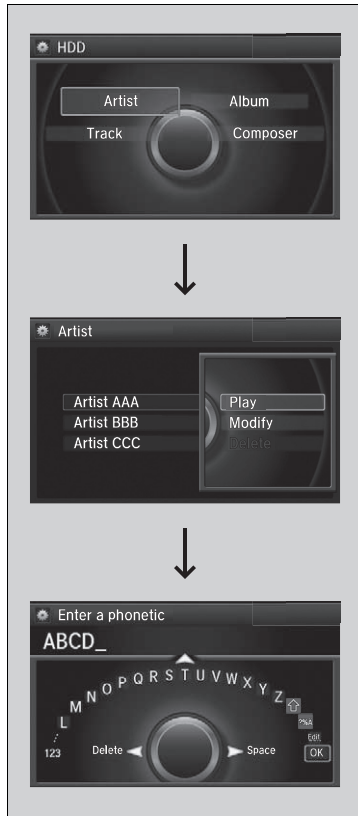

7. Rotate to select the item to modify (e.g., **Artist**), then press .
 - ▶ The list of the selected item appears on the screen.
8. Rotate to select an entry (e.g., **No Name**), then press .
 - ▶ The pop-up menu appears on the screen.
 - ▶ The listen to the current phonetic modification, rotate to select **Play**, then press .
 - ▶ To delete the current phonetic modification, rotate to select **Delete**, then press .
9. Rotate to select **Modify**, then press .
10. Enter the phonetic spelling you wish to use (e.g., "Artist A") when prompted.
11. Move to select **OK** to exit.
 - ▶ The artist "No Name" is phonetically modified to "Artist A." When in the SBV mode, you can press the (Talk) button and use the voice command "Play 'Artist A'" to play songs by the artist "No Name."

Compatible phones only

Playing Internet Radio

Connect a compatible phone through *Bluetooth*®.

iPhone

You can also connect the phone using your dock connector to the USB port.

Select **Audio Source** to select Pandora or Aha mode.

▶▶ Playing Internet Radio

Pandora®, the Pandora logo, and the Pandora trade dress are trademarks or registered trademarks of Pandora Media, Inc., used with permission. Pandora is currently available exclusively in the United States.

Audio/Information Screen — Points to the top section of the Pandora app interface.

Album Art — Points to the album art displayed in the Pandora app.

Audio Source — Select Pandora® or Aha™.

(Power) Button — Press to turn the audio system on and off.

VOL (Volume) Knob (Pushed out) — Turn to adjust the volume.

Play/Pause Icon — Select to resume or play a song.

BACK Button — Press to go back to the previous display.

Interface Dial/ENTER Button — Press and turn to select an item, then press to set your selection. Move up, down, right and left to select secondary menu.

Bluetooth® Indicator — Appears when your phone is connected to HFL.

USB Indicator — Appears when a phone is connected.

Rating Icon —

On Demand Multi-Use Display™ —

Station Up/Down Icons — Select to change a station.

Skip Icon — Select to skip a song.

More — Select to display the menu items.

Like/Dislike Icons — Select to evaluate a song.

Features

U.S. models



Pandora® Menu

You can operate some of the Pandora® menu items from your vehicle's audio system. The available items are:

- **Skip Forward**
- **Play/Pause**
- **Station List**
- **Like**
- **Dislike**
- **Bookmark Track**
- **Bookmark Artist**
- **Change Source**
- **Sound**

Operating a menu item

The menu items are shown in the lower half of the audio/information screen.

Rotate  to select an item and press .

To select **Change Source** or **Sound**, press the **MENU** button, then press .



▶▶ Playing Internet Radio

To find out if your phone is compatible with this feature, visit www.acura.com/handsfreelink, or call 1-888-528-7876.

Pandora® is a personalized Internet radio service that selects music based on an artist, song, or genre a user enters, and streams what is likely to be of interest.

To use this service in your vehicle, the Pandora® app must first be installed on your phone. Visit www.pandora.com for more information.

If you cannot operate Pandora® through the audio system, it may be streaming through *Bluetooth®* Audio. Make sure Pandora® mode on your audio system is selected.

▶▶ Pandora® Menu

You can control Pandora® using voice commands.

▶▶ Voice Control Operation P. 211

Available operating functions vary on software versions. Some functions may not be available on the vehicle's audio system.

If there is a problem, you may see an error message on the audio/information screen.

▶▶ Pandora® P. 256

There are restrictions on the number of songs you can skip or dislike in a given hour.

Aha™ Radio Menu



You can operate some of the Aha™ menu items from your vehicle's audio system. The available items are:

- Like
- Dislike
- Play/Pause
- 15sec Back
- 30sec Skip
- Sound
- View text
- View list
- Reply
- Change Source
- Stations

Operating a menu item



The menu items are shown in the lower half of the audio/information screen.

Rotate  to select an item and press .

To select **Sound**, **Change Source** or **Stations**, press the **MENU** button, then press .

Aha™ Radio Menu

Aha™ by Harman is a cloud-based service that organizes your favorite web content into live radio stations. You can access podcasts, internet radio, location-based services, and audio updates from social media sites.

You can control Aha™ Radio using voice commands.

 **Voice Control Operation** P. 211

Available operating functions vary on software versions. Some functions may not be available on the vehicle's audio system.

If there is a problem, you may see an error message on the audio/information screen.

 **Aha™ Radio** P. 257

The menu items vary depending on the station you selected.

To use this service in your vehicle, the AcuraLink app must be installed on your phone. Visit owners.acura.com/apps for more information.

You must have a previously set up Aha account prior to using the service in your vehicle. Visit www.aharadio.com for more information.

Playing a USB Flash Drive

Your audio system reads and plays sound files on a USB flash drive in either MP3, WMA, or AAC*1 format.

Connect your USB flash drive to the USB port, then select the USB mode.

➤ **USB Port** P. 193

Audio/Information Screen — Points to the top display area showing 'USB' mode and track information.

Audio Source — Select to change an audio source.

(Power) Button — Press to turn the audio system on and off.

VOL (Volume) Knob (Pushed out) — Turn to adjust the volume.

Scan — Select to use a scan feature.

Random — Select to use a random feature.

BACK Button — Press to go back to the previous display.

Interface Dial/ENTER Button — Press and turn to select an item, then press to set your selection. Move up, down, right and left to select secondary menu.

USB Indicator — Appears when a USB flash drive is connected.

On Demand Multi-Use Display™ — Points to the main display area showing track lists.

Folder Up/Down Icons — Select ▶ to skip to the next folder, and ◀ to skip to the beginning of the previous folder.

Repeat — Select to use a repeat feature.

More — Select to display the menu items.

Skip/Seek Icons — Select ◀◀ or ▶▶ to change files. Select and hold to move rapidly within a file.

MENU Button — Press to display the menu items.

*1: Only AAC format files recorded with iTunes are playable on this unit.

How to Select a File from the Music Search List

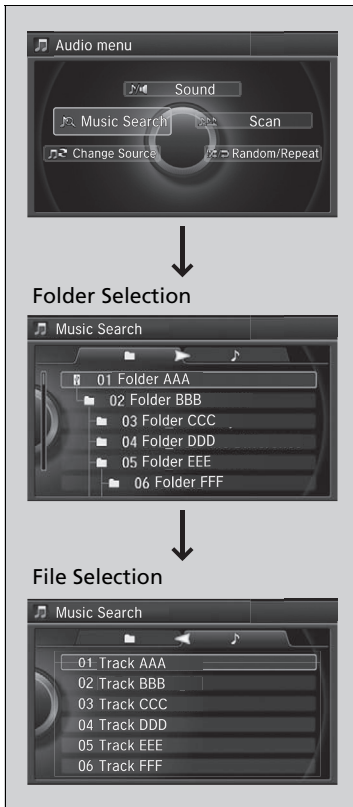

1. Press the **MENU** button.
2. Rotate to select **Music Search**, then press .

3. Rotate , move or , then press to select a file from the **Music Search** list.

You can also select a file by the following procedure.

1. Rotate or press to display the song list.
2. Rotate , move or , then press to select a file from the list.

▶▶ Playing a USB Flash Drive

You can control a USB flash drive using voice commands.

▶ **Voice Control Operation** P. 211

Use the recommended USB flash drives.

▶ **General Information on the Audio System**
P. 258

Files in WMA/AAC format protected by digital rights management (DRM) cannot be played.

The audio system displays **Unplayable File**, and then skips to the next file.

If there is a problem, you may see an error message on the audio/information screen.

▶ **iPod/USB Flash Drive** P. 255

How to Select a Play Mode

You can select scan, repeat, and random modes when playing a file.



Interface Dial

1. Press the **MENU** button.
2. Rotate to select **Scan** or **Random/Repeat**, then press .
3. Rotate to select a mode, then press .

On Demand Multi-Use Display™

1. Select **Scan**, **Random**, or **Repeat**.
 Playing a USB Flash Drive P. 248
2. Select a mode.

To turn off a play mode

Interface Dial

1. Press the **MENU** button.
2. Rotate to select the mode you want to turn off, then press .

On Demand Multi-Use Display™

1. Select **Scan**, **Random**, or **Repeat**.
 Playing a USB Flash Drive P. 248
2. Select the mode you want to turn off.

How to Select a Play Mode

Play Mode Menu Items

Scan

Scan Folders: Provides 10-second sampling of the first file in each of the main folders.

Scan Tracks: Provides 10-second sampling of all files in the current folder.

Random/Repeat

Repeat Folder: Repeats all files in the current folder.

Repeat Track: Repeats the current file.

Random in Folder: Plays all files in the current folder in random order.

Random All Tracks: Plays all files in random order.

Playing *Bluetooth*® Audio

Your audio system allows you to listen to music from your *Bluetooth*-compatible phone.

This function is available when the phone is paired and connected to the vehicle's *Bluetooth*® HandsFreeLink® (HFL) system.

☒ **Phone Setup** P. 296

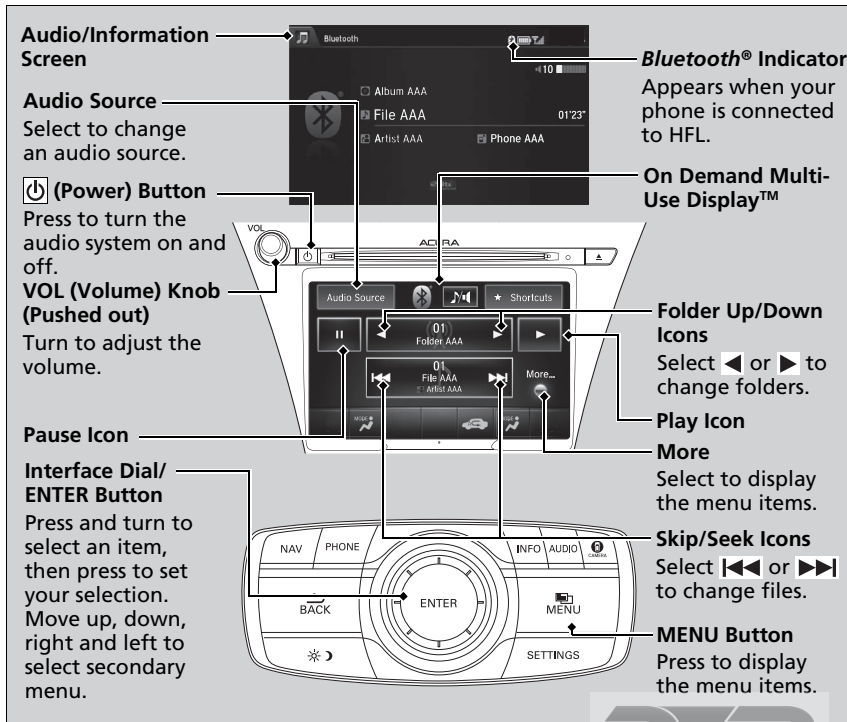

☒ Playing *Bluetooth*® Audio

Not all *Bluetooth*-enabled phones with streaming audio capabilities are compatible with the system.

For a list of compatible phones:

- U.S.: Visit www.acura.com/handsfreelink, or call 1-888-528-7876.
- Canada: Visit www.handsfreelink.ca, or call 1-888-528-7876.

In some states, it may be illegal to perform some data device functions while driving.

If more than one phone is paired to the HFL system, there will be a delay before the system begins to play.

You can control *Bluetooth*® Audio using voice commands.

☒ **Voice Control Operation** P. 211

■ To Play *Bluetooth*® Audio Files





1. Make sure that your phone is paired and connected to HFL.
2. Select the *Bluetooth*® Audio mode.

If the phone is not recognized, another HFL-compatible phone, which is not compatible for *Bluetooth*® Audio, may already be connected.

■ To pause or resume a file

Interface Dial

1. Press the **MENU** button.
2. Rotate  to select **Play** or **Pause**, then press .

On Demand Multi-Use Display™

Select the play icon or pause icon.

■ Switching to HFL

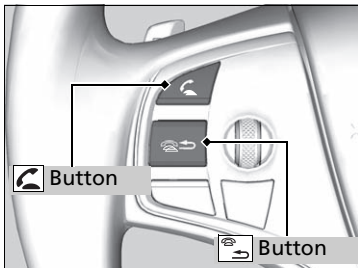

Press the  (pick-up) button on the steering wheel to receive a call when *Bluetooth*® Audio is playing.

➤ *Bluetooth*® HandsFreeLink® P. 290

Press the  (hang-up/back) button to end the call and return to *Bluetooth*® Audio.

▶▶ To Play *Bluetooth*® Audio Files

To play the audio files, you may need to operate your phone. If so, follow the phone maker's operating instructions.

The pause function may not be available on some phones.



Switching to another mode pauses the music playing from your phone. This function may not be available on some phones.

▶▶ Switching to HFL

If you receive a call while *Bluetooth*® Audio is in the pause mode, it will resume play after ending the call.

CD Player

If a disc error occurs, you may see the following error messages.

Error Message	Cause	Solution
Unplayable File	Track/file format not supported	<ul style="list-style-type: none"> • Current track/file will be skipped. The next supported track/file plays automatically.
Bad Disc Please Check Owner's Manual Push Eject	Mechanical error	<ul style="list-style-type: none"> • Press the  (eject) button and remove the disc, and check that the error message is cleared. • Check that the disc is not damaged or deformed, and insert the disc again. <ul style="list-style-type: none"> ➤ Protecting CDs P. 260
Mecha Error		<ul style="list-style-type: none"> • If the error message reappears, press the  button, and pull out the disc. • Insert a different disc. If the new disc plays, there is a problem with the first disc. • If the error message repeats, or the disc cannot be removed, contact a dealer. Do not try to force the disc out of the player.
Bad Disc Please Check Owner's Manual	Servo error	
Check Disc	Disc error	<ul style="list-style-type: none"> • Check that the disc is not damaged or deformed. <ul style="list-style-type: none"> ➤ Protecting CDs P. 260
Heat Error	High temperature	<ul style="list-style-type: none"> • Turn the audio system off and allow the player to cool down until the error message is cleared.

Hard Disk Drive (HDD) Audio

If an error occurs while playing the Hard Disk Drive (HDD) Audio, you may see the following error messages. If you cannot clear the error message, contact a dealer.

Error Message	Solution
HDD access error. Please consult your dealer.	—
The display system temperature is too high. For protection, the system will shut off until the display cools down.	Turn the audio system off and allow the player to cool down until the error message is cleared.
The navigation system temperature is too low. For protection, the system will shut off until it warms up.	The navigation system has difficulty reading the HDD when the temperature is below approximately -22°F (-30°C). The navigation system starts up automatically when the display warms up.
Unplayable File	Appears when a file format not supported. Current track will be skipped. The next supported track plays automatically.

iPod/USB Flash Drive

If an error occurs while playing an iPod or USB flash drive, you may see the following error messages. If you cannot clear the error message, contact a dealer.

Error Message	Solution
USB Error	Appears when there is a problem with the audio system. Check if the device is compatible with the audio system.
Incompatible USB Device Please Check Owner's Manual	Appears when an incompatible device is connected. Disconnect the device. Then turn the audio system off, and turn it on again. Do not reconnect the device that caused the error.
Unsupported Version	Appears when an unsupported iPod is connected. If it appears when a supported iPod is connected, update the iPod software to the newer version.
Connect Retry	Appears when the system does not acknowledge the iPod. Reconnect the iPod.
Unplayable File	Appears when the files in the USB flash drive are DRM or an unsupported format. This error message appears for about 3 seconds, then plays the next song.
No Data	iPod Appears when the iPod is empty.
	USB flash drive Appears when the USB flash drive is empty or there are no MP3, WMA, or AAC files in the USB flash drive.
	iPod and USB flash drive Check that compatible files are stored on the device.
Unsupported	Appears when an unsupported device is connected. If it appears when a supported device is connected, reconnect the device.

U.S. models

Pandora®

If an error occurs while playing Pandora®, you may see the following error messages.

If you cannot clear the error message, contact a dealer.

Error Message	Solution
Incompatible USB Device Please Check Owner's Manual	Appears when an incompatible device is connected. Disconnect the device. Then turn the audio system off, and turn it again. Do not reconnect the device that caused the error.
No stations have been created. Please create a station on the device.	Appears when there is no station list on the device. Use the device to create a station.
Music licenses force us to limit the number of tracks you may skip each hour.	Appears when you try to skip a song or select Dislike over the predetermined number of times in an hour.
Unable to save rating. Unable to save bookmark or Unable to skip	Appears when the commanded operation is failed. Try again later.
No data	Appears when no data is available with Pandora® activated. Reboot the app and reconnect the device.
PANDORA Unsupported	Appears when Pandora® version is not supported. Update Pandora® to the latest version.
PANDORA system maintenance	Appears when the Pandora® server is in maintenance. Try again later.
Cannot connect to PANDORA. When stopped, make sure PANDORA is running on the phone. For iPhone, set connection priority to USB and reconnect.	Appears when Pandora® is unable to play music. Check your device.

Aha™ Radio

If an error occurs while playing Aha™ Radio, you may see the following error messages.

If you cannot clear the error message, contact a dealer.

Error Message	Solution
Cannot connect to aha. When stopped, make sure aha is running on the phone. For iPhone, set connection priority to USB and reconnect.	Appears when the Aha™ app is not activated. Check your device.
Incompatible USB Device Please Check Owner's Manual	Appears when an incompatible device is connected. Disconnect the device. Then turn the audio system off, and turn it on again. Do not reconnect the device that caused the error.

SiriusXM® Radio Service

Subscribing to SiriusXM® Radio

1. You need your radio ID ready before registering for subscription. To see the ID in the display: Turn the interface dial until **0** appears.
2. Have your radio ID and credit card number ready, and either call or visit the SiriusXM® website to subscribe.

Receiving SiriusXM® Radio

Switch to the SiriusXM® mode by pressing the **SOURCE** button repeatedly or operating the On Demand Multi-Use Display™, and stay in this mode for about 30 minutes until the service is activated. Make sure your vehicle is in an open area with good reception.

SiriusXM® Radio Display Messages

Loading:

SiriusXM® is loading the audio or program information.

Ch off air:

The channel is not currently broadcasting.

Ch unauthorized:

SiriusXM® radio is receiving information update from the network.

No signal:

The signal is too weak in the current location.

Ch unavailable:

No such channel exists, the channel is not part of your subscription, or the artist or title information is unavailable.

Check antenna:

There is a problem with the SiriusXM® antenna. Contact a dealer.

Subscribing to SiriusXM® Radio

Contact Information for SiriusXM® Radio:

- U.S.: SiriusXM® Radio at www.siriusxm.com or (800) 852-9696
- Canada: SiriusXM® Canada at www.xmradio.ca, or (877) 209-0079

Receiving SiriusXM® Radio

The SiriusXM® satellites are in orbit over the equator; therefore, objects south of the vehicle may cause satellite reception interruptions. Satellite signals are more likely to be blocked by tall buildings and mountains the farther north you travel from the equator.

You may experience reception problems under the following circumstances:

- In a location with an obstruction to the south of your vehicle.
- In tunnels
- On the lower level of a multi-tiered road
- Large items carried on the roof rack

Recommended CDs

- Use only high-quality CD-R or CD-RW discs labeled for audio use.
- Use only CD-R or CD-RW discs on which the recordings are closed.
- Play only standard round-shaped CDs.

The CD packages or jackets should have one of these marks.



Also includes:



CDs with MP3, WMA or AAC files

- Some software files may not allow for audio play or text data display.
- Some versions of MP3, WMA or AAC formats may be unsupported.

Recommended CDs

A Dual-disc cannot play on this audio unit. If recorded under certain conditions, a CD-R or CD-RW may not play either.

For DTS patents, see <http://patents.dts.com>. Manufactured under license from DTS Licensing Limited. DTS, the Symbol, & DTS and the Symbol together are registered trademarks, and DTS Digital Surround and DTS Neural Surround are trademarks of DTS, Inc. © DTS, Inc. All Rights Reserved.

■ Protecting CDs

Follow these precautions when handling or storing CDs:

- Store a CD in its case when it is not being played.
- When wiping a CD, use a soft clean cloth from the center to the outside edge.
- Handle a CD by its edge. Never touch either surface.
- Never insert foreign objects into the CD player.
- Keep CDs out of direct sunlight and extreme heat.
- Do not place stabilizer rings or labels on the CD.
- Avoid fingerprints, liquids, and felt-tip pens on the CD.

►► Protecting CDs

NOTICE

Do not insert a damaged CD. It may be stuck inside and damage the audio unit.

Examples:

- Bubbled, wrinkled, labeled, and excessively thick CDs

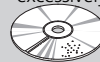

Bubbled/
Wrinkled



With Label/
Sticker



Using
Printer Label
Kit

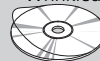

Sealed



With Plastic Ring

- Damaged CDs

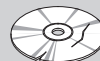

Chipped/
Cracked



Warped



Burrs

- Poor quality CDs

- Small CDs



3-inch
(8-cm)
CD

Compatible iPod, iPhone, and USB Flash Drives

■ iPod and iPhone Model Compatibility

Model
iPod (5th generation)
iPod classic 80GB/160GB (launch in 2007)
iPod classic 120GB (launch in 2008)
iPod classic 160GB (launch in 2009)
iPod nano (1st to 7th generation) released between 2005 and 2012
iPod touch (1st to 5th generation) released between 2007 and 2012
iPhone 3G/iPhone 3GS/iPhone 4/iPhone 4s/iPhone 5/iPhone 5c/iPhone 5s/iPhone 6/ iPhone 6 Plus/iPhone 6s/iPhone 6s Plus

■ USB Flash Drives

- Use a recommended USB flash drive of 256 MB or higher.
- Some digital audio players may not be compatible.
- Some USB flash drives (e.g., a device with security lockout) may not work.
- Some software files may not allow for audio play or text data display.
- Some versions of MP3, WMA, or AAC formats may be unsupported.

⌘ iPod and iPhone Model Compatibility



This system may not work with all software versions of these devices.

⌘ USB Flash Drives

Files on the USB flash drive are played in their stored order. This order may be different from the order displayed on your PC or device.

Use the audio/information screen to customize certain features.





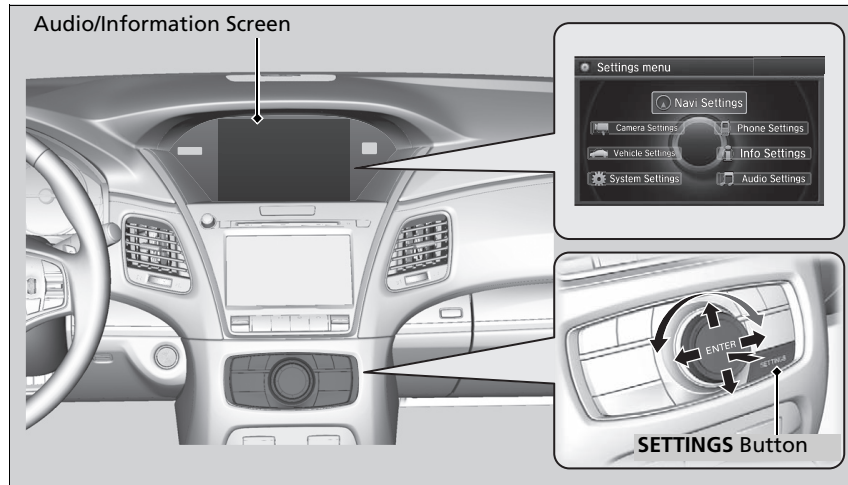

■ How to customize

Select your desired setting item by pressing the **SETTINGS** button, then rotating  while the power mode is ON, and the vehicle is at a complete stop. Press .



▶ Customized Features

When you customize setting, make sure that the vehicle is at a complete stop and shift to **P**.

To customize other features, rotate , move , , , or , and press .

▶ **List of customizable options** P. 272

■ Customization flow

Press the **SETTINGS** button.

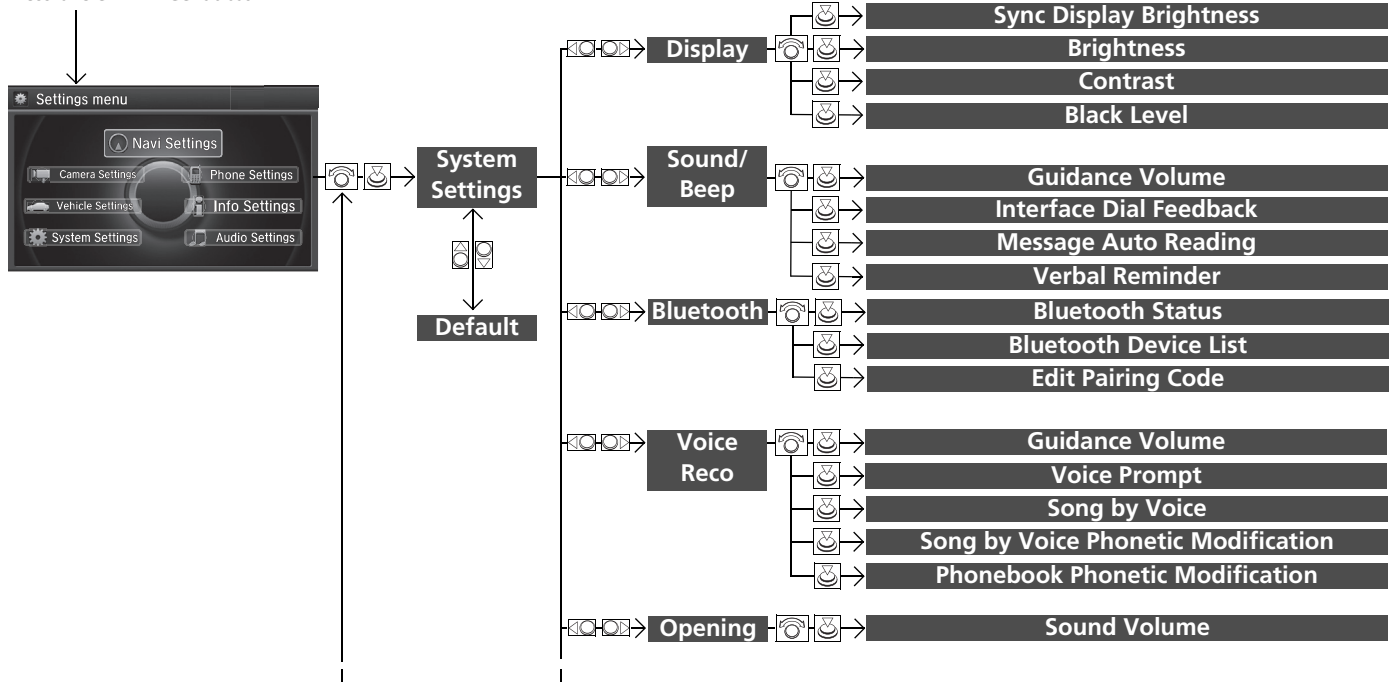

Features

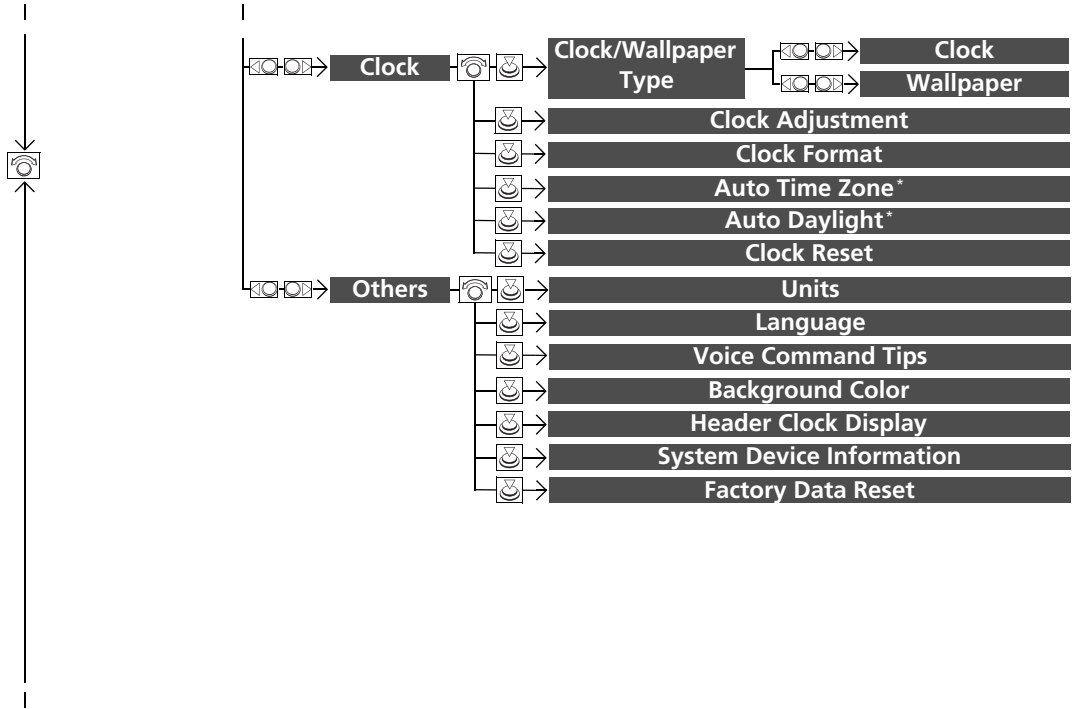

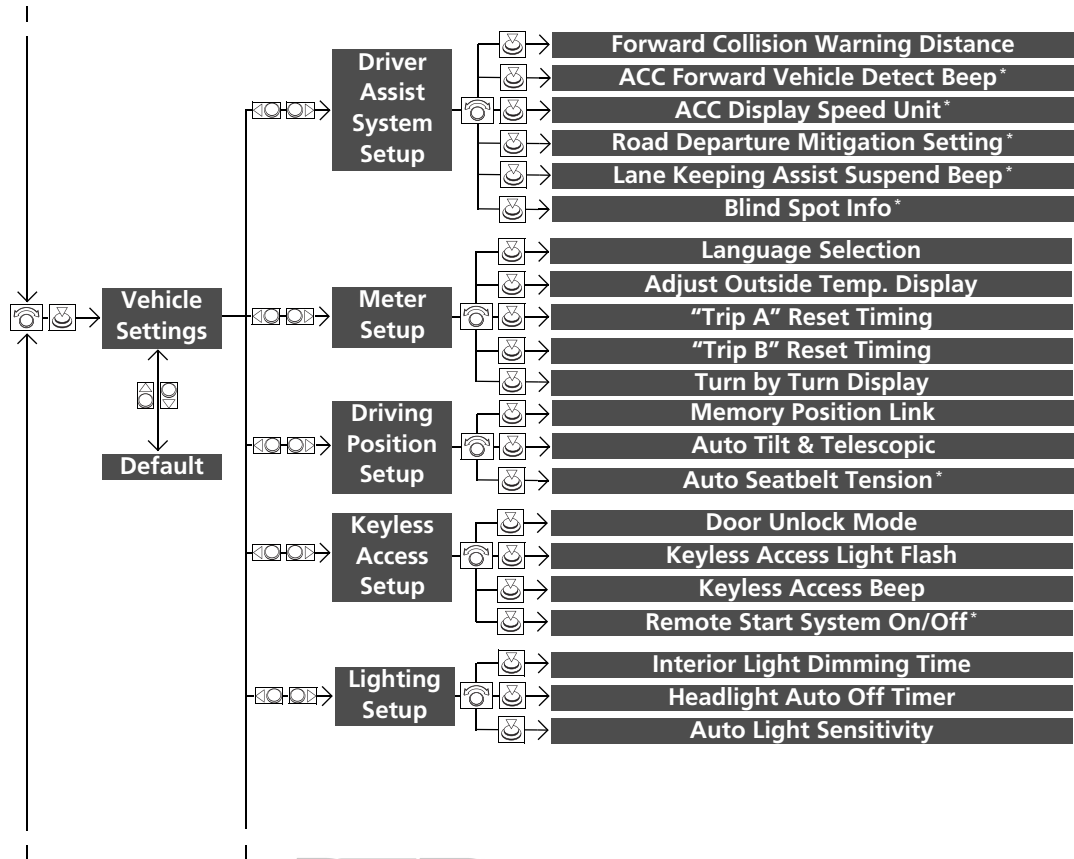

Features

* Not available on all models

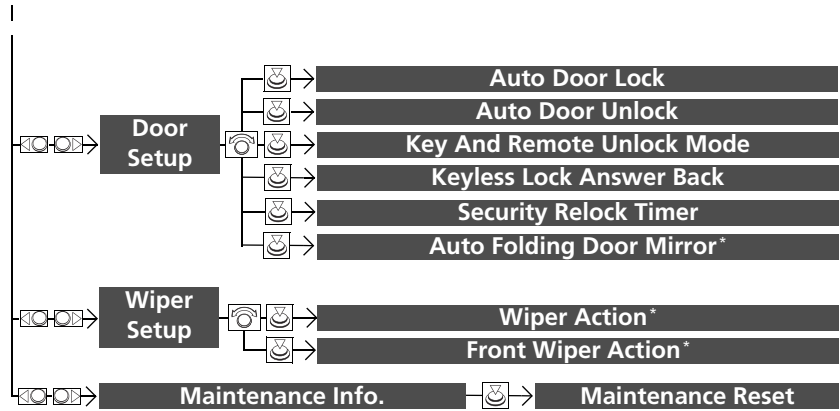

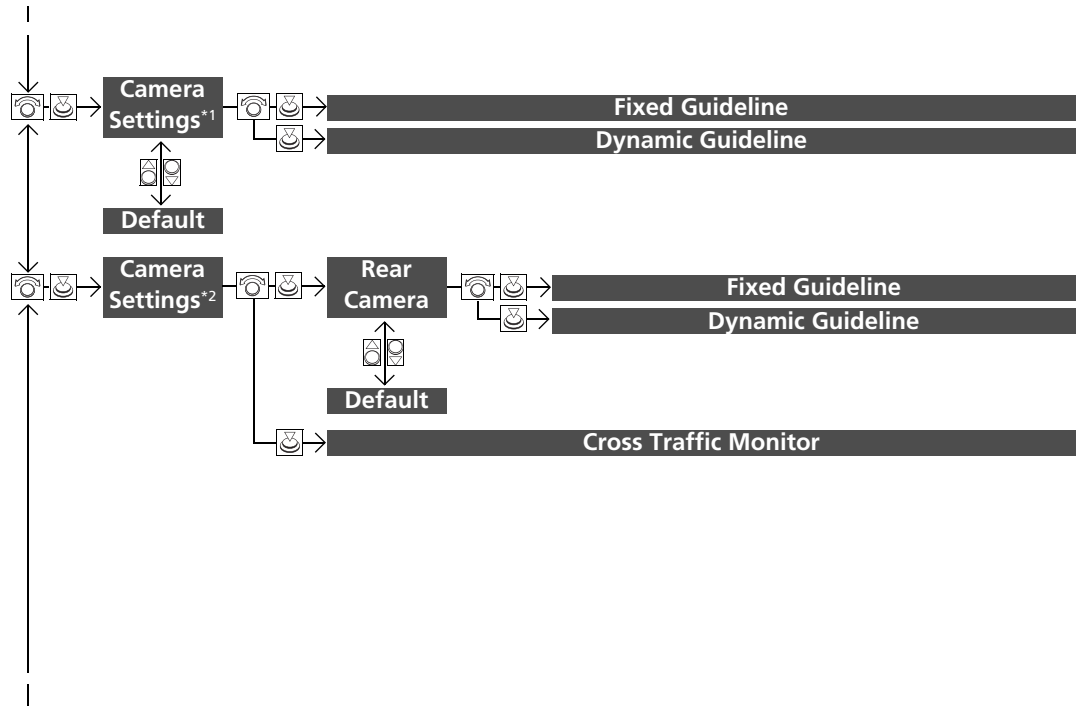

Features

*1: Models with multi-view rear camera

*2: Models with multi-view rear camera and cross traffic monitor

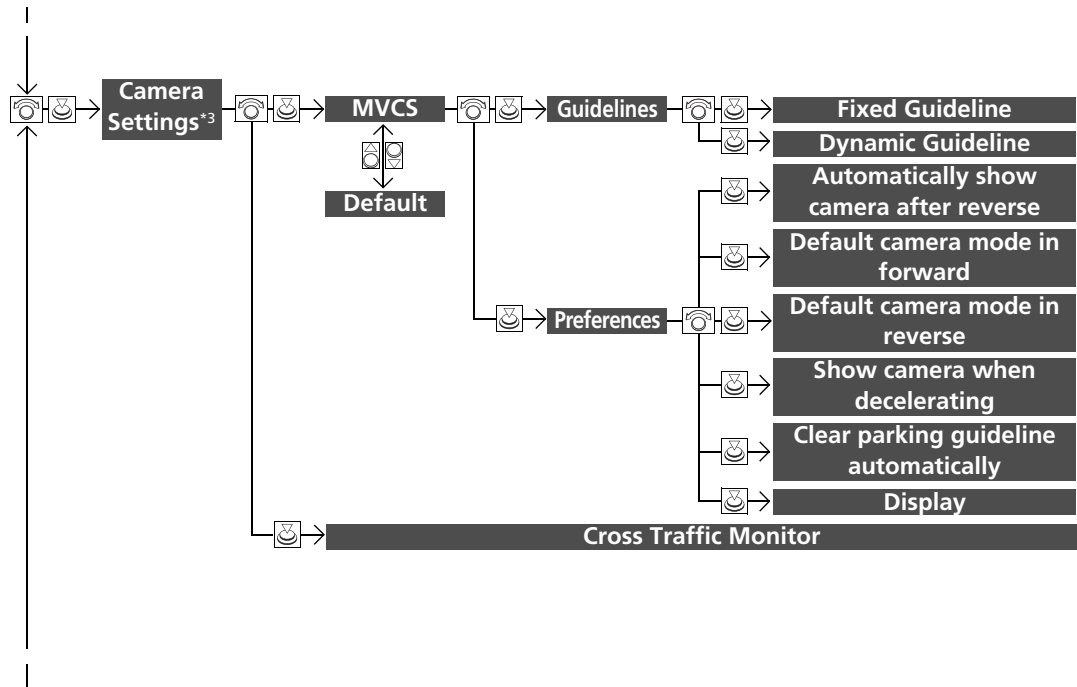

*3: Models with surround view camera system (MVCS)

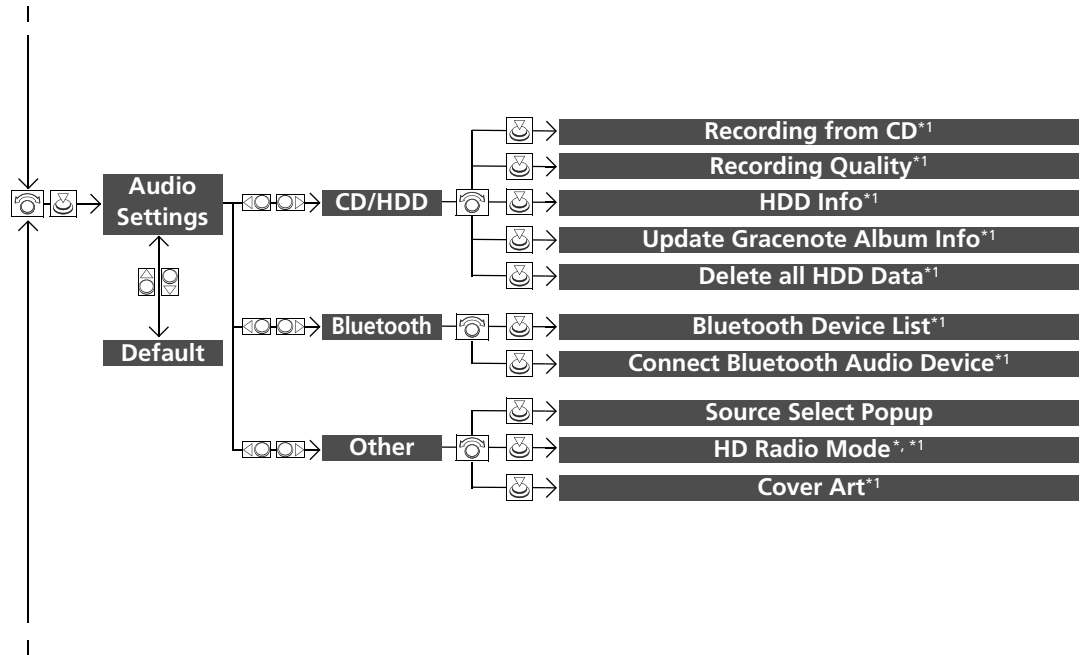

* 1: May change depending on your currently selected source.

* Not available on all models



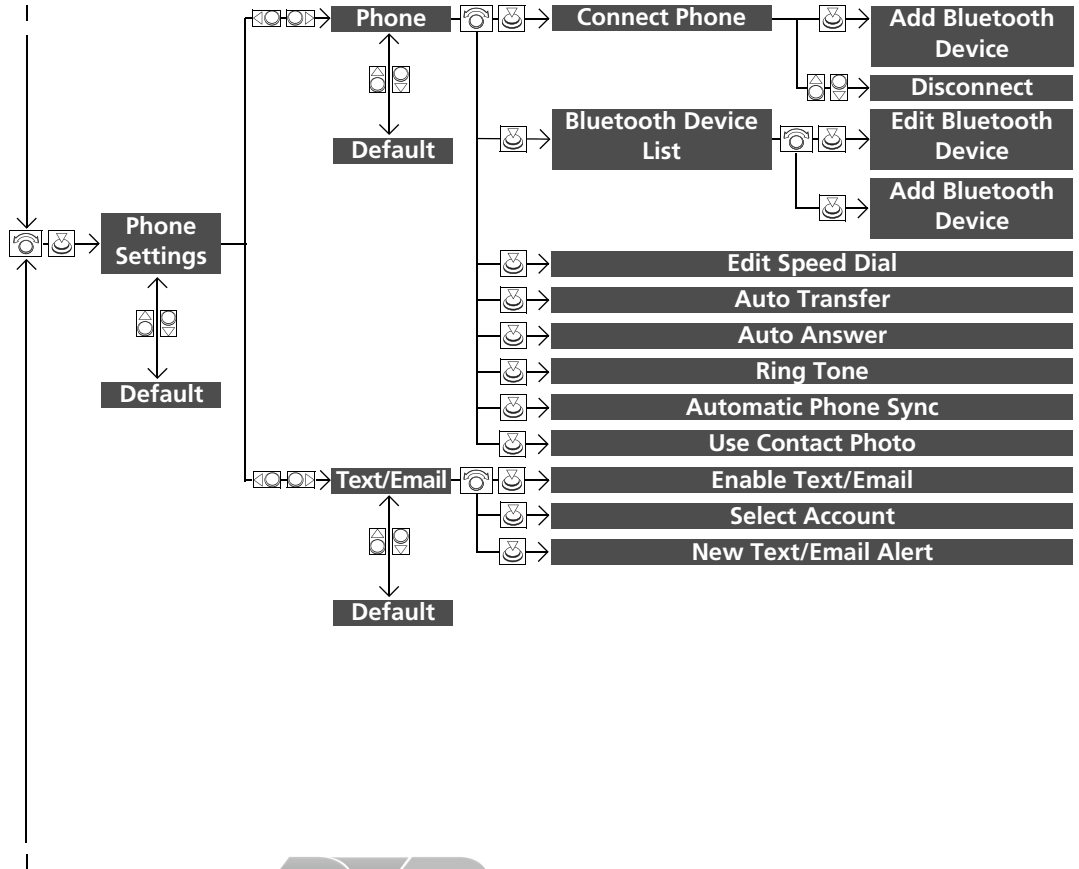

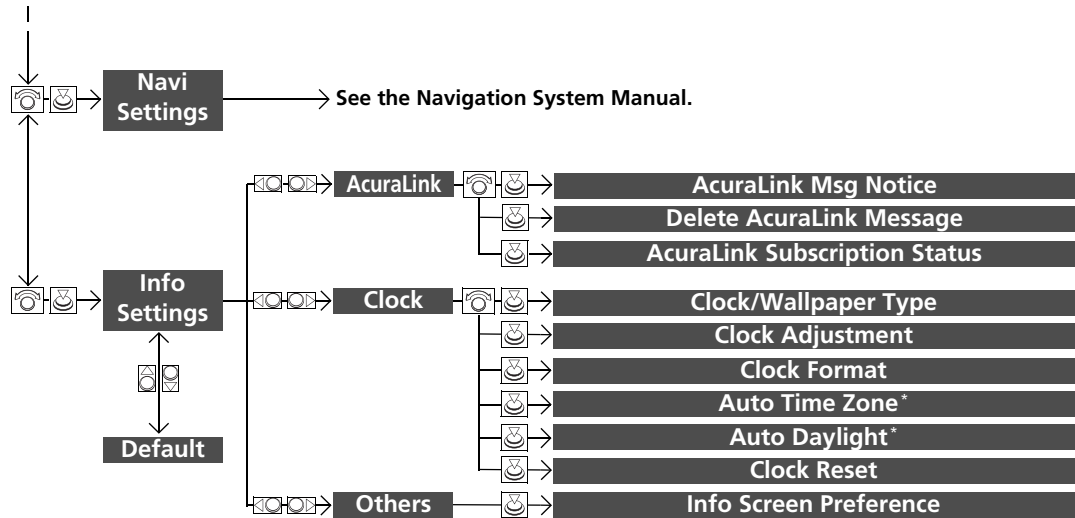

* Not available on all models

■ List of customizable options

Setup Group	Customizable Features	Description	Selectable Settings
System Settings	Display	Sync Display Brightness	Selects whether the display brightness synchronizes with the instrument panel brightness. On*1/Off
		Brightness	Changes the brightness of the audio/information screen. —
		Contrast	Changes the contrast of the audio/information screen. —
		Black Level	Changes the black level of the audio/information screen. —
		Guidance Volume	Changes the volume of the audio speakers. —
	Sound/Beep	Interface Dial Feedback	Sets if and when the system reads aloud a selection made using the Interface Dial. On*1/Off/Auto
		Message Auto Reading	Selects whether the system automatically reads out messages, and, if selected, whether only when driving. On/Off/Auto*1
		Verbal Reminder	Turns the verbal reminders on and off. On*1/Off
		Bluetooth Status	Turns the <i>Bluetooth</i> ® on and off. On*1/Off
	Blue-tooth	Bluetooth Device List	Pairs a new phone to HFL, edits and deletes a paired phone, and creates a security PIN. ☞ Phone Setup P. 296 —
	Edit Pairing Code	Changes a pairing code. ☞ To change the pairing code setting P. 298 Random/Fixed*1	

*1: Default Setting

Setup Group	Customizable Features	Description	Selectable Settings	
Voice Reco	Guidance Volume	Changes the volume of the voice prompt.	—	
	Voice Prompt	Turns the voice prompt on and off.	On*¹/Off	
	Song by Voice	Turns the Song By Voice™ on and off. ▶ Song By Voice™ (SBV) P. 241	On*¹/Off	
	Song by Voice Phonetic Modification	Modifies a voice command for music stored in the HDD or an iPod. ▶ Phonetic Modification P. 243	—	
	Phonebook Phonetic Modification	Modifies a voice command for the phonebook. ▶ Phonebook Phonetic Modification P. 311	—	
System Settings	Opening	Sound Volume	Changes the volume of the system's startup sound.	—
	Clock	Clock	Changes the clock display type.	Analog/Digital*¹/Small Digital/Off
		Wallpaper	<ul style="list-style-type: none"> • Changes the wallpaper type. • Imports an image file for a new wallpaper. • Deletes an image file for a wallpaper. ▶ Wallpaper Setup P. 207	Blank/Galaxy*¹/Metallic
	Clock Adjustment	Adjusts Clock. ▶ Clock P. 114	—	
	Clock Format	Selects the digital clock display from 12H to 24H.	12H*¹/24H	
	Auto Time Zone*	Sets the navigation system to automatically adjust the clock when driving through different time zones.	On*¹/Off	

*1:Default Setting

* Not available on all models



Setup Group	Customizable Features	Description	Selectable Settings	
System Settings	Clock	Auto Daylight*	Sets the navigation system to automatically adjust the clock ("spring ahead" or "fall back" by one hour) when a daylight saving time change occurs.	On*1/Off
		Clock Reset	Resets the settings of all items in the Clock group.	—
	Others	Units*	Changes the distance unit on the navigation map screen.	miles*1/km (U.S.) miles/km*1 (Canada)
		Language	Changes the display language.	English*1/French/ Spanish
		Voice Command Tips	Alerts you when manual control of the system is disabled to prevent distraction while driving. Only voice commands are available.	On*1/Off
		Background Color	Changes the background color of the audio/information screen and the On Demand Multi-Use Display™.	Blue*1/Amber/Red/ Green
		Header Clock Display	Selects whether the clock display comes on.	On/Off*1
		System Device Information	Displays the system/device information.	—
		Factory Data Reset	Resets all the settings to their factory default. ☑ Defaulting All the Settings P. 286	—
		Default	Cancels /Resets all customized items in the System Settings group as default.	Default/OK

*1: Default Setting

* Not available on all models

Setup Group	Customizable Features	Description	Selectable Settings	
Vehicle Settings	Driver Assist System Setup	Forward Collision Warning Distance	Changes at which distance FCW* or CMBS™* alerts, or turns FCW* on and off.	Long/Normal*¹/Short/Off
		ACC Forward Vehicle Detect Beep*	Causes the system to beep when the system detects a vehicle, or when the vehicle goes out of the ACC with LSF range.	On/Off*¹
		ACC Display Speed Unit*	Changes the speed unit for ACC with LSF on the multi-information display.	mph*¹/km/h (U.S.) mph/km/h*¹ (Canada)
		Road Departure Mitigation Setting*	Changes the setting for the road departure mitigation system.	Normal*¹/Wide/Warning Only
		Lane Keeping Assist Suspend Beep*	Causes the system to beep when the LKAS is suspended.	On/Off*¹
		Blind Spot Info*	Changes the setting for the blind spot information.	Audible And Visual Alert*¹/Visual Alert/Off

*1:Default Setting

* Not available on all models



Setup Group	Customizable Features	Description	Selectable Settings
Vehicle Settings	Meter Setup	Language Selection	Changes the displayed language on the multi-information display. English^{*1}/French/Spanish
		Adjust Outside Temp. Display	Adjusts the temperature reading by a few degrees. -5°F ~ ±0°F^{*1} ~ +5°F (U.S.) -3°C ~ ±0°C^{*1} ~ +3°C (Canada)
		"Trip A" Reset Timing	Changes the setting of how to reset trip meter A, average fuel economy A, average speed A, and elapsed time A. When Refueled/IGN Off/Manually Reset^{*1}
		"Trip B" Reset Timing	Changes the setting of how to reset trip meter B, average fuel economy B, average speed B, and elapsed time B. When Refueled/IGN Off/Manually Reset^{*1}
		Turn by Turn Display	Selects whether the turn-by-turn display comes on during the route guidance. On^{*1}/Off

*1:Default Setting

Setup Group	Customizable Features	Description	Selectable Settings	
Vehicle Settings	Driving Position Setup	Memory Position Link	Turns the driving position memory system on and off.	On^{*1}/Off
		Auto Tilt & Telescopic	Moves the steering wheel fully up when you get in/get out of the vehicle.	On^{*1}/Off
		Auto Seatbelt Tension*	Turns the auto seatbelt tension setting for the seat belt e-pretensioner on and off.	On^{*1}/Off
	Keyless Access Setup	Door Unlock Mode	Changes which doors unlock when you grab the driver's door handle.	Driver Door Only^{*1}/ All Doors
		Keyless Access Light Flash	Causes some exterior lights to flash when you unlock/lock the doors.	On^{*1}/Off
		Keyless Access Beep	Causes the beeper to sound when you unlock/lock the doors.	On^{*1}/Off
		Remote Start System On/Off*	Turns the remote engine start feature on and off.	On^{*1}/Off
	Lighting Setup	Interior Light Dimming Time	Changes the length of time the interior lights stay on after you close the doors.	60seconds/30seconds^{*1}/ 15seconds
		Headlight Auto Off Timer	Changes the length of time the exterior lights stay on after you close the driver's door.	60seconds/30seconds/ 15seconds^{*1}/0seconds
Auto Light Sensitivity		Changes the timing for the headlights to come on.	Max/High/Mid^{*1}/ Low/Min	

*1:Default Setting

* Not available on all models



Setup Group	Customizable Features	Description	Selectable Settings	
Vehicle Settings	Auto Door Lock	Changes the setting for when the doors automatically lock.	With Vehicle Speed^{*1}/ Shift from P/Off	
	Auto Door Unlock	Changes the setting for when the doors automatically unlock.	All Doors When Driver's Door Opens^{*1}/ All Doors When Shifted to Park/All Doors When Ignition Switched Off/Off	
	Door Setup	Key And Remote Unlock Mode	Sets up either the driver's door or all doors to unlock on the first push of the remote.	Driver Door^{*1}/All Doors
	Keyless Lock Answer Back	LOCK/UNLOCK- The exterior lights flash. LOCK (2nd push)- The beeper sounds.	On^{*1}/Off	
	Security Relock Timer	Changes the time it takes for the doors to relock and the security system to set after you unlock the vehicle without opening any door.	90seconds/ 60seconds/ 30seconds^{*1}	
	Auto Folding Door Mirror[*]	Changes how you can fold the door mirrors.	Auto Fold With Keyless^{*1}/Manual Only	
Wiper Setup	Wiper Action[*]	Changes the setting for the automatic intermittent wipers in the AUTO position.	Rain Sensing^{*1}/ Intermittent/Speed Sensitive	
	Front Wiper Action[*]	Changes the setting for the wipers in the INT position.	Speed Sensitive^{*1}/ Intermittent	

*1:Default Setting

* Not available on all models



Setup Group	Customizable Features	Description	Selectable Settings	
Vehicle Settings	Maintenance Info. Maintenance Reset	Resets the engine oil life display when you have performed the maintenance service.	—	
	Default	Cancels/Resets all customized items in the Vehicle Settings group as default.	Default/OK	
<div style="background-color: #cccccc; padding: 2px;">Models with multi-view rear camera</div> Camera Settings	Fixed Guideline	Selects whether the fixed guidelines come on the rear camera monitor.	On*1/Off	
	Dynamic Guideline	Selects whether the dynamic guidelines come on the rear camera monitor.	On*1/Off	
	Default	Cancels/Resets all customized items in the Camera Settings group as default.	Default/OK	
<div style="background-color: #cccccc; padding: 2px;">Models with multi-view rear camera and cross traffic monitor</div> Camera Settings	Rear Camera	Fixed Guideline	Selects whether the fixed guidelines come on the rear camera monitor.	On*1/Off
		Dynamic Guideline	Selects whether the dynamic guidelines come on the rear camera monitor.	On*1/Off
		Default	Cancels/Resets all customized items in the Rear Camera group as default.	Default/OK
	Cross Traffic Monitor		Turns the cross traffic monitor feature on and off.	On*1/Off

*1:Default Setting

Setup Group	Customizable Features	Description	Selectable Settings	
<div style="border: 1px solid black; padding: 2px; width: fit-content;">Models with surround view camera system (MVCS)</div> Camera Settings	Guidelines	Fixed Guideline	Sets whether to turn on the reference line display.	On*¹/Off
		Dynamic Guideline	Sets whether to turn on the projection line display.	On*¹/Off
		Automatically show camera after reverse	Sets the rear view to be automatically switched to the front view when the shift lever is moved out of R .	On*¹/Off
	Preferences	Default camera mode in forward	Selects which screen to display when the surround view camera system is turned on while the vehicle is moving forward.	Front Ground View*¹/Last Used/ Front Blind View/ Side View
		Default camera mode in reverse	Sets which screen to display when the surround view camera system is turned on while the vehicle is reversing.	Rear Ground View*¹/ Last Used/Rear View/Rear Wide View

*1:Default Setting

Setup Group	Customizable Features	Description	Selectable Settings
Models with surround view camera system (MVCS) Camera Settings	MVCS Preferences	Show camera when decelerating Sets the screen to automatically return to the camera view at vehicle speeds of 7 mph (12 km/h) or lower. The screen can return only when the display has been switched to the audio/information screen at the vehicle speed of over 9 mph (15 km/h).	On*¹/Off
		Clear parking guidance automatically Turns the parking guide lines on and off.	On*¹/Off
		Display Adjusts the screen's preferences.	—
	Default Cancels/Resets all customized items in the Camera Settings group as default.	Default/OK	
	Cross Traffic Monitor Turns the cross traffic monitor feature on and off.	On*¹/Off	

*1:Default Setting

Setup Group	Customizable Features	Description	Selectable Settings
Audio Settings	CD mode Recording from CD	Selects whether the songs on music CDs are automatically recorded to the HDD.	Auto*¹/Manual
	CD mode Recording Quality	Selects the quality of the music files recorded to the HDD.	Standard*¹/High
	HDD mode HDD Info	Displays the HDD capacity.	—
	CD or HDD mode Update Gracenote Album Info	Updates the Gracenote® Album Info (Gracenote® Media Database).	Update by USB*¹/Update by CD
	HDD mode Delete All HDD Data	 Deleting all HDD Data P. 287	—
	Bluetooth	Bluetooth® Audio, Pandora®* or Aha™ mode Bluetooth Device List	Edits or deletes a <i>Bluetooth</i> ® Audio device paired to HFL.
Bluetooth® Audio, Pandora®* or Aha™ mode Connect Bluetooth Audio Device		Connects, disconnects or pairs a <i>Bluetooth</i> ® Audio device to HFL.	—

*1:Default Setting

Setup Group	Customizable Features	Description	Selectable Settings	
Audio Settings	Other	Source Select Popup	Selects whether the list of selectable audio sources comes on when the AUDIO button is pressed.	On/Off* ¹
		AM/FM mode HD Radio Mode*	Selects whether the audio system automatically switches to the digital radio waves or receives the analogue waves only.	Auto* ¹ /Analog
		CD (MP3/WMA/AAC), iPod, USB, Pandora®* or Aha™ mode Cover Art	Turns on and off the cover art display.	On* ¹ /Off
	Default		Cancels/Resets all customized items in the Audio Settings group as default.	Default/OK
Phone Settings	Phone	Connect phone	Pairs a new phone to HFL, connects or disconnects a paired phone. ➤ Phone Setup P. 296	—
		Bluetooth Device List	Pairs a new phone to HFL, edits or deletes a paired phone, or creates a security PIN. ➤ Phone Setup P. 296	—
		Edit Speed Dial	Edits, adds or deletes a speed dial entry. ➤ Phone Setup P. 296	—

*1:Default Setting

* Not available on all models



Setup Group	Customizable Features	Description	Selectable Settings	
Phone Settings	Auto Transfer	Sets calls to automatically transfer from your phone to HFL when you enter the vehicle.	On*1/Off	
	Auto Answer	Sets whether to automatically answer an incoming call after about four seconds.	On/Off*1	
	Phone Ring Tone	Selects the ring tone.	Fixed/Mobile Phone*1/Off	
	Automatic Phone Sync	Sets a phonebook data to be automatically imported when a phone is paired to HFL.	On*1/Off	
	Use Contact Photo	Displays a caller's picture on an incoming call screen.	On*1/Off	
	Text/Email	Enable Text/Email	Turns the text/e-mail message function on and off.	On*1/Off
		Select Account	Selects a text/e-mail message account.	—
		New Text/Email Alert	Selects whether a pop-up alert comes on the screen when HFL receives a new text/e-mail message.	On/Off*1
	Default	Cancels/Resets all customized items in the Phone Settings group as default.	Default/OK	

*1:Default Setting

Setup Group	Customizable Features	Description	Selectable Settings
Acura Link	AcuraLink Msg Notice	Selects whether newly received AcuraLink messages to be displayed.	On^{*1}/Off
	Delete AcuraLink Message	Deletes AcuraLink messages.	—
	AcuraLink Subscription Status	Displays your current AcuraLink subscription status.	—
Info Settings	Clock/ Wallpaper Type	Clock Wallpaper	
	Clock Adjustment		
	Clock	Clock Format	See System Settings on P. 272 to P. 274.
		Auto Time Zone*	
		Auto Daylight*	
		Clock Reset	
	Other	Info Screen Preference	
Default		Cancels/Resets all customized items in the Info Settings group as default.	Default/OK

* 1:Default Setting

* Not available on all models



Defaulting All the Settings

You can reset all the menu and customized settings as the factory defaults.



1. Press the **SETTINGS** button.
2. Rotate to select **System Settings**, then press .
3. Move or to select the **Others** tab.
4. Rotate to select **Factory Data Reset**, then press .
 - The pop-up menu appears on the screen.
5. Rotate to select **Yes**, then press .
 - The confirmation message will appear.
6. Rotate to select **Yes**, then press again to reset the settings.
 - The confirmation message will appear. Press to select **OK**.

►► Defaulting All the Settings

When you transfer the vehicle to a third party, reset all settings to default and delete all personal data.

The following settings will be reset:

- Routing & Guidance: Rerouting, Unverified Area Routing, Traffic Rerouting, Edit Waypoint Search Area, Guidance Mode, Street Name Guidance
- Route Preference
- Audio preset settings
- Phonebook entries
- Other display and each item settings.

Deleting all HDD Data

You can reset all the menu and customized settings, and delete all music data on the HDD.



1. Turn on the audio system and select the HDD mode.
2. Press the **SETTINGS** button.
3. Rotate to select **Audio Settings**, then press .
4. Move or to select the **CD/HDD** tab.
5. Rotate to select **Delete all HDD Data**, then press .
 - ▶ The confirmation message will appear.
6. Rotate to select **Yes**, then press .

The HomeLink® Universal Transceiver can be programmed to operate up to three remote controlled devices around your home, such as garage doors, lighting, or home security systems.

Important Safety Precautions

Refer to the safety information that came with your garage door opener to test that the safety features are functioning properly. If you do not have the safety information, contact the manufacturer.

Before programming HomeLink, make sure that people and objects are out of the way of the garage or gate to prevent potential injury or damage.

When programming a garage door opener, park just outside the garage door's path.

Training HomeLink

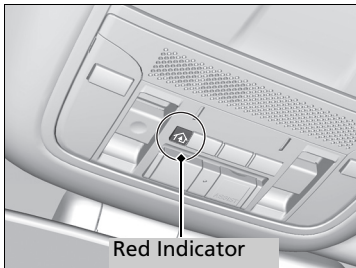

If you have not trained any of the buttons in HomeLink before, you should erase any previously learned codes. To do this:

- Press and hold the two outside buttons for about 20 seconds, until the red indicator blinks. Release the buttons, and proceed to step 1.
- If you are training the second or third button, go directly to step 1.

HomeLink® Universal Transceiver

HomeLink® is a registered trademark of Johnson Controls., Inc.

Before programming HomeLink to operate a garage door opener, confirm that the opener has an external entrapment protection system, such as an "electronic eye," or other safety and reverse stop features. If it does not, HomeLink may not be able to operate it.

Training a Button

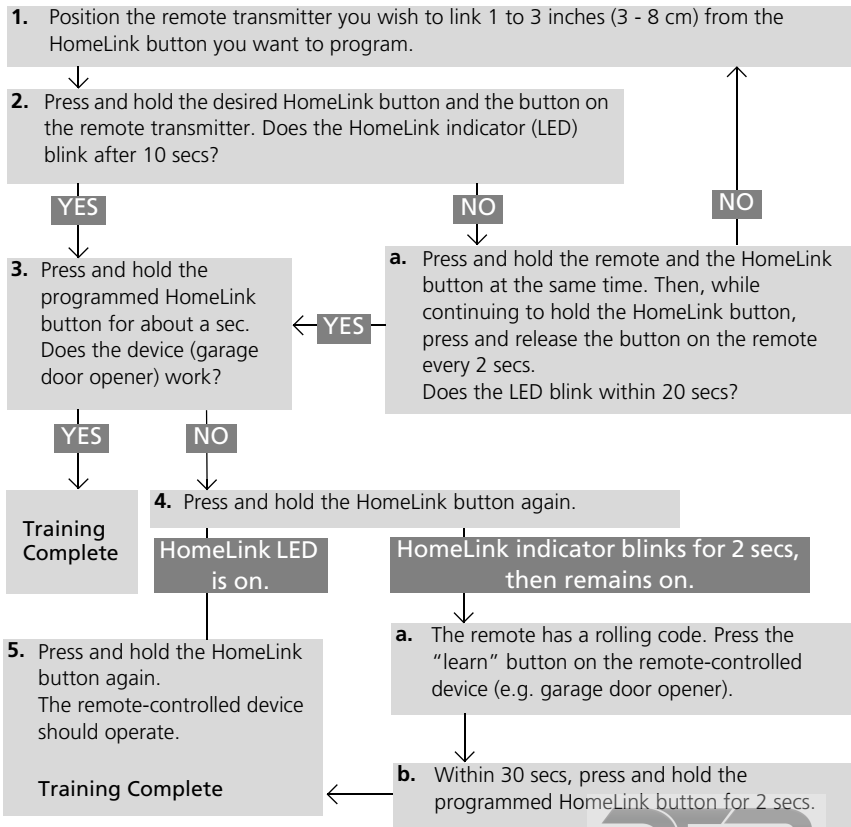

Training HomeLink

Retraining a Button
 If you want to retrain a programmed button for a new device, you do not have to erase all button memory. You can replace the existing memory code using this procedure:

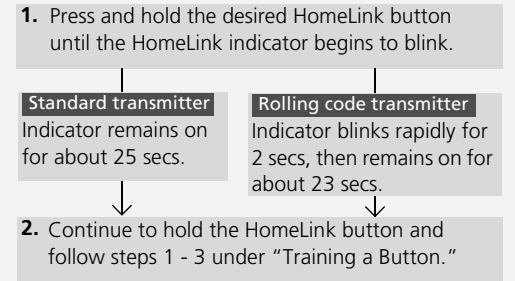

Erasing Codes
 To erase all the codes, press and hold the two outside buttons until the HomeLink indicator begins to blink (about 10 to 20 secs). You should erase all codes before selling the vehicle.

If you have any problems, see the device's instructions, visit www.homelink.com, or call HomeLink at (800) 355-3515.



Bluetooth® HandsFreeLink® (HFL) allows you to place and receive phone calls using your vehicle's navigation system, without handling your cell phone.

Using HFL

HFL Buttons

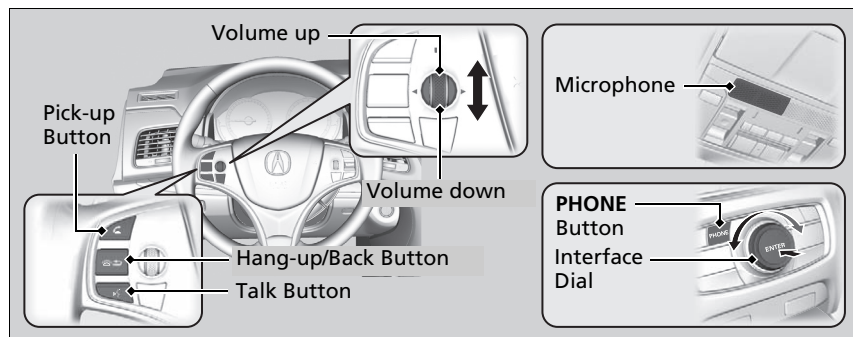

(Pick-up) button: Press to go to the **Speed Dial/Call History** on the multi-information display or to answer an incoming call.

(Hang-up/back) button: Press to end a call, to cancel a command or to clear the phone information on the multi-information display.

(Talk) button: Press to give HFL voice commands.

PHONE button: Press to go directly to the Phone screen.

Interface dial: Rotate to select an item on the screen, then press . Move , or to select secondary menu.

Bluetooth® HandsFreeLink®

To use HFL, you need a *Bluetooth*-compatible cell phone. For a list of compatible phones, pairing procedures, and special feature capabilities:

- U.S.: Visit www.acura.com/handsfreelink, or call 1-888-528-7876.
- Canada: Visit www.handsfreelink.ca, or call 1-888-528-7876.

To use HFL, the **Bluetooth** setting must be **On**.

Customized Features P. 262

Voice control tips:

- Aim the vents away from the ceiling and close the windows, as noise coming from them may interfere with the microphone.
- Press and release the button when you want to call a number using a stored voice tag, a phonebook name, or a number. Speak clearly and naturally after a beep.
- If the microphone picks up voices other than yours, the command may be misinterpreted.
- To change the volume level, use the audio system's volume knob or the remote audio controls on the steering wheel.

State or local laws may prohibit the operation of handheld electronic devices while operating a vehicle.

■ HFL Status Display

The audio/information screen notifies you when there is an incoming call.

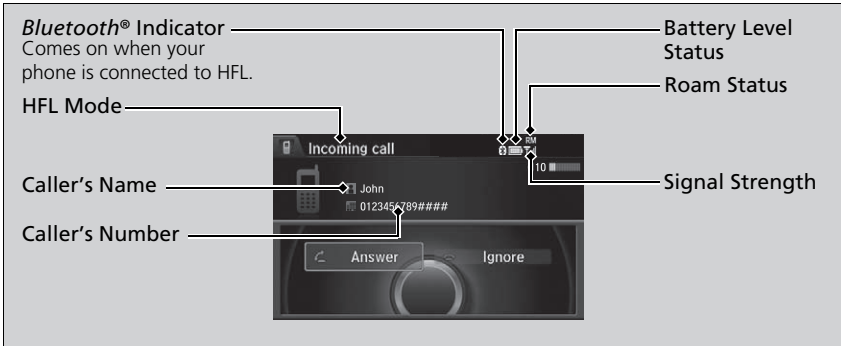

■ Limitations for Manual Operation

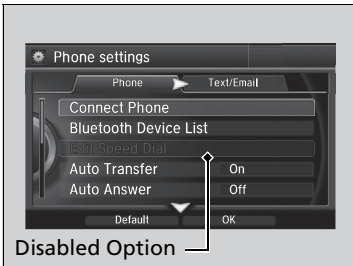

Certain manual functions are disabled or inoperable while the vehicle is in motion. You cannot select a grayed-out option until the vehicle is stopped.

Only previously stored speed dial entries with voice tags, phonebook names, or numbers can be called using voice commands while the vehicle is in motion.

▶ **Speed Dial** P. 308

▶▶ Bluetooth® HandsFreeLink®

Bluetooth® Wireless Technology

The *Bluetooth*® word mark and logos are registered trademarks owned by Bluetooth SIG, Inc., and any use of such marks by Honda Motor Co., Ltd., is under license. Other trademarks and trade names are those of their respective owners.

HFL Limitations

An incoming call on HFL will interrupt the audio system when it is playing. It will resume when the call is ended.

▶▶ HFL Status Display

The information that appears on the audio/information screen varies between phone models.

You can change the system language to English, French, or Spanish.

▶ **Customized Features** P. 262

HFL Menu

The power mode must be in ACCESSORY or ON to use HFL.

■ Phone Settings screen



1. Press the **SETTINGS** button.
2. Rotate to select **Phone Settings**, then press .

▶▶ HFL Menu

To use HFL, you must first pair your *Bluetooth*-compatible cell phone to the system while the vehicle is parked.

Some functions are limited while driving. A message appears on the screen when the vehicle is moving and the operation is canceled.

Features

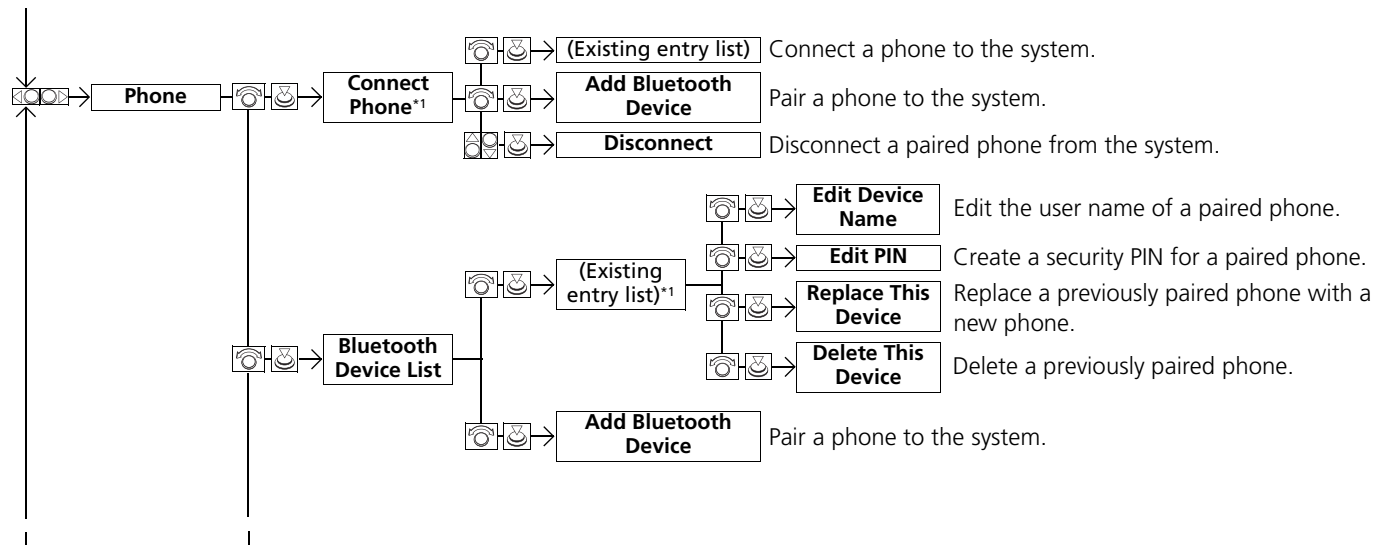

* 1: Appears when a phone has already been paired to HFL.



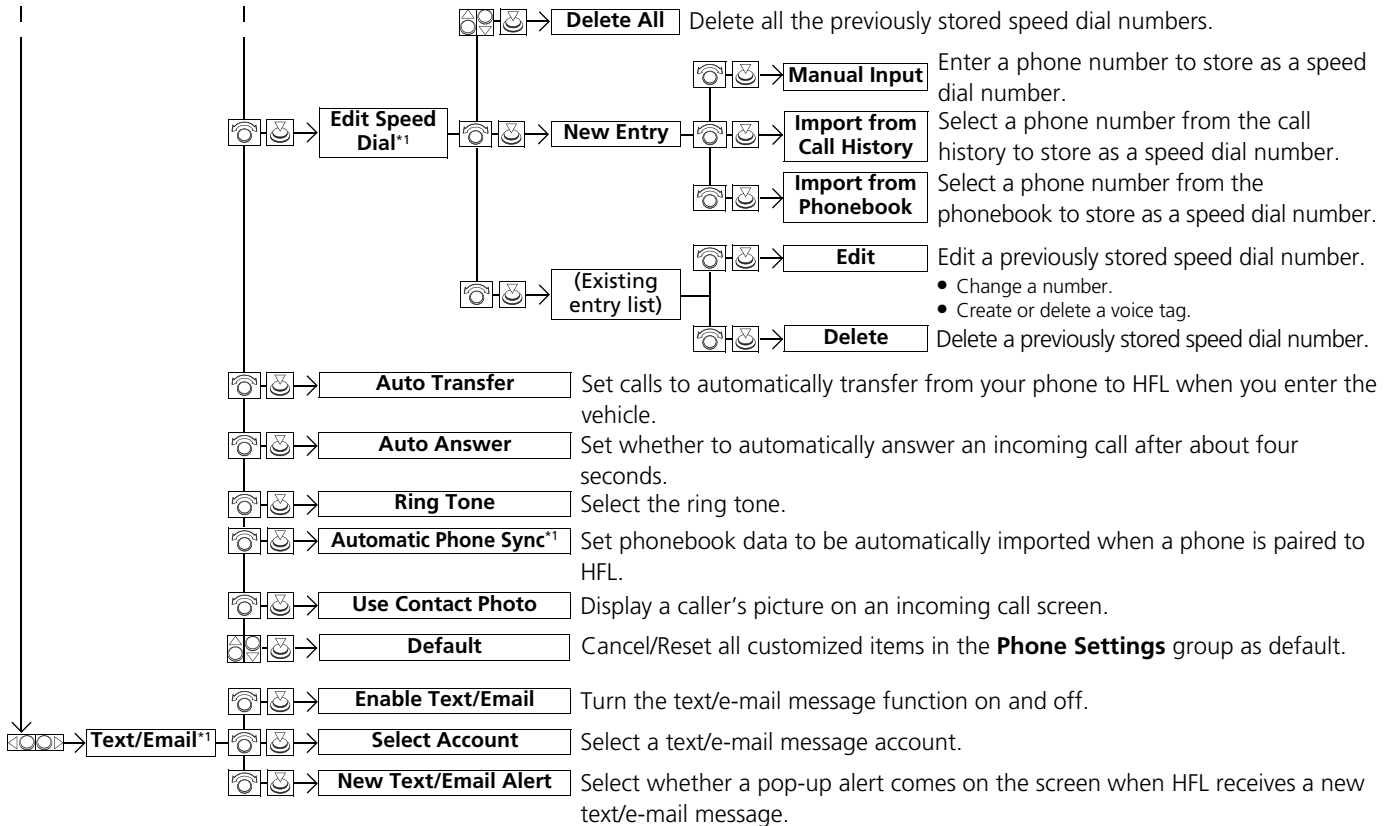

*1: Appears only when a phone is connected to HFL.

■ Phone screen



1. Press the **PHONE** button.
2. Press the **MENU** button to display the menu items.

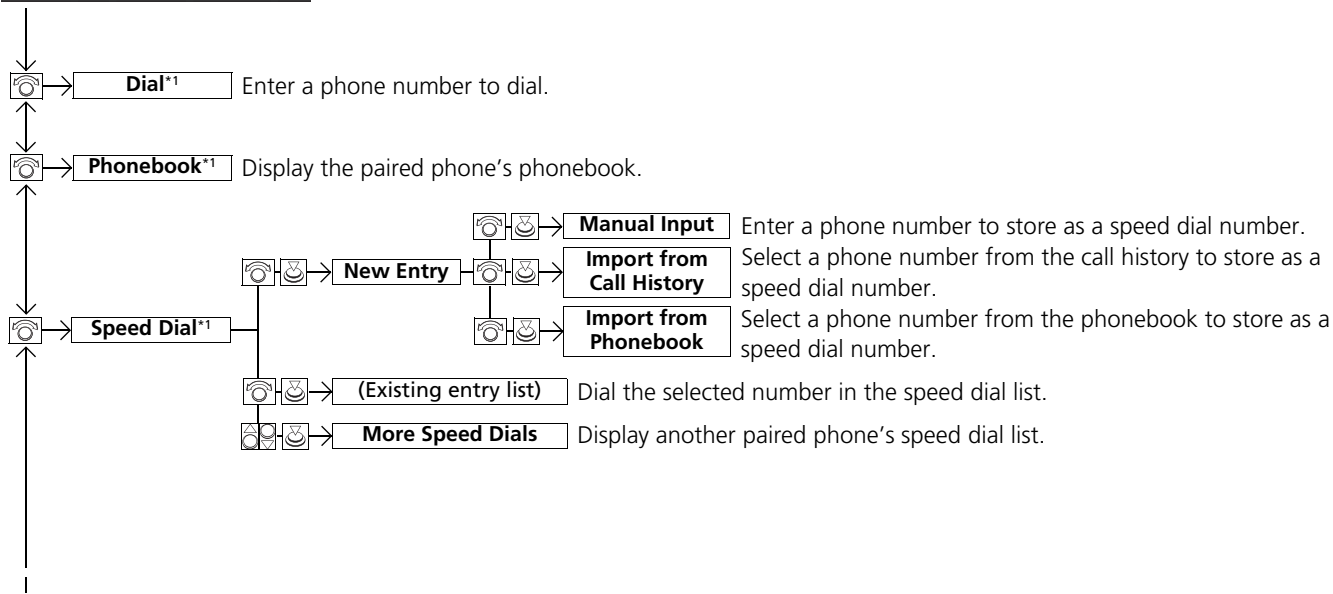

*1: Appears only when a phone is connected to HFL.

Features



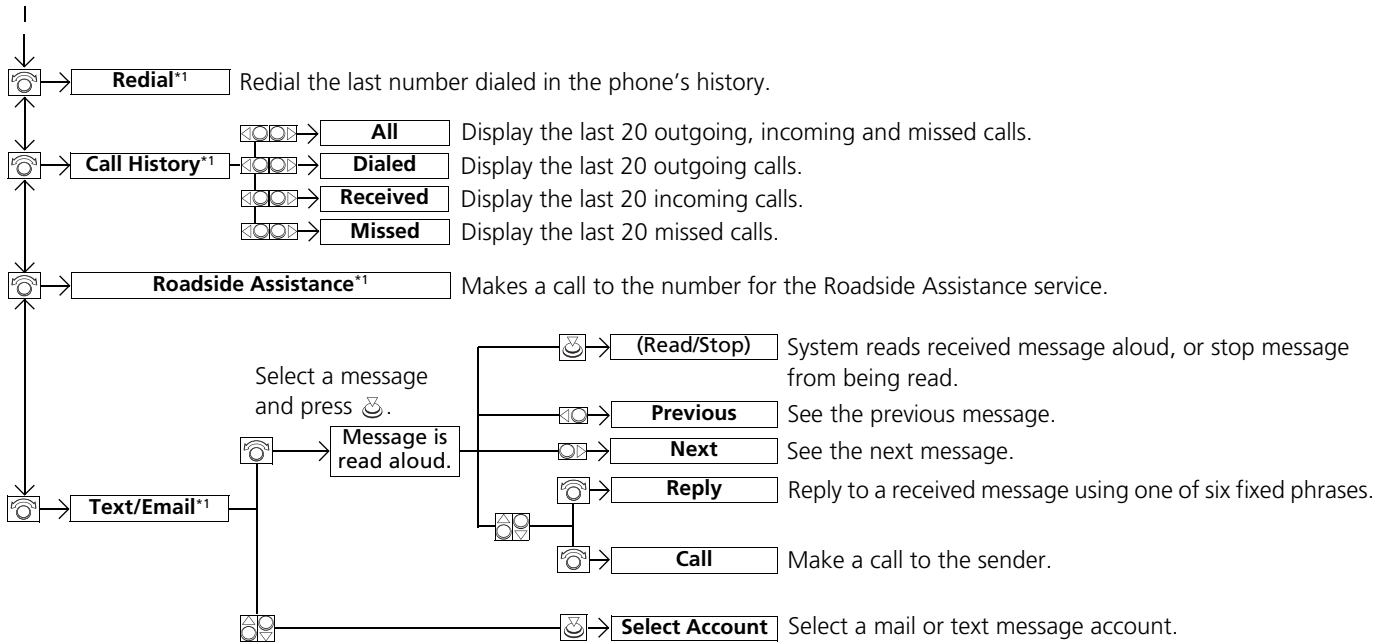

*1: Appears only when a phone is connected to HFL.

Phone Setup



■ To pair a cell phone (when there is no phone paired to the system)

1. Press the **PHONE** button.
2. Rotate to select **Yes**, then press .
3. Make sure your phone is search or discoverable mode, then press .
 - ▶ HFL automatically searches for a *Bluetooth* device.
4. When your phone appears on the list, select it by pressing .
 - ▶ If your phone does not appear, you can select **Refresh** to search again.
 - ▶ If your phone still does not appear, move to select **Phone not Found?** and search for *Bluetooth* devices using your phone. From your phone, select **HandsFreeLink**.
5. HFL gives you a pairing code on the audio/information screen.
 - ▶ Confirm if the pairing code on the screen and your phone match. This may vary by phone.
6. You will receive a notification on the screen if pairing is successful.

☒ Phone Setup

Your *Bluetooth*-compatible phone must be paired to HFL before you can make and receive hands-free calls.

Phone Pairing Tips:

- You cannot pair your phone while the vehicle is moving.
- Up to six phones can be paired.
- Your phone's battery may drain faster when it is connected to HFL.
- If your phone is not ready for pairing or not found by the system within three minutes, the system will time out and returns to idle.

Once you have paired a phone, you can see it displayed on the screen with one or two icons on the right side.

These icons indicate the following:

- : The phone can be used with HFL.
- : The phone is compatible with *Bluetooth*® Audio.

When pairing is completed, an **Automatic Phone Sync** prompt appears. Select **On** if you want your call history and phonebook automatically imported to HFL.

▶ Changing the Automatic Phone Sync setting P. 307

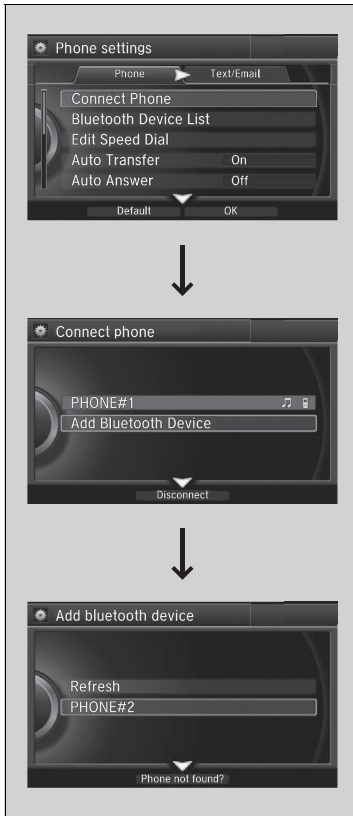

■ **To pair a cell phone (when a phone has already been paired to the system)**

1. Press the **SETTINGS** button.
2. Rotate to select **Phone Settings**, then press .
3. Move or to select the **Phone** tab.
4. Rotate to select **Connect Phone**, then press .
 - ▶ Repeat the procedure to select **Add Bluetooth Device**.
5. Make sure your phone is in search or discoverable mode, then press .
 - ▶ HFL automatically searches for a *Bluetooth* device.
6. When your phone appears on the list, select it by pressing .
 - ▶ If your phone does not appear, you can select **Refresh** to search again.
 - ▶ If your phone still does not appear, move to select **Phone not Found?** and search for *Bluetooth* devices using your phone. From your phone, select **HandsFreeLink**.
7. HFL gives you a pairing code on the audio/ information screen.
 - ▶ Confirm if the pairing code on the screen and your phone match.
This may vary by phone.
8. You will receive a notification on the screen if pairing is successful.

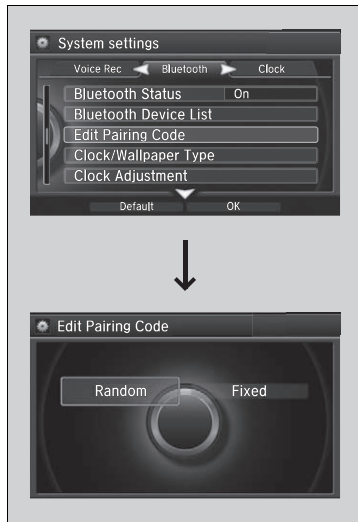

■ **To change the pairing code setting**

1. Press the **SETTINGS** button.
2. Rotate to select **System Settings**, then press .
3. Move or to select the **Bluetooth** tab.
4. Rotate to select **Edit Pairing Code**, then press .
5. Rotate to select **Fixed** or **Random**, then press .

▶▶ To change the pairing code setting

The pairing code may be six or four digits depending on your phone.

The default pairing code is **0000** until you change the setting.

To create your own, select **Fixed**, and delete the current code, then enter a new one.

For a randomly generated pairing code each time you pair a phone, select **Random**.

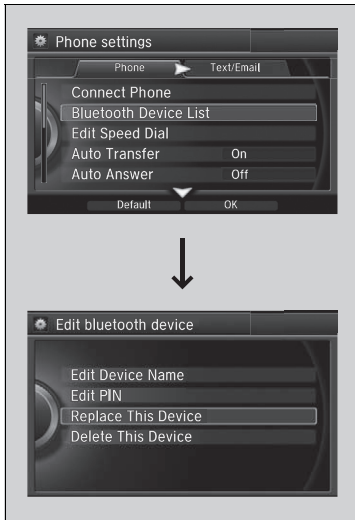

■ **To replace an already-paired phone with a new phone**

1. Press the **SETTINGS** button.
2. Rotate to select **Phone Settings**, then press .
3. Move or to select the **Phone** tab.
4. Rotate to select **Bluetooth Device List**, then press .
5. Rotate to select a paired phone you want to replace, then press .
6. Rotate to select **Replace This Device**, then press .
7. HFL enters the pairing process and searches a new phone.
 - ▶ Follow the prompts to pair a new phone.
8. You will receive a notification on the screen if pairing is successful.

▶▶ To replace an already-paired phone with a new phone

The replaced phone will keep the same speed dial entries, and security PIN information from the previously paired phone.

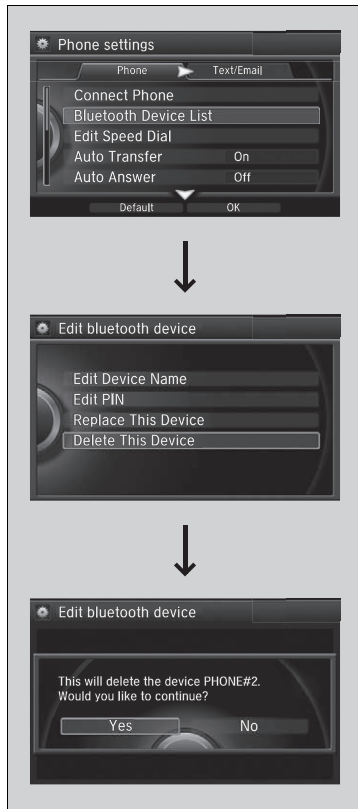

■ To delete a paired phone

1. Press the **SETTINGS** button.
2. Rotate to select **Phone Settings**, then press .
3. Move or to select the **Phone** tab.
4. Rotate to select **Bluetooth Device List**, then press .
5. Rotate to select a phone you want to delete, then press .
6. Rotate to select **Delete This Device**, then press .
7. You will receive a confirmation message on the screen. Rotate to select **Yes**, then press .
8. You will receive a notification on the screen if it is successful.

To Set Up a Text/E-mail Message Options

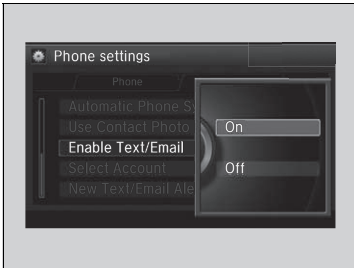

■ To turn on or off the text/e-mail message function

1. Press the **SETTINGS** button.
2. Rotate to select **Phone Settings**, then press .
3. Move or to select the **Text/Email** tab.
4. Rotate to select **Enable Text/Email**, then press .
 - ▶ A pop-up menu appears on the screen.
5. Rotate to select **On** or **Off**, then press .

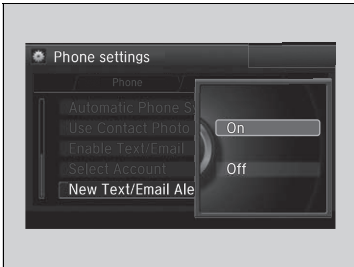

■ To turn on or off the text/e-mail message notice

1. Press the **SETTINGS** button.
2. Rotate to select **Phone Settings**, then press .
3. Move or to select the **Text/Email** tab.
4. Rotate to select **New Text/Email Alert**, then press .
 - ▶ A pop-up menu appears on the screen.
5. Rotate to select **On** or **Off**, then press .

☒ To Set Up a Text/E-mail Message Options

To use the text/e-mail message function, you need a *Bluetooth*-compatible cell phone. For a list of compatible phones, pairing procedures, and special feature capabilities:

- U.S.: Visit www.acura.com/handsfreelink, or call 1-888-528-7876.
- Canada: Visit www.handsfreelink.ca, or call 1-888-528-7876.

☒ To turn on or off the text/e-mail message notice

- On:** A pop-up notification comes on every time you receive a new message.
- Off:** The message you receive is stored in the system without notification.

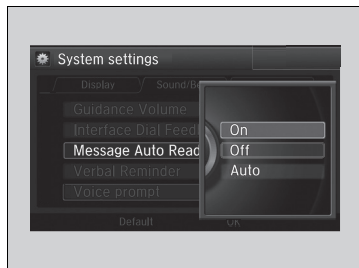

■ To set up the auto reading option

1. Press the **SETTINGS** button.
2. Rotate to select **System Settings**, then press .
3. Move or to select the **Sound/Beep** tab.
4. Rotate to select **Message Auto Reading**, then press .
 - ▶ A pop-up menu appears on the screen.
5. Rotate to select **On**, **Off** or **Auto**, then press .

☒ To set up the auto reading option

On: A text/e-mail message is always read aloud.

Off: A text/e-mail message is not read aloud.

Auto: A text/e-mail message is read aloud only when driving.

To Create a Security PIN

You can protect each of the six cell phones with a security PIN.



1. Press the **SETTINGS** button.
2. Rotate to select **Phone Settings**, then press .
3. Move or to select the **Phone** tab.
4. Rotate to select **Bluetooth Device List**, then press .
5. Rotate to select a phone you want to add a security PIN to, then press .
6. Rotate to select **Edit PIN**, then press .
7. Enter a new four-digit number.

▶ Audio/information screen

Rotate to select, then press .
Move to delete. Rotate to select **OK** to enter the security PIN.

▶ On Demand Multi-Use Display™

You can also enter a number using the icons.

8. Re-enter the four-digit number.
 - ▶ The screen returns to the screen in step 4.

▶▶ To Create a Security PIN

If the phone is already security PIN protected, you need to enter the current security PIN before clearing the PIN or creating a new one.

■ Editing User Name

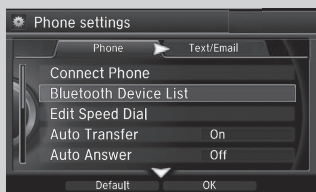

Audio/information screen



On Demand Multi-Use Display™



Edit the user name of a paired phone as follows:

1. Press the **SETTINGS** button.
2. Rotate to select **Phone Settings**, then press .
3. Move or to select the **Phone** tab.
4. Rotate to select **Bluetooth Device List**, then press .
5. Rotate to select a phone you want to edit, then press .
6. Rotate to select **Edit Device Name**, then press .
7. Enter a new name of the phone.

- ▶ **Audio/information screen**
Rotate to select, then press . Move to delete. Rotate or move to select **OK** then press to enter the name.
- ▶ **On Demand Multi-Use Display™**
You can also enter a name using the icons.

▶▶ Editing User Name

Audio/information screen



Select to enter symbols.

Automatic Transferring

If you get into the vehicle while you are on the phone, the call can be automatically transferred to HFL.



1. Press the **SETTINGS** button.
2. Rotate to select **Phone Settings**, then press .
3. Move or to select the **Phone** tab.
4. Rotate to select **Auto Transfer**, then press .
5. Rotate to select **On**, then press .

Auto Answer

You can set HFL to automatically answer an incoming call in four seconds.

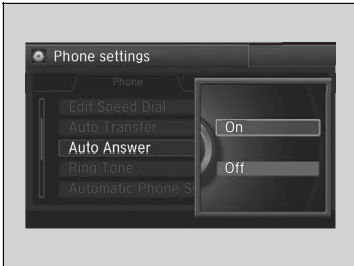

1. Press the **SETTINGS** button.
2. Rotate to select **Phone Settings**, then press .
3. Move or to select the **Phone** tab.
4. Rotate to select **Auto Answer**, then press .
5. Rotate to select **On**, then press .

Ring Tone

You can change the ring tone setting.



1. Press the **SETTINGS** button.
2. Rotate to select **Phone Settings**, then press .
3. Move or to select the **Phone** tab.
4. Rotate to select **Ring Tone**, then press .
5. Rotate to select **Fixed**, **Mobile Phone** or **Off**, then press .

Use Contact Photo

You can display a caller's picture on an incoming call screen.



1. Press the **SETTINGS** button.
2. Rotate to select **Phone Settings**, then press .
3. Move or to select the **Phone** tab.
4. Rotate to select **Use Contact Photo**, then press .
5. Rotate to select **On** or **Off**, then press .

Ring Tone

Fixed: The fixed ring tone sounds from the speaker.

Mobile Phone: The ring tone stored in the connected cell phone sounds from the speaker.

Off: No ring tones sound from the speaker.

Automatic Import of Cellular Phonebook and Call History



■ When Automatic Phone Sync is set to On:

When your phone is paired, the contents of its phonebook and call history are automatically imported to HFL.

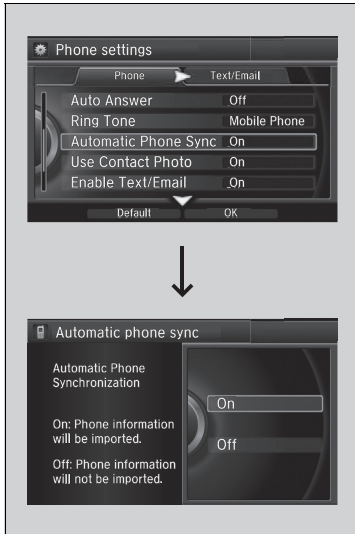

■ Changing the Automatic Phone Sync setting

1. Press the **SETTINGS** button.
2. Rotate to select **Phone Settings**, then press .
3. Move or to select the **Phone** tab.
4. Rotate to select **Automatic Phone Sync**, then press .
5. Rotate to select **On** or **Off**, then press .

⌘ Automatic Import of Cellular Phonebook and Call History

When you select a person from the list in the cellular phonebook, you can see up to three category icons. The icons indicate what types of numbers are stored for that name.

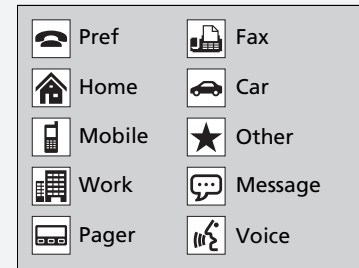

On some phones, it may not be possible to import the category icons to HFL.

The phonebook is updated after every connection. Call history is updated after every connection or call.

■ Speed Dial

Up to 20 speed dial numbers can be stored per phone.

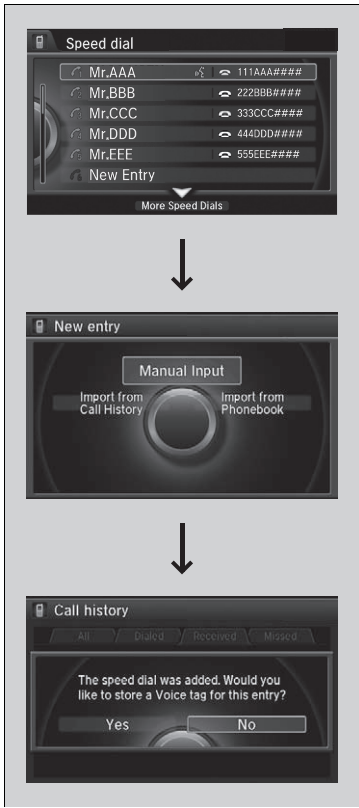

To store a speed dial number:

1. Press the **PHONE** button.
2. Press the **MENU** button.
3. Rotate to select **Speed Dial**, then press .
- ▶ Repeat the procedure to select **New Entry**.
4. Rotate to select a place to choose a number from, then press .
 - From **Import from Call History**:
 - ▶ Select a number from the call history.
 - From **Manual Input**:
 - ▶ Input the number manually.
 - From **Import from Phonebook**:
 - ▶ Select a number from the linked cell phone's imported phonebook.
5. When the speed dial is successfully stored from **Import from Call History** or **Import from Phonebook**, you are asked to create a voice tag for the number. Rotate to select **Yes** or **No**, then press .
6. Using the button, follow the prompts to store a voice tag for the speed dial entry.

▶▶ Speed Dial

When a voice tag is stored, press the button to call the number using the voice tag. Say "Call" and the voice tag name.



■ **To add a voice tag to a stored speed dial number**

1. Press the **SETTINGS** button.
2. Rotate to select **Phone Settings**, then press .
3. Move or to select the **Phone** tab.
4. Rotate to select **Edit Speed Dial**, then press .
5. Select an existing speed dial entry.
 - ▶ From the pop-up menu, rotate to select **Edit**, then press .
6. Rotate to select **Voice Tag**, then press .
 - ▶ From the pop-up menu, rotate to select **Record**, then press .
7. Using the button, follow the prompts to complete the voice tag.

▶▶ Speed Dial

Avoid using duplicate voice tags.
 Avoid using "home" as a voice tag.
 It is easier for HFL to recognize a longer name. For example, use "John Smith" instead of "John."



■ To delete a voice tag

1. Press the **SETTINGS** button.
2. Rotate to select **Phone Settings**, then press .
3. Move or to select the **Phone** tab.
4. Rotate to select **Edit Speed Dial**, then press .
5. Select an existing speed dial entry.
 - ▶ From the pop-up menu, rotate to select **Edit**, then press .
6. Rotate to select **Voice Tag**, then press .
 - ▶ From the pop-up menu, rotate to select **Clear**, then press .
7. You will receive a confirmation message on the screen. Rotate to select **Yes**, then press .

■ To delete a speed dial

1. Press the **SETTINGS** button.
2. Rotate to select **Phone Settings**, then press .
3. Move or to select the **Phone** tab.
4. Rotate to select **Edit Speed Dial**, then press .
5. Select an existing speed dial entry.
 - ▶ From the pop-up menu, rotate to select **Delete**, then press .
6. You will receive a confirmation message on the screen. Rotate to select **Yes**, then press .

Phonebook Phonetic Modification

Add phonetic modifications or a new voice tag to the phone's contact name so that it is easier for HFL to recognize voice commands.

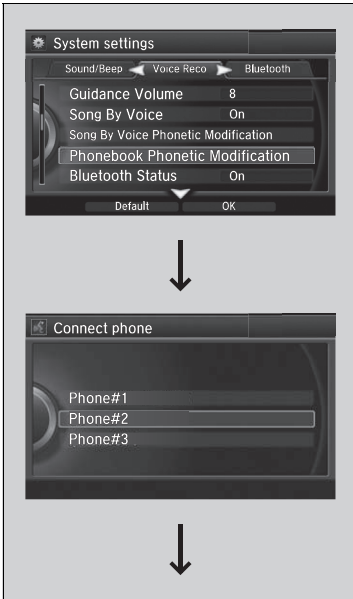

To add a new voice tag

1. Press the **SETTINGS** button.
2. Rotate to select **System Settings**, then press .
3. Move or to select the **Voice Reco** tab.
4. Rotate to select **Phonebook Phonetic Modification**, then press .
5. Rotate to select the phone you want to add phonetic modification to, then press .

Phonebook Phonetic Modification

You can store up to 20 phonetic modification items.

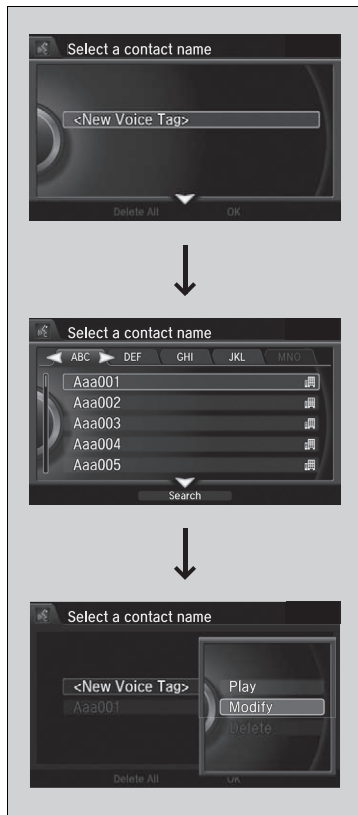

6. Rotate to select **New Voice Tag**, then press .
7. Move or and rotate to select a contact name, then press .
 - ▶ The pop-up menu appears on the screen.
8. Rotate to select **Modify**, then press .
9. Using the button, follow the prompts to complete the voice tag.
10. You will receive a confirmation message on the screen. Rotate to select **OK**, then press .



■ To modify a voice tag

1. Press the **SETTINGS** button.
2. Rotate to select **System Settings**, then press .
3. Move or to select the **Voice Reco** tab.
4. Rotate to select **Phonebook Phonetic Modification**, then press .
5. Rotate to select the phone you want to add phonetic modification to, then press .
6. Rotate to select a contact name you want to modify, then press .
 - ▶ The pop-up menu appears on the screen.
7. Rotate to select **Modify**, then press .
8. Using the button, follow the prompts to complete the voice tag.
9. You will receive a confirmation message on the screen. Rotate to select **OK**, then press .

▶▶ Phonebook Phonetic Modification

You can only modify or delete contact names for the currently connected phone.



■ **To delete a modified voice tag**

1. Press the **SETTINGS** button.
2. Rotate to select **System Settings**, then press .
3. Move or to select the **Voice Reco** tab.
4. Rotate to select **Phonebook Phonetic Modification**, then press .
5. Rotate to select the phone you want to delete phonetic modification, then press .
6. Rotate to select a contact name you want to delete, then press .
 - ▶ The pop-up menu appears on the screen.
7. Rotate to select **Delete**, then press .
8. Move and rotate to select **OK**, then press .



■ **To delete all modified voice tags**

1. Press the **SETTINGS** button.
2. Rotate to select **System Settings**, then press .
3. Move or to select the **Voice Reco** tab.
4. Rotate to select **Phonebook Phonetic Modification**, then press .
5. Rotate to select the phone you want to delete phonetic modification, then press .
 - ▶ The contact name list appears.
6. Move and rotate to select **Delete All**, then press .
7. You will receive a confirmation message on the screen. Rotate to select **Yes**, then press .

■ Making a Call

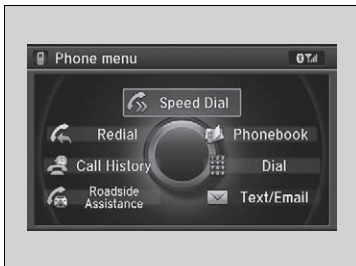

You can make calls by inputting any phone number, or by using the imported phonebook, call history, speed dial entries, or redial.

▶ Making a Call

Any voice-tagged speed dial entry, phonebook name, or number can be dialed by voice from most screens. Press the  button and say "Call" and the voice tag name, "Call by name" and the phonebook name, or "Call" and the phone number.

The maximum range between your phone and vehicles is 30 feet (10 meters).

Once a call is connected, you can hear the voice of the person you are calling through the audio speakers.

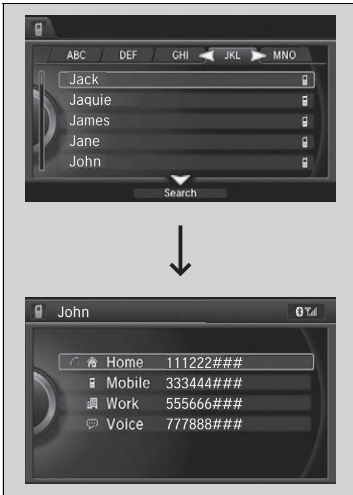

■ **To make a call using the imported phonebook**

1. Press the **PHONE** button.
2. Press the **MENU** button.
3. Rotate to select **Phonebook**, then press .
4. The phonebook is stored alphabetically. Move to **Search**.
 - ▶ You can use the keyboard on the touch screen for an alphabetical search.
5. Rotate to select a number, then press .
 - ▶ Dialing starts automatically.

☒ To make a call using the imported phonebook

This function is disabled while the vehicle is moving. However, you can call a stored voice-tagged speed dial number, phonebook name, or number using voice commands.

- ☒ **Limitations for Manual Operation** P. 291
- ☒ **Speed Dial** P. 308

You can use the keyboard on the On Demand Multi-Use Display™ for an alphabetical search.





■ **To make a call using a phone number**

1. Press the **PHONE** button.
2. Press the **MENU** button.
3. Rotate to select **Dial**, then press .
4. Rotate to select a number, then press .
5. Rotate to select , then press .
 - ▶ Dialing starts automatically.

■ **To make a call using redial**

1. Press the **PHONE** button.
2. Press the **MENU** button.
3. Rotate to select **Redial**, then press .
 - ▶ Dialing starts automatically.

▶▶ To make a call using a phone number

This function is disabled while the vehicle is moving. However, you can call a stored voice-tagged speed dial number, phonebook name, or number using voice commands.

- ▶ **Limitations for Manual Operation** P. 291
- ▶ **Speed Dial** P. 308

You can use the keyboard on the On Demand Multi-Use Display™ to input numbers. Select numbers, then to start dialing.



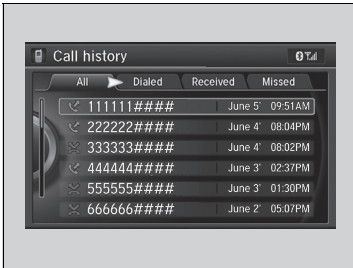

■ **To make a call using the call history**

Call history is stored by **All, Dialed, Received, and Missed.**

1. Press the **PHONE** button.
2. Press the **MENU** button.
3. Rotate to select **Call History**, then press .
4. Move or to select **All, Dialed, Received, and Missed.**
5. Rotate to select a number, then press .
 - ▶ Dialing starts automatically.

Steering switches

1. Press the button.
2. Move the left selector wheel right to select **Call History.**
3. Roll the left selector wheel to select a number.
4. Push the left selector wheel or the button.
 - ▶ Dialing starts automatically.

On multi-information display

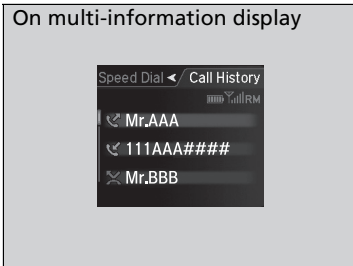

▶▶ To make a call using the call history

The call history displays the last 20 dialed, received, or missed calls.
(Appears only when a phone is connected to HFL.)

These icons next to the number indicate the following:

- : Dialed calls.
- : Received calls.
- : Missed calls.

Steering switches

The call history displays the last 12 dialed, received, or missed calls.

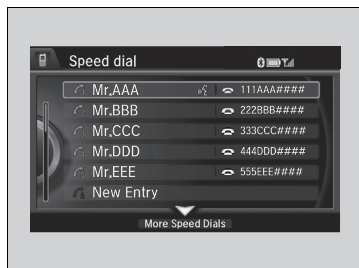

■ To make a call using a speed dial entry

1. Press the **PHONE** button.
2. Press the **MENU** button.
3. Rotate to select **Speed Dial**, then press .
4. Rotate to select a number, then press .
 - ▶ Dialing starts automatically.

▶▶ To make a call using a speed dial entry

Move to select **More Speed Dials** to view another paired phone's speed dial list. You can make a call from that list using the currently connected phone.

When a voice tag is stored, press the button to call the number using the voice tag.

Speed Dial P. 308

Any voice-tagged speed dial entry, phonebook name or number can be dialed by voice from any screen. Press the button and follow the prompts.

Steering switches

The speed dial displays the 20 speed dial entries.

On multi-information display

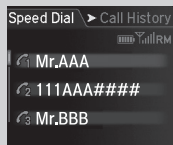



Steering switches

1. Press the button.
2. Move the left selector wheel left to select **Speed Dial**.
3. Roll the left selector wheel to select a number.
4. Push the left selector wheel or the button.
 - ▶ Dialing starts automatically.

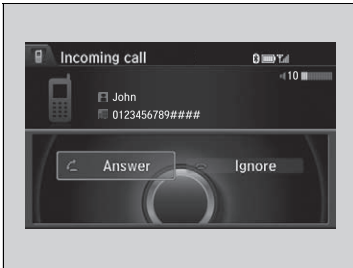
Receiving a Call





When there is an incoming call, an audible notification sounds (if activated) and the **Incoming call** screen appears.

Press the  button to answer the call.
Press the  button to decline or end the call.

Receiving a Call



Call Waiting

Press the  button to put the current call on hold to answer the incoming call.

Press the  button again to return to the current call.

Ignore the incoming call if you do not want to answer it.

Press the  button if you want to hang up the current call.

You can select the icons on the On Demand Multi-Use Display™ instead of the  and  buttons.

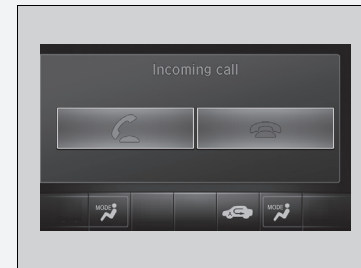

■ Options During a Call

The following options are available during a call.



Mute: Mute your voice.

Transfer: Transfer a call from HFL to your phone.

Touch Tones: Send numbers during a call. This is useful when you call a menu-driven phone system.



The available options are shown on the Phone screen.

Rotate  to select the option, then press .

- ▶ The mute icon appears when **Mute** is selected. Select **Mute** again to turn it off.

☞ Options During a Call

Touch Tones: Available on some phones.

You can select the icons on the On Demand Multi-Use Display™.



Receiving a Text/E-mail Message

HFL can display newly received text/e-mail messages as well as 20 of the most recently received messages on a linked cell phone. Each received message can be read aloud and replied to using a fixed common phrase.



1. A pop-up appears and notifies you of a new text/e-mail message.
2. Rotate to select **Read** to listen to the message, then press .
 - ▶ The text/e-mail message is displayed. The system automatically starts reading out the message.
3. To discontinue the message read-out, press .

Receiving a Text/E-mail Message

The system does not display any received messages while you are driving. You can only hear them read aloud.

With some phones, you may be able to display up to 20 most recent text/e-mail messages.

State or local laws may limit your use of the HFL text/e-mail message feature. Only use the text/e-mail message feature when conditions allow you to do so safely.

When you receive a text/e-mail message for the first time since the phone is paired to HFL, you are asked to turn the **New Text/Email Alert** setting to **On**.

➤ **To turn on or off the text/e-mail message notice P. 301**



■ Selecting a Mail Account

If a paired phone has text message or mail accounts, you can select one of them to be active and receive notifications.



1. Press the **SETTINGS** button.
2. Rotate to select **Phone Settings**, then press .
3. Move or to select the **Text/Email** tab.
4. Rotate to select **Select Account**, then press .
5. Rotate to select **Text Messages** or an e-mail account you want, then press .

▶▶ Selecting a Mail Account

You can also select a mail account from the folder list screen or the message list screen.

Move to select **Select Account**, then press .

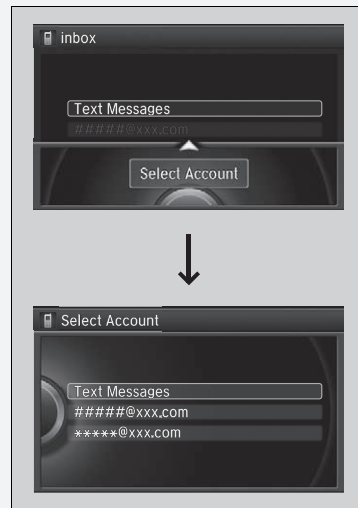

You can only receive notifications from one text message or mail account at a time.

Displaying Messages



■ Displaying text messages

1. Press the **PHONE** button.
2. Press the **MENU** button.
3. Rotate to select **Text/Email**, then press .
- ▶ Select account if necessary.
4. Rotate to select a message, then press .
- ▶ The text message is displayed. The system automatically starts reading the message aloud.

☒ Displaying Messages

The icon appears next to an unread message.

If you delete a message on the phone, the message is also deleted in the system. If you send a message from the system, the message goes to your phone's mailbox.

To see the previous or next message, move or on the text message screen.

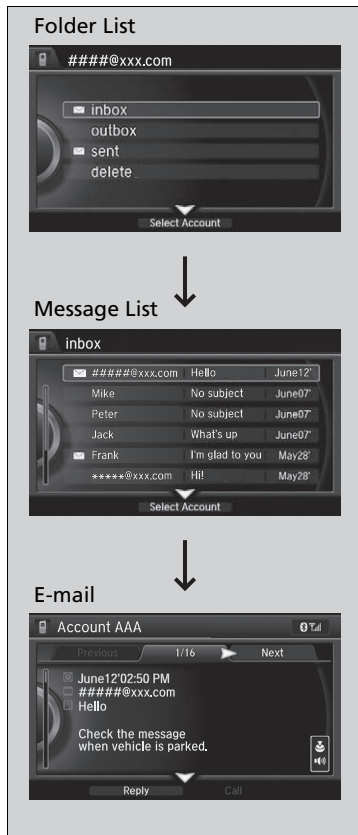

■ Displaying e-mail messages

1. Press the **PHONE** button.
 2. Press the **MENU** button.
 3. Rotate to select **Text/Email**, then press .
 4. Rotate to select a folder, then press .
 5. Rotate to select a message, then press .
- ▶ The e-mail is displayed. The system automatically starts reading the message aloud.

▶▶ Displaying e-mail messages

Received text/e-mail messages may appear in the message list screen at the same time. In this case, text messages are titled **No subject**.

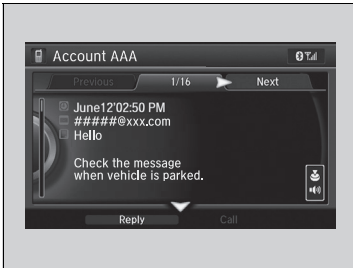

■ Read or stop reading a message

1. Go to the text/e-mail message screen.
 - ▶ The system automatically starts reading the message aloud.
 - ▣ **Displaying Messages** P. 325
2. Press to stop reading. Press again to start reading the message from the beginning.

■ Reply to a message

1. Go to the text/e-mail message screen.
 - ▶ The system automatically starts reading the message aloud.
 - ▣ **Displaying Messages** P. 325
2. Move and rotate to select **Reply**, then press .
3. Rotate to select the reply message, then press .
 - ▶ The pop-up menu appears on the screen.
4. Select **Send** to send the message.
 - ▶ **Message sent** appears on the screen when the reply message was successfully sent.

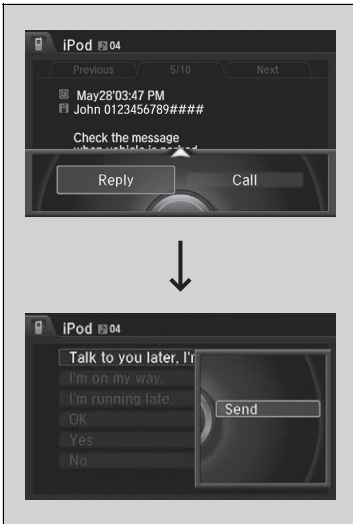

▣ Reply to a message



The available fixed reply messages are as follows:

- **Talk to you later, I'm driving.**
- **I'm on my way.**
- **I'm running late.**
- **OK**
- **Yes**
- **No**

You cannot add, edit, or delete reply messages.







■ Making a call to a sender

1. Go to the text message screen.
 - ▶ The system automatically starts reading the message aloud.
 - ▶ **Displaying text messages** P. 325
2. Move  and rotate  to select **Call**, then press .

Roadside Assistance*

Provides a nationwide service for unexpected incidents. You can call for assistance using a phone paired and connected to *Bluetooth*® HandsFreeLink®.



1. From the **Phone** screen, press the **MENU** button.
2. Rotate  to select **Roadside Assistance**, then press .
3. Rotate  to select a phone number, then press .
 - ▶ Dialing starts automatically.

Roadside Assistance*

If you are subscribed to a paid AcuraLink package, you can call the roadside assistance using the **LINK** button instead of your phone.

▶ **AcuraLink**® P. 330

* Not available on all models

Is a subscription-based service that provides convenient features such as voice communication in case of emergency, online security, one-on-one operator assistance, and the transmission of important messages regarding your vehicle's status.

For information on traffic rerouting and traffic information updates, provided by the AcuraLink server, see the Navigation System Manual.

In Case of Emergency

Automatic collision notification

When connected to the AcuraLink operator:

Audio/information screen

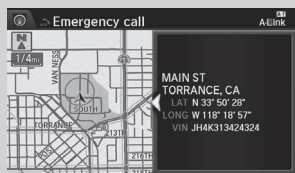

On Demand Multi-Use Display™

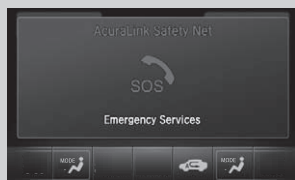

If your vehicle's airbags deploy or if the unit detects that the vehicle is severely impacted, your vehicle automatically will attempt to connect to the AcuraLink operator. Once connected, information about your vehicle, its positioning, and its condition will be sent to the operator; you also can speak to the operator when connected.

AcuraLink®

AcuraLink also provides services you can operate from the Internet or your smartphone.

To subscribe to AcuraLink, or to get more information about all of its features, contact an Acura dealer, or visit owners.acura.com (in U.S.) or www.acura.ca (in Canada).

In Case of Emergency

Your vehicle may not be able to connect to the operator if the battery level is low, the line is disconnected or you do not have adequate cellular coverage.

You cannot use emergency services when:

- You travel outside the AcuraLink service coverage areas.
- There is a problem with the connecting devices, such as the **ASSIST** button, microphone, speakers, or the unit itself.
- You are not subscribed to the service or your subscription is no longer valid.

You cannot operate other navigation- or phone-related functions using the screens while talking to the operator.

Only the operator can terminate the connection to your vehicle.

Automatic collision notification

If the unit fails to connect to the operator, it repeatedly tries until it succeeds.

■ Manual operator connection

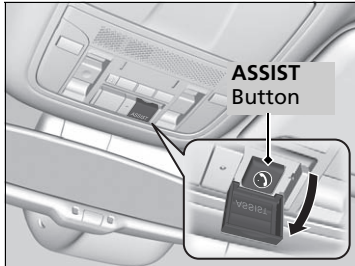

If you need to talk to the AcuraLink operator in an emergency situation, you can manually connect to them by pressing the **ASSIST** button with the power mode in ACCESSORY or ON.

1. Open the cover attached to the ceiling console.
2. Press the **ASSIST** button.
 - ▶ You are connected to the AcuraLink operator.

☒ Manual operator connection

Do not press the button while driving. When you need to contact the operator, park the vehicle in a safe place.

If the unit fails to connect to the operator, it automatically cancels the action after three minutes.

In an emergency, the cover can be broken through to press the **ASSIST** button.

■ Security Features

Your subscribed telematics service provider can track your vehicle's location, remotely lock or unlock doors, and help you find your vehicle.

To use these features, you need your user ID and personal identification number (PIN).

■ Stolen vehicle tracking

This feature searches and tracks down your vehicle position even if it is on the move. If you believe that your vehicle has been stolen, contact the police as well as the provider.

■ Remote door lock/unlock

The provider can remotely lock or unlock doors upon your request.

■ Vehicle finder

This feature is convenient to use when trying to locate your vehicle in large areas, such as a crowded parking lot. If you cannot locate your vehicle after using the remote transmitter's answerback function, you can contact the provider which can then flash your vehicle's exterior lights and sound the horn.

■ Security alarm notification

If the security system in your vehicle detects an abnormal condition, such as someone tampering with the lock on your vehicle, the provider notifies you by email.

▶ Security Features

The contact information of your provider, your user ID and PIN will be given when you subscribe to AcuraLink. If you forget any of the above, contact a dealer, or go to owners.acura.com (in U.S.) or www.acura.ca (in Canada).

You can also activate the remote door lock/unlock and vehicle finder features from the Internet or using your smartphone app. Ask a dealer, or visit owners.acura.com (in U.S.) or www.acura.ca (in Canada) for details.

▶ Vehicle finder

The lights will stop flashing and horn will stop sounding under the following conditions:

- When 30 seconds have elapsed.
- You unlock the doors using the remote transmitter.
- You unlock the doors using the keyless access system.
- You unlock the doors using the built-in key.
- The power mode is set to ACCESSORY or ON.

Operator Assistance

Connect to the AcuraLink operator when trying to find a destination or for roadside assistance.

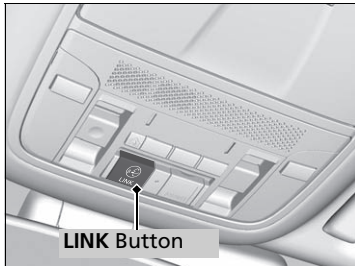

LINK Button

1. Press the **LINK** button.
 - ▶ Connection to the operator begins.

2. Talk to the operator.
 - ▶ To disconnect, press the selector knob, select **End Call** on the On Demand Multi-Use Display™, or press the Hang-up button.

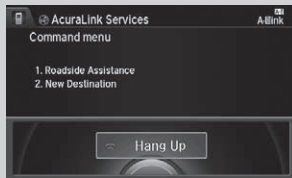

Audio/information screen when connected to the AcuraLink operator.

Operator Assistance

Remain attentive to road conditions and driving during operator assistance.

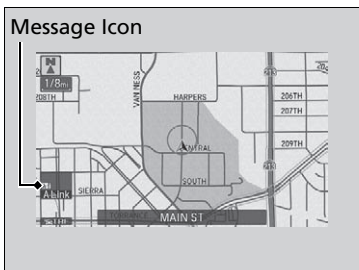

■ AcuraLink Message



AcuraLink sends you messages on vehicle features, safety and emissions recall campaigns, maintenance reminders (U.S. models only), and diagnostic information. When you receive a new message, an icon appears on the audio/information screen.

■ Message category



There are six message categories.

- **Feature Guide:** Appears for the first 90 days of ownership, introducing vehicle features each day.
- **Quick Tips:** Supplements your Owner’s Manual with updated vehicle information.
- **Diagnostic Info:** Appears when a warning indicator or message comes on. Rotate  to select **Check Later** or **Check Now**.
 - ▶ Selecting **Check Now** lets you know if you should see a dealer immediately or later in accordance with the warning severity level.
- **Scheduled Dealer Appointment** (U.S. models only): An appointment made through the Acura server or Acura Owners website can be rescheduled or canceled from this option.  P. 336
- **Maintenance Minder** (U.S. models only): Lets you know which maintenance item is due along with a reminder message.
- **Recalls/Campaigns:** Reminds you of a recall or important safety information. You should also be notified by mail.

▶▶ AcuraLink Message

Messages may not appear immediately after your vehicle purchase. It can take several days for your dealer to register your vehicle’s ID.

If an icon includes an exclamation point, it indicates that Acura gives high priority to this message compared to the one without.

- : An unread message with high priority
- : An unread message

▶▶ Message category

Message categories can be added, edited, or deleted through broadcast messages from Acura.

You can call your dealer, find the nearest dealer, or schedule appointments (U.S. models only) from the message options in **Maintenance Minder** (U.S. models only), **Recalls/Campaigns**, and **Diagnostic Info**.

 **Message Options** P. 335



■ Reading a message



1. Press the **INFO** button, rotate to select **AcuraLink/Messages**, then press .
 - ▶ If your display has changed from **Info** menu to **Current Drive**, press the **MENU** button.
 - ▶ AcuraLink messages appears.
2. Rotate to select a category, then press .
 - ▶ If there are unread messages in a category, a message icon appears next to that category.
3. Rotate to select a message you want to read, then press .

■ Message Options

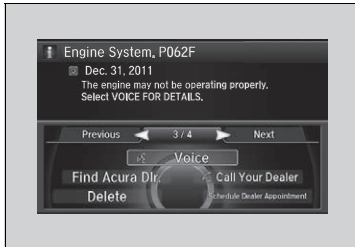

Available options are:

- **Voice:** Reads the message aloud. Select Stop to cancel it.
- **Find Acura Dir.:** Searches for the nearest Acura dealer.
- **Delete:** Deletes the displayed message. Rotate to select this option, then press .
- **Call Your Dealer:** Calls your Acura dealer using HFL.

While a message is displayed, you can use options to take immediate action to the message.

▶▶ Reading a message

If there is no message listed on the menu, **AcuraLink/Messages** is grayed out and cannot be selected.

The message icon disappears once you read the message.

However, the exclamation mark that indicates that the message has a high priority remains.

- : A read message with high priority.

▶▶ Message Options

The available options vary by message category.

You can delete all messages in a category at once.

▶ **Customized Features** P. 262

Voice is available only when the **Message Auto Reading** setting is in ON, and the language selected is English.

▶ **Customized Features** P. 262

- **Schedule Dealer Appointment** (U.S. models only): Automatically sets an appointment date at your dealer.
- **Phone number**: Dials a number displayed in the message via HFL.
- **Diagnostic Info**: Updates the current diagnostic message by connecting to the Acura server using HFL.

U.S. models only

■ Dealer Appointments

You can confirm the scheduled appointment date when you receive a **Maintenance Minder** or **Recalls/Campaigns** message, or reschedule any existing appointments.



1. Select a **Maintenance Minder, Recalls/Campaigns, or Scheduled Dealer Appointment** message.
2. Rotate to select **Scheduled Dealer Appointment** or **Reschedule Appointment** (depending on the screen). Press .
 - ▶ A suggested time and date are displayed.
3. Rotate to select **Confirm Appointment**. Press to accept the time and date.
4. Press to select **OK**.

▶▶ Dealer Appointments

To set up an automated dealer appointment when a regular maintenance is due, visit the Acura Owners website at www.owners.acura.com (in U.S.) or www.acura.ca (in Canada), and set the required option. A reminder message will be sent as the date for the dealer appointment approaches. A reminder message will also be sent if you schedule an appointment online using **Acura Owners' Schedule Service Appointment** function.

If you are not satisfied with the proposed appointment date and time, call your dealer directly.

To cancel the scheduled appointment, select **Cancel Appointment** when a message is displayed.

Driving



This chapter discusses driving, refueling, and information on items such as accessories.

Before Driving

Driving Preparation	338
Maximum Load Limit.....	341

Towing a Trailer

Towing Your Vehicle	343
---------------------------	-----

When Driving

Starting the Engine	344
Precautions While Driving.....	349
Automatic Transmission	350
Shifting	351
SPORT Mode.....	355
Cruise Control*.....	356
Front Sensor Camera*.....	359
Adaptive Cruise Control (ACC) with Low Speed Follow (LSF)*.....	361

Forward Collision Warning (FCW)	375
Lane Departure Warning (LDW)	378
Road Departure Mitigation (RDM) System*....	382
Lane Keeping Assist System (LKAS)*.....	386
Vehicle Stability Assist (VSA®), aka Electronic Stability Control (ESC), System	393
Agile Handling Assist	395
Precision All-Wheel Steer™ (P-AWS®) System	395
Blind Spot Information (BSI) System*.....	396
Tire Pressure Monitoring System (TPMS)....	398
Tire Pressure Monitoring System (TPMS) - Required Federal Explanation	400

Braking

Brake System	402
Anti-lock Brake System (ABS).....	407

Brake Assist System	408
Collision Mitigation Braking System™ (CMBS™)*.....	409

Parking Your Vehicle

When Stopped	417
Parking Sensor System*	418
Cross Traffic Monitor*.....	422

Multi-View Rear Camera*

Surround View Camera System*

Refueling

Fuel Information	437
How to Refuel	438

Fuel Economy and CO₂ Emissions

Improving Fuel Economy and Reducing CO ₂ Emissions.....	439
---	-----

* Not available on all models

Driving Preparation

Check the following items before you start driving.

Exterior Checks

- Make sure there are no obstructions on the windows, door mirrors, exterior lights, or other parts of the vehicle.
 - ▶ Remove any frost, snow, or ice.
 - ▶ Remove any snow on the roof, as this can slip down and obstruct your field of vision while driving. If frozen solid, remove ice once it has softened.
 - ▶ When removing ice from around the wheels, be sure not to damage the wheel or wheel components.
- Make sure the hood is securely closed.
 - ▶ If the hood opens while driving, your front view will be blocked.
- Make sure the tires are in good condition.
 - ▶ Check air pressures, and check for damage and excessive wear.
 - ▶ **Checking and Maintaining Tires** P. 471
- Make sure there are no people or objects behind or around the vehicle.
 - ▶ There are blind spots from the inside.

Exterior Checks

NOTICE

When doors are frozen shut, use warm water around the door edges to melt any ice. Do not try to force them open, as this can damage the rubber trim around the doors. When done, wipe dry to avoid further freezing.

Do not pour warm water into the key cylinder. You will be unable to insert the key if the water freezes in the hole.

Heat from the engine and exhaust can ignite flammable materials left under the hood, causing a fire. If you've parked your vehicle for an extended period, inspect and remove any debris that may have collected, such as dried grass and leaves that have fallen or have been carried in for use as a nest by a small animal. Also check under the hood for leftover flammable materials after you or someone else has performed maintenance on your vehicle.

Interior Checks

- Store or secure all items on board properly.
 - ▶ Carrying too much cargo, or improperly storing it, can affect your vehicle's handling, stability, stopping distance, and tires, and make it unsafe.
 - ✦ **Maximum Load Limit** P. 341
- Do not pile items higher than the seat height.
 - ▶ They can block your view and may be thrown forward in the event of sudden braking.
- Do not place anything in the front seat footwells. Make sure to secure the floor mat.
 - ▶ An object or unsecured floor mat can interfere with your brake and accelerator pedal operation while driving.
- If you have any animals on board, do not let them move around in the vehicle.
 - ▶ They may interfere with driving and a crash could occur.
- Securely close and lock all doors and the trunk.
 - ✦ **Locking/Unlocking the Doors from the Inside** P. 124
- Adjust your seating position properly.
 - ▶ Adjust the head restraint, too.
 - ✦ **Adjusting the Seats** P. 156
 - ✦ **Adjusting the Head Restraints** P. 159
- Adjust the mirrors and steering wheel properly for your driving.
 - ▶ Adjust them while sitting in the proper driving position.
 - ✦ **Adjusting the Mirrors** P. 153
 - ✦ **Adjusting the Steering Wheel** P. 152

Interior Checks

The headlight aim is set by the factory, and does not need to be adjusted. However, if you regularly carry heavy items in the trunk have the aiming readjusted at a dealer or by a qualified technician.

- Be sure items placed on the floor behind the front seats cannot roll under the seats.
 - ▶ They can interfere with the driver's ability to operate the pedals, the operation of the seats, or the operation of the sensors under the seats.
- Everyone in the vehicle must fasten their seat belt.
 - ▶ **Fastening a Seat Belt** P. 33
- Make sure that the indicators in the instrument panel come on when you start the vehicle, and go off soon after.
 - ▶ Always have a dealer check the vehicle if a problem is indicated.
 - ▶ **Indicators** P. 68

Maximum Load Limit

The maximum load for your vehicle is 850 lbs (385 kg). See the Tire and Loading Information label attached to the driver's doorjamb.

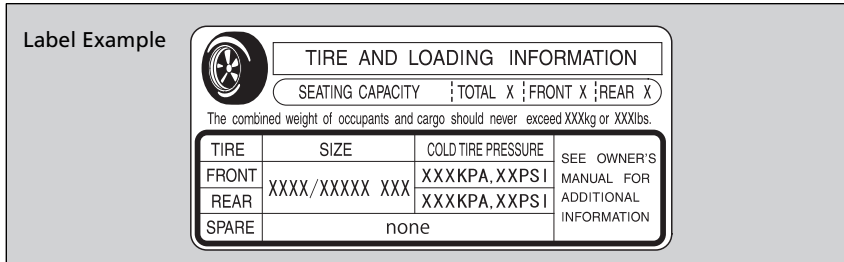

This figure includes the total weight of all occupants, cargo, and accessories, and the tongue load if you are towing a trailer.

Steps for Determining Correct Load Limit -

- (1) Locate the statement "The combined weight of occupants and cargo should never exceed XXX kg or XXX lbs." on your vehicle's placard.
- (2) Determine the combined weight of the driver and passengers that will be riding in your vehicle.
- (3) Subtract the combined weight of the driver and passengers from XXX kg or XXX lbs.
- (4) The resulting figure equals the available amount of cargo and luggage load capacity. For example, if the "XXX" amount equals 1,400 lbs. and there will be five 150 lb. passengers in your vehicle, the amount of available cargo and luggage load capacity is 650 lbs. (1,400 - 750 (5 x 150) = 650 lbs.)

Maximum Load Limit

⚠ WARNING

Overloading or improper loading can affect handling and stability and cause a crash in which you can be hurt or killed.

Follow all load limits and other loading guidelines in this manual.

Gross Vehicle Weight Rating (GVWR):

The maximum allowable weight of the vehicle, all occupants, all accessories and all cargo.

➤ **Specifications** P. 532

Gross Axle Weight Rating (GAWR):







The maximum allowable weight of the vehicle axle.

➤ **Specifications** P. 532

- (5) Determine the combined weight of luggage and cargo being loaded on the vehicle. That weight may not safely exceed the available cargo and luggage load capacity calculated in step 4.
- (6) If your vehicle will be towing a trailer, load from your trailer will be transferred to your vehicle. Consult this manual to determine how this reduces the available cargo and luggage load capacity of your vehicle.

In addition, the total weight of the vehicle, all occupants, accessories, cargo, and trailer tongue load must not exceed the Gross Vehicle Weight Rating (GVWR) or the Gross Axle Weight Rating (GAWR). Both are on a label on the driver's doorjamb.

Load Limits Example

<p>Example 1</p>  <p>Max Load 850 lbs (385 kg)</p>	\geq	 <p>Passenger Weight 150 lbs x 2 = 300 lbs (68 kg x 2 = 136 kg)</p>	<p>+</p>	 <p>Cargo Weight 550 lbs (249 kg)</p>
<p>Example 2</p>  <p>Max Load 850 lbs (385 kg)</p>	\geq	 <p>Passenger Weight 150 lbs x 5 = 750 lbs (68 kg x 5 = 340 kg)</p>	<p>+</p>	 <p>Cargo Weight 100 lbs (45 kg)</p>



Your vehicle is not designed to tow a trailer. Attempting to do so can void your warranties.

Towing Your Vehicle

Your vehicle is not designed to be towed behind a motor home. If your vehicle needs to be towed in an emergency, refer to the emergency towing information.

📄 **Emergency Towing** P. 527

Starting the Engine

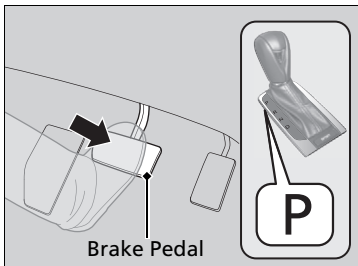
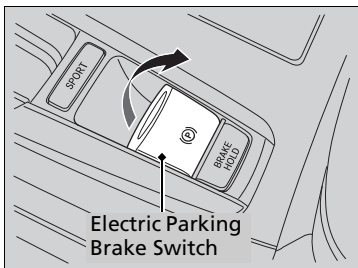

1. Make sure the parking brake is applied.
 - ▶ The electric parking brake indicator comes on for 15 seconds when you pull up the electric parking brake switch.
2. Check that the shift lever is in **P**, then depress the brake pedal.
 - ▶ Although it is possible to start the vehicle in **N**, it is safer to start it in **P**.

Starting the Engine

Keep your foot firmly on the brake pedal when starting the engine.

The engine is harder to start in cold weather and in thinner air found at altitudes above 8,000 feet (2,400 meters).

When starting the engine in cold weather, turn off all electrical accessories such as the lights, climate control system, and rear defogger in order to reduce battery drain.

If you live in a region where winter is extremely cold, an engine block heater will improve starting and warming of the engine. Consult a dealer for details.

If the exhaust system sounds abnormal or you can smell exhaust gas inside the vehicle, have your vehicle checked by a dealer. There may be a problem with the engine or exhaust system.

The immobilizer system protects your vehicle from theft.

If an improperly coded device is used, the engine's fuel system is disabled.

➤ **Immobilizer System** P. 131

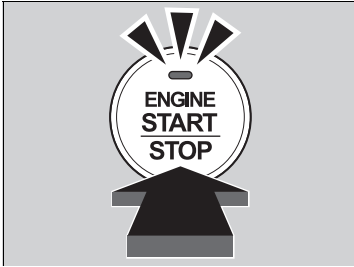

3. Press the **ENGINE START/STOP** button without depressing the accelerator pedal.

Stopping the Engine

You can turn the engine off when the vehicle is completely stopped.

1. Shift to **P**.
2. Press the **ENGINE START/STOP** button.

Starting the Engine

Bring the keyless access remote close to the **ENGINE START/STOP** button if the battery in the keyless access remote is weak.

▣ If the Keyless Access Remote Battery is Weak P. 510

The engine may not start if the keyless access remote is subjected to strong radio waves.

Do not hold the **ENGINE START/STOP** button to start the engine.
If the engine does not start, wait at least 30 seconds before trying again.

■ Remote Engine Start with Vehicle Feedback*

You can remotely start the engine using the two-way keyless access remote from extended distances.

■ To start the engine

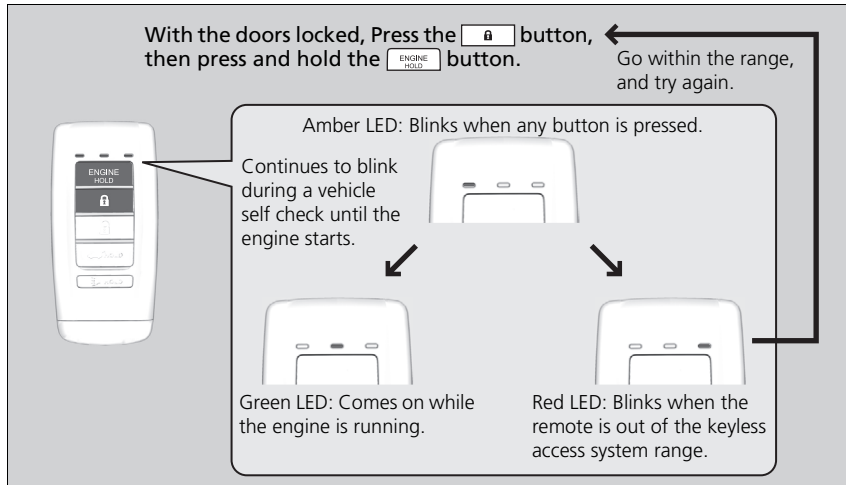

The engine runs for up to 10 minutes without you starting the vehicle.

To extend the run time for another 10 minutes during the first run, press the button, then press and hold the button.

▶ The amber LED blinks, then the green LED comes back on if a 10-minute extension request was transmitted successfully.

After pressing the (lock) button, wait for the green LED to blink. This indicates that all the doors and the trunk are locked.

⊠ Remote Engine Start with Vehicle Feedback*

⚠ WARNING

Engine exhaust contains toxic carbon monoxide.

Breathing carbon monoxide can kill you or cause unconsciousness.

Never use the remote engine starter when the vehicle is parked in a garage or other area with limited ventilation.

If there are buildings and obstacles between your vehicle and the remote, the range will be reduced. This distance may vary by external electrical interference.

The engine may not start by the remote engine start if:

- You have disabled a remote engine start setting using the multi-information display.
- The power mode is not in VEHICLE OFF (LOCK).
- The shift lever is in a position other than **P**.
- The hood is open, or any door or the trunk is unlocked.
- You have already used the remote twice to start the engine.
- Another registered keyless access remote is in the vehicle.
- There is any antenna failure.
- Door is unlocked with the built-in key.

■ To stop the engine

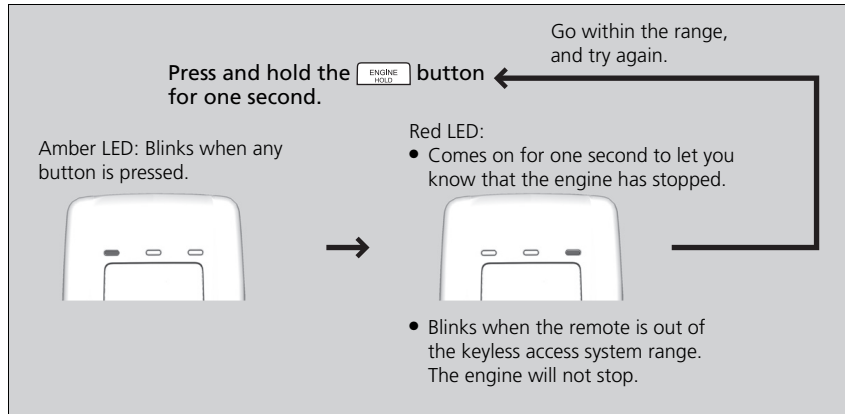

▶▶ Remote Engine Start with Vehicle Feedback*

- The engine oil pressure is low.
- The engine coolant temperature is extremely high.
- The telematics unit malfunctions.
- The security system alarm is not set.

Before starting the engine, make sure to check the door lock status using the remote. When you press the  button, wait for the green LED to blink. If the red LED turns on, the doors and trunk did not lock, and the engine does not start.

While the engine is running, the vehicle will automatically precondition inside the vehicle.

When it is warm outside:

- The air conditioning is activated in recirculation mode.

When it is cold outside:

- The defroster is activated at a moderately warm temperature.
- The rear defogger and door mirror heaters are activated.

* Not available on all models

Starting to Drive

When the engine was started using the two-way keyless access remote*

1. While depressing the brake pedal, press the **ENGINE START/STOP** button.

When the engine was started in any case

2. Put the shift lever to **[D]**. Select **[R]** when reversing.

3. With the parking brake applied, release the brake pedal and gently depress the accelerator pedal.

▶ Make sure the electric parking brake indicator goes off.

4. Gradually release the brake pedal and gently depress the accelerator pedal to pull away.

Hill Start Assist System

Hill start assist keeps the brake engaged briefly to help prevent the vehicle from rolling on inclines as you move your foot from the brake pedal to the accelerator.

Move the shift lever to **[D]** when facing uphill, or **[R]** when facing downhill, then release the brake pedal.

Starting to Drive

You can also release the parking brake by pressing the electric parking brake switch while depressing the brake pedal.

When facing downhill, you can start your vehicle more smoothly by manually releasing it with the electric parking brake switch than by releasing it with the accelerator pedal.

When the engine was started using the two-way keyless access remote*

The engine stops when the shift lever is moved out of **[P]** before the **ENGINE START/STOP** button is pressed. Follow the step 1 when starting to drive.

Hill Start Assist System

Hill start assist may not prevent the vehicle from rolling downhill on a very steep or slippery slope, and does not operate on small inclines.

Hill start assist is not a replacement for the parking brake.

Precautions While Driving

In Rain

Avoid driving in deep water and on flooded roads. This can damage the engine, driveline, or cause electrical component failure.

Precautions While Driving

NOTICE

Do not operate the shift lever while pressing the accelerator pedal. You could damage the transmission.

NOTICE

The following can damage the under spoiler:

- Parking the vehicle by a parking block
- Parallel parking along the road shoulder
- Driving toward the bottom of a hill
- Driving up or down to a different surface level (such as a road shoulder)
- Driving on a rutted or bumpy road
- Driving on a road with potholes.

NOTICE

If you repeatedly turn the steering wheel at an extremely low speed, or hold the steering wheel on the full left or right position for a while, the electric power steering (EPS) system heats up. The system goes into a protective mode, and limits its performance. The steering wheel becomes harder and harder to operate. Once the system cools down, the EPS system is restored.

Repeated operation under these conditions can eventually damage the system.

If the power mode is set to ACCESSORY while driving, the engine will shut down and all steering and brake power assist functions will stop, making it difficult to control the vehicle.

■ Other Precautions

If there is a strong impact with something under the vehicle, stop in a safe location. Check the underside of the vehicle for damage or any fluid leaks.

Automatic Transmission

■ Creeping

The engine runs at a higher idle speed and creeping increases. Keep the brake pedal firmly depressed when stopped.

■ Kickdown

Quickly depressing the accelerator pedal while driving uphill may cause the transmission to drop to a lower gear, unexpectedly increasing vehicle speed. Depress the accelerator pedal carefully, especially on slippery roads and curves.

⚠ Precautions While Driving

Do not put the shift lever in **[N]**, as you will lose engine braking (and acceleration) performance.

During the first 600 miles (1,000 km) of operation, avoid sudden acceleration or full throttle operation so as to not damage the engine or powertrain.

Avoid hard braking for the first 200 miles (300 km). You should also follow this when the brake pads are replaced.

Shifting

Change the shift position in accordance with your driving needs.

■ Shift lever positions

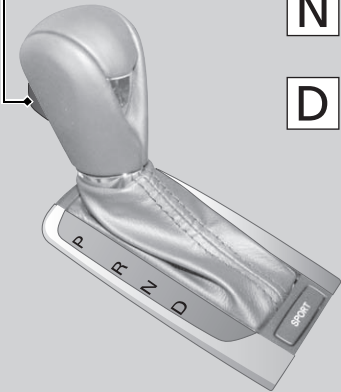

P **Park**
Used when parking or starting the engine

R **Reverse**
Used when reversing

N **Neutral**
Used when idling

D **Drive**
Used for:

- Normal driving (gears change between 1st and 6th automatically)
- Temporarily driving in the sequential shift mode
- Driving in the sequential shift mode (when driving in SPORT mode)

☒ Shifting

You cannot change the power mode from ON to VEHICLE OFF (LOCK) unless the shift lever is in **P**.

The vehicle may move forward very slightly even in **N** while the engine is cold. Depress the brake pedal firmly and, when necessary, apply the parking brake.

When shifting gears in extremely low temperatures (-22°F/-30°C), there may be a short delay before the shift is indicated in the display. Always confirm you are in the correct gear before driving.

Shift Lever Operation

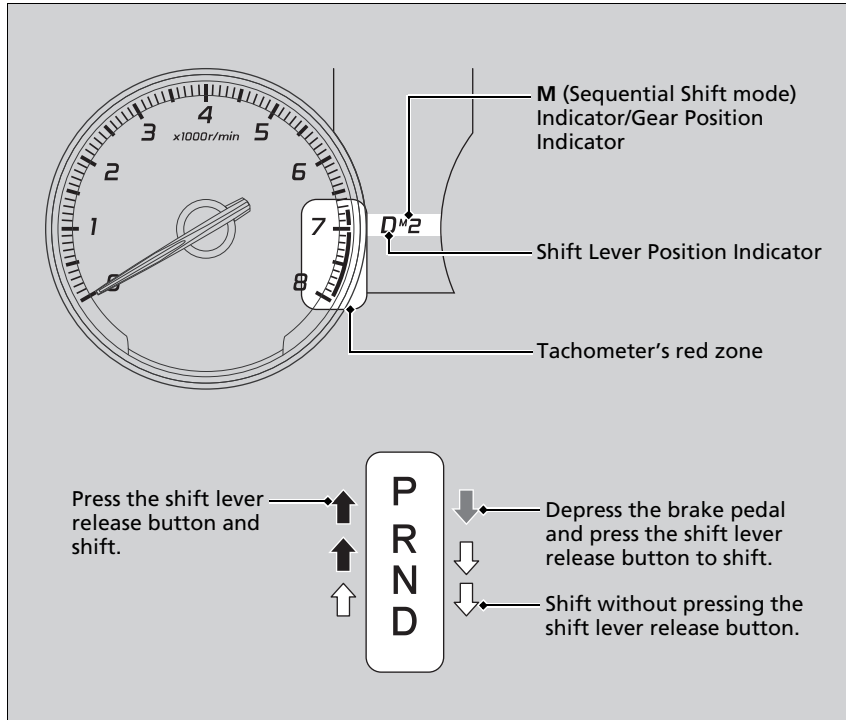

Shift Lever Operation

NOTICE

When you change the shift lever from **D** to **R** and vice versa, come to a complete stop and keep the brake pedal depressed. Operating the shift lever before the vehicle has come to a complete standstill can damage the transmission.

Use the shift lever position indicator to check the lever position before pulling away.

If the transmission indicator blinks when driving, in any shift position, there is a problem with the transmission.

Avoid sudden acceleration and have the transmission checked by a dealer as soon as possible.

The fuel supply may be cut off if you drive at engine speeds in or over the tachometer's red zone (engine speed limit). If this happens, you may experience a slight jolt.

When the engine speed is increased while the shift lever is in **N**, **P** or **R**, the fuel supply may be cut off even without the engine speed entering the tachometer's red zone.

It may not be possible to operate the shift lever if the brake pedal is applied while the shift lever release button is held down.

Depress the brake pedal first.

Sequential Shift Mode

Use the paddle shifters to change between 1st and 6th gears without removing your hands from the steering wheel. The transmission will switch to the sequential shift mode.

■ When the shift lever is in **D**:

The vehicle will go into the sequential shift mode momentarily, and the gear position indicator will come on.

Once you start traveling at a constant speed, the sequential shift mode will automatically switch off, and the gear position indicator will go off.

Hold the **+** paddle shifter for two seconds to return to normal drive.

■ When the shift lever is in **D** with **SPORT** mode:

The vehicle will go into the sequential shift mode, and the **M** (sequential shift) indicator and gear position indicator will come on. At speeds of 6 mph (10 km/h) or less, the vehicle automatically shifts down into 1st gear. If you do not operate the paddle shifters while in 1st gear, the transmission automatically shifts up to 2nd gear.

If the vehicle speed increases and the engine speed reaches near the tachometer's red zone, the transmission automatically shifts up to 6th.

You can cancel this mode by pressing the **SPORT** button, or pulling the **+** paddle shifter for a few seconds. When the sequential shift mode is canceled, the sequential shift mode indicator and shift indicator go off.

■ Second gear lock mode

If you pull the **+** paddle shifter while stopped or driving at 6 mph (10 km/h) or less, the gear position will be locked in 2nd gear. This makes it easier to pull away on slippery surfaces such as snow covered roads.

To cancel the 2nd gear lock mode, pull the **-** paddle shifter.

■ Sequential Shift Mode Operation

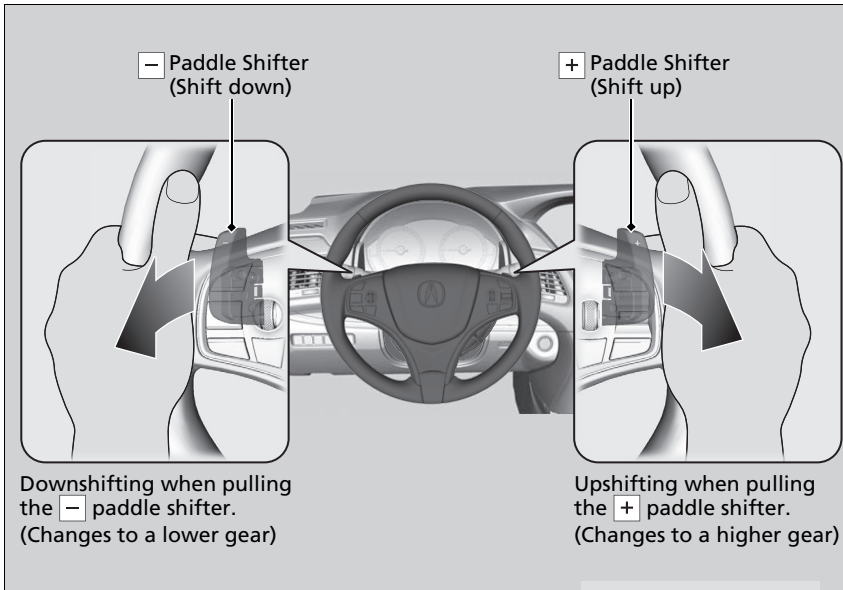

▣ Sequential Shift Mode Operation

Each paddle shift operation makes a single gear change.

To change gears continuously, release the paddle shifter before pulling it again for the next gear.

Recommended Shift Points

Use this table as a guideline for efficient fuel economy and effective emission control.

Shift Up	Normal Acceleration
1st to 2nd	17 mph (28 km/h)
2nd to 3rd	27 mph (44 km/h)
3rd to 4th	36 mph (57 km/h)
4th to 5th	41 mph (66 km/h)
5th to 6th	44 mph (71 km/h)

If the gear position indicator blinks when you try to shift up or down, this means your vehicle speed is not in its allowable gear range.

Slightly accelerate to shift up and decelerate to shift down while the indicator is blinking.

In sport mode, to prioritize the engine performance enhancement, the transmission may not allow for shifting up while the engine speed is low.

SPORT Mode

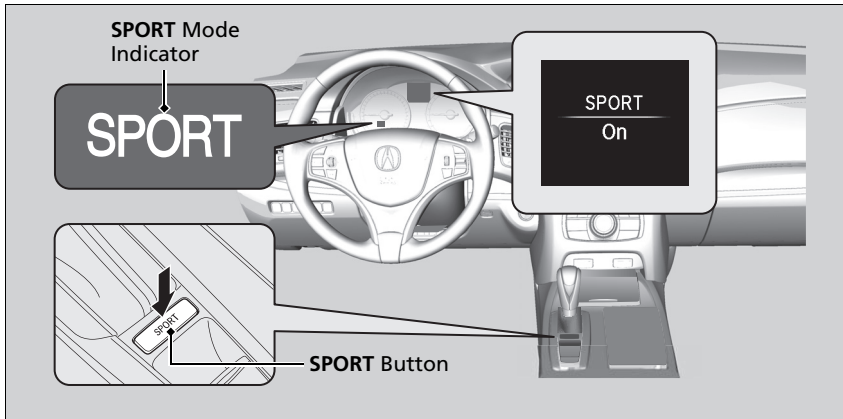

To turn the SPORT mode on and off, press the **SPORT** button.

The SPORT mode increases engine performance and handling. This mode is suitable for driving on hills or through curves on mountain roads.

The SPORT mode is turned off every time you start the engine, even if you turned it on the last time you drove the vehicle.

Cruise Control *

Maintains a constant vehicle speed without having to keep your foot on the accelerator. Use cruise control on freeways or open roads where you can travel at a constant speed with little acceleration or deceleration.

When to use

- Vehicle speed for cruise control:
Desired speed in a range above roughly 25 mph (40 km/h) ~
- Shift positions for cruise control:
In **D**

Always keep sufficient distance between you and the vehicle in front of you.



How to use

- Press the **CRUISE** button on the steering wheel.



CRUISE MAIN is on in the instrument panel.
Cruise control is ready to use.

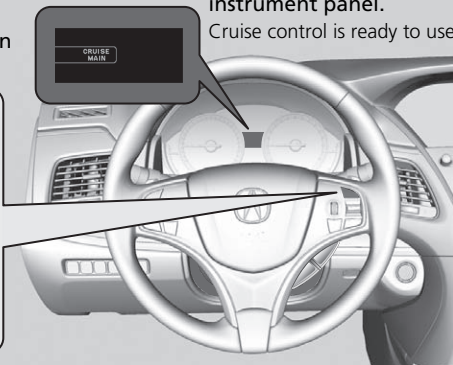

⚠ Cruise Control *

⚠ WARNING

Improper use of the cruise control can lead to a crash.

Use the cruise control only when traveling on open highways in good weather.

It may not be possible to maintain a constant speed when driving uphill or downhill.

When not using cruise control:
Turn off cruise control by pressing the **CRUISE** button.

■ To Set the Vehicle Speed

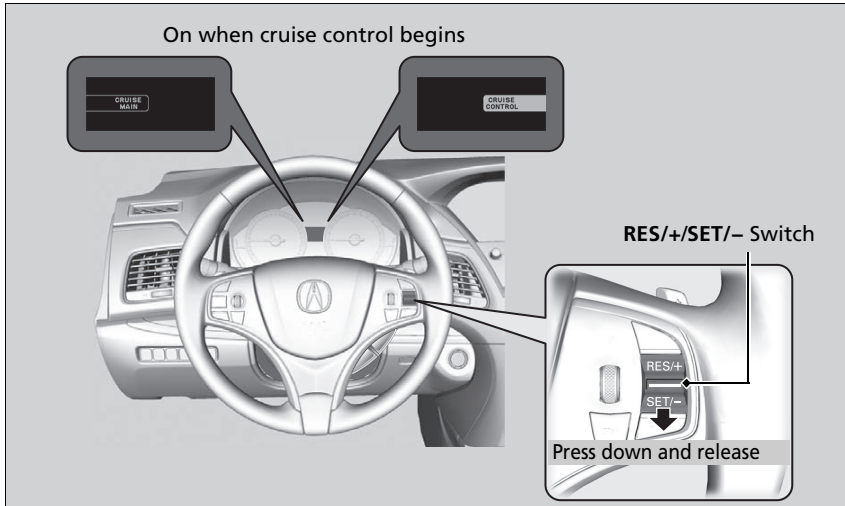

Take your foot off the pedal and press the **RES/+ / SET/-** switch down when you reach the desired speed.

The moment you release the **RES/+ / SET/-** switch, the set speed is fixed, and cruise control begins. The **CRUISE CONTROL** indicator comes on.

■ To Adjust the Vehicle Speed

Increase or decrease the vehicle speed using the **RES/+ / SET/-** switch on the steering wheel.

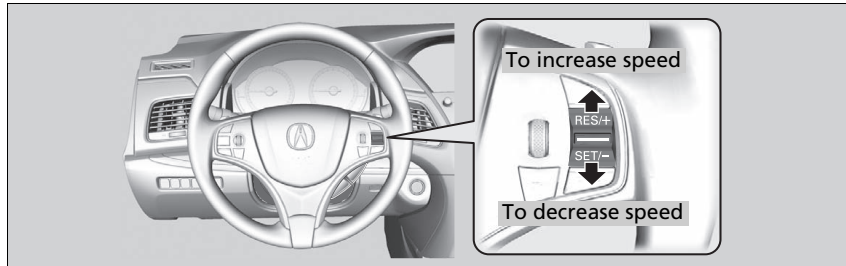

- Each time you press the switch up or down, the vehicle speed is increased or decreased by about 1 mph (1.6 km/h).
- If you keep the switch pressed up or down, the vehicle speed increases or decreases until you release it. This speed is then set.

■ To Cancel

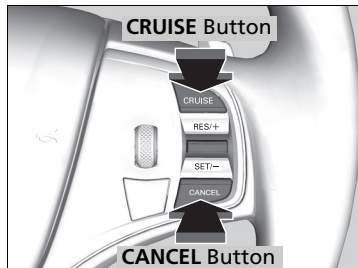

To cancel cruise control, do any of the following:

- Press the **CANCEL** button.
- Press the **CRUISE** button.
- Depress the brake pedal.

The **CRUISE CONTROL** indicator goes off.

▶▶ To Adjust the Vehicle Speed

You can set the vehicle speed pressing the **RES/+ / SET/-** switch down on the steering wheel when adjusting the speed with the accelerator and brake pedals.

▶▶ To Cancel

Resuming the prior set speed:

After cruise control has been canceled, you can still resume the prior set speed by pressing the **RES/+ / SET/-** switch up while driving at a speed of at least 25 mph (40 km/h) or more.

You cannot set or resume in the following situations:

- When vehicle speed is less than 25 mph (40 km/h)
- When the **CRUISE** button is turned off

At vehicle speeds of 22 mph (35 km/h) or less, cruise control is canceled automatically.

Front Sensor Camera *

The camera, used in systems such as LKAS, RDM, ACC with LSF, and CMBS™, is designed to detect an object that triggers any of the systems to operate its functions.

■ Camera Location and Handling Tips

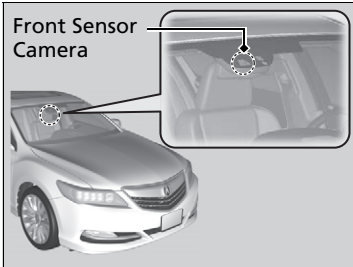

This camera is located behind the rearview mirror.

To help reduce the likelihood that high interior temperatures will cause the camera's sensing system to shut off, when parking, find a shady area or face the front of the vehicle away from the sun. If you use a reflective sun shade, do not allow it to cover the camera housing. Covering the camera can concentrate heat on it.

▣ Front Sensor Camera *

Never apply a film or attach any objects to the windshield, the hood, or the front grill that could obstruct the camera's field of vision and cause the system to operate abnormally. Scratches, nicks, and other damage to the windshield within the camera's field of vision can cause the system to operate abnormally. If this occurs, we recommend that you replace the windshield with a genuine Acura replacement windshield. Making even minor repairs within the camera's field of vision or installing an aftermarket replacement windshield may also cause the system to operate abnormally. After replacing the windshield, have a dealer recalibrate the camera. Proper calibration of the camera is necessary for the system to operate properly.

Do not place an object on the top of the instrument panel. It may reflect onto the windshield and prevent the system from detecting lane lines properly.

* Not available on all models

Front Sensor Camera*

If the **Some Driver Assist Systems Cannot Operate: Camera Temperature Too High** message appears:

- Use the climate control system to cool down the interior and, if necessary, also use defroster mode with the airflow directed towards the camera.
- Start driving the vehicle to lower the windshield temperature, which cools down the area around the camera.

If the **Some Driver Assist Systems Cannot Operate: Clean Front Windshield** message appears:

- Park your vehicle in a safe place, and clean the windshield. If the message does not disappear after you have cleaned the windshield and driven for a while, have your vehicle checked by a dealer.

Adaptive Cruise Control (ACC) with Low Speed Follow (LSF)*

Helps maintain a constant vehicle speed and a set following-interval behind a vehicle detected ahead of yours and, if the detected vehicle slows to a stop, decelerates and stops your vehicle, without you having to keep your foot on the brake or the accelerator.

When ACC with LSF slows your vehicle by applying the brakes, your vehicle's brake lights will illuminate.

When to use

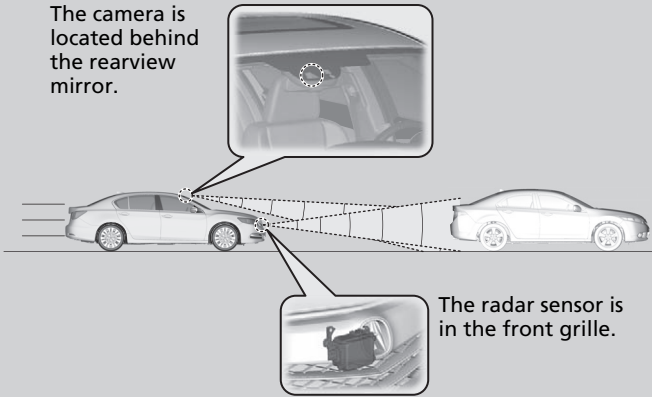

The camera is located behind the rearview mirror.

The radar sensor is in the front grille.

- Vehicle speed for ACC with LSF: **A vehicle is detected ahead within ACC with LSF range** – ACC with LSF operates at speeds up to 90 mph (145 km/h).
- **No vehicle is detected within ACC with LSF range** – ACC with LSF operates at the speed of 25 mph (40 km/h) or above.
- Shift position for ACC with LSF: In **D**.

⚠ Adaptive Cruise Control (ACC) with Low Speed Follow (LSF)*

⚠ WARNING

Improper use of ACC with LSF can lead to a crash.

Use ACC with LSF only when driving on expressways or freeways and in good weather conditions.

⚠ WARNING

ACC with LSF has limited braking capability and may not stop your vehicle in time to avoid a collision with a vehicle that quickly stops in front of you.

Always be prepared to apply the brake pedal if the conditions require.

Important Reminder

As with any system, there are limits to ACC with LSF. Use the brake pedal whenever necessary, and always keep a safe distance between your vehicle and other vehicles.

* Not available on all models

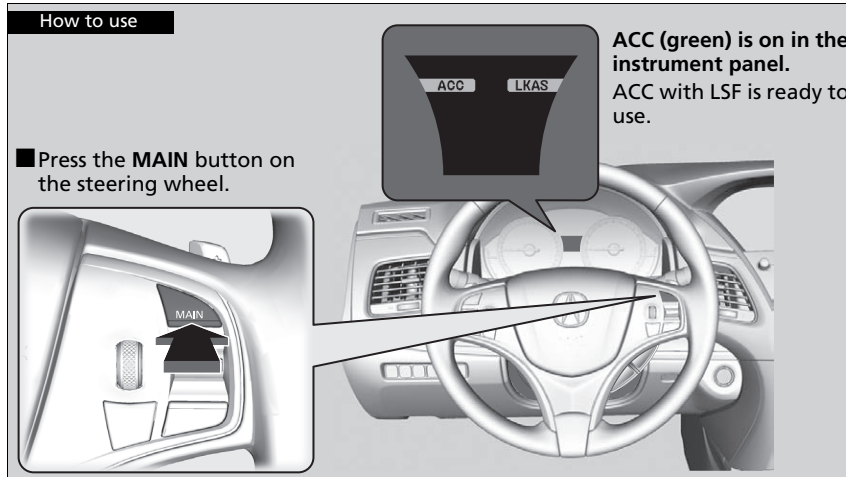

▶ Adaptive Cruise Control (ACC) with Low Speed Follow (LSF)*

When the **MAIN** button is pressed, ACC with LSF and Lane Keeping Assist System (LKAS) are both turned on or off.

ACC with LSF may not work properly under certain conditions.

▶ **ACC with LSF Conditions and Limitations**
P. 366

When not using ACC with LSF: Turn off adaptive cruise by pressing the **MAIN** button. This also will turn off the Lane Keeping Assist System (LKAS).

Do not use ACC with LSF under the following conditions:

- On roads with heavy traffic or while driving in continuous stop and go traffic.
- On roads with sharp turns.
- On roads with steep downhill sections, as the set vehicle speed can be exceeded by coasting. In such cases, ACC with LSF will not apply the brakes to maintain the set speed.
- On roads with toll collection facilities or other objects between lanes of traffic, or in parking areas, or facilities with drive through access.

■ To Set the Vehicle Speed

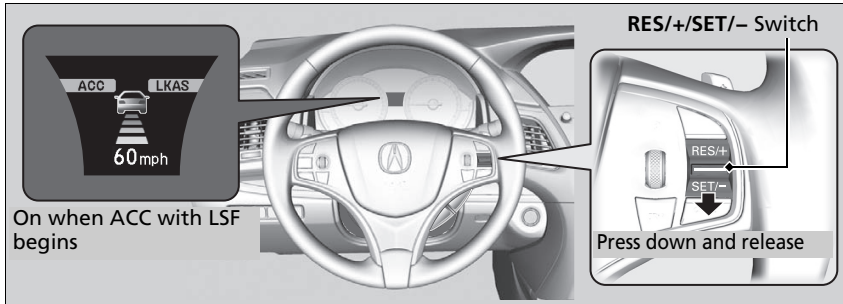

When driving at about 25 mph (40 km/h) or above: Take your foot off the pedal and press down the **RES/+ / SET/-** switch when you reach the desired speed. The moment you release the switch, the set speed is fixed, and ACC with LSF begins.

When driving at slower than about 25 mph (40 km/h): If the vehicle is moving and the brake pedal is not depressed, pressing the switch fixes the set speed to about 25 mph (40 km/h) regardless of current vehicle speed. If the vehicle is stationary, you can set the vehicle speed even with the brake pedal depressed.

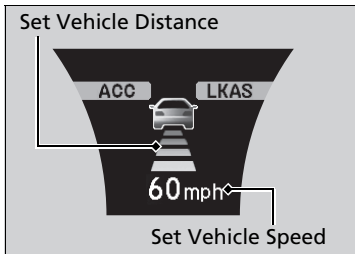

When ACC with LSF starts operating, the vehicle icon, distance bars and set speed appear on the multi-information display.

▣ To Set the Vehicle Speed

You can switch the displayed set speed measurements on the multi-information display between mph and km/h.

▶ **Customized Features P. 103, 262**

■ When in Operation

■ There is a vehicle ahead

ACC with LSF monitors if a vehicle ahead of you enters the ACC with LSF range. If a vehicle is detected doing so, the ACC with LSF system maintains or decelerates your vehicle's set speed in order to keep the vehicle's set following-distance from the vehicle ahead.

➤ **To Set or Change Following-Distance** P. 369

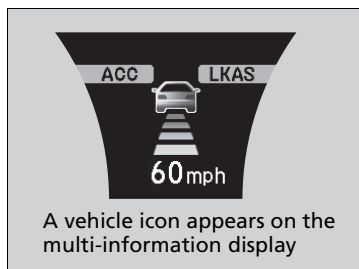
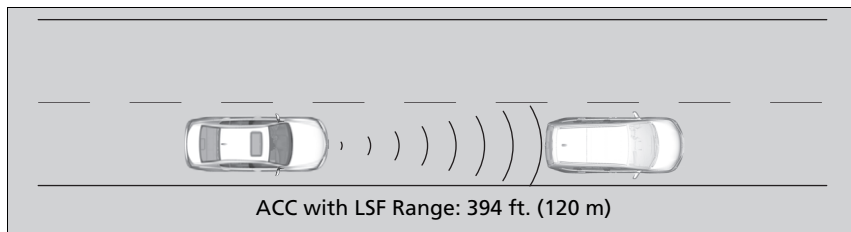

When a vehicle whose speed is slower than your set speed comes in or cuts in front of you and is detected by the radar, your vehicle starts to slow down.

⊠ When in Operation

If the vehicle detected ahead of you slows down abruptly, or if another vehicle is detected cutting in front of you, the beeper sounds and a message appears on the multi-information display. Depress the brake pedal, and keep an appropriate distance from the vehicle ahead.

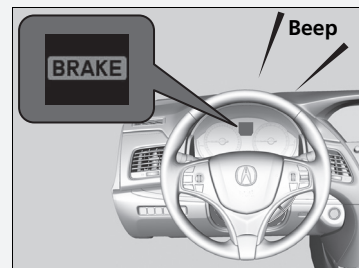

Even if the distance between your vehicle and the vehicle detected ahead is short, ACC with LSF may start accelerating your vehicle under the following circumstances:

- The vehicle ahead of you is going at almost the same speed as, or faster than, your vehicle.
- A vehicle that cuts in front of you is going faster than your vehicle, gradually increasing the distance between the vehicles.

You can also set the system to beep when a vehicle detected in front of you comes in and goes out of the ACC with LSF detecting range. Change the **ACC Forward Vehicle Detect Beep** setting.

➤ **Customized Features** P. 103, 262

■ **There is no vehicle ahead**

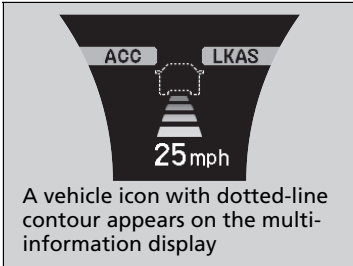

Your vehicle maintains the set speed without having to keep your foot on the brake or accelerator pedal. If there previously was a vehicle detected ahead that kept your vehicle from traveling at the set speed, ACC with LSF accelerates your vehicle to the set speed, and then maintains it.

■ **When you depress the accelerator pedal**

You can temporarily increase the vehicle speed. In this case, there is no audible or visual alert even if a vehicle is in the ACC with LSF range. ACC with LSF stays on unless you cancel it. Once you release the accelerator pedal, the system resumes the set speed. There are times when the vehicle speed will decrease when the accelerator pedal is lightly applied.

■ **A vehicle detected ahead is within ACC with LSF range and slows to a stops**



Your vehicle also stops, automatically. The **Stopped** message appears on the multi-information display. When the vehicle ahead of you starts again, the vehicle icon on the multi-information display blinks. If you press the **RES/+/SET/-** switch up or down, or depress the accelerator pedal, ACC with LSF operates again within the prior set speed.

⌘ When in Operation

Limitations

You may need to use the brake to maintain a safe distance when using ACC with LSF. Additionally, ACC with LSF may not work properly under certain conditions.

➤ **ACC with LSF Conditions and Limitations**
P. 366

⌘ A vehicle detected ahead is within ACC with LSF range and slows to a stops

⚠ WARNING

Exiting a vehicle that has been stopped while the ACC with LSF system is operating can result in the vehicle moving without operator control.

A vehicle that moves without operator control can cause a crash, resulting in serious injury or death.

Never exit a vehicle when the vehicle is stopped by ACC with LSF.

■ ACC with LSF Conditions and Limitations

The system may automatically shut off and the **ACC** indicator will come on under certain conditions. Some examples of these conditions are listed below. Other conditions may reduce some of the ACC functions.

➤ **Front Sensor Camera*** P. 359

■ Environmental conditions

- Driving in bad weather (rain, fog, snow, etc.).

■ Roadway conditions

- Driving on a snowy or wet roadway (obscured lane marking, vehicle tracks, reflected lights, road spray, high contrast).

■ Vehicle conditions

- The outside of the windshield is blocked by dirt, mud, leaves, wet snow, etc.
- An abnormal tire or wheel condition (Wrong sized, varied size or construction, improperly inflated, compact spare tire*, etc.).
- The camera temperature gets too high.
- The parking brake is applied.
- When the front grille is dirty.
- When the front of the vehicle tilts up due to heavy cargo in the trunk or rear seats.
- When tire chains are installed.

➤ ACC with LSF Conditions and Limitations

The radar sensor for ACC with LSF is shared with the collision mitigation braking system™ (CMBS™).

➤ **Collision Mitigation Braking System™ (CMBS™)*** P. 409

You can read about handling information for the camera equipped with this system.

➤ **Front Sensor Camera*** P. 359

■ Detection limitations

- A vehicle or pedestrian suddenly crosses in front of you.
- The distance between your vehicle and the vehicle or pedestrian ahead of you is too short.
- A vehicle cuts in front of you at a slow speed, and it brakes suddenly.
- When you accelerate rapidly and approach the vehicle or pedestrian ahead of you at high speed.
- The vehicle ahead of you is a motorcycle, bicycle, mobility scooter, or other small vehicle.
- When there are animals in front of your vehicle.
- When you drive on a curved or winding or undulating road that makes it difficult for the sensor to properly detect a vehicle or a pedestrian in front of you.
- The speed difference between your vehicle and a vehicle or pedestrian in front of you is significantly large.
- An oncoming vehicle suddenly comes in front of you.
- Your vehicle abruptly crosses over in front of an oncoming vehicle.
- When driving through a narrow iron bridge.
- When the vehicle ahead of you brakes suddenly.
- When the vehicle ahead of you has a unique shape.
- When your vehicle or the vehicle ahead of you is driving on one edge of the lane.

■ To Adjust the Vehicle Speed

Increase or decrease the vehicle speed using the **RES/+**/**SET/-** switch on the steering wheel.

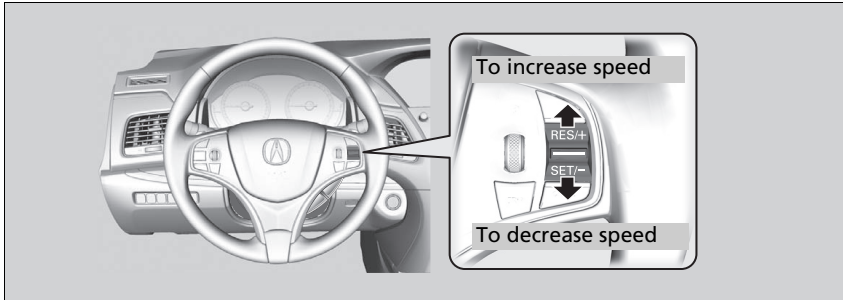



- Each time you press the switch up or down, the vehicle speed is increased or decreased by about 1 mph or 1 km/h accordingly.
- If you keep the switch pressed up or down, the vehicle speed increases or decreases by about 5 mph or 5 km/h accordingly.

▶▶ To Adjust the Vehicle Speed

If a vehicle detected ahead is going at a speed slower than your increased set speed, ACC with LSF may not accelerate your vehicle. This is to maintain the set following-distance between your vehicle and the vehicle ahead.

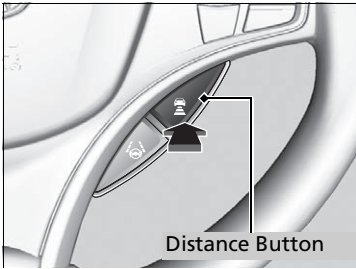



■ To Set or Change Following-Distance



Press the  (distance) button to change the ACC with LSF following-distance. Each time you press the button, the following-distance (the interval behind a vehicle detected ahead of you) setting cycles through short, middle, long, and extra long following-distances.

Determine the most appropriate following-distance setting based on your specific driving conditions. Be sure to adhere to any following-distance requirements set by local regulation.

The higher your vehicle's following-speed is, the longer the short, middle, long or extra long following-distance becomes. See the following examples for your reference.

Following-distance		When the Set Speed is:	
		50 mph (80 km/h)	65 mph (104 km/h)
Short		83 feet 25 meters 1.1 sec	100 feet 31 meters 1.1 sec
Middle		110 feet 33 meters 1.5 sec	137 feet 42 meters 1.5 sec
Long		154 feet 47 meters 2.1 sec	200 feet 61 meters 2.1 sec
Extra Long		204 feet 62 meters 2.8 sec	265 feet 81 meters 2.8 sec

When your vehicle stops automatically because a vehicle detected ahead of you has stopped, the interval between the two vehicles will vary based on the ACC with LSF interval setting.

■ To Cancel

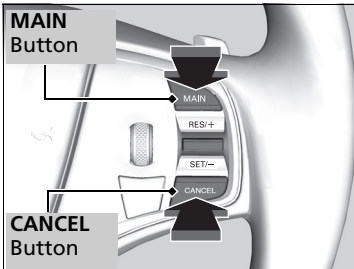

To cancel ACC with LSF, do any of the following:

- Press the **CANCEL** button.
- Press the **MAIN** button.
 - ▶ ACC with LSF indicator goes off.
- Depress the brake pedal.
 - ▶ When the LSF function has stopped the vehicle, you cannot cancel ACC with LSF by depressing the brake pedal.

☒ To Cancel

Resuming the prior set speed: After you have canceled ACC with LSF, you can resume the prior set speed while it is still displayed. Press the **RES/+ / SET / -** switch up.

The set speed cannot be set or resumed when ACC with LSF has been turned off using the **MAIN** button. Press the **MAIN** button to activate the system, then set the desired speed.

■ Automatic cancellation

The beeper sounds and a message appears on the multi-information display when ACC with LSF is automatically canceled. Any of these conditions may cause the ACC with LSF to automatically cancel:

- Bad weather (rain, fog, snow, etc.)
- When the radar sensor in the front grille gets dirty.
- The vehicle ahead of you cannot be detected.
- An abnormal tire condition is detected, or the tires are skidding.
- Driving on a mountainous road, or driving off road for extended periods.
- Abrupt steering wheel movement.
- When the ABS, VSA® or CMBS™ is activated.
- When the ABS or VSA® system indicator comes on.
- When the vehicle is stopped on a very steep slope.
- When you manually apply the parking brake.
- When the detected vehicle within the ACC with LSF range is too close to your vehicle.
- The camera behind the rearview mirror, or the area around the camera, including the windshield, gets dirty.

The ACC with LSF automatic cancellation can be also triggered by the following causes. In these cases, the parking brake will be automatically applied.

- The driver's seat belt is unfastened when the vehicle is stationary.
- The vehicle stops for more than 10 minutes.
- The engine is turned off.

▶ Automatic cancellation

Even though ACC with LSF has been automatically canceled, you can still resume the prior set speed. Wait until the condition that caused ACC with LSF to cancel improves, then press the **RES/+SET/-** switch down.

■ To Switch ACC with LSF to Cruise Control

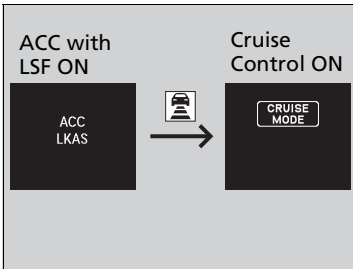

Press and hold the  (distance) button for one second. **Cruise Mode Selected** appears on the multi-information display for two seconds, and then the mode switches to Cruise.

To switch back to ACC with LSF, press and hold the  button again for one second. **ACC Mode Selected** appears on the multi-information display for two seconds.

☒ To Switch ACC with LSF to Cruise Control

Always be aware which mode you are in. When you are driving in Cruise mode, the system will not assist you to maintain a following-distance from a vehicle ahead of you.

■ When to use

Desired speed in a range above roughly 25 mph (40 km/h) ~.

■ To Set the Vehicle Speed

Take your foot off the pedal and press the **RES/+ / SET/-** switch down when you reach the desired speed.

The moment you release the **RES/+ / SET/-** switch, the set speed is fixed, and cruise control begins. The **CRUISE CONTROL** indicator comes on.

■ To Adjust the Vehicle Speed

Each time you press the **RES/+ / SET/-** switch up or down, the vehicle speed is increased or decreased by about 1 mph (1.6 km/h).

If you keep the **RES/+ / SET/-** switch pressed up or down, the vehicle speed increases or decreases until you release it. This speed is then set.

■ To Cancel

To cancel cruise control, do any of the following:

- Press the **CANCEL** button.
- Press the **MAIN** button.
- Depress the brake pedal.

The **CRUISE CONTROL** indicator goes off.

☒ To Cancel

Resuming the prior set speed:

After cruise control has been canceled, you can still resume the prior set speed by pressing the **RES/+ / SET/-** switch up while driving at a speed of at least 25 mph (40 km/h) or more.

You cannot set or resume in the following situations:

- When vehicle speed is less than 25 mph (40 km/h)
- When the **MAIN** button is turned off.

At vehicle speeds of 22 mph (35 km/h) or less, cruise control canceled automatically.

Models without Collision Mitigation Braking System™ (CMBS™)

Forward Collision Warning (FCW)

Alerts you when it detects the possibility of your vehicle colliding with the vehicle in front of yours.

If the system determines a collision is possible, it gives both visual and audible alerts.

- ▶ Take appropriate action to prevent a collision (apply the brakes, change lanes, etc.).

■ How the system works

The system may give warnings of potential collisions when your vehicle speed is above 10 mph (15 km/h).

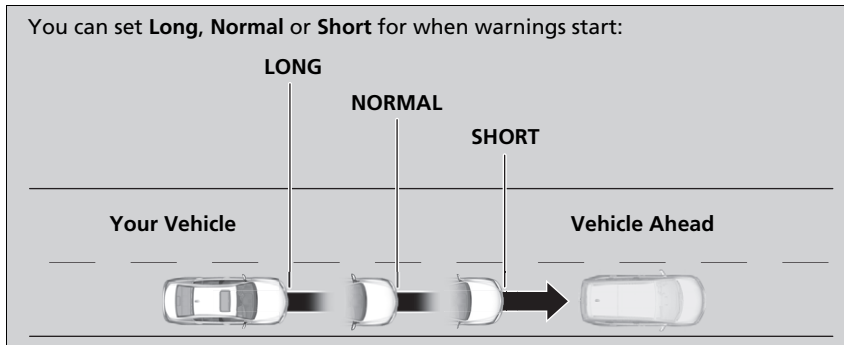

⌘ Forward Collision Warning (FCW)

Important Safety Reminder

FCW cannot detect all objects ahead and may not detect a given object; accuracy of the system will vary based on weather, speed and other factors. FCW does not include a braking function. It is always your responsibility to safely operate the vehicle and avoid collisions.

You can change the **Forward Collision Warning Distance** setting or turn the system on and off.

➤ **Customized Features** P. 103, 262

The camera is shared with Lane Departure Warning (LDW).

➤ **Lane Departure Warning Camera (LDW Camera)** P. 379

Never apply a film or attach any objects to the windshield that could obstruct the FCW camera's field of vision.

Scratches, nicks, and other damage to the windshield within the FCW camera's field of vision can cause the system to operate abnormally. If this occurs, we recommend that you replace the windshield with a genuine Acura replacement windshield. Making even minor repairs within the camera's field of vision or installing an aftermarket replacement windshield may also cause the system to operate abnormally. After replacing the windshield, have a dealer recalibrate the camera. Proper calibration of the FCW camera is necessary for the system to operate properly.

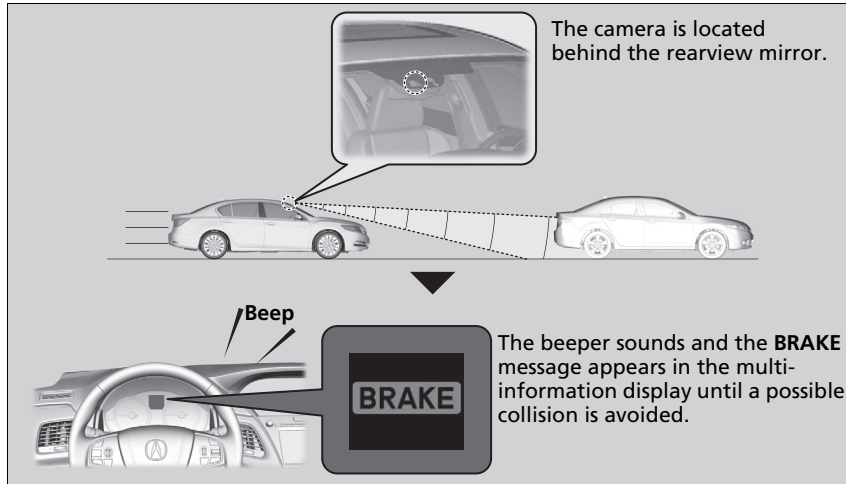

■ Automatic shutoff

FCW may automatically shut itself off and the FCW indicator comes and stays on when:

- The temperature inside the system is high.
- The windshield is blocked by dirt, mud, leaves, wet snow, etc.

Once the conditions that caused FCW to shut off improve or are addressed (e.g., cleaning), the system comes back on.

▶ Automatic shutoff

To help reduce the likelihood that high interior temperatures will cause the camera system to shut off, when parking, find a shady area or face the front of the vehicle away from the sun.

If you use a reflective sun shade, do not allow it to cover the camera housing. Covering the camera can concentrate heat on the camera.



If the **Can Not Operate: Camera Too Hot** message appears:

- Use the climate control system to cool down the interior and, if necessary, the defroster mode when windows are fogged.
- Start driving the vehicle to lower the windshield temperature, which cools down the area around the FCW camera.

FCW Limitations

FCW may not activate or may not detect a vehicle in front of your vehicle, and may activate even when you are aware of a vehicle ahead of you, or when there is no vehicle ahead, under the following conditions.

Condition

- The distance between your vehicle and the vehicle ahead of you is too short.
- A vehicle cuts in front of you at a slow speed, and it brakes suddenly.
- A vehicle suddenly crosses in front of you.
- When either your vehicle or the vehicle ahead of you accelerates rapidly.
- The vehicle ahead of you is a motorcycle, a small vehicle, or a unique vehicle such as a tractor.
- When you drive off-road or on a mountain road, or curved and winding road for an extended period that makes it difficult for the sensor/camera to properly detect a vehicle in front of you.
- When there are pedestrians or animals in front of your vehicle.
- When you drive in bad weather (rain, fog, etc.).
- A heavy load in the rear or modifications to the suspension tilts your vehicle.
- An abnormal tire condition is detected (wrong tire size, flat tire, etc.).
- When the windshield is blocked by dirt, mud, leaves, wet snow, etc.
- When the temperature inside the system is high.
- A sudden change between light and dark such as an entrance or exit of a tunnel.
- You drive into the sunlight (e.g. at dawn or dusk).
- When the windshield is dirty or cloudy.
- When streetlights are perceived as the taillight of a vehicle in front of yours.
- When driving at night, the vehicle ahead of you is running with either taillight bulb burned out.
- When you drive in the shadows of trees, buildings, etc.

Models without Road Departure Mitigation (RDM) System

Lane Departure Warning (LDW)

Alerts you when the system detects a possibility of your vehicle unintentionally crossing over detected lane markings.

How the System Works

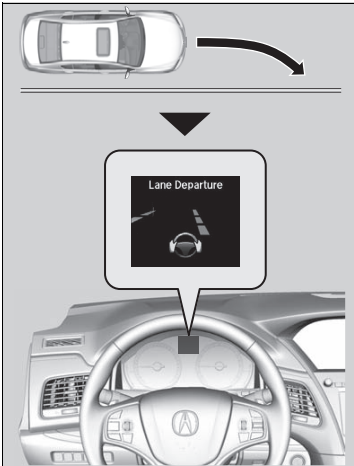

If your vehicle is getting too close to detected left or right side lane markings without a turn signal activated, LDW will give audible and visual alerts.

The beeper sounds and the **Lane Departure** message appears on the multi-information display, letting you know that you need to take appropriate action.

How the System Activates

The system begins to search for lane markings when all the following conditions are met:

- The vehicle is traveling between 45 and 90 mph (72 and 145 km/h).
- The vehicle is on a straight or slightly curved road.
- The turn signals are off.
- The brake pedal is not depressed.

▶▶ Lane Departure Warning (LDW)

Important Safety Reminder

Like all assistance systems, LDW has limitations. Over-reliance on LDW may result in a collision. It is always your responsibility to keep the vehicle within your driving lane.

LDW only alerts you when lane drift is detected without a turn signal in use. LDW may not detect all lane markings or lane departures; accuracy will vary based on weather, speed and lane marker condition. It is always your responsibility to safely operate the vehicle and avoid collisions.

▶▶ How the System Activates

LDW may automatically shut off and the LDW indicator comes and stays on.

▶▶ Indicators P. 68

■ Lane Departure Warning Camera (LDW Camera)

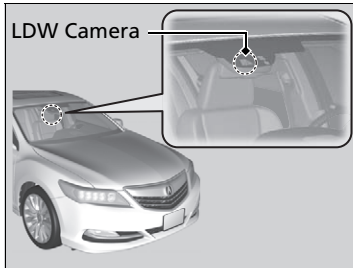

The camera is located behind the rearview mirror.

▣ Lane Departure Warning Camera (LDW Camera)

Never apply a film or attach any objects to the windshield that could obstruct the LDW camera's field of vision.

Scratches, nicks, and other damage to the windshield within the LDW camera's field of vision can cause the system to operate abnormally. If this occurs, we recommend that you replace the windshield with a genuine Acura replacement windshield. Making even minor repairs within the camera's field of vision or installing an aftermarket replacement windshield may also cause the system to operate abnormally. After replacing the windshield, have a dealer recalibrate the camera. Proper calibration of the LDW camera is necessary for the system to operate properly.

■ LDW On and Off

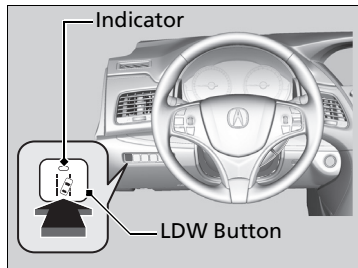

Press the LDW button to turn the system on and off.

- ▶ The indicator in the button comes on when the system is on.

▶ Lane Departure Warning Camera (LDW Camera)

Do not place an object on the top of the instrument panel. It may reflect onto the windshield and prevent the system from detecting lane lines properly.

To help reduce the likelihood that high interior temperatures will cause the camera system to shut off, when parking, find a shady area or face the front of the vehicle away from the sun. If you use a reflective sun shade, do not allow it to cover the camera housing. Covering the camera can concentrate heat on the camera.



If the **Can Not Operate: Camera Too Hot** message appears:

- Use the climate control system to cool down the interior and, if necessary, the defroster mode when windows are fogged.
- Start driving the vehicle to lower the windshield temperature, which cools down the area around the LDW camera.

LDW Limitations

LDW may not activate or may not recognize lanes, and may activate even when keeping in the middle of a lane, under the following conditions.

Condition

- When you drive in bad weather (rain, fog, etc.).
- A heavy load in the rear or modifications to the suspension tilts your vehicle.
- An abnormal tire condition is detected (wrong tire size, flat tire, etc.).
- When the windshield is blocked by dirt, mud, leaves, wet snow, etc.
- When the temperature inside the system is high.
- A sudden change between light and dark such as an entrance or exit of a tunnel.
- You drive into the sunlight (e.g. at dawn or dusk).
- When the windshield is dirty or cloudy.
- When you drive in the shadows of trees, buildings, etc.
- When you drive on a wet road surface following another vehicle.
 - ▶ The camera may perceive the tire tracks in the water as lane lines.
- When there is snow or wheel tracks on the side of the road.
- When the road has many repaired area or an erased lane line.
- When the vehicle is running over painted signs or crosswalk markings.
- When you drive in a lane with worn-out lane markings.

Road Departure Mitigation (RDM) System*

Alerts and helps to assist you when the system determines a possibility of your vehicle unintentionally crossing over detected lane markings.

How the System Works

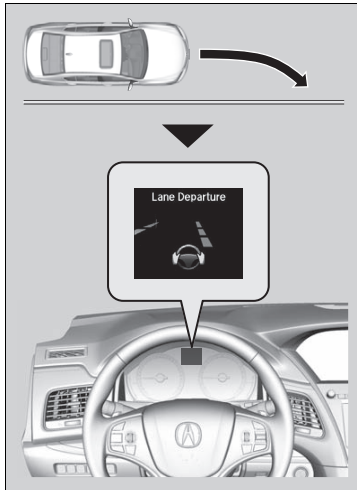

The front camera behind the rearview mirror monitors left and right lane markings (in white or yellow). If your vehicle is getting too close to detected lane markings without a turn signal activated, the system, in addition to a visual alert, applies steering torque and alerts you with rapid vibrations on the steering wheel, to help you remain within the detected lane.

▶ **Customized Features** P. 103, 262

As a visual alert, the **Lane Departure** message appears on the multi-information display.

If the system determines that its steering input is insufficient to keep your vehicle on the roadway, it may apply braking.

▶ Braking is applied only when the lane markings are solid continuous lines.

The system cancels assisting operations when you turn the steering wheel to avoid crossing over detected lane markings.

If the system operates several times without detecting driver response, the system beeps to alert you.

* Not available on all models

▶▶ Road Departure Mitigation (RDM) System*

Important Safety Reminder

Like all assistance systems, the RDM system has limitations.

Over-reliance on the RDM system may result in a collision. It is always your responsibility to keep the vehicle within your driving lane.

The RDM system only alerts you when lane drift is detected without a turn signal in use. The RDM system may not detect all lane markings or lane or roadway departures; accuracy will vary based on weather, speed and lane marker condition. It is always your responsibility to safely operate the vehicle and avoid collisions.

You can read about handling information for the camera equipped with this system.

▶ **Front Sensor Camera*** P. 359

The RDM system may not work properly or may work improperly under the certain conditions:

▶ **RDM Conditions and Limitations** P. 384

There are times when you may not notice RDM functions due to your operation of the vehicle, or road surface conditions. If the **Lane Departure** message displays repeatedly and you do not apply responsive actions, the system beeps and cancels RDM functions.

How the System Activates

The system becomes ready to start searching for lane markings when all the following conditions are met:

- The vehicle is traveling between about 45 and 90 mph (72 and 145 km/h).
- The vehicle is on a straight or slightly curved road.
- The turn signals are off.
- The brake pedal is not depressed.
- The wipers are not in continuous operation.
- The system makes a determination that the driver is not actively accelerating, braking or steering.

RDM On and Off

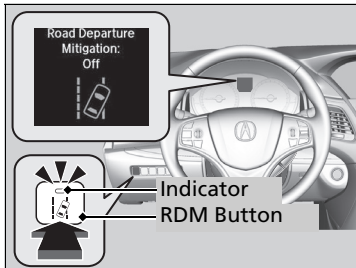

Press the RDM button to turn the system on and off.

- ▶ The indicator in the button comes on and the message appears on the multi-information display when the system is on.

How the System Activates

The RDM system may automatically shut off and the  indicator comes and stays on.

▶ **Indicators** P. 68

RDM system function can be impacted when the vehicle is:

- Not driven within a traffic lane.
- Driven on the inside edge of a curve, or outside of a lane.
- Driven in a narrow lane.

RDM On and Off

When you have selected **Warning Only** from the customized options using the multi-information display, the system does not operate the steering wheel and braking.

■ RDM Conditions and Limitations

The system may not properly detect lane markings and the position of your vehicle under certain conditions. Some examples of these conditions are listed below.

■ Environmental conditions

- Driving in bad weather (rain, fog, snow, etc.).
- Sudden changes between light and dark, such as an entrance or exit of a tunnel.
- There is little contrast between lane lines and the roadway surface.
- Driving into low sunlight (e.g., at dawn or dusk).
- Strong light is reflected onto the roadway.
- Driving in the shadows of trees, buildings, etc.
- Shadows of adjacent objects are parallel to lane markings.
- Roadway objects or structures are misinterpreted as lane markers.
- Reflections on the interior of the windshield.
- Driving at night or in a dark condition such as a tunnel.

■ Roadway conditions

- Driving on a snowy or wet roadway (obscured lane marking, vehicle tracks, reflected lights, road spray, high contrast).
- Driving on a road with temporary lane markings.
- Faint, multiple, or varied lane markings are visible on the roadway due to road repairs or old lane markings.
- The roadway has merging, split, or crossing lines (e.g., such as at an intersection or crosswalk).
- The lane markings are extremely narrow, wide, or changing.
- The vehicle in front of you is driving near the lane lines.
- The road is hilly or the vehicle is approaching the crest of a hill.
- Driving on rough or unpaved roads, or over bumpy surfaces.
- When objects on the road (curb, guard rail, pylons, etc.) are recognized as white lines (or yellow lines).
- Driving on roads with double lines.

■ Vehicle conditions

- Headlight lenses are dirty or the headlights are not properly adjusted.
- The outside of the windshield is streaked or blocked by dirt, mud, leaves, wet snow, etc.
- The inside of the windshield is fogged.
- The camera temperature gets too high.
- An abnormal tire or wheel condition (wrong sized, varied size or construction, improperly inflated, compact spare tire*, etc.).
- The vehicle is tilted due to a heavy load or suspension modifications.
- When tire chains are installed.

* Not available on all models

Lane Keeping Assist System (LKAS)*

Provides steering input to help keep the vehicle in the middle of a detected lane and provides tactile and visual alerts if the vehicle is detected drifting out of its lane.

■ Tactile and visual alerts

Rapid vibrations on the steering wheel and a warning display alert you that the vehicle is drifting out of a detected lane.



■ LKAS camera
Monitors the lane lines

■ Steering input assist

The system applies torque to the steering to keep the vehicle between the left and right lane lines. The applied torque becomes stronger as the vehicle gets closer to either of the lane lines.

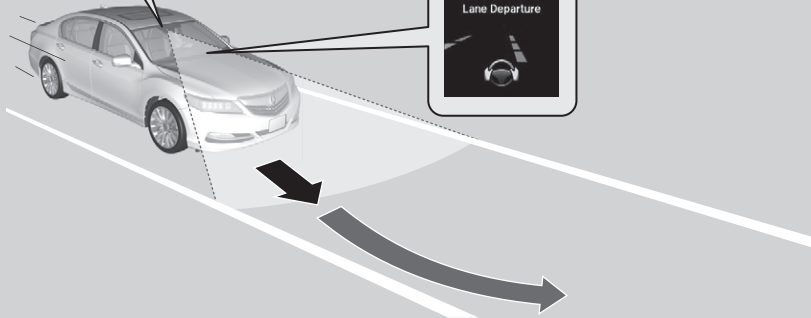

When you operate the turn signals to change lanes, the system is suspended, and resumes after the signals are off.

➡ If you make a lane change without operating the turn signals, the LKAS alerts activate, and torque is applied to the steering.

▶ Lane Keeping Assist System (LKAS)*

Important Safety Reminders

The LKAS is for your convenience only. It is not a substitute for your vehicle control. The system does not work if you take your hands off the steering wheel or fail to steer the vehicle.

▶ Multi-Information Display Warning and Information Messages P. 95

Do not place objects on the instrument panel. Objects may reflect on the front windshield and prevent correct detection of the traffic lanes.

The LKAS only alerts you when lane drift is detected without a turn signal in use. The LKAS may not detect all lane markings or lane departures; accuracy will vary based on weather, speed, and lane marker condition.

It is always your responsibility to safely operate the vehicle and avoid collisions.

The LKAS is convenient when it is used on freeways.

The LKAS may not work properly or may work improperly under the certain conditions:

▶ LKAS Conditions and Limitations P. 391

You can read about handling information for the camera equipped with this system.

▶ Front Sensor Camera* P. 359

■ Lane Keep Support Function

Provides assistance to keep the vehicle in the center of the lane. When the vehicle nears a white or yellow line, steering force of the electric power steering will become stronger.

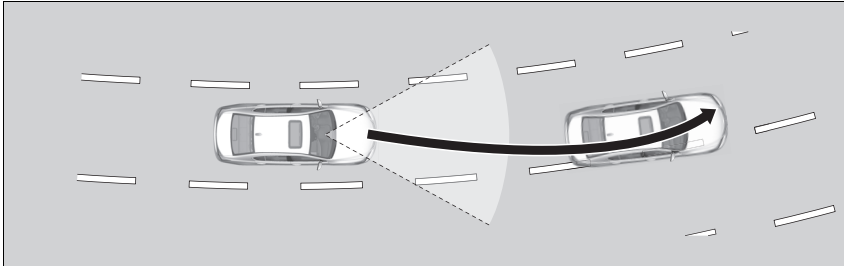

■ Lane Departure Warning Function

When the vehicle enters the warning area, the LKAS alerts you with slight steering wheel vibration as well as a warning display.

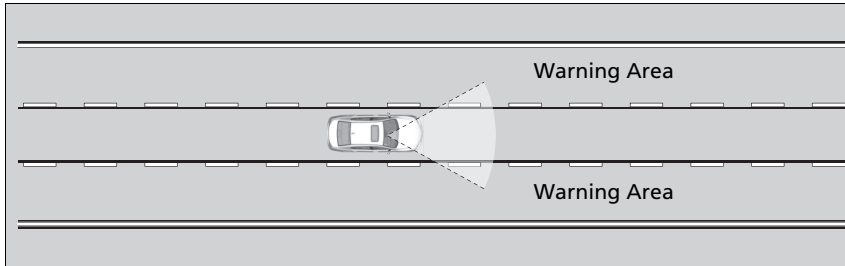

☒ Lane Keeping Assist System (LKAS)*

The LKAS may not function as designed on while driving in frequent stop and go traffic, or on roads with sharp curves.

When it fails to detect lanes, the system will temporarily be canceled. When lane is detected, system will recover automatically.

* Not available on all models

■ When the System can be Used

The system can be used when the following conditions are met.

- The lane in which you are driving has detectable lane markers on both sides, and your vehicle is in the center of the lane.
- The vehicle speed is between 45 and 90 mph (72 and 145 km/h).
- You are driving on a straight or slightly curved road.
- The turn signals are off.
- The brake pedal is not depressed.
- The wipers are not in continuous operation.

■ How to activate the system

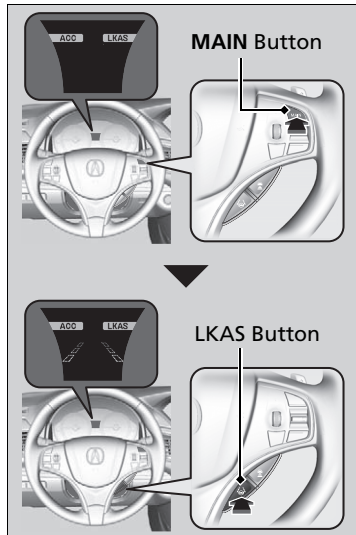

1. Press the **MAIN** button.

- ▶ The LKAS is on in the multi-information display.
The system is ready to use.

2. Press the LKAS button.

- ▶ Lane outlines appear on the multi-information display.
The system is activated.

▶▶ When the System can be Used

If the vehicle drifts toward either left or right lane line due to the system applying torque, turn off the LKAS and have your vehicle checked by a dealer.

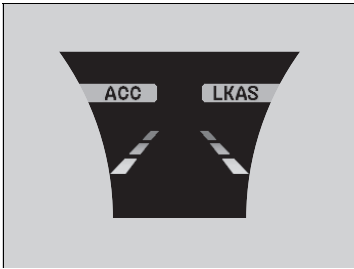

3. Keep your vehicle near the center of the lane while driving.
 - ▶ The dotted outer lines change to solid ones once the system starts operating after detecting the left and right lane markings.

To cancel

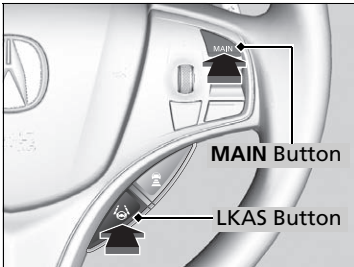

To cancel the LKAS:
Press the **MAIN** or LKAS button.

The LKAS is turned off every time you stop the engine, even if you turned it on the last time you drove the vehicle.

When the System can be Used

The LKAS temporarily deactivates when it fails to detect lane lines. When the system detects the lines again, it comes back on automatically.

To cancel

Pressing the **MAIN** button also turns ACC with LSF on and off.

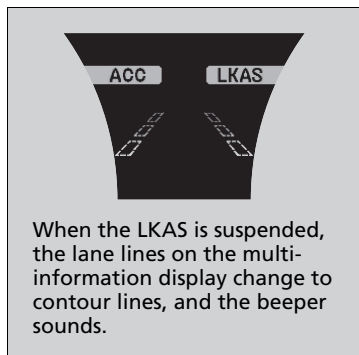

■ **The system operation is suspended if you:**

- Set the wipers to continuous operation.
 - ▶ Turning the wipers off resumes the LKAS.
- Decrease the vehicle speed to about 40 mph (64 km/h) or less.
 - ▶ Increasing the vehicle speed to about 45 mph (72 km/h) or more resumes the LKAS.
- Depress the brake pedal.
 - ▶ The LKAS resumes and starts detecting the lane lines again once you release the brake pedal.

■ **The LKAS may automatically be suspended when:**

- The system fails to detect lane lines.
 - The steering wheel is quickly turned.
 - You fail to steer the vehicle.
 - The vehicle runs on a curved road over the speed limit.
- Once these conditions no longer exist, the LKAS automatically resumes.

■ **The LKAS may automatically be canceled when:**

- The camera temperature gets extremely high or low.
- The camera behind the rearview mirror, or the area around the camera, including the windshield, gets dirty.
- Driving through a sharp curve.
- Driving at a speed in excess of approximately 90 mph (145 km/h).
- The ABS or VSA system engages.

The beeper sounds if the LKAS is automatically canceled.

■ LKAS Conditions and Limitations

The system may not detect lane markings and therefore may not keep the vehicle in the middle of a lane under certain conditions, including the following:

■ Environmental conditions

- Driving in bad weather (rain, fog, snow, etc.).
- Sudden changes between light and dark, such as an entrance or exit of a tunnel.
- There is little contrast between lane lines and the roadway surface.
- Driving into low sunlight (e.g., at dawn or dusk).
- Strong light is reflected onto the roadway.
- Driving in the shadows of trees, buildings, etc.
- Shadows of adjacent objects are parallel to lane markings.
- Roadway objects or structures are misinterpreted as lane markers.
- Reflections on the interior of the windshield.
- Driving at night or in a dark condition such as a tunnel.

■ Roadway conditions

- Driving on a snowy or wet roadway (obscured lane marking, vehicle tracks, reflected lights, road spray, high contrast).
- Driving on a road with temporary lane markings.
- Faint, multiple, or varied lane markings are visible on the roadway due to road repairs or old lane markings.
- The roadway has merging, split, or crossing lines (e.g., such as at an intersection or crosswalk).
- The lane markings are extremely narrow, wide, or changing.
- The vehicle in front of you is driving near the lane lines.
- The road is hilly or the vehicle is approaching the crest of a hill.
- Driving on rough or unpaved roads, or over bumpy surfaces.
- When objects on the road (curb, guard rail, pylons, etc.) are recognized as white lines (or yellow lines).
- Driving on roads with double lines.

■ Vehicle conditions

- Headlight lenses are dirty or the headlights are not properly adjusted.
- The outside of the windshield is streaked or blocked by dirt, mud, leaves, wet snow, etc.
- The inside of the windshield is fogged.
- The camera temperature gets too high.
- An abnormal tire or wheel condition (wrong sized, varied size or construction, improperly inflated, compact spare tire*, etc.).
- The vehicle is tilted due to a heavy load or suspension modifications.

Vehicle Stability Assist (VSA®), aka Electronic Stability Control (ESC), System

Helps to stabilize the vehicle during cornering if the vehicle turns more or less than what was intended. It also assists in maintaining traction on slippery surfaces. It does so by regulating engine output and selectively applying the brakes.

■ VSA® Operation

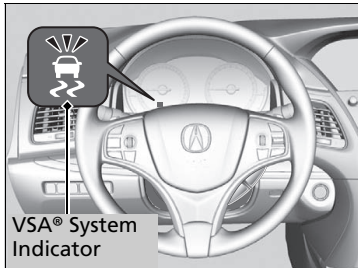

When VSA® activates, you may notice that the engine does not respond to the accelerator. You may also notice some noise from the hydraulic system. You will also see the indicator blink.

▣ Vehicle Stability Assist (VSA®), aka Electronic Stability Control (ESC), System

VSA® may not function properly if tire type and size are mixed. Make sure to use the same size and type of tire, and the air pressures as specified.

When the VSA® system indicator comes on and stays on while driving, there may be a problem with the system. While this may not interfere with normal driving, have your vehicle checked by a dealer immediately.

VSA® cannot enhance stability in all driving situations and does not control the entire braking system. You still need to drive and corner at speeds appropriate for the conditions and always leave a sufficient margin of safety.

The main function of the VSA® system is generally known as Electronic Stability Control (ESC). The system also includes a traction control function.

■ VSA® OFF Button

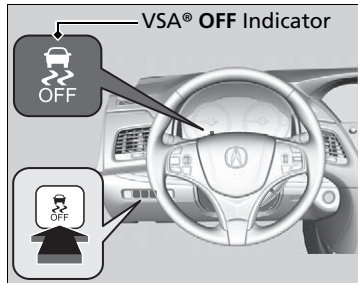

This button is on the driver side control panel. To partially turn the VSA features on and off, press and hold it until you hear a beep.

The traction control stops fully functioning, allowing the wheels to spin more freely at low speed. The VSA® **OFF** indicator will also come on.



To turn it on again, press the  (VSA® OFF) button until you hear a beep.



VSA® is turned on every time you start the engine, even if you press the button the last time you drove the vehicle.

▶▶ Vehicle Stability Assist (VSA®), aka Electronic Stability Control (ESC), System

With the  button pressed, your vehicle will have normal braking and cornering ability, but VSA® traction and stability enhancement becomes less effective.

In certain unusual conditions when your vehicle gets stuck in shallow mud or fresh snow, it may be easier to free it with the  button pressed.

When the  button is pressed, the traction control function becomes less effective. This allows for the wheels to spin more freely at low speed. You should only attempt to free your vehicle with the  button pressed if you are not able to free it without.

Immediately after freeing your vehicle, be sure to press the  button again. We do not recommend driving your vehicle with the  button pressed (indicator on).

You may hear a motor sound coming from the engine compartment while system checks are being performed immediately after starting the engine or while driving. This is normal.

Agile Handling Assist

Lightly brakes each of the front and rear wheels, as needed, when you turn the steering wheel, and helps support the vehicle's stability and performance during cornering.

Precision All-Wheel Steer™ (P-AWS®) System

Monitors road conditions while you are driving. In response to current driving conditions, the system automatically makes slight adjustment to the relative rear wheel toe settings to help enhance vehicle control and stability.

Agile Handling Assist

The agile handling assist cannot enhance stability in all driving situations. You still need to drive and corner at speeds appropriate for the conditions and always leave a sufficient margin of safety.

When the VSA® system indicator comes on and stays on while driving, the agile handling assist does not activate.

You may hear a sound coming from the engine compartment while the agile handling assist is activated. This is normal.

Precision All-Wheel Steer™ (P-AWS®) System

The Precision All-Wheel Steer™ (P-AWS®) System cannot enhance vehicle control and stability in all driving situations. You still need to drive and corner at speeds appropriate for the conditions and always leave a sufficient margin of safety.

The toe setting of the rear wheels may get stuck in a non-centered setting if the system malfunctions while driving. This can cause the vehicle to pull to a side even as you keep the steering wheel in the center position. If this occurs, the system automatically limits the vehicle speed to a maximum of 50 mph (80 km/h). Reduce your speed and be extra cautious, as handling may be difficult. Go to a dealer immediately.

Blind Spot Information (BSI) System*

Is designed to detect vehicles in specified alert zones adjacent to your vehicle, particularly in harder to see areas commonly known as “blind spots.”

When the system detects vehicles approaching from behind in adjacent lanes, the appropriate indicator comes on for a few seconds, providing assistance when you change lanes.

■ How the system works

Radar sensors detect a vehicle in the alert zone when your vehicle is moving forward at 20 mph (32 km/h) or faster.

Alert zone range

- A: Approx. 1.6 ft. (0.5 m)
- B: Approx. 10 ft. (3 m)
- C: Approx. 10 ft. (3 m)

Radar Sensors:
underneath the
rear bumper
corners

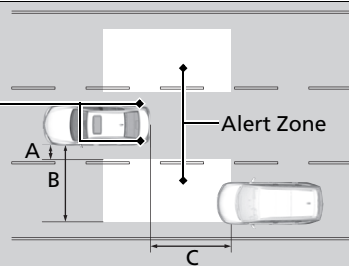

▶▶ Blind Spot Information (BSI) System*

⚠ WARNING

Failure to visually confirm that it is safe to change lanes before doing so may result in a crash and serious injury or death. Do not rely only on the blind spot information system when changing lanes.

Always look in your mirrors, to either side of your vehicle, and behind you for other vehicles before changing lanes.

Important Safety Reminder

Like all assistance systems, BSI has limitations. Over reliance on BSI may result in a collision.

The system is for your convenience only. Even if an object is within the alert zone, the following situations may occur.

- The BSI alert indicator may not come on due to obstruction (splashes, etc.) even without the **Blind Spot Info Not Available** multi-information display appearing.
- The BSI alert indicator may come on even with the message appearing.

The BSI alert indicator may not come on under the following conditions:

- A vehicle does not stay in the alert zone for more than two seconds.
- A vehicle is parked in a side lane.
- The speed difference between your vehicle and the vehicle you are passing is greater than 6 mph (10 km/h).

■ When the system detects a vehicle

BSI Alert Indicator: Located near the outside rearview mirror on both sides.

Comes on when:

- A vehicle enters the alert zone from behind to overtake you with a speed difference of no more than 31 mph (50 km/h) from your vehicle.
- You pass a vehicle with a speed difference of no more than 12 mph (20 km/h).

Blinks and a beeper sounds when:

You move the turn signal lever in the direction of the detected vehicle. The beeper sounds three times.

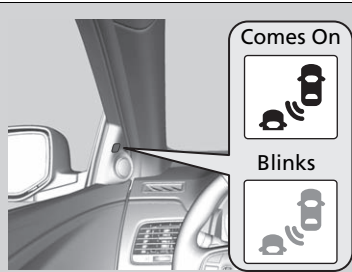

▣ Blind Spot Information (BSI) System*

- An object not detected by the radar sensors approaches or passes your vehicle.
- A vehicle running in the adjacent lane is a motorcycle or other small vehicle.

The system does not operate when in **[R]**.

You can change the setting for BSI.

▣ **Customized Features** P. 103, 262

BSI may be adversely affected when:

- Objects (guard rails, poles, trees, etc.) are detected.
- An object that does not reflect radio waves well, such as a motorcycle, is in the alert zone.
- Driving on a curved road.
- A vehicle is moving from a far lane to the adjacent lane.
- The system picks up external electrical interference.
- The rear bumper or the sensors have been improperly repaired or the rear bumper has been deformed.
- The orientation of the sensors has been changed.
- In bad weather (Heavy rain, snow, and fog).

For proper BSI operation:

- Always keep the rear bumper corner area clean.
- Do not cover the rear bumper corner area with labels or stickers of any kind.
- Take your vehicle to a dealer if you need the rear bumper corner area or the radar sensors to be repaired, or the rear bumper corner area is strongly impacted.

* Not available on all models

Tire Pressure Monitoring System (TPMS)

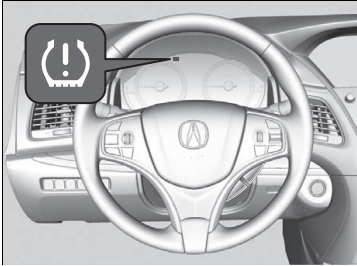

Monitors the tire pressure while you are driving. If your vehicle's tire pressure becomes significantly low, the low tire pressure/TPMS indicator comes on and a message appears on the multi-information display.

▶▶ Tire Pressure Monitoring System (TPMS)

Conditions such as low ambient temperature and altitude change directly affect tire pressure and can trigger the low tire pressure/TPMS indicator to come on.

▶▶ **If the Low Tire Pressure/TPMS Indicator Comes On or Blinks** P. 521

Tire pressure checked and inflated in:

- Warm weather can become under-inflated in colder weather.
- Cold weather can become over-inflated in warmer weather.

The low tire pressure/TPMS indicator will not come on as a result of over inflation.

■ Tire Pressure Monitor

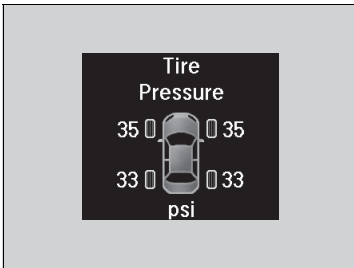

To select the tire pressure monitor, set the power mode to ON, and roll the right selector wheel until you see the tire pressure screen.

The pressure for each tire is displayed in PSI (U.S.) or kPa (Canada).



Tire Pressures Low is displayed when a tire has significantly low pressure. The specific tire is displayed on the screen.

▣ Tire Pressure Monitor

The pressure displayed on the multi-information display can be slightly different from the actual pressure as measured by a gauge. If there is a significant difference between the two values, or if the low tire pressure/TPMS indicator and the message on the multi-information display do not go off after you have inflated the tire to the specified pressure, have the system checked by a dealer.

Tire Pressure Monitor Problem may appear if you drive with the compact spare tire*, or there is a problem with the TPMS.

* Not available on all models

Tire Pressure Monitoring System (TPMS) - Required Federal Explanation

Each tire, including the spare (if provided), should be checked monthly when cold and inflated to the inflation pressure recommended by the vehicle manufacturer on the vehicle placard or tire inflation pressure label.

(If your vehicle has tires of a different size than the size indicated on the vehicle placard or tire inflation pressure label, you should determine the proper tire inflation pressure for those tires.)

As an added safety feature, your vehicle has been equipped with a tire pressure monitoring system (TPMS) that illuminates a low tire pressure telltale



when one or more of your tires is significantly under-inflated.

Accordingly, when the low tire pressure telltale illuminates, you should stop and check your tires as soon as possible, and inflate them to the proper pressure.

Driving on a significantly under-inflated tire causes the tire to overheat and can lead to tire failure. Under-inflation also reduces fuel efficiency and tire tread life, and may affect the vehicle's handling and stopping ability.

Please note that the TPMS is not a substitute for proper tire maintenance, and it is the driver's responsibility to maintain correct tire pressure, even if under-inflation has not reached the level to trigger illumination of the TPMS low tire pressure telltale.

Your vehicle has also been equipped with a TPMS malfunction indicator to indicate when the system is not operating properly. The TPMS malfunction indicator is combined with the low tire pressure telltale. When the system detects a malfunction, the telltale will flash for approximately one minute and then remain continuously illuminated. This sequence will continue upon subsequent vehicle start-ups as long as the malfunction exists.

When the malfunction indicator is illuminated, the system may not be able to detect or signal low tire pressure as intended.

TPMS malfunctions may occur for a variety of reasons, including the installation of replacement or alternate tires or wheels on the vehicle that prevent the TPMS from functioning properly.

Always check the TPMS malfunction telltale after replacing one or more tires or wheels on your vehicle to ensure that the replacement or alternate tires and wheels allow the TPMS to continue to function properly.

Brake System

■ Parking Brake

Use the parking brake to keep the vehicle stationary when parked. You can manually apply and release, or automatically release it.

■ Manual operations

Use the electric parking brake switch to apply or release the brake. Manually releasing the parking brake using the switch helps your vehicle start slowly and smoothly when facing down hill on steep hills.

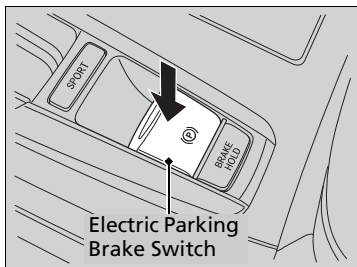
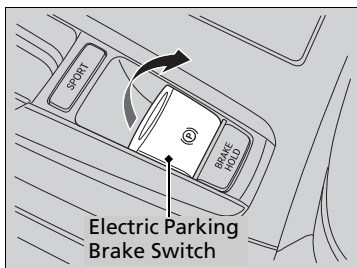

■ To apply manually

Pull the electric parking brake switch up gently and securely.

- ▶ The electric parking brake indicator comes on.

■ To release manually

1. Depress the brake pedal.
 2. Press the electric parking brake switch.
- ▶ The electric parking brake indicator goes off.

⊠ Parking Brake

You may hear the electric parking brake system operating when you apply or release the parking brake, or set the power mode to OFF. This is normal.

The brake pedal may slightly move due to the electric parking brake system operation when you apply or release the parking brake. This is normal.

You cannot apply or release the parking brake if the battery goes dead.

▶ **Jump Starting** P. 512

The parking brake is applied while the vehicle is moving with the electric parking brake switch being pulled.

■ To release automatically

Depressing the accelerator pedal releases the parking brake. Use the accelerator pedal to release the brake when you are starting the vehicle facing uphill, or in a traffic jam.

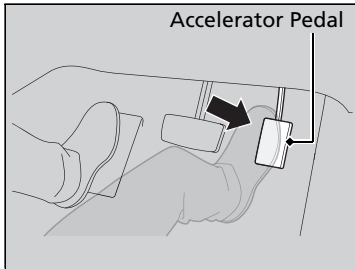

Gently depress the accelerator pedal. When on a hill, it may require more accelerator input to release.

- The electric parking brake indicator goes off.

You can release the parking brake automatically when:

- You are wearing the driver's seat belt.
- The engine is running.
- The shift lever is in any position other than **P** or **N**.

▣ Parking Brake

In the following situations, the parking brake automatically operates.

- When the vehicle stops more than 10 minutes while ACC with LSF* is activated.
- When the driver's seat belt is unfastened while your vehicle is stopped automatically by ACC with LSF*.
- When the engine is turned off while ACC with LSF* is activated.
- When the vehicle stops with the automatic brake hold system activated for more than 10 minutes.
- When the driver's seat belt is unfastened while your vehicle is stopped and brake hold is applied.
- When the engine is turned off while brake hold is applied.
- When there is a problem with the Brake Hold System.

If the parking brake cannot be released automatically, release it manually.

The parking brake cannot be released automatically while the following indicators are on:

- Malfunction indicator lamp
- Transmission indicator

The parking brake may not be released automatically while the following indicators are on:

- Electric parking brake system indicator
- VSA® system indicator
- **ABS** indicator
- Supplemental restraint system indicator

* Not available on all models

■ Foot Brake

Your vehicle is equipped with disc brakes at all four wheels. A vacuum power assist helps reduce the effort needed on the brake pedal. The brake assist system increases the stopping force when you depress the brake pedal hard in an emergency situation. The anti-lock brake system (ABS) helps you retain steering control when braking very hard.

➤ **Brake Assist System** P. 408

➤ **Anti-lock Brake System (ABS)** P. 407

☒ Foot Brake

Check the brakes after driving through deep water, or if there is a buildup of road surface water. If necessary, dry the brakes by lightly depressing the pedal several times.

If you hear a continuous metallic friction sound when applying the brakes, this is caused by the brake wear indicator rubbing on the brake rotor and indicates that the brake pads need to be replaced. Have the vehicle checked by a dealer. If you hear only an occasional squeak or squeal when you initially apply the brake pedal, this may be normal and caused by high frequency vibration of the brake pads against the rotating brake disc.

Constantly using the brake pedal while going down a long hill builds up heat, which reduces the brake effectiveness. Apply engine braking by taking your foot off the accelerator pedal and downshifting to a lower gear.

Do not rest your foot on the brake pedal while driving, as it will lightly apply the brakes and cause them to lose effectiveness over time and reduce pad life. It will also confuse drivers behind you.

Your vehicle is equipped with a hydraulic brake booster that, under certain conditions, such as braking at high altitudes, supplements the vacuum power assist. When the hydraulic brake booster activates, you may hear a motor sound and a slight vibration in the pedal. This is normal.

Automatic Brake Hold

Keeps the brake applied after releasing the brake pedal until the accelerator pedal is pressed. You can use this system while the vehicle is temporarily stopped, such as when you stop at a traffic light.

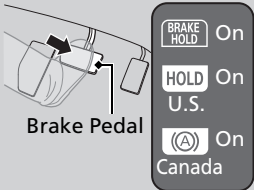
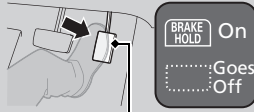
<p>■ Turning on the system</p>  <p>Automatic Brake Hold Button</p> <p>Fasten your seat belt properly, then start the engine. Press the automatic brake hold button.</p> <ul style="list-style-type: none"> The automatic brake hold system indicator comes on. The system is turned on. 	<p>■ Activating the system</p>  <p>Brake Pedal</p> <p>Depress the brake pedal to come to a complete stop. The shift lever must be in D or N.</p> <ul style="list-style-type: none"> The automatic brake hold indicator comes on. Braking is kept for up to 10 minutes. Release the brake pedal after the automatic brake hold indicator comes on. 	<p>■ Canceling the system</p>  <p>Accelerator Pedal</p> <p>Depress the accelerator pedal while the shift lever is in D. The system is canceled and the vehicle starts to move.</p> <ul style="list-style-type: none"> The automatic brake hold indicator goes off. The system continues to be on.
---	--	--

Automatic Brake Hold

⚠ WARNING

Activating the automatic brake hold system on steep hills or slippery roads may still allow the vehicle to move if you remove your foot from the brake pedal.

If a vehicle unexpectedly moves, it may cause a crash resulting in serious injury or death.

Never activate the automatic brake hold system or rely on it to keep a vehicle from moving when stopped on a steep hill or slippery roads.

⚠ WARNING

Using the automatic brake hold system to park the vehicle may result in the vehicle unexpectedly moving.

If a vehicle moves unexpectedly, it may cause a crash, resulting in serious injury or death.

Never leave the vehicle when braking is temporarily kept by automatic brake hold and always park the vehicle by putting the transmission in **P** and applying the parking brake.

■ **The system automatically cancels when:**

- You depress the brake pedal and move the shift lever to **P** or **R**.
- You engage the parking brake.

Under the following conditions, the system automatically cancels, and the parking brake is applied:

- Braking is kept for more than 10 minutes.
- The driver's seat belt is unfastened.
- The engine is turned off.
- **Brake Hold System Problem** appears on the multi-information display.

■ **Turning off the automatic brake hold system**

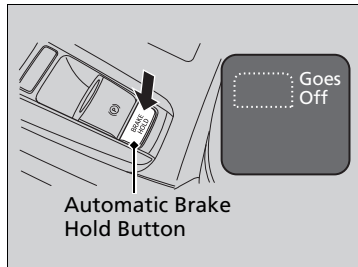

While the system is on, press the automatic brake hold button again.

- The automatic brake hold system indicator goes off.

If you want to turn off automatic brake hold while the system is in operation, press the automatic brake hold button with the brake pedal depressed.

⌘ **Automatic Brake Hold**

While the system is activated, you can turn off the engine or park the vehicle through the same procedure as you normally do.

⌘ **When Stopped** P. 417

Whether the system is on, or the system is activated, the automatic brake hold turns off once the engine is off.

⌘ **Turning on the system**

Make sure to turn off the automatic brake hold system before using an automated car wash.

You may hear an operating noise if the vehicle moves while the automatic brake hold system is in operation. The system generates sound while holding the vehicle and it moves.

Anti-lock Brake System (ABS)

■ ABS

Helps prevent the wheels from locking up, and helps you retain steering control by pumping the brakes rapidly, much faster than you.

The electronic brake distribution (EBD) system, which is part of the ABS, also balances the front-to-rear braking distribution according to vehicle loading.

You should never pump the brake pedal. Let the ABS work for you by always keeping firm, steady pressure on the brake pedal. This is sometimes referred to as “stomp and steer.”

■ ABS operation

The brake pedal may pulsate slightly when the ABS is working. Keep holding the pedal firmly down. On dry pavement, you will need to press on the brake pedal very hard before the ABS activates. However, you may feel the ABS activate immediately if you are trying to stop on snow or ice.

When the vehicle speed goes under 6 mph (10 km/h), the ABS stops.

▶▶ Anti-lock Brake System (ABS)

NOTICE

The ABS may not function correctly if you use an incorrect tire type and size.

When the **ABS** indicator comes on while driving, there may be a problem with the system. While normal braking is not affected, there is a possibility of the ABS not operating. Have your vehicle checked by a dealer immediately.

The ABS does not reduce the time or distance it takes to stop the vehicle. It only helps with steering control during hard braking.

In the following cases, your vehicle may need more stopping distance than a vehicle without the ABS:

- When driving on rough road surfaces, including when driving on uneven surfaces, such as gravel or snow.
- When tire chains are installed.

You may hear a motor sound coming from the engine compartment while system checks are being performed immediately after starting the engine or while driving. This is normal.

Brake Assist System

■ Brake Assist System

Designed to assist the driver by generating greater braking force when you depress the brake pedal hard during emergency braking.

■ Brake assist system operation

Press the brake pedal firmly for more powerful braking.

When brake assist operates, the pedal may wiggle slightly and an operating noise may be heard. This is normal. Keep holding the brake pedal firmly down.

Collision Mitigation Braking System™ (CMBS™)*

Can assist you when there is a possibility of your vehicle colliding with a vehicle or a pedestrian detected in front of yours. The CMBS™ is designed to alert you when a potential collision is determined, as well as to reduce your vehicle speed to help minimize collision severity when a collision is deemed unavoidable.

■ How the system works

When to use

The camera is located behind the rearview mirror.

The radar sensor is in the front grille.

The system starts monitoring the roadway ahead when your vehicle speed is about 3 mph (5 km/h) and there is a vehicle in front of you.

The CMBS™ activates when:

- The speed difference between your vehicle and a vehicle or pedestrian detected in front of you becomes about 3 mph (5 km/h) and over with a chance of a collision.
- Your vehicle speed is about 62 mph (100 km/h) or less and there is a chance of a collision with an oncoming detected vehicle or a pedestrian in front of you.

* Not available on all models

►► Collision Mitigation Braking System™ (CMBS™)*

Important Safety Reminder

The CMBS™ is designed to reduce the severity of an unavoidable collision. It does not prevent collision nor stop the vehicle automatically. It is still your responsibility to operate the brake pedal and steering wheel appropriately according to the driving conditions.

The CMBS™ may not activate or may not detect a vehicle in front of your vehicle under certain conditions:

► **CMBS™ Conditions and Limitations** P. 413

You can read about handling information for the camera equipped with this system.

► **Front Sensor Camera*** P. 359

►► How the system works

Rapid vibrations on the steering wheel alert you when the your vehicle speed is between 19 and 62 mph (30 and 100 km/h) with an oncoming vehicle detected in front of you.

When the CMBS™ activates, it may automatically apply the brake. It will be canceled when your vehicle stops or a potential collision is not determined.

■ When the system activates

The system provides visual, audible and tactile alerts of a possible collision, and stops if the collision is avoided.

- ▶ Take appropriate action to prevent a collision (apply the brakes, change lanes, etc.)

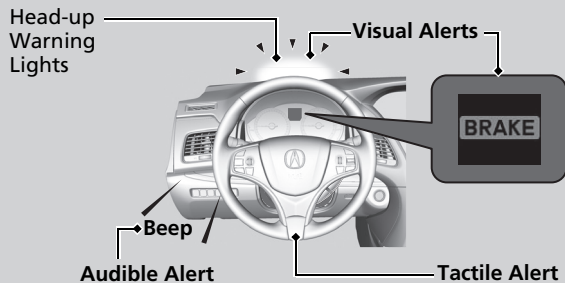

At system's earliest collision alert stage, you can change the distance (**Long/Normal/Short**) between vehicles at which alerts will come on through multi-information display setting options.

- ▶ **List of customizable options** P. 106

■ Vibration alert on the steering wheel

When a potential collision to an oncoming detected vehicle is determined, the system alerts you with rapid vibration on the steering wheel, in addition to visual and audible alerts.

- ▶ Take appropriate action to prevent a collision (apply the brakes, operate the steering wheel, etc.).

▶ When the system activates

The camera in the CMBS™ is also designed to detect pedestrians.

However, this pedestrian detection feature may not activate or may not detect a pedestrian in front of your vehicle under certain conditions.

Refer to the ones indicating the pedestrian detection limitations from the list.

- ▶ **CMBS™ Conditions and Limitations** P. 413

The head-up warning uses a lens located at the front end of the dashboard.

Do not cover the lens or spill any liquid on it.

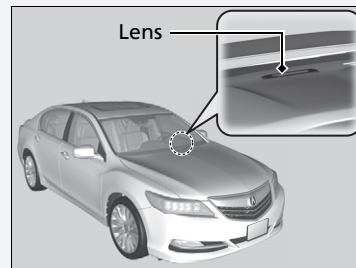

▶ Vibration alert on the steering wheel

Vibration alert function is disabled when the electric power steering (EPS) system indicator comes on.

- ▶ **Electric Power Steering (EPS) System Indicator** P. 74

■ Collision Alert Stages

The system has three alert stages for a possible collision. However, depending on circumstances, the CMBS™ may not go through all of the stages before initiating the last stage.

Distance between vehicles		CMBS™				
		The radar sensor detects a vehicle	E-pretensioner	Audible & Visual WARNINGS	Steering Wheel	Braking
Stage one		There is a risk of a collision with the vehicle ahead of you.	—	When in Long , visual and audible alerts come on at a longer distance from a vehicle ahead than in Normal setting, and in Short , at a shorter distance than in Normal .	In case of an oncoming vehicle detected, rapid vibration is provided.	—
Stage two		The risk of a collision has increased, time to respond is reduced.	Retracts the driver's seat belt gently a few times, providing a physical warning. 	Visual and audible alerts.	—	Lightly applied
Stage three		The CMBS™ determines that a collision is unavoidable.	Forcefully tightens driver and front passenger seat belts. 			Forcefully applied

■ CMBS™ On and Off

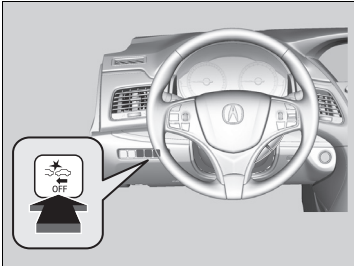

Press this button until the beeper sounds to switch the system on or off.

When the CMBS™ is off:

- The CMBS™ indicator in the instrument panel comes on.
- A message on the multi-information display reminds you that the system is off.

The CMBS™ is in the previously selected ON or OFF setting each time you start the engine.

► Collision Mitigation Braking System™ (CMBS™)*

The CMBS™ may automatically shut off, and the CMBS™ indicator will come and stay on under certain conditions:

► **CMBS™ Conditions and Limitations** P. 413

CMBS™ Conditions and Limitations

The system may automatically shut off and the CMBS™ indicator will come on under certain conditions. Some examples of these conditions are listed below. Other conditions may reduce some of the CMBS™ functions.

📷 **Front Sensor Camera*** P. 359

■ Environmental conditions

- Driving in bad weather (rain, fog, snow, etc.).
- Sudden changes between light and dark, such as an entrance or exit of a tunnel.
- There is little contrast between objects and the background.
- Driving into low sunlight (e.g., at dawn or dusk).
- Strong light is reflected onto the roadway.
- Driving in the shadows of trees, buildings, etc.
- Roadway objects or structures are misinterpreted as vehicles and pedestrians.
- Reflections on the interior of the windshield.
- Driving at night or in a dark condition such as a tunnel.

■ Roadway conditions

- Driving on a snowy or wet roadway (obscured lane marking, vehicle tracks, reflected lights, road spray, high contrast).
- Driving on curvy, winding, or undulating roads.
- The road is hilly or the vehicle is approaching the crest of a hill.

* Not available on all models

■ Vehicle conditions

- Headlight lenses are dirty or the headlights are not properly adjusted.
- The outside of the windshield is blocked by dirt, mud, leaves, wet snow, etc.
- The inside of the windshield is fogged.
- An abnormal tire or wheel condition (wrong sized, varied size or construction, improperly inflated, compact spare tire*, etc.).
- When tire chains are installed.
- The vehicle is tilted due to a heavy load or suspension modifications.
- The camera temperature gets too high.
- Driving with the parking brake applied.
- When the radar sensor in the front grille gets dirty.

■ Detection limitations

- A vehicle or pedestrian suddenly crosses in front of you.
- The distance between your vehicle and the vehicle or pedestrian ahead of you is too short.
- A vehicle cuts in front of you at a slow speed, and it brakes suddenly.
- When you accelerate rapidly and approach the vehicle or pedestrian ahead of you at high speed.
- The vehicle ahead of you is a motorcycle, bicycle, mobility scooter or other small vehicle.
- When there are animals in front of your vehicle.
- When you drive on a curved, winding or undulating road that makes it difficult for the sensor to properly detect a vehicle in front of you.
- The speed difference between your vehicle and a vehicle or pedestrian in front of you is significantly large.
- An oncoming vehicle suddenly comes in front of you.
- Another vehicle suddenly comes in front of you at an intersection, etc.
- Your vehicle abruptly crosses over in front of an oncoming vehicle.
- When driving through a narrow iron bridge.
- When the lead vehicle suddenly slows down.

Limitations applicable to pedestrian detection only

- When there is a group of people in front of your vehicle walking together side by side.
- Surrounding conditions or belongings of the pedestrian alter the pedestrian's shape, preventing the system from recognizing that the person is a pedestrian.
- When the pedestrian is shorter than about 3.3 feet (1 meter) or taller than about 6.6 feet (2 meters) in height.
- When a pedestrian blends in with the background.
- When a pedestrian is bent over or squatting, or when their hands are raised or they are running.
- When several pedestrians are walking ahead in a group.
- When the camera cannot correctly identify that a pedestrian is present due to an unusual shape (holding luggage, body position, size).

■ Automatic shutoff

The CMBS™ may automatically shut itself off and the CMBS™ indicator comes and stays on when:

- The temperature inside the system is high.
- You drive off-road or on a mountain road, or curved and winding road for an extended period.
- An abnormal tire condition is detected (wrong tire size, flat tire, etc.).
- The camera behind the rearview mirror, or the area around the camera, including the windshield, gets dirty.

Once the conditions that caused the CMBS™ to shut off improve or are addressed (e.g., cleaning), the system comes back on.

■ With Little Chance of a Collision

The CMBS™ may activate even when you are aware of a vehicle ahead of you, or when there is no vehicle ahead. Some examples of this are:

■ When Passing

Your vehicle approaches another vehicle ahead of you and you change lanes to pass.

■ At an intersection

Your vehicle approaches or passes another vehicle that is making a left or right turn.

■ On a curve

When driving through curves, your vehicle comes to a point where an oncoming vehicle is right in front of you.

■ Through a low bridge at high speed

You drive under a low or narrow bridge at high speed.

■ Speed bumps, road work sites, train tracks, roadside objects, etc.

You drive over speed bumps, steel road plates, etc., or your vehicle approaches train tracks or roadside objects [such as a traffic sign and guard rail] on a curve.

► Collision Mitigation Braking System™ (CMBS™)*

For the CMBS™ to work properly:

Always keep the radar sensor cover clean.

Never use chemical solvents or polishing powder for cleaning the sensor cover. Clean it with water or a mild detergent.

Do not put a sticker on the emblem or replace the emblem.

If you need the radar sensor to be repaired, or removed, or the radar sensor cover is strongly impacted, turn off the system by pressing the CMBS™ off button and take your vehicle to a dealer.

When Stopped

1. Depress the brake pedal firmly.
2. With the brake pedal depressed, pull up the electric parking brake switch slowly, but fully.
3. Move the shift lever from **D** to **P**.
4. Turn off the engine.
 - ▶ The electric parking brake indicator goes off in about 15 seconds.

Always set the parking brake firmly, in particular if you are parked on an incline.

▣ Parking Your Vehicle

Do not park your vehicle near flammable objects, such as dry grass, oil, or timber. Heat from the exhaust can cause a fire.

▣ When Stopped

NOTICE

The following can damage the transmission:

- Depressing the accelerator and brake pedals simultaneously.
- Holding the vehicle in place when facing uphill by depressing the accelerator pedal.
- Moving the shift lever into **P** before the vehicle stops completely.

If extremely cold temperatures, the parking brake may freeze up if applied. If such temperatures are expected, do not apply the parking brake but, if parking on a slope, either turn the front wheels so they will contact the curb if the vehicle is rolls down the slope or block the wheels to keep the vehicle from moving. If you do not take either precaution, the vehicle may roll unexpectedly, leading to a crash.

Parking Sensor System *

The corner and center sensors monitor obstacles around your vehicle, and the beeper and audio/information screen let you know the approximate distance between your vehicle and the obstacle.

■ The sensor location and range

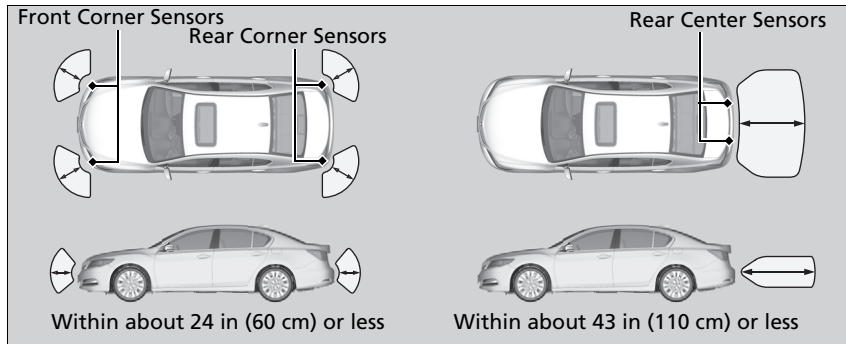

▣ Parking Sensor System *

Even when the system is on, always confirm if there is no obstacle near your vehicle before parking.

The system may not work properly when:

- The sensors are covered with snow, ice, mud or dirt.
- The vehicle is on uneven surface, such as grass, bumps, or a hill.
- The vehicle has been out in hot or cold weather.
- The system is affected by devices that emit ultrasonic waves.
- Driving in bad weather.

The system may not sense:

- Thin or low objects.
- Sonic-absorptive materials, such as snow, cotton, or sponge.
- Objects directly under the bumper.

Do not put any accessories on or around the sensors.

■ Parking sensor system on and off

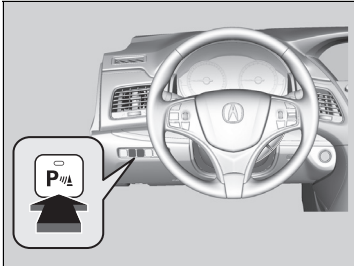

With the power mode in ON, press the parking sensor system button to turn on or off the system. The indicator in the button comes on and the beeper sounds when the system is on.

The rear center and corner sensors start to detect an obstacle when the shift lever is in **[R]**, and the vehicle speed is less than 5 mph (8 km/h).

The front corner sensors start to detect an obstacle when the shift lever is in any position other than **[P]**, and the vehicle speed is less than 5 mph (8 km/h).

■ When the distance between your vehicle and obstacles behind becomes shorter

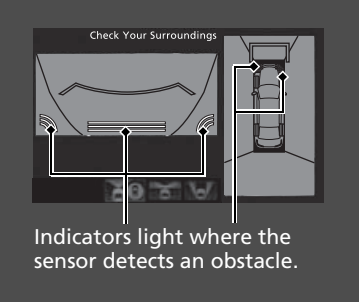
Length of the intermittent beep	Distance between the Bumper and Obstacle		Indicator	Audio/information screen
	Corner Sensors	Center Sensors		
Moderate	—	Rear: About 43-24 in (110-60 cm)	Blinks in Yellow*1	 <p>Check Your Surroundings</p> <p>Indicators light where the sensor detects an obstacle.</p>
Short	About 24-18 in (60-45 cm)	About 24-18 in (60-45 cm)	Blinks in Amber	
Very short	About 18-14 in (45-35 cm)	About 18-14 in (45-35 cm)		
Continuous	About 14 in (35 cm) or less	About 14 in (35 cm) or less	Blinks in Red	

*1: At this stage, only the center sensors detect obstacles.

■ Turning off All Rear Sensors

1. Make sure that the parking sensor system is not activated. Set the power mode to VEHICLE OFF (LOCK).
2. Press and hold the parking sensor system button, and set the power mode to ON.
3. Keep pressing the button for ten seconds. Release the button when the indicator in the button blinks.
4. Press the button again. The indicator in the button goes off.
 - ▶ The beeper sounds twice. The rear sensors are now turned off.

To turn the rear sensors on again, follow the above procedure. The beeper sounds three times when the rear sensors come back on.

☒ Turning off All Rear Sensors

When you shift to [R], the indicator in the parking sensor system button blinks as a reminder that the rear sensors have been turned off.

Cross Traffic Monitor*

Monitors the rear corner areas using the radar sensors when reversing, and alerts you if a vehicle approaching from a rear corner is detected.

The system is convenient when you are backing out of a parking space.

ⓘ Cross Traffic Monitor*

CAUTION

Cross Traffic Monitor cannot detect all approaching vehicles and may not detect an approaching vehicle at all.

Failure to visually confirm that it is safe to back up the vehicle before doing so may result in a collision.

Do not solely rely on the system when reversing; always also use your mirrors, and look behind and to the sides of your vehicle before reversing.

Models with parking sensor system

The parking sensor system's alerting buzzer overrides the Cross Traffic Monitor buzzer when the sensors are detecting obstacles at the closest range.

How the System Works

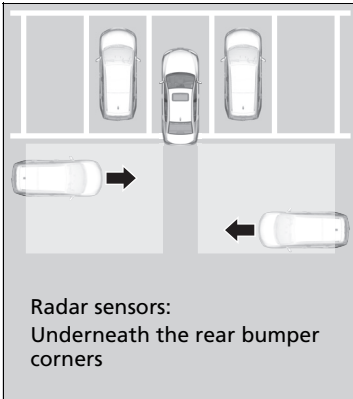

The system activates when:

- The power mode is in ON.
- The Cross Traffic Monitor is turned on.
 - ▶ **Cross Traffic Monitor On and Off** P. 425
 - ▶ **Customized Features** P. 262
- The shift lever is in **R**.
- Your vehicle is moving at 3 mph (5 km/h) or lower.

When a vehicle is detected approaching from a rear corner, Cross Traffic Monitor alerts you with a buzzer and a displayed warning.

The system will not detect a vehicle that approaches from directly behind your vehicle, nor will it provide alerts about a detected vehicle when it moves directly behind your vehicle.

The system does not provide alerts for a vehicle that is moving away from your vehicle, and it may alert for pedestrians, bicycles, or stationary objects.

⊠ Cross Traffic Monitor*

Cross Traffic Monitor may not detect or may delay alerting an approaching vehicle, or may alert without an approaching vehicle under the following conditions:

- An obstacle, such as another vehicle and a wall, near your vehicle's rear bumper, is blocking the radar sensor's scope.
- Your vehicle is moving at the speed of about 3 mph (5 km/h) or higher.
- A vehicle is approaching at the speed other than between about 6 mph (10 km/h) and 16 mph (25 km/h).
- The system picks up external interference such as other radar sensors from another vehicle or strong radio wave transmitted from a facility nearby.
- Either corner of the rear bumper is covered with snow, ice, mud or dirt.
- When there is bad weather.
- Your vehicle is on an incline.
- Your vehicle is tilted due to a heavy load in the rear.
- Your vehicle is reversing towards a wall, a poll, a vehicle, and so on.
- The rear bumper or the sensors have been improperly repaired or the rear bumper has been deformed. Have your vehicle checked by a dealer.

For proper operation, always keep the rear bumper corner area clean.

Do not cover the rear bumper corner area with labels or stickers of any kind.

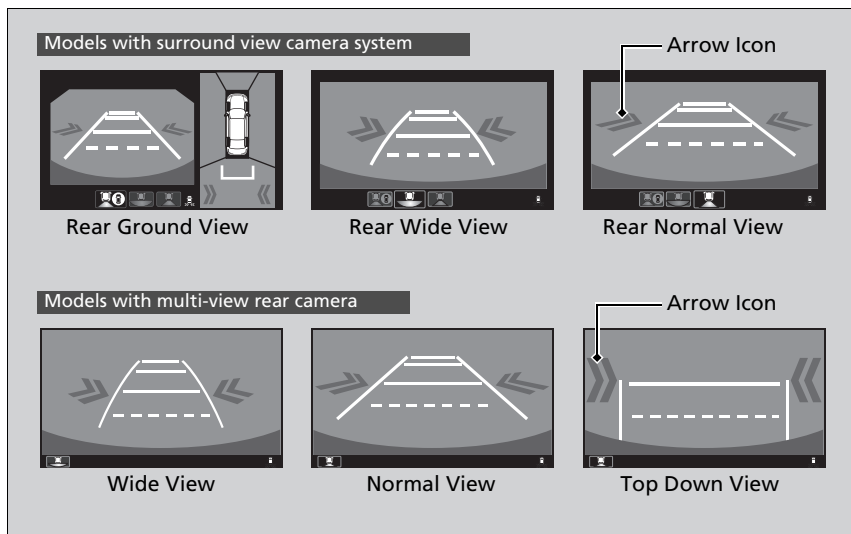

* Not available on all models

When the System Detects a Vehicle



An arrow icon appears on the side a vehicle is approaching on the audio/information screen.

When the System Detects a Vehicle

If  on the lower right changes to  (amber) when the shift lever is in **R**, mud snow or ice, etc. may have accumulated in the vicinity of the sensor. The system is temporarily canceled. Check the bumper corners for any obstructions, and thoroughly clean the area if necessary.

If  (amber) comes on when the shift lever is in **R**, there may be a problem with the Cross Traffic Monitor system. Do not use the system and have your vehicle checked by a dealer.

If the display remains the same with the shift lever in **R**, there may be a problem with the rear camera system and the Cross Traffic Monitor system. Do not use the system and have your vehicle checked by a dealer.

■ Cross Traffic Monitor On and Off

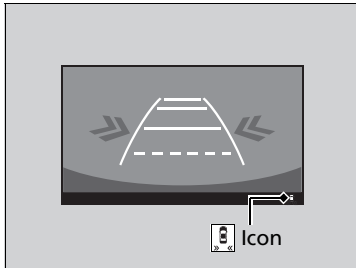

You can switch on and off the system using the audio/information screen.

▶ **Customized Features** P. 262

About Your Multi-View Rear Camera

The audio/information screen can display your vehicle's rear view. The display automatically changes to the rear view when the shift lever is moved to **R**.

Multi-View Rear Camera Display Area

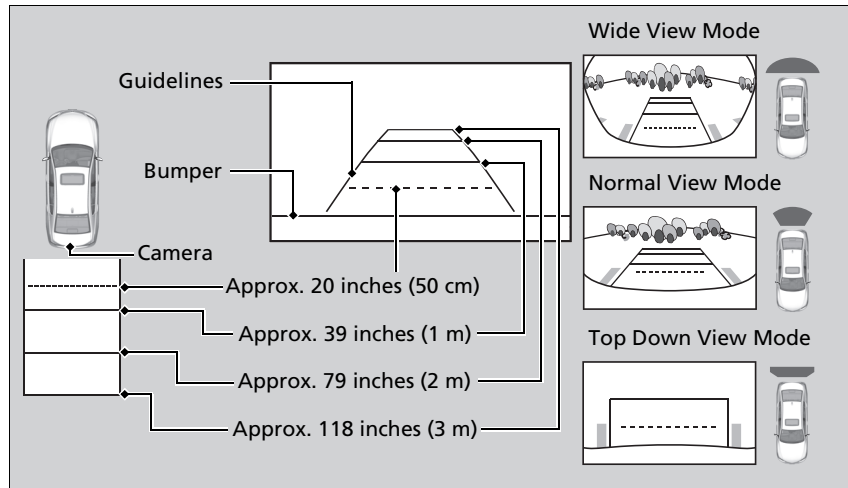

You can view three different camera angles on the rearview display. Press the interface dial to switch the angle.

If Top View is last used before you turn the power mode to OFF, Wide mode is selected next time you turn the power on and move the shift lever to **R**.

About Your Multi-View Rear Camera

The rear camera view is restricted. You cannot see the corner ends of the bumper or what is underneath the bumper. Its unique lens also makes objects appear closer or farther than they actually are.

Visually confirm that it is safe to drive before backing up. Certain conditions (such as weather, lighting, and high temperatures) may also restrict the rear view. Do not rely on the rearview display which does not give you all information about conditions at the back of your vehicle.

If the camera lens is covered with dirt or moisture, use a soft, moist cloth to keep the lens clean and free of debris.

You can change the **Fixed Guideline** and **Dynamic Guideline** settings.

➤ **Customized Features** P. 262

Fixed Guideline

On: Guidelines appear when you shift into **R**.

Off: Guidelines do not appear when the dynamic guideline is off.

Dynamic Guideline

On: Guidelines move according to the steering wheel direction.

Off: Guidelines do not move.

Surround View Camera System*

Is a four camera system that views areas commonly known as “blind spots” from different angles, then displays the images on the audio/information screen. This system can be used to:

- Check the right and left sides of the vehicle while crossing at intersections with poor visibility (fog, heavy rain, obstructed view, etc.).
 - **Checking from the front wide view at intersections** P. 435
- Check for obstacles in front of the vehicle when parking or maneuvering in confined areas.
 - **Checking the sides of your vehicle** P. 435
- Check for obstacles when you are moving in **R**.
 - **Checking for Obstacles at the Back of Your Vehicle** P. 431
- Assist you when backing into or parallel parking the vehicle in a lined parking space.
 - **Reversing into a Parking Space Marked with Parking Lines** P. 432
 - **Parallel Parking into a Parking Space Marked with Parking Lines** P. 433

* Not available on all models



Surround View Camera System*

⚠ WARNING

Failure to visually assess the area around the vehicle (directly or by use of the mirrors) may result in a crash causing serious injury or death.

The areas shown in the surround view camera system display are limited. The display may not show all pedestrians or other objects around your vehicle.

Do not solely rely only on the surround view camera system display to assess whether it is safe to move your vehicle.

⚠ WARNING

Failure to pay proper attention to your surroundings while driving may result in a crash causing serious injury or death.

To help mitigate the chances of a collision, only look at the surround view camera system display when it is safe to do so.

Displaying an Image From the Surround View Cameras

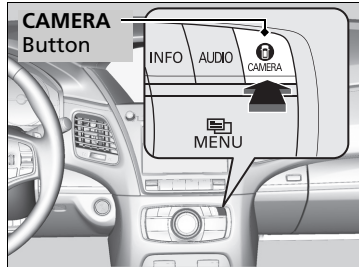

■ For frontal views:

Press the **CAMERA** button when the vehicle is stationary or moving at 12 mph (20 km/h) or slower. Press the button again or the interface dial to switch camera views.

■ For rear reviews:

Move the shift lever to **R** when the vehicle is stationary. Press the **CAMERA** button or the interface dial to switch to rear view mode.

You can customize the display setting.

▶ **Customized Features** P. 262

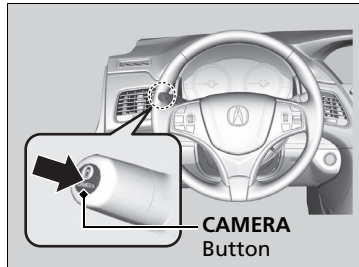

▶▶ Surround View Camera System*

The surround view camera system does not eliminate all blind spots. The system is for your convenience only.

Always keep the camera lenses clean and free from debris.

The navigation system is disabled when the shift lever is in **R**.

■ Camera Locations and Images

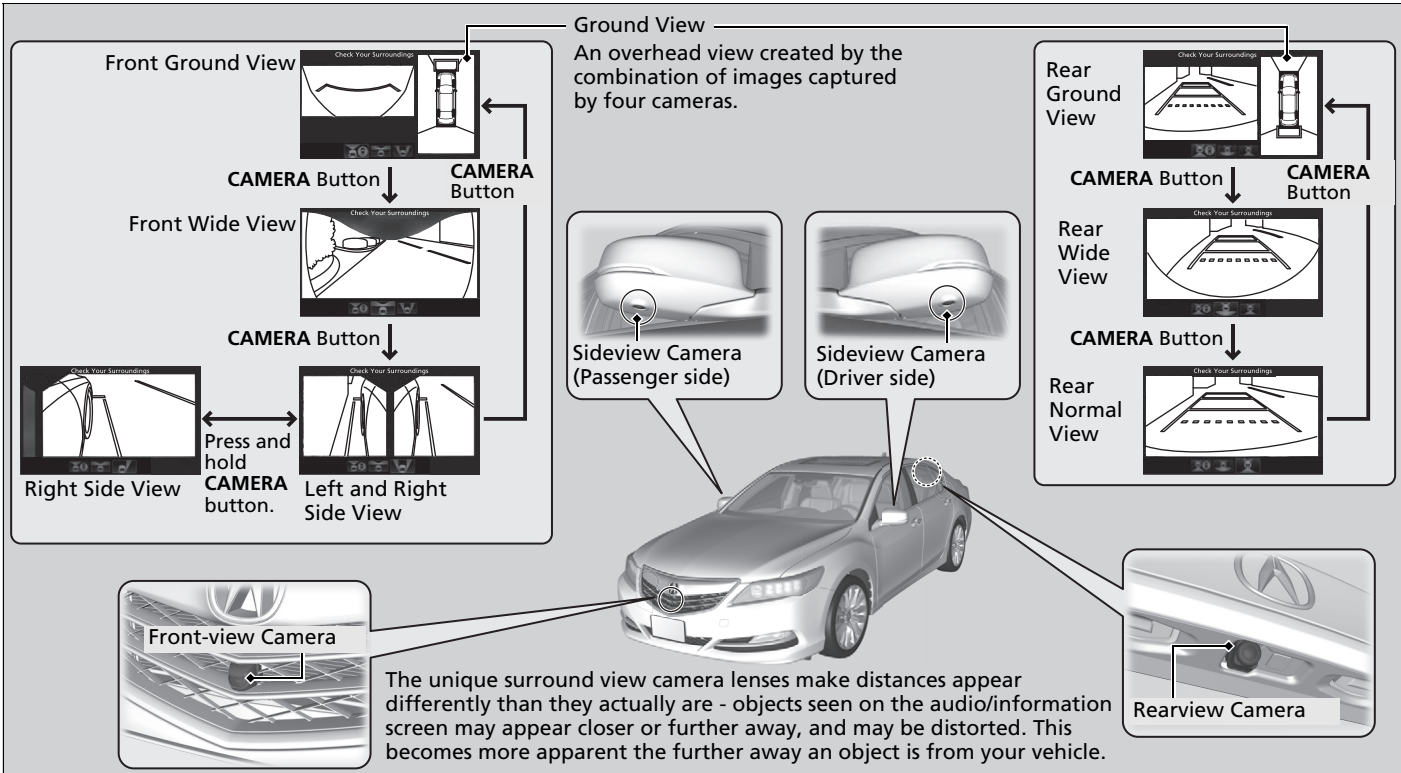

■ Reference Lines and Guides

Following can be displayed when the system is on.

Guide lines: Help you to get a sense of a distance between your vehicle and the rear surroundings. The distance may appear differently than the actual distance.

Projection lines: Indicate vehicle direction while the steering wheel is in the current position.

Depending on your parking situation, you can select **Back-in left park guidance**, **Back-in right park guidance**, **Left parallel park guidance**, or **Right parallel park guidance** from **Parking Guideline menu** to display:

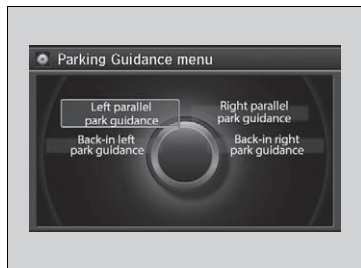

Initial position guide: Marks the point where your vehicle is headed when reversing.

Steering position alignment guide: Indicates when to change the steering wheel position.

▶▶ Displaying an Image From the Surround View Cameras

Operating the navigation system or audio system while the surround view camera system screen is displayed cancels the surround view camera system screen and starts up the navigation system screen.

If you press the **CAMERA** button while the vehicle speed is more than 15 mph (25 km/h), the standby screen appears.

When the vehicle speed is reduced below 12 mph (20 km/h), the screen switches to a surround view camera system image.

▶▶ Reference Lines and Guides

The positions/distances indicated by the guide lines and camera views on the display may differ from the actual positions/distances due to the changes in the vehicle height, road conditions, and other factors. The guide lines should be used as a reference only.

The guide lines can be turned on and off using the audio/information screen.

▶▶ Customized Features P. 262

If you turn the guide lines off, they remain off until you turn them back on.

To see the guidance on how to use the reference lines and guides while they appear on the display, press and hold the **CAMERA** button or the interface dial. To close the guidance, press and hold the **CAMERA** button or the interface dial again, or press the **BACK** button.

When Parking Your Vehicle

■ Checking for Obstacles at the Back of Your Vehicle

The display automatically changes to the rear view when the shift lever is moved to **R**.

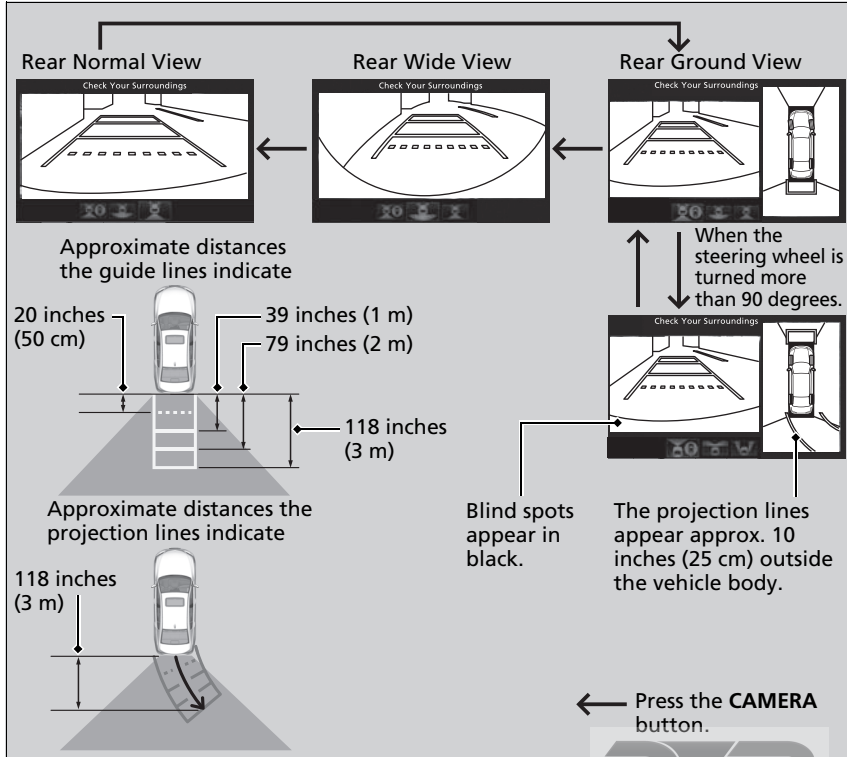

▶▶ When Parking Your Vehicle

The ground view can be displayed even with the door mirrors folded. However, the viewable angle and blind spot change.

Do not refer to the surround view camera system when the door mirrors are folded.

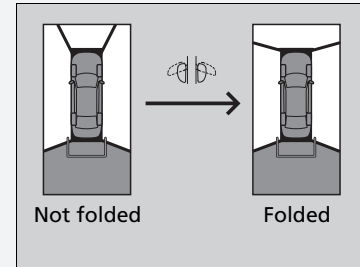



▶▶ Checking for Obstacles at the Back of Your Vehicle

When moving the shift lever from/to **R**, you may experience a delay in switching between the audio/information screen and a rear view image.

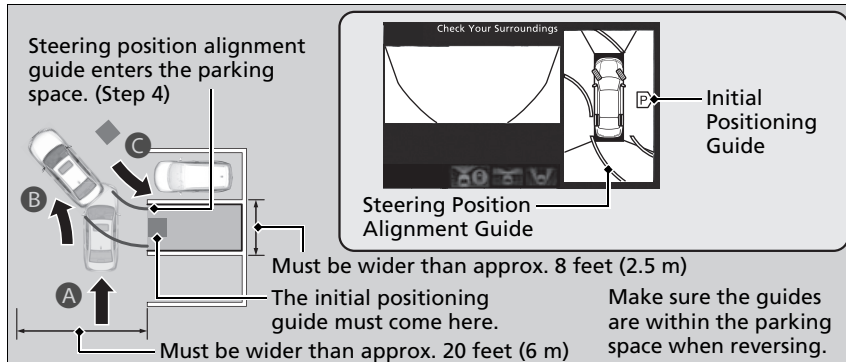
■ Reversing into a Parking Space Marked with Parking Lines



1. With your vehicle at a complete stop, press the **CAMERA** button, then press the **MENU** button. Rotate  to select **Back- in left park guidance** or **Back-in right park guidance**. Press .
2. Move the vehicle forward perpendicular to the parking space and stop where the initial positioning guide in the display is at the center of the parking space.
3. Turn the steering wheel fully to the left (if the parking space is on the passenger side) at a stop.
 - ▶ The steering position alignment guide is displayed.
4. Slowly move the vehicle forward.
 - ▶ Stop the vehicle when the steering position alignment guide enters the parking space.
5. Turn the steering wheel fully to the right (if the parking space is on the passenger side) at a stop. Start reversing the vehicle slowly.
6. Stop the vehicle when it is parallel to the parking lines.
7. Return the steering wheel to its center position, then reverse the vehicle slowly until it is parked within the space.

▣ Reversing into a Parking Space Marked with Parking Lines

If the steering position alignment guide does not fit in the parking lines, the parking space is too small for the vehicle.

Reference lines can be useful only when the parking space is in a rectangular shape with straight parking marks and when vehicles in the next parking spaces are within the spaces.

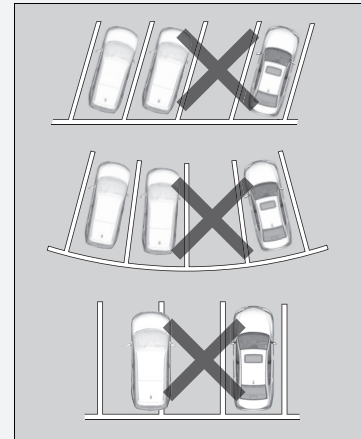

Parallel Parking into a Parking Space Marked with Parking Lines

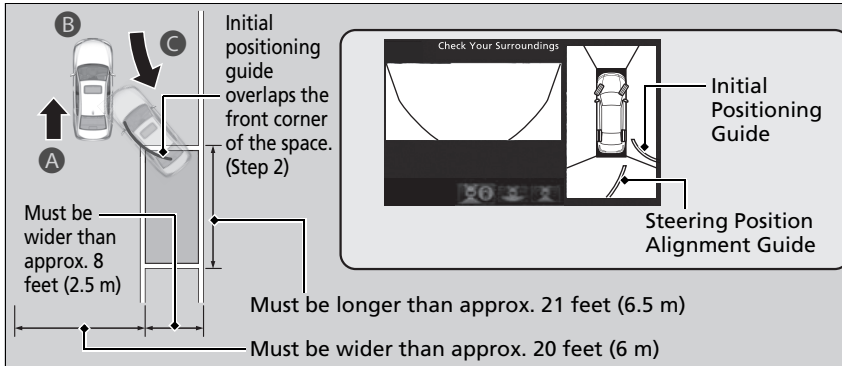

1. Press the **CAMERA** button, then press the **MENU** button. Rotate to select **Left parallel park guidance** or **Right Parallel park guidance**. Press .
2. Move the vehicle forward parallel to the parking space and stop when the initial positioning guide shown in the display overlaps the front corner of the space.
3. Turn the steering wheel fully to the right (if the parking space is on the passenger side) at a stop.
 - ▶ The steering position alignment guide is displayed.
4. Slowly reverse the vehicle.
 - ▶ Stop the vehicle when the steering position alignment guide overlaps the sideline of the parking space.
5. Turn the steering wheel fully to the left (if the parking space is on the passenger side) at a stop. Reverse the vehicle slowly.
6. Stop the vehicle when it is parallel to the parking lines.
7. Return the steering wheel to its center position, then reverse the vehicle slowly until it is parked within the space.

Parallel Parking into a Parking Space Marked with Parking Lines

Reference lines can be useful only when the parking space is in a rectangular shape with straight parking marks and when vehicles in the next parking spaces are within the spaces.

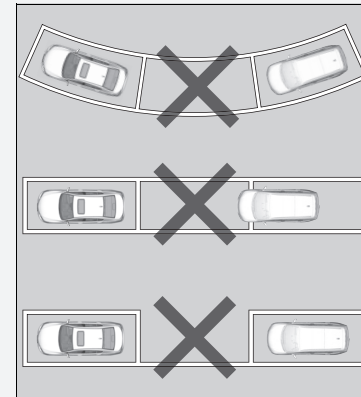

■ Checking for the Sides of Your Vehicle

You can display the front ground view screen using all the four cameras for the system. Pressing the **CAMERA** button when the vehicle speed is at below 12 mph (20 km/h) changes the image as follows.

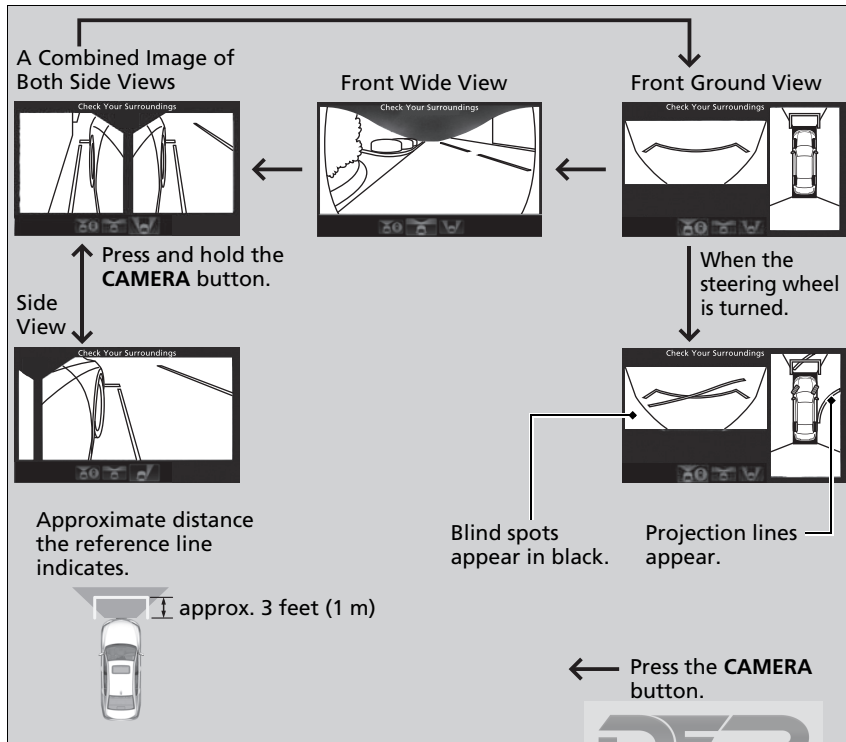

▣ Checking for the Sides of Your Vehicle

When the vehicle speed exceeds 15 mph (25 km/h), the front or side view on the screen automatically switches to the audio information screen. The front or side view screen resumes when the vehicle speed is reduced below 12 mph (20 km/h).

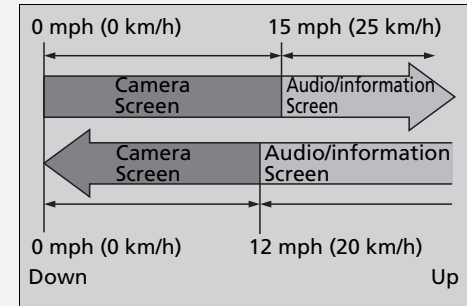

■ Checking from the front wide view at intersections

The front wide view screen is useful when you need to check for vehicles crossing from either direction at an intersection with poor visibility.

The angle provided by the front wide view screen is 180 degrees.



Front Wide View Screen

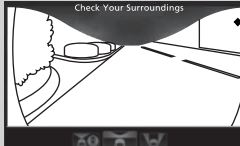

When the vehicle speed is below 12 mph (20 km/h), press the **CAMERA** button repeatedly until the front wide view comes on.

▶▶ Checking from the front wide view at intersections

The front wide view image is a wide-angled view. The displayed image will be largely distorted, and objects may appear closer or more distant than they actually are.

■ Checking the sides of your vehicle

The side view screens are convenient when you pull over at a curb or tollbooth, or slowly pass by oncoming vehicles on a narrow road.

Side Views
The images from the side cameras.

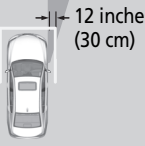

12 inches (30 cm) 12 inches (30 cm)

Side View Screen



Press and hold the **CAMERA** button.



Approximate distance the projection lines indicate is 12 inches (30 cm) from the vehicle.

▶▶ Checking the sides of your vehicle

When the door mirrors are folded, the side views cannot be displayed.

■ Surround View Camera System Limitations

The system may not work properly under the following conditions.

Conditions		Solutions
The images may not appear clearly when:	<ul style="list-style-type: none"> You activate the system in bad weather (heavy rain, snow, fog, etc.) or in the dark. Camera temperatures are high. A sudden change between light and dark such as an entrance or exit of a tunnel. You drive into the sunlight (e.g., at dawn or dusk.) 	Do not use the surround view camera system but rely only on visual confirmation until the conditions allow the system to work properly.
	<ul style="list-style-type: none"> A camera lens is covered with dirt, moisture, or debris. A camera lens is scratched. 	Clean camera lenses with a soft cloth moisturized with water, mild detergent or glass cleaner.
	The audio/information screen is dirty.	Wipe off the screen using a soft dry cloth.
A camera angle is altered.	A camera or the area around the camera has been severely impacted.	Do not use the surround view camera system and contact a dealer.
An error message is displayed while the surround view camera system is in use.		

Fuel Information

■ Fuel recommendation

Unleaded premium gasoline, pump octane number 91 or higher

Use of lower octane gasoline can cause occasional metallic knocking noise in the engine and will result in decreased engine performance.

Use of gasoline with a pump octane less than 87 can lead to engine damage.

■ Top tier detergent gasoline

Because the level of detergency and additives in gasoline vary in the market, Acura endorses the use of "TOP TIER Detergent Gasoline" where available to help maintain the performance and reliability of your vehicle. TOP TIER Detergent Gasoline meets a new gasoline standard jointly established by leading automotive manufacturers to meet the needs of today's advanced engines.

Qualifying gasoline retailers will, in most cases, identify their gasoline as having met "TOP TIER Detergent Gasoline" standards at the retail location. This fuel is guaranteed to contain the proper level of detergent additives and be free of metallic additives. The proper level of detergent additives, and absence of harmful metallic additives in gasoline, help avoid build-up of deposits in your engine and emission control system.

For further important fuel-related information for your vehicle, or on information on gasoline that does not contain MMT, visit Acura Owners at owners.acura.com. In Canada, visit www.acura.ca for additional information on gasoline. For more information on top tier gasoline, visit www.toptiergas.com.

■ Fuel tank capacity: 18.5 US gal (70 liters)

⌘ Fuel Information

NOTICE

We recommend quality gasoline containing detergent additives that help prevent fuel system and engine deposits. In addition, in order to maintain good performance, fuel economy, and emissions control, we strongly recommend the use of gasoline that does NOT contain harmful manganese-based fuel additives such as MMT, if such gasoline is available.

Use of gasoline with these additives may adversely affect performance, and cause the malfunction indicator lamp on your instrument panel to come on. If this happens, contact a dealer for service. Some gasoline today is blended with oxygenates such as ethanol. Your vehicle is designed to operate on oxygenated gasoline containing up to 15% ethanol by volume. Do not use gasoline containing methanol. If you notice any undesirable operating symptoms, try another service station or switch to another brand of gasoline.

How to Refuel

Your fuel tank is not equipped with a fuel filler cap. You can insert the filler nozzle directly into the filler neck. The tank seals itself again when you pull out the filler nozzle.

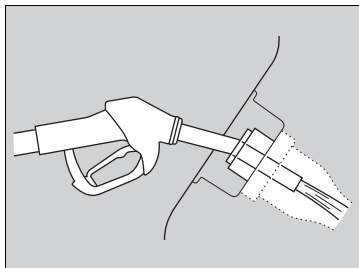

1. Stop your vehicle with the service station pump on the left side of the vehicle in the rear.
2. Turn off the engine.
3. Press the fuel fill door release button.
 - ▶ The fuel fill door opens.
4. Place the end of the filler nozzle on the lower part of filler opening, then insert it slowly and fully.
 - ▶ Make sure that the end of the filler nozzle goes down along with the filler pipe.
 - ▶ Keep the filler nozzle level.
 - ▶ When the tank is full, the filler nozzle will click off automatically.
 - ▶ After filling, wait about five seconds before removing the filler nozzle.
5. Shut the fuel fill door by hand.

How to Refuel

⚠ WARNING

Gasoline is highly flammable and explosive. You can be burned or seriously injured when handling fuel.

- Stop the engine, and keep heat, sparks, and flame away.
- Handle fuel only outdoors.
- Wipe up spills immediately.

The fuel filler opening is designed to accept only service station filler nozzles for refueling. Use of smaller diameter tubes (e.g., those used to siphon fuel for other uses) or other non-service station devices can damage the area in and around the filler opening.

The filler nozzle automatically stops to leave space in the fuel tank so that fuel does not overflow as a result of changes in air temperature.

If the filler nozzle keeps turning off when the tank is not full, there may be a problem with the pump's fuel vapor recovery system. Try filling at another pump. If this does not fix the problem, consult a dealer.

Do not continue to add fuel after the nozzle has automatically stopped. Additional fuel can exceed the full tank capacity.

If you have to refuel your vehicle from a portable container, use the funnel provided with your vehicle.

▶▶ Refueling From a Portable Fuel Container P. 530

Improving Fuel Economy and Reducing CO₂ Emissions

Achieving fuel economy and reducing CO₂ emissions is dependent on several factors, including driving conditions, load weight, idling time, driving habits, and vehicle condition. Depending on these and other factors, you may not achieve the rated fuel economy of this vehicle.

Maintenance and Fuel Economy

You can optimize your fuel economy with proper maintenance of your vehicle. Always maintain your vehicle in accordance with the messages displayed on the multi-information display.

- Use the recommended viscosity engine oil, displaying the API Certification Seal.
- Maintain the specified tire pressure.
- Do not load the vehicle with excess cargo.
- Keep your vehicle clean. A buildup of snow or mud on your vehicle's underside adds weight and increases wind resistance.

Improving Fuel Economy and Reducing CO₂ Emissions

Direct calculation is the recommended method to determine actual fuel consumed while driving.



In Canada, posted fuel economy numbers are established following a simulated test. For more information on how this test is performed, please visit <http://oee.nrcan.gc.ca/>

Maintenance

This chapter discusses basic maintenance.



Before Performing Maintenance

Inspection and Maintenance	442
Safety When Performing Maintenance.....	443
Parts and Fluids Used in Maintenance	
Service	444

Maintenance Minder™

Maintenance Under the Hood

Maintenance Items Under the Hood.....	450
Opening the Hood	451
Engine Compartment Cover.....	452
Recommended Engine Oil	453
Oil Check.....	454
Adding Engine Oil	455

Changing the Engine Oil and Oil Filter	456
Engine Coolant.....	458
Transmission Fluid.....	460
Brake Fluid.....	461
Refilling Window Washer Fluid.....	461

Replacing Light Bulbs

Checking and Maintaining Wiper Blades

Checking and Maintaining Tires

Checking Tires	471
Tire and Loading Information Label.....	472
Tire Labeling	472
DOT Tire Quality Grading (U.S. Vehicles).....	474

Wear Indicators	476
Tire Service Life	476
Tire and Wheel Replacement	477
Tire Rotation	478
Winter Tires	479
Battery	480

Remote Transmitter Care

Replacing the Button Battery	481
------------------------------------	-----

Climate Control System Maintenance

Cleaning

Interior Care	484
Exterior Care.....	486

Accessories and Modifications



Inspection and Maintenance

For your safety, perform all listed inspections and maintenance to keep your vehicle in good condition. If you become aware of any abnormality (noise, smell, insufficient brake fluid, oil residue on the ground, etc.), have your vehicle inspected by a dealer. (Note, however, that service at a dealer is not mandatory to keep your warranties in effect.)

Types of Inspection and Maintenance

■ Daily inspections

Perform inspections before long distance trips, when washing the vehicle, or when refueling.

■ Periodic inspections

- Check the brake fluid level monthly.
 - **Brake Fluid** P. 461
- Check the tire pressure monthly. Examine the tread for wear and foreign objects.
 - **Checking and Maintaining Tires** P. 471
- Check the operation of the exterior lights monthly.
 - **Replacing Light Bulbs** P. 462
- Check the condition of the wiper blades at least every six months.
 - **Checking and Maintaining Wiper Blades** P. 468

Inspection and Maintenance

U.S. models

Maintenance, replacement, or repair of emissions control devices and systems may be done by any automotive repair establishment or individuals using parts that are “certified” to EPA standards.

According to state and federal regulations, failure to perform maintenance on the maintenance main items marked with # will not void your emissions warranties. However, all maintenance services should be performed in accordance with the intervals indicated by the multi-information display.

➤ **Maintenance Service Items** P. 448

If you want to perform complex maintenance tasks that require more skills and tools, you can purchase a subscription to the Service Express website at www.techinfo.honda.com.

➤ **Authorized Manuals** P. 541

If you want to perform maintenance yourself, make sure that you have the necessary tools and skills first. After performing maintenance, update the records in the separate maintenance booklet.

Safety When Performing Maintenance

Some of the most important safety precautions are given here. However, we cannot warn you of every conceivable hazard that can arise in performing maintenance. Only you can decide whether or not you should perform a given task.

Maintenance Safety

- To reduce the possibility of fire or explosion, keep cigarettes, sparks, and flames away from the battery and all fuel related parts.
- Never leave rags, towels, or other flammable objects under the hood.
 - ▶ Heat from the engine and exhaust can ignite them causing a fire.
- To clean parts, use a commercially available degreaser or parts cleaner, not gasoline.
- Wear eye protection and protective clothing when working with the battery or compressed air.
- Engine exhaust contains carbon monoxide, which is poisonous and can kill you.
 - ▶ Operate the engine only when there is sufficient ventilation.

Vehicle Safety

- The vehicle must be in a stationary condition.
 - ▶ Make sure your vehicle is parked on level ground, the parking brake is set, and the engine is off.
- Be aware that hot parts can burn you.
 - ▶ Make sure to let the engine and exhaust system cool thoroughly before touching vehicle parts.
- Be aware that moving parts can injure you.
 - ▶ Do not start the engine unless instructed, and keep your hands and limbs away from moving parts.

⚠ Safety When Performing Maintenance

⚠ WARNING

Improperly maintaining this vehicle or failing to correct a problem before driving can cause a crash in which you can be seriously hurt or killed.

Always follow the inspection and maintenance recommendations according to the schedules in this owner's manual.

⚠ WARNING

Failure to properly follow maintenance instructions and precautions can cause you to be seriously hurt or killed.

Always follow the procedures and precautions in this owner's manual.

Parts and Fluids Used in Maintenance Service

The use of Acura genuine parts and fluids is recommended when maintaining and servicing your vehicle. Acura genuine parts are manufactured according to the same high quality standards used in Acura vehicles.

If the engine oil life is less than 15%, you will see the Maintenance Minder messages appear the multi-information display every time you set the power mode to ON. The messages notify you when to change the engine oil, or when to bring your vehicle to a dealer for indicated maintenance services.

To Use Maintenance Minder™

■ Displaying the Engine Oil Life and Maintenance Items

Maintenance items, which should be serviced at the same time that you replace the engine oil, appear on the multi-information display.

You can view them on the engine oil life screen at any time.

1. Set the power mode to ON.
2. Roll the right selector wheel until the engine oil life appears on the multi-information display.

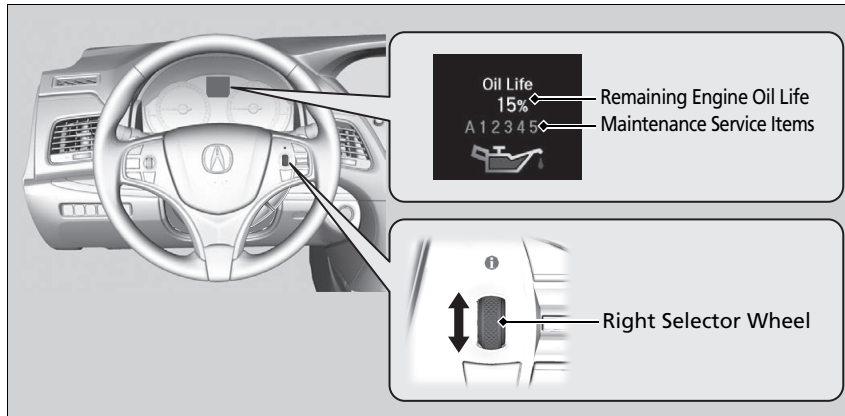





►► Displaying the Engine Oil Life and Maintenance Items

Based on the engine operating conditions, the remaining engine oil life is calculated and displayed as a percentage.

Displayed Engine Oil Life (%)	Calculated Engine Oil Life (%)
100	100 to 91
90	90 to 81
80	80 to 71
70	70 to 61
60	60 to 51
50	50 to 41
40	40 to 31
30	30 to 21
20	20 to 16
15	15 to 11
10	10 to 6
5	5 to 1
0	0

Maintenance Minder Messages on the Multi-Information Display

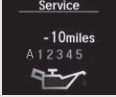
Maintenance Message	Oil Life Display	Explanation	Information
Maintenance Due Soon 	15 % 	The remaining engine oil life is 15 to 6 percent. Once you switch the display by rolling the right selector wheel, this message will go off.	The engine oil is approaching the end of its service life, and the maintenance items should be inspected and serviced soon.
Maintenance Due Now 	5 % 	The remaining engine oil life is 5 to 1 percent. Roll the right selector wheel to switch to another display.	The engine oil has almost reached the end of its service life, and the maintenance items should be inspected and serviced as soon as possible.
Maintenance Past Due 	Negative Distance 	The remaining engine oil life has passed its service life, and a negative distance appears after driving over 10 miles (U.S. models) or 10 km (Canadian models). Roll the right selector wheel to switch to another display.	The engine oil life has passed. The maintenance items must be inspected and serviced immediately.

The system message indicator (i) comes on along with the Maintenance Minder message.

Maintenance

Maintenance Service Items

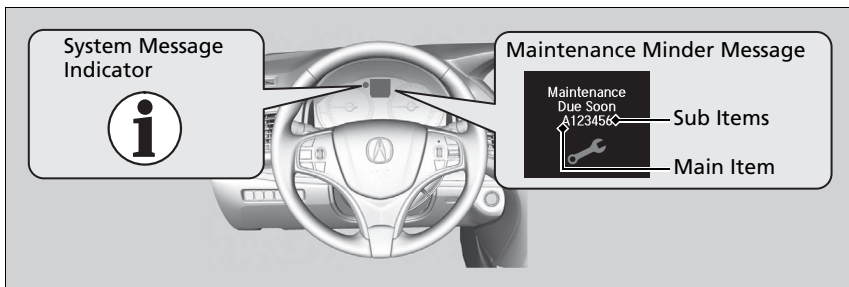

Maintenance Service Items

- Independent of the Maintenance Minder information, replace the brake fluid every 3 years.
- Inspect idle speed every 160,000 miles (256,000 km).
- Adjust the valves during services A, B, 1, 2, or 3 if they are noisy.

CODE	Maintenance Main Items
A	<ul style="list-style-type: none"> • Replace engine oil*¹
B	<ul style="list-style-type: none"> • Replace engine oil*¹ and oil filter • Inspect front and rear brakes • Inspect tie rod ends, steering gearbox, boots, and drain plug • Inspect suspension components • Inspect driveshaft boots • Inspect brake hoses and lines (Including ABS/VSA) • Inspect all fluid levels and condition of fluids • Inspect exhaust system[#] • Inspect fuel lines and connections[#] • Check expiration information for Temporary Tire Repair Kit bottle

CODE	Maintenance Sub Items
1	<ul style="list-style-type: none"> • Rotate tires
2	<ul style="list-style-type: none"> • Replace air cleaner element*² • Replace dust and pollen filter*³
3	<ul style="list-style-type: none"> • Replace transmission fluid
4	<ul style="list-style-type: none"> • Replace spark plugs • Replace timing belt and inspect water pump*⁴ • Inspect valve clearance
5	<ul style="list-style-type: none"> • Replace engine coolant

*2: If you drive in dusty conditions, replace the air cleaner element every 15,000 miles (24,000 km).

*3: If you drive primarily in urban areas that have high concentrations of soot in the air from industry and from diesel-powered vehicles, replace the dust and pollen filter every 15,000 miles (24,000 km).

*4: If you drive regularly in very high temperatures (over 110°F, 43°C), in very low temperatures (under -20°F, -29°C), replace every 60,000 miles/100,000 km.

*1: If a message **Maintenance Due Now** does not appear more than 12 months after the display is reset, change the engine oil every year.

#: See information on maintenance and emissions warranty.

■ Resetting the Display

Reset the engine oil life display if you have performed the maintenance service.

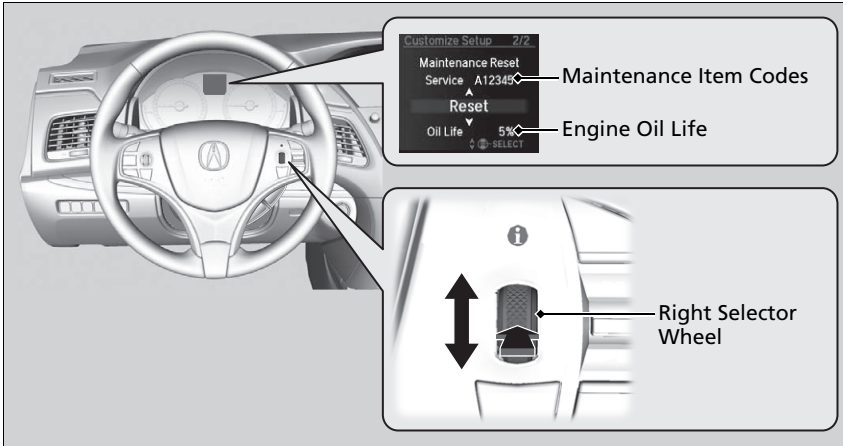

1. Set the power mode to ON.
 2. Go to the **Maintenance Info.** group.
 - ▶ **Customized Features** P. 103
 3. Push the right selector wheel.
 - ▶ The oil life reset mode is displayed on the multi-information display.
 4. Select **Reset** with the right selector wheel, then push the right selector wheel.
 - ▶ The displayed maintenance items disappear, and the engine oil life display returns to **100%**.
- To cancel the oil life reset mode, select **Cancel**, then push the right selector wheel.

⌘ Resetting the Display

NOTICE

Failure to reset the engine oil life after a maintenance service results in the system showing incorrect maintenance intervals, which can lead to serious mechanical problems.

The dealer will reset the engine oil life display after completing the required maintenance service. If someone other than a dealer performs maintenance service, reset the engine oil life display yourself.

Maintenance Items Under the Hood

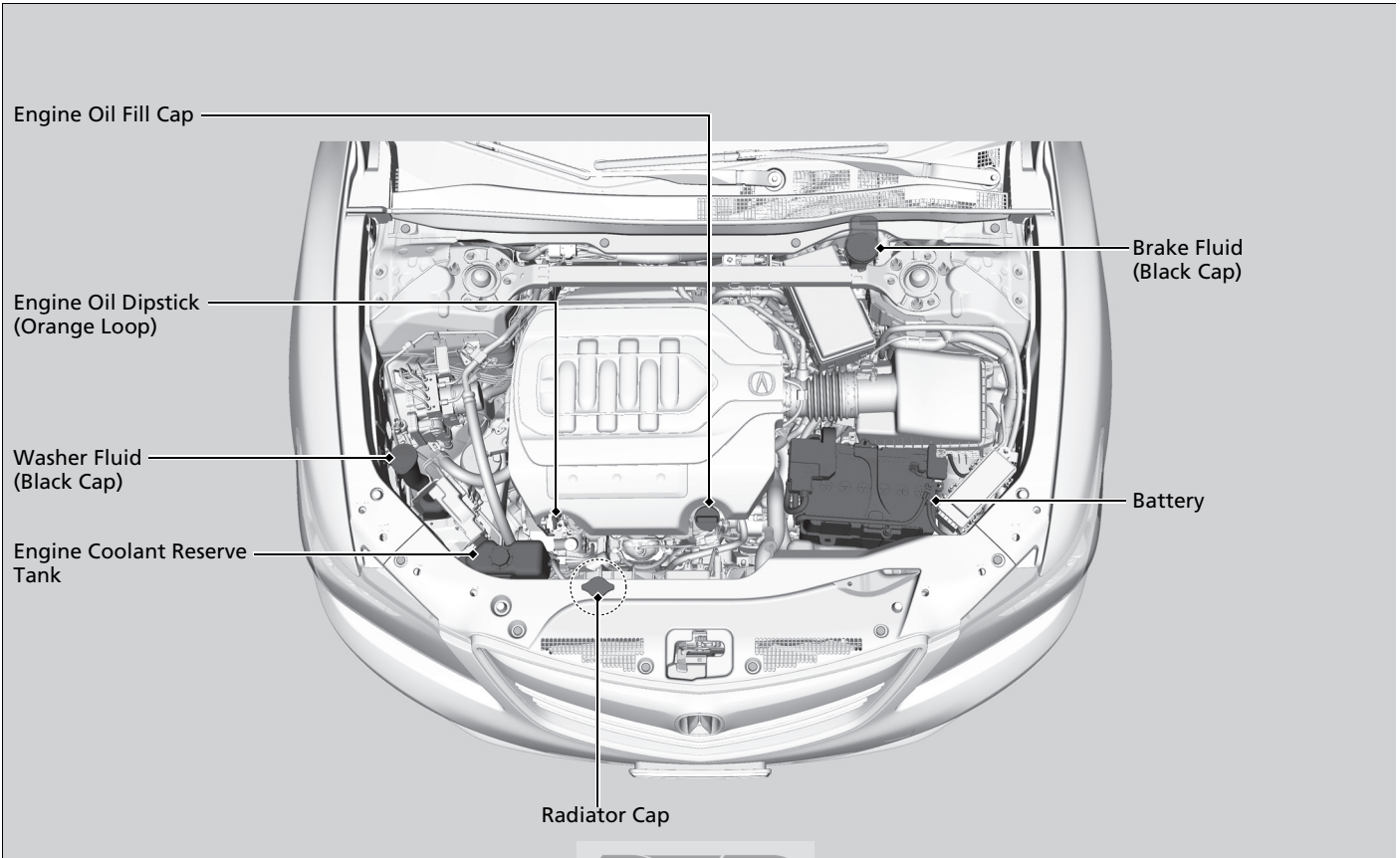

Opening the Hood

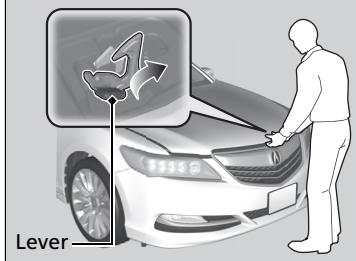
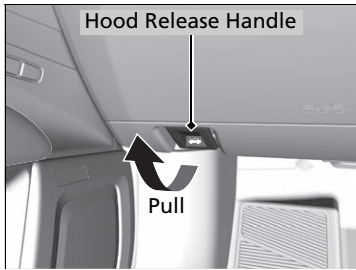

1. Park the vehicle on a level surface, and set the parking brake.
2. Pull the hood release handle under the lower left corner of the dashboard.
 - The hood will pop up slightly.
3. Push up the hood latch lever in the center of the hood to release the lock mechanism, and open the hood.
4. Lift the hood up most of the way.
 - The hydraulic supports will lift it up the rest of the way and hold it up.

When closing, lower it to approximately 12 inches (30 cm), then press down firmly with your hands.

Opening the Hood

NOTICE

Do not open the hood when the wiper arms are raised. The hood will strike the wipers, and may damage either the hood or the wipers.

When closing the hood, check that the hood is securely latched.

If the hood latch lever moves stiffly, or if you can open the hood without lifting the lever, the latch mechanism should be cleaned and lubricated.

Engine Compartment Cover

The component parts in the engine compartment are protected by a cover. You may need to remove the cover when you perform certain maintenance work. To remove the cover:

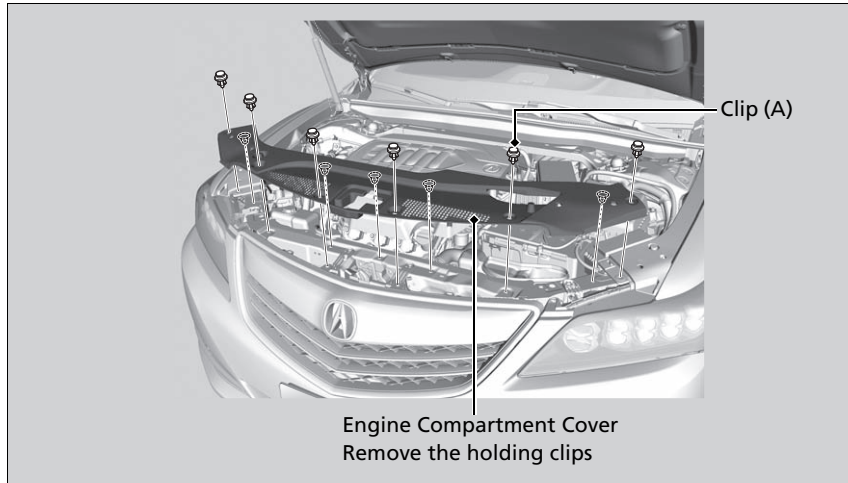

► Engine Compartment Cover

Holding clip (A-type)

Insert a flat-tip screwdriver, lift and remove the center pin to remove the clip.

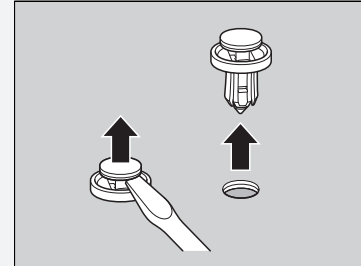

Insert the clip with the center pin raised, and push until it is flat.

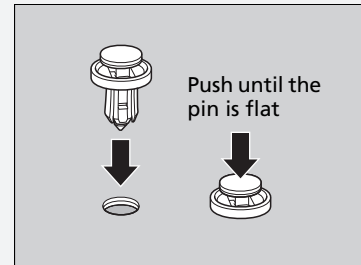

Recommended Engine Oil

- **Genuine Acura Motor Oil**
- **Premium-grade 0W-20 detergent oil with an API Certification Seal on the container.**



Oil is a major contributor to your engine's performance and longevity. If you drive the vehicle with insufficient or deteriorated oil, the engine may fail or be damaged.

This seal indicates the oil is energy conserving and that it meets the American Petroleum Institute's latest requirements.

Use a Genuine Acura Motor Oil or another commercial engine oil of suitable viscosity for the ambient temperature as shown here.

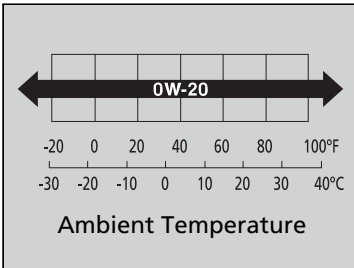

■ Synthetic oil

You may also use synthetic motor oil if it is labeled with the API Certification Seal and is the specified viscosity grade.

☒ Recommended Engine Oil

Engine Oil Additives

Your vehicle does not require oil additives. In fact, they may adversely affect the engine performance and durability.

Oil Check

We recommend that you check the engine oil level every time you refuel.

Park the vehicle on level ground.

Wait approximately three minutes after turning the engine off before you check the oil.

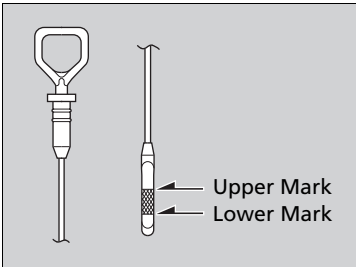
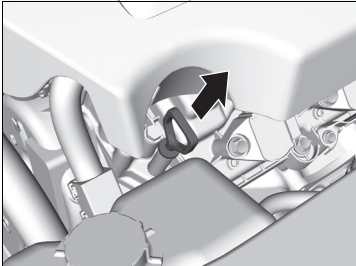

1. Remove the dipstick (orange loop).
2. Wipe the dipstick with a clean cloth or paper towel.
3. Insert the dipstick back all the way into its hole.

4. Remove the dipstick again, and check the level. It should be between the upper and lower marks. Add oil if necessary.

Oil Check

If the oil level is near or below the lower mark, slowly add oil being careful not to overfill.

Adding Engine Oil

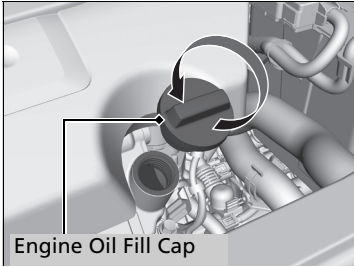

Engine Oil Fill Cap

1. Unscrew and remove the engine oil fill cap.
2. Add oil slowly.
3. Reinstall the engine oil fill cap, and tighten it securely.
4. Wait for three minutes and recheck the engine oil dipstick.

✘ Adding Engine Oil

If any oil spills, wipe it away immediately. Spilled oil may damage the engine compartment components.

NOTICE

Do not fill the engine oil above the upper mark. Overfilling the engine oil can result in leaks and engine damage.

Changing the Engine Oil and Oil Filter

You must change the engine oil and oil filter regularly in order to maintain the engine's lubrication. The engine may be damaged if they are not changed regularly.

Change the oil and filter in accordance with the maintenance message on the multi-information display.

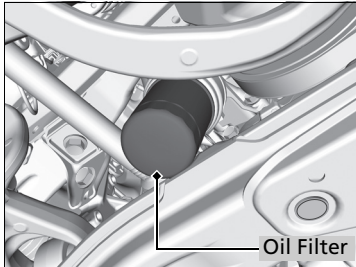
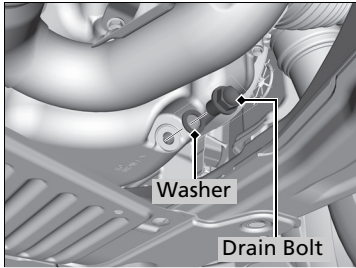

1. Run the engine until it reaches normal operating temperature, and then turn the engine off.
2. Open the hood and remove the engine oil fill cap.
3. Remove the drain bolt and washer from the bottom of the engine, and drain the oil into a suitable container.
4. Remove the oil filter and dispose of the remaining oil.
5. Check that the filter gasket is not stuck to the engine contact surface.
 - If it is stuck, you must detach it.
6. Wipe away dirt and dust adhering to the contact surface of the engine block, and install a new oil filter.
 - Apply a light coat of new engine oil to the oil filter rubber seal.
7. Put a new washer on the drain bolt, then reinstall the drain bolt.
 - Tightening torque:
30 lbf-ft (40 N·m, 4.0 kgf·m)

► Changing the Engine Oil and Oil Filter

NOTICE

You may damage the environment if you do not dispose of the oil in a suitable way. If you are changing the oil by yourself, appropriately dispose of the used oil. Put the oil in a sealed container and take it to a recycling center. Do not throw the oil away into a garbage can or onto the ground.

You will need a special wrench to replace the oil filter. You can buy this wrench from a dealer.

When installing the new oil filter, follow the instructions supplied with the oil filter.

Reinstall the engine oil fill cap. Start the engine. The low oil pressure indicator should go off within five seconds. If it does not, turn off the engine, and check your work.

8. Pour the recommended engine oil into the engine.
 - ▶ Engine oil change capacity (including filter):
4.5 US qt (4.3 L)
9. Reinstall the engine oil fill cap securely and start the engine.
10. Run the engine for a few minutes, and then check that there is no leak from the drain bolt or oil filter.
11. Stop the engine, wait for three minutes, and then check the oil level on the dipstick.
 - ▶ If necessary, add more engine oil.

Engine Coolant

Specified coolant: Acura Long Life Antifreeze/Coolant Type 2

This coolant is premixed with 50% antifreeze and 50% water. Do not add any straight antifreeze or water.

We recommend you check the engine coolant level every time you refuel. Check the reserve tank first. If it is completely empty, also check the coolant level in the radiator. Add the engine coolant accordingly.

Reserve Tank

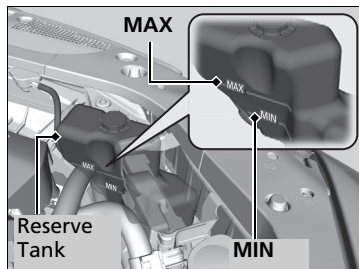

1. Check the amount of coolant in the reserve tank.

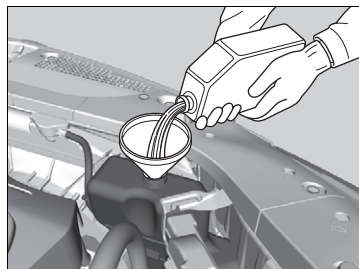

2. If the coolant level is below the **MIN** mark, add the specified coolant until it reaches the **MAX** mark.
3. Inspect the cooling system for leaks.

Engine Coolant

Genuine Acura engine coolant is a 50/50 mixture of antifreeze and water that can withstand freezing at temperatures as low as about -31°F (-35°C). If your vehicle is consistently subjected to temperatures below this, the concentration of antifreeze in the coolant should be increased. Consult a dealer for details.

If Honda antifreeze/coolant is not available, you may use another major brand non-silicate coolant as a temporary replacement. Check that it is a high quality coolant recommended for aluminum engines. Continued use of any non-Acura coolant can result in corrosion, causing the cooling system to malfunction or fail. Have the cooling system flushed and refilled with Acura antifreeze/coolant as soon as possible.

Do not add rust inhibitors or other additives to your vehicle's cooling system. They may not be compatible with the coolant or with the engine components.

Radiator

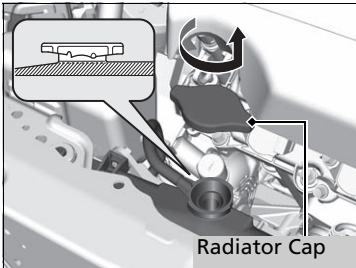

1. **Make sure the engine and radiator are cool.**
2. Remove the engine compartment cover.
➤ **Engine Compartment Cover** P. 452
3. Turn the radiator cap counterclockwise to relieve any pressure in the cooling system. Do not push the cap down when turning.
4. Push down and turn the radiator cap counterclockwise to remove it.
5. The coolant level should be up to the base of the filler neck. Add coolant if it is low.
6. Put the radiator cap back on, and tighten it fully.
7. Pour coolant into the reserve tank until it reaches the **MAX** mark. Put the cap back on the reserve tank.

ⓘ Radiator

⚠ WARNING

Removing the radiator cap while the engine is hot can cause the coolant to spray out, seriously scalding you.

Always let the engine and radiator cool down before removing the radiator cap.

NOTICE

Pour the fluid slowly and carefully so you do not spill any. Clean up any spills immediately; they can damage components in the engine compartment.

Transmission Fluid

■ Automatic Transmission Fluid

Specified fluid: Acura Automatic Transmission Fluid ATF DW-1

Have a dealer check the fluid level and replace if necessary.

Do not attempt to check or change the automatic transmission fluid yourself. The location of the ATF dipstick and fill increases the likelihood that you could be burned when trying to check or change the ATF.

►► Automatic Transmission Fluid

NOTICE

Do not mix Acura ATF DW-1 with other transmission fluids.

Using a transmission fluid other than Acura ATF DW-1 may adversely affect the operation and durability of your vehicle's transmission, and damage the transmission.

Any damage caused by using a transmission fluid that is not equivalent to Acura ATF DW-1 is not covered by Acura's new vehicle warranty.

Brake Fluid

Specified fluid: Acura Heavy Duty Brake Fluid DOT 3

Checking the Brake Fluid

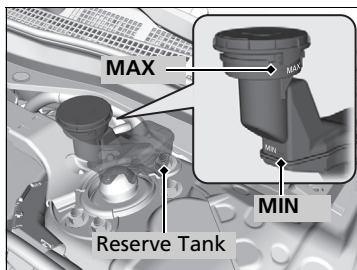

The fluid level should be between the **MIN** and **MAX** marks on the side of the reserve tank.

Refilling Window Washer Fluid

If the washer fluid is low, a message appears on the multi-information display. Pour the washer fluid carefully. Do not overflow the reservoir.

Brake Fluid

NOTICE

Brake fluid marked DOT 5 is not compatible with your vehicle's braking system and can cause extensive damage.

If the specified brake fluid is not available, you should use only DOT 3 or DOT 4 fluid from a sealed container as a temporary replacement.

Using any non-Acura brake fluid can cause corrosion and decrease the longevity of the system. Have the brake system flushed and refilled with Acura Heavy Duty Brake Fluid DOT 3 as soon as possible.

If the brake fluid level is at or below the **MIN** mark, have a dealer inspect the vehicle for leaks or worn brake pads as soon as possible.

Refilling Window Washer Fluid

NOTICE

Do not use engine antifreeze or a vinegar/water solution in the windshield washer reservoir. Antifreeze can damage your vehicle's paint. A vinegar/water solution can damage the windshield washer pump.

Headlights

Headlights are LED type. Have an authorized Acura dealer inspect and replace the light assembly.

Daytime Running Lights

Daytime running lights are LED type. Have an authorized Acura dealer inspect and replace the light assembly.

▣ Headlights

The headlight aim is set by the factory, and does not need to be adjusted. However, if you regularly carry heavy items in the trunk, have the aiming readjusted at a dealer or by a qualified technician.

Front Turn Signal/Parking Light Bulbs

When replacing, use the following bulbs.

Front Turn Signal/Parking Light: 27/8 W (Amber)

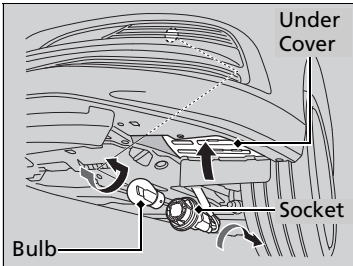
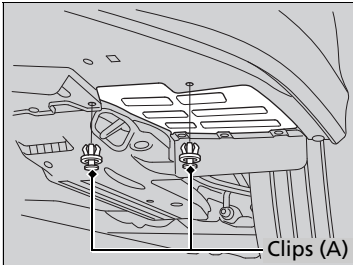

1. Remove the holding clips (A).
2. Push up the under cover.
3. Turn the socket counter-clockwise and remove it.
4. Push in the old bulb, rotate counter-clockwise until it unlocks, and remove.
5. Insert a new bulb.

Front Turn Signal/Parking Light Bulbs

Holding clip (A-type)

Insert a flat-tip screwdriver, lift and remove the center pin to remove the clip.

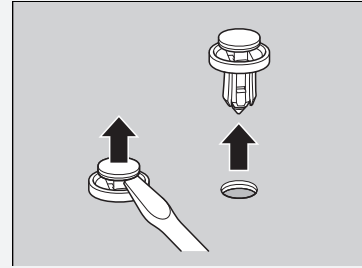

Insert the clip with the center pin raised, and push until it is flat.

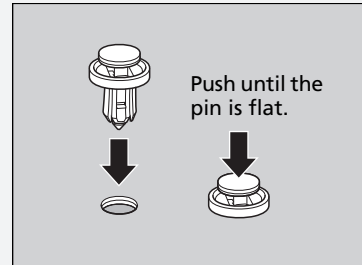

Front Side Marker Light Bulbs

When replacing, use the following bulbs.

Front Side Marker Light: 2 CP

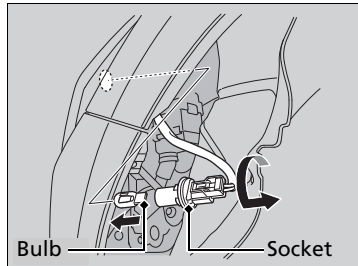
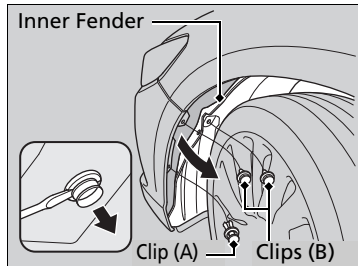

1. Turn the steering wheel all the way to the opposite side from the light being replaced.
Passenger's side: Turn the steering wheel to the left.
Driver's side: Turn the steering wheel to the right.
2. Remove the holding clips (A) and (B), pull the inner fender back.
3. Turn the socket counter-clockwise and remove it, then remove the old bulb.
4. Insert a new bulb.

Front Side Marker Light Bulbs

Holding clip (B-type)

When removing the clip, insert a flat-tip screwdriver, then lift and remove the clip.

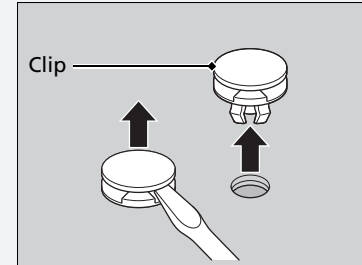

Insert the clip with the pin raised, and push until it is flat.

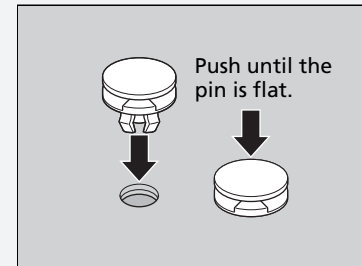

Side Turn Signal/Emergency Indicator Lights

Door mirror side turn lights are LED type. Have an authorized Acura dealer inspect and replace the light assembly.

Rear Turn Signal Light Bulbs

When replacing, use the following bulbs.

Rear Turn Signal Light: 21 W

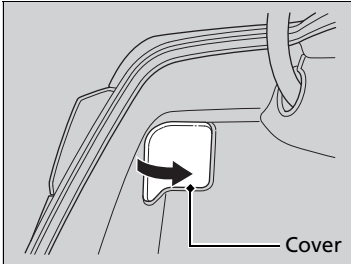

1. Remove the cover.

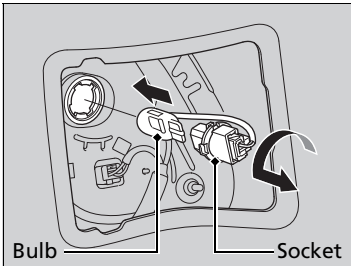

2. Turn the socket counter-clockwise and remove it, then remove the old bulb.

3. Insert a new bulb.

Brake/Taillight and Rear Side Marker Lights

Brake/taillight and rear side marker lights are LED type. Have an authorized Acura dealer inspect and replace the light assembly.

Taillights

Taillights are LED type. Have an authorized Acura dealer inspect and replace the light assembly.

Back-Up Light Bulbs

When replacing, use the following bulbs.

Back-Up Light: 16 W

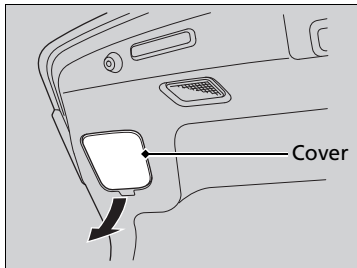

1. Remove the cover.

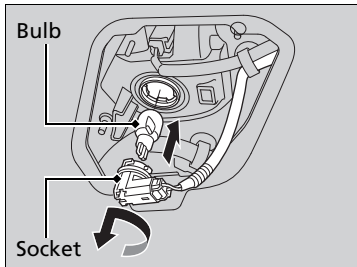

2. Turn the socket counter-clockwise and remove it, then remove the old bulb.
3. Insert a new bulb.

Rear License Plate Lights

Rear license plate lights are LED type. Have an authorized Acura dealer inspect and replace the light assembly.

High-Mount Brake Light

High-mount brake light is LED type. Have an authorized Acura dealer inspect and replace the light assembly.

Door Outer Handle Ambient Lights

Door outer handle ambient lights are LED type. Have an authorized Acura dealer inspect and replace the light assembly.

Checking Wiper Blades

If the wiper blade rubber has deteriorated, it will leave streaks and the hard surfaces of the blade may scratch the window glass.

Changing the Wiper Blade Rubber

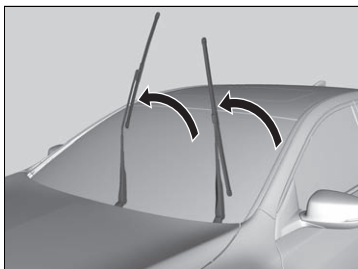
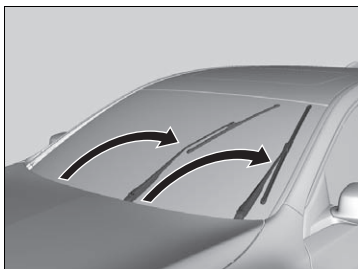

1. Set the power mode to VEHICLE OFF (LOCK).
2. While holding the wiper switch in the **MIST** position, set the power mode to ON, then to VEHICLE OFF (LOCK).
 - ▶ Both wiper arms are set to the maintenance position as shown in the image.
3. Lift both wiper arms.

Changing the Wiper Blade Rubber

NOTICE

Avoid dropping the wiper arm; it may damage the windshield.

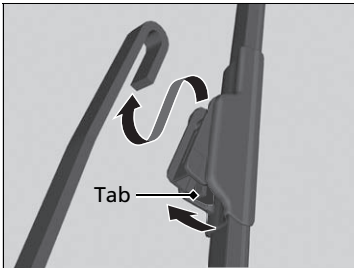

4. Press and hold the tab, then slide the blade out from the wiper arm.

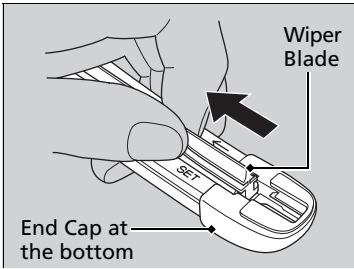

5. Pull the end of the wiper blade to the direction of the arrow in the image until it unfastens from the holder's end cap.

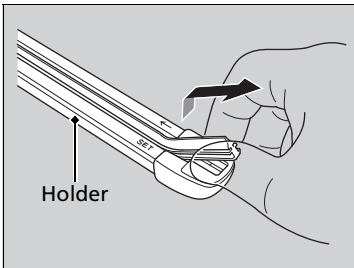

6. Pull the wiper blade to the opposite direction to slide it out from its holder.

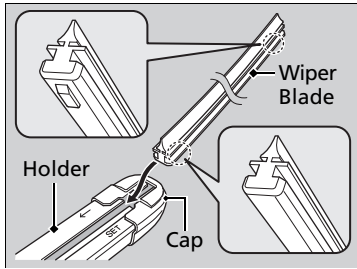

7. Insert the flat side of the new wiper blade onto the bottom part of the holder. Insert the blade all the way.
8. Install the end of the wiper blade into the cap.
9. Slide the wiper blade onto the wiper arm until it locks.
10. Lower both wiper arms.
11. Set the power mode to ON and hold the wiper switch in the **MIST** position until both wiper arms return to the standard position.

Checking Tires

To safely operate your vehicle, your tires must be of the proper type and size, in good condition with adequate tread, and properly inflated.

■ Inflation guidelines

Properly inflated tires provide the best combination of handling, tread life, and comfort. Refer to the driver's doorjamb label or specification's page for the specified pressure.

Underinflated tires wear unevenly, adversely affect handling and fuel economy, and are more likely to fail from overheating.

Overinflated tires make your vehicle ride harshly, are more prone to road hazards, and wear unevenly.

Every day before you drive, look at each of the tires. If one looks lower than the others, check the pressure with a tire gauge.

At least once a month or before long trips, use a gauge to measure the pressure in all tires. Even tires in good condition can lose 1 to 2 psi (10 to 20 kPa, 0.1 to 0.2 kgf/cm²) per month.

■ Inspection guidelines

Every time you check inflation, also examine the tires and valve stems. Look for:

- Bumps or bulges on the side or in the tread. Replace the tire if you find any cuts, splits, or cracks in the side of the tire. Replace it if you see fabric or cord.
- Remove any foreign objects and inspect for air leaks.
- Uneven tread wear. Have a dealer check the wheel alignment.
- Excessive tread wear.

➤ **Wear Indicators** P. 476

- Cracks or other damage around valve stem.

☒ Checking Tires

⚠ WARNING

Using tires that are excessively worn or improperly inflated can cause a crash in which you can be seriously hurt or killed.

Follow all instructions in this owner's manual regarding tire inflation and maintenance.

Measure the air pressure when tires are cold. This means the vehicle has been parked for at least three hours, or driven less than 1 mile (1.6 km). If necessary, add or release air until the specified pressure is reached.

If checked when hot, tire pressure can be as much as 4 – 6 psi (30 – 40 kPa, 0.3 – 0.4 kgf/cm²) higher than if checked when cold.

Have a dealer check the tires if you feel a consistent vibration while driving. New tires and any that have been removed and reinstalled should be properly balanced.

☒ Vehicles with optional spare tire kit

Measure the spare tire pressure once a month or before long trips.

Tire and Loading Information Label

The label attached to the driver’s doorjamb provides necessary tire and loading information.

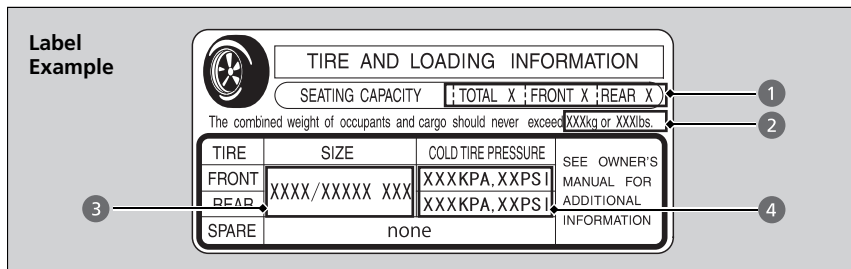

▶▶ Tire and Loading Information Label

The tire and loading information label attached to the driver’s doorjamb contains:

- 1 The number of people your vehicle can carry.
- 2 The total weight your vehicle can carry. Do not exceed this weight.
- 3 The original tire sizes for front, rear, and spare, if equipped.
- 4 The proper cold tire pressure for front, rear, and spare, if equipped.

Tire Labeling

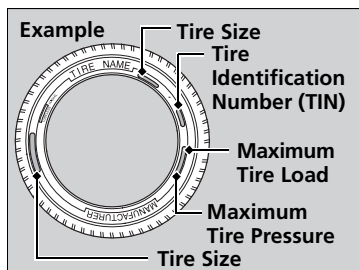

The tires that came on your vehicle have a number of markings. Those you should be aware of are described below.

▶▶ Tire Sizes

Following is an example of tire size with an explanation of what each component means.

245/40R19 98W

245: Tire width in millimeters.

40: Aspect ratio (the tire’s section height as a percentage of its width).

R: Tire construction code (R indicates radial).

19: Rim diameter in inches.

98: Load index (a numerical code associated with the maximum load the tire can carry).

W: Speed symbol (an alphabetical code indicating the maximum speed rating).

Tire Sizes

Whenever tires are replaced, they should be replaced with tires of the same size.

■ Tire Identification Number (TIN)

The tire identification number (TIN) is a group of numbers and letters that look like the example in the side column. TIN is located on the sidewall of the tire.

■ Glossary of Tire Terminology

Cold Tire Pressure – The tire air pressure when the vehicle has been parked for at least three hours or driven less than 1 mile (1.6 km).

Load Rating – Means the maximum load that a tire is rated to carry for a given inflation pressure.

Maximum Inflation Pressure – The maximum tire air pressure that the tire can hold.

Maximum Load Rating – Means the load rating for a tire at the maximum permissible inflation pressure for that tire.

Recommended Inflation Pressure – The cold tire inflation pressure recommended by the manufacturer.

Treadwear Indicators (TWI) – Means the projections within the principal grooves designed to give a visual indication of the degrees of wear of the tread.

☒ Tire Identification Number (TIN)

DOT B97R FW6X 2209

DOT: This indicates that the tire meets all requirements of the U.S. Department of Transportation.

B97R: Manufacturer's identification mark.

FW6X: Tire type code.

22 09: Date of manufacture.

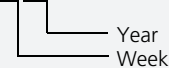

DOT Tire Quality Grading (U.S. Vehicles)

The tires on your vehicle meet all U.S. Federal Safety Requirements. All tires are also graded for treadwear, traction, and temperature performance according to Department of Transportation (DOT) standards. The following explains these gradings.

■ Uniform Tire Quality Grading

Quality grades can be found where applicable on the tire sidewall between tread shoulder and maximum section width.

■ Treadwear

The treadwear grade is a comparative rating based on the wear rate of the tire when tested under controlled conditions on a specified government test course. For example, a tire graded 150 would wear one and one-half (1 1/2) times as well on the government course as a tire graded 100. The relative performance of tires depends upon the actual conditions of their use, however, and may depart significantly from the norm due to variations in driving habits, service practices and differences in road characteristics and climate.

▣ Uniform Tire Quality Grading

For example:
Treadwear 200
Traction AA
Temperature A

All passenger car tires must conform to Federal Safety Requirements in addition to these grades.

■ Traction

The traction grades, from highest to lowest, are AA, A, B, and C. Those grades represent the tire's ability to stop on wet pavement as measured under controlled conditions on specified government test surfaces of asphalt and concrete. A tire marked C may have poor traction performance.

■ Temperature

The temperature grades are A (the highest), B, and C, representing the tire's resistance to the generation of heat and its ability to dissipate heat when tested under controlled conditions on a specified indoor laboratory test wheel. Sustained high temperature can cause the material of the tire to degenerate and reduce tire life, and excessive temperature can lead to sudden tire failure. The grade C corresponds to a level of performance which all passenger car tires must meet under the Federal Motor Vehicle Safety Standard No. 109. Grades B and A represent higher levels of performance on the laboratory test wheel than the minimum required by law.

⌘ Traction

Warning: The traction grade assigned to this tire is based on straight-ahead braking traction tests, and does not include acceleration, cornering, hydroplaning, or peak traction characteristics.

⌘ Temperature

Warning: The temperature grade for this tire is established for a tire that is properly inflated and not overloaded. Excessive speed, underinflation, or excessive loading, either separately or in combination, can cause heat buildup and possible tire failure.

Wear Indicators

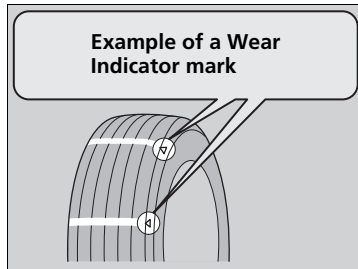

The groove where the wear indicator is located is 1/16 inch (1.6 mm) shallower than elsewhere on the tire. If the tread has worn so that the indicator is exposed, replace the tire.

Worn out tires have poor traction on wet roads.

Tire Service Life

The life of your tires is dependent on many factors, including driving habits, road conditions, vehicle loading, inflation pressure, maintenance history, speed, and environmental conditions (even when the tires are not in use).

In addition to regular inspections and inflation pressure maintenance, it is recommended that you have annual inspections performed once the tires reach five years old. All tires, including the spare*, should be removed from service after 10 years from the date of manufacture, regardless of their condition or state of wear.

Checking Tires

High speed driving

We recommend that you do not drive faster than the posted speed limits and conditions allow. If you drive at sustained high speeds (over 118 mph or 190 km/h), adjust the cold tire pressures as shown below to avoid excessive heat build up and sudden tire failure.

Tire Size	245/40R19 98W
Pressure	Front: 38 psi (260 kPa, 2.7 kgf/cm ²) Rear: 36 psi (250 kPa, 2.5 kgf/cm ²)

Tire and Wheel Replacement

Replace your tires with radials of the same size, load range, speed rating, and maximum cold tire pressure rating (as shown on the tire's sidewall). Using tires of a different size or construction can cause the ABS and vehicle stability assist (VSA®) system to work incorrectly.

It is best to replace all four tires at the same time. If that isn't possible, replace the front or rear tires in pairs.

Make sure that the wheel's specifications match those of the original wheels.

If you replace a wheel, only use TPMS specified wheels approved for your vehicle.

⚠ Tire and Wheel Replacement

⚠ WARNING

Installing improper tires on your vehicle can affect handling and stability. This can cause a crash in which you can be seriously hurt or killed.

Always use the size and type of tires recommended in this owner's manual.

Tire Rotation

Rotating tires according to the maintenance messages on the multi-information display helps to distribute wear more evenly and increase tire life.

■ Tires without rotation marks

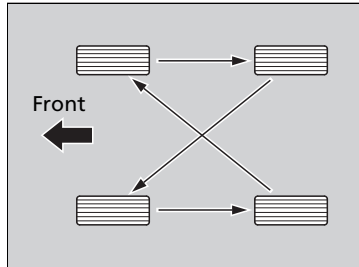

Rotate the tires as shown here.

■ Tires with rotation marks

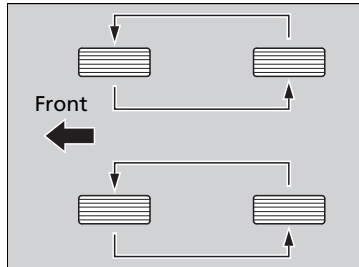

Rotate the tires as shown here.

▶▶ Tire Rotation

Tires with directional tread patterns should only be rotated front to back (not from one side to the other). Directional tires should be mounted with the rotation indication mark facing forward, as shown below.

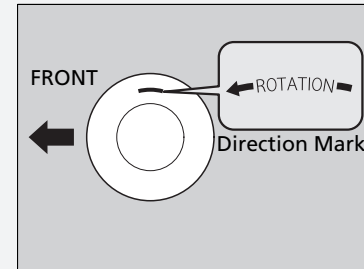

Winter Tires

If driving on snowy or frozen roads, mount all season marked **M+S** tires, snow tires, or tire chains; reduce speed; and maintain sufficient distance between vehicles when driving.

Be particularly careful when operating the steering wheel or brakes to prevent skidding.

Use tire chains, snow tires, or all season tires when necessary or according to the law.

When mounting, refer to the following points.

For winter tires:

- Select the size and load ranges that are the same as the original tires.
- Mount the tires to all four wheels.

For tire chains:

- Install them on the front tires only.
- Because your vehicle has limited tire clearance, we strongly recommend using the chains listed below:

Cable-type: SCC Radial Chain SC1040

- Follow the chain manufacturer's instruction when installing. Mount them as tightly as you can.
- Check that the chains do not touch the brake lines or suspension.
- Drive slowly.

❗ Winter Tires

⚠ WARNING

Using the wrong chains, or not properly installing chains, can damage the brake lines and cause a crash in which you can be seriously injured or killed.

Follow all instructions in this owner's manual regarding the selection and use of tire chains.

NOTICE

Traction devices that are the wrong size or improperly installed can damage your vehicle's brake lines, suspension, body, and wheels. Stop driving if they are hitting any part of the vehicle.

When tire chains are mounted, follow the chain manufacturer's instructions regarding vehicle operational limits.

If your vehicle is equipped with summer tires, be aware that these tires are not designed for winter driving conditions. For more information, contact a dealer.

Checking the Battery

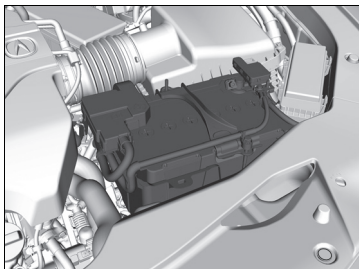

Check the battery terminals for corrosion monthly.

The battery condition is being monitored by the sensor on the negative terminal. If there is a problem with the sensor, the warning message on multi-information display will let you know. Have your vehicle checked by a dealer.

If your vehicle's battery is disconnected or goes dead:

- The audio system is disabled.
 - **Reactivating the audio system** P. 194
- The clock resets.
 - **Clock** P. 114
- The navigation system is disabled.
 - **Refer to the Navigation System Manual**

Charging the Battery

Disconnect both battery cables to prevent damaging your vehicle's electrical system. Always disconnect the negative (-) cable first, and reconnect it last.

ⓘ Battery

⚠ WARNING

The battery gives off explosive hydrogen gas during normal operation.

A spark or flame can cause the battery to explode with enough force to kill or seriously hurt you.

When conducting any battery maintenance, wear protective clothing and a face shield, or have a skilled technician do it.

WARNING: Battery post, terminals, and related accessories contain lead and lead compounds.
Wash your hands after handling.

When you find corrosion, clean the battery terminals by applying a baking powder and water solution. Clean terminals with a damp towel. Cloth/towel dry the battery. Coat the terminals with grease to help prevent future corrosion.

When replacing the battery, the replacement must be of the same specifications.
Please consult a dealer for more information.

Replacing the Button Battery

If the indicator does not come on when the button is pressed, replace the battery.

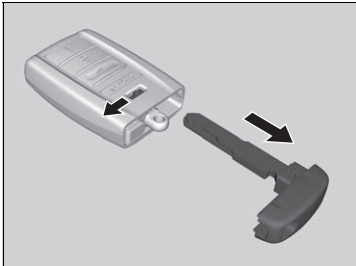

Battery type: CR2032

1. Remove the built-in key.
2. Remove the upper half of the cover by carefully prying on the edge with a coin.
 - ▶ Remove carefully to avoid losing the buttons.
 - ▶ Wrap a coin with a cloth to prevent scratching the keyless access remote.
3. Make sure to replace the battery with the correct polarity.

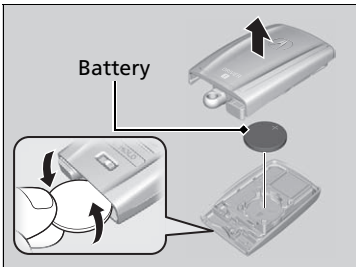

Replacing the Button Battery

NOTICE

An improperly disposed of battery can damage the environment. Always confirm local regulations for battery disposal.

Replacement batteries are commercially available or at a dealer.

Models with remote control engine start system

If the indicator does not come on when the button is pressed, replace the battery.

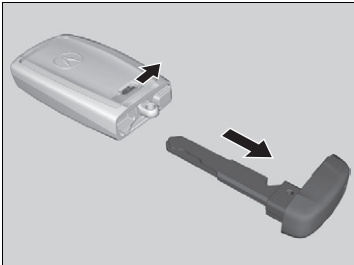

Battery type: CR2032

1. Remove the built-in key.
 - ▶ As a convenience, lightly place masking tape over the remote buttons to hold them in place.
2. Remove the upper half by carefully prying on the edge with a coin.
 - ▶ Wrap a coin with a cloth to prevent scratching the transmitter.
3. Press down on the center of the assembly and remove the battery.
 - ▶ When removing the button battery, be careful not to touch parts around it.
4. Make sure to replace the battery with the correct polarity.

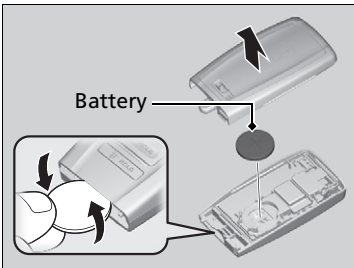

▶▶ Replacing the Button Battery

Models with remote control engine start system

NOTICE

The Remote transmitter is equipped with two batteries: A standard replaceable CR2032 coin button battery and an integral non-replaceable rechargeable battery. To prevent permanent damage to the rechargeable battery, replace the CR2032 battery every three to four years.

Dust and Pollen Filter

The climate control system is equipped with a dust and pollen filter that collects pollen, dust, and other debris in the air. The Maintenance Minder™ messages will let you know when to replace the filter.

We recommend that you replace the dust and pollen filter sooner when using your vehicle in areas with high concentrations of dust.

☒ Dust and Pollen Filter

If the airflow from the climate control system deteriorates noticeably, and the windows fog up easily, the filter may need to be replaced. Please contact a dealer for replacement.

Interior Care

Use a damp cloth with a mixture of mild detergent and warm water to remove dirt. Use a clean cloth to remove detergent residue.

■ Cleaning Seat Belts

Use a soft brush with a mixture of mild soap and warm water to clean the seat belts. Let the belts air dry. Wipe the openings of the seat belt anchors using a clean cloth.



■ Cleaning the Window

Wipe using a glass cleaner.

▣ Interior Care

Do not spill liquids inside the vehicle. Electrical devices and systems may malfunction if liquids are splashed on them.

Do not use silicone based sprays on electrical devices such as audio devices and switches. Doing so may cause the items to malfunction or a fire inside the vehicle. If a silicone based spray is inadvertently used on electrical devices, consult a dealer.

Depending on their composition, chemicals and liquid aromatics may cause discoloration, wrinkles, and cracking to resin-based parts and textiles. Do not use alkali solvents or organic solvents such as benzene or gasoline.

After using chemicals, make sure to gently wipe them away using a dry cloth. Do not place used cloths on top of resin based parts or textiles for long periods of time without washing.

▣ Cleaning the Window

Wires are mounted to the inside of the rear window. Wipe along the same direction as the wires with a soft cloth so as not to damage them.

■ Floor Mats

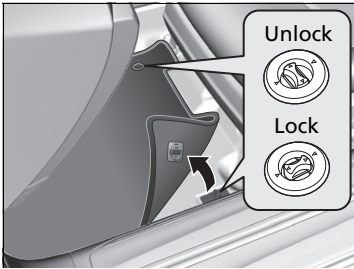

The floor mats hook over the floor anchors, which keep the mats from sliding forward. To remove the mats for cleaning, turn the anchor knobs to the unlock position. When reinstalling the mats after cleaning, turn the knobs to the lock position.

Do not put additional floor mats on top of the anchored mat.

■ Maintaining Genuine Leather

Vacuum dirt and dust from the leather frequently. Pay close attention to the pleats and seams. Clean the leather with a soft cloth dampened with a 90% water and 10% neutral soap solution. Then buff it with a clean, dry cloth. Remove any dust or dirt on leather surfaces immediately.

▣ Floor Mats

If you use any floor mats that were not originally provided with your vehicle, make sure they are designed for your specific vehicle, fit correctly, and are securely anchored by the floor anchors. Position the rear seat floor mats properly. If they are not properly positioned, the floor mats can interfere with the front seat functions.

Exterior Care

Dust off the vehicle body after you drive.

Regularly inspect your vehicle for scratches on painted surfaces. A scratch on a painted surface can result in body rust. If you find a scratch, promptly repair it.

■ Washing the Vehicle

Wash the vehicle regularly. Wash more frequently when driving in the following conditions:

- If driving on roads with road salt.
- If driving in coastal areas.
- If tar, soot, bird droppings, insects, or tree sap are stuck to painted surfaces.

■ Using an Automated Car Wash

- Make sure to follow the instructions indicated on the automated car wash.
- Fold in the door mirrors.
- Turn off the automatic intermittent wipers*.

■ Using High Pressure Cleaners

- Keep sufficient distance between the cleaning nozzle and the vehicle body.
- Take particular care around the windows. Standing too close may cause water to enter the vehicle interior.
- Do not spray high pressure water directly into the engine compartment. Instead, use low pressure water and a mild detergent.

■ Applying Wax

A good coat of automotive body wax helps protect your vehicle's paint from the elements. Wax will wear off over time and expose your vehicle's paint to the elements, so reapply as necessary.

* Not available on all models

► Washing the Vehicle

Do not spray water into the air intake vents. It can cause a malfunction.

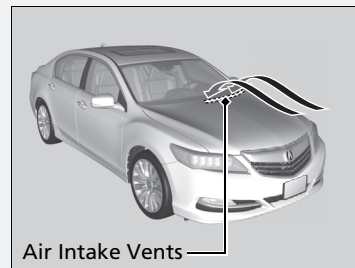

Do not spray water on to the capless unit when the fuel fill door is open. It can cause damage to the fuel system or engine.

► Applying Wax

NOTICE

Chemical solvents and strong cleaners can damage the paint, metal, and plastic on your vehicle. Wipe away spills immediately.

■ Maintaining the Bumpers and Other Resin Coated Parts

If you get gasoline, oil, engine coolant, or battery fluid on resin coated parts, they may be stained or the coating may peel. Promptly wipe it away using a soft cloth and clean water.

■ Cleaning the Window

Wipe using a glass cleaner.

■ Maintaining Aluminum Wheels

Aluminum is susceptible to deterioration caused by salt and other road contaminants. Use a sponge and mild detergent to wipe away promptly. Be careful not to use harsh chemicals (including some commercial wheel cleaners) or a stiff brush. They can damage the clear coat of the aluminum alloy wheels that helps keep the aluminum from corroding and tarnishing.

■ Fogged Exterior Light Lenses

The inside lenses of exterior lights (headlights, brake lights, etc.) may fog temporarily if you have driven in the rain, or after the vehicle has been run through a car wash. Dew condensation also may build up inside the lenses when there is a significant enough difference between the ambient and inside lens temperatures (similar to vehicle windows fogging up in rainy conditions). These conditions are natural processes, not structural design problems in the exterior lights.

Lens design characteristics may result in moisture developing on the light lens frame surfaces. This also is not a malfunction.

However, if you see large amounts of water accumulation, or large water drops building up inside the lenses, have your vehicle inspected by a dealer.

▣ Maintaining the Bumpers and Other Resin Coated Parts

Ask a dealer about the correct coating material when you want to repair the painted surface of the parts made of resin.

Accessories

When installing accessories, check the following:

- Do not install accessories on the windshield. They can obstruct your view and delay your reaction to driving conditions.
- Do not install any accessories over areas marked **SRS AIRBAG**, on the sides or backs of the front seats, on front or side pillars, or near the side windows. Accessories installed in these areas may interfere with proper operation of the vehicle's airbags or may be propelled into you or another occupant if the airbags deploy.
- Be sure electronic accessories do not overload electrical circuits or interfere with proper operation of your vehicle.
 - ▣ **Fuses** P. 522
- Before installing any electronic accessory, have the installer contact a dealer for assistance. If possible, have a dealer inspect the final installation.

Modifications

Do not modify your vehicle in a manner that may affect its handling, stability, or reliability, or install non-genuine Acura parts or accessories that may have a similar effect.

Even minor modifications to vehicle systems can affect overall vehicle performance. Always make sure all equipment is properly installed and maintained, and do not make any modification to your vehicle or its systems that might cause your vehicle to no longer meet federal, state, provincial, territorial, or local regulations.

Do not modify or attempt to repair any of the electrical components.

Accessories and Modifications

WARNING

Improper accessories or modifications can affect your vehicle's handling, stability, and performance, and cause a crash in which you can be seriously hurt or killed.

Follow all instructions in this owner's manual regarding accessories and modifications.

Acura Genuine accessories are recommended to ensure proper operation on your vehicle.

Handling the Unexpected

This chapter explains how to handle unexpected troubles.

Tools

Types of Tools..... 490

If a Tire Goes Flat

Temporarily Repairing a Flat Tire..... 491

Changing a Flat Tire..... 503

Engine Does Not Start

Checking the Engine..... 509

If the Keyless Access Remote Battery is

Weak..... 510

Emergency Engine Stop..... 511

Jump Starting..... 512

Shift Lever Does Not Move..... 515

Overheating

How to Handle Overheating..... 516

Indicator, Coming On/Blinking

If the Low Oil Pressure Indicator Comes On..... 518

If the Charging System Indicator Comes On..... 518

If the Malfunction Indicator Lamp Comes On or Blinks..... 519

If the Brake System Indicator (Red) Comes On.. 519

If the Electric Power Steering (EPS) System Indicator Comes On..... 520

If the Electric Parking Brake System Indicator Comes On..... 520

If the Low Tire Pressure/TPMS Indicator Comes On or Blinks..... 521

Fuses

Fuse Locations..... 522

Inspecting and Changing Fuses..... 526

Emergency Towing..... 527

When You Cannot Unlock the Fuel Fill Door..... 528

When You Cannot Open the Trunk..... 529

Refueling

Refueling From a Portable Fuel Container ... 530



Types of Tools

Handling the Unexpected

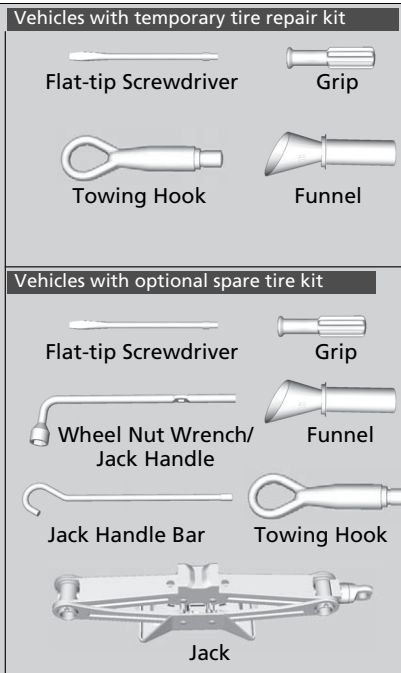
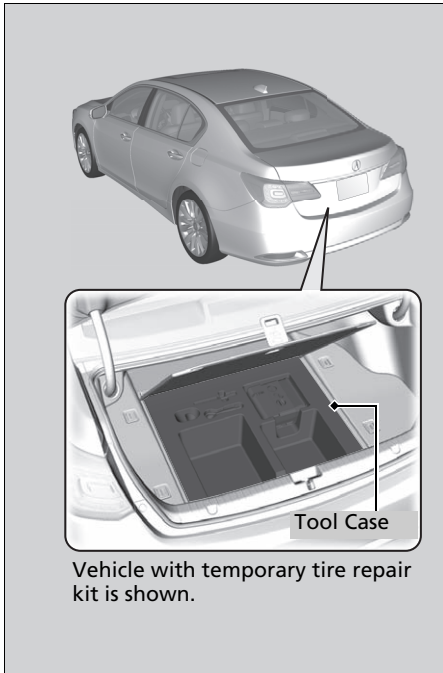

Types of Tools

The tools are stored in the trunk.

If a Tire Goes Flat

Vehicles with temporary tire repair kit

Temporarily Repairing a Flat Tire

If the tire has a large cut or is otherwise severely damaged, you will need to have the vehicle towed. If the tire only has a small puncture, from a nail for instance, you can use the temporary tire repair kit so that you can drive to the nearest service station for a more permanent repair.

If a tire goes flat while driving, grasp the steering wheel firmly, and brake gradually to reduce speed. Then stop in a safe place.

1. Park the vehicle on a firm, level, and non-slippery surface and apply the parking brake.
2. Move the shift lever to **P**.
3. Turn on the hazard warning lights and set the power mode to VEHICLE OFF (LOCK).

Temporarily Repairing a Flat Tire

The kit should not be used in the following situations. Instead, contact a dealer or a roadside assistant to have the vehicle towed.

- The tire sealant has expired.
- More than one tire is punctured.
- The puncture or cut is larger than 3/16 inch (4 mm).
- The tire side wall is damaged or the puncture is outside the contact area.



Contact Area

When the puncture is:	Kit Use
Smaller than 3/16 inch (4 mm)	Yes
Larger than 3/16 inch (4 mm)	No

- Damage has been caused by driving with the tire extremely under inflated.
- The tire bead is no longer seated.
- The rim is damaged.

Do not remove a nail or screw that punctured the tire. If you remove it from the tire, you may not be able to repair the puncture using the kit.

NOTICE

Do not use a puncture-repairing agent other than the one provided in the kit that came with your vehicle. If a different agent is used, you may permanently damage the tire pressure sensor.

■ Getting Ready to Temporarily Repair the Flat Tire

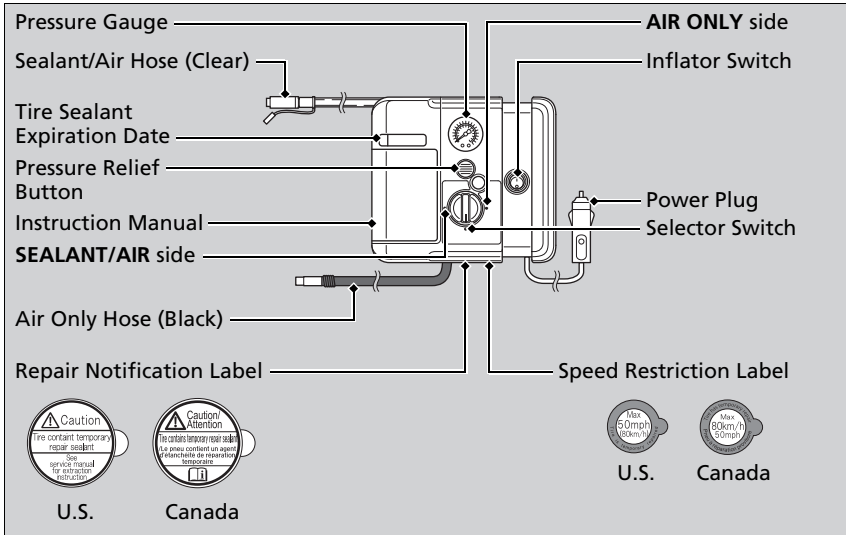

▶▶ Getting Ready to Temporarily Repair the Flat Tire

Repair notification label and speed restriction label are applied to the side of temporary tire repair kit.

When making a temporary repair, carefully read the instruction manual provided with the kit.

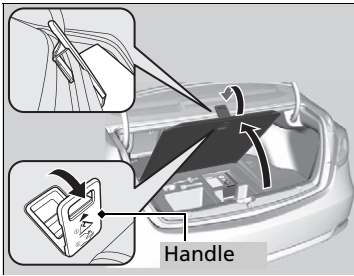

1. Pull the handle on the trunk floor lid and open the lid.
2. Hook the handle to the edge of the trunk opening.

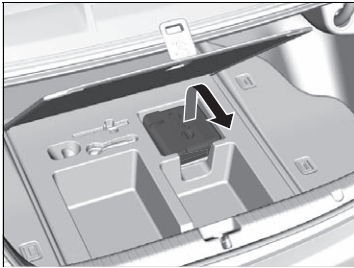

3. Take the kit out of the case.
4. Place the kit face up, on flat ground near the flat tire, and away from traffic. Do not place the kit on its side.

■ Injecting Sealant and Air

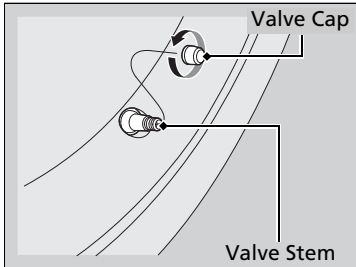

1. Remove the valve cap from the tire valve stem.

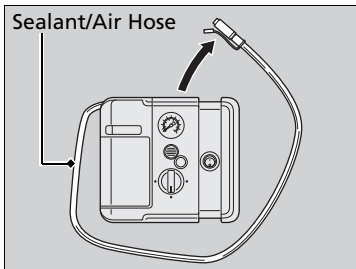

2. Remove the sealant/air hose from the packaging.

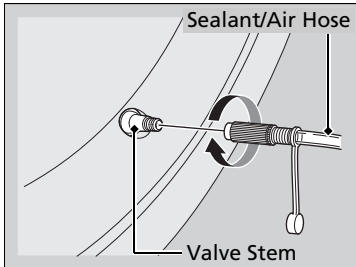

3. Attach the sealant/air hose onto the tire valve stem. Screw it until it is tight.

▶▶ Injecting Sealant and Air

⚠ WARNING

Tire sealant contains substances that are harmful and can be fatal if swallowed.

If accidentally swallowed, do not induce vomiting. Drink plenty of water and get medical attention immediately.

For skin or eye contact, flush with cool water and get medical attention if necessary.

In cold temperatures, the sealant may not flow easily. In this situation, warm it up for five minutes before using.

The sealant can permanently stain clothing and other materials. Be careful during handling and wipe away any spills immediately.

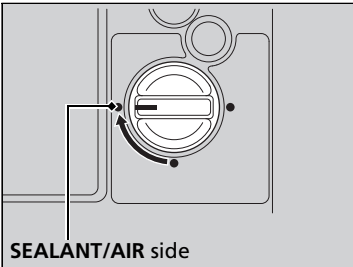
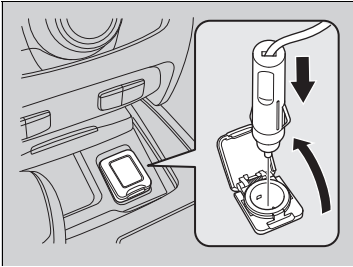

4. Plug in the compressor to the accessory power socket.

- Be careful not to pinch the cord in a door or window.
- Do not plug any other electronic devices into other accessory power sockets.

► **Accessory Power Sockets** P. 171

5. Start the engine.

- Keep the engine running while injecting sealant and air.

► **Carbon Monoxide Gas** P. 64

6. Turn the selector switch to **SEALANT/AIR**.

► Injecting Sealant and Air

⚠ WARNING

Running the engine with the vehicle in an enclosed or even partly enclosed area can cause a rapid build-up of toxic carbon monoxide.

Breathing this colorless, odorless gas can cause unconsciousness and even death. Only run the engine to power the air compressor with the vehicle outdoors.

NOTICE

Do not operate the temporary tire repair kit compressor for more than 15 minutes. The compressor can overheat and become permanently damaged.

Until the sealant injection is complete, the pressure shown on the pressure gauge will appear higher than actual. After the sealant injection is complete the pressure will drop and then begin to rise again as the tire is inflated with air. This is normal. To accurately measure the air pressure using the gauge, turn the air compressor off only after the sealant injection is complete.

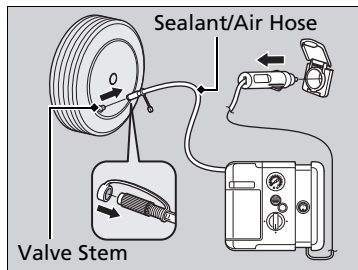
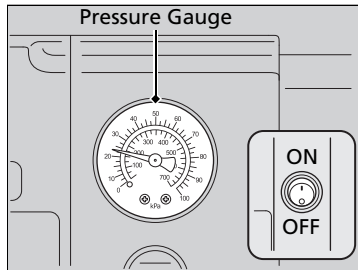

7. Press the inflator switch to turn on the compressor.
 - ▶ The compressor starts injecting sealant and air into the tire.
8. When the sealant injection is complete, continue to add air.
9. After the air pressure reaches front:35 psi (240 kPa)/rear:33 psi (230 kPa), turn off the kit.
 - ▶ To check the pressure, occasionally turn off the compressor and read the gauge.
10. Unplug the power plug from the accessory power socket.
11. Unscrew the sealant/air hose from the tire valve stem. Reinstall the valve cap.
12. Press the pressure relief button until the gauge returns to 0 psi (0 kPa).

▶▶ Injecting Sealant and Air

If the required air pressure is not reached within 15 minutes, the tire may be too severely damaged for the kit to provide the necessary seal and your vehicle will need to be towed.

See an Acura dealer for a replacement sealant bottle and proper disposal of an empty bottle.

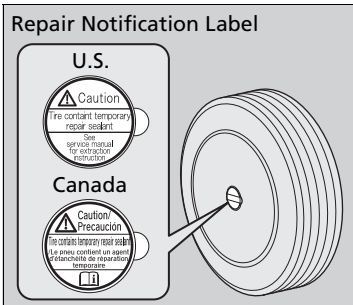

13. Apply the repair notification label to the flat surface of the wheel.
 - The wheel surface must be clean to ensure the label adheres properly.

■ Distributing the Sealant in the Tire

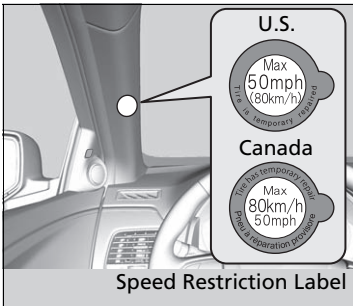

1. Apply the speed restriction label to the location as shown.
2. Drive the vehicle for about 10 minutes.
 - Do not exceed 50 mph (80 km/h).
3. Stop the vehicle in a safe place.

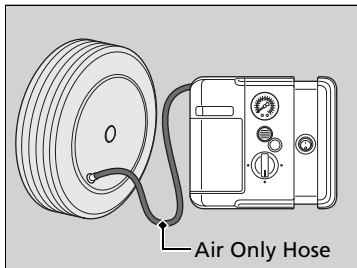

4. Recheck the air pressure using the air only hose on the compressor.
5. Turn the selector switch to **AIR ONLY**.
 - ▶ Do not turn the air compressor on to check the pressure.
 - ❑ **Inflating an Under-inflated Tire** P. 500
6. If the air pressure is
 - Less than 19 psi (130 kPa):
Do not add air or continue driving. The leak is too severe. Call for help and have your vehicle towed.
 - ❑ **Emergency Towing** P. 527
 - Front:35 psi (240 kPa)/rear:33 psi (230 kPa) or more:
Continue driving for another 10 minutes or until you reach the nearest service station. Do not exceed 50 mph (80 km/h).
 - ▶ If the air pressure does not go down after the 10 minute driving, you do not need to check the pressure any more.

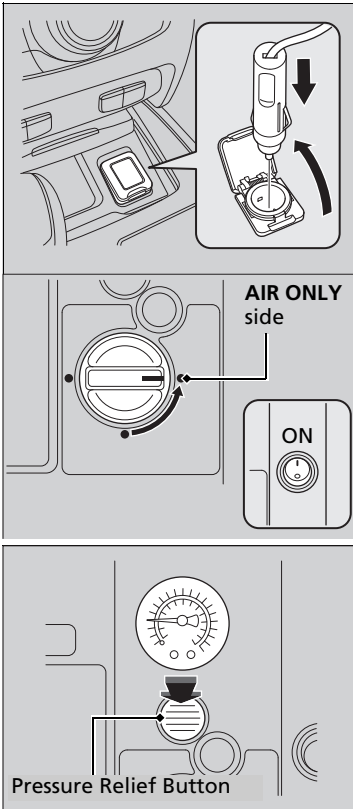

- Greater than 19 psi (130 kPa), but less than front:35 psi (240 kPa)/rear:33 psi (230 kPa):

Turn the air compressor on to inflate the tire until the tire pressure reaches front:35 psi (240 kPa)/rear:33 psi (230 kPa).

► **Inflating an Under-inflated Tire** P. 500

Then drive carefully for 10 more minutes or until you reach the nearest service station. Do not exceed 50 mph (80 km/h).

- You should repeat this procedure as long as the air pressure is within this range.

7. Press the pressure relief button until the gauge returns to 0 psi (0 kPa).
8. Repackage and properly stow the kit.

► Distributing the Sealant in the Tire

⚠ WARNING

Running the engine with the vehicle in an enclosed or even partly enclosed area can cause a rapid build-up of toxic carbon monoxide.

Breathing this colorless, odorless gas can cause unconsciousness and even death. Only run the engine to power the air compressor with the vehicle outdoors.

■ Inflating an Under-inflated Tire

You can use the kit to inflate a non-punctured under-inflated tire.

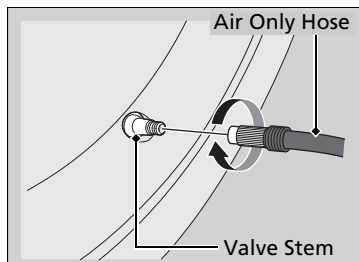
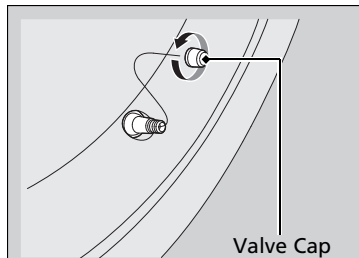
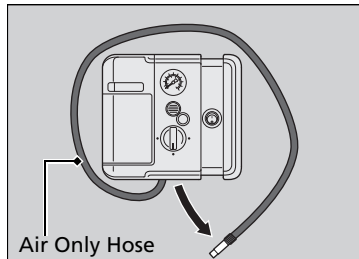

1. Open the trunk floor lid.
 - ❏ **Getting Ready to Temporarily Repair the Flat Tire** P. 492
2. Remove the kit from the case.
3. Place the kit, face up, on flat ground near the flat tire, away from traffic. Do not place the kit on its side.
4. Remove the air only hose from the kit.
5. Remove the valve cap.
6. Attach the air only hose onto the tire valve stem. Screw it until it is tight.

▶▶ Inflating an Under-inflated Tire

NOTICE

Do not operate the temporary tire repair kit compressor for more than 15 minutes. The compressor can overheat and become permanently damaged.

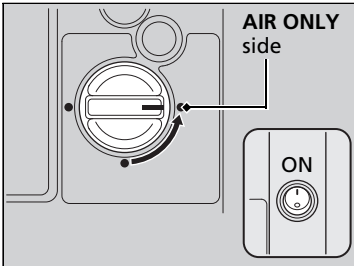
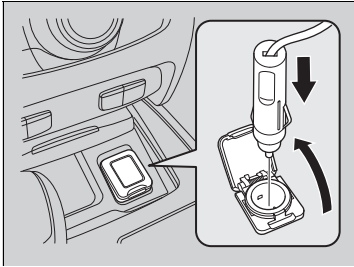

7. Plug in the kit to the accessory power socket.

- ▶ Be careful not to pinch the cord in a door or window.
- ▶ Do not plug any other electronic devices into other accessory power sockets.

➤ **Accessory Power Sockets** P. 171

8. Start the engine.

- ▶ Keep the engine running while injecting air.

➤ **Carbon Monoxide Gas** P. 64

9. Turn the selector switch to **AIR ONLY**.

10. Press the inflator switch to turn on the kit.

- ▶ The compressor starts to inject air into the tire.

11. Inflate the tire to the specified air pressure.

▶▶ Inflating an Under-inflated Tire

⚠ WARNING

Running the engine with the vehicle in an enclosed or even partly enclosed area can cause a rapid build-up of toxic carbon monoxide.

Breathing this colorless, odorless gas can cause unconsciousness and even death. Only run the engine to power the air compressor with the vehicle outdoors.

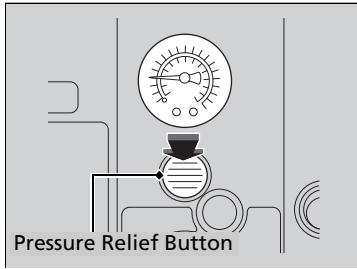

- 12.** Turn off the kit.
 - ▶ Check the pressure gauge on the air compressor.
 - ▶ If overinflated, press the pressure relief button.
- 13.** Unplug the kit from the accessory power socket.
- 14.** Unscrew the air only hose from the tire valve stem. Reinstall the valve cap.
- 15.** Press the pressure relief button until the gauge returns to 0 psi (0 kPa).
- 16.** Repackage and properly stow the kit.

Vehicles with optional spare tire kit

Changing a Flat Tire

If a tire goes flat while driving, grasp the steering wheel firmly, and brake gradually to reduce speed. Then, stop in a safe place. Replace the flat tire with a compact spare tire. Go to a dealer as soon as possible to have the full-size tire repaired or replaced.

1. Park the vehicle on firm, level, and non-slippery surface, and apply the parking brake.
2. Move the shift lever to **P**.
3. Turn on the hazard warning lights and set the power mode to VEHICLE OFF (LOCK).

Changing a Flat Tire

Periodically check the tire pressure of the compact spare. It should be set to the specified pressure.
Specified Pressure: 60 psi (420 kPa, 4.2 kgf/cm²)

When driving with the compact spare tire, keep the vehicle speed under 50 mph (80 km/h). Replace with a full-size tire as soon as possible.

The compact spare tire and wheel in your vehicle are specifically for this model. Do not use them with another vehicle. Do not use another type of compact spare tire or wheel with your vehicle.

Do not mount tire chains on a compact spare tire. If a chain-mounted front tire goes flat, remove one of the full-size rear tires and replace it with the compact spare tire. Remove the flat front tire and replace it with the full-size tire that was removed from the rear. Mount the tire chains on the front tire.

NOTICE

Do not use an unapproved puncture-repairing agent on a flat tire, as it can damage the tire pressure sensor.

■ Getting Ready to Replace the Flat Tire

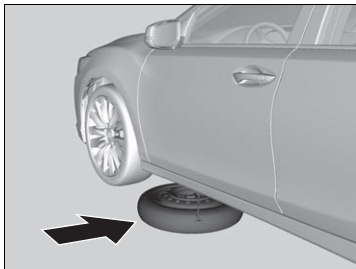
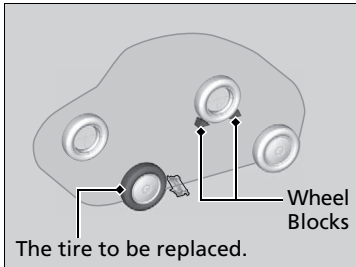
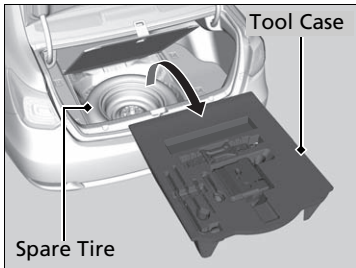

1. Open the trunk floor lid.
 ▶ **Temporarily Repairing a Flat Tire** P. 491
2. Take the tool case out of the trunk. Take the jack and wheel nut wrench out of the tool case.
3. Unscrew the wing bolt, and remove the spacer cone. Then, remove the spare tire.
4. Place a wheel block or rock in front and rear of the wheel diagonal to the flat tire.
5. Place the compact spare tire (wheel side up) under the vehicle body, near the tire that needs to be replaced.

▶▶ Getting Ready to Replace the Flat Tire

The shape of the tool case varies by model.

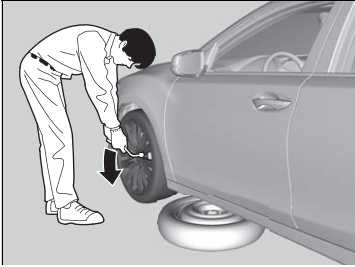

6. Loosen each wheel nut about one turn using the wheel nut wrench.

■ How to Set Up the Jack

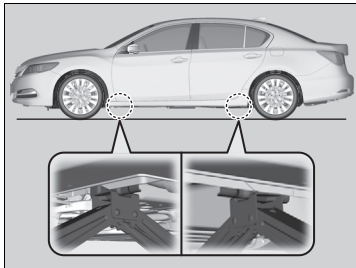

1. Place the jack under the jacking point closest to the tire to be changed.

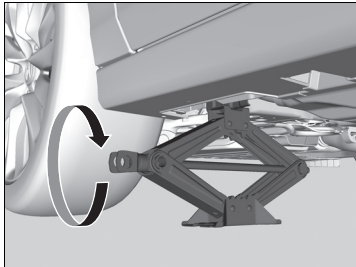

2. Turn the end bracket clockwise as shown in the image until the top of the jack contacts the jacking point.

▶ Make sure that the jacking point tab is resting in the jack notch.

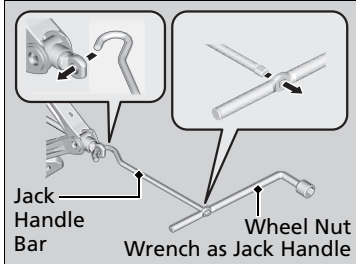

3. Raise the vehicle, using the jack handle bar and the jack handle, until the tire is off the ground.

▣ How to Set Up the Jack

⚠ WARNING

The vehicle can easily roll off the jack, seriously injuring anyone underneath.

Follow the directions for changing a tire exactly, and never get under the vehicle when it is supported only by the jack.

Do not use the jack with people or luggage in the vehicle.

Use the jack provided in your vehicle. Other jacks may not support the weight ("load") or may not fit the jacking point.

The following instructions must be followed to use the jack safely:

- Do not use while the engine is running.
- Use only where the ground is firm and level.
- Use only at the jacking points.
- Do not get in the vehicle while using the jack.
- Do not put anything on top of or underneath the jack.

Replacing the Flat Tire

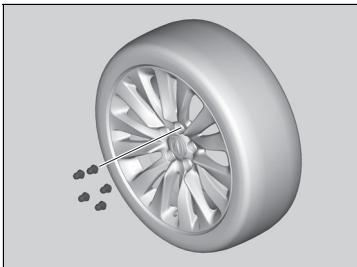

1. Remove the wheel nuts and flat tire.

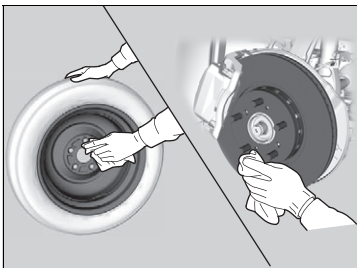

2. Wipe the mounting surfaces of the wheel with a clean cloth.

3. Mount the compact spare tire.

4. Screw the wheel nuts until they touch the lips around the mounting holes, then stop rotating.

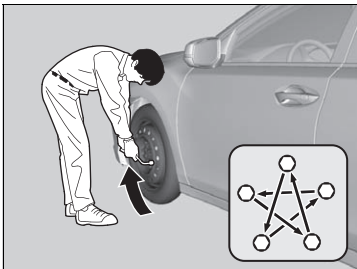

5. Lower the vehicle and remove the jack. Tighten the wheel nuts in the order indicated in the image. Go around, tightening the nuts, two to three times in this order.

Wheel nut torque:

94 lbf-ft (127 N-m, 13 kgf-m)

Replacing the Flat Tire

Do not over tighten the wheel nuts by applying extra torque using your foot or a pipe.

■ Storing the Flat Tire

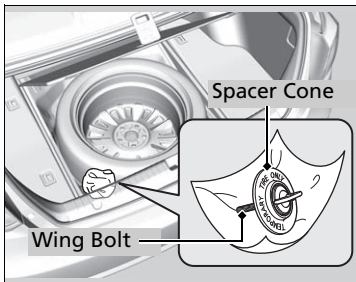

1. Place the flat tire face down in the spare tire well.
2. Wrap the spacer cone and spare tire wing bolt with cloth or paper, and store them in the spare tire well.
3. Store the jack and tools in the tool case. Place the tool case and the trunk floor lid on the flat tire.
4. Close the trunk.

■ TPMS and the Spare Tire

If you replace a flat tire with the spare tire, the low tire pressure/TPMS indicator comes on while you are driving. After driving for a few miles (kilometers), the indicator will start blinking for a short time and then stay on. **Tire Pressure Monitor Problem** appears on the multi-information display, but this is normal.

If you replace the tire with a full-size tire, the warning message on the multi-information display and the low tire pressure/TPMS indicator will go off after a few miles (kilometers).

▶▶ Storing the Flat Tire

⚠ WARNING

Loose items can fly around the interior in a crash and can seriously injure the occupants.

Store the wheel, jack, and tools securely before driving.

▶▶ TPMS and the Spare Tire

The system cannot monitor the pressure of the spare tire. Manually check the spare tire pressure to be sure that it is correct.

Use the TPMS specific wheels. Each is equipped with a tire pressure sensor mounted inside the tire behind the valve stem.

Checking the Engine

If the engine does not start, check the starter.

☒ Checking the Engine

If you must start the vehicle immediately, use an assisting vehicle to jump start it.

☒ **Jump Starting** P. 512

Starter condition	Checklist
<p>Starter doesn't turn or turns over slowly. The battery may be dead. Check each of the items on the right and respond accordingly.</p>	<p>Check for a message on the multi-information display.</p> <ul style="list-style-type: none">• If the To Start, Hold Remote Near Start Button message appears<ul style="list-style-type: none">☒ If the Keyless Access Remote Battery is Weak P. 510▶ Make sure the keyless access remote is in its operating range.<ul style="list-style-type: none">☒ ENGINE START/STOP Button Operating Range P. 137
<p>The starter turns over normally but the engine doesn't start. There may be a problem with the fuse. Check each of the items on the right and respond accordingly.</p>	<p>Check the brightness of the interior lights. Turn on the interior lights and check the brightness.</p> <ul style="list-style-type: none">• If the interior lights are dim or do not come on at all<ul style="list-style-type: none">☒ Battery P. 480• If the interior lights come on normally ☒ Fuses P. 522
<p>The starter turns over normally but the engine doesn't start. There may be a problem with the fuse. Check each of the items on the right and respond accordingly.</p>	<p>Review the engine start procedure. Follow its instructions, and try to start the engine again. ☒ Starting the Engine P. 344</p> <p>Check the immobilizer system indicator. When the immobilizer system indicator is blinking, the engine cannot be started. ☒ Immobilizer System P. 131</p>
	<p>Check the fuel level. There should be enough fuel in the tank. ☒ Fuel Gauge P. 97</p>
	<p>Check the fuse. Check all fuses, or have the vehicle checked by a dealer. ☒ Inspecting and Changing Fuses P. 526</p>
	<p>If the problem continues: ☒ Emergency Towing P. 527</p>

If the Keyless Access Remote Battery is Weak

If the beeper sounds, the **To Start, Hold Remote Near Start Button** message appears on the multi-information display, the indicator on the **ENGINE START/STOP** button flashes, and the engine won't start. Start the engine as follows.

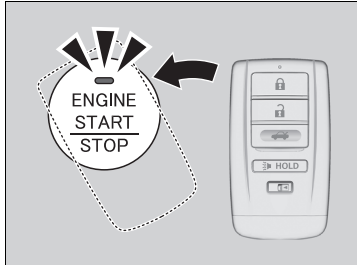

1. Touch the center of the **ENGINE START/STOP** button with the **A** logo on the keyless access remote while the indicator on the **ENGINE START/STOP** button is flashing. The buttons on the keyless access remote should be facing you.
 - ▶ The indicator flashes for about 30 seconds.

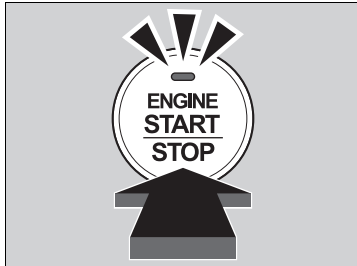

2. Depress the brake pedal and press the **ENGINE START/STOP** button within 10 seconds after the beeper sounds while the indicator stays on.
 - ▶ If you do not depress the pedal, the mode will change to ACCESSORY.

Emergency Engine Stop

The **ENGINE START/STOP** button may be used to stop the engine due to an emergency situation even while driving. If you must stop the engine, do either of the following operations:

- Press and hold the **ENGINE START/STOP** button for about two seconds.
- Firmly press the **ENGINE START/STOP** button twice.

The steering wheel will not lock. However, because turning off the engine disables the power assist the engine provides to the steering and braking systems, it will require significantly more physical effort and time to steer and slow the vehicle. Use both feet on the brake pedal to slow down the vehicle and stop immediately in a safe place.

The power mode is in ACCESSORY when the engine is stopped.

To change the mode to VEHICLE OFF, move the shift lever to **P** after the vehicle comes to a complete stop.

Emergency Engine Stop

Do not press the button while driving unless it is absolutely necessary for the engine to be switched off.

Jump Starting Procedure

Turn off the power to electric devices, such as audio and lights. Turn off the engine, then open the hood.

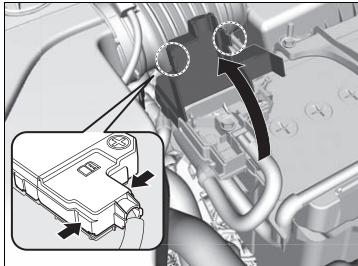

1. Open the fuse box cover on the positive (+) terminal.

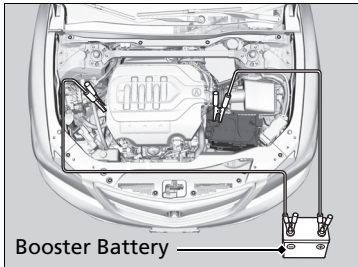

2. Connect the first jumper cable to your vehicle's battery (+) terminal.
3. Connect the other end of the first jumper cable to the booster battery (+) terminal.
 - ▶ If you use a booster battery, only use a 12-volt booster battery.
 - ▶ When using an automotive battery charger, select a charging voltage lower than 15-volts. Check the charger manual for the proper setting.
4. Connect the second jumper cable to the booster battery (-) terminal.

Jump Starting

⚠ WARNING

A battery can explode if you do not follow the correct procedure, seriously injuring anyone nearby.

Keep all sparks, open flames, and smoking materials away from the battery.

Securely attach the jumper cable clips so that they do not come off when the engine vibrates. Also be careful not to tangle the jumper cables or allow the cable ends to touch each other while attaching or detaching the jumper cables.

Battery performance degrades in cold conditions and may prevent the engine from starting.

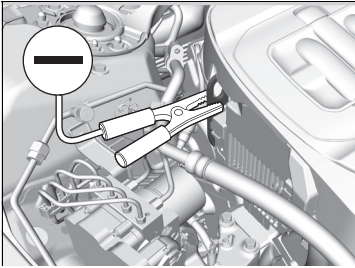

5. Connect the other end of the second jumper cable to the engine hanger as shown. Do not connect this jumper cable to any other part.
6. If your vehicle is connected to another vehicle, start the assisting vehicle's engine and increase its rpm slightly.
7. Attempt to start your vehicle's engine. If it turns over slowly, check that the jumper cables have good metal-to-metal contact.

■ What to Do After the Engine Starts

Once your vehicle's engine has started, remove the jumper cables in the following order.

1. Disconnect the jumper cable from your vehicle's ground.
2. Disconnect the other end of the jumper cable from the booster battery ⊖ terminal.
3. Disconnect the jumper cable from your vehicle's battery ⊕ terminal.
4. Disconnect the other end of the jumper cable from the booster battery ⊕ terminal.

Have your vehicle inspected by a nearby service station or a dealer.

Shift Lever Does Not Move

Follow the procedure below if you cannot move the shift lever out of the **P** position.

Releasing the Lock

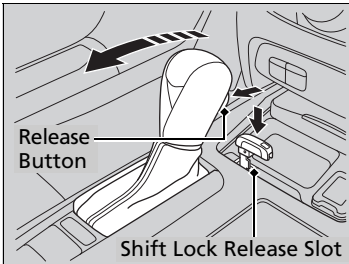
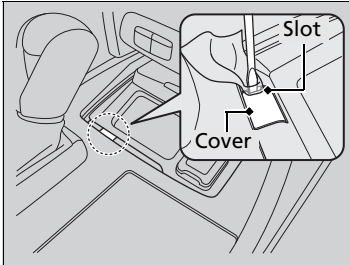

1. Set the parking brake.
2. Remove the built-in key from the keyless access remote.
3. Open the lid of the center pocket.
4. Wrap a cloth around the tip of a small flat-tip screwdriver. Put it into the shift lock release slot as shown in the image, and remove the cover.
5. Insert the key into the shift lock release slot.
6. While pushing the key down, press the shift lever release button and place the shift lever into **N**.
 - ▶ The lock is now released. Have the shift lever checked by a dealer as soon as possible.

How to Handle Overheating

Overheating symptoms are as follows:

- The temperature gauge needle is at the **H** mark or the engine suddenly loses power.
- Steam or spray comes out of the engine compartment.

■ First thing to do

1. Immediately park the vehicle in a safe place.
2. Turn off all accessories and turn on the hazard warning lights.
 - ▶ **No steam or spray present:** Keep the engine running and open the hood.
 - ▶ **Steam or spray is present:** Turn off the engine and wait until it subsides. Then open the hood.

▣ How to Handle Overheating

WARNING

Steam and spray from an overheated engine can seriously scald you.

Do not open the hood if steam is coming out.

NOTICE

Continuing to drive with the temperature gauge needle at the **H** mark may damage the engine.

■ Next thing to do

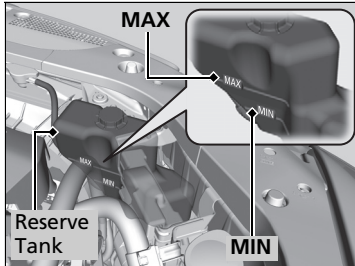

1. Check that the cooling fan is operating and stop the engine once the temperature gauge needle comes down.
 - If the cooling fan is not operating, immediately stop the engine.
2. Once the engine has cooled down, inspect the coolant level and check the cooling system components for leaks.
 - If the coolant level in the reserve tank is low, add coolant until it reaches the **MAX** mark.
 - If there is no coolant in the reserve tank, check that the radiator is cool. Cover the radiator cap with a heavy cloth and open the cap. If necessary, add coolant up to the base of the filler neck, and put the cap back on.

■ Last thing to do

Once the engine has cooled sufficiently, restart it and check the temperature gauge. If the temperature gauge needle has gone down, resume driving. If it has not gone down, contact a dealer for repairs.

►► How to Handle Overheating

⚠ WARNING

Removing the radiator cap while the engine is hot can cause the coolant to spray out, seriously scalding you.

Always let the engine and radiator cool down before removing the radiator cap.

If the coolant is leaking, contact a dealer for repairs.

Use water as an emergency/temporary measure only. Have a dealer flush the system with proper antifreeze as soon as possible.

If the Low Oil Pressure Indicator Comes On



■ Reasons for the indicator to come on

Comes on when the engine oil pressure is low.

■ What to do as soon as the indicator comes on

1. Immediately park the vehicle on level ground in a safe place.
2. If necessary, turn the hazard warning lights on.

■ What to do after parking the vehicle

1. Stop the engine and let it sit for about three minutes.
2. Open the hood and check the oil level.
 - **Oil Check** P. 454
3. Start the engine and check the low oil pressure indicator.
 - ▶ The indicator goes off: Start driving again.
 - ▶ The indicator does not go off within 10 seconds: Stop the engine and contact a dealer for repairs immediately.

If the Charging System Indicator Comes On



■ Reasons for the indicator to come on

Comes on when the battery is not being charged.

■ What to do when the indicator comes on

Turn off the climate control system, rear defogger, and other electrical systems, and immediately contact a dealer for repairs.

☒ If the Low Oil Pressure Indicator Comes On

NOTICE

Running the engine with low oil pressure can cause serious mechanical damage almost immediately.

☒ If the Charging System Indicator Comes On

If you need to stop temporarily, do not turn off the engine. Restarting the engine may rapidly discharge the battery.

If the Malfunction Indicator Lamp Comes On or Blinks



■ Reasons for the indicator lamp to come on or blink

- Comes on if there is a problem with the engine emissions control system.
- Blinks when engine misfiring is detected.

■ What to do when the indicator lamp comes on

Avoid high speeds and immediately get your vehicle inspected at a dealer.

■ What to do when the indicator lamp blinks

Park the vehicle in a safe place with no flammable items and wait at least 10 minutes or more with the engine stopped until it cools.

If the Brake System Indicator (Red) Comes On

U.S.



Canada



■ Reasons for the indicator to come on

- The brake fluid is low.
- There is a malfunction in the brake system.

■ What to do when the indicator comes on while driving

Depress the brake pedal lightly to check pedal pressure.

- If normal, check the brake fluid level the next time you stop.
- If abnormal, take immediate action. If necessary, downshift the transmission to slow the vehicle using engine braking.

▶▶ If the Malfunction Indicator Lamp Comes On or Blinks

NOTICE

If you drive with the malfunction indicator lamp on, the emissions control system and the engine could be damaged.

If the malfunction indicator lamp blinks again when restarting the engine, drive to the nearest dealer at 31 mph (50 km/h) or less. Have your vehicle inspected.

▶▶ If the Brake System Indicator (Red) Comes On

Have your vehicle repaired immediately.

It is dangerous to drive with low brake fluid. If there is no resistance from the brake pedal, stop immediately in a safe place. If necessary, downshift the gears.

If the brake system indicator and **ABS** indicator come on simultaneously, the electronic brake distribution system is not working. This can result in vehicle instability under sudden braking.

Have your vehicle inspected by a dealer immediately.

If the Electric Power Steering (EPS) System Indicator Comes On



■ Reasons for the indicator to come on

- Comes on if there is a problem with the EPS system.
- If you depress the accelerator pedal repeatedly to increase the engine speed while the engine is idling, the indicator comes on, and sometimes the steering wheel becomes harder to operate.

■ What to do when the indicator comes on

Stop the vehicle in a safe place and restart the engine.

If the indicator comes on and stays on, immediately have your vehicle inspected by a dealer.

If the Electric Parking Brake System Indicator Comes On



■ Reasons for the indicator to come on

Comes on when there is a problem with the electric parking brake system.

■ What to do when the indicator comes on

Avoid using the parking brake and immediately get your vehicle inspected at a dealer.

■ What to do when the electric parking brake indicator comes on or blinks at the same time.

- Release the parking brake. If you cannot release it, immediately stop the vehicle in a safe place and call a dealer.
- If only the electric parking brake indicator goes off, immediately get your vehicle inspected at a dealer.
- If the electric parking brake indicator remains on or blinks even after releasing the parking brake, immediately stop the vehicle in a safe place and call a dealer.

If the Low Tire Pressure/TPMS Indicator Comes On or Blinks



■ Reasons for the indicator to come on or blink

A tire pressure is significantly low. If there is a problem with the TPMS or the compact spare tire* is installed, the indicator blinks for about one minute, and then stays on.

■ What to do when the indicator comes on

Stop your vehicle in a safe place. Check the tire pressure and adjust the pressure to the specified level. The specified tire pressure is on a label on the driver's side doorjamb.

■ What to do when the indicator blinks

Have the tire inspected by a dealer as soon as possible. If the compact spare tire* causes the indicator to blink, change the tire to a full-size tire. The indicator goes off after driving for a few miles (kilometers).

▶▶ If the Low Tire Pressure/TPMS Indicator Comes On or Blinks

NOTICE

Driving on an extremely underinflated tire can cause it to overheat. An overheated tire can fail. Always inflate your tires to the prescribed level.

* Not available on all models

Fuse Locations

If any electrical devices are not working, set the power mode to VEHICLE OFF (LOCK) and check to see if any applicable fuse is blown.

Engine Compartment Fuse Box

There are three fuse boxes in the engine compartment.

Fuse locations are shown on the fuse box cover. Locate the fuse in question by the fuse number and box cover number.

Located near the brake fluid reservoir. Push the tabs to open the box.

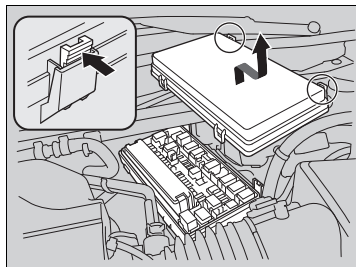

■ Circuit protected and fuse rating

	Circuit Protected	Amps
1	IG1A ACG FR	15 A
2	IG1A MISS SOL1	10 A
3	–	–
4	–	–
5	SMART	(7.5 A)
6	IG1B ECU FR	7.5 A
7	IG1B OP FR	7.5 A
8	IGP2	15 A
9	DBW	15 A
10	IGP	15 A
11	IG Coil	15 A
12	ACM	20 A
13	–	–
14	Interior Lights	10 A

	Circuit Protected	Amps
15	Back Up Radio	10 A
16	Back Up	10 A
17	MG Clutch	7.5 A
18	Front Washer	15 A
19	Stop	7.5 A
20	Right Headlight High Beam	10 A
21	Trunk	10 A
22	Small	15 A
23	–	–
24	Left Headlight High Beam	10 A
25	–	–
26	Right Headlight Low Beam	15 A
27	Left Headlight Low Beam	15 A
28	IGP2 Sub	7.5 A
29	Power Rear Sunshade*	(20 A)
30	Headlight Washer*	30 A
31	Wiper	30 A

Located near the battery. Push the tabs to open the box.

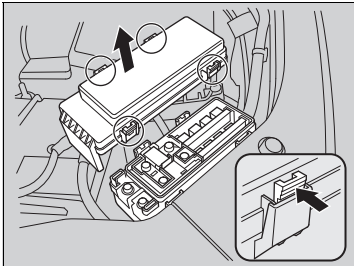

■ Circuit protected and fuse rating

	Circuit Protected	Amps
1	Main Fuse	150 A
	Horn & Hazard	30 A
	R/B Main 2	60 A
	ABS/VSA RLY	30 A
2	RFC	50 A
	R/B Main 3	50 A
	AS F/B Main 2	60 A
	ABS/VSA Motor	40 A
	Heater Motor	40 A

	Circuit Protected	Amps
3	R/B Main 1	60 A
	DR F/B Main 1	60 A
	AS F/B Main 1	60 A
	IG Main 1	30 A
	DR F/B Main 2	60 A
	IG Main 2	30 A
	Left Precision All Wheel Steer	40 A
4	Rear Defroster	40 A
	ST MG	30 A
5	Left Electric Parking Brake	30 A
6	Right Electric Parking Brake	30 A
7	Injector	20 A
8	Hazard	15 A
9	–	–
10	–	–
11	Horn	10 A

Located near the ⊕ terminal on the battery. Push the tabs to open the box.

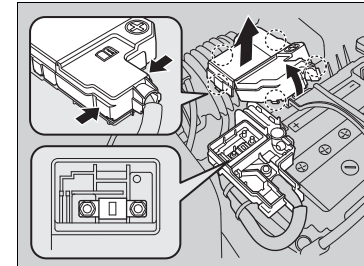

■ Circuit protected and fuse rating

	Circuit Protected	Amps
	EPS	80 A

■ Driver's Side Interior Fuse Box

Located under the dashboard.

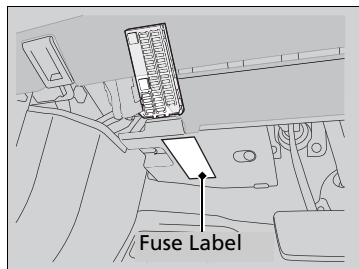

Fuse locations are shown on the label on the under panel.

Locate the fuse in question by the fuse number and label number.

■ Circuit protected and fuse rating

	Circuit Protected	Amps
1	Driver's Side Door Lock	10 A
2	Passenger's Side Door Lock	10 A
3	Driver's Door Lock	10 A
4	Driver's Side Door Unlock	10 A
5	Passenger's Side Door Unlock	10 A
6	Driver's Door Unlock	10 A
7	Door Lock	20 A
8	–	–
9	Tilt Steering Wheel	20 A
10	IG1 DR1	7.5 A
11	Meter	10 A
12	IG1 Box	20 A
13	ACCESSORY	7.5 A
14	–	–
15	Driver's Power Seat Sliding	20 A
16	Moonroof	20 A
17	Rear Driver's Side Power Window	20 A
18	Telescopic Steering Wheel	20 A
19	Driver's Power Window	20 A
20	Left e-pretensioner*	(20 A)
21	Fuel Pump	20 A
22	–	–
23	ST Cut	7.5 A
24	IG1 DR2	7.5 A

	Circuit Protected	Amps
25	Start DIAG	7.5 A
26	A/C	7.5 A
27	DRL	7.5 A
28	ACC Key Lock	7.5 A
29	Driver's Lumbar Support	7.5 A
30	SMART	10 A
31	–	–
32	Driver's Power Seat Reclining	20 A
33	Right Precision All Wheel Steer	40 A
34	IG1 Box	30 A

■ Passenger's Side Interior Fuse Box

Located on the lower side panel. Take off the cover to open.

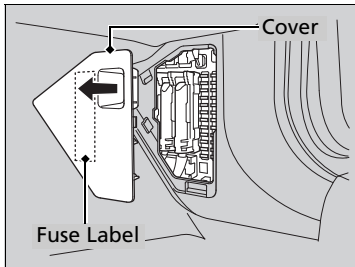

Fuse locations are shown on the cover.

■ Circuit protected and fuse rating

	Circuit Protected	Amps
1	–	–
2	Front Seat Heaters/AVS	20 A
3	Rear Passenger's Side Power Window	20 A
4	Front Passenger's Lumbar Support	7.5 A
5	–	–
6	–	–
7	Passenger's Power Seat Sliding	20 A
8	Passenger's Power Seat Reclining	20 A
9	Rear Seat Heaters*	(20 A)
10	–	–
11	Fly Start	15 A
12	Accessory Power Socket (Console Compartment)	20 A
13	Accessory Power Socket (Center Pocket)	20 A
14	AS ECU	7.5 A
15	Glove Box	7.5 A
16	–	–
17	–	–
18	Front Passenger's Power Window	20 A
19	SRS1	10 A

	Circuit Protected	Amps
20	ABS/VSA	7.5 A
21	–	–
22	e-pretensioner*	(7.5 A)
23	–	–
24	SRS2	7.5 A
25	Illumination	7.5 A
26	Right e-pretensioner*	(20 A)
27	Heated Steering Wheel*	10 A
28	Audio AMP	30 A ^{*1} 40 A ^{*2}

*1: Models without surround view camera system

*2: Models with surround view camera system

* Not available on all models

Inspecting and Changing Fuses

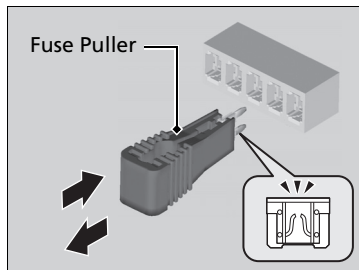
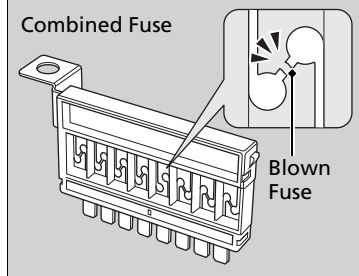
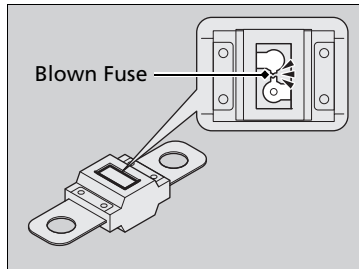

1. Set the power mode to VEHICLE OFF (LOCK). Turn headlights and all accessories off.
2. Remove the fuse box cover.
3. Check the large fuse in the engine compartment.
 - If the fuse is blown, use a Phillips-head screwdriver to remove the screw and replace it with a new one.
4. Inspect the small fuses in the engine compartment and the vehicle interior.
 - If there is a burned out fuse, remove it with the fuse puller and replace it with a new one.

Inspecting and Changing Fuses

NOTICE

Replacing a fuse with one that has a higher rating greatly increases the chances of damaging the electrical system.

Replace fuse with a spare fuse of the same specified amperage.

Confirm the specified amperage using the charts on P. 522 to 525.

There is a fuse puller in the engine compartment fuse box located near the brake fluid reservoir.

Call a professional towing service if you need to tow your vehicle.

■ Flat bed equipment

The operator loads your vehicle on the back of a truck.

This is the only way you can safely transport your vehicle.

Any other towing method will damage the vehicle's drive system.

» Emergency Towing

NOTICE

Trying to lift or tow your vehicle by the bumpers will cause serious damage. The bumpers are not designed to support the vehicle's weight.

NOTICE

Improper towing such as towing behind a motorhome or other motor vehicle can damage the transmission.

Never tow your vehicle with just a rope or chain. It is very dangerous since ropes or chains may shift from side to side or break.

When You Cannot Unlock the Fuel Fill Door

If you cannot unlock the fuel fill door, use the following procedure.

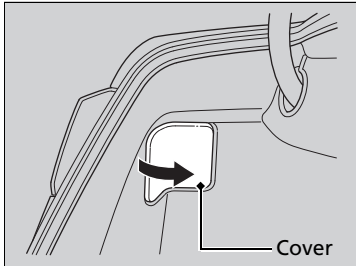

1. Open the trunk and remove the cover.

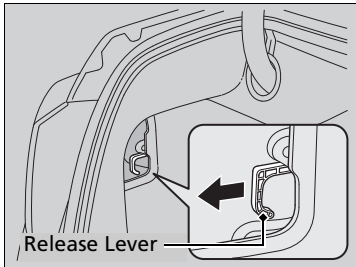

2. Pull the release lever toward you.
 - ▶ The release lever unlocks the fuel fill door when it is pulled.

When You Cannot Unlock the Fuel Fill Door

After taking these steps, contact a dealer to have your vehicle checked.

When You Cannot Open the Trunk

If you cannot open the trunk, use the following procedure.

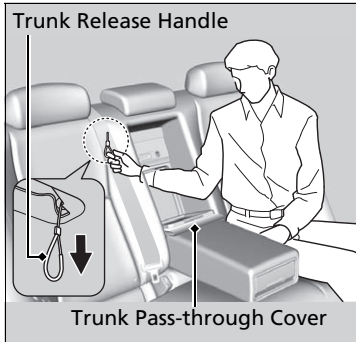

1. Open the trunk pass-through cover.
 ➤ **Trunk Pass-through Cover** P. 174
2. Pull the trunk release handle down.

When You Cannot Open the Trunk

What to do following up
After taking these steps, contact a dealer to have your vehicle checked.

Refueling From a Portable Fuel Container

If you have run out of fuel and need to refuel your vehicle from a portable fuel container, use the funnel provided with your vehicle.

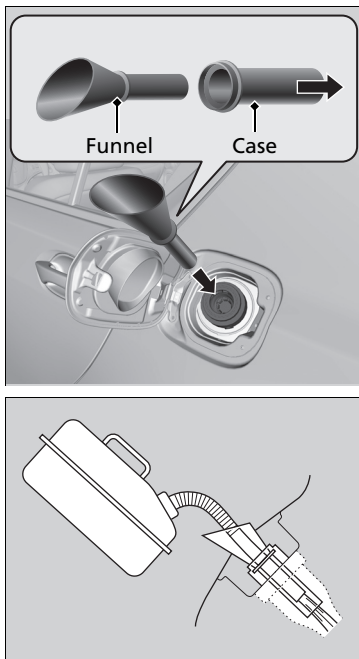

1. Turn off the engine.
2. Press the fuel fill door release button.
 - ▶ The fuel fill door opens.
3. Take the funnel out of the tool case in the trunk.
 - ▶ **Types of Tools** P. 490
4. Remove the **funnel from the case**.
5. Place the end of the funnel on the lower part of filler opening, then insert it slowly and fully.
 - ▶ Make sure that the end of the funnel goes down along with the filler pipe.
6. Fill the tank with fuel from the portable fuel container.
 - ▶ Pour fuel carefully so you do not spill any.
7. Remove the funnel from the filler neck.
 - ▶ Wipe up any fuel from the funnel before storing it.
8. Shut the fuel fill door by hand.

▶▶ Refueling From a Portable Fuel Container

⚠ WARNING

Gasoline is highly flammable and explosive. You can be burned or seriously injured when handling fuel.

- Stop the engine, and keep heat, sparks, and flame away.
- Handle fuel only outdoors.
- Wipe up spills immediately.

NOTICE

Do not insert the nozzle of a portable fuel container or any funnel other than the one provided with your vehicle. Doing so can damage the fuel system. Do not try to pry open or push open the sealed fuel tank with foreign objects. This can damage the fuel system and its seal.

Make sure the fuel in the portable fuel container is gasoline before you refuel.

Information

This chapter includes your vehicle's specifications, locations of identification numbers, and other information required by regulation.

Specifications	532
Identification Numbers	
Vehicle Identification Number (VIN), Engine Number, and Transmission Number ...	534
Devices that Emit Radio Waves	535
Reporting Safety Defects	536
Emissions Testing	
Testing of Readiness Codes.....	537
Warranty Coverages	539
Authorized Manuals	541
Client Service Information	542

■ Vehicle Specifications

Model	Acura RLX
No. of Passengers:	
Front	2
Rear	3
Total	5
Weights:	
Gross Vehicle Weight	U.S.: 4,993 lbs (2,265 kg)
Rating	Canada: 2,265 kg
Gross Axle Weight	U.S.: 2,778 lbs (1,260 kg)
Rating (Front)	Canada: 1,260 kg
Gross Axle Weight	U.S.: 2,271 lbs (1,030 kg)
Rating (Rear)	Canada: 1,030 kg

■ Air Conditioning

Refrigerant Type	HFC-134a (R-134a)
Charge Quantity	16.0 - 17.8 oz (455 - 505 g)
Lubricant Type	ND-OIL 8
Quantity	7.8 - 8.7 cu-in (127.5 - 142.5 cm ³)

■ Engine Specifications

Displacement	212 cu-in (3,471 cm ³)
Spark Plugs	NGK DILZKR7B11G

■ Fuel

Type	Unleaded premium gasoline, Pump octane number of 91 or higher
Fuel Tank Capacity	18.5 US gal (70 ℓ)

■ Washer Fluid

Tank Capacity	U.S.: 2.6 US qt (2.5 ℓ) Canada: 5.3 US qt (5.0 ℓ)
---------------	--

■ Light Bulbs

Headlights (Low Beam)	LED
Headlights (High Beam)	LED
Front Turn Signal/Parking Lights	27/8W (Amber)
Front Side Marker Lights	2CP
Side Turn Signal Lights (on Door Mirrors)	LED
Brake/Taillights/Rear Side Marker Lights	LED
Taillights	LED
Back-Up Lights	16W
Rear Turn Signal Lights	21W
High-Mount Brake Light	LED
Rear License Plate Lights	LED
Door Outer Handle Ambient Lights	LED
Interior Lights	
Front and Rear Map Lights	LED
Front and Rear Ambient Lights	LED
Vanity Mirror Lights	2.1W
Front Door Pocket Lights	LED
Center Pocket Light	LED
Beverage Holder Light	LED
Door Courtesy Lights	3.4W
Console Compartment Light	LED
Glove Box Light	LED
Front and Rear*1 Foot Lights	LED
Door Inner Handle Lights	LED
Trunk Light	5W

*1: Not available on all models

■ Brake Fluid

Specified	Acura Heavy Duty Brake Fluid DOT 3
-----------	------------------------------------

■ Automatic Transmission Fluid

Specified	Acura Automatic Transmission Fluid ATF DW-1	
Capacity	Change	3.3 US qt (3.1 ℓ)

■ Engine Oil

Recommended	-Genuine Acura Motor Oil 0W-20	
	-API Premium-grade 0W-20 detergent oil	
Capacity	Change	4.2 US qt (4.0 ℓ)
	Change including filter	4.5 US qt (4.3 ℓ)

■ Engine Coolant

Specified	Acura Long-Life Antifreeze/Coolant Type2	
Ratio	50/50 with distilled water	
Capacity	2.1 US gal (8.0 ℓ)	
	(change including the remaining 0.225 US gal (0.85 ℓ) in the reserve tank)	

■ Tire

Regular	Size	245/40R19 98W	
	Pressure psi (kPa [kgf/cm ²])	Front	35 (240 [2.4])
Rear		33 (230 [2.3])	
Compact Spare ^{*1}	Size	T155/70D17 110M	
	Pressure psi (kPa [kgf/cm ²])	60 (420 [4.2])	
Wheel Size		Regular	19 x 8J
	Compact Spare ^{*1}	17 x 4T	

*1: Vehicles with optional spare tire kit

Vehicle Identification Number (VIN), Engine Number, and Transmission Number

Your vehicle has a 17-digit vehicle identification number (VIN) used to register your vehicle for warranty purposes, and for licensing and insuring your vehicle. The locations of your vehicle's VIN, engine number, and transmission number are shown as follows.

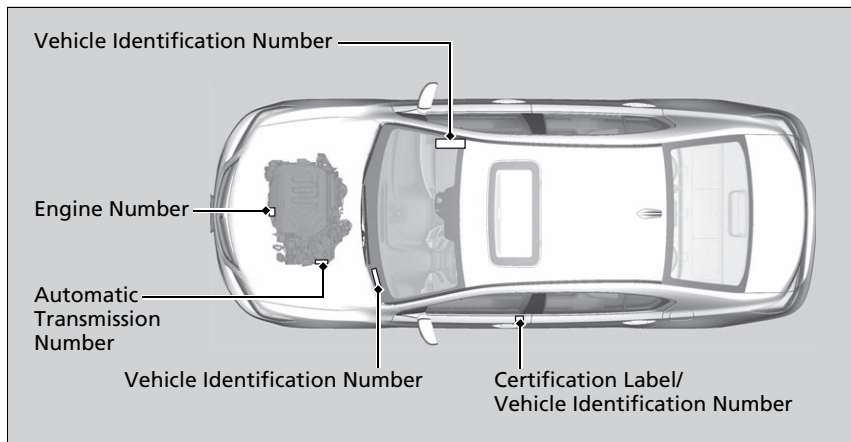

Vehicle Identification Number (VIN), Engine Number, and Transmission Number

The interior vehicle identification number (VIN) is located under the cover.

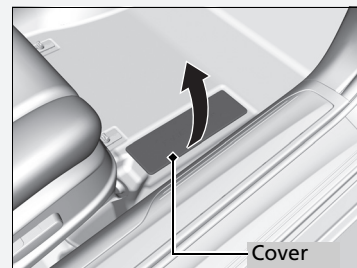

Devices that Emit Radio Waves

The following products and systems on your vehicle emit radio waves when in operation.

AcuraLink

Audio System

Blind Spot Information System

Bluetooth® Audio

Bluetooth® HandsFreeLink®

Collision Mitigation Braking System™

HomeLink® Universal Transceiver

Immobilizer System

Keyless Access System

Tire Pressure Monitoring System (TPMS)

Remote Engine Start with Vehicle Feedback

Each of the above complies with the appropriate requirements or the required standards of FCC (Federal Communications Commission) and Industry Canada Standard, described below:

As required by the FCC:

This device complies with Part 15 of the FCC rules. Operation is subject to the following two conditions: (1) This device may not cause harmful interference, and (2) this device must accept any interference received, including interference that may cause undesired operation.

Changes or modifications not expressly approved by the party responsible for compliance could void the user's authority to operate the equipment.

This device complies with industry Canada licence-exempt RSS standard(s). Operation is subject to the following two conditions: (1) this device may not cause interference, and (2) this device must accept any interference, including interference that may cause undesired operation of the device.

In the U.S.

If you believe that your vehicle has a defect which could cause a crash or could cause injury or death, you should immediately inform the National Highway Traffic Safety Administration (NHTSA) in addition to notifying American Honda Motor Co., Inc.

If NHTSA receives similar complaints, it may open an investigation, and if it finds that a safety defect exists in a group of vehicles, it may order a recall and remedy campaign. However, NHTSA cannot become involved in individual problems between you, your dealer, or American Honda Motor Co., Inc.

To contact NHTSA, you may call the Vehicle Safety Hotline toll-free at 1-888-327-4236 (TTY: 1-800-424-9153); go to <http://www.safercar.gov>; or write to: Administrator, NHTSA, 1200 New Jersey Avenue, SE., Washington, DC 20590. You can also obtain other information about motor vehicle safety from <http://www.safercar.gov>.

In Canada

If you believe that your vehicle has a defect which could cause a crash or could cause injury or death, you should immediately inform Honda Canada Inc. and you may also inform Transport Canada.

If Transport Canada receives similar complaints, it may open an investigation, and if it finds that a safety defect exists in a group of vehicles, it may lead to a recall and remedy campaign. However, Transport Canada cannot become involved in individual problems between you, your dealer, or Honda Canada Inc.

To contact Transport Canada's Defect Investigations and Recalls Division, you may call 1-800-333-0510. For more information on reporting safety defects or about motor vehicle safety, go to <http://www.tc.gc.ca/roadsafety>.

Testing of Readiness Codes

Your vehicle has readiness codes as part of the onboard self diagnostic system. Some States use these codes for testing to verify whether your vehicle's emissions components are working properly. The codes may not be read properly if testing is performed just after the battery has gone dead or been disconnected.

To check if they are set, set the power mode to ON, without starting the engine. The malfunction indicator lamp will come on for several seconds. If it then goes off, the readiness codes are set. If it blinks five times, the readiness codes are not set.

If you are required to have your vehicle tested before the readiness codes are ready, prepare the vehicle for retesting by doing the following:

1. Fill the gas tank to approximately 3/4 full.
2. Park the vehicle and leave the engine off for six hours or more.
3. Make sure the ambient temperature is between 40°F and 95°F (4°C and 35°C).
4. Start the engine without touching the accelerator pedal, and let it idle for 20 seconds.
5. Keep the vehicle in **P**. Increase the engine speed to 2,000 rpm, and hold it there for about three minutes.
6. Let the engine idle with your foot off the accelerator for 20 seconds.

Testing of Readiness Codes

The readiness codes are erased when the battery is disconnected, and set again only after several days of driving under a variety of conditions.

If a testing facility determines that the readiness codes are not set, you may be requested to return at a later date to complete the test.

If the testing facility determines the readiness codes are still not set, see a dealer.

7. Select a nearby, lightly traveled major highway where you can maintain a speed of 50 to 60 mph (80 to 97 km/h) for at least 20 minutes. Drive on the highway in **D**. Do not use cruise control. When traffic allows, drive for 90 seconds without moving the accelerator pedal. (Vehicle speed may vary slightly; this is okay.) If you cannot do this for a continuous 90 seconds because of traffic conditions, drive for at least 30 seconds, then repeat it two more times (for a total of 90 seconds).
8. Drive in city or suburban traffic for at least 10 minutes. When traffic conditions allow, let the vehicle coast for several seconds without using the accelerator pedal or the brake pedal.
9. Park the vehicle and leave the engine off for 30 minutes.

■ U.S. Owners

Your new vehicle is covered by these warranties:

New Vehicle Limited Warranty – covers your new vehicle, except for the emissions control systems and accessories, against defects in materials and workmanship.

Emissions Control Systems Defects Warranty and Emissions Performance Warranty – these two warranties cover your vehicle's emissions control systems. Time, mileage, and coverage are conditional. Please read your warranty booklet for exact information.

Seat Belt Limited Warranty – a seat belt that fails to function properly is covered by a limited warranty. Please read your warranty booklet for details.

Rust Perforation Limited Warranty – all exterior body panels are covered for rust-through from the inside for the specified time period with no mileage limit.

Accessory Limited Warranty – Acura accessories are covered under this warranty. Time and mileage limits depend on the type of accessory and other factors. Please read your warranty booklet for details.

Replacement Parts Limited Warranty – covers all Acura replacement parts against defects in materials and workmanship.

Replacement Battery Limited Warranty – provides prorated coverage for a replacement battery purchased from a dealer.

Replacement Muffler Lifetime Limited Warranty – provides coverage for as long as the purchaser of the muffler owns the vehicle.

Restrictions and exclusions apply to all these warranties. Please read the Acura warranty information booklet that came with your vehicle for precise information on warranty coverages. Your vehicle's original tires are covered by their manufacturer. Tire warranty information is in a separate booklet.

■ **Canadian Owners**

Please refer to the warranty manual that came with your vehicle.

■ **EPA Contact Information**

An owner may obtain further information concerning emission warranties or report violations of the terms of the emission warranties by contacting:

U.S. Environmental Protection Agency
Office of Transportation and Air Quality
Compliance Division, Light-Duty Vehicle Group
Attn: Warranty Complaints
2000 Traverwood Drive
Ann Arbor, MI 48105
Email: complianceinfo@epa.gov

Information

■ Service Express

For electronic copies of service publications, you can purchase a subscription to Service Express. Visit www.techinfo.honda.com for pricing and options.

■ For U.S. Owners

Manuals can be purchased from Helm Incorporated. You can order a manual by phone at (800) 782-4356 (credit card orders only), or online at www.helminc.com.

■ For Canadian Owners

Please contact a dealer to order any manuals that you may require.

Acura dealership personnel are trained professionals.

They should be able to answer all your questions. If you encounter a problem that your dealership does not solve to your satisfaction, please discuss it with the dealership's service manager or general manager. If you are dissatisfied with the decision made by the dealership's management, contact Acura Client Relations/Services.

U.S. Owners

American Honda Motor Co., Inc.
Acura Client Relations
Mail Stop 500-2N-7E 1919 Torrance Blvd.
Torrance, CA 90501-2746
Tel: 1-(800) 382-2238

Canadian Owners

Honda Canada Inc.
Acura Client Services
180 Honda Boulevard Markham, ON
L6C 0H9
Tel: 1-866-78-ACURA
Fax: 1-877-939-0909
E-mail: acura_cr@ch.honda.com

In Puerto Rico and the U.S. Virgin Islands

Bella International
P.O. Box 190816
San Juan, PR 00919-0816
Tel: 1-(787) 620-7546

Client Service Information

When you call or write, please give us the following information:

- Vehicle Identification Number
 - ▣ **Vehicle Identification Number (VIN), Engine Number, and Transmission Number** P. 534
- Date of purchase
- Odometer reading of your vehicle
- Your name, address, and telephone number
- A detailed description of the problem
- Name of the dealer who sold the vehicle to you

Gracenote Music Recognition Service (CDDB)



Music recognition technology and related data are provided by Gracenote®. Gracenote is the industry standard in music recognition technology and related content delivery.

For more information, visit www.gracenote.com.

When music is recorded to the HDD from a CD, information such as the recording artist and track name are retrieved from the Gracenote Database and displayed (when available).

Gracenote may not contain information for all albums.

Gracenote is an internet-based music recognition service that allows artist, album, and track information from CDs to display on the HDD.

Gracenote users are allowed 4 free updates a year. More information about Gracenote, its features, and downloads are available at

www.acura.com (in U.S.) or www.acura.ca (in Canada).

CD and music-related data from Gracenote, Inc., copyright © 2000 to present Gracenote. Gracenote Software, copyright © 2000 to present Gracenote.

One or more patents owned by Gracenote apply to this product and service. See the Gracenote website for a non-exhaustive list of applicable Gracenote patents.

Gracenote, CDDB, MusicID, MediaVOCS, the Gracenote logo and logotype, and the "Powered by Gracenote" logo are either registered trademarks or trademarks of Gracenote in the United States and/or other countries.

Gracenote® END USER LICENSE AGREEMENT

This application or device contains software from Gracenote, Inc. of Emeryville, California ("Gracenote"). The software from Gracenote (the "Gracenote Software") enables this application to perform disc and/or file identification and obtain music-related information, including name, artist, track, and title information ("Gracenote Data") from online servers or

embedded databases (collectively, "Gracenote Servers") and to perform other functions. You may use Gracenote Data only by means of the intended End-User functions or this application or device.

You agree that you will use Gracenote Data, the Gracenote Software, and Gracenote Servers for your own personal non-commercial use only.

You agree not to assign, copy, transfer, or transmit the Gracenote Software or any Gracenote Data to any third party.

YOU AGREE NOT TO USE OR EXPLOIT GRACENOTE DATA, THE GRACENOTE SOFTWARE, OR GRACENOTE SERVERS, EXCEPT AS EXPRESSLY PERMITTED HEREIN.

You agree that your non-exclusive license to use the Gracenote Data, the Gracenote Software, and Gracenote Servers will terminate if you violate these restrictions. If your license terminates, you agree to cease any and all use of the Gracenote Data, the Gracenote Software, and Gracenote Servers.



Gracenote reserves all rights in Gracenote Data, the Gracenote Software, and the Gracenote Servers, including all ownership rights. Under no circumstances will Gracenote become liable for any payment to you for any information that you provide. You agree that Gracenote, Inc. may enforce its rights under this Agreement against you directly in its own name.

The Gracenote service uses a unique identifier to track queries for statistical purposes. The purpose of a randomly assigned numeric identifier is to allow the Gracenote service to count queries without knowing anything about who you are. For more information, see the web page for the Gracenote Privacy Policy for the Gracenote service.

The Gracenote Software and each item of Gracenote Data are licensed to you "AS IS."

Gracenote makes no representations or warranties, express or implied, regarding the accuracy of any Gracenote Data from in the Gracenote Servers. Gracenote reserves the right to delete data from the Gracenote Servers or to change data categories for any

cause that Gracenote deems sufficient. No warranty is made that the Gracenote Software or Gracenote Servers are error-free or that functioning of Gracenote Software or Gracenote Servers will be uninterrupted.

Gracenote is not obligated to provide you with new enhanced or additional data types or categories that Gracenote may provide in the future and is free to discontinue its services at any time.

GRACENOTE DISCLAIMS ALL WARRANTIES EXPRESS OR IMPLIED, INCLUDING, BUT NOT LIMITED TO, IMPLIED WARRANTIES OF MERCHANTABILITY, FITNESS FOR A PARTICULAR PURPOSE, TITLE, AND NONINFRINGEMENT. GRACENOTE DOES NOT WARRANT THE RESULTS THAT WILL BE OBTAINED BY YOUR USE OF THE GRACENOTE SOFTWARE OR ANY GRACENOTE SERVER. IN NO CASE WILL GRACENOTE BE LIABLE FOR ANY CONSEQUENTIAL OR INCIDENTAL DAMAGES OR FOR ANY LOST PROFITS OR LOST REVENUES.

© Gracenote 2009



Disclaimer of Pandora®

Requirements to access Pandora®

- Latest version of the Pandora app installed on your Android, Blackberry, or iPhone.
- Registered Pandora account (you can create a free account at www.pandora.com <<http://www.pandora.com/>> or on your smartphone)
- Connection to the internet via WiFi or cellular data network.

Limitations

- Access to Pandora requires an active internet connection
- Ability to access Pandora through this system is subject to change without notice
- Certain functionality of Pandora service is not available when accessing the service through this system including, but not limited to, creating new stations, deleting stations, emailing current stations, buying songs, viewing additional text information, logging in to Pandora, and adjusting Cell Network Audio Quality. Pandora internet radio is a music service not affiliated with HONDA. More information is available at <http://www.pandora.com> <<http://www.pandora.com/>>. Pandora, the Pandora logo, and the Pandora trade dress are trademarks or registered trademarks of Pandora Media, Inc., used with permission.
- Mobile access requires a smartphone with an active data plan. Standard data rates may apply.
- Pandora is only available in the United States.

- A**
- AAC..... 224, 248
 - ABS (Anti-lock Brake System)..... 407
 - Accessories and Modifications..... 488
 - Accessory Power Sockets..... 171
 - AcuraLink..... 330
 - Adaptive Cruise Control (ACC) with Low Speed Follow (LSF)..... 82, 361
 - Additives
 - Coolant..... 458
 - Engine Oil..... 453
 - Washer..... 461
 - Additives, Engine Oil..... 453
 - Adjusting
 - Armrest..... 159, 161, 162
 - Front Seats..... 156
 - Head Restraints..... 159
 - Mirrors..... 153
 - Steering Wheel..... 152
 - Temperature..... 100
 - Adjusting the Clock..... 114
 - Agile Handling Assist..... 395
 - Aha™ Menu..... 247
 - Aha™ Radio..... 257
 - Air Conditioning System (Climate Control System)..... 181
 - Changing the Mode..... 184
 - Defrosting the Windshield and Windows..... 188
 - Dust and Pollen Filter..... 483
 - Rear Temperature Control Dial..... 189
 - Sensors..... 190
 - Using Automatic Climate Control..... 181
 - Air Pressure..... 472, 533
 - Airbags..... 37
 - Advanced Airbags..... 43
 - Airbag Care..... 51
 - Driver's Knee Airbag..... 44
 - Event Data Recorder..... 0
 - Front Airbags (SRS)..... 40
 - Indicator..... 49, 74
 - Passenger Airbag Off Indicator..... 50
 - Sensors..... 37
 - Side Airbags..... 46
 - Side Curtain Airbags..... 48
 - AM/FM Radio..... 216
 - Anti-lock Brake System (ABS)..... 407
 - Indicator..... 74
 - Armrest..... 159, 161, 162
 - Audio Remote Controls..... 195
 - Audio System..... 192
 - Adjusting the Sound..... 209
 - Auxiliary Input Jack..... 193
 - Error Messages..... 253
 - General Information..... 258
 - HDD..... 227
 - Internet Radio..... 245
 - iPod..... 237
 - MP3/WMA/AAC..... 224, 248
 - Reactivating..... 194
 - Recommended CDs..... 259
 - Recommended Devices..... 261
 - Remote Controls..... 195
 - Security Code..... 194
 - Shortcuts..... 198
 - Theft Protection..... 194
 - USB Flash Drives..... 261
 - USB Port..... 193
 - Audio/Information Screen..... 205
 - Authorized Manuals..... 541
 - Auto Door Locking/Unlocking..... 127
 - Customize..... 109, 278
 - Automatic Brake Hold..... 405
 - Indicator..... 70, 405
 - Automatic Brake Hold System
 - Indicator..... 70, 405
 - Automatic Lighting..... 142
 - Automatic Transmission..... 350
 - Creeping..... 350
 - Fluid..... 460
 - Kickdown..... 350
 - Operating the Shift Lever..... 17, 352
 - Shift Lever Does Not Move..... 515
 - Shifting..... 351
 - Auxiliary Input Jack..... 193
 - Average Fuel Economy..... 100
 - Average Speed..... 101
- B**
- Battery..... 480
 - Charging System Indicator..... 72, 518
 - Jump Starting..... 512

Maintenance (Checking the Battery)	480
Maintenance (Replacing).....	481
Belts (Seat)	30
Beverage Holders	170
Blind Spot Information (BSI) System	396
Bluetooth® Audio	251
Bluetooth® HandsFreeLink®	290
Booster Seats (For Children)	63
Brake System	402
Anti-lock Brake System (ABS)	407
Automatic Brake Hold.....	405
Brake Assist System.....	408
Fluid	461
Foot Brake	404
Parking Brake.....	402
Brake System Indicator (Amber)	71
Brake System Indicator (Red)	68, 519
Brightness Control (Instrument Panel) ...	148
BSI (Blind Spot Information) System	396
Bulb Replacement	462
Back-Up Lights.....	466
Brake/Taillights and Rear Side Marker Lights.....	465
Door Outer Handle Ambient Lights	467
Front Side Marker Lights	464
Front Turn Signal/Parking Lights	463
Headlights	462
High-Mount Brake Light.....	467
Rear License Plate Lights	467
Rear Turn Signal Lights.....	465

Side Turn Signal/Emergency Indicator Lights	462, 464
Taillights.....	466
Bulb Specifications	532

C

CAMERA Button	428
Carbon Monoxide Gas	64
Cargo Hooks	173
Carrying Cargo	339, 341
CD Player	224
Center Pocket	169
Certification Label	534
Changing Bulbs	462
Charging System Indicator	72, 518
Child Safety	52
Childproof Door Locks.....	126
Child Seat	52
Booster Seats.....	63
Child Seat for Infants.....	54
Child Seat for Small Children	55
Installing a Child Seat with a Lap/Shoulder Seat Belt	59
Larger Children.....	62
Rear-facing Child Seat	54
Selecting a Child Seat	56
Using a Tether	61
Childproof Door Locks	126
Cleaning the Exterior	486
Cleaning the Interior	484

Client Service Information	542
Climate Control System	181
Changing the Mode.....	184
Defrosting the Windshield and Windows.....	188
Dust and Pollen Filter.....	483
Rear Temperature Control Dial	189
Sensors	190
Using Automatic Climate Control	181
CMBS™ (Collision Mitigation Braking System™)	409
Coat Hooks	172
Collision Mitigation Braking System™ (CMBS™)	409
Compact Spare Tire (Optional)	503, 533
Console Compartment	168
Controls	113
Coolant (Engine)	458
Adding to the Radiator.....	459
Adding to the Reserve Tank.....	458
Overheating	516
Creeping (Automatic Transmission)	350
Cross Traffic Monitor	422
Cruise Control	356
Indicator.....	78
Cup Holders	170
Customized Features	103, 262

D

Daytime Running Lights	144
-------------------------------------	-----



Dead Battery	512
Defrosting the Windshield and Windows.....	188
Devices that Emit Radio Waves.....	535
Dimming	
Headlights	141
Rearview Mirror	153
Dipstick (Engine Oil)	454
Directional Signals (Turn Signal).....	140
Door Mirrors	154
Doors	115
Auto Door Locking	127
Auto Door Unlocking.....	127
Door Open Message.....	29
Keys	115
Locking/Unlocking the Doors from the Inside.....	12, 124
Locking/Unlocking the Doors from the Outside.....	118
Lockout Prevention System	122
DOT Tire Quality Grading	474
Driver's Knee Airbag	44
Driving.....	337
Automatic Transmission.....	350
Braking.....	402
Cruise Control	356
Shifting Gear	351
Starting the Engine.....	344
Driving Position Memory System.....	150
Dust and Pollen Filter.....	483

E

Elapsed Time.....	101
Electric Parking Brake	
Indicator.....	69
Electric Parking Brake System	
Indicator.....	69, 520
Electric Power Steering (EPS) System	
Indicator.....	74, 520
Electronic Stability Control (ESC).....	393
Emergency	527
Emissions Testing (Readiness Codes).....	537
Engine	534
Coolant.....	458
Jump Starting.....	512
Oil.....	453
Remote Engine Start.....	346
Starting	344
Switch Buzzer.....	137
Engine Compartment Cover	452
Engine Coolant.....	458
Adding to the Radiator.....	459
Adding to the Reserve Tank.....	458
Overheating	516
Temperature Gauge	97
Engine Oil	453
Adding.....	455
Checking.....	454
Displaying Oil Life.....	446
Low Oil Pressure Indicator	68, 518
Recommended Engine Oil	453
ENGINE START/STOP Button	137

e-pretensioners	32
EPS (Electric Power Steering) System	74
Exhaust Gas Hazard (Carbon Monoxide)..	64
Expanded Rear Door Sunshades	180
Expanded View Driver's Mirror	155
Exterior Care (Cleaning)	486
Exterior Mirrors.....	154

F

Features	191
Filters	
Dust and Pollen.....	483
Oil	456
Flat Tire.....	491
Floor Mats	485
Fluids	
Automatic Transmission	460
Brake	461
Engine Coolant	458
Windshield Washer	461
Foot Brake	404
Forward Collision Warning (FCW)	375
Front Airbags (SRS)	40
Front Seat Heaters	176
Front Seat Heaters and Seat Ventilation.....	177
Front Seats.....	156
Adjusting.....	156
Front Sensor Camera	359

Fuel	18, 437
Economy.....	439
Gauge	97
Instant Fuel Economy	101
Low Fuel Indicator.....	73
Range.....	101
Recommendation.....	437, 532
Refueling	437
Fuel Economy	439
Fuel Fill Door	18, 438
Fuses	522
Inspecting and Changing	526
Locations	522, 524, 525

G

Gasoline (Fuel)	
Economy.....	439
Gauge	97
Information.....	437
Instant Fuel Economy	101
Low Fuel Indicator.....	73
Refueling	437
Gauges	97
Gear Shift Lever Positions	
Automatic Transmission	351
Glass (care)	484, 487
Glove Box	165

H

Handling the Unexpected	489
HandsFreeLink® (HFL)	290
Auto Answer	305
Automatic Import of Cellular Phonebook and Call History	307
Automatic Transferring	305
Displaying Messages	325
Editing User Name	304
HFL Buttons	290
HFL Menus	292
HFL Status Display	291
Limitations for Manual Operation	291
Making a Call	316
Options During a Call	322
Phone Setup	296
Phonebook Phonetic Modification	311
Receiving a Call	321
Receiving a Text/E-mail Message	323
Ring Tone	306
Roadside Assistance.....	329
Selecting a Mail Account	324
Speed Dial	308
To Create a Security PIN	303
To Set Up a Text/E-mail Message Options	301
Use Contact Photo	306
Hard Disk Drive (HDD) Audio	227
Hazard Warning Button	4
Head Restraints	159
Headlight Washers	147

Headlights	141
Aiming	462
Automatic Operation	142
Dimming	141, 144
Operating.....	141
Heated Steering Wheel	175
Heaters (Seat)	176, 177, 178
HFL (HandsFreeLink®)	290
High Beam Indicator	77
Hill Start Assist System	348
HomeLink® Universal Transceiver	288

I

Identification Numbers	
Engine and Transmission	534
Vehicle Identification	534
Illumination Control	
Buttons	148
Immobilizer System	131
Indicator.....	77
Indicators	68
Adaptive Cruise Control (ACC) with Low Speed Follow (LSF).....	82, 361
Anti-lock Brake System (ABS).....	74
Automatic Brake Hold	70, 405
Automatic Brake Hold System	70, 405
Blind Spot Information (BSI).....	84, 397
Brake System (Amber)	71
Brake System (Red).....	68, 519
Charging System	72, 518

Collision Mitigation Braking System™ (CMBS™)	84, 85
CRUISE CONTROL	78, 357
CRUISE MAIN	78, 356
Door and Trunk Open	29
Electric Parking Brake	69
Electric Parking Brake System	69, 520
Electric Power Steering (EPS) System ..	74, 520
Forward Collision Warning (FCW)	79
High Beam	77
Immobilizer System	77
Keyless Access System	78
Lane Departure Warning (LDW)	80
Lane Keeping Assist System (LKAS)	83, 388
Lights On	77
Low Fuel	73
Low Oil Pressure	68, 518
Low Tire Pressure/TPMS	76, 398, 400
Malfunction Indicator Lamp	72, 519
Precision All-Wheel Steer™ (P-AWS®) System	78
Road Departure Mitigation (RDM)	81
Seat Belt Reminder	31, 73
Security System Alarm	77
Shift Lever Position	72
SPORT Mode	78, 355
Supplemental Restraint System	49, 74
System Message	76
Transmission	72
Turn Signal	77
Vehicle Stability Assist (VSA®) System	75, 393
VSA® OFF	75, 394
Information	531
Instant Fuel Economy	101
Instrument Panel	67
Brightness Control	148
Interface Dial	196
Interior Lights	163
Interior Rearview Mirror	153
J	
Jack (Wheel Nut Wrench)	506
Jump Starting	512
K	
Key Number Tag	117
Keyless Access System	118
Keyless Lockout Prevention	122
Keys	115
Lockout Prevention	122
Number Tag	117
Rear Door Won't Open	126
Remote Transmitter	120
Two-way Keyless Access Remote	123, 346
Types and Functions	115
Kickdown (Automatic Transmission)	350
L	
Lane Departure Warning (LDW)	378
Lane Keeping Assist System (LKAS)	386
Language (HFL)	291
LATCH (Child Seats)	57
Lights	141, 462
Automatic	142
Bulb Replacement	462
Daytime Running Lights	144
High Beam Indicator	77
Interior	163
Light Switches	141
Lights On Indicator	77
Turn Signals	140
Load Limits	341
Locking/Unlocking	115
Auto Door Locking/Unlocking	127
Childproof Door Locks	126
From Inside	124
From Outside	118
Keys	115
Using a Key	122
Lockout Prevention System	122
Low Battery Charge	518
Low Fuel Indicator	73
Low Keyless Access Remote Signal Strength	117
Low Oil Pressure Indicator	68, 518
Lower Anchors	57
Luggage (Maximum Load Limit)	341
Lumbar Support	157

M

Maintenance	441
Battery	480
Brake Fluid	461
Cleaning	484
Climate Control System	483
Coolant	458
Maintenance Minder™	445
Oil	454
Precautions	442
Radiator	459
Remote Transmitter	481, 482
Replacing Light Bulbs	462
Safety	443
Service Items	448
Tires	471
Transmission Fluid	460
Under the Hood	450
Malfunction Indicator Lamp	72, 519
Map Lights	164
Maximum Load Limit	341
Meters, Gauges	97
Mirrors	153
Adjusting	153
Door	154
Exterior	154
Interior Rearview	153
Modifications (and Accessories)	488
Moonroof	136
MP3	224, 248
Multi-Information Display	98

Multi-View Rear Camera	426
------------------------------	-----

N

Numbers (Identification)	534
--------------------------------	-----

O

Odometer	100
Oil (Engine)	453, 533
Adding	455
Checking	454
Displaying Oil Life	446
Low Oil Pressure Indicator	68, 518
Recommended Engine Oil	453, 533
Viscosity	453, 533
On Demand Multi-Use Display™	197
Opening	
Trunk	529
Opening/Closing	
Hood	451
Moonroof	136
Power Windows	134
Trunk	128
Operating the Switches Around the Steering Wheel	137
Outside Temperature Display	100
Overheating	516

P

Paddle Shifters (Sequential Shift Mode)	354
Pandora®	246
Panic Mode	133
Parking	417
Parking Brake	402
Parking Sensor System	418
Passenger Airbag Off Indicator	50
Passing Indicators	141
Power Rear Sunshade	179
Power Windows	134
Precautions While Driving	
Rain	349
Precision All-Wheel Steer™ (P-AWS®) System	395
Precision All-Wheel Steer™ (P-AWS®) System Indicator	78
Pregnant Women	35
Puncture (Tire)	491

R

Radiator	459
Radio (AM/FM)	216
Radio (SiriusXM®)	221
Radio Data System (RDS)	218
Range	101
RDS (Radio Data System)	218
Readiness Codes (Emissions Testing)	537



Rear Defogger/Heated Door Mirror		Side Curtain Airbags	48
Button.....	149	SiriusXM® Radio	221
Rear Seat Heaters	178	Snow Tires	479
Rear Temperature Control Dial	189	Spare Tire (Optional)	503, 533
Rearview Mirror.....	153	Spark Plugs	532
Refueling.....	437	Specifications	532
Fuel Gauge.....	97	Specified Fuel.....	437, 532
Gasoline.....	437, 532	SPORT Mode.....	355
Low Fuel Indicator	73	SPORT Mode Indicator.....	78, 355
Regulations	400, 474, 535	SRS Airbags (Airbags)	40
Remote Engine Start with Vehicle		Starting the Engine.....	344
Feedback	346	Does Not Start	509
Remote Transmitter.....	120	Engine Switch Buzzer	137
Replacement		Jump Starting	512
Battery.....	481, 482	Remote Engine Start	346
Bulbs	462	Steering Wheel	
Fuses	522, 524, 525	Adjusting.....	152
Tires	477	Stopping.....	417
Wiper Blade Rubber.....	468	Summer Tires.....	479, 488
Reporting Safety Defects	536	Supplemental Restraint System (SRS)	40
Resetting a Trip Meter	100	Surround View Camera System	427
Reverse Tilt Door Mirror.....	154	Switches (Around the Steering	
Right Selector Wheel.....	98, 103	Wheel)	4, 5, 137
Road Departure Mitigation (RDM).....	382	System Message Indicator	76
On and Off.....	383		
S		T	
Safe Driving.....	25	Temperature Sensor	190
Safety Labels	65	Temporary Tire Repair Kit	492
Safety Message	1	Tie-down Anchors.....	173
Seat Belts	30	Time (Setting).....	114
Adjusting the Shoulder Anchor.....	34		
Automatic Seat Belt Tensioners	32		
Checking.....	36		
e-pretensioners	32		
Fastening	33		
Installing a Child Seat with a Lap/Shoulder			
Seat Belt.....	59		
Pregnant Women	35		
Reminder	31, 73		
Warning Indicator	31, 73		
Seat Heaters.....	176, 177, 178		
Seats	156		
Adjusting	156		
Front Seats	156		
Seat Heaters.....	176, 177, 178		
Security System	131		
Immobilizer System Indicator.....	77		
Security System Alarm Indicator.....	77		
Selecting a Child Seat.....	56		
Sequential Shift Mode	353		
Sequential Shift Mode Operation	354		
Setting the Clock	114		
Shift Lever.....	17, 351		
Does Not Move	515		
Operation.....	17, 352		
Releasing.....	515		
Shift Lever Position Indicator	72, 352		
Shifting (Transmission).....	17, 351		
Shoulder Anchor	34		
Side Airbags.....	46		

Tire Pressure Monitoring System (TPMS).....	398	Troubleshooting	489	Using the Keyless Access System	118
Indicator	76, 521	Blown Fuse.....	522, 524, 525	V	
Tires	471	Brake Pedal Vibrates	21	Valet Mode	166
Air Pressure.....	472, 533	Buzzer Sounds When Opening Door.....	22	Vanity Mirrors	7
Chains	479	Emergency Towing	527	Vehicle Identification Number	534
Checking and Maintaining	471	Engine Won't Start	509	Vehicle Stability Assist (VSA®)	393
Flat Tire (Puncture).....	491, 503	Flat Tire/Puncture.....	491, 503	Off Button.....	394
Inspection	471	Noise When Braking	22	Off Indicator.....	75, 394
Labeling	472	Overheating	516	System Indicator	75, 393
Regulations.....	474	Premium Gasoline	437, 532	Viscosity (Oil)	453, 533
Rotation.....	478	Rear Door Won't Open	21, 126	VSA® (Vehicle Stability Assist)	393
Spare (Optional).....	503, 533	Shift Lever Does Not Move	515		
Summer	479, 488	Warning Indicators	68	W	
Temporary Tire Repair Kit.....	492	Trunk	128	Warning and Information Messages	86
Wear Indicators.....	476	Lid	128	Warning Indicator On/Blinking	518
Winter	479	Light Bulbs	532	Warning Labels	65
Tools	490	Release Handle	529	Warranties (Warranty Manual provided separately)	539
Towing a Trailer	343	Unable to Open	529	Watts	532
Towing Your Vehicle	343	Trunk Pass-through Cover	174	Wear Indicators (Tire)	476
Emergency	527	Turn Signals	140	Wheel Nut Wrench (Jack Handle)	506
TPMS (Tire Pressure Monitoring System)	398	Indicators (Instrument Panel).....	77	Window Washers	145
Transmission	17, 351	Turn-by-Turn Directions	101	Adding/Refilling Fluid	461
Automatic.....	17, 350, 351	Two-way Keyless Access Remote	123, 346	Switch.....	145
Fluid	460	U		Windows (Opening and Closing)	134
Number	534	Unlocking the Doors	118	Windshield	
Sequential Shift Mode.....	353	Unlocking the Front Doors from the Inside	12, 124	Cleaning	484, 487
Shift Lever Position Indicator	72, 352	USB Flash Drives	261	Defrosting/Defogging.....	188
TRIP Button	99	USB Port	193		
Trip Meter	100				



Washer Fluid..... 461
Wiper Blades 468
Wipers and Washers 145
Winter Tires..... 479
 Snow Tires..... 479
 Tire Chains 479
Wipers and Washers 145
 Checking and Replacing Wiper Blades 468
WMA 224, 248
Worn Tires..... 471

