



DIGI-TROLL 5
DIGI-TROLL 5 TS

Owner's Manual



TABLE OF CONTENTS

Introduction	3
Warranty / Service Information	4
Product Overview.....	5
Installation	6
Mounting	6
Boom and Ball Hook	8
Boom End Assembly.....	10
Spool Cover Removal	11
Rod Holders	12
Cable Termination.....	13
Line Release.....	13
Intellitroll Antenna	14
Power Loss Crank Handle	15
Wiring Your Downrigger.....	16
Getting Started	18
Display	18
Menu	20
Up and Down	20
Positive Ion Control.....	21
Line On Reel	21
Units.....	21
Un/Coated Line	22
Networking	23
Intellitroll Use	23
Fishing Theory	24
Positive Ion Control Theory	25
Blowback Calculations	26
Trolling Tips.....	27
Troubleshooting.....	28
Parts Lists.....	30
Wiring Diagram.....	34
WEEE Compliance	36

Introduction

Overview

Thank you for purchasing the Cannon Digi-Troll 5 electric downrigger. We have designed your new downrigger to be an accurate and reliable tool that will enhance fishing control and improve your ability to catch fish.

This manual covers installation and the functions of both the Digi-Troll 5 and Digi-Troll 5 TS. The Tournament Series version of the Digi-Troll is fitted with a cast stainless steel reel, brushed finish stainless steel boom, and a white frame.

Safety and Cautions

Your Cannon downrigger should only be used for its intended purpose. Improper use will void the warranty and may be a safety risk.

We hope that you enjoy the use of your new downrigger and enjoy the benefit of controlled depth fishing for years to come by always following safe boating practices and laws for wherever you are fishing.

Read this manual carefully before operating your new Cannon Downrigger. Retain this manual for future reference.

Warranty and Registration

To receive all the benefits for your product warranty please fill out and mail the registration card. You may also register your product online at www.cannondownriggers.com.

Digi-Troll 5



Digi-Troll 5 TS



CANNON LIMITED WARRANTY

Johnson Outdoors Marine Electronics, Inc. warrants to the original purchaser that if the accompanying product (see exclusions below) proves to be defective in material or workmanship within the following warranty periods, Johnson Outdoors Marine Electronics, Inc. will, at its option, either repair or replace same without charge (but no cash refunds will be made):

- 1) The boom, motor, and reels, plus all composite parts, including but not limited to frames and bases, will be free from defects in materials and workmanship, subject to normal wear and tear, for the original purchaser's lifetime.
- 2) All other items will have 1-year limited warranties from the date of original retail purchase, except THE FOLLOWING ITEMS THAT HAVE NO WARRANTY WHATSOEVER: boot covers, clothing, Dacron line, rubber bands, swivel lock pin, weights, and wire cable.

This limited warranty may be enforced only by the original purchaser; all subsequent purchasers acquire the product "as is" without any benefit of this limited warranty. Repair or replacement of the product as set forth in this limited warranty shall be the original purchaser's sole and exclusive remedy and Johnson Outdoors Marine Electronics, Inc.' sole and exclusive liability for breach of this warranty.

EXCLUSIONS

This warranty does not apply in the following circumstances:

- When the product has been connected, installed, combined, altered, adjusted, serviced, repaired, or handled in a manner other than according to the instructions furnished with the product
- When the motor housing is opened by anyone other than Cannon® Authorized service repair personnel.
- When any defect, problem, loss, or damage has resulted from any accident, misuse, negligence, carelessness, or abnormal use, or from any failure to provide reasonable and necessary maintenance in accordance with the instructions of the owner's manual

LIMITATION AND EXCLUSION OF IMPLIED WARRANTIES AND CERTAIN DAMAGES

THERE ARE NO EXPRESS WARRANTIES OTHER THAN THESE LIMITED WARRANTIES. JOHNSON OUTDOORS MARINE ELECTRONICS, INC. DISCLAIMS LIABILITY FOR INCIDENTAL AND CONSEQUENTIAL DAMAGES, AND IN NO EVENT SHALL ANY IMPLIED WARRANTIES (EXCEPT ON THE BOOM, MOTOR, REELS, AND ALL COMPOSITE PARTS), INCLUDING ANY IMPLIED WARRANTY OF MERCHANTABILITY OR FITNESS FOR PARTICULAR PURPOSE, EXTEND BEYOND ONE YEAR FROM THE DATE OF PURCHASE (AND IN THE CASE OF THE BOOT COVERS, CLOTHING, DACRON LINE, RUBBER BANDS, SWIVEL LOCK PIN, WEIGHTS, AND WIRE CABLE, JOHNSON OUTDOORS MARINE ELECTRONICS, INC. DISCLAIMS ALL IMPLIED WARRANTIES). THIS WRITING CONSTITUTES THE ENTIRE AGREEMENT OF THE PARTIES WITH RESPECT TO THE SUBJECT MATTER HEREOF; NO WAIVER OR AMENDMENT SHALL BE VALID UNLESS IN WRITING SIGNED BY JOHNSON OUTDOORS MARINE ELECTRONICS, INC.

Some states do not allow limitations on how long an implied warranty lasts or the exclusion or limitation of consequential damages, so the above limitation or exclusion may not apply to you. This warranty gives you specific legal rights, and you may also have other rights that vary from state to state.

CANNON® SERVICE POLICY

AFTER THE APPLICABLE WARRANTY PERIOD

After the applicable warranty period, or, if one of the above exclusions applies, Cannon products will be repaired for a charge of parts plus labor. All factory repairs, after the applicable warranty period, carry a 90-Day Limited Warranty, subject to the exclusions and limitations stated above.

TO ENFORCE WARRANTY OR TO OBTAIN REPAIRS AFTER WARRANTY

To obtain warranty service in the U.S., the downrigger or part believed to be defective and the proof of original purchase (including the date of purchase) must be presented to a Cannon Authorized Service Center or to Cannon's factory service center in Mankato, MN. Except as noted below, any charges incurred for service calls, transportation or shipping/freight to/from the Cannon Authorized Service Center or Cannon's factory, labor to haul out, remove, re-install or re-rig products for warranty service, or any similar items are the sole and exclusive responsibility of the purchaser. Downriggers purchased outside of the U.S. (or parts of such downriggers) must be returned prepaid with proof of purchase (including the date of purchase and serial number) to any Authorized Cannon Service Center in the country of purchase. Warranty service can be arranged by contacting a Cannon Authorized Service Center listed on the enclosed sheet, or by contacting the factory at 1-800-227-6433 or Fax 1-800-527-4464. If the necessary repairs are covered by the warranty, we will pay the return shipping charges to any destination within the United States.

DO NOT return your Cannon downrigger or parts to your retailer. Your retailer is not authorized to repair or replace them.

Major parts, such as the motor and main frame, must be returned to Johnson Outdoors Marine Electronics, Inc. in Mankato, Minnesota, or a Cannon Authorized Service Center, for repair or replacement. To reduce shipping costs, we suggest removal of loose parts such as the boom and rod holders. Small parts that can be easily removed such as the handle and/or the counter, may be removed from the downrigger and returned for repair or replacement.

Retain your sales receipt! Proof of purchase must accompany product when returned.

Return Address: Cannon
121 Power Drive
Mankato, MN 56001

FOR YOUR INFORMATION:

_____ Serial No.

_____ Date Purchased

_____ Store Where Purchased

RETAIN THIS SECTION FOR YOUR RECORDS

Introduction to Controlled Depth Fishing

Undoubtedly there are many fishermen familiar with the methods and use of controlled depth fishing. During the mid 1960's the state of Michigan introduced Pacific salmon into the Great Lakes in an attempt to revitalize its sport fishing industry. From this successful transplant, new fishing techniques and equipment were developed. One such method was controlled depth fishing which enabled fishermen to place a lure at a desired depth by utilizing downriggers.

Because of the varying factors (water temperature, thermocline, weather, tides, time of day, or time of year) it is necessary for successful fishing to maintain specific water depths that coincide with fish movements and feeding patterns.

One essential feature of the downrigger is the depth meter or gauge that indicates lure depth. This allows the angler to control as well as return to specific depths where fish have been caught.

Due to the success of controlled depth fishing, downriggers are now being used throughout the world to catch a wide variety of species in both fresh and salt water. Whether fishing for blues off Rhode Island, walleyes in Lake Erie, sailfish off the coast of Florida, or stripers in Tennessee, the use of downriggers will make your fishing more successful and more enjoyable.

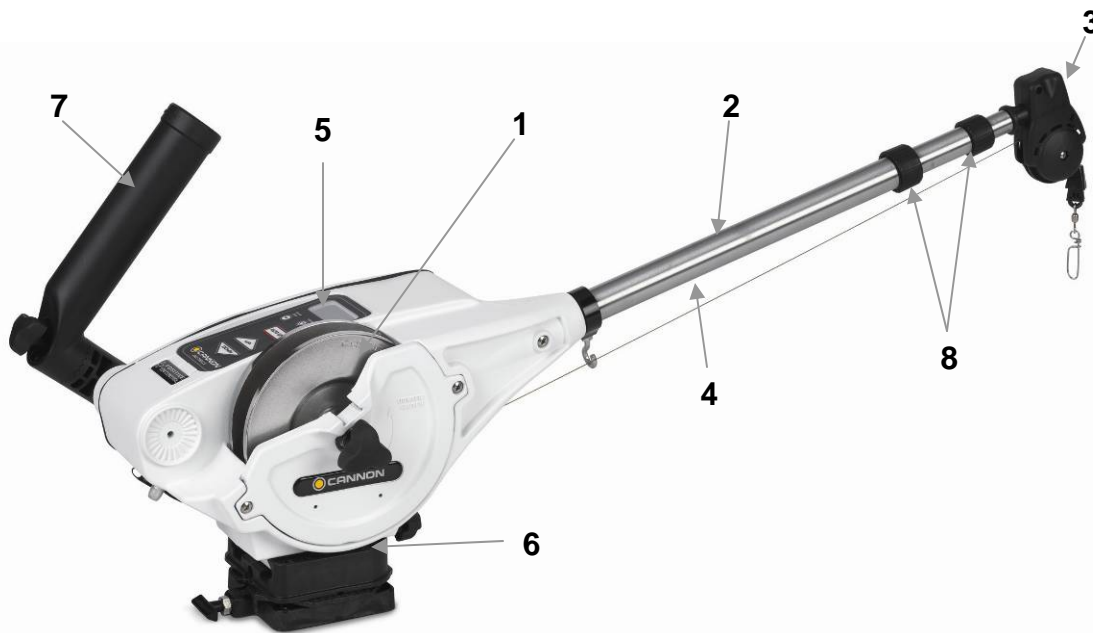

Digi-Troll 5 TS

Parts Description

1. **Reel** This is used to spool the cable, available in lengths ranging from 150 to 400 feet.
2. **Boom** This is used to extend the weight out from the body of the downrigger and has a pulley fixed to its end. Boom lengths range from 24 to 53 inches.
3. **Swivel Head** This relays the cable at the end of the boom to lower the weight.
4. **Cable** This connects to the weight. Cable material is 150 lb. test stainless steel cable.
5. **Keypad/LCD** Keypad is used to control the functions of the downrigger. The LCD display provides feedback of the downrigger functions.
6. **Mounting Base** This attaches to the boat, enabling you to place the downrigger where you choose.
7. **Rod Holder** This holds your fishing rods while trolling and may also be used for storing rods.
8. **Boom Clamps** These lock the boom sections together after the boom has been extended or retracted.

Downrigger Mounting on Boats

A downrigger should be mounted wherever it is easy to operate and observe. You want to be able to see your fishing rod and to react quickly. So, choosing a good location to mount your downrigger on your boat is very important.

Due to the great variety of boats available, mounting your downrigger can be a difficult decision. Cannon has a complete line of mounting and fishing accessories to aid in your fishing experience. Before making any permanent changes to your boat consider what accessories might be used in your application.

Arrows Indicate Typical Mounting Locations

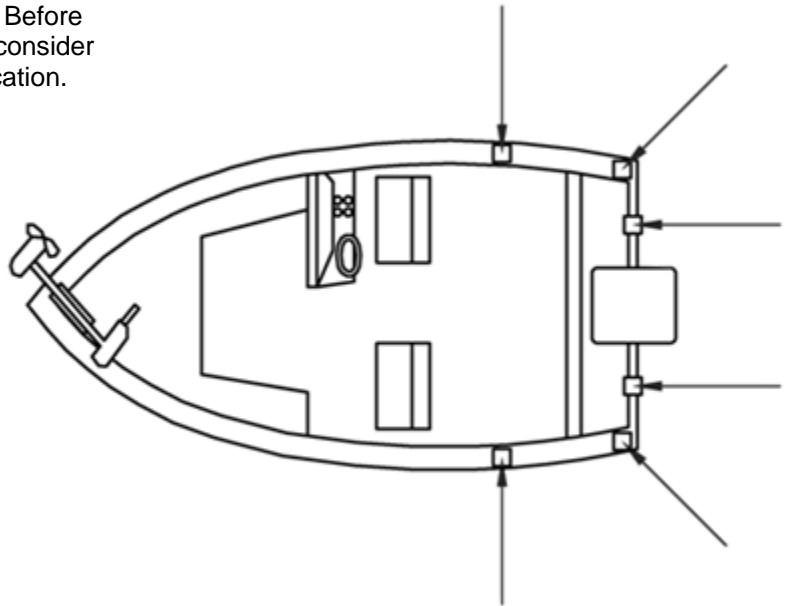

Installing the Base on Your Boat Decks up to 7/16" thick

Where access to the underside of the deck is not available, the mounting base can be mounted using wellnuts. Use the base as a template to mark locations and drill four wellnut clearance holes. Mount the base using four 1/4-20 x 1-1/2" truss head screws and four wellnuts. Tighten the screws so the wellnuts are firmly compressed as pictured.

Decks up to 7/16" Thick

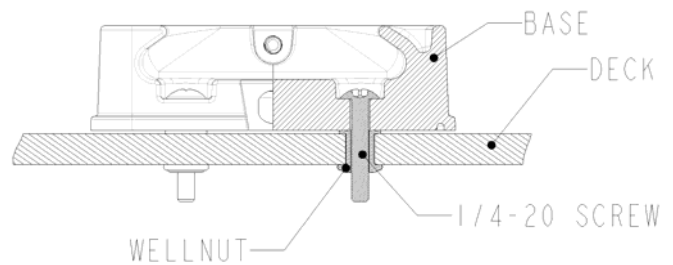

Decks thicker than 7/16"

For decks thicker than 7/16", or where the underside of the deck is accessible, mount the base with screws, nuts, and washers. Use the base as a template to mark the locations and drill four 9/32" holes. Use four 1/4-20 x 2" truss head screws and four each flat washers and nuts. Fasten the base to the deck as pictured. **NOTE: Wellnuts SHOULD NOT** be used on decks thicker than 7/16".

Decks Thicker Than 7/16" Thick

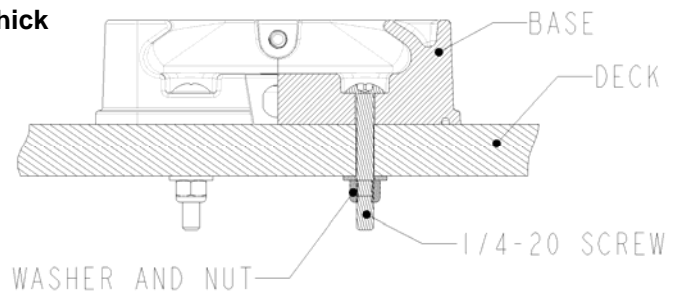

Decks thinner than 1/4"

Use a Cannon deck plate (PN 2200693) to prevent deflection and add stability to decks thinner than 1/4". Use the deck plate as a template to mark the hole locations.

If access to the underside of the deck is not available, the deck plate can be mounted using screws and wellnuts. Use the deck plate as a template to mark locations and drill 4 wellnut clearance holes. Use four 1/4-20 x 1-1/2" flat head screws and four wellnuts to mount deck plate. Tighten the screws so the wellnuts are firmly compressed.

Where the underside is accessible, the deck plate can be mounted using screws, nuts, and washers. Drill 9/32" holes. Use four 1/4-20 x 1-1/2" flat head screws, nuts and washers (flat and lock). Fasten plate to deck. To secure the mounting base to the deckplate use four 1/4-20 x 1" truss head screws.

NOTE: When using the telescopic boom, we strongly recommend the use of a deck plate on all boats to provide adequate stability for the downrigger.

The Low-Profile Swivel Base mounting follows the same procedure as for the deck plate except that four 1/4"-20 x 1-1/2" truss head screws are used to fasten the mounting base and four additional 1/4"-20 x 2" truss head screws fix the swivel base to the boat deck.

Low-Profile Swivel Base



INSTALLING THE BOOM AND BALL HOOK

- 1) Remove the ball hook collar, ball hook, and 1/4-20 nut from the included hardware bag assembly.
- 2) Thread the nut onto the ball hook, then thread the ball hook into the ball hook collar. Do not tighten yet. (Figure 1)
- 3) Slide ball hook collar onto the end of the boom and leave it loose. (Figure 2)
- 4) Insert boom with ball hook collar assembly into frame (Figure 3) and line up holes in boom with holes in frame (Figure 4).
- 5) Remove 1/4-20 x 2" bolt and 1/4-20 nylon locknut from included hardware bag assembly.

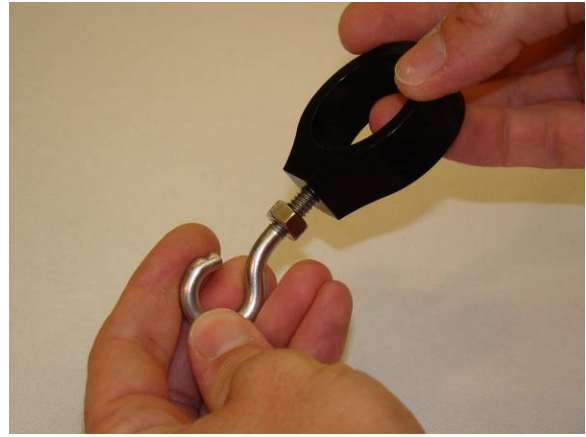

FIGURE 1



FIGURE 2



FIGURE 3



FIGURE 4



FIGURE 5

6) Insert the 1/4-20 nylon locknut into the hex pocket on the nose of the frame (motor side of frame). (Figure 5)



FIGURE 6

7) Insert 1/4-20 x 2" bolt into reel side of frame nose. With a Phillips head screw driver, thread bolt into the nylon locknut from step 6. Tighten bolt until the end of the bolt is flush with the top of the nut. (Figure 6)

8) Slide ball hook collar to your preferred location. Hand tighten the ball hook into boom tube. Tighten enough so that there is no movement on the boom. (Figure 7)

Important: Do not overtighten ball hook or permanent deformation of the boom is possible.

9) Once ball hook is secure, with a 7/16" wrench, tighten the 1/4-20 nut until secure with ball hook collar. (Figure 8)

****TELESCOPIC BOOM ONLY****

To adjust the boom length (with the boom extending away from you) rotate the clamps (See item # 8 on page 5) approximately 1/4 turn counter-clockwise to unlock and slide the boom section to the desired position. Once in place, lock the clamps by rotating clockwise until tight.



FIGURE 7



FIGURE 8

BOOM END PULLEY

Telescopic Boom

- 1) Remove boom end assembly from hardware bag.
- 2) Remove #8 self tapping screw from hardware bag.
- 3) Insert boom end post into end of the small tube of the telescopic boom assembly. (Figure 9)
- 4) Align hole in boom post with hole in small end tube. (Figure 10)
- 5) Secure boom end with #8 screw as shown. Tighten with Phillips head screw driver.



FIGURE 9



FIGURE 10



FIGURE 11



FIGURE 12



FIGURE 13



FIGURE 14

REMOVABLE SPOOL COVER

Your new downrigger comes with a removable spool cover. By removing this cover, you are able to gain easy access to your spooled cable and easy spool removal. This feature allows you to easily access tangled line, get it repaired and get you back into action quickly.

This feature also allows you to have multiple reels for different types of line. By purchasing additional reels, you can wind each with a different type of cable (i.e. Uncoated cable, Coated Cable, Mono, etc.). This allows you to switch out desired cables quickly and easily.

NOTE: Remove all tension from the line before removing or replacing the spool.

Follow the below steps to remove the side cover:

1) Loosen and remove the clutch knob. Turn the clutch knob clockwise until it is free of the motor shaft. (Figures 11 & 12)

2) Loosen the two 1/4-20 Phillips head screws on opposite sides on the cover. (Figure 13)

NOTE: Screws are captured in the cover and will not come out completely.

3) Remove the cover and you now have complete access to the spool. (Figures 14 & 15)

4) Reassemble by reversing the above steps.

Note: Take care when removing the spool over open water so that the clutch pad or clutch disk doesn't get pulled off as well.

WARNING: Do not touch the cable reel while the downrigger is in use.



FIGURE 15

REPLACING THE CLUTCH PAD

To replace the clutch pad, follow the steps for removing the spool. Once the spool is removed, you have access to the clutch pad. (Figure 16) Simply pull it off the shaft and replace. Reassemble the spool and cover in the reverse order.



FIGURE 16

ATTACHING THE ROD HOLDER(S)

The locking rod holder(s) incorporate a locking tooth design which can be easily adjusted every 15° with the soft grip knob. The symmetrical design will allow mounting of the rod holder on either side of the downrigger or two rod holders at the same time. The unique two piece design allows independent adjustment of the rod holder and the rod holder arm in two axes. (Figure 17)

Caution: This rod holder is intended for use of up to 30 lb. test line only and is not recommended for use with any tackle IGFA (International Game Fish Association) rated higher than 30 lb. A safety strap (not included) is rec-

NOTE: The rod holder assembly is not covered under warranty when used with tackle above 30 lbs. Equipment placed in the rod holders and the loss thereof is the responsibility of the user and is in no way warranted by Johnson Outdoors, Inc. Mounting must be in accordance with the above instructions and pictures to comply with the product warranty.

To install the rod holder(s):

- 1) Fasten rod holder to rod holder elbow using supplied spring and knob.
- 2) Attach the rod holder to the downrigger on either side using the supplied spring and knob. (Figure 19)
- 3) Repeat the above steps for the other side if (2) rod holders are to be mounted.

The rod holders can be adjusted by loosening either knob until the locking teeth are free from each other. Rotate the rod holder or arm to the desired position and re-tighten knob. (Figure 19)



FIGURE 17

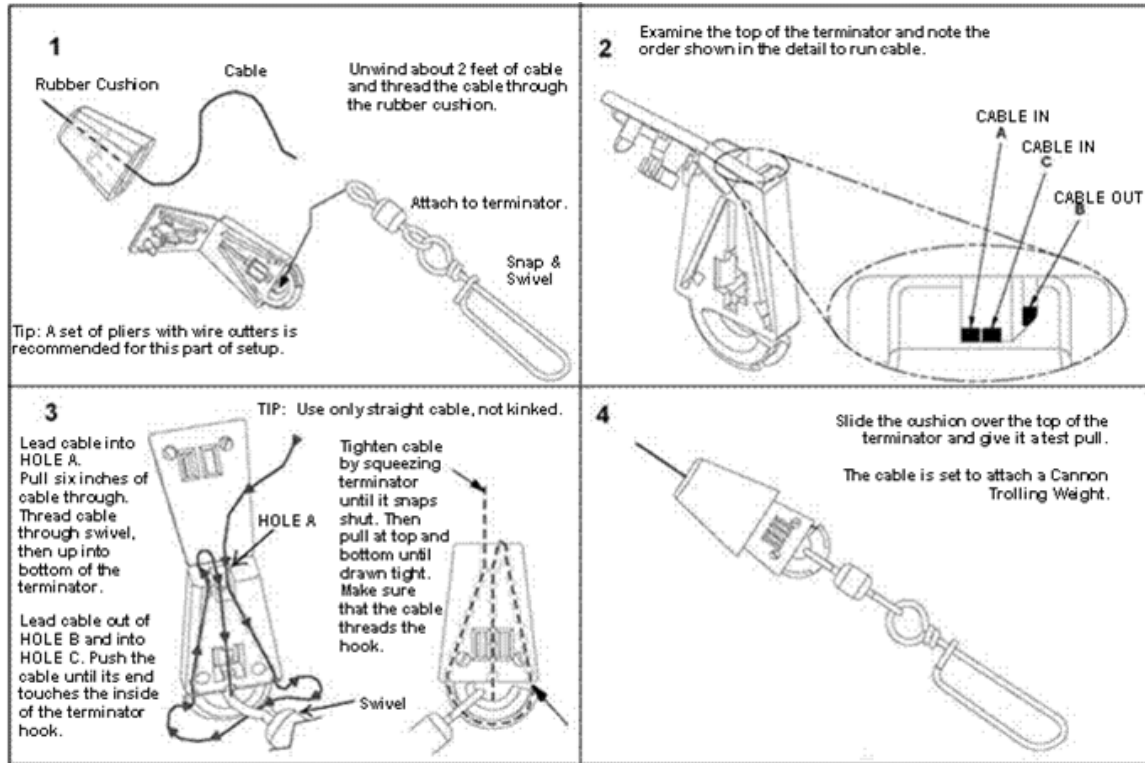

FIGURE 18



FIGURE 19

TERMINATING THE DOWNRIGGER CABLE



TIP: Use only straight cable when routing through the terminator. Worn or kinked cable can be stressed and may break prematurely when retrieving trolling weights.

ATTACHING THE LINE RELEASE (UNI-RELEASE)

The Cannon Uni-Release attaches directly to the downrigger weight. Attach fishing line to the clip at the end of the release, and then click through a series of increasing tension settings. The release can be used with any test line on salt or fresh water and may be adjusted from 2 to 22 pounds of grip tension on the line.

To change line release tension, turn tension knob to (+) to increase or (-) to decrease. Tension also may vary according to where the line is placed in the grips. Higher tension is on the line if it is set back toward the hinge, and lower if set closer to the opening. To open the release, spread the release arms with thumb and forefinger applying pressure to the sides.

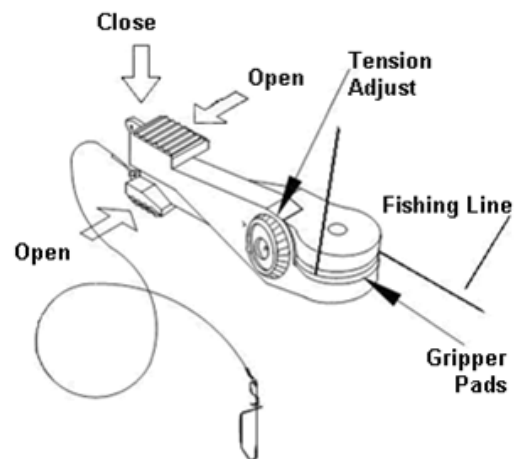

USING YOUR DIGI-TROLL WITH THE INTELLITROLL ACCESSORY

Both the Digi-Troll 5 and Digi-Troll 10 are compatible with the IntelliTroll accessory. The Digi-Troll 5 receives the IntelliTroll data and sends it to your Humminbird fishfinder (using the Cannonlink accessory). You can also use the IntelliTroll monitor and antenna cable assembly to display sensor information. The Digi-Troll 10 also displays the IntelliTroll information on the internal LCD display.

To install the IntelliTroll on the Digi-Troll follow the below steps:

- 1) Locate the antenna mounting bolt in the location shown. (Figure 20)
- 2) With a 1/4" wrench, loosen the bolt and remove. (Figure 21)
- 3) Install the antenna spring that came with the IntelliTroll sensor kit. Insert bolt into the closed loop on the spring. (Figure 22)
- 4) Tighten bolt until tight. (Figure 23)

Caution: Do not over tighten as the stainless steel bolt head may shear with too much torque.

- 5) Once the antenna is installed, run downrigger cable through center of spring. (Figures 24 & 25)

Note: It is recommended that you use the coated cable that came with your IntelliTroll sensor for proper sensor operation. The use of non-coated could result in poor display performance and/or a loss of data signal. Refer to your IntelliTroll owners manual for more detailed instructions.



FIGURE 20



FIGURE 21



FIGURE 22



FIGURE 23



FIGURE 24



FIGURE 25



FIGURE 26



FIGURE 27

6) Terminate cable as previously described.

Your Digi-Troll is now Intellitroll compatible. Once you attach your Intellitroll to the cable per the instructions included, your Digi-Troll 5 will pass this data on to the Cannonlink for display on your Humminbird fish finder.

USING THE INCLUDED POWER LOSS MANUAL CRANK HANDLE

In case of a dead battery, your downrigger comes equipped with a power loss manual crank handle. This handle allows for the retrieval of your weight should you lose power or have an electrical failure. To utilize the handle follow the below steps.

WARNING: LOOSENING OR REMOVING THE CLUTCH KNOB WILL RELEASE THE SPOOL AND ALLOW IT TO RUN FREE. MAKE SUIRE YOU HOLD THE SPOOL BEFORE REMOVING THE CLUTCH KNOB.

- 1) Unplug downrigger and secure reel. See note above.
- 2) Rotating clockwise, remove the clutch knob. (Figure 26)

CAUTION: Take care when removing the clutch knob over open water.

- 3) Install the handle's hex pattern to match the hex pattern on the spool. Once installed, you can start cranking up your weight. (Figure 27)

Wiring Your Downrigger

Your Boat's Electrical Condition

It is important to make sure that your boat is properly set up before installing your Digi-Troll with Positive Ion Control (PIC). Whenever a boat is in water, various submerged parts interact to create weak electrical currents. These weak electrical currents must be controlled to extend the life of the boat's metal parts and ensure a good fish catching environment.

Check the zinc sacrificial anodes on your boat and on the outboard/outdrive. If they are more than 50% dissolved they should be replaced. Any coating of slime or growth should be cleaned off. All metal parts including the hull (if metal) must be interconnected by a grounding wire. This includes motor shafts, outdrives, and through hull fittings. If your boat and zinc anodes are set up correctly, the voltage on the stainless steel downrigger wire should be positive when in contact with the water.

With your boat in the water and the downrigger cable deployed in the water, measure the dc voltage from the cable to a grounded metal surface of the boat touching the water. It should be 0.6-0.8VDC (fixed PIC) or it should match your Digi-Troll setting if properly wired.

- The use of Cannon vinyl coated lead weights is recommended.
- Use the trolling weight insulators supplied with your downrigger. This insulates your weight from the positive charge on the cable. This will also ensure that the trolling weight will stop at water level when retrieved.
- The cable on your downrigger should be replaced every 2 years. Etching of the cable can weaken it physically and electrically.
- In saltwater, make sure the sacrificial zinc anodes are replaced when half dissolved. This ensures that the boat will run with a neutral or slightly positive charge. Clean zincs on a regular basis with a non-corrosive brush.
- Always make sure the boat is properly grounded to the water. This will help ensure proper PIC voltage on the cable and that the Short Stop will function properly.

NOTE: To ensure proper operation of your Digi-Troll, ground the battery to your boat's electrical system's ground. Malfunctions with the PIC, communication between units, or loss of operation result from faulty grounding. Always check to see if your boat is properly grounded first.

Electrical Specifications & Wiring Instructions

The Digi-Troll is rated at 30 amps (full load), 12 volts DC and is protected by a 25 amp manual reset circuit breaker (located under motor housing). Be sure to measure the battery voltage of your boat.

WARNING! - DO NOT RUN THIS DOWNRIGGER ON A 24 VOLT BATTERY SYSTEM. THIS WILL DAMAGE THE UNIT AND VOID YOUR WARRANTY.

Connecting to the Battery:

It is strongly recommended that a fuse or manual reset circuit breaker be installed at the battery on the positive lead of the power cable or that you connect the downrigger to a battery selector switch. (See Fuse and Wire Specifications) Connect the positive lead (RED) to the (+) post on your battery and the negative lead (BLACK) to the (-) post on your battery or the downrigger will not operate. Use the quick disconnect plug to remove the downrigger without touching the battery.

NOTE: It is strongly recommended to power your Digi-Troll with a Deep-Cycle marine battery. Only run a Digi-Troll from a Starter battery if it is recharged by an alternator while trolling.

FUSE / BREAKER SPECIFICATIONS:

An over-current protection device (circuit breaker or fuse) must be used with this downrigger. Coast Guard requirements dictate that each ungrounded current-carrying conductor must be protected by a manually reset, trip-free circuit breaker or fuse.

The following breaker size is a recommended guideline:

- 1 downrigger—30A @ 12 vdc
- 2 downriggers—60A @ 12 vdc

For additional information, please consult appropriate ABYC (American Boat and Yacht Council) and Coast Guard requirements.

Reference:

- United States Code of Federal Regulations: 33 CFR 183—Boats and Associated Equipment
- ABYC E-11: AC and DC Electrical Systems on Boats

Powering Multiple Downriggers

When operating multiple Digi-Trolls, run a **maximum of 2 downriggers per dedicated battery**. The advanced features of the Digi-Troll can keep the unit working virtually all the time. (See below for the recommended wiring setup.)

Typical Operating Time*:

- 1 Digi-Troll per battery – 24 hours.
- 2 Digi-Trolls per battery – 10 hours.

*Time based on lab results using a 15lb weight and Deep-Cycle batteries. Actual run time will vary.

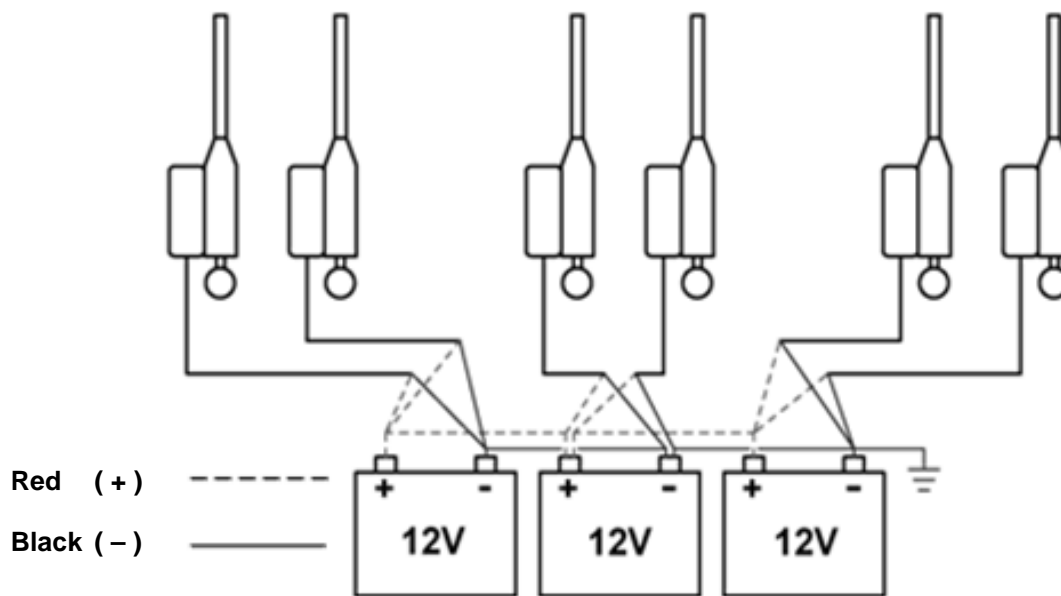

Connect Multiple Batteries in Parallel

GETTING STARTED

Operating the Digi-Troll 5

The Digi-troll 5 offers you the most advanced features available in a downrigger.

- Variable Positive Ion Control.
- Large LCD digital display for weight depth and easy programming.
- Networking operation allowing you to chain several Digi-Troll 5s together for use with Cannonlink.
- AUTO-UP key to quickly raise the weight to water surface.
- A permanent storage memory to retain all the settings.
- Variable speed operation through Cannonlink.
- High efficiency motor.
- Compatibility with Cannonlink and Humminbird fishfinders (1100, 900, 700, or Matrix Series).

Digi-Troll 5 Display

When the power cord is plugged in, press the power button on the keypad to turn on the downrigger. In normal usage, the display will indicate the depth of the weight in feet.

(Note: A negative depth indicates distance above the water surface).

During programming of special features, the display is used to indicate various settings.

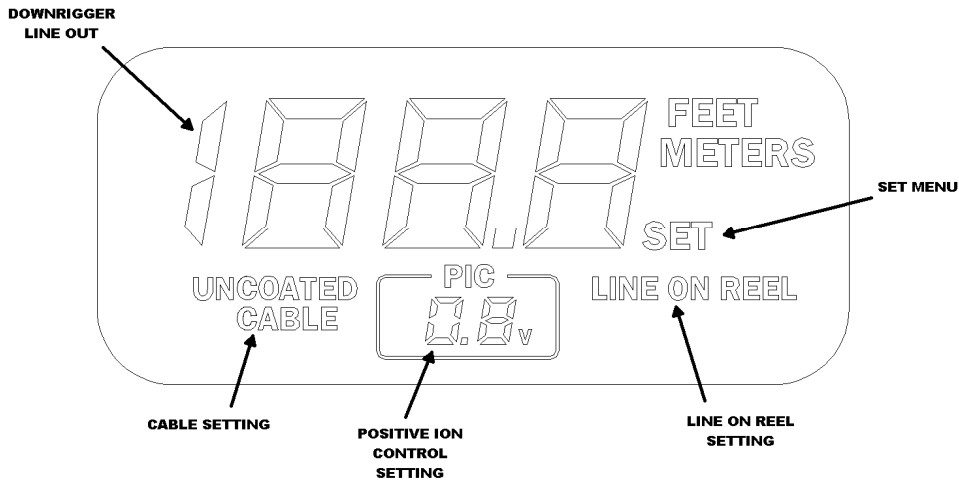

LCD Icon Layout

Digi-Troll 5 Keypad

The Digi-Troll 5's keypad has six keys located below the display.

Power

The ON/OFF key functions:

- 1) Turn the Digi-Troll ON - Simply press and release.
- 2) Turn the Digi-Troll OFF - Press and hold power button for three seconds.

MENU

The Menu moves the display through up to four screens for programming (see section on programming for details). After 7 seconds of inactivity on the key pad, the screen reverts back to the weight line out display.

UP

During manual operation, this key raises the weight when pressed. In programming mode, the UP key increases numeric values.

DOWN

During manual operation, this key lowers the weight when pressed. In programming mode, the DOWN key decreases numeric values.

WATER ZERO

The water zero key provides a reset option for depth. When pressed and held, the line out count will reset to zero.

MENU

The menu key provides access to all programming submenus.

AUTO UP

Press **AUTO UP** to raise the weight to the water zero set point at any time. **AUTO UP** uses the speed 5 regardless of your setting and cancels any other mode of operation (bottom following, cycling, etc.) when used.

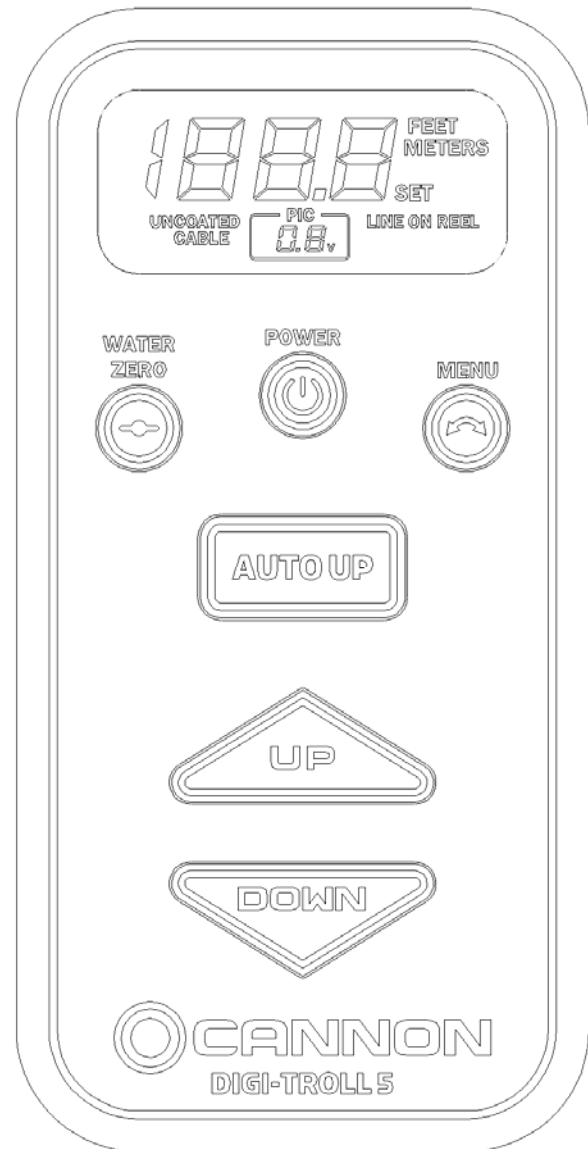

Programming the Digi-Troll 5

The Digi-Troll 5 contains four menus that enable you to program and customize its operation. Any changes made using the menu system are automatically saved in permanent memory when the downrigger is turned off.

NOTE: The downrigger must be turned off with the power button for the settings to be saved.

The **MENU** key is used to enter each of the menus starting from the default screen (referred to as the *depth screen*).

The Menu System

The chart below summarizes the Digi-troll 5's menu system in the order of occurrence.

While programming, the UP key is used to increase the value and the DOWN key is used to decrease the value. Remember during programming, if there is no activity on the keypad for 7 seconds, the menu reverts back to the main *screen*.

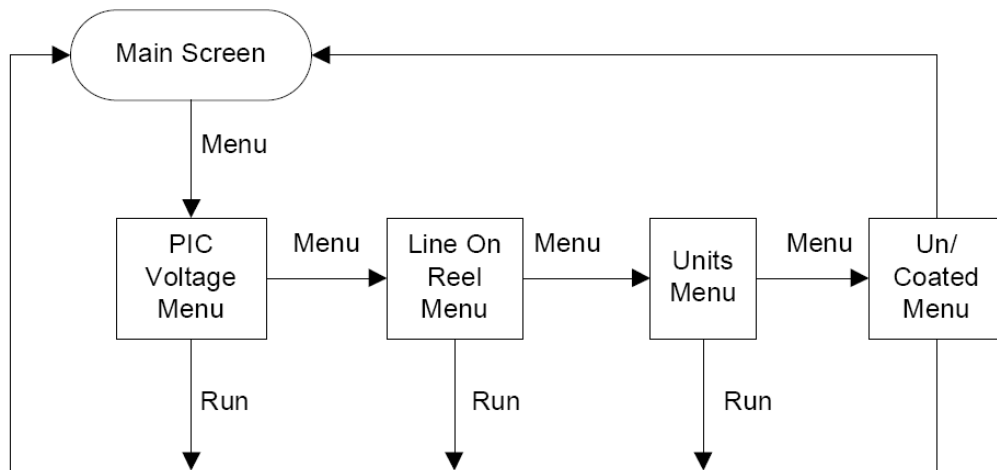

Note: If there is no button press for 7 seconds the system will exit the menu and go to the main screen.

Positive Ion Control Menu

This menu lets you control the PIC level from 0.2 vdc to 1.2 vdc.

Press the Menu four times from the depth screen or once from the up/down screen.

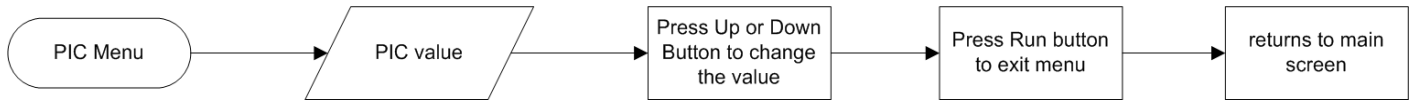

Line On Reel Menu

This menu lets you set the amount of line on the reel. Increments are in 50 ft. This setting is important in determining true line out.

Press the Menu (2) two times from the depth screen or once from the PIC screen.

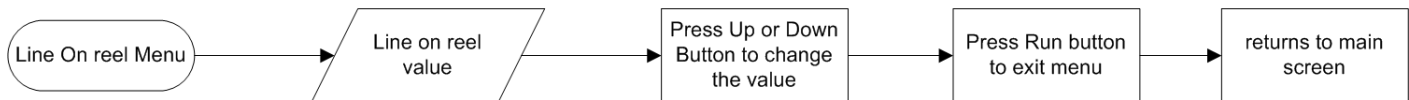

Units Menu

This menu lets you switch between English and Metric units.

Press the Menu (3) three times from the depth screen or once from the Line On Reel Screen

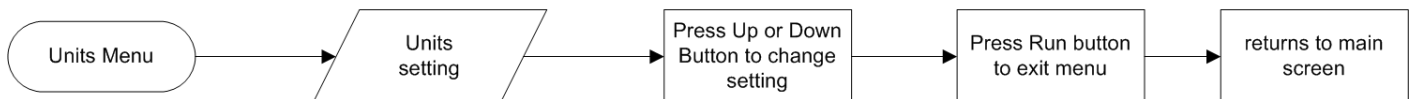

NOTE: The PIC and Line On Reel menus are NOT accessible through the downrigger when connected to Cannonlink.

Un/Coated Menu

This menu lets you switch between Cannon coated and uncoated cable. This setting is important as well in determining accurate line out.

Press the Menu (4) four times from the depth screen or once from the Units screen.

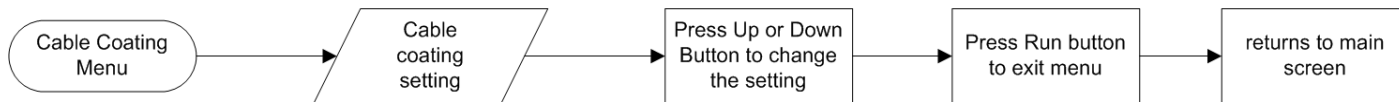

Digi-Troll Factory Settings

Your Digi-Troll 5 was shipped with the following factory settings so that you can use your downrigger immediately without further programming.

Line on Reel	400 feet
PIC	0.6 vdc
Cable setting	Uncoated
Units	English

Networking your Digi-Trolls

Up to six Digi-Troll series downriggers can be networked together, with the Cannonlink accessory. To network your downriggers you will need the Relay Cable Accessory (019634) between each downrigger you would like to link. The Cannonlink cable will install to the Data In connector on the first downrigger. Connect all other downriggers by connecting the Relay Cable Accessory from the Data Out to the Data In of the next downrigger. A terminator is needed on the last downrigger Data Out in order for the downriggers to properly communicate. This terminator is included in the Cannonlink accessory.

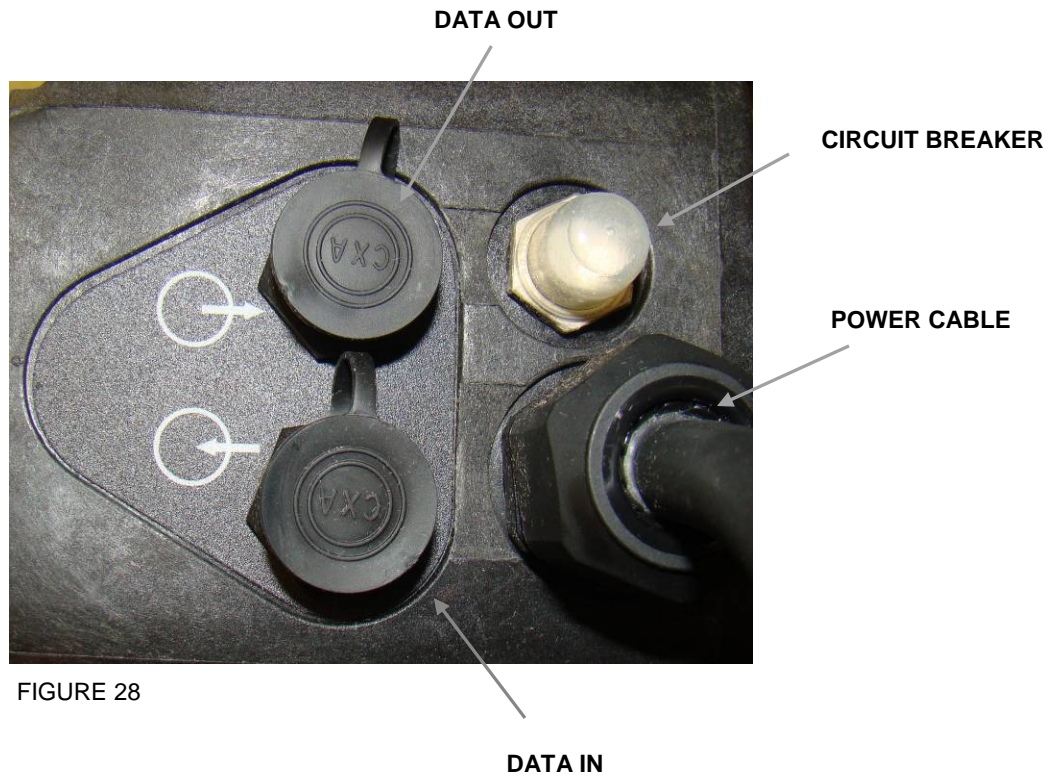

FIGURE 28

Optional Intellitroll Accessory

The Digi-Troll series is compatible with the Cannon Intellitroll Speed and Temp sensor. The Intellitroll sensor gives the user the speed, temperature, and depth at the weight. The Digi-Troll 5 downriggers are compatible with the Intellitroll but only when connected to the Cannonlink system. The Digi-Troll 5 will pass the Intellitroll data to the Humminbird fishfinder for display on the fishfinder screen.

Fishing With Your Downrigger

After programming your Digi-Troll, release some line from your rod and reel so that the lure is anywhere from 5 to 100 feet behind the boat. This is called drop back. Attach the fishing line firmly into the line release. Press and hold the down key to lower the weight to the desired depth as indicated on the display or select a pre-programmed weight depth. Place the fishing rod in the rod holder and reel up the slack so that your rod has a slight bend in it. When a fish strikes the lure, the line will separate from the release. Then you will be free to fight the fish and bring it in on your rod and reel.

Manual Descent

By turning the clutch knob gently clockwise (toward the boom), you can let your trolling weight descend as fast or as slowly as you wish. Turning the knob counter-clockwise (away from the boom) stops the weight. This gives you control to let it plunge rapidly or sink slowly to a predetermined trolling depth. With multiple downriggers, you could start all your weights creeping down, one at a time, and then stop them each in turn.

Note: In order to track line out, the Digi-Troll must be turned on.

WARNING—DO NOT TOUCH THE CABLE REEL WHILE THE DOWNRIGGER IS IN USE!

The Short Stop System

The Short Stop system is composed of three critical components: the electronic unit, the reel conductive path, and the trolling weight insulator.

While the downrigger cable is in the water, there is a minute electrical current that flows between the cable and the grounded metal boat components in the water. When the cable clears the water, this current flow will stop. The Short Stop system senses this interruption and turns off the motor. The trolling weight insulator is used to break the cable contact to the water while the weight is still in the water. The reel conductive path allows the circuit path to be made through the structure of the downrigger.

NOTICE: Short stop and Positive Ion Control features do not function when spooled with monofilament or super lines.

The Positive Ion Control System

Your boat has an electrical charge around the hull in water. If a boat is properly grounded and has a proper zinc anode, that charge should be slightly positive when measured from ground to the downrigger cable. Positive Ion Control (PIC) is the use of electricity to control that charge and its fluctuation so that it is always maintained at a specified set voltage.

The practice of setting up and maintaining a slight positive charge on fishing gear has been used by commercial fishermen for many years. This practice has enabled some fisherman to increase yield when used along with other good fishing and boating practices.

Cannon's electric downriggers offer fishermen a big advantage in being able to stabilize and control the positive charge around their boat. Because of the composite construction of the frame, Cannon downriggers are insulated from your boat's hull charge.

When the stainless steel downrigger cable is lowered into the water, the natural ionization between the cable and the boat creates a positive charge of 0.7 to 0.9 volts in saltwater and 0.3 to 0.6 volts in fresh water. This natural voltage is dependent upon salinity and mineral content of the water. Your actual voltage may vary.

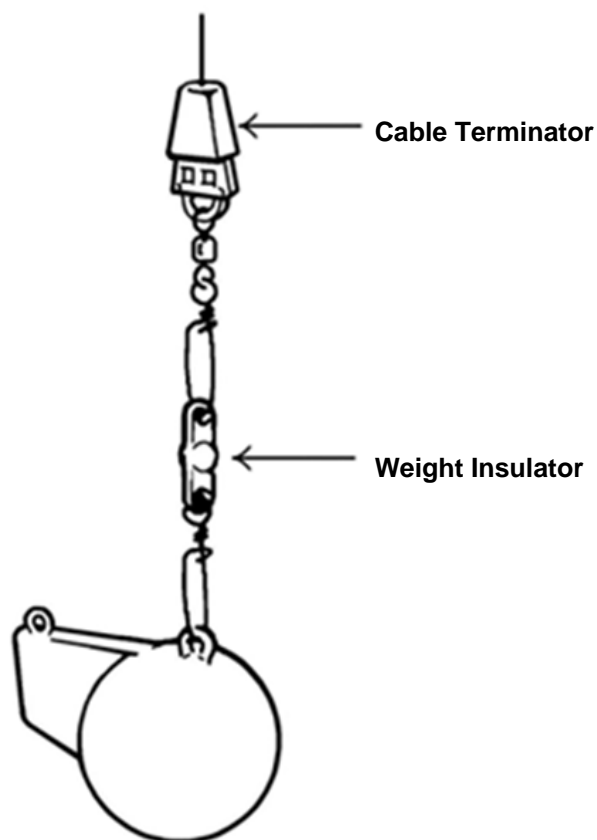

How the Positive Ion Control System Works

The PIC system uses an internal circuit that passes the voltage through the drive train of the Digi-Troll to the shaft. The shaft contacts the cable by means of a ball bearing, spring and, lastly, a one direction button head screw. Care must be taken to ensure contact between the cable and the screw when replacing the cable. When using coated cable, 3-4 ft of coating must be striped when terminating the cable to reel. Take care in ensuring that the striped portion is in contact with the button head screw.

The Positive Ion Control system applies a variable 0.2 to 1.2 volts on the trolling cable at all times.

Measuring the Natural Electrolysis and PIC Voltage on Your Boat

A voltmeter with a scale of zero to one volt will measure the natural electrolysis. Place the ground lead of the meter on the motor or the battery ground. Place the positive lead on the stainless steel downrigger cable while it is in the water. The downrigger must be unplugged. The voltage you measure on the volt meter is your boat's natural electrolysis voltage. Use the same set up to measure the PIC voltage; just plug in the Digi-Troll and adjust the PIC voltage desired.

Using Positive Ion Control

Positive Ion Control is very effective when trolling. The zone of attraction created at the downrigger wire will attract the fish. It is best to use a short drop back between the downrigger release and the lure. Drop backs of 10 to 20 ft. are typical. A drop back of 50 to 100 ft. will entirely negate the effects of the PIC circuit. Fishing depths greater than 125 ft. may require a slightly higher PIC voltage. If you return to shallow water fishing remember to turn the PIC voltage down again.

The correct PIC setting for best fishing advantage varies, depending on fish type and location. To fully benefit from PIC technology, it is important that you experiment with the PIC setting to find the proper voltage for the gamefish in the area.

Maintaining Your Downrigger

Periodically, lightly grease the thrust bearing and bearing race found behind the clutch knob. Replace the cable at least every two years.

There are no user serviceable parts internal to the Digi-Troll. Your warranty will be void if opened by anyone other than an authorized or factory service center. For repairs or servicing your downrigger refer to the Warranty Information section of this booklet.

Blowback

Simply stated, blowback is what happens to the downrigger weight when you pull it through the water behind your boat. As your speed increases, so does the horizontal distance between the weight and your downrigger. The faster you go, the farther the weight is behind you. The farther the weight is behind you, the shallower the weight is.

The following charts provide you with blowback information for three sizes of Cannon downrigger weights pulled at three different speeds with no lures attached and with no current. Current drag, water salinity and the use of non-Cannon products will affect your actual trolling depth.

As an example, the first chart shows that if you are trolling at 4 MPH with an 8 pound weight and you have 100 FT. of cable in the water with no current; the downrigger ball is actually at a depth of about 80 FT.

Blowback Charts

8-Lb. Weight at 2, 4, and 6 MPH

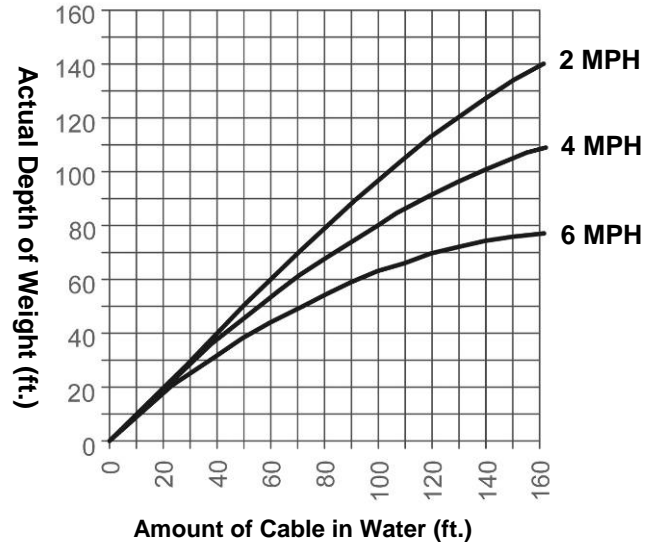

10-Lb. Weight at 2, 4, and 6 MPH

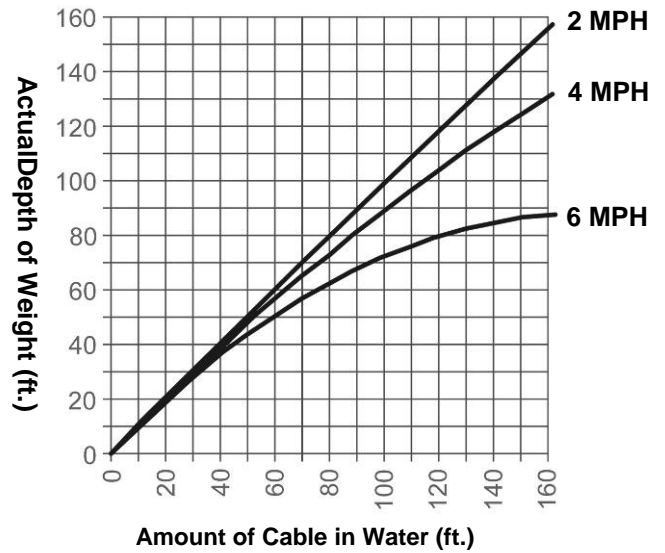

12-Lb. Weight at 2, 4, and 6 MPH

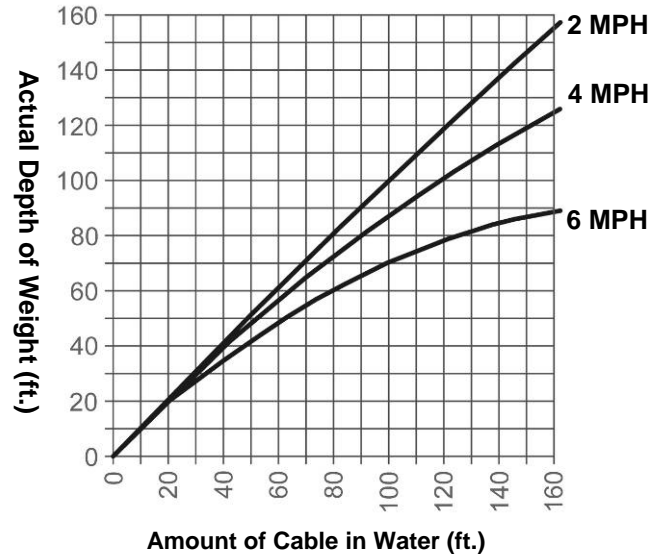

Ten Good Trolling Tips

1) Test your lures over the boat side before sending them down and back. Do this to make sure the lure wiggles and wobbles properly without going belly up or wandering off. Some lures can be adjusted, fine tuned actually, to impart maximum action. For example, a slight bend in the tail of a spoon or twist of the hook eye in the nose of a plug can make a noticeable difference in how the lure performs.

Also, when running two or more lures, make sure the offerings are compatible. Lures that run out of harmony with each other are bound to tangle and that means wasted time to straighten out the mess. Testing them first will avoid the problem.

2) Consider different sizes, shapes, and colors of lures. No one has ever figured out with precision what makes a fish strike or snub a lure. There is no doubt, that matching the forage (minnows, crayfish, etc.) in color, shape, action, and size can help trigger those strikes from hungry fish. On the other hand, if fish such as bluegills, small mouth bass or Coho salmon are protecting spawning beds, they may attack whatever is threatening. So, bright colors in lures may out produce bland colors.

3) Vary trolling speeds. Goosing the engine now and then or slowing to a crawl every so often will change the action of the lures and may get fish to strike them.

4) Vary trolling patterns and lead lengths. The amount of line you let out often determines how deep the lure will run and, to some extent, what degree of action it will impart. For starters, consider running lures about ten feet behind downrigger weights. If flat line trolling, put them back about fifty feet, then experiment depending on what the fish do.

Trolling patterns affect lure action too, that is why some anglers like to wheel a lazy S course. On turns, outside lures will speed up momentarily while inside lures hang for a moment or two. Fish may nail lures that change speeds. Also, zigzag patterns allow for more water coverage, plus it keeps lures out of propeller boil, an important consideration for browns and other wary species.

5) Locate fish on a vertical plane. Place lures in areas where fish might be. Skilled fishermen call these areas the "strike zones". They include the edges of the weed beds, structure along bottom, drop-offs, preferred temperature of the target species, and the thermocline. Remember

that fish occupy certain areas for certain reasons (sources of food, protective cover, preferred temperatures, etc.).

6) Consider special knots and swivels. A good ball bearing swivel will all but eliminate line twist and will aid in getting maximum performance from a lure. Many anglers add the tiny swivels to split rings already on the lure itself. On the other hand, a swivel may dampen the action of a sensitive lure, such as a Rapala. Some fisherman tie tiny improved clinch or loop knots. Loop knots in particular may enhance up and down and side to side action of lures. Any good fishing manual will explain how to tie these and other knots.

7) Consider releases for flatline trolling. A good tip is to secure a piece of downrigger cable or heavy monofilament to the water ski hook or handle below the transom of most boats. To the other end of the mono or cable, add a pinch-r-release. After letting out your lure to the desire distance, put the rod in its holder, then bend the tip and secure the fishing line in the release.

8) Add a weed guard. Having trouble with weeds hanging up lures? Consider tying a three-inch piece of monofilament a foot above the lure. Leaves, smaller weeds and other debris may catch here momentarily then fall off to the side of the lure without tangling. Weedless lures are another smart consideration. Downrigger cables are effective weed catchers when trolling for pike, muskies, or bass in weed-infested lakes.

9) Add a stinger hook. When fish short strike, slap at lures without becoming hooked, adding a stinger hook can solve the problem. Simply tie a treble hook to one end of a four inch piece of monofilament and then tie the extra hook to the last gang of hooks on your lure. The stinger hook, which trails the lure, provides extra insurance.

10) Keep hooks sharp. Some of the best fishermen sharpen all hooks after every fish caught. Hooks get dull through both use and misuse, and probably more fish are lost to dull points than anything else.

Troubleshooting

PROBLEM:

In the UP or AUTO-UP mode the downrigger stops periodically but the display stays on or the circuit breaker trips repeatedly.

SOLUTION:

- Low battery. The battery voltage at the power cord is less than 11.5 volts (measure with a volt meter while the downrigger is pulling up the weight).
- Power cable is too long or too small in diameter.
- Do not overload the downrigger. It is designed to lift up to 20 lb. weights only.

PROBLEM:

Unit does not turn on.

SOLUTION:

- Check polarity on power cable.
- Check circuit breaker(s)

PROBLEM:

Unit does not count the amount of cable retrieved correctly.

SOLUTION:

Verify the correct line type (Coated/Uncoated) and line on reel is set to the correct length.

PROBLEM:

Unit does not count the depth correctly.

SOLUTION:

- Current was interrupted and circuit board was reset.
- Check power cable connections and try to prevent power interruption.
- Retrieve the trolling weight using UP or AUTO-UP.
- Unplug the power cable for 30 seconds and then reconnect.
- Reset the Zero Depth to your desired position.
- Verify all magnets are present in the spool.

PROBLEM:

Clutch slips

SOLUTION:

- Retighten clutch knob. Clutch knob should be just tight enough that the clutch does not slip when downrigger is in normal use. Do not use tools of any kind to tighten the clutch, hand tightening should always be sufficient.
- Check clutch disc condition by removing side cover and spool. Replace if necessary.

PROBLEM:

Unit does not stop at water line.

SOLUTION:

Using the up and down buttons, adjust the weight so it is at or a little below the water line. Use the Water Zero button to set that as the new water zero point. Note: due to cable stack this water zero point may shift up or down. It may have to be adjusted continuously depending on the amount of up and down cycles.

THIS PAGE INTENTIONALLY LEFT BLANK

1902315 Digi-Troll 5

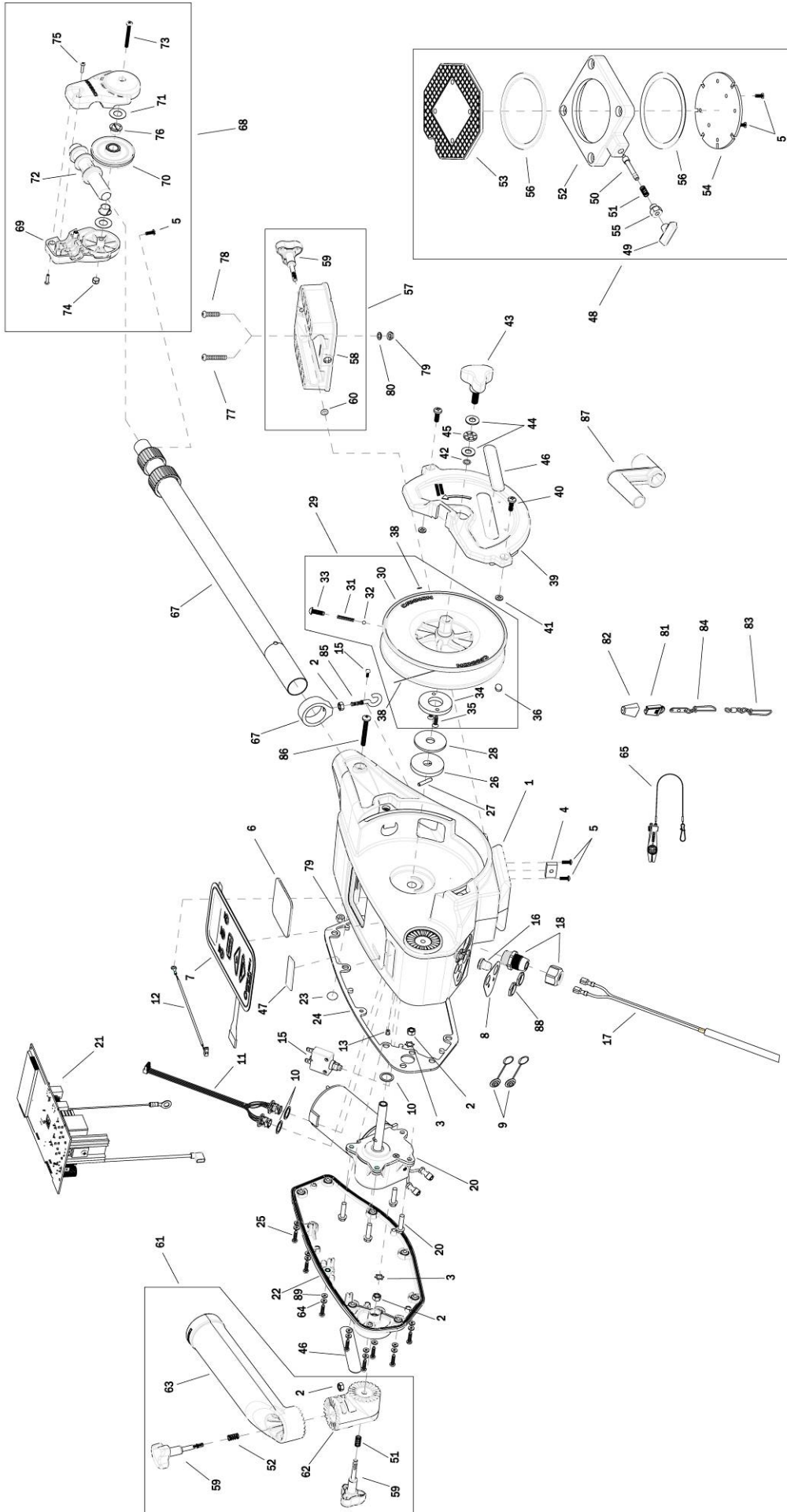

1902315 Digi-Troll 5

In the U.S.A., replacement parts may be ordered directly from CANNON Parts Dept., 121 Power Drive, Mankato, Minnesota 56001. Be sure to provide the MODEL and SERIAL numbers of your downrigger when ordering parts. Please use the correct part numbers from the parts list. Payment for any parts ordered from the CANNON parts department, may be by cash, personal check, MasterCard or VISA. To order, call 1-800-227-6433 or FAX 1-800-527-4464.

1	3392524	FRAME, RAW	31	3392707	SPRING, REEL	61	3991904	ASSY-CNN, ROD HOLDER
2	2263102	NUT-HEX 1/4-20 SS 300SR5	32	3396020	BALL BEARING, REEL	62	3394200	ARM, DUAL AXIS-ROD HOLDER
3	3394722	INSERT, PUSH ON	33	3393474	SCREW-DRIVE #14 X .75" SS	63	3392033	TUBE, DUAL AXIS RD HLDR
4	3394702	INSERT, BASE	34	3391906	PLATE, CLUTCH REEL	64	3394602	WASHER, FLAT #8, SS
5	2372100	SCREW-#8-18 X 5/8 THD* (SS)	35	3393418	SCREW-#10-16X.75"HI-LO SS	65	2277002	ASY HDW RELEASE UNIVERSAL
6	3396510	LENS-WINDOW MAG DTIV	36	1459666	CERAMIC MAGNET P/N 42-B-5020	66	2210821	ASY BOOM TELESCOPIC
7	3394015	KEYPAD, DIGI-TROLL 5	37	1015391	WIRE, .034 DIA, CAMO BULK	67	3397900	BALL HOOK EXTRUSION
8	3396602	SEAL PLATE, DT5	38	9100070	CON LEADER SLEEVE	68	3990200	ASSY-CNN, BOOM END (SUB)
9	700176	CON XCAP MINI-CON PANEL MOUNT	39	3390205	COVER, REEL	69	3392520	CASE, PULLEY
10	3391730	WASHER, SEAL, DATA	40	2373434	SCREW-1/4-20 X 3/4 SS PPMS	70	3392300	SHEEVE, PULLEY
11	3391220	HARNES, COMM	41	2071718	WASHER #10 NYLON RETAINING	71	3391507	SHIM, BOOM END
12	3391223	HARNES, RF ANTENNA	42	3394605	O-RING, KNOB	72	3392013	BOOM END, NEW
13	1234002	HDW INSERT SS PRESS 1/4IN(SUB)	43	3390103	KNOB, SOFT GRIP, CLUTCH	73	3393485	SCREW-#10-24X1.75 PPHMS S
14	3393426	SCREW-#6-32x3/8,TRIM'D HEX CAP	44	9010310	HDW WASHER, THRUST	74	3393124	NUT-#10-32 NYLOK 18-8 SS
15	3398205	CIRCUIT BREAKER, 25 AMP	45	9010280	HDW BEARING, THRUST	75	2303412	SCREW-#6-20 X 5/8 SELF TAP
16	1221491	BOOT CIRCUIT BREAKER	46	3396634	DECAL- SIDE, BLACK	76	3390005	BEARING-NYLINER, #8L5-1/2-F
17	3993220	ASSY, POWER CABLE, RETRO(SUB)	47	3395710	DECAL-PIC BLACK	77	9280720	HDW SCR 1/4 20X2 TRUSS HD PHIL
18	3392920	STRAIN-RELIEF, HEYCO M4502	48	2998905	CNN ASY, SWIVEL BASE	78	9280713	HDW SCR 1/4 20X1 1/2 TRUSS HEA
19	3996515	MOTOR/GEAR HOUSING ASSY	49	2249001	HDW KNB RELEASE PIN	79	2263103	NUT-1/4-20 NYLOCK SS
20	3393411	SCREW-FLANGE HEX HI-LO	50	3392600	PIN - RELEASE	80	2371712	WASHER-FLAT 9/32 X 5/8 X 1/16
21	3394007	ASY PCA,DIGI-TRLL 5,5TS	51	2287002	HDW SPRING RELEASE PIN	81	9100100	CON TERMINATOR
22	3390203	COVER, MOTOR	52	2267001	ASY PLATE BASE MACHINED	82	9100101	CUSHION SLEEVE TERMINATOR
23	401966-3	MIC VENT,PTFE LU LRA MATERIAL	53	2267002	BRK PLATE SWIVEL	83	9100620	HDW SNAP SWIVEL 4/0-37 MARLIN
24	3396902	GASKET, COVER	54	3391919	PLATE, INDEX TS	84	2200148	ASY SNAP & INSULATOR
25	3393480	SCREW-#10X.75"PPH HI-LO SS	55	2277001	HDW RETAINER RELEASE NUT	85	9040040	HDW BOLT 1/4-20 ROLLEDTHD HOOK
26	3391907	PLATE, CLUTCH SHAFT	56	9010004	HDW BEARING SWIVEL BASE	86	3393461	SCREW-1/4-20 x 2" SS, PPH
27	3392640	PIN, DRIVESHAFT	57	3991930	ASY, MNT BASE DT/MAG(SUB)	87	3390910	HANDLE-CRANK, MANUAL
28	3391711	PAD, CLUTCH	58	3391955	BASE-MOUNT, DT PROMAG ST	88	3393113	NUT, HEX, MINI-CON-X
29	3397927	REEL, 3.75" OD - NO GEAR	59	3390101	KNOB-CANNON, SOFT GRIP	89	3391732	WASHER, SEALING
30	3397907	REEL, ROUGH, 3.75" OD	60	3393000	RING, RETAINING, 1/4" SHAFT			

1902320 Digi-Troll 5 TS

In the U.S.A., replacement parts may be ordered directly from CANNON Parts Dept., 121 Power Drive, Mankato, Minnesota 56001. Be sure to provide the MODEL and SERIAL numbers of your downrigger when ordering parts. Please use the correct part numbers from the parts list. Payment for any parts ordered from the CANNON parts department, may be by cash, personal check, MasterCard or VISA. To order, call 1-800-227-6433 or FAX 1-800-527-4464.

1	3392525	FRAME, TS	29	3397907	REEL, ROUGH, 3.75" OD	57	3392033	TUBE, DUAL AXIS RD HLDR
2	2263102	NUT-HEX 1/4-20 SS 300SRS	30	1459666	CERAMIC MAGNET P/N 42-B-5020	58	2200109	SALTWATER RELEASE
3	3394722	INSERT, PUSH ON	31	1015391	WIRE, .034 DIA, CAMO BULK	59	3394602	WASHER, FLAT, #8, SS
4	3394702	INSERT, BASE	32	9100070	CON LEADER SLEEVE	60	3392010	ASY BOOM TELESCOPIC, SS
5	2372100	SCREW-#8-18 X 5/8 THD* (SS)	33	3390206	COVER, REEL, TS	61	3397900	BALL HOOK EXTRUSION
6	3396510	LENS-WINDOW MAG DTIV	34	2373434	SCREW-1/4-20 X 3/4 SS PPM5	62	3990200	ASSY-CNN, BOOM END (SUB)
7	3394015	KEYPAD, DIGI-TROLL 5	35	2071718	WASHER #10 NYLON RETAINING	63	3392520	CASE, PULLEY
8	3396602	SEAL PLATE, DT5	36	3394605	O-RING, KNOB	64	3392300	SHEEVE, PULLEY
9	700176	CON XCAP MINI-CON PANEL MOUNT	37	3390103	KNOB, SOFT GRIP, CLUTCH	65	3391507	SHIM, BOOM END
10	3391730	WASHER, SEAL, DATA	38	9010310	HDW WASHER, THRUST	66	3392013	BOOM END, NEW
11	3391220	HARNES, COMM	39	9010280	HDW BEARING, THRUST	67	3393485	SCREW-#10-24X1.75 PPHMS S
12	3391223	HARNES, RF ANTENNA	40	3395634	DECAL- SIDE, BLACK	68	3393124	NUT-#10-32 NYLOK 18-8 SS
13	1234002	HDW INSERT SS PRESS 1/4IN(SUB)	41	3395711	DECAL-PIC TS	69	2303412	SCREW-#6-20 X 5/8 SELF TAP
14	3393426	SCREW-#6-32x3/8,TRIM'D HEX CAP	42	2998905	CNN ASY, SWIVEL BASE	70	3390005	BEARING-NYLINER, #8L5-1/2-F
15	3398205	CIRCUIT BREAKER, 25 AMP	43	2249001	HDW KNB RELEASE PIN	71	9280720	HDW SCR 1/4 20X2 TRUSS HD PHIL
16	1221491	BOOT CIRCUIT BREAKER	44	3392600	PIN - RELEASE	72	9280713	HDW SCR 1/4 20X1 1/2 TRUSS HEA
17	3993220	ASSY, POWER CABLE, RETRO(SUB)	45	2287002	HDW SPRING RELEASE PIN	73	2263103	NUT-1/4-20 NYLOCK SS
18	3392920	STRAIN-RELIEF, HEYCO M4502	46	2267001	ASY PLATE BASE MACHINED	74	2371712	WASHER-FLAT 9/32 X 5/8 X 1/16
19	3996515	MOTOR/GEAR HOUSING ASSY	47	2267002	BRK PLATE SWIVEL	75	9100100	CON TERMINATOR
20	3393411	SCREW-FLANGE HEX HI-LO	48	3391919	PLATE, INDEX TS	76	9100101	CUSHION SLEEVE TERMINATOR
21	3394007	ASY PCA,DIGI-TRLL 5,5TS	49	2277001	HDW RETAINER RELEASE NUT	77	9100620	HDW SNAP SWIVEL 4/0-37 MARLIN
22	3390204	COVER, MOTOR, TS	50	9010004	HDW BEARING SWIVEL BASE	78	2200148	ASY SNAP & INSULATOR
23	401966-3	MIC VENT,PTFE LU LRA MATERIAL	51	3991930	ASY, MNT BASE DT/MAG(SUB)	79	9040040	HDW BOLT 1/4-20 ROLLEDTHD HOOK
24	3396902	GASKET, COVER	52	3391955	BASE-MOUNT, DT PROMAG ST	80	3393461	SCREW-1/4-20 x 2" SS, PPH
25	3393480	SCREW-#10X.75"PPH HI-LO SS	53	3390101	KNOB-CANNON, SOFT GRIP	81	3390910	HANDLE-CRANK, MANUAL
26	3391907	PLATE, CLUTCH SHAFT	54	3393000	RING, RETAINING, 1/4" SHAFT	82	1459666	CERAMIC MAGNET
27	3392640	PIN, DRIVESHAFT	55	3991904	ASSY-CNN, ROD HOLDER	83	3393113	NUT, HEX, MINI-CON-X
28	3391711	PAD, CLUTCH	56	3394200	ARM, DUAL AXIS-ROD HOLDER	84	3391732	WASHER, SEALING

Digi-Troll 5 Series Wiring Diagram

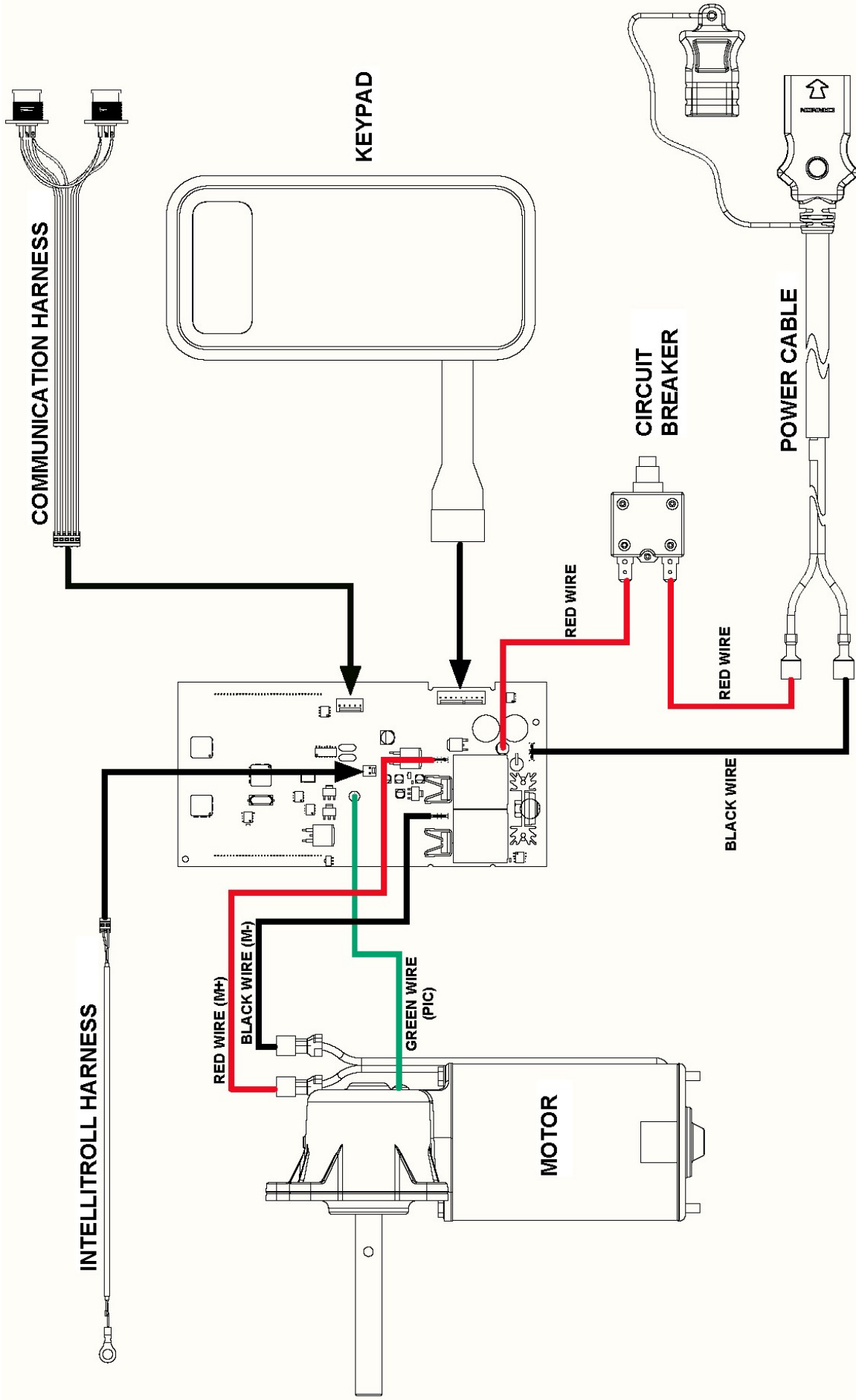

ENVIRONMENTAL COMPLIANCE STATEMENT:

It is the intention of Johnson Outdoors Marine Electronics, Inc. to be a responsible corporate citizen, operating in compliance with known and applicable environmental regulations, and a good neighbor in the communities where we make or sell our products.

WEEE Directive:

EU Directive 2002/96/EC "Waste of Electrical and Electronic Equipment Directive (WEEE)" impacts most distributors, sellers, and manufacturers of consumer electronics in the European Union. The WEEE Directive requires the producer of consumer electronics to take responsibility for the management of waste from their products to achieve environmentally responsible disposal during the product life cycle.

WEEE compliance may not be required in your location for electrical & electronic equipment (EEE), nor may it be required for EEE designed and intended as fixed or temporary installation in transportation vehicles such as automobiles, aircraft, and boats. In some European Union member states, these vehicles are considered outside of the scope of the Directive, and EEE for those applications can be considered excluded from the WEEE Directive requirement.

This symbol (WEEE wheelee bin) on product indicates the product must not be disposed of with other household refuse. It must be disposed of and collected for recycling and recovery of waste EEE.

Johnson Outdoors Marine Electronics, Inc. will mark all EEE products in accordance with the WEEE Directive. It is our goal to comply in the collection, treatment, recovery, and environmentally sound disposal of those products; however, these requirements do vary within European Union member states. For more information about where you should dispose of your waste equipment for recycling and recovery and/or your European Union member state requirements, please contact your dealer or distributor from which your product was purchased.



To download product manuals or purchase Cannon products from an authorized dealer, please visit our web page at www.cannondownriggers.com



Cannon
Johnson Outdoors Marine Electronics, LLC.
121 Power Drive, Mankato, MN 56001
1-800-227-6433

©2010 Johnson Outdoors Marine Electronics, LLC. All rights reserved. Product conforms to EU EMC directive 204/108/EC and Machinery Directive 2006/42/EC.

WARNING: This product contains chemical(s) known to the state of California to cause cancer and/or reproductive toxicity.

Form No. 3397131 Rev B ECN 32601 11/10