

SONY®

LCD Digital Colour TV

Instructions on "Installing the Wall-Mount Bracket" are not supplied in the form of a separate leaflet with this TV. These installation instructions are included within this TV's instructions manual.



For useful information about Sony products

<http://www.sony-europe.com/myproduct/>

<http://www.sony.net/>

Printed in Spain



4116578112

4-116-578-11(2)

KDL-52Z4500

KDL-46Z4500

KDL-40Z4500



BRAVIA

— © 2008 Sony Corporation

4-116-578-11(2)

NOTICE FOR CUSTOMERS IN THE UNITED KINGDOM

A moulded plug complying with BS1363 is fitted to this equipment for your safety and convenience.

Should the fuse in the plug supplied need to be replaced, a 10 AMP fuse approved by ASTA or BSI to BS 1362 (i.e., marked with  or ) must be used.

If the plug supplied with this equipment is used it should be fitted with a 10 AMP FUSE otherwise the circuit should be protected by a 10 AMP FUSE at the distribution board.

If the plug supplied with this equipment has a detachable fuse cover, be sure to attach the fuse cover after you change the fuse. Never use the plug without the fuse cover. If you should lose the fuse cover, please contact your nearest Sony service station.

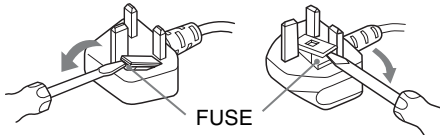

How to replace the fuse

Open the fuse compartment with a blade screwdriver, and replace the fuse.

Please refer to the illustration that actually equipped with the product.

Introduction

Thank you for choosing this Sony product.

Before operating the TV, please read this manual thoroughly and retain it for future reference.

The manufacturer of this product is Sony Corporation, 1-7-1 Konan Minato-ku Tokyo, 108-0075 Japan. The Authorized Representative for EMC and product safety is Sony Deutschland GmbH, Hedelfinger Strasse 61, 70327 Stuttgart, Germany. For any service or guarantee matters please refer to the addresses given in separate service or guarantee documents.

Notice for Digital TV function

- Any functions related to Digital TV (**DVB**) will only work in countries or areas where DVB-T (MPEG2 and MPEG4 AVC) digital terrestrial signals are broadcast or where you have access to a compatible DVB-C (MPEG2 and MPEG4 AVC) cable service. Please confirm with your local dealer if you can receive a DVB-T signal where you live or ask your cable provider if their DVB-C cable service is suitable for integrated operation with this TV.
- The cable provider may charge an additional fee for such a service and you may be required to agree to their terms and conditions of business.
- Although this TV set follows DVB-T and DVB-C specifications, compatibility with future DVB-T digital terrestrial and DVB-C digital cable broadcasts cannot be guaranteed.
- Some Digital TV functions may not be available in some countries/regions and DVB-C cable may not operate correctly with all providers.
- For more information about DVB-C functionality please see our cable support site:
<http://support.sony-europe.com/TV/DVBC/>

Trademark information

- DVB** is a registered trademark of the DVB Project
- DLNA and DLNA CERTIFIED are trademarks and/or service marks of Digital Living Network Alliance.
- GUIDE Plus+ is (1) a registered trademark or trademark of, (2) manufactured under license from and (3) subject of various international patents and patent applications owned by, or licensed to, Gemstar-TV Guide International, Inc. and/or its related affiliates.

- GEMSTAR-TV GUIDE INTERNATIONAL, INC. AND/OR ITS RELATED AFFILIATES ARE NOT IN ANY WAY LIABLE FOR THE ACCURACY OF THE PROGRAM SCHEDULE INFORMATION PROVIDED BY THE GUIDE PLUS+ SYSTEM. IN NO EVENT SHALL GEMSTAR-TV GUIDE INTERNATIONAL, INC. AND/OR ITS RELATED AFFILIATES BE LIABLE FOR ANY AMOUNTS REPRESENTING LOSS OF PROFITS, LOSS OF BUSINESS, OR INDIRECT, SPECIAL, OR CONSEQUENTIAL DAMAGES IN CONNECTION WITH THE PROVISION OR USE OF ANY INFORMATION, EQUIPMENT, OR SERVICES RELATING TO THE GUIDE PLUS+ SYSTEM.
- Manufactured under license from Dolby Laboratories. Dolby and the double-D symbol are trademarks of Dolby Laboratories.
- HDMI, the HDMI logo and High-Definition Multimedia Interface are trademarks or registered trademarks of HDMI Licensing LLC.
- "BRAVIA" and BRAVIA are trademarks of Sony Corporation.
- "XMB" and "cross media bar" are the trademarks of Sony Corporation and Sony Computer Entertainment Inc.



Table of Contents

<i>Start-up Guide</i>	4
Safety information	9
Precautions	11
Remote and TV Controls/Indicators	12
<i>Watching TV</i>	
Watching TV	16
Using GUIDE Plus+™ System and the Digital Electronic Programme Guide (EPG) DVB	18
Using the Digital Favourite List DVB	22
<i>Using Optional Equipment</i>	
Connecting Chart	23
Viewing Pictures from Connected Equipment	26
Playing Back Photo/Music via USB	27
Using BRAVIA Sync with Control for HDMI	30
Operating Optional Equipment using the TV Remote	31
<i>Using Network Features</i>	
Connecting the TV to the Network	34
Enjoying Photo/Music Files via the Network	34
Checking the Network Connection	36
Adjusting the Server Display Settings	36
<i>Using MENU Functions</i>	
Navigating through TV Home Menu (XMB™)	38
Settings	39
<i>Additional Information</i>	
Installing the Accessories (Wall-Mount Bracket)	52
Specifications	54
Troubleshooting	56

DVB : for digital channels only

 Before operating the TV, please read the "Safety information" section of this manual.
Retain this manual for future reference.

Start-up Guide

Before Use

To check the accessories

Mains lead (1)

Remote RM-ED012 (1)

Size AA batteries (R6 type) (2)

Stand (1) and screws for stand (4)
(KDL-46Z4500/KDL-40Z4500 only)

To insert batteries into the remote

Push and lift the cover to open.

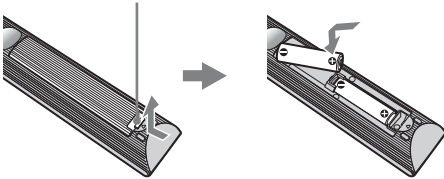

- Observe the correct polarity when inserting batteries.
- Do not use different types of batteries together or mix old and new batteries.
- Dispose of batteries in an environmentally friendly way. Certain regions may regulate the disposal of batteries. Please consult your local authority.
- Handle the remote with care. Do not drop or step on it, or spill liquid of any kind onto it.
- Do not place the remote in a location near a heat source, a place subject to direct sunlight, or a damp room.

To replace the speaker grille

The speaker grille unit can be replaced with others that are sold separately. However, do not remove the unit except to replace it. For details, see the instructions supplied with speaker grille units.

1: Attaching the stand (for KDL-46Z4500/ KDL-40Z4500)

- 1 Open the carton box and take out the stand and the screws.
- 2 Place the TV set on the stand. Take care not to interfere with cables.

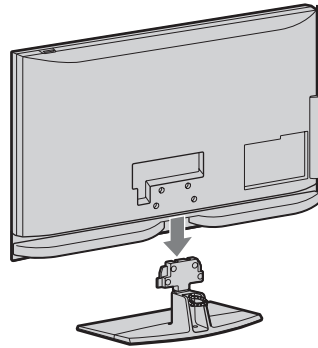

- 3 Fix the TV to the stand according to the arrow marks  that guide the screw holes using the supplied screws.

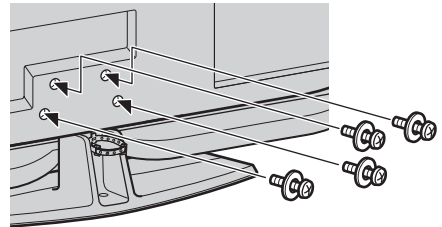

- If using an electric screwdriver, set the tightening torque at approximately 1.5 N·m { 15 kgf·cm }.

2: Connecting an aerial/Set Top Box/recorder (e.g. DVD recorder)

Connecting a Set Top Box/recorder (e.g. DVD recorder) with SCART

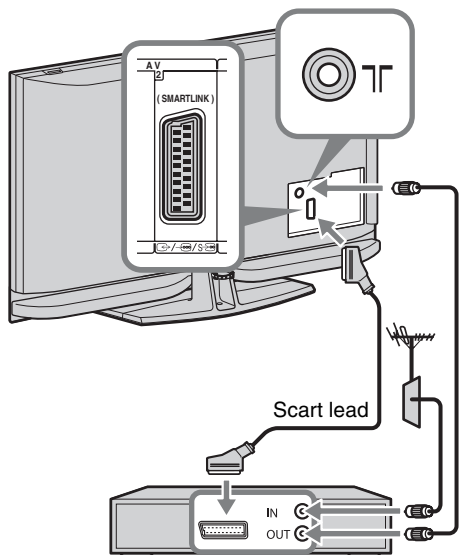

Set Top Box/recorder (e.g. DVD recorder)

Connecting a Set Top Box/recorder (e.g. DVD recorder) with HDMI

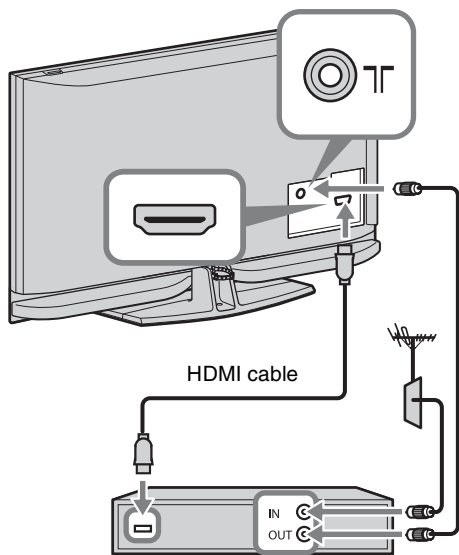

Set Top Box/recorder (e.g. DVD recorder)

3: Preventing the TV from toppling over

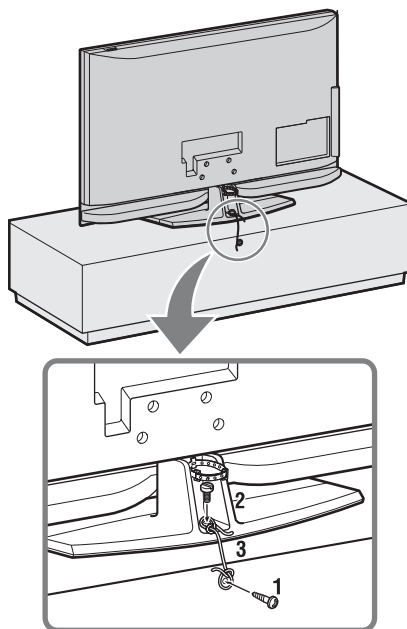

- 1 Install a wood screw (4 mm in diameter, not supplied) in the TV stand.
- 2 Install a machine screw (M6 x 12-15, not supplied) into the screw hole of the TV.
- 3 Tie the wood screw and the machine screw with a strong cord.

4: Bundling the cables

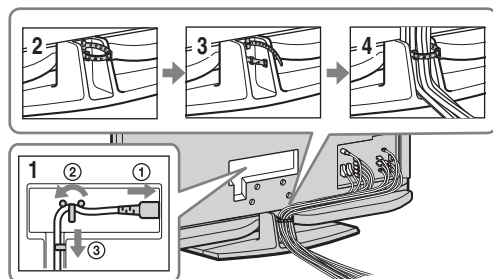

- Do not bundle the mains lead together with other cables.

5: Performing the initial set-up

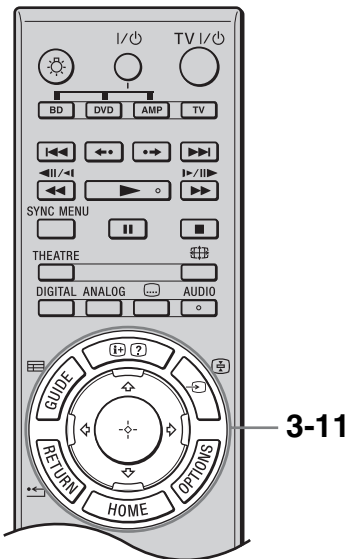
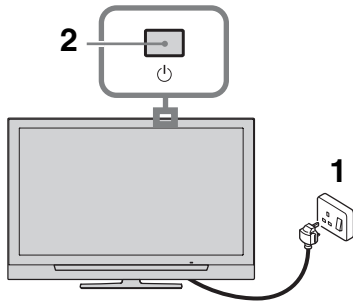

- 1 Connect the TV to your mains socket (220-240V AC, 50Hz).
- 2 Press on the TV.
When you switch on the TV for the first time, the Language menu appears on the screen.
- 3 Press to select the language displayed on the menu screens, then press .

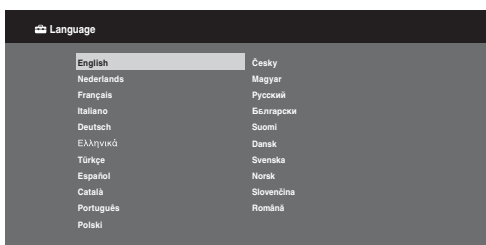

- 4 Press to select the country in which you will operate the TV, then press .

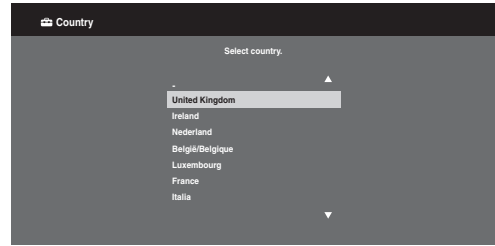

If the country in which you want to use the TV does not appear in the list, select “-” instead of a country.

- 5 Press to select the location type in which you will operate the TV, then press .



- Select “Home” for the best TV settings to use the TV in the home.

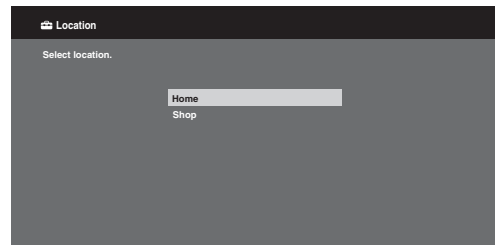

- 6 Select “Yes” then press .

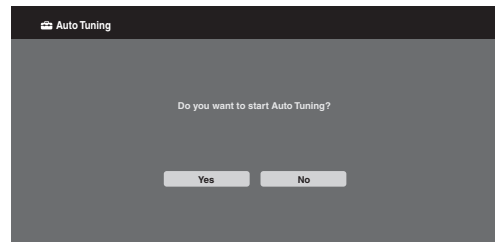

- 7 Press to select “Antenna” or “Cable”, then press .

If you select “Cable”, the screen for selecting the scan type appears. See “To tune the TV for Cable connection” (page 7).

The TV starts searching for all available digital channels, followed by all available analogue channels. This may take some time, so do not press any buttons on the TV or remote while proceeding.

If a message appears for you to confirm the aerial connection

No digital or analogue channels were found. Check all the aerial/cable connection and then press ⊕ to start auto-tuning again.

- 8** When the Programme Sorting menu appears on the screen, follow the steps of “Programme Sorting” (page 46).

If you do not change the order in which the analogue channels are stored on the TV, press  **RETURN** to go to step 9.

9

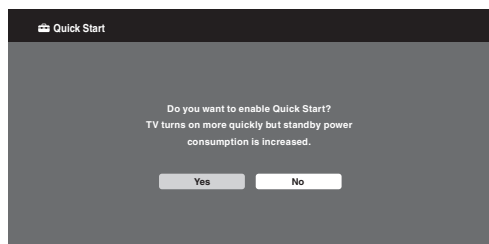

For details, see page 41.

10

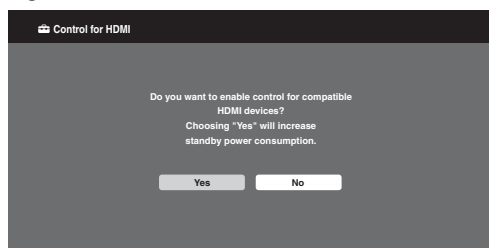

For details, see page 30.

Following this step, GUIDE Plus+ setting screen appears only when GUIDE Plus+ is available.

- 11** Press ⊕.

The TV has now tuned in all the available channels.



- When a digital broadcast channel cannot be received, or when selecting a country in which there are no digital broadcasts in step 4, the time must be set after performing step 8.

To tune the TV for Cable connection

- 1 Press ⊕.
- 2 Press ⇅ to select “Quick Scan” or “Full Scan”, then press ⊕.

“Quick Scan” : channels are tuned according to the cable operator information within the broadcast signal. Recommended setting for “Frequency”, “Network ID” and “Symbol Rate” is “Auto.”

This option is recommended for fast tuning when supported by your cable operator.

If the “Quick Scan” does not tune, please use the “Full Scan” method below.

“Full Scan” : All available channels are tuned and stored. This procedure may take some time.

This option is recommended when “Quick Scan” is not supported by your cable provider.

For further information about supported cable providers, refer to support web site: <http://support.sony-europe.com/TV/DVBC/>

- 3 Press ⇅ to select “Start”, then press ⊕.

The TV starts searching for channels. Do not press any buttons on the TV or remote.



- Some cable providers do not support “Quick Scan.” If no channels are detected using “Quick Scan”, perform “Full Scan.”

To setup GUIDE Plus+ system (only when GUIDE Plus+ system is available)*

- * Condition you can setup this feature:
- in UK, Italy, Germany or Spain.
 - you can receive digital broadcasting.
 - when “Antenna” is selected in step 7 of “ 5: Performing the initial set-up.”

- 1 Enter Postal Code of region you live using ⇅/⇅/⇅/⇅/+.



- Enter from the left, when the postal code is fewer than seven digits.

2 Select language for GUIDE Plus+.

This step will be skipped if any one of the following languages is selected in “5: Performing the initial set-up” step 3: “English”, “Deutsch”, “Español”, “Italiano”, “Français” or “Nederlands.”

3 GUIDE Plus+ Data Download.

The initial download may take some time, so do not press any buttons on the TV or remote while proceeding. Once you have received the first download of TV listings data, all future downloads will be done automatically.

Adjusting the Viewing Angle of the TV

This TV can be adjusted within the angles shown below.

Adjust the angle left and right (swivel)

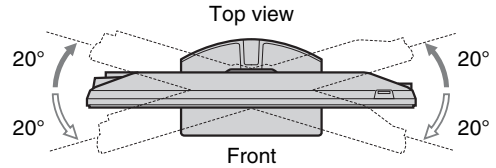

- When adjusting the angle, hold the Table-Top Stand with one hand to avoid slipping or tipping the TV.

Detaching the Table-Top Stand from the TV



- Remove the screws guided by the arrow marks  of the TV.
- Do not remove the Table-Top Stand for any reason other than listed below.
 - To wall-mount the TV.
 - To put the TV in the carton at time of purchase (KDL-46Z4500/KDL-40Z4500 only).

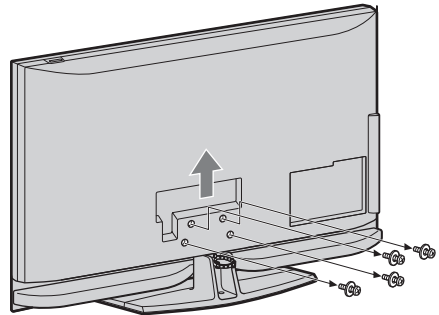

Safety information

Installation/Set-up

Install and use the TV set in accordance with the instructions below in order to avoid any risk of fire, electrical shock or damage and/or injuries.

Installation

- The TV set should be installed near an easily accessible mains socket.
- Place the TV set on a stable, level surface.
- Only qualified service personnel should carry out wall installations.
- For safety reasons, it is strongly recommended that you use Sony accessories, including:
 - Wall-mount bracket SU-WL500
- Be sure to use the screws supplied with the Wall-mount bracket when attaching the mounting hooks to the TV set. The supplied screws are designed so that they are 8 mm to 12 mm in length when measured from the attaching surface of the mounting hook. The diameter and length of the screws differ depending on the Wall-mount bracket model. Use of screws other than those supplied may result in internal damage to the TV set or cause it to fall, etc.

8mm – 12mm

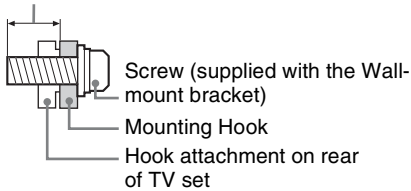

Transporting

- Before transporting the TV set, disconnect all cables.
- Two or three people are needed to transport a large TV set.
- When transporting the TV set by hand, hold it as shown on the right. Do not put stress on the LCD panel and the frame around the screen.
- When lifting or moving the TV set, hold it firmly from the bottom.
- When transporting the TV set, do not subject it to jolts or excessive vibration.
- When transporting the TV set for repairs or when moving, pack it using the original carton and packing material.

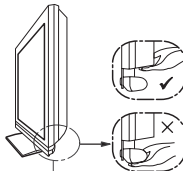
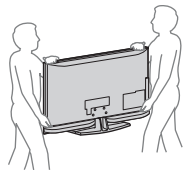

Be sure to hold the bottom of the panel, and not the transparent part, speaker, or speaker grille area. Do not compress the panel's speaker grille area.

Ventilation

- Never cover the ventilation holes or insert anything in the cabinet.
- Leave space around the TV set as shown below.
- It is strongly recommended that you use a Sony wall-mount bracket in order to provide adequate air-circulation.

Installed on the wall

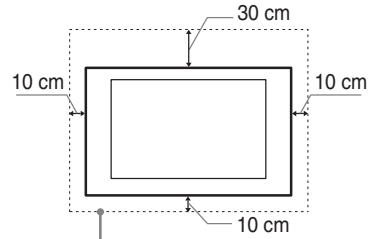

Leave at least this space around the set.

Installed with stand

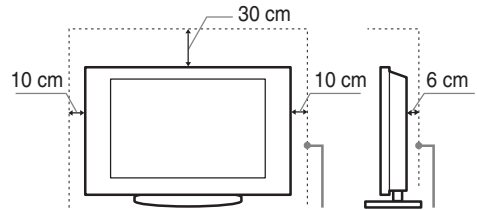

Leave at least this space around the set.

- To ensure proper ventilation and prevent the collection of dirt or dust:
 - Do not lay the TV set flat, install upside down, backwards, or sideways.
 - Do not place the TV set on a shelf, rug, bed or in a closet.
 - Do not cover the TV set with a cloth, such as curtains, or items such as newspapers, etc.
 - Do not install the TV set as shown below.

Air circulation is blocked.

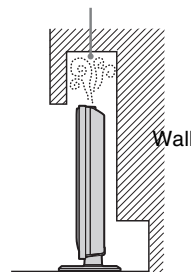

Air circulation is blocked.

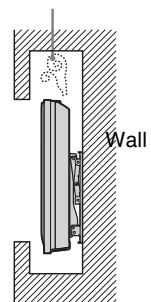

Mains lead

Handle the mains lead and socket as follows in order to avoid any risk of fire, electrical shock or damage and/or injuries:

- Use only mains leads supplied by Sony, not other suppliers.
- Insert the plug fully into the mains socket.
- Operate the TV set on a 220-240 V AC supply only.
- When wiring cables, be sure to unplug the mains lead for your safety and take care not to catch your feet on the cables.
- Disconnect the mains lead from the mains socket before working on or moving the TV set.
- Keep the mains lead away from heat sources.
- Unplug the mains plug and clean it regularly. If the plug is covered with dust and it picks up moisture, its insulation may deteriorate, which could result in a fire.

Notes

- Do not use the supplied mains lead on any other equipment.
- Do not pinch, bend, or twist the mains lead excessively. The core conductors may be exposed or broken.
- Do not modify the mains lead.
- Do not put anything heavy on the mains lead.
- Do not pull on the mains lead itself when disconnecting the mains lead.
- Do not connect too many appliances to the same mains socket.
- Do not use a poor fitting mains socket.

Prohibited Usage

Do not install/use the TV set in locations, environments or situations such as those listed below, or the TV set may malfunction and cause a fire, electrical shock, damage and/or injuries.

Location:

Outdoors (in direct sunlight), at the seashore, on a ship or other vessel, inside a vehicle, in medical institutions, unstable locations, near water, rain, moisture or smoke.

Environment:

Places that are hot, humid, or excessively dusty; where insects may enter; where it might be exposed to mechanical vibration, near flammable objects (candles, etc).

The TV set shall not be exposed to dripping or splashing and no objects filled with liquids, such as vases, shall be placed on the TV.

Situation:

Do not use when your hands are wet, with the cabinet removed, or with attachments not recommended by the manufacturer.

Disconnect the TV set from mains socket and aerial during lightning storms.

Broken pieces:

- Do not throw anything at the TV set. The screen glass may break by the impact and cause serious injury.
- If the surface of the TV set cracks, do not touch it until you have unplugged the mains lead. Otherwise electric shock may result.

When not in use

- If you will not be using the TV set for several days, the TV set should be disconnected from the mains for environmental and safety reasons.
- As the TV set is not disconnected from the mains when the TV set is just turned off, pull the plug from the mains to disconnect the TV set completely.
- However, some TV sets may have features that require the TV set to be left in standby to work correctly.

For children

- Do not allow children to climb on the TV set.
- Keep small accessories out of the reach of children, so that they are not mistakenly swallowed.

If the following problems occur...

Turn off the TV set and unplug the mains lead immediately if any of the following problems occur.

Ask your dealer or Sony service centre to have it checked by qualified service personnel.

When:

- Mains lead is damaged.
- Poor fitting of mains socket.
- TV set is damaged by being dropped, hit or having something thrown at it.
- Any liquid or solid object falls through openings in the cabinet.

Precautions

Viewing the TV

- View the TV in moderate light, as viewing the TV in poor light or during long period of time, strains your eyes.
- When using headphones, adjust the volume so as to avoid excessive levels, as hearing damage may result.

LCD Screen

- Although the LCD screen is made with high-precision technology and 99.99% or more of the pixels are effective, black dots may appear or bright points of light (red, blue, or green) may appear constantly on the LCD screen. This is a structural property of the LCD screen and is not a malfunction.
- Do not push or scratch the front filter, or place objects on top of this TV set. The image may be uneven or the LCD screen may be damaged.
- If this TV set is used in a cold place, a smear may occur in the picture or the picture may become dark. This does not indicate a failure. These phenomena disappear as the temperature rises.
- Ghosting may occur when still pictures are displayed continuously. It may disappear after a few moments.
- The screen and cabinet get warm when this TV set is in use. This is not a malfunction.
- The LCD screen contains a small amount of liquid crystal. Some fluorescent tubes used in this TV set also contain mercury. Follow your local ordinances and regulations for disposal.

Handling and cleaning the screen surface/cabinet of the TV set

Be sure to unplug the mains lead connected to the TV set from mains socket before cleaning.

To avoid material degradation or screen coating degradation, observe the following precautions.

- To remove dust from the screen surface/cabinet, wipe gently with a soft cloth. If dust is persistent, wipe with a soft cloth slightly moistened with a diluted mild detergent solution.
- Never use any type of abrasive pad, alkaline/acid cleaner, scouring powder, or volatile solvent, such as alcohol, benzene, thinner or insecticide. Using such materials or maintaining prolonged contact with rubber or vinyl materials may result in damage to the screen surface and cabinet material.
- Periodic vacuuming of the ventilation openings is recommended to ensure to proper ventilation.
- When adjusting the angle of the TV set, move it slowly so as to prevent the TV set from moving or slipping off from its table stand.

Optional Equipment

Keep optional components or any equipment emitting electromagnetic radiation away from the TV set. Otherwise picture distortion and/or noisy sound may occur.

Disposal of the TV set



Disposal of Old Electrical & Electronic Equipment (Applicable in the European Union and other European countries with separate collection systems)

This symbol on the product or on its packaging indicates that this product shall not be treated as household waste. Instead it shall be handed over to the applicable collection point for the recycling of electrical and electronic equipment. By ensuring this product is disposed of correctly, you will help prevent potential negative consequences for the environment and human health, which could otherwise be caused by inappropriate waste handling of this product. The recycling of materials will help to conserve natural resources. For more detailed information about recycling of this product, please contact your local Civic Office, your household waste disposal service or the shop where you purchased the product.



Disposal of waste batteries (applicable in the European Union and other European countries with separate collection systems)

This symbol on the battery or on the packaging indicates that the battery provided with this product shall not be treated as household waste. By ensuring these batteries are disposed of correctly, you will help prevent potentially negative consequences for the environment and human health which could otherwise be caused by inappropriate waste handling of the battery. The recycling of the materials will help to conserve natural resources. In case of products that for safety, performance or data integrity reasons require a permanent connection with an incorporated battery, this battery should be replaced by qualified service staff only. To ensure that the battery will be treated properly, hand over the product at end-of-life to the applicable collection point for the recycling of electrical and electronic equipment. For all other batteries, please view the section on how to remove the battery from the product safely. Hand the battery over to the applicable collection point for the recycling of waste batteries. For more detailed information about recycling of this product or battery, please contact your local Civic Office, your household waste disposal service or the shop where you purchased the product.

Remote and TV Controls/Indicators

Remote and TV controls

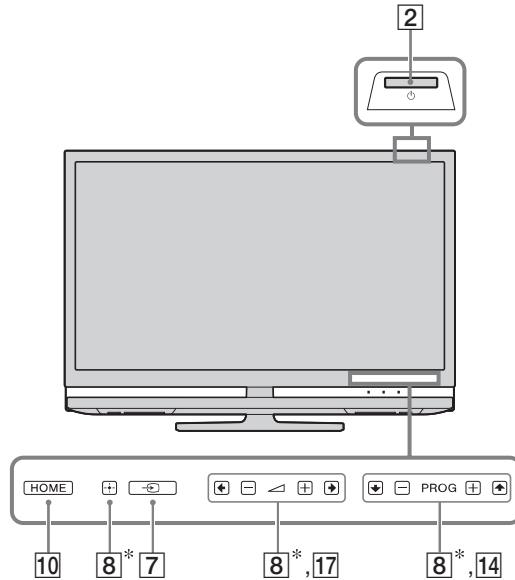

A button or touch sensors on the TV will work the same as those on the remote.

* In the TV menu, these touch sensors will work as ////.



- The number 5, button, **PROG +** and **AUDIO** buttons on the remote have a tactile dot. Use the tactile dots as a reference when operating the TV.

Button	Description
1 TV I/Power (TV standby)	Press to turn the TV on and off from standby mode.
2 (Power)	Press to turn the TV on or off. • To disconnect the TV completely, turn off the TV, then unplug the mains lead from the mains.
3 (Screen mode)	Press to change the screen format (page 17).
4 AUDIO	In analogue mode: Press to change the dual sound mode (page 41). In digital mode: Press to change the language to be used for the programme currently being viewed (page 49).
5 (Subtitle setting)	Press to change the subtitle language (page 49) (in digital mode only).

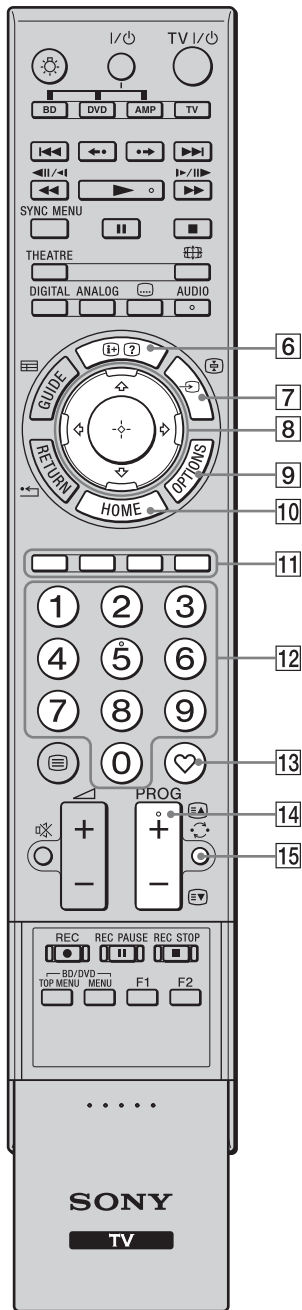



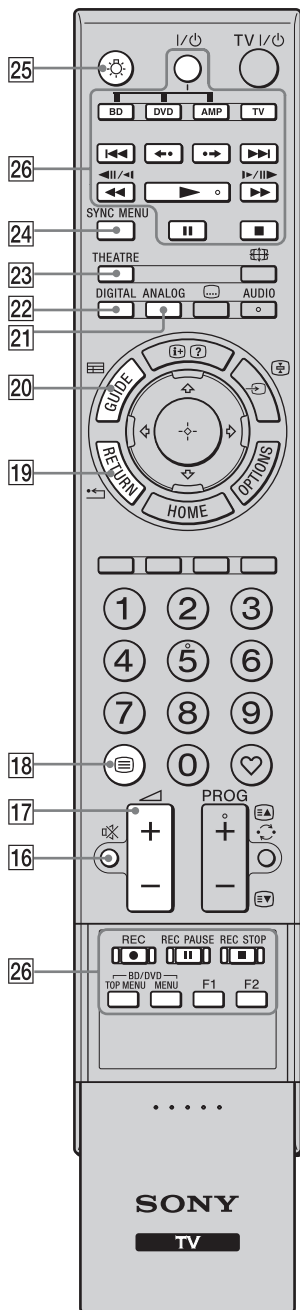

Button	Description
6 ⊕/? (Info/Text reveal)	In digital mode: Displays details of the programme currently being viewed. In analogue mode: Displays information. Press once to display the current channel number and screen mode. Press again to display clock information. Press a third time to remove the display from the screen. In Analogue Text mode (page 17): Reveals hidden information (e.g. answers to a quiz).
7 →/⊕ (Input select/Text hold)	In TV mode: Press to display a list of inputs (page 26). In Analogue Text mode: Press to hold the current page.
8 ⬆/⬇/⬅/➡/⊕	Press ⬆/⬇/⬅/➡ to move the on-screen cursor. Press ⊕ to select/confirm the highlighted item. When playing a photo file: Press ⊕ to pause/start a slideshow. Press ⬆/⬇ to select the previous file. Press ⬇/➡ to select the next file. When playing a music file: Press ⊕ to pause/start the playback. Press and hold ⬆/⬇ to fast forward/fast reverse, then release the button at the point where you want to resume playback. Press ⬆ to start playback from the beginning of the current file. Press ⬇ to go to the next file.
9 OPTIONS	Press to display a list that contains “PAP” (page 26), “PIP” (page 27), “Device Control”, or shortcuts to some setting menus. Use the “Device Control” menu to operate equipment that is compatible with control for HDMI. The listed options vary depending on the input source.
10 HOME	Press to display the TV Home menu (page 38).
11 Coloured buttons	When the coloured buttons are available, an operation guide appears on the screen. Follow the operation guide to perform a selected operation.
12 Number buttons	In TV mode: Press to select channels. For channel numbers 10 and above, press the second and third digits in quick succession. In Analogue Text mode: Press to enter a page number.
13 ♥ (Favourite)	Press to display the digital favourite list that you have specified (page 22).
14 PROG +/- (EA/EV)	In TV mode: Press to select the next (+) or previous (-) channel. In Analogue Text mode: Press to select the next (EA) or previous (EV) page.
15 ⌂ (Previous channel)	Press to return to the channel that was last viewed (for more than five seconds).

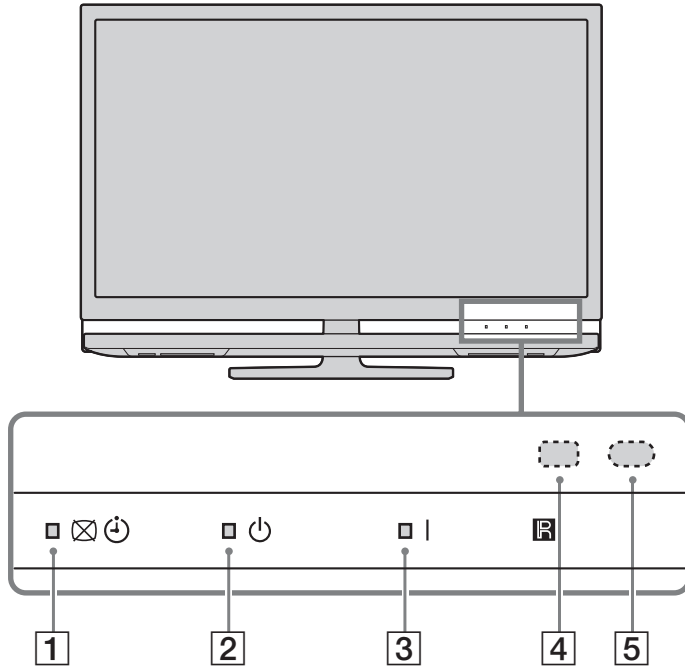

Button	Description
16 (Mute)	Press to mute the sound. Press again to restore the sound. • In standby mode, if you want to turn on the TV without sound, press this button.
17 (+/-) (Volume)	Press to adjust the volume.
18 (Text)	Press to display text information (page 17).
19 RETURN /	Press to return to the previous screen of the displayed menu. When playing a photo/music file: Press to stop the playback. (The display returns to the file or folder list.)
20 GUIDE /	Press to display the Digital Electronic Programme Guide (EPG) (page 18, 21).
21 ANALOG	Press to display the analogue channel that was last viewed.
22 DIGITAL	Press to display the digital channel that was last viewed.
23 THEATRE	You can set Theatre Mode to on or off. When Theatre Mode is set to on, the optimum audio output (if the TV is connected with an audio system using an HDMI cable) and picture quality for film-based contents are automatically set. • If you turn the TV off, Theatre Mode is also turned off. • “Control for HDMI” (BRAVIA Sync) is only available with the connected Sony equipment that has the BRAVIA Sync or BRAVIA Theatre Sync logo or is compatible with control for HDMI.
24 SYNC MENU	Displays the menu of connected HDMI equipment. While viewing other input screens or TV programmes, “HDMI Device Selection” is displayed when the button is pressed. • “Control for HDMI” (BRAVIA Sync) is only available with the connected Sony equipment that has the BRAVIA Sync logo or is compatible with control for HDMI.
25 (Light)	Press to illuminate the buttons on the remote so that you can see them easily even if the room is dark.
26 Buttons for using optional equipment	You can operate the equipment connected to the TV (page 24, 30, 31).

Indicators



Indicator	Description
1   (Picture Off/Timer indicator)	Lights up in green when the picture is switched off (page 41). Lights up in orange when the reminder is set (page 19, 21) or the timer is set (page 43).
2  (Standby indicator)	Lights up in red when the TV is in standby mode.
3  (Power indicator)	Lights up in green when the TV is turned on.
4 Light Sensor	Do not put anything over the sensor, as its function may be affected.
5 Remote control sensor	Receives IR signals from the remote. Do not put anything over the sensor, as its function may be affected.



- Make sure that the TV is completely turned off before unplugging the mains lead. Unplugging the mains lead while the TV is turned on may cause the indicator to remain lit or may cause the TV to malfunction.
- Do not put anything over the indicators as their functions may be affected.

Watching TV

Watching TV

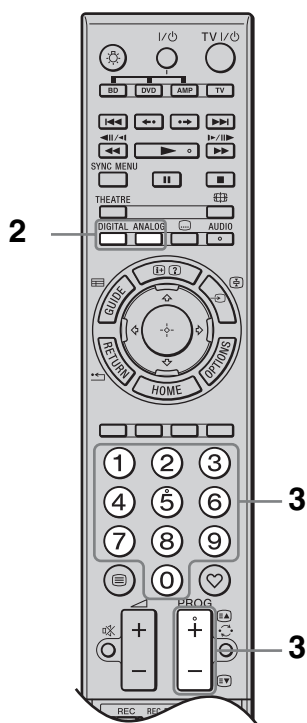
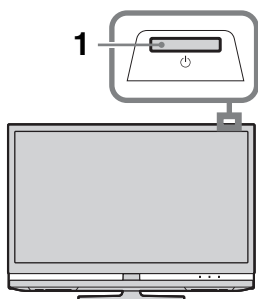

- 1 Press on the TV to switch on the TV. When the TV is in standby mode (the (standby) indicator on the TV (front) is red), press **TV I/** on the remote to switch on the TV.
- 2 Press **DIGITAL** to switch to digital mode or **ANALOG** to switch to analogue mode. The channels available vary depending on the mode.
- 3 Press the number buttons or **PROG +/-** to select a TV channel.

To select channel numbers 10 and above using the number buttons, enter the second and third digits within two seconds.

To select a digital channel using the Guide, see page 18 or 21.

In digital mode

An information banner appears briefly. The following icons may be indicated on the banner.

- : Interactive service (MHEG Digital Text) is available
- : Interactive service (MHEG Digital Text) is currently disabled
- : Radio service
- : Scrambled/Subscription service
- : Multiple audio languages available
- : Subtitles available
- : Subtitles available for the hearing impaired
- : Recommended minimum age for current programme (from 4 to 18 years)
- : Parental Lock

Additional operations

To	Do this
Turn on the TV from Standby mode without sound	Press . Press +/- to set the volume level.
Adjust the volume	Press + (increase)/ - (decrease).

To access Digital Text

Many broadcasters provide a Digital Text service. Digital Text offers graphically rich contents, compared to Analogue Text. Select a digital channel which provides Digital Text, then press **⊞**.

When a broadcaster provides a dedicated Digital Text channel, select this channel to access Digital Text.

To navigate through Digital Text, follow the instructions on the screen.

To exit Digital Text, press **↩ RETURN**.

To move around, press **↶/↷/↵/↷**.

To select items, press **⊕** and the number buttons.

To access shortcuts, press the coloured buttons.

To access Analogue Text

In analogue mode, press **⊞**. Each time you press **⊞**, the display changes cyclically as follows:

Text → Text and TV picture (mix mode) →

No Text (exit the Text service)

To select a page, press the number buttons or **PROG +/-**.

To hold a page, press **↶/⊞**.

To reveal hidden information, press **⊕/?**.



- When four coloured items appear at the bottom of the Text page, Fastext is available. Fastext allows you to access pages quickly and easily. Press the corresponding coloured button to access the page.

To change the screen format manually

Press **⊞** repeatedly to select the desired screen format.

Smart*

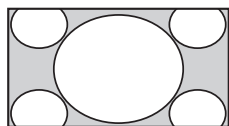

Displays conventional 4:3 broadcasts with an imitation wide screen effect. The 4:3 picture is stretched to fill the screen.

4:3

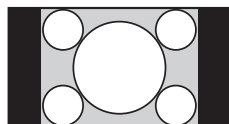

Displays conventional 4:3 broadcasts (e.g. non-wide screen TV) in the correct proportions.

Wide

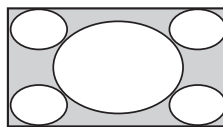

Displays wide screen (16:9) broadcasts in the correct proportions.

Zoom*

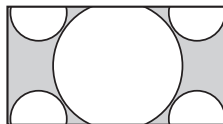

Displays cinemascopic (letter box format) broadcasts in the correct proportions.

14:9*

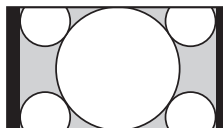

Displays 14:9 broadcasts in the correct proportions. As a result, black border areas are visible on the screen.

* Parts of the top and bottom of the picture may be cut off.



- Some characters and/or letters at the top and the bottom of the picture may not be visible in Smart mode. In such a case, you can select “Vertical Size” using the “Screen Settings” (page 43) menu and adjust vertical size to make it visible.



- When “Auto Format” is set to “On”, the TV will automatically select the best mode to suit input signal.
- You can adjust the position of the picture when selecting “Smart”, “14:9” or “Zoom.” Press **↶/↷** to move up or down (e.g. to read subtitles).

Using the Options menu

Press **OPTIONS** to display the following options when viewing a TV programme.

Options	Description
Picture Mode	See page 39.
Sound Mode	See page 40.
Surround	See page 40.
Speaker	See page 45.
Motionflow	See page 42.
Subtitle Setting (in digital mode only)	See page 49.
Sleep Timer	See page 43.
Power Saving	See page 41.
System Information (in digital mode only)	See page 50.

Using GUIDE Plus+™ System* and the Digital Electronic Programme Guide (EPG) DVB**

* Condition you can set-up this feature:

- in UK, Italy, France, Germany or Spain.
- you can receive digital broadcasting.
- when “Antenna” is selected in step 7 of “ 5: Performing the initial set-up.”

** This function may not be available in some countries/regions.

GUIDE Plus+ works with full functionality only if GUIDE Plus+ data is available by digital feed. Please check the GUIDE Plus+ website whether or not DTT Guide Plus+ is already available in your country.



- When you use GUIDE Plus+, it is recommended that you turn off your TV by using the standby button on the remote, not the power button on your TV, in order to update the programme information.

Using GUIDE Plus+

Use GUIDE Plus+ system to find the show that you want to watch. The feature allows you to search for shows by programme categories and by keyword. The GUIDE Plus+ programme provides up to eight days of TV programming information. Be sure to complete the initial set-up on page 6 to use this service.

GUIDE Plus+ System Components

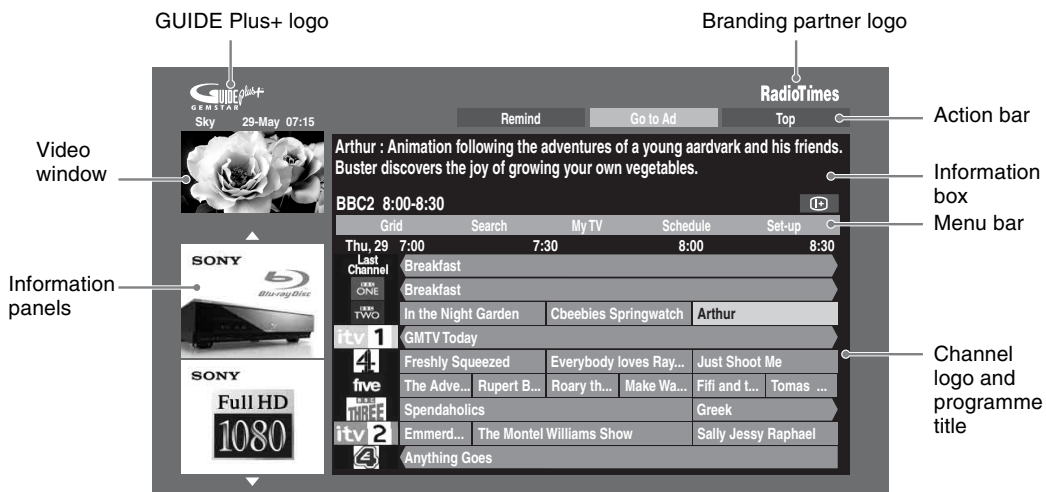

- Image shown above varies depending on country/region.
- Information panels is not Sony provided, adverts from Branding Partner.
- The function of action bar varies with cursor location and when in settings.

1 Press **GUIDE**.

2 Perform the desired operation as shown in the following table or displayed on the screen.

To	Do this
View a programme	Press $\uparrow/\downarrow/\leftarrow/\rightarrow$ to select a programme, then press \oplus .  • The programme information will appear in the information box. • Press $\oplus/?$ to access the extended information box for a long synopsis. • You can use PROG+/- to page up/down through the listings. Press BRAVIA sync \leftarrow/\rightarrow to go to the next day or one day back.
Turn off the TV Guide	Press GUIDE to exit TV Guide.

To	Do this
Set a programme to be displayed automatically on the screen when it starts – Reminder	<p>Press / / / to select a future programme you want to watch, then press the green button.</p> <p></p> <ul style="list-style-type: none"> • To cancel a reminder, press red button when the reminder is highlighted or use “Schedule” on the menu bar. • If you switch the TV to standby mode, it will automatically turn itself on when the programme is about to start.
Menu bar	<p>Press repeatedly to access the menu bar.</p> <p>Press / to select area. (“Grid”, “Search”, “My TV”, “Schedule” and “Set-up”)</p> <p>You can view a programme or set a reminder in “Grid” area.</p>
Search a programme – Search	<p>You can quickly and easily find something of interest to watch or to set a reminder by category (e.g. Sport) or subcategory (e.g. Football) of a programme.</p> <ol style="list-style-type: none"> 1 Highlight “Search” on the menu bar, then, press only one time. 2 Press / / / to select a category or subcategory, then press .
Search your own keyword – My Choice	<p>In addition to the standard categories and sub-categories, you can set your own search keywords.</p> <ol style="list-style-type: none"> 1 Highlight “My Choice” in the “Search” area on the menu bar. 2 Press yellow button to add a keyword, then the virtual keyboard appears. 3 Use the virtual keyboard to enter your keyword. 4 Confirm with the green button. 5 Your personal keyword appears in the “My Choice.” 6 Select your keyword and press to start a search according to your personal keyword.
Set a Profile and receive recommendations according to your preferences – My TV	<p>The “My TV” area allows you to set up a personal profile. You can define a personal profile by channels, categories and/or by keywords.</p> <p>The “My TV” area is making recommendations to you to quickly and easily find something of interest to watch or to set a reminder.</p> <p>How to set your profile:</p> <ol style="list-style-type: none"> 1 Highlight “My TV” on the menu bar, press the green button to set your profile. 2 Press / to select channels, categories or keywords. 3 Press the yellow button to add a channel, a category or a keyword to your profile. 4 Press / / / to select a channel, a category or a keyword, then press . 5 Repeat step 2 to 4 to add more items. 6 Press to activate your profile. <p></p> <ul style="list-style-type: none"> • You can delete or edit with the red and green buttons.
Delete and edit reminder – Schedule	<ol style="list-style-type: none"> 1 Highlight “Schedule” on the menu bar. 2 Press / to delete or edit with the red and green buttons. <p></p> <ul style="list-style-type: none"> • When no reminder is set, “No programmes” is displayed. Press to highlight “Frequency” (e.g. weekly) or “Timing” (e.g. reminder timing: 10 min early), you can change this settings by pressing colour buttons.

To	Do this
Configure the GUIDE Plus+ system according to your personal situation – Set-up	<ol style="list-style-type: none">1 Highlight “Set-up” on menu bar.2 Press \leftarrow/\rightarrow for you to select below items you want to configure. “Personal Preferences”: You can change the on screen language, change reminder timing and set overnight download. “Start Installation Sequence”: This feature provides an easy way to restart your installation from scratch. This will delete all your current TV listing data. “Manual Data Download”: Update your TV listings immediately. If the TV is switched off during several days, TV listings will not be updated automatically. In this case, use this feature to update TV listings. “GUIDE Plus+ System Information” screen: Display GUIDE Plus+ system information. This screen is providing several values that are helpful for troubleshooting.

Using the Digital Electronic Programme Guide (EPG) DV3**

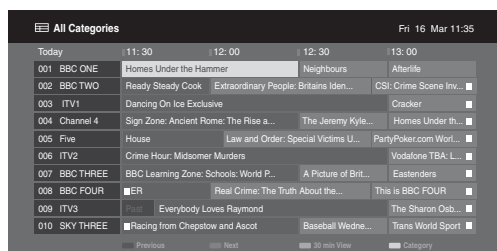

- 1 In digital mode, press **GUIDE**.
- 2 Perform the desired operation as shown in the following table or displayed on the screen.

** This function may not be available in some countries/regions.
To switch the GUIDE (Sony Guide or GUIDE Plus+), see page 50.

To	Do this
Watch a programme	Press $\leftarrow/\rightarrow/\leftarrow/\rightarrow$ to select the programme, then press \oplus .
Turn off the Guide	Press GUIDE .
Sort the programme information by category – Category list	<ol style="list-style-type: none"> 1 Press the blue button. 2 Press \leftarrow/\rightarrow to select a category, then press \oplus.
Set a programme to be displayed automatically on the screen when it starts – Reminder	<ol style="list-style-type: none"> 1 Press $\leftarrow/\rightarrow/\leftarrow/\rightarrow$ to select the future programme you want to display, then press $\oplus/?$. 2 Press \leftarrow/\rightarrow to select “Reminder”, then press \oplus. A \ominus symbol appears by that programme’s information. The \boxtimes \odot indicator on the TV front panel lights up in orange. <p> If you switch the TV to standby mode, it will automatically turn itself on when the programme is about to start.</p>
Cancel reminder – Cancel Timer	<ol style="list-style-type: none"> 1 Press $\oplus/?$. 2 Press \leftarrow/\rightarrow to select “Timer list”, then press \oplus. 3 Press \leftarrow/\rightarrow to select the programme you want to cancel, then press \oplus. 4 Press \leftarrow/\rightarrow to select “Cancel Timer”, then press \oplus. A display appears to confirm that you want to cancel the programme. 5 Press \leftarrow/\rightarrow to select “Yes”, then press \oplus to confirm.

Using the Digital Favourite List **DVB***



Digital favourite list

- 1** In digital mode, press ♥.
- 2** Perform the desired operation as shown in the following table or displayed on the screen.

* This function may not be available in some countries/regions.









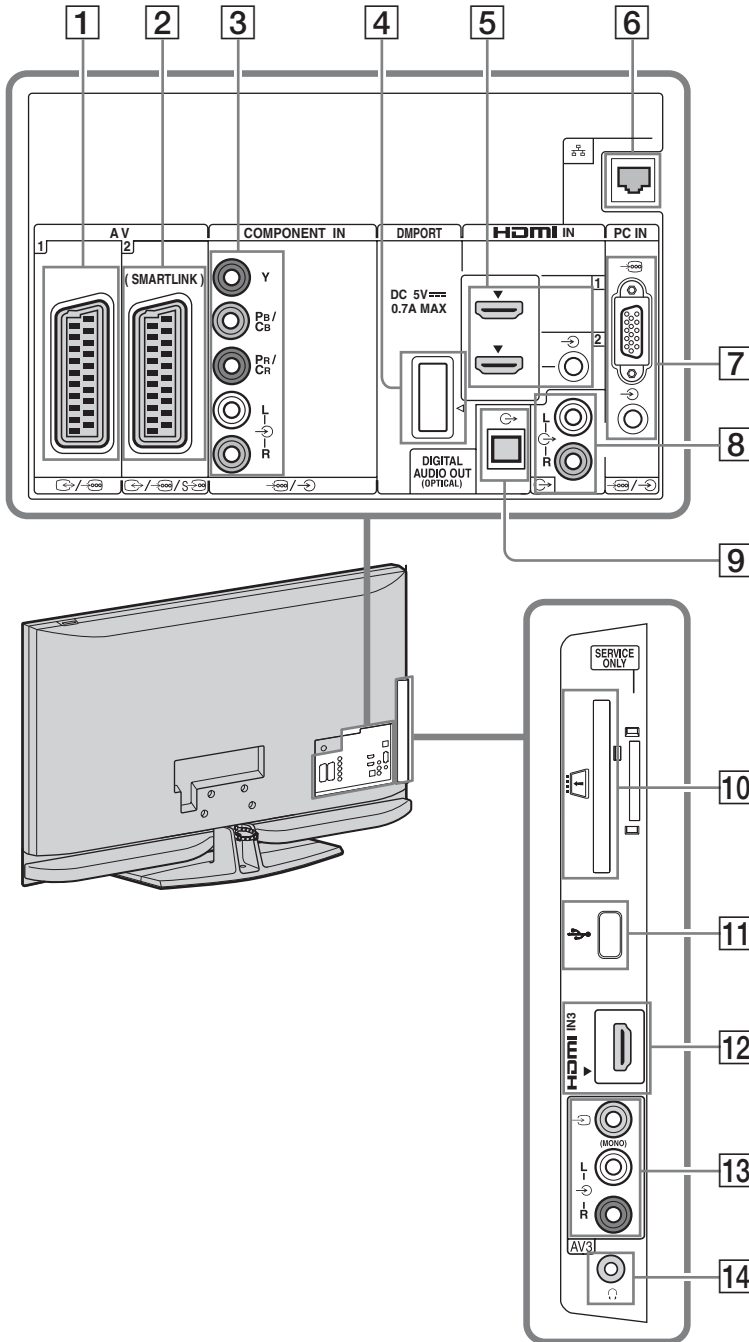





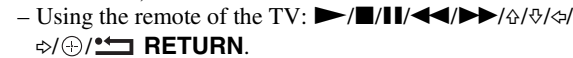

To	Do this
Create your favourite list for the first time	<ol style="list-style-type: none"> 1 Press ⊕ to select “Yes.” 2 Press the yellow button to select the favourite list. 3 Press ⇄ to select the channel you want to add, then press ⊕. A ♥ symbol appears next to channels that you have stored in the favourite list.
Watch a channel	<ol style="list-style-type: none"> 1 Press yellow key to navigate through favourite lists. 2 Press ⇄ to select the channel, then press ⊕.
Turn off the favourite list	Press RETURN .
Add or remove channels in the currently edited favourite list	<ol style="list-style-type: none"> 1 Press the blue button. 2 Press the yellow button to choose the list you want to edit. 3 Press ⇄/⇄ to select the channel you want to add or remove, then press ⊕.
Remove all channels from the current favourite list	<ol style="list-style-type: none"> 1 Press the blue button. 2 Press the yellow button to select the favourite list you want to edit. 3 Press the blue button. 4 Press ⇄ to select “Yes”, then press ⊕ to confirm.







Using Optional Equipment

Connecting Chart

You can connect a wide range of optional equipment to your TV. Connecting cables are not supplied.

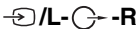

Connect to	Input symbol on screen	Description
1  AV1	 AV1	When you connect a decoder, the TV tuner outputs scrambled signals to the decoder, and the decoder unscrambles the signals before outputting them.
2  AV2 (SMARTLINK)	 AV2	SmartLink is a direct link between the TV and a VCR/DVD recorder.
3  COMPONENT IN	 Component	The component video sockets support the following video inputs only: 480i, 480p, 576i, 576p, 720p, 1080i and 1080p.
4 DMPORT	DMPORT	<p>You can play audio or video (optional cable required) of a portable audio player that is connected to the TV using a DIGITAL MEDIA PORT (DMPORT) adaptor.</p> <p>Depending on the connected DIGITAL MEDIA PORT adaptor, you can operate the connected equipment using the TV as follows;</p> <ul style="list-style-type: none"> – Using the remote of the TV:  RETURN. – Using the Options menu function: Press OPTIONS, and select “Control Panel” or “Device Control (Menu).” <p></p> <ul style="list-style-type: none"> • Do not connect or disconnect a DIGITAL MEDIA PORT adapter while the TV is turned on. • The connected equipment is not charged when the TV is turned off or in standby mode.
5 HDMI IN 1 or 2	 HDMI 1 or HDMI 2	Digital video and audio signals are input from the connected equipment.
12 HDMI 3	 HDMI 3	<p>In addition, when you connect the equipment that is compatible with control for HDMI, communication with the connected equipment is supported. See page 46 to set up this communication.</p> <p>If the equipment has a DVI socket, connect the DVI socket to the HDMI IN socket through a DVI-HDMI adaptor interface (not supplied), and connect the equipment’s audio out socket to the audio in HDMI IN socket.</p> <p></p> <ul style="list-style-type: none"> • The HDMI sockets support the following video inputs only: 480i, 480p, 576i, 576p, 720p, 1080i, 1080p and 1080/24p. For PC video inputs, see page 55. • Be sure to use only an authorised HDMI cable bearing the HDMI logo. We recommend that you use a Sony HDMI cable (high speed type). • When connecting an audio system that is compatible with control for HDMI, be sure to also connect it to the DIGITAL AUDIO OUT (OPTICAL) socket.
6  LAN		You can enjoy contents stored on DLNA-compatible devices via a network (page 34).
7  PC IN	PC	It is recommended to use a PC cable with ferrites, such as the “Connector, D-sub 15” (ref. 1-793-504-11, available in Sony Service Centre) or equivalent.
8 L-  -R		Connect to the audio output sockets  to listen to the sound from the TV on Hi-Fi audio equipment.
9  DIGITAL AUDIO OUT (OPTICAL)		Use an optical audio cable.

Connect to	Input symbol on screen	Description
10  CAM (Conditional Access Module)		<p>To use Pay Per View services. For details, refer to the instruction manual supplied with your CAM. To use the CAM, remove the dummy card from the CAM slot, then turn off the TV and insert your CAM card into the slot. When you are not using the CAM, we recommend that you keep the dummy card in the CAM slot.</p>  <ul style="list-style-type: none"> • CAM is not supported in all countries. Please check with your authorised dealer.
11  USB		<p>You can enjoy photo/music files stored in a Sony digital still camera or camcorder through a USB cable or USB storage device on your TV (page 27).</p>
13  AV3	 AV3	<p>When connecting mono equipment, connect to the  AV3 L socket.</p>
14 		<p>You can listen to TV sound through headphones.</p>

Viewing Pictures from Connected Equipment

Switch on the connected equipment, then perform one of the following operation.

For equipment connected to the scart sockets using a fully-wired 21-pin scart lead

Start playback on the connected equipment. The picture from the connected equipment appears on the screen.

For an auto-tuned VCR/ DVD recorder

In analogue mode, press **PROG +/-**, or the number buttons, to select the video channel.



For a USB device

See page 27.

For a Network device

See page 34.

For other connected equipment

Press  to display a list of connected equipment. Press  to select the desired input source, then press .

The highlighted item is automatically selected if you do not perform any operation for two seconds after pressing .

If you have set an input source to “Skip” in the “AV Preset” menu (page 44), that input source does not appear in the list.



- To return to normal TV mode, press **DIGITAL** or **ANALOG**.

Using the Options menu

Press **OPTIONS** to display the following options when viewing pictures from connected equipment.

Options	Description
Picture Mode (except PC input mode)	See page 39.
Display Mode (in PC input mode only)	See page 39.
Sound Mode	See page 40.
Surround	See page 40.
Speaker	See page 45.
Motionflow	See page 42.



Options	Description
PIP (in PC input mode only)	See page 27.
PAP (except PC input mode and DIGITAL MEDIA PORT mode)	See page 26.
Auto Adjustment (in PC input mode only)	See page 44.
Horizontal Shift (in PC input mode only)	See page 44.
Sleep Timer (except PC input mode)	See page 43.
Power Saving	See page 41.
Device Control (Menu) (in DIGITAL MEDIA PORT mode only)	See page 24.
Control Panel (in DIGITAL MEDIA PORT mode only)	See page 24.
Device Control (in HDMI mode only)	See page 30.

To view two pictures simultaneously – PAP (Picture and Picture)

You can view two pictures (external input and TV programme) on the screen simultaneously. Connect an optional equipment (page 23), and make sure that images from the equipment appear on the screen (page 26).



- This function is not available for a PC input and DIGITAL MEDIA PORT input.
- You cannot change the size of the pictures.
- You cannot display analogue TV video in the TV programme picture while displaying AV1, AV2 or AV3 video in the external inputs picture.

- 1 Press **OPTIONS**.
- 2 Press  to select “PAP”, then press .

The picture from the connected equipment is displayed on the left, and the TV programme is displayed on the right.

- 3 Press the number buttons or **PROG +/-** to select the TV channel.

To return to single picture mode

Press  **RETURN**.



- The highlighted picture is audible. You can switch the audible picture by pressing .

To view two pictures simultaneously – PIP (Picture in Picture)

You can view two pictures (PC input and TV programme) on the screen simultaneously. Connect a PC (page 23), and make sure that image from a PC appear on the screen.

- 1 Press **OPTIONS** to display the Options menu.
- 2 Press \swarrow/\searrow to select “PIP”, then press \oplus .
The picture from the connected PC is displayed in full size, and the TV programme is displayed in the small screen.
You can use $\swarrow/\searrow/\swarrow/\searrow$ to move the TV programme screen position.
- 3 Press number buttons or **PROG +/-** to select the TV channel.

To return to single picture mode

Press \leftarrow **RETURN**.



- You can switch the audible picture by selecting “Audio Swap” from the Options menu.

Playing Back Photo/Music via USB

You can enjoy photo/music files stored in a Sony digital still camera or camcorder through a USB cable or USB storage media on your TV.

- 1 Connect a supported USB device to the TV.
- 2 Press **HOME**.
- 3 Press \swarrow/\searrow to select “Photo” or “Music.”
- 4 Press \swarrow/\searrow to select a USB device, then press \oplus .

In “Music”, “List View” appears. In “Photo”, “Thumbnail View” appears. Press the yellow button to switch between “List View” and “Thumbnail View.”

- 5 Press $\swarrow/\searrow/\swarrow/\searrow$ to select a file or folder, then press \oplus .

When you select a folder, select a file, then press \oplus .
Playback starts.

Photo Playback Auto Start

The TV automatically starts photo playback when the TV is turned on and a digital still camera or other device storing photo files is connected to the USB port and then turned on (page 41).

(Photo) Available Options



Option	Description
Picture Mode	See page 39.
Sound Mode	See page 40.
Surround	See page 40.
Cropping	Crops a photograph.
Display map	Displays a map of the location where a photo was shot along with the photo itself.
Show Options	Allows you to set repeat/shuffle for photo playback.
Photo Set-up	Sets how playback should be performed and what effects to use during slideshows.
Rotate and Save	Rotates and saves unprotected files.

Option	Description
Speaker	See page 45.
Picture Frame Image	Allows you to select a photograph to be displayed as picture frame.
Information	Displays information about the device, folders, and files.

🎵 (Music) Available Options

Option	Description
Sound Mode	See page 40.
Surround	See page 40.
Add to Slideshow	Registers the background music to be played during a slideshow using  (Photo).
Omit from Slideshow	Cancels the registered background music.
Playback Options	Allows music options to be set for repeat, shuffle, or regular playback.
Speaker	See page 45.
Information	Displays information about the device, folders, and files.



- Picture quality may appear coarse when using  (Photo) because images may be enlarged depending on the file. Also, images may not fill the entire screen depending on the image size and aspect ratio.
- Some photo files may take some time to be displayed when using  (Photo).
- The file name and folder name support only English.
- While the TV is accessing the data on the USB device, observe the following:
 - Do not turn off the TV or connected USB device.
 - Do not disconnect the USB cable.
 - Do not remove the USB device.
 The data on the USB device may be damaged.
- Sony will not be held liable for any damage to, or loss of, data on the recording media due to a malfunction of any connected devices or the TV.
- Playback does not start automatically if the TV is turned on after connecting the digital still camera or other device to the USB port.
- USB playback is supported for the following photo file formats:
 - JPEG (JPEG format files with the extension “.jpg” and conforming to DCF 2.0 or Exif 2.21)

– RAW (ARW/ARW 2.0 format files with this extension “.arw.”) For preview only.

- When you connect a Sony digital still camera, set the camera’s USB connection mode to Auto or “Mass Storage.” For more information about USB connection mode, refer to the instructions supplied with your digital camera.
- USB playback is supported for the following music file formats:
 - MP3 (files with the extension “.mp3” that have not been copyrighted)
- USB Photo Viewer supports FAT12, FAT16 and FAT32 file systems.
- Depending on the exact file specifications, some files, including those modified on a PC, cannot be played even if the file format is supported.
- Check the website below for updated information about compatible USB devices.
<http://support.sony-europe.com/TV/compatibility/>

To display a photograph

— Picture Frame

You can display a photograph on the screen for a selected period of time. After that period, the TV automatically switches itself into standby mode.

1 Select a photograph.

You can select a photograph from the connected USB device or preset picture folder. For details on selecting a photograph, see page 27.



2 Press **OPTIONS** while the selected photograph is displayed, then press to select “Picture Frame Image” and press .

3 Press **RETURN** repeatedly to return to the Home Menu.

4 Press / to select “Photo”, then select “Picture Frame” and press .

The TV is switched to Picture Frame mode, and the selected photograph is displayed on the screen.

To set the duration of displaying a photograph

Press **OPTIONS**, then select “Duration” and press . Then, select the duration, and press .

The counter appears on the screen.

To return to the XMB™

Press  **RETURN**.



- If the photograph is selected from a USB device, it must remain connected to the TV.
- If “Sleep Timer” is activated, the TV automatically will switch into standby mode.

To display a photograph with the location on the map

When using an image capture device with GPS function (digital still camera, etc.), it is possible to display a photograph with a map of the location where the photograph was taken using a function of GPS for recording longitude and latitude. Because map information is downloaded from the Internet online map service, the network connection must be required and the TV has to be connected to the network (page 34).

- 1 Select a photograph (page 27).
- 2 Press the green/red buttons to zoom in/out on the map.

To change the display position of the map on the TV screen, press the blue button repeatedly.



- Because the Internet online map service is provided by a third party, service may be changed or terminated without prior notification to the user.
- The position indicated on the map may differ depending on the image capture device.
- Only a large-scale map that cannot be zoomed in or out is displayed if the TV is not connected to the Internet or the Internet online map service is terminated.
- You can also display a slideshow with the location on the map. Set “Photo Set-up” to “Simple with map” (page 27).



- A map can be displayed in the case of photograph’s EXIF data includes a date information, and the associated longitude and latitude information (“Log files”) has been recorded using a Sony GPS unit. Follow the procedure described below.
- 1 Connect the GPS unit to the USB port.
 - 2 Press **HOME**.
 - 3 Press \leftarrow/\rightarrow to select “Photo.”
 - 4 Press \uparrow/\downarrow to select the GPS unit, then press \oplus .

- 5 Select the following items using \uparrow/\downarrow and press \oplus , then set them using \uparrow/\downarrow .
 - Time Zone
 - DST
- 6 Select “Yes”, then press \oplus .
The GPS log files are loaded.
- 7 Disconnect the GPS unit and connect the device on which the photograph is stored.
- 8 Select a photograph (page 27).
- 9 Press the green/red buttons to zoom in/out on the map.

Using BRAVIA Sync with Control for HDMI

The control for HDMI function enables the TV to communicate with the connected equipment that is compatible with the function, using HDMI CEC (Consumer Electronics Control). For example, by connecting Sony equipment that is compatible with control for HDMI (with HDMI cables), you can control them together.

Be sure to connect the equipment correctly, and make the necessary settings.

Control for HDMI

- Automatically turns the connected equipment off when you switch the TV to standby mode using the remote.
- Automatically turns the TV on and switches the input to the connected equipment when the equipment starts to play.
- If you turn on a connected audio system while the TV is on, the sound output switches from the TV speaker to the audio system.
- Adjusts the volume (◀ +/-) and mutes the sound (⊗) of a connected audio system.
- You can operate the connected Sony equipment that has the BRAVIA Sync logo by the TV remote by pressing:
 - ▶/■/II/◀◀/▶▶ to operate the connected equipment directly.
 - **SYNC MENU** to display the menu of the connected HDMI equipment on the screen. After displaying the menu, you can operate the menu screen by using ↶/↷/↵/↶ and ⊕.
 - **OPTIONS** to display “Device Control”, then select options from “Menu”, “Options”, and “Content List” to operate the equipment.
 - Refer to the instruction manual of the equipment for available control.

To connect the equipment that is compatible with control for HDMI

Connect the compatible equipment and the TV with a HDMI cable. When connecting an audio system, be sure to also connect the DIGITAL AUDIO OUT (OPTICAL) socket of the TV and the audio system using an optical audio cable. For details, see page 24.

To make the control for HDMI settings

The control for HDMI settings must be set on both the TV side and connected equipment side. See “HDMI Set-up” on page 46 for the TV side settings. For settings on the connected equipment, refer to the operating instructions for that equipment.

Operating Optional Equipment using the TV Remote

Buttons for using optional equipment

For details, refer to the operating instructions supplied with the connected equipment.



- The ► button has a tactile dot. Use the tactile dot as a reference when operating other equipment.

Item	Description
1 I/⏻	Turns on or off the optional equipment you have selected with the function buttons.
2 Function buttons	Allows you to operate the corresponding equipment. For details, see “Programming the remote” on page 31.
3 BD/DVD operating buttons	<ul style="list-style-type: none"> • ◀◀/▶▶: Goes to the beginning of the previous/next title/chapter/scene/track. • ◀◀/▶▶: Replays the scene/briefly fast forwards the scene. • ◀◀▶▶: Fast reverses/fast forwards the disc when pressed during playback. • ▶: Plays a disc at normal speed. • : Pauses the playback. • ■: Stops the playback.
4 DVD record buttons	<ul style="list-style-type: none"> • ● REC: Starts the recording. • REC PAUSE: Pauses the recording. • ■ REC STOP: Stops the recording.
5 F1/F2	<ul style="list-style-type: none"> • Selects a disc when using a disc changer. • Selects a function when using a combination unit (e.g. a DVD/HDD).
6 BD/DVD MENU	Displays the BD/DVD disc menu.
7 BD/DVD TOP MENU	Displays the top menu of the BD/DVD disc.

Programming the remote

This remote is preset to operate Sony TVs, and most Sony Blu-ray disc players, DVD players, DVD recorders, and audio systems (Home Theatre, etc.).

To control Blu-ray disc players, DVD players, and DVD recorders of other manufacturers (and some other Sony models), programme the remote as follows.



- Before you start, look up the three-digit code of your equipment from the “Manufacturer’s codes” on page 32.

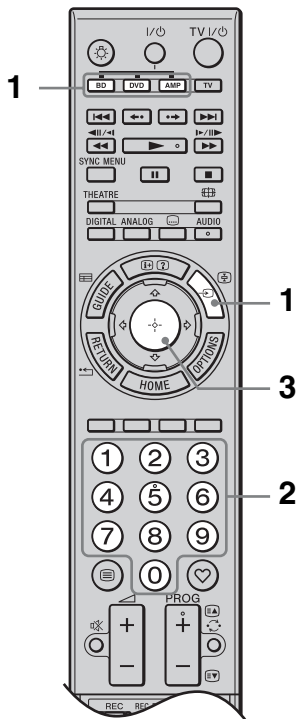

- 1 Press and hold the **BD**, **DVD**, or **AMP** function button you want to programme on the remote, then press \rightarrow .
The selected function button (**BD**, **DVD**, or **AMP**) flashes.
- 2 Press the number buttons to enter the three-digit manufacturer's code number when the function button flashes.
If you do not enter the code within 10 seconds, you need to go back to step 1.
- 3 Press \oplus .
The selected function button flashes twice.
If the selected function button flashes five times, repeat from step 1.
- 4 Turn on your equipment and check that the following main functions work.
For Blu-ray disc players, DVD players and DVD recorders, check:
▶ (playback), ■ (stop), ◀ (rewind), ▶▶ (fast forward), channel selection.
For DVD players and DVD recorders, check:
TOP MENU/MENU and $\updownarrow/\leftarrow/\rightarrow$.

If your equipment is not working, or some of the functions do not work

Enter the correct code or try the next code listed for the brand. Note that the list may not include codes for all models of all brands.

To return to normal TV operation

Press the TV function button.

Manufacturer's codes

DVD players

Manufacturer	Code
SONY	001, 029, 030, 036 – 044, 053 – 055
AIWA	021
AKAI	032
DENON	018, 027, 020, 002
GRUNDIG	009, 028, 023, 024, 016, 003
HITACHI	025, 026, 015, 004, 035
JVC	006, 017
KENWOOD	008
LG	015, 014, 034
LOEWE	009, 028, 023, 024, 016, 003
MATSUI	013, 016
ONKYO	022, 033
PANASONIC	018, 027, 020, 002, 045 – 047
PHILIPS	009, 028, 023, 024, 016, 003, 031
PIONEER	004, 050, 051, 052
SAMSUNG	011, 014
SANYO	007
SHARP	019, 027
THOMSON	012
TOSHIBA	003, 048, 049
YAMAHA	018, 027, 020, 002

Blu-ray disc (BD) players

Manufacturer	Code
SONY	101 – 103

DVD/video cassette recorders

Manufacturer	Code
SONY	251

DVD/HDD recorders

Manufacturer	Code
SONY	201 – 203

VCRs

Manufacturer	Code
SONY	301 – 310, 362
AIWA	325, 331, 351
AKAI	326, 329, 330
DAEWOO	342, 343
GRUNDIG	358, 355, 360, 361, 320, 351, 366
HITACHI	327, 333, 334
JVC	314, 315, 322, 344, 352 – 354, 348, 349

Manufacturer	Code
LG	332, 338
LOEWE	358, 355, 360, 361, 320, 351
MATSUI	356, 357
ORION	328
PANASONIC	321, 323
PHILIPS	311 – 313, 316 – 318, 358, 359, 363, 364
SAMSUNG	339 – 341, 345
SANYO	335, 336
SHARP	324
THOMSON	319, 350, 365
TOSHIBA	337

DAV Home Theatre Systems

Manufacturer	Code
SONY (DAV)	401 – 404

AV receivers

Manufacturer	Code
SONY	451 – 454

Digital terrestrial receivers

Manufacturer	Code
SONY	501 – 504

Using Network Features

With this TV, you can enjoy contents stored on DLNA-compatible devices on the home network.

Devices that store and provide contents, such as photo/music files, is called “server.” The TV receives the photo/music files from the server via the network, and you can enjoy them on the TV even in other rooms.

To enjoy the home network, a DLNA-compatible device (VAIO, Cyber-shot, etc.) is necessary as a server.

Connecting the TV to the Network

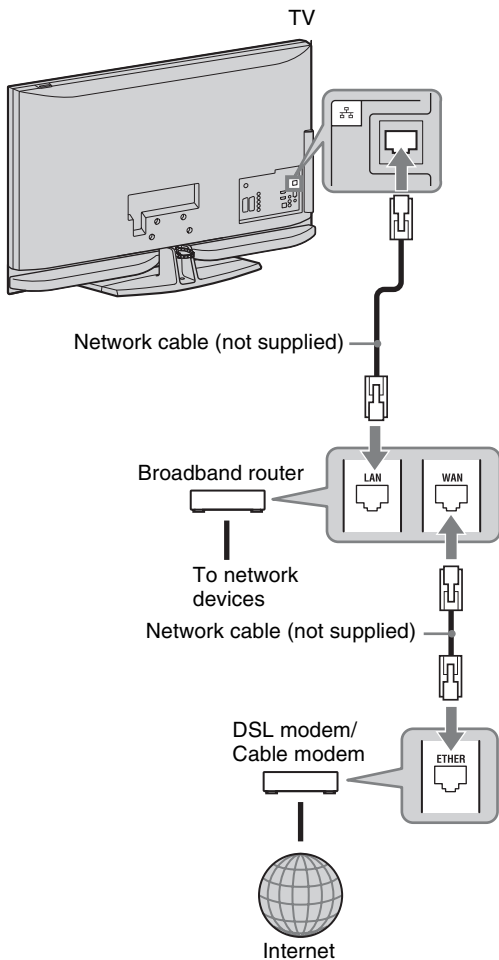

Enjoying Photo/Music Files via the Network

You can enjoy photo/music files on the server easily by selecting an icon on the Home Menu of the TV.

- 1 Press **HOME**.
- 2 Press \leftarrow/\rightarrow to select “Photo” or “Music.”
- 3 Press \uparrow/\downarrow to select a server, then press \oplus .

In “Music”, “List View” appears. In “Photo”, “Thumbnail View” appears. You can switch the view mode between “List View” and “Thumbnail View” by pressing the yellow button.

When the server cannot be found

See “Checking the Network Connection” (page 36) and “Adjusting the Server Display Settings” (page 36).

- 4 Press $\uparrow/\downarrow/\leftarrow/\rightarrow$ to select a file or folder, then press \oplus .

When you select a folder, select a file, then press \oplus . Playback starts.



- A map can be displayed with a photograph in the case of longitude and latitude information has been recorded to photograph’s EXIF data (page 29).



- Depending on the network device, it may be necessary to register the TV with the network device.
- Picture quality may appear coarse when using (Photo) because images may be enlarged depending on the file. Also, images may not fill the entire screen depending on the image size and aspect ratio.
- Some photo files may take some time to be displayed when using (Photo).
- The file name and folder name support only English.
- To play files that are received from a network device, they need to conform to one of the following file formats.
 - Still images: JPEG format
 - Music: MP3 format or linear PCM format

Depending on the network device, the file format may be converted before transfer. In such cases, the file format resulting after conversion is used for playback. For details, see the instruction manual for the network device being used. Even files conforming to one of the file formats given above cannot be played in some cases.

To enjoy photographs and music on the TV screen by operating devices – Renderer

“Renderer” is a feature for playing photo files and music files stored in network devices (digital still cameras, mobile phones, etc.) on the TV by operating the controller device in question. To use this feature, a renderer-compatible device such as a digital still camera or mobile phone is required as the controller. Refer as well to the instruction manual supplied with the controller.

- 1 Set “Renderer Function”, “Renderer Access Control” and “Renderer Set-up” in “Network Settings” if necessary (page 51).
- 2 Play the file selected using the controller on the TV.

The file is played on the TV over the connected network.

Use the controller or the TV’s remote to perform operations during playback.

(Photo) Available Options

Option	Description
Picture Mode	See page 39.
Sound Mode	See page 40.
Surround	See page 40.
Cropping	Crops a photograph.
Display map	Displays a map of the location where a photo was shot along with the photo itself.
Show Options	Allows you to set repeat/shuffle for photo playback.
Photo Set-up	Sets how playback should be performed and what effects to use during slideshows.
Rotate	Rotates files.
Speaker	See page 45.

Option	Description
Information	Displays information about the device, folders, and files.

(Music) Available Options

Option	Description
Sound Mode	See page 40.
Surround	See page 40.
Add to Slideshow	Registers the background music to be played during a slideshow using  (Photo).
Omit from Slideshow	Cancels the registered background music.
Playback Options	Allows music options to be set for repeat, shuffle, or regular playback.
Speaker	See page 45.
Information	Displays information about the device, folders, and files.

Checking the Network Connection

Enter the respective (alphanumeric) values for your router. The items that need to be set may differ, depending on the Internet service provider or the router. For details, refer to the instruction manuals that have been provided by your Internet service provider or supplied with the router.

- 1 Press **HOME**.
- 2 Press \leftarrow to select “Settings.”
- 3 Press \uparrow/\downarrow to select “Network Settings”, then press \oplus .
- 4 Select “Network”, then press \oplus .
- 5 Select “IP Address settings”, then press \oplus .
- 6 Select an item, and press \oplus .

When you select “DHCP (DNS automatic)”

Go to step 7.

When you select “DHCP (DNS manual)”

Set “Primary DNS”/“Secondary DNS” using $\uparrow/\downarrow/\rightarrow$ and the number buttons.

When you select “Manual”

Set the following items using $\uparrow/\downarrow/\rightarrow$ and the number buttons.

- IP Address
- Subnet Mask
- Default Gateway
- Primary DNS/Secondary DNS

If your ISP has a specific proxy server setting

Press **OPTIONS**, then press \uparrow/\downarrow to select “Proxy Set-up” and press \oplus . Then enter the settings.

- 7 Press \oplus .
- 8 Select “Test”, then press \oplus .
- 9 Select “Yes”, then press \oplus .

The network diagnostic starts. When the message “Connection successful.” appears, press \leftarrow **RETURN** repeatedly to exit.

Adjusting the Server Display Settings

You can select home network servers to be displayed on the Home Menu.

Up to 10 servers can be displayed on the Home Menu automatically.

- 1 Set the server to allow connections from the TV.
For details on settings on the server, refer to the Operating Instructions supplied with the server.
- 2 Press **HOME**.
- 3 Press \leftarrow/\rightarrow to select “Settings.”
- 4 Press \uparrow/\downarrow to select “Network Settings”, then press \oplus .
- 5 Select “Server Display Settings”, then press \oplus .
- 6 Select the server you want to display on the Home Menu, then press \oplus .
- 7 Select “Yes”, then press \oplus .

To set the server not to be displayed on the Home Menu

In step 7, press \uparrow/\downarrow to select “No”, then press \oplus .

Available Options (on the connected server settings display)

Option	Description
Delete All	Deletes all connected servers.
Update List	Updates the server list to the latest information.
Information	Displays information about the connected server currently selected.
Delete	Deletes the connected server currently selected.

If you cannot connect to your home network

The TV can check if the server is being correctly recognised.

- 1** Press **HOME**.
- 2** Press \leftarrow/\rightarrow to select “Settings.”
- 3** Press \uparrow/\downarrow to select “Network Settings”, then press \oplus .
- 4** Select “Server Diagnostics”, then press \oplus .
- 5** Select “Yes”, then press \oplus .

The server diagnostic starts.

When the server diagnostic is complete, the diagnostic result list appears.

- 6** Select the server you want to confirm, then press \oplus .

The diagnostic results of the selected server appear.

If the diagnostic results indicate a failure, look up the possible causes and what to do, and check connections and settings.

Using MENU Functions

Navigating through TV Home Menu (XMB™)





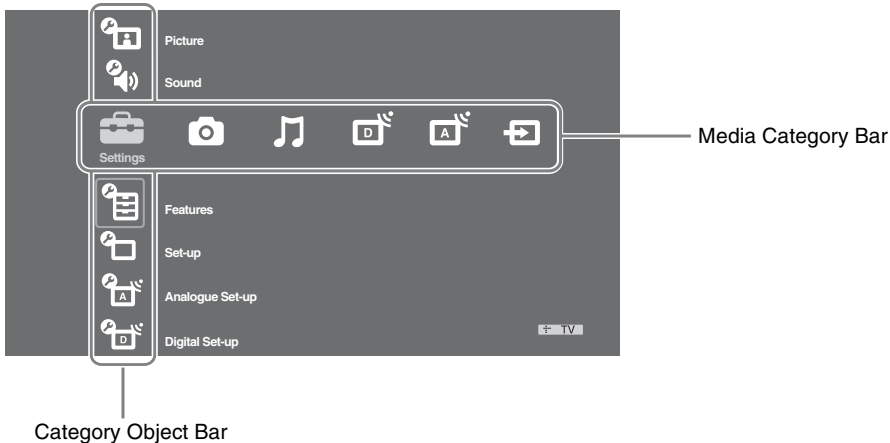

The XMB™ (XrossMediaBar) is a menu of BRAVIA features and input sources displayed on the TV screen. The XMB™ is an easy way to select programming and adjust settings on your BRAVIA TV.

1 Press **HOME**.

The TV Home menu appears on the screen.



2 Press \leftarrow/\rightarrow to select the category.

Media category icon	Description
 Settings	You can make advanced settings and adjustments. For details about settings, see page 39.
 Photo	You can enjoy photo files via USB devices or the network (page 27, 34).
 Music	You can enjoy music files via USB devices or the network (page 27, 34).
 Digital	You can select a digital channel, favourite list (page 22), or Guide (page 18, 21). You can also select a channel using the number buttons or PROG +/- .
 Analogue	You can select an analogue channel. You can also select a channel using the number buttons or PROG +/- . To hide the list of analogue channels, set “Programme List Display” to “Off” (page 46).
 External Inputs	You can select equipment connected to the TV. To assign a label to an external input, see “AV Preset” (page 44).

3 Press \uparrow/\downarrow to select the item, then press \oplus .

4 Follow the instructions on the screen.

5 Press **HOME** to exit.





- The options you can adjust vary depending on the situation.
- Unavailable options are greyed out or not displayed.



Settings



Picture

Picture Mode	Selects the picture mode except for PC input source. "Picture Mode" includes options best suited for video and photographs, respectively. The options that can be selected differ depending on the input source.
Vivid	For enhanced picture contrast and sharpness.
Standard	For standard picture. Recommended for home entertainment.
Cinema	For viewing film-based content. Most suitable for viewing in a theatre-like environment.
Photo-Vivid	For viewing photographs. Enhances picture contrast and sharpness.
Photo-Standard	For viewing photographs. Provides the optimum picture quality for viewing in the home.
Photo-Original	For viewing photographs. Represents the picture quality used when imaging developed photographs.
Display Mode (only in PC Input/HDMI PC Input)	Selects the display mode for PC input source.
Video	For video images.
Text	For text, charts or tables.
Reset	Resets all picture settings except "Picture Mode" and "Display Mode" (only in PC mode) to the factory settings.
Backlight	Adjusts the brightness of the backlight.
Contrast	Increases or decreases picture contrast.
Brightness	Brightens or darkens the picture.
Colour	Increases or decreases colour intensity.
Hue	Increases or decreases the green and red tones.  <ul style="list-style-type: none"> "Hue" can only be adjusted for an NTSC colour signal (e.g., U.S.A. video tapes).
Colour Temperature	Adjusts the whiteness of the picture.  <ul style="list-style-type: none"> "Warm 1" and "Warm 2" are not available when "Picture Mode" is set to "Vivid" (or "Photo-Vivid").
Cool	Gives the white colours a blue tint.
Neutral	Gives the white colours a neutral tint.
Warm 1/Warm 2	Gives white colours a red tint. "Warm 2" gives a redder tint than "Warm 1."
Sharpness	Sharpens or softens the picture.
Noise Reduction	Reduces the picture noise (snowy picture) in a weak broadcast signal.
Auto	Automatically reduces the picture noise (in analogue mode only).
High/Medium/Low	Modifies the effect of the noise reduction.
Off	Turns off the "Noise Reduction" feature.

MPEG Noise Reduction	Reduces picture noise in MPEG-compressed videos. This is effective when viewing a DVD or digital broadcast.
Advanced Settings	Allows you to set “Picture” settings in more detail. These settings are not available when “Picture Mode” is set to “Vivid”(or “Photo-Vivid”).
Adv. Contrast Enhancer	Automatically adjusts “Backlight” and “Contrast” to the most suitable settings judging from the brightness of the screen. This setting is especially effective for dark images scenes. It will increase the contrast distinction of the darker picture scenes.
Live Colour	Makes colours more vivid.
Colour Space	Changes the colour reproduction gamut. “Wide” reproduces the vivid colour and “Standard” reproduces the standard colour.



- “Live Colour” is not available when “Colour Space” is set to “Standard.”

“Noise Reduction”, “MPEG Noise Reduction” and “Advanced Settings” are not available for PC.

Sound

Sound Mode	Selects the sound mode.
Dynamic	Enhances the treble and bass sounds.
Standard	For standard sounds.
Clear Voice	Makes voice sound clearer.
Reset	Resets all the sound settings to the factory settings excluding “Dual Sound.”
Treble	Adjusts higher-pitched sounds.
Bass	Adjusts lower-pitched sounds.
Balance	Emphasises left or right speaker balance.
Auto Volume	Keeps a constant volume level even when volume level gaps occur (e.g., adverts tend to be louder than programmes).
Volume Offset	Adjusts the volume level of the current input relative to other inputs.
Woofers Level	Adjusts the bass level to taste since the bass level varies depending on where the television is located. Decrease the level if you feel too much bass is being output, and increase the level if you feel not enough bass is being output.
	 <ul style="list-style-type: none"> • This adjustment is only necessary when the TV is first installed or when its location has been changed. Adjustment is not required for regular listening.
Surround	Live Sports Delivers surround effects that make you feel like you are watching a live sports contest. Music Hall Delivers surround effects that make you feel like you are surrounded by sound as in a music hall. Cinema Delivers surround effects just like the high-grade audio systems found in movie theatres. Custom A “Voice Zoom” adjustment can be stored according to taste. Off Selects for normal stereo or mono reception.
Voice Zoom	Adjusts the sound level of human voices. For example, if the voice of a news announcer is indistinct, you can turn up this setting to make the voice louder. Conversely, if you are watching a sports programme, you can turn down this setting to soften the voice of the commentator.
Sound Booster	Produces a fuller sound for more impact, by emphasising the treble and bass sounds.



Dual Sound	Selects the sound from the speaker for a stereo or bilingual broadcast.
Stereo/Mono	For a stereo broadcast.
A/B/Mono	For a bilingual broadcast, select “A” for sound channel 1, “B” for sound channel 2, or “Mono” for a mono channel, if available.
	<ul style="list-style-type: none"> If you select other equipment connected to the TV, set “Dual Sound” to “Stereo”, “A” or “B.”







- “Treble”, “Bass”, “Balance” and “Auto Volume” are not available when “Speaker” is set to “Audio System” and headphones are connected.



Features

USB Auto Start	Automatically starts photo playback when the TV is turned on and a digital still camera or other device storing photo files is connected to the USB port and then turned on.
Slideshow	Select to view JPEG files as a slideshow.
Thumbnail View	Select to view JPEG files as a thumbnail.
Off	Select to disable this function.
	<ul style="list-style-type: none"> Playback does not start automatically if the TV is turned on after connecting the digital still camera or other device to the USB port.
Quick Start	The TV turns on faster than usual within two hours after switching to standby mode. However, power consumption in standby mode is 20 Watt higher than usual.
Power Saving	Selects the power saving mode to reduce the power consumption of the TV. When “Picture Off” is selected, the picture is switched off and the  (Picture Off) indicator on the TV front panel lights up in green. The sound remains unchanged.
Standard Power	Default settings.
Reduced Power	Reduces the power consumption of the TV.
Picture Off	Switches off the picture. You can listen to the sound with the picture off.
Light Sensor	<p>On Automatically optimises the picture settings according to the ambient light in the room.</p> <p>Off Turns off the “Light Sensor” feature.</p> <p></p> <ul style="list-style-type: none"> Be sure not to put anything over the sensor, as its function may be affected. See page 15 for the location of the light sensor.
Logo Illumination	Lights up and turns off the Sony logo on the front of the TV.
Panel Key Illumination	<p>Auto Touch sensor keys light up when you touch the sensor keys on the front of the TV or when the TV is on.</p> <p>On Touch sensors are lit constantly.</p>

Motionflow	Provides smoother picture movement and reduces picture blur.
	Max Provides smoother picture movement such as for film-based contents.
	Standard Provides smooth picture movement. Use this setting for standard use.
	Min Provides smooth picture movement. Use this setting to reduce unwanted picture noise.
	Off Use this setting when the “Max”, “Standard” and “Min” settings result in noise.
	 <ul style="list-style-type: none"> Depending on the video, you may not see the effect visually, even if you have changed the setting.
Film Mode	Provides an improved picture quality which is optimised for film when playing DVD images taken on film.
	Auto 1/Auto 2 “Auto 1” Provides smoother picture movement than the original film-based content. “Auto 2” Provides the original film-based content as is.
	Off Turns off the “Film Mode” feature.
	 <ul style="list-style-type: none"> If the image contains irregular signals or too much noise, “Film Mode” will be automatically turned off even if “Auto 1/Auto 2” is selected. “Film Mode” is not available when “Video/Photo” is set to “Photo” or when photograph is detected if “Video-A” is set.
Game/Text Mode	Provides the optimum screen for viewing images with fine lines and characters that are input from video game equipment and PCs. Set to “On” for the sharp display of fine lines or characters.
Video/Photo	Provides suitable image quality by selecting the option depending on the input source (video or photograph data).
	Video-A Sets suitable image quality, depending on the input source, video data or photograph data when directly connecting Sony HDMI output-capable equipment that supports “Video-A” mode.
	Video Produces suitable image quality for moving pictures.
	Photo Produces suitable image quality for still images.
	 <ul style="list-style-type: none"> The setting is fixed to “Video” when Video-A mode is not supported on the connected equipment, even if “Video-A” is selected. Only available for HDMI 1, HDMI 2, HDMI 3 and Component in format 1080i or 1080p.
x.v.Colour	Displays moving pictures that is more faithful to the original source by matching the colour space of source.
	 <ul style="list-style-type: none"> The setting is fixed to “Normal” when the input signal is HDMI (RGB), even if “x.v.Colour” is selected. Only available for HDMI 1, HDMI 2, HDMI 3 and Component in format 720p, 1080i or 1080p.
Photo Colour Space	Selects the option (sRGB, sYCC, Adobe RGB) to match the output colour space within the output signal from the equipment connected to the HDMI, component input jacks or USB.
	 <ul style="list-style-type: none"> Select “sYCC” when using the equipment that supports “x.v.Colour.” Only available for HDMI 1, HDMI 2, HDMI 3 and Component in format 1080i or 1080p. Not available when “Colour Space” is set to “Wide” (page 40).













Timer Settings	Sets the timer to turn on/off the TV.	
Sleep Timer	Sets a period of time after which the TV automatically switches itself into standby mode. When the “Sleep Timer” is activated, the ⏰ (Timer) indicator on the TV (front) lights up in orange. 💡	
	<ul style="list-style-type: none"> • If you switch off the TV and switch it on again, “Sleep Timer” is reset to “Off.” • A notification message appears on the screen one minute before the TV switches to standby mode. 	
On Timer Settings	On Timer	Sets the timer to turn on the TV from standby mode.
	Timer Mode	Sets the desired day(s) of the week you want the timer to turn on the TV.
	Time	Sets the time to turn on the TV.
	Duration	Sets how long you want the TV to stay on before switching to standby mode again.
Clock Set	Allows you to adjust the clock manually. When the TV is receiving digital channels, the clock cannot be adjusted manually since it is set to the time code of the broadcasted signal.	



Set-up

Auto Start-up	Starts the “first time operation menu” to select the language, country and location, and tune in all available digital and analogue channels. Usually, you do not need to do this operation because the language and country/region will have been selected and channels already tuned when the TV was first installed (page 6). However, this option allows you to repeat the process (e.g., to retune the TV after moving house, or to search for new channels that have been launched by broadcasters).		
Language	Selects the language in which the menus are displayed.		
Screen Settings	Screen Format	See “To change the screen format manually” on page 17.	
	Auto Format	Automatically changes the screen format according to the input signal. To keep your setting, select “Off.”	
	Display Area	Adjusts the picture display area in 1080i/p and 720p sources when “Screen Format” is set to “Wide.”	
		Auto	During digital broadcasts, displays pictures in accordance with the settings recommended by the broadcast station.
		Full Pixel	Displays pictures in their original size.
		Normal	Displays pictures in their recommended size.
	Horizontal Shift	Adjusts the horizontal position of the picture.	
	Vertical Shift	Adjusts the vertical position of the picture when “Screen Format” is set to “Smart”, “Zoom” or “14:9.”	
Vertical Size	Adjusts the vertical size of the picture when “Screen Format” is set to “Smart”, “Zoom” or “14:9.”		

PC Settings	Screen Format	Selects a screen format for displaying input from your PC.
	Full 1	Enlarges the picture to fill the vertical display area, keeping its original horizontal-to-vertical aspect ratio.
	Full 2	Enlarges the picture to fill the display area.
	Reset	Resets the PC screen settings to the factory settings.
	Auto Adjustment	Automatically adjusts the display position, phase and pitch of the picture when the TV receives an input signal from the connected PC.  <ul style="list-style-type: none"> • “Auto Adjustment” may not work well with certain input signals. In such cases, manually adjust “Phase”, “Pitch” and “Horizontal Shift.”
	Phase	Adjusts the phase when the screen flickers.
	Pitch	Adjusts the pitch when the picture has unwanted vertical stripes.
	Horizontal Shift	Adjusts the horizontal position of the picture.
	Power Management	Switches the TV to standby mode if no signal is received for 30 seconds in the PC input.
	AV Set-up	AV Preset
Edit		Creates your own label. <ol style="list-style-type: none"> 1 Press \leftarrow/\rightarrow to select the desired letter or number (“_” for a blank space), then press \rightleftarrows. If you input a wrong character Press \leftarrow/\rightarrow to select the wrong character. Then, press \leftarrow/\rightarrow to select the correct character. 2 Repeat the procedure in step 1 until the name is completed. 3 Select “OK”, then press \oplus.
Skip		Skips an input source that is not connected to any equipment when you press \leftarrow/\rightarrow to select the input source.

AV2 Input	Sets a signal to be input through the socket labelled  /  /  AV2 on the rear of the TV.	
	Auto	Switches automatically among the signals of RGB input, S video input, Composite video input depending on the input signal.
	RGB	Inputs the RGB signal.
	S Video	Inputs the S Video signal.
	Composite	Inputs the Composite video signal.
AV2 Output	Sets a signal to be output through the socket labelled  /  /  AV2 on the rear of the TV. If you connect a VCR/ DVD recorder or other recording equipment to the  /  AV2 socket, you can then record from the equipment connected to other sockets of the TV.	
	TV	Outputs a broadcast.
	Auto	Outputs whatever is being viewed on the screen (except signals from the HDMI IN 1, HDMI IN 2, HDMI IN 3,  /  COMPONENT IN and  /  PC IN sockets).
Speaker	Turns on/off the TV's internal speakers.	
	TV Speaker	The TV speakers are turned on in order to listen to the TV's sound through the TV speakers.
	Audio System	The TV speakers are turned off in order to listen to the TV's sound only through your external audio equipment connected to the audio output sockets. When connected with "Control for HDMI" compatible equipment, you can turn the connected equipment on interlocked with the TV. This setting must be made after connecting the equipment.
Audio Out	Variable	The audio output from your audio system can be controlled by the TV's remote.
	Fixed	The audio output of the TV is fixed. Use your audio receiver's volume control to adjust the volume (and other audio settings) through your audio system.



- "Audio Out" is not available for audio system connected to the TV using the HDMI sockets.



HDMI Set-up	This is used to set the “Control for HDMI” compatible equipment connected to the HDMI sockets. Note that the interlock setting must also be made on the connected “Control for HDMI” compatible equipment side.
Control for HDMI	This sets whether to interlock the “Control for HDMI” compatible equipment and the TV. When set to “On”, the following menu items can be performed. However, power consumption in standby mode is higher than usual. If the specific Sony equipment that is compatible with “Control for HDMI” is connected, this setting is applied to the connected equipment automatically when the “Control for HDMI” is set to “On” using the TV.
Auto Devices Off	When this is set to “On”, the “Control for HDMI” compatible equipment turns off when you switch the TV to standby mode using the remote.
Auto TV On	When this is set to “On” and if the connected HDMI, control compatible equipment is turned on, the TV automatically turns on, and the displays the HDMI input from the connected equipment.
Tuner Box Control	If set to “Advanced”, you can select a channel tuned by connected equipment using the TV’s remote.
Device List Update	Creates or updates the “HDMI Device List.” Up to 14 “Control for HDMI” compatible equipment can be connected, and up to 4 equipment can be connected to a single socket. Be sure to update the “HDMI Device List” when you change the “Control for HDMI” compatible equipment connections or settings. Select them manually one by one until getting a correct picture for several seconds.
HDMI Device List	Displays the connected “Control for HDMI” compatible equipment.  <ul style="list-style-type: none"> You cannot use “Control for HDMI” if the TV operations are linked to the operations of an audio system that is compatible with control for HDMI.







Product Information	Displays your TV’s product information.
All Reset	Resets all settings to the factory settings and then displays the “Auto Start-up” screen.  <ul style="list-style-type: none"> Be sure not to turn the TV off during this period (it takes about 30 seconds) or press any buttons. All settings, including digital favourite list, country, language, auto tuned channels, etc. will be reset.















Analogue Set-up









Programme List Display	Select “Off” to hide the list of analogue channels from the XMB™ (XrossMediaBar).
Auto Tuning	Tunes in all the available analogue channels. This option allows you to retune the TV after moving house, or to search for new channels that have been launched by broadcasters.
Programme Sorting	Changes the order in which the analogue channels are stored on the TV. <ol style="list-style-type: none"> Press \updownarrow to select the channel you want to move to a new position, then press \oplus. Press \updownarrow to select the new position for your channel, then press \oplus.

Manual Programme Preset	Before selecting “Label/AFT/Audio Filter/LNA/Skip/Decoder”, press PROG +/- to select the programme number with the channel. You cannot select a programme number that is set to “Skip” (page 44).
System/Channel	<p>Presets programme channels manually.</p> <ol style="list-style-type: none"> 1 Press \leftarrow/\rightarrow to select the programme number you want to manually tune (if tuning a VCR/ DVD recorder, select channel 00), then press \oplus. 2 Press \leftarrow/\rightarrow to select “System”, then press \oplus. 3 Press \leftarrow/\rightarrow to select one of the following TV broadcast systems, then press \oplus. <ul style="list-style-type: none"> B/G: For western European countries/regions I: For the United Kingdom D/K: For eastern European countries/regions L: For France 4 Press \leftarrow/\rightarrow to select “Channel”, then press \oplus. 5 Press \leftarrow/\rightarrow to select “S” (for cable channels) or “C” (for terrestrial channels), then press \rightleftarrows. <ul style="list-style-type: none">  • “S” is not available when “United Kingdom” is selected for “Country” (page 6). 6 Tune the channels as follows: <p>If you do not know the channel number (frequency)</p> <p>Press \leftarrow/\rightarrow to search for the next available channel. When a channel has been found, the search will stop. To continue searching, press \leftarrow/\rightarrow.</p> <p>If you know the channel number (frequency)</p> <p>Press the number buttons to enter the channel number of the broadcast you want or your VCR/DVD recorder channel number.</p> 7 Press \oplus to jump to “Confirm”, then press \oplus. Your changes have been saved. Repeat the above procedure to preset other channels manually.
Label	Assigns a name of your choice, up to five letters or numbers, to the selected channel. This name will be displayed briefly on the screen when the channel is selected. To input characters, follow steps 1 to 3 of “Edit” (page 44).
AFT	Allows you to fine-tune the selected programme number manually if you feel that a slight tuning adjustment will improve the picture quality. You can adjust the fine tuning over a range of -15 to +15. When “On” is selected, the fine tuning is performed automatically.
Audio Filter	Improves the sound for individual channels in the case of distortion in mono broadcasts. Sometimes a non-standard broadcast signal can cause sound distortion or intermittent sound muting when watching mono programmes. If you do not experience any sound distortion, we recommend that you leave this option set to the factory setting “Off.” <ul style="list-style-type: none">  • You cannot receive stereo or dual sound when “Low” or “High” is selected.

LNA	Improves the picture quality for individual channels in the case of very weak broadcast signals (noisy picture). If you cannot see any improvement in the picture quality even if you set to “On”, set this option to “Off” (factory setting).
Skip	Skips unused analogue channels when you press PROG +/- to select channels. (You can still select a skipped channel using the number buttons.)
Decoder	Shows and records the scrambled channel selected when using a decoder connected directly to scart connector  /  AV1, or to scart connector  /  /  AV2 via a VCR/DVD recorder.  <ul style="list-style-type: none"> Depending on the country selected for “Country” (page 6), this option may not be available.
Confirm	Saves changes made to the “Manual Programme Preset” settings.

Digital Set-up DVB

Digital Tuning	Digital Auto Tuning	Tunes in the available digital channels. This option allows you to retune the TV after moving house, or to search for new channels that have been launched by broadcasters. For details, see step 6 of “5: Performing the initial set-up” (page 6).
	Programme Sorting	Removes any unwanted digital channels stored on the TV, and changes the order of the digital channels stored on the TV. 1 Press  to select the channel you want to remove or move to a new position. You can also select a channel by pressing the number buttons to enter its three-digit channel number. 2 Remove or change the order of the digital channels as follows: To remove the digital channel Press  . After a confirmation message appears, press  to select “Yes”, then press  . To change the order of the digital channels Press  , then press  to select the new position for the channel and press  . 3 Press  RETURN .
	Digital Manual Tuning	Tunes the digital channels manually. This feature is available when “Digital Auto Tuning” is set to “Antenna.” 1 Press the number button to select the channel number you want to manually tune, then press  to tune the channel. 2 When the available channels are found, press  to select the channel you want to store, then press  . 3 Press  to select the programme number where you want to store the new channel, then press  . Repeat the above procedure to manually tune other channels.

Subtitle Set-up	Subtitle Setting	When “For Hard Of Hearing” is selected, some visual aids may also be displayed with the subtitles (if TV channels broadcast such information).
	Subtitle Language	Allows you to select the language of the subtitles.
Audio Set-up	Audio Type	Switches to broadcast for the hearing impaired when “For Hard Of Hearing” is selected.
	Audio Language	Selects the language used for a programme. Some digital channels may broadcast several audio languages for a programme.
	Audio Description	Provides audio description (narration) of visual information if TV channels broadcast such information.
	Mixing Level*	Adjusts the TV main audio and Audio Description output levels.
	Dynamic Range	Compensates for differences in the audio level between different channels. Note that this function may have no effect for some channels.
	Optical Out	Selects the audio signal that is output from the DIGITAL AUDIO OUT (OPTICAL) terminal on the rear of the TV. Set to “Auto” when equipment compatible with Dolby Digital is connected, and set to “PCM” when non-compatible equipment is connected.
		
	* This option is only available when “Audio Description” is set to “On.”	
Radio Display	Displays the screen wallpaper when you listen to a radio broadcast. You can select the screen wallpaper colour, display a random colour or view a slide show (page 27, 34). To cancel the screen wallpaper display temporarily, press any button.	
Parental Lock	Sets an age restriction for programmes. Any programme that exceeds the age restriction can only be watched after a PIN code is entered correctly.	
	<ol style="list-style-type: none"> Press the number buttons to enter your existing PIN code. If you have not previously set a PIN, a PIN code entry screen appears. Follow the instructions of “PIN Code” below. Press  to select the age restriction or “None” (for unrestricted watching), then press . Press  RETURN. 	
PIN Code	To set your PIN for the first time <ol style="list-style-type: none"> Press the number buttons to enter the new PIN code. Press the number buttons to enter the PIN code entered in step 1. Press  RETURN. To change your PIN <ol style="list-style-type: none"> Press the number buttons to enter your existing PIN code. Press the number buttons to enter the new PIN code. Press the number buttons to enter the new PIN code entered in step 2. Press  RETURN. 	
	 PIN code 9999 is always accepted.	
Technical Set-up	Auto Service Update	Enables the TV to detect and store new digital services as they become available.
	 • For the service update to be able to take place the TV set should be left in stand-by mode from time to time.	

System Update Enables the TV to automatically receive software updates free through your existing aerial/cable (when issued). We recommend that you leave the setting to “On” at all times.



- For the software upgrade to be able to take place the TV set should be left in stand-by mode from time to time.

System Information Displays the current software version and the signal level.



- If signal bar is red (no signal) or amber (low signal), check the aerial/cable connection.

Time Zone Allows you to manually select the time zone you are in, if it is not the same as the default time zone setting for your country/region.

Auto DST Sets whether or not to automatically switch between summer time and winter time.

On Automatically switches between summer time and winter time according to the calendar.

Off The time is displayed according to the time difference set by “Time Zone.”

Programme Guide (only when GUIDE Plus+ is available) You can switch GUIDE (Sony Guide or GUIDE Plus+). If you change Sony Guide to GUIDE Plus+ programme, see page 18.

Condition that this feature is displayed is following:

- in UK, Italy, France, Germany or Spain.
- you can receive digital broadcasting.
- when “Antenna” is selected in step 7 of “5: Performing the initial set-up.”

CA Module Set-up Allows you to access a pay TV service once you obtain a Conditional Access Module (CAM) and a view card. See page 23 for the location of the  (PCMCIA) socket.



Network Settings

Network	IP Address Settings	DHCP (DNS automatic)	Automatically acquires the network settings through the Dynamic Host Configuration Protocol server function of the router or Internet service provider.
		DHCP (DNS manual)	Automatically acquires the network settings except for DNS server settings. You can manually set the DNS settings.
		Manual	Allows you to set the network settings according to your network environment.
		Test	Diagnoses whether the network is correctly connected.
	IP Address/ Subnet Mask/ Default Gateway/ Primary DNS/ Secondary DNS		You need to configure each item when “Manual” is selected in “IP Address Settings.” When “DHCP (DNS manual)” is selected, be sure to enter “Primary DNS” and “Secondary DNS” server addresses manually.
	MAC Address		Displays the MAC address, which is a fixed, globally unique identifier of the network device.

Server Display Settings	Displays the connected server list and allows you to select the server you want to display on the Home Menu.	
Server Diagnostics	Diagnoses whether the TV can connect to each server on the home network.	
Renderer Function	Enables playback of photos or music on the TV through other control devices on the network, such as a digital still camera or mobile phone.	
Renderer Access Control	Allows you to specify the accessible controller to the TV. When this setting is set to “On”, you can playback photos or music on the TV using the controller.	
Renderer Set-up	Automatic Access Permission	Allows you to select whether to permit access to the TV automatically when the network device accesses the TV for the first time.
	Renderer Name	Allows you to set the name of the TV to be shown on the controller.

Additional Information

Installing the Accessories (Wall-Mount Bracket)

To Customers:

For product protection and safety reasons, Sony strongly recommends that installing of your TV be performed by Sony dealers or licensed contractors. Do not attempt to install it yourself.

To Sony Dealers and Contractors:

Provide full attention to safety during the installation, periodic maintenance and examination of this product.

Your TV can be installed using the Wall-Mount Bracket SU-WL500 (sold separately).

- Refer to the Instructions supplied with the Wall-Mount Bracket to properly carry out the installation.
- Refer to “Detaching the Table-Top Stand from the TV” (page 8).
- Refer to “TV installation dimensions table” (page 53).
- Refer to “Screw and Hook locations diagram/table” (page 53).



- Place the TV on the Table-Top Stand, when securing the Mounting Hook.

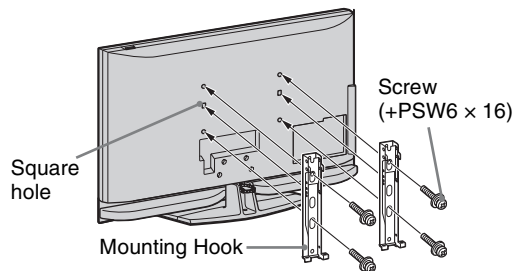

Sufficient expertise is required for installing this product, especially to determine the strength of the wall for withstanding the TV's weight. Be sure to entrust the attachment of this product to the wall to Sony dealers or licensed contractors and pay adequate attention to safety during the installation. Sony is not liable for any damage or injury caused by mishandling or improper installation.

TV installation dimensions table

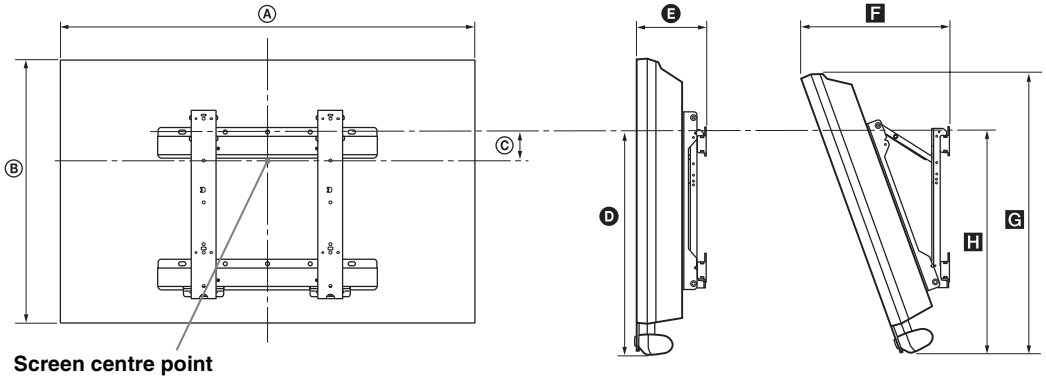

Unit: mm

Model Name	Display dimensions		Screen centre dimension	Length for each mounting angle				
				Angle (0°)		Angle (20°)		
	A	B	C	D	E	F	G	H
KDL-52Z4500	1,281	839	39	494	194	428	796	535
KDL-46Z4500	1,140	749	84	492	192	396	710	533
KDL-40Z4500	1,005	666	122	490	187	364	633	529

Figures in the above table may differ slightly depending on the installation.

WARNING

The wall that the TV will be installed on should be capable of supporting a weight of at least four times that of the TV. Refer to “Specifications” (page 54) for its weight.

Screw and Hook locations diagram/table

Model Name	Screw location	Hook location
KDL-52Z4500/KDL-46Z4500/KDL-40Z4500	d, g	b

* Hook position “a, c” cannot be used for the models in the table above.



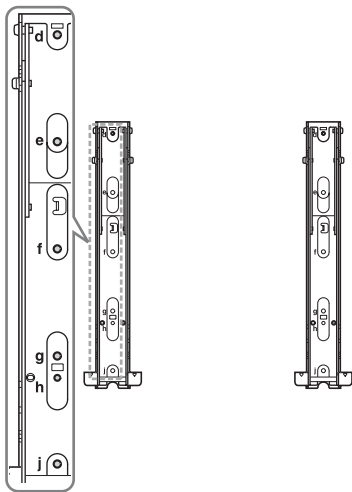



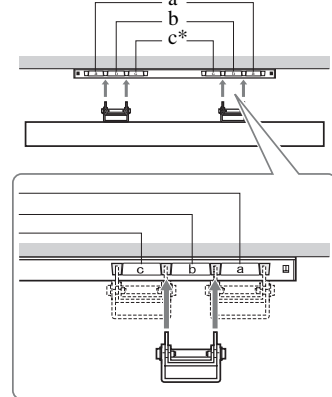







Screw location



Hook location



Specifications

Model name	KDL-52Z4500	KDL-46Z4500	KDL-40Z4500	
System				
Panel system	LCD (Liquid Crystal Display) Panel			
TV system	Analogue: Depending on your country selection: B/G/H, D/K, L, I Digital: DVB-T/DVB-C			
Colour/video system	Analogue: PAL, SECAM, NTSC 3.58/4.43 (only Video In) Digital: MPEG-2 MP@ML/HL, H.264/MPEG-4 AVC HP@L4.0, MP@L3.0			
Channel coverage	Analogue: VHF: E2–E12/UHF: E21–E69/CATV: S1–S20/HYPER: S21–S41 D/K: R1–R12, R21–R69/L: F2–F10, B–Q, F21–F69/I: UHF B21–B69 Digital: VHF/UHF			
Sound output	9 W + 9 W, 12 W (Woofer)			
Input/Output jacks				
Aerial	75 ohm external terminal for VHF/UHF			
 AV1	21-pin Scart connector (CENELEC standard) including audio/video input, RGB input and TV audio/video output.			
 /  /  AV2 (SMARTLINK)	21-pin Scart connector (CENELEC standard) including audio/video input, RGB input, S Video input, selectable audio/video output, and SMARTLINK interface.			
 AV3	Video input (phono jack)			
 AV3	Audio input (phono jacks)			
	DIGITAL AUDIO OUT (OPTICAL)(digital optical jack)/Audio output (phono jack)			
 COMPONENT IN	Supported formats: 1080p, 1080i, 720p, 576p, 576i, 480p, 480i Y: 1 Vp-p, 75 ohms, 0.3V negative sync Pb/Cb: 0.7 Vp-p, 75 ohms Pr/Cr: 0.7 Vp-p, 75 ohms			
HDMI IN 1, 2, 3	Video: 1080/24p, 1080p, 1080i, 720p, 576p, 576i, 480p, 480i Audio: Two channel linear PCM 32, 44.1 and 48 kHz, 16, 20 and 24 bits PC Input (see page 55) Analogue audio (minijack): 500 mVrms (HDMI IN 2 only)			
PC IN 	PC Input (D-sub 15-pin) G: 0.7 Vp-p, 75 ohms, non Sync on Green B: 0.7 Vp-p, 75 ohms, non Sync on Green R: 0.7 Vp-p, 75 ohms, non Sync on Green HD: 1-5 Vp-p VD: 1-5 Vp-p  PC audio input (minijack)			
	Headphones jack			
	CAM (Conditional Access Module) slot			
	USB port			
DMPort	DIGITAL MEDIA PORT			
 LAN	10BASE-T/100BASE-TX connector (Depending on the operating environment of the network, connection speed may differ. 10BASE-T/100BASE-TX communication rate and communication quality is not guaranteed for this TV.)			
Power and others				
Power requirements	220–240V AC, 50Hz			
Screen size (measured diagonally)	52 inches	46 inches	40 inches	
Display resolution	1,920 dots (horizontal) × 1,080 lines (vertical)			
Power consumption	in “Home”/ “Standard” mode	280 W	260 W	210 W
	in “Shop”/“Vivid” mode	320 W	283 W	235 W
Standby power consumption*	0.2 W or less (20 W when Quick Start is “On”)			
Dimensions (Approx.) (w × h × d)	with Table-Top Stand	128.1 × 88.2 × 34.6 cm	114.0 × 79.0 × 30.7 cm	100.5 × 70.5 × 27.9 cm
	without Table-Top Stand	128.1 × 83.9 × 13.5 cm	114.0 × 74.9 × 13.2 cm	100.5 × 66.6 × 12.8 cm

Model name		KDL-52Z4500	KDL-46Z4500	KDL-40Z4500
Mass (Approx.)	with Table-Top Stand	41.0 kg	34.5 kg	25.5 kg
	without Table-Top Stand	34.0 kg	30.0 kg	22.0 kg
Supplied accessories		See "Before Use" on page 4.		
Optional accessories	Wall-Mount Bracket	See "Installing the Accessories (Wall-Mount Bracket)" on page 52.		
	Colour Variation Unit	CRU-52SG13	CRU-46SG13	CRU-40SG13

* Specified standby power is reached after the TV finishes necessary internal processes.

PC Input Signal Reference Chart for PC

Resolution				Horizontal frequency (kHz)	Vertical frequency (Hz)	Standard
Signals	Horizontal (Pixel)	× Vertical (Line)				
VGA	640	× 480		31.5	60	VGA
	640	× 480		37.5	75	VESA
	720	× 400		31.5	70	VGA-T
SVGA	800	× 600		37.9	60	VESA Guidelines
	800	× 600		46.9	75	VESA
XGA	1024	× 768		48.4	60	VESA Guidelines
	1024	× 768		56.5	70	VESA
	1024	× 768		60.0	75	VESA
WXGA	1280	× 768		47.4	60	VESA
	1280	× 768		47.8	60	VESA
	1280	× 768		60.3	75	
	1360	× 768		47.7	60	VESA
SXGA	1280	× 1024		64.0	60	VESA

- This TV's PC input does not support Sync on Green or Composite Sync.
- This TV's PC input does not support interlaced signals.
- This TV's PC input supports signals in the above chart with a 60 Hz vertical frequency.

PC Input Signal Reference Chart for HDMI IN 1, 2, 3



Resolution				Horizontal frequency (kHz)	Vertical frequency (Hz)	Standard
Signals	Horizontal (Pixel)	× Vertical (Line)				
VGA	640	× 480		31.5	60	VGA
SVGA	800	× 600		37.9	60	VESA Guidelines
XGA	1024	× 768		48.4	60	VESA Guidelines
WXGA	1280	× 768		47.4	60	VESA
WXGA	1280	× 768		47.8	60	VESA
SXGA	1280	× 1024		64.0	60	VESA

Troubleshooting

Check whether the  (standby) indicator is flashing in red.











When it is flashing

The self-diagnosis function is activated.

- 1 Count how many  (standby) indicator flashes between each two second break.
For example, the indicator flashes three times, then there is a two second break, followed by another three flashes, etc.
- 2 Press  on the top edge of the TV to turn it off, disconnect the mains lead, and inform your dealer or Sony service centre of how the indicator flashes (number of flashes).

When it is not flashing

- 1 Check the items in the tables below.
- 2 If the problem still persists, have your TV serviced by qualified service personnel.

Condition	Explanation/Solution
Picture	
No picture (screen is dark) and no sound	<ul style="list-style-type: none">• Check the aerial/cable connection.• Connect the TV to the mains, and press  on the top edge of the TV.• If the  (standby) indicator lights up in red, press TV I/.
No picture or no menu information from equipment connected to the scart connector	<ul style="list-style-type: none">• Press / to display the connected equipment list, then select the desired input.• Check the connection between the optional equipment and the TV.
Double images or ghosting (only in analogue mode)	<ul style="list-style-type: none">• Check the aerial/cable connection.• Check the aerial location and direction.
Only snow and noise appear on the screen (only in analogue mode)	<ul style="list-style-type: none">• Check if the aerial is broken or bent.• Check if the aerial has reached the end of its serviceable life (three to five years in normal use, one to two years at the seaside).
Picture or sound noise when viewing a TV channel (only in analogue mode)	<ul style="list-style-type: none">• Adjust “AFT” (Automatic Fine Tuning) to obtain better picture reception (page 47).
Some tiny black points and/or bright points appear on the screen	<ul style="list-style-type: none">• The picture of a display unit is composed of pixels. Tiny black points and/or bright points (pixels) on the screen do not indicate a malfunction.
No colour on programmes	<ul style="list-style-type: none">• Select “Reset” (page 39).
No colour or irregular colour when viewing a signal from the  /  COMPONENT IN sockets	<ul style="list-style-type: none">• Check the connection of the / COMPONENT IN sockets and check if each sockets are firmly seated in their respective sockets.
Picture freezes or contains blocks on the screen	<ul style="list-style-type: none">• Check signal level (page 50). If signal bar is red (no signal) or amber (low signal), check the aerial/cable connection.• Remove the connected USB device. It can be damaged or not supported by the TV. Check the website below for updated information about compatible USB devices: http://support.sony-europe.com/TV/compatibility/
Sound	
No sound, but good picture	<ul style="list-style-type: none">• Press  +/- or  (Mute).• Check if the “Speaker” is set to “TV Speaker” (page 45).• When using HDMI input with Super Audio CD or DVD-Audio, DIGITAL AUDIO OUT (OPTICAL) may not output audio signals.

Condition	Explanation/Solution
There is a significant difference in the output volume level between DIGITAL MEDIA PORT input and TV or other equipment input.	<ul style="list-style-type: none"> • Adjust “Volume Offset” setting in the “Sound” menu (page 40).
Connection Diagnostic Results	
“Connection successful.” does not appear.	<p>Check Connections</p> <ul style="list-style-type: none"> • Use a straight cable for the LAN cable. • Check if the cable is connected firmly. • Check the connection between the TV and the broadband router. <p>Check Settings</p> <ul style="list-style-type: none"> • Change the IP address for the DNS server (see “Checking the Network Connection” on page 36) while referring to the following. <ul style="list-style-type: none"> – Contact your Internet provider. – Specify the IP address of the router if you do not know the DNS of your Internet provider.
Home Network	
The server cannot be found, a list cannot be retrieved, and playback fails.	<ul style="list-style-type: none"> • Once server settings are changed, turn the TV off and on by pressing  on the TV. • Execute “Server Diagnostics” (page 37). <p>When using a PC as the server</p> <ul style="list-style-type: none"> • Check if the PC is turned on. Do not turn off the PC while accessing. • If security software is installed on the server, be sure to allow connections from external devices. For details, see the manual supplied with your security software. • The load on the PC may be too high or the server application may become unstable. Try the following: <ul style="list-style-type: none"> – Stop the server application and restart it. – Restart the PC. – Reduce the number of applications running on the PC. – Reduce the amount of content.
Changes on the server are not being applied or displayed content differs from content on the server.	<ul style="list-style-type: none"> • Sometimes changes are not applied to displays on the TV even though content has been added and/or deleted on the server. If this happens, go back up one level and try opening the folder or server again.
Photo and/or music files do not appear or icons are not displayed.	<p>Preliminary Check</p> <ul style="list-style-type: none"> • Check that the connected device supports DLNA. • Operations are not guaranteed for all servers. Also, operations differ depending on the features of the server and the content in question. • Turn the connected device on. <p>Check Connections</p> <ul style="list-style-type: none"> • Check that the LAN cable and/or mains lead of the server has not become disconnected. <p>Check Settings</p> <ul style="list-style-type: none"> • Check that the connected device is registered under “Server Display Settings” (page 36). • Check that the server is correctly configured. • Check that the selected equipment is connected to the network and can be accessed. • If the “IP Address” in “Network” under “Network Settings” is set to “DHCP (DNS automatic)” or “DHCP (DNS manual)”, it may take some time to recognise a device if there is no DHCP server. Execute “Server Diagnostics” (page 37).

Condition	Explanation/Solution
The TV cannot be found from renderer-compatible equipment (the controller).	<p>Check Connections</p> <ul style="list-style-type: none"> • Check that the LAN cable and/or mains lead of the server has not become disconnected. <p>Check Settings</p> <ul style="list-style-type: none"> • Check if the “Renderer Function” is activated (page 51). • Check that the connected device is registered under “Renderer Access Control” (page 51).
Channels	
The desired channel cannot be selected	<ul style="list-style-type: none"> • Switch between digital and analogue mode and select the desired digital/analogue channel.
Some channels are blank	<ul style="list-style-type: none"> • Scrambled/Subscription only channel. Subscribe to the pay TV service. • Channel is used only for data (no picture or sound). • Contact the broadcaster for transmission details.
Digital channels are not displayed	<ul style="list-style-type: none"> • Contact a local installer to find out if digital transmissions are provided in your area. • Upgrade to a higher gain aerial.
General	
Distorted picture and/or sound	<ul style="list-style-type: none"> • Keep the TV away from electrical noise sources such as cars, motorcycles, hair-dryers or optical equipment. • When installing optional equipment, leave some space between the optional equipment and the TV. • Check the aerial/cable connection. • Keep the aerial/cable TV cable away from other connecting cables.
The TV turns off automatically (the TV enters standby mode)	<ul style="list-style-type: none"> • Check if the “Sleep Timer” is activated, or confirm the “Duration” setting of “On Timer Settings” (page 43). • If no signal is received and no operation is performed in the TV mode for 10 minutes, the TV automatically switches to standby mode.
The TV turns on automatically	<ul style="list-style-type: none"> • Check if the “On Timer” is activated (page 43).
Some input sources cannot be selected	<ul style="list-style-type: none"> • Select “AV Preset” and cancel “Skip” of the input source (page 44).
The remote does not function	<ul style="list-style-type: none"> • Replace the batteries.
The BD, DVD, AMP and TV function buttons on the remote flash at the same time.	<ul style="list-style-type: none"> • The batteries inside the remote run out of battery life. Replace the batteries with new ones.
You have a blank TV listings in the GUIDE Plus+ system	<ul style="list-style-type: none"> • Check the aerial/cable connection. • Your cabling and Setup is OK, but your GUIDE Plus+ system was not connected for enough time to receive TV listings data. Leave the TV “STANDBY” overnight (24 hours) or use “Manual Data Download” (page 20). • You live in a country/region where the GUIDE Plus+ system is not yet available. Check the list of countries to see if you are in a region that is supported. (http://www.europe.guideplus.com/)
HDMI equipment does not appear on “HDMI Device List”	<ul style="list-style-type: none"> • Check that your equipment is “Control for HDMI” compatible equipment.
Not all channels are tuned	<ul style="list-style-type: none"> • Check support web site for cable provide information. http://support.sony-europe.com/TV/DVBC/
You cannot select “Off” in “Control for HDMI.”	<ul style="list-style-type: none"> • If any “Control for HDMI” compatible audio equipment is connected to the TV, you cannot select “Off” in this menu. If you want to change the audio output to the TV speaker, select “TV Speaker” in the “Speaker” menu (page 45).

Condition

The speaker grille has come off

Explanation/Solution

- To attach the speaker grille, first turn off the TV, then unplug the mains lead. Then follow the procedure below.

Orient the speaker grille so that the location of the marks on the speaker grille and TV match, insert the protrusions on the speaker grille into the holes on the TV, and support gently. Check that the speaker grille and TV are in contact without any gaps, and then secure it by pushing and sliding the speaker grille left into place.

To prevent the TV set from being damaged, do not touch the speakers or their surroundings.

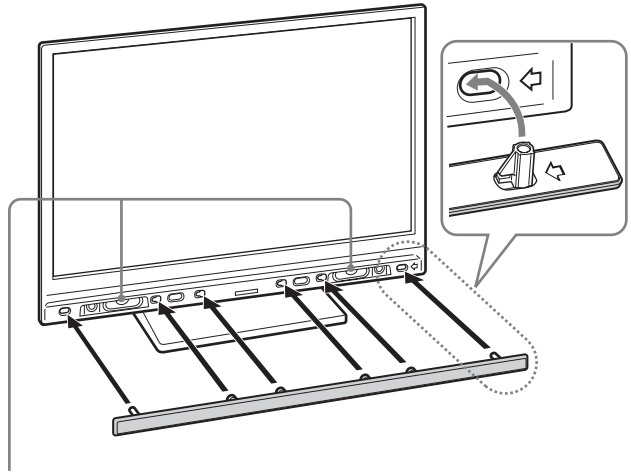

Do not touch the speakers.