



# Digital Alarm Communicator/Transmitter 411

# Fire Alarm System Limitations

**An automatic fire alarm system**—typically made up of smoke detectors, heat detectors, manual pull stations, audible warning devices, and a fire alarm control with remote notification capability—can provide early warning of a developing fire. Such a system, however, does not assure protection against property damage or loss of life resulting from a fire.

The Manufacturer recommends that smoke and/or heat detectors be located throughout a protected premise following the recommendations of the current edition of the National Fire Protection Association Standard 72 (NFPA 72), manufacturer's recommendations, State and local codes, and the recommendations contained in the Guide for Proper Use of System Smoke Detectors, which is made available at no charge to all installing dealers. A study by the Federal Emergency Management Agency (an agency of the United States government) indicated that smoke detectors may not go off in as many as 35% of all fires. While fire alarm systems are designed to provide early warning against fire, they do not guarantee warning or protection against fire. A fire alarm system may not provide timely or adequate warning, or simply may not function, for a variety of reasons:

**Smoke detectors** may not sense fire where smoke cannot reach the detectors such as in chimneys, in or behind walls, on roofs, or on the other side of closed doors. Smoke detectors also may not sense a fire on another level or floor of a building. A second-floor detector, for example, may not sense a first-floor or basement fire.

**Particles of combustion or "smoke"** from a developing fire may not reach the sensing chambers of smoke detectors because:

- Barriers such as closed or partially closed doors, walls, or chimneys may inhibit particle or smoke flow.
- Smoke particles may become "cold," stratify, and not reach the ceiling or upper walls where detectors are located.
- Smoke particles may be blown away from detectors by air outlets.
- Smoke detectors may be drawn into air returns before reaching the detector.

The amount of "smoke" present may be insufficient to alarm smoke detectors. Smoke detectors are designed to alarm at various levels of smoke density. If such density levels are not created by a developing fire at the location of detectors, the detectors will not go into alarm.

Smoke detectors, even when working properly, have sensing limitations. Detectors that have photoelectronic sensing chambers tend to detect smoldering fires better than flaming fires, which have little visible smoke. Detectors that have ionizing-type sensing chambers tend to detect fast-flaming fires better than smoldering fires. Because fires develop in different ways and are often unpredictable in their growth, neither type of detector is necessarily best and a given type of detector may not provide adequate warning of a fire.

Smoke detectors cannot be expected to provide adequate warning of fires caused by arson, children playing with matches (especially in bedrooms), smoking in bed, and violent explosions (caused by escaping gas, improper storage of flammable materials, etc.).

*While a fire alarm system may lower insurance rates, it is not a substitute for fire insurance!*

Heat detectors do not sense particles of combustion and alarm only when heat on their sensors increases at a predetermined rate or reaches a predetermined level. Rate-of-rise heat detectors may be subject to reduced sensitivity over time. For this reason, the rate-of-rise feature of each detector should be tested at least once per year by a qualified fire protection specialist. *Heat detectors are designed to protect property, not life.*

**IMPORTANT! Smoke detectors must be installed in the same room as the control panel and in rooms used by the system for the connection of alarm transmission wiring, communications, signaling, and/or power.** If detectors are not so located, a developing fire may damage the alarm system, crippling its ability to report a fire.

**Audible warning devices** such as bells may not alert people if these devices are located on the other side of closed or partly open doors or are located on another floor of a building. Any warning device may fail to alert people with a disability or those who have recently consumed drugs, alcohol or medication. Please note that:

- Strobes can, under certain circumstances, cause seizures in people with conditions such as epilepsy.
- Studies have shown that certain people, even when they hear a fire alarm signal, do not respond or comprehend the meaning of the signal. It is the property owner's responsibility to conduct fire drills and other training exercise to make people aware of fire alarm signals and instruct them on the proper reaction to alarm signals.
- In rare instances, the sounding of a warning device can cause temporary or permanent hearing loss.

**A fire alarm system** will not operate without any electrical power. If AC power fails, the system will operate from standby batteries only for a specified time and only if the batteries have been properly maintained and replaced regularly.

**Equipment used in the system** may not be technically compatible with the control. It is essential to use only equipment listed for service with your control panel.

**Telephone lines** needed to transmit alarm signals from a premise to a central monitoring station may be out of service or temporarily disabled. For added protection against telephone line failure, backup radio transmission systems are recommended.

**The most common cause** of fire alarm malfunction is inadequate maintenance. To keep the entire fire alarm system in excellent working order, ongoing maintenance is required per the manufacturer's recommendations, and UL and NFPA standards. At a minimum, the requirements of Chapter 7 of NFPA 72 shall be followed. Environments with large amounts of dust, dirt or high air velocity require more frequent maintenance. A maintenance agreement should be arranged through the local manufacturer's representative. Maintenance should be scheduled monthly or as required by National and/or local fire codes and should be performed by authorized professional fire alarm installers only. Adequate written records of all inspections should be kept.

# Installation Precautions

**WARNING** - Several different sources of power can be connected to the fire alarm control panel. Disconnect all sources of power before servicing. Control unit and associated equipment may be damaged by removing and/or inserting cards, modules, or interconnecting cables while the unit is energized. Do not attempt to install, service, or operate this unit until this manual is read and understood.

**CAUTION** - *System Reacceptance Test after Software Changes.* To ensure proper system operation, this product must be tested in accordance with NFPA 72 Chapter 7 after any programming operation or change in site-specific software. Reacceptance testing is required after any change, addition or deletion of system components, or after any modification, repair or adjustment to system hardware or wiring.

All components, circuits, system operations, or software functions known to be affected by a change must be 100% tested. In addition, to ensure that other operations are not inadvertently affected, at least 10% of initiating devices that are not directly affected by the change, up to a maximum of 50 devices, must also be tested and proper system operation verified.

**This system** meets NFPA requirements for operation at 0-49° C/32-120° F and at a relative humidity of 85% RH (non-condensing) at 30° C/86° F. However, the useful life of the system's standby batteries and the electronic components may be adversely affected by extreme temperature ranges and humidity. Therefore, it is recommended that this system and all peripherals be installed in an environment with a nominal room temperature of 15-27° C/60-80° F.

**Verify that wire sizes are adequate** for all initiating and indicating device loops. Most devices cannot tolerate more than a 10% I.R. drop from the specified device voltage.

*Adherence to the following will aid in problem-free installation with long-term reliability:*

**Like all solid state electronic devices**, this system may operate erratically or can be damaged when subjected to lightning-induced transients. Although no system is completely immune from lightning transients and interferences, proper grounding will reduce susceptibility. *Overhead or outside aerial wiring is not recommended, due to an increased susceptibility to nearby lightning strikes.* Consult with the Technical Services Department if any problems are anticipated or encountered.

**Disconnect AC power and batteries** prior to removing or inserting circuit boards. Failure to do so can damage circuits.

**Remove all electronic assemblies** prior to any drilling, filing, reaming, or punching of the enclosure. When possible, make all cable entries from the sides or rear. Before making modifications, verify that they will not interfere with battery, transformer, and printed circuit board location.

**Do not tighten screw terminals** more than 9 in-lbs. Over-tightening may damage threads, resulting in reduced terminal contact pressure and difficulty with screw terminal removal.

**Though designed to last many years**, system components can fail at any time. This system contains static-sensitive components. Always ground yourself with a proper wrist strap before handling any circuits so that static charges are removed from the body. Use static-suppressive packaging to protect electronic assemblies removed from the unit.

**Follow the instructions** in the installation, operating, and programming manuals. These instructions must be followed to avoid damage to the control panel and associated equipment. FACP operation and reliability depend upon proper installation by authorized personnel.

## FCC Warning

**WARNING:** This equipment generates, uses, and can radiate radio frequency energy and if not installed and used in accordance with the instruction manual, may cause interference to radio communications. It has been tested and found to comply with the limits for class A computing device pursuant to Subpart B of Part 15 of FCC Rules, which is designed to provide reasonable protection against such interference when operated in a commercial environment. Operation of this equipment in a residential area is likely to cause interference, in which case the user will be required to correct the interference at his own expense.

### Canadian Requirements

This digital apparatus does not exceed the Class A limits for radiation noise emissions from digital apparatus set out in the Radio Interference Regulations of the Canadian Department of Communications.

Le présent appareil numérique n'émet pas de bruits radioélectriques dépassant les limites applicables aux appareils numériques de la classe A prescrites dans le Règlement sur le brouillage radioélectrique édicté par le ministère des Communications du Canada.

## Notes

# Table of Contents

<b>CHAPTER 1: Product Description .....</b>	<b>8</b>
1.1: Product Features .....	8
FIGURE 1-1: 411 Digital Communicator.....	8
1.2: Specifications .....	9
1.3: Circuits .....	9
1.3.1: Power Requirements .....	9
1.3.2: Channels/Inputs.....	10
1.3.3: Primary and Secondary Phone Lines .....	10
1.3.4: Earth Ground.....	10
1.4: Controls and Indicator.....	10
FIGURE 1-2: 411 Indicator .....	10
1.5: Digital Communicator Operation.....	11
1.6: Telephone Requirements and Warnings .....	11
1.6.1: Telephone Circuitry - PH1 & PH2 .....	11
1.6.2: Digital Communicator: .....	11
1.6.3: Telephone Company Rights and Warnings: .....	12
1.6.4: For Canadian Applications.....	12
1.7: Operational Modes .....	13
1.7.1: Normal Mode .....	13
1.7.2: Real Time Clock Mode .....	13
1.7.3: Program Mode.....	13
1.7.4: Troubleshoot Mode .....	13
1.7.5: Default Mode .....	13
<b>CHAPTER 2: Installation.....</b>	<b>14</b>
2.1: Mounting Options .....	14
FIGURE 2-1: 411 Enclosure.....	14
2.2: Operating Power.....	14
2.3: Input Channels.....	14
FIGURE 2-2: Fire• Lite MS-9200 Connection to 411.....	15
FIGURE 2-3: Notifier AFP-200 Connection to 411 .....	15
FIGURE 2-4: Style B Channel Connections.....	16
2.4: Telephone Circuits.....	17
TABLE 2-1: Wiring Phone Jacks .....	17
2.5: Optional Programmer.....	18
FIGURE 2-5: Programmer Connection to 411 .....	18
2.6: UL Power-limited Wiring Requirements .....	19
<b>CHAPTER 3: Modes of Operation .....</b>	<b>20</b>
3.1: Normal Mode .....	20
3.1.1: Programmer Key Functions .....	21
FIGURE 3-1: Programmer Keypad .....	21
3.1.2: Programmer Display .....	22
3.2: Real Time Clock Mode .....	22
3.3: Program Mode.....	24
3.3.1: DACT Programming .....	25
TABLE 3-1: Ademco Contact ID Format - Primary .....	26
TABLE 3-2: 4+2 Standard and 4+2 Express Formats - Primary.....	27
TABLE 3-3: All 3+1, 4+1 and 4+2 Expanded Formats - Primary .....	27
TABLE 3-4: Ademco Contact ID Format - Secondary .....	30
TABLE 3-5: 4+2 Standard and 4+2 Express Formats - Secondary.....	30
TABLE 3-6: All 3+1, 4+1 and 4+2 Expanded Formats - Secondary .....	31

**Table of Contents**

3.4: Default Mode .....35

3.5: Troubleshoot Mode.....35

    FIGURE 3-2: Handset/Speaker Connection .....35

**CHAPTER 4: Central Station Communications .....36**

    TABLE 4-1: Format Selection Addresses ( 20 and 50) Programming .....37

    TABLE 4-2: Format Selection Address Explanation.....38

    4.0.1: Transmittal Priorities .....39

    4.0.2: Ademco Contact ID Format Event Code Description.....40

        TABLE 4-3: Compatible UL Listed Receivers.....41

**Appendix A: Programming Sheets .....42**

    A.1: Digital Communicator Options Program Sheets .....42

    A.2: Digital Communicator Options Program Sheet (Factory Defaults) .....44

**Appendix B: Event Codes/Transmission Format Programming Sheets .....46**

    B.1: 4+2 Standard & 4+2 Express Formats Primary Central Station .....46

    B.2: 4+2 Standard & 4+2 Express Formats Secondary Central Station .....46

    B.3: 4+2 Standard & 4+2 Express Formats Primary Central Station .....47

    B.4: 4+2 Standard & 4+2 Express Formats Secondary Central Station .....47

    B.5: All 3+1, All 4+1 and 4+2 Expanded Formats for Primary Central Station .....48

    B.6: All 3+1, All 4+1 and 4+2 Expanded Formats for Secondary Central Station .....48

    B.7: All 3+1, All 4+1 and 4+2 Expanded Formats for Primary Central Station (Factory Defaults) .....48

    B.8: All 3+1, All 4+1 and 4+2 Expanded Formats for Secondary Central Station (Factory Defaults) .....48

    B.9: Ademco Contact ID Format Primary Central Station .....49

    B.10: Ademco Contact ID Format Secondary Central Station .....49

    B.11: Ademco Contact ID Format Primary Central Station (Factory Defaults) .....50

    B.12: Ademco Contact ID Format Secondary Central Station (Factory Defaults) .....50

**Appendix C: Ademco Contact ID Format Event Code Description .....51**

**Appendix D: Wire Requirements .....55**

    TABLE 4-4: Wire Specifications.....55

**Appendix E: Operational Modes .....56**

    TABLE 4-5: Operational Modes.....56

This digital communicator has been designed to comply with standards set forth by the following regulatory agencies:

- Underwriters Laboratories Standard
- NFPA 72 National Fire Alarm Code
- CAN/ULC - S527-M87 Standard for Control Units for Fire Alarm Systems

**Before proceeding, the installer should be familiar with the following documents.**



#### **NFPA Standards**

**This digital communicator complies with the NFPA 72 National Fire Alarm Code for:**

Central Station Signaling Systems Protected Premises Unit (Automatic, Manual and Waterflow)

Local Fire Alarm Systems (Automatic, Manual, Waterflow and Sprinkler Supervisory)

Proprietary Fire Alarm Systems (Protected Premises Unit)

Remote Station Fire Alarm Systems

Automatic Fire Detectors

Installation, Maintenance and Use of Notification Appliances for Fire Alarm Systems

Inspection, Testing and Maintenance for Fire Alarm Systems



#### **Underwriters Laboratories Documents:**

UL 217 Smoke Detectors, Single and Multiple Station

UL 268 Smoke Detectors for Fire Protective Signaling Systems

UL 346 Waterflow Indicators for Fire Protective Signaling Systems

UL 464 Audible Signaling Appliances

UL 521 Heat Detectors for Fire Protective Signaling Systems

UL 864 Standard for Control Units for Fire Protective Signaling Systems

UL 1076 Proprietary Burglar Alarm Units and Systems

UL 1481 Power Supplies for Fire Protective Signaling Systems

UL 1635 Digital Alarm Communicator System Units

UL 1638 Visual Signaling Appliances

UL 1971 Signaling Devices for Hearing Impaired

CAN/ULC - S524-M91 Standard for Installation of Fire Alarm Systems



#### **Other:**

NEC Article 250 Grounding

NEC Article 300 Wiring Methods

NEC Article 760 Fire Protective Signaling Systems

Applicable Local and State Building Codes

Requirements of the Local Authority Having Jurisdiction (LAHJ)

# CHAPTER 1 *Product Description*

The 411 is a three input/channel, dual line, digital alarm communicator transmitter which can be used as a slave communicator with UL listed fire and nonfire control panels. The three inputs are compatible with normally open relay contacts, require End-Of-Line (EOL) resistors, are supervised and are fully programmable. The 411 interfaces with the public switched telephone network and is compatible with most central station receivers. A total of fifteen popular communications formats are supported, including Ademco Contact ID. The communicator also contains a unique DACT option that eliminates 'dialer runaway'. It restricts the transmission of any trouble event to 10 attempts in a 24 hour period. Power supplied must be 12 or 24 volts, filtered and nonresettable. The Fire-Watch 411 Series DACT Programmer is available for 411 programming. The 411 comes in a small 6.841" (17.376 cm) X 4.595" (11.671 cm) X 1.00" (2.54 cm) metal enclosure, providing a variety of mounting options.

## 1.1 Product Features

- Three input channels
- Dual telephone lines
- Dual telephone line voltage detect
- Program locations for entering up to 20-digit central station and service terminal telephone numbers
- Surface mount technology
- Compact in size
- Separate external keypad and display
  - ✓ provides means of programming digital communicator in program mode
  - ✓ provides means of testing phone circuits in troubleshoot mode
- 6.841" (17.376 cm) X 4.595" (11.671 cm) X 1.0" (2.54 cm) metal enclosure facilitates internal and external control panel mounting
- Communicates vital status of monitored control panel:
  - ✓ fire alarm
  - ✓ host control panel trouble
  - ✓ fire supervisory
  - ✓ process monitor
  - ✓ AC (mains) power loss (programmable)
  - ✓ security alarm
  - ✓ other
- Communicates vital status of 411 digital communicator:
  - ✓ digital communicator troubles
  - ✓ telephone Line 1 and 2 voltage fault
  - ✓ Primary Central Station number communication fault
  - ✓ Secondary Central Station number communication fault
  - ✓ system off-normal (local Program Mode entered)
  - ✓ 24 Hour normal test
  - ✓ 24 Hour abnormal test (24 hour test message with previously reported alarm or trouble still active)

FIGURE 1-1:411 Digital Communicator

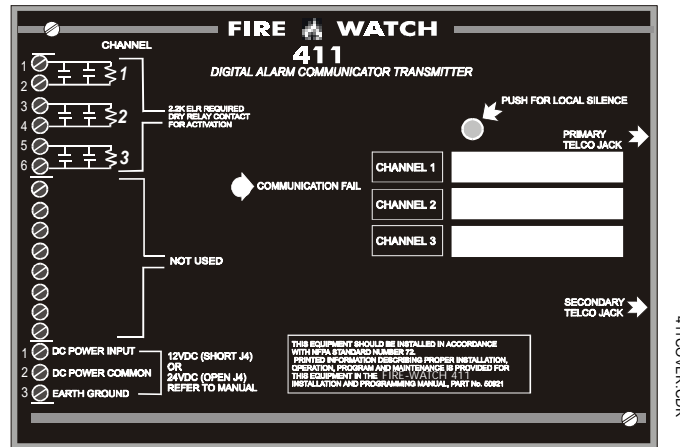



## Specifications

- LED for Communication Fail (visible with cover on)
- Piezo sounder
- Local piezo silence switch which silences onboard piezo sounder (accessible without removing cover)
- Real time clock
- Extensive transient protection
- Option that prevents 'dialer runaway'

## 1.2 Specifications

### Operating Power

The 411 may be powered from UL listed control panels that output nonresettable and power-limited 12 or 24 VDC power. The configuration of Jumper J4 determines whether 12 VDC power is to be supplied directly to the 411 circuit board or 24 VDC power is to be supplied and then internally regulated down to 12 VDC.

### DC Power - TB1 Terminals 1(+) and 2(-), Terminal 3 is Earth Ground

- J4 Jumper removed - Filtered, nonresettable and power-limited 24 VDC (nominal) power must be supplied at TB1 Terminals 1(+) and 2(-). Operating voltage provided must be within 21.3 to 24.0 VDC (UL tested range: -15%, +10%). Current requirements are 78 mA in standby and 126 mA<sup>1</sup> while communicating.
- J4 Jumper installed - Filtered, nonresettable and power-limited 12 VDC (nominal) power must be supplied at TB1 Terminals 1(+) and 2(-). Operating voltage provided must be within 11.2 to 12.4 VDC (UL tested range: -15%, +10%). Current requirements are 78 mA in standby and 126 mA<sup>1</sup> while communicating.

### Channels/Inputs<sup>2</sup> - TB2 Terminals 1 through 6

Programmable Channels 1 through 3

Power-limited circuitry

Fully supervised

Operation: All channels NFPA Style B (Class B). Requires Normally Open contact to trigger

Normal Operating Voltage: 12 VDC

Maximum Line Resistance: 100 ohms per channel

Alarm Current: 3.34 mA

End-of-Line Resistor: 2.2K ohms, ½ watt (P/N 27070)

Short Circuit Current: 3.8 mA per channel/input

## 1.3 Circuits

The 411 circuit board utilizes surface mount technology and contains a MicroController Unit (MCU), dual modular phone line jacks, piezo sounder and two connectors for input, output and power wiring.

### 1.3.1 Power Requirements

Voltage for the digital communicator may be a power-limited, filtered, nonresettable nominal 12 VDC [11.2 to 12.4 VDC (UL tested range: -15%, +10%)] or nominal 24 VDC [21.3 to 24.0 VDC (UL tested range: -15%, +10%)]. Jumper J4 is used to select the power source.

- 
1. A maximum of 240 mA is possible with all input channels active, the 411 communicating, the Programmer connected and Lamp Test active.
  2. Channels/inputs do not support 2-wire smoke detectors.

## Controls and Indicator

### 1.3.2 Channels/Inputs

Three input channels are provided on the 411 digital communicator which are used for connection to the control panel being monitored. Each input can be programmed to monitor the control panel for:

- fire alarm activation
- process monitoring activation
- trouble activation
- fire supervisory activation
- security alarm activation
- AC loss activation

Each input channel is configured as a Class B circuit and must be wired to a Normally Open contact.

### 1.3.3 Primary and Secondary Phone Lines

Modular jacks are used to interface the primary and secondary phone lines to the public telephone network.

### 1.3.4 Earth Ground

Connect a separate earth ground wire to TB1 terminal 3 for transient protection.

## 1.4 Controls and Indicator

FIGURE 1-2: 411 Indicator

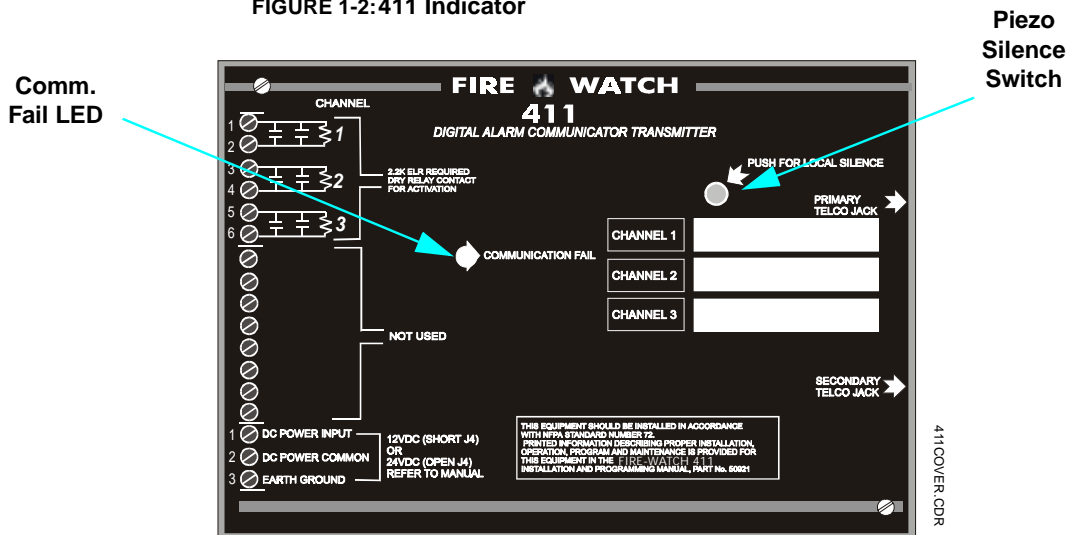

### Front Panel Switch

- Silence Switch - press to silence local 411 piezo sounder

### 411 Piezo Sounder

- The 411 piezo sounder is used to locally annunciate DACT troubles. DACT troubles include input channel open circuit, phone line 1 or 2 voltage fault, phone number 1 or 2 communication fault, total communication failure and communications disabled.

### Front Panel Indicator

- Communication Fail - yellow LED

## 1.5 Digital Communicator Operation

The 411 has been designed to be compatible with a wide variety of fire alarm, nonfire and combination control panels. Numerous formats are also available for communication to a central station. Two modular phone jacks allow easy connection to telephone lines. Modular jacks are labeled PH1 and PH2 for the Primary and Secondary phone lines. The digital communicator provides the following functions:

- Line Seizure- takes control of the phone lines, disconnecting any premises phones using the same lines
- Off/On-Hook - perform on and off-hook status to phone lines
- Listen for dial tone - 440 hertz tone typical in most networks
- Dialing the Central Station(s) phone number - default is Touch-Tone®, programmable to rotary
- Discern proper Central Station 'ACK' and 'Kiss-off' tone(s)
- Transmit data to the Central Station(s)
- Verify data has been accepted by the Central Station(s)
- Hang-up and release phone lines
- Communicate in a variety of formats (Refer to Table 4-1, "Format Selection Addresses ( 20 and 50) Programming," on page 37).

## 1.6 Telephone Requirements and Warnings

### 1.6.1 Telephone Circuitry - PH1 & PH2

DC Ringer Equivalence Number (REN) = 0.5B

AC Ringer Equivalence Number = 1.3

Complies with FCC Part 68

Mates with RJ31X Male Connector

Supervision Threshold: less than 4.0 volts for 2 minutes

The REN is used to determine the quantity of devices which may be connected to the telephone line. Excessive RENs on the telephone line may result in the devices not ringing in response to an incoming call. In most, but not all areas, the sum of the RENs should not exceed five (5.0). To be certain of the number of devices that may be connected to the line, as determined by the total RENs, contact the telephone company to determine the maximum REN for the calling area.

### 1.6.2 Digital Communicator:

Before connecting the 411 to the public switched telephone network, the installation of two RJ31X jacks is necessary. The following information is provided if required by the local telephone company:

Manufacturer: Fire•Lite Alarms Inc./Notifier  
One Fire-Lite Place  
Northford, CT 06472

Product Model Number: 411

FCC Registration Number: OAAUSA-25431-AL-E

Ringer Equivalence 0.5B

### 1.6.3 Telephone Company Rights and Warnings:

*The telephone company, under certain circumstances, may temporarily discontinue services and/or make changes in its facilities, services, equipment or procedures which may affect the operation of this digital communicator. However, the telephone company is required to give advance notice of such changes or interruptions. If the digital communicator causes harm to the telephone network, the telephone company reserves the right to temporarily discontinue service. Advance notification will be provided except in cases when advance notice is not practical. In such cases, notification will be provided as soon as possible. The opportunity will be given to correct any problems and to file a complaint.*

*DO NOT CONNECT THIS PRODUCT TO COIN TELEPHONE, GROUND START OR PARTY LINE SERVICES.*

*When the digital communicator activates, premise phones will be disconnected.*

*Two separate phone lines are required. Do not connect both telephone interfaces to the same telephone line.*

*The digital communicator must be connected to the public switched telephone network upstream of any private telephone system at the protected premises.*

*An FCC compliant telephone cord must be used with this equipment. This equipment is designed to be connected to the telephone network or premises wiring using a compatible RJ31X male modular plug which is Part 68 compliant.*

### 1.6.4 For Canadian Applications

The following is excerpted from CP-01 Issue 5:

“NOTICE: The Industry Canada (IC) label identifies certified equipment. This certification means that the equipment meets certain telecommunications network protective, operational and safety requirements as prescribed in the appropriate Terminal Equipment Technical Requirements document(s). The Department does not guarantee the equipment will operate to the user’s satisfaction.”

Before installing this equipment, users should ensure that it is permissible to be connected to the facilities of the local telecommunications company. The equipment must also be installed using an acceptable method of connection. The customer should be aware that compliance with the above conditions may not prevent degradation of service in some situations.

Repairs to certified equipment should be made by an authorized Canadian maintenance facility designated by the supplier. Any repairs or alterations made by the user to this equipment, or equipment malfunctions, may give the telecommunications company cause to request the user to disconnect the equipment.

Users should ensure for their own protection that the electrical ground connections of the power utility, telephone lines and internal metallic water pipe system, if present, are connected together. This precaution may be particularly important in rural areas.

#### **CAUTION**

Users should not attempt to make such connections themselves, but should contact the appropriate electric inspection authority, or electrician.

“The Ringer Equivalence Number (REN) assigned to each terminal device provides an indication of the maximum number of terminals allowed to be connected to a telephone interface. The termination of an interface may consist of any combination of devices subject only to the requirement that the sum of the REN of all devices does not exceed 5.”

Representative: NOTIFIER, CANADA  
24 Viceroy Road  
Concord, Ontario L4K2L9

IC Certificate Number: 2132 9028 A  
Ringer Equivalence Number (REN): 0.2

## 1.7 Operational Modes

### 1.7.1 Normal Mode

Normal Mode is the standard mode of operation in which the 411 digital communicator monitors the host control panel status as well as telephone line voltage and other internal circuits. In addition to locally annunciating communication fail, the digital communicator transmits system status information to UL listed central station receivers. Transmitted data includes fire alarm, fire alarm trouble, supervisory alarm, security alarm, AC loss and process monitoring information. Specific digital communicator troubles are also transmitted.

### 1.7.2 Real Time Clock Mode

Real Time Clock Mode allows the user to change the digital communicator's internal 24 hour clock. Connecting an external Programmer allows access to the various Modes of operation. While the communicator is in Real Time Clock Mode, it does not monitor channel inputs.

### 1.7.3 Program Mode

Program Mode is used to change the programmed functions of the 411 digital communicator. While the communicator is in Program Mode, it does not monitor channel inputs.

### 1.7.4 Troubleshoot Mode

Troubleshoot Mode may be used for testing the telephone line interconnect wiring. Connection from the 411's modular jacks, through the RJ31X jacks and into the telephone network may be easily checked. In this mode, the Programmer keypad acts similar to a telephone touchpad. While the communicator is in Troubleshoot Mode, it does not monitor channel inputs.

### 1.7.5 Default Mode

Default Mode may be used to return all 411 programming back to the factory default settings.

## CHAPTER 2 *Installation*

### 2.1 Mounting Options

The 411 with enclosure may be mounted in the cabinet of the Fire•Lite/Notifier control panel which is being monitored or in any enclosure UL listed for fire protective use. When using with other than Fire•Lite/Notifier control panels, the 411 may be mounted in any enclosure UL listed for fire protective use. Mounting tabs are provided for ease of mounting.

**FIGURE 2-1: 411 Enclosure**

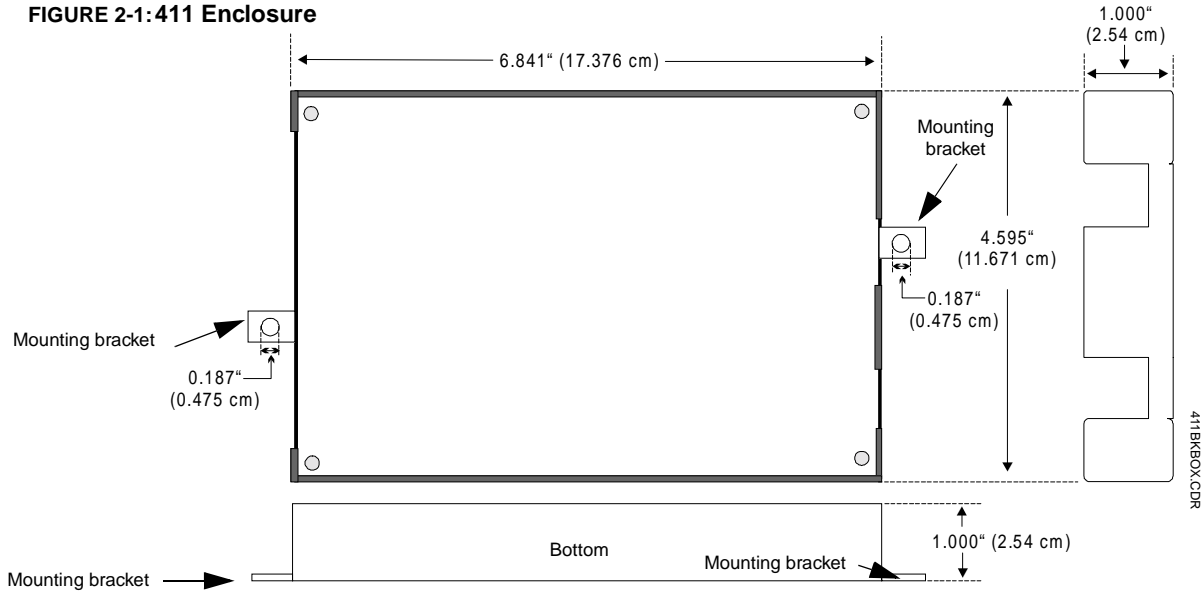

### 2.2 Operating Power



**CAUTION:** Disconnect all power before servicing the 411. The digital communicator may be damaged by removing and/or inserting components or interconnecting cables while the unit is energized.

12VDC or 24VDC nominal power connections are made to TB1 on the 411 circuit board. When jumper J4 is installed, the 11.2 to 12.4 VDC operating voltage range (UL tested range: -15%, +10%) for the digital communicator must be power-limited, filtered, nonresettable. This 12 VDC nominal operating power can be supplied directly to the 411 by a UL listed 12 VDC power supply listed for fire protection or by a nonresettable 12 VDC output from a control panel. Alternatively, removing J4 Jumper on the digital communicator circuit board allows the 411 to be supplied by a power-limited, nonresettable 21.3 to 24.0 VDC (UL tested range: -15%, +10%). This 24 VDC nominal operating power can be supplied by a UL listed 24 VDC power supply, which, in order to comply with UL 864 must be listed for Fire Protective Signaling Systems or by a nonresettable 24 VDC output from a control panel. This nominal 24 VDC power is then internally regulated by the digital communicator to 12 VDC operating power.

*Note that upon power-up, the 411 will immediately announce a DACT trouble since the communicator is factory defaulted to 'communicator disabled' at program location 64.*

### 2.3 Input Channels

The 411 digital communicator has three channel inputs. Each channel is supervised for opens (trouble) and shorts (alarm) by the digital communicator. Each channel is a Style B (Class B) Initiating Device Circuit designed to accept any normally-open contact device. Since channels do not latch, a reset switch is not provided by the 411. The communicator transmissions to a central station track the state of the inputs. Refer to Figure 2-4, “Style B Channel Connections,” on page 16 for information on wiring Style B circuits. Figure 2-2 illustrates the connection of the 411 to a Fire•Lite MS-9200 and Figure 2-3 illustrates connection of the 411 to a Notifier AFP-200.

Input Channels

FIGURE 2-2: Fire• Lite MS-9200 Connection to 411

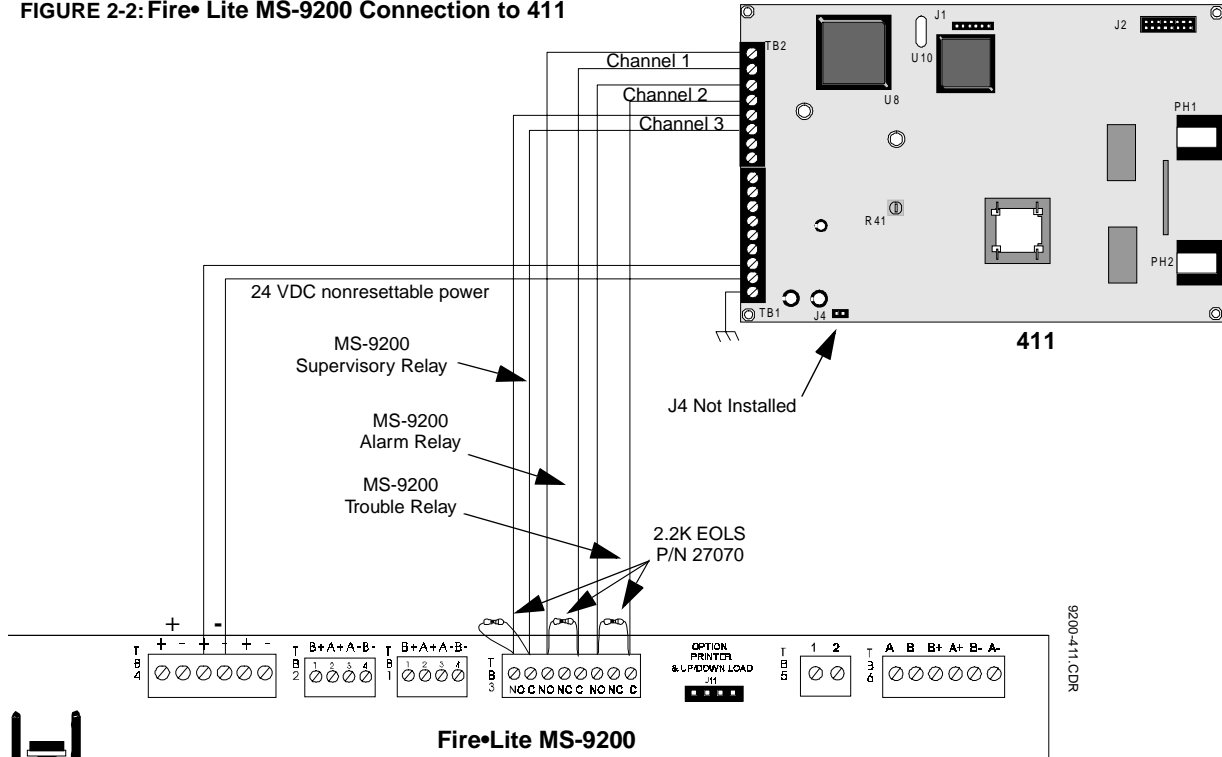
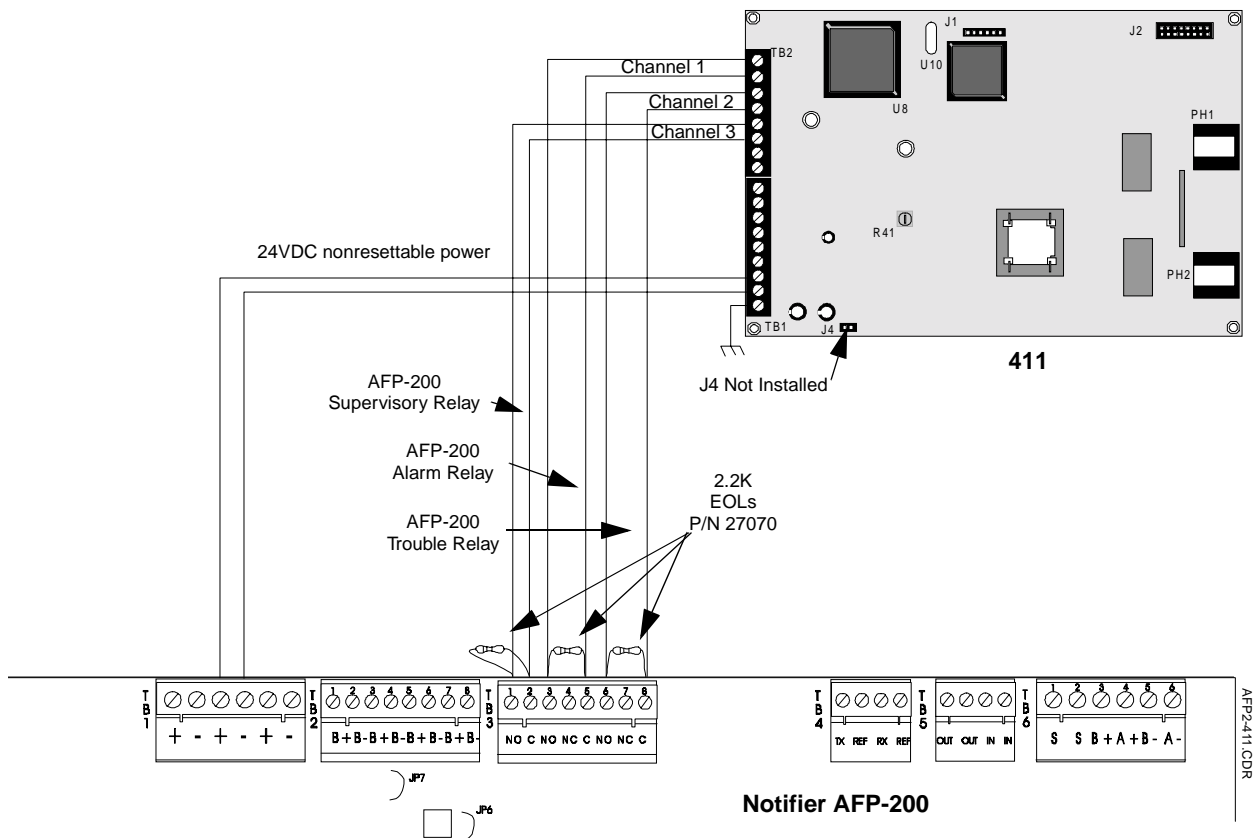

FIGURE 2-3: Notifier AFP-200 Connection to 411



## Input Channels

Each input channel monitors a normally open device and may be programmed as follows:

- fire alarm
- process monitor
- host control panel trouble
- fire supervisory
- AC Loss
- security alarm

Programming the input channel automatically programs the transmitted event code, however, the event code can be changed since it is fully programmable. Event code transmissions can be tailored to the specific application and requirements of the Central Station.

**AC Loss Reporting:** Any channel programmed for AC Loss, will transmit a specific AC loss signal only if the assigned Normally Open contact provides this function. Some panels provide an option that will automatically delay the trigger of their system trouble relays upon loss of AC (such as the Fire•Lite Sensiscan 2000, MS-9200 and Notifier AFP-200, AFP-300 and AFP-400). If this is provided by the host panel, program no additional delay in the 411. Be certain to verify the method employed by the host panel to be monitored.

Note that Process Monitor refers to circuits which may not specifically tie into elements of a fire system. With the exception of burglary functions, process monitoring circuits could be used to monitor any nonfire functions such as water temperature, room temperature, door open/closed, gas leakage, chemical leakage, etc.

The factory default programming for each channel is as follows:

- ✓ Channel 1 - fire alarm
- ✓ Channel 2 - host control panel trouble
- ✓ Channel 3 - fire supervisory

## Channel Labels

Note that space is provided for labeling the function of each channel. Write the function that has been programmed for each channel in the white boxes located to the right of the channel designator.

FIGURE 2-4: Style B Channel Connections

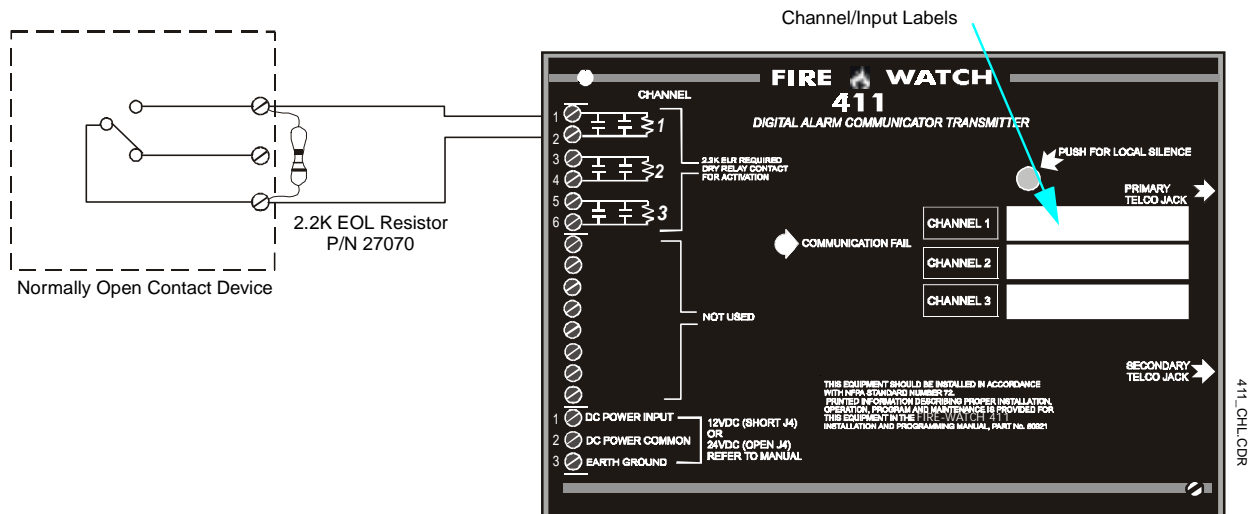



## 2.4 Telephone Circuits

Provision to connect two independent telephone lines is available via two telephone jacks labeled PH1 (Primary) and PH2 (Secondary). Telephone line control/command is possible via double line seizure as well as usage of an RJ31X style interconnection. (RJ31X jacks must be ordered separately).

**CAUTION:** It is critical that the 411 be located as the first device on the incoming telephone circuit to properly function.

**TABLE 2-1: Wiring Phone Jacks**

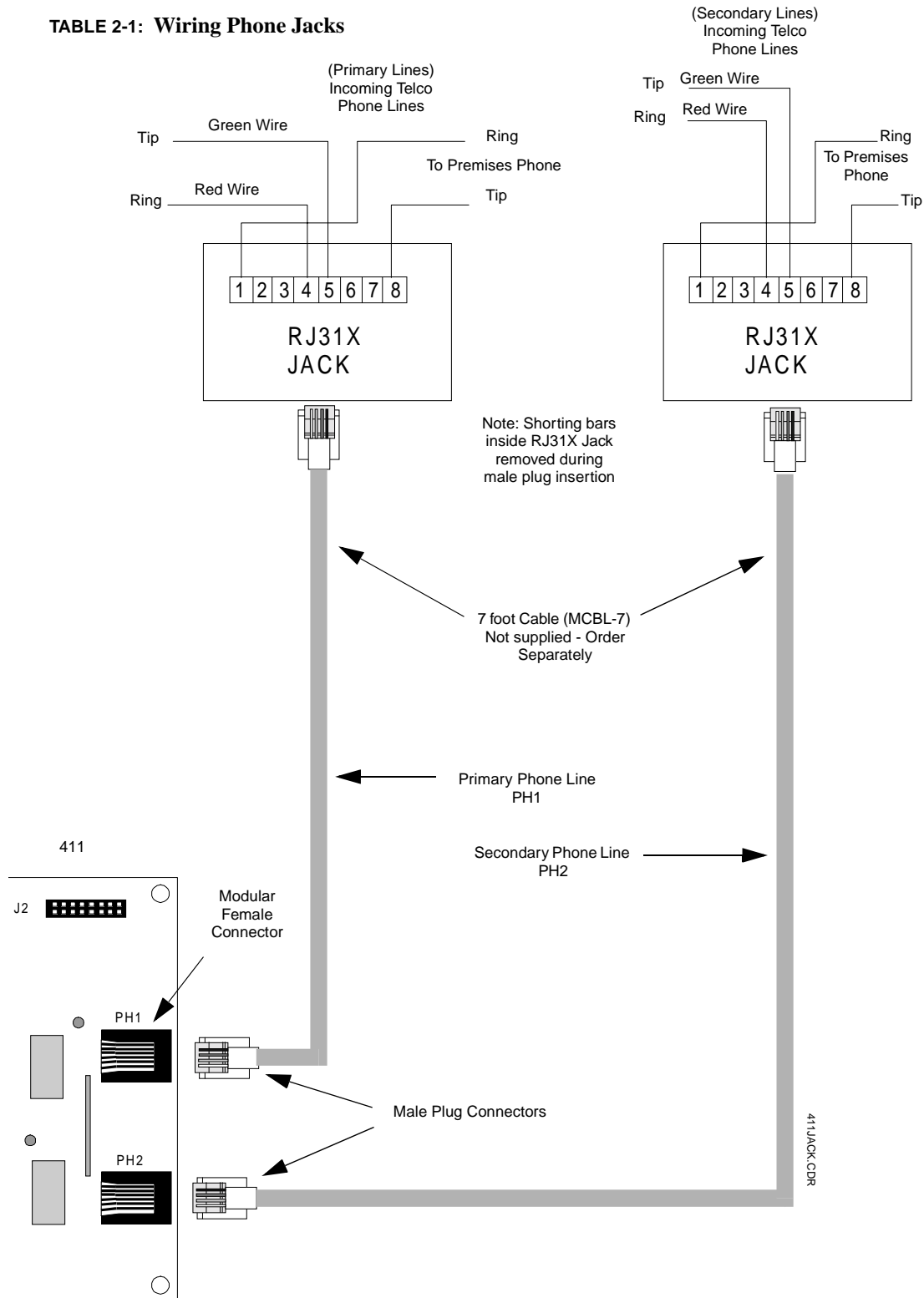

## 2.5 Optional Programmer

The optional Fire-Watch 411 Series DACT Programmer is used to:

- ✓ switch between the digital communicator's five Modes of operation
- ✓ set the digital communicator's 24 hour internal clock in Real-Time Clock Mode
- ✓ program the 411 digital communicator in Program Mode
- ✓ test the telephone lines interconnect in Troubleshoot Mode
- ✓ return all digital communicator programming to the factory default settings in Default Mode

To use the 411 Series DACT Programmer:

1. Remove all power from the 411
2. Remove the two screws holding the 411 cover in place and remove the cover
3. Connect the Programmer cable to connector J2 located in the upper right corner of the 411. Note that the key on the connector must align with the slot in the J2 connector
4. Reapply power to the 411
5. Operate the Programmer by pressing the **MODE** key. Enter the appropriate four digit Mode code and then press the **[ENTER/STORE]** key.

Note that it is not possible to switch from Normal Mode to any other mode if any of the four Channels is programmed for fire alarm, fire supervisory or security alarm, and is active, that is, in alarm (shorted).

**FIGURE 2-5: Programmer Connection to 411**

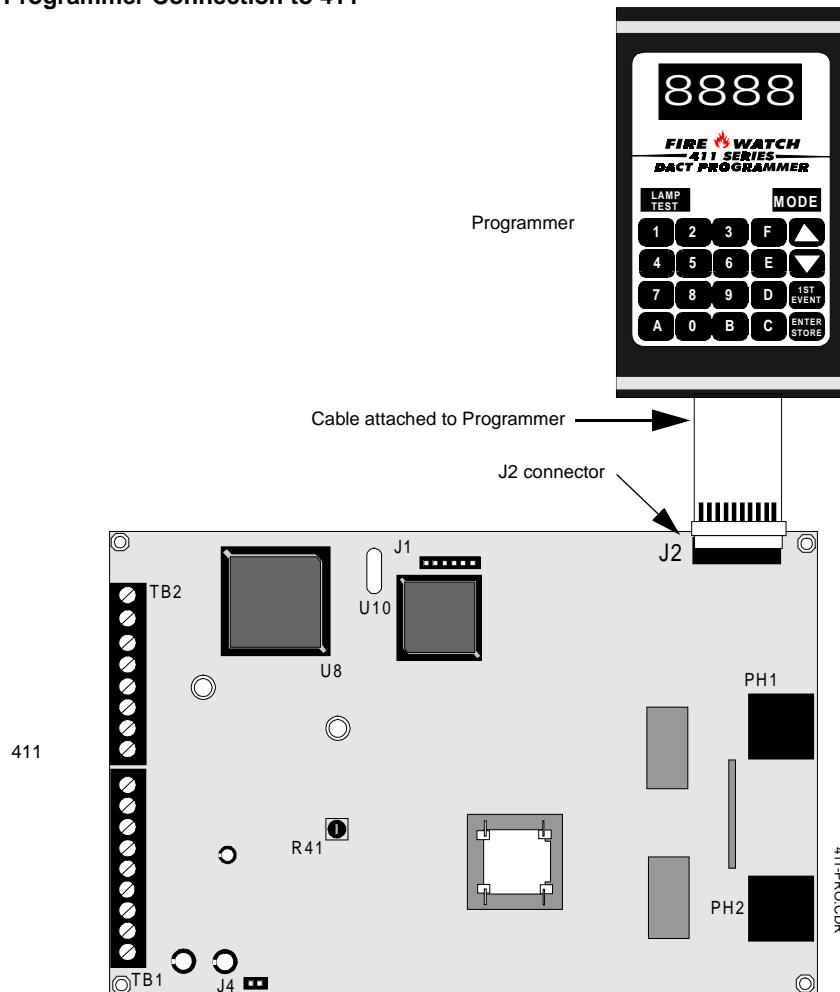

## 2.6 UL Power-limited Wiring Requirements

The three 411 input channels are power-limited circuits. Power supplied to the 411 must be power-limited 12 or 24 volts, filtered and nonresettable. *Do not connect nonpower-limited wiring to any circuits on the 411.*

## CHAPTER 3 *Modes of Operation*

The 411 digital communicator has five operational modes:

- Normal Mode
- Real Time Clock Mode
- Program Mode
- Troubleshoot Mode
- Default Mode

The operational mode for the digital communicator is Normal Mode. The operator is able to switch between any modes of operation provided no alarm events are active in the system. It should be noted that the digital communicator will not respond to input activations while in any mode except Normal Mode.

Access to any other Mode requires connection of the optional Fire-Watch 411 Series DACT Programmer which consists of a keypad and display. Refer to Figure 3-1, “Programmer Keypad,” on page 21:

### 3.1 Normal Mode

Normal Mode is the standard (default) mode of operation for the 411 digital communicator. The communicator continuously monitors and reports to a central station, the status of the three input channels as well as the status of the digital communicator itself. If no activity is detected on the three input channels (no shorts or opens) and the communicator is operating free of internal troubles, the digital communicator will display the following conditions:

- ✓ Communication Fail LED is off
- ✓ Onboard piezo sounder is off
- ✓ Communicator is not transmitting to the Central Station

The 411 digital communicator transmits system status reports to a central station via the public switched telephone network. Two supervised telephone line connections are made to interface the digital communicator to the telephone lines. Both telephone lines are supervised by the 411 for proper voltage.

The 411 is capable of line seizure on both the primary and secondary telephone line interfaces. *Any time the digital communicator detects the necessity to call the Central Station, line seizure will disconnect any local premises phones sharing the same telephone line. Sharing of phone lines, for fire systems, must be approved by the Local Authority Having Jurisdiction.* All transmissions to the Central Station will be sent over the Primary phone line. In the event of a noisy or faulty phone line, transmissions will be sent over the backup Secondary phone line.

Transmission options exist to:

- send reports to the secondary phone number as backup only
- send reports to both the primary and secondary phone numbers
- send reports to the first available central station phone number

If 10 total attempts to communicate are unsuccessful, the digital communicator will turn on the Communication Fail LED.

The 411 meets NFPA 72 requirements for Remote Station Protective Signaling Service and Central Station Signaling Service reporting requirements for: (a) the type of signal, (b) condition and (c) location of the reporting premises. See “Central Station Communications” on page 36, for additional information.

## Normal Mode

The 411 can be switched from Normal Mode to any other Mode, provided no channel programmed for fire alarm, fire supervisory or security alarm is active, that is, in alarm (shorted). The Fire-Watch 411 Series DACT Programmer must be connected to the 411 in order to change from mode to mode.

### 3.1.1 Programmer Key Functions

FIGURE 3-1: Programmer Keypad

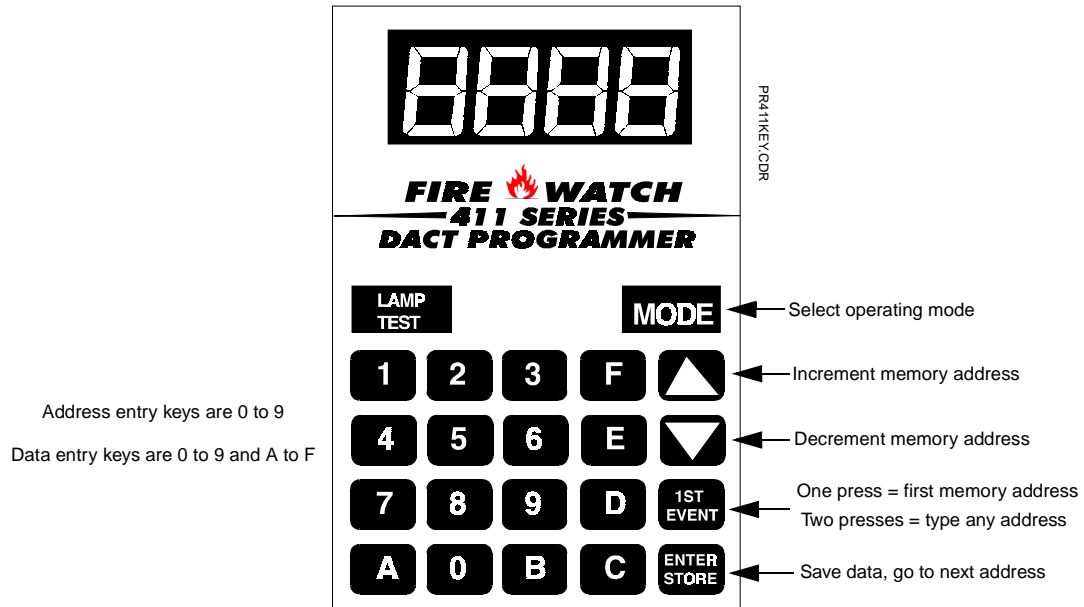

#### MODE KEY

Pressing the **MODE** key followed by a valid 4-digit numerical code and the **[ENTER/STORE]** key selects one of the five modes of operation. To enter Normal Mode from any other mode, press the **MODE** key followed by **6676** and then **[ENTER/STORE]**.

☛ **6676** spells NORM on a Touch-Tone® phone.

If an incorrect key is entered, reenter the proper 4-digit code before pressing the **[ENTER/STORE]** key. Note that as information is entered into the 411, the digits will scroll across the Programmer display from right to left.

\_\_\_6  
\_\_66  
\_667  
6676

A pause of up to 10 seconds between each number is allowed while entering the code.

#### LAMP TEST KEY

Pressing the Lamp Test key on the Programmer, while the digital communicator is in Normal Mode, will cause the front panel LED and all segments of the four 7-segment display on the programmer to light. Lamp Test works only in Normal Mode.

## Real Time Clock Mode

### 1st EVENT KEY

This key, along with the **UP** and **DOWN** arrow keys, are used only in Program Mode. Press the **1st EVENT** key at any time to display the first program memory address and its content. The following may be displayed on the Programmer:

**00\_F**  
(address)(data)

If the **1st EVENT** key is pressed a second time, the following will be displayed on the Programmer display:

**0.**  
↑  
Digit to be programmed

The contents of any address can be viewed by entering the digits of the desired address. For example, to view the contents of address 86, press the '8' key on the keypad. '8' will appear as the first digit in the display, a blank will appear in the position of the second digit and the decimal point will move one position to the right, indicating that the next digit can now be entered.

**8\_.**  
↑  
Digit to be programmed

Press the '6' key on the keypad. '6' will appear as the second digit on the display and the decimal point will move one position to the right. Press the **[ENTER/STORE]** to view the contents of address 86.

**86\_.**

### DOWN ARROW

Use the **DOWN** arrow key to decrement the memory address and view its content.

### UP ARROW

Use the **UP** arrow key to increment the memory address and view its content.

### [ENTER/STORE]

Stores entry into nonvolatile E<sup>2</sup> memory located on the 411 printed circuit board, then increments to the next higher address.

### 3.1.2 Programmer Display

Four 7-segment red LED characters provide visual display of information in the various modes of operation.

## 3.2 Real Time Clock Mode

Real Time Clock Mode is entered by pressing the **MODE** key followed by the 4-digit entry code **2525** and pressing the **[ENTER/STORE]** key.

☛ **2525** spells CLCK on a Touch-Tone® phone.

## Real Time Clock Mode

If an incorrect key is entered, reenter the proper 4-digit code before pressing the [ENTER/STORE] key. Note that as information is entered into the 411, the digits will scroll across the Programmer display from right to left.

\_\_\_2  
\_\_25  
\_252  
2525

A pause of up to 10 seconds between each number is allowed while entering the code. After pressing the [ENTER/STORE] key, the digital communicator will be in Real Time Clock Mode. A maximum of 10 minutes idle time is allowed at this point before beginning program entries and between each key stroke, otherwise, the digital communicator will return to Normal Mode. Note that the time is not stored until the fourth and final digit is selected and the [ENTER/STORE] key is pressed. If the 411 returns to Normal Mode prior to entering the fourth digit, no changes will be stored and the original time is retained.

On entering Real Time Clock Mode, **0.001** will appear on the Programmer display:

0.001  
↑  
Digit to be programmed

The time is displayed in military time. Note the position of the decimal point in the display. This indicates that the first digit to be programmed is the one to the left of the decimal point. To program the first hour digit, press the corresponding number on the Programmer keypad and then press the [ENTER/STORE] key. For example, to program 2:00 PM (**1400** in military time), press '1' on the keypad and then the [ENTER/STORE] key. The number '1' will appear as the far left digit and the decimal point will move one position to the right indicating that the second digit from the left is now ready for programming.

10.01  
↑  
Digit to be programmed

Enter the second hour digit (4 in this example) and press the [ENTER/STORE] key. The number '4' will appear as the digit second from the left and the decimal point will move one position to the right indicating that the third digit from the left is now ready for programming.

140.1  
↑  
Digit to be programmed

Enter the first minute digit (0 in this example) and press the [ENTER/STORE] key. The number '0' will appear as the digit third from the left and the decimal point will move one position to the right indicating that the fourth digit from the left is now ready for programming.

1400.  
↑  
Digit to be programmed

Enter the second minute digit (0 in this example) and press the [ENTER/STORE] key. The number '0' will appear as the digit fourth from the left. Following the entry of the fourth and final digit, the operating mode will immediately switch to Normal Mode, indicating that programming of the time is now completed.

## Program Mode

To exit Real Time Clock Mode before completing clock programming, press the **MODE** key, followed by the 4-digit code for an alternate mode and then the **[ENTER/STORE]** key. During Real Time Clock Mode, if no key is pressed within 10 minutes, the communicator will revert to Normal Mode.

*Note that upon power-up, the internal clock starts running at 00:00 midnight. It must be changed so that the 411 can accurately call in test signals to the Central Station. Upon power loss, the clock reverts to 00:00 midnight and must be reset.*

### 3.3 Program Mode

All programming selections made during Program Mode are stored in nonvolatile Electrically-Erasable Programmable Read-Only Memory (EEPROM). This ensures that the 411 will retain all entries made in Programming Mode even if power is removed.

The user must program the primary and secondary phone numbers, account numbers, 24-hour test report times and verify event codes for each Central Station account. The 411 is shipped with the program options/features already factory programmed. Alternative options/features may be programmed if desired. If all factory default settings are acceptable, programming is complete.

Program Mode is entered by pressing the **MODE** key followed by the 4-digit program mode entry code **7764** and pressing the **[ENTER/STORE]** key.

☛ **7764** spells PROG on a Touch-Tone® phone.

If an incorrect key is entered, reenter the proper 4-digit code before pressing the **[ENTER/STORE]** key. Note that as information is entered into the 411, the digits will scroll across the Programmer display from right to left.

\_\_\_7  
\_\_77  
\_776  
7764

A pause of up to 10 seconds between each number is allowed while entering the code. After pressing the **[ENTER/STORE]** key, the digital communicator will be in Program Mode. A maximum of 10 minutes idle time is allowed at this point before beginning program entries and between each key stroke, otherwise, the digital communicator will return to Normal Mode. All entries made prior to the 10 minute time-out are valid and are stored.

Once in Program Mode, the digital communicator will:

- ✓ Ignore all other keys other than those mentioned in this section
- ✓ Display **00\_F** on the Programmer display
- ✓ Continue to communicate any events not previously acknowledged at a central station prior to entering Programming Mode

While in Program Mode, the first three locations on the left of the Programmer display represent the memory address and the last location (farthest right) represents the contents of the memory address. The first address displayed is shown below:

**00\_F**  
(address)(data)

When desired changes have been completed, exit Programming Mode by pressing the **MODE** key, followed by the 4-digit code for an alternate mode and then the **[ENTER/STORE]** key. During Program Mode, if no key is pressed within 10 minutes, the communicator will revert to Normal Mode.



## Program Mode

The Programmer cable should not be removed from the 411 unless the communicator is in Normal Mode. If the Programmer cable is removed while the 411 is in a Mode other than Normal Mode, the communicator will automatically revert to Normal Mode following a 10 minute time-out period. Note that if the Programmer is in Troubleshoot Mode when the cable is removed, the 411 will revert to Normal Mode following a 20 minute time-out period.

### 3.3.1 DACT Programming

#### Primary Central Station Phone Number (00 - 19)

The first twenty addresses (00 - 19) are factory set to 'F' (00\_F to 19\_F). Programming is done as follows:

- ✓ If your phone number is 484-7161, press **4**.
- ✓ The display will read **00\_4**.
- ✓ Press [**ENTER/STORE**] to save the entry to memory and increment to the next address **01\_F**.
- ✓ Enter the remaining numbers in their respective addresses as shown below:

Entry	<b>4</b>	<b>8</b>	<b>4</b>	<b>7</b>	<b>1</b>	<b>6</b>	<b>1</b>	<b>F</b>	<b>F</b>	<b>F</b>	<b>F</b>	<b>F</b>	<b>F</b>	<b>F</b>	<b>F</b>	<b>F</b>	<b>F</b>	<b>F</b>	<b>F</b>	
Address	<b>00</b>	<b>01</b>	<b>02</b>	<b>03</b>	<b>04</b>	<b>05</b>	<b>06</b>	<b>07</b>	<b>08</b>	<b>09</b>	<b>10</b>	<b>11</b>	<b>12</b>	<b>13</b>	<b>14</b>	<b>15</b>	<b>16</b>	<b>17</b>	<b>18</b>	<b>19</b>

Valid entries for both the primary and secondary phone numbers are 0 to 9 and A to F with the numeric digits as dialed numbers and the hexadecimal digits representing the following functions:

- A = \* on a Touch-Tone phone keypad
- B = # on a Touch-Tone phone keypad
- C = look for secondary dial tone for up to two seconds (then dial anyway)
- D = three second pause
- E = five second pause
- F = end of phone number (Note: F must remain in all unused phone number addresses)

*New FCC regulations allow extra digits to the carrier ID code, to identify the long distance carrier. The expanded phone number field of 20 digits facilitates this function. Simply enter the digits required by the telephone company if desired.*

#### Primary Central Station Number Communication Format (20)

One location is needed to select the Communication Format to the primary phone number. Address 20 is used for this purpose. The factory default setting for this address is 'E', which is Contact ID Format. You may enter '0' through 'D' in place of the default, then press [**ENTER/STORE**]. Choose from the list of formats below:

- 0: 4+1 Ademco Express Standard, DTMF, 1400/2300 ACK
- 1: 4+2 Ademco Express Standard, DTMF, 1400/2300 ACK
- 2: 3+1 Standard 1800 Hz Carrier, 2300 Hz ACK
- 3: 3+1 Expanded 1800 Hz Carrier, 2300 Hz ACK
- 4: 3+1 Standard 1900 Hz Carrier, 1400 Hz ACK
- 5: 3+1 Expanded 1900 Hz Carrier, 1400 Hz ACK
- 6: 4+1 Standard 1800 Hz Carrier, 2300 Hz ACK
- 7: 4+1 Expanded 1800 Hz Carrier, 2300 Hz ACK
- 8: 4+1 Standard 1900 Hz Carrier, 1400 Hz ACK
- 9: 4+1 Expanded 1900 Hz Carrier, 1400 Hz ACK
- A: 4+2 Standard 1800 Hz Carrier, 2300 Hz ACK
- B: 4+2 Expanded 1800 Hz Carrier, 2300 Hz ACK
- C: 4+2 Standard 1900 Hz Carrier, 1400 Hz ACK
- D: 4+2 Expanded 1900 Hz Carrier, 1400 Hz ACK
- E: Contact ID, DTMF, 1400/2300 ACK
- F: Future use

## Program Mode

Consult the Central Station for proper Format selection. For any Format chosen, all event codes are automatically programmed by the 411. Refer to Table 3-2, "4+2 Standard and 4+2 Express Formats - Primary," on page 27, Table 3-3, "All 3+1, 4+1 and 4+2 Expanded Formats - Primary," on page 27 and Table 3-1, "Ademco Contact ID Format - Primary," on page 26.

### Event Codes - Setting Entries

The Format selected in address 20 will cause the digital communicator to automatically program addresses 138 - 201 with the factory default settings. Any of the Event Code settings may be altered. Consult your Central Station prior to altering the event code settings. An entry of all zeros for any event code will cause the communicator to NOT transmit the report. *Transmission of reports to either or both Central Station phone numbers may be disabled.*

Upon accessing the first address (address 138) shown in Table 3-2, the following may be displayed on the Programmer 7-Segment Display, if the corresponding Format was selected in address 20.

**1381**  
(address)(data)

The first three locations on the left of the Programmer display represent the memory address **138** of the Format previously selected in address 20. The last location **1** (farthest right) represents the contents of memory address **138** (which is the first digit of the event code).

The following Tables list the data which is automatically programmed for each Format that can be selected in address 20. The addresses shown in each Table contain the Setting data which is automatically programmed by the 411. To change the value, key in the new digit and then press the [ENTER/STORE] key to save the new value. Use the **Up** and **Down Arrow** keys to increment to the next address or decrement to the previous address.

### Ademco Contact ID Format Primary Central Station Event Codes

If 'E' is entered for address 20, the following data is automatically programmed for the Primary Central Station phone number event codes. Enter '000' for the Setting to disable the report to the Central Station. The Channel # is not programmable.

**TABLE 3-1: Ademco Contact ID Format - Primary**

<u>Address</u>	<u>Description</u>	<u>Setting</u>	<u>Channel/ Input #</u>
138 - 140	Primary # Input Channel 1 Active Event Code	110	001
141 - 143	Primary # Input Channel 2 Active Event Code	373	002
144 - 146	Primary # Input Channel 3 Active Event Code	200	003
147 - 149	not used		
150 - 152	Primary # Input Channel 1 Fault Event Code	380	001
153 - 155	Primary # Input Channel 2 Fault Event Code	380	002
156 - 158	Primary # Input Channel 3 Fault Event Code	380	003
159 - 161	not used		
162 - 164	Primary # Phone Line 1 Voltage Fault Event Code	351	000
165 - 167	Primary # Phone Line 2 Voltage Fault Event Code	352	000
168 - 170	Primary # Phone Number 1 Comm. Fault Event Code	354	001
171 - 173	Primary # Phone Number 2 Comm. Fault Event Code	354	002
174 - 176	Primary # System Off Normal Fault Code	308	000
177 - 179	Primary # System Test Message	602	000
180 - 182	Primary # System Abnormal Test Message	608	000
183 - 185	not used		
186 - 188	not used		
189 - 191	not used		
192 - 194	not used		

## Program Mode

### 4+2 Standard and 4+2 Express Formats Primary Central Station Event Codes

If 1, A or C is entered for address 20, the following data is automatically programmed for the Primary Central Station phone number event codes. Enter '00' for the Setting to disable the report to the Central Station.

**TABLE 3-2: 4+2 Standard and 4+2 Express Formats - Primary**

<u>Address</u>	<u>Description</u>	<u>Setting</u>
138 - 139	Primary # Input Channel 1 Active Event Code	11
140 - 141	Primary # Input Channel 2 Active Event Code	FF
142 - 143	Primary # Input Channel 3 Active Event Code	83
144 - 145	not used	
146 - 147	Primary # Input Channel 1 Fault Event Code	F1
148 - 149	Primary # Input Channel 2 Fault Event Code	F2
150 - 151	Primary # Input Channel 3 Fault Event Code	F3
152 - 153	not used	
154 - 155	Primary # Phone Line 1 Voltage Fault Event Code	64
156 - 157	Primary # Phone Line 2 Voltage Fault Event Code	65
158 - 159	Primary # Phone Number 1 Comm. Fault Event Code	6A
160 - 161	Primary # Phone Number 2 Comm. Fault Event Code	6B
162 - 163	Primary # System Off Normal Fault Code	6F
164 - 165	Primary # Input Channel 1 Active Restoral Code	E1
166 - 167	Primary # Input Channel 2 Active Restoral Code	E2
168 - 169	Primary # Input Channel 3 Active Restoral Code	E3
170 - 171	not used	
172 - 173	Primary # Input Channel 1 Fault Restoral Code	D1
174 - 175	Primary # Input Channel 2 Fault Restoral Code	D2
176 - 177	Primary # Input Channel 3 Fault Restoral Code	D3
178 - 179	not used	
180 - 181	Primary # Phone Line 1 Restoral Code	A4
182 - 183	Primary # Phone Line 2 Restoral Code	A5
184 - 185	Primary # Phone Number 1 Restoral Code	AA
186 - 187	Primary # Phone Number 2 Restoral Code	AB
188 - 189	Primary # System Off Normal Restoral Code	AF
190 - 191	Primary # System Test Message	99
192 - 193	Primary # System Abnormal Test Message	91
194 - 195	not used	
196 - 197	not used	
198 - 199	not used	
200 - 201	not used	

### All 3+1, 4+1 and 4+2 Expanded Formats Primary Central Station Event Codes

If 0, 2, 3, 4, 5, 6, 7, 8, 9, B or D is entered for address 20, the following data is automatically programmed for the Primary Central Station phone number event codes. Enter '0' for the Setting to disable the report to the Central Station.

**TABLE 3-3: All 3+1, 4+1 and 4+2 Expanded Formats - Primary**

<u>Address</u>	<u>Description</u>	<u>Setting</u>
138	Primary # Input Channel 1 Active Event Code	I
139	Primary # Input Channel 2 Active Event Code	F
140	Primary # Input Channel 3 Active Event Code	8
141	not used	
142	Primary # Input Channel 1 Fault Event Code	F
143	Primary # Input Channel 2 Fault Event Code	F
144	Primary # Input Channel 3 Fault Event Code	F
145	not used	
146	Primary # Phone Line 1 Voltage Fault Event Code	6

**TABLE 3-3: All 3+1, 4+1 and 4+2 Expanded Formats - Primary**

<u>Address</u>	<u>Description</u>	<u>Setting</u>
147	Primary # Phone Line 2 Voltage Fault Event Code	6
148	Primary # Phone Number 1 Comm. Fault Event Code	6
149	Primary # Phone Number 2 Comm. Fault Event Code	6
150	Primary # System Off Normal Fault Code	6
151	Primary # Input Channel 1 Active Restoral Code	E
152	Primary # Input Channel 2 Active Restoral Code	E
153	Primary # Input Channel 3 Active Restoral Code	E
154	not used	
155	Primary # Input Channel 1 Fault Restoral Code	D
156	Primary # Input Channel 2 Fault Restoral Code	D
157	Primary # Input Channel 3 Fault Restoral Code	D
158	not used	
159	Primary # Phone Line 1 Restoral Code	A
160	Primary # Phone Line 2 Restoral Code	A
161	Primary # Phone Number 1 Restoral Code	A
162	Primary # Phone Number 2 Restoral Code	A
163	Primary # System Off Normal Restoral Code	A
164	Primary # System Test Message	9
165	Primary # System Abnormal Test Message	F
166	not used	
167	not used	
168	not used	
169	not used	

**Primary Central Station Number Account Code (21 - 24)**

The four locations at addresses 21 - 24 default to all '0's. Valid entries are 0 - 9 and A - F. The number of digits entered must match the format selection. If programming '2, 3, 4 or 5' into address 20, enter three digits (one digit each in locations 21, 22 and 23 - location 24 is ignored). If programming '0, 1, 6, 7, 8, 9, A, B, C, D or E' into address 20, enter four digits (one each in locations 21, 22, 23 and 24).

**Primary Central Station Number 24 Hour Test Time (25 - 28)**

Use military time when entering the 24 hour 'test' time. The 24 hour test report to phone number 1 takes up four locations, from addresses 25 - 28. The default is 00:00 (12:00 midnight). The limits for each location are as follows (do not use values of A - F as entries).

- 25: enter 0, 1 or 2
- 26: enter 0 - 9
- 27: enter 0 - 5
- 28: enter 0 - 9

**Primary Central Station Number 24/12/8/6 Hour Test Time Interval (29)**

The test report sent to the Primary phone number may be sent every 6, 8, 12 or 24 hours. If the message is to be sent every 24 hours, leave the factory default entry of '0'. If other test report times are needed, enter 1 = 12 hour, 2 = 8 hour or 3 = 6 hour.

**Secondary Central Station Phone Number (30 - 49)**

Addresses **30 - 49** are factory set to 'F' (**30\_F to 49\_F**). Programming is typically done as follows:

- ✓ If your phone number is 484-7161, press **4**.
- ✓ The display will read **30\_4**.
- ✓ Press **[ENTER/STORE]** to save the entry to memory and increment to the next address **31\_F**.

## Program Mode

✓ Enter the remaining numbers in their respective addresses as shown below:

Entry	4	8	4	7	1	6	1	F	F	F	F	F	F	F	F	F	F	F	F	
Address	30	31	32	33	34	35	36	37	38	39	40	41	42	43	44	45	46	47	48	49

Valid entries for both the primary and secondary phone numbers are 0 to 9 and A to F with the numeric digits as dialed numbers and the hexadecimal digits representing the following functions:

- A = \* on a Touch-Tone phone keypad
- B = # on a Touch-Tone phone keypad
- C = look for secondary dial tone for up to two seconds (then dial anyway)
- D = three second pause
- E = five second pause
- F = end of phone number (Note: F must remain in all unused phone number addresses)

### Secondary Central Station Number Communication Format (50)

One location is needed to select the Communication Format to the secondary phone number. Address 50 is used for this purpose. The factory default setting for this address is 'E', which is Contact ID Format. You may enter '0' through 'D' in place of the default, then press [ENTER/STORE]. Choose from the list of formats below:

- 0: 4+1 Ademco Express Standard, DTMF, 1400/2300 ACK
- 1: 4+2 Ademco Express Standard, DTMF, 1400/2300 ACK
- 2: 3+1 Standard 1800 Hz Carrier, 2300 Hz ACK
- 3: 3+1 Expanded 1800 Hz Carrier, 2300 Hz ACK
- 4: 3+1 Standard 1900 Hz Carrier, 1400 Hz ACK
- 5: 3+1 Expanded 1900 Hz Carrier, 1400 Hz ACK
- 6: 4+1 Standard 1800 Hz Carrier, 2300 Hz ACK
- 7: 4+1 Expanded 1800 Hz Carrier, 2300 Hz ACK
- 8: 4+1 Standard 1900 Hz Carrier, 1400 Hz ACK
- 9: 4+1 Expanded 1900 Hz Carrier, 1400 Hz ACK
- A: 4+2 Standard 1800 Hz Carrier, 2300 Hz ACK
- B: 4+2 Expanded 1800 Hz Carrier, 2300 Hz ACK
- C: 4+2 Standard 1900 Hz Carrier, 1400 Hz ACK
- D: 4+2 Expanded 1900 Hz Carrier, 1400 Hz ACK
- E: Contact ID, DTMF, 1400/2300 ACK
- F: Future use

The Format selected in address 50 will cause the digital communicator to automatically program addresses 202 - 265 with the factory default settings. Any of the Event Code settings may be altered. Consult your Central Station prior to altering the event code settings. An entry of all zeros for any event code will cause the communicator to NOT transmit the report. *Transmission of reports to either or both Central Station phone numbers may be disabled.*

Refer to “Central Station Communications” on page 36 for information on Format reporting.

Upon accessing the first address which is 202 (Refer to Table 3-5, “4+2 Standard and 4+2 Express Formats - Secondary,” on page 30), the following may be displayed on the Programmer’s 7-Segment Display, if the corresponding Format was selected in address 50.

**2021**  
(address)(data)

The first three locations on the left of the Programmer’s display represent the memory address **202**. The last location **1** (farthest right) represents the contents of memory address **202** which is the first digit of the event code.

**Program Mode**

The following Tables list the data which is automatically programmed for each Format that can be selected in address 50. The addresses shown in each Table contain the event code Setting data which is automatically programmed by the 411. To change the value, key in the new digits and then press the [ENTER/STORE] key to save the new value. Use the **Up** and **Down Arrow** keys to increment to the next address or decrement to the previous address.

**Ademco Contact ID Format Secondary Central Station Event Codes**

If E is entered for address 50, the following data is automatically programmed for the Secondary Central Station phone number event codes. Enter '000' for the Setting to disable the report to the Central Station.

**TABLE 3-4: Ademco Contact ID Format - Secondary**

<u>Address</u>	<u>Description</u>	<u>Setting</u>	<u>Channel/ Input #</u>
202 - 204	Secondary # Input Channel 1 Active Event Code	110	001
205 - 207	Secondary # Input Channel 2 Active Event Code	373	002
208 - 210	Secondary # Input Channel 3 Active Event Code	200	003
211 - 213	not used		
214 - 216	Secondary # Input Channel 1 Fault Event Code	380	001
217 - 219	Secondary # Input Channel 2 Fault Event Code	380	002
220 - 222	Secondary # Input Channel 3 Fault Event Code	380	003
223 - 225	not used		
226 - 228	Secondary # Phone Line 1 Voltage Fault Event Code	351	000
229 - 231	Secondary # Phone Line 2 Voltage Fault Event Code	352	000
232 - 234	Secondary # Phone Number 1 Comm. Fault Event Code	354	001
235 - 237	Secondary # Phone Number 2 Comm. Fault Event Code	354	002
238 - 240	Secondary # System Off Normal Fault Code	308	000
241 - 243	Secondary # System Test Message	602	000
244 - 246	Secondary # System Abnormal Test Message	608	000
247 - 249	not used		
250 - 252	not used		
253 - 255	not used		
256 - 258	not used		

**4+2 Standard and 4+2 Express Formats Secondary Central Station Event Codes**

If 1, A or C is entered for address 50, the following data is automatically programmed for the Secondary Central Station phone number event codes. Enter '00' for the Setting to disable the report to the Central Station.

**TABLE 3-5: 4+2 Standard and 4+2 Express Formats - Secondary**

<u>Address</u>	<u>Description</u>	<u>Setting</u>
202 - 203	Secondary # Input Channel 1 Active Event Code	11
204 - 205	Secondary # Input Channel 2 Active Event Code	FF
206 - 207	Secondary # Input Channel 3 Active Event Code	83
208 - 209	not used	
210 - 211	Secondary # Input Channel 1 Fault Event Code	F1
212 - 213	Secondary # Input Channel 2 Fault Event Code	F2
214 - 215	Secondary # Input Channel 3 Fault Event Code	F3
216 - 217	not used	
218 - 219	Secondary # Phone Line 1 Voltage Fault Event Code	64
220 - 221	Secondary # Phone Line 2 Voltage Fault Event Code	65
222 - 223	Secondary # Phone Number 1 Comm. Fault Event Code	6A
224 - 225	Secondary # Phone Number 2 Comm. Fault Event Code	6B
226 - 227	Secondary # System Off Normal Fault Code	6F
228 - 229	Secondary # Input Channel 1 Active Restoral Code	E1
230 - 231	Secondary # Input Channel 2 Active Restoral Code	E2

**Program Mode**

**TABLE 3-5: 4+2 Standard and 4+2 Express Formats - Secondary**

<u>Address</u>	<u>Description</u>	<u>Setting</u>
232 - 233	Secondary # Input Channel 3 Active Restoral Code	E3
234 - 235	not used	
236 - 237	Secondary # Input Channel 1 Fault Restoral Code	D1
238 - 239	Secondary # Input Channel 2 Fault Restoral Code	D2
240 - 241	Secondary # Input Channel 3 Fault Restoral Code	D3
242 - 243	not used	
244 - 245	Secondary # Phone Line 1 Restoral Code	A4
246 - 247	Secondary # Phone Line 2 Restoral Code	A5
248 - 249	Secondary # Phone Number 1 Restoral Code	AA
250 - 251	Secondary # Phone Number 2 Restoral Code	AB
252 - 253	Secondary # System Off Normal Restoral Code	AF
254 - 255	Secondary # System Test Message	99
256 - 257	Secondary # System Abnormal Test Message	91
258 - 259	not used	
260 - 261	not used	
262 - 263	not used	
264 - 265	not used	

**All 3+1, 4+1 and 4+2 Expanded Formats Secondary Central Station Event Codes**

If 0, 2, 3, 4, 5, 6, 7, 8, 9, B or D is entered for address 50, the following data is automatically programmed for the Secondary Central Station phone number event codes. Enter '0' for the Setting to disable the report to the Central Station.

**TABLE 3-6: All 3+1, 4+1 and 4+2 Expanded Formats - Secondary**

<u>Address</u>	<u>Description</u>	<u>Setting</u>
202	Secondary # Input Channel 1 Active Event Code	I
203	Secondary # Input Channel 2 Active Event Code	F
204	Secondary # Input Channel 3 Active Event Code	8
205	not used	
206	Secondary # Input Channel 1 Fault Event Code	F
207	Secondary # Input Channel 2 Fault Event Code	F
208	Secondary # Input Channel 3 Fault Event Code	F
209	not used	
210	Secondary # Phone Line 1 Voltage Fault Event Code	6
211	Secondary # Phone Line 2 Voltage Fault Event Code	6
212	Secondary # Phone Number 1 Comm.Fault Event Code	6
213	Secondary # Phone Number 2 Comm. Fault Event Code	6
214	Secondary # System Off Normal Fault Code	6
215	Secondary # Input Channel 1 Active Restoral Code	E
216	Secondary # Input Channel 2 Active Restoral Code	E
217	Secondary # Input Channel 3 Active Restoral Code	E
218	not used	
219	Secondary # Input Channel 1 Fault Restoral Code	D
220	Secondary # Input Channel 2 Fault Restoral Code	D
221	Secondary # Input Channel 3 Fault Restoral Code	D
222	not used	
223	Secondary # Phone Line 1 Restoral Code	A
224	Secondary # Phone Line 2 Restoral Code	A
225	Secondary # Phone Number 1 Restoral Code	A
226	Secondary # Phone Number 2 Restoral Code	A
227	Secondary # System Off Normal Restoral Code	A
228	Secondary # System Test Message	9
229	Secondary # System Abnormal Test Message	F
230	not used	
231	not used	
232	not used	
233	not used	

## Program Mode

### Secondary Central Station Number Account Code (51 - 54)

The four locations at addresses 51 - 54 default to all '0's. Valid entries are 0 - 9 and A - F. The number of digits entered must match the format selection. If programming '2, 3, 4 or 5' into address 50, enter three digits (one digit each in locations 51, 52 and 53 - location 54 is ignored). If programming '0, 1, 6, 7, 8, 9, A, B, C, D or E' into address 50, enter four digits (one each in locations 51, 52, 53 and 54).

### Secondary Central Station Number 24 Hour Test Time (55 - 58)

Use military time when entering the 24 hour 'test' time. The 24 hour test report to phone number 1 takes up four locations, from addresses 55 - 58. The default is 00:00 (12:00 midnight). The limits for each location are as follows (do not use values of A - F as entries):

55: enter 0, 1 or 2

56: enter 0 - 9

57: enter 0 - 5

58: enter 0 - 9

### Secondary Central Station Number 24/12/8/6 Hour Test Time Interval (59)

The test report sent to the Secondary phone number may be sent every 6, 8, 12 or 24 hours. If the message is to be sent every 24 hours, leave the factory default entry of '0'. If other test report times are needed, enter 1 = 12 hour, 2 = 8 hour or 3 = 6 hour.

### AC Loss Reporting Delay (60)

Enter a digit of 0 - 9 or A - F corresponding to the number of hours to be delayed in reporting the loss of AC power. The factory default is '0' for no delay. The valid entries are '0' = no delay; '1' = 6 hours; '2' = 7 hours; '3' = 8 hours; '4' = 9 hours; '5' = 10 hours; '6' = 11 hours; '7' = 15 hours; '8' = 16 hours; '9' = 17 hours; 'A' = 18 hours; 'B' = 19 hours; 'C' = 20 hours; 'D' = 21 hours; 'E' = 22 hours; 'F' = 23 hours. *Note: Use when the host panel has a dedicated relay output. Verify the delay period programmed at the host panel. Location 60 is valid for all inputs programmed as AC Loss.*

### Backup Reporting (61)

Leaving address 61 at '0' means that reports will be transmitted to the secondary Central Station phone number only if attempts to communicate to the primary Central Station phone number are unsuccessful. Programming a '1' causes all reports to be transmitted to both the primary and secondary Central Station phone numbers. Programming a '2' causes reports to go to the first available receiver.

**CAUTION:** Do not alter this entry while the digital communicator is active.



### Reserved for Future Use (62)

### DACT Trouble Reminder (63)

The factory default entry of '0' in address location 63 disables the trouble reminder feature. Selecting '1' for location 63 will cause a reminding beep (after the Silence switch is pressed) every two minutes during a DACT trouble condition. The beeps from the onboard piezo sounder will occur until the DACT fault is cleared.

### Communicator Enable/Disable (64)

Leaving address 64 at the factory default setting of '0' prevents the digital communicator from transmitting status information to the Central Station(s). An entry of '1' in this location enables communication to the Central Station(s).

*Note that upon power-up, the 411 will immediately announce a DACT trouble since the communicator is factory defaulted to 'communicator disabled' at program location 64.*



## Program Mode

**Input Channel Function Selections** - When selecting Input Channel functions, be certain to match the host panel relay output functions with the Input Channel functions. Test all wiring connections completely. All Input Channels require Normally Open contact closure to trigger. Input Channels do not latch.

### Input Channel 1 Function Selection (65)<sup>1</sup>

Factory default for Channel 1 is '0' for activation on Fire Alarm. Enter '1' for Host Control Panel Trouble; '2' for Fire Supervisory; '3' for Process Monitoring; '4' for AC Loss; '5' for Security Alarm.

### Input Channel 2 Function Selection (66)<sup>1</sup>

Factory default for Channel 2 is '1' for activation on Host Control Panel Trouble. Enter '0' for Fire Alarm; '2' for Fire Supervisory; '3' for Process Monitoring; '4' for AC Loss; '5' for Security Alarm.

### Input Channel 3 Function Selection (67)<sup>1</sup>

Factory default for Channel 3 is '2' for activation on Fire Supervisory. Enter '0' for Fire Alarm; '1' for Host Control Panel Trouble; '3' for Process Monitoring; '4' for AC Loss; '5' for Security Alarm.

### Reserved for Future Use (68)

### Input Channel 1 Delay Timer (69 - 71)<sup>2</sup>

The Delay Timer is used to delay activation of the digital communicator when the Input Channel is activated. Input Channel 1 Delay Timer is factory set to '000' seconds for no delay. The timer may be programmed for a delay of from 0 to 179 seconds. *Inputs programmed for fire alarm, host control panel trouble and fire supervisory, must not be delayed. A delay, therefore, cannot be selected for inputs programmed for these fire applications.*

### Input Channel 2 Delay Timer (72 - 74)<sup>2</sup>

The Delay Timer is used to delay activation of the digital communicator when the Input Channel is activated. Input Channel 2 Delay Timer is factory set to '000' seconds for no delay. The timer may be programmed for a delay of from 0 to 179 seconds. *Inputs programmed for fire alarm, host control panel trouble and fire supervisory, must not be delayed. A delay, therefore, cannot be selected for inputs programmed for these fire applications.*

### Input Channel 3 Delay Timer (75 - 77)<sup>2</sup>

The Delay Timer is used to delay activation of the digital communicator when the Input Channel is activated. Input Channel 3 Delay Timer is factory set to '000' seconds for no delay. The timer may be programmed for a delay of from 0 to 179 seconds. *Inputs programmed for fire alarm, host control panel trouble and fire supervisory, must not be delayed. A delay, therefore, cannot be selected for inputs programmed for these fire applications.*

### Reserved for Future Use (78 - 80)<sup>2</sup>

### Touchtone/Rotary Select for Primary Phone (81)

A '0' programmed in this address by the factory, triggers Touchtone dialing over the primary phone line. Select '1' for rotary dialing.

### Make/Break Ratio for Primary Phone (82)

This address is used only if a '1' has been programmed for address 81. The Make/Break ratio is factory set to '0' which is 67/33 ratio, but may be changed to '1' which is 62/38 ratio.

### Touchtone/Rotary Select for Secondary Phone (83)

A '0' programmed in this address by the factory, triggers Touchtone dialing over the secondary phone line. Select '1' for rotary dialing.

- 
1. Changing the input function will automatically change the corresponding Primary and Secondary event codes to reflect the new input function. The Communication Format should be programmed first, followed by the Input Channel Function.
  2. This timer does not delay LED activation and is not used for channels programmed as AC Loss circuits.

## Program Mode

### Make/Break Ratio for Secondary Phone (84)

This address is used only if a '1' has been programmed for address 83. The Make/Break ratio is factory set to '0' which is 67/33 ratio, but may be changed to '1' which is 62/38 ratio.

### Reserved for Future Use (85)

### Reserved for Future Use (86)

### Reserved for Future Use (87)

### Reserved for Future Use (88)

### Trouble Call Limit (89)

Factory default setting of '0' in address 89, allows the digital communicator to call the Central Station each time any DACT trouble and any active Channel programmed for host panel trouble is detected by the 411. Programming a '1' in this address enables the Trouble Call Limit feature, which limits the number of 411 and Input Channel Trouble calls to the Central Station to 10 calls for each unique trouble event within a 24 hour period. Separate limit counters keep track of each unique type of trouble (i.e. open input channel). To clear the limit counters, disable and then enable this location. Note that the number of phone line (communication) faults called to the Central Station are not limited by this feature.

No subsequent restoral message is sent to the Central Station(s) for a particular trouble whose limit of 10 calls has been reached. Local DACT annunciation will still track the particular trouble and restoral.

### Reserved for Future Use (90 - 93)

### Reserved for Future Use (94 - 113)

### Reserved for Future Use (114 - 115)

### Reserved for Future Use (116)

### Reserved for Future Use (117 - 136)

### Reserved for Future Use (137)

### Programming Event Code Settings (138 - 265)

Event Code Settings, corresponding to the Formats selected for the Primary Central Station phone number in address 20 and the Secondary Central Station phone number in address 50, are automatically set to factory default values. Refer to Table 3-2, "4+2 Standard and 4+2 Express Formats - Primary," on page 27, Table 3-3, "All 3+1, 4+1 and 4+2 Expanded Formats - Primary," on page 27 and Table 3-1, "Ademco Contact ID Format - Primary," on page 26 for format designated by address 20. Refer to Table 3-5, "4+2 Standard and 4+2 Express Formats - Secondary," on page 30, Table 3-6, "All 3+1, 4+1 and 4+2 Expanded Formats - Secondary," on page 31 and Table 3-4, "Ademco Contact ID Format - Secondary," on page 30 for format designated by address 50. The Event Code Settings can be altered. *Consult your Central Station prior to changing the event code settings.*

### 3.4 Default Mode

To return all program entries to their factory original settings, perform the following steps only when the system is idle (i.e. the communicator is not active) and there are no active fire alarms, fire supervisories or security alarms in the system:

Press the **MODE** key followed by the 4-digit code **3337** and press the **[ENTER/STORE]** key.

☛ **3337** spells DEFP (**DE**fault **P**rogramming) on a Touch-Tone® phone.

If an incorrect key is entered, reenter the proper 4-digit code before pressing the **[ENTER/STORE]** key. Within five seconds, repeat this entry by again pressing the **MODE** key followed by the 4-digit code **3337** and pressing the **[ENTER/STORE]** key. The display will read **3337** while the E<sup>2</sup> nonvolatile memory (storage area for all programming options) is being reprogrammed with the original default settings. When reprogramming is complete, the display will be blank.

### 3.5 Troubleshoot Mode

To access the Troubleshoot Mode, press the **MODE** key followed by the digits 8768 and then the **[ENTER/STORE]** key.

☛ **8768** spells TROU on a Touch-Tone® phone.

Once in this mode, the 411 will continue to communicate any events not yet acknowledged at a central station prior to entering Troubleshoot Mode. The **UP** arrow, **DOWN** arrow and **1st EVENT** keys do not function in this mode.

#### Telephone Line Testing

Pressing **C** for touchtone dialing or **D** for rotary dialing, followed by **[ENTER/STORE]** causes seizure of the Primary phone line, which in turn, lights the red LED 1 on the circuit board near the PH1 connector, signifying that the Primary phone line is active. After a delay of three seconds, the 411 goes off-hook to acquire a dial tone.

The Programmer keypad may be used as a telephone touchpad for number dialing. Once the first digit is pressed, the display will move the **C** or **D** character one position to the left, while placing the digit to be dialed on the farthest right display position. Continue to press the phone numbers to be dialed. Successive depressions of the **[ENTER/STORE]** key hangs up and picks up the phone (places the phone on or off the hook).

The secondary phone line may be tested by pressing the **E** key for touchtone dialing or the **F** key for rotary dialing and then following the same procedure used for the primary phone line. A handset may be temporarily connected across transformer T1 of the 411 as indicated in Figure 3-2. The handset, when connected across T1, may be used only as an amplifier/speaker or telephone with the keypad used for number dialing.

**FIGURE 3-2: Handset/Speaker Connection**

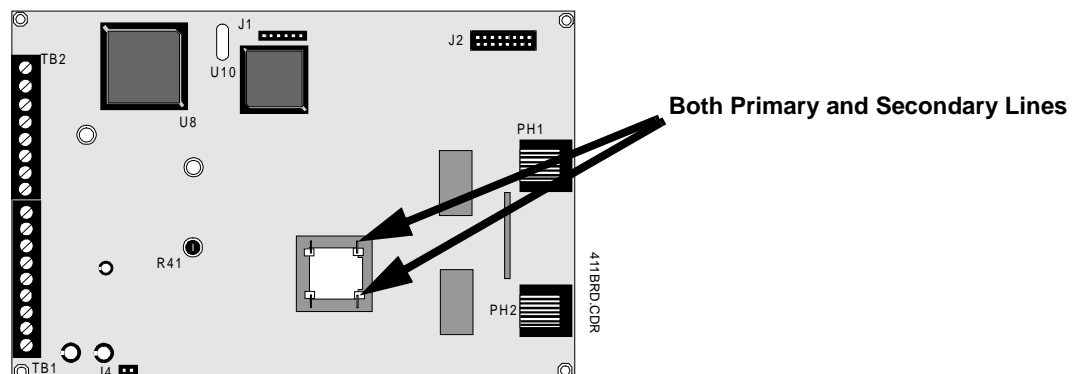

## CHAPTER 4 *Central Station Communications*

The 411 digital communicator transmits system status reports to Central Stations via the public switched telephone network. Two supervised telephone line connections are made to interface the communicator to the telephone lines. Two 7-foot telephone cords P/N MCBL-7 may be used for this purpose (not supplied - order separately).

The digital communicator supervises both telephone lines for proper voltage. A delay of two minutes will occur before a fault in either phone line connection is reported as a trouble. When a fault is detected, an audible trouble signal will sound and the trouble condition will be reported to a central station over the remaining good phone line.

The digital communicator comes with line seizure capability provided for both the primary and secondary telephone line interfaces. Any time that the DACT needs to make a call to a central station, line seizure will disconnect any local premises phones sharing the same telephone line. All transmissions to central stations will be sent over the Primary Central Station phone line. In the event of noisy phone lines, transmissions will be sent over the backup Secondary phone line.

Two phone numbers must be programmed, the Primary Central Station phone number and the Secondary Central Station phone number. There are three options for transmission to the Central Station:

- All reports are always sent to the Primary Central Station phone number with the Secondary Central Station number for emergency backup purposes only
- All reports are sent to both Central Station phone numbers
- Reports are sent to the first available Central Station phone number only

**Central Station Communications**

The digital communicator is capable of reporting detailed messages depending upon the Format in use. Table 4-1 shows the data reporting structure for each of the pulsed formats as well as the Ademco Express Formats. Ademco Express Formats allow a typical data message to be transmitted to the Central Station in under 5 seconds. Pulsed formats typically require 15 to 20 seconds in comparison. Table 4-2 defines each letter code used in Table 4-1. See “Ademco Contact ID Format Event Code Description” on page 40 for a description of the data reporting structure for Ademco Contact ID Format.

**TABLE 4-1: Format Selection Addresses ( 20 and 50) Programming**

	<b>Format # 0, 2, 4, 6, 8</b>	<b>Format # 3, 5, 7, 9</b>	<b>Format # 1, A, C</b>	<b>Format # B, D</b>
Report	3+1/4+1/Standard 4+1 Express	3+1/4+1/Expanded	4+2/Standard 4+2 Express	4+2/Expanded
Fire Alarm	SSS(S) FA	SSS(S) FA FAFAFA(FA) 2	SSSS FAFA2	SSSS FAZ
Fire Alarm Restore	SSS(S) RFA	SSS(S) RFA RFARFARFA (RFA) 2	SSSS RFARFA2	SSSS RFAZ
Security Alarm	SSS(S) SA	SSS(S) SA SASASA(SA) 2	SSSS SASA2	SSSS SAZ
Security Alarm Restore	SSS(S) RSA	SSS(S) RSA RSARSARSA (RSA) 2	SSSS RSARSA2	SSSS RSAZ
Channel/Input Trouble (Channel/Input Open)	SSS(S) TZ	SSS(S) TZ TZTZTZ(TZ) Z	SSSS TZTZ2	SSSS TZZ
Channel/Input Trouble Restore	SSS(S) RTZ	SSS(S) RTZ RTZRTZRTZ(RTZ) Z	SSSS RTZRTZ2	SSSS RTZZ
System Trouble	SSS(S) TS	SSS(S) TS TSTSTS(TS) Y	SSSS TSTS2	SSSS TSY
System Trouble Restore	SSS(S) RTS	SSS(S) RTS RTSRTSRTS(RTS) Y	SSSS RTSRTS2	SSSS RTSY
AC Loss	SSS(S) P	SSS(S) P PPP(P) Z	SSSS PP2	SSSS PP2
AC Loss Restore	SSS(S) RP	SSS(S) RP RPRPRP(RP) Z	SSSS RPRP2	SSSS RPRP2
Fire Supervisory Condition	SSS(S) V	SSS(S) V VVV(V) Z	SSSS VV2	SSSS VZ
Fire Supervisory Condition Restore	SSS(S) RV	SSS(S) RV RVRVR(RV) Z	SSSS RVRV2	SSSS RVZ
Test Report	SSS(S) X	SSS(S) X	SSSS XX2	SSSS XX2

**TABLE 4-2: Format Selection Address Explanation**

**Where:**

SSS or SSSS	= Subscriber ID
FA	= Fire Alarm (1st digit)
FA2	= Fire Alarm (2nd digit)
Z	= Channel/Input Number
RFA	= Fire Alarm Restore (1st digit)
RFA2	= Fire Alarm Restore (2nd digit)
SA	= Security Alarm (1st digit)
SA2	= Security Alarm (2nd digit)
RSA	= Security Alarm Restore (1st digit)
RSA2	= Security Alarm Restore (2nd digit)
TZ	= Zone Trouble (1st digit)
TZ2	= Zone Trouble (2nd digit)
RTZ	= Zone Trouble Restore (1st digit)
RTZ2	= Zone Trouble Restore (2nd digit)
TS	= System Trouble (1st digit)
TS2	= System Trouble (2nd digit)
RTS	= System Trouble Restore (1st digit)
RTS2	= System Trouble Restore (2nd digit)
P	= AC Loss (1st digit)
P2	= AC Loss (2nd digit)
RP	= AC Loss Restore (1st digit)
RP2	= AC Loss Restore (2nd digit)
V	= Fire Supervisory Condition (1st digit)
V2	= Fire Supervisory Condition (2nd digit)
RV	= Fire Supervisory Condition Restore (1st digit)
RV2	= Fire Supervisory Condition Restore (2nd digit)
X	= Test Report (1st digit)
X2	= Test Report (2nd digit)
Y	= Trouble corresponding to the following:
	1 = Not Used
	2 = Not Used
	3 = Not Used
	4 = Telco Primary Line Fault
	5 = Telco Secondary Line Fault
	6 = Not Used
	7 = Not Used
	8 = Not Used
	9 = Not Used
	A = Communication Failure Primary Number
	B = Communication Failure Secondary Number
	C = Not Used
	D = Not Used
	E = Not Used
	F = System Off Normal

Note that for Expanded Reporting, the digital communicator automatically adds the digit corresponding to the Channel/Input number, and the second digit corresponding to any system trouble condition. Only the first digit shown in Table 3-3 and Table 3-6 is programmable.

#### 4.0.1 Transmittal Priorities

The digital communicator transmits highest priority events first. Events in terms of priority are listed below in descending order:

1. Fire Alarm (highest priority level)
2. Security Alarm
3. Fire Supervisory
4. System Troubles
  - Host Panel Trouble (active input programmed for trouble)
  - AC Fail (after delay)
  - Channel/Input faults
  - Telephone line fault
  - Communication trouble
  - System Off Normal
5. Process Monitoring Alarm
6. Restoral Reports
  - Fire Alarm
  - Security Alarm
  - Fire Supervisory
  - Host Panel Trouble
  - AC
  - Channel/Input fault
  - Telephone line
  - Communication
  - System Off Normal
  - Process Monitoring restored
7. System Test

### 4.0.2 Ademco Contact ID Format Event Code Description

This section describes the various Event Codes and their messages which are available for the Ademco Contact ID Format. The reporting structure for the Ademco Contact ID Format is as follows:

#### SSSS 18 QXYZ GG CCC

Where:

- SSSS = Four digit Subscriber ID Account Code (addresses 21 - 24 and 51 - 54)
- 18 = Identifies transmission as Contact ID to the receiver at the Central Station
- Q = Event Qualifier where 1 = New Event and 3 = New Restore
- XYZ = Event code (shown in Tables)
- GG = Group number
- CCC = Channel/Input number

Notes:

1. **18**, which is used in the reporting structure to identify the transmission as Contact ID, is not printed out in the alarm and trouble report.
2. **Q**, which is the Event Qualifier for the reporting structure, is printed out in the report as an E for New Event or R for New Restore.
3. GG Group Number is fixed at '00' and cannot be changed.
4. CCC Channel/Input Number is transmitted as '001' for Channel/Input 1, '002' for Channel/Input 2, '003' for Channel/Input 3.

#### Ademco Contact ID Reporting Structure

A typical printout from a Central Station receiver (such as the Ademco 685) of alarm and trouble reports in the Ademco Contact ID Reporting Structure follows:

<u>Time</u>	<u>Date</u>	<u>Rcvr/Line ID</u>	<u>SSSS</u>	<u>QXYZ</u>	<u>GG</u>	<u>CCCC</u>
11:28	03/25	11	7777	E110	00	C001 - general fire alarm on Channel/Input 1
11:28	03/25	11	7777	E111	00	C002 - smoke detector alarm on Channel/Input 2
11:28	03/25	11	7777	E380	00	C003 - fault on Channel/Input 3
11:28	03/25	11	7777	R110	00	C001 - Channel/Input 1 alarm restored
11:28	03/25	11	7777	R111	00	C002 - smoke detector Channel/Input 2 restored
11:28	03/25	11	7777	R380	00	C003 - Channel/Input 3 fault restored



**Central Station Communications**

The following table contains UL listed receivers compatible with the 411 digital communicator.

**TABLE 4-3: Compatible UL Listed Receivers**

Format # (Addresses 20 and 50)		Ademco 685 (1)	Silent Knight 9000 (2)	ITI CS-4000 (3)	FBI CP220FB	Osborne Hoffman Models 1 & 2	Radionics 6000/6500 (5)	Sescoa 3000R (7)	Surguard MLR-2 (9)
0	4+1 Ademco Express	✓			✓				✓
1	4+2 Ademco Express	✓			✓	✓(8)		✓	✓
2	3+1/Standard/1800/2300	✓	✓	✓	✓(4)	✓	✓(5, 6)	✓	✓
3	3+1/Expanded/1800/2300	✓	✓	✓	✓(4)	✓		✓	✓
4	3+1/Standard/1900/1400	✓	✓		✓(4)	✓		✓	✓
5	3+1/Expanded/1900/1400	✓	✓		✓(4)	✓		✓	✓
6	4+1/Standard/1800/2300	✓	✓	✓	✓(4)	✓	✓(5)	✓	✓
7	4+1/Expanded/1800/2300	✓	✓		✓(4)	✓		✓	✓
8	4+1/Standard/1900/1400	✓	✓		✓(4)	✓		✓	✓
9	4+1/Expanded/1900/1400	✓	✓		✓(4)	✓		✓	✓
A	4+2/Standard/1800/2300	✓	✓	✓	✓(4)	✓	✓(5)	✓	✓
B	4+2/Expanded/1800/2300	✓	✓		✓(4)	✓		✓	✓
C	4+2/Standard/1900/1400	✓	✓		✓(4)	✓		✓	✓
D	4+2/Expanded/1900/1400	✓	✓		✓(4)	✓		✓	✓
E	Ademco Contact ID	✓			✓	✓			✓

- (1) With 685-8 Line Card with Rev. 4.4d software.
- (2) With 9002 Line Card Rev. 9035 software or 9032 Line Card with 9326A software.
- (3) Rev. 4.0 software.
- (4) FBI CP220FB Rec-11 Line Card with Rev. 2.6 software and a memory card with Rev. 3.8 software.
- (5) Model 6500 with Rev. 600 software.
- (6) Model 6000 with Rev. 204 software.
- (7) With Rev. B control card at Rev. 1.4 software and Rev. C line card at Rev. 1.5 software.
- (8) Model 2 only.
- (9) Version 1.62 software.

# Appendix A *Programming Sheets*

## A.1 Digital Communicator Options Program Sheets

--To enter Programming Mode, press the **MODE** key, **7764** and then the **[ENTER/STORE]** key.



Addresses 00 to 19 store the Primary Central Station phone number. *Enter 'F' to represent the end of number.*

- <sub>20</sub> Primary Central Station Communication Format: *Valid entries are 0 to 9 and A to F.*
  - <sub>21</sub> <sub>22</sub> <sub>23</sub> <sub>24</sub> Primary Central Station Account Code: *Valid entries are 0 to 9 and A to F.*
  - <sub>25</sub> <sub>26</sub> <sub>27</sub> <sub>28</sub> Primary Central Station 24-hour Test Time: *Use military time (i.e. 1400 for 2:00 PM).*
  - <sub>29</sub> Primary Number Test Time Interval. Enter '0' for 24-hour; '1' for 12-hour; '2' for 8-hour; '3' for 6-hour.
- 

Addresses 30 to 49 store the Secondary Central Station phone number. *Enter 'F' to represent the end of number.*

- <sub>50</sub> Secondary Central Station Communication Format: *Valid entries are 0 to 9 and A to F.*
- <sub>51</sub> <sub>52</sub> <sub>53</sub> <sub>54</sub> Secondary Central Station Account Code: *Valid entries are 0 to 9 and A to F.*
- <sub>55</sub> <sub>56</sub> <sub>57</sub> <sub>58</sub> Secondary Central Station 24-hour Test Time: *Use military time (i.e. 1400 for 2:00 PM).*
- <sub>59</sub> Secondary Number Test Time Interval. Enter '0' for 24-hour; '1' for 12-hour; '2' for 8-hour; '3' for 6-hour.
- <sub>60</sub> AC Loss Reporting Delay. Enter '0' for no delay; '1' for 6 hours; '2' for 7 hours; '3' for 8 hours; '4' for 9 hours; '5' for 10 hours; '6' for 11 hours; '7' for 15 hours; '8' for 16 hours; '9' for 17 hours; 'A' for 18 hours; 'B' for 19 hours; 'C' for 20 hours; 'D' for 21 hours; 'E' for 22 hours; 'F' for 23 hours.
- <sub>61</sub> Backup Reporting. Enter '0' to report to Secondary phone number as backup only; '1' to report to both Primary and Secondary phone number for all reports/messages; '2' reports go to first available receiver.
- <sub>62</sub> Reserved for Future Use.
- <sub>63</sub> DACT Trouble Reminder. Enter '0' to disable; '1' to enable.
- <sub>64</sub> Communicator Enable/Disable. Enter '0' to disable communication to Central Station; '1' to enable. Default entry of '0' causes the 411 to announce a DACT trouble immediately on power-up.
- <sub>65</sub> Input Channel 1 Function Selection. Enter '0' for fire alarm; '1' for host control panel trouble; '2' for fire supervisory; '3' for process monitoring; '4' for AC loss; '5' for security alarm.
- <sub>66</sub> Input Channel 2 Function Selection. Enter '0' for fire alarm; '1' for host control panel trouble; '2' for fire supervisory; '3' for process monitoring; '4' for AC loss; '5' for security alarm.
- <sub>67</sub> Input Channel 3 Function Selection. Enter '0' for fire alarm; '1' for host control panel trouble; '2' for fire supervisory; '3' for process monitoring; '4' for AC loss; '5' for security alarm.
- <sub>68</sub> Future use.

## Programming Sheets

<sub>69</sub> <sub>70</sub> <sub>71</sub> Input Channel 1 Delay Timer. Enter 0 - 179 seconds delay. *Factory default is '000' for no delay.*

*Does not delay Input Channels programmed for fire functions.*

<sub>72</sub> <sub>73</sub> <sub>74</sub> Input Channel 2 Delay Timer. Enter 0 - 179 seconds delay. *Factory default is '000' for no delay.*

*Does not delay Input Channels programmed for fire functions.*

<sub>75</sub> <sub>76</sub> <sub>77</sub> Input Channel 3 Delay Timer. Enter 0 - 179 seconds delay. *Factory default is '000' for no delay.*

*Does not delay Input Channels programmed for fire functions.*

<sub>78</sub> <sub>79</sub> <sub>80</sub> Future use.

<sub>81</sub> Touchtone/Rotary Select for Primary Phone. Enter '0' for touchtone dialing; '1' for rotary dialing.

<sub>82</sub> Make/Break Ratio for Primary Phone. Enter '0' for 67/33 ratio; '1' for 62/38 ratio.

<sub>83</sub> Touchtone/Rotary Select for Secondary Phone. Enter '0' for touchtone dialing; '1' for rotary dialing.

<sub>84</sub> Make/Break Ratio for Secondary Phone. Enter '0' for 67/33 ratio; '1' for 62/38 ratio.

<sub>85</sub> Future use.

<sub>86</sub> Future use.

<sub>87</sub> Future use.

<sub>88</sub> Future use.

<sub>89</sub> Trouble Call Limit. Enter a '0' to disable this feature; '1' to enable Trouble Call Limit. *Factory default is '0' for disabled.*

<sub>90</sub> <sub>91</sub> <sub>92</sub> <sub>93</sub> Future Use.

<sub>94</sub> <sub>95</sub> <sub>96</sub> <sub>97</sub> <sub>98</sub> <sub>99</sub> <sub>100</sub> <sub>101</sub> <sub>102</sub> <sub>103</sub> <sub>104</sub> <sub>105</sub> <sub>106</sub> <sub>107</sub> <sub>108</sub> <sub>109</sub> <sub>110</sub> <sub>111</sub>

<sub>112</sub> <sub>113</sub> Future use.

<sub>114</sub> <sub>115</sub> Future use.

<sub>116</sub> Future use.

<sub>117</sub> <sub>118</sub> <sub>119</sub> <sub>120</sub> <sub>121</sub> <sub>122</sub> <sub>123</sub> <sub>124</sub> <sub>125</sub> <sub>126</sub> <sub>127</sub> <sub>128</sub> <sub>129</sub> <sub>130</sub> <sub>131</sub> <sub>132</sub> <sub>133</sub>

<sub>134</sub> <sub>135</sub> <sub>136</sub> Future use.

<sub>137</sub> Future use.

## A.2 Digital Communicator Options Program Sheet (Factory Defaults)

--To enter Programming Mode, press the **MODE** key, **7764** and then the **[ENTER/STORE]** key.

**F**<sub>00</sub> **F**<sub>01</sub> **F**<sub>02</sub> **F**<sub>03</sub> **F**<sub>04</sub> **F**<sub>05</sub> **F**<sub>06</sub> **F**<sub>07</sub> **F**<sub>08</sub> **F**<sub>09</sub> **F**<sub>10</sub> **F**<sub>11</sub> **F**<sub>12</sub> **F**<sub>13</sub> **F**<sub>14</sub> **F**<sub>15</sub> **F**<sub>16</sub> **F**<sub>17</sub> **F**<sub>18</sub> **F**<sub>19</sub>

Addresses 00 to 19 store the Primary Central Station phone number. *Enter 'F' to represent the end of number.*

**E**<sub>20</sub> Primary Central Station Communication Format. *'E' for Ademco Contact ID Format.*

**0**<sub>21</sub> **0**<sub>22</sub> **0**<sub>23</sub> **0**<sub>24</sub> Primary Central Station Account Code.

**0**<sub>25</sub> **0**<sub>26</sub> **0**<sub>27</sub> **0**<sub>28</sub> Primary Central Station 24-hour Test Time. *'0000' = 12:00 midnight.*

**0**<sub>29</sub> Primary Number Test Time Interval. *'0' for 24 hours.*

**F**<sub>30</sub> **F**<sub>31</sub> **F**<sub>32</sub> **F**<sub>33</sub> **F**<sub>34</sub> **F**<sub>35</sub> **F**<sub>36</sub> **F**<sub>37</sub> **F**<sub>38</sub> **F**<sub>39</sub> **F**<sub>40</sub> **F**<sub>41</sub> **F**<sub>42</sub> **F**<sub>43</sub> **F**<sub>44</sub> **F**<sub>45</sub> **F**<sub>46</sub> **F**<sub>47</sub> **F**<sub>48</sub> **F**<sub>49</sub>

Addresses 30 to 49 store the Secondary Central Station phone number. *Enter 'F' to represent the end of number.*

**E**<sub>50</sub> Secondary Central Station Communication Format. *'E' for Ademco Contact ID Format.*

**0**<sub>51</sub> **0**<sub>52</sub> **0**<sub>53</sub> **0**<sub>54</sub> Secondary Central Station Account Code.

**0**<sub>55</sub> **0**<sub>56</sub> **0**<sub>57</sub> **0**<sub>58</sub> Secondary Central Station 24-hour Test Time: *'0000' = 12:00 midnight.*

**0**<sub>59</sub> Secondary Number Test Time Interval. *'0' for 24 hours.*

**0**<sub>60</sub> AC Loss Reporting Delay. *'0' for no delay.*

**0**<sub>61</sub> Backup Reporting. *'0' to report to Secondary Central Station phone number as backup only.*

**1**<sub>62</sub> Future Use.

**0**<sub>63</sub> DACT Trouble Reminder. *'0' disables Trouble Reminder.*

**0**<sub>64</sub> Communicator Enable/Disable. *'0' disables communication to Central Station.*

**0**<sub>65</sub> Input Channel 1 Function Selection. *'0' for fire alarm.*

**1**<sub>66</sub> Input Channel 2 Function Selection. *'1' for host control panel trouble.*

**2**<sub>67</sub> Input Channel 3 Function Selection. *'2' for fire supervisory.*

**4**<sub>68</sub> Future Use.

**0**<sub>69</sub> **0**<sub>70</sub> **0**<sub>71</sub> Input Channel 1 Delay Timer. *'000' for no delay. Does not delay fire functions.*

**0**<sub>72</sub> **0**<sub>73</sub> **0**<sub>74</sub> Input Channel 2 Delay Timer. *'000' for no delay. Does not delay fire functions.*

**0**<sub>75</sub> **0**<sub>76</sub> **0**<sub>77</sub> Input Channel 3 Delay Timer. *'000' for no delay. Does not delay fire functions.*

**0**<sub>78</sub> **0**<sub>79</sub> **0**<sub>80</sub> Future Use.

**0**<sub>81</sub> Touchtone/Rotary Select for Primary Phone. *'0' for touchtone dialing.*

**0**<sub>82</sub> Make/Break Ratio for Primary Phone. *'0' for 67/33 ratio.*

**Programming Sheets**

**0**<sub>83</sub> Touchtone/Rotary Select for Secondary Phone. '0' for touchtone dialing.

**0**<sub>84</sub> Make/Break Ratio for Secondary Phone. '0' for 67/33 ratio.

**1**<sub>85</sub> Future Use.

**0**<sub>86</sub> Future Use.

**1**<sub>87</sub> Future Use.

**7**<sub>88</sub> Future Use.

**0**<sub>89</sub> Trouble Call Limit. '0' for disabled feature.

**0**<sub>90</sub> **0**<sub>91</sub> **0**<sub>92</sub> **0**<sub>93</sub> Future Use.

**F**<sub>94</sub> **F**<sub>95</sub> **F**<sub>96</sub> **F**<sub>97</sub> **F**<sub>98</sub> **F**<sub>99</sub> **F**<sub>100</sub> **F**<sub>101</sub> **F**<sub>102</sub> **F**<sub>103</sub> **F**<sub>104</sub> **F**<sub>105</sub> **F**<sub>106</sub> **F**<sub>107</sub> **F**<sub>108</sub> **F**<sub>109</sub> **F**<sub>110</sub> **F**<sub>111</sub>

**F**<sub>112</sub> **F**<sub>113</sub> Future Use.

**0**<sub>114</sub> **3**<sub>115</sub> Future Use.

**0**<sub>116</sub> Future Use.

**F**<sub>117</sub> **F**<sub>118</sub> **F**<sub>119</sub> **F**<sub>120</sub> **F**<sub>121</sub> **F**<sub>122</sub> **F**<sub>123</sub> **F**<sub>124</sub> **F**<sub>125</sub> **F**<sub>126</sub> **F**<sub>127</sub> **F**<sub>128</sub> **F**<sub>129</sub> **F**<sub>130</sub> **F**<sub>131</sub> **F**<sub>132</sub> **F**<sub>133</sub>

































































**F**<sub>134</sub> **F**<sub>135</sub> **F**<sub>136</sub> Future Use.

**0**<sub>137</sub> Future Use.

































































# Appendix B *Event Codes/Transmission Format Programming Sheets*

--To enter Programming Mode, press the **MODE** key, **7764** and then the **[ENTER/STORE]** key.

## **B.1 4+2 Standard & 4+2 Express Formats Primary Central Station**

 138	 139	 140	 141	 142	 143	 144	 145	 146	 147	 148	 149	 150	 151	 152	 153
 154	 155	 156	 157	 158	 159	 160	 161	 162	 163	 164	 165	 166	 167	 168	 169
 170	 171	 172	 173	 174	 175	 176	 177	 178	 179	 180	 181	 182	 183	 184	 185
 186	 187	 188	 189	 190	 191	 192	 193	 194	 195	 196	 197	 198	 199	 200	 201

## **B.2 4+2 Standard & 4+2 Express Formats Secondary Central Station**

 202	 203	 204	 205	 206	 207	 208	 209	 210	 211	 212	 213	 214	 215	 216	 217
 218	 219	 220	 221	 222	 223	 224	 225	 226	 227	 228	 229	 230	 231	 232	 233
 234	 235	 236	 237	 238	 239	 240	 241	 242	 243	 244	 245	 246	 247	 248	 249
 250	 251	 252	 253	 254	 255	 256	 257	 258	 259	 260	 261	 262	 263	 264	 265

--To enter Programming Mode, press the **MODE** key, **7764** and then the [ENTER/STORE] key.

### B.3 4+2 Standard & 4+2 Express Formats Primary Central Station

**1**<sub>138</sub> **1**<sub>139</sub> **F**<sub>140</sub> **F**<sub>141</sub> **8**<sub>142</sub> **3**<sub>143</sub> **9**<sub>144</sub> **2**<sub>145</sub> **F**<sub>146</sub> **1**<sub>147</sub> **F**<sub>148</sub> **2**<sub>149</sub> **F**<sub>150</sub> **3**<sub>151</sub> **F**<sub>152</sub> **4**<sub>153</sub>  
**6**<sub>154</sub> **4**<sub>155</sub> **6**<sub>156</sub> **5**<sub>157</sub> **6**<sub>158</sub> **A**<sub>159</sub> **6**<sub>160</sub> **B**<sub>161</sub> **6**<sub>162</sub> **F**<sub>163</sub> **E**<sub>164</sub> **1**<sub>165</sub> **E**<sub>166</sub> **2**<sub>167</sub> **E**<sub>168</sub> **3**<sub>169</sub>  
**9**<sub>170</sub> **3**<sub>171</sub> **D**<sub>172</sub> **1**<sub>173</sub> **D**<sub>174</sub> **2**<sub>175</sub> **D**<sub>176</sub> **3**<sub>177</sub> **D**<sub>178</sub> **4**<sub>179</sub> **A**<sub>180</sub> **4**<sub>181</sub> **A**<sub>182</sub> **5**<sub>183</sub> **A**<sub>184</sub> **A**<sub>185</sub>  
**A**<sub>186</sub> **B**<sub>187</sub> **A**<sub>188</sub> **F**<sub>189</sub> **9**<sub>190</sub> **9**<sub>191</sub> **9**<sub>192</sub> **1**<sub>193</sub> **7**<sub>194</sub> **1**<sub>195</sub> **7**<sub>196</sub> **2**<sub>197</sub> **7**<sub>198</sub> **3**<sub>199</sub> **7**<sub>200</sub> **4**<sub>201</sub>

### B.4 4+2 Standard & 4+2 Express Formats Secondary Central Station

**1**<sub>202</sub> **1**<sub>203</sub> **F**<sub>204</sub> **F**<sub>205</sub> **8**<sub>206</sub> **3**<sub>207</sub> **9**<sub>208</sub> **2**<sub>209</sub> **F**<sub>210</sub> **1**<sub>211</sub> **F**<sub>212</sub> **2**<sub>213</sub> **F**<sub>214</sub> **3**<sub>215</sub> **F**<sub>216</sub> **4**<sub>217</sub>  
**6**<sub>218</sub> **4**<sub>219</sub> **6**<sub>220</sub> **5**<sub>221</sub> **6**<sub>222</sub> **A**<sub>223</sub> **6**<sub>224</sub> **B**<sub>225</sub> **6**<sub>226</sub> **F**<sub>227</sub> **E**<sub>228</sub> **1**<sub>229</sub> **E**<sub>230</sub> **2**<sub>231</sub> **E**<sub>232</sub> **3**<sub>233</sub>  
**9**<sub>234</sub> **3**<sub>235</sub> **D**<sub>236</sub> **1**<sub>237</sub> **D**<sub>238</sub> **2**<sub>239</sub> **D**<sub>240</sub> **3**<sub>241</sub> **D**<sub>242</sub> **4**<sub>243</sub> **A**<sub>244</sub> **4**<sub>245</sub> **A**<sub>246</sub> **5**<sub>247</sub> **A**<sub>248</sub> **A**<sub>249</sub>  
**A**<sub>250</sub> **B**<sub>251</sub> **A**<sub>252</sub> **F**<sub>253</sub> **9**<sub>254</sub> **9**<sub>255</sub> **9**<sub>256</sub> **1**<sub>257</sub> **7**<sub>258</sub> **1**<sub>259</sub> **7**<sub>260</sub> **2**<sub>261</sub> **7**<sub>262</sub> **3**<sub>263</sub> **7**<sub>264</sub> **4**<sub>265</sub>

--To enter Programming Mode, press the **MODE** key, **7764** and then the **[ENTER/STORE]** key.

### B.5 All 3+1, All 4+1 and 4+2 Expanded Formats for Primary Central Station

<sub>138</sub> <sub>139</sub> <sub>140</sub> <sub>141</sub> <sub>142</sub> <sub>143</sub> <sub>144</sub> <sub>145</sub> <sub>146</sub> <sub>147</sub> <sub>148</sub> <sub>149</sub> <sub>150</sub> <sub>151</sub> <sub>152</sub> <sub>153</sub>  
<sub>154</sub> <sub>155</sub> <sub>156</sub> <sub>157</sub> <sub>158</sub> <sub>159</sub> <sub>160</sub> <sub>161</sub> <sub>162</sub> <sub>163</sub> <sub>164</sub> <sub>165</sub> <sub>166</sub> <sub>167</sub> <sub>168</sub> <sub>169</sub>

### B.6 All 3+1, All 4+1 and 4+2 Expanded Formats for Secondary Central Station

<sub>202</sub> <sub>203</sub> <sub>204</sub> <sub>205</sub> <sub>206</sub> <sub>207</sub> <sub>208</sub> <sub>209</sub> <sub>210</sub> <sub>211</sub> <sub>212</sub> <sub>213</sub> <sub>214</sub> <sub>215</sub> <sub>216</sub> <sub>217</sub>  
<sub>218</sub> <sub>219</sub> <sub>220</sub> <sub>221</sub> <sub>222</sub> <sub>223</sub> <sub>224</sub> <sub>225</sub> <sub>226</sub> <sub>227</sub> <sub>228</sub> <sub>229</sub> <sub>230</sub> <sub>231</sub> <sub>232</sub> <sub>233</sub>

### B.7 All 3+1, All 4+1 and 4+2 Expanded Formats for Primary Central Station (Factory Defaults)

<sub>138</sub>  **F**<sub>139</sub>  **8**<sub>140</sub>  **9**<sub>141</sub>  **F**<sub>142</sub>  **F**<sub>143</sub>  **F**<sub>144</sub>  **F**<sub>145</sub>  **6**<sub>146</sub>  **6**<sub>147</sub>  **6**<sub>148</sub>  **6**<sub>149</sub>  **6**<sub>150</sub>  **E**<sub>151</sub>  **E**<sub>152</sub>  **E**<sub>153</sub>  
 **9**<sub>154</sub>  **D**<sub>155</sub>  **D**<sub>156</sub>  **D**<sub>157</sub>  **D**<sub>158</sub>  **A**<sub>159</sub>  **A**<sub>160</sub>  **A**<sub>161</sub>  **A**<sub>162</sub>  **A**<sub>163</sub>  **9**<sub>164</sub>  **F**<sub>165</sub>  **7**<sub>166</sub>  **7**<sub>167</sub>  **7**<sub>168</sub>  **7**<sub>169</sub>

























































### B.8 All 3+1, All 4+1 and 4+2 Expanded Formats for Secondary Central Station (Factory Defaults)

<sub>202</sub>  **F**<sub>203</sub>  **8**<sub>204</sub>  **9**<sub>205</sub>  **F**<sub>206</sub>  **F**<sub>207</sub>  **F**<sub>208</sub>  **F**<sub>209</sub>  **6**<sub>210</sub>  **6**<sub>211</sub>  **6**<sub>212</sub>  **6**<sub>213</sub>  **6**<sub>214</sub>  **E**<sub>215</sub>  **E**<sub>216</sub>  **E**<sub>217</sub>  
 **9**<sub>218</sub>  **D**<sub>219</sub>  **D**<sub>220</sub>  **D**<sub>221</sub>  **D**<sub>222</sub>  **A**<sub>223</sub>  **A**<sub>224</sub>  **A**<sub>225</sub>  **A**<sub>226</sub>  **A**<sub>227</sub>  **9**<sub>228</sub>  **F**<sub>229</sub>  **7**<sub>230</sub>  **7**<sub>231</sub>  **7**<sub>232</sub>  **7**<sub>233</sub>



























































--To enter Programming Mode, press the **MODE** key, **7764** and then the [ENTER/STORE] key.

### B.9 Ademco Contact ID Format Primary Central Station

	138		139		140		141		142		143		144		145		146		147		148		149		150		151		152		153
	154		155		156		157		158		159		160		161		162		163		164		165		166		167		168		169
	170		171		172		173		174		175		176		177		178		179		180		181		182		183		184		185
	186		187		188		189		190		191		192		193		194														

### B.10 Ademco Contact ID Format Secondary Central Station

	202		203		204		205		206		207		208		209		210		211		212		213		214		215		216		217
	218		219		220		221		222		223		224		225		226		227		228		229		230		231		232		233
	234		235		236		237		238		239		240		241		242		243		244		245		246		247		248		249
	250		251		252		253		254		255		256		257		258														

### B.11 Ademco Contact ID Format Primary Central Station (Factory Defaults)

1<sub>138</sub> 1<sub>139</sub> 0<sub>140</sub> 3<sub>141</sub> 7<sub>142</sub> 3<sub>143</sub> 2<sub>144</sub> 0<sub>145</sub> 0<sub>146</sub> 3<sub>147</sub> 0<sub>148</sub> 1<sub>149</sub> 3<sub>150</sub> 8<sub>151</sub> 0<sub>152</sub> 3<sub>153</sub>  
8<sub>154</sub> 0<sub>155</sub> 3<sub>156</sub> 8<sub>157</sub> 0<sub>158</sub> 3<sub>159</sub> 8<sub>160</sub> 0<sub>161</sub> 3<sub>162</sub> 5<sub>163</sub> 1<sub>164</sub> 3<sub>165</sub> 5<sub>166</sub> 2<sub>167</sub> 3<sub>168</sub> 5<sub>169</sub>  
4<sub>170</sub> 3<sub>171</sub> 5<sub>172</sub> 4<sub>173</sub> 3<sub>174</sub> 0<sub>175</sub> 8<sub>176</sub> 6<sub>177</sub> 0<sub>178</sub> 2<sub>179</sub> 6<sub>180</sub> 0<sub>181</sub> 8<sub>182</sub> 4<sub>183</sub> 1<sub>184</sub> 1<sub>185</sub>  
4<sub>186</sub> 1<sub>187</sub> 6<sub>188</sub> 4<sub>189</sub> 1<sub>190</sub> 2<sub>191</sub> 4<sub>192</sub> 1<sub>193</sub> 3<sub>194</sub>

### B.12 Ademco Contact ID Format Secondary Central Station (Factory Defaults)

1<sub>202</sub> 1<sub>203</sub> 0<sub>204</sub> 3<sub>205</sub> 7<sub>206</sub> 3<sub>207</sub> 2<sub>208</sub> 0<sub>209</sub> 0<sub>210</sub> 3<sub>211</sub> 0<sub>212</sub> 1<sub>213</sub> 3<sub>214</sub> 8<sub>215</sub> 0<sub>216</sub> 3<sub>217</sub>  
8<sub>218</sub> 0<sub>219</sub> 3<sub>220</sub> 8<sub>221</sub> 0<sub>222</sub> 3<sub>223</sub> 8<sub>224</sub> 0<sub>225</sub> 3<sub>226</sub> 5<sub>227</sub> 1<sub>228</sub> 3<sub>229</sub> 5<sub>230</sub> 2<sub>231</sub> 3<sub>232</sub> 5<sub>233</sub>  
4<sub>234</sub> 3<sub>235</sub> 5<sub>236</sub> 4<sub>237</sub> 3<sub>238</sub> 0<sub>239</sub> 8<sub>240</sub> 6<sub>241</sub> 0<sub>242</sub> 2<sub>243</sub> 6<sub>244</sub> 0<sub>245</sub> 8<sub>246</sub> 4<sub>247</sub> 1<sub>248</sub> 1<sub>249</sub>  
4<sub>250</sub> 1<sub>251</sub> 6<sub>252</sub> 4<sub>253</sub> 1<sub>254</sub> 2<sub>255</sub> 4<sub>256</sub> 1<sub>257</sub> 3<sub>258</sub>

# Appendix C *Ademco Contact ID Format Event Code Description*

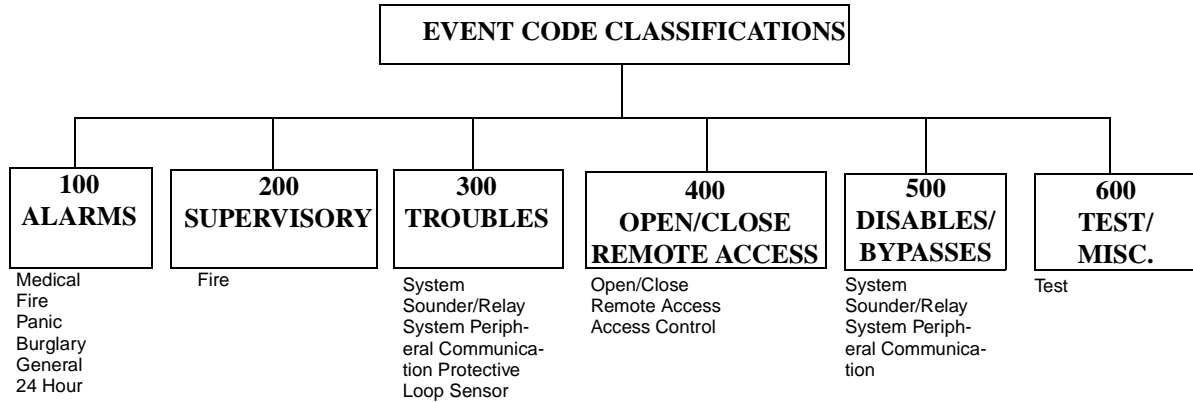

**EVENT**

Medical Alarms - 100

- 100 Medical
- 101 Pendant transmitter
- 102 Fail to report in

Fire Alarms - 110

- 110 Fire Alarm
- 111 Smoke
- 112 Combustion
- 113 Waterflow
- 114 Heat
- 115 Pull station
- 116 Duct
- 117 Flame
- 118 Near Alarm

Panic Alarms - 120

- 120 Panic Alarm
- 121 Duress
- 122 Silent
- 123 Audible

Burglar Alarms - 130

- 130 Burglary
- 131 Perimeter
- 132 Interior
- 133 24-Hour
- 134 Entry/Exit
- 135 Day/Night
- 136 Outdoor
- 137 Tamper
- 138 Near Alarm

**MESSAGE**

- EMERG - Personal Emergency - #
- EMERG - Personal Emergency - #
- EMERG - Fail to Check-in - #

- FIRE - Fire Alarm - #
- FIRE - Smoke Detector - #
- FIRE - Combustion - #
- FIRE - Waterflow - #
- FIRE - Heat Sensor - #
- FIRE - Pull Station - #
- FIRE - Duct Sensor - #
- FIRE - Flame Sensor - #
- FIRE - Near Alarm - #

- PANIC - Panic - #
- PANIC - Duress
- PANIC - Silent Panic - #
- PANIC - Audible Panic - #

- BURG - Burglary - #
- BURG - Perimeter - #
- BURG - Interior - #
- BURG - 24-Hour - #
- BURG - Entry/Exit - #
- BURG - Day/Night - #
- BURG - Outdoor - #
- BURG - Tamper - #
- BURG - Near Alarm - #

**Ademco Contact ID Format Event Code Description**

**EVENT**

**MESSAGE**

General Alarms - 140

140 General Alarm	ALARM - General Alarm - #
141 Polling loop open	ALARM - Polling Loop Open - #
142 Polling loop short	ALARM - Polling Loop Short - #
143 Expansion module failure	ALARM - Exp. Module Fail - #
144 Sensor tamper	ALARM - Sensor Tamper - #
145 Expansion module tamper	ALARM - Exp. Module Tamper - #

24 Hour Non-Burglary - 150 and 160

150 24-Hour Non-Burg	ALARM - 24-Hr. Non-Burg - #
151 Gas detected	ALARM - Gas Detected - #
152 Refrigeration	ALARM - Refrigeration - #
153 Loss of heat	ALARM - Heating System - #
154 Water leakage	ALARM - Eater Leakage - #
155 Foil break	ALARM - Foil Break - #
156 Day trouble	ALARM - Day Zone - #
157 Low bottled gas level	ALARM - Low Gas Level - #
158 High temp	ALARM - High Temperature - #
159 Low temp	ALARM - Low Temperature - #
161 Loss of air flow	ALARM - Air Flow - #

Fire Supervisory - 200 and 210

200 Fire supervisory	SUPER. - Fire Supervisory - #
201 Low water pressure	SUPER. - Low Water Pressure - #
202 Lox CO2	SUPER. - Low CO2
203 Gate valve sensor	SUPER. - Gate Valve - #
204 Low water level	SUPER. - Low Water Level - #
205 Pump activated	SUPER. - Pump Activation - #
206 Pump failure	SUPER. - Pump Failure - #

System Troubles - 300 and 310

300 System trouble	TROUBLE - System Trouble
301 AC loss	TROUBLE - AC Power
302 Low system battery	TROUBLE - System Low Battery
303 RAM checksum bad	TROUBLE - Bad RAM Checksum (Restore not applicable)
304 ROM checksum bad	TROUBLE - Bad ROM Checksum (Restore not applicable)
305 System reset	TROUBLE - System Reset (Restore not applicable)
306 Panel program changed	TROUBLE - Programming Changed (Restore not applicable)
307 Self-test failure	TROUBLE - Self Test Failure
308 System shutdown	TROUBLE - System Shutdown
309 Battery test failure	TROUBLE - Battery Test Failure
310 Ground fault	TROUBLE - Ground Fault - #
311 No battery	TROUBLE - No Battery

Sounder/Relay Troubles - 320

320 Sounder/Relay	TROUBLE - Sounder Relay - #
321 Bell 1	TROUBLE - Bell/Siren #1
322 Bell 2	TROUBLE - Bell/Siren #2
323 Alarm relay	TROUBLE - Alarm Relay
324 Trouble relay	TROUBLE - Trouble Relay
325 Reversing	TROUBLE - Reversing Relay
326 Bell 3	TROUBLE - Bell/Siren #3
327 Bell 4	TROUBLE - Bell/Siren #4

**Ademco Contact ID Format Event Code Description**

<b>EVENT</b>	<b>MESSAGE</b>
<u>System Peripheral Troubles - 330 and 340</u>	
330 System peripheral	TROUBLE - Sys. Peripheral - #
331 Polling loop open	TROUBLE - Polling Loop Open
332 Polling loop short	TROUBLE - Polling Loop Short
333 Expansion module failure	TROUBLE - Exp. Module Fail - #
334 Repeater failure	TROUBLE - Repeater Failure - #
335 Local printer paper out	TROUBLE - Printer Paper Out
336 Local printer failure	TROUBLE - Local Printer
<u>Communication Troubles - 350 and 360</u>	
350 Communication	TROUBLE - Communication Trouble
351 Telco 1 fault	TROUBLE - Phone Line #1
352 Telco 2 fault	TROUBLE - Phone Line #2
353 Long range radio xmitter fault	TROUBLE - Radio Transmitter
354 Fail to communicate	TROUBLE - Fail to Communicate
355 Loss of radio supervision	TROUBLE - Radio Supervision
356 Loss of central polling	TROUBLE - Central Radio Polling
<u>Protection Loop Troubles - 370</u>	
370 Protection loop	TROUBLE - Protection Loop - #
371 Protection loop open	TROUBLE - Protection Loop Open - #
372 Protection loop short	TROUBLE - Protection Loop Short - #
373 Fire Trouble	TROUBLE - Fire Loop - #
<u>Sensor Troubles - 380</u>	
380 Sensor trouble	TROUBLE - Sensor Trouble - #
381 Loss of supervision - RF	TROUBLE - RF Sensor Supervision - #
382 Loss of supervision - RPM	TROUBLE - RPM Sensor Supervision - #
383 Sensor tamper	TROUBLE - Sensor Tamper - #
384 RF transmitter low battery	TROUBLE - RF Sensor Batt. - #
<u>Open/Close - 400</u>	
400 Open/Close	OPENING                      CLOSING
401 Open/Close by user	OPENING - User #          CLOSING - User #
402 Group Open/Close	OPENING - Group User # CLOSING - Group User #
403 Automatic Open/Close	OPENING - Automatic      CLOSING - Automatic
404 Late Open/Close	OPENING - Late              CLOSING - Late
405 Deferred Open/Close	Opening not used          Closing not used
406 Cancel	OPENING - Cancel          Closing not used
407 Remote arm/disarm	OPENING - Remote          CLOSING - Remote
408 Quick arm	Opening not applicable    CLOSING - Quick arm
409 Keyswitch Open/Close	OPENING - Keyswitch      CLOSING - Keyswitch
<u>Remote Access - 410</u>	
411 Callback request made	REMOTE - Callback Requested    Restore not applicable
412 Success - download/access	REMOTE - Successful Access      Restore not applicable
413 Unsuccessful access	REMOTE - Unsuccessful Access    Restore not applicable
414 System shutdown	REMOTE - System Shutdown
415 Dialer shutdown	REMOTE - Dialer Shutdown
416 Success - upload/access	REMOTE - Successful Access      Restore not applicable
<u>Access Control - 420</u>	
421 Access denied	ACCESS - Access Denied - User # Restore not used
422 Access report by user	ACCESS - Access Gained - User # Restore not used
<u>System Disables - 500 and 510</u>	

**Ademco Contact ID Format Event Code Description**

**EVENT**

**MESSAGE**

Sounder/Relay Disables - 520

520 Sounder/Relay disable	DISABLE - Sounder/Relay - #
521 Bell 1 disable	DISABLE - Bell/Siren - #1
522 Bell 2 disable	DISABLE - Bell/Siren - #2
523 Alarm relay disable	DISABLE - Alarm Relay
524 Trouble relay disable	DISABLE - Trouble Relay
525 Reversing relay disable	DISABLE - Reversing Relay
526 Bell 3 disable	DISABLE - Bell/Siren - #3
527 Bell 4 disable	DISABLE - Bell/Siren - #4

System Peripheral Disables - 530 and 540

Communication Disables - 550 and 560

551 Dialer disabled	DISABLE - Dialer Disable
552 Radio transmitter disabled	DISABLE - Radio Disable

Bypasses - 570

570 Zone bypass	BYPASS - Zone Bypass - #
571 Fire bypass	BYPASS - Fire Bypass - #
572 24-Hour zone bypass	BYPASS - 24-Hour Bypass - #
573 Burglar bypass	BYPASS - Burg. Bypass - #
574 Group bypass	BYPASS - Group Bypass - #

Test Misc. - 600

601 Manual trigger test	TEST - Manually Triggered	Restore not applicable
602 Periodic test report	TEST - Periodic	Restore not applicable
603 Periodic RF transmission	TEST - Periodic Radio	Restore not applicable
604 Fire test	TEST - Fire Test	Restore not used
605 Status report to follow	STATUS - Status Follows	Restore not applicable
606 Listen-in to follow	LISTEN - Listen-in Active	Restore not applicable
607 Walk test mode	TEST - Walk Test Mode	
608 System abnormal test	TEST - System Abnormal Test	

## Appendix D *Wire Requirements*

It is important to use the correct type of wire, wire gauge and wire run length per each 411 circuit. Reference the following table to specify wire requirements and limitations for each digital communicator.

**TABLE 4-4: Wire Specifications**

CIRCUIT CONNECTIONS		WIRE REQUIREMENTS		
CIRCUIT TYPE	CIRCUIT FUNCTION	WIRE TYPE AND LIMITATIONS	RECOMMENDED MAX. DISTANCE FEET (METERS)	WIRE GAUGE
Channels/ <i>Inputs</i>	Connects to normally open contact triggers DACT	Untwisted, unshielded wire (Do not exceed 100 ohms).	10,000 (3,000m) 8,000 (2,400m) 4,875 (1,450m) 3,225 (980m)	12 AWG (3.25 mm <sup>2</sup> ) Signal 88202 Belden 9583 WPW999 14 AWG (2.00 mm <sup>2</sup> ) Signal 88402 Belden 9581 WPW995 16 AWG (1.30 mm <sup>2</sup> ) Signal 88602 Belden 9575 WPW991 18 AWG (0.75 mm <sup>2</sup> ) Signal 88802 Belden 9574 WPW975
Power Input Nominal 12VDC or 24 VDC	Powers 411	Voltage limits  12 VDC (11.2 to 12.4 VDC - UL tested range: -15%, +10%)  24 VDC (21.3-24.0 - UL tested range: -15%, +10%)	not applicable	12 - 18 AWG  (3.25 mm <sup>2</sup> - 0.75 mm <sup>2</sup> )

## Appendix E *Operational Modes*

**TABLE 4-5: Operational Modes**

<b>CODE</b>	<b>ACTIVITY</b>	<b>NOTES</b>
6676 (NORM)	Returns to normal operation	Fire protection is on.
2525 (CLCK)	Enters Real-Time Clock Mode	Program digital communicator time. Fire protection is off.
7764 (PROG)	Enters Program Mode	Allows programming of digital communicator. Fire protection is off.
3337 (DEFP)	Returns digital communicator to factory default program settings	Fire protection is off during Default Mode.
8768 (TROU)	Allows testing of both telephone lines.	Fire protection is off during Troubleshoot Mode.



# Index

## Numerics

411  
see DACT

## A

AC Loss Reporting 16, 32

## B

Backup Reporting 32  
Burglary Functions 16

## C

Central Station  
Communication 36  
Channel 9, 14  
Alarm Current 9  
Default Programming 16  
Delay Timer 33  
Function Selection 33  
Labels 16  
Line Resistance 9  
Operating Voltage 9  
Programming 10, 16  
Style B 9  
Class B  
see Style B  
Communication Fail 10  
Communicator Disabled 14

## D

DACT 8  
AFP-200 Connection 15  
MS-9200 Connection 15  
Programming 25  
Default Mode 13, 35  
Description 8  
Dialer Runaway 8  
Digital Alarm Communicator  
Transmitter  
see also DACT 8

## E

Earth Ground 10  
Enclosure 14  
End-Of-Line Resistor 8, 16  
Channel 9  
EOL  
see End-Of-Line Resistor  
Event Code 16, 26, 34

## F

FCC Registration 11  
Features 8  
Fire-Watch 411 Series DACT  
Programmer  
see Programmer  
Format 25, 29, 37

## I

Indicator 10  
see also LED 10  
Inputs  
see Channels

## J

Jumper J4 9, 14  
12 VDC 9  
24 VDC 9

## L

LED 9  
Line Seizure 11, 20

## M

Modes of Operation 13, 20, 56  
Mounting 8, 14

## N

Normal Mode 13, 20

## O

Off/On-Hook 11

## P

Phone 10, 11  
Circuit 11, 17  
Line Testing 35  
Phone Connector - Male 11  
Piezo  
see Sounder  
Power 8  
Operating 9, 14  
12 VDC 9, 14  
24 VDC 9, 14  
Current Requirements 9  
UL Tested Range 9

Process Monitor 16

Program Mode 13, 24

Programmer 8, 18

Connection 18

Display 22

Key Functions 21

1st Event 22

Down Arrow 22

Enter/Store 22

Lamp Test 21

Mode 21

Up Arrow 22

Operation 18

## R

Real Time Clock Mode 13, 22

Receivers

UL Listed 41

REN

see Ringer Equivalence Number

Ringer Equivalence Number 11

RJ31X 17

see Phone Connector - Male

## S

Silence

see also switch 9

Sounder 9, 10

Specifications 9

Status

Control Panel 8

DACT 8

Style B 9

switch

Control 10

Silence 9

## T

Time

Power-up 24

Setting 24

Transmittal Priorities 39

Trouble Call Limit 34

Troubleshoot Mode 13, 35

## U

UL Power-limited Wiring 19

## W

Wire Specifications 55

## Notes

## ***Limited Warranty***

The manufacturer warrants its products to be free from defects in materials and workmanship for eighteen (18) months from the date of manufacture, under normal use and service. Products are date-stamped at time of manufacture. The sole and exclusive obligation of the manufacturer is to repair or replace, at its option, free of charge for parts and labor, any part which is defective in materials or workmanship under normal use and service. For products not under the manufacturer's date-stamp control, the warranty is eighteen (18) months from date of original purchase by the manufacturer's distributor unless the installation instructions or catalog sets forth a shorter period, in which case the shorter period shall apply. This warranty is void if the product is altered, repaired, or serviced by anyone other than the manufacturer or its authorized distributors, or if there is a failure to maintain the products and systems in which they operate in a proper and workable manner. In case of defect, secure a Return Material Authorization form from our customer service department. Return product, transportation prepaid, to the manufacturer.

This writing constitutes the only warranty made by this manufacturer with respect to its products. The manufacturer does not represent that its products will prevent any loss by fire or otherwise, or that its products will in all cases provide the protection for which they are installed or intended. Buyer acknowledges that the manufacturer is not an insurer and assumes no risk for loss or damages or the cost of any inconvenience, transportation, damage, misuse, abuse, accident, or similar incident.

THE MANUFACTURER GIVES NO WARRANTY, EXPRESSED OR IMPLIED, OF MERCHANTABILITY, FITNESS FOR ANY PARTICULAR PURPOSE, OR OTHERWISE WHICH EXTEND BEYOND THE DESCRIPTION ON THE FACE HEREOF. UNDER NO CIRCUMSTANCES SHALL THE MANUFACTURER BE LIABLE FOR ANY LOSS OF OR DAMAGE TO PROPERTY, DIRECT, INCIDENTAL, OR CONSEQUENTIAL, ARISING OUT OF THE USE OF, OR INABILITY TO USE THE MANUFACTURER'S PRODUCTS. FURTHERMORE, THE MANUFACTURER SHALL NOT BE LIABLE FOR ANY PERSONAL INJURY OR DEATH WHICH MAY ARISE IN THE COURSE OF, OR AS A RESULT OF, PERSONAL, COMMERCIAL, OR INDUSTRIAL USE OF ITS PRODUCTS.

This warranty replaces all previous warranties and is the only warranty made by the manufacturer. No increase or alteration, written or verbal, of the obligation of this warranty is authorized.



World Headquarters  
One Fire-Lite Place, Northford, CT 06472-1653 USA  
203-484-7161 • Fax 203-484-7118  
[www.firelite.com](http://www.firelite.com)

**ISO 9001**  
**CERTIFIED**  
ENGINEERING & MANUFACTURING