

---

# **VISTA SERIES**

---

---

**4140XMP  
INSTALLATION  
INSTRUCTIONS**

**® ADEMCO**

## **CONGRATULATIONS on your purchase of the VISTA 4140XMP!**

The purpose of these Installation Instructions is to give you a brief overview of the VISTA 4140XMP system, and provide instructions for installing a basic system.

As always, ADEMCO is there for YOU! Our SALES and TECHNICAL SUPPORT staff are eager to assist you in any way they can, so don't hesitate to call, for any reason!

*East Coast Technical Support: 1-800-645-7492 (8 a.m.-6 p.m. E.S.T.)*  
*West Coast Technical Support: 1-800-458-9469 (8 a.m.-5 p.m. P.S.T.)*

**PLEASE,**

Before you call Technical Support, be sure you:

- Check all wiring connections.
- Determine that the power supply and/or backup battery are supplying proper voltages.
- Verify your programming information where applicable.
- Note the proper model number of this product, and the version level (if known) along with any documentation that came with the product.
- Note your Ademco customer number and/or company name.

Having this information handy will make it easier for us to serve you quickly and effectively.

**Again, CONGRATULATIONS, and WELCOME ABOARD!**

## TABLE OF CONTENTS

<p><b>I. GENERAL INFORMATION</b> ..... 5</p> <p style="padding-left: 20px;">The VISTA Control ..... 5</p> <p style="padding-left: 20px;">Easy Programming ..... 5</p> <p style="padding-left: 20px;">4140XMP Enhancements ..... 5</p> <p style="padding-left: 20px;">Note to 4140XM Users ..... 5</p> <p><b>II. ZONE CONFIGURATIONS</b> ..... 6</p> <p style="padding-left: 20px;"><b>ZONE TYPE DEFINITIONS</b> ..... 6</p> <p style="padding-left: 20px;"><b>BASIC 9 HARD-WIRED ZONES</b> ..... 6</p> <p style="padding-left: 40px;">Zone 1 ..... 6</p> <p style="padding-left: 40px;">Zone 9 ..... 6</p> <p style="padding-left: 40px;">Zones 2-8 ..... 6</p> <p style="padding-left: 20px;"><b>2-WIRE POLLING LOOP (Multiplex Loop)</b> ..... 7</p> <p style="padding-left: 40px;">Wire Run Lengths ..... 7</p> <p style="padding-left: 40px;">Advisories ..... 7</p> <p style="padding-left: 20px;"><b>WIRELESS EXPANSION</b> ..... 8</p> <p style="padding-left: 40px;">4280/4280-8 RF Receivers ..... 8</p> <p style="padding-left: 40px;">Programming Notes for Wireless Devices ..... 8</p> <p style="padding-left: 40px;">Supervision ..... 8</p> <p style="padding-left: 40px;">House Identification ..... 8</p> <p style="padding-left: 40px;">Transmitter Identification ..... 8</p> <p style="padding-left: 40px;">Sniffer Mode to Determine House ID ..... 8</p> <p style="padding-left: 40px;">Sniffer Mode to Check Transmitters ..... 8</p> <p style="padding-left: 40px;">Go/No Go Test Mode ..... 8</p> <p style="padding-left: 40px;">Important Battery Notice ..... 9</p> <p style="padding-left: 40px;">Wireless Zone Types ..... 9</p> <p style="padding-left: 40px;">Advisories ..... 9</p> <p><b>III. PERIPHERAL DEVICES</b> ..... 10</p> <p style="padding-left: 20px;"><b>REMOTE CONSOLES</b> ..... 10</p> <p style="padding-left: 40px;">4127 Fixed Word Console ..... 10</p> <p style="padding-left: 40px;">4137 Deluxe Fixed word Console ..... 10</p> <p style="padding-left: 40px;">5137 Alpha Custom LCD Console ..... 10</p> <p style="padding-left: 40px;">Console Wiring ..... 10</p> <p style="padding-left: 20px;"><b>EXTERNAL SOUNDERS</b> ..... 10</p> <p style="padding-left: 40px;">Relay Output ..... 10</p> <p style="padding-left: 40px;">Non-UL Installations ..... 10</p> <p style="padding-left: 40px;">UL Installations ..... 10</p> <p style="padding-left: 20px;"><b>SMOKE DETECTORS</b> ..... 11</p> <p style="padding-left: 40px;">Zone 1 ..... 11</p> <p style="padding-left: 40px;">Zones 2-8 ..... 11</p> <p style="padding-left: 40px;">Compatible Smoke Detectors ..... 11</p> <p style="padding-left: 40px;">Polling Loop Smoke Detectors ..... 11</p> <p style="padding-left: 40px;">Advisories ..... 11</p> <p style="padding-left: 20px;"><b>PASSIVE INFRARED DETECTORS</b> ..... 11</p> <p style="padding-left: 40px;">Polling Loop PIR (4275) ..... 11</p> <p style="padding-left: 40px;">Polling Loop PIR (4196/4278) ..... 11</p> <p style="padding-left: 40px;">Wireless PIR (5775) ..... 11</p> <p style="padding-left: 20px;"><b>GLASS BREAK DETECTORS</b> ..... 11</p> <p style="padding-left: 20px;"><b>PHONE LINE CONNECTIONS</b> ..... 12</p> <p style="padding-left: 20px;"><b>CONNECTOR J7 TRIGGER OUTPUTS</b> ..... 12</p> <p style="padding-left: 40px;">General Information ..... 12</p> <p style="padding-left: 40px;">Ground Start Module ..... 12</p> <p style="padding-left: 40px;">Remote Keyswitch (4146) ..... 13</p> <p><b>IV. MOUNTING &amp; POWERING</b> ..... 14</p> <p style="padding-left: 20px;"><b>MOUNTING</b> ..... 14</p> <p style="padding-left: 40px;">Mounting the 4140XMP PC Board ..... 14</p> <p style="padding-left: 40px;">Mounting the 4140XMP Lock ..... 14</p> <p style="padding-left: 40px;">Mounting the 4127 Console ..... 14</p> <p style="padding-left: 40px;">Surface Mounting the 4137/5137 Consoles ..... 15</p> <p style="padding-left: 40px;">Flush Mounting with Trim Ring Kit (5137TRK) ..... 15</p> <p style="padding-left: 40px;">Adjusting the Alpha Console Viewing Angle ..... 15</p> <p style="padding-left: 20px;"><b>POWERING THE SYSTEM</b> ..... 16</p> <p style="padding-left: 40px;">Primary Power ..... 16</p> <p style="padding-left: 40px;">Back-Up Power ..... 16</p> <p style="padding-left: 40px;">Battery Standby Table ..... 16</p> <p style="padding-left: 40px;">Earth Ground Connections ..... 16</p> <p style="padding-left: 40px;">Power-Up Procedure ..... 16</p> <p style="padding-left: 40px;">Polling Loop Current Draw Worksheet ..... 16</p> <p style="padding-left: 40px;">Auxiliary Device Current Draw Worksheet ..... 16</p>	<p><b>V. SYSTEM OPERATION</b> ..... 17</p> <p style="padding-left: 20px;"><b>SECURITY ACCESS CODES</b> ..... 17</p> <p style="padding-left: 40px;">Master Code ..... 17</p> <p style="padding-left: 40px;">Duress Code ..... 17</p> <p style="padding-left: 40px;">Temporary Codes ..... 17</p> <p style="padding-left: 40px;">Babysitter Code (User 22) ..... 17</p> <p style="padding-left: 20px;"><b>KEYPAD FUNCTIONS</b> ..... 18</p> <p style="padding-left: 40px;">General Information ..... 18</p> <p style="padding-left: 40px;">Viewing Downloaded Messages ..... 18</p> <p style="padding-left: 40px;">Using the Built-in User's Guide ..... 18</p> <p style="padding-left: 40px;">Displaying Descriptors ..... 18</p> <p style="padding-left: 40px;">Panic Keys ..... 18</p> <p style="padding-left: 20px;"><b>TROUBLE CONDITIONS</b> ..... 19</p> <p style="padding-left: 40px;">"Check" Message ..... 19</p> <p style="padding-left: 40px;">Power Failure ..... 19</p> <p style="padding-left: 40px;">Other Trouble Conditions ..... 19</p> <p style="padding-left: 20px;"><b>RECALLING ALARM &amp; TROUBLE MESSAGES</b> ..... 19</p> <p style="padding-left: 20px;"><b>SETTING THE REAL-TIME CLOCK</b> ..... 19</p> <p><b>VI. SYSTEM COMMUNICATIONS</b> ..... 20</p> <p style="padding-left: 20px;">Split/Dual Reporting ..... 20</p> <p style="padding-left: 20px;">Ademco Low Speed ..... 20</p> <p style="padding-left: 20px;">SESCOA/Radionics ..... 20</p> <p style="padding-left: 20px;">4+2 Reporting ..... 20</p> <p style="padding-left: 20px;">4+2 Express ..... 20</p> <p style="padding-left: 20px;">Ademco High Speed Reporting ..... 20</p> <p style="padding-left: 20px;">Contact ID Reporting ..... 20</p> <p style="padding-left: 20px;">Table of Contact ID Event Codes ..... 21</p> <p style="padding-left: 20px;">4140XMP Communication Programming Guide ..... 21</p> <p><b>VII. PROGRAMMING THE SYSTEM</b> ..... 22</p> <p style="padding-left: 20px;"><b>GENERAL PROGRAMMING PROCEDURES</b> ..... 22</p> <p style="padding-left: 40px;">Default Programming ..... 22</p> <p style="padding-left: 40px;">Data Programming ..... 22</p> <p style="padding-left: 40px;">Programming Steps ..... 22</p> <p style="padding-left: 20px;"><b>COMMUNICATION DEFAULT PROGRAMMING</b> ..... 23</p> <p style="padding-left: 40px;">Easy-to-Program Communication Fields ..... 23</p> <p style="padding-left: 40px;">Low Speed ..... 23</p> <p style="padding-left: 40px;">Ademco Express ..... 23</p> <p style="padding-left: 40px;">Ademco High Speed ..... 23</p> <p style="padding-left: 40px;">Contact ID ..... 23</p> <p style="padding-left: 20px;"><b>PROGRAMMING ZONE DESCRIPTORS</b> ..... 24</p> <p style="padding-left: 40px;">Entering Zone Descriptors ..... 24</p> <p style="padding-left: 40px;">Adding Custom Words ..... 24</p> <p style="padding-left: 40px;">Creating a Custom Message ..... 25</p> <p style="padding-left: 40px;">Vocabulary of Words in Memory* ..... 25</p> <p><b>VIII. DOWNLOADING PRIMER*</b> ..... 26</p> <p><b>IX. TESTING THE SYSTEM</b> ..... 27</p> <p style="padding-left: 20px;">Using Test Mode ..... 27</p> <p style="padding-left: 20px;">Armed System Test ..... 27</p> <p style="padding-left: 20px;">Turning the System Over to the User ..... 27</p> <p style="padding-left: 20px;">Note To The Installer ..... 27</p> <p><b>X. TROUBLESHOOTING*</b> ..... 28</p> <p style="padding-left: 20px;"><b>CONSOLES</b> ..... 28</p> <p style="padding-left: 20px;"><b>HARD-WIRED ZONES 1-9</b> ..... 28</p> <p style="padding-left: 20px;">RPMs ..... 28</p> <p style="padding-left: 20px;"><b>WIRELESS</b> ..... 29</p> <p style="padding-left: 20px;"><b>COMMUNICATIONS</b> ..... 30</p> <p><b>XI. SPECIFICATIONS</b> ..... 31</p> <p><b>XII. 4190WH OPERATION &amp; WIRING</b> ..... 31</p> <p style="padding-left: 20px;">— DIP SWITCH SETTING TABLES ..... 33</p> <p style="padding-left: 20px;">— PROGRAMMING FORM ..... 36</p>
--	---

\* This issue has a revised format and includes the new sections indicated by asterisks. Margin lines indicate other principal changes.

## LIST OF FIGURES

1.	4140XMP SYSTEM.....	5
2.	POLLING LOOP DEVICES.....	7
3.	4280/4280-8 RF RECEIVER.....	8
4.	CONNECTOR J7.....	12
5.	GROUND START MODULE.....	12
6.	REMOTE KEYSWITCH WIRING.....	13
7.	MOUNTING THE PC BOARD.....	14
8.	MOUNTING THE CABINET LOCK.....	14
9.	SURFACE MOUNTING THE CONSOLES.....	15
10.	FLUSH MOUNTING THE CONSOLES.....	15
11.	ADJUSTING THE VIEW ANGLE/INSERTING THE NAMEPLATE.....	15
12.	4190WH OPERATION & WIRING DIAGRAM.....	31
13.	SUMMARY OF CONNECTIONS DIAGRAM.....	32

---

## SEVEN STEPS TO EASY INSTALLATION

The following steps are required to properly install a VISTA XMP system:

- STEP 1** Become familiar with the system by reading the GENERAL INFORMATION section and determine the hardware required for the installation.
- STEP 2** Determine the system's zone configuration and wiring requirements by reviewing section II: ZONE CONFIGURATIONS and section III: PERIPHERAL DEVICES. If the installation is UL rated, check the special UL requirements included in each section.
- STEP 3** Once the wiring is completed, mount the Control and make power connections following the instructions provided in section IV: MOUNTING & POWERING THE SYSTEM.
- STEP 4** Learn how the system operates, including security codes, keypad functions, trouble conditions and how to set the real-time clock, by reading section V: SYSTEM OPERATION.
- STEP 5** If the system is to be supervised by a central monitoring station, read section VI: SYSTEM COMMUNICATIONS and section VII: PROGRAMMING THE SYSTEM, COMMUNICATION DEFAULT PROGRAMMING for descriptions of reporting formats and a list of communication programming default values.
- STEP 6** Program the system via the keypad or by downloading from a remote location, following the instructions in section VII: PROGRAMMING THE SYSTEM and section VIII: DOWNLOADING PRIMER (if applicable).
- STEP 7** Test the system and teach the user how to perform all commands, following the procedures in section IX: TESTING THE SYSTEM.  
If problems occur, refer to section X: TROUBLESHOOTING.
- ADVISORIES** Throughout this manual, information that requires special attention is highlighted in the ADVISORIES paragraphs. This information includes system limitations, caveats and other information vital to the proper operation of the system. Be sure to read these paragraphs carefully.
- MODEL NUMBERS** Unless otherwise noted, product model numbers listed in this manual refer to Ademco products.

# I. GENERAL INFORMATION

## THE VISTA CONTROL

The VISTA 4140XMP Control is a microprocessor based programmable system and features EEROM memory technology (power loss does not result in the loss of information). The Control supports up to 9 wired zones of protection, expandable to 64 zones (wired and/or wireless) using 2-wire polling loop devices, and/or wireless transmitters (5700 series).

## EASY PROGRAMMING

Programming can be performed at the office prior to installation, or on the job site directly from the console, or can be downloaded from a remote location or at the job site (using a PC Laptop with 4100SM Serial Module) by using the Ademco 4130PC Downloading Software. For installer convenience, the Control is pre-programmed with a set of standard values that is designed to meet the needs of many installations. These values, however, can be changed to suit the needs of any particular installation. The Control can also be pre-programmed by the installer with one of four standard communication default programming values, eliminating the need for extensive programming time and effort.

**NOTE TO 4140XM USERS:** The following are some differences between the 4140XMP & 4140XM panels that will affect your installation practices:

- Revised, easy to follow terminal block layout.
- AC power supplied by No. 1361 transformer (unpolarized) rated at 16.5VAC, 40VA.
- One value (2k  $\Omega$ ) is used for all EOLR supervised zones.
- Zone 1 operates as an EOLR supervised zone only.
- Revised rating and wiring method to the auxiliary triggers.
- Revised programming form to accommodate new features. Use PC Download software that supports the 4140XMP.
- Real-time clock must be set (using 5137 console) before test reports are sent.
- Revised method for programming the dialer reports.
- Program mode can't be entered while system is armed.
- Temporary user codes cannot be assigned while the system is armed.

## 4140XMP ENHANCEMENTS

- Built-in Polling Loop interface, with polling loop terminals located on the panel's terminal block.
- Supports latching type 2-wire glass break detectors on zone 8.
- Supports up to 16 smoke detectors on zone 1
- Up to 70 user security codes can be programmed.
- Choice of normal (4-digit) or high security (6-digit) security codes.
- All zones can be assigned alpha descriptions.
- Up to 20 custom words can now be added to the built-in vocabulary. The letter "s" or "S" can now be added to descriptors.
- Easier programming for communication fields. Simply enter the desired code for each zone.
- Communication default programming can be loaded anytime, and does not affect non-communication program fields.
- All 64 zones can report to a central station using any reporting format.
- Callback defeat option for downloading.
- Real-Time clock included for time related functions. **NOTE: 5137 console required to set the real-time clock.**
- Random AC Loss reporting option sends report randomly from 10-40 minutes after AC loss, to help prevent central stations from receiving an overload of reports due to area blackouts.
- Intelligent test reporting option means test reports will not be sent if any other report was sent within the programmed test report interval.
- Quick (forced) bypass feature bypasses all faulted zones with single key entry sequence (Code + BYPASS + #).
- Installer code override feature. Installer code will disarm system only if it was used to arm the system.
- Self resetting circuit breaker protection eliminates the need to replace blown cartridge fuses.
- Larger cabinet with removable door.
- Direct wire downloading can be done without a modem, using a PC computer and 4100SM Serial Module.
- Split/Dual reporting communicator option has been added.
- Option to allow a cancel report to be sent, even after Bell Time-out has ended.
- PC Downloader ability to individually command output voltage triggers to pulse on for 2 seconds.

Three technologies to suit every installation:  
HARDWARE. SUPERVISED WIRELESS. 2-WIRE MULTIPLEX

## VISTA XMP CONTROL

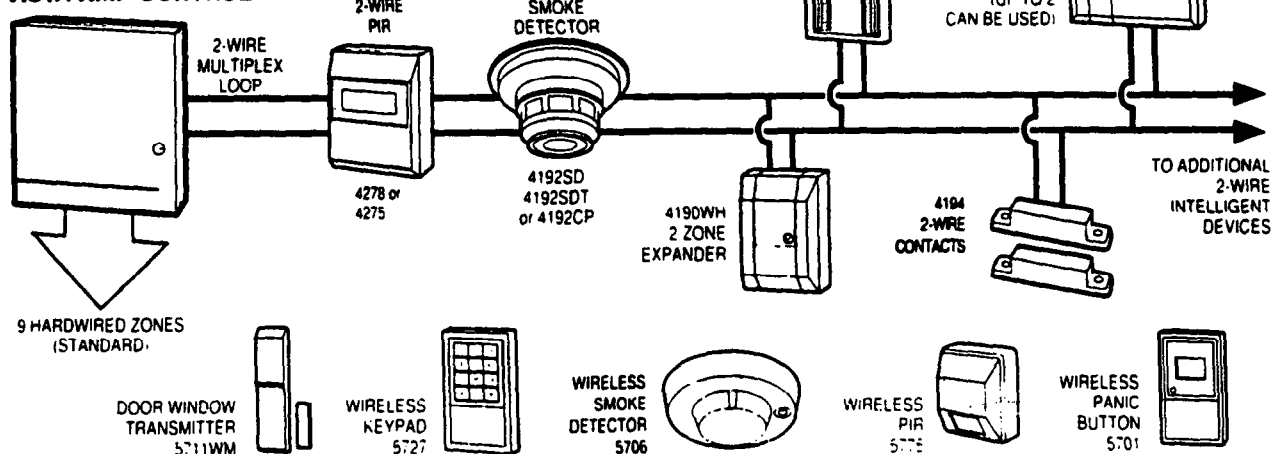

Figure 1. 4140XMP SYSTEM

## II. ZONE CONFIGURATIONS

### ZONE TYPE DEFINITIONS

The VISTA 4140XMP System allows up to 64 zones of hard-wire, polling loop and/or wireless protection. Each zone must be assigned to a zone type, which defines the way in which the system responds to faults in that zone. In addition, there are three keypad activated zones (PANIC keys), a polling loop supervision zone, and two RF supervisory zones, one for each 4280 or 4280-8 RF Receiver installed.

#### TYPE 1: ENTRY/EXIT #1

Used for the primary entry/exit route (ex: front door, main entrance).

#### TYPE 2: ENTRY/EXIT #2

Used for a secondary entry/exit route (ex: Garage door, loading dock door, basement door), where more time might be needed to get to and from the console.

#### TYPE 3: PERIMETER BURGLARY

Used for exterior doors and/or windows which require an instant alarm when violated.

#### TYPE 4: INTERIOR BURGLARY (FOLLOWER)

Used for areas where an entry delay is required only if an entry/exit delay zone is faulted first.

#### TYPE 5: DAY/NIGHT BURGLARY

Used for zones which contain a foil-protected door or window (such as in a store), or to a zone covering a sensitive area such as a stock room, drug supply room, etc., or other controlled access area where immediate notification of an entry is desired.

#### TYPE 6: 24 HOUR SILENT ALARM

This zone type is generally assigned to a zone containing a Hold-up or Panic button that is designed to initiate an alarm report to the Central Station, but which produces no visual displays or alarm sounds (ex: banks, jewelry counters).

#### TYPE 7: 24 HOUR AUDIBLE

This type also assigned to a zone containing a Panic button, but which will initiate an audible alarm in addition to an alarm report to the Central Station (ex: bedside panic).

#### TYPE 8: 24 HOUR AUXILIARY

This type assigned to a zone containing a button for use in personal emergencies or to a zone containing monitoring devices such as water sensors, temperature sensors, etc. Designed to initiate an alarm report to the Central Station and only provides Console alarm sounds and alarm displays.

#### TYPE 9: SUPERVISED FIRE

Used for zones containing smoke detectors, heat detectors, pull stations, etc. An open in this zone will initiate a trouble signal. A short in this zone will initiate a fire alarm (pulsed external sounder and report to central station).

#### TYPE 10: INTERIOR BURGLARY (DELAY)

This type is similar to type 4, except that entry delay begins whenever sensors in this zone are violated, regardless of whether or not an entry/exit delay zone was faulted first.

### BASIC 9 HARD-WIRED ZONES

#### ZONE 1

This zone has a 350 millisecond response and can be assigned to any zone type and is set up for EOLR supervision only. This zone is the only zone that can support 2-wire smoke detectors. See SMOKE DETECTORS section for a list of compatible detectors.

Connect all closed-circuit sensors in series with one another between terminals 10 & 11 (see SUMMARY OF CONNECTIONS Diagram). The 2,000 ohm EOLR should also be in series with the loop at the last device.

If the sensors used are open-circuit devices, such as smoke detectors, each one must be in parallel to the next. The EOLR must then be placed across the last wired detector. Maximum zone resistance, excluding EOLR, is 100 Ohms.

UL NOTE: The 4100 EOL resistor, rated 2.0k ohms, must be used on hardwire fire loops.

#### ZONE 9

This zone is unsupervised and can be assigned to any zone type except fire. Only closed-circuit devices can be used. Connect these devices in series with one another between terminals 22 & 23 (see SUMMARY OF CONNECTIONS Diagram). This zone can be programmed for either normal response (350mS, the default response) or for fast response (10mS). This zone is suitable for monitoring fast acting glass break sensors or vibration sensors when programmed for fast response. Avoid using mechanical magnetic or relay type contacts in this zone when programmed for fast response. Note that the maximum resistance for this zone is 300 ohms.

#### ZONES 2 THROUGH 8

These zones have a 350 millisecond response and can be assigned to any zone type. They can be EOLR supervised or closed circuit unsupervised, as required (program field \*41 determines whether or not these zones will use the 2,000 ohm EOLR: Enter [1] in field \*41 to disable the use of EOLR's on zones 2 through 8). If programmed for use with EOLR's, both closed-circuit and open-circuit devices can be used with the 2,000 ohm EOLR resistor in series with the loop at the last device. If the use of EOLR's is disabled (\*41=1), only closed-circuit devices can be used.

Zone 8 has the added capability of supporting 2 wire, latching type glass break detectors. See GLASS BREAK DETECTORS section for a list of compatible detectors. These detectors may be reset at the console in the same manner as two wire smoke detectors. (i.e. second entry of "OFF" sequence). Zone 8 should be configured as an EOLR type zone when glass break detectors are used.

UL NOTE: The connection to glass break detectors is not applicable for UL Listed applications.

The maximum resistance per zone, excluding EOLR, is 300 ohms for zones 2-7, and 100 ohms for zone 8.

## 2-WIRE POLLING LOOP (Zones 10-64)

The 4140XMP provides a built-in 2-wire polling loop interface which allows the number of zones to be expanded from the basic 9 zones to up to 64 zones using various RPMs, and the 4280 RF Receiver. See below for a list of compatible sensors.

The polling loop provides power to sensors and serves as a communication path between the panel and sensors. Each sensor must be assigned a unique address ID number (from 10-64) before being connected to the polling loop. Most sensors have DIP switches for this purpose. See the DIP SWITCH SETTING TABLE FOR POLLING LOOP DEVICES for information on how to assign ID numbers using DIP switches. Care must be taken to assign unique ID numbers to each sensor in order to allow the panel to supervise and provide unique console status indications for individual sensors.

Connect these sensors to terminals 24 & 25. Sensors can be connected to a single run, or groups of sensors may be connected to separate wire runs without affecting the panel's ability to supervise individual sensors. Follow the wiring instructions provided with individual sensors (4190WH wiring diagram is provided at the end of this manual). Be sure to observe sensor polarity when wiring. The maximum allowable wire run length between the panel and the last sensor on a given wire run is as follows:

WIRE RUN LENGTHS
#22 gauge @ 650 feet max
#20 gauge @ 950 feet max
#18 gauge @ 1500 feet max
#16 gauge @ 2400 feet max

NOTE: Twisted pair recommended for all normal wire runs.

**IMPORTANT:** The maximum combined polling loop run is 4000'. If using shielded wire, the maximum is 2000'. If longer wire runs are needed, a 4197 Loop Extender Module must be used.

### INTERCOM INTERFERENCE

If an intercom system is being used, the polling loop wires must be as far from the intercom wiring as possible (minimum 6"). If this spacing cannot be achieved, shielded wire must be used. If this is not done, interference on the intercom system might occur. Also note that the maximum total wire length supported is cut in half when shielded wire is used.

### ADVISORIES

The maximum allowable current draw on the polling loop is 64mA. Refer to the POLLING LOOP CURRENT DRAW WORKSHEET (found in the POWERING THE SYSTEM section) for current draws of various polling loop devices. If more than 64mA is being drawn, use of the 4197 provides another loop with 64mA available.

Make certain to include the total current drawn on the polling loop in the AUXILIARY CURRENT DRAW WORKSHEET (see POWERING THE SYSTEM section) when figuring the total auxiliary load on the panel's power supply.

## POLLING LOOP DEVICES

See PERIPHERAL DEVICES section for compatible polling loop smoke detectors and passive infrared motion detectors.

### 4208 Eight Zone Polling Loop Expansion Module

- Used to supervise up to 8 hard-wired devices via the polling loop. NOTE: Does not support 2-wire smoke detectors.
- Set DIP switches to identify 8 zones.
- The first two zones can be either normal or fast response (DIP switch selectable).
- All zones are EOLR supervised (first six zones = 4.7k ohms, last two zones = 30k ohms), provided with the 4208.

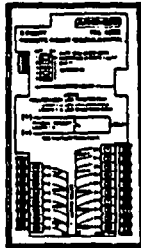

### 4190WH Two Zone Remote Point Module

- Used to supervise 2 hard-wired devices via the polling loop.
- DIP switch programmable.
- The left zone can be EOLR supervised, if necessary, and can accept either open or closed circuit sensors. The right zone is unsupervised and can accept closed circuit sensors only. Refer to the 4190WH OPERATION section at the end of this manual for more information.

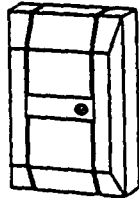

### 4194 Surface Mounted Reed Contact (Wide Gap)

- Wide gap surface mounted reed contact with built-in RPM, which is DIP switch programmable.

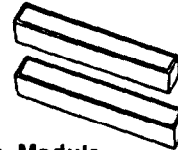

### 4197 Polling Loop Extender Module

- Can be used if the 2-wire polling loop must be greater than the recommended length (4000' max). By installing a 4197 at the end of the first loop, the polling loop can be continued. If more than 64mA needs to be drawn from the polling loop to power RPMs, use of the 4197 provides another loop with 64mA available.
- Connects to the polling loop and is powered from auxiliary power or by a separate 729 power supply with battery backup.

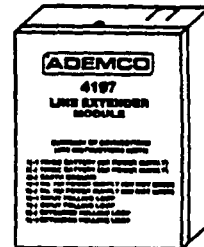

Figure 2. Polling Loop Devices

# WIRELESS EXPANSION (Zones 1-63)

## 4280/4280-8 RF RECEIVER

The VISTA XMP system supports up to 63 wireless transmitters (5700 series), plus a 5727 wireless keypad. To expand the system using wireless, one or two 4280 RF Receivers (or 4280-8 if only 8 wireless zones are used) must be connected to the polling loop. The 4280 receives status and alarm signals from wireless transmitters (@345MHz USA; 315MHz Canada) within a nominal range of 200 feet, and relays this information to the control via the polling loop. Two 4280s can be used to provide either a greater area of coverage, or provide redundant protection.

**IMPORTANT:** Note that if using two RF Receivers, one of them must be powered from auxiliary power. For more information regarding the 4280 installation, refer to the installation instructions provided with the 4280.

**NOTE:** Unless stated otherwise, references to the 4280 Receiver represent the 4280 and/or 4280-8 Receivers.

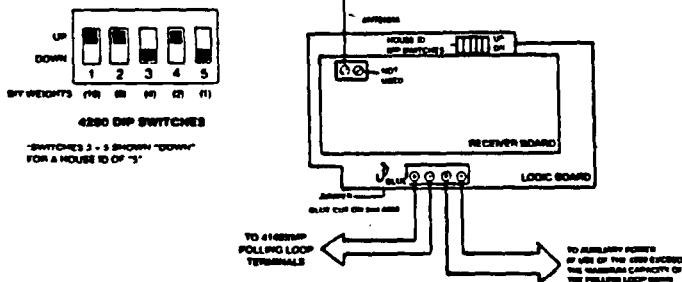

Figure 3. 4280/4280-8 RF RECEIVER

### PROGRAMMING NOTES FOR WIRELESS DEVICES

All RF zones must be designated as such in their respective program fields (1\*18-1\*25). Any zone from 1-63 can be designated as an RF zone. To enable a zone as wireless, simply enter a "1" in the location for that zone. **Be careful when designating RF zones.** If you want a zone to be either hard-wired or on the polling loop, but accidentally enable it as RF, the system will ignore that zone. RF enable overrides hard-wire! If using a 4280-8, only up to 8 zones can be enabled as RF zones. If more than 8 zones are enabled, the message "SET-UP ERROR" (5137) or "E8" (4137/4127) will be displayed.

### SUPERVISION

Each transmitter (except 5701 and 5727) is supervised by a check-in signal that is sent to the receiver at 70-90 minute intervals. If at least one Check-in is not received from a transmitter within a programmed interval (field 1\*31), the console will display the transmitter number and "CHECK" will be displayed.

Each transmitter (including 5701 and 5727) is also supervised for low battery conditions, and will transmit a low battery signal to the 4280 when the battery has approximately 30 days of life remaining.

**NOTE:** After replacing a low or dead battery, activate the transmitter and enter the security code + OFF to clear its memory of the "Low Battery" signal.

The 4280 itself is also supervised three ways:

1. If the cover of the 4280 is removed, an ALARM or TROUBLE will be displayed depending upon the response programmed for zones 89 & 91 (field 1\*09).
2. If the connection is broken between the 4280 and the control panel, or the 4280's cover is removed, an ALARM or TROUBLE will be displayed depending on the response programmed for zones 89 & 91 (field 1\*09). This response is usually that of a DAY/NIGHT or 24 hour type.

3. If, within a programmed interval of time, the 4280 does not hear from any of its transmitters, an ALARM or TROUBLE will be displayed depending on the response programmed for zones 88 & 90 (fields 1\*08 & 1\*09).

### HOUSE IDENTIFICATION

The 4280 responds only to transmitters with the same house ID (DIP switch programmable from 01-31). This prevents system interference from transmitters in other nearby systems. To make sure you do not choose a House ID that is in use nearby, put the system in the Sniffer Mode, which is described later in this section.

### TRANSMITTER IDENTIFICATION

Each transmitter has its own unique ID number (Zone #), which is DIP switch programmable in each unit. Whenever a transmission takes place, either for an alarm, fault, check-in or low battery, this ID number is sent along with the message to the 4280 which, in turn, relays this information to the control panel, which displays the condition and zone number on the console. See the DIP SWITCH TABLES FOR WIRELESS DEVICES at the end of this manual, for individual transmitter settings.

### SNIFFER MODE TO DETERMINE HOUSE ID (Code + [#] + 2)

To check for house IDs being used in nearby systems, set the DIP switches in the 4280 for a House ID of "00" (all switches up), then enter your "Installer Code" + [#] + [2]. The 4280 will now "sniff" out any House IDs in the area and display them. Keeping the 4280 in this mode for about 2 hours will give a good indication of the house IDs being used. To exit the Sniffer Mode, simply key your installer code + OFF, then set your house ID to one not displayed in the "Sniffer Mode".

### SNIFFER MODE TO CHECK TRANSMITTERS (Code + [#] + 3)

To check that all transmitters have been set for the proper house ID, set the 4280 to the proper house ID and enter the Installer code + [#] + [3]. All transmitter ID numbers that have the house ID set for the 4280 will be displayed when each transmitter number checks in (up to 2 hours). A faster way to do this is to fault each transmitter, which causes a transmission to be sent to the 4280. Check that the ID number is displayed when the transmitter is faulted.

### GO/NO GO TEST MODE (Patented)

This mode helps determine the best location for each transmitter and is activated by putting the control panel in the TEST mode and removing the 4280's cover. The receiver's sensitivity is reduced by half. Once transmitters are placed in their desired locations and the approximate length of wire to be run to sensors is connected to the transmitter's screw terminals, open circuit each transmitter. *Do not conduct this test with your hand wrapped around the transmitter.*

If a single 4280 is used, the console will beep three times to indicate signal reception. If two 4280s are used, the console will beep once if the first 4280 received the signal, twice if the second 4280 received the signal and three times if both receivers heard the signal (which is desirable for redundant configurations).

If the console does not beep, reorient or move the transmitter to another location.

To exit this mode, replace the 4280's cover, then enter the installer code and press OFF. Note that the Receiver's sensitivity is fully restored when the cover is replaced.



### IMPORTANT BATTERY NOTICE

The VISTA wireless transmitters are designed to provide long battery life under normal operating conditions. Longevity of batteries may be as much as 4-7 years depending on the environment, usage, and the specific wireless device being used. External factors such as humidity, high or low temperatures, as well as large swings in temperature may all reduce the actual battery life in a given installation. The VISTA wireless system can identify a true low battery situation, thus allowing the dealer or user of the system time to arrange a change of battery and maintain protection for that given point within the system.

### WIRELESS ZONE TYPES

Each RF zone can be programmed to respond as any zone type such as ENTRY/EXIT, INTERIOR, PERIMETER, etc. (see the section under ZONE TYPES for a complete explanation of each zone type). Desired alarm responses can be broken down as follows:

ZONE TYPE	TRANSMITTER ID #
Entry/Exit Burg	1 through 47 *
Perimeter Burg	1 through 47 *
Interior Burg	1 through 47 * 32 through 47 * (5775)
Fire	48 through 63 * 48 through 55 ** (5706)
24 Hour Panic (silent or audible)	48 through 63 * 62 or 63 *** (5701)
Day/Night Burglary	1 through 47 *
24 Hour Auxiliary	1 through 47 *

### NOTES:

- \* Note that zones 1-63 can be used, but have the following limitations: Transmitters set for zones 48-55 will transmit once every 12 seconds while the zone is faulted. Transmitters set for zones 56-63 will transmit once every 3 seconds while faulted. These two ranges of zone numbers could adversely affect transmitter battery life. Transmitters set for an ID of 32 through 47 will have a 3 minute lock-out between transmissions. Use this last range of zone ID numbers for sensors protecting frequently used doors or windows to conserve battery life.
- \*\* Transmitter IDs 48 through 55 have highest signal priority.
- \*\*\* Transmitter IDs 62 and 63 are unsupervised to allow removal of the 5701 off premises -- signal priority is lower than that of fire, but higher than burglary.

### WIRELESS DEVICES

See the PERIPHERAL DEVICES section for compatible wireless smoke detectors and passive infrared motion detectors.

#### 5701 Panic Transmitter

- Programmable for either silent or audible 24 hour alarm (DIP switch programmed for zones 62 or 63).



#### 5711 Slimline Door/Window Transmitter

- Can be used with any closed circuit sensor. NOTE: Can be used on any zone 1-63 but, if programmed for zones 32-47, there will be a 3 minute lock-out between transmissions.



#### 5711WM Door/Window Transmitter w/Reed Switch

- Slimline door/window transmitter with built-in reed switch (magnet included). Can be used with any closed circuit sensor. NOTE: Can be used on any zone 1-63 but, if programmed for zones 32-47, there will be a 3 minute lock-out between transmissions.



#### 5716 Door/Window Transmitter

- Can be used with any open or closed circuit sensor (DIP switch selectable), and features a built-in reed switch. NOTE: Can be used on any zone 1-63 but, if programmed for zones 32-47, there will be a 3 minute lock-out between transmissions.



### ADVISORIES

1. Do not place transmitters on or near metal objects. This will decrease range and/or block transmissions.
2. Place the 4280 in a high, centrally located area for best reception. Do not place receiver on or near metal objects.
3. The 4280 receiver must be at least 10 feet from the Control panel or any remote consoles to avoid interference from their microprocessor.
4. When connecting a door/window contact to a 5711, 5711WM, or 5715 transmitter, avoid a wire length of 20-24 inches. This particular length decreases range. A shorter or longer length has no effect.

For UL Household Burglary Installations, wired loops connected to these devices cannot exceed 3 feet.

5. If dual 4280s or 4280-8s are used:
  - A. Both must be at least 10 feet from each other, as well as from the Control panel and remote consoles.
  - B. One of the 4280s or 4280-8s must be powered from Aux. power so as not to exceed 64 mA polling loop current rating.
  - C. The house IDs must be the same.
  - D. Using two Receivers does not increase the number of transmitters the system can support (63 transmitters, plus a wireless keypad).
6. Refer to the maximum polling loop wire runs described in the POLLING LOOP section when connecting 4280s to the polling loop.

**IMPORTANT:** The maximum combined polling loop run is 4000'. If using shielded wire, the maximum is 2000'.

#### 5715WH Universal Transmitter

- DIP switch selectable for fast response, open or closed circuit sensor usage, and has a tamper protected cover. Use in applications where open circuit heat detectors are needed or where fast response devices are needed.
- NOTE: Can be used on any zone 1-63 but, if programmed for zones 32-47, there will be a 3 minute lock-out between transmissions.

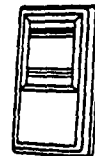

#### 5727 Wireless Keypad

- Wireless keypad that can be used to turn the burglary protection on and off, and features the same built-in panic functions as wired consoles for either silent or audible 24 hour alarm. An LED indication lights each time a key is pressed to verify transmission (LED located in the [\*] READY key).
- The keypad is identified as zone "00" when it transmits low battery messages. The keypad panics are identified as "99" for [\*] + [#], "96" for [#] + [3], and "95" for [\*] + [1] if programmed.

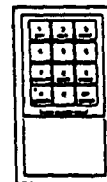

## III. PERIPHERAL DEVICES

### REMOTE CONSOLES

The 4140XMP supplies up to 750 mA of auxiliary power for remote consoles, polling loop devices and/or other auxiliary devices such as motion detectors or 4-wire smoke detectors\*. The 4140XMP supports, independent of auxiliary power considerations, up to six 4127, 4137 or 5137 remote consoles. All consoles may be powered from the auxiliary power output provided that the total current drawn from this output does not exceed 750 mA. You must keep this in mind when adding remote consoles so you don't overdraw current from the panel. This would result in a battery which does not charge properly or possibly a tripped auxiliary solid state circuit breaker.

If the auxiliary load is determined to be greater than 750 mA, then additional consoles (total of 6) can be powered from a supplementary regulated 12VDC power supply (e.g. 487-12 supplies 12V, 250mA; 488-12 supplies 12V, 500mA). Connect the console's red and black leads to the supplementary supply's positive (+) and negative (-) terminals. Also make a connection between this supply's negative (-) terminal and the 4140XMP's Auxiliary power (-) terminal 7 so that both have a common ground reference.

**NOTE:** Consoles connected to supplementary power supplies which do not have a backup battery will not operate when AC power is lost. In this case, make sure to power at least one console from the panel's auxiliary power output. The panel's backup battery will supply power to this console when AC power is lost.

\* 4-wire smoke detectors cannot be used in UL Listed applications.

#### 4127 FIXED-WORD LCD CONSOLE

Compact design, equipped with a liquid crystal display (LCD) using 2-digit numerics for zone identification, and a set of pre-designated English language prompts, such as "READY", "NOT READY", etc. for system status. A built-in alarm sounder is also included, which eliminates the need for a separate indoor sounder. 20mA current draw.

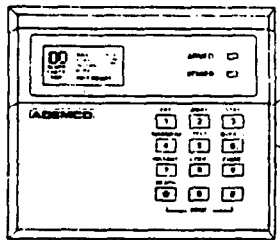

#### 4137 DELUXE FIXED-WORD LCD CONSOLE

Equipped with a liquid crystal display (LCD) using 2-digit numerics for zone identification, and a set of pre-designated English language prompts, such as "READY", "NOT READY", etc. for system status. Keys are backlit. A built-in alarm sounder is also included, which eliminates the need for a separate indoor sounder. 60mA current draw.

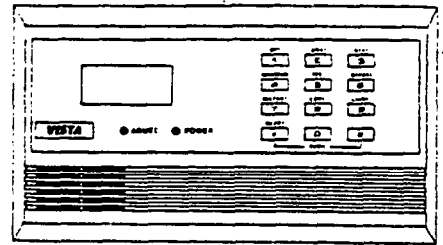

#### 5137 ALPHA CUSTOM LCD CONSOLE

Equipped with a programmable 2-line, 32-character (16 characters per line), ALPHA-NUMERIC LCD for complete zone identification in English language (if descriptors are programmed). Keys are backlit. An alarm sounder is built in, eliminating the need for a separate indoor sounder. 90mA current draw.

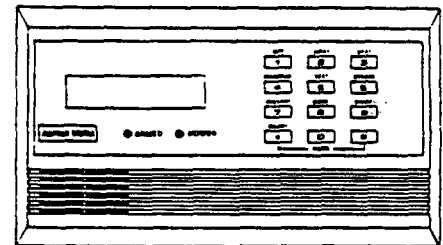

#### WIRING

Consoles may be wired to a single wire run or individual consoles may be connected to separate wire runs. The maximum wire run length from the panel to a console which is homerun back to the panel must not exceed:

CONSOLE WIRE LENGTHS
#22 gauge @ 250 feet max
#20 gauge @ 400 feet max
#18 gauge @ 625 feet max
#16 gauge @ 900 feet max

**NOTE:** The length of all wire runs combined must not exceed 900 feet when unshielded quad conductor cable is used (450 feet if shielded cable is used.)

If more than one console is wired to a run, then the above maximum lengths must be divided by the number of consoles on the run (i.e. the maximum length would be 125 feet if two consoles are wired on a #22 gauge run).

## EXTERNAL SOUNDERS

### RELAY OUTPUT

The 4140XMP provides a wet bell relay output which is used to power external alarm sounders. Connections are made to terminals 4 (positive output) and 5 (negative return). See SUMMARY OF CONNECTIONS Diagram.

### UL INSTALLATIONS

For UL installations, the total current drawn from this output and the auxiliary power output, combined, cannot exceed 750 mA. In addition, the sounding device must be a UL Listed audible signal appliance rated to operate in a 10.2-13.8 VDC voltage range, and must be mounted indoors. Example: Wheelock Signals Inc. siren model 34T-12 (provides 85dB[A] for NFPA 74 & Standard 985).

**IMPORTANT:** Going beyond these limits will overload the power supply or may possibly trip the bell output thermal circuit breaker.

### NON-UL INSTALLATIONS

The total current drawn from this output cannot exceed 2.8 amps. A battery must be installed since this current is supplied by the battery. Up to two 702 sirens can be used, wired in series. Up to two 719 sirens can be used, wired in parallel.

### COMPATIBLE SOUNDERS

#### 702 Outdoor Siren

- Self-contained siren (driver built-in) and weatherproof for outdoor use. Can be wired for either a steady or yelp sound and is rated at 120 dB @ 10 feet. This siren can also be tamper protected, or can be mounted in a metal cabinet (716), which can be tamper protected.

#### 719 Outdoor Siren (Compact)

- Compact, self-contained siren (driver built-in), and weatherproof for outdoor use. Can be wired for a steady or yelp sound, and rated at 90 dB @ 10 feet. A tamper protected 708BE cabinet is available.

#### 740 High Intensity Sounder

- Compact high intensity sounder rated at 123 dB @ 10 feet. This sounder emits an "ear piercing", high frequency sound, and can be mounted indoors (bracket included) or outdoors (in 708BE cabinet).

#### ABB1031 Motor Bell & Box

- AMSECO motor bell & box, rated at 81 dB @ 10 feet.

#### PA400B (beige)/PA400R (red) Indoor Piezo Sounder

- BRK indoor piezo sounder (red or beige), rated at 90 dB @ 10 feet.

# SMOKE DETECTORS

## ZONE 1

When programmed as an EOLR supervised FIRE zone (type 09 in program field \*02), up to sixteen 2-wire smoke detectors can be used. When programmed for fire, the second CODE + OFF sequence momentarily interrupts power to reset the smoke detectors.

### COMPATIBLE SMOKE DETECTORS

DETECTOR TYPE	BRK MODEL
Photoelectric, direct wire	BRK2400
Photoelectric w/heat sensor, direct wire	BRK2400TH
Photoelectric w/B401B base	BRK2451
Photoelectric w/heat sensor and B401B base	BRK2451TH
Ionization, direct wire	BRK1400
Ionization w/B401B base	BRK1451
Photoelectric duct detector w/DH2851DC base	BRK2851DH
Ionization duct detector w/DH1851DC base	BRK1851DH

### ADVISORIES

If the EOLR is not at the end of the loop, the zone is not fully supervised. The system will not respond to an open circuit within the zone. The alarm current provided by this zone is sufficient to support operation of only one detector in the alarmed state. Refer to the maximum polling loop wire runs listed in the POLLING LOOP section when using polling loop smoke detectors.

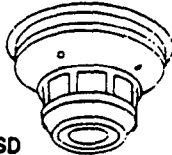

4192SD

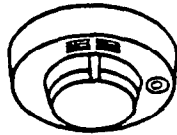

5706

## ZONES 2 THROUGH 8

These zones can support as many 4-wire smoke detectors\* as can be powered, when programmed as a FIRE zone, type 09, in program field \*02. There are only two requirements: (1) The zones must be configured for EOLR supervision, and (2) a normally-closed, momentary switch must be installed in series with the power to the detectors in order to allow reset of the smoke detectors after an alarm. The detectors must be wired in parallel, with the EOLR at the last detector for full supervision. To supervise power, a BRK No. A7771601 EOL Relay Module is recommended.

\* 4-wire smoke detectors cannot be used in UL Listed applications.

### POLLING LOOP SMOKE DETECTORS (4192SD, 4192SDT, 4192CP)

Can be added to the 2-wire Polling Loop on zones 10 through 64 (as programmed in fields \*03, \*04, \*05, 1\*01, 1\*02, 1\*03, 1\*04 and 1\*05). These detectors have a built-in RPM which is DIP switch programmable. They are wired in parallel to the polling loop, and do not need auxiliary power or a separate reset switch. The polling loop provides power and reset signals to the detectors, as well as alarm and trouble signals from the detectors.

### WIRELESS SMOKE DETECTOR (5706)

One piece photoelectric smoke detector with built-in transmitter (DIP switch programmable for zones 48-55). Built-in 85 dB piezoelectric alarm sounder and audible low battery warning.

# PIR MOTION DETECTORS

Select a mounting site with the following notes in mind: Best coverage will be obtained if the mounting site is selected such that the likely direction of intruder motion is across the pattern of protection.

### NOTES ON PIR MOUNTING LOCATIONS

- Avoid locating the unit where central heating radiators, flames or heating outlet ducts are within the protective zones.
- Avoid locating the unit in direct sunlight or directly above strong sources of heat.
- Avoid locating the unit on unstable surfaces.
- Avoid running alarm wiring close to heavy duty electrical cables.

### POLLING LOOP PIR (4275)

The 4275 is a dual element passive infrared detector, with a built-in RPM, that is connected directly to the 2-wire polling loop.

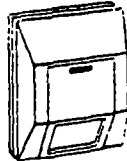

### POLLING LOOP PIR (4196/4278)

The 4196/4278 are quad element passive infrared detectors with a built-in RPM that is connected directly to the 2-wire polling loop. The detectors feature an auxiliary sensor loop that permits connection of another nearby alarm sensor (reed contact, etc.).

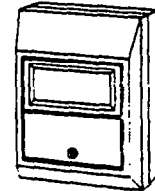

### WIRELESS PIR (5775)

The 5775 is a battery operated, wireless, dual element passive infrared motion detector that can be monitored by a 4280 (4280-8) wireless receiver. The 4280 is connected to the 2-wire polling loop.

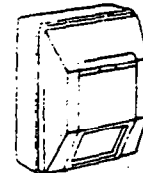

# GLASS BREAK DETECTORS

Zone 8 can support 2-wire, latching type glass break detectors when configured as an EOLR supervised zone. The second CODE + OFF sequence momentarily interrupts power to this zone to reset devices wired to it. Use detectors which are compatible with the ratings below:

Standby Voltage: 5VDC - 13.8VDC

Standby Resistance: Greater than 20k ohms (equivalent resistance of all detectors in parallel)

Alarm Resistance: Less than 1.1k ohms (see note below)

Alarm Current: 2 mA - 10 mA

Reset Time: Less than 6 seconds

UL NOTE: Connection of glass break detectors to zone 8 is not permitted for UL Listed applications.

The IEI 735L series detectors have been tested and found to be compatible with these ratings. Up to 50 IEI 735L detectors, connected in parallel, may be used (the alarm current provided by this zone is sufficient to support operation of only one detector in alarmed state). Follow the manufacturer's recommendations on proper detector installation.

NOTES: Detectors which exceed 1.1k ohms in alarm, but maintain a voltage drop in alarm of less than 3.8 volts can also be used.

Use of N.O. or N.C. contacts on the same zone may prevent proper glass break detector operation.

# PHONE LINE CONNECTIONS

Incoming phone line and handset wiring is connected to the main terminal block as follows (refer to SUMMARY OF CONNECTIONS Diagram):

- TB1-26: Local Handset (TIP)
- TB1-27: Local Handset (RING)
- TB1-28: Incoming Phone Line (TIP)
- TB1-29: Incoming Phone Line (RING)

If it is desired to connect the panel to phone lines that require ground start capability, then a 675 Ground Start Module\* must be used. This module is triggered by one of the outputs on the connector labeled J7 (see CONNECTOR J7 TRIGGER OUTPUTS).

\* The 675 Ground Start Module is not UL Listed.

**WARNING:** To prevent the risk of shock, disconnect phone lines at telco jack before servicing the panel.

## IMPORTANT

If the communicator is connected to a telephone line inside a PABX, be sure the PABX has a back-up power supply that can support the PABX for 24 hours. Many PABXs are *not* power backed up and connection to such a PABX will result in a communication failure if power is lost.

## CONNECTOR J7 TRIGGER OUTPUTS (Ground Start Module, Keyswitch, etc.)

### GENERAL INFORMATION

Connector J7, located on the right hand side of the main PCB provides 4 trigger outputs for operating the 675 Ground Start Module, the 4146 Keyswitch\*, and for triggering auxiliary alarm signalling equipment (LORRA's, STU's, etc.)

The pin assignments of this connector are shown below. Use only the 4142TR 9-wire cable (available as an option) for making connections to this connector.

Each output is rated as follows:

- When Activated: 10 - 13.8 VDC through 5K Ohms
- When De-activated: 1K Ohms to Ground

Output 1 operates, by default, as a trigger for the 675 ground start module. This output may optionally be programmed to operate as an open/close trigger. Only one of these options may be used at any time.

Outputs 2 & 4 operate, by default, as Fire and Silent Panic/Duress triggers respectively. These triggers may optionally be programmed to act as Arm and Ready status indicators when it is desired to use the 4146 keyswitch.

\* The Model 4146 Keyswitch is not UL Listed.

### GROUND START MODULE

Not intended for use in UL Listed applications.

An optional 675 Ground Start module can be used for installations having telephone lines which require ground start instead of loop start operation to obtain dial tone from the telco central office. If used, program field 1\*46 must be set to "0" (factory default) and the 675 Ground Start Module must be connected to the panel's J7 connector trigger output 1, to auxiliary power, and to the "RING" side of the telephone line as shown in the diagram below.

Use the following procedure to determine which side of the telephone line is the "RING" side:

- a. Connect the "+" lead of a DC voltmeter to earth ground, and the "-" lead to one side of the telephone line.
- b. The wire which reads +50VDC is the "RING" side.

When the panel has a message to transmit to the central station, it will seize the line, go off hook, and then trigger the 675 module to connect the "RING" side of the telephone line to earth ground. The panel will cause the module to break the connection between "RING" and earth ground when a dial tone is obtained.

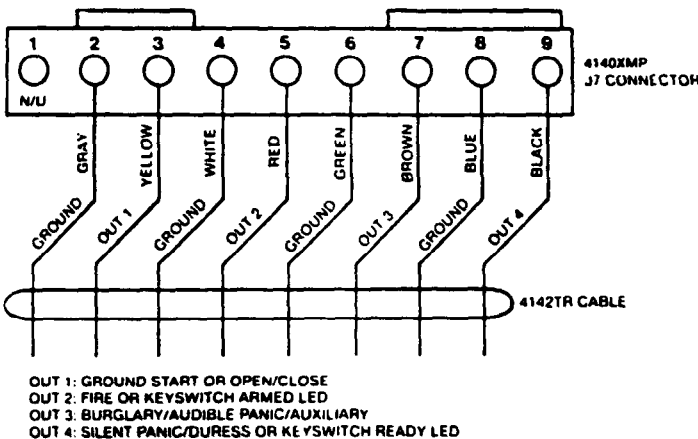

Figure 4. CONNECTOR J7

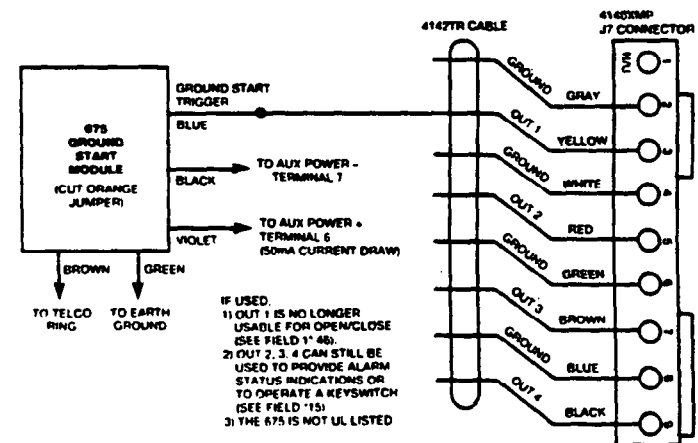

Figure 5. GROUND START MODULE

## REMOTE KEYSWITCH

**NOTE:** 4146 Keyswitch is not UL approved.

If the keyswitch option is selected (field \*15), the alarm trigger outputs are disabled.

An optional Remote Keyswitch can be used for remote arming and disarming of the system. If used, program field \*15 must be set to "1" to enable the keyswitch option, and the 4146 keyswitch's normally open momentary switch and LEDs must be connected to Zone 7 and to the J7 connector trigger outputs respectively. A 2k EOL resistor must be connected across the switch regardless of whether or not zones 2-8 are selected to use EOL resistors. See diagram below.

A momentary short across this zone will arm the system in the "AWAY" mode. If the short is held for more than 3 seconds, the system will arm in the "STAY" mode. (i.e. all zones designated as zone types 4 or 10 will be automatically bypassed). After the system has been armed, the next time zone 7 is shorted, the system will disarm.

An optional closed-circuit tamper switch (model 112) can be wired in series with zone 7, so that, if the switchplate is removed from the wall, the tamper will open, disabling keyswitch operation until the system is next disarmed from the console.

**NOTE:** Only one keyswitch with LEDs can be supported by the system's power supply.

LED Indications are defined as follows:

GREEN	RED	MEANING
OFF	OFF	DISARMED & NOT READY
ON	OFF	DISARMED & READY
OFF	ON STEADY	ARMED AWAY
OFF	SLOW FLASH	ARMED STAY
OFF	RAPID FLASH	ALARM MEMORY

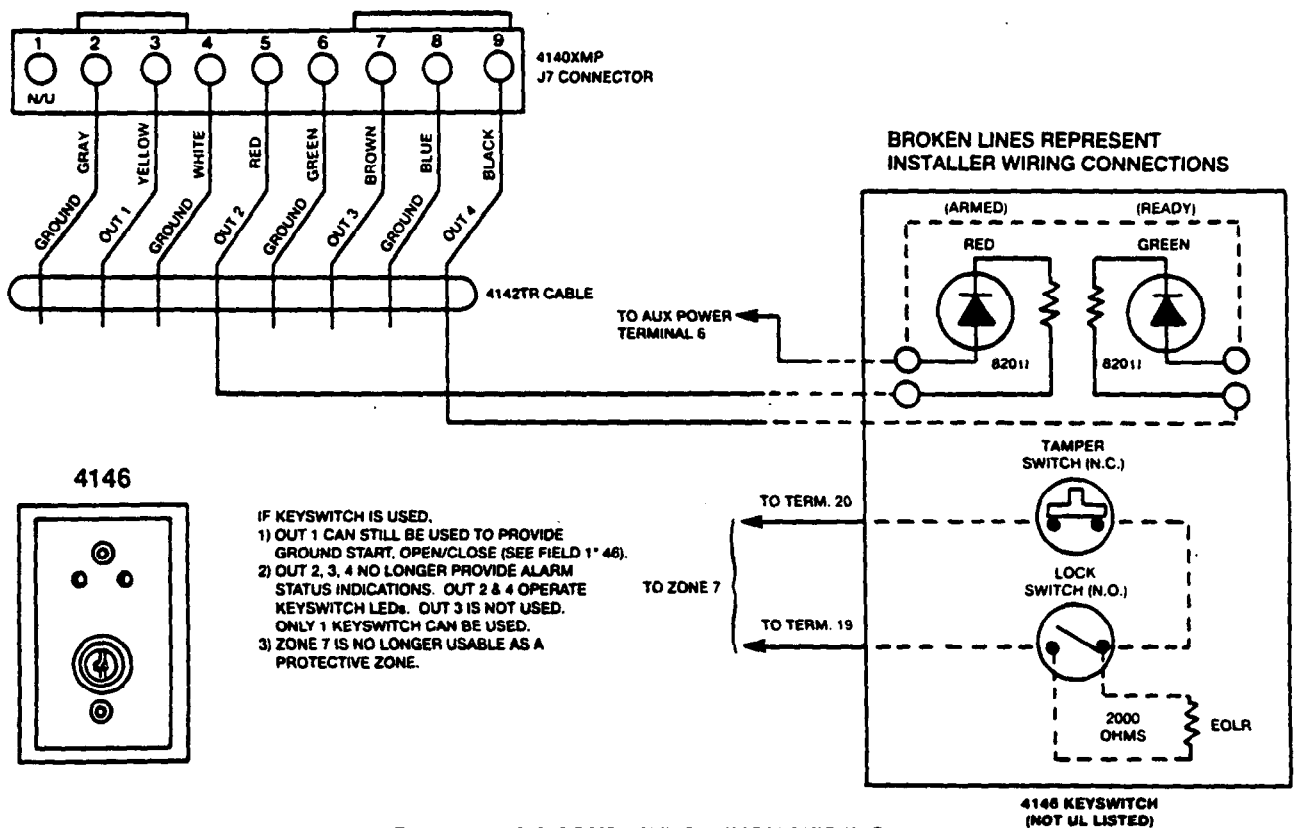

**Figure 6. REMOTE KEYSWITCH WIRING**

## IV. MOUNTING AND POWERING THE SYSTEM

### MOUNTING

#### MOUNTING THE 4140XMP PC BOARD

Before mounting the circuit board be certain that the appropriate metal knockouts have been removed. DO NOT ATTEMPT TO REMOVE THE KNOCKOUTS AFTER THE CIRCUIT BOARD HAS BEEN INSTALLED.

1. Hang the three mounting clips on the raised cabinet tabs. Observe proper clip orientation to avoid damage to the clip when mounting screws are tightened and to avoid problems with insertion and removal of the PC board.
2. Insert the top of the circuit board into the slots at the top of the cabinet. Make certain that the board rests in the slots indicated in step 2 detail.
3. Swing the base of the board into the mounting clips and secure the board to the cabinet with the accompanying screws (as illustrated in step 3 detail).

#### ADVISORY

Make certain that the mounting screws are reasonably tight to insure that there is a good ground connection between the PC board and the cabinet. Also, dress field wiring away from the microprocessor (center) section of the PC board. The cabinet provides 2 loops on its left and right sidewalls for anchoring field wiring using tie wraps. These steps are important to minimizing the risk of panel RF interference with television reception.

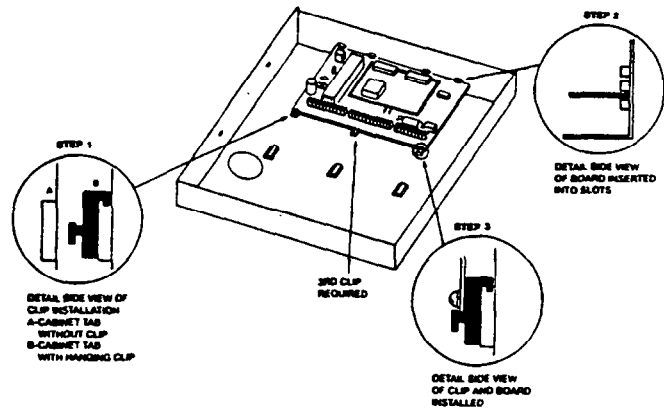

Figure 7. MOUNTING THE PC BOARD

#### MOUNTING THE 4140XMP LOCK

1. Remove the lock knockout on the control cabinet cover. Insert the key into the lock. Position the lock in the hole making certain that the latch will make contact with the latch bracket when the door is closed.
2. While holding the lock steady, insert the retainer clip into the retainer slots. Position clip as illustrated in the diagram on the next page to facilitate easy removal.

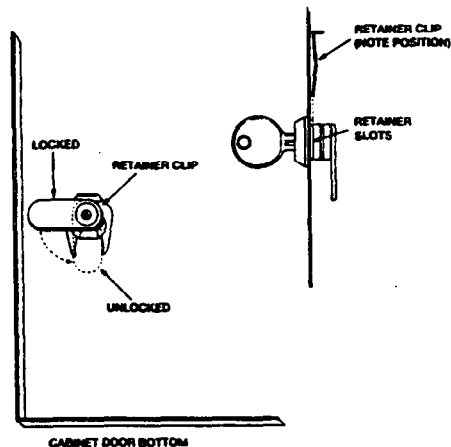

Figure 8. MOUNTING THE CABINET LOCK

#### MOUNTING THE 4127 CONSOLE

1. Separate the console from its backplate by removing the two screws from the top and bottom edges.
2. Use the backplate to mark the positions on the wall for the screw mounting holes and the cut-out for the interface wiring. Use wall anchors for the screws and make the cut-out in the wall no larger than indicated on the template. The backplate is designed to be directly mounted to either a single or double gang electrical box.
3. Pull the interface wiring in the wall through the cut-out.
4. Pass the interface wiring through the opening in the backplate, then mount the backplate to the wall surface with screws.
5. Splice the interface wiring to the console wires. Insulated solderless wire splices (eg. Ademco 311) may be used for splicing.
6. Attach the main body of the console to the wall-mounted backplate. The console is properly attached when it is screwed to the backplate by the top and bottom screws previously removed.

**SURFACE MOUNTING THE 4137/5137 CONSOLES**

1. Use the template provided (on a separate sheet) to mark the positions on the wall for the screw mounting holes and the cut-out for the wiring.
2. Pull the interface wiring in the wall through the cut-out.
3. Remove the console's back cover. The securing screw at the front of the console must be removed to release the back cover.
4. Pass the interface wiring through the opening in the back cover, then mount the back cover to the wall surface with screws.
5. Splice the interface wiring to the console wires (or to the wires on the interface connector supplied with 4137s). Insulated solderless wire splices (eg. 311) may be used for splicing.
6. Attach the main body of the console to the wall-mounted back cover. The console is properly attached when it snaps into place. Use the securing screw (previously removed) to secure the console to the back cover.

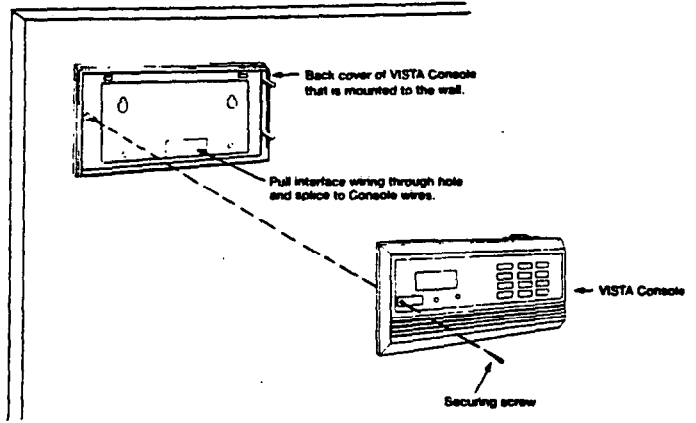

Figure 9. SURFACE MOUNTING CONSOLES

**FLUSH MOUNTING WITH TRIM RING KIT (5137TRK)**

1. Cut out a 4-3/4" high by 8" wide opening in the wall between studs, no less than 1-1/2" from either stud. Use the template provided to mark the cut-out.
2. Insert the four 1-1/2" long #6 screws through the mounting holes in the Trim Ring and then attach the four metal securing clips, as shown in the diagram. Use only two or three turns of each screw, allowing the metal clips to hang freely. The clips must not protrude beyond the sides of the Trim Ring or you will not be able to install the Trim Ring into the cut-out in the next step.
3. Install the trim ring into the opening in the wall with the hinge clasps to the right. Making sure the trim ring is straight, tighten each clip screw, making sure that the attached clip slides down into its guide track.
4. Install the Console as follows: Engage the hinge clasps on the trim ring with the notches located in the back (right-hand side) of the Console's front panel. Swing the left side of the panel toward the trim ring (the panel will pivot on the hinge clasps), and press firmly until the panel "snaps" closed.
5. Use the panel securing screw (supplied with the Console) to secure the left side of the panel.

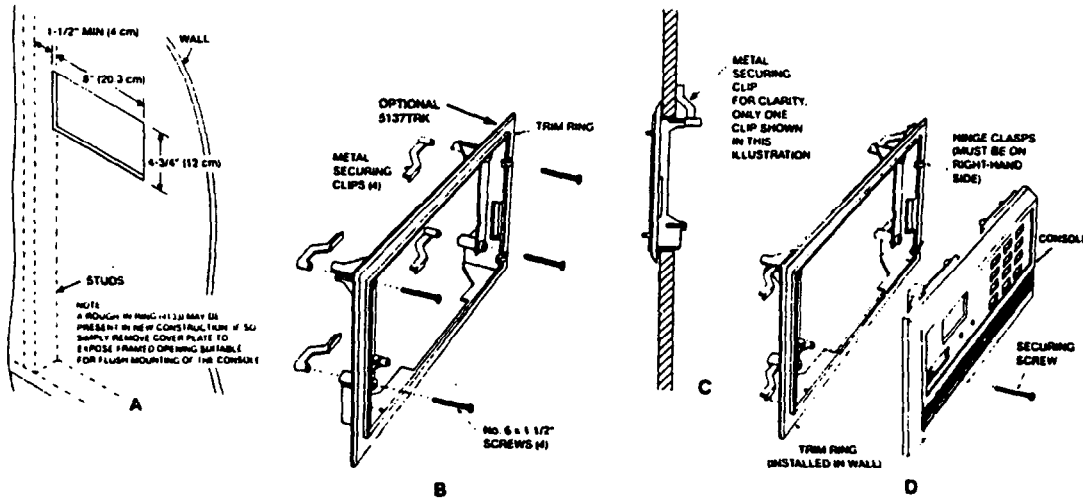

Figure 10. FLUSH MOUNTING THE REMOTE KEYPADS

**ADJUSTING THE ALPHA CONSOLE LCD VIEWING ANGLE (5137 ONLY)**

Insert the end of the small, key-shaped tool (supplied) into the small hole to the left of the console display window (the adjustment screw is recessed in this hole). Turn the adjustment screw to the left or right until optimum viewing is achieved. Be sure to take the height of the users into account when making this adjustment.

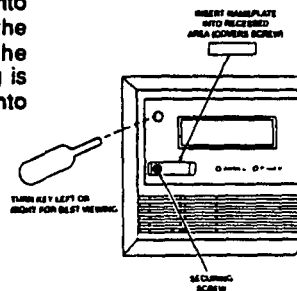

Figure 11. ADJUSTING THE VIEW ANGLE/INSERTING THE NAMEPLATE

# POWERING THE SYSTEM

## PRIMARY POWER

Power to the 4140XMP control panel is supplied by model No. 1361\* Plug-in Transformer which is rated at 16.5VAC, 40VA. Caution must be taken when wiring this transformer to the panel to guard against blowing the fuse inside the transformer.

\* NOTE: Use 1361CN Transformer in Canadian installations. Do not use the 1361CN in UL Listed applications.

## BACK-UP POWER

In the event of an AC power loss, the 4140XMP control panel is supported by a back-up, rechargeable gel cell battery. YUASA NP4-12 (12V, 4AH) and NP7-12 (12V, 7AH) batteries are recommended. Do not use Gates batteries (sealed lead-acid type).

The standby battery is automatically tested every 24 hours, beginning 24 hours after exiting programming mode. In addition, entry into the test mode will cause a battery test to be initiated.

**BATTERY STANDBY TABLE**

4140XMP AUX. STANDBY CURRENT DRAW				
AMP-HRS.	200mA	400mA	600mA	750mA
4.0*	6 hrs.	4 hrs.	3 hrs.	2.5 hrs.
7.0	11 hrs.	7 hrs.	5.5 hrs.	4 hrs.

NOTE: The above figures are approximate, and may vary depending upon the age, quality, and capacity of the battery at the time of the AC loss.

\* Use 4AH battery for UL installations.

**POLLING LOOP CURRENT DRAW WORKSHEET**

RPM DEVICE	CURRENT	# UNITS	TOTAL CURRENT
4194 Contact	1 mA		
4192SD Photo Smoke	0.4 mA		
4192SDT Smoke w/Heat	0.4 mA		
4192CP Ion Smoke	0.4 mA		
4275 Dual PIR	1 mA		
4278 Quad PIR	1 mA		
4190 2-Zone RPM	1 mA (LOW) 2 mA (HIGH)		
4208 8-Zone RPM	16 mA		
4280 63 Zone RF	40 mA		
4280-8 8 Zone RF	40 mA		
		TOTAL **	

\*\* If the total current draw exceeds 64 mA, a 4197 Loop Extender module must be used.

\*\* If using two 4280s or 4280-8s, you can power one of them from auxiliary power instead of using a 4197 loop extender module.

## EARTH GROUND CONNECTIONS

In order for the lightning transient protective devices in this product to be effective, the designated earth ground terminal, must be terminated in a good earth ground. The following are examples of good earth grounds available at most installations:

**Metal Cold Water Pipe:** Use a non-corrosive metal strap firmly secured to the pipe to which the ground lead is electrically connected and secured.

**AC Power Outlet Ground:** Available from 3-prong, 120VAC, power outlets only. To test the integrity of the ground terminal, use a three-wire circuit tester with neon lamp indicators, such as the UL-Listed Ideal Model 61-035, or equivalent, available at most electrical supply stores.

## POWER-UP PROCEDURE

1. Fill out the Polling Loop Current Draw and Auxiliary Device Current Draw Worksheets shown below. Make sure that the currents drawn from these outputs do not exceed their respective ratings.

**CAUTION:** Failure to observe the polling loop current rating will cause polling loop malfunction. Failure to observe the auxiliary output current rating will result in a battery which does not charge properly or possibly a tripped circuit breaker.

2. Wire the 1361 transformer (1361CN in Canada) to the panel (before connecting the battery) as shown in the SUMMARY OF CONNECTIONS diagram. Do not plug in at this time.

2. Connect all polling loop and auxiliary devices, such as consoles, PIRs, etc.

3. Plug the 1361 into an 24 hour, uninterrupted AC outlet. In a few seconds, the green POWER LED on the console(s) should light and the console(s) should display "READY" (4127, 4137) or "DISARMED READY TO ARM" (5137).

4. Connect the battery as shown in the SUMMARY OF CONNECTIONS diagram.

**AUXILIARY DEVICE CURRENT DRAW WORKSHEET**

DEVICE	CURRENT	# UNITS	TOTAL CURRENT
4127 Console	20 mA		
4137 Console	60 mA		
5137 Console	80 mA		
675 Ground Start Module	50 mA		
4280 or 4280-8 Receiver	40 mA†		
Built-in Polling Loop	(total poll loop worksht)		
4197 Poll Loop Extender	80 mA†		
		TOTAL	(750mA max)

\* If using hard-wire devices such as PIRs, refer to the specifications for that particular unit's current draw.

† Only applies if powered from Control's auxiliary power.



## V. SYSTEM OPERATION

### SECURITY ACCESS CODES

The VISTA 4140XMP System allows up to 70 security access codes to be assigned, each identified by a user ID number. The system also offers either standard (4-digit) or high security (6-digit = user # + 4-digits) security codes (field 1\*54). If High Security mode is selected, the 2-digit user # followed by the 4-digit code must be entered for all operations (Installer=01, Master code =02, etc.). For example, if user 14, whose code is 5678, wishes to disarm the system, the sequence would be 1+4+5+6+7+8 + OFF.

The installer programs an Installer's Code initially as part of the programming procedure, and this code is the only code that permits re-entry into the programming mode (unless \*98 has been previously used to exit the programming mode, see below). The Installer's Code can also be used to perform normal system functions, but cannot assign temporary codes. Note that the installer's code cannot disarm the system unless it was used to arm the system, and that it cannot be used to disarm the system if the system was armed with the QUICK ARM key [#].

As shipped from the factory, an initial Installer's code and master code is pre-programmed, and can be changed by the installer to any code desired. The pre-programmed codes are as follows: Installer: 4-1-4-0; Master: 1-2-3-4.

#### MASTER CODE (User #2)

The installer is considered user 1. The person to whom the Master code is assigned is considered user 2. The Master Code is the code intended for use by the primary user of the system when performing system functions, and is a permanent code. The factory default master code is 1-2-3-4. For additional security, the Master Code can be used to assign up to 68 temporary codes, which can be used by secondary users of the system who do not have a need to know the Master Code (supervisors, employees, cleaning personnel, tenants, etc.). Each user (ID number 03-70) can be assigned a temporary code which can be individually eliminated or changed at any time.

Note that the Master Code (assigned to user 2) and all temporary codes can be used interchangeably when performing system functions (a system armed with a user's temporary code can be disarmed with the Master Code or another user's temporary code), with the exception of the Babysitter Code described later in this section. Temporary user 3 has the ability to assign and eliminate temporary codes 04-69. User 3 cannot assign a code to user 70.

#### TEMPORARY CODES

User 2 (master code) can assign and delete all temporary codes, 03-70. User 3 can assign and delete temporary user codes 04-69. User 3 cannot assign or delete user 70's code.

##### To add or delete temporary codes:

User 2: Master Code + CODE key + User # (03-70) + 4-digit Code

User 3: User 3's CODE + CODE key + User # (04-69) + 4-digit Code

##### To delete temporary codes:

Master Code + CODE key + User # + Master Code

User numbers must be entered as 2-digit entries. Single digit user numbers must, therefore, always be preceded by a "0" (example, 03, 04, 05, etc.). Make sure the end user understands this requirement. The system will emit a single beep when each temporary code has been successfully entered. If the 6-digit code feature is in effect (field 1\*54), temporary users must also use 6-digit codes (2-digit User # + 4-digit code).

It is recommended that obvious codes, such as 1111 or 1234, not be used.

The system also provides an Installer Code lock-out feature, which prevents the use of the Installer's Code from re-accessing the Programming mode after the initial programming. This feature is activated by pressing \*98 to exit Programming mode. The only way to access Programming mode once this feature is activated, is by powering down the system and powering up again, and then pressing both the \* and # keys at the same time within 30 seconds of power up. If re-access to Programming mode using the Installer's Code is desired after initial programming, then exit Programming mode by pressing \*99. For additional security, the installer code can be used to disarm the system only if it was used to arm the system.

The Installer also programs the master security code, which is the code intended for use by the primary user of the system. The master code can then be used to assign up to 68 temporary codes (03-70), which can be used by secondary users of the system who do not have a need to know the master code. In addition, the Quick Arm feature can also be programmed, which enables the [#] key to be pressed in lieu of entering the security code when arming the system.

#### DURESS CODE

The duress code is a means of sending a silent alarm to a central monitoring station if the user is being forced to disarm (or arm) the system under threat. This feature is only useful if the system is connected to a central station. When the system's Auxiliary Voltage Triggers are connected to another communication's media (Derived Channel/Long Range Radio), note that duress is signalled on the same trigger that signals silent panic (whereas duress has its own unique report when digitally communicated).

The duress code is simply the usual security code, but with the fourth digit increased by 1. For example, if the security code is "1 2 3 4", the duress code is "1 2 3 5". When used, the system will disarm (or arm), but will also send a silent alarm to the central station. There will be no indication at the console that an alarm was sent. Note that duress codes are not available for security codes ending in the digit "9".

**IMPORTANT!:** Users of temporary codes should be instructed to enter their codes carefully, to avoid the possibility of accidentally entering the duress code.

Note: When a temporary code is inadvertently repeated for different users, or one user's code is another's duress code, the lower user number will take priority. Do not assign sequential codes 1 digit apart from each other (ex. 4096, 4097, 4098) as this will cause a Duress to be sent each time (one user's code is another user's duress code).

**IMPORTANT!:** Unless Ademco Contact ID reporting is used, only user codes #1 - #15 can uniquely report to the central station using the communication formats provided. Users #16 - #70 will report as User #15, if enabled for open/close reporting, for the other reporting formats.

#### BABYSITTER CODE (User #22)

If program field 1\*50 is enabled, the code assigned to User 22 cannot be used to disarm the system unless the system was armed with that code. This code is usually assigned to persons who may have the need to arm and disarm the system at specific times only (ex. a babysitter needs to control the system only when babysitting). It is recommended that temporary users, such as babysitters, not be shown the bypass procedure.

## KEYPAD FUNCTIONS

The keypad allows the user to arm and disarm the system, and perform other system functions, such as bypassing zones, view messages from the central station and display zone descriptors. Zone and system conditions (alarm, trouble, bypass) are displayed in the Display Window.

The system provides four modes of burglary protection: STAY, AWAY, INSTANT, and MAXIMUM. In addition, if any zones are faulted prior to arming (NOT READY condition), the console can display them one at a time, and specific zones can be selectively bypassed.

When an alarm occurs, console sounding and external sounding will occur, and the zone(s) in alarm will be displayed on the console. Pressing any key will silence the console sounder for 10 seconds. Disarming the system will silence both console and external sounders. When the system is disarmed, any zones that were in an alarm condition during the armed period will be displayed (memory of alarm). To clear this display, simply repeat the disarm sequence (enter the security code and press the OFF key).

The consoles also feature chime annunciation, and 3 panic key pairs (for silent, audible, fire or auxiliary alarms) which can notify the central station of an alarm condition, if that service is connected.

Note that if QUICK ARM is enabled (field \*29), the [#] key can be pressed instead of entering the security code, for any of the arming procedures (Away, Stay, Instant, Maximum, etc.).

For additional information, refer to the User's Manual.

### VIEWING DOWNLOADED MESSAGES

5137 consoles only.

Users may occasionally receive messages on the console display from their installation company. When this occurs, the console will display "Message. Press 0 for 5 secs.". Instruct the user to press and hold the 0 key to display the central station's message. Note that the system must be in the READY state to view these messages.

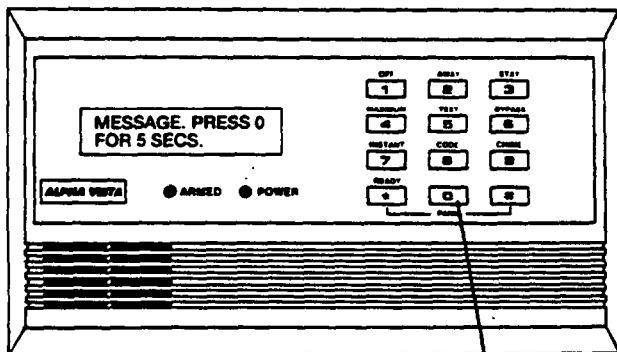

PRESS & HOLD  
DOWN FOR  
5 SECONDS

### USING THE BUILT-IN USER'S GUIDE (5137 only)

An abbreviated User's Manual is stored in the system's memory, and can be particularly useful to the end user if the printed User's Manual is not conveniently accessible when the user needs to perform a seldom used and unfamiliar system procedure. The Built-in User's Guide is displayed by simply pressing any of the function keys (e.g., OFF, AWAY, STAY, MAXIMUM, BYPASS, INSTANT, CODE, TEST, READY, #, and CHIME) for approximately 5 seconds and then releasing it. Abbreviated instructions relative to the key that has been pressed will then be displayed (2 lines of text are displayed at a time). This function is available when the system is in the armed or the disarmed state.

### DISPLAYING DESCRIPTORS (5137 only)

The Alpha Consoles can display all programmed descriptors, which is useful to the installer when checking entries, and can be helpful to the user when there is a need to identify zones. To display descriptors, press and hold the READY key until the built-in instructions for that key appear, then release the key. The zone descriptors will appear one at a time, for about 2-3 seconds each. For faster viewing, press the READY key to display the next descriptor in numerical order and so on. When all descriptors have been displayed, the Control will exit display mode. To exit display mode before all descriptors have been displayed, enter the security code and press the OFF key.

### PANIC KEYS

There are three pairs of keys ([\* + 1], [# + 3], [\* + #]) that, if programmed, can be used to manually initiate alarms and send a report to the central station. Each pair of keys can be individually programmed for 24 Hour Silent, Audible or Auxiliary responses. The panic function is activated when the appropriate pair of keys are pressed at the same time.

The panic functions are identified by the system as follows:

PANIC PAIR	Displayed as Zone
* + 1	95
# + 3	96
* + #	99

For 5137 consoles, these panic keys can also be programmed with an alpha descriptor.

**IMPORTANT:** For the Panic functions to be of practical value, the system must be connected to a central station.

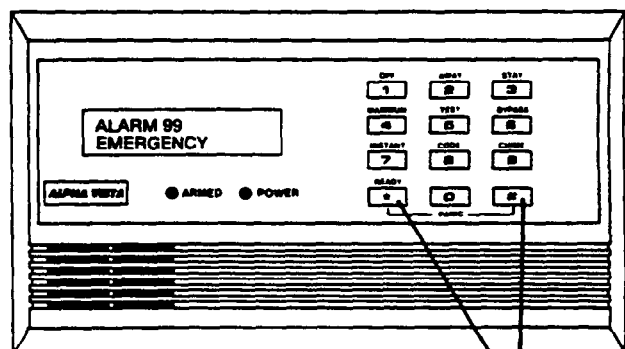

PRESS AT  
SAME TIME

## TROUBLE CONDITIONS

The word "CHECK" on the Console's display, accompanied by a rapid "beeping" at the Console, indicates that there is a trouble condition in the system. The audible warning sound can be silenced by pressing any key. Instruct users to call for service immediately upon seeing any of the following messages.

### "CHECK" MESSAGES

A display of "CHECK" accompanied by a display of one or more zone descriptor(s) (5137) or numeric zone ID(s) (4137, 4127) indicates that a problem exists with those zone(s). First, determine if the zone(s) displayed are intact and make them so if they are not. If the problem has been corrected, key an OFF sequence (Code plus OFF) to clear the display.

A display of the word "CHECK" accompanied by a numeric display of "97" indicates that a short exists on the Polling Loop and may eliminate some of the protection. Fault "97" can be assigned an alpha descriptor when using the 5137 console.

A display of the word "CHECK" accompanied by a numeric display of "88", "89", "90", or "91" indicates a 4280 Receiver problem. Faults "88", "89", "90" & "91" can be assigned alpha descriptors when using the 5137 console.

### POWER FAILURE

If the POWER indicator is off, and the message "AC LOSS" (5137) or "NO AC" (4137, 4127) is displayed, the Console is operating on battery power only. Check to see that your system's plug-in transformer has not been accidentally pulled out. Instruct the user to call a service representative immediately if AC power cannot be restored.

## OTHER TROUBLE CONDITIONS

A display of "COMM. FAILURE" (5137) or "FC" (4137, 4127) at the Console indicates that a failure occurred in the telephone communication portion of your system.

A display of "LO BAT" (5137) or "BAT" (4137, 4127) and a zone descriptor, accompanied by a once per minute beep at the Console indicates that a low battery condition exists in the wireless transmitter displayed. The audible warning sound may be silenced by pressing any key. A display of "SYSTEM LO BAT" (5137) or "BAT" with no zone ID (4137, 4127) indicates that a low battery condition exists with the system's backup battery.

A display of "4280 SET UP ERROR" (5137) or "E8" (4137, 4127) at the console indicates that a 4280-8 receiver is being used in a system with more than 8 RF zones programmed. If this is not corrected, none of the zones in the system will be protected. If more than 8 RF zones are desired, a 4280 Receiver must be used.

A display of "MODEM COM" (5137) or "CC" (4137, 4127) indicates that the control is on-line with the remote computer and the control is not operating.

A display of two numbers and "NO AC" (all keypads) indicates the control is in the programming mode and is not operating.

---

## RECALLING ALARM & TROUBLE MESSAGES (Memory of Alarm)

The system's alarm memory retains all events for a period of 10 days, starting at the time of the first event. Upon expiration of the 10-day period, all history is automatically erased and the alarm memory will reset. The next 10-day cycle will begin when the next event occurs.

Recall by service personnel will display all events that have occurred from the start of the 10-day cycle to the time of recall. Note that Recall will end any 10-day cycle in progress. The LCD display on the 4127/4137 console will indicate the number of the zone in which the event occurred (e.g., 01, 02, etc.), accompanied by the word CHECK (trouble), ALARM and, if applicable, FIRE, to describe the type of event that occurred in the displayed zone.

If a 5137 is used, an alpha descriptor of the zone will be displayed in addition to its zone number. If more than one event had occurred, the events will be displayed in numerical sequence. Each display will appear for 1-2 seconds, then the next event will be displayed. When all events have been displayed, the displays are repeated.

To display 10-day history, enter the security code and press the 0 key. Note that recall will end any 10-day cycle in progress.

To exit recall mode, enter the security code and press the OFF key. All existing history is erased and the alarm memory is reset. The 10-day cycle will start again only when the next event occurs.

---

## SETTING THE REAL-TIME CLOCK

The real-time clock must be set before test reports can be sent. Be sure to set the FIRST TEST REPORT TIME in program field \*83, and the test report interval in field \*27. To set the clock, a 5137 console must be connected to the panel.

To enter real-time clock mode, press CODE + #63. The display will show: TIME/DATE - ? ON

12:01 AM 01/01/90

The "?" indicates the current mode. The [6] key changes the mode from DAY to HOUR to MINUTE to MONTH to DATE to YEAR. The [4] key changes the mode in reverse order.

The [3] & [1] keys are used to set the TIME/DATE values. The [3] key moves the TIME/DATE ahead, the [1] key moves the TIME/DATE backward.

To set the day, use the [3] or [1] key to change from ? ON to MON to TUE, etc.

To set the time, press [6] until the "?" appears in the hours position, then use the [3] or [1] key to set the hour. Press [6] again and use the [3] or [1] key to set the minute. Use the [7] key to set AM or PM.

To set the date, press the [6] key until the "?" appears in the month position, then use the [3] or [1] key to set the month. Press the [6] key again and use the [3] or [1] key to set the date. Press the [6] key again and use the [3] or [1] key to set the year.

To exit clock mode, press either the [8] key or the [-] key. Exiting with the [8] key will save all changes. Exiting with the [-] key will exit without changing any of the values (used when viewing the time settings, but no changes are desired).

## VI. SYSTEM COMMUNICATION

### SPLIT/DUAL REPORTING

Dual reporting (\*51) sends all reports to both primary and secondary phone numbers. Split reporting allows reports to be divided between the phone numbers according to the field's (1\*34) selections. Split/Dual reporting can be selected by enabling dual reporting and enabling one of the split reporting options in field 1\*34. If option [1] is selected, all alarms, alarm restores and cancel reports will go to both phone numbers, while all other reports will go to the secondary phone number. If [2] is selected, open/close and test messages will go to both phone numbers, while all other reports will go to the primary phone number.

### ADEMCO LOW SPEED

ADEMCO LOW SPEED is a pulsed format which responds to a 1400 Hz handshake and kiss-off, and transmits data with 1900Hz pulse tones @ 10 pulses per second (pps). A typical message consists of two rounds which must be verified by the receiver. A complete standard report consists of either a 3 or 4-digit account number followed by a 1-digit alarm code. Even though 2 rounds are sent, only the valid report is displayed on the receiver.

In expanded reporting, two messages are sent, two rounds per message, the first being the account number and alarm code, the second being the zone ID code to which the alarm was assigned. A complete expanded report consists of a 3 or 4-digit account number followed by a 1-digit alarm code, then the alarm code is repeated, followed by the channel number.

EX.Standard: CCCC E      where: CCCC = account number  
Expanded:    CCCC EE      EE = event code  
              EEEE ZZ      ZZ = zone ID code

### SESCO/RADIONICS

Standard and expanded reporting in the SESCO/RADIONICS format is virtually the same as ADEMCO Low Speed except for the following:

1. The handshake and kiss-off frequency is 2300 Hz.
2. The data is transmitted with 1800 Hz pulse tones.
3. The rate of transmission is 20 pps.

### 4+2 REPORTING

A 4+2 report consists of a 4-digit account number and a 2-digit alarm code, or event code. 4+2 reports can be accomplished either in ADEMCO Low Speed (10 pps), or SESCO/RADIONICS (20 pps) format.

In 4+2 reporting a unique 2-digit code for each zone is reported. A 4-digit account number followed by a 2-digit code is sent, where the first digit is the actual event, such as ALARM, RESTORE, or TROUBLE, etc., and the second digit of the code represents the "zone" where the event occurred. (but not necessarily the actual zone number). Each code in itself is unique to a specific zone. A typical report follows:

1 2 3 4 5 9 ("5 9" might be a unique "TROUBLE RESTORE, ZONE 25).

### 4+2 EXPRESS

ADEMCO's new Express format provides the same information as the 4+2 format, but with three differences:

1. Data is transmitted in DTMF (Dual Tone Multi-Frequency, known as "TouchTone", at the rate of 10 characters per second). This greatly decreases the time it takes a report to reach the central station. An average 4+2 Low Speed report might take as long as 20 seconds to complete its report, but 4+2 Express takes under 3 seconds.
2. Two message rounds are eliminated by the use of a checksum digit. Instead of the communicator sending 2 rounds per report, it sends only 1 round with a checksum digit at the end. Doing this also helps in decreasing the time it takes for a report to be sent. (CHECKSUM is explained further at the end of this section).
3. The handshake frequency is 1400 Hz followed by 2300 Hz, and the kissoff frequency is 1400 Hz.

- 20 -

### ADEMCO HIGH SPEED REPORTING

ADEMCO's High Speed format transmits data in DTMF at a rate of 10 characters per second. The handshake frequency is 1400 Hz followed by 2300 Hz, and the kissoff frequency is 1400 Hz. The message contains 13 digits as follows: A 4-digit account number + eight channels of zone information (1-8 or duress plus 9-15) + one status channel, which identifies the type of events being reported in the eight zone locations. A typical High Speed report will be kissed off in under 5 seconds.

Channels 1 through 8 might have one of the following conditions:

- 1 = NEW EVENT
- 2 = OPENING (Status Channel Always = 2)\*
- 3 = RESTORE
- 4 = CLOSING (Status Channel Always = 4)\*
- 5 = NORMAL, NO EVENT TO REPORT
- 6 = PREVIOUSLY REPORTED, NOT YET RESTORED)

\* NOTE: Channel 1 will contain the user ID 1-9, A-F if Open/Close reporting is enabled.

The status channel might have the following conditions:

- 1 = DURESS (For Duress Plus Channels 9-15 Only)
- 2 = OPENING
- 3 = BYPASS (For Channels 1-8 Only)
- 4 = CLOSING
- 5 = TROUBLE (For Channels 1-8 Only)
- 6 = SYSTEM STATUS:
  - AC LOSS in Channel 1
  - LOW BATTERY in Channel 2
  - PROGRAM TAMPER in Channel 3
  - POWER ON RESET in Channel 4
- 7 = NORMAL ALARM STATUS (For Channels 1-8 Only)
- 9 = TEST REPORT

A typical high speed report may look as follows:

1234 5115 5555 7 (Acct #1234 with alarms on channels 2 & 3)

### ADEMCO HIGH SPEED LIMITATIONS

1. When using Ademco high speed, remember there are only 15 channels available, plus a duress channel. If more than 15 zones are being used, they must share channels.
2. With high speed reporting, channels 9-15 cannot report troubles or bypasses. Use these channels for zones that will not have to report these conditions.

### CONTACT ID REPORTING

This is the only format that can identify all 64 protection zones by their unique zone (Contact) ID numbers, and provides a 1-digit event qualifier and 3-digit, specifically defined event code which quickly identifies the reported condition.

Contact ID reports in DTMF (Dual Tone Multi-Frequency @ 10 characters per second) and responds to a 1400 Hz followed by 2300 Hz handshake, and a 1400 Hz kissoff. This format also uses checksum instead of two message verification. A complete report takes under 3 seconds.

Contact ID Reporting takes the following format:

CCCC Q EEE GG ZZZ

where:

- CCCC= Customer (subscriber) number.
- Q = Event qualifier, where: E=new event (1) and R= restore (3)
- EEE= Event code (3 hexadecimal digits), defined in the table on the next page.
- GG= Always 00.
- ZZZ= Zone/contact ID number reporting the alarm (001-099), or user number (001-070) for open/close reports. System status messages (AC Loss, Walk Test, etc.) contain zeroes in the ZZZ location.

## TABLE OF CONTACT ID EVENT CODES

Code	Definition	Code	Definition
110	Fire Alarm	333	RF Receiver Failure-Trouble
121	Duress	373	Fire Loop Trouble
122	Silent Panic	380	Trouble (global)
123	Audible Panic	381	Loss of Supervision - RF
131	Perimeter Burglary	382	Loss of RPM Supervision
132	Interior Burglary	383	RPM Sensor Tamper
133	24 Hour Burglary	384	RF Transmitter Low Battery
134	Entry/Exit Burglary	401	O/C By User
135	Day/Night Burglary	403	Power-Up Armed
142	Polling Loop Short Alarm	406	Cancel by User
143	RF Receiver Failure-Alarm	407	Remote Arm/Disarm (Download)
150	24 Hour Auxiliary	408	Quick Arm
301	AC Loss	409	Keypad O/C
302	Low System Battery	411	Call back Requested
305	System Reset	570	Bypass
306	Program Tamper	601	Manually Triggered Test
309	Battery Test Fail	602	Periodic Test
332	Poll Loop Short-Trouble		

### ADVISORY

Ademco's new Contact ID reporting is capable of uniquely reporting all 64 zones of information, as well as openings and closings for all 70 users, to central stations equipped with the Ademco 685 receiver using software level 4.4 or higher. 685 software levels below 4.4 cannot support Contact ID reporting. For information regarding updating the 685 receiver, contact Ademco's Technical Support group at 1-800-645-7492.

## 4140XMP COMMUNICATION PROGRAMMING GUIDE

Field #	Low Speed	Contact ID	High Speed	Express
*46, *48	Choose transmission speed and frequency	No effect	No effect	No effect
*52, *53	Send as either 4+2 or expanded	No effect	No effect	No effect
*79, *80	Enables alarm restores	Enables alarm restores	Enables alarm restores	Enables alarm restores
*49	Add checksum digit	No effect	Add checksum digit	No effect
*81, *82	Define codes and selects 4+1 or 4+2	1st digit enables report if it is non-zero	1st digit enables report if it is non-zero	Define codes and selects 4+1 or 4+2
*54, *56, *59, *61, *64, *66, *69, *71, *74, *76	Defines alarm event code	Enables reports	Assigns reporting chnl for all reports from this zone. Enables alarm reporting	Defines alarm event code
*55, *57, *60, *62, *65, *67, *70, *72, *75, *77	Defines code and selects 4+1 or 4+2	No effect	No effect	Defines code and selects 4+1 or 4+2
*58, *63, *68, *73, *78	Enables report and selects code. Note: No restores if event not sent.	Enables report	Enables report Note: Alarm channel must be programmed. (01-15)	Enables report and selects 1st digit of the 2-digit event code. NOTE: No restores if event not sent.
*50	Sescoa/Radionics; Selects fixed digit time instead of fixed interdigit.	No effect	No effect	No effect
NOTES	Note: Low Speed will not send 3+2 messages. Zone ID digit is suppressed.	Note: If Contact ID is desired, it must be used on both primary & secondary phone #s.	If High Speed is used for secondary, it must be used for primary. If used on primary, any other format can be used on secondary.	

# VII. PROGRAMMING THE SYSTEM

## GENERAL PROGRAMMING PROCEDURES

The system is shipped with a set of pre-programmed values that are designed to meet the needs of many installations. These can be changed by the installer to suit specific needs if desired. In addition, four sets of pre-programmed communication default values can also be loaded by the installer, each set designed for a specific communication format. These too can be changed to suit the needs of a particular installation.

Changes to these pre-programmed values can be programmed directly from the console or from a computer terminal using the 4130PC Downloading software (be sure that the software version used includes a 4140XMP menu selection), an IBM compatible computer and a HAYES 1200 SMARTMODEM. The following paragraphs describes how to load the various default programming sets. For detailed instructions on making changes to particular programming fields, refer to the programming sheet at the end of this manual.

For alpha consoles, English Language descriptions of the zones and a custom installer message (which appears when the system is ready to arm) can be programmed using the built-in vocabulary of words (see PROGRAMMING ZONE DESCRIPTIONS paragraphs later in this section).

### DEFAULT PROGRAMMING

There are five sets of pre-programmed defaults available (one standard, plus four different communication defaults). Any one of these can be loaded into the system's memory. Refer to the COMMUNICATION DEFAULT PROGRAMMING section for instructions.

### DATA PROGRAMMING

The programming fields are grouped into two sets of addresses. The first set is accessed as soon as programming mode is entered. To access the second set of addresses (indicated on the programming form by a "1" in front of the 2-digit field address), press \*94 while in programming mode, then press [#] plus the first field number desired. Note that the alpha consoles display the words ALT PROGRAM MODE, and the 4137/4127 consoles display the word CHECK to indicate the second set of addresses. To return to the first set of addresses, press \*99, then press [#] plus the field number desired.

To program specific data fields, press [#] plus the 2-digit field address, then make the required entry. The console will beep when a field has been completely programmed and will automatically display the next field in numerical order. If the number of digits that you enter in the data field is less than the maximum permitted (for example, phone number), the console displays the last entry and waits. To proceed, the next data field address to be programmed must be entered manually (for example, press \*05).

To view the contents of a data field, press [#] plus the 2-digit field address. The field's entries will be displayed, but no changes to these entries can be made.

In case of errors: If an address is improperly entered, the console will display FC. If a program entry is improperly entered (for example, a larger number than that which is permitted), the console display will go blank. In either case, simply re-enter the correct number.

To exit programming mode, press either \*98 or \*99. Use \*98 to prevent re-access to programming mode by installer code method. \*99 allows installer code access to programming mode.

## PROGRAMMING STEPS

### 1. Enter Programming mode

Programming mode can be entered in one of two ways.

- 1) Press both the [\*] and [#] keys at the same time within 30 seconds after power is applied to the Control. OR
- 2) Key the installer code, followed by depression of CODE [8] + 0 + 0 keys. The factory installer code can be changed once in the program mode.

Immediately following entry into the program mode, the following will be displayed on a 5137: Program Mode (The 4127/4137 consoles display: 00) \* Fill # View - 00

Following the above display, the system is ready to be programmed for the communication format parameters, or accept data entries. To begin data entries, press [#] plus the first field number desired.

### 2. Set Standard Defaults

Once the Programming mode is entered, clear the system's memory by pressing \*97. This ensures all program fields are set to their factory set, pre-programmed values. If desired, load one of the communication default programming sets by entering one of the following code sequences:

TABLE OF DEFAULT PROGRAMMING COMMANDS

PRESS	TO LOAD THIS DEFAULT SET
*97	Loads standard default values for the panel
*94*80	Low Speed communication defaults
*94*81	Ademco Express communication defaults
*94*82	Ademco High Speed communication defaults
*94*83	Contact ID communication defaults

Refer to the PROGRAMMING COMMUNICATION DEFAULTS section for further instructions if one of the four communication default programming sets is used.

### 3. Program the data fields

Program the appropriate phone numbers and account numbers, as well as any other programming fields required to customize the system to the needs of the installation. Refer to the PROGRAMMING FORM at the end of this manual.

### 4. Enter Zone Descriptions (5137 only)

Refer to the PROGRAMMING ZONE DESCRIPTIONS section to enter zone descriptors and a custom installer's message.

### 5. Exit Programming Mode

When all fields have been entered and checked, and zone descriptors have been assigned, exit programming mode by pressing either \*98 or \*99. A second entry of \*99 is required if the exit is being done from fields 1\*00 and above. To prevent re-access to Programming mode using the Installer's code, use \*98. The only way to re-access Programming mode is by depressing both the [\*] and [#] keys at the same time within 30 seconds of power up. Exiting by using \*99 always allows reentry into Programming mode using the Installer's code. Either way of exiting will allow access via downloading.

## COMMUNICATION DEFAULT PROGRAMMING

To help expedite the installation, Ademco has incorporated 4 different communication defaults in the VISTA XMP Control (Low Speed, Ademco Express, Ademco High Speed & Ademco's new Contact ID). These defaults automatically program industry-standard code assignments for zones, keypad panics, non-alarm and supervisory conditions, and can be loaded at any time without affecting non-communication program fields.

Using these defaults saves programming time! After loading one of the communication defaults, you only need to wire the devices to their appropriate zones, and program the following:

- Central station phone number(s), fields \*33 & \*34
- Subscriber's account number(s), fields \*32 & \*90
- Zone type responses, fields \*02-\*05 & 1\*01-1\*05
- Delays, timeouts, and miscellaneous control options.

The system is then operational.

The program fields that are affected by loading one of the communication defaults are fields \*45 - \*82. Default values for each communication default are listed on the pages following the Programming Form at the end of this manual.

For detailed information about reporting formats, see the SYSTEM COMMUNICATION section.

### EASY-TO-PROGRAM COMMUNICATION FIELDS

The VISTA XMP programming scheme eliminates the need to program zones to channels, and then channels to codes. If programming communication fields manually, simply enter whatever code (3+1, 4+1, 4+2 or Ademco Express) is to be sent for each zone (including panics, non-alarm codes and supervisory codes). NOTE: Enter "10" to transmit an "A", which appears as "0" at the receiver.

All zones are separated into groups of 8, with common restore, trouble and bypass codes for every 2 groups (16 zones). There are 2 double-digit entries for each code. For 3+1, 4+1, 4+2 and Ademco Express, the first entry is the alarm code for a standard report. The second entry is the ID digit for an expanded 3+1 or 4+1 report, or for a 4+2 or Ademco Express report. If the second digit is 0, only 3+1 or 4+1 (or 4+1 express) non-expanded messages will be sent. If only three digits are entered in the account number field, the ID or second digits are ignored, if entered. For Ademco High Speed format, the first digit entry is the channel assignment for that zone, and the second digit is ignored, if entered. For Contact ID reporting, the first digit entry (any non zero entry) enables reporting for that zone, and the second digit is ignored.

NOTE: Restoral reports for an event will not be sent if the event itself is not enabled, even if a restore code is programmed for that event.

### LOW SPEED (\*94\*80)

Loading this default does the following:

- Selects low speed, standard format with no checksum, for both phone numbers.
- Assigns the following report codes:
  - 03 for zones 2-47
  - 01 for zones 1 & 48-55 (fire zones)
  - 02 for zones 62,63 (panic transmitters), & 95, 96,99 (keypad panics)
  - 09 for all alarm restores
- Enables all zone type restores.

### ADEMCO EXPRESS (\*94\*81)

Loading this default does the following:

- Selects Ademco express reporting format, with checksum, for both phone numbers.
- Report codes for zones 1-64, 4280s and keypad panics are sent as their respective zone ID numbers (01-64, 88-91, 95-99), Duress is sent as "DD". Alarm restore is "E" + second digit.
- Enables all zone type restores.

### ADEMCO HIGH SPEED (\*94\*82)

Loading this default does the following:

- Selects Ademco High Speed format, with no checksum, for both phone numbers.
- Reporting is assigned to the following channels:
  - Channel 1 for zones 1 & zones 48-55 (Fire zones)
  - Channel 2 for zones 2-8
  - Channel 3 for zones 9-16
  - Channel 4 for zones 17-31
  - Channel 5 for zones 32-47 (RF interior zones)
  - Channel 6 for zones 56-61 & 64
  - Channel 9 for zones 62 & 63 (panic transmitter)
  - Channel 7 for second 4280 (88 & 89) & pol loop short (97)
  - Channel 8 for first 4280 (90 & 91)
  - Channels 10, 11 & 12 for keypad panics 95, 96 & 99 respectively
- Enables all zone type restores.
- Enables Duress to be sent.

### CONTACT ID (\*94\*83)

Loading this default does the following:

- Selects Contact ID format for both phone numbers.
- Reporting is enabled for all zones.
- Enables all zone type restores.
- Refer to the SYSTEM COMMUNICATION section for event code definitions.

# PROGRAMMING ZONE DESCRIPTIONS

If using a 5137 console, a user friendly English language description/location of all protection zones, keypad panics, polling loop short and 4280 supervision faults can be programmed into the system. Each description can be composed of a combination of words (up to a maximum of 3) that are selected from a vocabulary of approximately 220 words stored in memory, and any word can have an "s" or " 's " added to it. In addition, up to 20 installer-defined words can be added to those already in memory. Thus, when an alarm or trouble occurs in a zone, an appropriate description for the location of that zone will be displayed at the console. An installer's message can also be programmed which will be displayed when the system is "Ready" (ex. THE PETERSON'S). **NOTE:** Alpha descriptor entry can be accomplished locally at the 5137 console or remotely using a 4130PC Downloader.

## ENTERING ZONE DESCRIPTIONS

1. Enter programming mode as described previously.
2. Key \*93. The following will be displayed: \* ZN ??

In this mode, the console keys have these functions:

- [3] Scrolls both alphabet and actual words in ascending alphabetical order.
- [1] Scrolls both alphabet and actual words in descending alphabetical order.
- [2] Adds or removes an "s" or " 's " to a vocabulary word.
- [6] Toggles between alphabet and actual word list, and used to accept desired entries.
- [8] Saves the zone description in the system's memory.
- [#] # plus zone number will display the description for that zone.

**NOTE:** When programming descriptors for zones 95-99 (panics and poll short), the following numbers must be entered in place of the corresponding zone number.

ZONE #	ENTER #
95 (1 + * panic)	94
96 (3 + # panic)	95
97 (Poll Short)	93
99 (* + # panic)	96

3. Key \*01 to begin entering the description for zone 1, (key \*02 for zone 2, \*03 for zone 3 etc.). The following will be displayed: \* ZN 01 A

Note that the first letter of the alphabet appears after the zone number, and that the zone number is automatically included with the proposed description.

4. Select the first letter of the desired description (note that "A" is already displayed). Use key [3] to advance through the alphabet and key [1] to go backward. For example, assume the desired description for zone 1 is BACK DOOR. Press key [3] repeatedly (or hold down the key) until "B" appears, then press key [6], to display the first available word beginning with B. Repeatedly press key [3] to advance through the available words until the word BACK is displayed. Press key [1] to move backward through the word list.

To add an "s" or " 's ", press the [2] key. The first depression adds an "s", the second depression adds an " 's ", the third depression displays no character (to erase the character), the fourth depression adds an "s", etc.

To accept the chosen word, press the [6] key, which toggles back to the alphabet list.

5. For selection of the next word (DOOR), repeat step 4, but press key [3] until the desired first letter of the next word appears (in this example, "D"). Then press key [6] to display the first available word beginning with "D". Press key [3] repeatedly until the desired word (DOOR) appears. To accept the word, press the [6] key, which again toggles back to the alphabet list.
6. When all desired words have been entered, press key [8] to store the description in memory.
7. To review the zone descriptions, key [#] plus zone number (e.g., #01). To edit zone descriptions, key [\*] plus zone number (e.g., \*01)
9. To exit the zone description mode, key \*99.

## ADDING CUSTOM WORDS

Up to 20 installer-defined words can be added to the built-in vocabulary. Each of the 20 "words" can actually consist of several words, but bear in mind that a maximum of 10 characters can be used for each word string. To create the custom word or word string, proceed as follows:

1. Enter the programming mode.
2. Key \*93. The following will be displayed: \* ZN ??
3. Now key 00 to get into the mode which will allow the custom words to be created. The following will be displayed: \* ED ??

In this mode, the keys perform the following functions:

- [3] Advances through alphabet in ascending order.
- [1] Advances through alphabet in descending order.
- [6] Selects the desired letter, and moves the cursor to the right one space.
- [4] Moves the cursor one space to the left.
- [7] Inserts a space at the cursor location, erasing any character at that location.
- [8] Saves the new word in the system's memory.
- [\*] Returns to description entry mode.

4. Key the number of the custom word or word string to be created (01-20). For example, if you are creating the first word (or word string), enter 01; when creating the second word, enter 02, and so on. A cursor will now appear at the beginning of the second line.

5. Use the [3] key to advance through the alphabet (numbers, symbols and special characters are included). Use the [1] key to move back through the alphabet.

**IMPORTANT:** Custom words must begin with an alphabetic character. If numbers or symbols are used as the first character, the word will not be saved.

6. When you have reached the desired character, press the [6] key to select it. The cursor will then move to the right, in position for the next character.
7. Repeat steps 5 and 6 to create the desired word (or words). Note that the [4] key can be used to move the cursor to the left if necessary, and that key [7] can be used to enter a blank (or to erase an existing character). Each word or word string cannot exceed 10 characters.
8. Press the [8] key to save the custom word(s) and return to the \* ED ?? display. The custom word (or string of words) will be automatically added to the built-in vocabulary at the end of the group of words beginning with the same letter.
9. Repeat steps 4 through 8 to create up to 19 additional custom words (or word strings).
10. Press the [\*] key to return to the \*ZN ?? display, and follow the zone description entry procedure to assign the new words to a zone description.
11. Key \*99 to exit the zone description programming mode.



# 4140XMP PROGRAMMING FORM

DEFAULT VALUES ARE SHOWN IN BRACKETS [ ]; OTHERWISE DEFAULT = 0

## SECURITY ACCESS OPTIONS

\*00 INSTALLER CODE   
Enter 4 digits, 0-9 [4140]

\*01 MASTER SECURITY CODE   
Enter 4 digits, 0-9 [1234] See 1\*54 for 6-digit enable

\*15 KEYSWITCH ENABLE  1=enable; [0=disable]

\*29 QUICK ARM  [1=yes]; 0=no

1\*50 BABYSITTER CODE  1=enable; [0=disable]; (User 22)

1\*54 HIGH SECURITY MODE  1=6-digit high security; [0=4-digit normal]

## EXIT/ENTRY DELAY OPTIONS

\*09 ENTRY DELAY #1  [02] (00-15 times 15 seconds)

\*10 EXIT DELAY #1  [03] (00-15 times 15 seconds)

\*11 ENTRY DELAY #2  [06] (00-15 times 15 seconds)

\*12 EXIT DELAY #2  [08] (00-15 times 15 seconds)

\*87 ENTRY WARNING  [1=continuous]; 0=3 beeps

1\*45 ENABLE CONSOLE  1=enable; [0=disable]

ANNUN. DURING EXIT DELAY

## ASSIGN RESPONSE TYPE FOR ZONES (Enter 00-10; see Response Types box below)

*02		*03		*04		*05		1*01		1*02		1*03		1*04		1*05		1*08		1*09		
1	<input type="text"/>	9	<input type="text"/>	17	<input type="text"/>	25	<input type="text"/>	28	<input type="text"/>	33	<input type="text"/>	41	<input type="text"/>	49	<input type="text"/>	57	<input type="text"/>	NU	<input type="text" value="010"/>	89	<input type="text"/>	2nd RCVR
2	<input type="text"/>	10	<input type="text"/>	18	<input type="text"/>	26	<input type="text"/>	29	<input type="text"/>	34	<input type="text"/>	42	<input type="text"/>	50	<input type="text"/>	58	<input type="text"/>	NU	<input type="text" value="010"/>	90	<input type="text"/>	1st RCVR
3	<input type="text"/>	11	<input type="text"/>	19	<input type="text"/>	27	<input type="text"/>	30	<input type="text"/>	35	<input type="text"/>	43	<input type="text"/>	51	<input type="text"/>	59	<input type="text"/>	NU	<input type="text" value="010"/>	91	<input type="text"/>	1st RCVR
4	<input type="text"/>	12	<input type="text"/>	20	<input type="text"/>	010	<input type="text"/>	31	<input type="text"/>	36	<input type="text"/>	44	<input type="text"/>	52	<input type="text"/>	60	<input type="text"/>	NU	<input type="text" value="010"/>	For UL applications, use of 1 or 2 RF RCVRs requires enabling their respective faults (88-91) as applicable (type 5).		
5	<input type="text"/>	13	<input type="text"/>	21	<input type="text"/>	97	<input type="text"/>	32	<input type="text"/>	37	<input type="text"/>	45	<input type="text"/>	53	<input type="text"/>	61	<input type="text"/>	NU	<input type="text" value="010"/>			
6	<input type="text"/>	14	<input type="text"/>	22	<input type="text"/>	95	<input type="text"/>	(1+ #)	<input type="text"/>	38	<input type="text"/>	46	<input type="text"/>	54	<input type="text"/>	62	<input type="text"/>	NU	<input type="text" value="010"/>			
7	<input type="text"/>	15	<input type="text"/>	23	<input type="text"/>	96	<input type="text"/>	(3+ #)	<input type="text"/>	39	<input type="text"/>	47	<input type="text"/>	55	<input type="text"/>	63	<input type="text"/>	NU	<input type="text" value="010"/>			
8	<input type="text"/>	16	<input type="text"/>	24	<input type="text"/>	99	<input type="text"/>	(#+ #)	<input type="text"/>	40	<input type="text"/>	48	<input type="text"/>	56	<input type="text"/>	64	<input type="text"/>	88	<input type="text"/>	2nd RCVR		

NOTES: 87= Poll Loop Short; 88 & 90 = RCVR not receiving transmitter signals. 89 & 91 = RCVR not responding, bad conn. to panel.

RESPONSE TYPES: 00 = Disabled zone; 01 = Entry/Exit #1; 02 = Entry/Exit #2; 03 = Perimeter; 04 = Interior Follower; 05 = Day/Night; 06 = 24 hour Silent Alarm; 07 = 24 hour Audible Alarm; 08 = 24 hour Auxiliary; 09 = Fire; 10 = Interior, Delay;

## DESIGNATE RIGHT LOOP FOR MULTIPLEX EXPANSION 1=yes; [0=no]

*06	<input type="checkbox"/>	<input type="checkbox"/>	<input type="checkbox"/>	<input type="checkbox"/>	<input type="checkbox"/>	<input type="checkbox"/>	<input type="checkbox"/>	1*10	<input type="checkbox"/>	<input type="checkbox"/>	<input type="checkbox"/>	<input type="checkbox"/>	<input type="checkbox"/>	<input type="checkbox"/>	<input type="checkbox"/>		
ZONES:	10	11	12	13	14	15	16	ZONES:	33	34	35	36	37	38	39	40	
*07	<input type="checkbox"/>	<input type="checkbox"/>	<input type="checkbox"/>	<input type="checkbox"/>	<input type="checkbox"/>	<input type="checkbox"/>	<input type="checkbox"/>	1*11	<input type="checkbox"/>	<input type="checkbox"/>	<input type="checkbox"/>	<input type="checkbox"/>	<input type="checkbox"/>	<input type="checkbox"/>	<input type="checkbox"/>		
ZONES:	17	18	19	20	21	22	23	34	ZONES:	41	42	43	44	45	46	47	48
*08	<input type="checkbox"/>	<input type="checkbox"/>	<input type="checkbox"/>	<input type="checkbox"/>	<input type="checkbox"/>	<input type="checkbox"/>	<input type="checkbox"/>	1*12	<input type="checkbox"/>	<input type="checkbox"/>	<input type="checkbox"/>	<input type="checkbox"/>	<input type="checkbox"/>	<input type="checkbox"/>	<input type="checkbox"/>		
ZONES:	25	26	27	28	29	30	31	32	ZONES:	49	50	51	52	53	54	55	56
*24	4190WH TAMPER DISABLE	<input type="checkbox"/>	1=disable; [0=enable]						1*13	<input type="checkbox"/>	<input type="checkbox"/>	<input type="checkbox"/>	<input type="checkbox"/>	<input type="checkbox"/>	<input type="checkbox"/>	<input type="checkbox"/>	
*86	ZONE EXPANDER DEVICE	<input type="checkbox"/>	1=only one 4208 installed for zones 10-17; [0=more than one 4208 or other devices]						ZONES:	57	58	59	60	61	62	63	64

## SELECTION OF WIRELESS FOR ZONES 1-63

Enter "1" to enable a zone as wireless; 0=non-wireless

1*18	<input type="checkbox"/>	<input type="checkbox"/>	<input type="checkbox"/>	<input type="checkbox"/>	<input type="checkbox"/>	<input type="checkbox"/>	<input type="checkbox"/>	
ZONES:	1	2	3	4	5	6	7	8
1*19	<input type="checkbox"/>	<input type="checkbox"/>	<input type="checkbox"/>	<input type="checkbox"/>	<input type="checkbox"/>	<input type="checkbox"/>	<input type="checkbox"/>	
ZONES:	9	10	11	12	13	14	15	16
1*20	<input type="checkbox"/>	<input type="checkbox"/>	<input type="checkbox"/>	<input type="checkbox"/>	<input type="checkbox"/>	<input type="checkbox"/>	<input type="checkbox"/>	
ZONES:	17	18	19	20	21	22	23	24
1*21	<input type="checkbox"/>	<input type="checkbox"/>	<input type="checkbox"/>	<input type="checkbox"/>	<input type="checkbox"/>	<input type="checkbox"/>	<input type="checkbox"/>	
ZONES:	25	26	27	28	29	30	31	32
1*22	<input type="checkbox"/>	<input type="checkbox"/>	<input type="checkbox"/>	<input type="checkbox"/>	<input type="checkbox"/>	<input type="checkbox"/>	<input type="checkbox"/>	
ZONES:	33	34	35	36	37	38	39	40
1*23	<input type="checkbox"/>	<input type="checkbox"/>	<input type="checkbox"/>	<input type="checkbox"/>	<input type="checkbox"/>	<input type="checkbox"/>	<input type="checkbox"/>	
ZONES:	41	42	43	44	45	46	47	48
1*24	<input type="checkbox"/>	<input type="checkbox"/>	<input type="checkbox"/>	<input type="checkbox"/>	<input type="checkbox"/>	<input type="checkbox"/>	<input type="checkbox"/>	
ZONES:	49	50	51	52	53	54	55	56
1*25	<input type="checkbox"/>	<input type="checkbox"/>	<input type="checkbox"/>	<input type="checkbox"/>	<input type="checkbox"/>	<input type="checkbox"/>	<input type="checkbox"/>	
ZONES:	57	58	59	60	61	62	63	

## MISCELLANEOUS WIRELESS OPTIONS

1\*26 FIRST RF RECEIVER SELECT  1=yes; [0=no]

1\*27 SECOND RF RECEIVER SELECT  1=yes; [0=no]

1\*28 RF TRANSMITTER LOW  1=immediate; [0=when disarmed]  
 BATTERY ANNUN. Must be "1" for UL

1\*29 RF TRANSMITTER LOW  1=enable; [0=disable]  
 BATTERY REPORT ENABLE Must be "1" for UL

1\*30 RF RECEIVER SUPERVISION   
 CHECK-IN INTERVAL 02-15 times 2 hours;  
 00 disables supervision [6] Max. "6" (12 hr) for UL

1\*31 RF TRANSMITTER   
 CHECK-IN INTERVAL 02-15 times 2 hours;  
 00 disables transmitter supervision [12] Max. "6" (12 hr) for UL

1\*44 WIRELESS KEYPAD   
 TAMPER DETECT ENABLE 1=enable; [0=disable]

1\*48 WIRELESS KEYPAD DISABLE  1=disable; [0=enable]

1\*49 DISABLE TROUBLE SOUNDER   
 FOR RF SUPERVISION [1=disable]; 0=enable. Must be "0" for UL.

**SOUNDER OPTIONS**

- \*13 ALARM SOUNDER DURATION   01-15 times 2 minutes [04]. Minimum 4 minutes for UL.
- \*16 CONFIRMATION OF ARMING DING  1=enable; [0=disable]
- \*21 DISABLE FIRE TIME-OUT  1=no timeout; [0=fire timeout]
- \*23 MULTIPLE ALARMS  [1=yes]; 0=no
- 1\*47 ENABLE CHIME ANNUN. ON EXTERNAL ALARM SOUNDER  1=enable; [0=disable]

**AC LOSS OPTIONS**

- \*17 AC POWER LOSS SOUNDING  1=yes; [0=no]
- \*18 AC POWER LOSS ALARM  1=yes; [0=no]
- \*19 AC RANDOMIZE  1=randomize 10-40 min.; [0=no]
- \*28 POWER UP IN PREVIOUS STATE  [1=yes]; 0=no; \*1\* for UL.

**TEST TIMER OPTIONS**

- \*26 INTELLIGENT TEST REPORTING  Set \*0\* for UL. 1=yes, (no report sent if any other report was recently sent); [0=no]
- \*27 TEST REPORT INTERVAL    Enter interval in hours, 001-199; 000=no report [024]; Max. 024 for UL.
- \*83 FIRST TEST REPORT TIME    [Day 00; hour 12; min 00] Days 01-07 Hours 00-23 Min 00-59; 00 in all boxes=instant (Day 01= Monday)

**MISCELLANEOUS SYSTEM OPTIONS**

- \*14 ZONE 9 FAST/SLOW RESP.  1=fast; [0=slow]; \*0\* for UL.
- \*38 INHIBIT BYPASS OF A ZONE   01-31; [00 if all zones (except Fire zones) can be bypassed]
- \*41 EOLR DISABLE (Zones 2-8)  [1=N.C. loops]; 0=EOLR supervision; Must be \*0\* for UL.
- 1\*46 AUXILIARY OUTPUT ENABLE  [0=ground start]; 1=open/close trigger; 2=console sounding

**PHONE LINE & COMMUNICATOR OPTIONS**

- \*30 TOUCH-TONE OR ROTARY DIAL  1=TouchTone; [0=rotary]
- 1\*33 TOUCH-TONE W/ROTARY BACKUP ENABLE  1=enable; [0=disable]
- \*31 PABX ACCESS CODE     00-09; B-F (11-15)
- \*32 PRIMARY SUBSCRIBER ACCT #     Enter 00-09; B-F (11-15) [15 15 15 15]
- \*90 SCNDRY SUBSCRIBER ACCT #     Enter 00-09; B-F (11-15) [15 15 15 15]

- \*33 PRIMARY PHONE NUMBER             Enter 0-9 for each digit
- \*34 SECONDARY PHONE NUMBER             Enter 0-9 for each digit

- \*42 DIAL TONE PAUSE  [0=5 seconds; 1=11 seconds; 2=30 seconds; Must be \*0\* for UL.
- \*43 DIAL TONE DETECTION  [1=wait for true dial tone]; 0=pause, then dial
- \*45 PRIMARY FORMAT  [0=Low Speed]; 1=Contact ID; 2=Ademco High Speed; 3=Ademco Express
- \*46 LOW SPEED FORMAT (Primary)  [0=Ademco Low Speed]; 1=Secoac/Radionics
- \*47 SECONDARY FORMAT  [0=Low Speed]; 1=Contact ID; 2=Ademco High Speed; 3=Ademco Express
- \*48 LOW SPEED FORMAT (Sec.)  [0=Ademco Low Speed]; 1=Secoac/Radionics

- \*51 DUAL REPORTING  1=yes; [0=no] If used with Split Reporting \*1\* option (1\*34), alarms go to both primary & secondary numbers, while all other reports go to secondary only. If used with Split Reporting \*2\* option, open/close and test messages go to both lines, while all other reports go to primary.

- 1\*34 COMM. SPLIT REPORT SELECTION  [0=no]; 1=alarms primary, others secondary; 2=open/close, test secondary, others primary; See \*51 for comments.

- \*52 STANDARD/EXPANDED REPORT FOR PRIMARY       Alarm Rstr Bypass Trbl Opr/Cls Low Bat [0=standard]; 1=expanded; Note: Expanded overrides 4+2 format.

- \*53 STANDARD/EXPANDED REPORT FOR SECONDARY       Alarm Rstr Bypass Trbl Opr/Cls Low Bat [0=standard]; 1=expanded; Note: Expanded overrides 4+2 format.

- \*49 CHECKSUM VERIFICATION   1=yes; [0=no] Primary Secondary
- \*50 SESCOA/RADIONICS SELECT  1=Secoac; [0=Radionics]
- 1\*52 CANCEL REPORT RESTRICTION  1=no restriction; [0=within Bell Timeout period only]
- \*84 SWINGER SUPPRESSION   01-15 alarms [15]; Must be \*00\* (disabled) for UL.
- \*88 BURG. ALARM COMM. DELAY   1=16 seconds; [0=no delay]

**DOWNLOADING OPTIONS**

- \*35 DOWNLOAD PHONE No.             Enter 0-9 for each digit
- \*36 DOWNLOAD ID No.           Enter 00-09; A-F (10-15) [15 15 15 15 15 15 15]

- \*37 DOWNLOAD COMMAND ENABLES          [1=enable]; 0=disable  
See field 1\*53 for Callback disable option  
For UL installations, Upload & Download must be enabled. All others must be disabled.  
Dialer System Not Remote Remote Remote Upload Download  
Shutdown Shutdown Used Bypass Disarm Arm Program Program

- \*44 RING DETECTION COUNT   01-14; 15=answering machine; [00=no detection]
- 1\*53 DOWNLOAD CALLBACK  1=callback not required; [0=callback required]; Must be \*0\* for UL.

**ALARM REPORT CODE & ID DIGITS FOR ZONES 1-32 & SUPERVISORY & RESTORE CODES**

[All codes default to 00]

*54 CODE	*55 ID	*56 CODE	*57 ID	*58	*59 CODE	*60 ID	*61 CODE	*62 ID	*63
1		9		Alarm Rst.	17		25		Alarm Rst.
2		10		Trouble	18		26		Trouble
3		11		Trble Rst.	19		27		Trble Rst.
4		12		Bypass	20		28		Bypass
5		13		Bypas Rst.	21		29		Bypas Rst.
6		14			22		30		
7		15			23		31		
8		16			24		32		

**ALARM REPORT CODE & ID DIGITS FOR ZONES 33-64 & SUPERVISORY & RESTORE CODES**

[All codes default to 00]

*64 CODE	*65 ID	*66 CODE	*67 ID	*68	*69 CODE	*70 ID	*71 CODE	*72 ID	*73
33		41		Alarm Rst.	49		57		Alarm Rst.
34		42		Trouble	50		58		Trouble
35		43		Trble Rst.	51		59		Trble Rst.
36		44		Bypass	52		60		Bypass
37		45		Bypas Rst.	53		61		Bypas Rst.
38		46			54		62		
39		47			55		63		
40		48			56		64		

**ALARM REPORT CODE & ID DIGITS FOR RF RCVRs & PANICS & THEIR SUPV & RESTORE CODES**

[All codes default to 00]

*74 CODE	*75 ID	*76 CODE	*77 ID	*78
NU 0 0	0 0	89		Alarm Rst.
NU 0 0	0 0	90		Trouble
NU 0 0	0 0	91		Trble Rst.
NU 0 0	0 0	Dures		Bypass
NU 0 0	0 0	97		Bypas Rst.
NU 0 0	0 0	95		(1 + #)
NU 0 0	0 0	96		(3 + #)
88		99		(* + #)

NOTES: 97 = Poll Loop Short; 88 & 90 = RCVR not receiving transmitter signals. 89 & 91 = RCVR not responding, bad conn. to panel.

**SYSTEM NON ALARM CODES**

	*81 First Digit	*82 Second Digit	
Close			Second digit of each code applies only to 4+2 or expanded (fields *52 & *53) formats.
Open			
Low Battery			
Low Bat Res.			
AC Loss			
AC Restore			
Test			
Power			
Cancel			
Prog. Tamper			

**ZONE TYPE RESTORE ENABLES**

1=enable; 0=disable

*79	ZONE TYPES 1-8							
	<input type="checkbox"/>	<input type="checkbox"/>	<input type="checkbox"/>	<input type="checkbox"/>	<input type="checkbox"/>	<input type="checkbox"/>	<input type="checkbox"/>	<input type="checkbox"/>
	1	2	3	4	5	6	7	8
*80	ZONE TYPES 9 & 10		<input type="checkbox"/>	<input type="checkbox"/>				
			9	10				

**OPEN/CLOSE REPORT ENABLES**

1=enable; 0=disable (User 1 enabled)

*39	<input type="checkbox"/>	<input type="checkbox"/>	<input type="checkbox"/>	<input type="checkbox"/>	<input type="checkbox"/>	<input type="checkbox"/>	<input type="checkbox"/>	<input type="checkbox"/>
	1	2	3	4	5	6	7	8
*40	<input type="checkbox"/>	<input type="checkbox"/>	<input type="checkbox"/>	<input type="checkbox"/>	<input type="checkbox"/>	<input type="checkbox"/>	<input type="checkbox"/>	<input type="checkbox"/>
	9	10	11	12	13	14	15	16
1*00	<input type="checkbox"/>	<input type="checkbox"/>	<input type="checkbox"/>	<input type="checkbox"/>	<input type="checkbox"/>	<input type="checkbox"/>	<input type="checkbox"/>	<input type="checkbox"/>
	17	18	19	20	21	22	23-70	

### INDEX TO PROGRAM FIELDS

FLD	FUNCTION	SECTION
*00	INSTALLER CODE	ACCESS OPTS
*01	MASTER SECURITY CODE	ACCESS OPTS
*02	RESPONSE TYPE FOR ZONES 1-8	RESPONSE TYPES
*03	RESPONSE TYPE FOR ZONES 9-16	RESPONSE TYPES
*04	RESPONSE TYPE FOR ZONES 17-24	RESPONSE TYPES
*05	RESPONSE TYPE FOR ZONES 25-27	RESPONSE TYPES
*06	RIGHT LOOP FOR ZONES: 10-16	RIGHT LOOP
*07	RIGHT LOOP FOR ZONES: 17-24	RIGHT LOOP
*08	RIGHT LOOP FOR ZONES: 25-32	RIGHT LOOP
*09	ENTRY DELAY #1	EXIT/ENTRY
*10	EXIT DELAY #1	EXIT/ENTRY
*11	ENTRY DELAY #2	EXIT/ENTRY
*12	EXIT DELAY #2	EXIT/ENTRY
*13	ALARM SOUNDER DURATION	SOUNDER OPTS
*14	ZONE 9 FAST/SLOW RESPONSE	MISC SYSTEM OPTS
*15	KEYSWITCH ENABLE	ACCESS OPTS
*16	CONFIRMATION OF ARMING DING	SOUNDER OPTS
*17	AC POWER LOSS SOUNDING	AC LOSS OPTS
*18	AC POWER LOSS ALARM	AC LOSS OPTS
*19	AC RANDOMIZE	AC LOSS OPTS
*21	DISABLE FIRE TIME-OUT	SOUNDER OPTS
*23	MULTIPLE ALARMS	SOUNDER OPTS
*24	4190WH TAMPER DISABLE	RIGHT LOOP
*26	INTELLIGENT TEST REPORTING	TEST TIMER
*27	TEST REPORT INTERVAL	TEST TIMER
*28	POWER UP IN PREVIOUS STATE	AC LOSS OPTS
*29	QUICK ARM	ACCESS OPTS
*30	TOUCH-TONE OR ROTARY DIAL	PHONE LINE/COMM.
*31	PABX ACCESS CODE	PHONE LINE/COMM.
*32	PRIMARY SUBSCRIBER ACCT #	PHONE LINE/COMM.
*33	PRIMARY PHONE NUMBER	PHONE LINE/COMM.
*34	SECONDARY PHONE NUMBER	PHONE LINE/COMM.
*35	DOWNLOAD PHONE No.	DOWNLOADING
*36	DOWNLOAD ID No.	DOWNLOADING
*37	DOWNLOAD COMMAND ENABLES	DOWNLOADING
*38	INHIBIT BYPASS OF ONE ZONE	MISC SYSTEM OPTS
*39	OPEN/CLOSE REPORTING ENABLE BY USERS 1-8	OPEN/CLOSE REP.
*40	OPEN/CLOSE REPORTING ENABLE BY USERS 9-16	OPEN/CLOSE REP.
*41	EOLR DISABLE (Zones 2-8)	MISC SYSTEM OPTS
*42	DIAL TONE PAUSE	PHONE LINE/COMM.
*43	DIAL TONE DETECTION	PHONE LINE/COMM.
*44	RING DETECTION COUNT	DOWNLOADING
*45	PRIMARY FORMAT	PHONE LINE/COMM.
*46	LOW SPEED FORMAT	PHONE LINE/COMM.
*47	SECONDARY FORMAT	PHONE LINE/COMM.
*48	LOW SPEED FORMAT (Sec.)	PHONE LINE/COMM.
*49	CHECKSUM VERIFICATION	PHONE LINE/COMM.
*50	SESCOVA/RADIONICS SELECT	PHONE LINE/COMM.
*51	DUAL REPORTING	PHONE LINE/COMM.
*52	STANDARD/EXP REPORT PRIMARY	PHONE LINE/COMM.
*53	STANDARD/EXP REPORT SECNDRY	PHONE LINE/COMM.

FLD	FUNCTION	SECTION
*54-*78	REPORT CODES FOR ZONES 1-64	ALARM CODES
*79-*80	ZONE TYPE RESTORE ENABLES	ZONE TYPE REST.
*81-*82	SYSTEM NON-ALARM CODES	SYSTEM CODES
*83	FIRST TEST REPORT TIME	TEST TIMER
*84	SWINGER SUPPRESSION	PHONE LINE/COMM.
*86	ZONE EXPANDER DEVICE	RIGHT LOOP
*87	ENTRY WARNING	ENTRY/EXIT
*88	BURG. ALARM COMM. DELAY	PHONE LINE/COMM.
*90	SECONDARY SUBSCRIBER ACCT	PHONE LINE/COMM.
1*00	OPEN/CLOSE REPORTING ENABLE BY USERS 17-70	OPEN/CLOSE REP.
1*01	RESPONSE TYPE FOR ZONES 28-32	RESPONSE TYPES
1*02	RESPONSE TYPE FOR ZONES 33-40	RESPONSE TYPES
1*03	RESPONSE TYPE FOR ZONES 41-48	RESPONSE TYPES
1*04	RESPONSE TYPE FOR ZONES 49-56	RESPONSE TYPES
1*05	RESPONSE TYPE FOR ZONES 57-64	RESPONSE TYPES
1*08	RESPONSE TYPE FOR ZONE 88	RESPONSE TYPES
1*09	RESPONSE TYPE FOR ZONES 89-91	RESPONSE TYPES
1*10	RIGHT LOOP FOR ZONES:33-40	RIGHT LOOP
1*11	RIGHT LOOP FOR ZONES:41-48	RIGHT LOOP
1*12	RIGHT LOOP FOR ZONES:49-56	RIGHT LOOP
1*13	RIGHT LOOP FOR ZONES:57-64	RIGHT LOOP
1*18	SELECT WIRELESS FOR ZONES 1-8	SELECT WIRELESS
1*19	SELECT WIRELESS FOR ZONES 9-16	SELECT WIRELESS
1*20	SELECT WIRELESS ZONES 17-24	SELECT WIRELESS
1*21	SELECT WIRELESS ZONES 25-32	SELECT WIRELESS
1*22	SELECT WIRELESS ZONES 33-40	SELECT WIRELESS
1*23	SELECT WIRELESS ZONES 41-48	SELECT WIRELESS
1*24	SELECT WIRELESS ZONES 49-56	SELECT WIRELESS
1*25	SELECT WIRELESS FZONES 57-63	SELECT WIRELESS
1*26	1stRF RECEIVER EXPSELECT	MISC WIRELESS
1*27	2ndRF RECEIVER EXP SELECT	MISC WIRELESS
1*28	RF TRANSMITTER LOW	MISC WIRELESS
1*29	RF TRANS. LOW BATTERY ANNUN	MISC WIRELESS
1*30	RF RECEIVER SUPERVISION	MISC WIRELESS
1*31	RF TRANS.CHECK-IN INTERVAL	MISC WIRELESS
1*33	TOUCHTONE DIAL W/ROTARY BACK-UP ENABLE	PHONE LINE/COMM.
1*34	COMMUNICATOR SPLIT REPORT NG	PHONE LINE/COMM.
1*44	WIRELESS KEYPAD	MISC WIRELESS
1*45	ENABLE CONSOLE ANNUN. DURING EXIT DELAY	EXIT/ENTRY
1*46	AUXILIARY OUTPUT ENABLE	MISC SYSTEM OPTS
1*47	ENABLE CHIME ANNUN. ON EXTERNAL ALARM SOUNDER	SOUNDER OPTS
1*48	WIRELESS KEYPAD DISABLE TAMPER DETECT ENABLE	MISC WIRELESS
1*49	DISABLE TROUBLE SOUNDER FOR RF SUPERVISION	MISC WIRELESS
1*50	BABYSITTER CODE ENABLE	ACCESS OPTS
1*52	CANCEL REPORT RESTRICTION	PHONE LINE/COMM.
1*53	DOWNLOAD CALLBACK	DOWNLOADING
1*54	SECURITY CODE MODE	ACCESS OPTS

### PROGRAMMING COMMANDS

- To enter program mode, enter installer code + [8] + [0] + [0]
- To set standard defaults, press \*97
- To set communication defaults, press \*94 + one of the following: \*80=low speed; \*81=Ademco Express; \*82=Ademco High Speed; \*83=Ademco's Contact ID
- To change to next set of program fields, press \*94
- To return to previous set of fields, press \*99
- To erase account & phone number field entries, press [\*] + field number + [\*]
- To assign zone descriptors, press \*93 + zone number
- To add custom words, press \*93 + 00 + word number (1-20)
- To enter Installer's Message, press \*93 + 00 + 00
- To exit program mode, press \*99 OR \*98: \*99 allows re-access to programming mode by installer code. \*98 prevents re-access to programming mode by installer code.

**CREATING A CUSTOM MESSAGE DISPLAY (INSTALLER'S MESSAGE)**

Normally, when the system is in the disarmed state, the following display is present on the Console.

\*\*\*\*DISARMED\*\*\*\* READY TO ARM

Part or all of the above message can be modified to create a custom installer message. For example, \*\*\*\*DISARMED\*\*\*\* on the first line or READY TO ARM on the second line could be replaced by the installation company name or phone number for service. Note that there are only 16 character spaces on each of the two lines. To create a custom display message, proceed as follows:

1. Enter the programming mode.
2. Key \*93. The following will be displayed: \* ZN ??
3. Key 00. The following will appear: \* ED ??
4. Key 00 again. The following will appear:

\*\*\*\*DISARMED\*\*\*\*  
READY TO ARM

A cursor will be present at the extreme left of the first line (over the first "star"). The [6] key is used to move the cursor to the right and the [4] key to move the cursor to the left. Key [7] may be used to insert spaces or erase existing characters.

5. For example, to replace READY TO ARM with the message SERVICE:424-0177, proceed as follows:  
Press the [6] key to move the cursor to the right, and continue until the cursor is positioned over the first location on the second line.  
Press the [3] key to advance through the alphabet to the first desired character (in this case, "S"). Use the [1] key to go backward, when necessary. When the desired character is reached, press [6]. The cursor will then move to the next position, ready for entry of the next character (in this example, "E"). When the cursor reaches a position over an existing character, pressing the [3] or [1] key will advance or back up from that character in the alphabet. Proceed in this manner until all characters in the message have been entered.
6. To store this new display message in memory, press the [8] key.
7. Press the [\*] key to return to the \* ZN ?? display. To confirm that the new message has been stored in memory, press 00 and then press 00 again. The new message should be displayed.
8. Key \*99 to exit the descriptor/programming mode.

**VOCABULARY OF WORDS STORED IN MEMORY\* (5137 CONSOLE ONLY)**

AIR	COLD	FOIL	MAGNETIC	REFRIGERATIO	THERMOSTAT
ALARM	COATROOM	FOYER	MAIDS	N	TOOL
ALCOVE	COLLECTION	FREEZER	MAIN	FF	TRANSMITTER
ALLEY	COMBUSTION	FRONT	MASTER	RIGHT	TRAP
AMBUSH	COMPLUTER	FUR	MAT	ROOM	ULTRA
AREA	CONTACT	FURNACE	MEDICAL	ROOF	UP
APARTMENT	DAUGHTERS	GALLERY	MEDICINE	SAFE	UPPER
ART	DELAYED	GARAGE	MICROWAVE	SCREEN	UPSTAIRS
ATTIC	DEN	GAS	MONEY	SENSOR	UTILITY
AUDIO	DESK	GATE	MONITOR	SERVICE	VALVE
AUXILIARY	DETECTOR	GLASS	MOTHERS	SHED	VAULT
BABY	DINING	GUEST	MOTION	SHOCK	VIBRATION
BACK	DISCRIMINATOR	GUN	MOTOR	SHOP	VOLTAGE
BAR	DISPLAY	HALL	MUD	SHORT	WALL
BARN	DOCK	HEAT	NORTH	SHOW	WAREHOUSE
BASEMENT	DOOR	HIGH	NURSERY	SIDE	WASH
BATHROOM	DORMER	HOLDUP	OFFICE	SKYLIGHT	WEST
BED	DOWN	HOUSE	OIL	SLIDING	WINDOW
BEDROOM	DOWNSTAIRS	INFRARED	OPEN	SMOKE	WINE
BELL	DRAWER	INSIDE	OPENING	SONIC	WING
BLOWER	DRIVEWAY	INTERIOR	OUTSIDE	SONS	WIRELESS
BOILER	DRUG	INTRUSION	OVERFLOW	SOUTH	WORK
BOTTOM	DUCT	JEWELRY	OVERHEAD	SPRINKLER	XMITTER
BOX	EAST	KITCHEN	PAINTING	STAMP	YARD
BREAK	ELECTRIC	LAUNDRY	PANIC	STATION	ZONE
BUILDING	EMERGENCY	LEFT	PASSIVE	STEREO	0
BURNER	ENTRY	LEVEL	PATIO	STORE	1ST
CABINET	EQUIPMENT	LIBRARY	PERIMETER	STORAGE	2ND
CALL	EXECUTIVE	LIGHT	PHONE	STORY	3RD
CAMERA	EXIT	LINE	PHOTO	STRESS	4TH
CAR	EXTERIOR	LIQUOR	POINT	STRIKE	5TH
CASE	FACTORY	LIVING	POLICE	SUMP	6TH
CASH	FAILURE	LOADING	POOL	SUPERVISED	7TH
CCTV	FAMILY	LOCK	POWER	SUPERVISION	8TH
CEILING	FATHERS	LOOP	QUAD	SWIMMING	9TH
CELLAR	FENCE	LOW	RADIO	SWITCH	
CENTRAL	FILE	LOWER	REAR	TAMPER	
CIRCUIT	FIRE	MACHINE	RECREATION	TAPE	
CLIP	FLOOR		REFRIG	TELCOPHONE	
CLOSED	FLOW			TELLER	
COIN				TEMPERATURE	

\*Note: This factory-provided vocabulary of words is subject to change.

## VIII. DOWNLOADING PRIMER

### WHAT IS DOWNLOADING?

Downloading allows the installer or central station operator to remotely access, program, and control the security system over normal telephone lines. Anything that can be done directly from the keypad can be done remotely, using DOWNLOADING. To Download, the following is required:

1. An IBM PC, or compatible computer with MS DOS 3.1 or higher, to run the DOWNLOADING program. MS DOS stands for: MicroSoft Disk Operating System.
3. A HAYES 1200 SMARTMODEM (external: level 1.2 or higher; internal: level 1.1 or higher). If these levels cannot be found locally, an external modem can be purchased from ADEMCO, or contact HAYES for a free update. *Other brands are not compatible, even if claimed to be 100% compatible.*
4. 4130PC V-LINK® DOWNLOADING software, from ADEMCO. This software is available in both 3-1/2" (4130P3-3) and 5-1/4" diskettes, and includes a complete User's Manual.

### HOW DOES DOWNLOADING WORK?

At the protected premises, the Control panel must be connected to the existing telephone line (refer to the PHONE LINE CONNECTIONS section). No programming of the panel is required before downloading to an initial installation.

To download, do the following:

1. Enter the installer code + [#] + [5]. The panel temporarily enables a ring count of 5 and sets the Download Callback option to "1" (callback not required).
2. Call the panel using the downloader software set to "FIRST COMMUNICATION" mode.
3. The downloader will establish a session with no callback. The panel information can then be downloaded.

In order to remotely access, control, or program the alarm panel, a "link" must be established between the computer and the control panel, as follows:

1. The computer calls up the Control panel. (The phone number for each customer is entered into the customer's account file on the computer).
2. The Control panel "answers" at the pre-programmed ring count and executes a handshake with the computer.
3. The computer sends a request for call-back to the Control, unless call-back is not required.
4. The panel acknowledges the request and hangs up. During the next few seconds, the Control will process the request making sure certain encrypted information, received from the computer, matches its own memory.
5. Upon a successful match, the Control panel will seize the phone line and call the computer back, unless call-back is not required.
6. The computer answers, usually by the second ring, and executes a handshake with the panel.
7. The panel then sends other default information to the computer. If this information matches the computer's information, a successful link is established. This is known as being "ON-LINE".

### ADVISORIES:

1. Alarm and trouble responses and reports are disabled during on-line time. Should an event occur during this time, the response will take place and the report will go through as soon as the remote access sequence is completed. Alarm and trouble conditions are not ignored, they are simply delayed.
2. The keypads are inactive during downloading communication, and resume normal functions after hang up. All keypad entries are ignored during on-line time.

### WHAT CAN BE DONE ONCE PANEL IS "ON-LINE"?

- Arm the System in the Away Mode; Disarm the System
- Bypass a Zone
- Force the System to Accept a New Program Download
- Shut Down Communication (dialer) Functions (non-payment of monitoring fees in an owned system)
- Shut Down all Security System Functions (non-payment for a leased system)
- Inhibit Local Keypad Programming (prevents takeover of your accounts)
- Leave a message for customer (5137 ONLY)
- Command the System to Upload a Copy of its Resident Program to the office
- Read: Arming Status, AC Power Status, List of Faulted Zones, List of Bypassed Zones, 10-Day Alarm History Log, 10-Day Trouble History Log, List of Zones Currently in Alarm, List of Zones Currently in Trouble, List of RF sensors with low battery conditions

### HOW SECURE IS DOWNLOADING?

Accessing the Control from a remote location is protected against compromise by the use of 4 levels of protection:

1. Security Code Handshake: The subscriber's account number as well as an 8-digit ID number (known only to the office) must be matched between the Control and computer.
2. Hang-Up and Call-Back: The Control panel will "hang-up" and call the computer back at the pre-programmed number only if the security codes match.
3. Data Encryption: All data that is exchanged between the computer and Control is encrypted to reduce the possibility of anyone "tapping" the line and corrupting data.
4. Operator Access Levels: Up to 15 operators can have access to the DOWNLOADER, each having their own log-on code. However, each operator can be assigned one of three levels of access in both FILE and COMMAND functions, as follows:

#### FILE ACCESS:

Read Only: able only to look at the database; cannot change any information, and cannot see the customer's access codes.

Part Read/Write: able to look at and change all information, except the customer's access codes.

Full Read/Write: able to look at and change any and all information in the database.

#### CONTROL/COMM ACCESS:

Read Only: able only to Upload and arm the system. Not able to DISARM, BYPASS, or change any information.

Part Read/Write: able to ARM, BYPASS, UPLOAD, DOWNLOAD but cannot shutdown the system.

Full Read/Write: able to perform all control and status commands, as well as shutdown all or part of the system.

### NOTES:

1. Each time the Control panel is accessed (whether successful or unsuccessful), a PROGRAM TAMPER report (~40) is sent to central station, if programmed.
2. When downloading, the console will display "MODEM COMM" (5137) or "CC" (4137, 4127)
3. Whenever a download or a save is done, an automatic time stamp is done, indicating the date and time of the last download (or save) and the operator ID number.
4. The average time for a complete download, including initial call-up, hang-up and call-back is under 4 minutes.
5. A complete hard copy of each individual account can be obtained by connecting a printer to the computer. Refer to your computer owner's manual or contact your dealer for printer recommendations.

## IX. TESTING THE SYSTEM

### USING TEST MODE

After the installation is completed, the Security System should be thoroughly tested as follows:

1. With the System in the disarmed state, check that all zones are intact. If DISARMED - Press [\*] to show faults (5137) or NOT READY (4127/4137) is displayed, press the [\*] key to display the descriptors of the faulted zone(s). Restore faulted zone(s) if necessary, so that \*\*\*\*DISARMED\*\*\* READY TO ARM (5137) or READY (4127/4137) is displayed.
2. Enter the security code and press the TEST key. The external sounder (if used) should sound for 3 seconds and then turn off (the system is operating on the back-up battery only at this time).

NOTE 1. The system will not enter the Test mode if the battery voltage is too low, if the battery is not connected, or if any communication messages are waiting to be transmitted.

NOTE 2. As a reminder that the system is in the Test mode, the Console will sound a single beep at 15-second intervals if no protection zones are violated.

NOTE 3. In the Test mode, no alarm reports will be sent to the central station. Also, the external sounder (if used) will not be activated.

### Doors and Windows

Open and close each protected door and window in turn. Each action should produce three beeps from the Console. The descriptor for each protection zone will appear on the Console display.

### Motion Detectors

Walk in front of any interior motion detectors. Listen for three beeps when the detector senses movement. While it is activated, its descriptor will remain displayed on the Console. Note that wireless PIRs will have a 3 minute lockout between transmissions to conserve battery life (remove cover for walk test to override the 3-minute lock-out).

### Smoke Detectors

Follow the test procedure provided by the manufacturer of each smoke detector to ensure that all detectors are operational and are functioning properly.

NOTE: A 2-wire smoke detector display will not clear until the Test mode is exited.

### Turning Off TEST mode

Enter the security code and press the OFF key.

### ARMED SYSTEM TEST

**IMPORTANT!** A message will be sent to the central station during the following tests. Notify the central station that a test will be in progress.

NOTE: A display of "COMM. FAILURE" (Alpha consoles) or "FC" (Fixed-Word consoles) indicates a failure to communicate (no Kissoff by the receiver at the central station after the maximum number of transmission attempts is tried). If this occurs, verify that the phone line is connected, the correct report format is programmed, etc.

1. Arm the system and fault one or more zones. Silence alarm sounder(s) each time by entering the code and pressing OFF. Check that Entry/Exit delay zones provide the assigned delay times.
2. Check the keypad-initiated alarms, if programmed in field \*05, by pressing the Panic keys (\* and #, 1 and \*, and/or 3 and #). If the system has been programmed for audible emergency, the console will emit a loud, steady alarm sound. The word ALARM and a descriptor \*99\* will be displayed for \* and #. (if 1 and \* are pressed, a \*95\* will be displayed; if 3 and # are pressed, a \*96\* will be displayed). Silence the alarm by entering the security code and pressing OFF. If the system has been programmed for silent panic, there will be no audible alarms or displays. A report will be sent to the central station, however.
3. Notify the central station that all tests are finished and verify results with them.

### TURNING THE SYSTEM OVER TO THE USER

1. Fully explain the operation of the system to the user by going over each of its functions as well as the User's Manual supplied.
2. In particular, explain the operation of each zone (entry/exit, perimeter, interior, fire, etc.). Be sure the user understands how to operate any emergency feature(s) programmed into the system.  
**IMPORTANT!:** In the spaces provided in the User's Manual, record the Entry and Exit Delay times, and those functions that have been programmed into the available pairs of PANIC keys (\* & #, 1 & \*, 3 & #).
3. Make sure the user understands the importance of testing the system at least weekly, following the procedure provided in the User's Manual.

### TO THE INSTALLER

Regular maintenance and inspection (at least annually) by the installer and frequent testing by the user are vital to continuous satisfactory operation of any alarm system.

The installer should assume the responsibility of developing and offering a regular maintenance program to the user as well as acquainting the user with the proper operation and limitations of the alarm system and its component parts. Recommendations must be included for a specific program of frequent testing (at least weekly) to insure the system's proper operation at all times.

# X. TROUBLESHOOTING

## CONSOLES

### Console is inoperable; erratic display

- Power down completely (AC + battery), disconnect the battery, and power up again (AC only).
- Check that auxiliary voltage is between 12.5VDC-14.0VDC. If not, disconnect all auxiliary devices, and take another reading. If within the above range, there is too much current being drawn by the auxiliary devices. (see the Polling Loop & Auxiliary Device Worksheets for the current draw of each device). If still not within the above range, check incoming power from the No. 1361 transformer. Voltage should be 16.5VAC. If below 15VAC, carefully check the AC supply for a minimum of 110 VAC.
- With all auxiliary devices and battery still disconnected, check the voltage on the red & black battery leads. It should be 13.65VDC (approx.). If not, replace the Control. If it is @ 13.65VDC, the battery may not be at full charge (allow the battery to charge 12-24 hours before reconnecting the auxiliary devices) or the battery may be bad, and not able to hold a charge.

### Console displays "Not Ready" but no zone is displayed when the [\*] ready key is depressed

- Check to make sure there is a zone type response entered in program field \*05 for \*97" (polling loop short). If no zone response is entered and a loop short occurs, the display will only read "NOT READY", without an explanation.
- Check to determine if a right loop has been enabled for an RPM in a zone expanded system and no zone response is assigned to that sensor loop.
- A zone programmed as a 24 hour silent (type 06) is faulted.

## HARD-WIRED ZONES, 1-9

### Zone 1 in trouble ("CHECK")

- If programmed for fire or burglary using open-circuit sensors, a 2,000 ohm EOLR must be used across the zone, at the last device, as described in the SYSTEM CONFIGURATION: ZONES section.

### Zones 2-8 not detecting faults when their EOLRs are shorted (READY display stays on)

- If using EOLRs, check that program field \*41=0; if not using EOLRs, \*41=1.

### Zone 9 is indicating a fault ("READY" will not appear)

- This zone is for closed circuit, unsupervised use only. Do not use open circuit devices or an EOLR on this zone.

### Zone 9 false alarms periodically

- Zone has been programmed for a response time of 5-10 milliseconds (\*14), and should be used with "Fast response" devices, such as vibration sensors or glass break sensors, only. If devices with a response time of greater than 10 milliseconds are used, the zone may false alarm due to contact "bounce", if used in areas where vibrations may occur.

### Zones 1-9 not detecting faults (READY light stays on)

- Check program fields 1\*18 and 1\*19 to make sure the wired zone(s) in question have not been enabled as RF zones.

## RPMs

### Zones indicating "CHECK" conditions

- Check that the DIP switches are set correctly.
- If only left loops are being used, make sure program fields \*06, \*07, \*08, 1\*10, 1\*11, 1\*12, and 1\*13 are programmed as "0".
- If both left and right loops are being used, make sure program fields \*06, \*07, \*08, 1\*10, 1\*11, 1\*12, and 1\*13 are programmed with "0"s for the left loops and "1"s for the right loops. NOTE: On a 4190WH you cannot use a right loop unless the left loop is used also.
- Check polling loop voltage at the control as well as at each RPM. There should be fluctuating 8-11VDC on the loop.
- Check if programmed for tamper detection in program field \*24. If \*24 = 0, the RPM will come up in trouble when its cover is removed (4190WH only).
- If a 4208 is being used for zones 10-17, program field \*86 must be set for "1", and the DIP switches should be set as follows: 1,2,3,4,=ON, 5=OFF. If any other 4208 configuration is being used, field \*86 must = "0" and the DIP switches set according to the instructions accompanying the 4208.

### Zones indicating fault conditions ("READY" not displayed)

- If using a 4190WH, make sure that the jumpers are set up in accordance with the EOLR being used on the left loop (the right loop never uses an EOLR).
- If using a 4208, make sure the zones are set up with the correct EOLRs. See the SYSTEM CONFIGURATION: ZONES section for 4208 usage.
- If using a 4196 right loop, make sure only closed-circuit devices are used, and check the program fields \*06 through \*08, and 1\*10 through 1\*13 to make sure the zones in question are enabled as right loops ("1").

### "97" appears in console display with rapid beeping

- This indicates that a "short" has been detected on the polling loop.
- Check that polling loop polarity is correct at the control as well as at each RPM.
- Disconnect the polling loop and check for continuity from the positive (+) side of the loop to ground. There should be no continuity to ground. If there is a ground, the source must be found and eliminated.

### "READY" display not going out when zones faulted

- Check program fields 1\*19 through 1\*25 to make sure that the zones in question are not enabled as RF zones.
- Make sure each zone in question has been programmed for a response in fields \*02-\*05 and 1\*01-1\*05.

### Console displays "NOT READY" but no zone is displayed when [\*] READY key is depressed

- Check program fields \*06 through \*08, and 1\*10 through 1\*13 to make sure that right loops are enabled for the correct zones. If no right loops are being used, these fields should = "0".
- Check program field \*05 to make sure there is a zone type response entered for \*97". If a polling loop short occurs and no response is entered for \*97", the display would indicate "NOT READY" with no explanation.
- A point programmed for 24 hour silent (type 06) is faulted.



## WIRELESS

**"88" or "90" appears in console display and rapid beeping occurs**

- The receiver is not receiving any signals from any of the transmitters in the system. An "88" is for the 2nd receiver; a "90" is for the 1st receiver. These displays are enabled by assigning a zone response type in program fields 1\*08, and 1\*09. The recommended response is either zone type 05 or 07.
- Check that the antenna is installed properly and is not shorted to any metal object, refer to WIRELESS EXPANSION section for details.
- Check that the transmitters are powered up with fresh 9 volt batteries.
- Check that the house ID's match between transmitters and the receiver.
- Determine if anything is blocking transmission to the receiver (ex: metal cabinets or shelves, etc.)
- If 4280 is used, remove its cover. Put the system in the test mode, then see if the transmitters check-in. If not, move the receiver to another location and test again.

**"89" or "91" appears in console display and rapid beeping occurs**

- The receiver is not responding to the Control panel. An "89" refers to the second receiver and a "91" refers to the first receiver.
- If 4280 is used, check that the 4280's cover is on and the magnet is in close proximity to the reed switch.
- Check that the control is wired properly to the receiver.
- If 4280 is used, determine that the total current draw on the polling loop is not more than 64mA. If the draw does exceed 64mA, install a 4197 loop extender module, or power the 4280 from auxiliary power, as described.
- Check that the wire run length is in agreement with the recommended wire gauge.

**Zones, not programmed in the system, are indicating "CHECK" conditions**

- Check program fields \*02 through \*05, and 1\*01 through 1\*05 to make sure all unused zones are 00s.
- Check program fields 1\*18 through 1\*25 to make sure that all non-RF zones are 0s.

**Zones indicating "NOT READY" condition, but transmitter contact loop is intact**

- Put the system in the SNIFFER MODE for at least 2 hours, to see if another system in the area is using the same house ID. If so, change this system's house ID number.
- Make sure zones in question are selected as RF in fields 1\*18-1\*25.

**One or more transmitters are indicating "CHECK" conditions after a while; console beeping rapidly:**

- Check that the transmitters have the correct house ID programmed.
- Check that the transmitters have the correct transmitter ID assigned.
- Check that the transmitters have fresh batteries.

**"97" appears in the console display and rapid beeping occurs**

- This indicates that the polling loop has either a direct short, or a short to ground on the (+) side. Might also indicate that the 4280 RF Receiver is causing the short (disconnect 4280 to verify).
- Check that polling loop polarity is correct at the Control panel, as well as at each 4280.
- Check continuity from (+) side of the loop to ground (disconnect the polling loop from the Control first!) - an open should be read (no continuity). If a short to ground exists, find and eliminate the short.
- Check voltage across the polling loop at the Control panel as well as at each 4280, if used - there should be fluctuation between 8-11VDC.

**"READY" display not going out when RF zones faulted**

- Check that the house ID's match between the transmitters and the receiver.
- Check that the receiver is enabled in program fields 1\*26 for the first receiver and 1\*27 for the second receiver.
- Check that the zones in question are enabled for RF in program fields 1\*18 through 1\*25.
- Check that a zone response is programmed for the zones in question, in fields \*02 through \*05, and 1\*01 through 1\*05.
- Check that the receiver's antenna is properly installed.
- Remove any sensors from the transmitters and short across the transmitter terminals. Then fault the transmitter to see if the "READY" light goes out. If it does not go out, check the programming for that particular transmitter; if it does go out, check the sensors on that zone.
- Move the receiver to another location for better reception.

**Console displays "NOT READY" but no zone is displayed when [ ] READY key is depressed**

- Check program field \*05 to make sure "97" has a zone type response entered. If a loop short occurs and no response is entered for "97", the console would display only "NOT READY", with no explanation.
- A Silent Panic condition may be present. Key the security code + OFF to see if the condition clears.

**While in the "TEST" mode, some or all of the transmitters are not responding, or are responding irregularly**

- The Test mode cuts the receiver's sensitivity by 50%. This means that as long as a transmitter responds, its location is satisfactory.
- Move the affected transmitters to another location and re-test. There may be something blocking its transmission path.
- If all transmitters are affected, move the receiver to another location. There may be something blocking its reception.
- If no receiver location can be found that can reliably receive all transmitters, add a second receiver in a different location in the premises to extend the RF coverage of the system.

## COMMUNICATIONS

"FC" or "COMM FAILURE", is displayed

- "FC" (4137, 4127) or "COMM FAILURE" (5137) indicates that the communicator has attempted 8 times to send a report to the central station but did not get kissoff.
- Check with the central station to make sure the programmed format is acceptable to the central station's receiver.
- Check program field \*49 to see if single message with checksum has been enabled. The central station receiver might not be able to handle checksum.
- Check program field 1\*34 to see if split reporting is enabled. If only a primary central station phone number is being used, field 1\*34 must = 01
- Check program field \*31, PABX ACCESS CODE. Enter up to 4-digits only if an outside line must be accessed before the number is dialed or if "call waiting" is to be suppressed. The latter feature must be obtained from the local telephone company. To make sure this field is empty, key \*31\* to erase this location.
- Check program field \*30 for either TouchTone or rotary dialing. In most cases, if rotary is selected dialing will be successful, but if TouchTone is selected, then the line must be a TouchTone line. It is possible that a line that had permitted TouchTone service previously was now being blocked from that use by the telephone company because the user was not paying for that service. At installation time, it is important to check with the user to determine if they are paying for TouchTone service.
- If SESCO/RADIONICS format is being used, check program field \*50. If hexadecimal codes are being sent, enter a "0". If only 0-9 is being sent, either a "1" or a "0" is acceptable. Check with the central station to verify acceptance of B-F codes.
- If 3+1/4+1, LOW SPEED is being used, check the ID portion of the report code fields. There should be "0" in all of these fields. Some central station receivers cannot handle second digit reporting.
- Check the telephone numbers programmed in fields \*33 & \*34.
- Listen to the outgoing call attempts using a handset.
- Check the wiring on the Telco connector.

## NOTES

# XI. SPECIFICATIONS

## 4140XMP CONTROL

**Physical:** 12-1/2"W X 14-1/2"H X 3"D

**Electrical:**  
**Voltage Input:** From Ademco No. 1361 Plug-In Transformer (use 1361CN in Canada) rated 16.5VAC, 40 VA.

**Alarm Sounder Output:** 10VDC-13.8VDC, 2.8 amps max. (non-UL installations), 750mA less aux. current draw (UL installations).

**Aux. Power Output:** 9.6VDC-13.8VDC, 750mA max. For UL installations, the accessories connected to the output must be UL Listed, and rated to operate in the above voltage range.

**Back-up Battery:** 12VDC, 4AH or 7AH gel cell. YUASA NP4-12 (12V, 4AH) or NP7-12 (12V, 7AH) recommended. Use 4AH battery for UL installations.

**Standby:** 4 hours min. with 750 mA aux. load using 7 AH battery. 2.5 hours with 750 mA aux. load using 4AH.

**Circuit Protectors:** Thermal circuit breakers are used on battery input to protect against reverse battery connections and on alarm sounder output to protect against wiring faults (Shorts).  
 A solid state circuit breaker is used on auxiliary power output to protect against wiring faults (shorts).

## DIGITAL COMMUNICATOR

**FORMATS SUPPORTED:**  
 ADEMCO HIGH SPEED  
 ADEMCO 4+2 EXPRESS  
 ADEMCO LOW SPEED  
 ADEMCO CONTACT ID  
 SESCOA  
 RADIONICS LOW SPEED  
 LINE SEIZE: Double Pole  
 RINGER EQUIVALENCE: 0.7B  
 FCC REGISTRATION NO.: AC398U-68192-AL-E

## 4127 REMOTE CONSOLE

**Physical:** 5-5/8"W X 4-11/16"H X 7/8"D

**Electrical:** Voltage Input: 12VDC  
 Current Drain: 20 mA

**Interface Wiring:** RED: 12VDC input (+) - auxiliary power  
 GREEN: Data In  
 YELLOW: Data Out  
 BLACK: Ground

## 5137/4137 REMOTE CONSOLES

**Physical:** 8.4"W X 4.75"H X 1.1"D

**Electrical:** Voltage Input: 12VDC  
 Current Drain: 60 mA (4137)  
 90 mA (5137 with backlighting)

**Interface Wiring:** RED: 12VDC input (+) - auxiliary power  
 BLUE: not used  
 GREEN: Data In  
 YELLOW: Data Out  
 BLACK: Ground and (-) connection from supplementary power supply.

## 4190WH OPERATION & WIRING DIAGRAM

The 4190WH is a 2-zone (known as left and right loops) RPM. The left loop can be used for closed-circuit devices, with or without EOLR supervision, and for open-circuit devices, with EOLR supervision. The left loop can also be used with fast-response (10 millisecond) devices, if necessary. Follow the chart for cutting the correct jumpers and choosing the correct resistor when using the left loop.

The right loop is for closed-circuit, unsupervised use only, and has a response time of 400 milliseconds. The jumpers do not affect the right loop in any way. Do not use a resistor on this loop. Note that the right loop can only be used if the left loop is also used, and that the right loop numerically follows the left loop's zone number, which is set with the unit's DIP switches (ex. if left loop is zone 12, right loop is zone 13).

**IMPORTANT:** The tamper/supervision response of the 4190WH is determined by the zone response type assigned to the left loop (even if the right loop is assigned a different response type). While the system is disarmed, tamper/supervisory faults will always report as trouble messages. While the system is armed, tamper/supervisory faults will report as troubles if the left loop is assigned a non-burglary response type (i.e. fire, panic, aux), and will report as alarms if assigned a burglary response type.

JUMPERS USAGE (LEFT ZONE ONLY)	
RED	Cut for fast-response (10 millisecond).
WHITE	Cut for low current mode (reed type switches); use the 30,000 ohm resistor, provided. Must be cut if BLUE jumper is cut. 4190WH draws 1 mA from the polling loop in this mode.
BLUE	Cut for use with no EOLR (closed-circuit only). Doing this automatically puts an internal 30,000 ohm resistor in series with the zone, so the white jumper must also be cut.
NONE CUT	High current mode: Use the 4,700 ohm resistor, provided, with mechanical switches in either an open-circuit or closed-circuit configuration. 4190WH draws 2 mA from the polling loop in this mode.

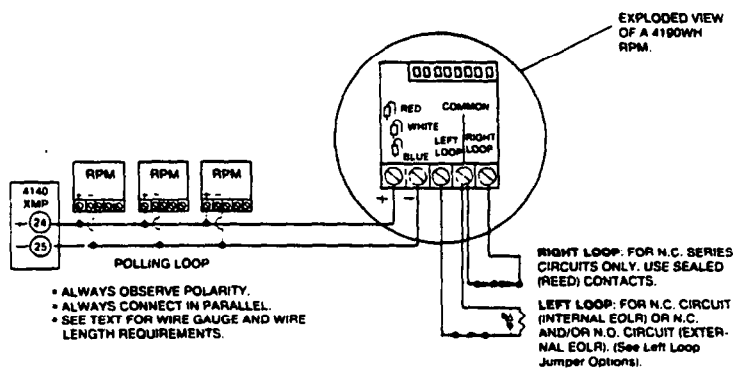

**WEEKLY TESTING IS REQUIRED TO ENSURE PROPER OPERATION OF THIS SYSTEM.**

**WARNING: OWNER'S INSTRUCTION NOTICE NOT TO BE REMOVED**

NOTES:

- Zone 2 & 8 may be programmed for end-of-line detection or normally closed (N.O./EOLR) operation.
- Zone 1 supports 2-wire smoke detectors and maximum number of detectors supported. Use 4100 EOLR, rated 2.0K ohms.
- Zone 7 may be used for remote keyswitch arming/disarming. See Installation Instructions N5008-1 for wiring instructions.
- Zone 8 supports 2-wire latching type glass break detectors. See Installation Instructions N5008-1 for recommended type and maximum number of detectors supported.

**COMPLIES WITH FCC RULES, PART 68**

FCC REGISTRATION NO. AC398U-88192-A1-E  
RINGER EQUIVALENCE: 0.7B

THIS DEVICE COMPLIES WITH PART 15 OF FCC RULES. OPERATION IS SUBJECT TO THE FOLLOWING TWO CONDITIONS: (1) IT MAY NOT CAUSE HARMFUL INTERFERENCE. (2) IT MUST ACCEPT ANY INTERFERENCE THAT MAY CAUSE UNDESIRABLE OPERATION.

**Optional programming**

Out 1: (Open/Close) or console like sounding  
Out 2: (Keyswitch) (Armed LED)  
Out 3: (Keyswitch) (Ready LED)  
Out 4: (Keyswitch) (Ready LED)

Ratings for each output:  
Active: 10VDC, 13.8VDC through 5k OHMS  
Not Active: 1k OHMS to ground

See Installation Instructions N5008-1 for wiring and programming instructions.

**MAKE CONNECTIONS USING**  
No. 14/2 FT. CABLE

00000000  
1 2 3 4 5 6 7 8 9

**BATTERY TABS**

Connect to 12VDC, 4Ah or 12VDC, 6Ah (6Ah battery shall not be used in UL listed applications)

**GEL CELL battery**

**CHARGING VOLTAGE** 13.2 VDC

See Installation Instructions N5008-1 for capacity required

Battery capacity for emergency standby at least 2.5 hrs.

Normally need not be replaced for at least 3 years

**NOTE:**

WHEN POWERING UP THE PANEL, PLUG THE TRANSFORMER IN BEFORE CONNECTING THE BATTERY.

**WARNING: TO PREVENT RISK OF ELECTRICAL SHOCK, DISCONNECT TELCO JACK BEFORE SERVICING THIS PANEL.**

**No. 4140XMP SUMMARY OF CONNECTIONS**

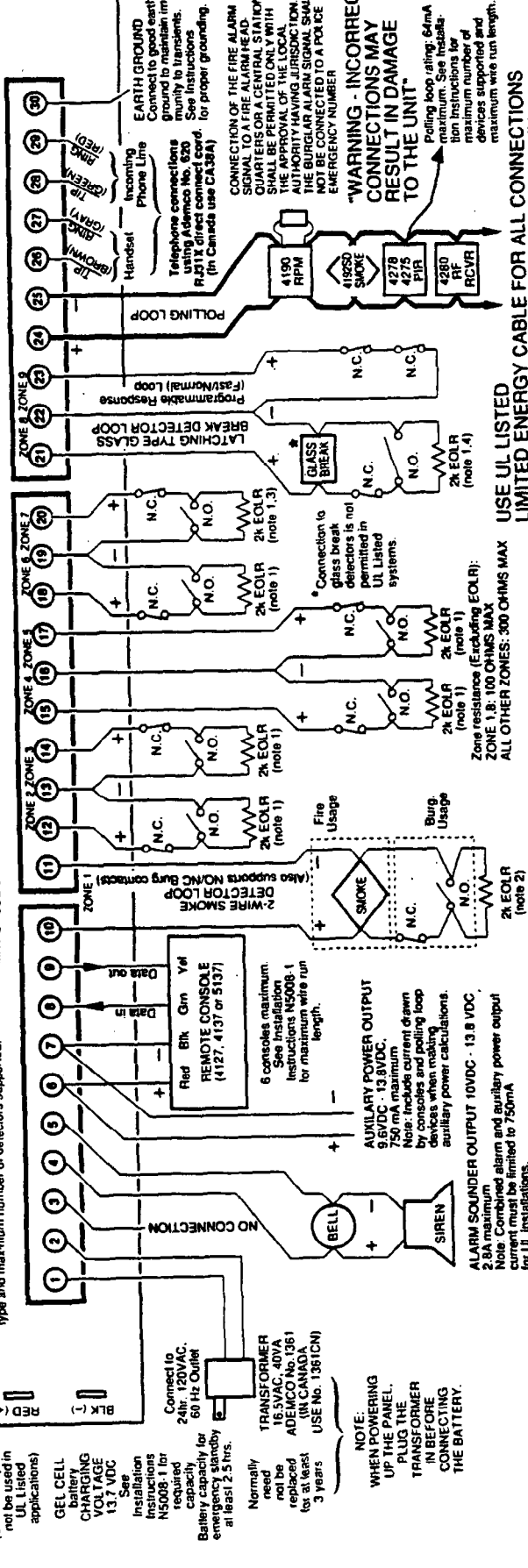

**WARNING - INCORRECT CONNECTIONS MAY RESULT IN DAMAGE TO THE UNIT**

CONNECTION OF THE FIRE ALARM SIGNAL TO A FIRE ALARM HEAD, QUARTERS OR A CENTRAL STATION SHALL BE PERMITTED ONLY WITH THE APPROVAL OF THE LOCAL AUTHORITY HAVING JURISDICTION. THE BELL CONNECTED TO A POLICE EMERGENCY NUMBER.

Polling loop rating: 64mA maximum. See installation instructions for maximum number of devices supported and maximum wire run length.

**USE UL LISTED LIMITED ENERGY CABLE FOR ALL CONNECTIONS THIS EQUIPMENT SHOULD BE INSTALLED IN ACCORDANCE WITH THE NATIONAL FIRE PROTECTION ASSOCIATION'S STANDARD 74 (NATIONAL FIRE PROTECTION ASSOC., BATTERYMARCH PARK, QUINCY, MA, 02269). PRINTED INFORMATION DESCRIBING PROPER INSTALLATION, OPERATION, TESTING, MAINTENANCE, EVACUATION PLANNING AND REPAIR SERVICE IS TO BE PROVIDED WITH THIS EQUIPMENT.**

**Zone response time:**  
ZONES 1-8: 350mSec-500mSec  
Fast: 10mSec-15mSec  
Normal: 350mSec-500mSec (default response)

**Zone resistance (Excluding EOLR):**  
ZONE 1,8: 100 OHMS MAX  
ALL OTHER ZONES: 300 OHMS MAX

**ALARM SOUNDER OUTPUT 10VDC - 13.8 VDC**  
2.5A maximum  
Note: Combined alarm and auxiliary power output current must be limited to 750mA for UL installations.

**AUXILIARY POWER OUTPUT**  
9.6VDC - 13.8VDC, 750 mA maximum  
Note: Include current drawn by console and polling loop devices in making auxiliary power calculations.

**DOC LOAD NO.: 5**

**SEE INSTRUCTIONS N5008-1**

DIP SWITCH TABLES FOR ADDRESSABLE CONSOLES AND POLLING LOOP DEVICES

Addressable Consoles  
(e.g. 5137AD)

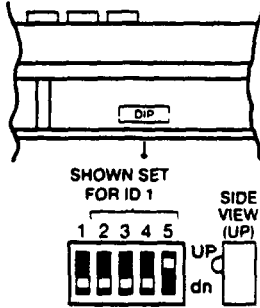

SHOWN SET FOR ID 1  
SIDE VIEW (UP)  
dn

† IMPORTANT: USE ID 31 FOR APPLICATIONS NOT REQUIRING ADDRESSABLE CONSOLES.

4208 Zone Expander

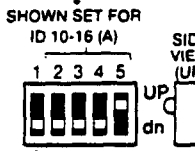
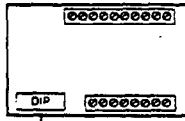

POS. 1: LOOPS 1 & 2  
RESPONSE TIME:  
W/TABLE FAST SLOW  
A UP dn  
B dn UP

4192SD/4192SDT/  
4192CP  
Smoke Detectors

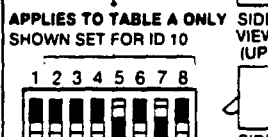
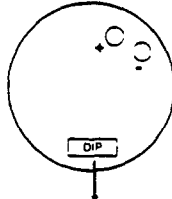

POS. 1: MUST BE dn

4190WH Zone Expander

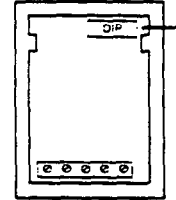

APPLIES TO TABLES A & B  
SHOWN SET FOR ID 10(A)

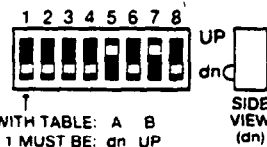

WITH TABLE: A B  
POS. 1 MUST BE: dn UP

DEVICE ID	1	2	3	4	5
0	dn	dn	dn	dn	dn
1	dn	dn	dn	dn	UP
2	dn	dn	dn	UP	dn
3	dn	dn	dn	UP	UP
4	dn	dn	UP	dn	dn
5	dn	dn	UP	dn	UP
6	dn	dn	UP	UP	dn
7	dn	dn	UP	UP	UP
8	dn	UP	dn	dn	dn
9	dn	UP	dn	dn	UP
10	dn	UP	dn	UP	dn
11	dn	UP	dn	UP	UP
12	dn	UP	UP	dn	dn
13	dn	UP	UP	dn	UP
14	dn	UP	UP	UP	dn
15	dn	UP	UP	UP	UP
16	UP	dn	dn	dn	dn
17	UP	dn	dn	dn	UP
18	UP	dn	dn	UP	dn
19	UP	dn	dn	UP	UP
20	UP	dn	UP	dn	dn
21	UP	dn	UP	dn	UP
22	UP	dn	UP	UP	dn
23	UP	dn	UP	UP	UP
24	UP	UP	dn	dn	dn
25	UP	UP	dn	dn	UP
26	UP	UP	dn	UP	dn
27	UP	UP	dn	UP	UP
28	UP	UP	UP	dn	dn
29	UP	UP	UP	dn	UP
30	UP	UP	UP	UP	dn
31	UP	UP	UP	UP	UP

BIT VALUE: 16 8 4 2 1

THIS TABLE FOR  
DIPS WITH  
WORD "OFF"

DEVICE ID	2	3	4	5
10-16	dn	dn	dn	UP
17-24	dn	dn	UP	dn
25-32	dn	dn	UP	UP
33-40	dn	UP	dn	dn
41-48	dn	UP	dn	UP
49-56	dn	UP	UP	dn
57-64	dn	UP	UP	UP

THIS TABLE FOR  
DIPS WITH  
WORD "ON"

DEVICE ID	2	3	4	5
10-16	UP	UP	UP	dn
17-24	UP	UP	dn	UP
25-32	UP	UP	dn	dn
33-40	UP	dn	UP	UP
41-48	UP	dn	UP	dn
49-56	UP	dn	dn	UP
57-64	UP	dn	dn	dn

THIS TABLE FOR DIPS WITH  
WORD "OFF"

DEVICE ID	2	3	4	5	6	7	8
10	dn	dn	dn	UP	dn	UP	dn
11	dn	dn	dn	UP	dn	UP	UP
12	dn	dn	dn	UP	UP	dn	dn
13	dn	dn	dn	UP	UP	dn	UP
14	dn	dn	dn	UP	UP	UP	dn
15	dn	dn	dn	UP	UP	UP	UP
16	dn	dn	UP	dn	dn	dn	dn
17	dn	dn	UP	dn	dn	dn	UP
18	dn	dn	UP	dn	dn	UP	dn
19	dn	dn	UP	dn	dn	UP	UP
20	dn	dn	UP	dn	UP	dn	dn
21	dn	dn	UP	dn	UP	dn	UP
22	dn	dn	UP	dn	UP	UP	dn
23	dn	dn	UP	dn	UP	UP	UP
24	dn	dn	UP	UP	dn	dn	dn
25	dn	dn	UP	UP	dn	dn	UP
26	dn	dn	UP	UP	dn	UP	dn
27	dn	dn	UP	UP	dn	UP	UP
28	dn	dn	UP	UP	UP	dn	dn
29	dn	dn	UP	UP	UP	dn	UP
30	dn	dn	UP	UP	UP	UP	dn
31	dn	dn	UP	UP	UP	UP	UP
32	dn	UP	dn	dn	dn	dn	dn
33	dn	UP	dn	dn	dn	dn	UP
34	dn	UP	dn	dn	dn	UP	dn
35	dn	UP	dn	dn	dn	UP	UP
36	dn	UP	dn	dn	UP	dn	dn
37	dn	UP	dn	dn	UP	dn	UP
38	dn	UP	dn	dn	UP	UP	dn
39	dn	UP	dn	dn	UP	UP	UP
40	dn	UP	dn	UP	dn	dn	dn
41	dn	UP	dn	UP	dn	dn	UP
42	dn	UP	dn	UP	dn	UP	dn
43	dn	UP	dn	UP	dn	UP	UP
44	dn	UP	dn	UP	dn	UP	dn
45	dn	UP	dn	UP	dn	UP	UP
46	dn	UP	dn	UP	UP	dn	dn
47	dn	UP	dn	UP	UP	UP	UP
48	dn	UP	UP	dn	dn	dn	dn
49	dn	UP	UP	dn	dn	dn	UP
50	dn	UP	UP	dn	dn	UP	dn
51	dn	UP	UP	dn	dn	UP	UP
52	dn	UP	UP	dn	UP	dn	dn
53	dn	UP	UP	dn	UP	dn	UP
54	dn	UP	UP	dn	UP	UP	dn
55	dn	UP	UP	dn	UP	UP	UP
56	dn	UP	UP	UP	dn	dn	dn
57	dn	UP	UP	UP	dn	dn	UP
58	dn	UP	UP	UP	dn	UP	dn
59	dn	UP	UP	UP	dn	UP	UP
60	dn	UP	UP	UP	UP	dn	dn
61	dn	UP	UP	UP	UP	dn	UP
62	dn	UP	UP	UP	UP	dn	UP
63	dn	UP	UP	UP	UP	UP	UP
64	UP	dn	dn	dn	dn	dn	dn

BIT VALUE: 64 32 16 8 4 2 1

THIS TABLE FOR DIPS WITH  
WORD "ON"

DEVICE ID	2	3	4	5	6	7	8
10	UP	UP	UP	dn	UP	dn	UP
11	UP	UP	UP	dn	UP	dn	dn
12	UP	UP	UP	dn	dn	UP	UP
13	UP	UP	UP	dn	dn	UP	dn
14	UP	UP	UP	dn	dn	dn	UP
15	UP	UP	UP	dn	dn	dn	dn
16	UP	UP	dn	UP	UP	UP	UP
17	UP	UP	dn	UP	UP	UP	dn
18	UP	UP	dn	UP	UP	dn	UP
19	UP	UP	dn	UP	UP	dn	dn
20	UP	UP	dn	UP	UP	dn	UP
21	UP	UP	dn	UP	UP	dn	UP
22	UP	UP	dn	UP	dn	dn	UP
23	UP	UP	dn	UP	dn	dn	dn
24	UP	UP	dn	dn	UP	UP	UP
25	UP	UP	dn	dn	UP	UP	dn
26	UP	UP	dn	dn	UP	UP	dn
27	UP	UP	dn	dn	UP	UP	dn
28	UP	UP	dn	dn	UP	UP	UP
29	UP	UP	dn	dn	UP	UP	dn
30	UP	UP	dn	dn	UP	UP	dn
31	UP	UP	dn	dn	UP	UP	dn
32	UP	dn	dn	dn	dn	dn	dn
33	UP	dn	dn	dn	dn	dn	UP
34	UP	dn	dn	dn	dn	UP	dn
35	UP	dn	dn	dn	dn	UP	dn
36	UP	dn	dn	dn	UP	dn	UP
37	UP	dn	dn	dn	UP	dn	UP
38	UP	dn	dn	dn	UP	UP	dn
39	UP	dn	dn	dn	UP	UP	UP
40	UP	dn	dn	UP	dn	dn	dn
41	UP	dn	dn	UP	dn	dn	UP
42	UP	dn	dn	UP	dn	UP	dn
43	UP	dn	dn	UP	dn	UP	UP
44	UP	dn	dn	UP	dn	UP	UP
45	UP	dn	dn	UP	dn	UP	UP
46	UP	dn	dn	UP	dn	dn	UP
47	UP	dn	dn	UP	dn	dn	dn
48	UP	dn	dn	UP	UP	dn	UP
49	UP	dn	dn	UP	UP	dn	dn
50	UP	dn	dn	UP	UP	dn	UP
51	UP	dn	dn	UP	UP	dn	dn
52	UP	dn	dn	UP	dn	dn	UP
53	UP	dn	dn	UP	dn	dn	UP
54	UP	dn	dn	UP	dn	dn	UP
55	UP	dn	dn	UP	dn	dn	dn
56	UP	dn	dn	UP	dn	dn	UP
57	UP	dn	dn	UP	dn	dn	UP
58	UP	dn	dn	UP	dn	UP	dn
59	UP	dn	dn	UP	dn	UP	UP
60	UP	dn	dn	UP	dn	dn	UP
61	UP	dn	dn	UP	dn	dn	UP
62	UP	dn	dn	UP	dn	dn	UP
63	UP	dn	dn	UP	dn	dn	dn
64	dn	UP	UP	UP	UP	UP	UP

BIT VALUE: 64 32 16 8 4 2 1

# DIP SWITCH TABLES FOR POLLING LOOP DEVICES

## 4196 PIR

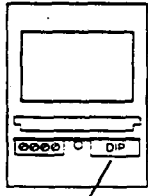

SHOWN SET FOR ID 10

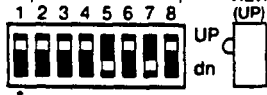

POS. 1: MUST BE UP

## 4275 PIR

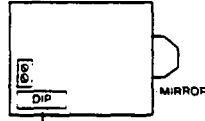

SHOWN SET FOR ID 10 (A)



POS. 6: UP (A), dn (B) = INST. MODE  
dn (A), UP (B) = PULSE COUNT  
POS. 7: UP (A), dn (B) = WALK TEST  
dn (A), UP (B) = W/T DISABLE

## 4278 PIR

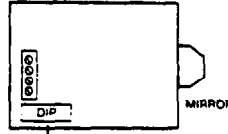

SHOWN SET FOR ID 10



POS. 7: UP = NORMAL MODE  
dn = INSTANT MODE  
POS. 8: UP = W/T DISABLE  
dn = WALK TEST

## 4194 Reed Contact (Surface Mount)

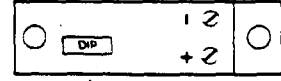

SHOWN SET FOR ID 10

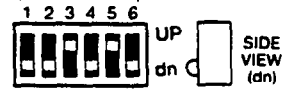

DEVICE ID	DIP SWITCH POSITION							
	2	3	4	5	6	7	8	
10	UP	UP	UP	dn	UP	dn	UP	
11	UP	UP	UP	dn	UP	dn	dn	
12	UP	UP	UP	dn	dn	UP	UP	
13	UP	UP	UP	dn	dn	UP	dn	
14	UP	UP	UP	dn	dn	dn	UP	
15	UP	UP	UP	dn	dn	dn	dn	
16	UP	UP	dn	UP	UP	UP	UP	
17	UP	UP	dn	UP	UP	UP	dn	
18	UP	UP	dn	UP	UP	dn	UP	
19	UP	UP	dn	UP	UP	dn	dn	
20	UP	UP	dn	UP	dn	UP	UP	
21	UP	UP	dn	UP	dn	UP	dn	
22	UP	UP	dn	UP	dn	dn	UP	
23	UP	UP	dn	UP	dn	dn	dn	
24	UP	UP	dn	dn	UP	UP	UP	
25	UP	UP	dn	dn	UP	UP	dn	
26	UP	UP	dn	dn	dn	UP	UP	
27	UP	UP	dn	dn	UP	dn	dn	
28	UP	UP	dn	dn	dn	UP	UP	
29	UP	UP	dn	dn	dn	UP	dn	
30	UP	UP	dn	dn	dn	dn	UP	
31	UP	UP	dn	dn	dn	dn	dn	
32	UP	dn	UP	UP	UP	UP	UP	
33	UP	dn	UP	UP	UP	UP	dn	
34	UP	dn	UP	UP	dn	UP	UP	
35	UP	dn	UP	UP	dn	dn	UP	
36	UP	dn	UP	UP	dn	UP	UP	
37	UP	dn	UP	UP	dn	UP	dn	
38	UP	dn	UP	UP	dn	dn	UP	
39	UP	dn	UP	UP	dn	dn	dn	
40	UP	dn	UP	UP	dn	UP	UP	
41	UP	dn	UP	dn	UP	UP	dn	
42	UP	dn	UP	dn	UP	dn	UP	
43	UP	dn	UP	dn	UP	dn	dn	
44	UP	dn	UP	dn	dn	UP	UP	
45	UP	dn	UP	dn	dn	UP	dn	
46	UP	dn	UP	dn	dn	dn	UP	
47	UP	dn	UP	dn	dn	dn	dn	
48	UP	dn	dn	UP	UP	UP	UP	
49	UP	dn	dn	UP	UP	UP	dn	
50	UP	dn	dn	UP	UP	dn	UP	
51	UP	dn	dn	UP	UP	dn	dn	
52	UP	dn	dn	UP	UP	UP	UP	
53	UP	dn	dn	UP	dn	UP	dn	
54	UP	dn	dn	UP	dn	dn	UP	
55	UP	dn	dn	UP	dn	dn	dn	
56	UP	dn	dn	dn	UP	UP	UP	
57	UP	dn	dn	dn	UP	UP	dn	
58	UP	dn	dn	dn	UP	dn	UP	
59	UP	dn	dn	dn	UP	dn	dn	
60	UP	dn	dn	dn	dn	UP	UP	
61	UP	dn	dn	dn	dn	UP	dn	
62	UP	dn	dn	dn	dn	dn	UP	
63	UP	dn	dn	dn	dn	dn	dn	
64	dn	UP	UP	UP	UP	UP	UP	

BIT VALUE: 64 32 16 8 4 2 1

### THIS TABLE FOR DIPS WITH WORD "OFF" A

DEVICE ID	DIP SWITCH POSITION				
	1	2	3	4	5
10	dn	UP	dn	UP	dn
11	dn	UP	dn	UP	UP
12	dn	UP	UP	dn	dn
13	dn	UP	UP	dn	UP
14	dn	UP	UP	UP	dn
15	dn	UP	UP	UP	UP
16	UP	dn	dn	dn	dn
17	UP	dn	dn	dn	UP
18	UP	dn	dn	UP	dn
19	UP	dn	dn	UP	UP
20	UP	dn	UP	dn	dn
21	UP	dn	UP	dn	UP
22	UP	dn	UP	UP	dn
23	UP	dn	UP	UP	UP
24	UP	UP	dn	dn	dn
25	UP	UP	dn	dn	UP
26	UP	UP	dn	UP	dn
27	UP	UP	dn	UP	UP
28	UP	UP	UP	dn	dn
29	UP	UP	UP	dn	UP
30	UP	UP	UP	UP	dn
31	UP	UP	UP	UP	UP

### THIS TABLE FOR DIPS WITH WORD "ON" B

DEVICE ID	DIP SWITCH POSITION				
	1	2	3	4	5
10	UP	dn	UP	dn	UP
11	UP	dn	UP	dn	dn
12	UP	dn	dn	UP	UP
13	UP	dn	dn	UP	dn
14	UP	dn	dn	dn	UP
15	UP	dn	dn	dn	dn
16	dn	UP	UP	UP	UP
17	dn	UP	UP	UP	dn
18	dn	UP	UP	dn	UP
19	dn	UP	UP	dn	dn
20	dn	UP	dn	UP	UP
21	dn	UP	dn	UP	dn
22	dn	UP	dn	dn	UP
23	dn	UP	dn	dn	dn
24	dn	dn	UP	UP	UP
25	dn	dn	UP	UP	dn
26	dn	dn	UP	dn	UP
27	dn	dn	UP	dn	dn
28	dn	dn	dn	UP	UP
29	dn	dn	dn	UP	dn
30	dn	dn	dn	dn	UP
31	dn	dn	dn	dn	dn

BIT VALUE: 16 8 4 2 1

DEVICE ID	DIP SWITCH POSITION					
	1	2	3	4	5	6
10	UP	UP	dn	UP	dn	UP
11	UP	UP	dn	UP	dn	dn
12	UP	UP	dn	dn	UP	UP
13	UP	UP	dn	dn	UP	dn
14	UP	UP	dn	dn	dn	UP
15	UP	UP	dn	dn	dn	dn
16	UP	dn	UP	UP	UP	UP
17	UP	dn	UP	UP	UP	dn
18	UP	dn	UP	UP	dn	UP
19	UP	dn	UP	UP	dn	dn
20	UP	dn	UP	dn	UP	UP
21	UP	dn	UP	dn	UP	dn
22	UP	dn	UP	dn	dn	UP
23	UP	dn	UP	dn	dn	dn
24	UP	dn	dn	UP	UP	UP
25	UP	dn	dn	UP	UP	dn
26	UP	dn	dn	dn	UP	UP
27	UP	dn	dn	UP	dn	dn
28	UP	dn	dn	dn	UP	UP
29	UP	dn	dn	dn	UP	dn
30	UP	dn	dn	dn	dn	UP
31	UP	dn	dn	dn	dn	dn
32	dn	UP	UP	UP	UP	UP
33	dn	UP	UP	UP	UP	dn
34	dn	UP	UP	UP	dn	UP
35	dn	UP	UP	UP	dn	dn
36	dn	UP	UP	dn	UP	UP
37	dn	UP	UP	dn	UP	dn
38	dn	UP	UP	dn	dn	UP
39	dn	UP	UP	dn	dn	dn
40	dn	UP	dn	UP	UP	UP
41	dn	UP	dn	UP	UP	dn
42	dn	UP	dn	UP	dn	UP
43	dn	UP	dn	UP	dn	dn
44	dn	UP	dn	dn	UP	UP
45	dn	UP	dn	dn	UP	dn
46	dn	UP	dn	dn	dn	UP
47	dn	UP	dn	dn	dn	dn
48	dn	dn	UP	UP	UP	UP
49	dn	dn	UP	UP	UP	dn
50	dn	dn	UP	UP	dn	UP
51	dn	dn	UP	UP	dn	dn
52	dn	dn	UP	UP	UP	UP
53	dn	dn	UP	dn	UP	dn
54	dn	dn	UP	dn	dn	UP
55	dn	dn	UP	dn	dn	dn
56	dn	dn	dn	UP	UP	UP
57	dn	dn	dn	UP	UP	dn
58	dn	dn	dn	UP	dn	UP
59	dn	dn	dn	UP	dn	dn
60	dn	dn	dn	dn	UP	UP
61	dn	dn	dn	dn	UP	dn
62	dn	dn	dn	dn	dn	UP
63	dn	dn	dn	dn	dn	dn

BIT VALUE: 32 16 8 4 2 1

DEVICE ID	DIP SWITCH POSITION					
	1	2	3	4	5	6
10	dn	dn	UP	dn	UP	dn
11	dn	dn	UP	dn	UP	UP
12	dn	dn	UP	UP	dn	dn
13	dn	dn	UP	UP	dn	UP
14	dn	dn	UP	UP	UP	dn
15	dn	dn	UP	UP	UP	UP
16	dn	UP	dn	dn	dn	dn
17	dn	UP	dn	dn	dn	UP
18	dn	UP	dn	dn	UP	dn
19	dn	UP	dn	dn	UP	dn
20	dn	UP	dn	UP	dn	dn
21	dn	UP	dn	UP	dn	UP
22	dn	UP	dn	dn	UP	dn
23	dn	UP	dn	UP	UP	UP
24	dn	UP	dn	dn	UP	dn
25	dn	UP	UP	dn	dn	UP
26	dn	UP	UP	dn	dn	UP
27	dn	UP	UP	dn	UP	UP
28	dn	UP	UP	dn	dn	dn
29	dn	UP	UP	dn	UP	dn
30	dn	UP	UP	UP	UP	dn
31	dn	UP	UP	UP	UP	UP
32	UP	dn	dn	dn	dn	dn
33	UP	dn	dn	dn	dn	UP
34	UP	dn	dn	dn	UP	dn
35	UP	dn	dn	dn	UP	UP
36	UP	dn	dn	UP	dn	dn
37	UP	dn	dn	UP	dn	UP
38	UP	dn	dn	UP	dn	UP
39	UP	dn	dn	UP	UP	UP
40	UP	dn	UP	dn	dn	dn
41	UP	dn	UP	dn	dn	UP
42	UP	dn	UP	dn	UP	dn
43	UP	dn	UP	dn	UP	UP
44	UP	dn	UP	UP	dn	dn
45	UP	dn	UP	UP	dn	UP
46	UP	dn	UP	UP	dn	dn
47	UP	dn	UP	UP	UP	UP
48	UP	UP	dn	dn	dn	dn
49	UP	UP	dn	dn	dn	UP
50	UP	UP	dn	dn	UP	dn
51	UP	UP	dn	dn	UP	UP
52	UP	UP	dn	UP	dn	dn
53	UP	UP	dn	UP	dn	UP
54	UP	UP	dn	UP	dn	UP
55	UP	UP	dn	UP	UP	UP
56	UP	UP	UP	dn	dn	dn
57	UP	UP	UP	dn	dn	UP
58	UP	UP	UP	dn	UP	UP
59	UP	UP	UP	dn	UP	UP
60	UP	UP	UP	UP	dn	dn
61	UP	UP	UP	UP	dn	UP
62	UP	UP	UP	UP	UP	dn
63	UP	UP	UP	UP	UP	UP

BIT VALUE: 32 16 8 4 2 1

### DIP SWITCH TABLES FOR WIRELESS DEVICES

#### House ID Switch Setting for All Devices Except 5716

HOUSE ID	DIP SWITCH SETTINGS				
	1	2	3	4	5
1	UP	UP	UP	UP	dn
2	UP	UP	UP	dn	UP
3	UP	UP	UP	dn	dn
4	UP	UP	dn	UP	UP
5	UP	UP	dn	UP	dn
6	UP	UP	dn	dn	UP
7	UP	UP	dn	dn	dn
8	UP	dn	UP	UP	UP
9	UP	dn	UP	UP	dn
10	UP	dn	UP	dn	UP
11	UP	dn	UP	dn	dn
12	UP	dn	dn	UP	UP
13	UP	dn	dn	UP	dn
14	UP	dn	dn	dn	UP
15	UP	dn	dn	dn	dn
16	dn	UP	UP	UP	UP
17	dn	UP	UP	UP	dn
18	dn	UP	UP	dn	UP
19	dn	UP	UP	dn	dn
20	dn	UP	dn	UP	UP
21	dn	UP	dn	UP	dn
22	dn	UP	dn	dn	UP
23	dn	UP	dn	dn	dn
24	dn	dn	UP	UP	UP
25	dn	dn	UP	UP	dn
26	dn	dn	UP	dn	UP
27	dn	dn	UP	dn	dn
28	dn	dn	dn	UP	UP
29	dn	dn	dn	UP	dn
30	dn	dn	dn	dn	UP
31	dn	dn	dn	dn	dn

BIT VALUE: 16 8 4 2 1

#### 5701 Panic Xmtr.

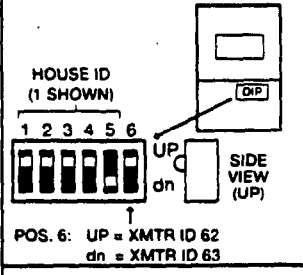

#### 5706 Smoke Detector/Transmitter

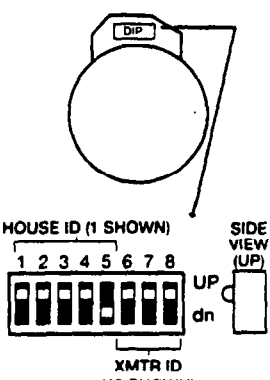

XMTR ID	DIP SWITCH SETTINGS		
ID	6	7	8
48	UP	UP	UP
49	UP	UP	dn
50	UP	dn	UP
51	UP	dn	dn
52	dn	UP	UP
53	dn	UP	dn
54	dn	dn	UP
55	dn	dn	dn

#### 5775 PIR Detector/Transmitter

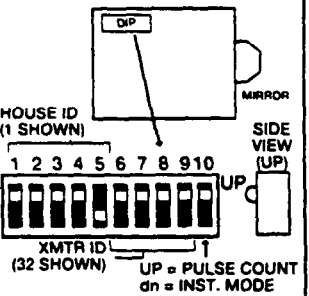

XMTR ID	DIP SWITCH SETTINGS			
ID	6	7	8	9
32	UP	UP	UP	UP
33	UP	UP	UP	dn
34	UP	UP	dn	UP
35	UP	UP	dn	dn
36	UP	dn	UP	UP
37	UP	dn	UP	dn
38	UP	dn	dn	UP
39	UP	dn	dn	dn
40	dn	UP	UP	UP
41	dn	UP	UP	dn
42	dn	UP	dn	UP
43	dn	UP	dn	dn
44	dn	dn	UP	UP
45	dn	dn	UP	dn
46	dn	dn	dn	UP
47	dn	dn	dn	dn

#### 5715 Universal Xmtr.

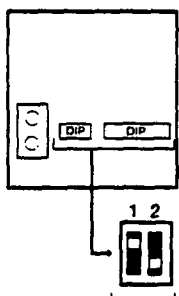

POS. 1: UP = NORMAL RESPONSE  
 dn = FAST RESPONSE  
 POS. 2: UP = NO COVER TAMPER  
 dn = COVER TAMPER (use N.C. setting)

XMTR ID	DIP SWITCH SETTINGS									
ID	8	7	6	5	4	3	2	1	0	11
1	UP	UP	UP	UP	UP	UP	UP	UP	dn	dn
2	UP	UP	UP	UP	UP	dn	UP	UP	UP	UP
3	UP	UP	UP	UP	dn	dn	UP	UP	UP	UP
4	UP	UP	UP	dn	UP	UP	UP	UP	UP	UP
5	UP	UP	UP	dn	dn	UP	UP	UP	UP	UP
6	UP	UP	dn	UP	UP	UP	UP	UP	UP	UP
7	UP	UP	dn	dn	UP	UP	UP	UP	UP	UP
8	UP	UP	dn	dn	dn	UP	UP	UP	UP	UP
9	UP	UP	dn	dn	dn	dn	UP	UP	UP	UP
10	UP	UP	dn	dn	dn	dn	dn	UP	UP	UP
11	UP	UP	dn	dn	dn	dn	dn	dn	UP	UP
12	UP	UP	dn	dn	dn	dn	dn	dn	dn	UP
13	UP	UP	dn	dn	dn	dn	dn	dn	dn	dn
14	UP	dn	UP	UP	UP	UP	UP	UP	UP	UP
15	UP	dn	UP	UP	UP	dn	UP	UP	UP	UP
16	UP	dn	UP	UP	UP	dn	dn	UP	UP	UP
17	UP	dn	UP	UP	UP	dn	dn	dn	UP	UP
18	UP	dn	UP	UP	dn	UP	UP	UP	UP	UP
19	UP	dn	UP	UP	dn	dn	UP	UP	UP	UP
20	UP	dn	UP	UP	dn	dn	dn	UP	UP	UP
21	UP	dn	UP	UP	dn	dn	dn	dn	UP	UP
22	UP	dn	UP	dn	UP	UP	UP	UP	UP	UP
23	UP	dn	UP	dn	dn	UP	UP	UP	UP	UP
24	UP	dn	UP	dn	dn	dn	UP	UP	UP	UP
25	UP	dn	UP	dn	dn	dn	dn	UP	UP	UP
26	UP	dn	dn	UP	UP	UP	UP	UP	UP	UP
27	UP	dn	dn	UP	UP	dn	UP	UP	UP	UP
28	UP	dn	dn	UP	UP	dn	dn	UP	UP	UP
29	UP	dn	dn	UP	UP	dn	dn	dn	UP	UP
30	UP	dn	dn	UP	dn	UP	UP	UP	UP	UP
31	UP	dn	dn	UP	dn	dn	UP	UP	UP	UP
32	UP	dn	dn	UP	dn	dn	dn	UP	UP	UP

BIT VALUE: 32 16 8 4 2 1

#### 5711/5711WM Door/Window Transmitter

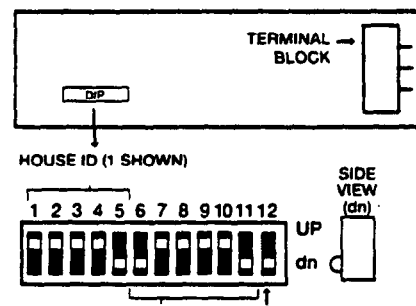

POS. 12: UP = N.O.  
 dn = N.C.  
 (Avoid ID 32-37 with N.O.)

XMTR ID	DIP SWITCH SETTINGS										
ID	6	7	8	9	10	11	12	13	14	15	16
32	dn	UP	UP	UP	UP	UP	dn	UP	UP	UP	UP
33	dn	UP	UP	UP	UP	UP	dn	dn	UP	UP	UP
34	dn	UP	UP	UP	UP	UP	dn	dn	dn	UP	UP
35	dn	UP	UP	UP	UP	UP	dn	dn	dn	dn	UP
36	dn	UP	UP	UP	dn	UP	UP	UP	UP	UP	UP
37	dn	UP	UP	UP	dn	dn	UP	UP	UP	UP	UP
38	dn	UP	UP	UP	dn	dn	dn	UP	UP	UP	UP
39	dn	UP	UP	UP	dn	dn	dn	dn	UP	UP	UP
40	dn	UP	UP	dn	UP	UP	UP	UP	UP	UP	UP
41	dn	UP	UP	dn	dn	UP	UP	UP	UP	UP	UP
42	dn	UP	UP	dn	dn	dn	UP	UP	UP	UP	UP
43	dn	UP	UP	dn	dn	dn	dn	UP	UP	UP	UP
44	dn	UP	UP	dn	dn	dn	dn	dn	UP	UP	UP
45	dn	UP	dn	UP	UP	UP	UP	UP	UP	UP	UP
46	dn	UP	dn	dn	UP	UP	UP	UP	UP	UP	UP
47	dn	UP	dn	dn	dn	UP	UP	UP	UP	UP	UP
48	dn	UP	dn	dn	dn	dn	UP	UP	UP	UP	UP
49	dn	UP	dn	dn	dn	dn	dn	UP	UP	UP	UP
50	dn	UP	dn	dn	dn	dn	dn	dn	UP	UP	UP
51	dn	dn	UP	UP	UP	UP	UP	UP	UP	UP	UP
52	dn	dn	UP	UP	UP	dn	UP	UP	UP	UP	UP
53	dn	dn	UP	UP	UP	dn	dn	UP	UP	UP	UP
54	dn	dn	UP	UP	dn	UP	UP	UP	UP	UP	UP
55	dn	dn	UP	UP	dn	dn	UP	UP	UP	UP	UP
56	dn	dn	UP	UP	dn	dn	dn	UP	UP	UP	UP
57	dn	dn	UP	UP	dn	dn	dn	dn	UP	UP	UP
58	dn	dn	dn	UP	UP	UP	UP	UP	UP	UP	UP
59	dn	dn	dn	UP	UP	dn	UP	UP	UP	UP	UP
60	dn	dn	dn	UP	UP	dn	dn	UP	UP	UP	UP
61	dn	dn	dn	UP	dn	UP	UP	UP	UP	UP	UP
62	dn	dn	dn	UP	dn	dn	UP	UP	UP	UP	UP
63	dn	dn	dn	UP	dn	dn	dn	UP	UP	UP	UP

BIT VALUE: 32 16 8 4 2 1

#### 5716 Door/Window Transmitter

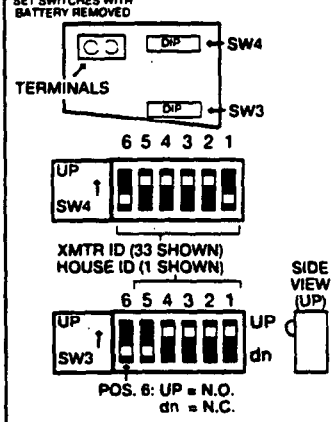

HOUSE ID	DIP SWITCH SETTINGS				
ID	5	4	3	2	1
1	UP	UP	UP	UP	UP
2	UP	UP	UP	UP	dn
3	UP	UP	UP	dn	UP
4	UP	UP	UP	dn	dn
5	UP	UP	dn	UP	UP
6	UP	UP	dn	UP	dn
7	UP	UP	dn	UP	dn
8	UP	UP	dn	dn	UP
9	UP	UP	dn	dn	dn
10	UP	dn	UP	UP	UP
11	UP	dn	UP	UP	dn
12	UP	dn	UP	UP	dn
13	UP	dn	UP	UP	dn
14	UP	dn	UP	UP	dn
15	UP	dn	UP	UP	dn
16	UP	dn	UP	UP	dn
17	UP	dn	UP	UP	dn
18	UP	dn	UP	UP	dn
19	UP	dn	UP	UP	dn
20	UP	dn	UP	UP	dn
21	UP	dn	UP	UP	dn
22	UP	dn	UP	UP	dn
23	UP	dn	UP	UP	dn
24	UP	dn	UP	UP	dn
25	UP	dn	UP	UP	dn
26	UP	dn	UP	UP	dn
27	UP	dn	UP	UP	dn
28	UP	dn	UP	UP	dn
29	UP	dn	UP	UP	dn
30	UP	dn	UP	UP	dn
31	UP	dn	UP	UP	dn

BIT VALUE: 1 2 4 8 16

#### TRANSMITTER DIP SWITCH SETTINGS

TRANSMITTER ID	6	5	4	3	2	1
1	UP	UP	UP	UP	UP	UP
2	UP	UP	UP	UP	UP	dn
3	UP	UP	UP	UP	UP	dn
4	UP	UP	UP	UP	dn	UP
5	UP	UP	UP	UP	dn	dn
6	UP	UP	UP	dn	UP	UP
7	UP	UP	UP	dn	UP	dn
8	UP	UP	UP	dn	dn	UP
9	UP	UP	UP	dn	dn	dn
10	UP	UP	dn	UP	UP	UP
11	UP	UP	dn	UP	UP	dn
12	UP	UP	dn	UP	UP	dn
13	UP	UP	dn	UP	UP	dn
14	UP	UP	dn	UP	UP	dn
15	UP	UP	dn	UP	UP	dn
16	UP	UP	dn	UP	UP	dn
17	UP	UP	dn	UP	UP	dn
18	UP	UP	dn	UP	UP	dn
19	UP	UP	dn	UP	UP	dn
20	UP	UP	dn	UP	UP	dn
21	UP	UP	dn	UP	UP	dn
22	UP	UP	dn	UP	UP	dn
23	UP	UP	dn	UP	UP	dn
24	UP	UP	dn	UP	UP	dn
25	UP	UP	dn	UP	UP	dn
26	UP	UP	dn	UP	UP	dn
27	UP	UP	dn	UP	UP	dn
28	UP	UP	dn	UP	UP	dn
29	UP	UP	dn	UP	UP	dn
30	UP	UP	dn	UP	UP	dn
31	UP	UP	dn	UP	UP	dn
32	UP	UP	dn	UP	UP	dn
33	UP	UP	dn	UP	UP	dn
34	UP	UP	dn	UP	UP	dn
35	UP	UP	dn	UP	UP	dn
36	UP	UP	dn	UP	UP	dn
37	UP					

# 4140XMP PROGRAMMING FORM

DEFAULT VALUES ARE SHOWN IN BRACKETS [ ]; OTHERWISE DEFAULT = 0

## SECURITY ACCESS OPTIONS

- \*00 INSTALLER CODE   
Enter 4 digits, 0-9 [4140]
- \*01 MASTER SECURITY CODE   
Enter 4 digits, 0-9 [1234] See 1\*54 for 6-digit enable
- \*15 KEYSWITCH ENABLE  1=enable; [0=disable]
- \*29 QUICK ARM  [1=yes]; 0=no
- 1\*50 BABYSITTER CODE  1=enable; [0=disable]; (User 22)
- 1\*54 HIGH SECURITY MODE  1=6-digit high security; [0=4-digit normal]

## EXIT/ENTRY DELAY OPTIONS

- \*09 ENTRY DELAY #1  [02] (00-15 times 15 seconds)
- \*10 EXIT DELAY #1  [03] (00-15 times 15 seconds)
- \*11 ENTRY DELAY #2  [06] (00-15 times 15 seconds)
- \*12 EXIT DELAY #2  [08] (00-15 times 15 seconds)
- \*87 ENTRY WARNING  [1=continuous]; 0=3 beeps
- 1\*45 ENABLE CONSOLE  1=enable; [0=disable]

## ASSIGN RESPONSE TYPE FOR ZONES (Enter 00-10; see Response Types box below)

*02	*03	*04	*05	1*01	1*02	1*03	1*04	1*05	1*08	1*09	
1 <input type="text" value=""/> <input type="text" value=""/>	9 <input type="text" value=""/> <input type="text" value=""/>	17 <input type="text" value=""/> <input type="text" value=""/>	25 <input type="text" value=""/> <input type="text" value=""/>	28 <input type="text" value=""/> <input type="text" value=""/>	33 <input type="text" value=""/> <input type="text" value=""/>	41 <input type="text" value=""/> <input type="text" value=""/>	49 <input type="text" value=""/> <input type="text" value=""/>	57 <input type="text" value=""/> <input type="text" value=""/>	NU <input type="text" value="0"/> <input type="text" value="0"/>	89 <input type="text" value=""/> <input type="text" value=""/>	2nd RCVR
2 <input type="text" value=""/> <input type="text" value=""/>	10 <input type="text" value=""/> <input type="text" value=""/>	18 <input type="text" value=""/> <input type="text" value=""/>	26 <input type="text" value=""/> <input type="text" value=""/>	29 <input type="text" value=""/> <input type="text" value=""/>	34 <input type="text" value=""/> <input type="text" value=""/>	42 <input type="text" value=""/> <input type="text" value=""/>	50 <input type="text" value=""/> <input type="text" value=""/>	58 <input type="text" value=""/> <input type="text" value=""/>	NU <input type="text" value="0"/> <input type="text" value="0"/>	90 <input type="text" value=""/> <input type="text" value=""/>	1st RCVR
3 <input type="text" value=""/> <input type="text" value=""/>	11 <input type="text" value=""/> <input type="text" value=""/>	19 <input type="text" value=""/> <input type="text" value=""/>	27 <input type="text" value=""/> <input type="text" value=""/>	30 <input type="text" value=""/> <input type="text" value=""/>	35 <input type="text" value=""/> <input type="text" value=""/>	43 <input type="text" value=""/> <input type="text" value=""/>	51 <input type="text" value=""/> <input type="text" value=""/>	59 <input type="text" value=""/> <input type="text" value=""/>	NU <input type="text" value="0"/> <input type="text" value="0"/>	91 <input type="text" value=""/> <input type="text" value=""/>	1st RCVR
4 <input type="text" value=""/> <input type="text" value=""/>	12 <input type="text" value=""/> <input type="text" value=""/>	20 <input type="text" value=""/> <input type="text" value=""/>	010	31 <input type="text" value=""/> <input type="text" value=""/>	36 <input type="text" value=""/> <input type="text" value=""/>	44 <input type="text" value=""/> <input type="text" value=""/>	52 <input type="text" value=""/> <input type="text" value=""/>	60 <input type="text" value=""/> <input type="text" value=""/>	NU <input type="text" value="0"/> <input type="text" value="0"/>	For UL applications, use of 1 or 2 RF RCVRs requires enabling their respective faults (88-91) as applicable (type 5).	
5 <input type="text" value=""/> <input type="text" value=""/>	13 <input type="text" value=""/> <input type="text" value=""/>	21 <input type="text" value=""/> <input type="text" value=""/>	97 <input type="text" value=""/> <input type="text" value=""/>	32 <input type="text" value=""/> <input type="text" value=""/>	37 <input type="text" value=""/> <input type="text" value=""/>	45 <input type="text" value=""/> <input type="text" value=""/>	53 <input type="text" value=""/> <input type="text" value=""/>	61 <input type="text" value=""/> <input type="text" value=""/>	NU <input type="text" value="0"/> <input type="text" value="0"/>		
6 <input type="text" value=""/> <input type="text" value=""/>	14 <input type="text" value=""/> <input type="text" value=""/>	22 <input type="text" value=""/> <input type="text" value=""/>	95 <input type="text" value=""/> <input type="text" value=""/>	(1+*)	38 <input type="text" value=""/> <input type="text" value=""/>	46 <input type="text" value=""/> <input type="text" value=""/>	54 <input type="text" value=""/> <input type="text" value=""/>	62 <input type="text" value=""/> <input type="text" value=""/>	NU <input type="text" value="0"/> <input type="text" value="0"/>		
7 <input type="text" value=""/> <input type="text" value=""/>	15 <input type="text" value=""/> <input type="text" value=""/>	23 <input type="text" value=""/> <input type="text" value=""/>	96 <input type="text" value=""/> <input type="text" value=""/>	(3+*)	39 <input type="text" value=""/> <input type="text" value=""/>	47 <input type="text" value=""/> <input type="text" value=""/>	55 <input type="text" value=""/> <input type="text" value=""/>	63 <input type="text" value=""/> <input type="text" value=""/>	NU <input type="text" value="0"/> <input type="text" value="0"/>		
8 <input type="text" value=""/> <input type="text" value=""/>	16 <input type="text" value=""/> <input type="text" value=""/>	24 <input type="text" value=""/> <input type="text" value=""/>	99 <input type="text" value=""/> <input type="text" value=""/>	(*)	40 <input type="text" value=""/> <input type="text" value=""/>	48 <input type="text" value=""/> <input type="text" value=""/>	56 <input type="text" value=""/> <input type="text" value=""/>	64 <input type="text" value=""/> <input type="text" value=""/>	88 <input type="text" value=""/> <input type="text" value=""/>	2nd RCVR	

NOTES: 97 = Poll Loop Short; 88 & 90 = RCVR not receiving transmitter signals. 89 & 91 = RCVR not responding, bad conn. to panel.

RESPONSE TYPES: 00 = Disabled zone; 01 = Entry/Exit #1; 02 = Entry/Exit #2; 03 = Perimeter; 04 = Interior Follower; 05 = Day/Night; 06 = 24 hour Silent Alarm; 07 = 24 hour Audible Alarm; 08 = 24 hour Auxiliary; 09 = Fire; 10 = Interior, Delay;

## DESIGNATE RIGHT LOOP FOR MULTIPLEX EXPANSION 1=yes; [0=no]

- |  |  |
|--|--|
| <ul style="list-style-type: none"> <li>*06 <input type="checkbox"/> <input type="checkbox"/> <input type="checkbox"/> <input type="checkbox"/> <input type="checkbox"/> <input type="checkbox"/> <input type="checkbox"/> <input type="checkbox"/></li> <li>ZONES: 10 11 12 13 14 15 16</li> <li>*07 <input type="checkbox"/> <input type="checkbox"/> <input type="checkbox"/> <input type="checkbox"/> <input type="checkbox"/> <input type="checkbox"/> <input type="checkbox"/> <input type="checkbox"/></li> <li>ZONES: 17 18 19 20 21 22 23 34</li> <li>*08 <input type="checkbox"/> <input type="checkbox"/> <input type="checkbox"/> <input type="checkbox"/> <input type="checkbox"/> <input type="checkbox"/> <input type="checkbox"/> <input type="checkbox"/></li> <li>ZONES: 25 26 27 28 29 30 31 32</li> <li>*24 4190WH TAMPERS DISABLE <input type="checkbox"/> 1=disable; [0=enable]</li> <li>*86 ZONE EXPANDER DEVICE <input type="checkbox"/> <input type="checkbox"/> 1=only one 4208 installed for zones 10-17; [0=more than one 4208 or other devices]</li> </ul> | <ul style="list-style-type: none"> <li>1*10 <input type="checkbox"/> <input type="checkbox"/> <input type="checkbox"/> <input type="checkbox"/> <input type="checkbox"/> <input type="checkbox"/> <input type="checkbox"/> <input type="checkbox"/></li> <li>ZONES: 33 34 35 36 37 38 39 40</li> <li>1*11 <input type="checkbox"/> <input type="checkbox"/> <input type="checkbox"/> <input type="checkbox"/> <input type="checkbox"/> <input type="checkbox"/> <input type="checkbox"/> <input type="checkbox"/></li> <li>ZONES: 41 42 43 44 45 46 47 48</li> <li>1*12 <input type="checkbox"/> <input type="checkbox"/> <input type="checkbox"/> <input type="checkbox"/> <input type="checkbox"/> <input type="checkbox"/> <input type="checkbox"/> <input type="checkbox"/></li> <li>ZONES: 49 50 51 52 53 54 55 56</li> <li>1*13 <input type="checkbox"/> <input type="checkbox"/> <input type="checkbox"/> <input type="checkbox"/> <input type="checkbox"/> <input type="checkbox"/> <input type="checkbox"/> <input type="checkbox"/></li> <li>ZONES: 57 58 59 60 61 62 63 64</li> </ul> |
|--|--|

## SELECTION OF WIRELESS FOR ZONES 1-63

Enter "1" to enable a zone as wireless; 0=non-wireless

- |  |  |
|--|--|
| <ul style="list-style-type: none"> <li>1*18 <input type="checkbox"/> <input type="checkbox"/> <input type="checkbox"/> <input type="checkbox"/> <input type="checkbox"/> <input type="checkbox"/> <input type="checkbox"/> <input type="checkbox"/></li> <li>ZONES: 1 2 3 4 5 6 7 8</li> <li>1*19 <input type="checkbox"/> <input type="checkbox"/> <input type="checkbox"/> <input type="checkbox"/> <input type="checkbox"/> <input type="checkbox"/> <input type="checkbox"/> <input type="checkbox"/></li> <li>ZONES: 9 10 11 12 13 14 15 16</li> <li>1*20 <input type="checkbox"/> <input type="checkbox"/> <input type="checkbox"/> <input type="checkbox"/> <input type="checkbox"/> <input type="checkbox"/> <input type="checkbox"/> <input type="checkbox"/></li> <li>ZONES: 17 18 19 20 21 22 23 24</li> <li>1*21 <input type="checkbox"/> <input type="checkbox"/> <input type="checkbox"/> <input type="checkbox"/> <input type="checkbox"/> <input type="checkbox"/> <input type="checkbox"/> <input type="checkbox"/></li> <li>ZONES: 25 26 27 28 29 30 31 32</li> <li>1*22 <input type="checkbox"/> <input type="checkbox"/> <input type="checkbox"/> <input type="checkbox"/> <input type="checkbox"/> <input type="checkbox"/> <input type="checkbox"/> <input type="checkbox"/></li> <li>ZONES: 33 34 35 36 37 38 39 40</li> <li>1*23 <input type="checkbox"/> <input type="checkbox"/> <input type="checkbox"/> <input type="checkbox"/> <input type="checkbox"/> <input type="checkbox"/> <input type="checkbox"/> <input type="checkbox"/></li> <li>ZONES: 41 42 43 44 45 46 47 48</li> <li>1*24 <input type="checkbox"/> <input type="checkbox"/> <input type="checkbox"/> <input type="checkbox"/> <input type="checkbox"/> <input type="checkbox"/> <input type="checkbox"/> <input type="checkbox"/></li> <li>ZONES: 49 50 51 52 53 54 55 56</li> <li>1*25 <input type="checkbox"/> <input type="checkbox"/> <input type="checkbox"/> <input type="checkbox"/> <input type="checkbox"/> <input type="checkbox"/> <input type="checkbox"/> <input type="checkbox"/></li> <li>ZONES: 57 58 59 60 61 62 63</li> </ul> |  |
|--|--|

## MISCELLANEOUS WIRELESS OPTIONS

- 1\*26 FIRST RF RECEIVER SELECT  1=yes; [0=no]
- 1\*27 SECOND RF RECEIVER SELECT  1=yes; [0=no]
- 1\*28 RF TRANSMITTER LOW  1=immediate; [0=when disarmed]  
BATTERY ANNUN. Must be "1" for UL
- 1\*29 RF TRANSMITTER LOW  1=enable; [0=disable]  
BATTERY REPORT ENABLE Must be "1" for UL
- 1\*30 RF RECEIVER SUPERVISION   
CHECK-IN INTERVAL 02-15 times 2 hours;  
00 disables supervision [6] Max. "6" (12 hr) for UL
- 1\*31 RF TRANSMITTER   
CHECK-IN INTERVAL 02-15 times 2 hours;  
00 disables transmitter supervision [12] Max. "6" (12 hr) for UL
- 1\*44 WIRELESS KEYPAD   
TAMPERS DETECT ENABLE 1=enable; [0=disable]
- 1\*48 WIRELESS KEYPAD DISABLE  1=disable; [0=enable]
- 1\*49 DISABLE TROUBLE SOUNDER   
FOR RF SUPERVISION [1=disable]; 0=enable. Must be "0" for UL.





**ALARM REPORT CODE & ID DIGITS FOR ZONES 1-32 & SUPERVISORY & RESTORE CODES**

[All codes default to 00]

*54 CODE	*55 ID	*56 CODE	*57 ID	*58	*59 CODE	*60 ID	*61 CODE	*62 ID	*63
1		9		Alarm Rst.	17		25		Alarm Rst.
2		10		Trouble	18		26		Trouble
3		11		Trble Rst.	19		27		Trble Rst.
4		12		Bypass	20		28		Bypass
5		13		Bypas Rst.	21		29		Bypas Rst.
6		14			22		30		
7		15			23		31		
8		16			24		32		

**ALARM REPORT CODE & ID DIGITS FOR ZONES 33-64 & SUPERVISORY & RESTORE CODES**

[All codes default to 00]

*64 CODE	*65 ID	*66 CODE	*67 ID	*68	*69 CODE	*70 ID	*71 CODE	*72 ID	*73
33		41		Alarm Rst.	49		57		Alarm Rst.
34		42		Trouble	50		58		Trouble
35		43		Trble Rst.	51		59		Trble Rst.
36		44		Bypass	52		60		Bypass
37		45		Bypas Rst.	53		61		Bypas Rst.
38		46			54		62		
39		47			55		63		
40		48			56		64		

**ALARM REPORT CODE & ID DIGITS FOR RF RCVRs & PANICS & THEIR SUPV & RESTORE CODES**

[All codes default to 00]

*74 CODE	*75 ID	*76 CODE	*77 ID	*78
NU 0 0	0 0	89		Alarm Rst.
NU 0 0	0 0	90		Trouble
NU 0 0	0 0	91		Trble Rst.
NU 0 0	0 0	Dures		Bypass
NU 0 0	0 0	97		Bypas Rst.
NU 0 0	0 0	95		(1 + #)
NU 0 0	0 0	96		(3 + #)
88		99		(* + #)

NOTES: 97= Poll Loop Short; 88 & 90 = RCVR not receiving transmitter signals. 89 & 91 = RCVR not responding, bad conn. to panel.

**SYSTEM NON ALARM CODES**

	*81 First Digit	*82 Second Digit	
Close			Second digit of each code applies only to 4+2 or expanded (fields *52 & *53) formats.
Open			
Low Battery			
Low Bat Res.			
AC Loss			
AC Restore			
Test			
Power			
Cancel			
Prog. Tamper			

**ZONE TYPE RESTORE ENABLES**

1=enable; [0=disable]

*79	ZONE TYPES 1-8							
	1	2	3	4	5	6	7	8
*80	ZONE TYPES 9 & 10							
			9	10				

**OPEN/CLOSE REPORT ENABLES**

1=enable; 0=disable [User 1 enabled]

*39								
	1	2	3	4	5	6	7	8
*40								
	9	10	11	12	13	14	15	16
1*00								
	17	18	19	20	21	22	23-70	

### INDEX TO PROGRAM FIELDS

FLD	FUNCTION	SECTION	FLD	FUNCTION	SECTION
*00	INSTALLER CODE	ACCESS OPTS	*54.*78	REPORT CODES FOR ZONES 1-64	ALARM CODES
*01	MASTER SECURITY CODE	ACCESS OPTS	*79.*80	ZONE TYPE RESTORE ENABLES	ZONE TYPE REST.
*02	RESPONSE TYPE FOR ZONES 1-8	RESPONSE TYPES	*81.*82	SYSTEM NON-ALARM CODES	SYSTEM CODES
*03	RESPONSE TYPE FOR ZONES 9-16	RESPONSE TYPES	*83	FIRST TEST REPORT TIME	TEST TIMER
*04	RESPONSE TYPE FOR ZONES 17-24	RESPONSE TYPES	*84	SWINGER SUPPRESSION	PHONE LINE/COMM.
*05	RESPONSE TYPE FOR ZONES 25-27	RESPONSE TYPES	*86	ZONE EXPANDER DEVICE	RIGHT LOOP
*06	RIGHT LOOP FOR ZONES: 10-16	RIGHT LOOP	*87	ENTRY WARNING	ENTRY/EXIT
*07	RIGHT LOOP FOR ZONES: 17-24	RIGHT LOOP	*88	BURG. ALARM COMM. DELAY	PHONE LINE/COMM.
*08	RIGHT LOOP FOR ZONES: 25-32	RIGHT LOOP	*90	SECONDARY SUBSCRIBER ACCT	PHONE LINE/COMM.
*09	ENTRY DELAY #1	EXIT/ENTRY	*100	OPEN/CLOSE REPORTING ENABLE BY USERS 17-70	OPEN/CLOSE REP.
*10	EXIT DELAY #1	EXIT/ENTRY	*101	RESPONSE TYPE FOR ZONES 28-32	RESPONSE TYPES
*11	ENTRY DELAY #2	EXIT/ENTRY	*102	RESPONSE TYPE FOR ZONES 33-40	RESPONSE TYPES
*12	EXIT DELAY #2	EXIT/ENTRY	*103	RESPONSE TYPE FOR ZONES 41-48	RESPONSE TYPES
*13	ALARM SOUNDER DURATION	SOUNDER OPTS	*104	RESPONSE TYPE FOR ZONES 49-56	RESPONSE TYPES
*14	ZONE 9 FAST/SLOW RESPONSE	MISC SYSTEM OPTS	*105	RESPONSE TYPE FOR ZONES 57-64	RESPONSE TYPES
*15	KEYSWITCH ENABLE	ACCESS OPTS	*108	RESPONSE TYPE FOR ZONE 88	RESPONSE TYPES
*16	CONFIRMATION OF ARMING DING	SOUNDER OPTS	*109	RESPONSE TYPE FOR ZONES 89-91	RESPONSE TYPES
*17	AC POWER LOSS SOUNDING	AC LOSS OPTS	*110	RIGHT LOOP FOR ZONES:33-40	RIGHT LOOP
*18	AC POWER LOSS ALARM	AC LOSS OPTS	*111	RIGHT LOOP FOR ZONES:41-48	RIGHT LOOP
*19	AC RANDOMIZE	AC LOSS OPTS	*112	RIGHT LOOP FOR ZONES:49-56	RIGHT LOOP
*21	DISABLE FIRE TIME-OUT	SOUNDER OPTS	*113	RIGHT LOOP FOR ZONES:57-64	RIGHT LOOP
*23	MULTIPLE ALARMS	SOUNDER OPTS	*118	SELECT WIRELESS FOR ZONES 1-8	SELECT WIRELESS
*24	4190WH TAMPER DISABLE	RIGHT LOOP	*119	SELECT WIRELESS FOR ZONES 9-16	SELECT WIRELESS
*26	INTELLIGENT TEST REPORTING	TEST TIMER	*120	SELECT WIRELESS ZONES 17-24	SELECT WIRELESS
*27	TEST REPORT INTERVAL	TEST TIMER	*121	SELECT WIRELESS ZONES 25-32	SELECT WIRELESS
*28	POWER UP IN PREVIOUS STATE	AC LOSS OPTS	*122	SELECT WIRELESS ZONES 33-40	SELECT WIRELESS
*29	QUICK ARM	ACCESS OPTS	*123	SELECT WIRELESS ZONES 41-48	SELECT WIRELESS
*30	TOUCH-TONE OR ROTARY DIAL	PHONE LINE/COMM.	*124	SELECT WIRELESS ZONES 49-56	SELECT WIRELESS
*31	PABX ACCESS CODE	PHONE LINE/COMM.	*125	SELECT WIRELESS FZONES 57-63	SELECT WIRELESS
*32	PRIMARY SUBSCRIBER ACCT #	PHONE LINE/COMM.	*126	1st RF RECEIVER EXPSELECT	MISC WIRELESS
*33	PRIMARY PHONE NUMBER	PHONE LINE/COMM.	*127	2nd RF RECEIVER EXP SELECT	MISC WIRELESS
*34	SECONDARY PHONE NUMBER	PHONE LINE/COMM.	*128	RF TRANSMITTER LOW	MISC WIRELESS
*35	DOWNLOAD PHONE No.	DOWNLOADING	*129	RF TRANS. LOW BATTERY ANNUN	MISC WIRELESS
*36	DOWNLOAD ID No.	DOWNLOADING	*130	RF RECEIVER SUPERVISION	MISC WIRELESS
*37	DOWNLOAD COMMAND ENABLES	DOWNLOADING	*131	RF TRANS.CHECK-IN INTERVAL	MISC WIRELESS
*38	INHIBIT BYPASS OF ONE ZONE	MISC SYSTEM OPTS	*133	TOUCHTONE DIAL W/ROTARY BACK-UP ENABLE	PHONE LINE/COMM.
*39	OPEN/CLOSE REPORTING ENABLE BY USERS 1-8	OPEN/CLOSE REP.	*134	COMMUNICATOR SPLIT REPORT NG	PHONE LINE/COMM.
*40	OPEN/CLOSE REPORTING ENABLE BY USERS 9-16	OPEN/CLOSE REP.	*144	WIRELESS KEYPAD	MISC WIRELESS
*41	EOLR DISABLE (Zones 2-8)	MISC SYSTEM OPTS	*145	ENABLE CONSOLE ANNUN. DURING EXIT DELAY	EXIT/ENTRY
*42	DIAL TONE PAUSE	PHONE LINE/COMM.	*146	AUXILIARY OUTPUT ENABLE	MISC SYSTEM OPTS
*43	DIAL TONE DETECTION	PHONE LINE/COMM.	*147	ENABLE CHIME ANNUN. ON EXTERNAL ALARM SOUNDER	SOUNDER OPTS
*44	RING DETECTION COUNT	DOWNLOADING	*148	WIRELESS KEYPAD DISABLE TAMPER DETECT ENABLE	MISC WIRELESS
*45	PRIMARY FORMAT	PHONE LINE/COMM.	*149	DISABLE TROUBLE SOUNDER FOR RF SUPERVISION	MISC WIRELESS
*46	LOW SPEED FORMAT	PHONE LINE/COMM.	*150	BABYSITTER CODE ENABLE	ACCESS OPTS
*47	SECONDARY FORMAT	PHONE LINE/COMM.	*152	CANCEL REPORT RESTRICTION	PHONE LINE/COMM.
*48	LOW SPEED FORMAT (Sec.)	PHONE LINE/COMM.	*153	DOWNLOAD CALLBACK	DOWNLOADING
*49	CHECKSUM VERIFICATION	PHONE LINE/COMM.	*154	SECURITY CODE MODE	ACCESS OPTS
*50	SESCOA/RADIONICS SELECT	PHONE LINE/COMM.			
*51	DUAL REPORTING	PHONE LINE/COMM.			
*52	STANDARD/EXP REPORT PRIMARY	PHONE LINE/COMM.			
*53	STANDARD/EXP REPORT SECNDRY	PHONE LINE/COMM.			

### PROGRAMMING COMMANDS

- To enter program mode, enter installer code + [8] + [0] + [0]
- To set standard defaults, press \*97
- To set communication defaults, press \*94 + one of the following: \*80=low speed; \*81=Ademco Express; \*82=Ademco High Speed; \*83=Ademco's Contact ID
- To change to next set of program fields, press \*94
- To return to previous set of fields, press \*99
- To erase account & phone number field entries, press [\*] + field number + [\*]
- To assign zone descriptors, press \*93 + zone number
- To add custom words, press \*93 + 00 + word number (1-20)
- To enter Installer's Message, press \*93 + 00 + 00
- To exit program mode, press \*99 OR \*98: \*99 allows re-access to programming mode by installer code. \*98 prevents re-access to programming mode by installer code.

**COMMUNICATION DEFAULTS for LOW SPEED FORMAT (\*94\*80)**

- \*45 PRIMARY FORMAT  Ademco Low Speed
- \*46 LOW SPEED FORMAT (Primary)  Ademco Low Speed
- \*47 SECONDARY FORMAT  Ademco Low Speed
- \*48 LOW SPEED FORMAT (Sec.)  Ademco Low Speed
- \*49 CHECKSUM VERIFICATION    
No checksum Primary Secondary
- \*50 SESCOA/RADIONICS SELECT  Radionics
- \*51 DUAL REPORTING  no
- \*52 STANDARD/EXPANDED REPORT FOR PRIMARY  
      standard  
Alarm Rstr Bypass Trbl Opn/Cls Low Bat
- \*53 STANDARD/EXPANDED REPORT FOR SECONDARY  
      standard  
Alarm Rstr Bypass Trbl Opn/Cls Low Bat

**ALARM REPORT CODE & ID DIGITS FOR ZONES 1-32 & SUPERVISORY & RESTORE CODES**

*54 CODE	*55 ID	*56 CODE	*57 ID	*58	*59 CODE	*60 ID	*61 CODE	*62 ID	*63	
1	0 1	9	0 3	0 0	0 9	17	0 3	25	0 9	Alarm Rst.
2	0 3	10	0 3	0 0	0 0	18	0 3	26	0 0	Trouble
3	0 3	11	0 3	0 0	0 0	19	0 3	27	0 0	Trble Rst.
4	0 3	12	0 3	0 0	0 0	20	0 3	28	0 0	Bypass
5	0 3	13	0 3	0 0	0 0	21	0 3	29	0 0	Bypas Rst.
6	0 3	14	0 3	0 0		22	0 3	30	0 0	
7	0 3	15	0 3	0 0		23	0 3	31	0 0	
8	0 3	16	0 3	0 0		24	0 3	32	0 0	

**ALARM REPORT CODE & ID DIGITS FOR ZONES 33-64 & SUPERVISORY & RESTORE CODES**

*64 CODE	*65 ID	*66 CODE	*67 ID	*68	*69 CODE	*70 ID	*71 CODE	*72 ID	*73	
33	0 3	41	0 3	0 0	0 9	49	0 1	57	0 9	Alarm Rst.
34	0 3	42	0 3	0 0	0 0	50	0 1	58	0 0	Trouble
35	0 3	43	0 3	0 0	0 0	51	0 1	59	0 0	Trble Rst.
36	0 3	44	0 3	0 0	0 0	52	0 1	60	0 0	Bypass
37	0 3	45	0 3	0 0	0 0	53	0 1	61	0 0	Bypas Rst.
38	0 3	46	0 3	0 0		54	0 1	62	0 2	
39	0 3	47	0 3	0 0		55	0 1	63	0 2	
40	0 3	48	0 1	0 0		56	0 3	64	0 3	

**ALARM REPORT CODE & ID DIGITS FOR RF RCVRs & PANICS & THEIR SUPV & RESTORE CODES**

*74 CODE	*75 ID	*76 CODE	*77 ID	*78		
NU	0 0	89	0 7	0 0	0 9	Alarm Rst.
NU	0 0	90	0 7	0 0	0 0	Trouble
NU	0 0	91	0 7	0 0	0 0	Trble Rst.
NU	0 0	Dures	0 2	0 0	0 0	Bypass
NU	0 0	97	0 7	0 0	0 0	Bypas Rst.
NU	0 0	95	0 2	0 0	(1 + #)	
NU	0 0	96	0 2	0 0	(3 + #)	
88	0 7	99	0 2	0 0	(# + #)	

SYSTEM NON ALARM CODES		
	*81 First Digit	*82 Second Digit
Close	0 0	0 0
Open	0 0	0 0
Low Battery	0 0	0 0
Low Bat Res.	0 0	0 0
AC Loss	0 0	0 0
AC Restore	0 0	0 0
Test	0 0	0 0
Power	0 0	0 0
Cancel	0 0	0 0
Prog. Tamper	0 0	0 0

Second digit of each code applies only to 4-2 or expanded (fields \*52 & \*53) formats.

NOTES: 97= Poll Loop Short; 88 & 90 = RCVR not receiving transmitter signals. 89 & 91 = RCVR not responding, bad conn. to panel.

**ZONE TYPE RESTORE ENABLES**

- \*79 ZONE TYPES 1-8 All enabled  
         
 1 2 3 4 5 6 7 8
- \*80 ZONE TYPES 9 & 10 All enabled  
   
 9 10

**COMMUNICATION DEFAULTS for ADEMCO EXPRESS FORMAT (\*94\*81)**

- \*45 PRIMARY FORMAT  Ademco Express
- \*46 LOW SPEED FORMAT (Primary)
- \*47 SECONDARY FORMAT  Ademco Express
- \*48 LOW SPEED FORMAT (Sec.)
- \*49 CHECKSUM VERIFICATION    
 No checksum Primary Secondary
- \*50 SESCO/RADIONICS SELECT  Radionics
- \*51 DUAL REPORTING  no
- \*52 STANDARD/EXPANDED REPORT FOR PRIMARY  
      standard  
 Alarm Rstr Bypass Trbl Oprn/Cls Low Bat
- \*53 STANDARD/EXPANDED REPORT FOR SECONDARY  
      standard  
 Alarm Rstr Bypass Trbl Oprn/Cls Low Bat

**ALARM REPORT CODE & ID DIGITS FOR ZONES 1-32 & SUPERVISORY & RESTORE CODES**

*54 CODE	*55 ID	*56 CODE	*57 ID	*58	*59 CODE	*60 ID	*61 CODE	*62 ID	*63						
1	1 0	0 1	9	1 0	0 9	1 4	Alarm Rst.	17	0 1	0 7	25	0 2	0 5	1 4	Alarm Rst.
2	1 0	0 2	10	0 1	1 0	0 0	Trouble	18	0 1	0 8	26	0 2	0 6	0 0	Trouble
3	1 0	0 3	11	0 1	0 1	0 0	Trble Rst.	19	0 1	0 9	27	0 2	0 7	0 0	Trble Rst.
4	1 0	0 4	12	0 1	0 2	0 0	Bypass	20	0 2	1 0	28	0 2	0 8	0 0	Bypass
5	1 0	0 5	13	0 1	0 3	0 0	Bypas Rst.	21	0 2	0 1	29	0 2	0 9	0 0	Bypas Rst.
6	1 0	0 6	14	0 1	0 4			22	0 2	0 2	30	0 3	1 0		
7	1 0	0 7	15	0 1	0 5			23	0 2	0 3	31	0 3	0 1		
8	1 0	0 8	16	0 1	0 6			24	0 2	0 4	32	0 3	0 2		

**ALARM REPORT CODE & ID DIGITS FOR ZONES 33-64 & SUPERVISORY & RESTORE CODES**

*64 CODE	*65 ID	*66 CODE	*67 ID	*68	*69 CODE	*70 ID	*71 CODE	*72 ID	*73						
33	0 3	0 3	41	0 4	0 1	1 4	Alarm Rst.	49	0 4	0 9	57	0 5	0 7	1 4	Alarm Rst.
34	0 3	0 4	42	0 4	0 2	0 0	Trouble	50	0 5	1 0	58	0 5	0 8	0 0	Trouble
35	0 3	0 5	43	0 4	0 3	0 0	Trble Rst.	51	0 5	0 1	59	0 5	0 9	0 0	Trble Rst.
36	0 3	0 6	44	0 4	0 4	0 0	Bypass	52	0 5	0 2	60	0 6	1 0	0 0	Bypass
37	0 3	0 7	45	0 4	0 5	0 0	Bypas Rst.	53	0 5	0 3	61	0 6	0 1	0 0	Bypas Rst.
38	0 3	0 8	46	0 4	0 6			54	0 5	0 4	62	0 6	0 2		
39	0 3	0 9	47	0 4	0 7			55	0 5	0 5	63	0 6	0 3		
40	0 4	1 0	48	0 4	0 8			56	0 5	0 6	64	0 6	0 4		

**ALARM REPORT CODE & ID DIGITS FOR RF RCVR & PANICS & THEIR SUPV & RESTORE CODES**

*74 CODE	*75 ID	*76 CODE	*77 ID	*78			
NU	0 0	0 0	89	0 8	0 9	1 4	Alarm Rst.
NU	0 0	0 0	90	0 9	1 0	0 0	Trouble
NU	0 0	0 0	91	0 9	0 1	0 0	Trble Rst.
NU	0 0	0 0	Dures	1 3	1 3	0 0	Bypass
NU	0 0	0 0	97	0 9	0 7	0 0	Bypas Rst.
NU	0 0	0 0	95	0 9	0 5	(1 + #)	
NU	0 0	0 0	96	0 9	0 6	(3 + #)	
88	0 8	0 8	99	0 9	0 9	(# + #)	

NOTES: 97- Poll Loop Short; 88 & 90 = RCVR not receiving transmitter signals. 89 & 91 = RCVR not responding, bad conn. to panel.

**SYSTEM NON ALARM CODES**

	*81 First Digit	*82 Second Digit
Close	0 0	0 0
Open	0 0	0 0
Low Battery	0 0	0 0
Low Bat Res.	0 0	0 0
AC Loss	0 0	0 0
AC Restore	0 0	0 0
Test	0 0	0 0
Power	0 0	0 0
Cancel	0 0	0 0
Prog. Tamper	0 0	0 0

Second digit of each code applies only to 4+2 or expanded (fields \*52 & \*53) formats.

**ZONE TYPE RESTORE ENABLES**

- \*79 ZONE TYPES 1-8 All enabled  
         
 1 2 3 4 5 6 7 8
- \*80 ZONE TYPES 9 & 10 All enabled  
   
 9 10

**COMMUNICATION DEFAULTS for ADEMCO HIGH SPEED FORMAT (\*94\*82)**

- \*45 PRIMARY FORMAT  Ademco High Speed
- \*46 LOW SPEED FORMAT (Primary)
- \*47 SECONDARY FORMAT  Ademco High Speed
- \*48 LOW SPEED FORMAT (Sec.)
- \*49 CHECKSUM VERIFICATION    
 No checksum Primary Secondary
- \*50 SESCO/RADIONICS SELECT  Radionics
- \*51 DUAL REPORTING  no
- \*52 STANDARD/EXPANDED REPORT FOR PRIMARY  
      standard  
 Alarm Rstr Bypass Trbl Opr/Cls Low Bat
- \*53 STANDARD/EXPANDED REPORT FOR SECONDARY  
      standard  
 Alarm Rstr Bypass Trbl Opr/Cls Low Bat

**ALARM REPORT CODE & ID DIGITS FOR ZONES 1-32 & SUPERVISORY & RESTORE CODES**

*54 CODE	*55 ID	*56 CODE	*57 ID	*58	*59 CODE	*60 ID	*61 CODE	*62 ID	*63
1	0 1	9	0 3	0 1	17	0 4	25	0 4	0 1
2	0 2	10	0 3	0 0	18	0 4	26	0 4	0 0
3	0 2	11	0 3	0 0	19	0 4	27	0 4	0 0
4	0 2	12	0 3	0 0	20	0 4	28	0 4	0 0
5	0 2	13	0 3	0 0	21	0 4	29	0 4	0 0
6	0 2	14	0 3	0 0	22	0 4	30	0 4	0 0
7	0 2	15	0 3	0 0	23	0 4	31	0 4	0 0
8	0 2	16	0 3	0 0	24	0 4	32	0 5	0 0

**ALARM REPORT CODE & ID DIGITS FOR ZONES 33-64 & SUPERVISORY & RESTORE CODES**

*64 CODE	*65 ID	*66 CODE	*67 ID	*68	*69 CODE	*70 ID	*71 CODE	*72 ID	*73
33	0 5	41	0 5	0 1	49	0 1	57	0 6	0 1
34	0 5	42	0 5	0 0	50	0 1	58	0 6	0 0
35	0 5	43	0 5	0 0	51	0 1	59	0 6	0 0
36	0 5	44	0 5	0 0	52	0 1	60	0 6	0 0
37	0 5	45	0 5	0 0	53	0 1	61	0 6	0 0
38	0 5	46	0 5	0 0	54	0 1	62	0 9	0 0
39	0 5	47	0 5	0 0	55	0 1	63	0 9	0 0
40	0 5	48	0 1	0 0	56	0 6	64	0 6	0 0

**ALARM REPORT CODE & ID DIGITS FOR RF RCVRs & PANICS & THEIR SUPV. & RESTORE CODES**

*74 CODE	*75 ID	*76 CODE	*77 ID	*78
NU	0 0	89	0 7	0 1
NU	0 0	90	0 8	0 0
NU	0 0	91	0 8	0 0
NU	0 0	Dures	0 1	0 0
NU	0 0	97	0 7	0 0
NU	0 0	95	1 0	0 0 (1 + #)
NU	0 0	96	1 1	0 0 (3 + #)
88	0 7	99	1 2	0 0 (# + #)

SYSTEM NON ALARM CODES		
	*81	*82
	First Digit	Second Digit
Close	0 0	0 0
Open	0 0	0 0
Low Battery	0 0	0 0
Low Bat Res.	0 0	0 0
AC Loss	0 0	0 0
AC Restore	0 0	0 0
Test	0 0	0 0
Power	0 0	0 0
Cancel	0 0	0 0
Prog. Tamper	0 0	0 0

Second digit of each code applies only to 4+2 or expanded (fields \*52 & \*53) formats.

NOTES: 97= Poll Loop Short; 88 & 90 = RCVR not receiving transmitter signals. 89 & 91 = RCVR not responding, bad conn. to panel.

**ZONE TYPE RESTORE ENABLES**

- \*79 ZONE TYPES 1-8 All enabled  
         
 1 2 3 4 5 6 7 8
- \*80 ZONE TYPES 9 & 10 All enabled  
   
 9 10

**COMMUNICATION DEFAULTS for ADEMCO's CONTACT ID FORMAT (\*94\*83)**

- |                                |                                     |                          |  |                          |                          |                          |                          |                          |                          |          |
|--------------------------------|-------------------------------------|--------------------------|--|--------------------------|--------------------------|--------------------------|--------------------------|--------------------------|--------------------------|----------|
| *45 PRIMARY FORMAT             | <input checked="" type="checkbox"/> | Ademco Contact ID        | *51 DUAL REPORTING                         | <input type="checkbox"/> | no                       |                          |                          |                          |                          |          |
| *46 LOW SPEED FORMAT (Primary) | <input type="checkbox"/>            |                          | *52 STANDARD/EXPANDED REPORT FOR PRIMARY   | <input type="checkbox"/> | <input type="checkbox"/> | <input type="checkbox"/> | <input type="checkbox"/> | <input type="checkbox"/> | <input type="checkbox"/> | standard |
| *47 SECONDARY FORMAT           | <input checked="" type="checkbox"/> | Ademco Contact ID        | Alarm                                      | Rstr                     | Bypass                   | Trbl                     | Oprv/Cls                 | Low Bat                  |                          |          |
| *48 LOW SPEED FORMAT (Sec.)    | <input type="checkbox"/>            |                          | *53 STANDARD/EXPANDED REPORT FOR SECONDARY | <input type="checkbox"/> | <input type="checkbox"/> | <input type="checkbox"/> | <input type="checkbox"/> | <input type="checkbox"/> | <input type="checkbox"/> | standard |
| *49 CHECKSUM VERIFICATION      | <input type="checkbox"/>            | <input type="checkbox"/> | Alarm                                      | Rstr                     | Bypass                   | Trbl                     | Oprv/Cls                 | Low Bat                  |                          |          |
| No checksum                    |                                     | Primary                  | Secondary                                  |                          |                          |                          |                          |                          |                          |          |
| *50 SESCOA/RADIONICS SELECT    | <input type="checkbox"/>            | Radionics                |  |                          |                          |                          |                          |                          |                          |          |

**ALARM REPORT CODE & ID DIGITS FOR ZONES 1-32 & SUPERVISORY & RESTORE CODES**

*54 CODE	*55 ID	*56 CODE	*57 ID	*58	*59 CODE	*60 ID	*61 CODE	*62 ID	*63						
1	0 1	0 0	9	0 9	0 0	0 1	Alarm Rst.	17	0 2	0 0	25	1 0	0 0	0 1	Alarm Rst.
2	0 2	0 0	10	1 0	0 0	0 0	Trouble	18	0 3	0 0	26	1 1	0 0	0 0	Trouble
3	0 3	0 0	11	1 1	0 0	0 0	Trble Rst.	19	0 4	0 0	27	1 2	0 0	0 0	Trble Rst.
4	0 4	0 0	12	1 2	0 0	0 0	Bypass	20	0 5	0 0	28	1 3	0 0	0 0	Bypass
5	0 5	0 0	13	1 3	0 0	0 0	Bypss Rst.	21	0 6	0 0	29	1 4	0 0	0 0	Bypss Rst.
6	0 6	0 0	14	1 4	0 0			22	0 7	0 0	30	1 5	0 0		
7	0 7	0 0	15	1 5	0 0			23	0 8	0 0	31	0 1	0 0		
8	0 8	0 0	16	0 1	0 0			24	0 9	0 0	32	0 2	0 0		

**ALARM REPORT CODE & ID DIGITS FOR ZONES 33-64 & SUPERVISORY & RESTORE CODES**

*64 CODE	*65 ID	*66 CODE	*67 ID	*68	*69 CODE	*70 ID	*71 CODE	*72 ID	*73						
33	0	0 0	41	1 1	0 0	0 1	Alarm Rst.	49	0 4	0 0	57	1 2	0 0	0 1	Alarm Rst.
34	0	0 0	42	1 2	0 0	0 0	Trouble	50	0 5	0 0	58	1 3	0 0	0 0	Trouble
35	0	0 0	43	1 3	0 0	0 0	Trble Rst.	51	0 6	0 0	59	1 4	0 0	0 0	Trble Rst.
36	0	0 0	44	1 4	0 0	0 0	Bypass	52	0 7	0 0	60	1 5	0 0	0 0	Bypass
37	0	0 0	45	1 5	0 0	0 0	Bypss Rst.	53	0 8	0 0	61	0 1	0 0	0 0	Bypss Rst.
38	0	0 0	46	0 1	0 0			54	0 9	0 0	62	0 2	0 0		
39	0	0 0	47	0 2	0 0			55	1 0	0 0	63	0 3	0 0		
40	1 0	0 0	48	0 3	0 0			56	1 1	0 0	64	0 4	0 0		

**ALARM REPORT CODE & ID DIGITS FOR RF RCVRs & PANICS & THEIR SUPV. & RESTORE CODES**

*74 CODE	*75 ID	*76 CODE	*77 ID	*78			
NU	0 0	0 0	89	1 4	0 0	0 1	Alarm Rst.
NU	0 0	0 0	90	1 5	0 0	0 0	Trouble
NU	0 0	0 0	91	0 1	0 0	0 0	Trble Rst.
NU	0 0	0 0	Dures	0 2	0 0	0 0	Bypass
NU	0 0	0 0	97	0 3	0 0	0 0	Bypss Rst.
NU	0 0	0 0	95	0 4	0 0	(1 + #)	
NU	0 0	0 0	96	0 5	0 0	(3 + #)	
88	1 3	0 0	99	0 6	0 0	(# + #)	

NOTES: 97 = Poll Loop Short; 88 & 90 = RCVR not receiving transmitter signals. 89 & 91 = RCVR not responding, bad conn. to panel.

**SYSTEM NON ALARM CODES**

	*81 First Digit	*82 Second Digit
Close	0 0	0 0
Open	0 0	0 0
Low Battery	0 0	0 0
Low Bat Res.	0 0	0 0
AC Loss	0 0	0 0
AC Restore	0 0	0 0
Test	0 0	0 0
Power	0 0	0 0
Cancel	0 0	0 0
Prog. Tamper	0 0	0 0

Second digit of each code applies only to 4+2 or expanded (fields \*52 & \*53) formats.

**ZONE TYPE RESTORE ENABLES**

- \*79 ZONE TYPES 1-8 All enabled  
         
 1 2 3 4 5 6 7 8
- \*80 ZONE TYPES 9 & 10 All enabled  
   
 9 10

### **"FEDERAL COMMUNICATIONS COMMISSION (FCC) STATEMENT"**

This equipment has been tested to FCC requirements and has been found acceptable for use. The FCC requires the following statement for your information:

This equipment generates and uses radio frequency energy and if not installed and used properly, that is, in strict accordance with the manufacturer's instructions, may cause interference to radio and television reception. It has been type tested and found to comply with the limits for a Class B computing device in accordance with the specifications in Subpart J of Part 15 of FCC Rules, which are designed to provide reasonable protection against such interference in a residential installation. However, there is no guarantee that interference will not occur in a particular installation. If this equipment does cause interference to radio or television reception, which can be determined by turning the equipment off and on, the user is encouraged to try to correct the interference by one or more of the following measures:

- If using an indoor antenna, have a quality outdoor antenna installed.
- Reorient the receiving antenna until interference is reduced or eliminated.
- Move the receiver away from the control/communicator.
- Move the antenna leads away from any wire runs to the control/communicator.
- Plug the control/communicator into a different outlet so that it and the receiver are on different branch circuits.

If necessary, the user should consult the dealer or an experienced radio/television technician for additional suggestions.

The user or installer may find the following booklet prepared by the Federal Communications Commission helpful:  
"Interference Handbook"

This booklet is available from the U.S. Government Printing Office, Washington, DC 20402.  
Stock No. 004-000-00450-7.

The user shall not make any changes or modifications to the equipment unless authorized by the Installation Instructions or User's Manual. Unauthorized changes or modifications could void the user's authority to operate the equipment.

### **IN THE EVENT OF TELEPHONE OPERATIONAL PROBLEMS**

In the event of telephone operational problems, disconnect the control panel by removing the plug from the RJ31X (CA38A in Canada) wall jack. We recommend that you demonstrate disconnecting the phones on installation of the system. Do not disconnect the phone connection inside the Control Panel. Doing so will result in the loss of your phone lines. If the regular phone works correctly after the Control Panel has been disconnected from the phone lines, The Control Panel has a problem and should be returned for repair. If upon disconnection of the Control Panel, there is still a problem on the line, notify the telephone company that they have a problem and request prompt repair service. The user may not under any circumstances (in or out of warranty) attempt any service or repairs to the system. It must be returned to the factory or an authorized service agency for all repairs.



## CANADIAN DEPARTMENT OF COMMUNICATIONS (DOC) STATEMENT

### NOTICE

The Canadian Department of Communications label identifies certified equipment. This certification means that the equipment meets certain telecommunications network protective, operational and safety requirements. The Department does not guarantee the equipment will operate to the user's satisfaction.

Before installing this equipment, users should ensure that it is permissible to be connected to the facilities of the local telecommunications company. The equipment must also be installed using an acceptable method of connection. In some cases, the company's inside wiring associated with a single line individual service may be extended by means of certified connector assembly (telephone extension cord). The customer should be aware that compliance with the above conditions may not prevent degradation of service in some situations.

Repairs to certified equipment should be made by an authorized Canadian maintenance facility designated by the supplier. Any repairs or alterations made by the user to this equipment, or equipment malfunctions, may give the telecommunications company cause to request the user to disconnect the equipment.

Users should ensure for their own protection that the electrical ground connections of the power utility, telephone lines and internal metallic water pipe system, if present, are connected together. This precaution may be particularly important in rural areas.

**Caution:** User should not attempt to make such connections themselves, but should contact the appropriate electric inspection authority, or electrician, as appropriate.

**The Load Number (LN)** assigned to each terminal device denotes the percentage of the total load to be connected to a telephone loop which is used by the device, to prevent overloading. The termination on a loop may consist of any combination of devices subject only to the requirement that the total of the Load Numbers of all the devices does not exceed 100.

### AVIS

L'étiquette du ministère des Communications du Canada identifie le matériel homologué. Cette étiquette certifie que le matériel est conforme à certaines normes de protection, d'exploitation et de sécurité des réseaux de télécommunications. Le ministère n'assure toutefois pas que le matériel fonctionnera à la satisfaction de l'utilisateur.

Avant d'installer ce matériel, l'utilisateur doit s'assurer qu'il est permis de le raccorder aux installations de l'entreprise locale de télécommunication. Le matériel doit également être installé en suivant une méthode acceptée de raccordement. Dans certains cas, les fils intérieurs de l'entreprise utilisés pour un service individuel à ligne unique peuvent être prolongés au moyen d'un dispositif homologué de raccordement (cordon prolongateur téléphonique interne). L'abonné ne doit pas oublier qu'il est possible que la conformité aux conditions énoncées ci-dessus n'empêchent pas la dégradation du service par certaines situations. Actuellement, les entreprises de télécommunication ne permettent pas que l'on raccorde leur matériel aux jacks d'abonnés, sauf dans les cas précis prévus par les tarifs particuliers de ces entreprises.

Les réparations de matériel homologué doivent être effectuées par un centre d'entretien canadien autorisé désigné par le fournisseur. La compagnie de télécommunications peut demander à l'utilisateur de débrancher un appareil à la suite de réparations ou de modifications effectuées par l'utilisateur ou à cause de mauvais fonctionnement.

Pour sa propre protection, l'utilisateur doit s'assurer que tous les fils de mise à la terre de la source d'énergie électrique, des lignes téléphoniques et des canalisations d'eau métalliques, s'il y en a, sont raccordés ensemble. Cette précaution est particulièrement importante dans les régions rurales.

**Avertissement:** L'utilisateur ne doit pas tenter de faire ces raccordements lui-même; il doit avoir recours à un service d'inspection des installations électriques, ou à un électricien, selon le cas.

**L'indice de charge (IC)** assigné à chaque dispositif terminal pour éviter toute surcharge indique le pourcentage de la charge totale qui peut être raccordée à un circuit téléphonique bouclé utilisé par ce dispositif. La terminaison du circuit bouclé peut être constituée de n'importe quelle combinaison de dispositifs, pourvu que la somme des indices de charge de l'ensemble des dispositifs ne dépasse pas 100.

**WARNING**  
**THE LIMITATIONS OF THIS ALARM SYSTEM**

While this system is an advanced design security system, it does not offer guaranteed protection against burglary, fire or other emergency. An alarm system, whether commercial or residential, is subject to compromise or failure to warn for a number of reasons. For example:

- Intruders may gain access through unprotected openings or have the technical sophistication to bypass an alarm sensor or disconnect an alarm warning device.
- Intrusion detectors (e.g. passive infrared detectors), smoke detectors, and many other sensing devices will not work without power. Battery operated devices will not work without batteries, with dead batteries, or if the batteries are not put in properly. Devices powered solely by AC will not work if their AC power supply is cut off for any reason, however briefly.
- Signals sent by wireless transmitters may be blocked or reflected by metal before they reach the alarm receiver. Even if the signal path has been recently checked during a weekly test, blockage can occur if a metal object is moved into the path.
- A user may not be able to reach a panic or emergency button quickly enough.
- While smoke detectors have played a key role in reducing residential fire deaths in the United States, they may not activate or provide early warning for a variety of reasons in as many as 35% of all fires, according to data published by the Federal Emergency Management Agency. Some of the reasons smoke detectors used in conjunction with this System may not work are as follows. Smoke detectors may have been improperly installed and positioned. Smoke detectors may not sense fires that start where smoke cannot reach the detectors, such as in chimneys, in walls, or roofs, or on the other side of closed doors. Smoke detectors also may not sense a fire on another level of a residence or building. A second floor detector, for example, may not sense a first floor or basement fire. Moreover, smoke detectors have sensing limitations. No smoke detector can sense every kind of fire every time. In general, detectors may not always warn about fires caused by carelessness and safety hazards like smoking in bed, violent explosions, escaping gas, improper storage or flammable materials, overloaded electrical circuits, children playing with matches, or arson. Depending on the nature of the fire and/or the location of the smoke detectors, the detector, even if it operates as anticipated, may not provide sufficient warning to allow all occupants to escape in time to prevent injury or death.
- Passive Infrared Motion Detectors can only detect intrusion within the designed ranges as diagrammed in their installation manual. Passive Infrared Detectors do not provide volumetric area protection. They do create multiple beams of protection, and intrusion can only be detected in unobstructed areas covered by the beams. They cannot detect motion or intrusion that takes place behind walls, ceilings, floors, closed doors, glass partitions, glass doors, or windows. Mechanical tampering, masking, painting or spraying of any material on the mirrors, windows or any part of the optical system can reduce their detection ability. Passive Infrared Detectors sense changes in temperature; however, as the ambient temperature of the protected area approaches the temperature range of 90° to 150°F, the detection performance can decrease.
- Alarm warning devices such as sirens, bells or horns may not alert people or wake up sleepers who are located on the other side of a closed or partly open doors. If warning device sound on a different level of the residence from the bedrooms, then they are less likely to waken or alert people inside the bedrooms. Even persons who are awake may not hear the warning if the alarm is muffled by noise from a stereo, air conditioner or other appliances, or by passing traffic. Finally, alarm warning devices, however loud, may not warn hearing-impaired people or waken deep sleepers.

Telephone lines needed to transmit alarm signals from a premises to a central monitoring station may be out of service or temporarily out of service. Telephone lines are also subject to compromise by sophisticated intruders.

- Even if the system responds to the emergency as intended, however, occupants may have insufficient time to protect themselves from the emergency situation. In the case of a monitored alarm system, authorities may not respond appropriately.
- This equipment, like other electrical devices, is subject to component failure. Even though this equipment is designed to last as long as 10 years, the electronic components could fail at any time.

The most common cause of an alarm system not functioning when an intrusion or fire occurs is inadequate maintenance. This alarm system should be tested weekly to make sure all sensors are working properly.

Installing an alarm system may make one eligible for lower insurance rates, but an alarm system is not a substitute for insurance. Homeowners, property owners and renters should continue to act prudently in protecting themselves and continue to insure their lives and property.

We continue to develop new and improved protection devices. Users of alarm systems owe it to themselves and their loved ones to learn about these developments.

#### ADEMCO LIMITED WARRANTY

Alarm Device Manufacturing Company, a Division of Pittway Corporation, and its divisions, subsidiaries and affiliates ("Seller"), 165 Eileen Way, Syosset, New York 11791, warrants its products to be in conformance with its own plans and specifications and to be free from defects in materials and workmanship under normal use and service for 18 months from the date stamp control on the product or, for products not having an Ademco date stamp, for 12 months from date of original purchase unless the installation instructions or catalog sets forth a shorter period, in which case the shorter period shall apply. Seller's obligation shall be limited to repairing or replacing, at its option, free of charge for materials or labor, any product which is proved not in compliance with Seller's specifications or proves defective in materials or workmanship under normal use and service. Seller shall have no obligation under this Limited Warranty or otherwise if the product is altered or improperly repaired or serviced by anyone other than Ademco factory service. For warranty service, return product transportation prepaid, to Ademco Factory Service, 165 Eileen Way, Syosset, New York 11791.

THERE ARE NO WARRANTIES, EXPRESS OR IMPLIED, OF MERCHANTABILITY, OR FITNESS FOR A PARTICULAR PURPOSE OR OTHERWISE, WHICH EXTEND BEYOND THE DESCRIPTION ON THE FACE HEREOF. IN NO CASE SHALL SELLER BE LIABLE TO ANYONE FOR ANY CONSEQUENTIAL OR INCIDENTAL DAMAGES FOR BREACH OF THIS OR ANY OTHER WARRANTY, EXPRESS OR IMPLIED, OR UPON ANY OTHER BASIS OF LIABILITY WHATSOEVER, EVEN IF THE LOSS OR DAMAGE IS CAUSED BY THE SELLER'S OWN NEGLIGENCE OR FAULT.

Seller does not represent that the products it sells may not be compromised or circumvented; that the products will prevent any personal injury or property loss by burglary, robbery, fire or otherwise; or that the products will in all cases provide adequate warning or protection. Customer understands that a properly installed and maintained alarm may only reduce the risk of a burglary, robbery, fire or other events occurring without providing an alarm, but it is not insurance or a guarantee that such will not occur or that there will be no personal injury or property loss as a result. CONSEQUENTLY, SELLER SHALL HAVE NO LIABILITY FOR ANY PERSONAL INJURY, PROPERTY DAMAGE OR OTHER LOSS BASED ON A CLAIM THE PRODUCT FAILED TO GIVE WARNING. HOWEVER, IF SELLER IS HELD LIABLE, WHETHER DIRECTLY OR INDIRECTLY, FOR ANY LOSS OR DAMAGE ARISING UNDER THIS LIMITED WARRANTY OR OTHERWISE, REGARDLESS OF CAUSE OR ORIGIN, SELLER'S MAXIMUM LIABILITY SHALL NOT IN ANY CASE EXCEED THE PURCHASE PRICE OF THE PRODUCT, WHICH SHALL BE THE COMPLETE AND EXCLUSIVE REMEDY AGAINST SELLER. This warranty replaces any previous warranties and is the only warranty made by Seller on this product. No increase or alteration, written or verbal, of the obligations of this Limited Warranty is authorized.

Faint, illegible text, likely bleed-through from the reverse side of the page.



N5008-1V1 1/82

**ALARM DEVICE MANUFACTURING CO.**  
A DIVISION OF PITTMAY CORPORATION  
**165 Eileen Way, Syosset, New York 11791**

Copyright 1991 PITTMAY CORPORATION