

400W Series



Pilot's Guide
& Reference

Foreword

Garmin International, Inc., 1200 East 151st Street, Olathe, Kansas 66062, U.S.A.

Tel: 913/397.8200

Fax: 913/397.8282

Garmin AT, Inc., 2345 Turner Rd., S.E., Salem, Oregon 97302, U.S.A.

Tel: 503/581.8101

Fax: 503/364.2138

Garmin (Europe) Ltd., Unit 5, The Quadrangle, Abbey Park, Romsey, Hampshire S051 9DL, U.K.

Tel: 44/0870.851241 (Europe)

Fax: 44/1794.519222

Tel: 0808.2380000 (UK)

Garmin Corporation, No. 68, Jangshu 2nd Road, Shijr, Taipei County, Taiwan

Tel: 886/02.2642.9199

Fax: 886/02.2642.9099

Web Site Address: www.garmin.com

© 2006 Garmin Ltd. or its subsidiaries. All rights reserved. Except as expressly provided herein, no part of this manual may be reproduced, copied, transmitted, disseminated, downloaded or stored in any storage medium, for any purpose without the express written permission of Garmin. Garmin hereby grants permission to download a single copy of this manual and of any revision to this manual onto a hard drive or other electronic storage medium to be viewed for personal use, provided that such electronic or printed copy of this manual or revision must contain the complete text of this copyright notice and provided further that any unauthorized commercial distribution of this manual or any revision hereto is strictly prohibited.

Information in this document is subject to change without notice. Garmin reserves the right to change or improve their products and to make changes in the content of this material without obligation to notify any person or organization of such changes or improvements.

October 2006

190-00356-00 Rev. A

Introduction

Cautions

CAUTION: The Global Positioning System is operated by the United States government, which is solely responsible for its accuracy and maintenance. The system is subject to changes which could affect the accuracy and performance of all GPS equipment. Although the Garmin 400W-series are precision electronic NAVigation AIDs (NAVAID), any NAVAID can be misused or misinterpreted and therefore become unsafe.



CAUTION: Use the 400W-series at your own risk. To reduce the risk of unsafe operation, carefully review and understand all aspects of this Owner's Manual and the Flight Manual Supplement, and thoroughly practice basic operation prior to actual use. When in actual use, carefully compare indications from the 400W-series to all available navigation sources, including the information from other NAVAIDS, visual sightings, charts, etc. For safety, always resolve any discrepancies before continuing navigation.



WARNING: The altitude calculated by the 400W-series is geometric height above mean sea level and could vary significantly from altitude displayed by pressure altimeters in aircraft.



WARNING: The Jeppesen database incorporated in the 400W-series must be updated regularly in order to ensure that its information is current. Updates are released every 28 days. A database information packet is included in your 400W-series package. Pilots using an out-of-date database do so entirely at their own risk!



CAUTION: GPS receivers operate by receiving and decoding very low power radio signals broadcast by satellites. It is possible that in some situations other radio equipment or electronic equipment used in close proximity to a GPS receiver may create electromagnetic interference (EMI) which may affect the ability of the GPS receiver to receive and decode the satellite signals. In such event, the interference may be reduced or eliminated by switching off the source of interference or moving the GPS receiver away from it.



CAUTION: The electronic chart is an aid to navigation and is designed to facilitate the use of authorized government charts, not replace them. Land and water data is provided only as a general reference to your surroundings. The positional accuracy of the land and water data is not of a precision suitable for use in navigation and it should not be used for navigation. Only official government charts and notices contain all information needed for safe navigation – and, as always, the user is responsible for their prudent use.



CAUTION: The Terrain feature is for supplemental awareness only. The pilot/crew is responsible for all terrain and obstacle avoidance using information not provided by the 400W-series Terrain feature.



CAUTION: The Garmin 400W-series does not contain any user-serviceable parts. Repairs should only be made by an authorized Garmin service center. Unauthorized repairs or modifications could void your warranty and authority to operate this device under FCC Part 15 regulations.



NOTE: The GNS 400W-series units use a different database than in the legacy units. The databases are incompatible between units. The GNS 400W-series units must use a WAAS enabled database.



NOTE: This product, its packaging, and its components contain chemicals known to the State of California to cause cancer, birth defects, or reproductive harm. This notice is being provided in accordance with California's Proposition 65. If you have any questions or would like additional information, please refer to our website at www.garmin.com/prop65.



NOTE: It is the pilot's responsibility for initial missed approach guidance in accordance with published procedure. The unit may not provide correct guidance until established on a defined leg.

NOTE: This device complies with Part 15 of the FCC limits for Class B digital devices. This equipment generates, uses, and can radiate radio frequency energy and, if not installed and used in accordance with the instructions, may cause harmful interference to radio communications. Furthermore, there is no guarantee that interference will not occur in a particular installation.

If this equipment does cause harmful interference, the user is encouraged to try to correct the interference by relocating the equipment or connecting the equipment to a different circuit than the affected equipment. Consult an authorized dealer or other qualified avionics technician for additional help if these remedies do not correct the problem.

Operation of this device is subject to the following conditions:

- (1) This device may not cause harmful interference, and
- (2) this device must accept any interference received, including interference that may cause undesired operation.

To obtain accessories for your 400W-series, please contact your Garmin dealer.

Help us better support you by completing our on-line registration form today! Registration ensures that you will be notified of product updates and new products and provides lost or stolen unit tracking. Please, have the serial number of your unit handy, connect to our web site (www.garmin.com) and look for our Product Registration link on the home page.

The 400W-series display lenses are coated with a special anti-reflective coating which is very sensitive to skin oils, waxes and abrasive cleaners. It is very important to clean the lens using an eyeglass lens cleaner which is specified as safe for anti-reflective coatings and a clean, lint-free cloth.

Garmin is fully committed to your satisfaction as a customer. If you have any questions regarding the 400W-series, please contact our customer service department at:

Garmin International, Inc.
1200 East 151st Street
Olathe, KS 66062-3426 U.S.A.

Phone: (913) 397-8200
Fax: (913) 397-8282

Accessories and Packing List

Congratulations on choosing the world's finest panel-mounted IFR navigation/communication system! The 400W-series represents Garmin's continued commitment to providing you with the most advanced technology available today — in an accurate, easy-to-use design suitable for all of your flying needs.



Unless otherwise specified within this manual, the term "400W-series" applies to the GPS 400W, GNC 420W, GNC 420AW, GNS 430W, and GNS 430AW models. Please note that the difference between these models is indicated in the Specifications section of this manual (see Appendix B).

Before installing and getting started with your new system, please ensure that your package includes the following items. If any parts are missing or are damaged, please contact your Garmin dealer.

Standard Package:

- Garmin 400W-series Unit
- NavData® Card
- Terrain Card
- GPS Antenna
- Installation Rack & Connectors
- Pilot's Guide
- Quick Reference
- 400W/500W Series Display Interfaces Addendum
- 400W/500W Series Garmin Optional Display Interfaces Addendum
- GNS 400W/500W-series Simulator Training CD-ROM
- Database Subscription Packet
- Warranty Registration Card

Upgrade Package:

- Garmin 400W-series Unit
- NavData® Card
- Terrain Card (optional)
- GPS Antenna
- Pilot's Guide & Reference
- Quick Reference
- 400W/500W Series Display Interfaces Addendum
- 400W/500W Series Garmin Optional Display Interfaces Addendum
- GNS 400W/500W-series Simulator Training CD-ROM
- Database Subscription Packet
- Warranty Registration Card

Your Garmin dealer will perform the installation and configuration of your new 400W-series unit. After installation, the NavData® card will already be installed into the correct slot on the front of the unit (see Appendix A). The 400W-series will be secured in the installation rack with the proper wiring connections. Have your dealer answer any questions you may have about the installation — such as location of antennas or any connections to other equipment in the panel.

Limited Warranty

This Garmin product is warranted to be free from defects in materials or workmanship for two years from the date of purchase. Within this period, Garmin will, at its sole option, repair or replace any components that fail in normal use. Such repairs or replacement will be made at no charge to the customer for parts and labor, provided that the customer shall be responsible for any transportation cost. This warranty does not cover failures due to abuse, misuse, accident, or unauthorized alterations or repairs.

THE WARRANTIES AND REMEDIES CONTAINED HEREIN ARE EXCLUSIVE AND IN LIEU OF ALL OTHER WARRANTIES EXPRESS OR IMPLIED OR STATUTORY, INCLUDING ANY LIABILITY ARISING UNDER ANY WARRANTY OF MERCHANTABILITY OR FITNESS FOR A PARTICULAR PURPOSE, STATUTORY OR OTHERWISE. THIS WARRANTY GIVES YOU SPECIFIC LEGAL RIGHTS, WHICH MAY VARY FROM STATE TO STATE.

IN NO EVENT SHALL GARMIN BE LIABLE FOR ANY INCIDENTAL, SPECIAL, INDIRECT OR CONSEQUENTIAL DAMAGES, WHETHER RESULTING FROM THE USE, MISUSE, OR INABILITY TO USE THIS PRODUCT OR FROM DEFECTS IN THE PRODUCT. Some states do not allow the exclusion of incidental or consequential damages, so the above limitations may not apply to you.

Garmin retains the exclusive right to repair or replace the unit or software, or to offer a full refund of the purchase price, at its sole discretion. SUCH REMEDY SHALL BE YOUR SOLE AND EXCLUSIVE REMEDY FOR ANY BREACH OF WARRANTY.

To obtain warranty service, contact your local Garmin Authorized Service Center. For assistance in locating a Service Center near you, visit the Garmin Web site at "<http://www.garmin.com>" or contact Garmin Customer Service at 800-800-1020.

Contents

Introduction	i
Cautions	i
Accessories and Packing List	iii
Limited Warranty	iv
Model Descriptions	1
GPS 400W.....	1
GNC 420W/420AW.....	1
GNS 430W/430AW.....	1
Takeoff Tour	1
Key and Knob Functions	2
Left-hand Keys and Knobs.....	2
Right-hand Keys and Knobs.....	3
Bottom Row Keys.....	4
Power On	5
Powering up the 400W-Series Unit	5
Instrument Panel Self-Test	6
Fuel On Board and Checklists	7
Acquiring Satellites/Messages	8
Selecting COM and VLOC Frequencies	9
Page Groups	10
Nav Pages	12
Default Nav Page	13
Map Page	14
NavCom Page	15
Direct-To Navigation	16
IFR Procedures	17
Nearest (NRST) Pages	18
Nearest Airport.....	19
Nearest Airspace Page	20
Flight Plans	21
Section 1 Communicating Using the GNC 420W/AW and GNS 430W/AW	23
Volume	23
Squelch	23
COM Window and Tuning	24
Auto-Tuning	25
Emergency Channel	27
Stuck Microphone	27
Section 2 NAV Pages	29
Main Page Groups	29
NAV Page Group	29
Default NAV Page	30
Selecting Desired On-Screen Data.....	31
Restoring Factory Settings.....	32
Dual Unit Considerations.....	32
Map Page	32
Map Symbols.....	33
Map Range.....	33
Map Page Auto Zoom.....	34
Map Panning.....	35
Map Direct-To.....	36
Airspace Information on the Map.....	36
Map Page Options	37
Map Setup.....	37
Data Fields on the Map.....	40
Selecting Desired On-Screen Data.....	40
Restoring Factory Settings.....	41
Terrain Operation	41
Terrain Limitations.....	41
Terrain Page.....	41
Inhibit Mode.....	42
Terrain Symbols.....	44
Color Interpretation.....	44
General Database Information.....	44
Database Versions.....	44
Database Updates.....	44
Terrain/Obstacle Database Areas of Coverage.....	45
Navigation Database.....	45
Terrain Phase of Flight.....	45
Nearest Airport Criteria & Terrain Phase of Flight.....	46
TERRAIN Destination Airport.....	46
TERRAIN Alerts	47
Pop-up Alerts.....	47
Forward Looking Terrain Avoidance.....	47
Premature Descent Alerting (PDA).....	48
TERRAIN Failure Alert.....	48
“TERRAIN Not Available” Alert.....	49
NAVCOM Page	51
Position Page	52
Restoring Factory Settings	54
Satellite Status Page	55
Vertical Navigation Page	56
Dead Reckoning	59
Section 3 Direct-To Navigation	61
Selecting a Destination by Facility Name or City	62
Selecting a Destination from the Active Flight Plan	63
Selecting the Nearest Airport as a Direct-To Destination	63
Shortcuts	64
Cancelling Direct-To Navigation	65
Specifying a Course to a Waypoint	65
Selecting Direct-To a Holding Pattern	66
Section 4 Flight Plans	67
Flight Plan Catalog	67
Flight Plan Catalog Editing	67
Flight Plan Catalog Options	68

INTRODUCTION

Activating Flight Plans.....	68	Airport Frequency Page	118
Inverting Flight Plans	69	Airport Approach Page.....	120
Create a new flight plan.....	69	Airport Arrival Page.....	122
Crossfill	70	Airport Departure Page	123
Copying Flight Plans	70	Intersection Page.....	125
Deleting Flight Plans.....	71	NDB Page	125
Deleting All Flight Plans	71	VOR Page	126
Sort List By Number?/Sort List by Comment?	72	User Waypoint Page.....	127
Active Flight Plan Page	72	Creating User Waypoints	127
Active Flight Plan Options	73	Creating User Waypoints from the Map Page.....	129
Activate Leg.....	73	Modifying User Waypoints	129
Crossfill	73	User Waypoint Page Options.....	130
Copy Flight Plan	73	User Waypoint List.....	131
Invert Flight Plan.....	73	Section 7 NRST Pages	133
Delete Flight Plan	74	NRST Page Group.....	133
Select Approach.....	74	Navigating to a Nearby Waypoint	135
Select Arrival.....	75	Nearest Airport Page.....	135
Select Departure.....	75	Nearest Intersection Page	137
Remove Approach, Arrival, or Departure	76	Nearest NDB Page	137
Closest Point of FPL	76	Nearest VOR Page.....	137
Parallel Track.....	77	Nearest User Waypoint Page	138
Change Fields.....	78	Nearest Center (ARTCC) Page.....	138
Restore Defaults	78	Nearest Flight Service Station (FSS) Page	139
Shortcuts	78	Nearest Airspace Page	140
Section 5 Approaches, Departures, & Arrivals	81	Section 8 VLOC (VOR/Localizer/Glideslope) Receiver Operations	145
Basic Approach Operations	83	Ident Audio and Volume.....	145
Approaches with Procedure Turns	84	VLOC Window and Tuning.....	145
Flying the Procedure Turn	85	CDI Key.....	148
Flying the Missed Approach	88	Section 9 AUX Pages	149
Flying an Approach with a Hold.....	89	AUX Page Group	149
Flying a DME Arc Approach	92	Flight Planning Page.....	150
Vectors to Final	95	Fuel Planning.....	151
Flying the Vectors Approach.....	96	Trip Planning	153
Course From Fix Flight Plan Legs.....	98	Density Alt / TAS / Winds.....	154
ILS Approaches.....	102	Crossfill	155
Selecting an ILS Approach	103	Scheduler	157
Flying the ILS Approach.....	104	Utility Page	158
Selecting an LPV Approach	107	Checklists	159
Flying the LPV Approach	107	Flight Timers	161
LNAV/VNAV and LNAV Approaches with Advisory Vertical		Trip Statistics	162
Guidance.....	109	RAIM Prediction.....	162
Points to Remember for All Approaches.....	109	Sunrise / Sunset	163
Points to Remember for Localizer or VOR-based Approaches	109	Software / Database Versions	164
Enabling Autopilot Outputs for the King KAP140/KFC225.....	111	Setup 1 Page	164
Section 6 WPT Pages	113	Airspace Alarms	167
WPT Page Group	113	CDI Scale / Alarms	167
Duplicate Waypoints	115	Units / Mag Var.....	168
Airport Runway Page	117		

Position Format.....	169
Map Datum	170
Date / Time	170
Restoring Factory Settings	170
Setup 2 Page	171
Display	172
Nearest Airport Criteria	172
SBAS Selection.....	173
COM Configuration.....	173
Restoring Factory Settings	174
Section 10 Fault Detection & Exclusion.....	175
Detection and Exclusion	175
Section 11 Messages, Abbreviations, and Navigation Terminology	
.....	177
Messages	177
Turn Advisory and Arrival Annunciations	183
Abbreviations.....	184
Navigation Terms	188
Appendix A NavData Card Use.....	190
Appendix B Specifications.....	191
Appendix C Troubleshooting Q&A	192
Index.....	198

Blank Page

Model Descriptions

This guide covers the operation of the GPS 400W, GNC 420W, GNC 420AW, GNS 430W, GNS 430AW. In general, all models will be referred to as the 400W-series, except where there are physical or operational differences. The 400W-series units are 6.25" wide and 2.66" high. The display is a 240 by 128 pixel color LCD. The units include two removable data cards, one with a Jeppesen database (inserted in the left-most card slot) and the second being a Terrain database (inserted in the right-most card slot).

GPS 400W

The GPS 400W has a WAAS GPS engine and is TSO C146a certified for primary domestic, oceanic, and remote navigation including en route, terminal, and non-precision approaches, and approaches with vertical guidance, such as LPV and LNAV/VNAV. The GPS 400W can simultaneously give aviators vital approach information and weather and traffic data in relation to their position on a color moving map display. Thanks to a high-contrast color display, the information can be easily read from wide viewing angles even in direct sunlight. Its color moving map features a built-in database that shows cities, highways, railroads, rivers, lakes, coastlines, and a complete Jeppesen database. The huge Jeppesen database (that can be updated with a front-loading data card) contains all airports, VORs, NDBs, Intersections, FSS, Approach, DPs/STARs, and SUA information.

Pilots will enjoy the GPS 400W as an MFD, especially when it is coupled with traffic, lightning detection, and weather interfaces like Ryan TCAD, TIS from the Garmin GTX 330 Mode S transponder, or L3 SKYWATCH™, or STORMSCOPE® WX 500. With the PC-based FDE prediction program, the GPS 400W may be used for oceanic or remote operations. For the latest in graphical and textual weather information, the GPS 400W can connect to XM Satellite Radio's XM WX Weather Service via the

GDL 69/69A datalink receiver.

GNC 420W/420AW

The GNS 430W/AW includes all of the features of the GPS 400W, and also includes TSO'd airborne VHF communications transceiver. This multipurpose unit is available with either a 10-watt (GNS 420W) or 16-watt 28 V dc (GNS 420AW) COM.

GNS 430W/430AW

The GNS 430W/AW includes all of the features of the GPS 420W/420AW, and also includes TSO'd airborne VOR/Localizer and Glideslope receivers. This multipurpose unit is available with either a 10-watt (GNS 430W) or 16-watt 28 V dc (GNS 430AW) COM.

Takeoff Tour

This Takeoff Tour is intended to provide a brief introduction of the 400W-series major features. The rest of this manual describes these features, and others, in additional detail. Use this guide, as needed, to learn or review the details regarding a particular feature. The Index may be used to quickly locate the information you want. Before flying with your 400W-series unit, take the time to review the information in the manuals and practice with the trainer.

After you're familiar with the basics, some suggested reading within the Reference section includes:

- Flight plan features - Section 4
- Waypoint information pages (database information) - Section 6
- IFR procedures - Section 5
- Unit settings (configuring the unit to your preferences) - Section 9

If you're unable to locate the information you need, we're here to help! Garmin's Customer Service staff is available during normal business hours (U.S. Central time zone) at the phone and fax numbers listed on page ii. You can also reach us by mail (see page ii) or at our web site address: www.garmin.com.

Key and Knob Functions

The 400W-series unit is designed to make operation as simple as possible. The key and knob descriptions on the next three pages provide a general overview of the primary function(s) for each key and knob. This Takeoff Tour section is intended to provide a brief overview of the primary functions of your 400W-series unit. Experiment with the unit and refer to the Reference sections for more information.

Left-hand Keys and Knobs

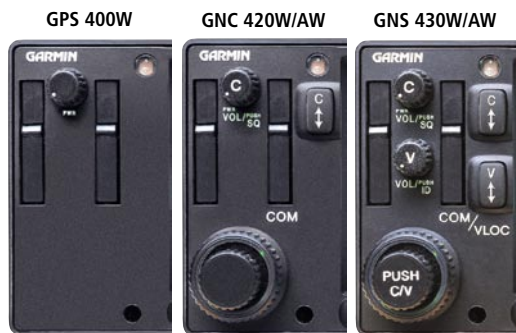

Left-hand Keys and Knobs

- C
 The **COM power/volume** knob (420W/430W only) controls unit power and communications radio volume. Press momentarily to disable automatic squelch control. In the GPS 400W, this control is used only for power.
- V
 The **VLOC volume** knob (430W only) controls audio volume for the selected VOR/Localizer frequency. Press momentarily to enable/disable the ident tone.
- The **large left** knob (COM/VLOC) (420W/430W only) is used to tune the megahertz (MHz) value (to the left of the decimal point) of the standby frequency for the communications transceiver (COM) or the VLOC receiver, whichever is currently selected by the tuning cursor.



The **small left** knob (COM/VLOC) (420W/430W only) is used to tune the kilohertz (kHz) value (to the right of the decimal point) of the standby frequency for the communications transceiver (COM) or the VLOC receiver, whichever is currently selected by the tuning cursor. Press this knob momentarily to toggle the tuning cursor between the COM and VLOC frequency fields.



The **COM flip-flop** key (420W/430W only) is used to swap the active and standby COM frequencies. Press and hold to select emergency channel (121.500 MHz).



The **VLOC flip-flop** key (430W only) is used to swap the active and standby VLOC frequencies (i.e., make the selected standby frequency active).

Right-hand Keys and Knobs



Right-hand Keys and Knobs



The **range** key (**RNG**) allows you to select the desired map scale. Use the up arrow side of the key to zoom out to a larger area, or the down arrow side to zoom in to a smaller area.



The **direct-to** key provides access to the direct-to function, which allows you to enter a destination waypoint and establishes a direct course to the selected destination. See Section 3.



The **MENU** key displays a context-sensitive list of options. This options list allows you to access additional features or make settings changes which relate to the currently displayed page.



The **clear** key (**CLR**) is used to erase information or cancel an entry. Press and hold this key to immediately display the Default Navigation Page, regardless of which page is currently displayed.



The **enter** key (**ENT**) is used to approve an operation or complete data entry. It is also used to confirm information, such as during power on.



The **large right** knob is used to select between the various page groups: NAV, WPT, AUX or NRST. With the on-screen cursor enabled, the large right knob allows you to move the cursor about the page.



The **small right** knob (**CRSR**) is used to select between the various pages within one of the groups listed above. Press this knob momentarily to display the on-screen cursor. The cursor allows you to enter data and/or make a selection from a list of options.

TAKEOFF TOUR

Key and Knob Functions

Bottom Row Keys

NRST

The **nearest (NRST)** key (400W/420W only) displays the nearest airports page. Then, turning the **small right** knob steps through the NRST pages.

CDI

The **CDI** key (430W only) is used to toggle which navigation source (GPS or VLOC) provides output to an external HSI or CDI.

OBS

The **OBS** key is used to select manual or automatic sequencing of waypoints. Pressing the **OBS** key selects OBS mode, which will retain the current “active to” waypoint as your navigation reference even after passing the waypoint (i.e., prevents sequencing to the next waypoint). Pressing the **OBS** key again will return to normal operation, with automatic sequencing of waypoints. Whenever OBS mode is selected, you may set the desired course to/from a waypoint using the OBS Page, or an external OBS selector on your HSI or CDI.

MSG

The **message** key (**MSG**) is used to view system messages and important warnings and requirements. See Sections 11 and 9 for more information on messages and unit settings.

FPL

The **flight plan** key (**FPL**) allows you to create, edit, activate and invert flight plans, as well as access approaches, departures and arrivals. A closest point to flight plan feature is also available from the flight plan key. See Section 4 for more information on flight plans.



GPS 400W / GNC 420W



GNS 430W



Whenever the 400W-series unit is displaying a list of information that is too long for the display screen, a scroll bar will appear along the right-hand side of the display. The scroll bar graphically indicates the number of additional items available within the selected category.

Simply press the small right knob to activate the cursor and turn the large right knob to scroll through the list.

PROC

The **procedures** key (**PROC**) allows you to select and remove approaches, departures and arrivals from your flight plan. When using a flight plan, available procedures for your departure and/or arrival airport are offered automatically. Otherwise, you may select the desired airport, then the desired procedure.

Power On

The Garmin 400W-series provides you accurate navigational data and some models also have communication capability, along with non-precision and precision approach certification in the IFR environment. The Takeoff Tour is designed to familiarize you with the operation of the 400W-series — including powering up the unit, changing frequencies, entering data, performing a simple direct-to, selecting IFR procedures and provides a limited introduction to using flight plans. In addition, this section briefly covers the default navigation, map and frequency pages available as part of the NAV page group. These pages will be used for most of your in-flight navigation.

The Takeoff Tour assumes that the unit and antennas have been properly installed and you have not changed any of the 400W-series unit default settings. If you have changed any of the factory default settings (position format, units of measure, selectable fields, etc.), the pictures shown here may not exactly match what you see on your 400W-series unit. Prior to using your unit for the first time, we recommend that you taxi to a location that is well away from buildings and other aircraft so the unit can collect satellite data without interruption.

Powering up the 400W-Series Unit

The 420W and 430W power and COM volume are controlled using the **power/volume** knob at the top left corner of the unit. The 400W **power** knob is located at the top left corner of the unit. Turning it clockwise will turn unit power on and increase the COM radio volume. After turning the unit on, a *welcome page* will be displayed while the unit performs a self test, followed by the database confirmation pages which show the current database information on the NavData card (with the valid operating dates, cycle number and database type indicated). The database is updated every 28 days, and must be current for approved instrument approach operations. Information on database subscriptions is available inside your 400W-series package.

To acknowledge the database information, press ENT.



Power-up Sequence

TAKEOFF TOUR

Instrument Panel Self-Test

Check CDI/HSI, RMI and other instruments to verify these indications

Should match current OBS course selection

Select to Set Fuel Level to Full Capacity

Select to display Checklists Page

Fuel Figures: May be entered manually if no sensor present

INSTRUMENT PANEL SELF-TEST					
LCDI	Half Left	CAP	120?		
LFLG	Out of View	FOB	110?		
VCDI	Half Up	FF	14.0?		
VFLG	Out of View				
TO/FRM	RHI	OBS		Set Full Fuel?	
To	135°	350M		Go To Chklist?	OK?
ANNUN	DTK				
On	150M				

Instrument Panel Self-Test

Once the database has been acknowledged, the instrument panel self-test page will appear. To ensure that your 400W-series unit and any connected instruments are working properly, check for the following indications on your CDI/HSI, RMI, external annunciators and other connected instruments:

- Course deviation
- Glideslope
- TO/FROM flag
- Time to destination
- Bearing to destination
- Desired track
- Distance to dest.
- Ground speed
- All external annunciators (if installed)

The *instrument panel self-test page* indicates the currently selected OBS course, fuel capacity (CAP), fuel on board (FOB) and fuel flow (FF). The fuel capacity, fuel on board and fuel flow may be manually entered if your installation does not include connection to sensors which automatically provide these figures.

To enter fuel capacity, fuel on board or fuel flow figures (if not provided by sensors):

1. Turn the **large right** knob to select the “CAP”, “FOB” or “FF” field.
2. Turn the **small and large right** knobs to enter the desired figure, then press **ENT**.

INSTRUMENT PANEL SELF-TEST					
LCDI	Half Left	CAP	00120?		
LFLG	Out of View	FOB	110?		
VCDI	Half Up	FF	14.0?		
VFLG	Out of View				
TO/FRM	RHI	OBS		Set Full Fuel?	
To	135°	350M		Go To Chklist?	OK?
ANNUN	DTK				
On	150M				

INSTRUMENT PANEL SELF-TEST					
LCDI	Half Left	CAP	120?		
LFLG	Out of View	FOB	110?		
VCDI	Half Up	FF	012.0?		
VFLG	Out of View				
TO/FRM	RHI	OBS		Set Full Fuel?	
To	135°	350M		Go To Chklist?	OK?
ANNUN	DTK				
On	150M				

Enter the fuel capacity, fuel on board or fuel flow figures directly onto the appropriate field of the instrument panel self-test page. These figures will automatically be provided if your installation includes connection to external sensors.

Fuel On Board and Checklists

The *instrument panel self-test page* includes selections to set fuel on board (FOB) to full capacity and access the *checklists page*. This allows you to quickly set fuel to full limits and display any checklists you've entered, such as start up or takeoff checklists.

To set fuel on board to full (if not provided by sensor):

1. Turn the **large right** knob to highlight "Set Full Fuel?".

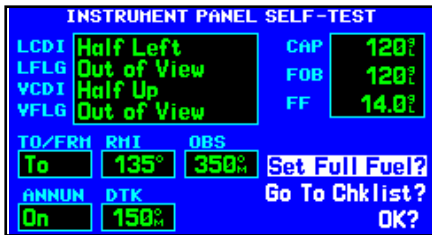

Select "Set Full Fuel?" to set fuel on board (FOB) to full capacity.

2. Press **ENT** and verify that fuel on board ("FOB") now matches the fuel capacity (CAP) figure. Fuel on board will now be reduced, over time, based on the fuel flow (FF) figure.

To view the checklists page:

1. Turn the **large right** knob to highlight "Go To Chklist?" and press **ENT**.

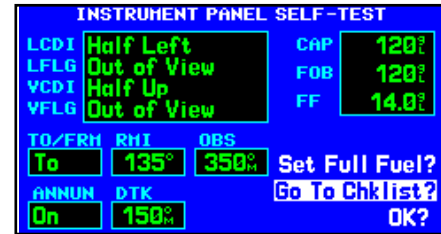

Select "Go To Chklist?" to display the checklist page and any available checklists. The 400W-series unit can hold up to nine checklists with up to 30 entries in each checklist.

2. Turn the **large right** knob to select the desired checklist, then follow the steps in *Section 9 - Aux Pages - Utility Page* to execute each step in the selected checklist.
3. Once you complete the desired checklist(s), press the **small right** knob to return to the checklists page. Press the **small right** knob again to return to normal operation on the satellite status or map pages.

Once you've verified instrument operation with the instrument panel self-test page displayed, press the ENT key.

The *satellite status page* will appear as the 400W-series unit begins to collect satellite information. An "Acquiring" status will be displayed on the *satellite status page*, and the signal strength of any satellites received will appear as "bar graph" readings. This is a good indication that you are receiving signals and a position fix will be determined. Following the first-time use of your 400W-series unit, the time required for a position fix will vary—within two minutes.

Acquiring Satellites/Messages

If the 400W-series unit has not been operated for a period of six months or more, it may have to “Search the Sky” to collect new data. This means the unit is acquiring satellite data to establish almanac and satellite orbit information, which can take 5 to 10 minutes. The Satellite Status Page displays a “Searching Sky” status, and the message annunciator (MSG) above the **MSG** key also flashes to alert you of a system message, “Searching the Sky”.

To view a system message, press the MSG key.



Message Page

The *message page* will appear and display the status or warning information applicable to the receiver’s current operating condition.

To return to the previous page after viewing a message, press the MSG key again.



The satellite status page shows the ID numbers for the satellites and the relative signal strength of each satellite received (as a “bar graph” reading).

“Searching Sky” indicates that satellite almanac data is not available. The data is recollected from the first available satellite.

“Acquiring” indicates that satellites have been located and information is being acquired, but the receiver does not have enough satellites for a 3-dimensional position.

“3D NAV” indicates that a 3-dimensional position is available.

“3D DIFF NAV” indicates when a 3-dimensional position is available and differential corrections are being used.

The “INTEG” annunciator (bottom left corner of the screen) indicates that satellite coverage is insufficient to pass built-in integrity monitoring tests.

Selecting COM and VLOC Frequencies

While the 400W-series unit is acquiring a position, let's take a minute to dial in the active and standby frequencies you'll be using for the first phase of your flight. The 400W-series display is divided into separate "windows" (or screen areas), including a COM window, VLOC window, and the GPS window.

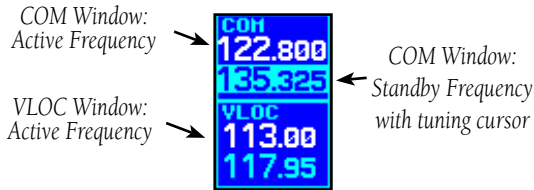

Pushing the **small left** knob activates the tuning cursor in the desired frequency window. To select the active frequency, you must first enter the frequency in the standby field, and use the **COM flip-flop** (or **VLOC flip-flop**) key to move it to the active field.

To change the standby communication (COM) or VLOC frequency:

1. If the tuning cursor is not currently in the desired window (COM or VLOC), press the **small left** knob momentarily to switch the highlight between the COM and VLOC windows. Adjusting the frequencies with the **large** and **small left** knobs will affect the standby frequency.
2. Turn the **large left** knob to select the desired megahertz (MHz) value. For example, the "135" portion of the frequency "135.325".
3. Turn the **small left** knob to select the desired kilohertz (kHz) value. For example, the ".325" portion of the frequency "135.325".
4. To activate the selected frequency, press the appropriate **flip-flop** key—COM for communication frequencies or VLOC for VOR/Localizer frequencies.

Once you've entered the active frequency, simply repeat steps 1 through 3, above, to enter the standby frequency. After both communication frequencies have been entered, you may elect to keep the COM window 'hot' by leaving the cursor on the standby frequency, or move the cursor to the VLOC window by pressing the **small left** knob.

Once you've entered the active frequency, simply repeat steps 1 to 3, above, to enter the standby frequency. After both communication frequencies have been entered, you may elect to keep the COM window "hot" by leaving the cursor on the standby frequency, or move the cursor to the VLOC window by pressing the **small left** knob.



NOTE: When selecting VLOC frequencies, the tuning cursor automatically returns to the COM window after 30 seconds of inactivity.

These features are only available in the 420W/430W units.

Page Groups



(Large right knob to change page groups)

(Small right knob to select pages within the group)

NAV Group

Default NAV

Map

Terrain

NAVCOM

Position

Satellite Status

VNAV

WPT Group

Arpt Location

Arpt Runway

Arpt Frequency

Arpt Approach

Arpt Arrival

Arpt Departure

Intersection

NDB

VOR

User Waypoint

Selection of any main page is performed using the **large** and **small right** knobs. The **large right** knob selects the page group: NAV, WPT, AUX or NRST. The **small right** knob selects the desired page within a group. To quickly select the default NAV page, press and hold the **CLR** key.

10



(Large right knob to change page groups)

AUX Group

Flight Planning

Utility

Setup 1

Setup 2

NRST Group

Nrst Airport

Nrst Intersection

Nrst NDB

Nearest VOR

NRST User Waypt

Nrst User Waypt

Nrst Center

Nrst Flight Service

Nrst Airspace

(Large right knob to select pages with the group)

FPL Group

Flight plan pages are selected by pressing the **FPL** key and using the **small right** knob to select the desired page.

Active Flight Plan

Flight Plan Catalog

Active Flight Plan

Flight Plan Catalog

PROC Group

The Procedures pages are selected by pressing the **PROC** key and using the **small or large right** knobs to select a procedure.

Procedure

Procedure

Nav Pages

The map page is one of seven, or more, pages available under the NAV group*:

- Default NAV page
- Terrain page
- Position page
- Vertical navigation page
- Map page
- NAVCOM page
- Satellite status page

To select the desired NAV page, turn the small right knob until the desired page is displayed.

If you are currently viewing a page that is not part of the NAV group, you can quickly return to the NAV group using the **CLR** key.

To select the NAV group and display the default NAV page, press and hold CLR.

NAV
7+ available pages* (see list above)

WPT
10 available pages (see Section 6)

AUX
4 available pages (see Section 9)

NRST
8 available pages (see Section 7)

MAIN PAGE GROUPS

In addition to the NAV group of pages, additional groups of pages are available for waypoint information (WPT), auxiliary (AUX) functions such as flight planning or unit settings, and listings for nearest (NRST) airports or other facilities.

To select the desired page group, turn the large right knob until a page from the desired group is displayed.

To select the desired page within the group, turn the small right knob until the desired page is displayed.



The bottom right corner of the screen indicates the page group currently being displayed (e.g., NAV or NRST), the number of screens available within that group (indicated by square icons) and the placement of the current screen within that group (indicated by a highlighted square icon). To select a different page within the group, turn the small right knob.

* Seven, or more, NAV Pages are available when the 400W-series installation includes connection to traffic, XM radio, and/or weather information sources. See the 400W/500W Series Display Interfaces Pilot's Guide Addendum, part number 190-00356-31 and the 400W/500W Series Garmin Optional Displays Pilot's Guide Addendum, part number 190-00356-30.

Default Nav Page

During most flights, the *default NAV*, *map* and *NAVCOM* pages will be the primary pages used for navigation. The *default NAV page* displays a graphic course deviation indicator (CDI), the active leg of your flight plan (as defined by the current “from” and “to” waypoints), and six user-selectable data fields. The default settings for these fields are distance to waypoint (DIS), desired track (DTK), bearing to waypoint (BRG), ground speed (GS), ground track (TRK) and estimated time en route (ETE). See Section 11 for definitions of these navigation terms. The *default NAV page* is selected by pressing and holding the **CLR** key or turning the **small right** knob.

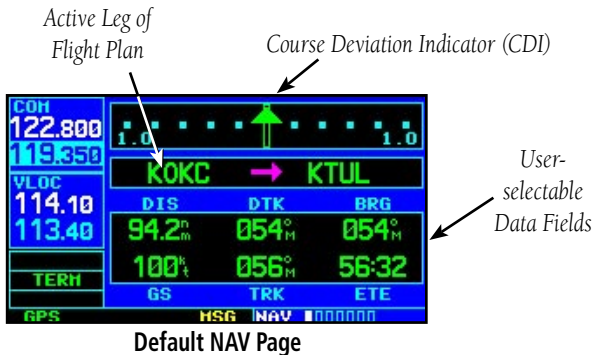

To change the data fields in the corners of the Default NAV Page:

1. Press **MENU** (with the Map Page displayed).
2. Turn the **large right** knob to highlight “Change Fields?” and press **ENT**.
3. Turn the **large right** knob to highlight the data field you wish to change.



4. Turn the **small right** knob to select the type of data you want to appear on this field and press **ENT**.



5. Press the **small right** knob to remove the cursor.

Map Page

The *map page* displays your present position (using an airplane symbol) relative to nearby airports, VORs, NDBs, intersections, user waypoints and airspace boundaries—and your route displayed as a solid line. Data fields for destination waypoint (WPT), distance to waypoint (DIS), desired track (DTK) and ground speed (GS) appear on the right hand side of the display. These fields are user-selectable to allow you to configure the unit to your own preferences. Available settings include: altitude, bearing, en route safe altitude, estimated time of arrival, minimum safe altitude, and ground track. See Section 11 for definitions of these navigation terms.

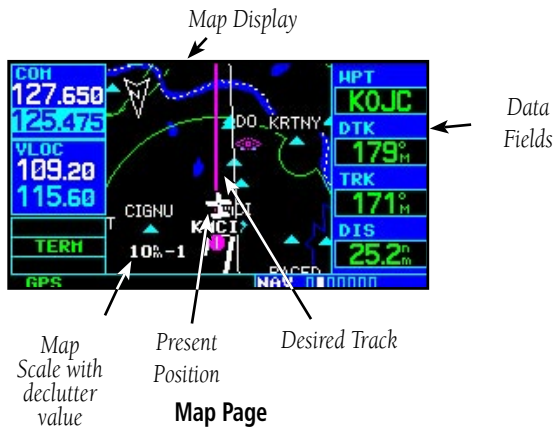

The map page combines a moving map display and navigation data for complete situational awareness. Map setup pages are provided to designate the maximum scale at which each map feature will appear. These settings provide an automatic decluttering of the map (based upon your preferences) as you adjust the scale.

While viewing the map page, you can quickly declutter and remove many of the background map details by pressing the CLR key (repeatedly) until the desired detail is depicted.

To change the map scale, press the ▼ or ▲ sides of the RNG key.

NavCom Page

From the *default NAV page*, simply turn the **small right** knob to display the *map page* and again to display the *NAVCOM page*. The *NAVCOM page* displays the available frequencies (communications and navigation) for the departure airport, any en route airports that are included in your flight plan, and the final destination airport. When using the direct-to function, frequencies will be listed for the airport nearest to your starting position and the destination airport.

A frequency listed on the *NAVCOM page* can be quickly transferred to the standby field of the COM or VLOC windows. This time-saving process prevents having to “re-key” a frequency already displayed elsewhere on the screen.

To display the frequency list for the active flight plan or direct-to airport:

1. In the Nav function, turn the **small right** knob to reach the NAVCOM page.
2. Push the **small right** knob to activate the cursor on the airport identifier field (in the GPS window). Turn the **small right** knob to display the list of airports (departure, arrival and en route) for your flight plan or direct-to. Continue to turn the **small right** knob until the desired airport is selected.
3. Press **ENT** to display the frequency list for the selected airport.



Press ENT to show the frequencies for the selected airport.

To select a communication or navigation frequency:

1. On the NAVCOM page, push the **small right** knob to activate the cursor in the GPS window.
2. Turn the **large right** knob to select the desired frequency from the list.



Selecting a frequency on the NAVCOM page.

3. Press **ENT** to transfer the selected frequency to the standby field in the COM or VLOC window. COM frequencies will automatically go to the standby field of the COM window and navigation frequencies will automatically go to the standby field of the VLOC window, regardless of which window is currently highlighted by the cursor.
4. To activate the selected frequency, press the **COM flip-flop** (or **VLOC flip-flop**) key.



Swap the standby COM frequency into the active Com frequency location.

Direct-To Navigation

The 400W-series unit can use direct point-to-point navigation to guide you from takeoff to touchdown, even in the IFR environment. Once a destination is selected, the unit will provide speed, course and distance data based upon a direct course from your present position to your destination. A destination can be selected from any page with the **direct-to** key.

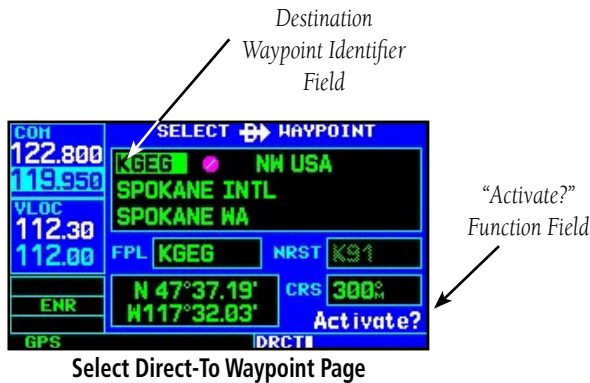

To select a direct-to destination:

1. Press the **direct-to** key. The Select Direct-To Waypoint page will appear with the destination field highlighted. The direct-to waypoint may also be selected by facility or city name. See Section 3 for more information.
2. Turn the **small right** knob to enter the first letter of the destination waypoint identifier. The destination waypoint may be an airport, VOR, NDB, intersection or user waypoint, as long as it is in the database or stored in memory as a user waypoint.
3. Turn the **large right** knob to the right to move the cursor to the next character position.
4. Repeat steps 2 and 3 to spell out the rest of the waypoint identifier.

5. Press **ENT** to confirm the identifier. The “Activate?” function field will be highlighted.



Confirm the selected direct-to destination by highlighting “Activate?” and pressing ENT.

6. Press **ENT** to activate a direct-to course to the selected destination.



Once a direct-to destination is selected, press and hold **CLR** to display the default NAV page.

You can then press and hold the **CLR** key to return to the default NAV page, as desired.

IFR Procedures

Once the direct-to or flight plan is confirmed, the whole range of instrument procedures is available to you. Departures (SIDs), arrivals (STARs), non-precision and precision approaches are stored within the NavData card and available using the **PROC** (procedures) key.

To display the procedures page, press PROC.

The steps required to select and activate an approach, departure or arrival are identical. In this introductory section, we'll show examples of the steps required to select an approach, but keep in mind the same process also applies to departures and arrivals.

To select an approach, departure, or arrival:

1. Turn the **small right** knob to select the desired option ("Select Approach?", "Select Arrival?" or "Select Departure?") from the procedures page.



Press the PROC key to display the procedures page. Turn the large right knob to select the desired option.

2. Press **ENT** to display a list of available procedures for the arrival (when using approaches or STARs) or departure (when using SIDs) airport.
3. Turn the **small right** knob to select the desired procedure and press **ENT**.

4. For approaches, a window appears to select the desired initial approach fix (IAF) or provide a "vectors" option to select just the final course segment of the approach. Turn the **small right** knob to select the desired option and press **ENT**. Vectors guidance is relative to the final inbound course. A line is drawn beyond the final approach fix, allowing you to intercept the final course segment beyond its normal limits.



A window will appear to select the desired procedure. Use the large right knob to make your selection.

5. For departures and arrivals, a window appears to select the desired transition. Turn the **small right** knob to select the desired option and press **ENT**.
6. With "Load?" highlighted, press **ENT** to add the procedure to the flight plan or direct-to.

In your flight plan or direct-to, the departure or arrival airport is replaced with the sequence of waypoints contained within the selected procedure.

Nearest (NRST) Pages

The NRST main page groups provides listings for nearest airports or other facilities. The NRST group provides detailed information on the 25 nearest airports, VORs, NDBs, intersections and user-created waypoints within 200 NM of your current position. In addition, pages are also provided to display the five nearest center (ARTCC/FIR) and Flight Service Station (FSS) points of communication, plus alert you to any special-use or controlled airspace you may be in or near.

The *nearest airport page* is one of eight pages available under the NRST group:

- Nearest airport page
- Nearest intersection page
- Nearest NDB page
- Nearest VOR page
- Nearest user waypoints page
- Nearest ARTCC page
- Nearest FSS page
- Nearest airspace page

To display the NRST pages:

1. If necessary, press the **small right** knob to remove the cursor from the page.
2. Turn the **large right** knob to select the NRST page group, as indicated by "NRST" appearing in the lower right corner of the screen.



To display a list of nearby airports, turn the **large right** knob to select the NRST page group and (if needed) the **small right** knob to select the nearest airport page.

3. Press and then turn the **large right** knob to select the desired NRST page.



To scroll through the list, press the **small right** knob, then turn the **large right** knob.

Nearest Airport

You may examine both the communication frequencies and runway information directly from the nearest airport page. As discussed earlier for the NAVCOM page, you may also place any displayed frequency into the standby COM or VLOC field by highlighting the frequency with the cursor and pressing **ENT**.

To view additional information for a nearby airport from the Nearest Airport page:

1. Press the **small right** knob to activate the cursor.
2. Turn the **large right** knob to select the desired airport from the list.
3. Press **ENT** to display waypoint (WPT) information pages for the selected airport.



Additional information for a nearby airport is available by highlighting an identifier on the list and pressing ENT.

4. To display runway and frequency information, press the **small right** knob to remove the cursor and turn the **small right** knob to display the desired information page.

The *nearest airport page* may be used in conjunction with the **direct-to** key to quickly set a course to a nearby facility in an in-flight emergency. Selecting a nearby airport as a direct-to destination will override your flight plan or cancel a previously selected direct-to destination. You'll still have the option of returning to your flight plan by cancelling the direct-to.

To select a nearby airport as a direct-to destination:

From the nearest airport page...

1. Press the **small right** knob to activate the cursor.
2. Turn the **large right** knob to select the desired airport from the list.
3. Press **direct-to**, **ENT**, and **ENT** (again) to navigate to the nearby airport.



To select a nearby airport as a new destination, highlight its identifier, press **direct-to**, **ENT**, and **ENT** (again).

From an airport information page...

1. Press **direct-to**, **ENT**, and **ENT** (again) to navigate to the nearby airport.

Nearest Airspace Page

The last page in the NRST group, the *nearest airspace page*, provides information for up to nine controlled or special-use airspaces near or in your flight path. Airspace information appears on this page based upon the same criteria used for airspace alert messages. Nearby airspace information and airspace alert messages are provided according to the following conditions:

- If your projected course will take you inside an airspace within the next ten minutes, the message “Airspace ahead -- less than 10 minutes” will appear.
- If you are within two nautical miles of an airspace and your current course will take you inside, the message “Airspace near and ahead” will appear.
- If you are within two nautical miles of an airspace and your current course will not take you inside, the message “Near airspace less than 2NM” will appear.
- If you have entered an airspace, the message “Inside Airspace” will appear.

By default, airspace alert messages are turned off. When turned on, the message (MSG) annunciator located directly above the **MSG** key will flash to alert you to the airspace message. (See *Section 9 Aux Pages - Setup 1* for information on enabling airspace alert messages.)

To view an airspace alert message:

1. Press the **MSG** key. The message page appears with the alert message.



When an airspace alert occurs, the message (MSG) annunciator will flash. Press **MSG** to view the alert message.

2. Press **MSG** again to return to the previous display.

To view nearest airspace information:

1. Turn the **large right** knob to reach the NRST function.

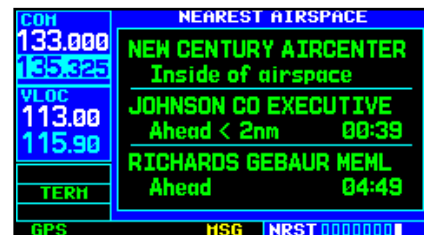

To view additional information about the airspace, select the nearest airspace page. Detailed information is available by highlighting the airspace name and pressing **ENT**.

2. Turn the **small right** knob to reach the Nearest Airspace page.

Note that the airspace alerts are based upon three-dimensional data (latitude, longitude and altitude) to avoid nuisance alerts. The alert boundaries for controlled airspace are also sectorized to provide complete information on any nearby airspace. Additional information about a nearby airspace—such as controlling agency, frequency and floor/ceiling limits—is available from the *nearest airspace page*.

Flight Plans

The 400W-series lets you create up to 20 flight plans, with up to 31 waypoints in each flight plan. Flight plans are created, edited and activated using the **FPL** key. The FPL page group includes two pages: the *active flight plan page* and the *flight plan catalog*. The *active flight plan page* provides information and editing features for the flight plan currently in use (referred to as “flight plan 00”). The *flight plan catalog* serves as the main page for creating new flight plans, as well as editing or activating previously created flight plans.



Active flight plan page with flight plan currently in use.

Since using flight plans is arguably one of the more complex features of the 400W-series, we'll only discuss it briefly here — focusing on creating a new flight plan and activating it to use for navigation. Additional information about flight plans can be found in *Section 4 Flight Plans*.

To create a new flight plan:

1. Press the **FPL** key and turn the **small right** knob to select the flight plan catalog.
2. Press the **MENU** key to display the flight plan catalog options.
3. Turn the **large right** knob to select “Create New Flight Plan?” and press **ENT**.



To create a new flight plan, select “Create New Flight Plan?” from the flight plan catalog options.

4. The cursor will appear on the first waypoint identifier field (located directly below “WAYPOINT”). Use the **large** and **small right** knobs to enter the identifier of the first waypoint in the flight plan. (The **small** knob is used to select the desired letter or number and the **large knob** is used to move to the next character space.)



Enter the identifier for each airport and/or navaid into the flight plan in the same sequence you wish to fly.

5. Press **ENT** once the identifier has been selected. The cursor will move to the next blank waypoint identifier field.

- Repeat steps 4 and 5, above, until all waypoints for the flight plan have been entered. Once the flight plan is created, it may be activated from an options window. Activating the flight plan will place a copy into "flight plan 00" (the original flight plan still resides in the flight plan catalog). It replaces any flight plan which currently exists in "flight plan 00."

To activate the new flight plan:

- On the Flight Plan Catalog page, press the **small right** knob to activate the cursor. Rotate the **large right** knob to highlight the desired flight plan.
- Press the **MENU** key to display the flight plan catalog options.
- Turn the **small right** knob to select "Activate Flight Plan?" and press **ENT**.



Select "Activate Flight Plan?" from the page menu to begin using the new flight plan.

420W / 430W Only

Section 1

Communicating Using the GNC 420W/AW and GNS 430W/AW

Some models of the 400W-series feature a digitally-tuned VHF COM radio that provides a seamless transition from communication to navigation. The GNC 420W and GNS 430W's COM radio operates in the aviation voice band, from 118.000 to 136.975 MHz, in 25 kHz steps (default). For European operations, a COM radio configuration of 8.33 kHz steps is provided (Section 9 - Aux - Setup 2). The GNC 420AW and GNS 430AW use a 16-watt transmitter, instead of the standard 10-watt transmitter.



"TX" appears at the upper right corner of the screen while transmitting.

Volume

COM radio volume is adjusted using the **COM power/volume** knob. Turn the **COM power/volume** knob clockwise to increase volume, or counterclockwise to decrease volume.

Squelch

The COM radio features an automatic squelch to reject many localized noise sources. You may override the squelch function by pressing the **COM power/volume** knob. This facilitates listening to a distant station or setting the desired volume level.



Press the **COM power/volume** knob momentarily to override the automatic squelch. Note the "RX" receive indication when receiving a station.

To override the automatic squelch, press the **COM power/volume** knob momentarily. Press the **COM power/volume** knob again to return to automatic squelch operation.

COM Window and Tuning

Communication frequencies are selected with the tuning cursor in the *standby* COM frequency field, and using the **small** and **large left** knobs to dial in the desired frequency. The standby frequency always appears below the *active* frequency. The active frequency is the frequency currently in use for transmit and receive operations.



Tuning cursor in the COM window. Use the small and large left knobs to dial in the desired standby frequency.

A frequency may also be quickly selected from the database by simply highlighting the desired frequency on any of the main pages and pressing the **ENT** key. This process is referred to as *auto-tuning*. Once a frequency is selected in the standby field, it may be transferred to the active frequency by pressing the **COM flip-flop** key.



Once the standby frequency is selected, use the **COM flip-flop** key to make the frequency active for transmit and receive operations.

While receiving a station, an “RX” indication appears in the upper right corner of the COM window — to the immediate right of “COM”. A “TX” indication appears at this location while you are transmitting.



NOTE: The tuning cursor will normally appear in the COM window, unless placed in the VLOC window by pressing the **small left knob**. When the tuning cursor is in the VLOC window, it will automatically return to the COM window after 30 seconds of inactivity. This does not apply to the GNS 420W.

The active frequency in either window cannot be accessed directly—only the standby frequency will be highlighted by the tuning cursor.

To select a COM frequency:

1. If the tuning cursor is not currently in the COM window, press the **small left** knob momentarily.
2. Turn the **large left** knob to select the desired megahertz (MHz) value. For example, the “118” portion of the frequency “118.300”.
3. Turn the **small left** knob to select the desired kilohertz (kHz) value. For example, the “.300” portion of the frequency “118.300”.

To make the standby frequency the active frequency, press the COM flip-flop key.

The tuning cursor will remain in the *COM window*. The GNS 430W/AW unit has a built-in VOR/Localizer/Glideslope capability. If you wish to select a VOR/localizer/ILS frequency, press the **small left** knob momentarily to place the cursor in the *VLOC window*. Additional instructions for VOR/localizer/ILS operations are available in Sections 5 and 8.



Cursor in VLOC window allows for VOR and ILS operations. See Section 8.

Auto-Tuning

The 400W-series auto-tune feature allows you to quickly select any database frequency in the GPS window as your standby frequency. Any COM frequency displayed in the GPS window can be transferred to the standby COM frequency field, with a minimum of keystrokes required. The following are some examples of selecting COM frequencies from some of the main GPS pages.

To select a COM frequency for a nearby airport:

1. Select the nearest airport page from the NRST page group. Press and hold the **CLR** key, then turn the **large right** knob until the nearest pages appears. Finally, if necessary, turn the **small right** knob to display the nearest airport page.
2. Press the **small right** knob momentarily to place the cursor on the airport identifier field of the first airport in the list. Turn the **large right** knob to highlight the desired airport frequency.

3. Press **ENT** to place the frequency in the standby field of the COM window.



Nearest airport page with the Tower frequency (TWR) for the closest airport highlighted.

4. Press the **Com flip/flop** key to swap the standby and active frequencies.



From the nearest airport page, select the desired airport to show a more detailed listing of frequencies for that airport.

5. Before leaving the frequency page, use the **large right** knob to highlight "Done?" and press **ENT**. "Done?" always needs to be acknowledged before leaving a page group.

To select a COM frequency for a nearby flight service station (FSS) or center (ARTCC):

1. Select the nearest center or flight service page from the NRST page group. Turn the **large right** knob until the NRST pages appear. Then, if necessary, turn the **small right** knob to display the desired NRST page.



Use the nearest ARTCC page to quickly retrieve the frequency(s) for the nearest center (ARTCC) facility.

2. Press the **small right** knob momentarily to place the cursor on the page.
3. Turn the **large right** knob to highlight the FSS/ARTCC frequency and press **ENT** to place the frequency in the standby field of the COM window.

To select a COM frequency for any airport in your flight plan:

1. Select the NAVCOM page from the NAV page group. (Press and hold the **CLR** key, then turn the **small right** knob until the NAVCOM page appears.)



The NAVCOM page provides a frequency list for all the airports (departure, en route and arrival) along your active flight plan.

2. Press the **small right** knob to place the cursor on the airport identifier field. To the left of this field appears Departure, En Route or Arrival — depending on the placement of the displayed airport within your flight plan.
3. Turn the **small right knob** to display a window listing the airports in your flight plan. Continue turning the **small right** knob to select the desired airport.
4. Press **ENT** to return to the NAVCOM page with the frequencies for the selected airport.
5. Turn the **large right** knob to highlight the desired frequency.
6. Press **ENT** to place the highlighted frequency in the standby COM window field.

To select a COM frequency for any airport in the database:

1. Select the airport frequencies page from the WPT page group. (Turn the **large right** knob to select the WPT page group. Then turn the **small right** knob until the airport frequencies page appears.)



Use the airport frequencies page to retrieve a frequency list for ANY airport in the Jeppesen NavData database.

2. Press the **small right** knob to place the cursor on the airport identifier field.
3. Use the **small** and **large right** knobs to enter the identifier of the desired airport. Press **ENT**

when finished.

4. Turn the **large right** knob to highlight the desired frequency.
5. Press **ENT** to place the highlighted frequency in the standby COM window field.

Emergency Channel

The 420W/430W emergency channel select provides a quick method of selecting 121.500 MHz as the active frequency in the event of an in-flight emergency. The emergency channel select is available whenever the unit is on, regardless of GPS or cursor status, or loss of the display.

To quickly tune and activate 121.500, press and hold the COM flip-flop key for approximately two seconds.



Press and hold the COM flip-flop key for two seconds to activate the 121.500 MHz emergency frequency.



Note: Under some circumstances if the com system loses communication with the main system, the radio will automatically tune to 121.500 MHz for transmit and receive regardless of the displayed frequency.

Stuck Microphone

Whenever the 420W/430W is transmitting, a 'TX' indication will appear in the COM window. If the microphone is stuck or accidentally left in the keyed position, or continues to transmit after the key is released, the COM transmitter will automatically time out (or cease transmitting) after 35 seconds of continuous broadcasting. You'll also receive a "COM push-to-talk key stuck" message as long as the stuck condition exists.



A "COM push-to-talk key stuck" message appears to warn you of a stuck microphone. Transmitting is disabled after 35 seconds of continuous broadcasting.

Blank Page

Section 2 NAV Pages

Main Page Groups

The 400W-series main pages are divided into groups: NAV, WPT, AUX and NRST. While viewing any of these pages, selection of another page is a simple selection process using the **small** and **large right** knobs.

NAV 7+ available pages (see list below)	WPT 10 available pages (see Section 6)
AUX 4 available pages (see Section 9)	NRST 8 available pages (see Section 7)

To select the desired page group, turn the large right knob until a page from the desired group is displayed.

To select the desired page within the group, turn the small right knob until the desired page is displayed.

NAV Page Group

The NAV page group includes seven, or more, pages. While viewing any NAV page, turn the **small right** knob to select a different NAV page. You may find this selection process convenient to cycle between the *default NAV* and *map pages*—two of the most frequently used pages. Other pages are provided to list frequencies for your flight plan, show your current position, display current satellite reception, and make vertical navigation settings.

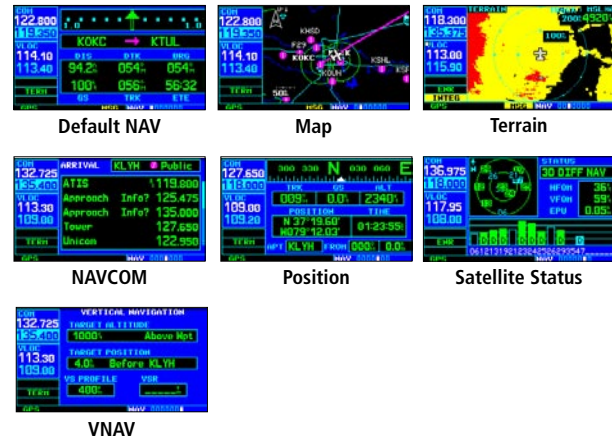

The bottom right corner of the screen indicates which page group is currently being displayed (e.g., NAV or NRST), the number of screens available within that group (indicated by square icons) and the placement of the current screen within that group (indicated by a highlighted square icon). To select a different page within the group, turn the small right knob.

DTK 313° 9 S

LT TO 030° NOW

ARRIVING WPT

HOLD TEARDROP

This part of the screen is also used to display the 400W-series turn advisories (e.g., "DTK 313° 9 S", or LT TO 030° NOW) and waypoint alerts (e.g., "ARRIVING WPT" or "HOLD TEARDROP") during flight plan and approach operations. Seconds will be abbreviated as "S" and Now may be seen as "N". See Section 5 for more information.

2 - NAV PAGES

Default Nav Page

Default NAV Page

The first NAV page is the *default NAV page*. This page may be quickly selected from ANY page by using the **CLR** key.

To select the NAV group and display the default NAV page, press and hold the CLR key.

The *default NAV page* displays a graphic course deviation indicator (CDI) across the top of the page. Unlike the angular limits on a CDI coupled to a VOR or ILS receiver, full scale limits for this CDI are defined by a GPS-derived distance (2.0, 1.0 or 0.3 NM). By default, the CDI scale automatically adjusts to the desired limits based upon the current phase of flight: en route, terminal area or approach.

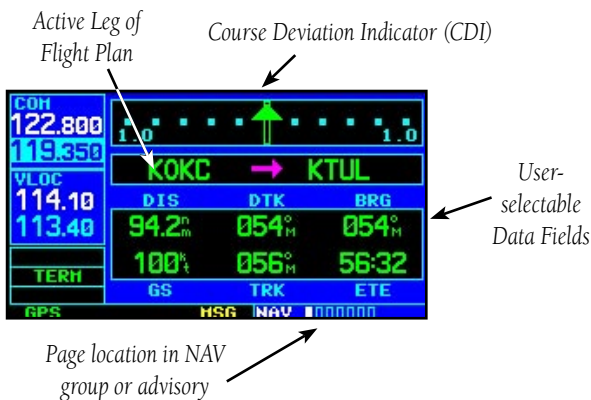

NOTE: Approaching the FAF, the GNS 400W-series unit automatically rescales in an angular fashion. This allows the LPV approach to be flown identically to a standard ILS. At 2.0 NM from the FAF, CDI scaling is tightened from 1.0 to the angular full scale deflection defined for the approach.

You may also manually select the desired scale setting as outlined in the Aux Setup section.

The graphic CDI shows your position at the center of the indicator, relative to the desired course (the moving course deviation needle). As with a traditional mechanical CDI, when you're off course simply steer toward the needle. The TO/FROM arrow in the center of the scale indicates whether you are heading to the waypoint (an up arrow) or if you have passed the waypoint (a down arrow).

The following symbols are used—on the default NAV page directly below the CDI—to depict the "active leg" of a flight plan or direct-to:

- Direct-To a Waypoint
- Course to a Waypoint, or Desired Course between Two Waypoints
- Right Procedure Turn
- Left Procedure Turn
- Vectors-To-Final
- DME Arc to the left
- DME Arc to the right
- Left-hand Holding Pattern
- Right-hand Holding Pattern

Directly below the CDI appears the active leg of your flight plan, or the direct-to destination when using the **direct-to** key. This will automatically sequence to the next leg of your flight plan as you reach each interim waypoint. If no flight plan or direct-to destination has been selected, the destination field will remain blank.

Selecting Desired On-Screen Data

At the bottom of the *default NAV page* you'll find six user-definable fields which display the data you'll need as your flight progresses. By default these fields display: distance to destination (DIS), desired track (DTK), bearing to destination (BRG), ground speed (GS), ground track (TRK) and estimated time en route (ETE). However, each of these fields can be customized to your preferences by selecting a different data item. Available data items include:

- Bearing to destination (BRG)
- Distance to destination (DIS)
- Desired track (DTK)
- En route safe altitude (ESA)
- Estimated time of arrival (ETA)
- Estimate time en route (ETE)
- Fuel Flow (FLOW) (When Configured)
- Ground speed (GS)
- Minimum safe altitude (MSA)
- Track angle error (TKE)
- Ground track (TRK)
- Vertical speed required (VSR)
- Cross track error (XTK)

If no flight plan or direct-to destination has been selected only speed, track, altitude and minimum safe altitude data may be displayed. All other data types will appear as blank lines—on the *default NAV page*—until a destination is selected.

To select a different data item for any data field:

1. Starting with the default NAV page, press the **MENU** key to display an options menu.
2. The "Change Fields?" option is already highlighted, so press **ENT** to select this option.



3. Use the **large right** knob to highlight the data field you wish to change.



4. Turn the **small right** knob to display the list of available data items. Continue turning the **small right** knob to select the desired data item from the list.



5. Press **ENT** to select the desired data item and return to the default NAV page.
6. Press the **small right** knob momentarily to remove the cursor from the page.

2 - NAV PAGES

Map Page

Restoring Factory Settings

You can also quickly return all data field settings to their original factory settings.

To restore all six data fields to factory default settings:

1. Starting with the default NAV page, press the **MENU** key to display an options menu.
2. Turn the **large right** knob to highlight the “Restore Defaults?” option and press **ENT**.



Dual Unit Considerations

A “Crossfill?” option is provided from the Default NAV Page. This option allows you to transfer a direct-to destination, the active flight plan, any stored flight plan or user waypoints to a second 400W or 500W-series Garmin unit.

Some crossfill operations can be done automatically. If the crossfill method in both 400W (or 500W)-series units is set to “auto”, a change in the direct-to destination or active flight plan on one unit can also be seen on the other. See Section 4 - Flight Plans - Flight Plan Catalog Options for additional details on using the “Crossfill?” option.



NOTE: The databases of the 400/500 series and the 400W/500W are incompatible so you may not mix systems.

Map Page

The second NAV page is the map page, which displays your present position using an airplane symbol, along with nearby airports, nav aids, user-defined waypoints, airspace boundaries, lakes, rivers, highways and cities.





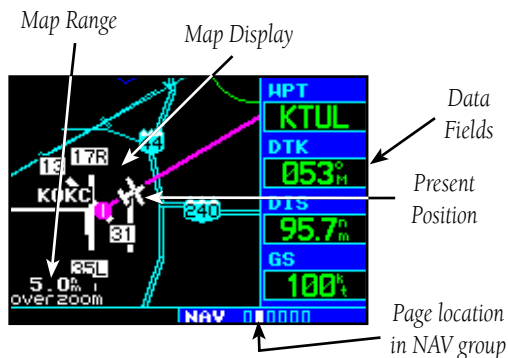









NOTE: The electronic chart is an aid to navigation and is designed to facilitate the use of authorized government charts, not replace them. Land and water data is provided only as a general reference to your surroundings. The positional accuracy of the land and water data is not of a precision suitable for use in navigation and it should not be used for navigation. Only official government charts and notices contain all information needed for safe navigation – and, as always, the user is responsible for their prudent use.



NOTE: If the 400W-series unit is unable to determine a GPS position, the present position (airplane) symbol will appear on the Map Page in yellow. No symbol will be present when there is no active flight plan.

Map Symbols

Various symbols are used to distinguish between waypoint types. The identifiers for any on-screen waypoints can also be displayed. (By default the identifiers are enabled). Special-use and controlled airspace boundaries appear on the map, showing the individual sectors in the case of Class B or Class C airspace. The following symbols are used to depict the various airports and nav aids on the *map page*:

	Airport with hard surface runway(s); Primary runway shown		Intersection
	Airport with soft surface runway(s) only		VORTAC
	Private Airfield		TACAN
	VOR		NDB
	VOR/DME		Locator Outer Marker
	DME		
	Localizer		
	Heliport		

Map Range

The map display can be set to 23 different scale settings from 500 feet to 2000 nautical miles (statute and metric units are also available). The scale is indicated in the lower left-hand corner of the map display, and represents the top-to-bottom distance covered by the map display.

To select a map Range:

1. Press the **up arrow** side of the **RNG** key to zoom out to a larger map area.
2. Press the **down arrow** side of the **RNG** key to zoom in to a smaller map area and more detail.



Map Page Auto Zoom

An autozoom feature is available which will automatically adjust from an en route range of 200 NM through each lower range, stopping at a range of 1.0 NM as you approach your destination waypoint. The autozoom feature is turned on/off from the map setup page.

The *map page* also displays a background map showing lakes, rivers, coastlines, highways, railways and towns. When a map scale is selected below the lower limit at which the map detail was originally created, an “overzoom” indication will appear on the map display, below the scale reading. “Overzoom” indicates that the detail at this scale may not accurately represent actual conditions. If you continue to zoom in to lower scale settings, “overzoom” will be replaced with “no map” and the geographic detail is removed from the map display (but, the airport and navaid detail will remain).

The “Setup Map?” option allows you to define the maximum scale at which each map feature will appear. This provides you with complete control to minimize screen clutter. You can also quickly remove items from the map using the **CLR** key.

To quickly declutter the map display, press the **CLR** key momentarily (as often as needed) to select the desired amount of map detail.

The right-hand side of the map page includes four user-selectable data fields. By default, the displayed data is: destination waypoint name (WPT), desired track (DTK), distance to destination waypoint (DIS) and ground speed (GS). Any of these data fields may be changed to display a different data type. You may also remove the four data fields from the map to show a larger map image.



The CLR key allows you to quickly declutter the map display, providing four levels of map detail. Note the “-1” and “-2” (“-3” is also provided) suffix designations above, indicating each successive declutter level.

Map Panning

Panning allows you to move the map beyond its current limits without adjusting the map range. When you select the panning function — by pressing the **small right** knob — a target pointer will flash on the map display. A window will also appear at the top of the map display showing the latitude/longitude position of the pointer, plus the bearing and distance to the pointer from your present position.

To select the panning function and pan the map display:

1. Press the **small right** knob to activate the panning target pointer.



2. Turn the **small right** knob to move up (turn clockwise) or down (counterclockwise).



3. Turn the **large right** knob to move right (turn clockwise) or left (counterclockwise).
4. To cancel the panning function and return to your present position, press the **small right** knob.

When the target pointer is placed on an object, the name of that object will be highlighted (even if the name wasn't originally displayed on the map). This feature applies to airports, nav aids, user-created waypoints, roads, lakes, rivers — almost everything displayed on the map except route lines.

When an airport, nav aid, or user waypoint is selected on the map display, you can review information about the waypoint or designate the waypoint as your direct-to destination.

To review information for an on-screen airport, nav aid or user waypoint:

1. Use the panning function (as described above) to place the target pointer on a waypoint.
2. Press **ENT** to display the waypoint information page(s) for the selected waypoint.



3. Press **CLR** to exit the information page(s).

Map Direct-To

To designate an on-screen airport, navaid or user waypoint as your direct-to destination:

1. Use the panning function (see previous page) to place the target pointer on a waypoint.
2. Press **direct-to** key to display the select direct-to waypoint page, with the selected waypoint already listed.



3. Press **ENT** twice to confirm the selection and begin navigating to the waypoint.

The direct-to function can be used anywhere on the map. If nothing currently exists at the crosshair position, a new waypoint (called "+MAP") will be created at the target pointer location before the direct-to is initiated.

Airspace Information on the Map

When a special-use or controlled airspace boundary appears on the map display, you can quickly retrieve information — such as floor/ceiling limits and controlling agency — directly from the map.

To view airspace information for an on-screen special-use or controlled airspace:

1. Use the panning function (see previous page) to place the target pointer on an open area within the boundaries of an airspace. If the area is congested and it is difficult to select an open area, you may need to zoom in or press **CLR** to make the selection easier.



2. Press **ENT** to display an options menu.
3. "Review Airspace?" should already be highlighted, if not select it with the **small right** knob. Press **ENT** to display the airspace information page for the selected airspace.



To display airspace frequencies:

1. While viewing the airspace information display in the above example, turn the **large right** knob to highlight "Frequencies?" and press **ENT**. Press **CLR** to return to the airspace information page.
2. Press **CLR** to exit the airspace information page. Press the **small right** knob (**CRSR**) to exit panning.

Map Page Options

Many of the 400W-series functions are menu driven. Each of the main pages has an options menu, allowing you to custom tailor the corresponding page to your preferences and/or select special features which specifically relate to that page. A *map page options menu* provides additional settings to customize the **map page** and additional features related specifically to the *map page*.

To display the map page options menu, press MENU (with the map page displayed).

The following options are available: “Setup Map?”, “Measure Dist?”, “Data Fields On?”, “Change Fields?” and “Restore Defaults?”.

Map Setup

“Setup Map?” allows you to configure the map display to your preferences, including map orientation, land data enable/disable, Jeppesen data enable/disable, automatic zoom, airspace boundaries, and text size. The following table lists the group names and available settings:

Feature	Description
Map	Orientation, AutoZoom, Land Data, Aviation Data
Weather	Lightning Mode/Symbol (when applicable)
Traffic	Traffic Mode/Symbol/Label (when applicable)
Airport	Large/Medium/Small Airports and Text
NAVAID	VORs, NDBs, Intersections and Text
Waypoint	User Waypoints, Flight Plan Wpts, and Text
Line	Active Flight Plan/Direct-To, Lat/Long Grid
Control	Controlled Airspace: Class B, C, D (tower zone)

Feature	Description
Airspace	Special-Use Airspace: Restricted, MOA, Other
City	Large/Medium/Small Cities and Text
Road	Freeway, National Highway, Local Hwy, Local Road
Other	States/Prov, Rivers/Lakes, Railroads, Wind Vector



Large, Medium and Small classifications are used on the 400W-series for airports and cities. Large airports are those with a runway longer than 8100 feet. Medium airports include those with a runway longer than 5000 feet or with a control tower. Large cities are those with approximate populations greater than 200,000 and Medium cities are greater than 50,000.

2 - NAV PAGES

Map Page Options

To change a map setup feature:

1. On the Map page, press **MENU** to bring up the Page Menu. Then, turn the **large right** knob to highlight "Setup Map?" and press **ENT**.
2. To change map orientation, turn the **small right** knob to select "Map" and press **ENT**.



3. Turn the **large right** knob to highlight the "Orientation" field and turn the **small right** knob to select the desired option. Select "North up" to fix the top of the map display to a north heading. Select "Track up" to adjust the top of the map display to your current track heading.

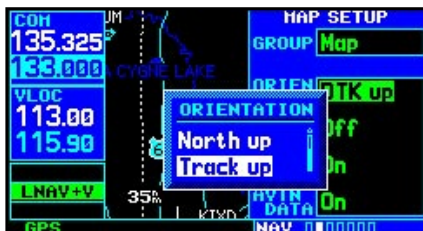

Select "DTK up" to fix the top of the map display to your desired course. Press **ENT** to accept the selected option.



4. To enable/disable automatic zoom, turn the **small right** knob to select "Map" and press **ENT**. Turn the **large right** knob to highlight the "Auto Zoom" field and turn the **small right** knob to select "On" or "Off". Press **ENT** to accept the selected option. The automatic zoom feature will automatically adjust the map scale from 2000 NM through each lower scale, stopping at 1.0 NM as you approach your destination waypoint.
5. To enable/disable background land data, or all Jeppesen aviation data, turn the **small right** knob to select "Map" and press **ENT**. Use the **large right knob** to highlight the appropriate field and turn the **small right** knob to select "On" or "Off". Press **ENT** to accept the selected option.
6. For airports, NAVAIDs, active flight plan waypoints, user-created waypoints, state/provincial boundaries, rivers/lakes and cities: turn the **small right** knob to select the appropriate "Group" name (per the chart on the previous page) and press **ENT**. Use the **large right** knob to highlight the zoom field for the desired feature and turn the **small right** knob to select the maximum scale at which the feature should appear on screen. Or select "Off" to never display the selected feature. Press **ENT** to accept the selected option. Next, turn the **large right** knob to highlight the text field for the desired feature and turn the **small right** knob to select the desired text size, or select "None" to disable text descriptions. Press **ENT** to accept the selected option.

- For airspace boundaries, highways, roads, railroad lines, wind vector, track log data, active flight plan course lines, and lat/long grid lines: turn the **small right** knob to select the appropriate "Group" name (per the chart on the previous page) and press **ENT**. Use the **large right** knob to highlight the zoom field for the desired feature and turn the **small right** knob to select the maximum scale at which the feature should appear on screen. Or select "Off" to never display the selected feature. Press **ENT** to accept the selected option. Distance Measurements

The "Measure Dist?" option provides a quick, easy method for determining the bearing and distance between any two points on the map display.

To measure bearing and distance between two points:

- On the Nav Map page, press **MENU**. Then, turn the **large right** knob to highlight "Measure Dist?" and press **ENT**. An on-screen reference pointer will appear on the map display at your present position.



- Use the **small** and **large right** knobs to place the reference pointer at the location you wish to measure FROM and press **ENT**.
- Again, use the **small** and **large right** knobs to place the reference pointer at the location you wish to measure TO. The bearing and distance from the first reference location will appear at

the top of the map display.



- To exit the "Measure Dist?" option, press the **small right** knob.

Data Fields on the Map

The “Data Fields Off?” option provides a full-screen map display (shown bottom right), without the four data fields along the right-hand side of the screen. Select this option when you wish to display a larger map area. If this option has been selected and the data fields are off, “Data Fields On?” will appear as an option instead.

To turn the data fields on or off, press **MENU** and turn the large right knob to highlight “Data Fields Off?” (or “Data Fields On?”), then press **ENT**.



Selecting Desired On-Screen Data

“Change Fields?” allows you to choose the data displayed on the four user-selectable data fields along the right-hand side of the *map page*. There are twelve available data types, including bearing to destination, distance to destination, estimated time of arrival, ground speed, minimum safe altitude and track. See Section 11 for descriptions of these (and other) navigation terms.

To change a data field:

1. Press **MENU** on the Map page and then turn the **large right** knob to highlight “Change Fields?”. Then, press **ENT**.



2. Turn the **large right** knob to highlight the data field you wish to change.
3. Turn the **small right** knob to select the type of data you want to appear on this field and press **ENT**.



4. Press the **small right** knob to remove the cursor.



NOTE: The on-screen traffic information will occupy two data fields, leaving room to display only two additional data types. Traffic information is only available when the 400W-series installation includes connection to traffic information sources. See the 400W Series Pilot’s Guide Addendum, part number 190-00356-31.

Restoring Factory Settings

“Restore Defaults?” resets all four user-selectable data fields to their original factory default settings.



To restore the factory default settings, press **MENU** and turn the large right knob to highlight “Restore Defaults?”, then press **ENT**.

Terrain Operation

During power-up of the 400W Series unit, the terrain/obstacle database versions are displayed along with a disclaimer. At the same time, the TERRAIN system self-test begins. A failure message is issued if the test fails.

Terrain Limitations

Terrain Proximity displays altitudes of terrain and obstructions relative to the aircraft position and altitude with reference to a database that may contain inaccuracies. Terrain and obstructions are shown only if they are in the database. Terrain and obstacle information should be used as an aid to situational awareness. They should never be used to navigate or maneuver around terrain.

Note that all obstructions may not be available in the terrain and obstacle database. No terrain and obstacle information is shown without a valid 3-D GPS position.

Terrain Page

To display the TERRAIN Page, select the NAV group and turn the **small right** knob until the TERRAIN Page is displayed. The page displays terrain information, aircraft ground track, and GPS-derived MSL altitude. Altitude is shown in increments of 20 feet or in increments of 10 meters, depending on unit configuration. The “G” to the right of the MSL altitude display reminds the pilot that altitude is GPS-derived.

2 - NAV PAGES

Terrain Operation

The TERRAIN Page has two selectable view settings:

- 360° View—View from above aircraft depicting surrounding terrain on all sides
- 120° View—View of terrain ahead of and 60° to either side of the aircraft flight path

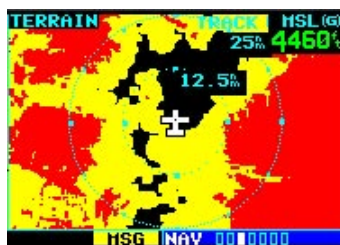

TERRAIN Page



NOTE: The TERRAIN Page gives a “Track Up” display orientation, as indicated by the “TRK” label shown on the display. This is the only orientation available on this page.

To display a 120° view:

1. Select the TERRAIN Page and press **MENU**.
2. Select “View 120°?”.
3. Press **ENT**. To switch back to a 360° view, repeat step 1, select “View 360°?”, and press **ENT**.

Seven display ranges are available, allowing for a more complete view of the surrounding area.

To change the display range:

1. Select the TERRAIN Page and press up or down on the **RNG** key to select the desired range: 1 NM, 2 NM, 5 NM, 10 NM, 25 NM, 50 NM, 100 NM.

Aviation information such as airports, VORs, and other nav aids can be turned on or off from the TERRAIN Page.

To show or hide aviation data:

1. Select the TERRAIN Page and press **MENU**.
2. Select “Show (or Hide) Aviation Data” and press **ENT**. Pressing the **CLR** key when the TERRAIN Page is displayed will also toggle aviation information on or off.



Inhibit Mode

The Garmin TERRAIN system provides an “inhibit mode”. This mode is designed to deactivate Premature Descent Alert/Forward Looking Terrain Avoidance (PDA/FLTA) visual alerts when they are deemed unnecessary by the pilot. Flying VFR into an area where unique terrain exists could cause the system to annunciate a nuisance alert. Pilots should use discretion when inhibiting the TERRAIN system and always remember to enable the system when appropriate. When terrain is inhibited, the Terrain page will still be active, but alerts and messages will not be generated. See the Terrain Alerts section for more information on terrain alerts.

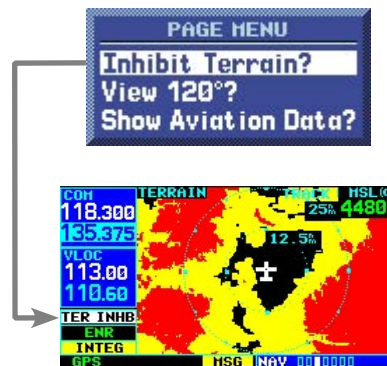

Inhibiting Terrain

To inhibit TERRAIN:

1. Select the TERRAIN Page and press **MENU**.
"Inhibit Terrain?" is selected by default.
2. Press **ENT**. The TERRAIN system is inhibited.
The **TER INHB** annunciation is displayed in the terrain annunciator field whenever terrain is inhibited.

To enable TERRAIN:



Enabling Terrain

1. Select the TERRAIN Page and press **MENU**.
"Enable Terrain?" is selected by default.
2. Press **ENT**. The TERRAIN system is functional again.

Obstacle Symbol	Unlighted Obstacle		Lighted Obstacle		Color	TERRAIN/Obstacle Location
	< 1000' AGL	> 1000' AGL	< 1000' AGL	> 1000' AGL		
				Red	Terrain/Obstacle above or within 100 ft below current aircraft altitude	
					Black	TERRAIN/Obstacle is more than 1000 ft below the aircraft altitude

Terrain Color Symbology

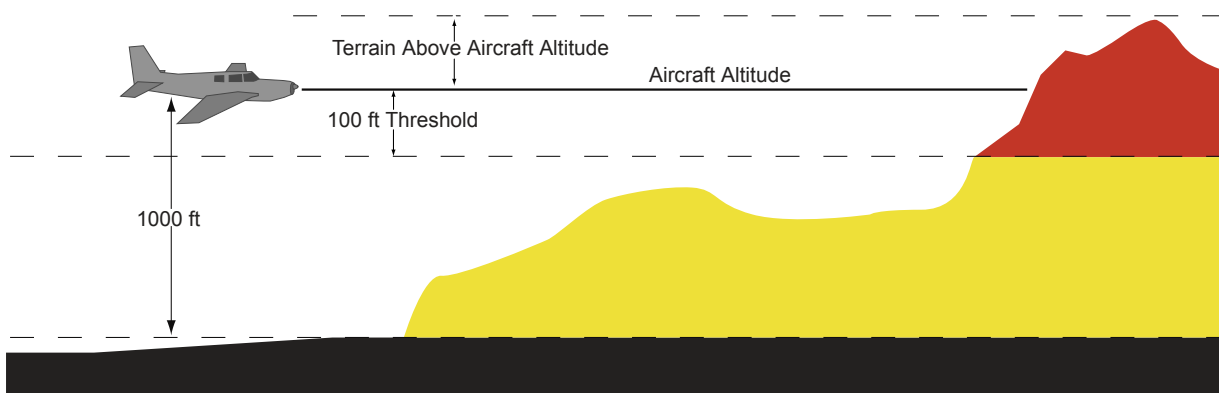

TERRAIN Altitude/Color Correlation

Terrain Symbols

The symbols on the previous page are used to represent obstacles and potential impact points on the Terrain Page. Note that obstacle symbols are shown on display zoom ranges up to 10 NM:

Color Interpretation

The Garmin TERRAIN system uses black, yellow, and red to depict terrain information relative to aircraft altitude.

General Database Information

The Garmin TERRAIN system uses terrain and obstacle information supplied by government sources. The data undergoes verification by Garmin to confirm accuracy of the content, per TSO-C151b. **However, the information displayed should never be understood to be all-inclusive. Pilots must familiarize themselves with the appropriate charts for safe flight.**



NOTE: *The data contained in the terrain and obstacle databases comes from government agencies. Garmin accurately processes and cross-validates the data, but cannot guarantee the accuracy and completeness of the data.*

The terrain/obstacle databases are contained on a datacard which is inserted in the right-most slot of the 400W Series units.

Database Versions

The version and area of coverage of each terrain/obstacle database is shown on the Terrain Database Versions Page, located in the AUX Page Group. Databases are checked for integrity at power-up. If a database is found to be missing and/or deficient, the TERRAIN system fails the self-test and issues a failure message.

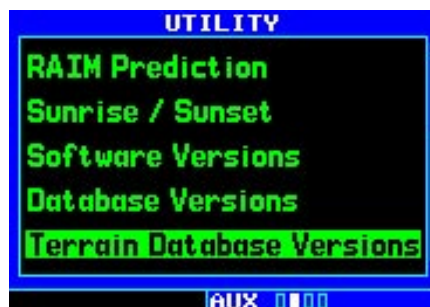

TERRAIN Database Information

Database Updates

Terrain/obstacle databases are updated periodically with the latest terrain and obstacle data. Visit the Garmin website to check for newer versions of terrain/obstacle databases. Compare database cycle numbers to determine if a newer version is available.

The database update process includes either reprogramming or replacing the database card and inserting the updated card in the right card slot on the unit front panel. The terrain/obstacle database may be downloaded via the internet and the card reprogrammed using a USB programmer available from Garmin. Contact Garmin at 800-800-1020 or at www.garmin.com for more information.

To update the terrain or obstacle database:

1. Acquire a new terrain data card from Garmin.
2. Turn off the power to the 400W Series unit.
3. Remove the old terrain data card from and insert the new card into the right-most slot of the 400W Series unit.
4. Turn on the 400W Series unit and verify that the TERRAIN system passes the self-test. The "TER TEST" annunciator will clear after checking and no failure message appears.

Terrain/Obstacle Database Areas of Coverage

The following describes the area of coverage available in each database. Regional definitions may change without notice.

The terrain and airport terrain databases include worldwide coverage that includes: Latitudes South 60° to North 75°.

The obstacle database provides coverage for the USA and Europe that includes:

United States: Limited to the United States, some areas of Canada, Mexico, the Caribbean, and the Pacific.

Europe: Limited to Austria, Belgium, Czech Republic, Denmark, Estonia, Finland, France, Germany, Greece, Iceland, Ireland, Italy, Latvia, Lithuania, Netherlands, Norway, Poland, Portugal, Slovakia, Spain, Sweden, Switzerland, and the United Kingdom.



CAUTION: *Obstacles 200 feet and higher are included in the Obstacle Database. It is very important to note that not all obstacles are necessarily charted and therefore may not be contained in the Obstacle Database.*

Navigation Database

As explained in the "Premature Descent Alerting (PDA)" section, the Garmin TERRAIN premature descent alerting (PDA) algorithms utilize data contained in the Navigation Database. It is therefore important to also have the latest Navigation Database installed to ensure correct TERRAIN alerting.

Terrain Phase of Flight

The TERRAIN Phase of Flight definitions are listed below:

En Route Phase - Defined as when the conditions for Terminal, Approach, and Departure Phases are not met.

Terminal Phase - Defined as when all three of the following conditions are met:

- The aircraft is 15 NM or less from the destination runway.
- The distance to the destination runway threshold is decreasing.
- The aircraft is at or below (lower than) a straight line drawn between the two points specified in the table below (relative to the destination runway).

Distance to Runway	Height above Runway
15 NM	3500 feet
5 NM	1900 feet

Approach Phase - Defined as when all three of the following conditions are met:

- The distance to the destination runway threshold is equal to or less than 5 NM.
- The height above the destination runway threshold elevation is equal to or less than 1000 feet.
- The distance to the destination runway threshold is decreasing.

Departure Phase - Defined as when all five of the following conditions are met:

- It has been determined that the aircraft was previously “on-ground.”
- The aircraft has a vertical velocity greater than zero.
- The aircraft has a ground speed greater than 35 knots.
- The aircraft has an altitude greater than 150 feet AGL and less than 1500 feet AGL.
- The aircraft is within 15 NM of the departure airport.



NOTE: *There are additional factors beyond what is outlined above that may alter the determined TERRAIN flight phase.*

Nearest Airport Criteria & Terrain Phase of Flight

Changes to the Nearest Airport Criteria Page affect how the TERRAIN system performs. The nearest airport list is used to derive the terrain destination airport when there is no loaded active flight plan or when deviating from the active flight plan (whenever the terrain algorithms go into estimation mode). In turn, the nearest airport list is used to determine the terrain phase of flight. The terrain phase of flight dictates the Required Terrain Clearance (RTC) levels at which Forward Looking Terrain Avoidance (FLTA) alerting occurs, as described later in the Forward Looking Terrain Avoidance section. Premature Descent Alerting (PDA) is also affected as described later in the PDA section.



Nearest Airport Criteria Page

As an example, if the pilot configures the unit to include only airports with runways 5000 feet or longer, only these are added to the nearest airport list. The terrain phase of flight is affected in that all airport runways under 5000 feet are NOT included in terrain calculations. During a cross-country flight with this configuration, only airports runways 5000 feet or greater cause the unit to go into Terminal or Approach Mode from En Route mode. If the pilot makes an emergency landing at an airport that did not show up in the nearest airport list, FLTA alerts would be issued throughout the descent.

TERRAIN Destination Airport

The TERRAIN destination airport is considered to be the next airport in the flight plan while adhering to the flight plan path. If no flight plan is entered, or if the aircraft is not adhering to the entered flight plan path, the terrain destination airport is estimated using the Nearest Airport Criteria as described in the section above.

TERRAIN Alerts

TERRAIN alerts are issued when flight conditions meet parameters that are set within the TERRAIN system software algorithms. When an alert is issued, visual annunciations are displayed. Annunciations appear in a dedicated field in the lower left corner of the display.

TERRAIN Annunciation Field TERRAIN Pop-Up Alert

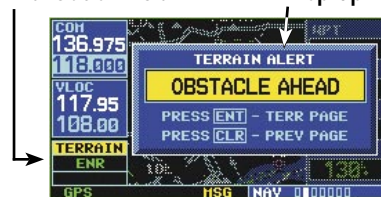

TERRAIN Annunciation and Pop-Up Alert

Pop-up Alerts

On any page except the TERRAIN Page, when a terrain or obstacle alert is issued, a pop-up window is displayed with the appropriate alert.

To acknowledge the pop-up alert and return to the currently viewed page:

Press the **CLR** key.

To acknowledge the pop-up alert and quickly display the TERRAIN Page:

Press the **ENT** key.

Forward Looking Terrain Avoidance

The Forward Looking Terrain Avoidance alert, or FLTA, is used by the TERRAIN system and is composed of two elements: Reduced Required Terrain Clearance (RTC) Avoidance and Imminent Terrain Impact (ITI) Avoidance.

RTC/ITI TERRAIN Severity Levels



TERRAIN

“TERRAIN ADVISORY” advisory—Estimated potential impact in approximately 60 seconds after pop-up alert and annunciation. Similarly, an “OBSTACLE ADVISORY” alert is also provided.



TERRAIN

“TERRAIN AHEAD” alert (flashing)—Estimated potential impact in approximately 30 seconds after pop-up alert and annunciation. Similarly, an “OBSTACLE AHEAD” alert is also provided.

- *Reduced Required Terrain Clearance (RTC) Avoidance* — Provides alerts when the aircraft flight path is above terrain, yet is projected to come within minimum clearance values outlined in the following Minimum Terrain Clearance Values table. When an RTC alert is issued, a potential impact point is displayed on the TERRAIN Page as shown in the previous Terrain Altitude/Color figure.

2 - NAV PAGES

Terrain Alerts

- *Imminent Terrain Impact (ITI) Avoidance* — Provides alerts when the aircraft is below the elevation of a terrain cell in the aircraft's projected path. ITI alerts are accompanied by a potential impact point displayed on the TERRAIN Page. The alert is given when the projected vertical flight path is calculated to come within minimum clearance altitudes in the following table.

Phase of Flight	Level Flight	Descending
En Route	700 ft.	500 ft.
Terminal	350 ft.	300 ft.
Approach	150 ft.	100 ft.
Departure	100 ft.	100 ft.

Minimum Terrain Clearance Values for RTC/ITI Alerts

During the final approach phase of flight, RTC/ITI alerts are automatically inhibited when the aircraft is below 200 feet AGL while within 0.5 NM of the approach runway or is below 125 feet AGL while within 1 NM of the runway threshold.

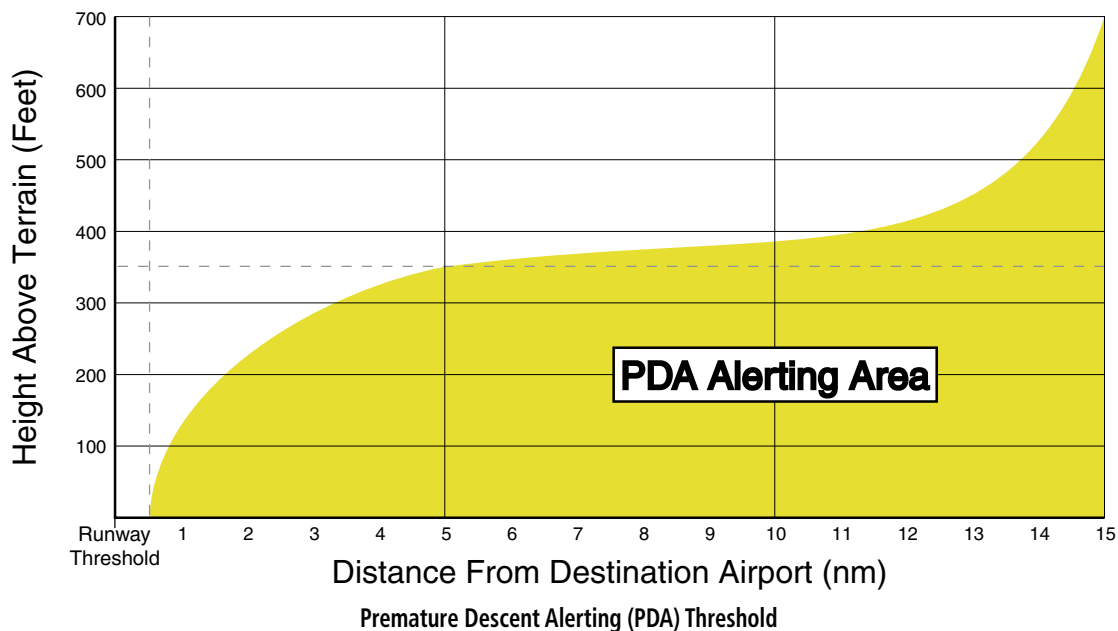

Premature Descent Alerting (PDA)

The TERRAIN system issues a Premature Descent Alert (PDA) when the system detects that the aircraft is significantly below the normal approach path to a runway. PDA begins when the aircraft is within 15 NM of the destination airport. PDA ends when the aircraft is either 0.5 NM from the runway threshold or is below an altitude of 125 feet AGL while within 1.0 NM of the threshold.

PDA Severity Levels



TERRAIN

CAUTION — The above annunciation and pop-up terrain alert are displayed during a PDA alert.

TERRAIN Failure Alert

The TERRAIN system continually monitors several system-critical items, such as database validity, hardware status, and GPS status. Should the system detect a failure, a message is annunciated “TERRAIN has failed”.



“TERRAIN has failed” message

“TERRAIN Not Available” Alert

The TERRAIN system requires a 3D GPS navigation solution along with specific vertical accuracy minimums. Should the navigation solution become degraded, if the terrain/obstacle database is not available, or if the aircraft is out of the database coverage area, the annunciation “TERRAIN NOT AVAILABLE” is displayed on the TERRAIN Page.



“TERRAIN NOT AVAILABLE” display

2 - NAV PAGES

Terrain Alerts

Alert Type	Annunciation	Pop-Up Alert
TERRAIN Failure	TER FAIL	None
TERRAIN Inhibited	TER INHB	None
TERRAIN Not Available	TER N/A	None
Required Terrain Clearance (RTC) Advisory	TERRAIN	TERRAIN ADVISORY
Required Terrain Clearance (RTC) Alert	TERRAIN (FLASHING)	TERRAIN AHEAD (FLASHING)
Imminent Terrain Impact (ITI) Advisory	TERRAIN	TERRAIN ADVISORY
Imminent Terrain Impact (ITI) Alert	TERRAIN (FLASHING)	TERRAIN AHEAD (FLASHING)
Required Obstacle Clearance (RTC) Advisory	TERRAIN	CAUTION - OBSTACLE
Required Obstacle Clearance (RTC) Alert	TERRAIN (FLASHING)	OBSTACLE AHEAD (FLASHING)
Imminent Obstacle Impact (IOI) Advisory	TERRAIN	OBSTACLE ADVISORY
Imminent Obstacle Impact (IOI) Alert	TERRAIN (FLASHING)	CAUTION - OBSTACLE (FLASHING)
Premature Descent Alert (PDA)	TERRAIN	TOO LOW - TERRAIN
TERRAIN Alerts Summary		

NAVCOM Page

The NAVCOM (*navigation communications*) page provides a list of the airport communication and navigation frequencies at your departure, en route and arrival airports. The NAVCOM page makes selection of the frequencies you'll need along your flight plan quick and convenient. If you do not have an active flight plan with a departure airport, the NAVCOM page will display the frequencies for the airport nearest your departure position. Only the 420AW and 430AW move frequencies to their Navcom.

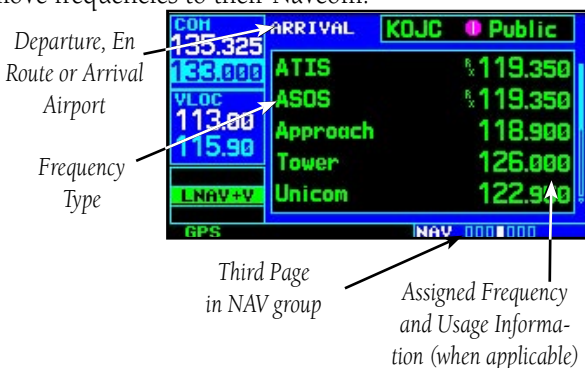

To select a frequency list for a departure, en route, or arrival airport:

1. Press the **small right** knob to activate the cursor.
2. Turn the **large right** knob to place the cursor on the airport identifier field (top line on the NAVCOM page).



3. Turn the **small right** knob to select the desired airport and press **ENT**.



To scroll through the list of frequencies:

1. Activate the cursor, if not already active, by pressing the **small right** knob.
2. Turn the **large right** knob to move the cursor through the list of frequencies. If there are more frequencies in the list that can be displayed on the screen, a scroll bar along the right-hand side of the screen will indicate which part of the list is currently being displayed.



3. To place a frequency in the standby field of the COM or VLOC window, highlight the desired frequency and press **ENT**. (420AW and 430AW only)



2 - NAV PAGES

Position Page

Some listed frequencies may include designations for limited usage, as follows:

- “TX” - transmit only
- “RX” - receive only
- “PT” - part time frequency

If a listed frequency has sector or altitude restrictions, the frequency will be preceded by an “Info?” designation.

To view usage restrictions for a frequency:

1. Turn the **large right** knob to place the cursor on the “Info?” designation directly in front of the desired frequency.
2. Press **ENT** to display the restriction information.



3. To return to the NAVCOM page, press **ENT**.

Position Page

The *position page* displays your present position (by default, in latitude and longitude) and altitude. The *position page* also displays your current track, ground speed, time and a reference waypoint field. These fields are user-selectable to configure the page to your own preferences and current navigation needs.

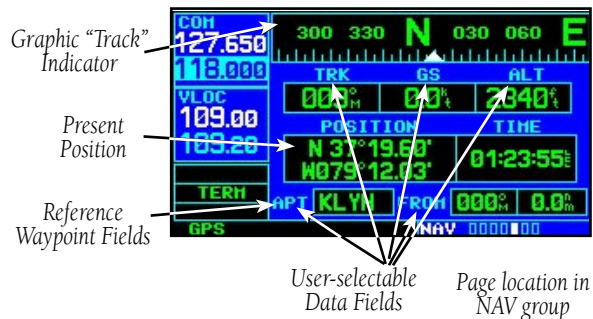

The graphic “track” indicator at the top of the page indicates the direction you’re heading, or track, only while you’re moving. Directly below are three user-selectable fields, which by default, display track, ground speed and altitude. Minimum safe altitude (MSA) can also be displayed on these fields. MSA is the recommended minimum altitude within approximately ten miles of your present position. MSA is calculated from the information contained in the database and generally includes mountains, buildings and other permanent features.

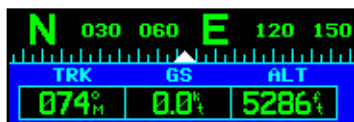

The graphic “track” indicator and the TRK indication directly below it provide the same information. Use the graphic “track” indicator for quick at-a-glance ground track information.



NOTE: Do not rely solely on MSA as an absolute measure of safe altitude. Consult current charts and NOTAMs for your area.

To change the user-selectable data fields:

1. Press **MENU** to display the Position page options menu.
2. Turn the **large right** knob to highlight "Change Fields?" and press **ENT**.



3. Turn the **large right knob** to highlight the data field you wish to change.



4. Turn the **small right** knob to display the list of available data items. Continue turning the **small right** knob to select the desired data item from the list.



5. Press **ENT** to select the desired data item and return to the position page.

6. Press the **small right** knob momentarily to remove the cursor from the page.

The position page also features a reference waypoint field, located at the bottom of the page, to indicate your bearing and distance to/from a selected waypoint. The reference waypoint field can display bearing and distance information for a nearby airport (default), VOR, NDB, intersection or user waypoint.

To change the reference waypoint information:

1. Press **MENU** to display the position page options menu.
2. Turn the **large right** knob to highlight "Change Fields?" and press **ENT**.
3. Turn the **large right** knob to highlight the waypoint type field (bottom left corner of the page; default setting will show "APT").
4. Turn the **small right** knob to display the list of available waypoint types. Continue turning the **small right** knob to select the desired data item from the list.



5. Press **ENT** to select the desired type and return to the position page.
6. To select between "bearing FROM" or "bearing TO" to the reference waypoint, turn the **small right** knob to select the desired bearing reference and press **ENT**.

2 - NAV PAGES

Restoring Factory Settings



7. Press the **small right** knob momentarily to remove the cursor from the page.
8. If “WPT” is selected as the waypoint type, you can designate any airport, NAVAID or user waypoint as a reference waypoint. Press the **small right** knob, turn the **large right** knob to highlight the waypoint identifier field, then use the **small** and **large right knobs** to enter the identifier of the desired waypoint. Press **ENT** to confirm the selected waypoint. Press the **small right** knob to remove the cursor.



Restoring Factory Settings

A “Restore Defaults?” option allows you to reset all data fields to their original factory default settings. This will return the three user-selectable fields at the top of the page AND the reference waypoint fields to default settings.

To restore the factory default settings:

1. Press **MENU** to display the position page options menu.
2. Turn the **large right** knob to highlight “Restore Defaults?” and press **ENT**.



Satellite Status Page

The Satellite Status Page is helpful in troubleshooting weak (or missing) signal levels due to poor satellite coverage or installation problems. You may wish to refer to this page occasionally to monitor GPS receiver performance and establish a normal pattern for system operation. Should problems occur at a later date, you may find it helpful to have an established baseline from which to compare.

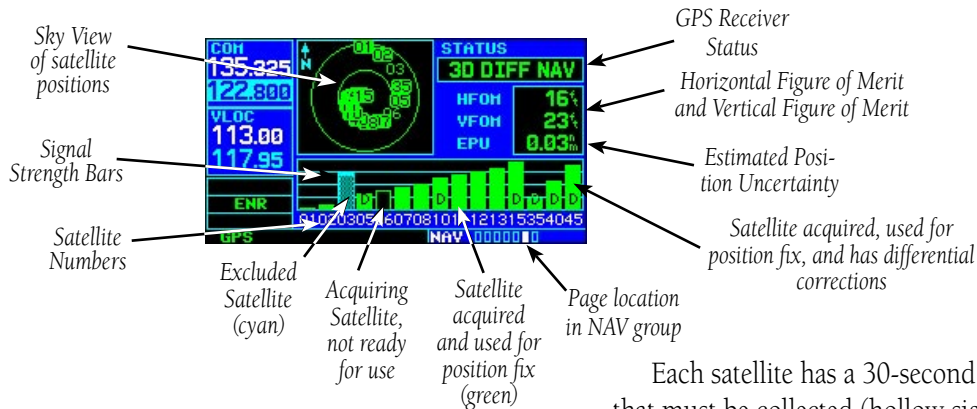

As the GPS receiver locks onto satellites, a signal strength bar appears for each satellite in view, with the appropriate satellite number (01-32, WAAS satellites will have higher numbers) underneath each bar. The progress of satellite acquisition is shown in the following conditions:

- Hollow signal strength bars — the receiver has found the satellite(s) and is collecting data.
- Cross-hatch cyan signal strength bars — the receiver has found the satellite(s) but it has been excluded by the FDE program as a faulty satellite.
- Solid cyan signal strength bars — the receiver has collected the necessary data, but is not using the satellite in the position solution.
- Solid green signal strength bars — the receiver has collected the necessary data and the satellite is being used in the position solution. The sky view display

(at top left corner of the page) shows which satellites are currently in view, and where they are. The outer circle of the sky view represents the horizon (with north at top of the page); the inner circle 45° above the horizon; and the center point directly overhead.

The “D” character inside the bars indicates differential corrections (e.g. WAAS) are being used for that satellite.

Each satellite has a 30-second data transmission that must be collected (hollow signal strength bar) before the satellite may be used for navigation (solid signal strength bar). Once the GPS receiver has determined your position, the 400W-series unit indicates your position, altitude, track and ground speed. The GPS receiver status field also displays the following messages under the appropriate conditions:

- Searching Sky — The GPS receiver is searching the sky for ANY visible satellites. You are also informed of this status with a “Searching the Sky” message.
- Acquiring Sat — The GPS receiver is acquiring satellites for navigation. In this mode, the receiver uses satellite orbital data (collected continuously from the satellites) and last known position to determine the satellites that should be in view.

2 - NAV PAGES

Satellite Status Page

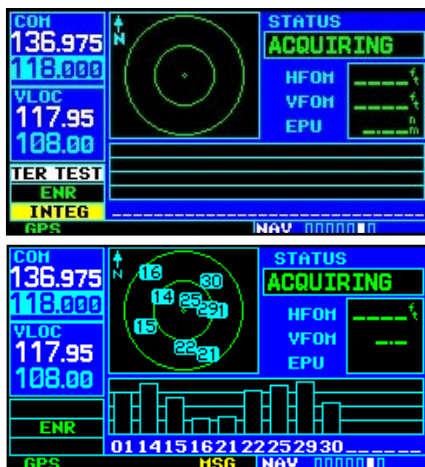

- 3D Navigation — The GPS receiver is in 3D navigation mode and computes altitude using satellite data.
- 3D Differential Navigation— The GPS receiver is in 3D navigation mode and differential corrections are being used.

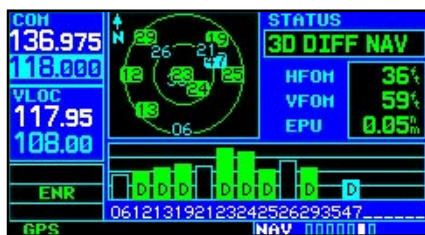

The Satellite Status Page also indicates the accuracy of the position fix, using Horizontal Figure of Merit (HFOM), Vertical Figure of Merit (VFOM), and Estimated Position Uncertainty (EPU). HFOM and VFOM represent the 95% confidence levels in horizontal and vertical accuracy. The lowest numbers are the best accuracy and the highest numbers are worse. EPU is the horizontal position error estimated by the Fault Detection and Exclusion (FDE) algorithm, in feet or meters.

Vertical Navigation Page

The 400W-series vertical navigation page (the last NAV page) allows you to create a three-dimensional profile which guides you from your present position and altitude to a final (target) altitude at a specified location. This is helpful when you'd like to descend to a certain altitude near an airport. Once the profile is defined, message alerts and additional data on the default NAV and map pages will keep you informed of your progress.

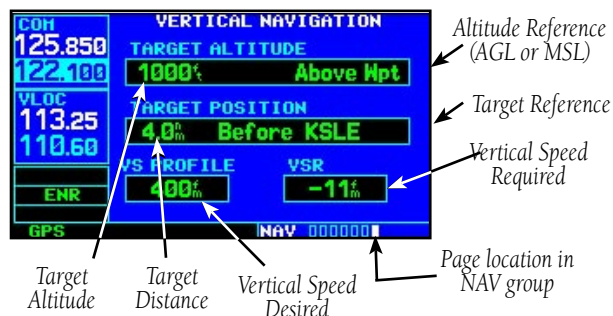

NOTE: To use the vertical navigation features, your ground speed must be greater than 35 knots and you must be navigating to a direct-to destination or using a flight plan. To create a vertical navigation profile:

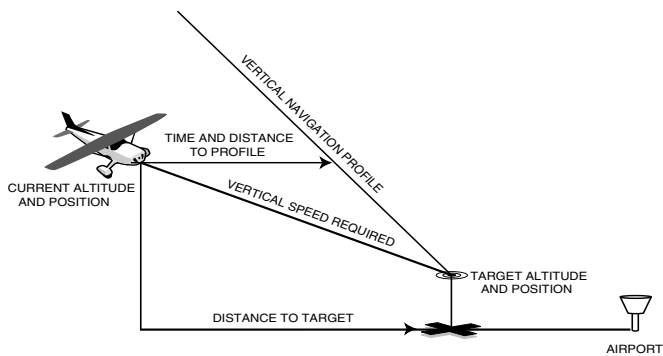

1. Press the **small right** knob to activate the cursor.
2. Turn the **large right** knob to highlight the target altitude field.
3. Turn the **small** and **large right** knobs to select the target altitude and press **ENT**.



4. Turn the **small right** knob to select "Above Wpt" (AGL) or "MSL", and press **ENT**. "Above Wpt" will use the altitude of a destination airport as stored in the Jeppesen NavData card. "MSL" lets you set a specific target altitude for any waypoint category: airport, VOR, NDB, intersection or user waypoint.



5. Turn the **small** and **large right** knobs to select a distance from the target reference waypoint and press **ENT**. If the target altitude should occur at the target reference waypoint, enter a distance of zero.



6. Turn the **small right** knob to select "Before" or "After", and press **ENT**. This setting designates whether the offset distance defines a point before you reach the target reference waypoint or after you reach the waypoint. "After" is not available for the last waypoint.
7. When using a flight plan, the target reference waypoint itself can be specified from the waypoints contained in the flight plan. By default, the last waypoint in the flight plan will be selected. To select a different waypoint, turn the **small right** knob to select the desired waypoint and press **ENT**.



8. The default profile utilizes a 400 foot-per-minute descent rate. To change the rate, turn the **large right** knob to highlight the "VS Profile" field and use the **small** and **large right** knobs to enter a new rate. Press **ENT** when finished.



2 - NAV PAGES

Vertical Navigation - VNAV

With the profile set, the vertical speed required (VSR) is displayed on the *vertical navigation page*. Expect the following to occur when using the vertical navigation feature:

- At one minute prior to reaching the initial descent point, a message “Approaching VNAV Profile” occurs. The descent angle will also lock to prevent changes in speed from altering the profile.
- If selected, the vertical speed required (VSR) readout on the default NAV and map pages will show the desired vertical speed to maintain the proper descent angle.
- At 500 feet above the target altitude, an “Approaching Target Altitude” message is provided. The VSR readout on the default NAV and map pages is blanked out, at this point.

Vertical navigation messages can be turned on or off. (By default the messages are off.) Turning the messages off allows you to keep the profile settings you’ve entered previously, without having them generate messages when the feature isn’t needed.

To disable/enable the vertical navigation (VNAV) messages:

1. Press **MENU** to display the vertical navigation page options menu.



2. With “VNAV Messages On?” highlighted, press **ENT**. Or, if the messages are already on and you wish to turn them off, make sure “VNAV Messages Off?” is highlighted and press **ENT**.

To restore the factory default VNAV settings:

1. On the Nav VNAV page, press the **MENU** key.
2. Turn the **large right** knob to highlight “Restore Defaults” and then press **ENT**.



Dead Reckoning

Dead reckoning is the process of continuing navigation using your last known position and speed after a loss of GPS navigation while on an active flight plan.



CAUTION: *Navigation using dead reckoning is therefore only an estimate and should not be used as the sole means of navigation. Use other means of navigation, if possible.*

Dead reckoning becomes active after a loss of GPS position while you are navigating using an active flight plan. A pop-up message will appear and you must clear the message before continuing operation.

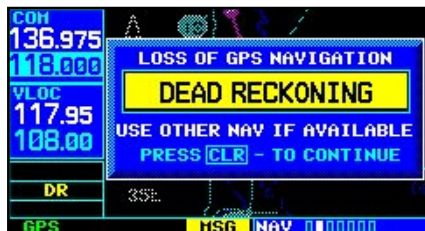

The ownship icon color is changed to yellow. The To/From flag is removed from the CDI. The Dead Reckoning annunciator (DR) appears on the left side of the map display when GPS position is unavailable and the unit is in Dead Reckoning mode. All external outputs dependent on GPS position are flagged.

Terrain will be noted as not available and new terrain advisory pop-ups will not occur. Traffic and Stormscope information will not be shown on the Map page, but will continue to be available on their own dedicated pages. XM weather will still be available on the Map page.

Dead Reckoning mode will continue until GPS position is restored, when GPS navigation is restored Dead Reckoning mode is exited. The DR annunciations will be removed and GPS information will be used to

compute navigation related information for the current flight phase.

Dead Reckoning is only allowed in En Route and Oceanic flight modes. If the unit is in a Terminal or Approach flight mode when Dead Reckoning takes place, “No GPS Position” will be displayed on the map pages and all navigation data will be dashed. If you are operating in Dead Reckoning mode and a transition to Terminal or Approach flight modes would occur from the projected Dead Reckoning position, Dead Reckoning mode will be discontinued. “No GPS Position” will be displayed on the map pages and all navigation data will be dashed.

Blank Page

Section 3

Direct-To Navigation

The 400W-series direct-to function provides a quick method of setting a course to a destination waypoint. Once a direct-to is activated, the 400W-series will establish a point-to-point course line (geodesic path) from your present position to the selected direct-to destination. Navigation data on the various NAV pages will provide steering guidance until the direct-to is cancelled or replaced by a new destination.

To select a direct-to destination:

1. Press the **direct-to** key. The select direct-to waypoint page will appear, with the waypoint identifier field highlighted.



2. Use the **small** and **large right knobs** to enter the identifier of the desired destination waypoint.



3. Press **ENT** to confirm the selected waypoint, and **ENT** again to activate the direct-to function.



If you're navigating to a waypoint and get off course, the direct-to function may also be used to re-center the CDI (HSI) needle and proceed to the same waypoint.

To re-center the CDI (HSI) needle to the same destination waypoint:

1. Press the **direct-to** key, followed by pressing **ENT** twice.



NOTE: If you're navigating an approach with the missed approach point (MAP) as the current destination, re-centering the CDI (HSI) needle with the direct-to key will cancel the approach.

3 - DIRECT-TO

Selecting a Destination

Selecting a Destination by Facility Name or City

In addition to selecting a destination by identifier, the *select direct-to waypoint page* also allows you to select airports, VORs and NDBs by facility name or city location. If duplicate entries exist for the entered facility name or city, additional entries may be viewed by continuing to turn the **small right** knob during the selection process.



To select a direct-to destination by facility name or city:

1. Press the **direct-to** key. The select direct-to waypoint page will appear, with the waypoint identifier field highlighted.
2. Turn the **large right** knob to highlight the facility name (second line; see above) or the city (third line; see above) field.
3. Use the **small** and **large right** knobs to enter the facility name or city location of the desired destination waypoint. As you spell the facility name or city, the 400W-series Spell'N'Find feature will select the first entry in the database based upon the characters you have entered up to that point.

4. Continue turning the **small right knob** to scroll through any additional database listings for the selected facility name or city. You can also scroll backwards with the **small right** knob if you scroll past the desired waypoint.
5. Press **ENT** to confirm the selected waypoint, and **ENT** to activate the direct-to function.



To select the direct-to destination by facility name (shown above) or city location (shown below), highlight the second or third line on the direct-to waypoint page. Use the small and large right knobs to enter the facility name or city. The identifier(s) for any matching entries will appear on the top line of the page.



Selecting a Destination from the Active Flight Plan

If you're navigating an active flight plan, any waypoint contained in the flight plan may be selected as a direct-to destination from the *select direct-to waypoint page*. (see *Section 4 - Flight Plans*, for more information on flight plans.)

To select a direct-to destination from the active flight plan:

1. Press the **direct-to** key. The select direct-to waypoint page will appear, with the waypoint identifier field highlighted.
2. Turn the **large right** knob to highlight the flight plan (FPL) field.



3. Turn the **small right** knob to display a window showing all waypoints in the active flight plan.



4. Continue turning the **small right** knob to scroll through the list and highlight the desired waypoint.
5. Press **ENT** to confirm the selected waypoint, and **ENT** to activate the direct-to function.

Selecting the Nearest Airport as a Direct-To Destination

The *select direct-to waypoint page* always displays the nearest airports (from your present position) on the NRST field. Navigating directly to a nearby airport is always just a few simple steps away. (Nearby airports may also be selected as direct-to destinations using the steps described *Section 7 - NRST Pages - Navigating to a Nearby Waypoint*.)

To select a nearby airport as a direct-to destination:

1. Press the **direct-to** key. The select direct-to waypoint page will appear, with the waypoint identifier field highlighted.
2. Turn the **large right** knob to highlight the nearest airport (NRST) field.
3. Turn the **small right** knob to display a window showing up to nine nearby airports.



4. Continue turning the **small right** knob to scroll through the list and highlight the desired airport.
5. Press **ENT** to confirm the selected airport, and **ENT** to activate the direct-to function.



NOTE: Performing a direct-to for the MAP of an active approach will cancel approach mode.

Shortcuts

Shortcuts are available when using the **direct-to** key, allowing you to bypass the use of the **small** and **large right** knobs to enter the destination waypoint's identifier. A direct-to can be performed from any page displaying a single waypoint identifier (such as the WPT pages for airports and nav aids) by simply pressing **direct-to** and **ENT**. For pages that display a list of waypoints (e.g., the *nearest airport page*), you must highlight the desired waypoint with the cursor before pressing the **direct-to** key.

To select an on-screen waypoint (other than the map page) as a direct-to destination:

1. If a single airport, nav aid or user waypoint is displayed on-screen: press **direct-to**, then press **ENT** twice.



2. If a list of waypoints is displayed on-screen: press the **small right** knob to activate the cursor, turn the **large right** knob to highlight the desired waypoint, then press **direct-to** followed by **ENT** twice.



Direct-to destinations may also be selected from the *map page*, by panning to the desired destination location and pressing **direct-to** and **ENT** (twice). If no airport, nav aid or user waypoint exists at the desired location, a waypoint named "+MAP" will automatically be created at the location of the panning pointer.

To select a direct-to destination from the map page:

1. From the map page, press the **small right** knob to display a panning pointer.
2. Turn the **small** and **large right** knobs to place the panning pointer at the desired destination location.



3. If the panning pointer is placed on an existing airport, nav aid or user waypoint, the waypoint name will be highlighted. Press **direct-to** and then **ENT** twice to navigate to the waypoint.
4. If the panning pointer is placed on an open location, press **direct-to** and **ENT** twice to create a "MAP" waypoint and navigate to it.

Cancelling Direct-To Navigation

Once a direct-to is activated, the 400W-series will provide navigation guidance to the selected destination until the direct-to is replaced with a new direct-to or flight plan, cancelled, or the unit is turned off.

To cancel a direct-to:

1. Press the **direct-to** key to display the select direct-to waypoint page.
2. Press **MENU** to display the direct-to options menu.



3. With "Cancel Direct-To NAV?" highlighted, press **ENT**. If a flight plan is still active, the 400W-series will resume navigating the flight plan along the closest leg.

Specifying a Course to a Waypoint

Whenever you perform a direct-to, the 400W-series will set a direct geodesic course to your selected destination. You can also manually define the course to your destination, using the "CRS" course field on the *select direct-to waypoint page*.

To manually define the direct-to course:

1. Press the **direct-to** key.
2. Use the **small** and **large right** knobs to select the destination waypoint.
3. Press **ENT** to confirm the selected waypoint, then turn the **large right** knob to highlight the course ("CRS") field.



4. Turn the **small** and **large right** knobs to select the desired course and press **ENT**.



5. Press **ENT** again to begin navigation using the selected destination and course.
6. To reselect a direct course from present position (or select a new manually-defined course), simply press **direct-to**, followed by **ENT** twice.

Selecting Direct-To a Holding Pattern

You may select a Direct-To course to a holding pattern that is in your flight plan.

To set a direct-to course to a holding pattern:

1. Press the **FPL** key to reach the active flight plan page.
2. Press the **small right** knob to activate the cursor. Turn the **large right** knob to highlight the hold leg of the flight plan.



3. Press **direct-to**. "Activate" will be highlighted. Press **ENT** to activate a course Direct-To the holding pattern. Or, press **CLR** to cancel the process.



4. The holding pattern will now be set as your next waypoint.



Section 4 Flight Plans

The 400W-series lets you create up to 20 different flight plans, with up to 31 waypoints in each flight plan. The flight plan page group consists of two pages, accessed by pressing the **FPL** key. The Active Flight Plan page shows the legs and details in the active flight plan. The Flight Plan Catalog contains flight plans that you have created and saved for future use. The flight plan pages allow you to create, edit and copy flight plans. There are separate options available in both the Active Flight Plan page and the Flight Catalog page.



Active Flight Plan Page



Flight Plan Catalog Page

Flight Plan Catalog

The Flight Plan Catalog allows you to create, edit, activate, delete and copy flight plans. Flight plans numbered from 1 through 19 are used to save flight plans for future use. “Flight plan 00” is reserved exclusively for the flight plan currently in use for navigation. Any time you activate a flight plan, a copy of the flight plan is automatically transferred to “flight plan 00” and overwrites any previously active flight plan.

Flight Plan Catalog Editing

To add a waypoint to an existing flight plan:

1. Press **FPL** and turn the **small right** knob to display the flight plan catalog.
2. Press the **small right** knob to activate the cursor.
3. Turn the **large right** knob to highlight the desired flight plan and press **ENT**.

4. Turn the **large right** knob to select the point where you wish to add the new waypoint. If an existing waypoint is highlighted, the new waypoint will be placed directly in front of this waypoint.



5. Use the **small** and **large right** knobs to enter the identifier of the new waypoint and press **ENT**.



6. Once all changes have been made, press the **small right** knob to return to the flight plan catalog.

To delete a waypoint from an existing flight plan:

1. Press **FPL** and turn the **small right** knob to display the flight plan catalog.
2. Press the **small right** knob to activate the cursor.
3. Turn the **large right** knob to highlight the desired flight plan and press **ENT**.
4. Turn the **large right** knob to select the waypoint you wish to delete and press **CLR** to display a “remove waypoint” confirmation window.

4 - FLIGHT PLANS

Flight Plan Catalog

5. With "Yes" highlighted, press **ENT** to remove the waypoint.
6. Once all changes have been made, press the **small right** knob to return to the flight plan catalog.

A one-line user comment may be added to any flight plan, which will be displayed on the flight plan catalog, next to the flight plan's number. By default, as the flight plan is being created, the comment will show the first and last waypoints in the flight plan.

To change the comment line for an existing flight plan:

1. From the flight plan catalog, press the **small right** knob to activate the cursor.
2. Turn the **large right** knob to highlight the desired flight plan and press **ENT**.
3. Turn the **large right** knob to select the comment line at the top of the screen.
4. Use the **small** and **large right** knobs to enter the new comment. Press **ENT** when finished.



5. Once all changes have been made, press the **small right** knob to return to the flight plan catalog.

Flight Plan Catalog Options

The following options are available for the Flight Plan Catalog:

- Activate Flight Plan
- Invert and Activate Flight Plan
- Create New Flight Plan
- Crossfill
- Copy Flight Plan
- Delete Flight Plan
- Delete All Flight Plans
- Sort List by Number/Comment

Activating Flight Plans

Activate Flight Plan? allows you to select the flight plan for navigation guidance. Once a flight plan is defined through the Flight Plan Catalog, it may be activated for navigation. Activating the flight plan places it into "flight plan 00" and overwrites any previous information at that location.

To activate an existing flight plan:

1. From the flight plan catalog, press the **small right** knob to activate the cursor.
2. Turn the **large right** knob to highlight the desired flight plan and press **MENU** to display the flight plan catalog options.
3. Turn the **large right** knob to highlight "Activate Flight Plan?" and press **ENT**.



Inverting Flight Plans

Invert FPL? allows you to reverse the highlighted flight plan and select it for navigation guidance. After travelling along a flight plan, you may wish to reverse the route for navigation guidance back to your original departure point.

To activate an existing flight plan in reverse order:

1. From the flight plan catalog, press the **small right** knob to activate the cursor.
2. Turn the **large right** knob to highlight the desired flight plan and press **MENU** to display the flight plan catalog options.
3. Turn the **large right** knob to highlight "Invert FPL?" and press **ENT**. The original flight plan will remain intact in its flight plan catalog storage location.



Create a new flight plan

Create New Flight Plan? allows you to create a new flight plan. The new flight plan will be saved in the Flight Plan Catalog.

To create a new flight plan:

1. Press **FPL** and turn the **small right** knob to display the flight plan catalog.
2. Press **MENU** to display the flight plan catalog options.



3. Turn the **large right** knob to highlight "Create New Flight Plan?" and press **ENT**.
4. A blank flight plan page will appear for the first empty storage location. Use the **small** and **large right** knobs to enter the identifier of the departure waypoint and press **ENT**.



5. Repeat step #4 above to enter the identifier for each additional flight plan waypoint.
6. Once all waypoints have been entered, press the **small right** knob to return to the flight plan catalog.

4 - FLIGHT PLANS

Flight Plan Catalog Options

Crossfill

Crossfill? allows you to transfer a direct-to destination, the active flight plan, any stored flight plan or user waypoints to a second 400W-Series or 500W-Series Garmin unit. Some crossfill operations can be done automatically. If both units are set to “auto”, a change in the direct-to destination or active flight plan on one unit will also be seen on the other.

To crossfill flight plans between two 400W- or 500W-Series Garmin units:

1. Select the “Crossfill?” option from the flight plan catalog options and press **ENT**.



2. Turn the **large right** knob to select the “Method” field.



3. Turn the **small right** knob to select “Auto” or “Manual” and press **ENT**. “Auto” will automatically transfer the active flight plan or direct-to selection to another 400W- or 500W-series Garmin unit, without user intervention.
4. If “Manual” is selected: Turn the **large right** knob to select the “Transfer” field, then turn the **small right** knob to select the type of information to transfer between units (active

flight plan, flight plan, all user waypoints or a single user waypoint). When “Flight Plan” or “User Waypoint” is selected, a second field will appear to the immediate right of the “Transfer” field. Use the **small** and **large right** knobs to enter the number of the flight plan or the name of the user waypoint you wish to transfer.

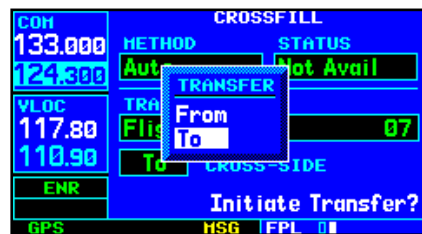

5. The “Cross-Side” field allows you to designate the sending and receiving units in a crossfill operation. Turn the **large right** knob to select the “Cross-Side” field, then turn the **small right** knob, to select “To” or “From”. Press **ENT** to confirm the selection.
6. Turn the **large right** knob to highlight “Initiate Transfer?” and press **ENT**.

Copying Flight Plans

Copy Flight Plan? allows you to copy the selected flight plan to a new flight plan location. The copy function is useful for duplicating an existing flight plan before making changes. If you want to save a flight plan currently located in “flight plan 0”, be sure to copy it to an open catalog location (1-19) before the flight plan is cancelled, overwritten or erased.

To copy a flight plan to another flight plan catalog location:

- 1a. From the active flight plan page, press **MENU** to display the active flight plan options window.
- or



- 1b. From the flight plan catalog, press the **small right** knob to activate the cursor, turn the **large right** knob to highlight the flight plan you wish to copy, then press **MENU** to display the flight plan catalog options.

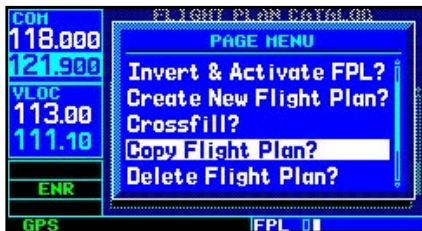

2. Turn the **large right** knob to highlight "Copy Flight Plan?" and press **ENT**.
3. By default, the next empty catalog location will be offered. To select a different location, turn the **large right** knob to select the flight plan number, use the **small** and **large right** knobs to enter a different number and press **ENT**.
4. With "Yes?" highlighted, press **ENT** to copy the flight plan.

Deleting Flight Plans

Delete Flight Plan? allows you to remove the selected flight plan from memory. Deleting a flight plan does not delete the individual waypoints contained in the flight plan from the database or user waypoint memory. Once you are finished with a flight plan, it can easily be deleted from the flight plan catalog or the active flight plan page.

To delete a flight plan:

- 1a. From the active flight plan page, press **MENU** to display the active flight plan options window.
- or
- 1b. From the flight plan catalog, press the **small right** knob to activate the cursor, turn the **large right** knob to highlight the flight plan you wish to copy, then press **MENU** to display the flight plan catalog options.



2. Turn the **large right** knob to highlight "Delete Flight Plan?" and press **ENT**.
3. With "Yes?" highlighted, press **ENT** to delete the flight plan.

Deleting All Flight Plans

Delete All Flight Plans? allows you to remove all flight plans from memory.

To delete all flight plans:

1. Select the "Delete All Flight Plans?" option from the flight plan catalog options and press **ENT**.



4 - FLIGHT PLANS

Flight Plan Catalog Options

2. A confirmation window will appear. With "Yes?" highlighted, press **ENT**.



Sort List by Number?/Sort List by Comment?

Sort List By Number?/Sort List by Comment?

The sorting function allows you to select between a flight plan catalog sorted numerically by the flight plan number or sorted alphanumerically based upon the comment assigned to each flight plan. When either option is selected, the other option will appear on the flight plan catalog options window.

To sort the catalog listing by number or comment:

1. Select the "Sort List By Number?" or "Sort List By Comment?" option (whichever is currently displayed) from the flight plan catalog options and press **ENT**.

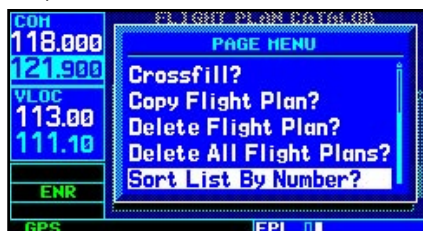

Active Flight Plan Page

The active flight plan page provides information and editing functions for "flight plan 00"—the flight plan currently in use for navigation. Once you have activated a flight plan, the active flight plan page will show each waypoint for the flight plan, along with the desired track (DTK) and distance (DIS) for each leg. The data fields for DTK and DIS are user-selectable and may be changed to display cumulative distance (CUM) to each waypoint, estimated time of arrival (ETA), estimated time en route (ETE) or en route safe altitude (ESA).

To change a data field on the active flight plan page:

1. With the active flight plan page displayed, press **MENU** to display the active flight plan page options window.
2. Turn the **large right** knob to highlight "Change Fields?" and press **ENT**.



3. Turn the **large right** knob to highlight the field you wish to change.
4. Turn the **small right** knob to select the desired data item and press **ENT**.



5. Press the **small right** knob to remove the cursor.

To restore factory default settings for data fields on the active flight plan page:

1. With the active flight plan page displayed, press **MENU** to display the active flight plan page options window.
2. Turn the **large right** knob to highlight "Restore Defaults?" and press **ENT**.

Active Flight Plan Options

The following options (some covered on the preceding pages) are available for the *active flight plan*:

- Activate Leg
- Crossfill
- Copy Flight Plan
- Invert Flight Plan
- Delete Flight Plan
- Select Approach
- Select Arrival
- Select Departure
- Remove Approach
- Remove Arrival
- Remove Departure
- Closest Point of Flight Plan
- Parallel Track
- Change Fields
- Restore Defaults

Activate Leg

Activate Leg? activates/reactivates the flight plan and selects the highlighted leg as the "active leg" (the leg which will currently be used for navigation guidance).

To activate a flight plan along a specific leg:

1. Press the **small right** knob to activate the cursor and turn the large right knob to highlight

the desired destination waypoint.

2. Select the "Activate Leg?" option from the active flight plan page options and press **ENT**.



3. A confirmation window will appear. With "Activate?" highlighted, press **ENT**.

Crossfill

Crossfill? allows you to transfer the active flight plan between two 400W- or 500W-series Garmin units in a dual unit installation. See the description on a previous page in the Flight Plan section.

Copy Flight Plan

Copy Flight Plan? copies the active flight plan to a flight plan catalog location. The copy function is useful for duplicating the active flight plan before making changes. This feature is described earlier in this section.

Invert Flight Plan

Invert Flight Plan? reverses the active flight plan. This feature is described earlier in this section.

1. With the Active Flight Plan Page displayed, press **MENU** to display the Active Flight Plan Page Options window.
2. Turn the **large right** knob to highlight "Invert Flight Plan?" and press **ENT**.

4 - FLIGHT PLANS

Active Flight Plan Options

Delete Flight Plan

Delete Flight Plan? allows you to remove all waypoints from the selected flight plan. Deleting a flight plan does not delete the waypoints contained in the flight plan from the database or user waypoint memory. This feature is described earlier in this section.

1. With the Active Flight Plan Page displayed, press **MENU** to display the Active Flight Plan Page Options window.
2. Turn the **large right** knob to highlight “Delete Flight Plan?” and press **ENT**.
3. A window will appear with the message “Delete all flight plans?”. Turn the **large right** knob to highlight “Yes” or “No”. Press **ENT**.

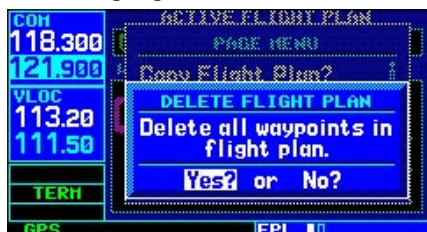

Select Approach

Select Approach? allows you to select a published instrument approach for the destination airport, or replace the current approach with a new selection. In many cases, you’ll find it more convenient to select approaches using the **PROC** key— as described in Section 5 - Procedures.

To select an approach for a direct-to or flight plan destination airport:

1. Press **MENU** and choose the “Select Approach?” option from the active flight plan page options with the **large right** knob and press **ENT**.



2. A window will appear listing the available approaches for your destination airport. Turn the **small right** knob to highlight the desired approach and press **ENT**.



3. A second window will appear listing available transitions for the approach. Turn the **small right** knob to highlight the desired transition waypoint and press **ENT**. (The “Vectors” option assumes you will receive vectors to the final course segment of the approach and will provide navigation guidance to intercept this final course.)



4. Turn the **large right** knob to highlight “Load?” or “Activate?” and press **ENT**. “Load?” will add the approach to the flight plan without immediately using the approach for navigation guidance. This allows you to continue navigat-

ing the original flight plan until cleared for the approach—but, keeps the approach available for quick activation when needed.

- For approaches not approved for GPS, a reminder window will appear indicating that GPS guidance on such approaches is strictly for monitoring only. To confirm this reminder, highlight “Yes?” and press **ENT**.

Select Arrival

Select Arrival? allows you to select a published standard terminal arrival route (STAR) for the destination airport, or replace the current arrival with a new selection.

To select an arrival for a direct-to or flight plan destination airport:

- Select the “Select Arrival?” option from the active flight plan page options and press **ENT**.



- A window will appear listing the available transitions for your destination airport. Turn the **small right** knob to highlight the desired transition waypoint and press **ENT**.



- A second window will appear listing available runways for the transition. Turn the **small right** knob to highlight the desired runway and press **ENT**.



- With “Load?” highlighted, press **ENT**.

Select Departure

Select Departure? allows you to select a published standard instrument departure (SID) for the departure airport, or replace the current departure with a new selection. When using a direct-to, the 400W-series will use the nearest airport as a reference when displaying available departures. See Sec 5 - Procedures for information on selecting departures using the **PROC** key.

To select a departure for the departure airport:

- Select the “Select Departure?” option from the active flight plan page options and press **ENT**.
- A window will appear listing the available departures for your departure airport. Turn the **small right** knob to select the desired departure and press **ENT**.
- A second window will appear listing available transitions for the departure. Turn the **small right** knob to highlight the desired transition waypoint and press **ENT**.
- With “Load?” highlighted, press **ENT**.

4 - FLIGHT PLANS

Active Flight Plan Options

Remove Approach, Arrival, or Departure

Remove Approach? deletes the currently selected approach from the active flight plan. **Remove Arrival?** deletes the current Arrival (STAR) from the active flight plan. **Remove Departure?** deletes the current departure (SID) from the active flight plan.

To remove an approach, arrival or departure from the active flight plan:

1. Press **MENU** and turn the **large right** knob to select the "Remove Approach?", "Remove Arrival?" or "Remove Departure?" option from the active flight plan page options and press **ENT**.



2. A confirmation window will appear listing the procedure you are about to remove. With "Yes?" highlighted, press **ENT**.



Closest Point of FPL

Closest Point of FPL? calculates the bearing and closest distance that a flight plan will pass from a reference waypoint. May also be used to create a new user waypoint along the flight plan at the location closest to the reference waypoint.

To determine the closest point, along the active flight plan, to a selected waypoint:

1. Select the "Closest Point of FPL?" option from the active flight plan page options and press **ENT**.



2. A window will appear with the reference waypoint field highlighted. Use the **small** and **large right** knobs to enter the identifier of the reference waypoint and press **ENT**.
3. A confirmation window will appear for the selected reference waypoint. Press **ENT** to accept the waypoint.
4. The 400W-series will display the bearing (BRG) and distance (DIST) to the closest point along the flight plan, from the selected reference waypoint. To create a user waypoint at this location and add it to the flight plan, highlight "Load?" and press **ENT**. The name for the new user waypoint will be derived from the identifier of the reference waypoint.



Parallel Track

Parallel Track? allows you to create a parallel course offset of 1 to 99 NM to the left or right of your current flight plan. After setting a parallel track to your current flight plan, a magenta parallel track line will be drawn offset from the original by the selected distance. The original course line will be drawn in white. The aircraft will navigate to the parallel track course line.

When you reach the end of the flight plan, an annunciator message will state “PTK END X S”. The message will give the pilot sufficient time to intercept the original course.

Points to remember with Parallel Track:

- You must have an active flight plan
- The current leg must support parallel track
- Parallel track is not allowed for the active leg of an approach
- Parallel track is not allowed if the active leg is not a track-to-fix or direct-to-fix leg
- Parallel track may be allowed but not the selected offset distance

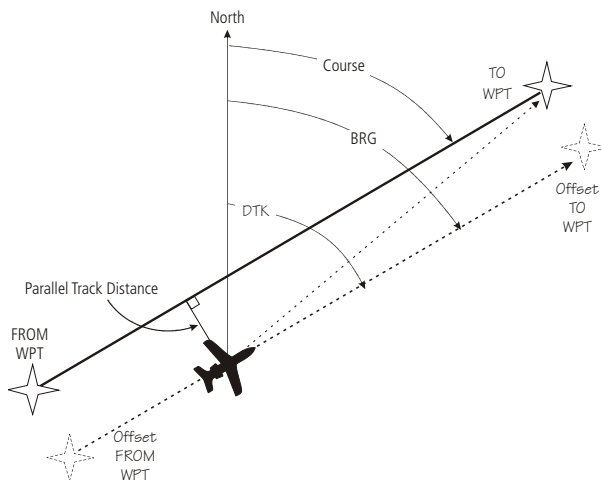

To set a parallel track to your flight plan.

1. With the Active Flight Plan Page displayed, press **MENU** to display the Active Flight Plan Page Options window.

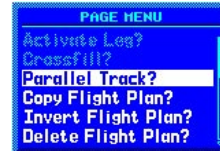

Select “Parallel Track?” to set a parallel track to your current flight plan.

2. Turn the **large right** knob to highlight “Parallel Track?” and press **ENT**.
3. Turn the **small** and **large right** knobs to set the Offset Distance value and then press **ENT**.



Turn the small and large knobs to select the parallel track distance from your current flight plan.

4. Turn the **large right** knob to highlight the Offset Direction.
5. Turn the **small right** knob to select the desired Offset Direction and press **ENT**.



Turn the small and large knobs to select the parallel track direction from your current flight plan.

6. **Activate?** is highlighted. Press **ENT** to activate the selected Parallel Track. Or, press **CLR** or the **CRSR** to cancel Parallel Track selection.

4 - FLIGHT PLANS

Active Flight Plan Shortcuts

To cancel a parallel track to your flight plan.

1. With the Active Flight Plan Page displayed, press **MENU** to display the Active Flight Plan Page Options window.
2. Turn the **large right** knob to highlight "Parallel Track?" and press **ENT**.
3. "Cancel?" is highlighted. Press **ENT**.

Change Fields

Change Fields? allows you to select the desired data items to display on the active flight plan page.

1. With the Active Flight Plan Page displayed, press **MENU** to display the Active Flight Plan Page Options window.
2. Turn the **large right** knob to highlight "Change Fields?" and press **ENT**. The field active for selection will flash. Turn the **large right** knob to highlight the field to change.



3. Turn the **small right** knob to open the list of selections and continue turning it to highlight the desired selection and then press **ENT**.

Restore Defaults

Restore Defaults? returns the data items to factory defaults.

1. With the Active Flight Plan Page displayed, press **MENU** to display the Active Flight Plan Page Options window.
2. Turn the **small right** knob to highlight "Restore Defaults?" and then press **ENT**.

Shortcuts

A number of shortcuts are available to save time when using the active flight plan page. These shortcuts speed the process of removing approaches, departures, and arrivals, and aid in selecting a specific flight plan leg for navigation guidance.

On the preceding page, options to remove approaches, departures and arrivals were introduced. This process may also be completed using the **CLR** key, as described below and illustrated at left.

To remove an approach, departure, or arrival using the CLR key:

1. With the active flight plan page displayed, press the **small right** knob to activate the cursor.
2. Turn the **large right** knob to highlight the title for the approach, departure or arrival you wish to delete. Titles will appear in light blue directly above the procedure's waypoints.



3. Press **CLR** to display a confirmation window.



4. With "Yes?" highlighted, press **ENT** to remove the selected procedure.

This same process may also be used to remove individual waypoints from the active flight plan.

To remove a waypoint using the CLR key:

1. With the active flight plan page displayed, press the **small right** knob to activate the cursor.
2. Turn the **large right** knob to highlight the identifier for the waypoint you wish to delete. Identifiers will appear in green text.
3. Press **CLR** to display a confirmation window.



4. With "Yes?" highlighted, press **ENT** to remove the selected procedure.

The "Activate Leg?" provides a shortcut that allows you to specify which leg of the flight plan will currently be used for navigation guidance, using the **direct-to** key.

To activate a specific leg of the active flight plan:

1. Press the **small right** knob to activate the cursor and turn the **large right** knob to highlight the desired destination waypoint.



2. Press **direct-to** twice to display an "Activate Leg" confirmation window.



3. With "Activate?" highlighted, press **ENT**.

When using instrument procedures, this feature can be used not only to activate a specific point-to-point leg, but to also activate the procedure turn portion of an approach, follow a DME arc or activate a holding pattern.

Any approach, departure or arrival can be reviewed on the appropriate airport page in the Waypoint page group.

To review a procedure while viewing a flight plan page:

1. With a flight plan page displayed, press the **small right** knob to activate the cursor.
2. Turn the **large right** knob to highlight the procedure header and press **ENT** to select the WPT page group.



Blank Page

Section 5 Approaches, Departures, & Arrivals

The 400W-series unit allows you to fly non-precision and precision approaches to airports with published instrument approach procedures. All available approaches are stored on your Jeppesen NavData® card, and are automatically updated when you replace the card with a new one. Subscription information for NavData cards is included in your 400W-series package.

The Procedures Page is displayed by pressing the **PROC** key. The Procedures Page provides direct access to approaches, departures and arrivals — based upon the active flight plan or direct-to destination. In either case, the departure and destination airports must have published procedures associated with them.

To select an approach, departure or arrival:

1. Press the **PROC** key to display the procedures page.

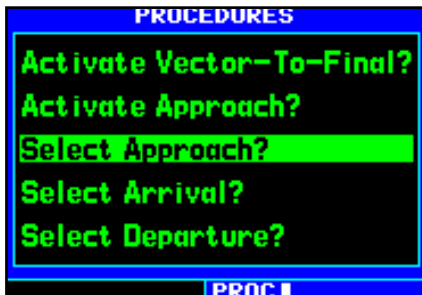

2. Turn the **large right** knob to highlight "Select Approach?", "Select Departure?" or "Select Arrival?" and press **ENT**.
3. A window will appear listing the available procedures. Turn the **large right** knob to highlight the desired procedure and press **ENT**. (When a direct-to destination is selected, departures are offered for the nearest airport.)



4. A second window will appear listing the available transitions. Turn the **large right** knob to highlight the desired transition waypoint and press **ENT**. (The approach "Vectors" option assumes you will receive vectors to the final course segment of the approach and will provide navigation guidance relative to the final approach course.)



5. Turn the **large right** knob to highlight "Load?" or "Activate?" (approaches only) and press **ENT**. "Load?" will add the procedure to the flight plan without immediately using it for navigation guidance. This allows you to continue navigating the original flight plan, but keeps the procedure available on the active flight plan page for quick activation when needed to later activate a departure or arrival.
6. For precision approaches and some non-precision approaches, a reminder window will appear indicating that GPS guidance on such approaches is strictly for monitoring only — use the VLOC receivers and external CDI (or HSI) for primary navigation. To confirm this reminder, highlight "Yes?" and press **ENT**.

5 - PROCEDURES

Activating Approaches



Not all approaches in the database are approved for GPS use. As you select an approach, a “G_P” designation to the right of the procedure name indicates the procedure can be flown using the GPS receiver. Some procedures will not have this designation, meaning the GPS receiver may be used for supplemental navigation guidance only. ILS approaches, for example, must be flown by tuning the VLOC receiver to the proper frequency and coupling the VLOC receiver to the external CDI (or HSI).

Once an approach is selected, it may be activated for navigation from the *procedures page*. Activating the approach overrides the “en route” portion of the active flight plan, proceeding directly to the “approach” portion (for a full approach, directly to the initial approach fix). Activating the approach also initiates automatic CDI scaling transition as the approach progresses.

To activate an approach:

1. Press the **PROC** key to display the procedures page.
2. Turn the **large right** knob to highlight “Activate Approach?” and press **ENT**.

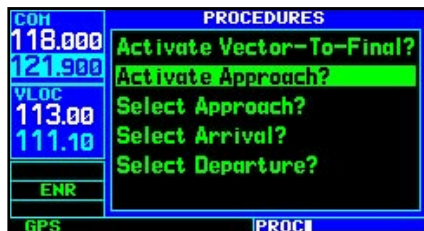

Another procedures page option allows you to activate the final course segment of the approach. This option assumes you will receive vectors to the final approach course and guides you to intercept the final course, before reaching the FAF.

To activate the approach, with vectors to final:

1. Press the **PROC** key to display the procedures page.
2. Turn the **large right** knob to highlight “Activate Vector-To-Final?” and press **ENT**.



In many cases, it may be easiest to “Load” the full approach while still some distance away, en route to the destination airport. Later, if vectored to final, use the steps above to select “Activate Vectors-To-Final”—which makes the inbound course to the FAF waypoint active. Otherwise, activate the full approach using the “Activate Approach?” option.

If you reactivate the approach currently being flown using the **PROC** key, prior to reaching the MAP a Restart Approach confirmation window appears on the screen. If you have passed the MAP, the 400W-series unit proceeds to the transition waypoint without a restart confirmation.

Basic Approach Operations

The 400W-series provides precision and non-precision approach guidance using its built-in GPS receiver. The moving map pages can also be used as a supplemental aid to situational awareness for ILS, VOR, and NDB approaches (and non-precision localizer-based approaches), but the localizer and glideslope receivers MUST be used for primary approach course guidance. The 400W-series also provides GPS precision capability, known as LPV and LNAV/VNAV approaches. LNAV+V approaches provide vertical guidance but are not precision approaches.

Approaches designed specifically for GPS are often very simple and don't require overflying a VOR or NDB. Currently, many non-precision approaches have "GPS overlays" to let you fly an existing procedure (VOR, VOR/DME, NDB, RNAV, etc.) more accurately using GPS. To date, there are over 2,400 GPS-only approaches and over 2,900 GPS overlay approaches worldwide.

Many overlay approaches are more complex (in comparison to GPS-only approaches). The 400W-series unit displays and guides you through each leg of the approach — automatically sequencing through each of these legs, up to the missed approach point (MAP). Approaches may be flown "as published" with the full transition — using any published feeder route or initial approach fix (IAF) — or may be flown with a vectors-to-final transition.

Flight mode annunciations are provided in the lower left corner of the display indicating the current mode of flight.

Annunciation	Description
LPV	Follow lateral and vertical guidance to LPV minimums. A yellow background indicates the current VPL and/or HPL values are not adequate for the approach and is an early indication that downgrading will occur if conditions do not improve.
L/VNAV	GPS approach identified in the database as LNAV/VNAV. Fly to LNAV/VNAV minimums.
LNAV+V	Non-precision GPS approach with advanced vertical guidance. Note that some LNAV/VNAV approaches are not yet marked in the database as such and will show up as LNAV+V. If the chart shows the approach as LNAV/VNAV, it can be flown to LNAV/VNAV minimums.
LNAV	Non-precision GPS approach or non-GPS approach, such as ILS or Localizer.
MAPR	Missed Approach, indicates the system is providing missed approach integrity and CDI full-scale deflection ± 0.3 NM. This also shows that the pilot has initiated a Missed Approach by pressing the OBS key after crossing the MAP.
ENR	En route, CDI full-scale deflection is 2.0 NM or current CDI scale selection, whichever is smaller.
TERM	Terminal, CDI full-scale deflection is 1.0 NM or current CDI scale selection, whichever is smaller.
DPRT	Departure, indicates the system is using non-precision approach integrity. HAL = 0.3 and CDI full-scale deflection is 0.3 NM.
OCN	Oceanic, CDI full-scale deflection is 2.0 NM.
LOW ALT (lower window)	In LNAV+V, LNAV/VNAV, or LPV approaches, the LOW ALT annunciation indicates the aircraft's estimated height is lower than the Final Approach waypoint height by more than the current VPL plus 50 meters.

5 - PROCEDURES

Procedure Turn Approach

Approach operations on the 400W-series will typically begin with the same basic steps:

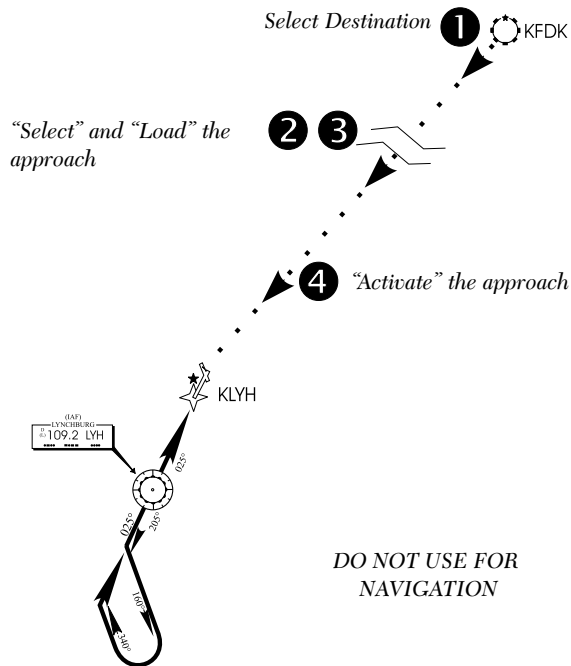

1. Select the destination airport using the **direct-to** key, or as the last waypoint in the active flight plan.
2. Choose the “Select Approach?” option from the procedures page or from the active flight plan options.
3. “Load” the approach (often while en route) in anticipation of its future use. This places the approach in the active flight plan, but retains course guidance in the en route section until the approach is “activated”.
4. “Activate” the full approach or vectors-to-final, as appropriate. In some scenarios, you may find it more convenient to immediately activate the approach and skip the “Load” process outlined above in step #3. The 400W-series provides both options.

Approaches with Procedure Turns

The procedure turn portion of an approach is stored as one of the legs of the approach. For this reason, the 400W-series requires no special operations from the pilot — other than flying the procedure turn itself — beyond what is required for any other type of approach.

This example uses the VOR Runway 04 GPS approach for Lynchburg (Virginia) Regional Airport, KLYH, and assumes a departure from Frederick (Maryland) Municipal Airport, KFDK. The steps required to set up and fly the approach are detailed below:

1. Prior to departing KFDK, the destination (KLYH) is selected using the **direct-to** key or by creating a flight plan terminating at Lynchburg Regional.
2. While en route to KLYH, some 40-50 nautical miles away, you select the ATIS frequency to monitor airport conditions and runway usage. This is accomplished by selecting the NAVCOM page and selecting the ATIS frequency from the list. This places the frequency on standby. Use the **COM flip-flop** key to make the ATIS frequency active.



3. From ATIS you learn that runway 04 is in use and plan your approach accordingly. Press the **PROC** key and select the "VOR 04-GPS" approach. From the transitions window, select LYH VOR (the IAF). Also, select "Load?" to load (but not activate) the approach.

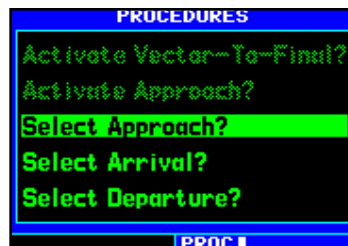

4. Once you are cleared for the approach, press the **PROC** key, select "Activate Approach?" and press **ENT**.

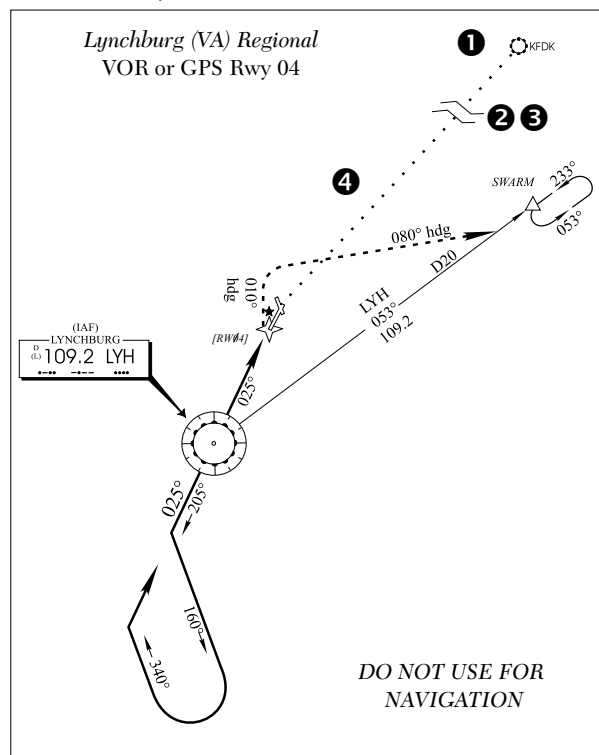

5 - PROCEDURES

Procedure Turn Approach

Flying the Procedure Turn

1. Within 31 nautical miles of the destination airport, the 400W-series will switch from "en route" mode to "terminal" mode (as indicated in the lower left corner of the screen). The switch to terminal mode is accompanied by a gradual Course Deviation Indicator (CDI) scale transition from 2.0 to 1.0 nautical miles, full scale deflection. (See example below)



2. Several miles prior to reaching the IAF (LYH), you may wish to review the approach sequence. Press the **FPL** key to display the active flight plan page. Press the **small right** knob, and then turn the **large right** knob to review each segment of the approach. When finished, press **FPL** again to return to the previous page.



3. As you approach the IAF (LYH), a waypoint alert ("LT TO 205° x S") will appear in the lower right corner of the screen. As the distance (DIS) to the IAF approaches zero, the alert is replaced by a turn advisory ("LT TO 205° NOW"). The unit will guide you automatically, or you can dial the outbound course of 205° into the CDI (or HSI) using the **OBS** knob and initiate a standard rate turn to this course heading.



4. Fly the outbound course, keeping the CDI needle centered.
5. Once you have flown approximately one minute past the FAF (LYH), the alert message "LT TO 160° x S" will appear in the lower right corner of the screen. You may initiate the procedure turn at any time after receiving this alert message.

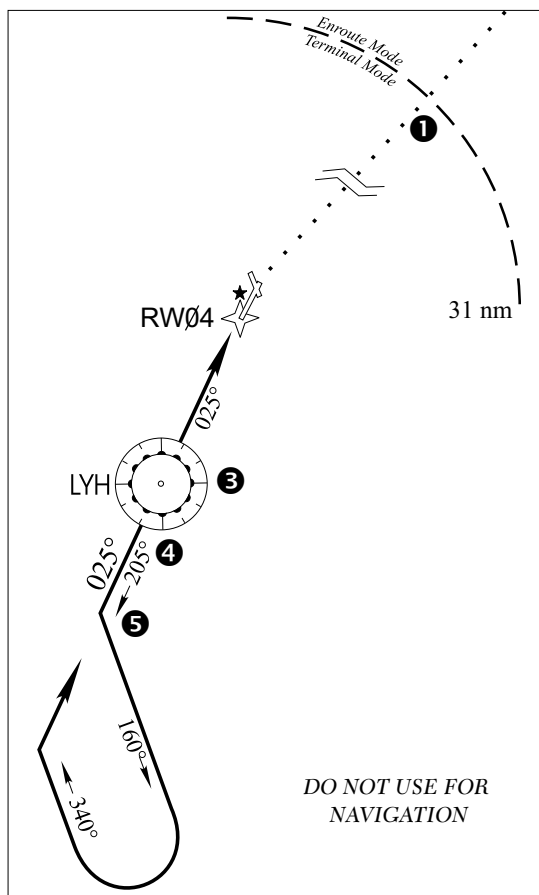

6. Turn left to a heading of 160° to initiate the procedure turn. Course guidance is provided relative to the outbound leg from the FAF. (The procedure turn is displayed on the map page and indicated as the active leg on the default NAV and active flight plan pages.) The CDI needle will start moving to the right.
7. After approximately one minute, make a 180° right turn to a heading of 340° to intercept the inbound course. The unit will sequence to the inbound leg to the FAF, the CDI needle will swing to the opposite side to provide proper

sensing along the final course segment and “DTK 025° NOW” will appear in the lower right corner of the screen.



8. As the CDI needle starts to center, make a right turn to 025°—the final approach course.
9. When within 45° of the final approach course and the FAF is the TO waypoint, the 400W-series unit switches from terminal mode to “approach” mode. CDI scaling is tightened from 1.0 NM full scale deflection to either 0.3 nautical mile or 2° full scale deflection whichever is less at the FAF. The change occurs over 2 NM and is completed by the FAF.
10. As you approach the FAF, a waypoint alert in the lower right corner (“NEXT DTK 025°”) will appear. Make any course adjustments necessary for the final course segment (FAF to MAP).
11. As you cross the FAF, the destination sequences to the MAP (“RW03”, the runway threshold). With the needle centered, fly toward the MAP, observing the altitude minimums dictated by the approach plate.

5 - PROCEDURES

Missed Approach

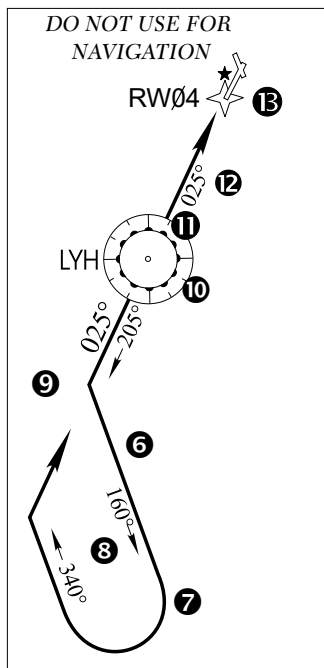

NOTE: When viewing the map page, note that the final course segment is displayed in magenta (the active leg of the flight plan always appears in magenta) and a dashed line extends the course beyond the MAP. The dashed line is provided for situational awareness only and should NOT be used for navigation. Follow the published missed approach procedures.

12. As you approach the MAP, a waypoint alert ("ARRIVING WPT") will appear in the lower right corner.
13. As you cross the MAP, "SUSP" will appear above the **OBS** key, indicating that automatic sequencing of approach waypoints will be sus-

pending at the MAP. A "from" indication will be displayed on the CDI and default NAV page, but course guidance along the final approach course will continue. If a missed approach is required, use the **OBS** key to initiate the missed approach sequence.



Flying the Missed Approach

After you pass the MAP, if the runway isn't in sight you must execute a missed approach. The 400W-series continues to give guidance along an extension of the final course segment (FAF to MAP) until you manually initiate the missed approach procedure (as mentioned previously in reference to the "SUSP" advisory).

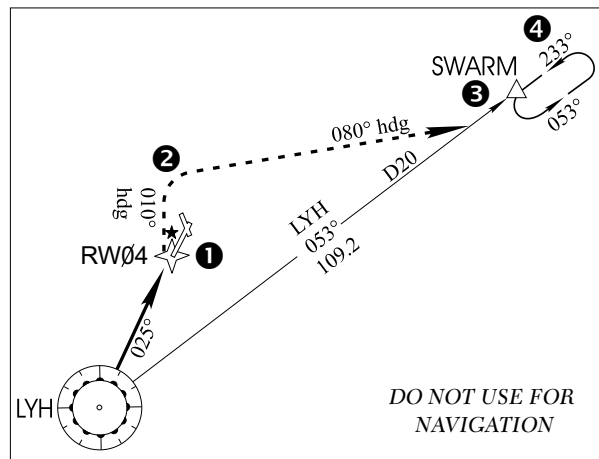

NOTE: It is the pilot's responsibility for initial missed approach guidance in accordance with published procedure. The unit may not provide correct guidance until established on a defined leg.

The **OBS** key is used to initiate the missed approach, as follows:

1. Press the **OBS** key after the SUSP annunciator appears. If you press the **OBS** key a second time, the missed approach holding point (MAHP; in this case "SWARM" intersection) is automatically offered as the destination waypoint.



NOTE: In some cases, an additional hold waypoint is added to the missed approach sequence. This additional waypoint is used as an aid in establishing the holding pattern—especially where the MAP and MAHP are the same waypoint.

2. Follow the missed approach procedures, as published on your approach plate, for proper climb and heading instructions. The 400W-series unit will guide you to the holding pattern, along the 053° radial from LYH VOR.
3. An alert message in the lower right hand corner of the screen will recommend entry procedures for the holding pattern (i.e., "HOLD DIRECT", "HOLD PARALLEL", or "HOLD TEARDROP"). As you fly the holding pattern, a timer appears on the default NAV page. The timer automatically resets on the outbound side of the hold when you are abeam the hold waypoint. The timer again resets as you turn inbound (within approximately 30° of the inbound course). This allows you to use standard timing (typically one minute) to fly the inbound and outbound legs of the hold.



4. The 400W-series unit will provide course guidance only on the inbound side of the holding pattern. When leaving the holding pattern to re-fly the approach (or another approach) press the **PROC** key to "Select Approach?" or "Activate Approach?" as previously described. (Or, use the **direct-to** key to select another destination.)

Flying an Approach with a Hold

Starting where the previous example left off, we'll assume weather conditions resulted in a missed approach at Lynchburg Regional. Now, you've decided to divert to Farmville Regional (KFVX) instead.

1. Press **direct-to**.
2. Use the **small** and **large right** knobs to enter the destination airport's identifier (KFVX).



5 - PROCEDURES

Approach with Hold

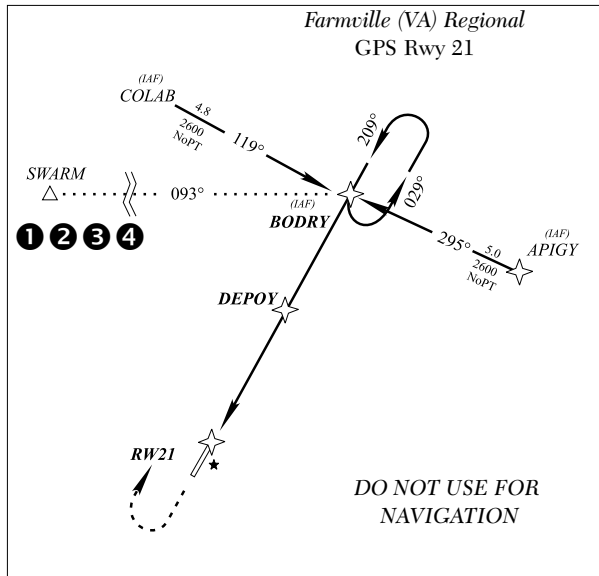

3. Press **ENT** twice.

This time, you select the GPS runway 21 approach into Farmville Regional. The GPS runway 21 approach begins with a holding pattern at the IAF, BODRY intersection.

4. Press **PROC** and select the "GPS 21" approach.

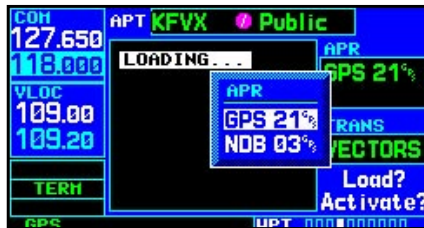

5. From the transitions window, select BODRY intersection as the IAF. Also, select "Activate?" to load and activate the approach.



6. Once you activate the approach, the active flight plan page will appear. You may review the approach sequence by pressing the **small right** knob and turning the **large right** knob. Press **FPL** to return to the navigation pages.



7. As in the last example, within 31 nautical miles of the airport, the 400W-series unit will switch from en route mode to terminal mode, and the CDI scale will transition from 2.0 to 1.0 nautical miles, full scale deflection.



NOTE: Upon activating an RNAV GPS approach, you are given the option to skip any non-required holding patterns during the initial transitions of the approach. In a GPS approach, you will not be given the option and you must manually reselect waypoint sequencing.

8. Just prior to crossing BODRY intersection, an alert—"HOLD TEARDROP"—will appear in the lower right corner of the screen to suggest the proper holding pattern entry. ("HOLD DIRECT" or "HOLD PARALLEL" may be offered on other similar approaches.)

COH	132.725	1.0 1.0		
VLOC	113.30	BODRY In		
TERH	109.00	DIS	DTK	BRG
GPS		0.96 ⁿ	083 ^o _M	083 ^o _M
		144 ^k	083 ^o _M	00:24
		GS	TRK	ETE
		HOLD TEARDROP		

9. As mentioned in the missed approach example, the default NAV page will display a timer during the holding pattern. Use this timer to fly the one minute outbound portion of the holding pattern. (The holding pattern is displayed on the map page and indicated as the active leg on the default NAV and active flight plan pages.)

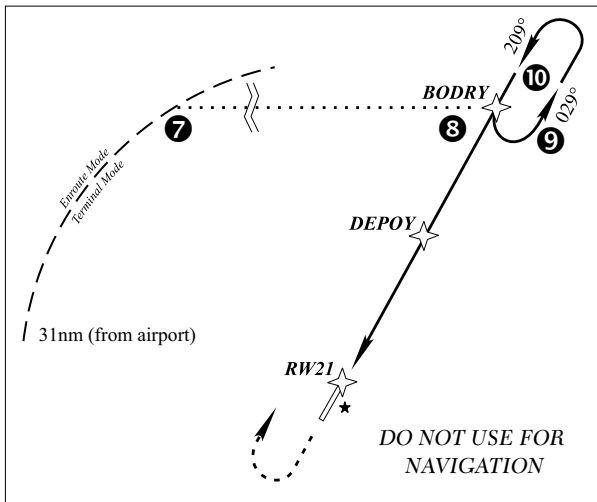

COH	132.725	1.0 1.0		
VLOC	113.30	00:10 BODRY		
TERH	109.00	DIS	DTK	BRG
GPS		0.40 ⁿ	209 ^o _M	244 ^o _M
		144 ^k	065 ^o _M	00:10
		GS	TRK	ETE
		NAV ■■■■■■■■		



NOTE: If you need to lose extra altitude or speed by going around the holding pattern again, press **OBS** to manually suspend waypoint sequencing **BEFORE** crossing the holding waypoint the second time. If you've already passed this waypoint, re-activate the holding pattern.

11. Also as you approach BODRY intersection, a waypoint alert ("NEXT DTK 209°") will appear in the lower right corner of the screen.

COH	135.400	1.0 1.0		
VLOC	113.30	01:00 BODRY		
ENR	109.00	DIS	DTK	BRG
GPS		0.27 ⁿ	209 ^o _M	214 ^o _M
		135 ^k	211 ^o _M	00:06
		GS	TRK	ETE
		NEXT DTK 209°		

12. When within 45° of the final approach course and the FAF is the TO waypoint. CDI scaling is tightened from 1.0 NM full scale deflection to either 0.3 nautical mile or 2° full scale deflection whichever is less at the FAF. The change occurs over 2 NM and is completed by the FAF.
13. As you approach the FAF, a waypoint alert in the lower right corner ("NEXT DTK 209°") will appear. Make any course adjustments necessary for the final course segment (FAF to MAP).

COH	132.725	0.4 0.4		
VLOC	113.30	BODRY → DEPOY In		
LNAV	109.00	DIS	DTK	BRG
GPS		0.39 ⁿ	210 ^o _M	213 ^o _M
		144 ^k	211 ^o _M	00:10
		GS	TRK	ETE
		DTK 210° 10 S		

5 - PROCEDURES

DME Arc Approach

14. As you cross the FAF, the destination sequences to the MAP ("RW21", the runway threshold). With the needle centered, fly toward the MAP, observing the altitude minimums dictated by the approach plate. (When viewing the map page, you'll note that the final course segment is displayed in magenta—the active leg of the flight plan always appears in magenta—and a dashed line extends the course beyond the MAP. Do NOT follow this extended course. Instead, follow published missed approach procedures.)

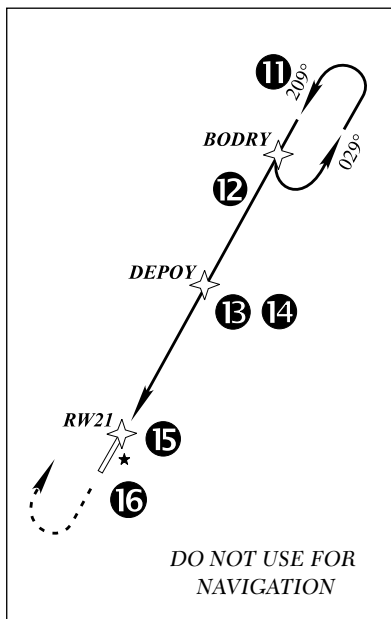

15. As you approach the MAP, a waypoint alert ("ARRIVING WPT") will appear in the lower right corner. CDI scaling continues to tighten from 0.3 NM to 350 feet, full-scale deflection.

16. As you cross the MAP, "SUSP" will appear above the **OBS** key, indicating that automatic sequencing of approach waypoints will be suspended at the MAP. A "from" indication will be displayed on the CDI and default NAV page, but course guidance along the final approach course will continue. If a missed approach is required, use the **OBS** key to initiate the missed approach sequence.



Flying a DME Arc Approach

The GPS overlay for a DME arc approach uses additional Jeppesen-provided waypoints to define the arc. These waypoints are indicated by “D” as the first letter in the waypoint name. This is followed by three numbers which indicate the radial the waypoint lies on. The last letter indicates the radius of the arc.

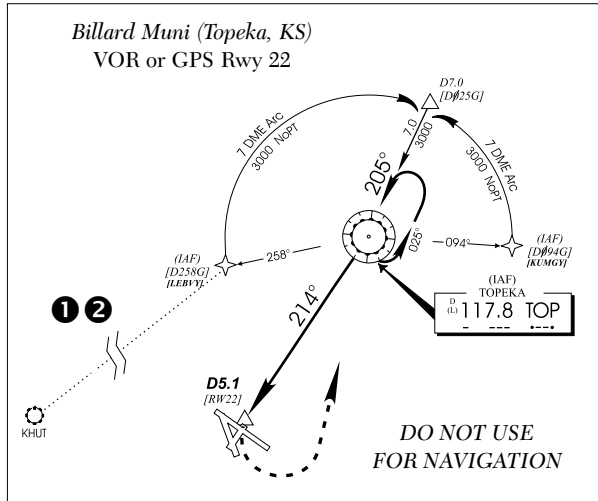

NOTE: As this manual was being written, the letter/number DME arc names were being replaced with standard five-letter intersection names. You may encounter either naming convention for an approach you select.

When you are cleared for a DME arc approach, you may do one of the following to intercept the arc:

- Follow a specified radial inbound to intercept the IAF.
- Fly directly to the IAF at the beginning of the arc.
- Follow ATC vectors which allow you to intercept the arc at any point along the arc.

This example is based upon a flight from Hutchinson (Kansas) Municipal (KHUT) to Billard Municipal

(KTOP) in Topeka, Kansas. The VOR/DME runway 22 approach will be selected, along with “D258G” as the IAF.

1. Select Billard Muni (KTOP) as your destination, via the **Direct-To** key or as the last waypoint in a flight plan.



2. Press the **PROC** key and select the “VOR 22” approach. From the transitions window, select “LEBVY” as the IAF. Also, select “Load?” (or “Activate?”, if already cleared direct to the IAF for the approach).



3. Within 31 nautical miles of KTOP, the 400W-series unit will switch from en route mode to terminal mode and the CDI scale will transition from 2.0 to 1.0 nautical miles, full scale deflection.

5 - PROCEDURES

DME Arc Approach

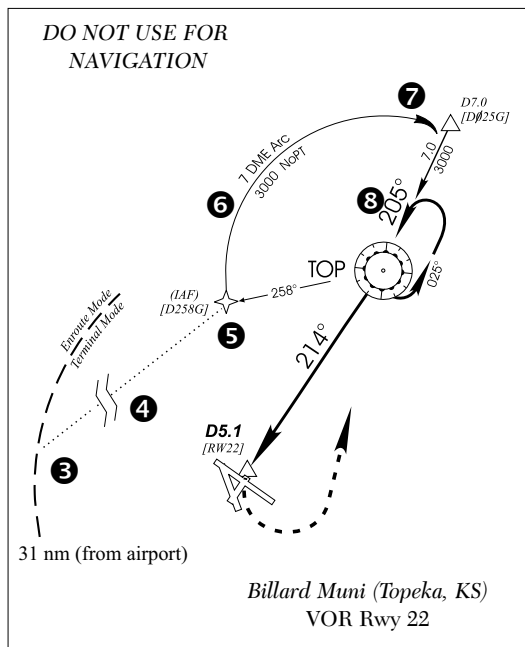

- If you haven't already activated the approach (in step #2 above), be sure to do so when cleared for the approach.



- As you approach the IAF (LEBVY/D258G), a waypoint alert ("LT TO 350° x S", meaning turn left to 350° in x seconds) will appear in the lower right corner of the screen. As the distance (DIS) to the IAF approaches zero, the alert is replaced by a turn advisory ("LT TO 350° NOW").



- Follow the arc, keeping the CDI needle centered. When using an autopilot, the course select on the CDI (or HSI) must be periodically updated with the desired track (DTK) to ensure proper tracking through the arc. Whenever the course select setting and desired track differ by more than 10°, a "Set course to ###°" message will appear on the message page.
- The next point in the approach is an intermediate fix, labeled "DMARY/D025G". As you approach this intermediate fix, a waypoint alert ("RT TO 205° x S") will appear in the lower right corner of the screen. As the distance to this fix approaches zero, the alert is replaced by a turn advisory ("RT TO 205° NOW"). Dial this course into the CDI (or HSI) using the **OBS** knob and initiate a standard rate turn to this course heading.



- When within 45° of the final approach course and the FAF is the TO waypoint, the 400W-series unit will switch from terminal mode to approach mode. CDI scaling is tightened from 1.0 NM full scale deflection to either 0.3 nautical mile or 2° full scale deflection whichever is

less at the FAF. The change occurs over 2 NM and is completed by the FAF.

9. As you approach the FAF, "RT TO 214° x S" will appear in the lower right corner of the screen. Select this course on the CDI (or HSI) using the **OBS** knob and turn to the final course segment (FAF to MAP) heading.

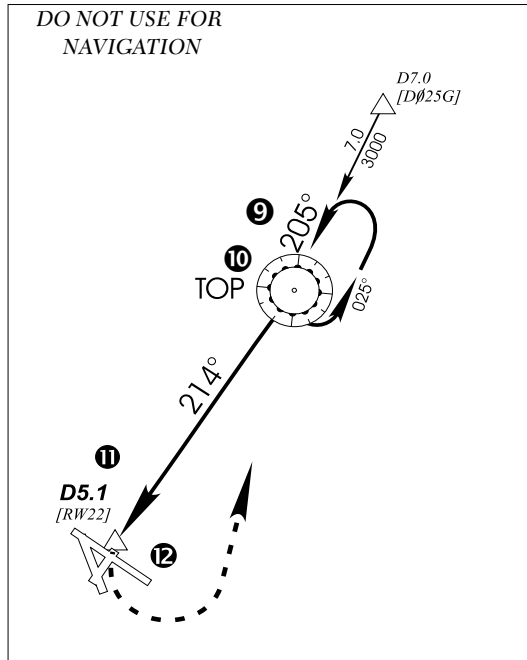

COH 136.975	0.4		0.4	
VLOC 117.95	DMARY → TOP Fa			
VLOC 117.80	DIS 0.55m	DTK 205°	BRG 205°	
LNAV	136°	205°	00:14	
GPS	GS	TRK	ETE	
RT TO 214° 8 S				



NOTE: Since this is not a GPS approach, the pilot should be using the VLOC receiver, tuned to the correct VOR (TOP) for navigation.

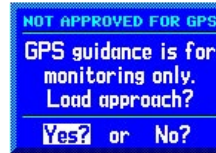

10. As you cross the FAF, the destination sequences to the MAP ("RW22", the runway threshold). With the needle centered, fly toward the MAP, observing the altitude minimums dictated by the approach plate. When viewing the map page, you'll note that the final course segment is displayed in magenta (the active leg of the flight plan always appears in magenta) and a dashed line extends the course beyond the MAP.



11. As you approach the MAP, a waypoint alert ("ARRIVING WPT") will appear in the lower right corner. CDI scaling continues to tighten from 0.3 NM to 350 feet, full-scale deflection.
12. As you cross the MAP, "SUSP" will appear above the **OBS** key, indicating that automatic sequencing of approach waypoints will be suspended at the MAP. A "from" indication will be displayed on the CDI and default NAV page, but course guidance along the final approach course will continue. Do NOT follow this extended course. Follow published missed approach procedures using the **OBS** key to initiate the missed approach sequence.

5 - PROCEDURES

Vectors-To-Final Approach



Vectors to Final

Let's take a second look at the "VOR 22" approach into Billard Municipal. Instead of following the DME arc, ATC tells you to expect vectors onto the final approach course. There are several ways to select "vectors to final" with the 400W-series unit. The first two options below will normally require the least workload to accomplish:

- When the approach is first selected, choose "VECTORS" from the transitions window.
- Load a full approach — including the IAF from the transitions window. When cleared, press **PROC** and select "Activate Vectors-To-Final?".
- Load the full approach. Use the **direct-to** key (by pressing it twice) from the active flight plan page to select the desired leg of the approach.

To select "VECTORS" from the transitions window:

1. Select Billard Municipal (KTOP) as your destination, using the **direct-to** key, or as the last waypoint in a flight plan.
2. Press the **PROC** key and select the "VOR 22" approach.
3. From the transitions window, select "VECTORS".



4. Select "Load?" (or "Activate?", if already on vectors-to-final).

To activate vectors-to-final from the procedures page:

1. Select Billard Municipal (KTOP) as your destination, using the **direct-to** key or as the last waypoint in a flight plan.
2. Press the **PROC** key and select the "VOR 22" approach.
3. From the transitions window, select "LEBVY" as the IAF. Also, select "Load?".



4. When cleared, press the **PROC** key and select "Activate Vector-To-Final?".

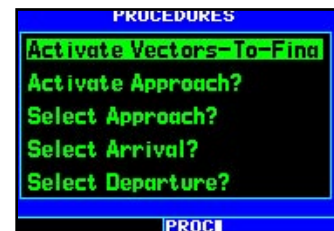

Flying the Vectors Approach

With “vectors to final” selected, the CDI needle will remain off center until you’re established on the final approach course. With the approach activated, the *map page* will display an extension of the final approach course in magenta (remember, magenta is used to depict the active leg of the flight plan) and “VTF” will appear as part of the active leg on the *default NAV page* (as a reminder that the approach was activated with vectors-to-final). In this example, we’ll assume ATC vectors result in a rectangular course to intercept final, as follows:

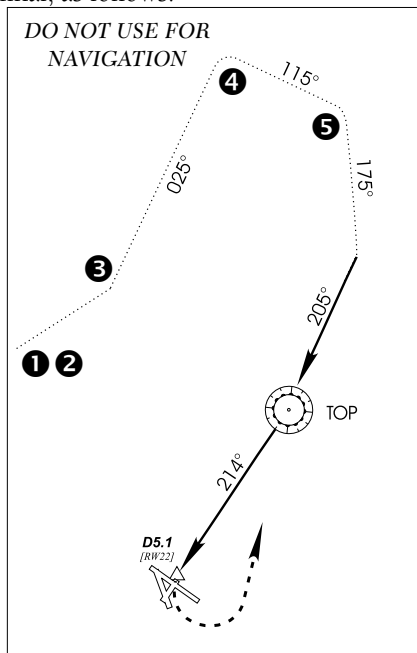

1. When VTF is activated, the 500W-series unit switches from en route mode to terminal mode and the CDI scale transitions from 2.0 to 1.0 nautical miles, full scale deflection.
2. If you haven’t already done so, activate the approach (with vectors-to-final). This allows the 400W-series unit to guide you to the final approach course.

3. ATC instructs you to turn left to a heading of 025°. This places you parallel to the final approach course in the opposite direction. CDI needle deflection is to the left.



4. ATC instructs you to turn right to a heading of 115°.



5. ATC instructs you to turn right to a heading of 175° to intercept the final approach course. As you converge with the final approach course the needle moves toward the center. (In the illustration below, the needle has not yet returned to the on-screen CDI, since your current position is still 1.9 NM right of the final approach course.)



5 - PROCEDURES

Course-From-Fix Legs

- As the CDI needle centers, make any remaining course corrections to establish yourself on the final approach course. Vectors-To-Final activates the approach immediately and gives a 2° angular full scale deflection all the way to and beyond the FAF (up to 1 NM full-scale deflection).

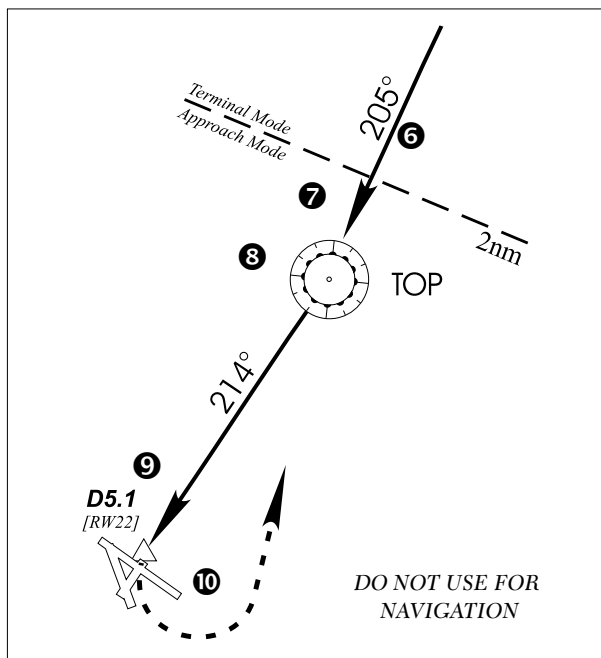

- As you approach the FAF, a waypoint alert in the lower right corner ("RT TO 214° x S") will appear. Make any course adjustments necessary for the final course segment (FAF to MAP).



- As you cross the FAF, the destination sequences to the MAP ("RW22"). With the needle centered, fly toward the MAP, observing the altitude minimums dictated by the approach plate. CDI scaling continues to tighten to 350 feet, full-scale deflection.
- As you approach the MAP, a waypoint alert ("ARRIVE WPT") appears in the lower right corner.
- As you cross the MAP, "SUSP" appears above the **OBS** key, indicating that automatic sequencing of approach waypoints is suspended at the MAP. A "from" indication is displayed on the CDI and Default NAV Page, but course guidance along the final approach course continues. Do NOT follow this extended course. Follow published missed approach procedures using the **OBS** key to initiate the missed approach sequence.

Course From Fix Flight Plan Legs

Certain approach, departure, and arrival procedures in the Jeppesen database contain *course from fix* flight plan legs. The 400W-series is able to load these legs into the flight plan along with the rest of the procedure data, and to provide navigation along these legs.

There are three different types of course from fix legs:

TYPE 1: Course from fix to distance, or Course from fix to DME distance

Course from fix to distance legs will appear in the flight plan like normal waypoints, but the destination name will always begin with a "D", followed by a distance in tenths of nautical miles from the waypoint fix. This example uses the VOR/DME RWY 25 approach into Palmdale, California (KPMD) and includes a teardrop course reversal.

5 - PROCEDURES

Course-From-Fix Legs

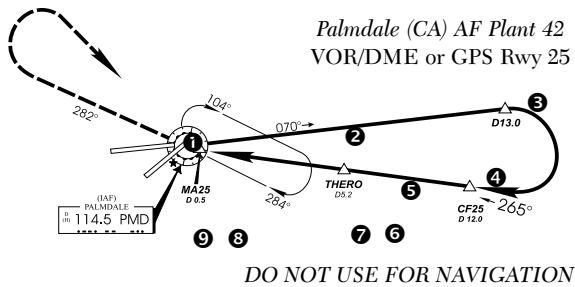

- As you reach the initial approach fix (PMD), a waypoint alert ("RT TO 070° x S") will appear in the lower right corner of the screen. As the distance to the IAF approaches zero, the alert is replaced by a turn advisory ("RT TO 070° NOW"). Dial the outbound course into the CDI (or HSI) using the **OBS** knob and initiate a standard rate turn to this course heading.
- Fly the outbound course, keeping the CDI needle centered. You are now on the "course from fix to distance" leg, as shown on the active flight plan and default NAV pages. Note the magenta line in the bottom figure, which represents the currently active leg of the approach. The distance (DIS) displayed on the above screens is TO the "D13.0" point. The

flight plan will automatically sequence to the next leg upon reaching "D13.0".



- At 13.0 NM from the IAF, a waypoint alert ("DTK 265° x S") will appear in the lower right corner of the screen. Make a standard rate turn to the right to intercept the final approach course and watch for the CDI needle to begin to center.
- As you approach the intermediate fix (CF25), a waypoint alert ("DTK 265° x S") will appear. Make any necessary course adjustments.
- Approach is active when the FAF is the TO waypoint and bearing and track are within 45° of the final approach course. The 400W-series unit will switch from terminal mode to approach mode. ("LNAV" will appear in the lower left corner of the screen—replacing "TERM".) CDI scaling will be tightened from 1.0 to 0.3 nautical mile full scale deflection, or 2° full scale deflection, whichever is less at the FAF, and as defined for the approach. The change occurs over 2 NM and is completed by the FAF.
- As you approach the FAF, "DTK 265° x S" will appear in the lower right corner of the screen.
- As you cross the FAF, the destination sequences to the MAP (MA25). With the CDI needle centered, fly toward the MAP, observing the altitude minimums dictated by the approach

5 - PROCEDURES

Course-From-Fix Legs

plate.

- As you approach the MAP, a waypoint alert ("ARRIVING WPT") will appear in the lower right corner of the screen. The CDI will continue to tighten to ± 350 feet full-scale deflection.
- As you cross the MAP, "SUSP" will appear above the **OBS** key, indicating that automatic sequencing of approach waypoints is suspended at the MAP. If a missed approach is required, use the **OBS** key to initiate the missed approach sequence, as outlined below.

TYPE 2: Course from fix to altitude

Course from fix to altitude legs will show the specific target altitude on the active flight plan and default NAV pages. The missed approach sequence for the Palmdale VOR/DME RWY 25 approach includes a course from fix to altitude leg. In this instance, the leg corresponds to the initial phase of the missed approach, which reads "Climb to 5000' outbound via PMD VOR R-282".



- After crossing the MAP, press the **OBS** key. The missed approach sequence is automatically offered, starting with the course from fix to altitude leg. The "DTK 282° NOW" alert appears in the lower right corner of the screen. Follow the missed approach procedures, as published on your approach plate, for proper climb and heading instructions.



- Note that within a few seconds of pressing **OBS** to release suspend mode and start the approach sequence, "SUSP" re-appears above the **OBS** key as the 400W-series unit returns to suspend mode. This is normal when flying a course from fix to altitude leg and indicates that automatic leg sequencing is suspended.



NOTE: If there is a valid baro-corrected pressure altitude input, the SUSP is not annunciated and the leg sequences automatically when the altitude (5,000 ft) is reached.

- Fly the outbound course keeping the CDI needle centered. The map page will depict the flight path extending indefinitely from PMD VOR.

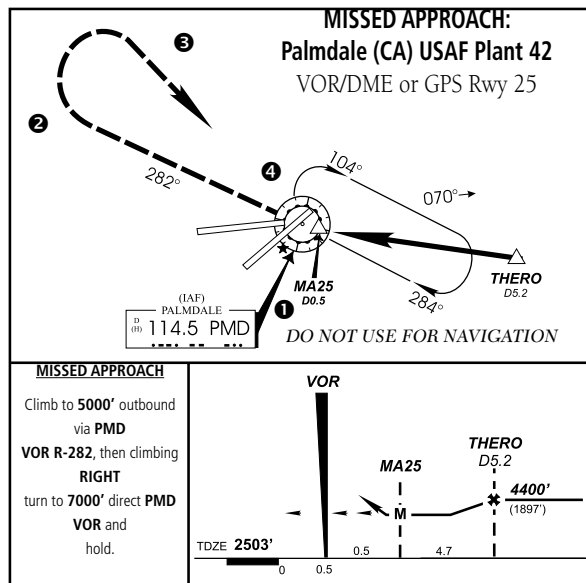

430W Only



- Upon reaching the desired altitude (5000'), press **OBS** to return to automatic leg sequencing. Confirm that "SUSP" no longer appears directly above the **OBS** key.
- An alert ("DTK 123° NOW") will appear guiding you to the inbound course. The actual desired track (DTK) will depend on your ground speed and distance from PMD VOR. Intercept and fly the inbound course, keeping the CDI needle centered.



- As you approach PMD VOR (the missed approach holding point), an alert message in the lower right hand corner of the screen will recommend the holding pattern entry procedure ("HOLD PARALLEL"). As you fly the holding pattern, a timer appears on the default NAV page. The timer automatically resets on each outbound and inbound portion of the holding pattern.
- Note that the 400W-series unit again displays "SUSP" above the **OBS** key. Automatic waypoint sequencing is suspended at the

missed approach holding point. A waypoint alert ("ARRIVING WPT") appears in the lower right corner of the screen each time you approach PMD VOR in the holding pattern.

- When leaving the holding pattern, press the **PROC** key to reactivate the approach or select a different approach, or press **direct-to** to select another destination.

TYPE 3: Course from fix to manual sequence

Course from fix to manual sequence legs will appear on the active flight plan and map pages with "man seq" in place of a waypoint identifier. An example of this type of course leg appears in the COASTAL ONE DEPARTURE from Westfield, Massachusetts (Barnes Muni). The example leg corresponds to the departure leg from Barnes Municipal and appears as follows on the active flight plan and default NAV pages:

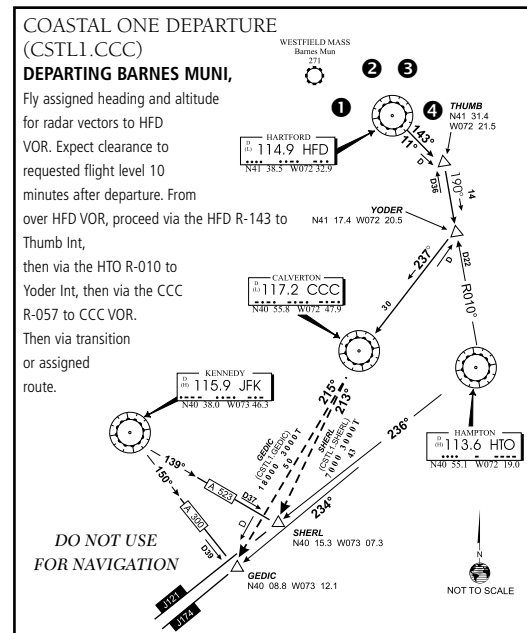

1. Select the departure (CSTL1) from the procedures page. Then select the departure runway (RW02, in this example) and transition (GEDIC).



2. As you depart the airfield, "NEXT DTK 026°" appears in the lower right corner of the screen and "SUSP" appears directly above the **OBS** key. You are now on the "course from fix to manual sequence" leg. The distance displayed on the active flight plan, default NAV and map pages is FROM the waypoint fix (the departure runway, in this example).



3. Fly the outbound course keeping the CDI needle centered. Once you are cleared to sequence to the next leg, press the **OBS** key. Confirm that "SUSP" no longer appears directly above the **OBS** key. An alert ("NEXT DTK 183°") will appear in the lower right corner of the screen to guide you to the next waypoint (HFD VOR). The actual desired track (DTK) will depend on your ground speed and distance from HFD VOR.



4. Once the **OBS** key is pressed, the 400W-series unit will automatically sequence to each waypoint along the remainder of the departure route, including the selected transition.

ILS Approaches

Precision approaches can be performed with the GNS 430W's built-in VLOC (VOR/localizer/glideslope) receivers. The GPS receiver can be used for guidance prior to reaching the final approach fix, but once there, the proper frequency must be selected on the VLOC window (left side of screen) and the CDI output set to "VLOC".

The GNS 430W can be set to automatically switch the external CDI output from GPS to VLOC as you intercept the final approach course (if used with a KAP140/KFC225 autopilot, you will need to manually enable outputs). When the ILS approach is activated, the GNS 430W will automatically switch within 1.2 nautical miles left or right of the final approach course. This switch can take place anywhere from 2.0 to 15.0 nautical miles from the FAF.

The illustration at right shows multiple locations along the approach path and which CDI selection you can expect: GPS or VLOC. Within the area of the shaded box, the automatic switch from GPS to VLOC should occur.



NOTE: If you attempt to intercept the approach course at a distance less than 2.0 nautical miles from the FAF, the GNS 430W will not automatically switch the CDI to VLOC. In this case, press the CDI key to manually switch from GPS to VLOC.

430W Only

The automatic switch from GPS to VLOC is not immediate, but instead occurs gradually to prevent abrupt CDI changes when coupled to an autopilot. The CDI selection can also be changed manually by pressing the **CDI** key. Once the switch from GPS to VLOC has occurred, either automatically or manually, it will not automatically switch again until the approach is reactivated or another approach is selected. To prevent automatic ILS CDI selection, choose the “Manual” ILS CDI setting. (The factory default setting is “Auto”, which enables the automatic switch to VLOC.)

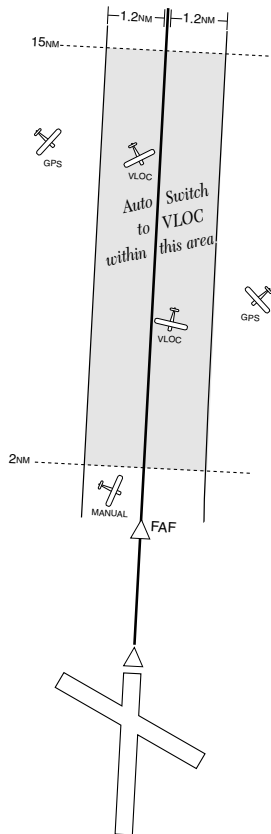

Selecting an ILS Approach

For this example, we'll use a flight from Laughlin Bullhead (Arizona) International to Flagstaff Pulliam (KFLG) and select the ILS runway 21 approach. “SHUTR” intersection will be selected as the IAF, which will include an outbound leg and a procedure turn. Of course, vectors-to-final could also be selected, as previously described for the non-precision approach examples.

1. Select Flagstaff Pulliam (KFLG) as your destination, via the **direct-to** key or as the last waypoint in a flight plan.



2. Press the **PROC** key and select the “ILS 21” approach.



3. From the transitions window, select “SHUTR” as the IAF. Also, select “Load?” (or “Activate?”, if already cleared for the approach).



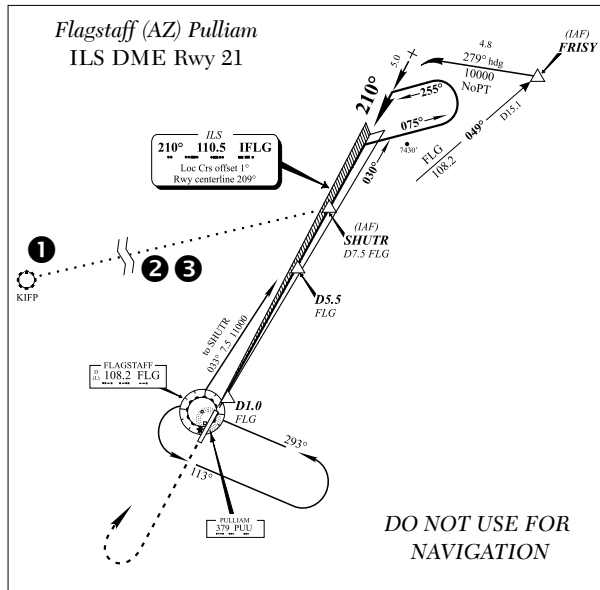

Flying the ILS Approach

When you “Activate?” an ILS approach, automatic switching of the external CDI is enabled (unless turned off from the CDI/Alarms Page). When you are established on the inbound course to the FAF, the external CDI guidance will automatically switch from “GPS” (shown in green text) to “VLOC” (shown in white text). If you have forgotten to activate the ILS frequency (step #4 below), automatic selection of “VLOC” will not occur.

1. Within 31 nautical miles of KFLG, the GNS 430W will switch from en route mode to terminal mode and the CDI scale will transition from 2.0 to 1.0 nautical miles, full scale deflection.
2. If you haven’t already activated the approach (in steps on previous page), be sure to do so when cleared for the approach.

4. A reminder message appears, indicating that GPS can only be used for approach monitoring. As mentioned, you will need to use the VLOC receiver for this approach. Press **ENT** to acknowledge the message.

When you “Load?” (or “Activate?”) an ILS approach, the ILS frequency is automatically placed in the standby field of the VLOC window. To use this frequency, simply press the **VLOC flip-flop** key to place it in the active frequency field.

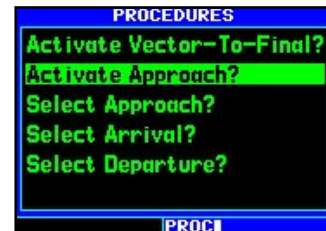

3. As you approach the IAF (SHUTR), a waypoint alert (“LTTO 030° x S”) will appear in the lower right corner of the screen.



4. If you haven’t already done so, press the **VLOC flip-flop** key to activate the ILS frequency. If you forget this step, the GNS 430W will display a reminder message (within 2 NM of the FAF) to activate the ILS frequency.

430W Only

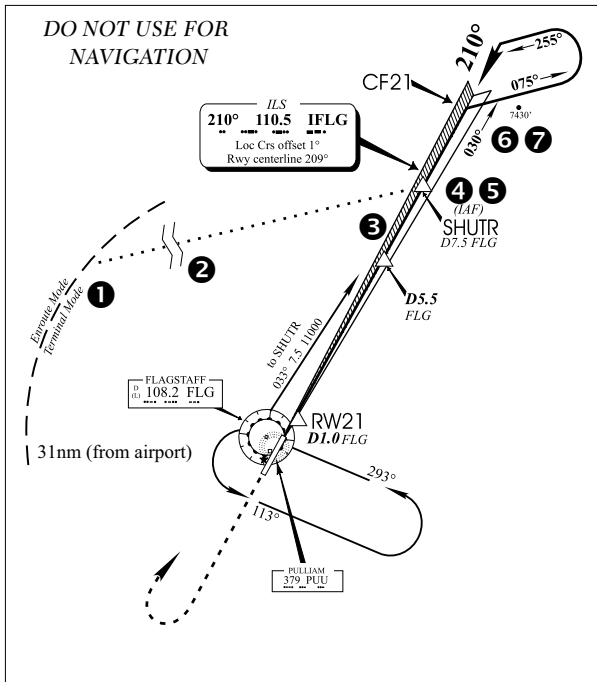

- As the distance (DIS) to the IAF approaches zero, the alert is replaced by a turn advisory ("LT TO 030° NOW").



- Fly the outbound course (030°), keeping the needle centered on the external CDI (or HSI).

- Once you have flown approximately one minute past SHUTR intersection, prepare for the procedure turn.
- Turn right to a heading of 075° to initiate the procedure turn. The GNS 430W will not guide you through the turn. (The procedure turn is displayed on the map page and indicated as the active leg on the default NAV and active flight plan pages.) The external CDI needle will start moving to the left.



- After approximately one minute, make a 180° left turn to a heading of 255° to intercept the ILS. The GNS 430W will sequence to the inbound leg and "DTK 210° NOW" will appear in the lower right corner of the screen. CDI coupling will automatically switch from the "GPS" receiver to the "VLOC" receiver as you complete the inbound turn. (If the ILS frequency has not been activated, per step #4, this automatic CDI switch will not occur.)



- As the CDI needle starts to center, make a left turn to 210° to track the ILS approach course.

5 - PROCEDURES

ILS Approach

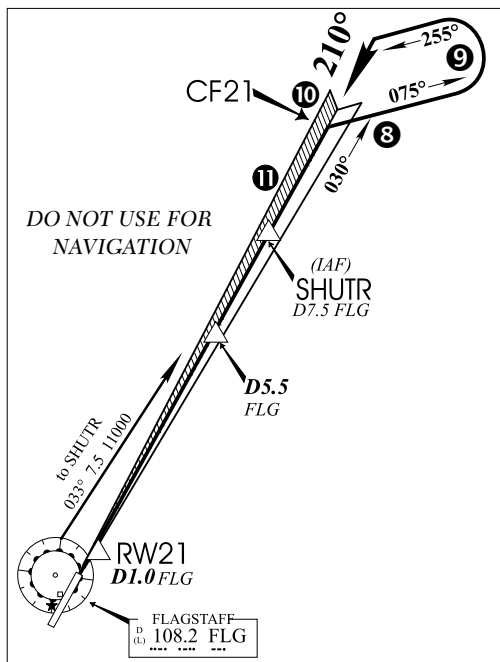

NOTE: From this point on, primary navigation is provided by the VLOC receiver. You may continue to use the GPS receiver for supplemental navigation guidance only. If automatic CDI switching is disabled (“Manual” selected), the reminder message “Select VLOC on CDI for approach” appears at 3.0 nautical miles prior to the FAF. In this instance, you must press CDI to manually switch CDI output to the VLOC receiver and continue the approach.

- As you approach the FAF (SHUTR), “LNAV” will appear in the lower left corner of the screen — indicating a CDI scale transition from 1.0 to 0.3 nautical miles, full scale deflection. This scale transition applies only to the default NAV page’s on-screen CDI, since the external CDI or HSI is now coupled to the VLOC receiver.

- Also as you approach SHUTR, a waypoint alert (“DTK 210° x S”) will appear in the lower right corner of the screen.



- As you cross SHUTR, the destination sequences to the MAP (“RW21”, the runway threshold). With the needle on the external CDI (or HSI) centered, fly toward the MAP, observing the altitude minimums dictated by the approach plate. (When viewing the map page, you’ll note that the final course segment is displayed in magenta — the active leg of the flight plan always appears in magenta — and a dashed line extends the course beyond the MAP.)



- As you approach the MAP, a waypoint alert (“ARRIVING WPT”) will appear in the lower right corner.

15. As you cross the MAP, "SUSP" will appear above the **OBS** key, indicating that automatic sequencing of approach waypoints will be suspended at the MAP.

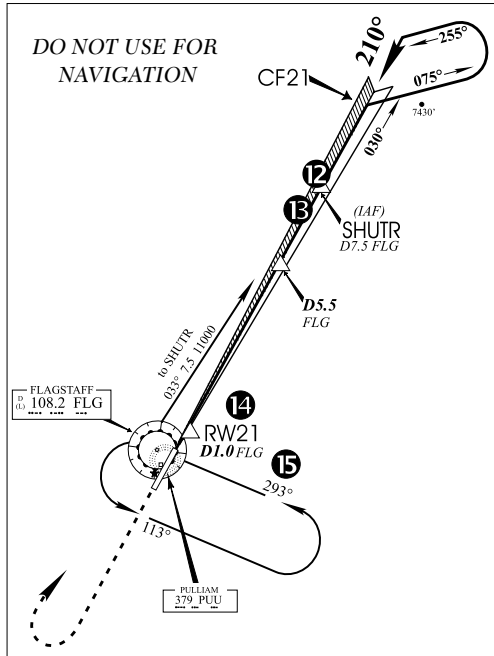

As you cross the MAP, "SUSP" appears above the **OBS** key, indicating that automatic sequencing of approach waypoints is suspended at the MAP. A "FROM" indication is displayed on the Default NAV Page, but course guidance along the final approach course continues. Do NOT follow this extended course. Follow published missed approach procedures using the **OBS** key to initiate the missed approach sequence.



NOTE: In addition to using the **OBS** key to initiate the missed approach sequence, you may wish to press the **CDI** key to manually switch external CDI output to the GPS receiver. "GPS" will be indicated above the **CDI** key. If you leave the external CDI output on "VLOC" and are using an external CDI (not an HSI), expect reverse sensing on the back course of the ILS.

Selecting an LPV Approach

For this example, we'll use a flight from Eugene Oregon (KEUG) to Salem Oregon (KSLE) and select the RNAV runway 31 approach. "GLORR" intersection is selected as the IAF. Of course, vectors-to-final could also be selected, as previously described for the non-precision approach examples.

1. With Salem (KSLE) as your destination in your flight plan, press the **PROC** key and select the "RNAV 31 Z (GPS)" approach.



2. From the transitions field, select "GLORR" as the IAF. Review and execute the modified flight plan. Go direct to GLORR when cleared "Direct GLORR" for the approach.
3. Press the **PROC** key to display the Procedures

5 - PROCEDURES

LPV Approach

page. With "Load?" highlighted press **ENT** to load the approach into the flight plan.



4. After the approach is loaded into the flight plan, you can view the approach waypoints.



5. Press the **PROC** key to display the Procedures page. With "Activate?" highlighted press **ENT** to activate the approach.

Flying the LPV Approach

1. Within 31 nautical miles of KSLE, the 400W Series unit switches from en route mode to terminal mode and the CDI scale transitions from 2.0 to 1.0 nautical miles, full scale deflection.
2. As you approach the IAF (GLORR), a waypoint message ("LT TO 314° x S") appears on the bottom of the screen.



3. As the distance (DIST) to the IAF approaches zero, the message is replaced by a turn advisory that counts down 10 seconds prior to the turn.
4. As you approach the FAF (LOTKE), the 400W Series unit will begin to automatically rescale in an angular fashion. This will allow the LPV approach to be flown in an identical fashion to a standard ILS. At 2.0 NM from the FAF, CDI scaling is tightened from 1.0 to the angular full scale deflection (typically the angular full-scale deflection is 2.0°, but will be as defined for the approach).



5. Sixty seconds prior to reaching the FAF (LOTKE), the unit will check the required Horizontal Alarm Limit (HAL) and Vertical Alarm Limit (VAL) to ensure the GPS position integrity is within limits to complete the LPV precision approach. In the event the HAL or VAL limits are exceeded, the approach will be downgraded to a non-precision approach indicated by "LNAV" on the moving map, a message that the approach is downgraded ("Approach downgraded - Use LNAV minima"), and the glideslope indicator will be flagged. You may continue the approach using LNAV non-precision minimums if there are LNAV minimums for this approach. In the rare event the GPS integrity cannot meet the non-precision HAL limits, the unit will send a message to the pilot to abort the approach ("Abort Approach - Loss of Navigation"). The

unit will revert to terminal limits to support navigation to the missed approach when the message is acknowledged.

6. Capture the glideslope as you would an ILS glideslope.
7. As you cross LOTKE, the destination sequences to the MAP ("RW31", the runway threshold). With the needle on the external CDI (or HSI) centered, fly toward the MAP, observing the altitude minimums dictated by the approach plate.



8. When viewing the Map Page, you'll note that the final course segment is displayed in magenta (the active leg of the flight plan always appears in magenta).
9. As you approach the MAP, a waypoint message ("DTK 312° x S") appears on the bottom of the screen.
10. Once the unit crosses the MAP (defined as the runway end waypoint), sequencing will be suspended. Prepare the aircraft for missed approach operation. Press the **OBS** key to sequence to the Missed Approach procedure.
11. Fly the guidance provided by the unit to the ARTTY intersection and hold.

LNAV/VNAV and LNAV Approaches with Advisory Vertical Guidance

GPS approaches with vertical guidance may be either LNAV/VNAV or LNAV approaches with advisory vertical guidance. LNAV-only approaches with advisory vertical guidance only have LNAV minima listed on the bottom of the approach plate. The glidepath is typically denoted by a light dashed line on the vertical profile (Jeppesen only) with an associated glidepath angle (usually in the 3.00° range). These approaches are indicated with "LNAV+V".

For approaches with LNAV/VNAV minimums, those will be controlling. For LNAV approaches with advisory vertical guidance, the LNAV minimums will be controlling. Approaches confirmed as LNAV/VNAV approaches in the Jeppesen NavData are indicated with an L/VNAV annunciation. At the time of this publication, not all of the LNAV/VNAV approaches have been identified as such in the Jeppesen NavData, therefore some LNAV/VNAV approaches may still be identified with LNAV+V annunciation.



NOTE: *When flying LNAV approaches with advisory vertical guidance, the vertical guidance may be ignored and descent is accomplished in accordance with published step-down altitudes and MDA.*

Points to Remember for All Approaches

- The GNS 400W-series unit is designed to complement your printed approach plates and vastly improve situational awareness throughout the approach. However, *you must always fly an approach as it appears on the approach plate.*
- The active leg (or the portion of the approach currently in use) is depicted in magenta on the Map Page. As you fly the approach, the 400W-series unit automatically sequences through each leg of the approach unless "SUSP" appears above the **OBS** key. "SUSP" indicates that automatic

5 - PROCEDURES

Additional Approach Info

sequencing of approach waypoints is *suspended* on the current leg and normally appears at holding patterns and upon crossing the missed approach point (MAP).



- For roll steering autopilots: roll steering is terminated when approach mode is selected on the autopilot and is available once the missed approach is initiated.
- Auto-Suspend is active for Vectors To Final (VTF) until on the “TO” side of the FAF and the aircraft ground track is within a 45° course of the published in bound course. At this point, it will automatically extinguish. *This is a new feature with the 400W-series.*
- For all approaches and departures, make sure to recheck the runway, transition, and all waypoints. If ATC directs you to make a change, recheck each element again.

Points to Remember for Localizer or VOR-based Approaches

- The default factory setting allows the CDI output to automatically switch from the GPS receiver to the LOC receiver. This may be changed to manual in some installations. If the “ILS CDI Selection” setting is changed to “Manual”, *you* must determine when to select “GPS” or “VLOC” guidance during the approach. Remember, “VLOC” is required for the final course segment from Final Approach Fix (FAF) to MAP.



NOTE: Installations with certain autopilots, such as the KAP 140 and KFC225, do not allow automatic ILS CDI switching.

- If the CDI output has not automatically switched from GPS to ILS upon reaching the FAF, you must manually switch to the VLOC receiver by pressing the **CDI** key. Verify that “VLOC” is displayed directly above to the **CDI** key.
- Automatic switching of CDI output is available for ILS, localizer, SDF and LDA approaches. Automatic CDI switching is *not* available for backcourse approaches or VOR approaches.
- When flying an approach with the autopilot coupled, you must monitor system functions at all times and verify that the autopilot and external CDI (or HSI) switch to the VLOC receiver with sufficient time to capture and track the approach course. Switching to “VLOC” late in the approach may not provide the autopilot enough time to respond and intercept the approach course prior to the FAF (depending upon the performance characteristics of your autopilot and aircraft). In such instances, you should manually fly the approach or refer to the documentation provided with your autopilot.
- When an ILS or VOR approach is first selected or executed, the frequency is automatically checked. If the frequency is correct, you will not receive a message regarding the frequency. If the frequency is incorrect, you will receive a message and you must place the ILS or VLOC frequency in the active frequency field.



- When flying a localizer-based approach (other than backcourse) with automatic CDI switching enabled:
 1. “GPS” guidance may be used while flying outbound and on the initial portion of the procedure turn.
 2. “VLOC” guidance is used on the remainder of the approach from the time you turn inbound on the procedure turn.
 3. The localizer frequency must be active to use “VLOC” guidance at the MAP. Press the CDI key to switch back to GPS data when the missed approach is initiated.
- When flying a localizer-based approach with automatic CDI switching disabled:



1. You may select “VLOC” guidance at any point on the approach prior to reaching the FAF.
2. The localizer frequency must be active to use “VLOC” guidance.

Enabling Autopilot Outputs for the King KAP140/KFC225

Autopilot outputs for the King KAP140/KFC225 autopilots are activated manually by the pilot after being prompted during the approach procedure. After enabling outputs, the 400W-series unit will provide guidance information consistent with what the autopilot expects (i.e., angular CDI scaling and glideslope capture for an LPV or other vertically guided GPS approach).

Conditions for autopilot outputs

1. The 400W-series unit must be configured during installation to interface with these autopilots and using “Prompt” for GPS Select.
2. Guidance to the FAF is active as indicated by Approach mode annunciation (LNAV, LNAV+V, L/VNAV, or LPV).

To enable autopilot outputs

1. Load and activate approach information as usual.
2. When you are turned on course to the FAF (Track and Desired Track are within 10°), a message will prompt you to enable the autopilot outputs before using your autopilot for an approach.



3. Press **PROC**. Highlight “Enable A/P APR Outputs?” with the **large right** knob, if necessary, and press ENT.

Blank Page

Section 6 WPT Pages

WPT Page Group

The Waypoint (WPT) page group provides information about the thousands of airports, VORs, NDBs, intersections, runways, frequencies, and procedures stored on your Jeppesen NavData® card. A WPT page is also provided to display information for up to 1,000 user-created waypoints.

To quickly select a WPT page:

1. From any page, press and hold **CLR** to select the default NAV page. (You may skip this step if you are already viewing any of the main pages.)
2. Turn the **large right** knob to select the WPT page group. "WPT" will appear in the lower right corner of the screen.
3. Turn the **small right** knob to select the desired WPT page.

NAV
7+ available pages
(see Section 2)

WPT
10 available pages
(see list below)

AUX
4 available pages
(see Section 9)

NRST
8 available pages
(see Section 7)



Airport Location



Airport Runway



Airport Frequency



Airport Approach



Airport Arrival



Airport Departure



Intersection



NDB



VOR



User Waypoint



NOTE: Please note that your 400W-series uses ICAO identifiers for all airports. All U.S. airport identifiers which contain only letters use the prefix "K". For example, Los Angeles International is KLAX under the ICAO standard. Other airports, such as Otten Memorial (3VS), that contain numbers in the identifier, do not require the "K" prefix. Many foreign countries use two letter prefixes.

6 - WPT PAGES

Identifier, Facility, Location or City

The WPT page group includes ten pages. While viewing any WPT page, turn the **small right** knob to select a different WPT page. The first six pages provide detailed information for the selected airport: location, runways, frequencies, approaches, arrivals, and departures. The last four pages provide information for intersections, NDBs, VORs and user-created waypoints.

After a WPT page is selected, information for a waypoint may be viewed by entering the identifier (or name) of the desired waypoint. Airports, NDBs and VORs may be selected by identifier, facility name or location (city).

To enter a waypoint identifier:

1. Select the desired WPT page and press the **small right** knob to activate the cursor.
2. Turn the **small right** knob to select the first character of the waypoint's identifier.
3. Turn the **large right** knob to select the next character field.
4. Turn the **small right** knob to select the desired character.
5. Repeat steps 3 and 4 until the identifier is selected, then press **ENT**.
6. To remove the flashing cursor, press the **small right** knob.

To enter a waypoint facility name or city location:

1. Select the airport location page, NDB page or VOR page from the WPT page group.
2. Press the **small right** knob to activate the cursor.
3. Turn the **large right** knob to select the facility name or location (city) field.
4. Turn the **small right** knob to select the desired character.

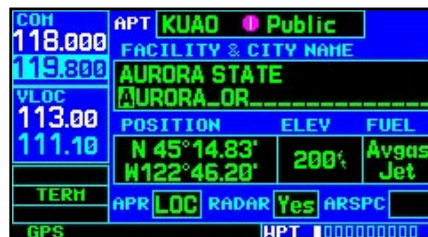

5. Turn the **large right** knob to select the next character field.
6. Repeat steps 4 and 5 until the facility name or location is selected, then press **ENT**.

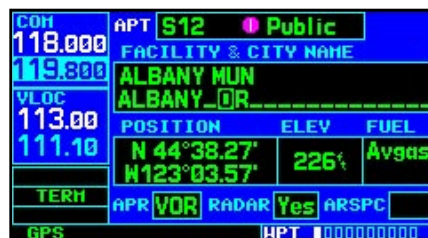

7. To remove the flashing cursor, press the **small right** knob.

Duplicate Waypoints

Once the identifier, facility name or location is entered, all six airport pages will display information for the selected airport. As you enter an identifier, facility name or location, the 400W-series Spell'N'Find™ feature will scroll through the database, displaying those waypoints matching the characters you have entered to that point. If duplicate entries exist for the entered facility name or location, additional entries may be viewed by continuing to turn the **small right** knob during the selection process. If duplicate entries exist for an entered identifier, a *duplicate waypoint page* will appear once you select the identifier (by pressing **ENT**).

To select a facility name or location, where duplicate entries exist:

1. Select the desired facility name or location.
2. As you spell the facility name or location, using the **small** and **large right** knobs, the 400W-series Spell'N'Find feature will select the first entry in the database based upon the characters you have entered up to that point.



3. Continue turning the **small right** knob to scroll through any additional database listings for the selected facility name or location. You can scroll backwards with the **small right** knob if you scroll past the desired facility name or location.



4. Press **ENT** to select the desired facility name or location.
5. To remove the flashing cursor, press the **small right** knob.

To select a waypoint identifier from a list of duplicates:

1. Select the desired airport or navaid identifier.
2. A duplicate waypoints window will appear. Turn the **large right** knob to select the desired waypoint and press **ENT**.



3. To remove the flashing cursor, press the **small right** knob.

Airport Location Page

The *airport location page* displays the latitude, longitude, and elevation of the selected airport. The *airport location page* also displays facility name and location, as well as fuel availability, available approaches, radar coverage and airspace type.

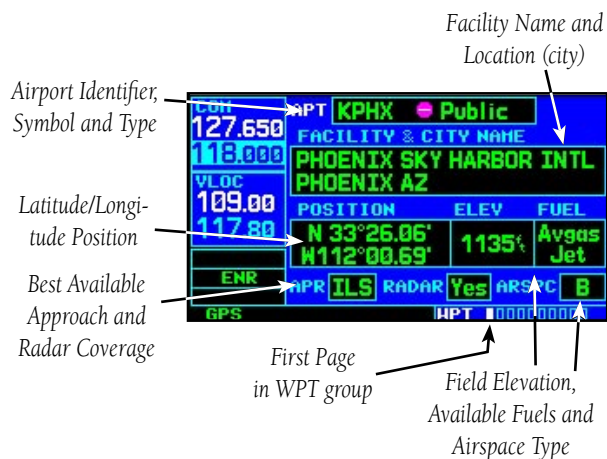

The following descriptions and abbreviations are used:

- Type— Usage type: Public, Military, Heliport, or Private
- Position— Latitude/Longitude (degrees/minutes or degrees/minutes/seconds), MGRS or UTM/UPS
- Elevation— In feet or meters
- Fuel— For public-use airports, the available fuel type(s) are: Avgas (80-87/100LL/100-130/Mogas), Jet, or None
- Approach— Best available approach: ILS, MLS, LOC, LDA, SDF, GPS, VOR, RNAV (“RNV”), LORAN (“LOR”), NDB, TACAN (“TCN”), Helicopter

(“HEL”), or VFR

- Radar— Radar coverage: Yes or No
- Airspace— Control environment: CTA, TMA, TRSA, Class B, Class C, Class D, or none

Airport Location Page Options**Select Next FPL Apt?**

Selecting the Next Airport page menu option allows you to display the next waypoint in the flight plan and activates it for editing.

To select the next FPL airport from the Airport Location Page:

1. Press **MENU** to display the Airport Location Page Options.
2. Turn the **small** or **large right** knob to highlight “Select Next FPL Apt?” and then press **ENT**.

Select Destination Apt?

Selecting the Destination Airport page menu option allows you to display the Destination waypoint in the flight plan.

To select the Destination airport from the Airport Approach Page:

1. Press **MENU** to display the Airport Approach Page Options.
2. Turn the **small** or **large right** knob to highlight “Select Destination Apt?” and then press **ENT**.

Airport Runway Page

The *airport runway page* displays runway designations, length, surface type and lighting for the selected airport. A map image of the runway layout and surrounding area is also displayed on the *airport runway page*. The map image scale appears in the lower left corner and is adjustable using the **RNG** key. For airports with multiple runways, information for each runway is available.

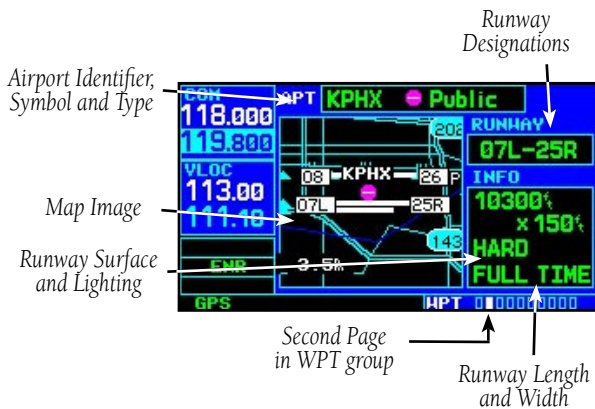

To display information for each additional runway:

1. Press the **small right** knob to activate the cursor.
2. Turn the **large right** knob to place the cursor on the runway designation field.



3. Turn the **small right** knob to display a window listing all runways for the selected airport.



4. Continue turning the **small right** knob to select the desired runway.
5. Press **ENT** to display information for the selected runway on the airport runway page.



6. To remove the flashing cursor, press the **small right** knob.

To adjust the scale of the map image:

1. Press the down arrow side of the **RNG** key to display a smaller map area.
2. Press the up arrow side of the **RNG** key to display a larger map area.

6 - WPT PAGES

Airport Frequencies

The following descriptions and abbreviations are used on the airport runway page:

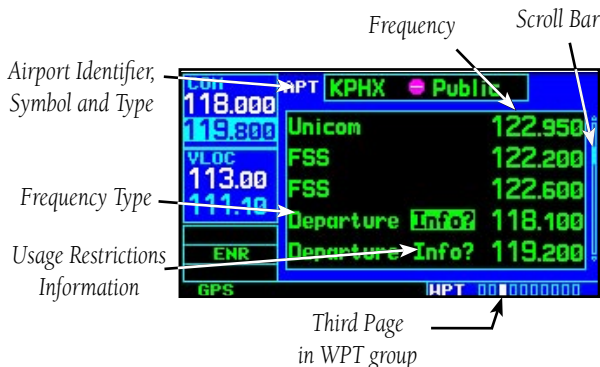

- Type— Usage type: Public, Military, Helicopter, or Private
- Surface— Runway surface types include: Hard, Turf, Sealed, Gravel, Dirt, Soft, Unknown or Water
- Lighting— Runway lighting types include: No Lights, Part Time, Full Time, Unknown or Frequency (for pilot-controlled lighting)

Airport Runway Page Options

Select Next FPL Apt?

As described earlier in this section.

Select Destination Apt?

As described earlier in this section.

Airport Frequency Page

The *airport frequency page* displays radio frequencies and frequency types for the selected airport, as well as sector and altitude restrictions (where applicable). If the selected airport has a localizer-based approach, the localizer frequency(s) is also listed on the *airport frequency page*. The *airport frequency page* may be used to quickly select and tune a COM or VLOC frequency.

To scroll through the frequency list and tune to a desired frequency on the list:

1. Press the **small right** knob to activate the cursor.
2. Turn the **large right** knob to scroll through the list, placing the cursor on the desired frequency. If there are more frequencies in the list than can be displayed on the screen, a scroll bar along the right-hand side of the screen will indicate where you are within the list.



3. Press **ENT** to place the selected frequency in the standby field of the COM or VLOC window.



- To remove the flashing cursor, press the **small right** knob.

Some listed frequencies may include designations for limited usage, as follows:

- “TX” - transmit only
- “RX” - receive only
- “PT” - part time frequency

If a listed frequency has sector or altitude restrictions, the frequency will be preceded by an “Info?” designation.

To view usage restrictions for a frequency:

- Turn the **large right** knob to place the cursor on the “Info?” designation directly to the left of the desired frequency.



- Press **ENT** to display the restriction information.



- To return to the airport frequency page, press **ENT**.

The following descriptions and abbreviations are used on the airport frequency page:

- Type— Usage type: Public, Military, Heliport, or Private
- Frequency— Communication frequencies which may include restrictions:

Approach	Arrival	Class B
Class C	CTA	Departure
TMA	Terminal	TRSA

Communication frequencies without restrictions:

ATIS	ASOS	AWOS
Center	Clearance	Gate
Control	Ground	Helicopter
Multicom	Pre-taxi	Radar
Ramp	Other	Tower
	Unicom	

Navigation frequencies:

ILS	LOC
-----	-----



Airport Frequency Page Options

Select Next FPL Apt?

As described earlier in this section.

Select Destination Apt?

As described earlier in this section.

Airport Approach Page

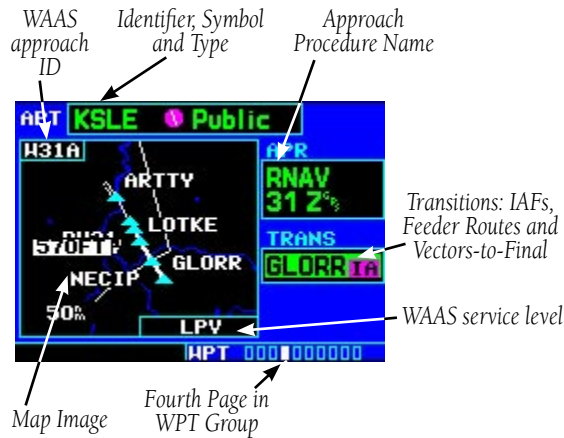

The *airport approach page* shows the available approach procedures for the selected airport. Where multiple initial approach fixes (IAFs) and feeder routes are available, that information may also be displayed. A map image provides a layout diagram for each approach and transition.

If a WAAS approach has been selected, the WAAS approach ID is displayed in the top left corner of the map. The approach service level is shown in the lower right corner of the map. Service level annunciations available are: LPV, L/VNAV, LNAV+V, or LNAV.

To scroll through the available approaches and transitions:

1. Press the **small right** knob to activate the cursor.

2. Turn the **large right** knob to place the cursor on the approach (APR) procedure name field.



3. Turn the **small right** knob to display a window of available approaches for the selected airport. Continue turning the **small right** knob to select the desired approach.



4. Press **ENT**. The cursor moves to the transitions (TRANS) field.
5. Turn the **small right** knob to display a window of available transitions. Continue turning the **small right** knob to select the desired transition or select "VECTORS" for guidance only along the final course segment of the approach.



6. Press **ENT**. To remove the flashing cursor, press the **small right** knob.



NOTE: Not all approaches in the database are approved for GPS use. As you select an approach, a “G_P” designation to the right of the procedure name indicates the procedure can be flown using the GPS receiver. Some procedures will not have this designation, meaning the GPS receiver may be used for supplemental navigation guidance only. ILS approaches, for example, must be flown by tuning the VLOC receiver to the proper frequency and coupling the VLOC receiver to the external CDI (or HSI).

Airport Approach Page Options

The following options are available for the airport approach page, by pressing the **MENU** key:

Load into Active FPL? allows you to load the selected approach into the active flight plan—with-out activating it. This performs the same operation as selecting “Load?” from the procedures page “Select Approach?” option.

To load an approach from the airport approach page:

1. Select the desired approach and transition using the steps outlined in Section 5.



2. Press **MENU** to display the airport approach page options.
3. Turn the **large right** knob to highlight “Load into Active FPL?” and press **ENT**.



4. The active flight plan page will appear. Press **FPL** to return to the airport procedures page.

Load and Activate? allows you to load the selected approach into the active flight plan and activate navigation guidance to the approach transition.

To load and activate an approach from the airport approach page, follow the steps above, but select “Load and Activate?” in step #3.

Select Approach Chnl? allows you to select the channel number for a WAAS approach for the current destination. The channel number for the WAAS approach is available from an approved approach chart.

If duplicate numbers are available for a channel, a list will be available where you may select the desired approach.



After selecting “Select Approach Chnl?”, choose the WAAS channel number for the current destination.

After selecting the Approach Channel, the WAAS approach ID will be shown in the top left corner of the map display.

To select an approach channel from the Airport Approach Page:

1. Press **MENU** to display the Airport Approach Page Options.
2. Turn the **small** or **large right** knob to highlight "Select Approach Chnl?" and then press **ENT**.
3. Turn the **small right** knob to change values and the **large right** knob to move the cursor. After selecting the WAAS approach channel, press **ENT**.
4. Select the desired transition and press **ENT**.

Select Next FPL Apt?

As described earlier in this section.

Select Destination Apt?

As described earlier in this section.

Airport Arrival Page

The airport arrival page shows the available Airport Standard Terminal Arrival (STAR) procedures for the selected airport. Where multiple transitions or runways are associated with the arrival procedure, that information may also be displayed. A map image provides a layout diagram for each arrival, transition and runway.

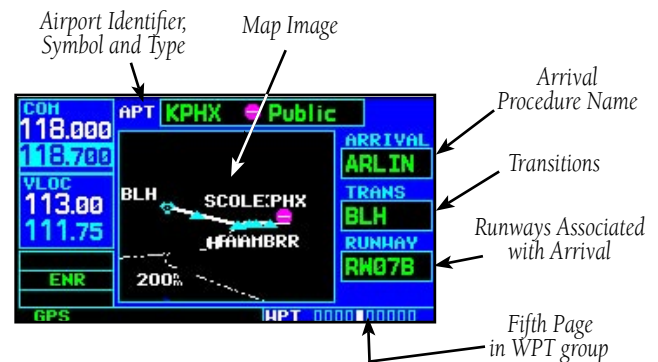

To scroll through the available arrivals:

1. Press the **small right** knob to activate the cursor.
2. Turn the **large right** knob to place the cursor on the arrival procedure name field.



3. Turn the **small right** knob to display a window of available arrivals for the selected airport. Continue turning the **small right** knob to select the desired arrival.



4. Press **ENT**. The cursor moves to the transitions (TRANS) field.
5. Turn the **small right** knob to display a window of available transitions. Continue turning the **small right** knob to select the desired transition.



6. Press **ENT**. The cursor moves to the runway field.
7. Turn the **small right** knob to display a window of available runways. Continue turning the **small right** knob to select the desired runway. ("ALL" may appear in the runway field, indicating the arrival procedure applies to all runways. For airports with parallel runways, "B" may appear at the end of the runway designation to indicate the arrival procedure applies to both runways.)



8. Press **ENT**. To remove the flashing cursor, press the **small right** knob.

Airport Arrival Page Options

The following options are available for the *airport arrival page*, by pressing the **MENU** key:

Load into Active FPL?

As described earlier in this section.

Select Next FPL Apt?

As described earlier in this section.

Select Destination Apt?

As described earlier in this section.

Airport Departure Page

The *airport departure page* shows the available Airport Standard Instrument Departure (SID) procedures for the selected airport. Where multiple runways or transitions are associated with the departure procedure, that information may also be displayed. A map image provides a layout diagram for each departure, runway and transition.

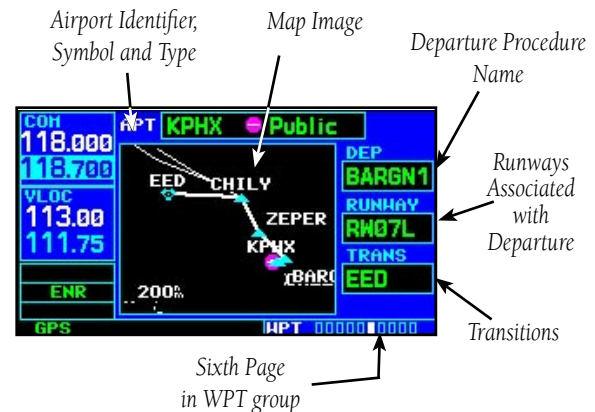

To scroll through the available departures:

1. Press the **small right** knob to activate the cursor.

6 - WPT PAGES

Airport Departure Page

- Turn the **large right** knob to place the cursor on the departure (DEP) procedure name field.



- Turn the **small right** knob to display a window of available departures for the selected airport. Continue turning the **small right** knob to select the desired departure.



- Press **ENT**. The cursor moves to the runway field.
- Turn the **small right** knob to display a window of available runways. Continue turning the **small right** knob to select the desired runway. ("ALL" may appear in the runway field, indicating the departure procedure applies to all runways. For airports with parallel runways, "B" may appear at the end of the runway designation to indicate the departure procedure applies to both runways.)



- Press **ENT**. The cursor moves to the transitions (TRANS) field.
- Turn the **small right** knob to display a window of available transitions. Continue turning the **small right** knob to select the desired transition.
- Press **ENT**. To remove the flashing cursor, press the **small right** knob.

Airport Departure Page Options

The following options are available for the *airport departure page*, by pressing the **MENU** key:



Load into Active FPL?

As described earlier in this section.

Select Next FPL Apt?

As described earlier in this section.

Select Destination Apt?

As described earlier in this section.

Intersection Page

The *intersection page* displays the latitude, longitude, region and country for the selected intersection. The *intersection page* also displays the identifier, radial and distance from the nearest VOR, VORTAC or VOR/DME. Intersections may only be selected by identifier. There are no Intersection page options.

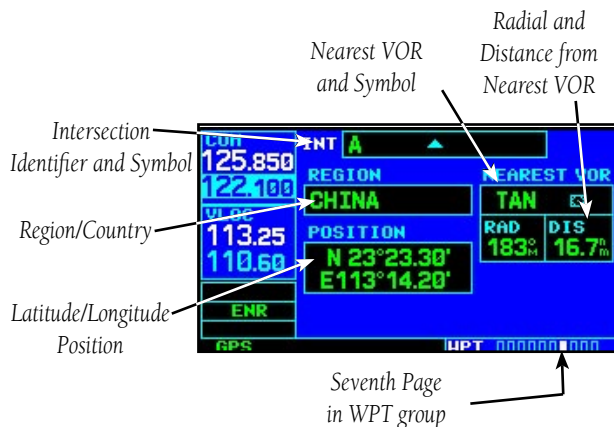

The following descriptions and abbreviations are used:

- Position— Latitude/Longitude (degrees/minutes or degrees/minutes/seconds), MGRS or UTM/UPS
- RAD— Radial from nearest VOR in degrees magnetic or degrees true (depending upon unit configuration)
- DIS— Distance from nearest VOR, in nautical miles/statute miles/kilometers (depending upon unit configuration)



NOTE: The VOR displayed on the intersection page is the nearest VOR, not necessarily the VOR used to define the intersection.

NDB Page

The *NDB page* displays the facility name, city, region/country, latitude and longitude for the selected NDB. The *NDB page* also displays the frequency and a weather broadcast indication (if applicable). NDBs may be selected by identifier, facility name or location (city). There are no NDB page options.

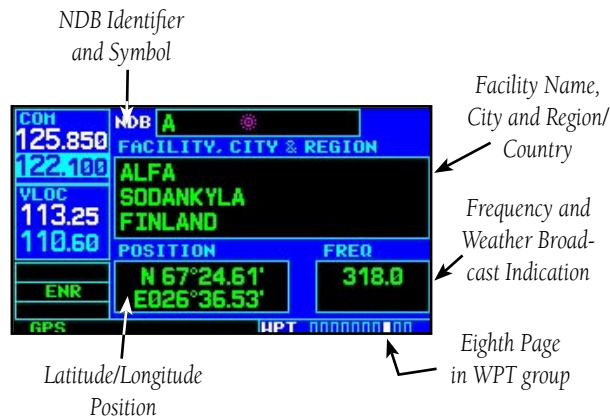

The following descriptions and abbreviations are used:

- Symbol— See Section 2 Nav Pages - Map Page for a graphic illustration of available NDB symbols
- Position— Latitude/Longitude (degrees/minutes or degrees/minutes/seconds), MGRS or UTM/UPS
- FREQ— Frequency in kilohertz (kHz)
- Wx Brdcast— Weather information is broadcast on the selected facility's frequency

VOR Page

The *VOR page* displays the facility name, city, region/country, magnetic variation, latitude and longitude for the selected VOR. The *VOR page* also displays the frequency and a weather broadcast indication (if applicable). There are no VOR page options.

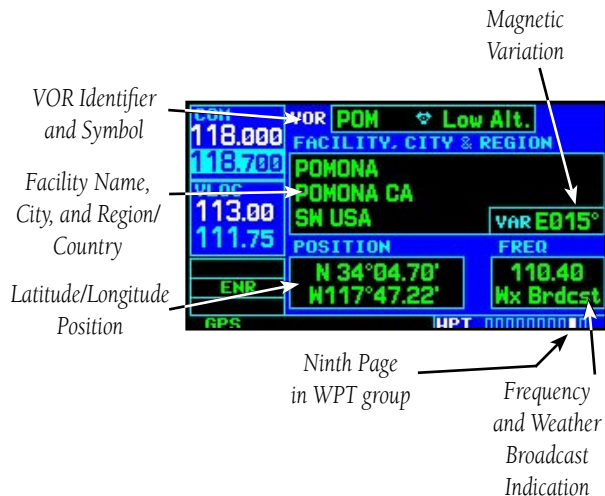

The following descriptions and abbreviations are used:

- Symbol— See Section 2 Nav Pages - Map Page for a graphic illustration of available VOR symbols
- VAR— Magnetic variation in degrees
- Position— Latitude/Longitude (degrees/minutes or degrees/minutes/seconds), MGRS or UTM/UPS
- FREQ— Frequency in megahertz (MHz)
- Wx Brdcast— Weather information is broadcast on the selected facility's frequency

As mentioned in the beginning of Section 6, VORs may be selected by identifier, facility name or location (city). The *VOR page* may also be used to quickly tune the VLOC receiver to the selected VOR's frequency.

To select a VOR frequency from the VOR page:

1. Select the VOR page from the WPT page group.
2. Press the **small right** knob momentarily to place the cursor on the VOR identifier field. If you wish to select another VOR, use the **small** and **large right** knobs and press **ENT** when finished.



3. Turn the **large right** knob to highlight the frequency field and press **ENT** to place the frequency in the standby field of the VLOC window.



4. To activate the standby VLOC frequency, press the **VLOC flip-flop** key.



User Waypoint Page

In addition to the airport, VOR, NDB and intersection information contained in your Jeppesen NavData® card, the 400W-series units allow you to store up to 1,000 user-defined waypoints. The user waypoint page displays the waypoint name (up to five characters long), identifier and radial from two reference waypoints, distance from one reference waypoint, along with the user waypoint's latitude/longitude position.

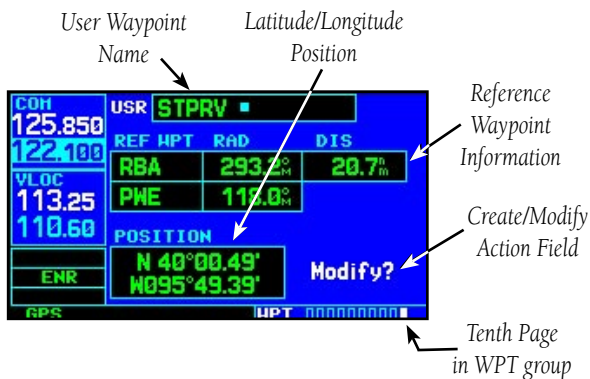

The following descriptions and abbreviations appear on the *user waypoint page*:

- REF WPT— Reference waypoint identifier (name)
- RAD— Radial from reference waypoint, in degrees magnetic or degrees true (depending upon unit configuration)
- DIS— Distance from reference waypoint, in nautical miles/statute miles/kilometers (depending upon unit configuration)
- Position— Latitude/Longitude (degrees/minutes or degrees/minutes/seconds), MGRS or UTM/UPS

User waypoints may only be selected by name (identifier), as described in the beginning of Section 6.

Creating User Waypoints

User waypoints may be created from the *user waypoint page* or the *map page*. To create a new user waypoint, simply enter its name (identifier) and position, or reference another waypoint by radial and distance.

To create a new user waypoint by entering its latitude/longitude position:

1. With the user waypoint page displayed, press the **small right** knob to activate the cursor.
2. Use the **small** and **large right** knobs to enter a name for the new waypoint and press **ENT**. Your present position appears in the position field at the bottom of the page. To create a waypoint at your present position, turn the **large right** knob to highlight "Create?" and skip to step #6.

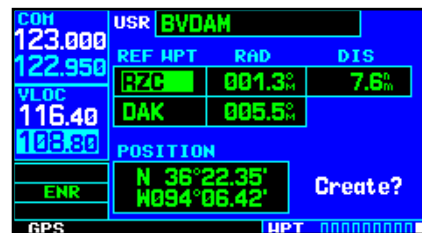
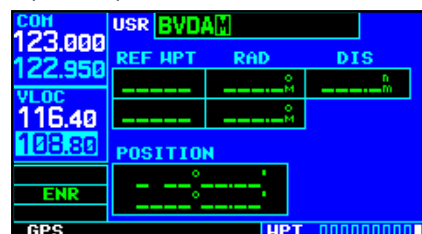

3. Turn the **large right** knob to highlight the position field at the bottom of the page.
4. Use the **small** and **large right** knobs to enter the position coordinates for the new waypoint.

6 - WPT PAGES

Creating User Waypoints

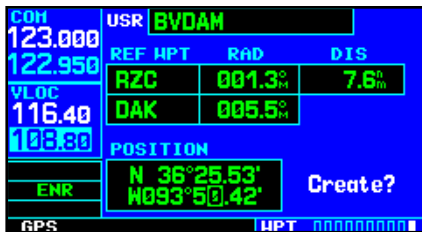

5. Press **ENT** to accept the selected position.
6. The cursor moves to "Create?". Press **ENT** to add the new waypoint to memory.
7. Press the **small right** knob to remove the flashing cursor.

To create a new user waypoint by referencing an existing waypoint:

1. With the user waypoint page displayed, press the **small right** knob to activate the cursor.
2. Use the **small** and **large right** knobs to enter a name for the new waypoint and press **ENT**.
3. Turn the **large right** knob to highlight the first reference waypoint (REF WPT) field.
4. Use the **small** and **large right** knobs to enter the identifier of the reference waypoint. The reference waypoint can be an airport, VOR, NDB, intersection or another user waypoint. Press **ENT** to accept the selected identifier.
5. The cursor moves to the radial (RAD) field. Use the **small** and **large right** knobs to enter the radial from the reference waypoint to the new user waypoint. Press **ENT** to accept the selected radial.



6. The cursor moves to the distance (DIS) field. Use the **small** and **large right** knobs to enter the distance from the reference waypoint to the new user waypoint. Press **ENT** to accept the selected distance.
7. Turn the **large right** knob to highlight "Create?" and press **ENT**.



8. Press the **small right** knob to remove the flashing cursor.



NOTE: The 400W-series units allow you to create a new user waypoint at a defined radial and distance from your present position. To reference your present position, follow the steps above, but press **CLR** in step #4. "P.POS" will appear in the reference waypoint (REF WPT) field to indicate that radial and distance information will reference your present position.

The second reference waypoint field (REF WPT) is a temporary reference only—not a reference that will be stored with the user waypoint. By default, this field will display a radial from the nearest VOR. However, you can select any waypoint—by identifier—to use as a reference in this field.

Your 400W-series unit can store user-defined

waypoints which are generated from other equipment in your panel. For example, an EFIS equipped with joystick inputs can be used to create user waypoints which will (if your installation supports this) automatically transfer to your 400W-series unit.

Creating User Waypoints from the Map Page

The map page and panning target pointer provide a quick means of saving your present position as a user-defined waypoint.

To capture and save your present position as a user waypoint:

1. With the map page displayed, press the **small right** knob to activate the panning function. The target pointer will appear at your present position.



2. Press **ENT** to capture the position and display the user waypoint page.

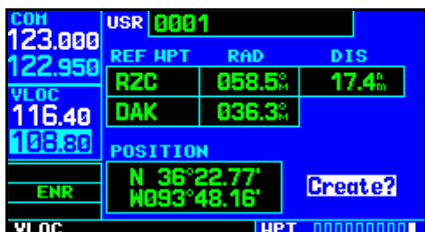

3. A four-digit name is automatically assigned to the waypoint. To change this name, turn the **large right** knob to highlight the name field, then use the **small** and **large right** knobs to select a new name. Press **ENT** to accept the selected name.

4. The cursor moves to the "Create?" action field. Press **ENT** to save the new waypoint.

Modifying User Waypoints

To modify an existing waypoint, select that waypoint on the user waypoint page and enter the new position information directly over the old information.

To modify a user waypoint by changing its latitude/longitude position:

1. With the user waypoint page displayed, press the **small right** knob to activate the cursor.
2. Use the **small** and **large right** knobs to enter the name of the desired waypoint and press **ENT**.
3. Turn the **large right** knob to highlight the position field at the bottom of the page.
4. Use the **small** and **large right** knobs to enter the new position coordinates and press **ENT** to accept the selected position.



5. The cursor moves to the "Modify?" action field. Press **ENT** to modify the waypoint.
6. Press the **small right** knob to remove the flashing cursor.

To modify a user waypoint by changing reference waypoint information:

1. With the user waypoint page displayed, press the **small right** knob to activate the cursor.
2. Use the **small** and **large right** knobs to enter the name of the desired waypoint and press **ENT**.

6 - WPT PAGES

Modifying User Waypoints

- Turn the **large right** knob to highlight the first reference waypoint (REF WPT) field, if you wish to change the reference waypoint. Otherwise, continue turning the **large right** knob to highlight the radial (RAD) or distance (DIS) field, as desired.
- Use the **small** and **large right** knobs to change the identifier — if desired — of the reference waypoint. The reference waypoint can be an airport, VOR, NDB, intersection or another user waypoint. Press **ENT** to accept the selected identifier.

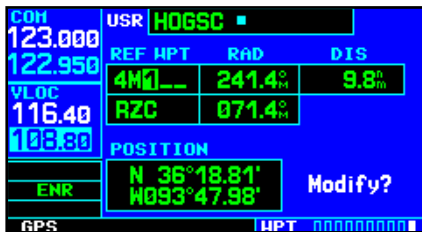

- The cursor moves to the radial (RAD) field. Use the **small** and **large right** knobs to change the radial from the reference waypoint, if desired. Press **ENT** to accept the selected radial.

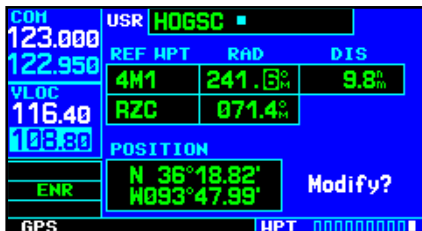

- The cursor moves to the distance (DIS) field. Use the **small** and **large right** knobs to change the distance from the reference waypoint to the new user waypoint, if desired. Press **ENT** to accept the selected distance.



- The cursor moves to the "Modify?" action field. Press **ENT** to modify the waypoint.
- Press the **small right** knob to remove the flashing cursor.



NOTE: If you attempt to modify or delete a waypoint which is currently a direct-to waypoint or the current "from" or "to" waypoint in the active flight plan, the 400W-series unit will alert you with the "Can't change an active waypoint" or "Waypoint is active and can't be deleted" message. You must first cancel the direct-to or remove the waypoint(s) from the active flight plan before modifying or deleting the waypoint(s).

User Waypoint Page Options

The following *user waypoint page* options are available by pressing the **MENU** key:

View User Waypoint List? displays a list of all user waypoints currently stored in memory.

To view a list of all user waypoints:

- From the user waypoint page, press **MENU** to display the user waypoint page options.
- Turn the **large right** knob to highlight "View User Waypoint List?" and press **ENT**.

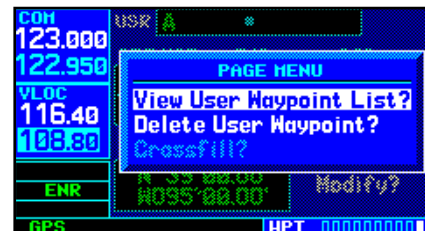

- The top of the user waypoint list will indicate the total number of user waypoints currently used and available memory. If more user waypoints are stored than can be displayed on a single screen, turn the **large right** knob to scroll through the user waypoint list.



- Press the **small right** knob to return to the user waypoint page.

Delete User Waypoint? allows you to delete the selected waypoint from memory.

To delete a user waypoint:

- Select the desired waypoint on the user waypoint page and press **MENU** to display the user waypoint page options.
- Turn the **large right** knob to highlight "Delete User Waypoint?" and press **ENT**.

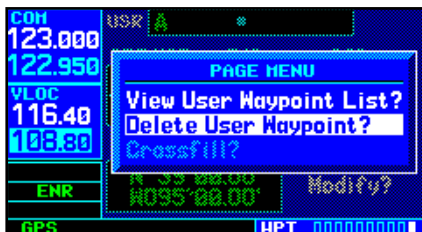

Crossfill? allows you to transfer a user waypoint to another 400W/500W series unit (if installed).

User Waypoint List

The user waypoint list allows you to review, modify, rename or delete a selected user waypoint, or to delete all user waypoints currently stored in memory. The top of the page shows the number of waypoints used and available memory.



To review and/or modify a user waypoint from the user waypoint list:

- Select the user waypoint list, as described in the User Waypoint Options.
- Turn the **large right** knob to highlight the desired user waypoint.
- Press **ENT** to display the user waypoint page for the selected waypoint. From this page you may review all information defining the waypoint and its position.
- To modify the waypoint's position or reference waypoint information, follow the steps described "Modifying User Waypoints." (Keep in mind that you've already selected a user waypoint page which displays the desired user waypoint, so you may skip the first two steps of the procedure.)
- To exit the user waypoint page, turn the **large right** knob to highlight "Done?" and press **ENT**.

6 - WPT PAGES

User Waypoint Page Options

To rename a user waypoint from the user waypoint list:

1. Select the user waypoint list.
2. Turn the **large right** knob to highlight the desired user waypoint.
3. Use the **small** and **large right** knobs to change the name of the user waypoint. (Enter the new name directly over the old name.) Press **ENT** to accept the new name.



4. A "rename waypoint" confirmation window is displayed. With "Yes?" highlighted, press **ENT** to rename the selected user waypoint.

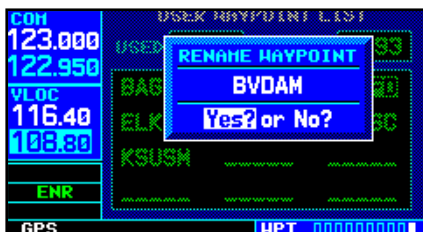

To delete a user waypoint from the user waypoint list:

1. Select the user waypoint list.
2. Turn the **large right** knob to highlight the desired user waypoint.
3. Press **CLR** to display a "delete waypoint" confirmation window.

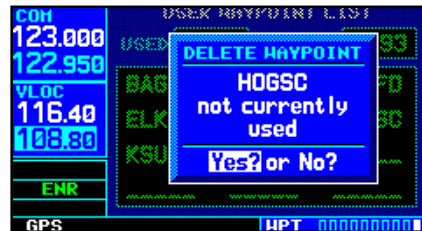

4. With "Yes?" highlighted, press **ENT** to delete the selected user waypoint.

To delete all user waypoints from memory:

1. Select the user waypoint list.
2. Press **MENU** to display an options window for the user waypoint list.
3. With "Delete All User Waypoints" highlighted, press **ENT**.
4. A "delete all waypoints" confirmation window is displayed. With "Yes?" highlighted, press **ENT** to delete all user waypoints from memory.

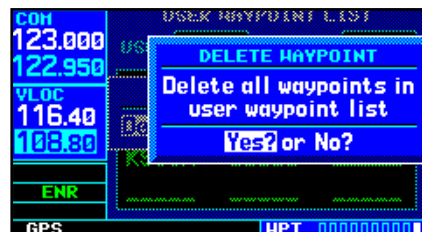

Section 7

NRST Pages

NRST Page Group

Section 2 introduced the 400W-series main page groups—NAV, WPT, AUX, NRST—and described each page in the NAV group. This fourth page group (NRST) provides detailed information for the 25 nearest airports, VORs, NDBs, intersections and user waypoints within 200 NM of your current position. In addition, the NRST pages include the five nearest Flight Service Station (FSS) and center (ARTCC/FIR) points of communication, plus alerts you to any Special Use (SUA) or Controlled Airspace you may be in or near.

To quickly select a NRST page:

1. In the GPS 400W and GNC 420W, press the **NRST** key. From any page in the GNS 430W, press and hold **CLR** to select the default NAV page. (You may skip this step if you are already viewing any of the main pages. See Section 2)
2. Turn the **large right** knob to select the NRST page group. "NRST" will appear in the lower right corner of the screen.



3. Turn the **small right** knob to select the desired NRST page.

NAV
7+ available pages
(see Section 2)

WPT
10 available pages
(see Section 6)

AUX
4 available pages
(see Section 9)

NRST
8 available pages
(see list below)



Nearest Airport



Nearest Intersection



Nearest NDB



Nearest VOR



Nearest User



Nearest Center



Nearest Flight Service



Nearest Airspace

Not all 25 nearest airports, VORs, NDBs, intersections or user waypoints can be displayed on the corresponding NRST page at one time. The *nearest airport page* displays detailed information for three nearest airports, with a scroll bar along the right-hand side of the page indicating which part of the list is currently being viewed. The *nearest airspace page* displays detailed information for up to three special use or controlled airspace alerts. The NRST pages for VORs, NDBs, intersections, and user waypoints will display five waypoints at a time. The flashing cursor and **large right** knob are used to scroll and view the rest of the waypoints or airspaces in the list.

To scroll through the list of nearest airports, VORs, NDBs, intersections, user waypoints or SUAs:

1. Select the desired NRST page.
2. Press the **small right** knob to activate the cursor.
3. Turn the **large right** knob to scroll through the list. The scroll bar along the right-hand side of the page will indicate which part of the list is currently being viewed.



4. Press the **small right** knob to remove the flashing cursor.

The nearest ARTCC and nearest FSS pages present detailed information for up to five nearby facilities—displaying only one facility at a time. Again, the additional information is viewed using the flashing cursor and **small right** knob to scroll through the list.

To scroll through the list of nearest flight service station or center points of communication:

1. Select the desired NRST page.
2. Press the **small right** knob to activate the cursor.
3. Turn the **small right** knob to scroll through the list.



4. Press the **small right** knob to remove the flashing cursor.

Navigating to a Nearby Waypoint

The NRST pages can be used in conjunction with the direct-to function to quickly set a course to a nearby facility. This feature can be a real time saver compared to retrieving information from the database using the WPT pages. More importantly, it instantly provides navigation to the nearest airport in case of an in-flight emergency.

To select a nearby airport, VOR, NDB, intersection or user waypoint as a direct-to destination:

1. Use the flashing cursor to scroll through a NRST page list and highlight the desired nearest waypoint.

COH		NEAREST VOR			
	VOR	BRG	DIS	FREQ	
123.000	FDK	197°	0.3 ⁿ	109.00	
122.950	EMI	086°	19.0 ⁿ	117.90	
VLOC	MRB	276°	22.1 ⁿ	112.10	
116.40	HGR	318°	27.9 ⁿ	109.80	
108.80	AML	199°	29.3 ⁿ	113.50	
ENR					
GPS					NRST00000000

2. Press **direct-to** to display the select direct-to waypoint page.

COH		SELECT → HAYPOINT	
123.000	FDK	NE USA	
122.950	FREDERICK		
VLOC	FREDERICK MD		
116.40	FPL	NRST	KFDK
108.80	ENR	N 39°24.73'	CRS 197°
		W077°22.51'	Activate?
GPS		DRCT	

3. Press **ENT** to accept the selected waypoint's identifier and press **ENT** a second time (with "Activate?" highlighted) to begin navigating to the selected waypoint.

COH		SELECT → HAYPOINT	
119.100	PDK	SE USA	
121.900	PEACHTREE		
VLOC	ATLANTA GA		
109.90	FPL	NRST	KATL
116.90	ENR	N 33°52.54'	CRS 026°
		W084°17.93'	Activate?
GPS		HSG	DRCT

Nearest Airport Page

The *nearest airport page* displays the identifier, symbol, bearing and distance to the 25 nearest airports (within 200 nautical miles of your present position). For each airport listed, the *nearest airport page* also indicates the best available approach, common traffic advisory frequency (CTAF) and the length of the longest runway.

COH		NEAREST AIRPORT			
	APT	BRG	DIS	APR	
127.650	5VA0	163°	35.8 ⁿ	GPS	
125.175	-----	-----	-----	-----	-----
VLOC	178	159°	37.6 ⁿ	GPS	
109.20	uni	122.800	rwly	4011'	
115.60	KFVX	089°	38.7 ⁿ	GPS	
ENR	uni	122.800	rwly	4400'	
GPS					NRST00000000

Airport Identifier, Symbol, Bearing To and Distance To

Tower or CTAF Frequency and Longest Runway

Best Available Approach

Scroll Bar

First Page in NRST group

The *nearest airport page* can be configured to exclude shorter runways or undesirable runway surface types, so that the corresponding airports do not appear on the list. You may wish to use this feature to exclude seaplane bases or runway lengths which would be difficult or impossible to land upon. See Sec 9 - Nearest Airport Criteria for additional details.

The *nearest airport page* may be used to quickly tune the COM transceiver to a nearby airport. The selected frequency is placed in the standby field of the COM window and activated using the **COM flip-flop** key.

7 - NRST PAGES

Nearest Airports

To quickly tune the common traffic advisory frequency (CTAF) from the nearest airport page:

1. Select the nearest airport page.
2. Press the **small right** knob to activate the cursor.
3. Turn the **large right** knob to scroll through the list, highlighting the COM frequency associated with the desired airport.

		NEAREST AIRPORT			
COM	APT	BRG	DIS	APR	
123.000	KFDK	000°	0.0 ^m	ILS	
122.950	uni	122.725	5220 ^{ft}		
VLOC	7MD3	290°	2.0 ^m	GPS	
116.40					
108.80					
ENR					
GPS					

4. Press **ENT** to place the selected frequency in the standby field of the COM window.

		NEAREST AIRPORT			
COM	APT	BRG	DIS	APR	
123.000	KFDK	000°	0.0 ^m	ILS	
122.725	uni	122.725	5220 ^{ft}		
VLOC	7MD3	290°	2.0 ^m	GPS	
116.40					
108.80					
ENR					
GPS					

5. Press the **COM flip-flop** key to activate the selected frequency.

		NEAREST AIRPORT			
COM	APT	BRG	DIS	APR	
123.000	KFDK	000°	0.0 ^m	ILS	
122.725	uni	122.725	5220 ^{ft}		
VLOC	7MD3	290°	2.0 ^m	GPS	
116.40					
108.80					
ENR					
GPS					

6. Press the **small right** knob to remove the flashing cursor.

Additional communication frequencies, runway information and more is available from the *nearest airport page* by highlighting the identifier of the desired airport and pressing **ENT**.

To view additional information for a nearby airport:

1. Select the nearest airport page.
2. Press the **small right** knob to activate the cursor.
3. Turn the **large right** knob to scroll through the list, highlighting the identifier of the desired airport.

		NEAREST AIRPORT			
COM	APT	BRG	DIS	APR	
122.725	KGAI	158°	17.8 ^m	RNA	
122.000		122.850	4202 ^{ft}		
VLOC	W73	014°	20.4 ^m	VFR	
116.40	mul	122.900	2700 ^{ft}		
108.80					
ENR	KDMM	067°	20.5 ^m	RNA	
	uni	122.700	5100 ^{ft}		
GPS					

4. Press **ENT** to display the airport location page for the selected airport.

COM	APT	Public		Done?
122.725	FACILITY & CITY NAME			
122.000	CARROLL CO REG'L POAGE			
	WESTMINSTER MD			
VLOC	POSITION		ELEV	FUEL
116.40	N 39°36.50'		789 ^{ft}	Avgas
108.80	W077°00.46'			Jet
ENR	APR	RNA	RADAR	Yes
		ARSPC		
GPS	IAPT 00000000			

5. To view additional WPT pages for the selected airport (including the airport runway and airport frequency pages) press the small right knob to remove the flashing cursor. Turn the **small right** knob to display the additional WPT pages. When finished, press the **small right** knob to return the flashing cursor to the screen.



- To return to the nearest airport page, verify that "Done?" is highlighted by the flashing cursor and press **ENT** (or press **CLR**).

Nearest Intersection Page

The *nearest intersection page* displays the identifier, symbol, bearing and distance to the 25 nearest intersections (within 200 nautical miles of your present position).

To view additional information for a nearby intersection, start from the nearest intersection page and follow steps 2 through 4 above.

Nearest NDB Page

The *nearest NDB page* displays the identifier, symbol, bearing, distance and frequency to the 25 nearest NDBs (within 200 nautical miles of your present position).

To view additional information for a nearby NDB, start from the nearest NDB page and follow steps 2 through 4 above.

Nearest VOR Page

The nearest VOR page displays the identifier, symbol, bearing and distance to the 25 nearest VORs (within 200 nautical miles of your present position). For each VOR listed, the nearest VOR page also indicates the frequency and may be used to quickly tune the VLOC receiver to the nearby VOR. The selected frequency is placed in the standby field of the VLOC window and activated using the **VLOC flip-flop** key.

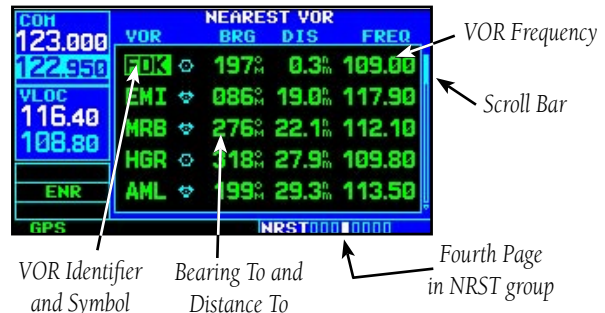

To quickly tune a VOR's frequency from the nearest VOR page:

- Select the nearest VOR page.
- Press the **small right** knob to activate the cursor.
- Turn the **large right** knob to scroll through the list, highlighting the frequency associated with the desired VOR.



- Press **ENT** to place the selected frequency in the standby field of the VLOC window.



- Press the **VLOC flip-flop** key to activate the selected frequency.
- Press the **small right** knob to remove the flashing cursor.

To view additional information for a nearby VOR:

- Select the nearest VOR page.
- Press the **small right** knob to activate the cursor.
- Turn the **large right** knob to scroll through the list, highlighting the identifier of the desired VOR.
- Press **ENT** to display the VOR page for the selected VOR.



- To return to the nearest VOR page, verify that "Done?" is highlighted by the flashing cursor and press **ENT** (or press **CLR**).
- Press the **small right** knob to remove the flashing cursor.

Nearest User Waypoint Page

The *nearest user waypoint page* displays the name, bearing and distance to the 25 nearest user waypoints (within 200 nautical miles of your present position).

Nearest Center (ARTCC) Page

The *nearest center page* displays the facility name, bearing to and distance to the five nearest ARTCC points of communication (within 200 nautical miles of your present position). For each ARTCC listed, the *nearest center page* also indicates the frequency(s) and may be used to quickly tune the COM transceiver to the center's frequency. The selected frequency is placed in the standby field of the COM window and activated using the **COM flip-flop** key.

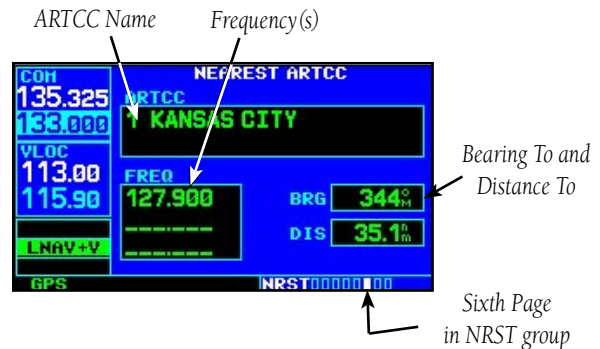

To quickly tune an ARTCC's frequency from the nearest center page:

1. Select the nearest center page.
2. Press the **small right** knob to activate the cursor.
3. Turn the **small right** knob to scroll through the list, selecting the desired ARTCC.



4. Turn the **large right** knob to scroll down the page, highlighting the desired frequency.



5. Press **ENT** to place the selected frequency in the standby field of the COM window.



6. Press the **COM flip-flop** key to activate the selected frequency.
7. Press the **small right** knob to remove the flashing cursor.

Nearest Flight Service Station (FSS) Page

The nearest flight service station page displays the facility name, bearing to and distance to the five nearest FSS points of communication (within 200 nautical miles of your present position). For each FSS listed, the nearest flight service station page also indicates the frequency(s) and may be used to quickly tune the COM transceiver to the FSS's frequency. The selected frequency is placed in the standby field of the COM window and activated using the **COM flip-flop** key.

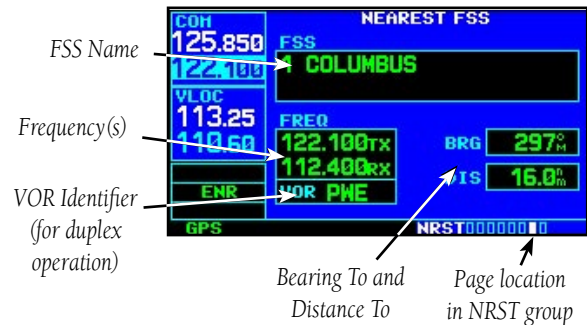

For duplex operations, “RX” and “TX” indications will appear beside the listed frequencies—indicating “receive only” or “transmit only” frequencies. The associated VOR is also provided for reference.

To quickly tune an FSS's frequency from the nearest flight service station page:

1. Select the nearest flight service station page and press the **small right** knob to activate the cursor.
2. Turn the **small right** knob to scroll through the list, selecting the desired FSS.



3. Turn the **large right** knob to scroll down the page, highlighting the desired frequency (COM frequency[s] or VOR frequency for duplex operation).



4. Press **ENT** to place the selected frequency in the standby field of the COM or VLOC window.



5. Press the **COM flip-flop** or **VLOC flip-flop** key, as appropriate, to activate the selected frequency.
6. Press the **small right** knob to remove the flashing cursor.

Nearest Airspace Page

The last page in the NRST group, the *nearest airspace page*, will alert you to as many as nine controlled or special use airspaces near or in your flight path. Alerts are provided according to the following conditions:

- If your projected course will take you inside an airspace within the next ten minutes, the alert message “**Airspace ahead -- less than 10 minutes**” will appear. The *nearest airspace page* will show the airspace as “**Ahead**”.



- If you are within two nautical miles of an airspace and your current course will take you inside, the message “**Airspace near and ahead**” will appear. The *nearest airspace page* will show “**Within 2nm of airspace**”.
- If you are within two nautical miles of an airspace and your current course will **not** take you inside, the message “**Near airspace less than 2nm**” will appear. The *nearest airspace page* will show the airspace as “**Ahead < 2nm**”.
- If you have entered an airspace, the message “**Inside Airspace**” will appear. The *nearest airspace page* will show “**Inside of airspace**”.



Note that the airspace alerts are based on three-dimensional data (latitude, longitude and altitude) to avoid nuisance alerts. The alert boundaries for controlled airspace are also sectorized to provide complete information on any nearby airspace. Once one of the described conditions exists, the message annunciator will flash, alerting you of an airspace message.

To view an airspace alert message:



1. When the message annunciator above the **MSG** key flashes, press **MSG**.
2. Press **MSG** again to return to the previous page.

Once you have been provided an airspace alert message, detailed information concerning the specific airspace is provided on the *nearest airspace page*. The *nearest airspace page* displays the airspace name, status (“Ahead”, “Ahead < 2nm”, etc. as described on the previous page), and a time to entry (if applicable). By selecting any airspace name listed on the *nearest air-*

space page, additional details will be provided—including controlling agency, communication frequencies and floor/ceiling limits.

To view additional details for an airspace listed on the nearest airspace page:

1. Select the nearest airspace page.



2. Press the **small right** knob to activate the cursor.
3. Turn the **large right** knob to scroll through the list, highlighting the desired airspace.



4. Press **ENT** to display the airspace page for the selected nearby airspace.



5. To return to the nearest airspace page, verify that “Done?” is highlighted by the flashing cursor and press **ENT**.

7 - NRST PAGES

Nearest Airspaces

- Press the **small right** knob to remove the flashing cursor.

To view and quickly tune the frequency for a controlling agency:

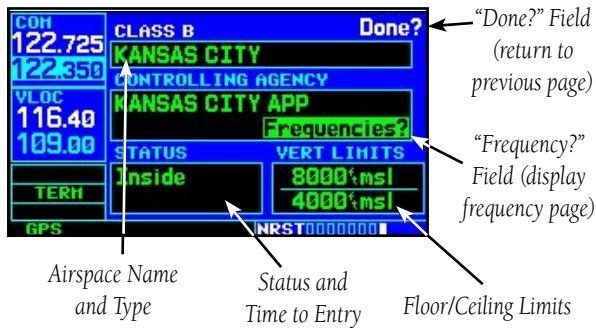

- Follow steps #1 through #4 on the previous page to display the airspace page for the desired controlled or special use airspace.
- Turn the **large right** knob to highlight "Frequencies?" and press **ENT**.



- Turn the **large right** knob to scroll through the list, highlighting the desired frequency.



- Press **ENT** to place the selected frequency in the standby field of the COM window.



- Press the **COM flip-flop** key to activate the selected frequency.
- To return to the airspace page, turn the **large right** knob to highlight "Done?" and press **ENT** (or press **CLR**).
- To return to the nearest airspace page, turn the **large right** knob to highlight "Done?" and press **ENT** (or press **CLR**).
- Press the **small right** knob to remove the flashing cursor.

The *airspace page* displays (and airspace alert messages are provided for) the following airspace types:

- Alert
- Caution
- Class B
- Class C
- Class D
- CTA
- Danger
- MOA
- Prohibited
- Restricted
- TMA
- Training
- TRSA
- Unspecified
- Warning

The bottom right-hand corner of the *airspace page* displays the floor and ceiling limits of the airspace. The following are examples of what may appear as vertical limits for an airspace:

- 5000 ft msl (5000 feet mean sea level)
- 5000 ft agl (5000 feet above ground level)
- MSL (at mean sea level)
- NOTAM (see Notice to Airmen) *
- Unknown * • Unlimited *
- See Chart * • Surface *

* Not shown in this example

All airspace alert messages, except for prohibited areas, may be turned on or off from the *airspace alarms* page. An altitude buffer is also provided on the *airspace alarms* page to provide an extra margin of safety above/below the published limits.

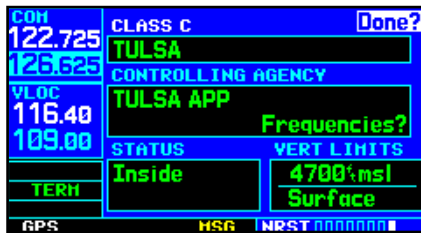

Blank Page

GNS 430W Only

Section 8

VLOC (VOR/Localizer/Glideslope) Receiver Operations

The GNS 430W includes digitally-tuned VOR/localizer and glideslope receivers with the desired frequency selected on a *VLOC window*, along the left-hand side of the display. Frequency selection is performed by pressing the **small left** knob and turning the **small** and **large left** knobs to select the desired frequency.



Ident Audio and Volume

VLOC ident is enabled by pressing the **VLOC volume** knob. When VLOC ident is enabled, an "ID" indication appears in the upper right corner of the VLOC window — to the immediate right of "VLOC".



Push for ident audio. Turn to adjust audio volume.

VLOC audio volume is adjusted using the **VLOC volume** knob. Turn the **VLOC volume** knob clockwise to increase volume, or counterclockwise to decrease volume.

VLOC Window and Tuning

VLOC frequencies are selected with the tuning cursor in the *standby* VLOC frequency field, and using the **small** and **large left** knobs to dial in the desired frequency. The standby frequency always appears below the *active* frequency. The active frequency is the frequency currently in use.



Push to toggle the tuning cursor (small left knob) between COM and VLOC windows. Turn to adjust the kHz value (the portion after the decimal point) of standby VLOC frequency.



Turn to adjust the MHz value (the portion before the decimal point) of the standby VLOC frequency.

The tuning cursor will remain in the COM window. If you wish to select a VOR/localizer/ILS frequency, press the **small left** knob momentarily to place the cursor in the VLOC window.



NOTE: *The tuning cursor will normally appear in the COM window, unless placed in the VLOC window by pressing the **small left** knob. When the tuning cursor is in the VLOC window, it will automatically return to the COM window after 30 seconds of inactivity.*

To select a VOR/localizer/ILS frequency:

1. If the tuning cursor is not currently in the VLOC window, press the **small left** knob momentarily.



2. Turn the **large left** knob to select the desired megahertz (MHz) value. For example, the "117" portion of the frequency "117.80".



3. Turn the **small left** knob to select the desired kilohertz (kHz) value. For example, the ".80" portion of the frequency "117.80".



4. To make the standby frequency the active frequency, press the **VLOC flip-flop** key.

Auto-Tuning

A frequency may also be quickly selected from the database by simply highlighting the desired frequency on the *VOR page* or the *nearest VOR page* and pressing the **ENT** key. This process is referred to as *auto-tuning*. Once a frequency is selected in the standby field, it may be transferred to the active frequency by pressing the **VLOC flip-flop** key. (Auto-tuning can also be performed from VLOC frequencies listed on the *NAVCOM*, *airport frequency*, and *nearest flight service station* pages.)

To select a VLOC frequency from the VOR or nearest VOR pages:

1. Select the desired page from the main pages. (See page references on the preceding page.)
2. Press the **small right** knob momentarily to activate the flashing cursor.
3. Turn the **large right** knob to highlight the frequency for the desired VOR.



4. Press **ENT** to place the frequency in the standby field of the VLOC window.



5. Press the **VLOC flip-flop** key to activate the selected frequency.

- Press the **small right** knob to remove the flashing cursor.



NOTE: For duplex COM operations, the VLOC receiver may be auto-tuned from the nearest flight service station page.

When selecting a VOR or ILS approach, manual tuning of the VLOC receiver is not required. Once the approach procedure is “Loaded” or “Activated”, the GNS 430W will automatically place the proper frequency in the standby field of the VLOC window. If you wish to use this frequency, simply press the **VLOC flip-flop** key to activate the frequency. Additional information on approach procedures is provided in Section 5.

To select an approach and automatically tune the proper VLOC frequency:

- Select the destination airport using the **direct-to** key or as the last waypoint in the active flight plan.
- Press the **PROC** key to display the procedures page.
- Turn the **large right** knob to highlight “Select Approach?” and press **ENT**.

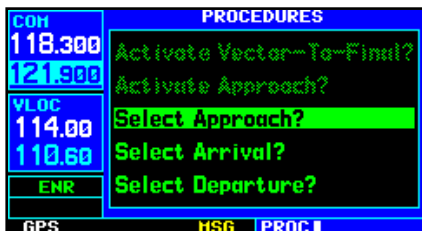

- A window will appear listing the available procedures. Turn the **small right** knob to highlight the desired procedure and press **ENT**. (When a direct-to destination is selected, departures are offered for the nearest airport.)

- A second window will appear listing available transitions. Turn the **small right** knob to highlight the desired transition waypoint and press **ENT**. (The approach “Vectors” option assumes you will receive vectors to the final course segment of the approach and will provide navigation guidance to intercept this final course.)
- Turn the **large right** knob to highlight “Load?” or “Activate?” and press **ENT**. (“Load?” will add the procedure to the flight plan without immediately using it for navigation guidance. This allows you to continue navigating the original flight plan, but keeps the procedure available on the active flight plan page for quick activation when needed.)



- For VOR and ILS approaches, the standby field of the VLOC window is automatically tuned to the proper frequency. To activate the frequency press the **VLOC flip-flop** key. To display VLOC course information on the external CDI (or HSI) press **CDI** and verify that “VLOC” is displayed at the bottom left corner of the screen, directly above the **CDI** key.

8 - VLOC RECEIVER

Auto-tuning / CDI Key

GNS 430W Only



- For precision approaches and some non-precision approaches, a reminder window will appear indicating that GPS guidance on such approaches is strictly for monitoring only—use the VLOC receivers and external CDI (or HSI) for primary navigation. To confirm this reminder, highlight “Yes?” and press **ENT**.

CDI Key

The GNS 430W's **CDI** key is used to couple the GPS or VLOC receiver to the external CDI (or HSI). When the external CDI (or HSI) is being driven by the GPS receiver, “GPS” will appear at the bottom left corner of the page, directly above the **CDI** key. When the external CDI (or HSI) is being driven by the VLOC receiver, “VLOC” will appear instead.

To couple the external CDI (or HSI) to the GPS receiver or VLOC receiver, press the CDI key to display “GPS” or “VLOC”, as desired.



NOTE: The external CDI (or HSI) must be coupled to the VLOC receiver for approaches which are not approved for GPS. See the ILS example in the Procedures section.

Section 9 AUX Pages

AUX Page Group

Section 2 introduced the 400W-series main page groups—NAV, WPT, AUX, NRST—and described each page in the NAV group. The third page group (AUX) allows you to change unit settings, customizing operation to your preferences. The AUX pages also provide E6B functions—such as trip planning, fuel planning, density altitude, true airspeed and winds aloft calculations.

To quickly select an AUX page:

1. From any page, press and hold **CLR** to select the default NAV page. (You may skip this step if you are already viewing any of the main pages.)

2. Turn the **large right** knob to select the AUX page group. “AUX” will appear in the lower right corner of the screen.



3. Turn the **small right** knob to select the desired AUX page.



NAV
7 available pages
(see Section 2)

WPT
10 available pages
(see Section 6)

AUX
4 available pages
(see list below)

NRST
8 available pages
(see Section 7)



Flight Planning



Utility



Setup 1



Setup 2

Flight Planning Page

The *flight planning page* provides access to E6B functions for fuel planning, trip planning, density altitude/true airspeed/winds aloft calculations and a “Crossfill” function to transfer flight plans/user waypoints to a second 400W-series unit. When a flight planning item is selected, the corresponding page will appear providing additional information and features.

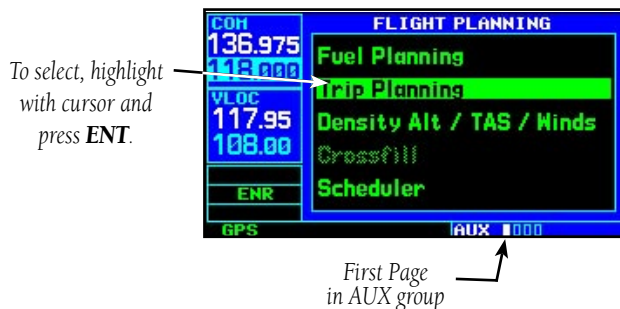
**To select an item from the flight planning page:**

1. Press the **small right** knob momentarily, to activate the flashing cursor.



2. Turn the **large right** knob to select the desired menu option, and press **ENT**.

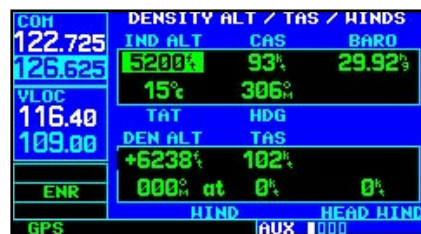

The following flight planning items are available:

Fuel Planning— when equipped with fuel flow (FF) and/or fuel on board (FOB) sensors, this item displays current fuel conditions along the active direct-to or flight plan. You may also manually enter fuel flow, ground speed (GS) and (in some instances) fuel on board figures for planning purposes. Fuel planning figures can be displayed not only for the currently active flight plan or direct-to, but also point-to-point between two specified waypoints and for any programmed flight plan.

Trip Planning— allows the pilot to view desired track (DTK), distance (DIS), estimated time en route (ETE), en route safe altitude (ESA) and estimated time of arrival (ETA) information for a direct-to, point-to-point between two specified waypoints or for any programmed flight plan.



NOTE: Point-to-point waypoints, flight plans and/or ground speed (default is current GPS-calculated ground speed) entered on the fuel planning page will automatically transfer to the trip planning page, and vice versa.

Density Alt / TAS / Winds— indicates the theoretical altitude at which your aircraft will perform depending upon several environmental conditions, including indicated altitude (IND ALT), barometric setting (BARO) and total air temperature (TAT; the temperature, including the heating effect of speed, read on a standard outside temperature gauge). This computes true airspeed (TAS), based upon the factors above and the calibrated airspeed (CAS). Also, this determines winds aloft—the wind direction and speed—and a head wind/tail wind component, based upon the calculated density altitude (DEN ALT), true airspeed, aircraft heading (HDG) and ground speed.

Crossfill— allows the pilot to transfer the active flight plan, any stored flight plan, a user waypoint or all user waypoints between two 400W-Series Garmin units in a dual-unit installation.

Scheduler— displays reminder messages (such as “Change oil”, “Switch fuel tanks”, “Overhaul”, etc.). One-time, periodic, and event-based messages are allowed. One-time messages will appear once the timer expires and will reappear each time the 400W-series unit is powered on, until the message is deleted. Periodic messages will automatically reset to the original timer value, once the message is displayed. Event-based messages do not use a timer, but rather a specific date and time.

Fuel Planning

To perform fuel planning operations:

1. Select “Fuel Planning” from the flight planning page.
2. The current fuel planning “mode” is displayed at the top of the page: “POINT TO POINT” or “FPL” (for a flight plan). To change the mode, press **MENU** to display an options window for

the other mode, then press **ENT** to accept the other mode.



The “Flight Plan?” option allows you to select the numbered flight plan for fuel planning. The “Change Fields?” option allows you to select fuel information for each field as desired.

- 3a. For point-to-point fuel planning, turn the **small** and **large right** knobs to enter the identifier of the “from” waypoint. Once the waypoint’s identifier is entered, press **ENT** to accept the waypoint. The flashing cursor moves to the “to” waypoint. Again, turn the **small** and **large right** knobs to enter the identifier of the “to” waypoint and press **ENT** to accept the waypoint.

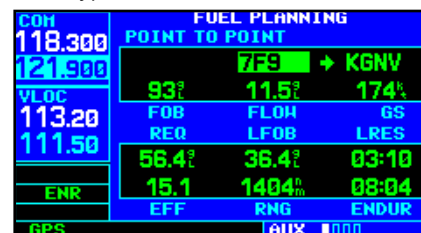

or,

- 3b. For flight plan fuel planning, turn the **small right** knob to select the desired flight plan by number (already stored in memory. "00" is the active flight plan). Turn the **large right** knob to highlight the "LEG" field and turn the **small right** knob to select the desired leg of the flight plan, or select "Cum" to apply fuel planning calculations to the entire flight plan.

COH		FUEL PLANNING		
118.300	FPL LEG	00	Cum	KOJC → KSJC
124.900	REQ	1200 [?]	30.0 [?]	340%
VLOC	FOB	FLOH	GS	
113.20	REQ	LFOB	LRES	
111.50		115.4 [?]	1084 [?]	36:08
ENR	EFF	RNG	ENDUR	
		11.3		39:59
GPS			AUX	0000

4. If your fuel management system does not enter the data automatically, turn the **large right** knob to highlight the fuel on board (FOB) field.

COH		FUEL PLANNING		
118.300	FPL LEG	00	Cum	KOJC → KSJC
124.900	REQ	1155 [?]	30.0 [?]	340%
VLOC	FOB	FLOH	GS	
113.20	REQ	LFOB	LRES	
111.50		115.4 [?]	1083 [?]	36:07
ENR	EFF	RNG	ENDUR	
		11.3		39:57
GPS			AUX	0000

5. Use the **small** and **large right** knobs to enter the amount of fuel on board. Press **ENT** when finished.
6. The flashing cursor moves to the fuel flow (FF) field. Use the **small** and **large right** knobs to enter the fuel flow rate. Press **ENT** when finished. Note that if a fuel system is providing current fuel flow, the fuel flow field will default to this value.
7. The flashing cursor moves to the ground speed

(GS) field. Use the **small** and **large right** knobs to enter the ground speed. Press **ENT** when finished.

8. With all variables entered, the following information will be provided:
- REQ — Quantity of fuel required
 - LFOB — Left-over fuel on board
 - LRES — Left-over fuel reserve time
 - EFF — Efficiency, expressed in distance per fuel units (e.g. nautical miles per gallon)
 - RNG — Range (distance)
 - ENDUR — Flight endurance, or total available flight time

COH		FUEL PLANNING		
118.300	POINT TO POINT	P.POS	→	-----
124.900	REQ	0 [?]	0.0 [?]	0%
VLOC	FOB	FLOH	GS	
113.20	REQ	LFOB	LRES	
111.50		0.0 [?]	0.0 [?]	00:00
ENR	EFF	RNG	ENDUR	
		0.0	0.00%	00:00
GPS			AUX	0000

9. To reconfigure the data fields press **MENU** to display the options window. Turn the **small right** knob to highlight the "change fields?" option. Press **ENT** to reconfigure the data fields. Turn the **large right** knob to select the desired field. Turn the **small right** knob to highlight the desired data. Press **ENT** to select the data configuration.



NOTE: Fuel planning figures can be entered and displayed based upon one of three possible configurations:

- 1) No fuel sensors connected—In this instance fuel flow is manually entered and is used to calculate fuel on board. When fuel flow or fuel on board is manually entered, the figures are retained the next time you view the page (with fuel on board continuously recalculated).
- 2) Fuel flow sensor installed, but no fuel on board sensor—Fuel on board is manually entered. Fuel flow is automatically provided by sensor. If fuel flow is manually entered (to override the sensor), it will not affect the FOB figure and is not retained the next time you view the page.
- 3) Fuel flow and fuel on board sensors installed—Fuel flow and fuel on board are automatically provided by sensors. Fuel on board can NOT be entered manually. Fuel flow can be entered manually, but will not affect the FOB figure and is not retained the next time you view the page.

Trip Planning

To perform trip planning operations:

1. Select "Trip Planning" from the flight planning page.
2. The current trip planning "leg mode" is displayed at the top of the page: "POINT TO POINT" or "FPL LEG" (for a flight plan leg). To change the leg mode, press **MENU** to display an options window for the other leg mode, then press **ENT** to accept the other leg mode.
- 3a. For point-to-point trip planning, turn the **small** and **large right** knobs to enter the identifier of the "from" waypoint. Once the waypoint's identifier is entered, press **ENT** to accept the waypoint. The flashing cursor moves to the "to" waypoint. Again, turn the **small** and **large right** knobs to enter the identifier of the "to" waypoint and press **ENT** to accept the waypoint.



OR,

- 3b. For "flight plan leg" trip planning, turn the **small right** knob to select the desired flight plan (already stored in memory), by number. Turn the **large right** knob to highlight the "LEG" field and turn the **small right** knob to select the desired leg of the flight plan, or select "Cum" to apply trip planning calculations to the entire flight plan.

9 - AUX PAGES

Flight Planning

COH		TRIP PLANNING	
118.300		FPL LEG	
121.900	00 02 KABQ → KOKC	19:24	162%
VL0C		DEP TIME	
113.20	DTK	DIS	GS
111.50	074°	443 ^m	02:44
ENR		ETA	
	15500%	ESA	23:54
VL0C		AUX 0000	

- Turn the **large right** knob to highlight the departure time (DEP TIME) field.
- Use the **small** and **large right** knobs to enter the departure time. Press **ENT** when finished. (Departure time may be entered in local or UTC time, depending upon unit settings.)
- The flashing cursor moves to the ground speed (GS) field. Use the **small** and **large right** knobs to enter the ground speed. Press **ENT** when finished.
- With all variables entered, the following information will be provided:
 - DTK— Desired track, or desired course
 - DIS— Distance
 - ETE— Estimated time en route
 - ESA— En route safe altitude
 - ETA— Estimated time of arrival

COH		TRIP PLANNING	
118.300		FPL LEG	
121.900	00 02 KABQ → KOKC	19:30	162%
VL0C		DEP TIME	
113.20	DTK	DIS	GS
111.50	074°	443 ^m	00:00
ENR		ETA	
	15500%	ESA	
VL0C		AUX 0000	

Density Alt / TAS / Winds

To calculate density altitude, true airspeed, winds aloft:

- Select "Density Alt / TAS / Winds" from the flight planning page.

COH		FLIGHT PLANNING	
122.725		Fuel Planning	
125.625	Trip Planning		
VL0C		Density Alt / TAS / Winds	
116.40	Crossfill		
109.00	Scheduler		
ENR			
GPS		AUX 0000	

- The flashing cursor highlights the indicated altitude (IND ALT) field. Use the **small** and **large right** knobs to enter the altitude indicated on your altimeter. Press **ENT** when finished.
- The flashing cursor moves to the calibrated airspeed (CAS) field. Use the **small** and **large right** knobs to enter the airspeed from your airspeed indicator. Press **ENT** when finished.

COH		DENSITY ALT / TAS / WINDS		
122.725		IND ALT	CAS	BARO
125.625	15%	93%	29.92 ^h	
VL0C		TAT	HDG	
116.40	+6238%	102%		
109.00	000% at 0%	0%		
ENR		HIND	HEAD	HIND
GPS				
				AUX 0000

- The flashing cursor moves to the barometric setting (BARO) field. Use the **small** and **large right** knobs to enter the barometric setting (altimeter setting). Press **ENT** when finished.
- The flashing cursor moves to the total air temperature (TAT) field. Use the **small** and **large right** knobs to enter the temperature. Press **ENT** when finished.

6. The flashing cursor moves to the aircraft heading (HDG) field. Use the **small** and **large right** knobs to enter the aircraft heading from the directional gyro or compass. Press **ENT** when finished.
7. With all variables entered, the following information will be provided:
 - DEN ALT— Density altitude
 - TAS— True airspeed
 - WIND— Wind direction and speed
 - HEAD/TAIL WIND— Magnitude of head wind or tail wind component

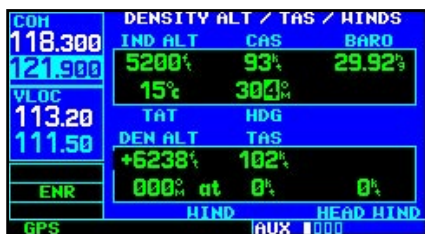

NOTE: If your installation includes components (such as an airdata sensor) to provide any of the variables above, the density alt/tas/winds page data will default to the values provided by these components.

Crossfill

Select *Crossfill?* from the Default Nav page or Flight Plan page by pressing the **MENU** key or while on the Flight Planning page by scrolling down to *Crossfill* and pressing **ENT**.



From Default NAV Page



From Flight Plan Pages

Automatic Operation: If both units are set to automatic, a change in the active flight plan of one unit will also be seen in the other. Initiating a direct-to to a waypoint on one unit will also initiate a direct-to to the same waypoint on the other unit.

If one unit is set for automatic crossfill and the other is set for manual crossfill, then only the auto unit will automatically send data to the manual unit. In this configuration, the auto unit could be thought of as the master unit.

Manual Operation: If manual operation is desired, the pilot must invoke all transfers from that unit. When a unit is configured for automatic transfer, a manual transfer can also be done on command. If either of the messages “data transfer error” or “data

transfer cancelled” are received during an automatic or manual transfer, the pilot must force another transfer.

To transfer flight plans or user waypoints to/from a second 400W (or 500W) Series unit:

1. Select “Crossfill” from the flight planning page.
2. The flashing cursor highlights the method field. Turn the **small right** knob to select “Auto” or “Manual”. “Auto” will automatically transfer any selection of (or any change to) a direct-to destination or active flight plan to a second 400W or 500W Series Garmin unit.



NOTE: Crossfill requires both 400W and/or 500W series units to have the same Jeppesen NavData® database cycle number.

3. The flashing cursor highlights the transfer data option (TRANSFER) field. Turn the **small right knob** to display a window of available data options:
 - **Active Flight Plan**—transfer the active flight plan to/from a second 400W/500W-series Garmin unit in a dual unit installation. This option is the default when selecting “Crossfill” from the flight planning page.
 - **Flight Plan**—transfer any stored flight plan to/from a second 400W/500W-series unit, by selecting the flight plan by number. This option is the default when selecting “Crossfill” from the flight plan catalog.
 - **User Waypoints (all)**—transfer all stored user waypoints to/from a second 400W/500W-series unit.
 - **User Waypoint**—transfer the specified user waypoint to a second 400W/500W-series unit.

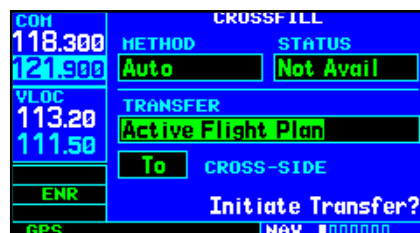

4. Continue turning the **small right** knob to select the desired data option. Press **ENT** when finished.
5. For a stored flight plan (“Flight Plan” data option), the flight plan number field is highlighted. Turn the **small right** knob to select the desired flight plan and press **ENT**.
6. For a specified user waypoint (“User Waypoint” data option), the waypoint identifier field is highlighted. Use the **small** and **large right** knobs to enter the identifier of the desired user waypoint. Press **ENT** when finished.
7. The flashing cursor moves to the “CROSS-SIDE” field. Turn the **small right** knob to select “To” or “From” and press **ENT**.
8. The flashing cursor moves to the “Initiate Transfer?” confirmation field. Press **ENT** to transfer the selected data.

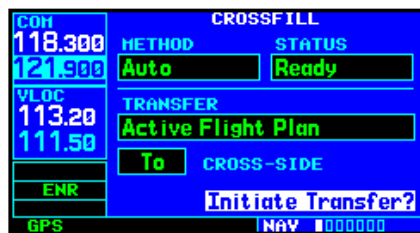

Scheduler

To enter a scheduled message:

1. Select "Scheduler" from the flight planning page.
2. The flashing cursor highlights the first message field. If necessary, turn the **large right** knob to highlight the first blank message field.
3. Use the **small** and **large right** knobs to enter the message text. Press **ENT** when finished. (The 400W-series unit will store up to nine scheduled messages holding 20 characters each.)
4. The flashing cursor moves to the type field under the new message. Turn the **small right** knob to display a window of available options: (Event, One Time, Periodic). Press **ENT** to select.

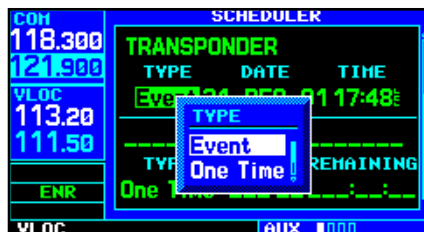

5. The flashing cursor moves to the time/date field. Use the **small** and **large right** knobs to set the time or date required before the message is displayed. Time is entered as hours/minutes (hhh:mm). Event-based messages expire at a specific date and time. Press **ENT**, when finished.

To edit a scheduled message:

1. Select "Scheduler" from the flight planning page.
2. The flashing cursor highlights the first message field.
3. To edit the message text, turn the **large right** knob to highlight the desired message field. Use the **small** and **large right** knobs to edit the message text—entering the new text directly over the old message. Press **ENT** when finished.
4. To edit the time field, turn the **large right** knob to highlight the field. Use the **small** and **large right** knobs to edit the new date or time—entering the new value directly over the old figure. Press **ENT** when finished.

To delete a scheduled message:

1. Select "Scheduler" from the flight planning page.
2. The flashing cursor highlights the first message field. Turn the **large right** knob to highlight the desired message field.
3. Press **CLR** to delete the message text, followed by **ENT** to confirm the deletion.

Utility Page

The *utility page* provides access to checklists, a count down/up timer, trip timers, trip statistics, RAIM (Receiver Autonomous Integrity Monitoring) prediction, sunrise/sunset time calculations and software/database version information. When a Utility item is selected, the corresponding page will appear providing additional information and features.

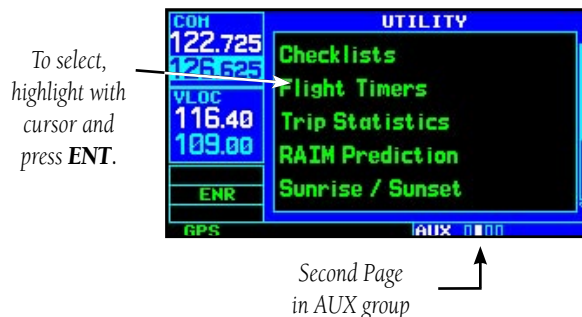
**To select an item from the utility page:**

1. Press the **small right** knob momentarily, to activate the flashing cursor.
2. Turn the **large right** knob to select the desired menu option, and press **ENT**.

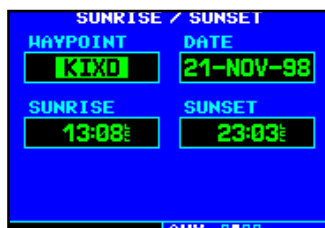

The following items are available:

Checklists— provides up to nine different user-defined checklists containing up to 30 items each.

Flight Timers— provides count up/down timers, plus automatic recording of departure time and total trip time. Departure and total trip time recording can be configured to run either any time 400W-series power is on, or only when your ground speed exceeds 30 knots.

Trip Statistics— provides readouts for trip odometers, average speed and maximum speed. These readouts are resettable (individually or all at once) by pressing **MENU** to display an options window.

RAIM Prediction— predicts if GPS coverage is available for your current location or at a specified waypoint at any time and date. Receiver Autonomous Integrity Monitoring performs checks to ensure that the 400W-series unit has adequate satellite geometry during your flight. RAIM availability is near 100% in Oceanic, En Route and Terminal phases of flight. Because the FAA's TSO requirements for non-precision approaches specify significantly better satellite coverage than other flight phases, RAIM may not be available when flying some approaches. The 400W-series unit automatically monitors RAIM during approach operations and warns you if RAIM is not available. In such cases, use the GNS 430W's VLOC receiver instead for the approaches. RAIM prediction helps you plan for a pending flight to confirm GPS operation during an approach.

RAIM prediction only predicts the availability of Fault Detection (FD) integrity in the absence of WAAS corrections. It cannot predict the availability of LPV approaches. The FAA provides a NOTAM

service for LPV approach availability.



An "INTEG" annunciation at the bottom left corner of the screen indicates that satellite coverage is insufficient to pass built-in receiver autonomous integrity monitoring (RAIM) tests. When this occurs, the GPS receiver will continue to provide navigation information, but should not be used for primary navigation guidance. Use the GNS 430W's VLOC receiver or another suitable navigation source.

Sunrise / Sunset— allows you to calculate the time of sunrise and sunset at any waypoint or your present position for a specified date.

Software Versions — provides software version information for the operating software within the GPS receiver, COM transceiver, VOR/localizer receiver, glideslope receiver and main processor board.

Database Versions — The Database Versions Page displays the current Jeppesen database type, effective date, and expiration date, along with the version and type of built-in land database.

Terrain Database Versions — The Terrain Database Versions Page displays the current terrain and obstacle database types, version, cycle, effective date, and expiration date.

Checklists

To create a checklist:

1. Select "Checklist" from the utility page. Press **ENT** to display a list of checklists.



2. Press **MENU** to display an options menu. Turn the **large right** knob to select "Create New Checklist?" and press **ENT**.
3. Use the **small** and **large right** knobs to enter the name of a checklist. Press **ENT** when finished. (Up to nine different checklists can be created and stored in the 400W-series unit.)

- Use the **small** and **large right** knobs to enter each checklist item, followed each time by **ENT**. (Each checklist may contain up to 30 line items of as much as sixteen characters long.)

To execute a checklist:

- With the checklists page displayed, turn the **large right** knob to select the desired checklist and press **ENT**.



- As you complete each checklist item, press **ENT** to move to the next item on the list.



To edit a checklist:

- With the checklists page displayed, turn the **large right** knob to select the desired checklist and press **ENT**.
- Press **MENU** to display an options menu. Select "Edit Item?" and press **ENT**, then use the **small** and **large right** knobs to edit each checklist item. Press **ENT** when finished.

To insert a checklist step into an existing checklist:

- With the checklists page displayed, turn the **large right** knob to select the desired checklist and press **ENT**.
- Turn the **large right** knob to highlight the existing checklist entry which will immediately follow the new checklist step.
- Turn the **small** and **large right** knobs to enter the new checklist step. Press **ENT** when finished.

To delete a checklist or all checklists:

- With the checklists page displayed, press **MENU** to display an options menu.
- Turn the **large right** knob to select "delete checklist" or "delete all checklists" and press **ENT** to remove the checklist or all checklists from memory.

To copy a checklist:

- With the checklists page displayed and the desired checklist selected, press **MENU**.
- Turn the **large right** knob to select "Copy Checklist?" and press **ENT** to copy the checklist to an empty checklist memory location.

To sort the checklists by name or entry:

- With the checklists page displayed, press **MENU** to display an options menu.
- Turn the **large right** knob to select "Sort List By Entry?" or "Sort List By Name?" and press **ENT**.

Flight Timers

To view, use or reset the generic timer:

1. Select "Flight Timers" from the utility page.



2. The flashing cursor highlights "Start?". To start the generic timer, press **ENT**. (You will typically begin with this step for count up timers. However, for count down timers, you may wish to enter a count direction and time before starting the timer.)
3. To change the count direction, turn the **large right** knob to highlight count direction field: "Down" or "Up". Turn the **small right** knob to select the desired count direction. Press **ENT** when finished.



4. For a count down timer, turn the **large right** knob to highlight the time field. Use the **small** and **large right** knobs to enter the count down time—in hours, minutes and seconds. Press **ENT** when finished.
5. To stop the generic timer, turn the **large right** knob to highlight "Stop?" and press **ENT**.
6. To reset the generic timer, turn the **large right** knob to highlight the time field. Press **CLR**, followed by **ENT**.

To record or reset the departure time:

1. Select "Flight Timers" from the utility page.
2. Turn the **large right** knob to highlight the reset mode field, under "Departure Time". (The reset mode field will indicate "Pwr-on" or "GS>30kt".)
3. Turn the **small right** knob to select the desired reset mode. ("Pwr-on" will record a departure time when the 400W-series unit is turned on. "GS>30kt" will record a departure time once the GPS-computed ground speed exceeds 30 knots.)



4. Press **ENT** when finished.
5. To reset the departure time, turn the **large right knob** to highlight "Reset?" and press **ENT**.

To view, use or reset total trip time:

1. Select "Flight Timers" from the utility page.
2. Turn the **large right** knob to highlight the reset mode field, under "Total Trip Time". (The reset mode field will indicate "Pwr-on" or "GS>30kt".)
3. Turn the **small right** knob to select the desired reset mode. ("Pwr-on" will record trip time, in hours/minutes/seconds, any time the 400W-series unit is turned on. "GS>30kt" will record trip time any time the GPS-computed ground speed exceeds 30 knots.)
4. Press **ENT** when finished.

9 - AUX PAGES

Utility Page

- To reset the total trip time, turn the **large right knob** to highlight "Reset?" and press **ENT**.



Trip Statistics

To reset trip statistics readouts:

- Select "Trip Statistics" from the utility page.

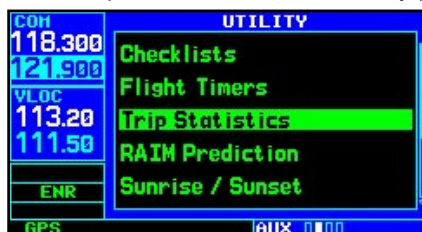

- Press **MENU** to display an options window with several reset options:
 - Reset Trip?— Resets trip odometer and average ground speed readouts
 - Reset Max Speed?— Resets maximum speed readout only
 - Reset Odometer?— Resets odometer readout only
 - Reset All?— Resets all trip statistics readouts



- Turn the **large right knob** to select the desired reset option and press **ENT**.

RAIM Prediction

To predict RAIM availability:

- Select "RAIM Prediction" from the utility page.



- The flashing cursor highlights the waypoint field. Use the **small** and **large right** knobs to enter the identifier of the waypoint at which you wish to determine RAIM availability. Press **ENT** when finished. (To determine RAIM availability for your present position, press **CLR**, followed by **ENT**.)

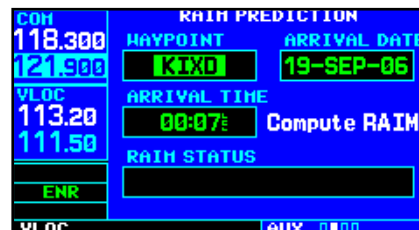

- The flashing cursor moves to the arrival date field. Use the **small** and **large right** knobs to enter the date for which you wish to determine RAIM availability. Press **ENT** when finished.
- The flashing cursor moves to the arrival time field. Use the **small** and **large right** knobs to enter the time for which you wish to determine RAIM availability. Press **ENT** when finished.

5. The flashing cursor moves to “Compute RAIM?”. Press **ENT** to begin RAIM prediction. Once calculations are complete, the 400W-series unit will display one of the following in the RAIM status field:

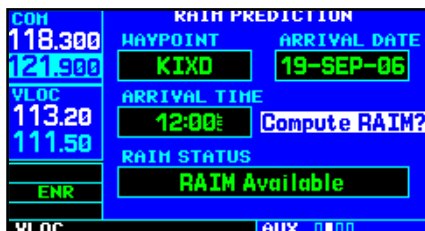

- RAIM Not Available— Satellite coverage is predicted to NOT be sufficient for reliable operation during non-precision approaches
- RAIM Available— Satellite coverage is predicted to be sufficient for reliable operation during all flight phases, including non-precision approaches



NOTE: RAIM computations predict satellite coverage within ± 15 minutes of the specified arrival date and time. Refer to the CDI/Alarms section of Aux pages Setup 1 for specific information regarding RAIM protection limits.

Sunrise / Sunset

To calculate sunrise and sunset times at any waypoint or your present position:

1. Select “Sunrise / Sunset” from the utility page.



2. The flashing cursor highlights the waypoint field. Use the **small** and **large right** knobs to enter the identifier of the waypoint at which you wish to determine sunrise and sunset times. Press **ENT** when finished. (To determine sunrise/sunset times for your present position, press **CLR**, followed by **ENT**.)
3. The flashing cursor moves to the date field. Use the **small** and **large right** knobs to enter the date for which you wish to determine sunrise and sunset times.



4. Press **ENT** to calculate sunrise and sunset times for the selected location and date.



9 - AUX PAGES

Utility Page

Software / Database Versions

The *software, database, and terrain database version pages* display software version information for each of the various subsystems contained within the 400W-series unit, as well as database versions for the Jeppesen NavData® card and built-in land data. These pages are for information purposes only—no user functions are available from this page. Reach these pages by turning the **small** or **large right** knobs and then press **ENT**. Press **CLR** or the **small right** knob to return to the *utility page*.



Setup 1 Page

The *Setup 1 page* provides access to airspace alarms, CDI scale adjustment, an arrival alarm, units of measure settings, position formats, map datums and settings for local or UTC time display. When a setup item is selected, the corresponding page will appear providing access to the various unit settings.



To select, highlight with cursor and press ENT.

Third Page in AUX group

To select a setup item from the setup 1 page:

1. Press the **small right** knob momentarily, to activate the flashing cursor.



2. Turn the **large right** knob to select the desired setup item, and press **ENT**.



The following setup items are available:

Airspace Alarms— allows you to turn the controlled / special-use airspace message alerts on or off. This will not affect the alerts listed on the *nearest airspace page* or the airspace boundaries depicted on the map page. It will simply turn on/off the warning provided when you are approaching or near an airspace.

An altitude buffer is also provided which “expands” the vertical range above or below an airspace. For example, if the buffer is set at 500 feet, and you are

more than 500 feet above or below an airspace, you will not be notified with an alert message; if you are less than 500 feet above or below an airspace and projected to enter it, you will be notified with an alert message. The default is 200 feet.

CDI / Alarms— allows you to define the scale for the 400W-series unit on-screen course deviation indicator. The scale values represent full scale deflection for the CDI to either side. The default setting is “Auto”. At this setting, the CDI scale is set to 2.0 NM during the “en route” phase of flight. Within 31 NM of your destination airport, the CDI scale gradually ramps down to 1.0 NM (terminal area). Likewise, when leaving your departure airport the CDI scale is set to 1.0 NM and gradually ramps up to 2 NM beyond 30 NM (from the departure airport). During approach operations the CDI scale gradually transitions down to an angular CDI scale. At 2.0 NM of the final approach fix (FAF), CDI scaling is tightened from 1.0 to the angular full scale deflection (typically the angular full-scale deflection is 2.0°, but will be as defined for the approach).

If a lower CDI scale setting is selected (i.e., 1.0 or 0.3 NM), the higher scale settings are not selected during ANY phase of flight. For example, if 1.0 NM is selected, the 400W-series unit uses this for en route and terminal phases and ramps down further during an approach. Note that the Horizontal Alarm (HAL) protection limits listed below follow the selected CDI scale, unless corresponding flight phases call for lower HAL. For example, if the 1.0 NM CDI setting is selected, full-scale deflection during approach will still follow the approach CDI scale settings.

CDI Scale

Horizontal Alarm Limit

Auto (oceanic)	2.0 NM
±2.0 NM or Auto (en route)	2.0 NM
±1.0 NM or Auto (terminal)	1.0 NM
±0.3 NM or Auto (approach)	0.3 NM

An “auto” ILS CDI selection allows the 500W-series unit to automatically switch the external CDI from the GPS receiver to the VLOC receiver, when intercepting the final approach course. Or, select “manual” to manually switch the external CDI connection, as needed (using the **CDI** key). If the unit is installed with a KAP140/KFC225 autopilot, automatic switching will not take place. See AUX - Setup 1 for ILS CDI Selection details.

CDI scales and corresponding Flight Phases:



Oceanic



En Route



Terminal



Approach

An arrival alarm, provided on the CDI / Alarms Page, may be set to notify you with a message when you have reached a user-defined distance to the final destination (the direct-to waypoint or the last waypoint in a flight plan). Once you have reached the set distance (up to 99.9 units), an “Arrival at [waypoint]” message is displayed.

Units / Mag Var— allows you to configure the displayed data to standard or metric units of measure. This setting applies to distance, speed, altitude, fuel, pressure and temperature. Also provides two magnetic variation (heading) options: Auto or True. If “Auto” is selected, all track, course and heading information is corrected to the magnetic variation computed by the GPS receiver. The “True” setting references all information to true north.

Position / Map Datum— configures position readout information to the desired position format and shows the Map Datum. The NavData® card uses the WGS 84 map datum to conform to WAAS requirements.

Date / Time— provides settings for time format (local or UTC; 12- or 24-hour) and time offset. The time offset is used to define current local time. UTC (also called “GMT” or “zulu”) date and time are calculated directly from the GPS satellites’ signals and cannot be changed. If you prefer to use local time, simply designate the offset by adding or subtracting the correct number of hours and minutes.

Not all time zones are offset from UTC by a whole number of hours (e.g., Newfoundland, Central Australia, India, Iraq, ...).

Airspace Alarms

To set the airspace warning messages or change the altitude buffer:

1. Select "Airspace Alarms" from the setup 1 page.



2. Turn the **large right** knob to highlight the "On"/"Off" field next to the desired airspace type.
3. Turn the **small right** knob to select "On" or "Off", as desired. Press **ENT** to accept the selection.



4. To change the altitude buffer, turn the **large right** knob to highlight the "Altitude Buffers" field. Use the **small** and **large right** knobs to enter the desired buffer distance. Press **ENT** when finished.



NOTE: When an approach has been loaded into the active flight plan, airspace alert messages will be disabled within 30 NM of the destination airport.

CDI Scale / Alarms

To change the CDI scale:

1. Select "CDI / Alarms" from the Setup 1 page.



2. The flashing cursor highlights the "Selected CDI" field. Turn the **small right** knob to select the desired CDI scale. The selected scale and any lower scale settings will be used during the various phases of flight.
3. Press **ENT** to accept the selected scale. The "System CDI" field will display the CDI scale currently in use. The "System CDI" setting may differ from the "Selected CDI" depending upon the current phase of flight.



NOTE: The CDI scale is always measured in nautical miles, regardless of the current distance units of measure selected on the units/mag var page.

To change the ILS CDI selection:

1. Select "CDI / Alarms" from the setup 1 page.
2. Turn the **large right** knob to highlight the "Auto"/"Manual" ILS CDI field.
3. Turn the **small right** knob to select "Auto" or "Manual", as desired. Press **ENT** to accept the selection.



NOTE: Installations with certain autopilots, such as the KAP 140 and KFC225) do not allow automatic ILS CDI switching.

To set the arrival alarm and alarm distance:

1. Select "CDI / Alarms" from the setup 1 page.
2. Turn the **large right** knob to highlight the "On"/"Off" field (directly below "Arrival Alarm").
3. Turn the **small right** knob to select "On" or "Off", as desired. Press **ENT** to accept the selection.
4. The flashing cursor moves to the alarm distance field (to the immediate right of "On" or "Off"). To enter an arrival alarm distance, use the **small** and **large right** knobs to enter the desired alarm distance. Press **ENT** when finished.

Units / Mag Var

To set the magnetic variation:

1. Select "Units / Mag Var" from the Setup 1 page.

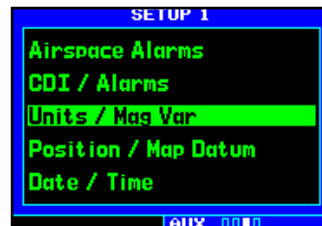

2. The flashing cursor highlights the heading mode field. Turn the **small right** knob to select the desired heading mode: Auto or True. Press **ENT** to accept the selection.

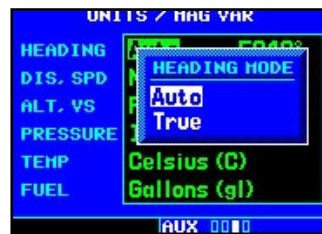

To change the units of measure:

1. Select "Units / Mag Var" from the Setup 1 page.
2. Turn the **large right** knob to highlight the desired units of measure category. The following categories, and corresponding units of measure, are available:



- **DIS, SPD**—distance and speed in Nautical (nautical miles/knots), Statute (miles/miles per hour) or Metric (kilometers/kilometers per hour) terms.
 - **ALT, VS**—altitude and vertical speed in Feet/feet per minute, Meters/meters per minute, or Meters/meters per second.
 - **PRESSURE**—barometric setting in Inches or Millibars.
 - **TEMP**—temperature in degrees Celsius or Fahrenheit.
 - **FUEL**—fuel units in Gallons, Imperial Gallons, Kilograms, Liters or Pounds.
3. Turn the **small right** knob to select the desired units of measure for the selected category. Press **ENT** to accept the selection.

Position Format**To change the position format:**

1. Select "Position Format / Map Datum" from the Setup 1 page.



2. The flashing cursor is on the position format field. Turn the **small right** knob to select the desired position format. The following position formats are available:



- **hddd°mm.mmm'**—latitude and longitude in degrees and decimal minutes
 - **hddd°mm'ss.s"**—latitude and longitude in degrees, minutes and decimal seconds
 - **MGRS**—Military Grid Reference System
 - **UTM/UPS**—Universal Transverse Mercator / Universal Polar Stereographic grids
3. Press **ENT** to accept the selected format.

Map Datum



NOTE: Per TSO C146a, the WGS-84 map datum is used.

Date / Time

To display local time or UTC:

1. Select "Date / Time" from the Setup 1 page.
2. The flashing cursor highlights the time format field. Turn the **small right** knob to display a window of available time formats: Local 12hr, Local 24hr, or UTC.



3. Continue turning the **small right** knob to select the desired time format.
4. Press **ENT** to accept the selection.

To set the local time:

1. Select "Date / Time" from the Setup 1 page.
2. Turn the **large right** knob to highlight the time offset field.



3. Use the **small** and **large right** knobs to enter the desired offset, beginning by entering a minus (-) or plus (+) sign to indicate whether the offset is behind UTC or ahead of UTC. (In

the United States, all local time offsets will use be minus, or behind UTC.)

4. Press **ENT** to accept the selected offset.

Restoring Factory Settings

When making changes to any *setup 1* page option, a "Restore Defaults?" menu selection allows you to restore the original factory settings (for the selected item only). For example, with the *airspace alarms* page displayed, the "Restore Defaults?" option will restore all *airspace alarms* page settings to the original factory values.

To restore a Setup 1 item to the original factory settings:

1. Select the desired item from the Setup 1 page.
2. Press **MENU** to display a page options window.



3. With "Restore Defaults?" highlighted, press **ENT**.

Setup 2 Page

To select, highlight with cursor and press ENT.



Fourth Page
in AUX group

The Setup 2 page provides access to display adjustments, parameters which define the nearest airport search, and COM transceiver channel spacing. When an item is selected, the corresponding page will appear providing access to the various unit settings.

To select an item from the Setup 2 page:

1. Press the **small right** knob momentarily, to activate the flashing cursor.



2. Turn the **large right** knob to select the desired setup item, and press **ENT**.



The following setup items are available:

Display— allows you to adjust the display for optimum viewing in any condition. Automatic back-lighting is available which uses a built-in photocell (at the top left corner of the display bezel) to make the proper display adjustments without any user intervention. Automatic contrast adjustment varies the screen contrast level based upon current unit temperature. You may also select manual control of the display contrast and backlighting to tailor the 400W-series unit display to your needs.



NOTE: Display backlighting changes are not saved when the 400W-series unit is turned off. Backlighting will revert to the "Auto" setting the next time the unit is turned on.

Nearest Airport Criteria— defines the minimum runway length and surface type used when determining the 25 nearest airports to display on the nearest airport page. A minimum runway length and/or surface type may be entered to prevent airports with small runways, or runways that are not of appropriate surface, from being displayed. The default settings are "0 feet (or meters)" for runway length and "any" for runway surface type.

SBAS Selection— selects the Space Based Augmentation System (SBAS) used for navigation and allows turning WAAS on and off.

COM Configuration— allows you to select 8.33 kHz or 25.0 kHz COM frequency channel spacing.



NOTE: 8.33 kHz VHF communication frequency channel spacing is not approved for use in the United States. Select the 25.0 kHz channel spacing option.

Display

To change the backlighting intensity:

1. Select "Display" from the Setup 2 page.



2. The flashing cursor highlights the backlight mode field. Turn the **small right** knob to select the desired mode: Auto or Manual. Press **ENT** to accept the selection.



3. If "Manual" is selected, the flashing cursor moves to the backlight level field. Turn the **small right** knob to select the desired level. Press **ENT** to accept the selection.

To change the display contrast:

1. Select "Display" from the Setup 2 page.
2. Turn the **large right** knob to highlight the contrast mode field.
3. Turn the **small right** knob to select the desired

mode: Auto or Manual. Press **ENT** to accept the selection.

4. If "Manual" is selected, the flashing cursor moves to the contrast level field. Turn the **small right** knob to select the desired level. Press **ENT** to accept the selection.



Nearest Airport Criteria

To set the minimum runway length and runway surface:

1. Select "Nearest Airport Criteria" from the Setup 2 page.
2. The flashing cursor highlights the runway surface field. Turn the **small right** knob to select the desired surface. The following options are available:
 - Any surface
 - Hard surfaces only
 - Hard / Soft surfaces
 - Water landings only



3. Press **ENT** to accept the runway surface selection.

- The flashing cursor moves to the minimum runway length field. To enter a different minimum runway length, use the **small** and **large right** knobs to enter the desired length. Press **ENT** when finished.



NOTE: Exercise caution when changing the Nearest Airport Criteria. Remember, by excluding certain surface types or shorter runway lengths, you may be excluding airports from the list that are more than adequate for an emergency landing!

SBAS Selection

To enable WAAS operation, in the Setup 2 page select the SBAS item and then select WAAS. If WAAS is disabled, the unit will not be able to fly vertically guided GPS approaches (LPV, LNAV/VNAV, or LNAV+V).

If WAAS was previously disabled, it may take several minutes to achieve a 3D-Diff fix after re-enabling WAAS.

- Select "SBAS Selection" from the Setup 2 Page and press **ENT**.



To enable WAAS operation, select the "SBAS Selection".

- The flashing cursor highlights the WAAS status selection. Turn the **small right** knob to allow On/Off selection.



Turn the small right knob to select On or Off and then press ENT.

- Turn the **small right** knob to select "On" or "Off" and then press **ENT**. Press the **small right** knob to exit WAAS selection.

COM Configuration

To set the COM channel spacing:

- Select "COM Configuration" and press ENT.
- Turn the **small right** knob to select "8.33 kHz" or "25.0 kHz" and press ENT.



Restoring Factory Settings

When making changes to any *Setup 2 page* item, a “Restore Defaults?” menu selection allows you to restore the original factory settings (for the selected option).

To restore a Setup 2 item to the original factory settings:

1. Select the desired item from the Setup 2 page.
2. Press **MENU** to display a page item window.
3. With “Restore Defaults?” highlighted, press **ENT**.

Section 10

Fault Detection & Exclusion

The Garmin 400W-series software incorporates a Fault Detection and Exclusion (FDE) algorithm, thus providing a basis for approval per FAA Notice N8110.60 requirements for “GPS as a Primary Means of Navigation for Oceanic/Remote Operations”.

The FDE consists of two distinct features, fault detection and fault exclusion. The fault detection feature detects the presence of an unacceptably large pseudorange error for a satellite (and presumably, position error) for a given mode of flight. Upon detection, fault exclusion follows and excludes the source of the unacceptably large pseudorange error, thereby allowing navigation to return to normal performance without an interruption in service. To enhance safety, FDE functionality is provided for other phases of flight (non-precision approach, terminal, en route). The FDE functionality for non-oceanic flight phases complies with missed alert probability, false alert probability and failed exclusion probability specified by DO-229C / TSO-C146a.

Detection and Exclusion

An FDE prediction must be performed prior to departure for a flight plan involving Oceanic/Remote operation where GPS is to be the sole source of navigation. Prior to departure, the operator must use the FDE prediction program supplied with the 400W/500W-series Trainer CD to demonstrate that there are no outages in the capability to navigate on the specified route of flight (the FDE prediction program determines whether the GPS constellation is robust enough to provide a navigation solution for the specified route of flight). Please, refer to the instructions included in the Garmin 400W/500W-series

Training CD for complete details on using the FDE prediction program.

Blank Page

Section 11

Messages, Abbreviations, and Navigation Terminology

Messages

The 400W-series unit uses a flashing “MSG” annunciator at the bottom of the screen (directly above the **MSG** key) to alert you of any important information or warnings. While most messages are advisory in nature, warning messages may require your intervention.

Whenever the “MSG” annunciator flashes, press the **MSG** key to display the message, when pilot workload allows. Press **MSG** again to return to the previous page.

The following is a list of available messages and their meanings:

ABORT APPROACH — Loss of Navigation — Execute missed approach using other navigation equipment.

Airport terrain database integrity error — The 400W-series unit has detected a problem with a database on the TAWS/Terrain data card. The message “<database name> database integrity error” indicates the data base in error. The data is not usable and the card should be returned to your Garmin dealer.

Airspace ahead — less than 10 minutes — Your GPS-calculated course is projected to enter a special use airspace within 10 minutes. This message is automatically disabled within 30 nautical miles of an arrival airport, when an approach is loaded.

Airspace near and ahead — Your GPS-calculated position is within 2 nautical miles of the boundary of a special use airspace and your course is projected to enter the airspace within 10 minutes. This message is automatically disabled within 30 nautical miles of an arrival airport, when an approach is loaded.

All data referenced to True North — the unit’s Heading mode has been set to “True” in the AUX Setup pages.

Approach downgraded — Use LNAV minima — This message will occur 60 seconds prior to the FAF if flying LNAV+V, L/VNAV, or LPV approaches and WAAS integrity parameters have fallen below minimal limits. As a result, vertical guidance has been discontinued and the LPV, LNAV+V, or L/VNAV approach you were flying has been downgraded.

Approach is not active — The approach could not transition to “active”, at 2 nautical miles or closer to the FAF. Verify that “SUSP” DOES NOT appear directly above the **OBS** key, indicating the auto waypoint sequencing is suspended.

Approaching target altitude — The current GPS-computed altitude is within 500 feet of the final Vertical Navigation target altitude.

Approaching VNAV profile — You are within one minute of reaching the initial Vertical Navigation descent point.

APR Guidance Available - Use PROC before A/P APR — For units configured with the KAP140 or KFC225 autopilot, this message reminds pilots, when they turn on course to the FAF, that they need to enable autopilot outputs (by pressing **PROC** and selecting “Enable A/P APR Outputs?”) before switching the autopilot control panel to APR.

Arrival at waypoint [waypoint name] — You are within the arrival alarm circle for the indicated waypoint. The size of the arrival alarm circle is defined from the “CDI / alarms” menu option on the Setup Page.

Aviation database integrity error — The 400W-series unit has detected a problem with a database on the NavData® card. The message “<database name> database integrity error” indicates the data base in error. The data is not usable and the card should be returned to Jeppesen or your Garmin dealer for service.

Bad geometry, parallel offset not activated — parallel offset is not activated because of flight plan geometry.

Basemap database integrity error — The 400W-series unit has detected a failure in the built-in basemap (land data) database. Land data does not appear on the Map Page. Other unit functions continue to work normally, however the 400W-series unit should be taken to your Garmin dealer for service at your earliest convenience.

Boot block verify failed - Return unit for repair — System integrity testing has determined that the boot block has become corrupted. Return the unit to your Garmin dealer for service.

Cannot navigate locked FPL — You have attempted to navigate a flight plan (FPL) with one or more locked waypoints. A waypoint can be “locked” when the NavData® card is replaced and the waypoint(s) does not exist in the new database.

Can't change an active waypoint — An attempt has been made to modify the position of the active “to” or “from” waypoint. The 400W-series unit does not allow modifications to user waypoints currently being utilized for navigation guidance.

Can't delete an active or FPL waypoint — An attempt has been made to delete the active “to” or “from” waypoint. The 400W-series unit does not allow you to delete user waypoints currently being utilized for navigation guidance.

CDI key stuck — The **CDI** key is stuck in the enabled (or “pressed”) state. Try pressing the **CDI** key again to cycle its operation. If the message persists, contact your Garmin dealer for assistance.

CDI key disabled — The installation has disabled the **CDI** key so that systems (such as an EFIS) connected to the 400 series unit will always have GPS deviation data on one output (main) and VLOC deviation data on the other output (Nav). See your installer for more information.

Check unit cooling — The 400W-series unit has detected excessive display backlighting temperature. The backlighting has been automatically dimmed to reduce the temperature. Check for adequate ventilation or check cooling airflow. Contact your Garmin dealer for assistance.

COM has failed — (GNS 430W/GNC 420W only) A failure has been detected in the communications transceiver. The COM transceiver is not available and the unit should be returned to your Garmin dealer for service.

COM is not responding — (GNS 430W/GNC 420W only) Internal system-to-system communication between the main processor and the COM transceiver has failed. Operational status of the COM transceiver is unknown and the unit should be returned to your Garmin dealer for service. If the Com board is still working, it will automatically tune to 121.500 MHz. Transmit and receive functions may still operate regardless of the displayed frequency.

COM needs service — (GNS 430W/GNC 420W only) A failure in the communications transceiver has been detected. The COM transceiver may still be usable, but the unit should be returned (at your earliest convenience) to your Garmin dealer for service.

COM push-to-talk key stuck — (GNS 430W/GNC 420W only) The external push-to-talk (PTT) switch is stuck in the enabled (or “pressed”) state. Try pressing the PTT switch again to cycle its operation. If the message persists, contact your Garmin dealer for assistance.

COM remote transfer key is stuck — (GNS 430W/GNC 420W only) The remote COM transfer switch is stuck in the enabled (or “pressed”) state. Try pressing the switch again to cycle its operation. If the message persists, contact your Garmin dealer for assistance.

COM transfer key stuck — (GNS 430W/GNC 420W only) The **COM flip-flop** key is stuck in the enabled (or “pressed”) state. Try pressing the **COM flip-flop** key again to cycle its operation. If the message persists, contact your Garmin dealer for assistance.

COM transmitter power has been reduced — (GNS 430W/GNC 420W only) Excessive unit temperature and/or an insufficient voltage level has been detected. The COM transceiver transmit power has been automatically reduced to compensate for the condition. For excessive temperatures, check for adequate ventilation or check cooling air flow. If the message persists, contact your Garmin dealer for assistance.

Configuration error - Config service req'd — The configuration information provided by the installer has been lost or corrupted. Contact your Garmin dealer for service.

Data transfer cancelled (crossfill is busy) — An attempt to transfer flight plan data during a unit-to-unit crossfill was cancelled. The host unit is busy. Wait until any previous crossfill operation is complete, before re-attempting the transfer.

Data transfer cancelled (data invalid) — An attempt to transfer a single user waypoint during a unit-to-unit crossfill was cancelled. No waypoint was specified on the Crossfill Page. Select a user waypoint and re-attempt the transfer.

Data transfer cancelled (version mismatch) — An attempt to transfer data during a unit-to-unit crossfill was cancelled. The database versions of the two 400W-series unit are not identical. If necessary, update the database(s) so they match. Contact Jeppesen or your Garmin dealer for assistance.

Data transfer error, please re-transmit — An error was detected during unit-to-unit crossfill of user data (user waypoints and/or flight plans). The data transfer should be re-attempted.

Data transfer is complete — The unit-to-unit crossfill of all user waypoint data has finished.

Database changed, validate user modified procedures — You have modified one or more approaches, departures or arrivals from their original published form. When the NavData® card is replaced (database update), you must manually verify your changes in the new database. This message occurs each time a flight plan containing a modified procedure (generated from a prior database version) is activated. To eliminate the message, re-create the flight plan from the new database, then make the desired modifications.

Display backlight failure — The 400W-series unit has detected a failure in the display backlighting. The unit should be taken to your Garmin dealer for service.

Do not use for navigation — The 400W-series unit is in Demo Mode and must not be used for actual navigation.

FPL has been truncated — The flight plan (FPL) was truncated because not enough room existed to insert an approach, departure or arrival. This may occur upon power up when a database change increases the number of waypoints within an instrument procedure.

FPL is full — remove unnecessary waypoints — An attempt has been made to add more than 31 waypoints to a flight plan (FPL). The 400W-series unit does not allow more than 31 waypoints per flight plan.

FPL leg will not be smoothed — The upcoming flight plan (FPL) leg is too short for smooth waypoint transitions. Expect a rapid change in the CDI.

FPL waypoint is locked — At least one flight plan (FPL) waypoint is locked because the waypoint has been removed from the current NavData® card (database change), the data card is missing, or the data card has failed.

FPL waypoint moved — The position data for one or more flight plan (FPL) waypoints moved at least 0.33 arc minutes in the current NavData® card (database change).

G/S has failed — (GNS 430W only) A failure in the glideslope receiver has been detected. The glideslope receiver is not available and the unit should be returned to your Garmin dealer for service.

G/S is not responding — (GNS 430W only) Internal system-to-system communication between the main processor and the glideslope receiver has failed. Operational status of the glideslope receiver is unknown and the unit should be returned to your Garmin dealer for service.

G/S needs service — (GNS 430W only) A failure in the glideslope receiver has been detected. The glideslope receiver may still be usable, but the unit should be returned (at your earliest convenience) to your Garmin dealer for service.

GAD configuration required — The GAD 42 Interface Adapter has lost the configuration information stored in its internal memory. Any mechanical indicators connected to your 400W-series unit are unusable and the GAD 42 should be returned to your Garmin dealer for service.

GAD needs service — The 400W-series unit has detected a failure in the GAD 42 interface adapter. Any mechanical indicators connected to your 400W-series unit are unusable and the GAD 42 should be returned to your Garmin dealer for service.

GDL 69 is not responding — No data is being received from the GDL 69. If the problem persists, contact your Garmin dealer for service.

GPS is not responding — Internal system-to-system communication between the main processor and the GPS receiver has failed. Operational status of the GPS receiver is unknown and the unit should be returned to your Garmin dealer for service.

GPS needs service — The 400W-series unit has detected a failure in its GPS receiver. The GPS receiver may still be usable, but the unit should be returned (at your earliest convenience) to your Garmin dealer for service.

Inside airspace — Your GPS-calculated position lies within the boundaries of a special use airspace. This message is automatically disabled within 30 nautical miles of an arrival airport, when an approach is loaded.

Invalid closest pt of FPL — A closest point cannot be created from the waypoint entered on the “Closest point of flight plan” window. This occurs when the selected waypoint is beyond the limits of all legs in the flight plan, too far away, or when a unique waypoint name for the closest point cannot be created.

Invalid FPL modification — An attempt was made to modify the final course segment (FAF to MAP) of an instrument approach. The 400W-series unit does not allow the modifications.

Invalid waypoint ident — An attempt was made to create a user waypoint with an invalid name. The 400W-series unit does not allow spaces between characters in the waypoint name.

Large magnetic variance — Verify all course angles — A valid value of magnetic variation is not available for this location. Check all course angles manually.

Loss of GPS Navigation - Use other NAV if available — The Dead Reckoning annunciator appears on the left side of the map display when GPS position is unavailable and the unit is in Dead Reckoning mode. Dead Reckoning mode will continue until GPS position is restored. If there is no flight plan, the message will only state “Loss of GPS Navigation.”

Low Battery - Unit Needs Service — Time data may have been lost due to a memory battery failure.

MAIN processor requires service — The 400W-series unit has detected a failure in the main system processor. The 400W-series unit is not usable and should be taken to your Garmin dealer for service.

Near airspace — less than 2 NM — Your GPS-calculated position is within 2 nautical miles of a special use airspace boundary, but you are not projected to enter the airspace. This message is automatically disabled within 30 nautical miles of an arrival airport, when an approach is loaded.

No altitude input is being received — No altitude data is being received from RS-232 (Serializer: Icarus, Rosetta or Shadin) or grey code inputs. If the problem persists, contact your Garmin dealer and check the installation and installation settings.

No basemap data available — The 400W-series unit has detected a failure in the built-in basemap (land data) memory. Land data does not appear on the Map Page. Other unit functions continue to work normally, however the 400W-series unit should be taken to your Garmin dealer for service at your earliest convenience.

Non-WGS84 wpt navigation — The active “to” and/or “from” waypoints are based upon a map datum other than WGS 84 and cannot be converted from that map datum to WGS 84. Expect some error in the position of the waypoint(s) and cross-check with an alternate means of navigation.

Not receiving input data on 429 Channel #1 or #2 — No data has been received on the ARINC 429 channel #1 connection for a period exceeding five seconds. If the problem persists, the installation should be checked by your Garmin dealer.

Not receiving input data on 232 Channel #(1 through 5) — No data has been received on one (or more) of the RS-232 channel connections for a period exceeding ten seconds. If the problem persists, the installation should be checked by your Garmin dealer.

Not receiving traffic data — No traffic data is being received. If the problem persists, the installation should be checked by your Garmin dealer.

OBS key stuck — The **OBS** key is stuck in the enabled (or pressed) state. Try pressing the **OBS** key again to cycle its operation. If the message persists, contact your Garmin dealer for assistance.

OBS not available — The **OBS** mode could not be activated, because 1) no destination waypoint has been selected, or 2) the GPS receiver cannot currently determine its position.

Poor GPS coverage — The GPS receiver cannot acquire a sufficient number of satellites to compute a position and provide navigation.

RAIM position warning — Although sufficient GPS satellite coverage may exist, Receiver Autonomous Integrity Monitoring (RAIM) has determined the information from one or more GPS satellites may be in error. The resulting GPS position may be in error beyond the limits allowed for your current phase of flight. Cross-check your position with an alternate navigation source. If the warning occurs during a final approach segment (FAF to MAP), execute the published missed approach.

Scheduler message [1-9] — [user entered text] — The user-entered scheduler message time has expired, and the scheduler message is displayed.

Searching the sky — The 400W-series unit is searching the sky for GPS satellites.

Select appropriate frequency for approach — You are inbound and within 3 nautical miles of the FAF; and the active VLOC frequency does not match the published frequency for the approach. Tune the standby VLOC frequency to the proper frequency and press the **VLOC flip-flop** key to “activate” the frequency.

Select VLOC on CDI for approach — (GNS 430W only) You are inbound and within 3 nautical miles of the FAF; and the active approach is not a GPS-approved approach. Verify that the VLOC receiver is tuned to the proper frequency and press the **CDI** key to display “VLOC” (directly above the **CDI** key).

Set course to [###]° — The course select for the external CDI (or HSI) should be set to the specified course. The message only occurs when the current selected course is greater than 10° different from the desired track.

Steep turn ahead — This message appears approximately one minute prior to a turn in one of the following three conditions: 1) the turn requires a bank angle in excess of 25° in order to stay on course, 2) the turn requires a course change greater than 175°, or 3) during a DME arc approach the turn anticipation distance exceeds 90 seconds.

Stored data was lost — All user waypoints, flight plans and system settings have been lost due to a memory battery failure or system reset.

Stormscope device has failed — The 400W-series unit cannot communicate with the WX-500 and/or the WX-500 is reporting a system failure.

Stormscope heading has failed — The WX 500 is reporting invalid heading data. The failure may be within the WX 500 or other connected equipment.

TERRAIN configuration has changed — The unit's terrain settings have changed since it was last turned on in normal mode. Contact your Garmin dealer for service.

TERRAIN has failed — The unit has detected a failure in the terrain system. The most likely cause is a missing or corrupt Terrain database. Terrain functionality is not available. If the Terrain database is not the cause, the unit should be returned to your Garmin dealer for service.

Timer has expired — The count down timer has reached zero.

Traffic device has failed — The 400W-series unit cannot communicate with the SKY497 or TCAD and/or the SKY497 or TCAD is reporting a system failure.

Traffic device needs service — the traffic device is reporting a system failure. The unit may still be usable, but should be returned (at your earliest convenience) to your Garmin dealer for service.

True north approach - Change Mag Var HDG to true — The selected approach requires navigation information be referenced to true north. In the AUX function, change Heading Mode to “true.”

User card format unknown — A data card has been inserted, but the format of the card is not recognized.

VLOC has failed — The GNS 430W has detected a failure in its VLOC receiver. The VLOC receiver is not available and the unit should be returned to your Garmin dealer for service.

VLOC is not responding — (GNS 430W only) Internal system-to-system communication between the main processor and the VLOC receiver has failed. Operational status of the VLOC receiver is unknown and the unit should be returned to your Garmin dealer for service.

VLOC needs service — (GNS 430W only) A failure in the VLOC receiver has been detected. The VLOC receiver may still be usable, but the unit should be returned (at your earliest convenience) to your Garmin dealer for service.

VLOC remote transfer key is stuck — (GNS 430W only) The remote VLOC transfer switch is stuck in the enabled (or “pressed”) state. Try pressing the switch again to cycle its operation. If the message persists, contact your Garmin dealer for assistance.

VLOC transfer key stuck — (GNS 430W only) The **VLOC flip-flop** key is stuck in the enabled (or “pressed”) state. Try pressing the **VLOC flip-flop** key again to cycle its operation. If the message persists, contact your Garmin dealer for assistance.

Waypoint already exists — The name you have entered for a user waypoint already exists in memory.

Waypoint(s) have been replaced — One or more user waypoints were updated during a unit-to-unit crossfill operation.

Waypoint memory is full — You have used all 1000 user waypoint locations in the 400W-series unit memory. Delete unwanted waypoints to make room for new entries.

Turn Advisory and Arrival Annunciations

The following annunciator messages may appear in the lower right corner of the 400W-series unit display:

ARRIVING WPT — Arriving at the destination waypoint for the active leg (waypoint alert).

DTK xxx° xx S — Waypoint alert. Prepare to turn to the indicated heading upon waypoint passage.

HOLD DIRECT — “Direct” holding pattern entry.

HOLD PARALLEL — “Parallel” holding pattern entry.

HOLD TEARDROP — “Teardrop” holding pattern entry.

LT TO xxx° xx S — Turn advisory. Turn to the indicated heading by the time shown.

LT TO xxx° NOW — Turn advisory. Turn to the indicated heading now.

PTK END xx S — Parallel Offset is terminating by the time shown.

RT TO xxx° xx S — Turn advisory. Turn to the indicated heading by the time shown.

RT TO xxx° NOW — Turn advisory. Turn to the indicated heading now.

11 - MESSAGES ABBREVIATIONS & NAV TERMS

Abbreviations

The following is a list of abbreviations used on the 400W-series unit and their meanings:

ACTV— Active

ALT— Altitude

APR— Approach

APT— Airport

ARSPC— Airspace

ARTCC— Air Route Traffic Control Center

ARVL— Arrival

AUX— Auxiliary

AVGAS— Aviation-grade Gasoline

AVTN— Aviation

BARO— Barometric setting

BRG— Bearing To

°C— Degree Celsius

C/V— COM/VLOC

CAS— Calibrated Airspeed

CDI— Course Deviation Indicator

CLR— Clear

COM— Communications Transceiver

CRSR— Cursor

CTA— ICAO Control Area

CTAF— Common Traffic Advisory Frequency

CTR— Center (see ARTCC)

CUM— Cumulative

DB— Database

DEN— Density

DEP— Departure

DEPT— Departure guidance

DIS— Distance

DME— Distance Measuring Equipment

DTK— Desired Track

EFF— Efficiency

ELEV— Elevation

ENDUR— Endurance

ENR— En Route

ENT— Enter

EPU— Estimated Position Uncertainty

ESA— En Route Safe Altitude

ETA— Estimated Time of Arrival

ETE— Estimated Time En Route

°F— Degrees Fahrenheit

FAF— Final Approach Fix

FF— Fuel Flow

FIR— Flight Information Region

FLTA— Forward Looking Terrain Avoidance

FOB— Fuel On Board

FPL— Flight Plan

fpm— Feet Per Minute

FREQ— Frequency

FSS— Flight Service Station

ft— Feet

G/S —	Glideslope	lb —	Pounds
gal —	gallons	LCL —	Local
GPS —	Global Positioning System	LFOB —	Left-over Fuel On Board
GS —	Ground Speed	LNAV —	Lateral Navigation only
HAL —	Horizontal Alarm Limit	LNAV+V —	Lateral Navigation with advisory vertical guidance
HDG —	Heading	LOC —	Localizer
HFOM —	Horizontal Figure of Merit	LPV —	Lateral Precision Performance with Vertical Guidance
hg —	Inches of Mercury	LRES —	Left-over Fuel Reserve Time
HPL —	Horizontal Protection Level	Lrg —	Large
HWY —	Highway	lt —	Liters
IAF —	Intermediate Approach Fix	°M —	Degrees Magnetic
ID —	Identifier	m —	Meters
ig —	Imperial Gallons	MAP —	Missed Approach Point
ILS —	Instrument Landing System	MAHP —	Missed Approach Hold Point
IND —	Indicated	MAPR —	Missed Approach guidance
INT —	Intersection	mb —	Millibars of Pressure
INTEG —	Integrity	Med —	Medium
ITI —	Imminent Terrain Impact	MGRS —	Military Grid Reference System
kg —	Kilograms	MHz —	Megahertz
kHz —	Kilohertz	mi —	Statute Miles
km —	Kilometers	MOA —	Military Operations Area
kph —	Kilometers Per Hour	mph —	Statute Miles Per Hour
kt —	Knots	mpm —	Meters Per Minute
L/VNAV —	Lateral and vertical navigation guidance, LNAV/VNAV service level	mps —	Meters Per Second
LAT/LON —	Latitude/Longitude	MSA —	Minimum Safe Altitude
		MSG —	Message
		MSL —	Mean Sea Level
		mul —	Multicom

11 - MESSAGES ABBREVIATIONS & NAV TERMS

NATNL — National	SPD — Speed
NAV — Navigation	SQ — Squelch
NAVAID — Navigational Aid	SRFC — Surface
NDB — Non-Directional Radio Beacon	STAR — Standard Terminal Arrival Route
NM — Nautical Miles	SUA — Special Use Airspace
NRST — Nearest	SUSP — Waypoint sequencing suspended
NUM — Number	
	°T — Degree True
OBS — Omnibearing Selector	TACAN — Tactical Air Navigation
OCN — Oceanic	TAS — True Airspeed
	TAT — Total Air Temperature
PDA — Premature Descent Alert	TEMP — Temperature
P.POS — Present Position	TER — Terrain
PROC — Procedure(s)	TERM — Terminal
PROV — Province	TKE — Track Angle Error
PTK — Parallel Track	TMA — ICAO Terminal Control Area
PWR — Power	TRANS —Transition
	TRFC — Traffic
RAD — Radial	TRK — Track (also Ground Track) Angle
RAIM — Receiver Autonomous Integrity Monitoring	TRSA — Terminal Radar Service Area
REF — Reference	twr — Tower
REQ — Required / Requirements	TX — Transmit
RESTRICTD — Restricted	
RNG — Range	uni — Unicom
RTC — Required Terrain Clearance	UTC — Coordinated Universal Time (also GMT or “zulu”)
RX — Receive	UTM/UPS —Universal Transverse Mercator / Universal Polar Stereographic grids
SBAS — Space-Based Augmentation System	VAL — Vertical Alarm Limit
SID — Standard Instrument Departure	VAR — Variation
Sml — Small	VER — Version

VFOM— Vertical Figure of Merit
VFR— Visual Flight Rules
VLOC— VOR/Localizer Receiver
VNAV— Vertical Navigation
VOL— Volume
VOR— VHF Omnidirectional Radio Range
VPL— Vertical Protection Level
VS— Vertical Speed
VSR— Vertical Speed Required

WAAS— Wide Area Augmentation System
WPT— Waypoint
WX— Weather

XTK— Crosstrack Error

Navigation Terms

The following navigation terms are used on the 400W-series and in this Pilot's Guide:

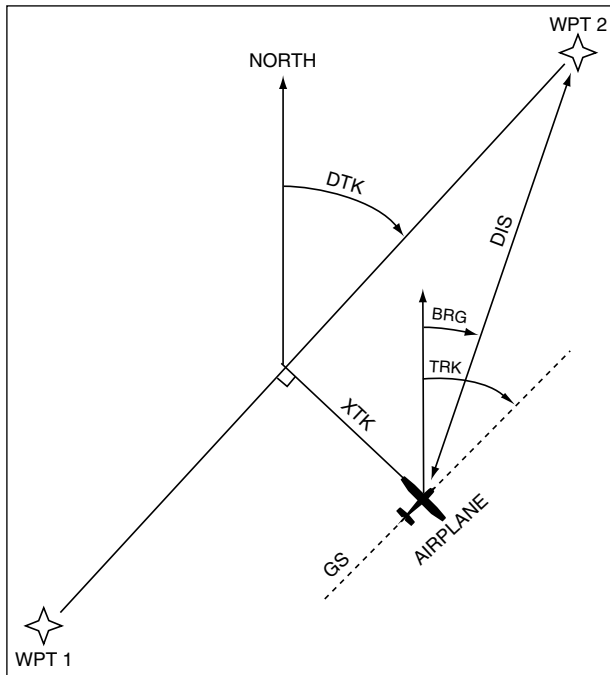

ALT (altitude)— Height above mean sea level (MSL).

BRG (bearing)— The compass direction from your present position to a destination waypoint.

CAS (calibrated airspeed)— Indicated airspeed corrected for instrument errors.

CUM (cumulative)— The total of all legs in a flight plan (such as “cumulative distance”).

DIS (distance)— The geodesic path from your present position to a destination waypoint.

DTK (desired track)— The desired course between the active “from” and “to” waypoints.

EFF (efficiency)— A measure of fuel consumption, expressed in distance per fuel units (e.g., nautical

miles per gallon).

ENDUR (endurance)— Flight endurance, or total available flight time based upon available fuel.

EPU (estimated position uncertainty)— A measure of satellite geometry quality and additional factors, expressed as a horizontal position error in feet or meters.

ESA (en route safe altitude)— The recommended minimum altitude within ten miles, left or right, of your desired course on an active flight plan or direct-to.

ETA (estimate time of arrival)— The estimated time at which you will reach your destination waypoint, based upon current speed and track.

ETE (estimated time en route)— The time it will take to reach the destination waypoint, from present position, based upon current ground speed.

FF (fuel flow)— The fuel flow rate, expressed in fuel units per time (e.g., gallons per hour).

FOB (fuel on board)— The total amount of usable fuel on board the aircraft.

Geodesic — an arc path that follows the shortest distance along an ellipsoid model of the earth (WGS-84). A geodesic is more accurate than a “great circle” which assumes a perfect sphere model of the earth.

GS (ground speed)— The velocity you are travelling relative to a ground position.

HDG (heading)— The direction an aircraft is pointed, based upon indications from a magnetic compass or a properly set directional gyro.

IND (indicated)— Information provided by properly calibrated and set instrumentation in the aircraft panel (e.g., “indicated altitude”).

LFOB (left-over fuel onboard)— The amount of fuel remaining on board after the completion of one or more legs of a flight plan (or a direct-to).

LRES (left-over fuel reserve)— The amount of fuel remaining on board after the completion of a one or more legs of a flight plan (or a direct-to), expressed in time and based upon a known fuel consumption (flow) rate.

MSA (minimum safe altitude)— Uses Grid Minimum Off-route Altitudes (Grid MORAs) to determine a safe altitude within ten miles of your present position. Grid MORAs are one degree latitude by one degree longitude in size and clear all reference points within the grid by 1000 feet in areas where the highest reference point is 5000 feet MSL or lower. If the highest reference point is above 5000 feet, the Grid MORA will clear the highest reference point by 2000 feet.

TKE (track angle error)— The angle difference between the desired track and your current track. An arrow indicates the proper direction to turn to reduce TKE to zero.

TRK (track)— The direction of movement relative to a ground position. Also referred to as “ground track”.

VSR (vertical speed required)— The vertical speed necessary to descend from current position and altitude to a defined target position and altitude, based upon your current ground speed.

XTK (crosstrack error)— The distance you are off a desired course in either direction, left or right.

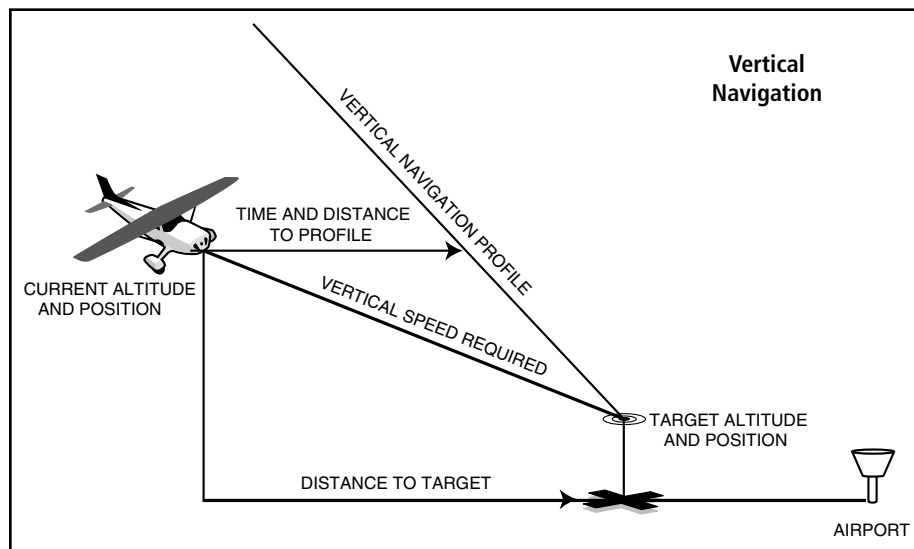

Appendix A NavData Card Use

The Jeppesen NavData® card supplied with your 400W-series unit can be installed or removed when the 400W-series unit is off. Insert the card with the swing arm handle at the bottom and the label facing to the left (see illustration right). If the NavData card is not present when the unit is turned on, you will receive a “No Jeppesen Aviation Database - Limited to user defined waypoints” message on the *database confirmation page*. If the NavData card is removed during operation, a “Data card removed-Unit will restart in 30 seconds” warning. The 400W-series unit will automatically reinitialize even if the card is reinserted. You may also reinitialize the unit manually by pressing **ENT**.

To insert the NavData card:

1. Place the card into the NavData card slot, with the label facing to the left and the swing arm handle at the bottom front.



NOTE: There are two data card slots on the face of the 400W-series. The Jeppesen NavData® card should be inserted in the left-most slot. The second slot is provided for the terrain card.

2. Press the NavData card into place until it seats on the internal connector and the front of the card is flush with the face of the 400W-series unit.
3. If the swing arm handle is up, gently lower the handle and push it into place—flush with the face of the 400W-series unit.

To remove the NavData card:

1. Gently press on the tab—using a slight upward motion—at the front center of the NavData card. This will partially deploy the swing arm handle.
2. Turn the swing arm handle upward (and outward) until it locks into place, perpendicular to the face of the 400W-series unit.
3. Grasp the top and bottom surfaces of the swing arm handle, between your thumb and forefinger, and pull directly away from the face of the 400W-series unit to unseat the connector and remove the NavData card.

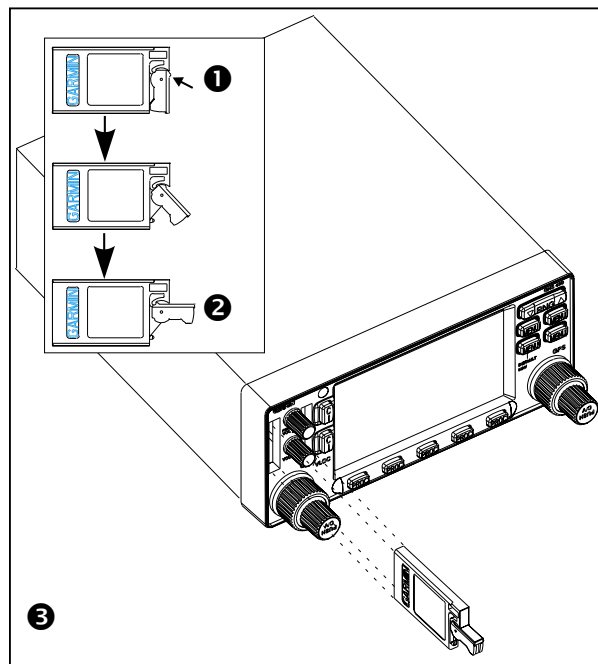

Appendix B Specifications

PHYSICAL

Unit Size: 6.25"W x 11.00"D x 2.69"H
(159 mm x 279 mm x 68 mm)

Unit Weight with tray:

400W	5.0 lbs (2.27 kg)
420W/420AW	5.5 lbs (2.49 kg)
430W/430AW	6.2 lbs (2.61 kg)

POWER

Input:	400W/420W/430W	14/28 Vdc
	420AW/430AW	28 Vdc

ENVIRONMENTAL

Temperature: -20°C to +55°C (operating range)
(-4°F to +131°F)

Humidity: 95% non-condensing

Altitude: -1,500 ft to 50,000 ft
(-457 m to 15,240 m)

GPS PERFORMANCE

Receiver: 15 parallel channel (12 + 3 WAAS)

Time to First Fix: 1 min 45 sec

Update Rate: Five per second, continuous

Accuracy: Position — < 1.25 m RMS horizontal
< 2 m vertical, with WAAS

Dynamics: 1000 kt maximum velocity

VHF COM PERFORMANCE (GNS 430W only)

Channels: 760 (25 kHz spacing) or
2280 (8.33 kHz spacing)

Frequency Range: 118.000 MHz to
136.992 MHz

Transmit Power: 10 watts minimum
(GNS 430W/GNC 420W)
16 watts minimum
(GNS 430AW/GNC 420AW)

VOR PERFORMANCE (GNS 430W/AW only)

Frequency Range: 108.00 MHz to
117.95 MHz

LOCALIZER PERFORMANCE

(GNS 430W/AW only)

Frequency Range: 108.10 MHz to
111.95 MHz

GLIDESLOPE PERFORMANCE

(GNS 430W/430AW only)

Frequency Range: 329.15 MHz to 335.00 MHz

INTERFACES

- Garmin GDL 69/69A
- ARINC 429
- Aviation RS-232
- CDI/HSI
- RMI (digital: clock/data)
- Superflag Out
- Altitude (serial: Icarus, Shadin-Rosetta or encoded: Gillham/Greycode)
- Fuel Sensor
- Fuel/Air Data
- L3 WX 500 Stormscope
- L3 SKY497 SkyWatch
- TIS from GTX 330
- Ryan 9900B TCAD

Appendix C Troubleshooting Q&A

This section is designed to answer some of the common questions regarding the 400W-series capabilities and operation. If you have a problem operating the unit, read through this appendix and refer to the reference section noted. If you don't find answers to your particular question here, use the index to find the appropriate section elsewhere in this manual. If, after reading through the appropriate reference section, you still haven't found the answer to your question, please see your authorized dealer or contact GARMIN directly at the address or phone numbers listed on page ii. GARMIN is dedicated to supporting its products and customers.

What is RAIM, and how does it affect approach operations?

RAIM is an acronym for Receiver Autonomous Integrity Monitoring, a GPS receiver function that performs a consistency check on all tracked satellites. RAIM ensures that the available satellite geometry will allow the receiver to calculate a position within a specified protection limit (4 NM for oceanic, 2 NM for en route, 1 NM for terminal and 0.3 NM for non-precision approaches).

During oceanic, en route and terminal phases of flight, RAIM will be available nearly 100% of the time. Because of the tighter protection limit on approaches, there may be times when RAIM is not available. The 400W-series unit automatically monitors RAIM and will warn you with an alert message (see Section 11) when it is not available, and the INTEG annunciator (**INTEG**) will appear at the bottom left corner of the screen. If RAIM is not available when crossing the FAF, the pilot must fly the missed approach procedure. The 400W-series unit RAIM prediction function will also allow you to see whether RAIM will be available for a specified date and time.



NOTE: RAIM prediction is not directly related to WAAS integrity.

RAIM integrity prediction is performed by the internal GPS receiver and is performed at all times. WAAS integrity is reported by the WAAS satellite system and only works within the WAAS service volume. WAAS approaches require WAAS integrity. Outside of the WAAS service volume, such as an Oceanic flight, RAIM prediction will be used.

Why aren't there any approaches available for my flight plan?

Approaches are available for the final destination airport in a flight plan or as a direct-to (keep in mind that some VOR/VORTAC identifiers are similar to airport identifiers). If a destination airport does not have a GPS approach, the 400W-series unit will indicate "NONE" for the available procedures—as listed on the *airport approach page*. For more information on selecting an approach, see Section 5 - Procedures.



What happens when I select an approach? Can I store a flight plan with an approach, departure or arrival?

Whenever you load an approach, departure or arrival into the active flight plan, a set of approach, departure or arrival waypoints is inserted into the flight plan—along with a header line describing the instrument procedure you selected. The original en route portion of the flight plan will remain active, unless you “Activate” the instrument procedure; which may be done when the procedure is loaded or at a later time.

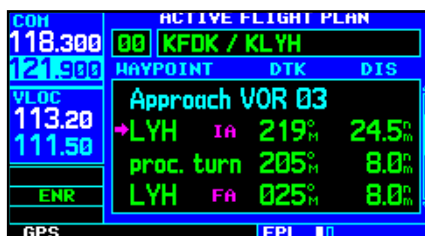

Flight plans can also be stored with an approach, departure or arrival. Keep in mind that the active flight plan is erased when the unit is turned off and overwritten when another flight plan is activated. When storing flight plans with an approach, departure or arrival, the 400W-series unit will use the waypoint information from the current database to define the waypoints. If the database is changed or updated, the 400W-series unit will automatically update the information if the procedure has not been modified. If an approach, departure or arrival procedure is no longer available, the flight plan will become locked until the procedure is deleted from the flight plan or the correct database is installed. For information on loading an approach, departure or arrival. See Section 4 - Flight Plans for instructions on saving and copying flight plans.

Can I file slant Golf (“/G”) using my GPS?

Yes, you may file your flight plan as /G if your 400W-series unit is an authorized IFR installation. The 400W series is a TSO C146a Gamma-3 (Class 3) authorized GPS navigator. If you are flying en route, you may file /G with an expired database only after you have verified all route waypoints. Approaches may not be flown with an expired database. See your approved Airplane Flight Manual Supplement for more information.

What does the OBS key do and when do I use it?

The OBS key is used to select manual (OBS mode) or to suspend automatic sequencing of waypoints. Activating OBS mode (as indicated by an **OBS** annunciation directly above the OBS key) holds your current “active to” waypoint as your navigation reference and prevents the GPS from sequencing to the next waypoint. When OBS mode is cancelled, automatic waypoint sequencing is selected, and the 400W-series unit will automatically select the next waypoint in the flight plan once the aircraft has crossed the present active-to waypoint.

NORMAL (no “OBS” annunciator)	OBS
Automatic sequencing of waypoints	Manual sequencing- “holds” on selected waypoint
Change in HSI does not affect CDI deflection	Manually select course to next waypoint from HSI
Always navigates “TO” the active waypoint	Will indicate “TO” or “FROM” waypoint
Must be in this mode for final approach course	Cannot be set for final approach course or published holding patterns

Whenever OBS mode is active, the 400W-series unit allows you to select the desired course to/from a waypoint using the HSI (much like a VOR) and display a to/from

flag for the active-to waypoint. If an external course input is not available, you may select the OBS course on-screen, via a “Select OBS Course” pop-up window. With OBS mode cancelled, the CDI will always display a “TO” indication for the next waypoint once you’ve crossed the active waypoint (provided the active waypoint is not the last waypoint). Refer to *Section 5 - Flying the Missed Approach* for an example using the OBS key.



One application for the **OBS** key is holding patterns. The **OBS** key is used to suspend waypoint sequencing and select the desired course along the waypoint side of the hold. For many approach operations, setting and resetting of waypoint sequencing is automatic. Holding patterns that are part of an approach will automatically disable waypoint sequencing, then re-enable waypoint sequencing after one time around the holding pattern. A “SUSP” annunciation will appear directly above the **OBS** key (see illustration left) to indicate that automatic waypoint sequencing is temporarily suspended and course selection is not available. If more than one trip around the holding pattern is desired, press the **OBS** key to again suspend waypoint sequencing. An example of this operation is an approach which begins with a holding pattern at the initial approach fix (IAF). *Section 5 - Flying an Approach with a Hold* for more information on the “SUSP” annunciation and approaches with holding patterns.

When should I use the OBS key to return to auto sequencing, and what happens when I do?

The most common application for using the **OBS** key is the missed approach. The 400W-series unit will suspend automatic waypoint sequencing (indicated by a “SUSP” annunciation directly above the **OBS** key; see right) when you cross the missed approach point (MAP). This prevents the 400W-series unit from automatically sequencing to the missed approach holding point (MAHP). If a missed approach is required, press the **OBS** key to return to automatic waypoint sequencing and sequence the approach to the MAHP. See *Section 5 - Flying the Missed Approach* for more information on missed approaches.



Why won't my unit automatically sequence to the next waypoint?

The 400W-series unit will only sequence flight plan waypoints when automatic sequencing is enabled (i.e., no “OBS” or “SUSP” annunciation directly above the **OBS** key). For automatic sequencing to occur, you must also cross the “bisector” of the turn you are navigating. The bisector is a line that bisects the angle formed by two flight plan legs; it passes through the waypoint common to both legs.

How do I skip a waypoint in an approach, departure, or arrival?

The 400W-series unit allows you to manually select any approach, departure or arrival leg as the active leg of your flight plan. This procedure is performed from the *active flight plan page* by highlighting the desired waypoint and pressing **direct-to** twice, then **ENT** to approve the selection (see illustration right). The GPS will then provide navigation along the selected flight plan leg, so be sure you have clearance to that position.



NOTE: If activating a leg while on the *From side*, sequencing will be suspended as indicated with the **SUSP** annunciation shown above the **OBS** key.

How do I fly the GPS with an autopilot and DG heading bug?

If you do not have an HSI, you should make your course selections on the external CDI's **OBS** knob and the DG heading bug.

When does turn anticipation begin, and what bank angle is expected?

The 400W-series unit will smooth adjacent leg transitions based upon a nominal 15° bank angle (with the ability to increase the bank angle up to 30°) and provide three pilot cues for turn anticipation:

- 1) A waypoint alert (“LT or RT to ###° x S”) will flash in the lower right corner of the screen 10 seconds before the turn point.
- 2) A flashing turn advisory (“LT or RT TO ###° NOW”) will appear in the lower right corner of the screen

when you are to begin the turn. Set the HSI to the next DTK value and begin the turn.

- 3) The To/From indicator on the HSI (or CDI) will flip momentarily to indicate that you have crossed the midpoint of the turn. For more information on waypoint alerts and turn advisories, see section 5.

When does the CDI scale change, and what does it change to?

The 400W-series unit begins a smooth CDI scale transition from the 2.0 NM (en route mode) to the 1.0 NM (terminal mode) scale within 31 NM from the destination airport (see below). The CDI scale further transitions to 2.0° angular (approach mode) at 2 NM prior to the FAF during an active approach CDI scaling is tightened from 1.0 NM to the angular full scale deflection (typically the angular full-scale deflection is 2.0°, but will be as defined for the approach.

If you are in a missed approach situation and would like to return the CDI to the 1.0 NM scale, activate the missed approach sequence by pressing the **OBS** key after you pass the MAP and the annunciation in the lower left of the screen changes from MAPR to TERM, as described in Section 5 - Procedures - Flying the Missed Approach. For this to occur however, the course to the MAHP must be greater than 3° away from the course line to the runway. The CDI scale is also 1.0 NM (terminal mode) within 31 NM of the departure airport.

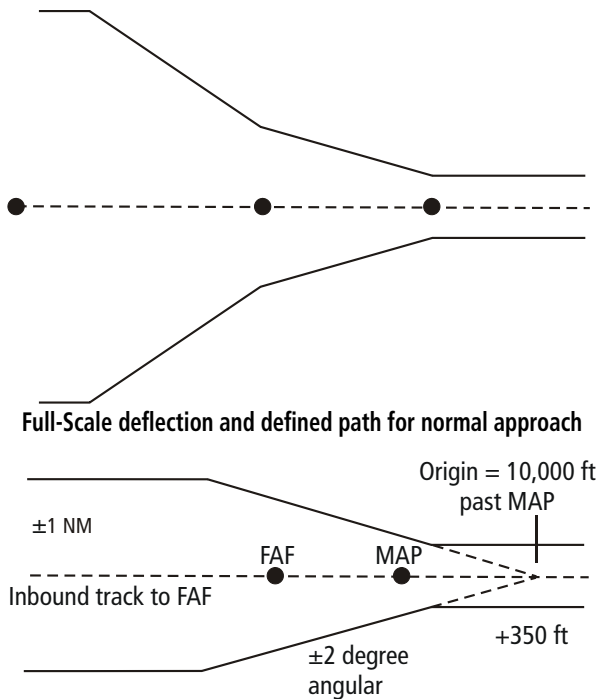

Full-Scale deflection and defined path for VTF approach

Sensitivity must change from ± 1 NM FSD to either ± 0.3 NM or $\pm 2^\circ$ FSD, whichever is less at the FAF. Change occurs over 2 NM and is completed at the FAF.

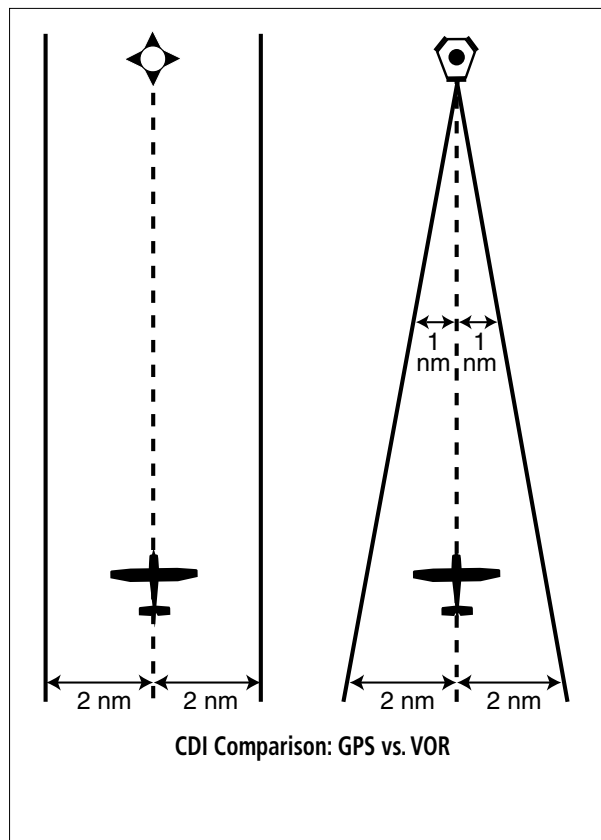

CDI Comparison: GPS vs. VOR

Why does my CDI not respond like a VOR when OBS mode is active?

Unlike a VOR, the CDI scale used on GPS equipment is based on the cross-track distance to the desired course, in OBS mode not an angular relationship to the destination. Therefore, the CDI deflection on the GPS will be constant regardless of the distance to the destination, and will not become less sensitive when you are further away from the destination.

What is the correct missed approach procedure? How do I select the missed approach holding point?

The 400W-series unit does not automatically sequence past the MAP. Waypoint sequencing to the first waypoint in the missed approach procedure will be enabled when the **OBS** key is pressed after crossing the MAP. All published missed approach procedures must be followed, as indicated on the approach plate.

To execute the missed approach procedure prior to the MAP (not recommended), select the active flight plan page and use the **direct-to** key (by pressing it twice) to activate the missed approach portion of the procedure.

How do I re-select the same approach or activate a new approach after a missed approach?

After flying all missed approach procedures, you may reactivate the same approach for another attempt from the *procedures page*. Once you have been given clearance for another attempt, activate the approach from the *procedures page* by highlighting “Activate Approach?” and then pressing **ENT**. The 400W-series unit will provide navigation along the desired course to the waypoint and rejoin the approach in sequence from that point on. See *Section 4 - Active Flight Plan Leg Selection* for information on activating a specific flight plan leg.

To activate a new approach for the same airport, select the new procedure from the *procedures page*. To view the *procedures page*, press **PROC** and turn the **large right** knob to highlight “Select Approach?”. Press **ENT** and turn the **large right** knob to highlight the new approach you want to fly. Press **ENT** to select the approach, then select the desired transition. Finally, highlight “Activate?” at the bottom right corner of the screen and press **ENT** to activate the new approach.

To activate a new approach to a different airport, press **direct-to** and select the desired airport using the **small** and **large right** knobs. Press **ENT** to accept the selected airport, then follow the steps in the preceding paragraph to select an approach for the new airport. See section 5 for more information on selecting and activating approaches.



NOTE: *Do not attempt to reactivate the same approach you’re currently on, prior to crossing the missed approach point (MAP). If you attempt to do so, an alert message (“Are you sure you want to discontinue the current approach?”) appears. If you still proceed with reactivating the approach, the 400W-series unit directs you back to the transition waypoint and does NOT take into consideration any missed approach procedures.*

Index

Symbols

3D navigation 8, 56

A

Abbreviations 116, 118, 119, 125, 126, 127, 177, 184

Accessories iii

Acquiring satellites 8, 55

Activate flight plan 22, 68

Active flight plan 21, 67, 70, 72, 76, 77, 79, 81, 121, 130, 151, 155, 156

Active leg 13, 30, 73, 77, 92, 97, 183, 195

Airport

Approach 113, 116, 120, 121, 192

Arrival 122

Departure 123

Frequency 118

Runway 117

Airspace 36, 140, 177, 181

Alarm 165, 167

Alert 20, 134, 141, 142, 143, 167

Frequencies 36

Alarms 165, 167

Alerts

Terrain 47

ALT 188

Altitude i, 14, 20, 31, 40, 41, 44, 46, 47, 52, 55, 56, 72, 87, 92, 95, 98, 100, 106, 109, 118, 119, 141, 143, 149, 150, 151, 154, 155, 165, 167, 169, 177, 181, 188, 191

Altitude buffer 143, 165, 167

Altitude input 100, 181

Annunciations 47, 59, 83, 120, 183

Approach 17, 45, 74, 78, 81, 177, 181, 192, 195

Activate 82

Airport 120

DME arc 93

Hold 89

ILS 102

LNAV/VNAV 83, 109

Localizer 110

LPV 83, 107

Procedure turn 85

VTF 82, 96

Approach Channel 122

ARINC 181, 191

Arrival 17, 51, 75, 78, 81, 122, 168, 177, 195

ARTCC 18, 26, 133, 134, 138, 139, 184

Auto-tuning 24, 25, 146

Automatic CDI switching 110

Automatic operation 155

Autopilot 94, 103, 110, 111, 195

Auto zoom 34, 38

Aux pages 149

Flight planning 150

Setup 1 164

Setup 2 171

Utility 158

Aviation data 42

B

Backcourse 107, 110

Backlight 171, 172, 178, 179

Bank angle 182, 195

Barometric pressure 151, 154, 169

Basemap 178, 181

Basic approach operation 83

C

Catalog 11, 21, 32, 67, 68, 156

Cautions i, 45, 48, 142

CDI 4, 61, 110, 148, 165, 167, 178, 194, 195

Ceiling 20, 36, 141, 142

Channel spacing 171, 172, 173

Checklists 7, 158, 159

City 37, 62, 125, 126

Clear 3

CLR 3

Com 2, 9, 178, 191

Configuration 172

Squelch 23

Tuning 24

Volume 23

Window 24

Comment 68, 72

Controlled airspace 20, 33, 36, 133, 134, 141

Count down timer 182
 Course from 98
 Course from fix to altitude 100
 Course from fix to distance 98
 Course from fix to DME distance 98
 Course from fix to manual sequence 101
 Create flight plan 21
 Creating user waypoints 127
 Cross-side 70, 156
 Crossfill 32, 70, 131, 151, 155, 179
 CRSR 3, 184
 CTAF 135, 136, 184
 Cursor 3

D

Database i, iii, 32, 41, 44, 45, 49, 82, 121, 156, 158, 190, 193
 Database version 44, 159, 164
 Data base integrity error 177, 178
 Data fields 13, 14, 30, 32, 34, 37, 40, 52, 72, 152
 Data transfer 155, 179
 Date 157, 162, 163, 166, 170
 Dead reckoning 59, 180
 Declutter 14, 34
 Default Nav page 13, 16, 30
 Density altitude 151, 154
 Departure 17, 46, 51, 75, 78, 81, 123, 195
 Departure time 154, 158, 161
 DG heading 195
 Direct-To 3, 16, 36, 61
 Cancelling 65
 Flight plan destination 63
 Manual course 65
 Nearest airport 63
 Shortcuts 64
 Display backlight 171, 172
 Distance measurements 39
 DME Arc 93
 Dual units 32
 Duplicate waypoint 115

E

E6B 149, 150
 EFF 152, 184, 188

EFIS 129
 Emergency channel 2, 27
 ENDUR 152, 184
 ENR 83
 ENT 3
 Enter 3
 Environmental 191
 En route 45, 51, 83
 EPU 56, 184, 188

F

Facility name 62, 114, 115, 116, 125, 126, 138, 139
 Factory settings 32, 41, 54, 170, 174
 FDE 56, 175
 FIR 18, 133, 184
 Flight plan 4, 21, 67, 150
 Activate 22, 68
 Active 72
 Catalog 21, 67, 68
 Copy 70
 Create 21, 69
 Delete 71
 Editing 67
 Invert 69
 Shortcuts 78
 Flight timers 158, 161
 Flip-flop key 2
 Floor 20, 36, 141, 142
 Foreword ii
 FPL 4
 Frequency 118
 Frequency list 15, 26, 51, 118
 FSS 26, 133, 134, 139
 Fuel flow 6
 Fuel on board 6
 Fuel planning 150

G

GAD 180
 Geodesic 188
 Glideslope 24, 145, 180, 191
 GNC 420W/AW 1
 GNS 430W/AW 1
 GPS 180, 191

GPS 400W 1

Great circle 188

H

HFOM 56

Hold 89, 183

HSI 61, 148, 193

I

Ident audio and volume 145

IFR 17

IFR procedures 17

ILS 102, 168

ILS CDI Selection 103, 110, 166, 168

Imminent terrain impact 48

Inhibit terrain 42

Inside airspace 20

Instrument panel self-test 6

Integ 8, 159, 185, 192

Interfaces 191

Intersection 125, 137

IOI 50

ITI 48

J

Jeppesen 190

K

Key descriptions 2

Key stuck 178

King autopilot 111

Knob descriptions 2

L

LFOB 152

LNAV/VNAV Approach 83, 108, 109

Localizer 145, 191

Localizer Approach 110

Low alt 83

LPV Approach 83, 107

LRES 152

M

Magnetic variation 166, 168

Map

Auto zoom 34

Create user waypoint 129

Data fields 40

Datum 166, 170, 181

Page 14, 32

Panning 35

Scale 33, 117

Setup 37

Symbols 33

MAPR 83

Measure dist? 39

Menu 3

Messages 4, 8, 177

Minimum safe altitude 52, 189

Missed approach 88, 197

Model descriptions 1

MSA 52, 189

MSG 4

N

Navcom 15, 51

NavData Card 190

Navigation database 45

Navigation Terms 188

Nav pages 12, 29

On-screen data 31

NDB 125, 137

Nearest 4, 18, 46, 133

Airport 171, 172

Airspace 20, 140

ARTCC 138

FSS 139

Intersection 137

Navigate to 135

NDB 137

User waypoint 138

VOR 137

Next FPL airport 116, 118, 120, 122, 123, 124

NRST 4

O

OBS 4, 181, 193

Oceanic 83

OCN 83

Odometer 162

P

Packing list iii

Page groups 10, 29

Panning 35

Parallel track 77

PDA 48

Phase of flight 46

Position 52, 166, 169

Power on 5

Power up 5

Premature descent alerting 48

PROC 4

Procedures 4, 17

Procedure turn 85

PTT 178

R

RAIM 158, 162, 192

Range 3

Reference waypoint 53, 127

REQ 152

Required terrain clearance 47

Reset all 162

Reset max speed 162

Reset odometer 162

Reset trip 162

Restore defaults 78

Restoring factory settings 32, 54, 170, 174

RNG 152

Roll steering 110

RTC 47

Runway 117, 172

S

Satellite status 55

SBAS 173

Scheduler 151, 157, 181

Searching sky 8, 55

Select frequency 9, 15

Self-test 6

Setup page 164, 171

SIDs 17, 123

Slant golf 193

Software version 159, 164

Sort list 72

Special use airspace 20

Specifications 191

Squelch 23

Standard package iii

Standby frequency 9

STARs 17, 75, 122

Stormscope 182

Stuck microphone 27

Sunrise/sunset 159, 163

Symbols 44

T

Takeoff tour 1

Target altitude 177

TAS 151, 154

TERM 83

Terminal 45, 83

Terminology 177

Terrain 41

Alerts 50

Symbols 44

Time 166, 170

Timer 182

Traffic 40, 182

Transitions 120

Trip planning 150

Trip statistics 162

Troubleshooting 192

Turn anticipation 195

U

Units of measure 166, 169

User comment 68

User waypoint 127

UTC 166, 170

Utility 158

V

Vectors to Final 74, 82, 96

Vertical guidance 109

Vertical navigation 56

Vertical speed 58, 169
VFOM 56
VHF com 191
VLOC 2, 9, 110, 145, 181, 182
 Ident audio 145
 Tuning 145
VNAV 56, 177
Volume 23
VOR 126, 137, 145, 191
VSR 58, 189

W

WAAS approach ID 122
Warranty iv
Waypoint 113, 195
 Airport 116
 Airport frequency 118
 Airport runway 117
 Approach 120
 Arrival 122
 City 114
 Departure 123
 Duplicate 115
 Facility 114
 Identifier 114
 Intersection 125
 Modify user 129
 NDB 125
 User 127, 138
 VOR 126
WGS 84 166, 181
Winds 151, 154
Wind vector 37, 39
Wx broadcast 126



© 2006 Garmin Ltd. or its subsidiaries

Garmin International, Inc.
1200 East 151st Street, Olathe, Kansas 66062, U.S.A.

Garmin AT, Inc.
2345 Turner Rd., S.E., Salem, Oregon 97302, U.S.A.

Garmin (Europe) Ltd.
Unit 5, The Quadrangle, Abbey Park Industrial Estate, Romsey, SO51 9DL, U.K.

Garmin Corporation
No. 68, Jangshu 2nd Road, Shijr, Taipei County, Taiwan

www.garmin.com

Part Number 190-00356-00 Rev A