

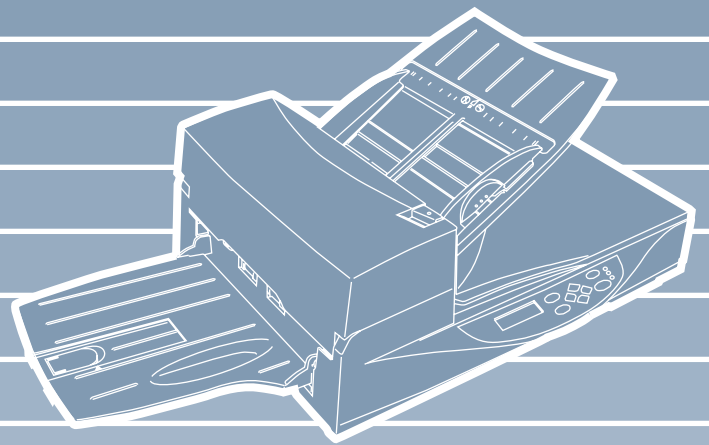

P3PC-E842-05EN

fi-4340C Image Scanner

Cleaning and Maintenance



Revisions, Disclaimers

Edition	Date published	Revised contents
01	October, 2001	First edition
02	March, 2003	Second edition
03	August, 2003	Third edition
04	October, 2004	Fourth edition
05	June, 2006	Fifth edition
Specification No. P3PC-E842-05EN		

■ Regulatory Information

FCC declaration

This equipment has been tested and found to comply with the limits for a Class B digital device, pursuant to Part 15 of the FCC Rules. These limits are designed to provide reasonable protection against harmful interference in a residential installation. This equipment generates, uses, and can radiate radio frequency energy and, if not installed and used in accordance with the instruction manual, may cause harmful interference to radio communications. However, there is no guarantee that interference will not occur in a particular installation. If this equipment does cause harmful interference to radio or television reception, which can be determined by turning the equipment off and on, the user is encouraged to try to correct the interference by one or more of the following measures:

- Reorient or relocate the receiving antenna.
- Increase the separation between the equipment and receiver.
- Connect the equipment into an outlet on a circuit different from that to which the receiver is connected.
- Consult the dealer or an experienced radio/TV technician for help.

FCC warning: Changes or modifications not expressly approved by the party responsible for compliance could void the user's authority to operate the equipment.

NOTE

- The use of a non-shielded interface cable with the referenced device is prohibited. The length of the parallel interface cable must be 3 meters (10 feet) or less. The length of the serial interface cable must be 15 meters (50 feet) or less.
- The length of the power cord must be 3 meters (10 feet) or less.

■ Canadian DOC Regulations

This digital apparatus does not exceed the Class B limit for radio noise emissions from digital apparatus set out in the Radio interference Regulations of the Canadian Department of Communications.

This Class B digital apparatus complies with Canadian ICES-003.

Le présent appareil numérique pas de bruits radioélectriques dépassant les limites applicables aux appareils numériques de la classe B prescrites dans le Règlement sur le brouillage radioélectrique dicté par le ministère des Communications du Canada.

Cet appareil numérique de la classe B est conforme à la norme NMB-003 du Canada.

■ Bescheinigung des Herstellers / Importeurs

Für den fi-4340C wird folgendes bescheinigt:

- In Übereinstimmung mit den Bestimmungen der EN45014(CE) funkentstört
- Maschinenlärminformationsverordnung 3.GPSGV: Der höchste Schalldruckpegel beträgt 70 dB (A) oder weniger, gemäß EN ISO 7779.

■ International ENERGY STAR® Program

As an ENERGY STAR® Partner, PFU LIMITED has determined that this product meets the ENERGY STAR guidelines for energy efficiency.

The International ENERGY STAR® Office Equipment Program is an international program that promotes energy saving through the penetration of energy efficient computers and other office equipment. The program backs the development and dissemination of products with functions that effectively reduce energy consumption. It is an open system in which business proprietors can participate voluntarily. The targeted products are office equipment such as computers, monitors, printers, facsimiles, copiers, scanners, and multifunction devices. Their standards and logos are uniform among participating nations.



■ Use in High-safety Applications

This product has been designed and manufactured on the assumption that it will be used in office, personal, domestic, regular industrial, and general-purpose applications. It has not been designed and manufactured for use in applications (simply called "high-safety applications" from here on) that directly involve danger to life and health when a high degree of safety is required, for example, in the control of nuclear reactions at nuclear power facilities, automatic flight control of aircraft, air traffic control, operation control in mass-transport systems, medical equipment for sustaining life, and missile firing control in weapons systems, and when provisionally the safety in question is not ensured. The user shall use this product with adopting measures for ensuring safety in such high-safety applications. PFU LIMITED assumes no liability whatsoever for damages arising from use of this product by the user in high-safety applications, and for any claims or compensation for damages by the user or a third party.

■ About the use of mercury

	Lamp(s) inside this product contain mercury and must be recycled or disposed of according to local, state, or federal laws.
---	---

To avoid unexpected injury, read the following carefully.

Doing the following actions may result in serious personal injuries:

Do not put the substance contained in the lamp in your mouth as it has mercury.

Do not incinerate, crush, or shred the lamps or scanner parts.

Do not breathe the chemical liquid contained in the scanner lamps.

■ Copying

Copying of paper money, coins, securities and passports issued by government authorities, licenses and permits issued by public authorities and private organizations, official documents, and private documents etc. is illegal and is subject to punishment.

■ Copyright

Copyright had items such as books, paintings, prints, maps, drawings, and photographs may be copied only for private or home use, or for similar applications. Copying for other applications without the consent of the holder of the copyright is illegal.

■ Trademarks

Microsoft, Windows, and Windows NT are registered trademarks of the Microsoft Corporation in the United States and/or other countries.

ISIS and QuickScan are trademarks or registered trademarks of EMC Corporation in the United States.

Adobe®, the Adobe logo, and Acrobat® are either registered trademarks of Adobe Systems Incorporated in the United States and/or other countries.

Other product names are the trademarks or registered trademarks of the respective companies.

■ How Trademarks Are Indicated In This Manual

References to Operating systems (OS) are indicated as follows:

Windows 95:	Microsoft® Windows® 95 operating system
Windows 98:	Microsoft® Windows® 98 operating system
Windows Me:	Microsoft® Windows® Millennium Edition operating system
Windows NT 4.0:	Microsoft® Windows NT® 4.0 Server operating system, Microsoft® Windows NT® 4.0 Workstation operating system
Windows 2000:	Microsoft® Windows® 2000 Professional operating system
Windows XP:	Microsoft® Windows® XP Professional operating system, Microsoft® Windows® XP Home Edition operating system

Where there is no distinction between the different versions of the above operating system, the general term "Windows" is used.

■ Manufacturer

PFU LIMITED

Image Products Sales Dept., Imaging Products Division, Products Group
Solid Square East Tower, 580 Horikawa-cho, Saiwai-ku, Kawasaki-shi Kanagawa
212-88563, Japan

Phone : (81-44) 540-4538

All Rights Reserved, Copyright © PFU LIMITED 2006

The contents of this manual may be revised without prior notice.

No part of this manual may be reproduced in any form without permission.

Fujitsu Group Offices

Please send your comments on this manual or on Fujitsu products to the following addresses:

FUJITSU COMPUTER PRODUCTS OF AMERICA, INC.

1255 East Arques Avenue Sunnyvale,
CA 94085-4701, U.S.A.
Phone: (1-408)746-7000
Technical Assistance Center:
(1-800)626-4686
Fax: (1-408)746-6910
Website: <http://www.fcpa.fujitsu.com/>
E-mail: info@fcpa.fujitsu.com

FUJITSU EUROPE LTD.

Hayes Park Central, Hayes End Road,
Hayes Middlesex UB4 8FE, U.K.
Phone: (44-208)573-4444
Fax: (44-208)573-2643
Website: <http://www.fel.fujitsu.com/>

FUJITSU ITALIA S.p.A.

Via Nazario Sauro, 38
20099 Sesto San Giovanni (MI), Italy
Phone: (39-02)26294.1
Fax: (39-02)26294.201
Website: <http://www.fis.fujitsu.com/>
E-mail: mbarondi@fis.fujitsu.com

FUJITSU AUSTRALIA LTD.

Fujitsu House 2 Julius Avenue
North Ryde, N.S.W 2113 Australia
Phone: (61-2)9776-4555
Fax: (61-2)9776-4024
Website: <http://au.fujitsu.com/>

FUJITSU TAIWAN LTD.

19th Fl., No39, Sec.1, Chung-hwa Rd.,
Taipei, Taiwan
Phone: (886-2)2311-2255
Fax: (886-2)2311-2277
Website: <http://tw.fujitsu.com/>

FUJITSU CANADA, INC.

6975 Creditview Road Unit 1
Mississauga, On L5N 8E9 Canada
Phone: (1-905)286-9666
Fax: (1-905)286-5988
Website: <http://www.fujitsu.ca/>
E-mail: imaging@fujitsu.ca
(For Sales Questions)
scantech@fujitsu.ca
(For technical questions)

FUJITSU DEUTSCHLAND GmbH.

Frankfurter Ring 211, 80807 München,
Germany
Phone: (49-89)323-78-0
Fax: (49-89)323-78-100
Website: <http://www.fdg.fujitsu.com/>
E-mail:
hotline_scanner@fdg.fujitsu.com

FUJITSU ESPAÑA Services, S.A.U.

Camino Cerro de los Gamos, 1 28224,
Pozuelo de Alarcon, Madrid, Spain
Phone: (34-91)784-9000
Fax: (34-91)784-9379
Website: <http://es.fujitsu.com/>
E-mail: info@mail.fujitsu.es

FUJITSU ASIA PTE.LTD.

20 Science Park Road, #03-01, Tele Teck
Park Singapore Science Park II, Sin-
gapore 117674
Phone: general (65)6512-7555
query (65)6512-7431
Fax: (65)6512-7499
Website: <http://www.fapl.fujitsu.com>
E-mail: query@sg.fujitsu.com

FUJITSU HONG KONG LTD.

10/F., Lincoln House, 979 King's Road,
Taikoo Place, Island East, Hong Kong
Phone: (852)2827-5780
Fax: (852)2827-4724
Website: <http://hk.fujitsu.com/>
E-mail: scanner@fujitsu.com.hk

**FUJITSU SYSTEMS BUSINESS
(THAILAND) LTD.**

12th Fl., Olympia Thai Tower, 444
Rachadapisek Road, Samsennok,
Huay kwang, Bangkok 10310, Thailand
Phone: +66 (0) 2500-1500
Fax: +66 (0) 2500-1555
Website: <http://th.fujitsu.com/>

FUJITSU MALAYSIA SDN.BHD.

Level 1 & 2
3505 Jalan Teknokrat 5
63000 Cyberjaya
MALAYSIA
Phone:
 general (603)8318-3700
 query (603)8318-3700 (ext 375)
Fax: (603)8318-8700
Website: <http://www.fujitsu.com/my/>
E-mail: WriteToUs@fms.my.fujitsu.com

**Imaging Business Division,
PFU LIMITED**

Solid Square East Tower, 580
Horikawa-cho, Saiwai-ku, Kawasaki-shi,
Kanagawa 212-8563, Japan
Phone: (81-44)540-4658
Fax: (81-44)540-4639
Website:
<http://imagescanner.fujitsu.com>
E-mail: scanners@pfu.fujitsu.com

FUJITSU KOREA LTD.

Susong Tower Building, 83-1
Susong-Dong, Jongno-Gu, Seoul,
Republic of Korea
Phone: (82-2)3787-6159
Fax: (82-2)3787-6164
Website: <http://kr.fujitsu.com/>
E-mail: webmaster@kr.fujitsu.com

FUJITSU PHILIPPINES, INC

2/F, United Life Building, 837 A. Arnaiz
Avenue (Pasay Road),
Legaspi Village, Makati City 1229,
Philippines
Phone: +63 (2) 812-4001
Fax: +63 (2) 817-7576
Website: <http://ph.fujitsu.com>

**PFU LIMITED
(Corporate headquarters)**

Nu 98-2 Unoke, Kahoku-shi,
Ishikawa 929-1192, Japan
Phone: (81-76)283-1212
Fax: (81-76)283-4689

Note, Liability

READ ALL OF THIS MANUAL CAREFULLY BEFORE USING THIS PRODUCT. IF NOT USED CORRECTLY, UNEXPECTED INJURY MAY BE CAUSED TO USERS OR BYSTANDERS.

Also, store this manual in a convenient and safe place so that it can be easily referred to during use of this product.

While all efforts have been made to ensure the accuracy of all information in this manual, PFU assumes no liability to any party for any damage caused by errors or omissions or by statements of any kind in this manual, its updates or supplements, whether such errors are omissions or statements resulting from negligence, accidents, or any other cause. PFU further assumes no liability arising from the application or use of any product or system described herein; nor any liability for incidental or consequential damages arising from the use of this manual. PFU disclaims all warranties regarding the information contained herein, whether expressed, implied, or statutory.

Preface

This manual explains how to clean and maintain the fi-4340C image scanner.

This manual contains chapters on the following topics:

DESCRIPTION

DAILY CARE

REPLACEMENT OF CONSUMABLES

TROUBLESHOOTING

Refer to "Operator's Guide" for basic information about the fi-4340C.

For instructions on how to install the device driver, refer to the "Installation Guide" or the device driver CD.

The fi-4340C is a very fast and highly functional color image scanner developed for high quality color image processing, using charge-coupled device (CCD) color image sensors. This scanner features high-speed duplex scanning with an automatic document feeder (ADF).

Conventions

Warning Indications Used In This Manual

Important information that requires special attention is indicated as follows:

WARNING

This indicates that serious personal injury may result if you do not follow a procedure correctly.

CAUTION

This indicates that minor personal injury, loss of data, or damage to the scanner may result if you do not follow a procedure correctly.

Official PFU part names are indicated with an initial capital letter, as in the part name "Pick roller".

Symbols Used In This Manual

NOTE

A NOTE provides "how-to" tips or suggestions to help you perform a procedure correctly.



A TRIANGLE symbol indicates that special care and attention is required. The drawing inside the triangle shows the specific caution.



A CIRCLE with a diagonal line inside shows action which users are not allowed to do.

The drawing inside or under the circle shows the specific action that is not allowed.



Outline characters on a colored background shows instructions users should follow.

It may include the drawing which shows the sepecific instruction.

■ Warning Label



The glass surface inside the ADF becomes hot during the operation. Be careful not to touch the glass surface inside the ADF.



CAUTION

Do NOT remove from the scanner, stain or scratch the warning labels.

■ About Maintenance

The user must not perform repairs on this scanner. Contact the store where you purchased the scanner or an authorized FUJITSU Image Scanner service provider to make repairs to this product.

Precautions

This section describes precautions to follow when installing the scanner.

To ensure the longevity and proper functioning of your scanner, do not install the scanner in the places and environments described below.

■ Warning

Important warnings employed in this manual are as follows.

Do not damage the power cable.



Damage to the power cable may result in fire or electric shock.

Do not place heavy objects on power cables, or pull, bend, twist, heat, damage or modify power cables.

Also, do not use damaged power cables or power plugs, and power cables or power plugs when the wall socket is loose.

Use only specified power cables and connector cables.



Use only specified power cables and connector cables. Failure to use the correct cables might cause electric shock and equipment failure.

Use this scanner only at the specified voltage. Do not connect to multiple-power strips.



Use this scanner only at the indicated power voltage and current. Improper power voltage and current might cause fire or electric shock. Also, do not connect to multiple-power strips.

Wipe any dust from the power plug.



Wipe off any dust from metal parts on the power plug or metal fittings with a soft, dry cloth. Accumulated dust might cause fire or electric shock.

Do not install the device in locations subject to oil smoke, steam, humidity, and dust.



Do not install the scanner in locations subject to oil smoke, steam, humidity, and dust. Doing so might cause a fire or electric shock.

Do not use the scanner if you smell strange odor.



If you detect heat coming from the device or detect other problems such as smoke, strange smells or noises, immediately turn off the scanner and then disconnect its power plug. Make sure that the smoking has stopped, and then contact the store where you purchased the scanner or an authorized FUJITSU scanner service provider.

Do not put liquids inside the scanner.



Do not insert or drop metal objects into the scanner. Do not scan wet documents or document with paper clips or staples. Do not splash or allow the scanner to get wet.



If foreign objects (water, small metal objects, liquids, etc.) get inside the scanner, immediately turn off the scanner and disconnect the power plug from the power outlet, then contact the store where you purchased the scanner or the Maintenance Service Center. Pay particular attention to this warning in households where there are small children.



Do not touch the inside of the scanner unless necessary.



Do not take apart or modify the scanner. The inside of the scanner contains high-voltage components. Touching these components might cause fire or electric shock.

Before moving the scanner, disconnect the power plug from the power outlet. .



Do not move the scanner with the power and interface cables connected as this might damage the cables, causing fire, electric shock or injuries. Before moving the scanner, be sure to disconnect the power plug from the power outlet, and disconnect data cables. Also, make sure that the floor is free of obstructions.

Turn OFF the scanner if it is damaged.



If the scanner is damaged for any reason, turn off the scanner and unplug the power cable before contacting the store where you purchased the scanner.

Do not place in wet areas.



Do not place the scanner where liquid spills may occur.

■ Caution

Important cautions employed in this manual are as follows.

Do not touch the power cable with wet hands.



Do not touch the power plug with wet hands. Doing so might cause electric shock.

Always remove the plug from the socket before installing or removing optional equipment.



Turn OFF the scanner and remove the power plug from the power outlet, before installing or removing optional equipment in accordance with the specified procedure.



Grip the plug to remove the power cable from the socket.

Earth the equipment.



This equipment must be earthed. Always connect the power cable to a 3-pin socket. If earthing is not possible, call your dealer or maintenance service center.

Do not install the scanner on unstable surfaces.



Install the scanner on a desk so that none of its parts protrude outside of the desktop. Also, make sure that the scanner is installed on a flat, level surface. Do not install the scanner on unstable surfaces.



Install the scanner on a level surface that is free of vibration to prevent it from falling. Install the scanner on a strong surface that will support the weight of the scanner and other devices.

Firmly insert the power plug.



Firmly insert the power plug into the power outlet as far as it can go.

Do not block the ventilation ports.



Do not block the ventilation ports. Blocking the ventilation ports generates heat inside of the scanner, that may results in fire or scanner failure.

Do not place heavy objects or stand on top of the scanner.



Do not place heavy objects on the scanner or use the scanner's top surface for performing other work. Improper use might cause injuries.

Before moving the scanner, disconnect the power plug from the power outlet.



Do not move the scanner with the power and interface cables connected as this might damage the cables, causing fire, electric shock or injuries. Before moving the scanner, be sure to disconnect the power plug from the power outlet, and disconnect data cables. Also, make sure that the floor is free of obstructions.

Protect the scanner from static electricity.



Install the scanner away from strong magnetic fields and other sources of interference. Also, protect the scanner from static electricity as this might cause the scanner to malfunction.

Be careful not to get neckties, necklaces, hair, etc. entangled in the scanner.



You may get injured if your clothing, neckties, or hair, etc. is entangled in the moving components such as gears and rollers.

Disconnect the power plug from the power outlet when the scanner is not used for a long period of time.



When the scanner is not used for a long period of time, be sure to disconnect the power plug from the power outlet for safety.

Do not install the scanner in direct sunlight.



Do not install the scanner in the direct sunlight or near heating apparatus. Doing so might cause excessive heat to build up inside the scanner, causing fire or scanner trouble. Install the scanner in a well-ventilated location.

CONTENTS

□ CHAPTER 1	DESCRIPTION	1
	Units	2
	Assemblies	4
	Operator panel	5
	Panel Display	7

□ CHAPTER 2	DAILY CARE	13
	Cleaning Supplies and Areas Requiring Cleaning	14
	Cleaning the ADF	17
	Cleaning the Document bed	23

□ CHAPTER 3	REPLACEMENT OF CONSUMABLES	25
	Consumable Lists	26
	Pad ASSY	27
	Pick Roller	32

□ CHAPTER 4	TROUBLESHOOTING	39
	Clearing Paper Jams	40
	Trouble Shooting	41
	Problem Checklist	57
	Checking Labels on the Scanner	60

CHAPTER 1

DESCRIPTION

1

CHAPTER 2

DAILY CARE

2

CHAPTER 3

REPLACEMENT OF CONSUMABLES

3

CHAPTER 4

TROUBLESHOOTING

4

DESCRIPTION

This chapter describes units, assemblies, indicators and LED functions.

Units

Assemblies

Operator panel

Panel Display

Units

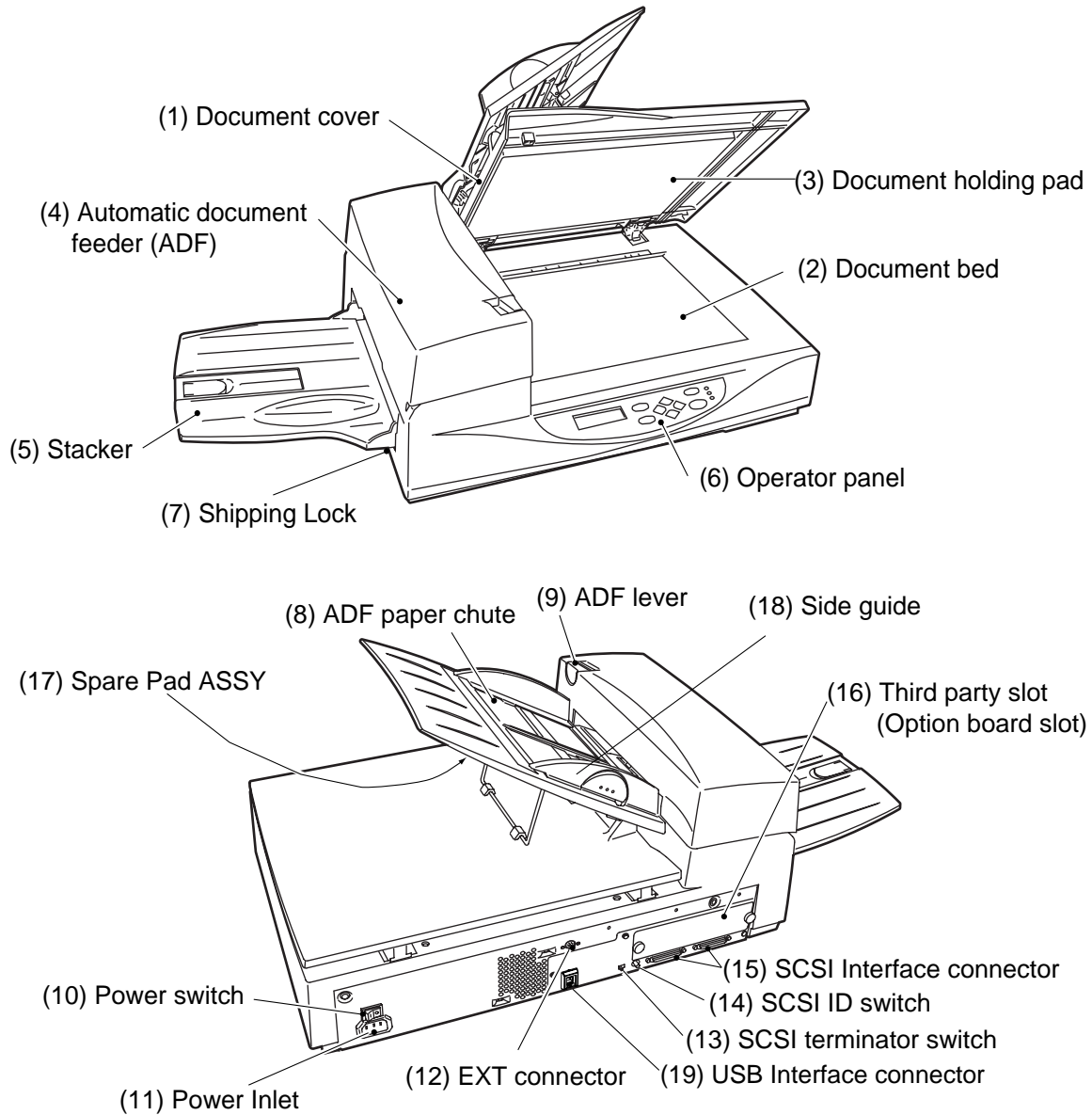

NOTE

The Shipping Lock should be switched to the operating position when the scanner is to be used. Refer to "Operator's Guide" for details of Shipping Lock.

No.	Part	Function
1	Document cover	Closes over and keeps in place the document to be read.
2	Document bed	Holds document to be read. Also called Flatbed (FB).
3	Document holding pad	Presses document to the Document bed.
4	Automatic document feeder (ADF)	Automatically feeds documents to the reading position.
5	Stacker	Stacks the read documents.
6	Operator panel	Contains indicator panel that indicates scanner status.
7	Transport Lever	Transport lever secures the carrier unit. Set to locked position when moving scanner.
8	ADF paper chute	Holds the documents to be fed by the automatic document feeder (ADF).
9	ADF lever	Opens/closes the ADF to enable the removal of documents jammed in the feeder.
10	Power switch	Turns the power On or Off.
11	Power inlet	Connects to an AC power outlet with the power cable.
12	EXT connector	Connects to an optional imprinter.
13	SCSI terminator switch	Set to ON when the image scanner is the final device on the SCSI daisy chain. Otherwise, set to OFF.
14	SCSI-ID switch	Sets the SCSI ID. (Default ID is 5.)
15	SCSI Interface connectors	Connect to the host system with SCSI interface cables.
16	Third party slot	A Fujitsu VIDEO INTERFACE OPTION BOARD or fi-475CMP3 (JPEG COMPRESSION BOARD) is installed.
17	Spare Pad ASSY	Spare Pad ASSY. (One spare Pad ASSY is provided as the default setting.)
18	Side guide	Adjust the Side guide to match the width of the document to avoid image skew.
19	USB interface connector	Used for connecting a USB interface cable from a PC.

Assemblies

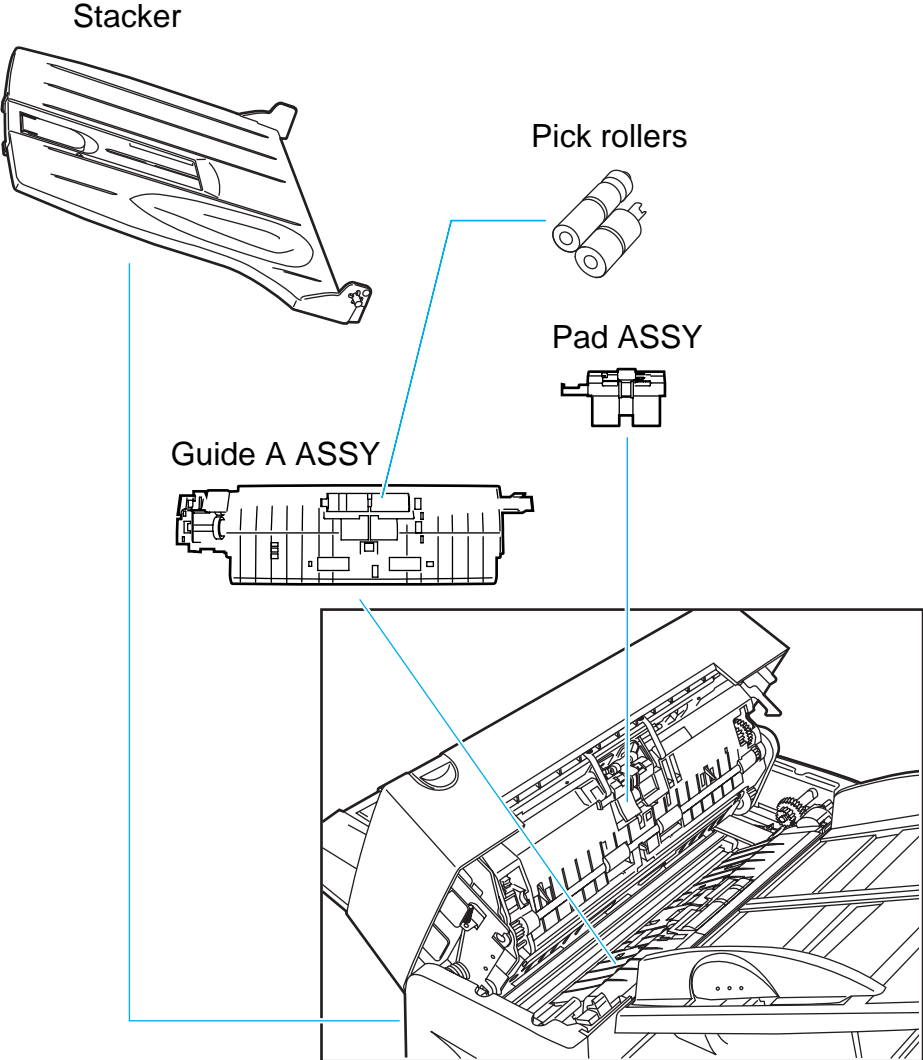

Operator panel

The Operator panel is located on the upper right hand side of the scanner. The panel consists of a status display (16 characters x 2 lines), LEDs, and control buttons.



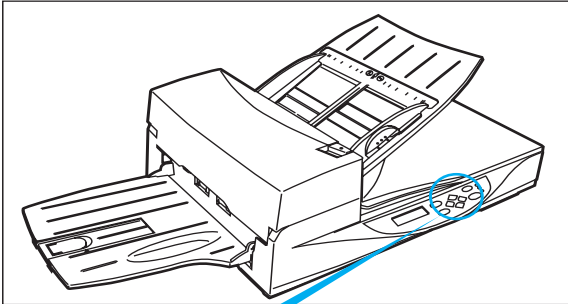

Layout

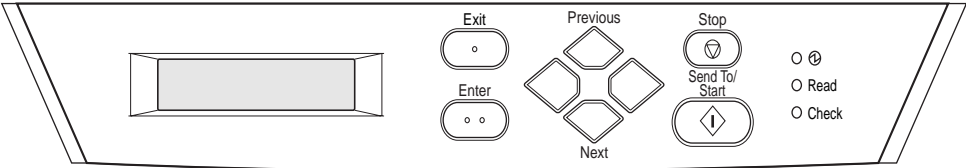

Operator panel



■ Button/LED Function

Name of the button and LED		Function
Button	Next 	Displays the next LCD screen.
	Previous 	Displays the previous LCD screen.
		Moves the cursor to the left.
		Moves the cursor to the right.
	Exit	When you are entering settings on the Operator panel, pressing this button returns you immediately to the Scanner Ready screen.
	Enter	Enters the parameter currently selected by the cursor.
	Send To/ Start	Operational only when Manual start mode is set or the Read lamp lights; Starts the reading when video interface option is used. Some application software packages make use of this button.
	Stop	When the Check LED lights, pressing this button releases the error status (turns off Check and returns to the Scanner Ready screen). Operational only during the reading operation; stops the reading when the video interface option is used. Also turns off the Check lamp.
LED		Indicates that the scanner is On.
	Read	Indicates the scanner is reading or ready to read.
	Check	<ul style="list-style-type: none"> • If lit, this indicates that an alarm occurred. Pressing the Stop button turns the Check lamp Off. • If it blinks at one second intervals, this means that a jam or multi feed has been detected. If the problem is jammed paper, removing the jammed paper turns off the Check lamp. If the problem is multi feed, pressing the Stop button turns off the Check lamp. • If it blinks at four seconds intervals, this means that cleaning the ADF is necessary.

Panel Display

■ Counter Display

The displays for the Paper and Abrasion counters are shown below:

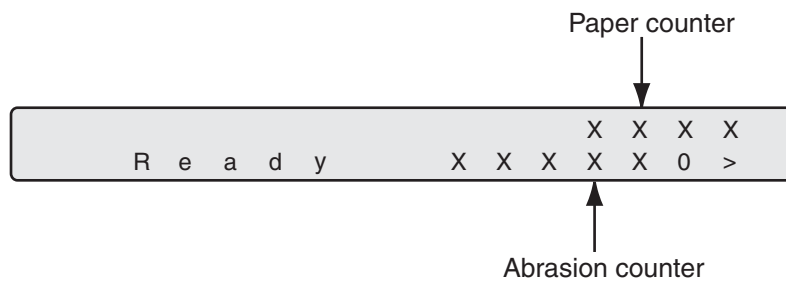

Simultaneously press the ◊ and ◊ arrow buttons for at least 1 second, to switch to Life counter panel display as shown below: The scanner is provided with a counter display.

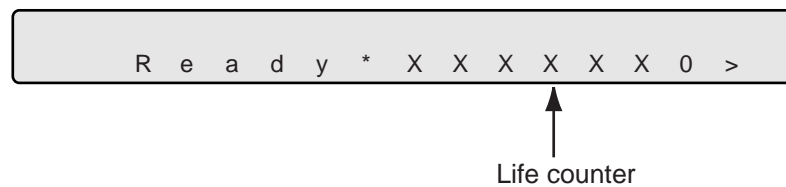

Counter	Function	
Paper counter	When the ◊ button is pressed for at least 1 second	The paper counter counts the number of scanned sheets from the start of reading until Paper Empty or an error is detected. The counter is automatically reset at the start of reading. The counter is used for checking the number of sheets scanned at one batch.
	When the ◊ button is pressed for at least 1 second	This counter increments each time a document is scanned. It is not initialized until the power is turned off. The counter can be used, for example, for checking the number of sheets that have been scanned in one day.
Abrasion counter	The abrasion counter counts the accumulated number of scanned sheets. This counter increments at every 10 sheets. It is useful to check the cleaning cycle or the parts replacement cycle. How to reset is described in "Operator's Guide".	
Life Counter	Keeps a cumulative count of the number of scans made after shipping. This counter increments by 1 after every 10 scans and may be used to estimate of the device's remaining scan life.	

NOTE

When the counter value is 0, no number is displayed.

■ Operation status

The operation status is indicated by the following messages:

<Power-on>

W a r m i n g - u p N o w ! !

<Reading>

N o w R e a d i n g ! x x x x

<Low Power Mode>

When the Scanner Display turns Off and the power  indicator remains "On", the scanner is in the Low Power Mode.

NOTE

One of the following will wake up from Lower Power Mode:

- Pressing any button on operator panel.
- Setting the paper on the ADF.
- Sending a command from the host system.

<Waiting for Start> (Only When the Video Interface Option is installed.)

The scanner displays the following screen when waiting for the Start button to be pressed:

S t a r t S W O N !

<Cleaning request>

When the Pick roller cleaning is necessary, the scanner displays the following on the upper line:

C l e a n P i c k r o l l e r

When the ADF glass cleaning is necessary, the scanner displays the following on the LCD:

C l e a n A D F G l a s s

When the ADF glass and Pick roller cleaning are necessary, the scanner displays the following on the LCD:

C l e a n P i c k r o l l e r
C l e a n A D F G l a s s

Clean the Pick roller or the ADF glass in accordance with the instructions given in "2 DAILY CARE" on page 13.

■ Temporary error

<Hopper empty>

P a p e r E m p t y

This message is displayed if there is no more document on the ADF paper chute during a read operation in ADF mode. Fill the ADF paper chute with document. To enable the read operation, press the stop button.

<Jam>

P a p e r J a m

This message is displayed if a document is jammed in the ADF. See "4 TROUBLESHOOTING" on page 39 for removing jammed documents.

<ADF cover open>

A D F - C o v e r O p e n

This message is displayed if the ADF is not closed completely. Close the ADF completely, and enable the read operation.

<Multi feed error>

M u l t i F e e d

This message is displayed when the ADF detects a Multi feed error. Check the document and re-scan it.

<No Ink Cartridge>

N o I n k C a r t r i d g e

This message is displayed when the print cartridge is not put in fi-434PR (Imprinter). Please place the cartridge.

<Print Error>

P r i n t E r r o r

This message is displayed when the print position mark of fi-434PR (Imprinter) is set to the area which is out of the paper path or when the stacker is full of documents. Please set the fi-434PR (Imprinter) to the correct position or take the paper away from the stacker.

■ Alarm

One of the following messages is displayed if an error occurs in the scanner. If one of the following error messages is displayed, turn the power Off and then On again. If the same message is displayed, contact your service representative.

<Optical alarm front>

F r o n t S i d e
O p t i c a l A l a r m

<Optical alarm back>

B a c k S i d e
O p t i c a l A l a r m

<FB mechanism alarm>

F l a t b e d
M e c h a n i c a l A l a r m

NOTE

When the total number of sheets scanned by the ADF is less than 100, the message above and the message below are displayed alternately.

Remove the bracket (Shipping Lock) that holds the unit. Refer to "Operator's Guide" for details of operation.

C h e c k S h i p p i n g
L o c k

<Motor fuse alarm>

M o t o r f u s e A l a r m

<Lamp fuse alarm>

L a m p f u s e A l a r m

<Image transfer alarm>

I m g T r a n s A l a r m

<Memory alarm>

M e m o r y A l a r m

<EEPROM alarm>

E E P R O M A l a r m

<FAN alarm>

F A N A l a r m

<IPC Board alarm>

(Only when the IPC-4D (Image Processing Circuit Board) is used)

I P C B o a r d A l a r m

<Imprinter Alarm>

I m p r i n t e r A l a r m

The Power Indicator (LED) and Check lamp blink alternately.

<Self-diagnostics Error>

The Power indicator and Check lamp blink alternately.

<SCSI Controller alarm>

H a r d w a r e E r r o r

<USB Controller Error>

U S B A l a r m

DAILY CARE

This chapter describes cleaning supplies, areas that require cleaning, and procedures for cleaning the ADF and the Document bed.

Cleaning Supplies and Areas Requiring Cleaning

Cleaning the ADF

Cleaning the Document bed



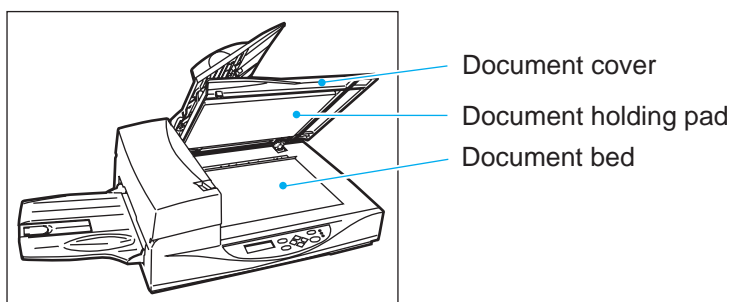

Cleaning Supplies and Areas Requiring Cleaning

WARNING

When cleaning the scanner, turn off the power, and unplug the AC cable from the outlet.



Supplies

Cleaning Materials	Supply No.	Frequencies (*1)(*3)	Remarks
Cleaning paper 	CA91001-2314	<ul style="list-style-type: none"> • Every 5,000 sheets • Apply Cleaner F1 to the cleaning paper before using. 	10 sheets.
Cleaner F2 	CA91001-2317	<ul style="list-style-type: none"> • Plastic rollers (*2) 	1 bottle Apply Cleaner F2 to cotton swab.
Cleaner F1 or Isopropyl alcohol 	CA91001-2316	<ul style="list-style-type: none"> • Pad ASSY Every 5,000 sheets • Pick roller/ Feedrollers/ Glass/Sheet guide Every 5,000 sheets 	1 bottle Apply Cleaner F1 to cloth.
Cotton swab 			
Dry cloth			

For more information on cleaning supplies, contact your dealer.

*1: If the display on the operator panel shows "Clean Pickroller", then clean it regardless of the frequencies recommended here.

 **CAUTION**

*2: Do not clean the rubber rollers with cleaner F2.

*3: Refer to the Abrasion counter on the Operator panel to estimate when the next cleaning is necessary.

 **NOTE**

When the following paper types are used, it may be necessary to clean more frequently:

- Paper with a smooth surface, such as coated paper.
 - Paper almost entirely covered with printing.
 - Paper with special chemical coatings, such as carbonless paper.
 - Paper including a great quantity of calcium.
 - When reading a great many documents written with a pencil.
-

Areas Requiring Cleaning

Area	Name	Cleaning paper with Cleaner F1	Dry cloth with Cleaner F1	Cotton swab with Cleaner F1 or F2
Document bed	Document holding pad		○	
	Document bed		○	
ADF	Pad	○	○	
	Glass/Sheet guide	○	○	
	Pick roller	○	○	
	Plastic rollers	○	○	○
	Feed rollers	○	○	
	Pick Arm Rollers		○	○

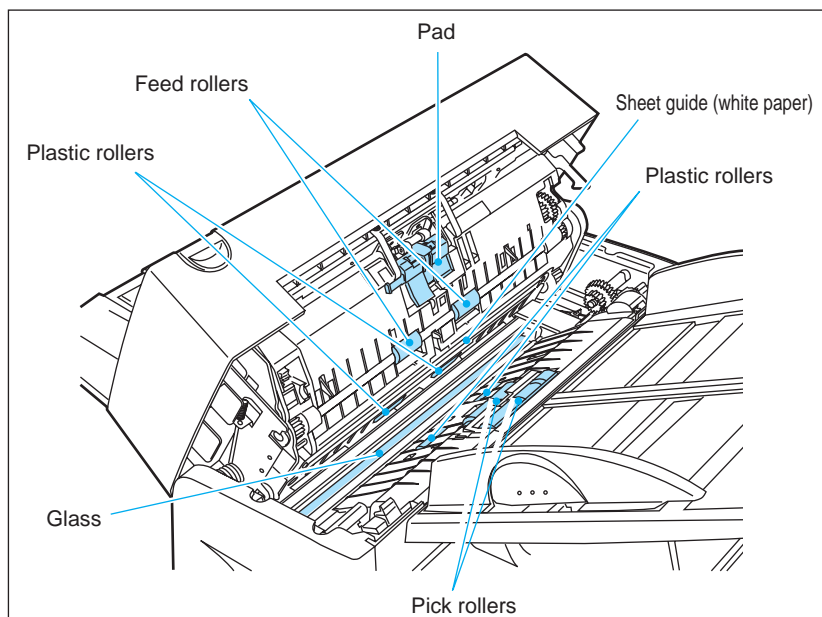
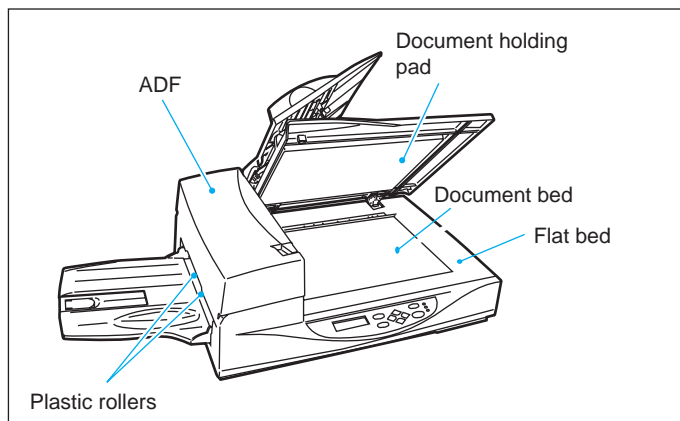

Cleaning the ADF

■ Cleaning the ADF with cleaning paper

- 1** Pull the ADF lever to open the ADF.
- 2** Apply cleaner F1 to a new piece of cleaning paper.

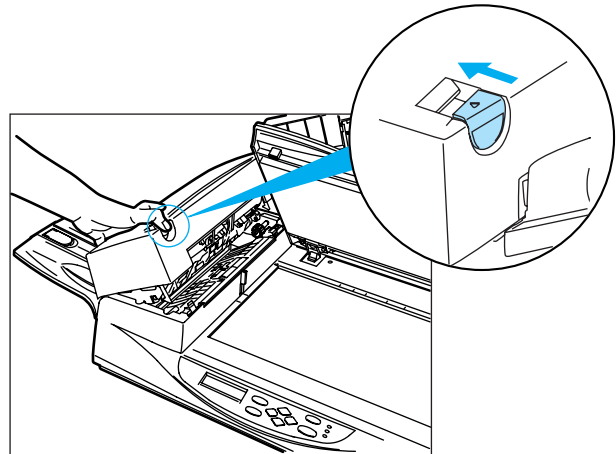

2

- 3** Place the cleaning paper on the ADF so that the edge of the short side touches the Plastic roller.

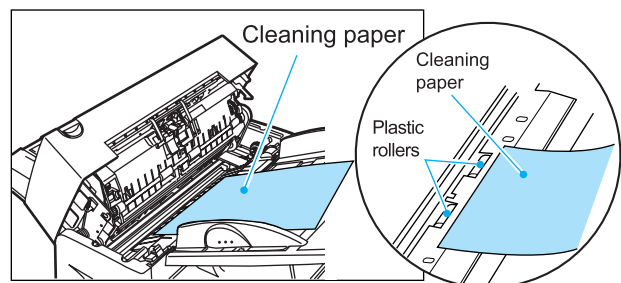

- 4** Close the ADF and turn the power on to start the cleaning.
- 5** Turn off the power.
- 6** Repeat steps 1 through 5.

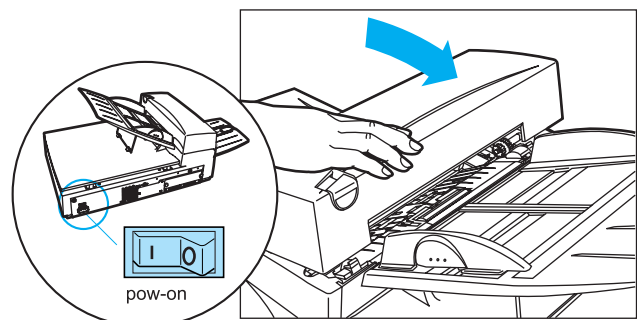

■ Cleaning the Pad ASSY with a Dry cloth or a Cloth with Cleaner F1

- 1** Pull the ADF lever to open the ADF.
- 2** Use a dry cloth or a cloth moistened with Cleaner F1 to softly remove dirt and dust as follows.

Pad ASSY:

Wipe the pad in a downward direction (as indicated by the arrow). Be careful not to catch the spring for the Pick when wiping.

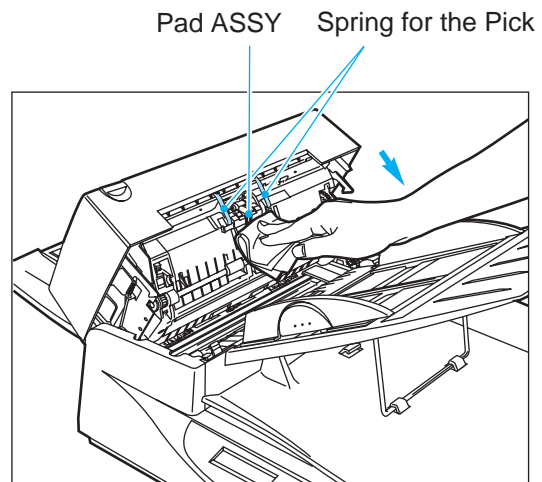

Glass:

Wipe the glass lightly,

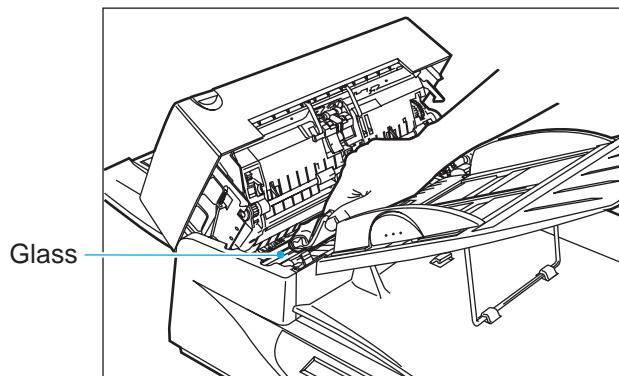

NOTE

If the glass is dirty, the image may include black vertical stripes.

CAUTION

Do not touch the glass immediately following a scan. The hot glass can cause burn.

Pick roller:

Wipe the roller.

Be careful not to damage the mylar strip of the Pick roller.

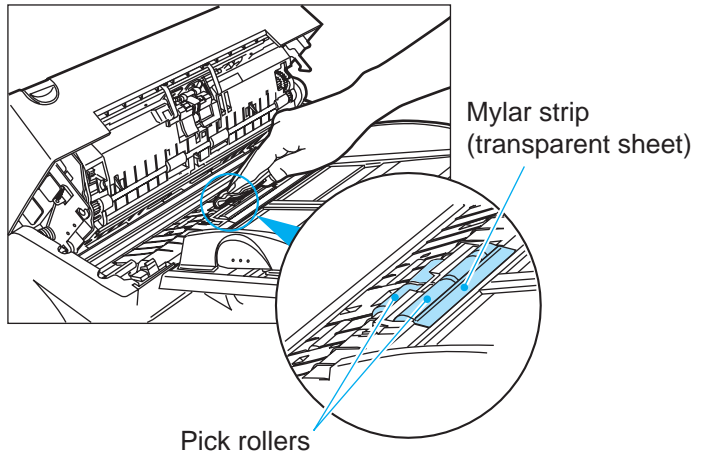

Feed rollers and Plastic rollers;

Wipe the rollers.

Be careful not to damage the surface of the rollers.

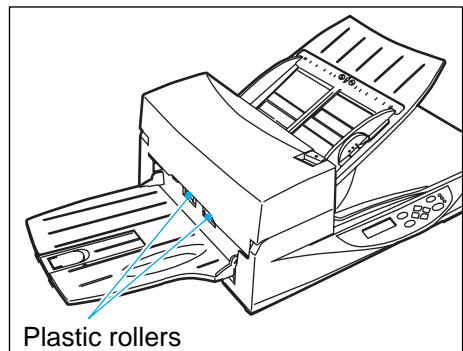
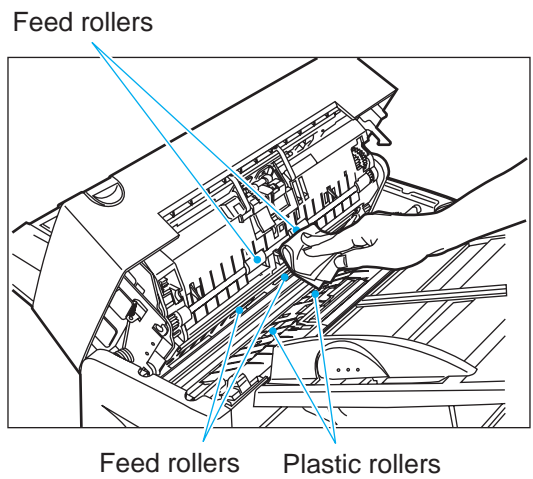

Sheet guide (white part):
Wipe the sheet guide.

Sheet guide (white part)

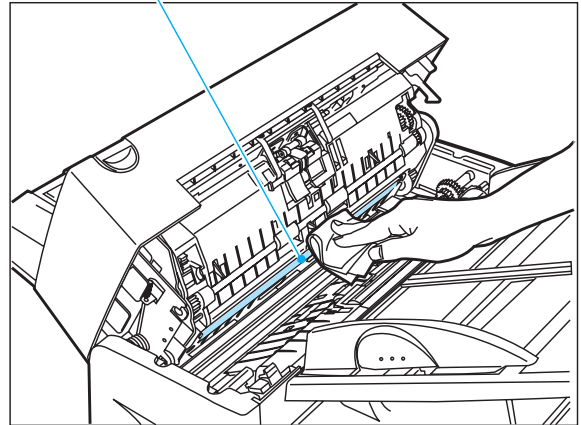

NOTE

If the Sheet guide is dirty, the front image may show vertical stripes.

3

Close the ADF to lock the ADF lever.

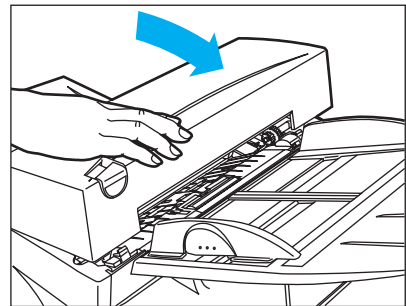

■ Cleaning the Pick Arm Rollers

- 1 Pull the ADF lever to open the ADF.

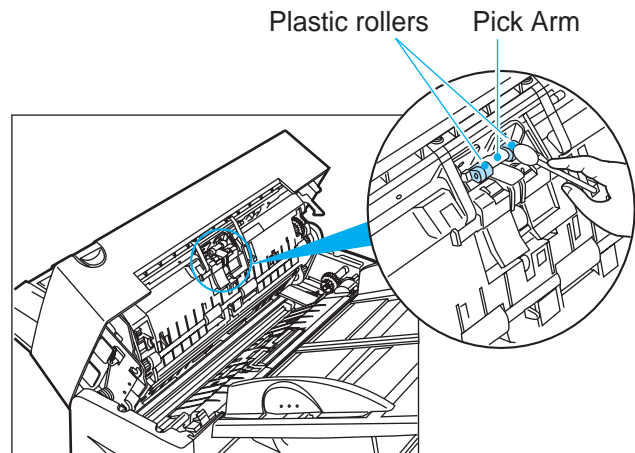

- 2 Moisten a cotton swab or Dry cloth with F1 or F2 Cleaner.
- 3 Wipe the small Plastic rollers at the tip of the Pick Arm.
- 4 Wipe the small Plastic rollers and the Pick Arm with a clean, dry cloth to dry them.

NOTE

When non-carbon paper is used, the Pick Arm rollers may become dirty with a black substance. Use Cleaner F2 to remove the contamination.

CAUTION

1. Don't wipe the pad rubbers with the F2 cleaner.
2. Don't apply the F2 cleaner to the pad rubber.

■ Cleaning the Plastic rollers with Cleaner F2

1 Pull the ADF lever to open the ADF.

2 Moisten a cotton swab with Cleaner F2.

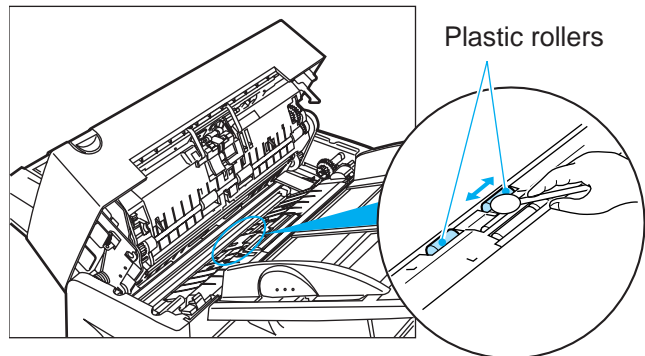

3 Wipe the Plastic roller surfaces.



CAUTION

Don't wipe the Pick Rollers with a cotton swab using cleaner F2.

4 Wipe the Plastic roller surface with a clean, dry cloth. Allow it to dry.

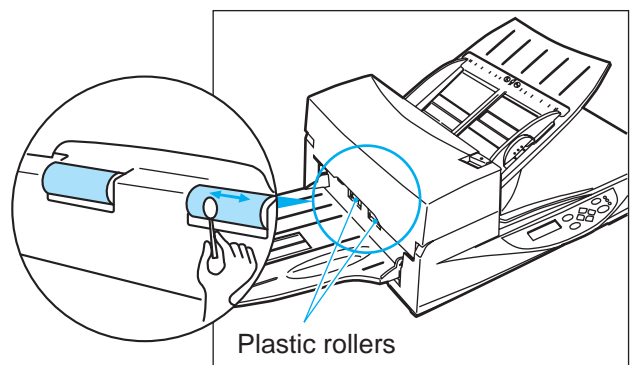

Cleaning the Document bed

■ Cleaning the Document Bed with a Cloth and Cleaner F1

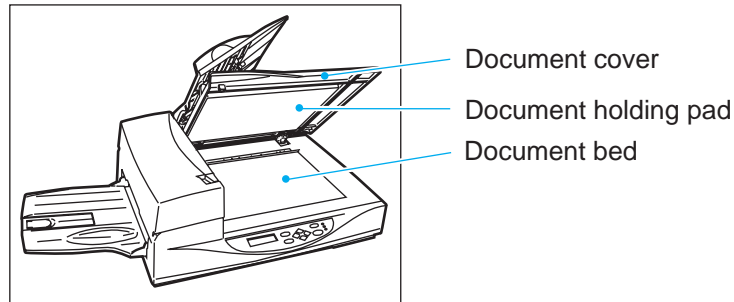

2

NOTE

Window or glass cleaner, excluding those not allowed for plastic, can be used instead of cleaner F1. However, do not use organic solvents like thinner.

- 1** Open the Document cover.
- 2** Apply Cleaner F1 to a clean cloth.
- 3** Wipe the Document holding pad and the Document bed.
- 4** Allow them to dry.

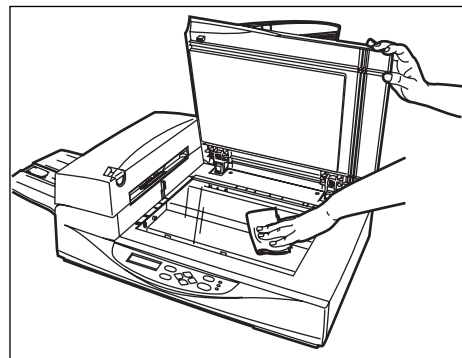

NOTE

Be sure to prevent liquid from seeping through the opening between the Document bed and the plastic cover.

REPLACEMENT OF CONSUMABLES

This chapter describes how to replace the basic product and the Pad ASSY and the pick roller.

Consumable Lists

Pad ASSY

Pick Roller

Consumable Lists

The following table lists consumables used for the scanner. Be sure to keep some consumables in stock. The customer is responsible for changing these items periodically, in accordance with the guidelines given below and "Pad ASSY" on page 27 or "Pick Roller" on page 32 in this Chapter. If they are not changed as recommended, the scanner may not function properly. The abrasion counter can be used to check the total number of documents scanned since the last replacement(s).

Name	Specification	Standard Replacement Cycle
Pad ASSY	PA03277-0002	Up to 100,000 sheets or one year.
Pick rollers	PA03277-0001	Up to 200,000 sheets or one year. (Two rollers are included.)

 **NOTE**

Refer to "Pad ASSY" on page 27 for replacing the consumables.

 **CAUTION**

Certain paper types or conditions might reduce the life of consumables.

Pad ASSY

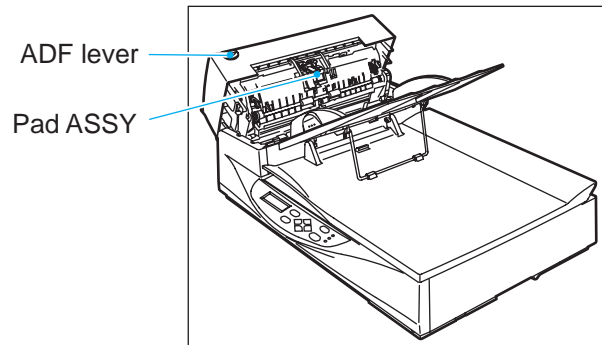

NOTE

The life span of the Pad ASSY is about 100,000 sheets or one year. Use the Abrasion counter on the Operator panel to estimate when the Pad ASSY needs replacement. The life span may be decreased by as much as half when carbonless paper is read frequently.

WARNING

Turn off the power before replacing the Pad ASSY.

- 1** Pull the ADF lever to open the ADF.

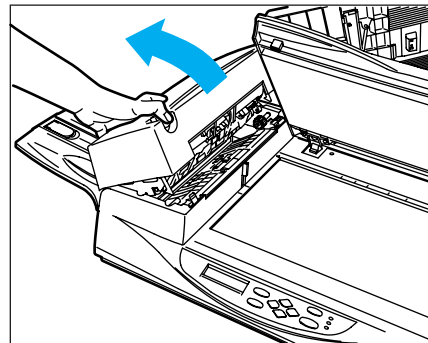

- 2** Push the Pick Arm carefully.

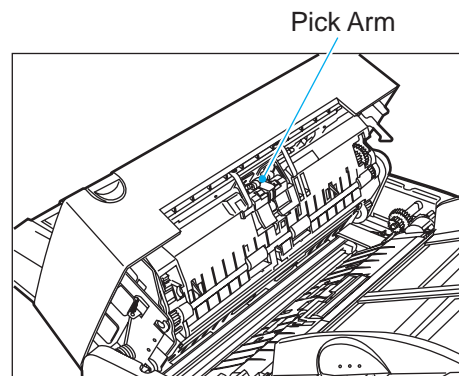

 **NOTE**

One spare Pad ASSY is provided on the rear of the ADF feed chute before the image scanner is shipped from the factory.

Before using the image scanner, slide the spare Pad ASSY to the left and draw towards you to remove.

- 3** Slide the Pad ASSY to the left and pull it towards you. Then, being careful not to hook the spring for the Pick, remove the Pad ASSY.

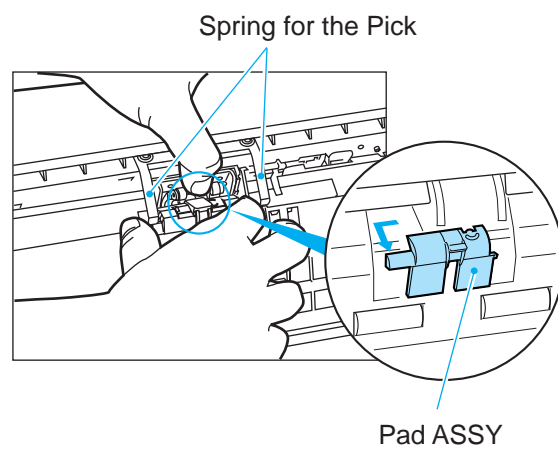

 **NOTE**

Hold both ends of the Pad ASSY as shown in the right graphic.

 **CAUTION**

Don't hold the sensor arm with the Pad ASSY.

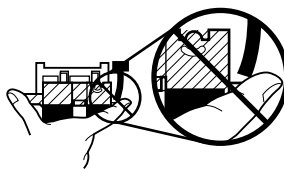

- 4** Attach the Pad ASSY to the ADF in the reverse sequence of step 3.

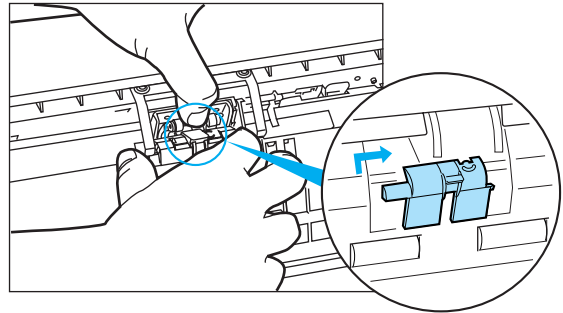

 **NOTE**

Fit the Pad ASSY pin into the larger hole, then slide it to the right until it stops.

- 5** Close the ADF.

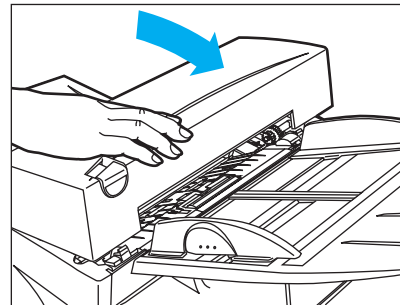

- 6** Reset the pad counter.

■ **The following shows the procedure for resetting the pad counter.**

- For Windows[®] 98 / Windows[®] Me / Windows[®] 2000 / Windows[®] XP

- 1) When turning on the power, check that the scanner is connected to your PC.
- 2) Open the [Scanners and Cameras] from the [Control Panel] of your PC.
- 3) Open the [Properties] of [fi-4340Cdj] from the [Scanners and Cameras]. The [fi-4340Cdj Properties] dialogbox appears

- 4) Click the "Device Set" tab.
The following screen appears.

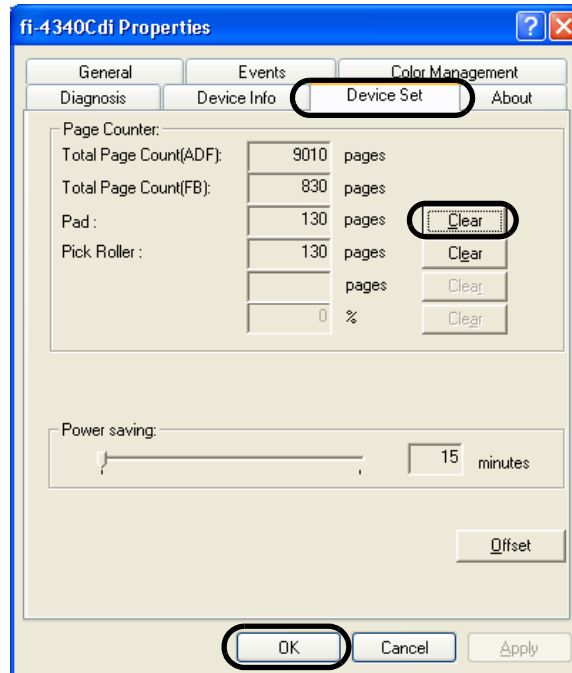

- 5) After clicking the [Clear] button beside the "Pad Counter" in "Page Counter", click the [OK] button.
The following screen is displayed

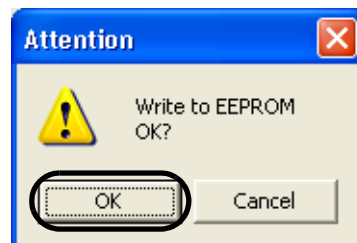

- 6) Click the [OK] button.
This returns the pad counter to "0".

- For Windows® 95 / Windows NT® 4.0

- 1) When turning on the power, check that the scanner is connected to your PC.
- 2) Right click the "FUJITSU Scanner Control Center" icon displayed in the task tray, then select "Option".
- 3) Click the "Device Setting" tab.
The following screen is displayed.

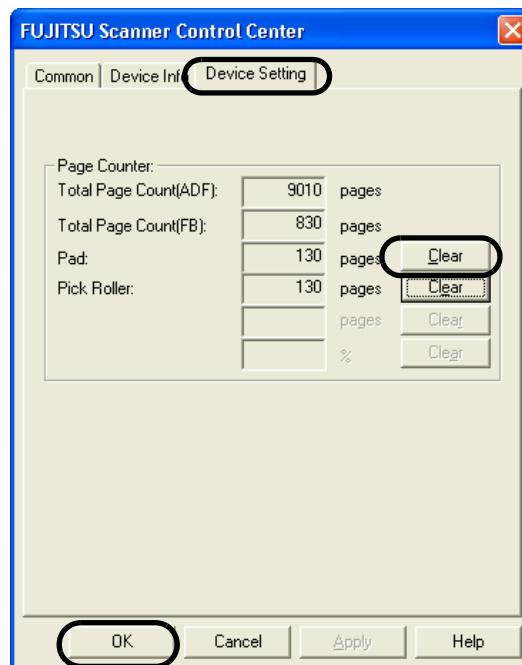

- 4) After clicking the [Clear] button beside "Pad" in "Page Counter", click the [OK] button.
The following screen is displayed.

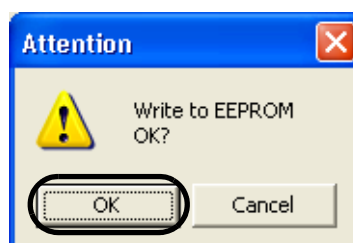

- 5) Click the [OK] button.
The Pad counter returns to "0".

Pick Roller

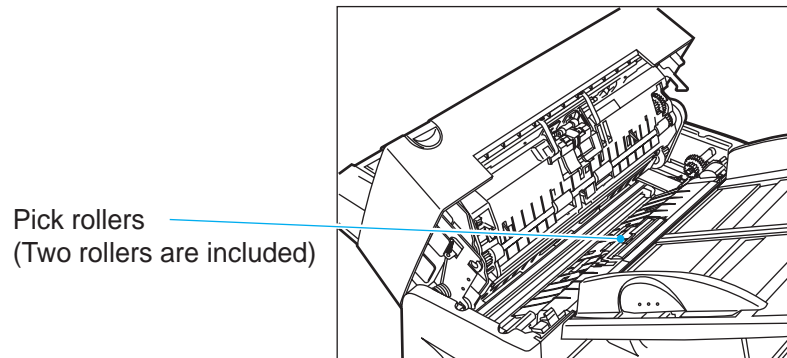

NOTE

The life span of the Pick roller is about 200, 000 sheets or one year.
Use the Abrasion counter on the operator panel to estimate when the Pick roller needs replacement.
The life span may be decreased by as much as half when carbonless sheets are frequently read.

WARNING

Turn off the power before replacing the Pick Rollers.

- 1** Pull the ADF lever to open the ADF.
- 2** With both hands, release the claws on the handles on the left and right of Guide A, and lift up Guide A to remove.

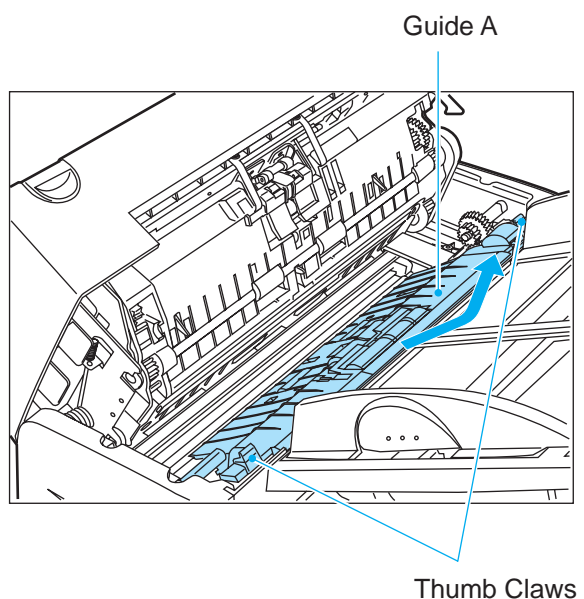

- 3** Place Guide A upside down, and rotate the Pick bearing to remove while releasing the claws of the Pick bearing on the gear-free side. (two bearings)

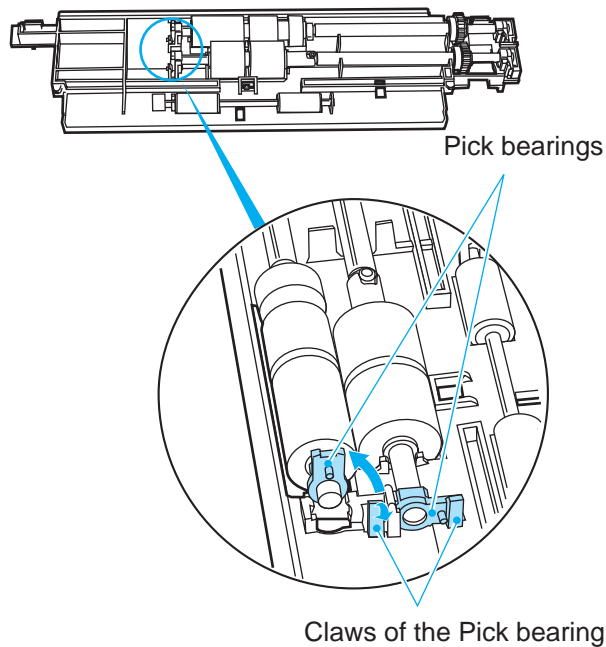

3

CAUTION

The Pick bearing is hard. Do not turn this bearing with your fingernails. Use a paper clip for turning the Pick bearing if you can not rotate it with your finger.

- 4** Lightly lift up the Pick shaft, and draw out the Pick roller to remove. (two rollers)

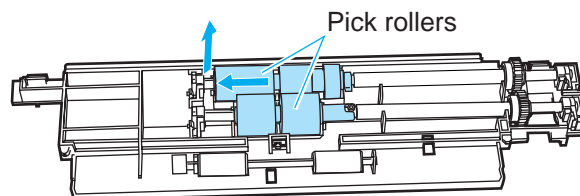

- 5** Insert the new Pick rollers with the notch aligned with the screw. (two rollers)

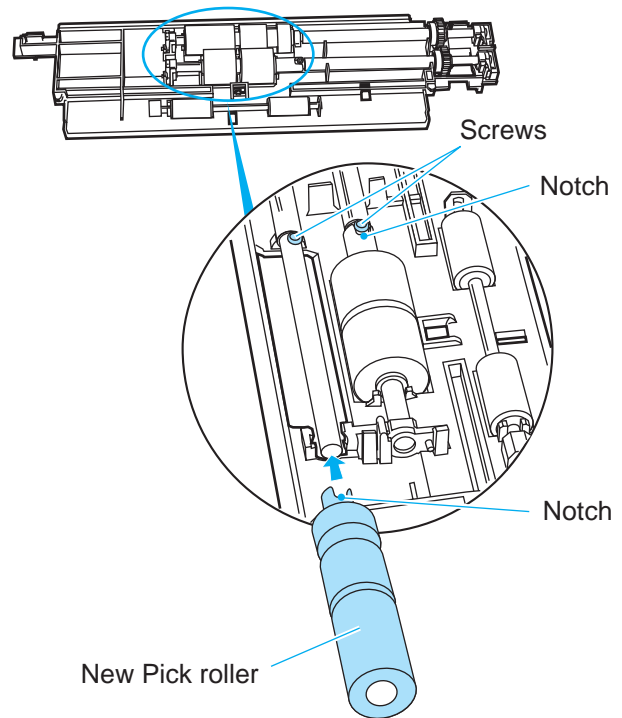

- 6** Pass the Pick shaft through the Pick bearing, and insert the Pick shaft into the groove of Guide A with the bearings upright. (two shafts)

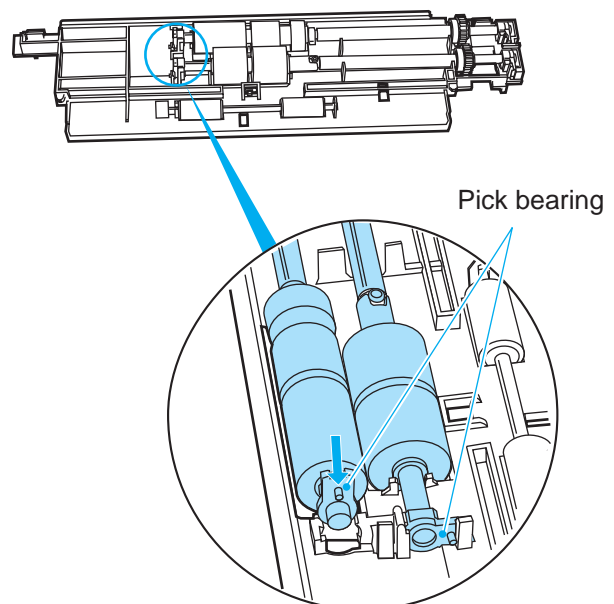

- 7** Rotate the Pick bearings, and lock the claws. (two claws)

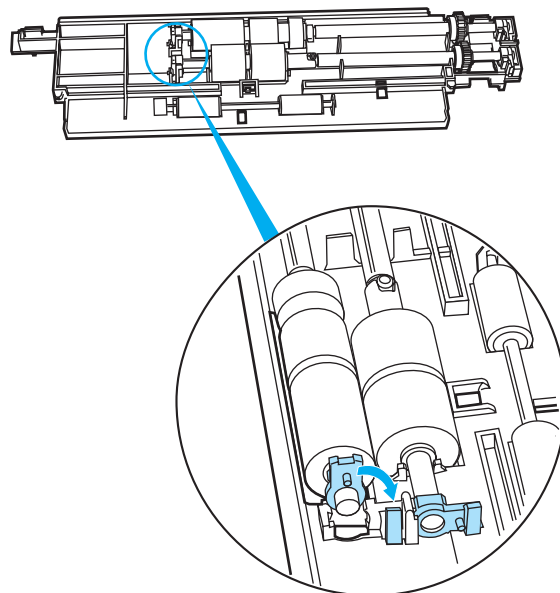

- 8** Attach Guide A in the reverse sequence of step 2 and insert the guide pin into the ADF unit's inner frame (hole) to fasten Guide A into place.

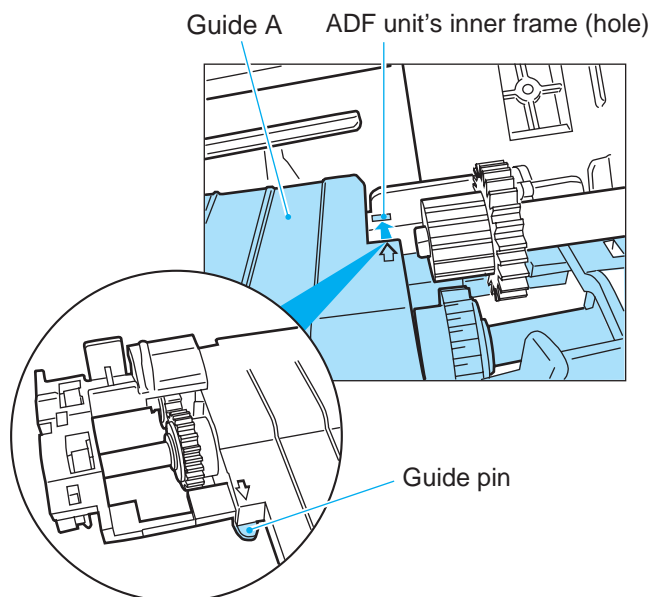

- 9** When attaching Guide A, make sure to fully insert it until you hear the thumb claws click into place.

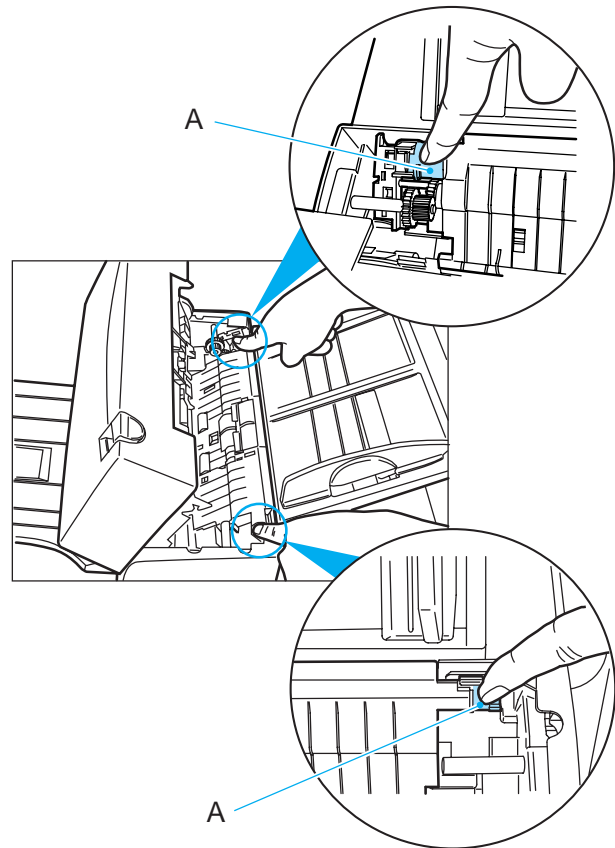

- 10** Close the ADF unit.

- 11** Reset the pick counter.

■ **The following shows the procedure for resetting the pick counter.**

- For Windows[®] 98 / Windows[®] Me / Windows[®] 2000 / Windows[®] XP

- 1) When turning on the power, check that the scanner is connected to your PC.
- 2) Open the [Scanners and Cameras] from the [Control Panel] of your PC.

- 3) Open the [Properties] of [fi-4340Cd] from the [Scanners and Cameras].
The [fi-4340Cd Properties] dialogbox appears
- 4) Click the "Device Set" tab.
The following screen appears.

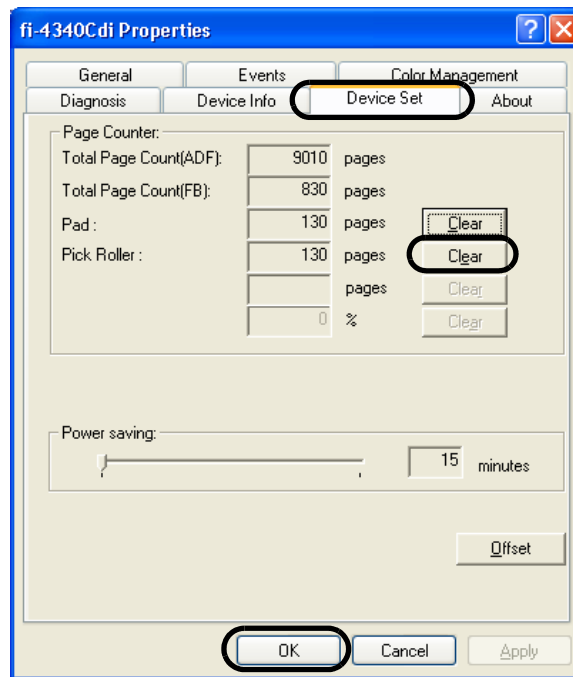

- 5) After clicking the [Clear] button beside the "Pick Counter" in "Page Counter", click the [OK] button.
The following screen is displayed

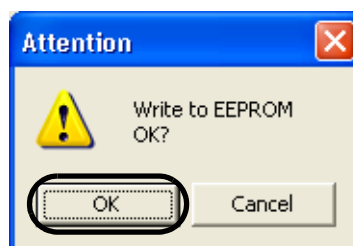

- 6) Click the [OK] button.
This returns the pick counter to "0".

- For Windows® 95 / Windows NT® 4.0

- 1) When turning on the power, check that the scanner is connected to your PC.
- 2) Right click the "FUJITSU Scanner Control Center" icon displayed in the task tray, then select "Option".
- 3) Click the "Device Setting" tab.
The following screen is displayed.

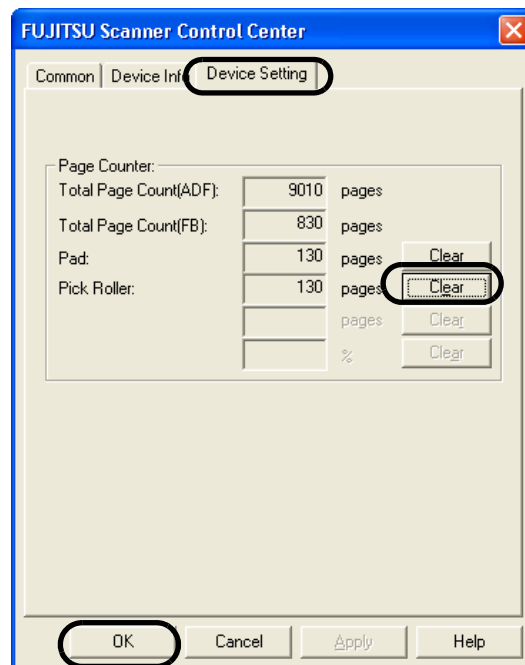

- 4) After clicking the [Clear] button beside "Pick Roller" in "Page Counter", click the [OK] button.
The following screen is displayed.

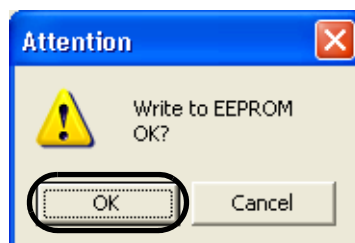

- 5) Click the [OK] button.
The Pick counter returns to "0".

TROUBLESHOOTING

This chapter describes how to clear paper jams and run initial checks. It also contains a Problem Checklist that should be completed before you call a service representative.

[Clearing Paper Jams](#)

[Trouble Shooting](#)

[Problem Checklist](#)

[Checking Labels on the Scanner](#)

Clearing Paper Jams

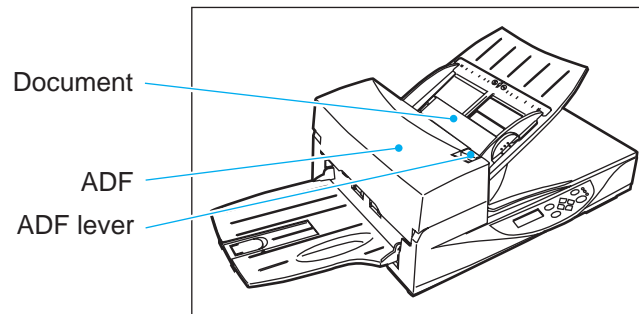

- 1** Remove all the documents from the ADF paper chute.
- 2** Pull the ADF lever to open the ADF.
- 3** Remove the jammed document(s).

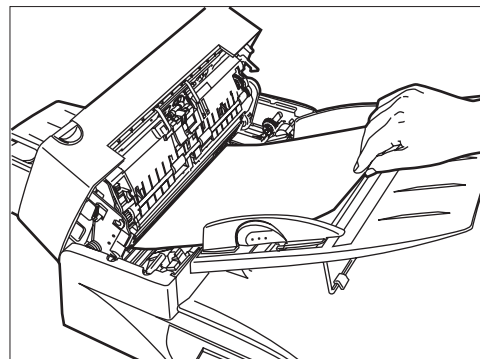

NOTES

- Inspect the paper and the paper path. Make sure no staples, paper clips or other materials caused the jam. All staples and paper clips should be removed from all documents before scanning.
 - Be careful not to pull the spring for the Pick roller while removing a jammed document.
-

- 4** Close the ADF.

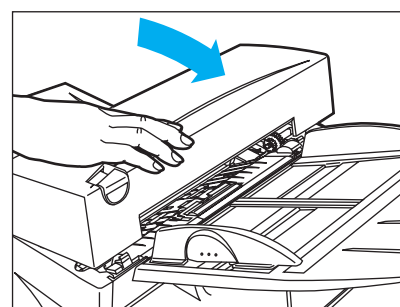

Trouble Shooting

If a problem occurs, check the following items before contacting the manufacturer's authorized service center.

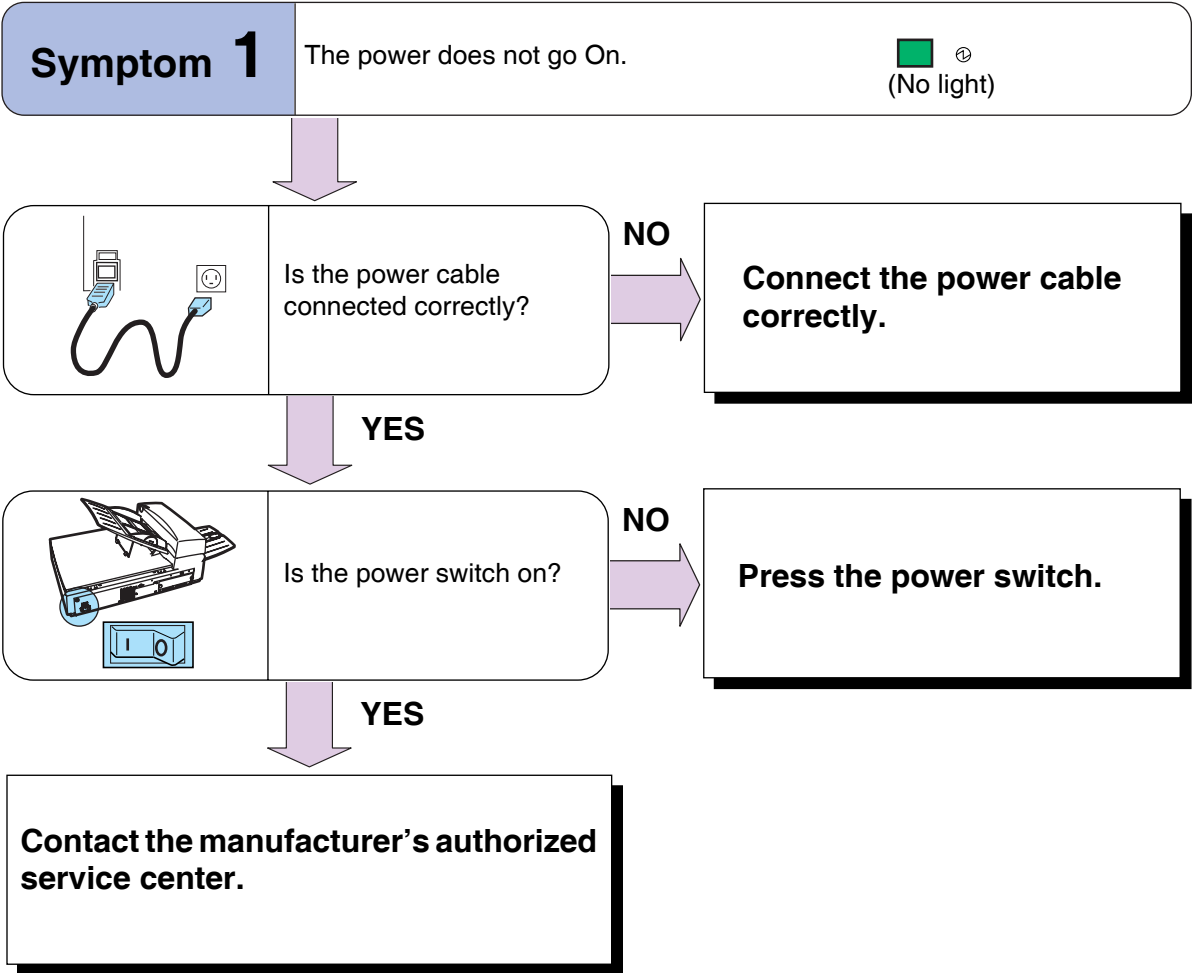

Symptom 2

The operator panel turns "Off".

Power "On"

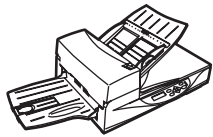

Has it been a long time since the scanner was last used?

YES

Press any button on the operator panel to wake up the system.

NO

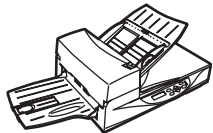

Did the scanner enter this state quickly?

YES

Extend the time for entering "Low Power Mode" in Set Up Mode.

NO

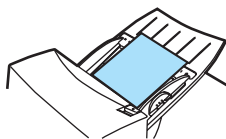

Did you load the paper on the ADF?

YES

Load the paper again, or press any button on the operator panel.

NO

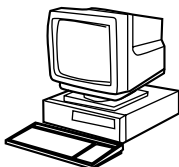

Have 10 seconds passed since the PC instructed a scan?

NO

Wait for at least 10 seconds.

YES

Contact the manufacturer's authorized service center.

Symptom 3

Read operation does not start.

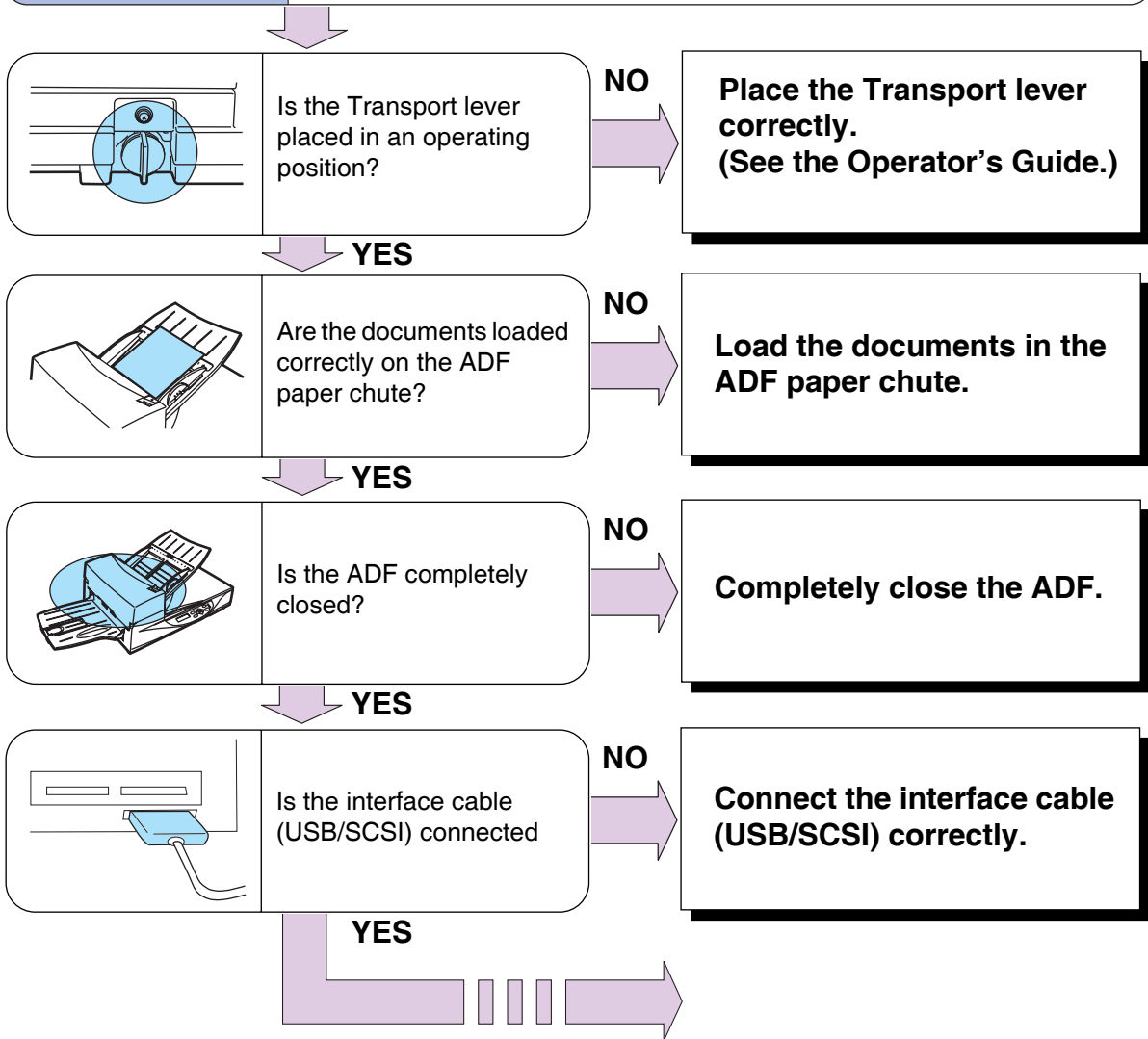

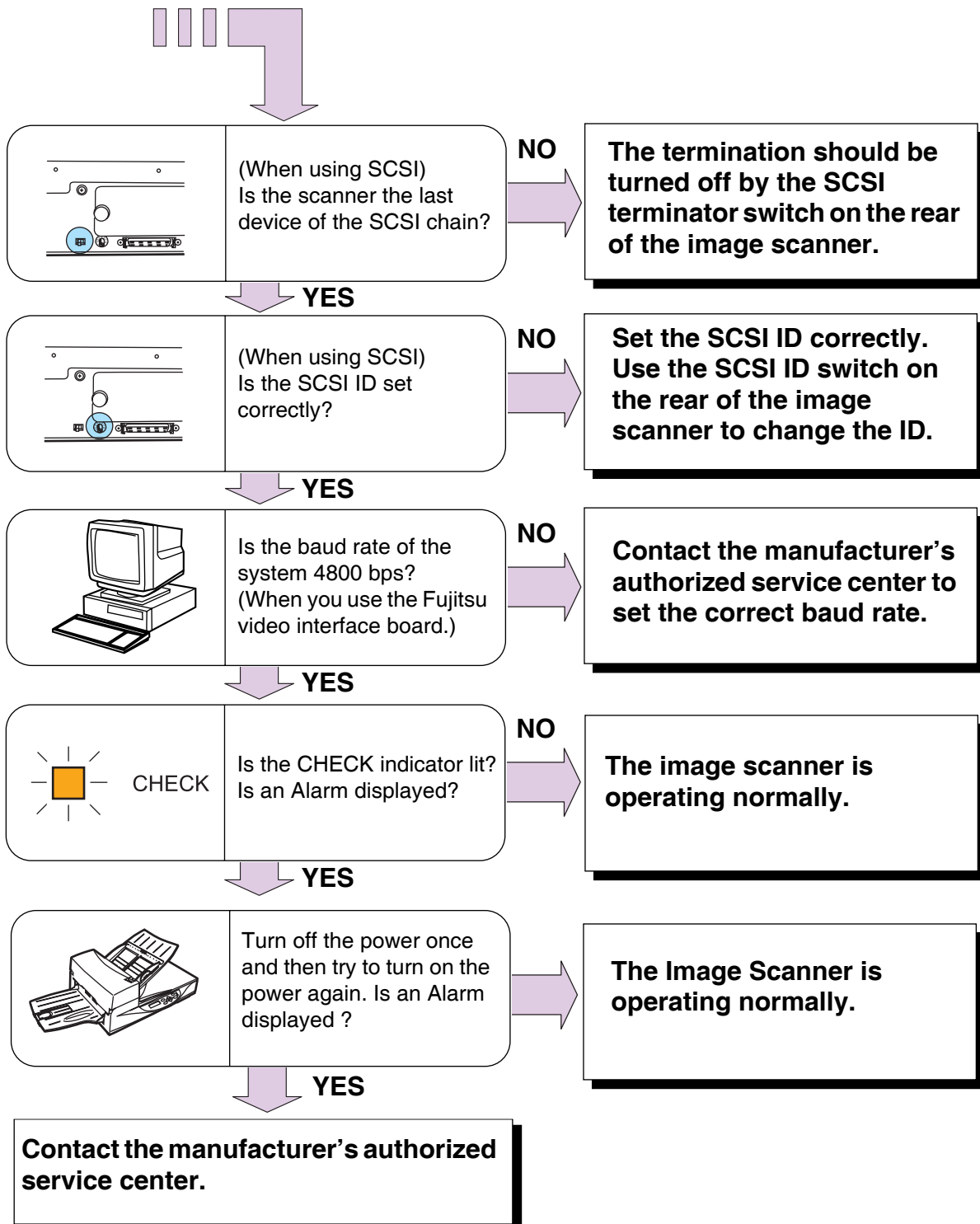

Symptom 4

Pictures and photographs are not read correctly.

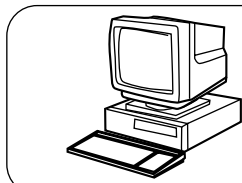

Is halftone or dither processing selected?

NO

Select the halftone or dithering mode from the host computer.

YES

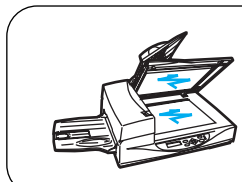

Are the Document bed, Document holding pad, glass, and sheet guides clean?

NO

Clean the dirty parts.
(See p. 17, p. 23)

YES

Contact the manufacturer's authorized service center.

Symptom 5

Quality of scanned texts or lines is unsatisfactory.

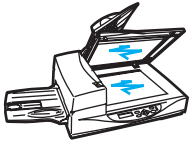

Are the Document bed, Document holding pad, glass, and sheet guides clean?

NO

Clean the dirty parts.
(See p. 17, p. 23)

YES

Contact the manufacturer's authorized service center.

Symptom 6

Images are distorted or unclear.

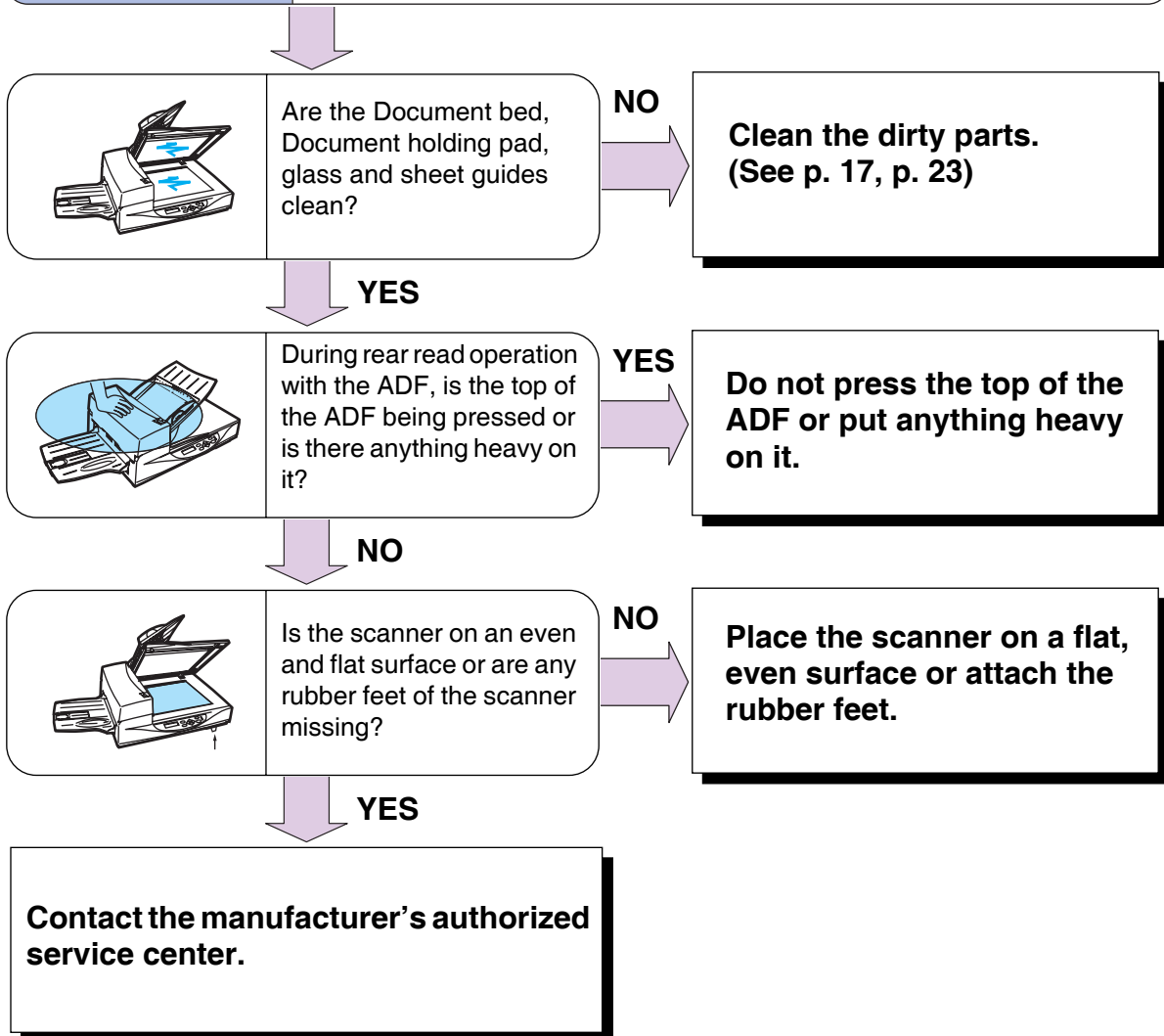

Symptom 7

Images have vertical lines.

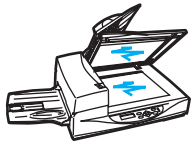

Did you scan the document using the Document bed?
Are the lines white?

YES

Contact the manufacturer's authorized service center.

NO

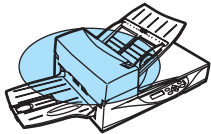

Are the lines black?

YES

Clean the ADF Glass.

NO

Contact the manufacturer's authorized service center.

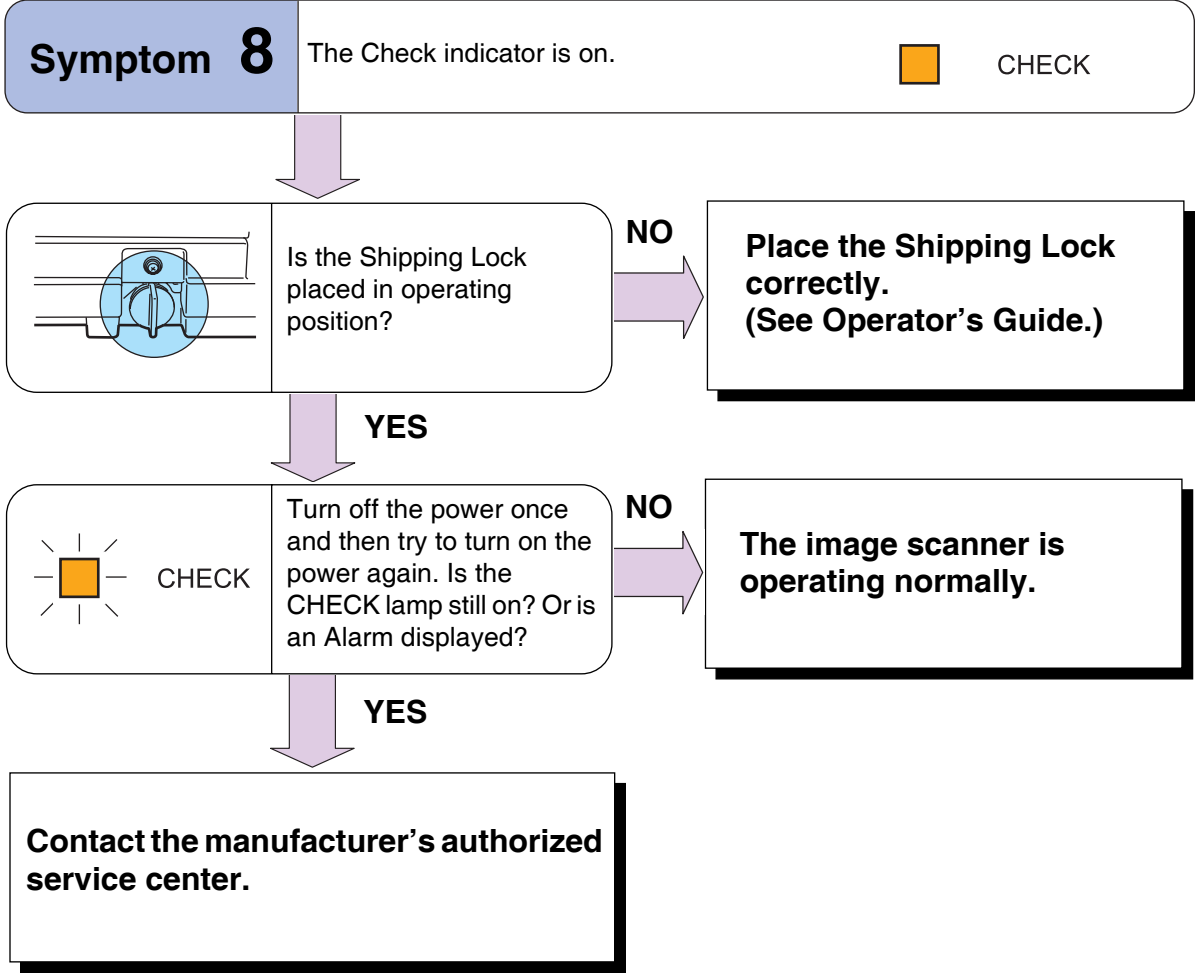

Symptom 9

"Clean Pickroller" is displayed.

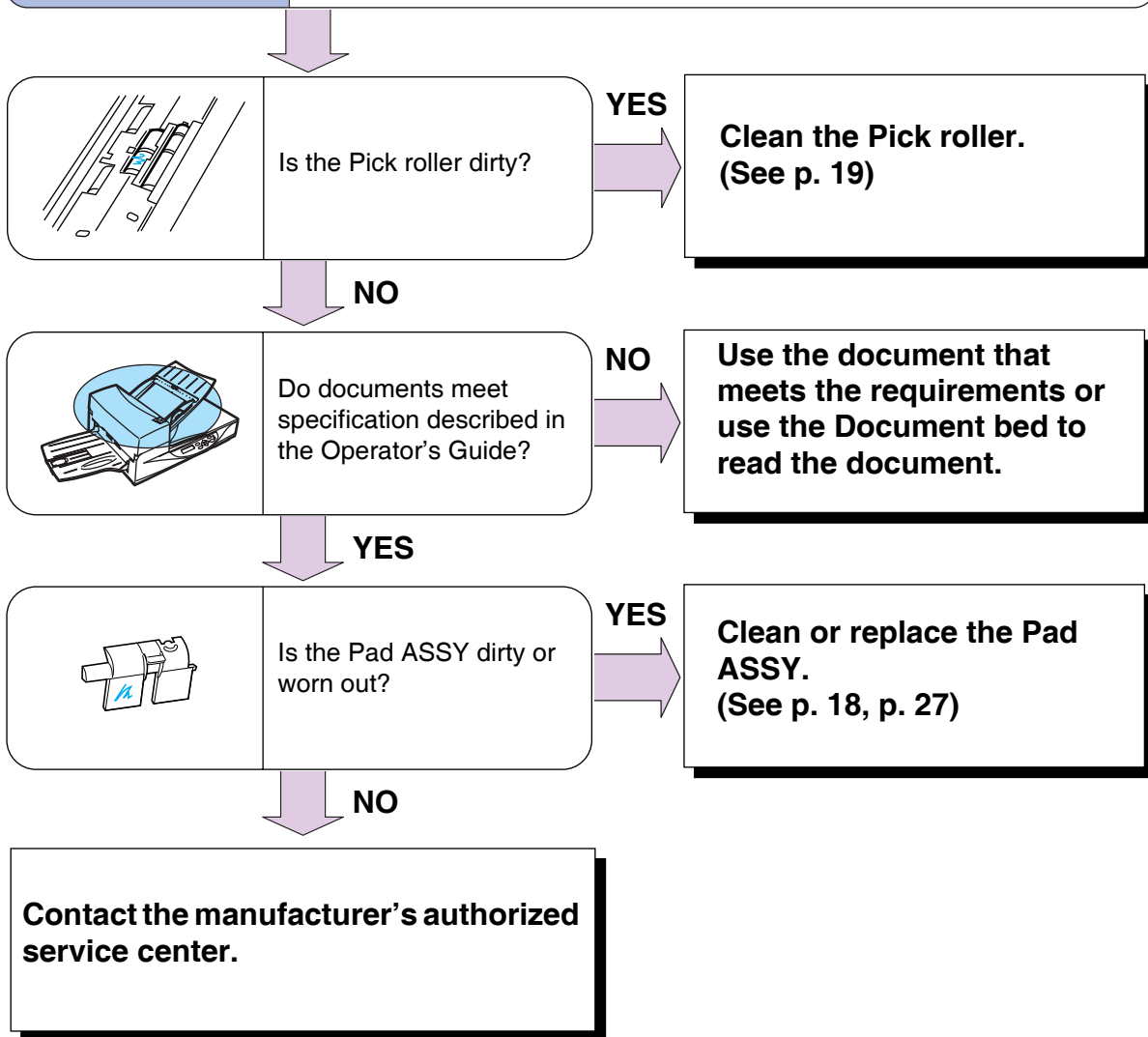

Symptom 10

Paper multi feed occurs frequently.

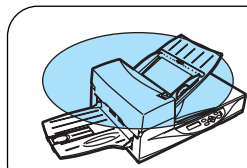

Does the condition of the documents meet the requirements described in the Operator's Guide?

NO

Flatten the curl or use the Document bed to read the documents.

YES

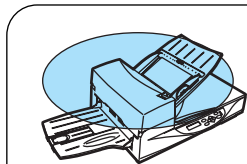

When multi feed detection is ON, are all the documents of the same length?

NO

Set multi feed detection to "Off". (See the Operator's Guide)

YES

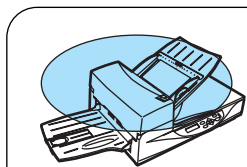

Are the documents fanned before being loaded on the ADF paper chute?

NO

Fan the documents before loading, or reduce the batch size.

YES

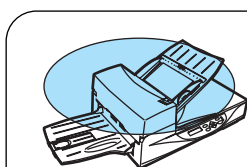

Have the documents recently been printed by copier or laser printer?

YES

Fan the stack 3 or 4 times to remove the static charge applied to the paper.

NO

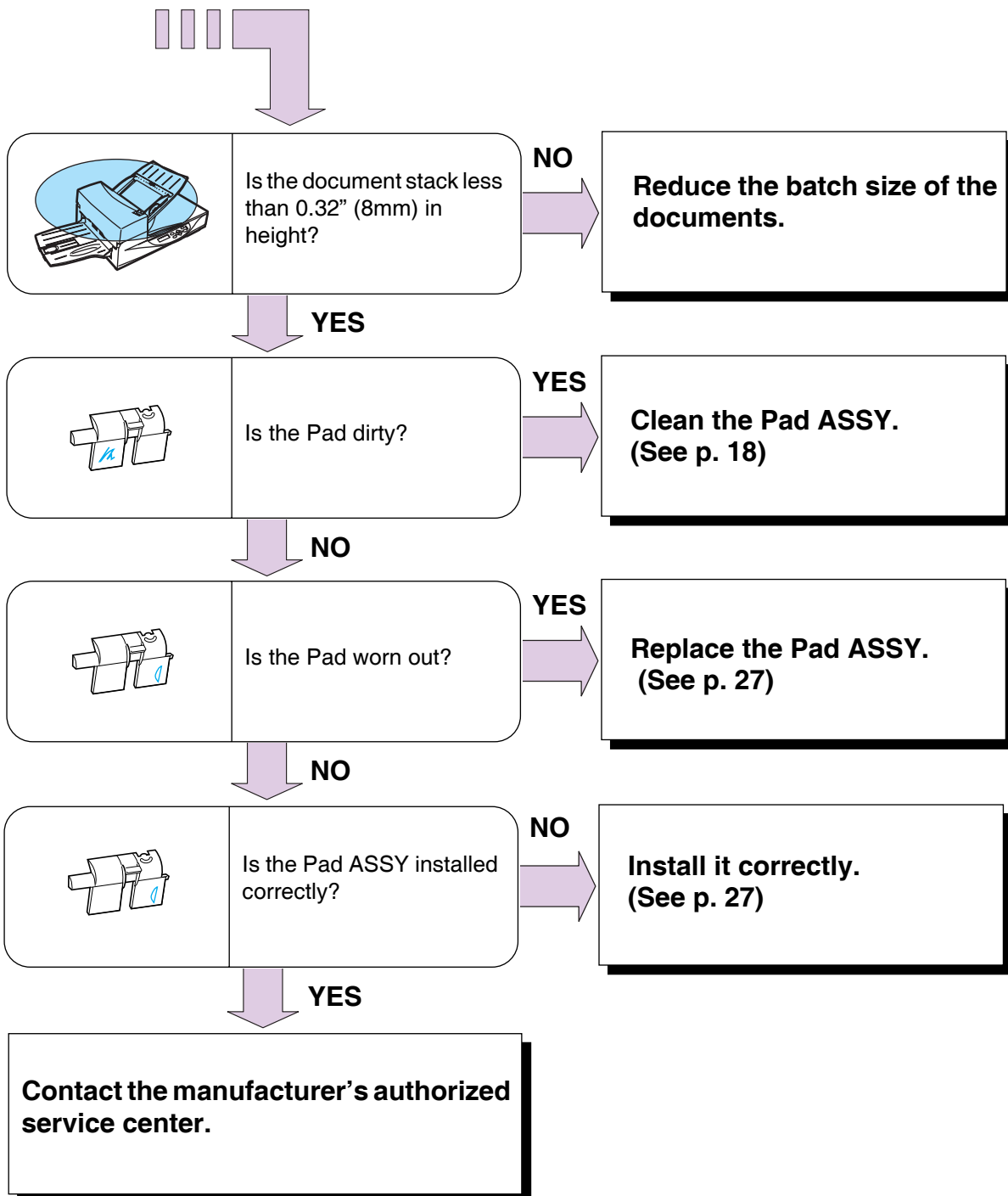

Symptom 11

Mispick occurs frequently.

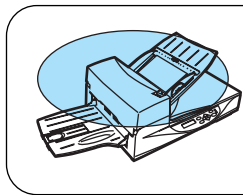

Do the conditions of the documents meet the requirements described in the Operator's Guide?

NO

Use the document that meet the requirements or use the Document bed to read the

YES

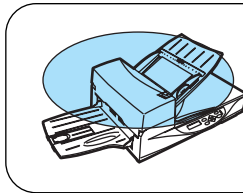

Have the documents been fanned before loading them on the ADF paper chute?

NO

Fan the documents before loading, or reduce the batch size.

YES

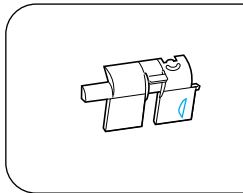

Is the Pad ASSY installed correctly?

NO

Install it correctly. (See p. 27)

YES

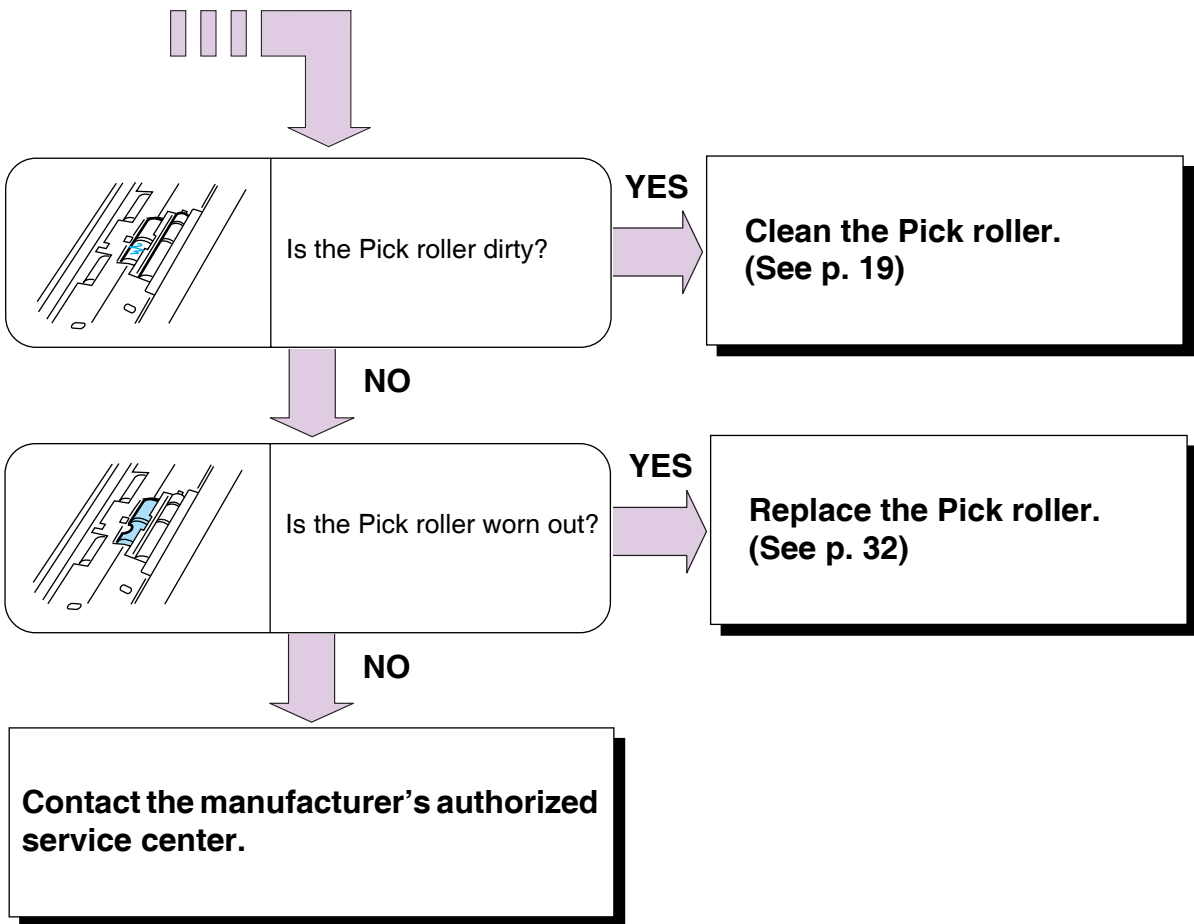

Symptom 12

Paper jams occur frequently.

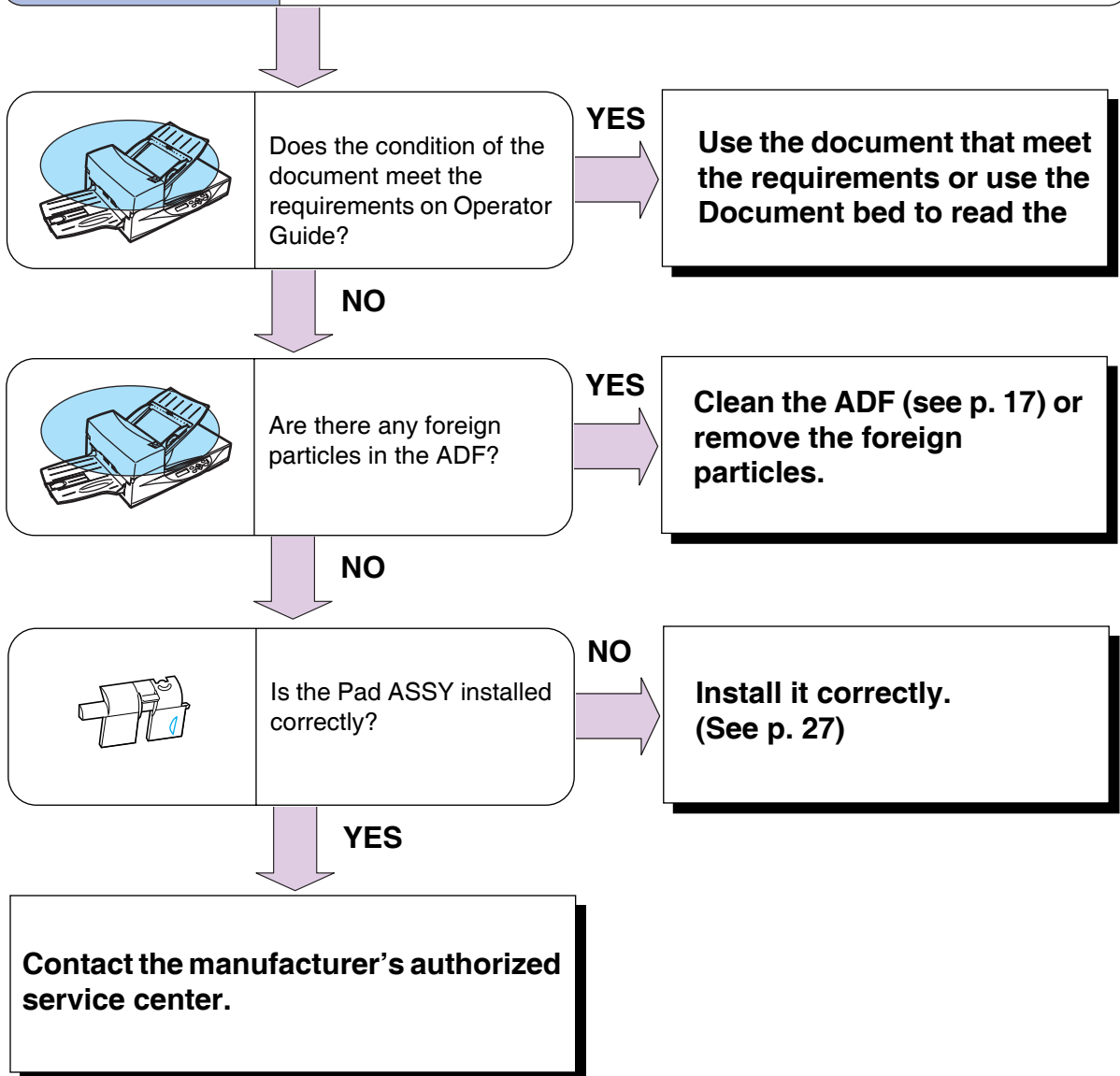

Symptom 13

“Clean ADF Glass” is displayed.

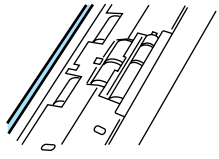

Is the ADF glass dirty?

YES

**Clean the ADF glass.
(See p. 18)**

NO

**Contact the manufacturer's authorized
service center.**

Problem Checklist

Check the following items before you contact the agent where you bought the scanner.

■ General Details

Item	findings
Model	(Example) fi-4340C For details on model, refer to "Checking Labels on the Scanner" on page 4-60.
Serial No.	(Example) 000001 For details on serial No., refer to "Checking Labels on the Scanner" on page 4-60.
Production date	(Example) 2004-10 (October, 2004) For details on production date, refer to "Checking Labels on the Scanner" on page 4-60.
Date of purchase	
Symptom	
Frequency of trouble	

■ **Problem at the time of personal computer connection**

Item	findings
OS	
Displayed error message	
Interface	(Example) SCSI interface
Interface controllers	(Example) made by Adaptec SCSI Card 2940AU

■ **Feed system trouble**

Item	findings
Document type	
Main purpose of use	
Last cleaning date	
Last consumables replacement date	
Operator panel status at trouble	

■ Imaging system trouble

Item	findings
Type and version of scanner driver	
Type of interface controller	(Example) made by Adaptec SCSI Card 2940Au
OS (Windows)	
Software application	(Example) ScandAll 21 (Example) Acrobat

■ Other

Item	findings
Can both the original document and scanner image be sent by e-mail or Fax?	

This section describes how to check the labels on the scanner.

■ Positions of Labels on the Scanner

The following shows where the two labels are located on the scanner.

Checking Labels on the Scanner

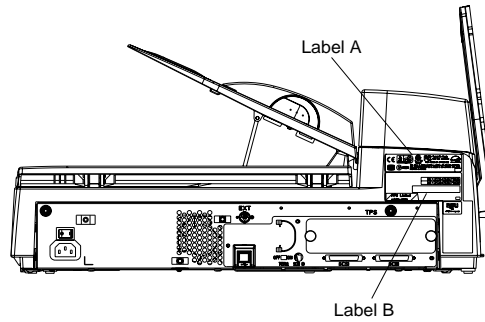

Label A (example): Indicates scanner conformity with various standards.

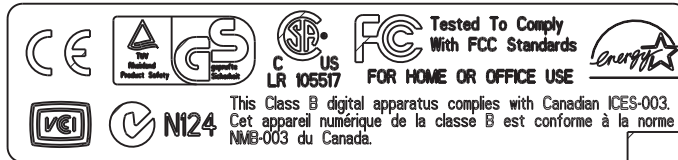

Label B (example): Indicates scanner information.



NOTE

Serial Number for dual interface (i.e. SCSI/USB) model is 700001 or later.

fi-4340C Image Scanner Cleaning and Maintenance

P3PC-E842-05EN

Date published: June, 2006

PFU LIMITED

- Copying of the contents of this manual in whole or in part and copying of the scanner application is forbidden under the copyright law.
- The contents of this manual are subject to change without notice.
- PFU LIMITED assumes no liability for incidental or consequential damages arising from the use of this manual, and any claims by a third party.