



Refrigerator

Contents

Appliance Registration	2	Power Saver Switch	5
Base Grille	4	Problem Solver	14, 15
Care and Cleaning	12, 13	Quick Serve System	7
Energy-Saving Tips	2	Quick Store	8
Food Saver System	9	Repair Service	13
Food Storage Suggestions	6, 9	Safety Instructions	3
Storage Times	6	Shelves	7, 8
Icemaker	11	Storage Drawers	9-11
Icemaker Accessory Kit	12	Drawer & Cover Removal	10
Ice Trays	12	Temperature Controls	5
Installation	3, 4	Vacation & Moving Tips	13
Adapter Plug	4	Warranty	Back Cover
Adjustable Rollers	4	Water Filter Accessory	12
Clearances	4		
Electrical Requirements	3, 4		
Extension Cord	4		
Grounding	3, 4		
Location	4		
Light Bulb Replacement	13	GE Answer Center®	
Model and Serial Numbers	2	800.626.2000	

Models **TBX20** **TBX24**
TBX21 **TBX25**
TBX22 **TBXW25**

GE Appliances

UC13

EXPDATE 10-13-89

49-6608

Help us help you...

Read this book carefully.

It is intended to help you operate and maintain your new refrigerator properly.

Keep it handy for answers to your questions.

If you don't understand something or need more help, write (include your phone number):

Consumer Affairs
GE Appliances
Appliance Park
Louisville, KY 40225

Write down the model and serial numbers.

You'll see them on a label at the bottom, just inside the fresh food compartment door.

These numbers are also on the Consumer Product Ownership Registration Card that came with your refrigerator.

Before sending in the registration card, please write these numbers here:

Model Number

Serial Number

Use these numbers in any correspondence or service calls concerning your refrigerator.

If you received a damaged refrigerator, immediately contact the dealer (or builder) that sold you the refrigerator.

Save time and money.

Before you request service, check the Problem Solver on pages 14 and 15. It lists causes of minor operating problems that you can correct yourself.

Energy-saving tips

- Location of your refrigerator is important. Avoid locating it next to your range, a heating vent or where the sun will shine directly on it.
- Don't open the doors more often than necessary.
- Close the doors as soon as possible, particularly in hot, humid weather.
- Keep power saver switch in the left position unless moisture forms on the outside of the refrigerator.
- Be sure the doors are closed tightly. Before leaving the house or retiring for the night, check to be sure the doors haven't been left open accidentally.
- Store only those foods requiring refrigeration in your refrigerator.
- Wipe moisture from bottles and cartons before putting them in the refrigerator.
- Keep foods covered to reduce moisture buildup inside the refrigerator.
- If you turn the controls to the coldest position for quick chilling or freezing, be sure to turn them back to regular settings.
- Don't overcrowd your refrigerator. Overcrowding can require extra electrical energy to keep everything cool.

IMPORTANT SAFETY INSTRUCTIONS

Read all instructions before using this appliance.

WARNING—When using this appliance, always exercise basic safety precautions, including the following:

• Use this appliance only for its intended purpose as described in this Use and Care Book.

• This refrigerator must be properly installed in accordance with the Installation Instructions before it is used. See grounding instructions below and on page 4.

• Never unplug your refrigerator by pulling on the power cord. Always grip plug firmly and pull straight out from the outlet.

• Repair or replace immediately all electric service cords that have become frayed or otherwise damaged. Do not use a cord that shows cracks or abrasion damage along its length or at either the plug or connector end.

• Do not allow children to climb, stand or hang on the shelves in the refrigerator. They could damage the refrigerator and seriously injure themselves.

• After your refrigerator is in operation, do not touch the cold surfaces, particularly when hands are damp or wet. Skin may adhere to these extremely cold surfaces.

• If your refrigerator has an icemaker, do not place fingers or hands on the automatic icemaking mechanism while the refrigerator is plugged in. This will help protect you from possible injury. It will also prevent interference with the moving parts of the ejector mechanism, or with the heating element that releases the cubes.

• When moving your refrigerator away from the wall, be careful not to roll over or damage the power cord.

• Don't refreeze frozen foods which have thawed completely. The United States Department of Agriculture in Home and Garden Bulletin No. 69 says:

"...You may safely refreeze frozen foods that have thawed if they still contain ice crystals or if they are still cold—below 40°F.

"...Thawed ground meats, poultry or fish that have any off-odor or off-color should not be refrozen and should not be eaten. Thawed ice cream should be discarded. If the odor or color of any food is poor or questionable, get rid of it. The food may be dangerous to eat.

"Even partial thawing and refreezing reduce the eating quality of foods, particularly fruits, vegetables and

prepared foods. The eating quality of red meats is affected less than that of many other foods. Use refrozen foods as soon as possible to save as much of their eating quality as you can!"

• If your old refrigerator is still around the house but not in use, be sure to remove the doors. This will reduce the possibility of danger to children.

• Unplug your refrigerator:

A. Before making any repairs. Note: We strongly recommend that any servicing be performed by a qualified individual.

B. Before cleaning.

C. Before replacing a burned-out light bulb, the refrigerator should be unplugged in order to avoid contact with a live wire filament. (A burned-out light bulb may break when being replaced.) Note: Turning control to OFF position does not remove power to the light circuit.

• Do not operate your refrigerator in the presence of explosive fumes.

SAVE THESE INSTRUCTIONS

Installation Requirements—IMPORTANT... Please Read Carefully.

How to connect electricity

For personal safety, this appliance must be properly grounded.

The power cord of this appliance is equipped with a three-prong (grounding) plug which mates with a standard three-prong (grounding) wall outlet (Fig. 1) to minimize the possibility of electric shock hazard from this appliance.

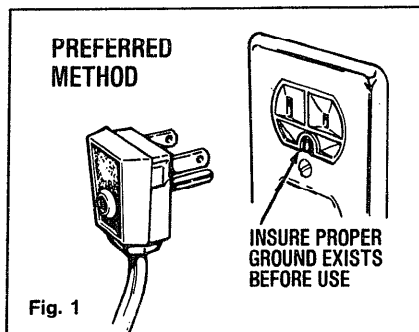

Have wall outlet and circuit checked by a qualified electrician to make sure outlet is properly grounded.

Where a standard two-prong wall outlet is encountered, it is your personal responsibility and obligation to have it replaced with a properly grounded three-prong wall outlet.

DO NOT, UNDER ANY CIRCUMSTANCES, CUT OR REMOVE THE THIRD (GROUND) PRONG FROM THE POWER CORD.

(continued next page)

Installation Requirements (continued)—IMPORTANT... Please Read Carefully.

Use of adapter plug

Because of potential safety hazards under certain conditions, we strongly recommend against use of an adapter plug. However, if you still elect to use an adapter, where local codes permit, a **TEMPORARY CONNECTION** may be made to a properly grounded two-prong wall outlet by use of a UL listed adapter (Fig. 2) available at most local hardware stores.

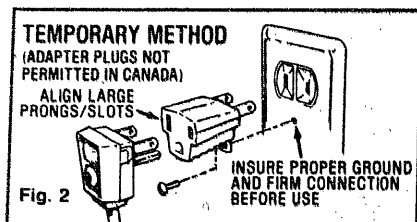

The larger slot in the adapter must be aligned with the larger slot in the wall outlet to provide proper polarity in the connection of the power cord.

CAUTION: Attaching an adapter ground terminal to the wall outlet cover screw does not ground the appliance unless the cover screw is metal, and not insulated, and the wall outlet is grounded through the house wiring. You should have circuit checked by a qualified electrician to make sure the outlet is properly grounded.

When disconnecting the power cord from the adapter, always hold the adapter with one hand. If this is not done, the adapter ground terminal is very likely to break with repeated use.

Should the adapter ground terminal break, **DO NOT USE** the appliance until a proper ground has again been established.

Use of extension cords

Because of potential safety hazards under certain conditions, we strongly recommend against the use of an extension cord. However, if you still elect to use an extension cord, it is absolutely necessary that it be a UL listed 3-wire grounding type appliance extension cord having

a grounding type plug and outlet and that the electrical rating of the cord be 15 amperes (minimum) and 120 volts.

The refrigerator should always be plugged into its own individual electrical outlet— (115 volt, 60 Hertz, or 100 volt, 50 Hertz, single phase AC). This is recommended for best performance and to prevent overloading house wiring circuits, which could cause a fire hazard from overheating wires.

Refrigerator location

Install the refrigerator on a floor strong enough to support it when it is fully loaded.

Do not install refrigerator where temperature will go below 60°F. because it will not run often enough to maintain proper temperatures.

Also see Energy-Saving Tips regarding location.

Clearances

Allow the following clearances for ease of installation and proper air circulation:

Sides	3/4"
Top	1"
Back	1"

If model TBX22Z, TBX25Z or TBXW25Z is to be installed against a wall on the hinge side, allow 1½" for door clearance.

Water Supply to Icemaker (on models so equipped)

If your refrigerator has an icemaker, or if you plan to add an icemaker later, the icemaker will have to be connected to a cold water line. A water supply kit containing copper tubing, shut-off valve, fittings and instructions is available at extra cost from your dealer. There should be sufficient tubing for the icemaker from the cold water supply to allow moving the refrigerator out from the wall several feet (approximately 8 feet of 1/4" copper tubing in three 10-inch diameter coils).

Rollers

Adjustable rollers, which enable you to move the refrigerator away from the wall for cleaning, are located near the front corners of the refrigerator. These rollers should be set so that the refrigerator is firmly positioned on the floor and the front is raised just enough that the doors close easily when opened about halfway.

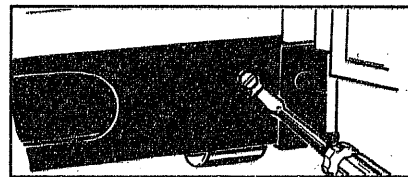

To adjust the rollers, turn the roller adjusting screws clockwise to raise the refrigerator, counterclockwise to lower it. Use a blade-type screwdriver.

When adjusting front rollers for proper door closure, we recommend that the bottom front edge of the cabinet be approximately 3/4" from the floor.

If your refrigerator has a base grille, you can turn the adjusting screws through openings in the grille.

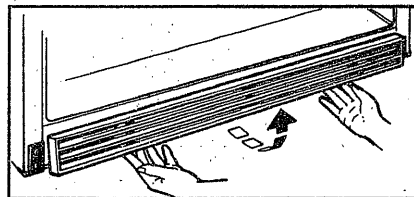

If you would rather remove the base grille, grasp the bottom of the grille and pull it out.

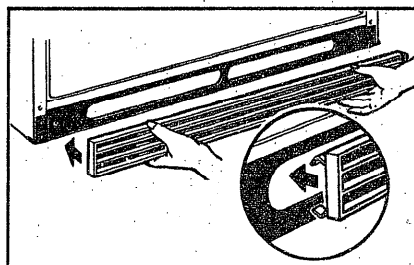

To replace the base grille, line up the clips on the back of the grille with the openings in the baseplate and push the grille forward until it snaps into place.

Operating Your Refrigerator

Set Temperature Controls

Your refrigerator has two controls that let you regulate the temperature in the fresh food and freezer compartments.

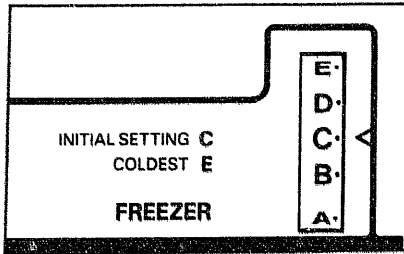

The freezer control has settings from "A" (the warmest) to "E" (the coldest). Initially set the freezer control at "C."

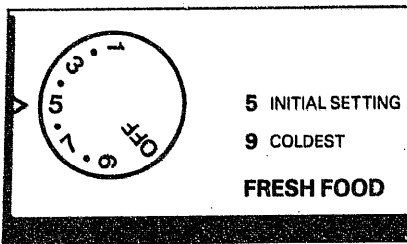

The fresh food control has settings from "1" (the warmest) to "9" (the coldest) and "OFF." Initially set the fresh food control at "5."

For colder or warmer temperatures, adjust the desired compartment control one number at a time.

IMPORTANT: When initially setting controls, or adjusting them, allow 24 hours for temperatures to stabilize, or even out.

Note: Turning the fresh food control to "OFF" position stops cooling in *both* compartments—fresh food *and* freezer—but does not shut off power to refrigerator.

How to Test Temperatures

Use the milk test for the fresh food compartment. Place a container of milk on the top shelf in the fresh food compartment. Check it a day later. If the milk is too warm or too cold, adjust the temperature controls.

Use the ice cream test for the freezer compartment. Place a container of ice cream in the center of the freezer compartment. Check it after a day. If it's too hard or too soft, adjust the temperature controls.

Always allow 24 hours for the refrigerator to reach the temperature you set.

If you turn your household thermostat below 60°F. at night

...you may want to turn the lettered control one step colder, as from "C" to "D." Cooler temperatures in the house may cause the compressor to operate less frequently, thus allowing the freezer compartment to warm somewhat. To protect your frozen food supply, leave your lettered setting at this colder setting for the entire winter or for whatever period of time you are turning down your thermostat. This is especially important when the thermostat is turned down for an extended period.

This change should have no effect on your fresh food compartment. However, if freezing occurs, turn the numbered control one step warmer, as from "5" to "4."

When you stop turning the thermostat down, turn temperature controls back to their regular settings.

Power Saver Switch

The power saver switch is located on the temperature control panel.

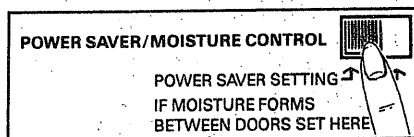

To reduce the amount of electricity required to operate your refrigerator, push switch to the left position.

This turns off the heater in your refrigerator that prevents moisture from forming on the cabinet surface between the doors.

With the heater turned off, there is a chance that moisture may form on the outside of your refrigerator, especially when the weather is humid. The humidity is most likely to be high in the summer, in the early morning hours, and in homes which are not air conditioned.

Over an extended period of time, moisture that forms on the cabinet surface may cause deterioration of the paint finish. It will be important to protect the finish by using appliance polish wax as described on page 12.

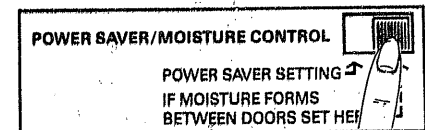

When the power saver switch is pushed to the right, electricity flows through the low wattage heater which warms the cabinet surface between the doors and, under most conditions, prevents the forming of moisture or water droplets.

No Defrosting

It is not necessary to defrost the freezer or fresh food compartments. Although your refrigerator is designed and equipped to defrost itself automatically, some frost on packages is normal.

Food Storage Suggestions

Suggested storage times for meat and poultry*

Eating quality drops after time shown	DAYS IN REFRIGERATOR AT 35° to 40°F.	MONTHS IN FREEZER AT 0°F.
	Fresh Meats	
Roasts (Beef & Lamb)	3 to 5	6 to 12
Roasts (Pork & Veal)	3 to 5	4 to 8
Steaks (Beef)	3 to 5	6 to 12
Chops (Lamb)	3 to 5	6 to 9
Chops (Pork)	3 to 5	3 to 4
Ground & Stew Meats	1 to 2	3 to 4
Variety Meats	1 to 2	3 to 4
Sausage (Pork)	1 to 2	1 to 2
Processed Meats		
Bacon	7	1
Frankfurters	7	½
Ham (Whole)	7	1 to 2
Ham (Half)	3 to 5	1 to 2
Ham (Slices)	3	1 to 2
Luncheon Meats	3 to 5	Freezing not recommended.
Sausage (Smoked)	7	
Sausage (Dry & Semi-Dry)	14 to 21	
Cooked Meats		
Cooked Meats and Meat Dishes	3 to 4	2 to 3
Gravy & Meat Broth	1 to 2	2 to 3
Fresh Poultry		
Chicken & Turkey (Whole)	1 to 2	12
Chicken (Pieces)	1 to 2	9
Turkey (Pieces)	1 to 2	6
Duck & Goose (Whole)	1 to 2	6
Giblets	1 to 2	3
Cooked Poultry		
Pieces (Covered with Broth)	1 to 2	6
Pieces (Not Covered)	3 to 4	1
Cooked Poultry Dishes	3 to 4	4 to 6
Fried Chicken	3 to 4	4
(Other than for meats & poultry) FREEZER		
Most fruits and vegetables		8-12 months
Lean fish		6-8 months
Fatty fish, rolls and breads, soups, stew, casseroles		2-3 months
Cakes, pies, sandwiches, leftovers (cooked), ice cream (original carton)		1 month max.

New techniques are constantly being developed. Consult the College or County Extension Service or your local Utility Company for the latest information on freezing and storing foods.

*U.S. Department of Agriculture

Meats, fish and poultry purchased from the store vary in quality and age; consequently, safe storage time in your refrigerator will vary.

To store unfrozen meats, fish and poultry:

- Always remove store wrappings.
- Rewrap in foil, film or wax paper and refrigerate immediately.

To store cheese, wrap well with wax paper or aluminum foil, or put in a plastic bag.

- Carefully wrap to expel air and help prevent mold.

- Store pre-packaged cheese in its own wrapping if you wish.

To store vegetables, use the vegetable drawers—they've been designed to preserve the natural moisture and freshness of produce.

- Covering vegetables with a moist towel helps maintain crispness.

- As a further aid to freshness, pre-packaged vegetables can be stored in their original wrapping.

Note: Special fresh food compartment drawers (on models so equipped) make it unnecessary to wrap certain foods which they've been designed to preserve. These drawers are described on pages 9 and 11.

To store ice cream—Fine-quality ice cream, with high cream content, will normally require slightly lower temperatures than more "airy" already-packaged brands with low cream content.

- It will be necessary to experiment to determine the freezer compartment location and temperature control setting to keep your ice cream at the right serving temperature.

- The rear of the freezer compartment is slightly colder than the front.

Tips on freezing foods

There are three essential requirements for efficient home freezing.

1. Initial quality. Freeze only top-quality foods. Freezing retains quality and flavor; it cannot improve quality.

2. Speed. The quicker fruits and vegetables are frozen after picking, the better the frozen product will be. You'll save time, too, with less culling and sorting to do.

3. Proper packaging. Use food wraps designed especially for freezing; they're readily available at most food stores.

To freeze meat, fish and poultry, wrap well in freezer-weight foil (or other heavy-duty wrapping material) forming it carefully to the shape of the contents. This expels air. Fold and crimp ends of the package to provide a good, lasting seal.

Don't refreeze meat that has completely thawed; meat, whether raw or cooked, can be frozen successfully only once.

Limit freezing of fresh (unfrozen) meats or seafoods to number of pounds at a time as follows:
TBX20, TBX21, TBX22 19
TBX24, TBX25, TBXW25 22

For convenience . . .

- Store like things together. This saves both time and electricity because you can find foods faster.

- Place the oldest items up front so they can be used up promptly.

- Use shelves or bins on the door for most often used sauces and condiments.

- Use the meat drawer, on models so equipped, for temporary storage of meats you do not freeze.

To save money in energy and food costs

- Place most perishable items, such as milk, cream or cottage cheese, toward the rear of the top shelf, as they will stay coldest in this part of the fresh food compartment.

- Cover moist foods with tight lids, plastic film or foil.

- Leaf vegetables and fruits placed in drawers will last longer when stored in closed plastic containers or wrapped in plastic film.

- Do not overload your fresh food or freezer compartment with a lot of warm food at once.

- Open the door the fewest times possible to save electrical energy.

- When going out of town for several days, leave as few perishables as possible in the refrigerator. If your refrigerator has an icemaker, move the icemaker feeler arm to the OFF (up) position and shut off water to the refrigerator.

Shelf Positions

How to rearrange your shelves

Adjustable Shelves (on models so equipped)

Shelves in the fresh food and freezer compartments are adjustable, enabling you to make efficient shelf arrangements to fit your family's food storage needs. Steel shelves in the freezer compartment in some models are adjustable in the same way.

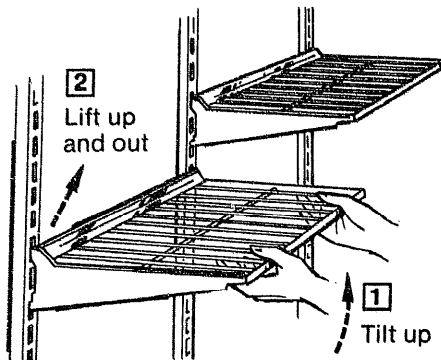

To remove shelves: Tilt shelf up at front, then lift it up and out of tracks on rear wall of refrigerator.

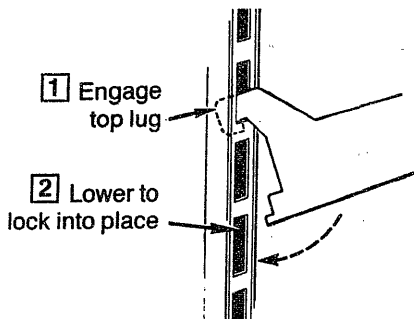

To replace shelves: Select desired shelf height. With shelf front raised slightly, engage top lugs in tracks at rear of cabinet. Then lower front of shelf until it locks into position.

Tempered glass shelves (on models so equipped) are adjustable in the same manner.

Two-Position Shelf (on models so equipped)

Some models have a two-position freezer-compartment shelf that can be placed on another set of shelf supports to provide extra storage flexibility.

Quick Serve™ System

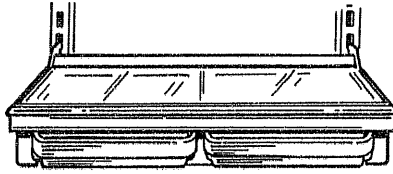

Cooking-serving-storage dishes with sealable, durable lids fit into a space-saving under-the-shelf rack. Dishes can be removed from and returned to the rack as needed, and the rack (and shelf to which it is attached) can be relocated anywhere in the fresh food compartment.

Dishes and lids are safe for use in microwave ovens, refrigerators, freezers, and are dishwasher-safe.

Quick Serve™ dishes only are safe for use in conventional ovens at temperatures up to 400°F.

CAUTION:

- Lids cannot withstand the heat generated in conventional ovens.
- Dishes and lids are not designed for range top cooking or broiler use. Such use can be hazardous.

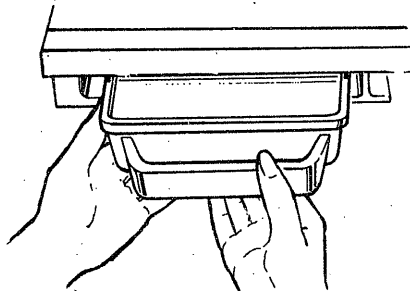

• **Note:** Reach in and support the rear of the tray with one hand when pulling the tray out past the second "stop" location. Otherwise the tray may slip out of your grasp and dishes may fall out of the tray.

Porta-Bins on the Doors (on models so equipped)

Adjustable Porta-Bins on fresh food and freezer compartment doors can easily be carried from the refrigerator to the work area.

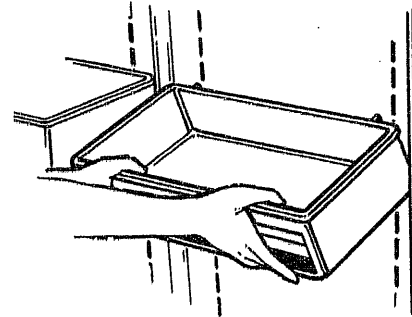

To remove: Lift Porta-Bin straight up until mounting hooks disengage.

To relocate: Select desired shelf height, engage Porta-Bin's hooks in slots on the tracks of the door, and push in and down. Porta-Bin will hook in place.

Snuggers (on models so equipped)

Snuggers are designed to give you storage flexibility in Porta-Bins and on your fresh food door shelves. Items such as salad dressings, steak sauces and other condiments can now be kept securely against the door liner to help prevent tipping, spilling or sliding.

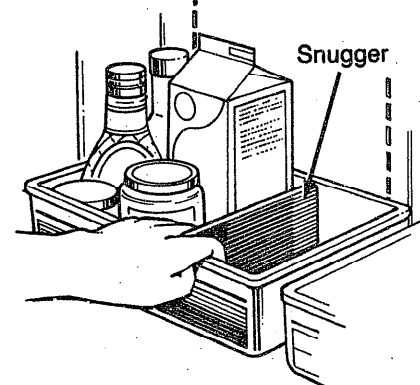

Place index finger and middle finger on either side of the snigger near the front and simply move it back and forth to fit your needs.

Shelf Positions (continued)

Quick Store Bin (on models so equipped)

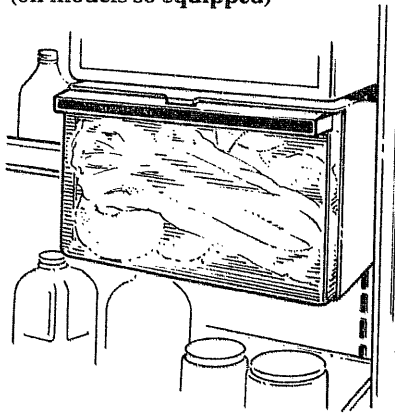

This removable tilt-out bin made of Lexan® polycarbonate resin can be located on the fresh food or freezer compartment door. It has been designed for convenient storage of those frequently-used items that do not fit easily into a Porta-Bin or soon-to-be-used items that require covered storage to keep from drying out.

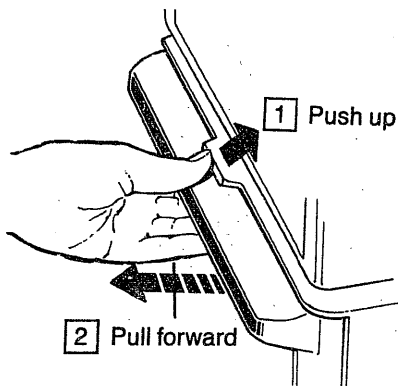

To open, push the latch up and pull the bin handle forward.

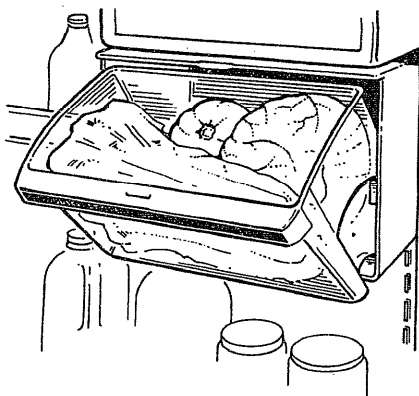

To avoid damaging the refrigerator, make sure the bin is closed and latched before closing the refrigerator door.

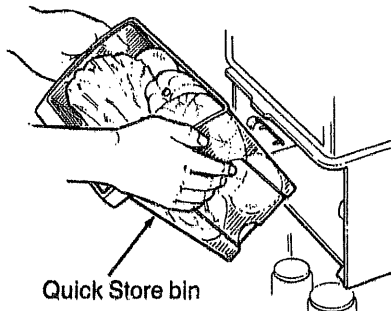

To remove the bin, lift it up and out of the bin housing.

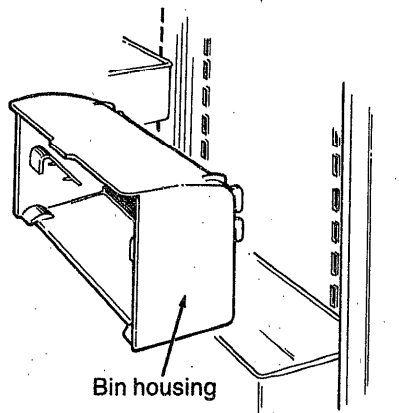

To relocate the Quick Store unit, lift the bin housing up and out of the slots on the door, move it to the desired new location, and lower the hooks on the housing into the slots on the door. You do not have to remove the bin from the housing when relocating the Quick Store unit.

Two-Position Shelf in Freezer Compartment (on models so equipped)

The shelf in the freezer compartment can be relocated for extra storage flexibility.

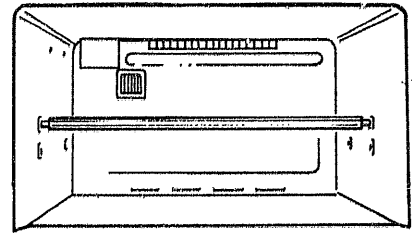

To relocate the shelf, lift one side and move it sideways to free the ends of the shelf from the holes in the walls. Then tilt the shelf and take it out. To reinstall the shelf, first insert one end and then the other into the second set of holes.

Sealed Snack Pan (on models so equipped)

The Sealed Snack Pan—and the shelf to which it is attached—can be relocated within the fresh food compartment.

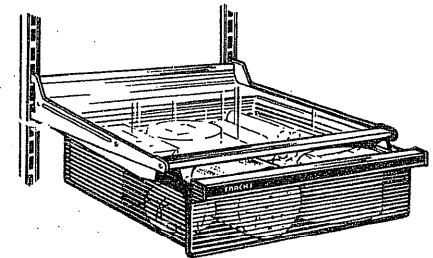

The sealed drawer retains high humidity for the convenient storage of meats and cheese, bacon, hors d'oeuvres, spreads and snacks.

GE Food-Saver System

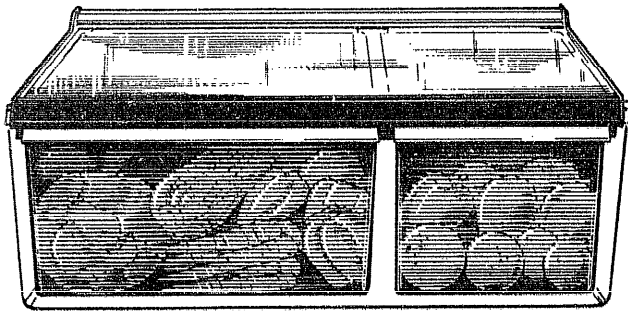

Moist'n Fresh Drawer

Cool'n Fresh Drawer

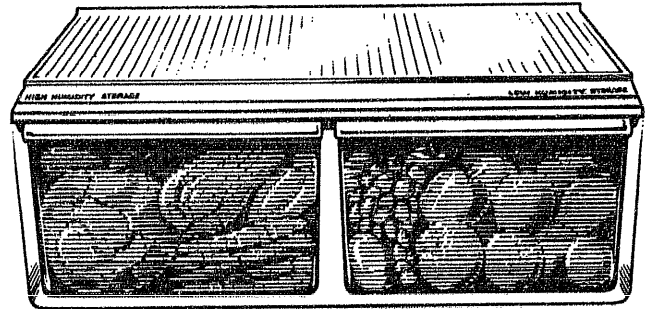

Moist'n Fresh Drawer

Cool'n Fresh Drawer

Fruit & Vegetable Drawers

The storage drawers at the bottom of the fresh food compartment are designed to provide high humidity levels required by most vegetables and lower humidity levels required for most fruits.

When replacing the drawers, always push them all the way in.

Storage time will depend upon the type of food and its condition when placed in the drawers.

Excess water which may accumulate in the bottom of the drawers should be emptied and the drawers wiped dry.

Moist'n Fresh Drawer

(on models so equipped)

This refrigerated drawer is designed to keep **unwrapped** foods fresh by retaining the natural moisture content of foods such as:

- Artichokes
- Asparagus
- Beets, topped
- Blueberries
- Carrots
- Celery
- Cherries
- Corn
- Currants
- Greens, leafy
- Lettuce
- Parsley
- Peas, green
- Plums
- Radishes
- Rhubarb
- Spinach
- Tomatoes, ripe

As in any refrigerated storage area, **it is recommended that foods with strong odors be stored wrapped**—foods such as:

- Broccoli
- Brussels Sprouts
- Cabbage
- Cauliflower
- Green Onions
- Parsnips
- Turnips

Cool'n Fresh Drawer

(on models so equipped)

This refrigerated drawer is designed to provide lower humidity storage for items such as:

- Apples
- Apricots
- Grapes
- Mushrooms
- Nectarines
- Oranges
- Peaches
- Pears
- Raspberries
- Squash, summer
- Strawberries
- Tangerines

Adjustable Humidity Drawers

(on models so equipped)

These drawers have individual, adjustable humidity controls that let you regulate the amount of cold air entering the drawers.

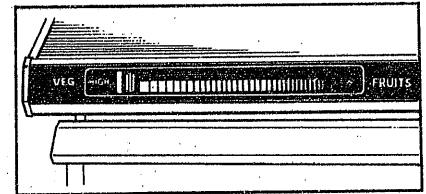

Slide the control all the way to the **VEG** setting and the drawer provides **high humidity** recommended for most vegetables.

Slide the control all the way to the **FRUITS** setting to provide lower humidity levels recommended for most fruits.

Storage Drawers

Drawer and Cover Removal

Drawers at the bottom of the fresh food compartment will stop before coming all the way out of the refrigerator, to help prevent contents from spilling onto floor. These drawers can be removed easily by grasping the sides and lifting up slightly while pulling drawers past the "stop" location.

To remove drawers and their cover when the fresh food compartment door cannot be opened fully, follow the procedure that applies to your model:

Drawers with Glass Cover

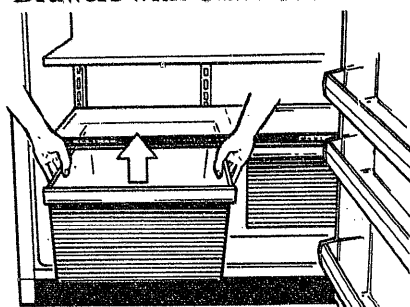

1. Remove the drawer farthest from the door.

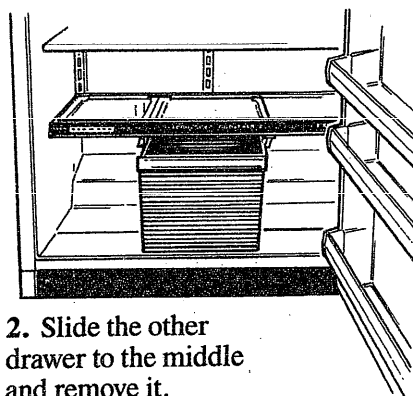

2. Slide the other drawer to the middle and remove it.

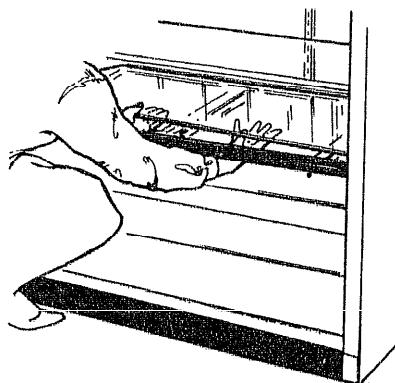

3. Reach in, push the front of the glass cover up and, at the same time, pull it forward until it clears the frame at the back.

4. Tilt and remove the glass cover.

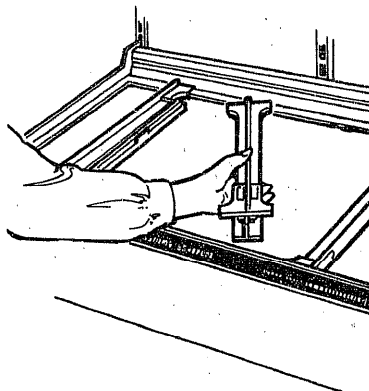

5. Remove the 3 drawer slides.

6. Remove the drawer frame as follows:

- Lift the front of the frame to free it from the supports at each side.
- Lift the rear of the frame to free its hooks from the tracks on the back wall of the refrigerator.
- Tilt the frame and take it out.

To replace:

1. Fit the hooks on the drawer frame into the second-from-the-bottom slots on the tracks at the rear of the refrigerator and lower the front of the frame until it locks into position and rests on the front supports at each side.

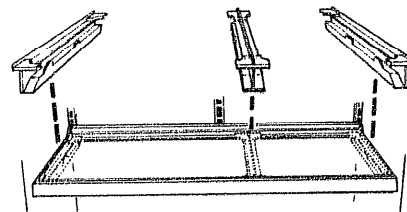

2. Put the drawer slides back on the frame. The sloped ends must be at the front.

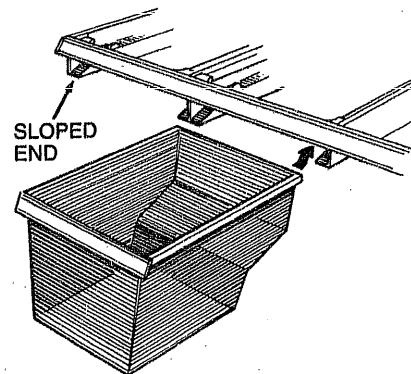

3. Slide the center and right drawer slides toward the middle and slide the 1/3-width drawer all the way into them.

4. Slide the 1/3-width drawer all the way to the right.

5. Mount the 2/3-width drawer onto the center and left slides.

6. Replace the glass cover, pushing its rear edge firmly into the rear frame channel and gently lowering the front into place.

Drawers with Plastic Cover

To remove drawers, lift front up slightly and pull drawer straight out.

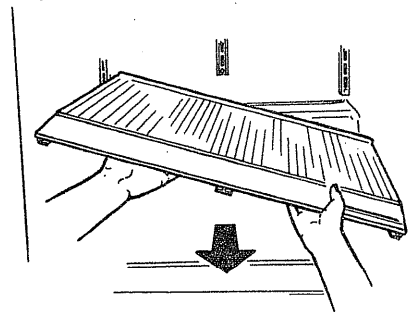

To remove cover, support it with one hand, tilt it and take it out.

Ice Service

Meat Drawer

(on models so equipped)

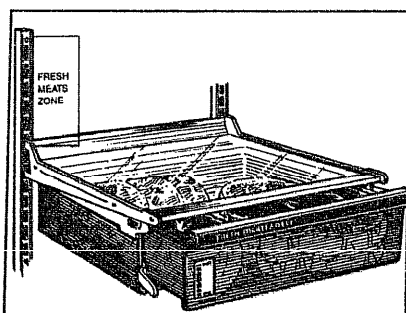

Fresh meats are stored best in the coldest part of the refrigerator.

When this drawer is placed in the top 6 slots on the left side and the lever is set at COLDEST, air from the freezer is forced around the drawer to keep it very cold.

You can move the drawer to any location for storage of items other than fresh meats.

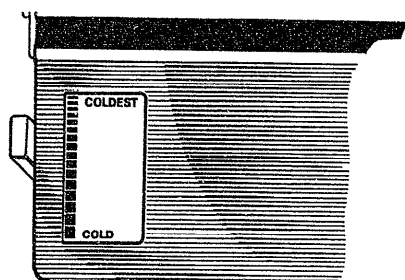

The variable temperature control lever lets you regulate the amount of cold air surrounding the drawer.

When the lever is all the way up, the damper over the opening in the drawer is fully open to provide the coldest storage area.

When the lever is all the way down, the damper is fully closed. Normal refrigerator temperatures will be maintained.

Variable settings between these extremes may be selected.

Automatic Icemaker

(on models so equipped)

Your icemaker will produce eight cubes per cycle—approximately 100 cubes in a 24-hour period, depending on freezer compartment temperature, room temperature, number of door openings and other use conditions.

If your refrigerator is operated before water connection is made to the icemaker, keep the icemaker feeler arm in the OFF (up) position as shown below.

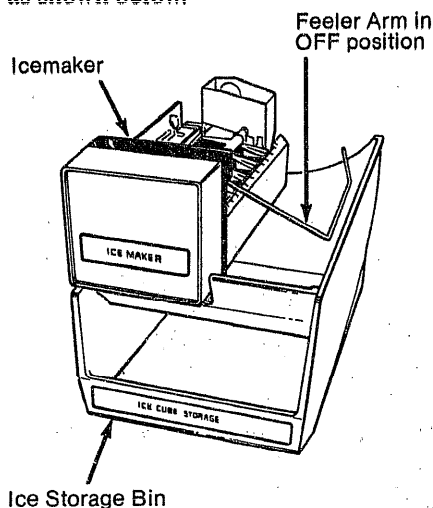

When refrigerator has been connected to water supply, move the feeler arm to the ON (down) position.

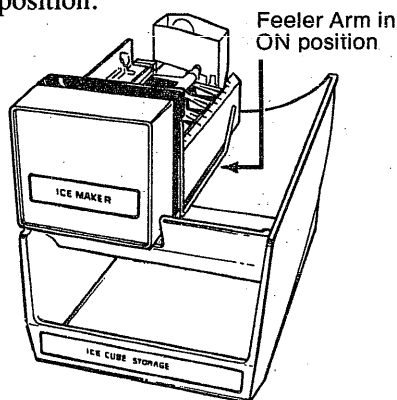

Ice cube mold will automatically fill with water after cooling to freezing temperature, and first cubes will normally freeze after several hours. When cubes are solidly frozen, they will be ejected from the mold into the ice storage bin by means of a sweeper arm.

Icemaking will continue until the feeler arm senses a sufficient accumulation of ice cubes in the storage bin and halts the operation temporarily. For maximum ice storage, level the stored cubes with your hand occasionally. Be sure nothing interferes with the swing of the feeler arm.

The icemaker ejects cubes in groups of eight and it is normal for several cubes to be joined together.

Once your icemaker is in operation, throw away the first few batches of ice cubes. This will flush away any impurities in the water line. Do the same thing after vacations or extended periods when ice isn't used.

Caution:

Under certain rare circumstances, ice cubes may be discolored, usually appearing with a green-bluish hue. The cause of this unusual discoloration is apparently due to a combination of factors such as certain characteristics of local waters, household plumbing and the accumulation of copper salts in an inactive water supply line which feeds the icemaker. Continued consumption of such discolored ice cubes may be injurious to health. If such discoloration is observed, discard the ice cubes and contact your GE Factory Service Center or an authorized Customer Care® servicer.

Move icemaker feeler arm to OFF (up) position when:

- home water supply is to be off for several hours
- ice storage bin is to be removed for a period of time
- going away on vacation, at which time you should also turn off the valve in the water supply line to your refrigerator

(continued next page)

Ice Service (continued)

Automatic Icemaker

(on models so equipped)

If ice is used infrequently, old cubes will become cloudy and taste stale. Empty ice storage bin periodically and wash it in lukewarm water.

If this is your first icemaker, you'll hear occasional sounds that may be unfamiliar. They are normal icemaking sounds and are not cause for concern.

Ice Trays

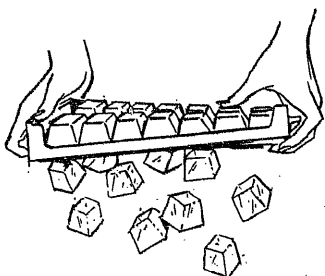

Ice trays are designed to release ice cubes easily. Hold tray upside-down over a container and twist both ends to release cubes.

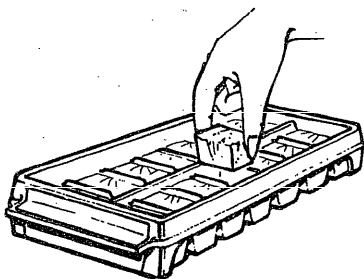

For only one or two ice cubes, leave the tray right-side up, twist both ends slightly and remove desired number of cubes.

Wash ice trays and storage bin in lukewarm water only. Do not put them in an automatic dishwasher.

Accessories

Automatic Icemaker

Accessory Kit

(optional at extra cost)

A GE automatic icemaker will replace the ice you use... automatically. It can keep you supplied with a binful of cubes—ice for everything, everybody—without fuss or muss.

If your refrigerator did not come already equipped with an automatic icemaker, you may add one—contact your local GE dealer; specify UK-KIT-4 or IM-1. A water supply kit containing copper tubing, shut-off valve, fittings and instructions needed to connect the icemaker to your cold water line is also available at extra cost.

The perfect companion to your automatic icemaker—a water filter accessory

Your ice cubes can only be as fresh-tasting as the water that produces them. That's why it's a good idea to purify your water with a water filter.

Its activated charcoal removes musty, stale odors and unpleasant medicinal, metallic tastes. A porous fiber cartridge catches dirt, rust particles, sand and silt while special crystals reduce deposits of hard scale.

The water filter is an option at extra cost and is available from your GE dealer. Specify WR97X0214. It has complete installation instructions and installs in minutes on 1/4" OD copper water line.



Care and Cleaning

Cleaning—Outside

The door handles and trim can be cleaned with a cloth dampened with a solution of mild liquid dishwashing detergent and water. Dry with a soft cloth. Don't wax handles or trim.

Keep the finish clean. Wipe with a clean cloth, lightly dampened with kitchen appliance wax or mild liquid dishwashing detergent. Dry and polish with a clean, soft cloth. **Do not** wipe the refrigerator with a soiled dishwashing cloth or wet towel. These will leave a residue that can damage the paint. **Do not** use scouring pads, powdered cleaners, bleach or cleaners containing bleach because these products can scratch and weaken the paint finish.

Protect the paint finish. The finish on the outside of the refrigerator is a high quality, baked-on paint finish. With proper care, it will stay new-looking and rust-free for years. Apply a coat of kitchen/appliance wax when the refrigerator is new, and then at least twice a year.

Appliance Polish Wax & Cleaner (Cat. No. WR97X0216) is available from GE Appliance Parts Marts.

Cleaning—Inside

Clean the inside of the fresh food and freezer compartments at least once a year. Unplug refrigerator before cleaning. If this is not practical, wring excess moisture out of sponge or cloth when cleaning around switches, lights or controls.

Use warm water and baking soda solution—about a tablespoon of baking soda to a quart of water. This both cleans and neutralizes odors. Rinse thoroughly with water and wipe dry.

Other parts of the refrigerator—including door gaskets, meat and vegetable drawers, Quick Store unit, ice storage bin and all plastic parts—can be cleaned the same way. Do not use cleansing powders or other abrasive cleaners.

To help prevent odors, leave an open box of baking soda in the rear of the refrigerator, on the top shelf. Change the box every three months. An open box of baking soda in the freezer will absorb stale freezer odors.

Do not wash any of your refrigerator's plastic parts in your automatic dishwasher.

Behind refrigerator

Care should be taken in moving your refrigerator away from the wall. All types of floor coverings can be damaged, particularly cushioned coverings and those with embossed surfaces. Pull the refrigerator straight out and return it to position by pushing it straight in. Moving your refrigerator in a side direction may result in damage to your floor covering or refrigerator.

Condenser

For most efficient operation, you need to keep the condenser clean. Turn temperature control to OFF. Remove the base grille, if your refrigerator has one—see page 4. Sweep away or vacuum dust that is readily accessible on condenser coils, then turn the control back on. For best results, use a brush specially designed for this purpose. It is available at most appliance parts stores. This easy cleaning operation should be done at least once a year.

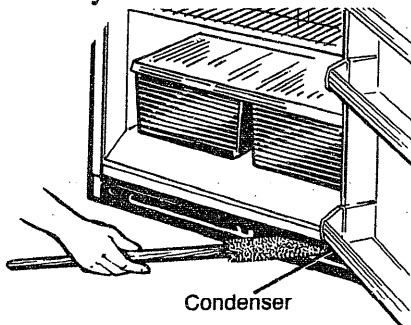

Light bulb replacement

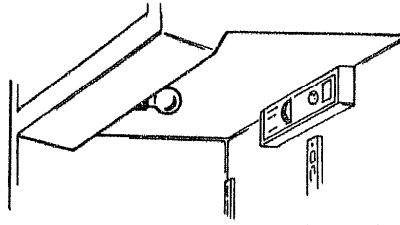

A light bulb and socket are located at the top of the fresh food compartment opposite the temperature control panel. To replace the bulb, unplug refrigerator from its electrical outlet, unscrew bulb when cool, and replace with similar size bulb.

When you go on vacation

For extended vacations or absences, remove food and shut off power to refrigerator. Clean the interior with a baking soda solution of one tablespoon of baking soda to one quart of water. Wipe dry. To prevent odors, leave open box of baking soda in refrigerator. Leave doors open.

For shorter vacations, remove perishable foods and leave controls at regular settings. However, if room temperature is expected to drop below 60°F., follow same instructions as for extended vacations.

If your refrigerator has an icemaker, move the icemaker feeler arm to the OFF (up) position and be sure to shut off the water supply to the refrigerator.

When you move

Disconnect the power cord from the wall outlet, remove all food and clean and dry the interior. **Secure all loose items** such as shelves and storage pans by taping them securely in place to prevent damage.

Be sure refrigerator stays in *upright position* during actual moving and in van. Refrigerator must be secured in van to prevent movement. Protect outside of refrigerator with blanket.

If You Need Service

To obtain service, see your warranty on the back page of this book.

We're proud of our service and want you to be pleased. If for some reason you are not happy with the service you receive, here are three steps to follow for further help.

FIRST, contact the people who serviced your appliance. Explain why you are not pleased. In most cases, this will solve the problem.

NEXT, if you are still not pleased, write all the details—including your phone number—to:

Manager, Consumer Relations
GE Appliances
Appliance Park
Louisville, Kentucky 40225

FINALLY, if your problem is still not resolved, write:

Major Appliance
Consumer Action Panel
20 North Wacker Drive
Chicago, Illinois 60606



Questions? Use This Problem Solver

PROBLEM	POSSIBLE CAUSE AND REMEDY
REFRIGERATOR DOES NOT OPERATE	<ul style="list-style-type: none"> • May be in defrost cycle when motor does not operate for about 35 minutes. • Temperature control in OFF position. • If interior light is not on, refrigerator may not be plugged in at wall outlet. • If plug is secure and the refrigerator still fails to operate, plug a lamp or a small appliance into the same outlet to determine if there is a tripped circuit breaker or burned out fuse.
MOTOR OPERATES FOR LONG PERIODS	<ul style="list-style-type: none"> • Modern refrigerators with more storage space and a larger freezer compartment require more operating time. • Normal when refrigerator is first delivered to your home—usually requires 24 hours to completely cool down. • Large amounts of food placed in refrigerator to be cooled or frozen. • Hot weather—frequent door openings. • Door left open. • Temperature controls are set too cold. Refer to page 5. • Grille and condenser need cleaning. Refer to page 13. • Check ENERGY-SAVING TIPS on page 2.
MOTOR STARTS & STOPS FREQUENTLY	<ul style="list-style-type: none"> • Temperature control starts and stops motor to maintain even temperatures.
VIBRATION OR RATTLING	<ul style="list-style-type: none"> • If refrigerator vibrates, more than likely it is not resting solidly on the floor. The front roller screws need adjusting, or floor is weak or uneven. Refer to ROLLERS on page 4. • If dishes vibrate on shelves, try moving them. Slight vibration is normal.
OPERATING SOUNDS	<ul style="list-style-type: none"> • The high speed compressor motor required to maintain near zero temperatures in the large freezer compartment may produce higher sound levels than your old refrigerator. • Normal fan air flow—one fan blows cold air through the refrigerator and freezer compartments—another fan cools the compressor motor. • These NORMAL sounds will also be heard from time to time: <ul style="list-style-type: none"> • Defrost timer switch clicks at defrost. • Defrost water dripping. • Temperature control clicks ON or OFF. • Refrigerant boiling or gurgling. • Cracking or popping of cooling coils caused by expansion and contraction during defrost and refrigeration following defrost. • Ice cubes dropping into the bin and water running in pipes as icemaker refills.
FOODS DRY OUT	<ul style="list-style-type: none"> • Foods not covered, wrapped or sealed properly.

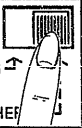
PROBLEM	POSSIBLE CAUSE AND REMEDY
HOT AIR FROM BOTTOM OF REFRIGERATOR	<ul style="list-style-type: none"> • Normal air flow cooling motor. In the refrigeration process, it is normal that heat be expelled in the area under the refrigerator. Some floor coverings will discolor at these normal and safe operating temperatures. Your floor covering supplier should be consulted if you object to this discoloration.
FRESH FOOD OR FREEZER COMPARTMENT TEMPERATURE TOO WARM	<ul style="list-style-type: none"> • Temperature control not set cold enough. Refer to page 5. • Warm weather—frequent door openings. • Door left open for too long a time. • Package holding door open or blocking air duct in freezer compartment.
FROST OR ICE CRYSTALS ON FROZEN FOOD	<ul style="list-style-type: none"> • Door may have been left ajar or package holding door open. • Too frequent or too long door openings. • Frost within package is normal.
AUTOMATIC ICEMAKER DOES NOT WORK (on models so equipped)	<ul style="list-style-type: none"> • Icemaker feeler arm in OFF (up) position. • Water supply turned off or not connected. • Freezer compartment too warm. • Cubes too small—water shutoff valve connecting refrigerator to home water line may be clogged.
SLOW ICE CUBE FREEZING	<ul style="list-style-type: none"> • Door may have been left ajar. • Turn temperature of freezer compartment colder.
ICE CUBES HAVE ODOR/TASTE	<ul style="list-style-type: none"> • Old cubes need to be discarded. • Ice storage bin needs to be emptied and washed. • Unsealed packages in refrigerator and/or freezer compartments may be transmitting odor/taste to ice cubes. • Interior of refrigerator needs cleaning. Refer to page 12.
MOISTURE FORMS ON CABINET SURFACE BETWEEN THE DOORS	<ul style="list-style-type: none"> • Not unusual during periods of high humidity. • Move power saver switch to the right. <div data-bbox="1007 1247 1417 1374" style="border: 1px solid black; padding: 5px;"> <p>POWER SAVER/MOISTURE CONTROL</p>  <p>POWER SAVER SETTING IF MOISTURE FORMS BETWEEN DOORS SET HERE</p> </div>
MOISTURE COLLECTS INSIDE	<ul style="list-style-type: none"> • Too frequent or too long door openings. • In humid weather, air carries moisture into refrigerator when doors are opened.
REFRIGERATOR HAS ODOR	<ul style="list-style-type: none"> • Foods with strong odors should be tightly covered. • Check for spoiled food. • Interior needs cleaning. Refer to page 12. • Defrost water system needs cleaning. • Keep open box of baking soda in refrigerator; replace every three months.

If you need more help...call, toll free:
GE Answer Center®
800.626.2000
 consumer information service

YOUR GE REFRIGERATOR WARRANTY

Save proof of original purchase date such as your sales slip or cancelled check to establish warranty period.

WHAT IS COVERED

FULL ONE-YEAR WARRANTY

For one year from date of original purchase, we will provide, free of charge, parts and service labor in your home to repair or replace **any part of the refrigerator** that fails because of a manufacturing defect.

FULL FIVE-YEAR WARRANTY

For five years from date of original purchase, we will provide, free of charge, parts and service labor in your home to repair or replace **any part of the sealed refrigerating system** (the compressor, condenser, evaporator and all connecting tubing) that fails because of a manufacturing defect.

LIMITED LIFETIME WARRANTY

For the life of the refrigerator, we will replace, free of charge, **the tinted see-through Quick Store bin made from Lexan® polycarbonate resin** if the bin breaks during normal household use. The bin housing is not included. The bin can be exchanged at a GE Appliance Parts Mart, Factory Service Center, or by writing to the address below.

This warranty is extended to the original purchaser and any succeeding owner for products purchased for ordinary home use in the 48 mainland states, Hawaii and Washington, D.C. In Alaska the warranty is the same except that it is LIMITED because you must pay to ship the product to the service shop or for the service technician's travel costs to your home.

All warranty service will be provided by our Factory Service Centers or by our authorized Customer Care® servicers during normal working hours.

Look in the White or Yellow Pages of your telephone directory for GENERAL ELECTRIC COMPANY, GENERAL ELECTRIC FACTORY SERVICE, GENERAL ELECTRIC-HOTPOINT FACTORY SERVICE or GENERAL ELECTRIC CUSTOMER CARE® SERVICE.

WHAT IS NOT COVERED

- Service trips to your home to teach you how to use the product.

Read your Use and Care material. If you then have any questions about operating the product, please contact your dealer or our Consumer Affairs office at the address below, or call, toll free:

GE Answer Center®
800.626.2000
consumer information service

- Improper installation.

If you have an installation problem, contact your dealer or installer. You are responsible for providing adequate electrical, plumbing and other connecting facilities.

- Replacement of house fuses or resetting of circuit breakers.

- Failure of the product if it is used for other than its intended purpose or used commercially.

- Damage to product caused by accident, fire, floods or acts of God.

WARRANTOR IS NOT RESPONSIBLE FOR CONSEQUENTIAL DAMAGES.

Some states do not allow the exclusion or limitation of incidental or consequential damages, so the above limitation or exclusion may not apply to you. This warranty gives you specific legal rights, and you may also have other rights which vary from state to state. To know what your legal rights are in your state, consult your local or state consumer affairs office or your state's Attorney General.

Warrantor: General Electric Company

**If further help is needed concerning this warranty, write:
Manager—Consumer Affairs, GE Appliances, Louisville, KY 40225**

Part No. 162D1930P004
Pub. No. 49-6608

TBX20 TBX24
TBX21 TBX25
TBX22 TBXW25