

NI PXI/PCI-5152 Specifications

8-Bit 2 GS/s Digitizer

Unless otherwise noted, the following conditions were used for each specification: all filter settings, all impedance selections, and sample clock set to 1 GS/s. Real-Time Interleaved Sampling (TIS) mode provides a 2 GS/s real-time sample rate for a single channel.

Typical values are representative of an average unit operating at room temperature. Specifications are subject to change without notice. For the most recent NI 5152 specifications, visit ni.com/manuals.

To access the NI 5152 documentation, including the NI High-Speed Digitizers Getting Started Guide, go to **Start»All Programs»National Instruments»NI-SCOPE»Documentation**.



Hot Surface If the NI 5152 has been in use, it may exceed safe handling temperatures and cause burns. Allow the NI 5152 to cool before removing it from the PXI chassis.

Contents

Vertical	2
Analog Input (Channel 0 and Channel 1)	2
Horizontal	9
Sample Clock	9
Phase-Locked Loop (PLL) Reference Clock	10
PFI 0 (Sample Clock and Reference Clock Input, Front Panel Connector)	11
PFI 1 (Reference Clock Output, Front Panel Connector)	11
Trigger	11
Reference (Stop) Trigger	11
TClk Specifications	15
Waveform Specifications	16
Calibration	17
Power	17
Software	18
Environment	19
NI PXI-5152	19
NI PCI-5152	20

Safety, Electromagnetic Compatibility, and CE Compliance	20
Safety	20
Electromagnetic Compatibility	21
CE Compliance	21
Waste Electrical and Electronic Equipment (WEEE)	21
Physical	22
Front Panel Connectors	22
Dimensions and Weigh.....	23
NI PXI-5152	23
NI PCI-5152	24
Where to Go for Support	25

Vertical

Analog Input (Channel 0 and Channel 1)

Specification	Value	Comments
Number of Channels	Two (simultaneously sampled)	—
Connectors	BNC	—
Impedance and Coupling		
Input Impedance	50 Ω \pm 1.5% 1 M Ω \pm 0.75% in parallel with a typical capacitance of 22 pF	Software selectable.
Input Coupling	AC, DC, GND	—

Specification	Value				Comments
Voltage Levels					
Full Scale (FS) Input Range and Programmable Vertical Offset	50 Ω		1 M Ω		—
	Range (V _{pk-pk})	Offset (Volts)	Range (V _{pk-pk})	Offset (Volts)	
	0.1	± 1	0.1	± 1	
	0.2	± 1	0.2	± 1	
	0.4	± 1	0.4	± 1	
	1	± 1	1	± 1	
	2	± 6	2	± 10	
	4	± 5	4	± 10	
10	± 2	10	± 10		
Maximum Input Overload	50 Ω		1 M Ω		—
	7 V _{rms} with Peaks ≤ 10 V		Peaks ≤ 42 V		
Accuracy					
Resolution	8 bits				—
DC Accuracy (Programmable Vertical Offset = 0 Volts)	Range (V _{pk-pk})		50 Ω and 1 M Ω		Within ± 5 °C of self-calibration temperature.
	0.1 to 1		$\pm (1.26\% \text{ of Input} + 1.0\% \text{ of FS} + 500 \mu\text{V})$		
	2 to 10		$\pm (1.26\% \text{ of Input} + 1.0\% \text{ of FS} + 5 \text{ mV})$		
Programmable Vertical Offset Accuracy	$\pm 0.9\%$ of offset setting				Within ± 5 °C of self-calibration temperature.
DC Drift	Range (V _{pk-pk})		50 Ω and 1 M Ω		Use DC drift to calculate errors when temperature changes more than ± 5 °C since the last self-calibration.
	0.1 to 1		$\pm (0.052\% \text{ of Input} + 100 \mu\text{V})$ per °C		
	2 to 10		$\pm (0.052\% \text{ of Input} + 1.0 \text{ mV})$ per °C		

Specification	Value		Comments	
Crosstalk, Typical	CH 0 to/from CH 1*	Ext Trig to CH 0 or CH 1**	* Measured on one channel with test signal applied to another channel, with same range setting on both channels. ** 10 V _{pk-pk} signal applied to external trigger channel. Applies to all ranges on CH 0 and CH1.	
	< -80 dB at 10 MHz < -60 dB at 100 MHz	< -80 dB at 10 MHz < -80 dB at 100 MHz		
Bandwidth and Transient Response				
Bandwidth (-3 dB)	Range (V _{pk-pk})	50 Ω	1 MΩ	Filter off. Bandwidth for 0 to 30 °C. Reduce by 0.25% per °C above 30 °C.
	All ranges except 0.1	340 MHz typical 300 MHz min.	300 MHz typical 260 MHz min.	
	0.1	165 MHz typical 135 MHz min.	135 MHz typical 110 MHz min.	
Rise/Fall Time, Typical	Range (V _{pk-pk})	50 Ω	1 MΩ	Filter off. * 50 Ω terminator connected to front panel BNC connector.
	All ranges except 0.1	1.2 ns	1.4 ns*	
	0.1	2.4 ns	2.8 ns*	
Bandwidth Limit Filter	20 MHz Noise Filter		—	
AC Coupling Cutoff (-3 dB), Typical	50 Ω	1 MΩ	50 Ω source assumed.	
	106 kHz	12 Hz		

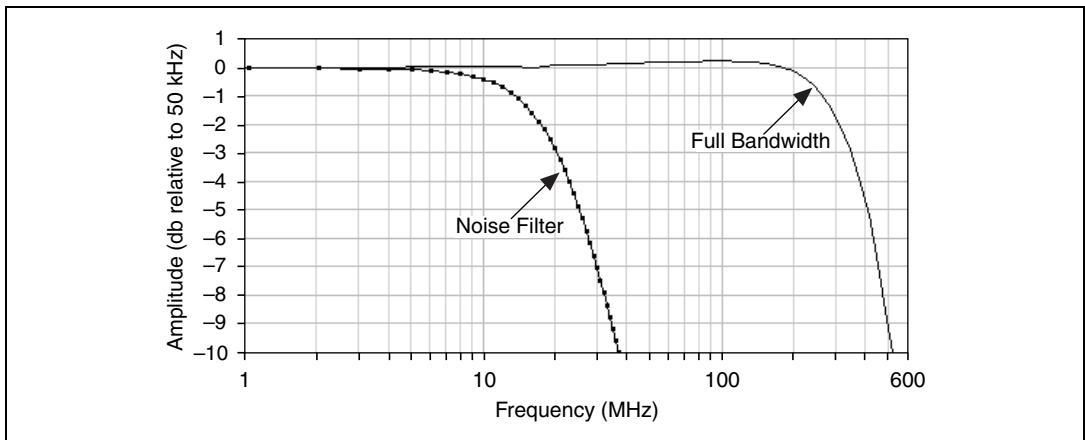

Figure 1. NI 5152 Frequency Response, 50 Ω , 1 V (Typical)

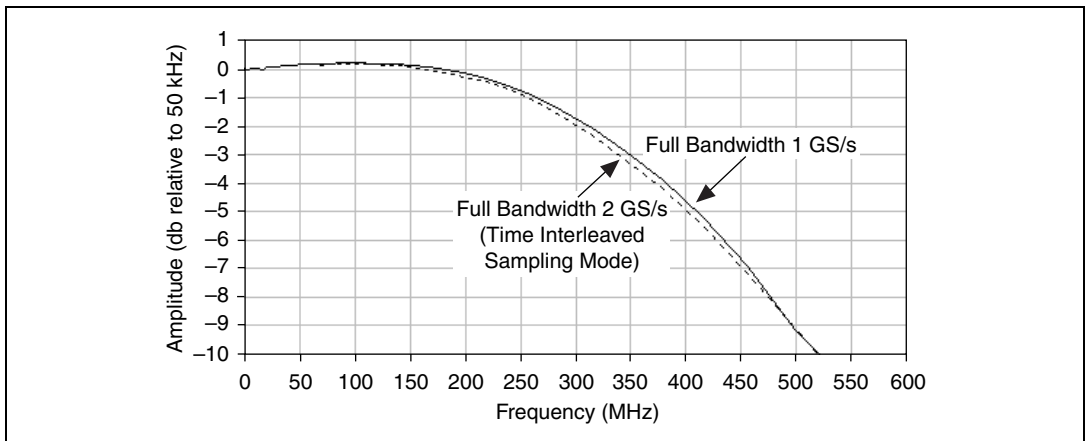

Figure 2. NI 5152 Frequency Response, 50 Ω , 1 V (Typical)

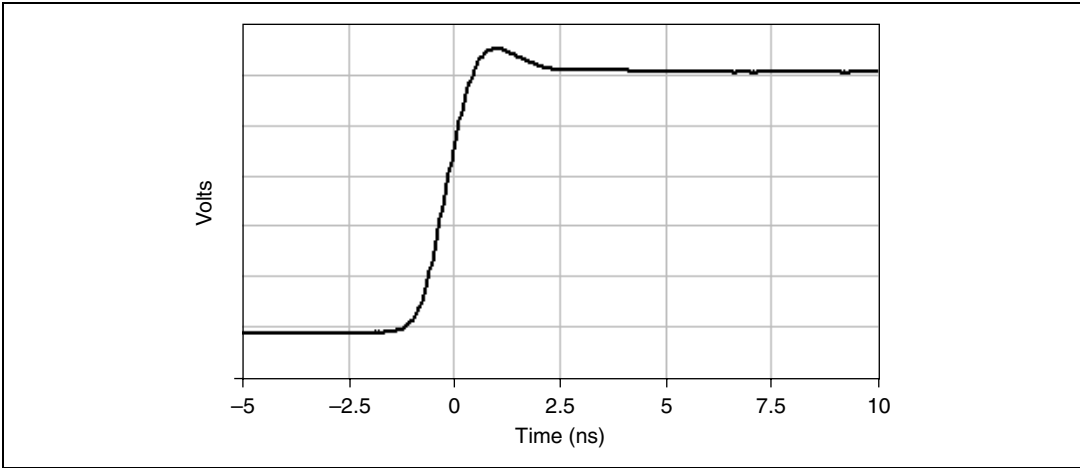

Figure 3. NI 5152 Step Response, 50 Ω , 10 V_{pk-pk} through 0.2 V_{pk-pk} Range, Typical

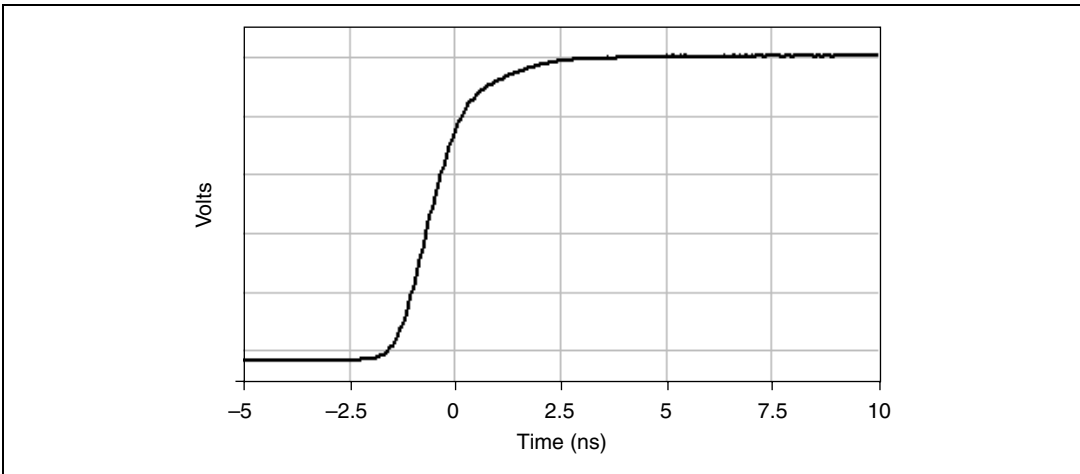

Figure 4. NI 5152 Step Response, 50 Ω , 0.1 V_{pk-pk} Range, Typical

Specification	Value		Comments
Spectral Characteristics			
ENOB	Noise Filter On	Noise Filter Off	1 V _{pk-pk} range, 10 MHz, -1 dBFS input signal. Includes the 2 nd through the 5 th harmonics.
	7.3	7.1	
Signal to Noise and Distortion (SINAD), Typical	45 dB	43 dB	

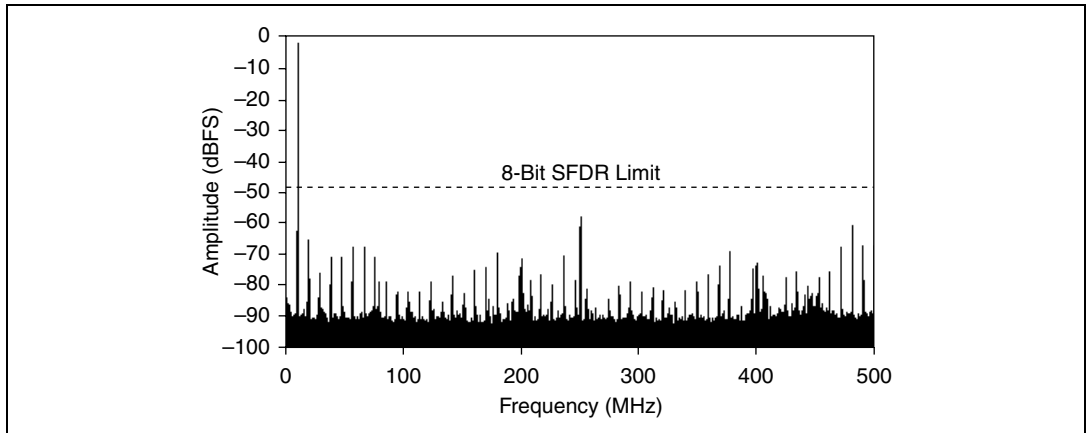

Figure 5. NI 5152 Typical Dynamic Performance, 50 Ω , 1 V_{pk-pk} Range, 9.425 MHz, -1 dBFS Input Signal

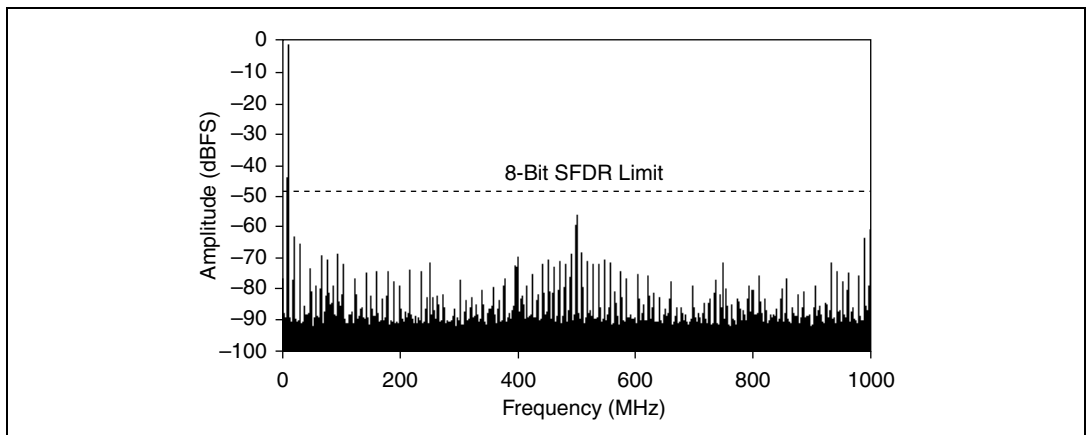

Figure 6. NI 5152 TIS Typical Dynamic Performance, 50 Ω , 1 V_{pk-pk} Range, 9.425 MHz, -1 dBFS Input Signal

Specification	Value			Comments
RMS Noise	Range (V_{pk-pk})	Noise Filter On	Noise Filter Off	50 Ω terminator connected to input.
	0.1	240 μV_{rms} (0.24% FS)	320 μV_{rms} (0.32% FS)	
	0.2	480 μV_{rms} (0.24% FS)	600 μV_{rms} (0.30% FS)	
	0.4	960 μV_{rms} (0.24% FS)	1.12 mV _{rms} (0.28% FS)	
	1	2.4 mV _{rms} (0.24% FS)	2.6 mV _{rms} (0.26% FS)	
	2	4.8 mV _{rms} (0.24% FS)	6.0 mV _{rms} (0.30% FS)	
	4	9.6 mV _{rms} (0.24% FS)	11.2 mV _{rms} (0.28% FS)	
	10	24 mV _{rms} (0.24% FS)	26 mV _{rms} (0.26% FS)	
Skew				
Channel to Channel Skew, Typical	< 100 ps			—

Horizontal

Sample Clock

Specification	Value			Comments
Sources	Internal: Onboard Clock (internal VCSCO)* External: PFI 0 (front panel SMB connector)			* Internal Sample Clock is locked to the Reference Clock or derived from the onboard VCSCO.
Onboard Clock (Internal VCSCO)				
Sample Rate Range	Real-Time Sampling, Single-Shot	TIS** Mode, Single-Shot	Random Interleaved Sampling (RIS)** Mode	* Divide by n decimation used for all rates less than 1 GS/s.
	15.26 kS/s to 1 GS/s*	2 GS/s (Single channel only)	2 GS/s to 20 GS/s in increments of 1 GS/s (Repetitive waveforms only)	** TIS is a type of real-time sampling that is sometimes called ping-pong. *** RIS is a type of equivalent-time sampling.
Timebase Accuracy	Not Phase-Locked to Reference Clock		Phase-Locked to Reference Clock	—
	1 GHz \pm 25 ppm within \pm 5 °C of external calibration temperature		Equal to the Reference Clock accuracy	
Sample Clock Delay Range	\pm 1 Sample Clock period			—
Sample Clock Delay/Adjustment Resolution	\leq 5 ps			—

Specification	Value	Comments
External Sample Clock		
Sources	PFI 0 (front panel SMB connector)	—
Frequency Range	350 MHz to 1 GHz	Divide by n decimation available where $1 \leq n \leq 65,535$. For more information about Sample Clock and decimation, refer to the <i>NI High-Speed Digitizers Help</i> .
Duty Cycle Tolerance	45% to 55%	—

Phase-Locked Loop (PLL) Reference Clock

Specification	Value		Comments
Sources	NI PXI-5152	NI PCI-5152	—
	PXI_CLK10 (PXI backplane connector) PFI 0 (front panel SMB connector)	RTSI 7 PFI 0 (front panel SMB connector)	
Frequency Range	1 MHz to 20 MHz in 1 MHz increments Default of 10 MHz The PLL Reference Clock frequency must be accurate to ± 50 ppm.		—
Duty Cycle Tolerance	45% to 55%		—
Exported Reference Clock Destinations	NI PXI-5152	NI PCI-5152	—
	PXI_Trig <0..7> (backplane connector) PFI 1 (front panel SMB connector)	RTSI <0..7> PFI 1 (front panel SMB connector)	

PFI 0 (Sample Clock and Reference Clock Input, Front Panel Connector)

Specification	Value	Comments
Input Voltage Range	Sine wave: 0.65 V _{pk-pk} to 2.8 V _{pk-pk} (0 dBm to 13 dBm)	—
Maximum Input Overload	7 V _{rms} with Peaks ≤ 10 V	—
Impedance	50 Ω	—
Coupling	AC	—

PFI 1 (Reference Clock Output, Front Panel Connector)

Specification	Value	Comments
Output Impedance	50 Ω	—
Logic Type	3.3 V CMOS	—
Maximum Drive Current	± 24 mA	—

Trigger

Reference (Stop) Trigger

Specification	Value		Comments
Trigger Types	Edge, Window, Hysteresis, Digital, Immediate, and Software		Refer to the following sections and to the <i>NI High-Speed Digitizers Help</i> for more information about what sources are available for each trigger type.
Trigger Sources	NI PXI-5152	NI PCI-5152	
	CH 0, CH 1, TRIG, PFI <0..1>, PXI_Trig <0..6>, PXI Star Trigger, and Software	CH 0, CH 1, TRIG, PFI <0..1>, RTSI <0..6>, and Software	

Specification	Value			Comments
Time Resolution	TDC	Onboard Clock	External Clock	TDC = Time to Digital Conversion Circuit.
	On	5 ps	N/A	
	Off	1 ns	External Clock Period	
Rearm Time	TDC		Rearm Time	Holdoff set to 0.
	On		8 μ s	
	Off		1 μ s	
Holdoff	From Rearm time up to $[(2^{32} - 1) \times \text{Sample Clock Period}]$			—
Trigger Delay	From 0 up to $[(2^{35} - 1) - \text{posttrigger samples}] \times (1/\text{sample rate})$, in seconds			—
Analog Trigger (Edge, Window, and Hysteresis Trigger Types)				
Sources	CH 0, CH 1, TRIG (front panel BNC connectors)			—
Trigger Level Range	CH 0, CH 1		TRIG (External Trigger)	DC to 300 MHz
	100% FS		± 5 V	
Voltage Resolution	8 bits (1 in 256)			—
Edge Trigger Sensitivity	CH 0, CH 1		TRIG (External Trigger)	DC to 300 MHz
	10% FS		0.5 V _{pk-pk}	
Trigger Level Accuracy, Typical	CH 0, CH 1		TRIG (External Trigger)	—
	$\pm 5\%$ FS up to 10 MHz		± 1 V ($\pm 10\%$ FS) up to 10 MHz)	
Trigger Jitter	≤ 10 ps rms typical, ≤ 20 ps rms maximum			Within ± 5 °C of self-calibration temperature.
Trigger Filters	Low Frequency (LF) Reject		High Frequency (HF) Reject	—
	50 kHz		50 kHz	

Specification	Value		Comments
Digital Trigger (Digital Trigger Type)			
Sources	NI PXI-5152	NI PCI-5152	—
	PXI_Trig <0..6> (backplane connector)	RTSI <0..6> PFI <0..1> (front panel SMB connector)	
	PFI <0..1> (front panel SMB connectors) PXI Star Trigger (backplane connector)		
External Trigger Input (Front Panel Connector)			
Connector	BNC		—
Impedance	1 MΩ in parallel with a typical capacitance of 22 pF		—
Coupling	AC, DC		—
AC Coupling Cutoff (–3 dB)	12 Hz		—
Input Voltage Range	± 5 V		—
Maximum Input Overload	Peaks ≤ 42 V		—
PFI 0 and PFI 1 (Programmable Function Interface, Front Panel Connectors)			
Connector	SMB jack		—
Direction	Bidirectional		—
As an Input (Trigger)			
Destination	Start Trigger (Acquisition Arm) Reference (Stop) Trigger Arm Reference Advance Trigger		—
Input Impedance	150 kΩ		—
V _{IH}	2.0 V		—
V _{IL}	0.8 V		—

Specification	Value	Comments
Maximum Input Overload	-0.5 V to 5.5 V	—
Maximum Frequency	25 MHz	—
As an Output (Event)		
Sources	Start Trigger (Acquisition Arm) Reference (Stop) Trigger End of Record Done (End of Acquisition) Probe Compensation (1 kHz, 50% duty cycle square wave, PFI 1 only)	—
Output Impedance	50 Ω	—
Logic Type	3.3 V CMOS	—
Maximum Drive Current	± 24 mA	—
Maximum Frequency	25 MHz	—

TClk Specifications

National Instruments TClk synchronization method and the NI-TClk driver are used to align the sample clocks on any number of SMC-based modules in a chassis. For more information about TClk synchronization, refer to the *NI-TClk Synchronization Help*, which is located within the *NI High-Speed Digitizers Help*.

- Specifications are valid for any number of modules installed in one NI PXI-1042 chassis.
- All parameters set to identical values for each SMC-based module.
- Sample Clock set to 1 GS/s and all filters are disabled.
- For other configurations, including multichassis systems, contact NI Technical Support at ni.com/support.



Note Although you can use NI-TClk to synchronize nonidentical modules, these specifications apply only to synchronizing identical modules.

Specification	Value	Comments
Intermodule SMC Synchronization Using NI-TClk for Identical Modules (Typical)		
Skew	500 ps	Caused by clock and analog path delay differences. No manual adjustment performed.
Skew After Manual Adjustment	≤ 5 ps	For information about manual adjustment, refer to the <i>Synchronization Repeatability Optimization</i> topic in the <i>NI-TClk Synchronization Help</i> . For additional help with the adjustment process, contact NI Technical Support at ni.com/support .
Sample Clock Delay/Adjustment Resolution	≤ 5 ps	—

Waveform Specifications

Specification	Value		Comments
Onboard Memory Size	Real-Time and RIS Modes	Real-Time TIS Mode	* PXI version only
	8 MB Standard (8 MS per channel)	8 MB Standard (8 MS)	
	64 MB Option (64 MS per channel)	64 MB Option (64 MS)	
	256 MB Option (256 MS per channel)	256 MB Option (256 MS)	
	512 MB Option* (512 MS per channel)	512 MB Option* (512 MS)	
Minimum Record Length	1 Sample		—
Number of Pretrigger Samples	Zero up to full record length		Single-record mode and multiple-record mode.
Number of Posttrigger Samples	Zero up to full record length		Single-record mode and multiple-record mode.
Maximum Number of Records in Onboard Memory	Memory Option	Real-Time Sampling Mode	* It is possible to exceed these numbers if you fetch records while acquiring data. For more information, refer to the <i>NI High-Speed Digitizers Help</i> .
	8 MB per channel	32,768*	
	64 MB per channel	100,000*	
	256 MB per channel	100,000*	
Allocated Onboard Memory per Record	[(Record length × 1 byte/sample) + 240 bytes] rounded up to next multiple of 128 bytes		—

Calibration

Specification	Value	Comments
Self-Calibration	Self-calibration is done on software command. The calibration corrects for gain, offset, triggering, and timing errors for all input ranges.	—
External Calibration (Factory Calibration)	The external calibration calibrates the VCISO and the voltage reference. Appropriate constants are stored in nonvolatile memory.	—
Interval for External Calibration	2 years	—
Warm-Up Time	15 minutes	—

Power

Specification	Typical Value		Comments
	NI PXI-5152	NI PCI-5152	
+3.3 VDC	1.1 A	2.5 A	—
+5 VDC	1.9 A	2.4 A	
+12 VDC	500 mA	200 mA	
-12 VDC	210 mA	0 A	
Total Power	21.65 W	22.65 W	

Software

Specification	Value	Comments
Driver Software	NI-SCOPE 3.2 or later for NI PXI-5152 NI-SCOPE 3.3 or later for NI PCI-5152 NI-SCOPE is an IVI-compliant driver that allows you to configure, control, and calibrate the NI 5152. NI-SCOPE provides application programming interfaces for many development environments.	—
Application Software	NI-SCOPE provides programming interfaces, documentation, and examples for the following application development environments: <ul style="list-style-type: none"> • LabVIEW • LabWindows™/CVI™ • Measurement Studio • Microsoft Visual C/C++ • Microsoft Visual Basic 	—
Interactive Soft Front Panel and Configuration	The Scope Soft Front Panel 2.5 or later supports interactive control of the NI 5152. The Scope Soft Front Panel is included on the NI-SCOPE CD. National Instruments Measurement & Automation Explorer (MAX) also provides interactive configuration and test tools for the NI 5152. MAX is included on the NI-SCOPE CD.	—

Environment

NI PXI-5152



Note To ensure that the NI PXI-5152 cools effectively, follow the guidelines in the *Maintain Forced-Air Cooling Note to Users* included in the hardware kit. The NI PXI-5152 is intended for indoor use only.

Specification	Value	Comments
Operating Temperature	0 °C to +55 °C in all NI PXI chassis except the following: 0 °C to +45 °C when installed in an NI PXI-1000/B or PXI-101x chassis. Meets IEC-60068-2-1 and IEC-60068-2-2.	—
Storage Temperature	–40 °C to +71 °C. Meets IEC-60068-2-1 and IEC-60068-2-2.	—
Operating Relative Humidity	10% to 90%, noncondensing. Meets IEC-60068-2-56.	—
Storage Relative Humidity	5% to 95%, noncondensing. Meets IEC-60068-2-56.	—
Operating Shock	30 g, half-sine, 11 ms pulse. Meets IEC-60068-2-27. Test profile developed in accordance with MIL-PRF-28800F.	—
Storage Shock	50 g, half-sine, 11 ms pulse. Meets IEC-60068-2-27. Test profile developed in accordance with MIL-PRF-28800F.	—
Operating Vibration	5 Hz to 500 Hz, 0.31 g _{rms} . Meets IEC-60068-2-64.	—
Storage Vibration	5 Hz to 500 Hz, 2.46 g _{rms} . Meets IEC-60068-2-64. Test profile exceeds requirements of MIL-PRF-28800F, Class B.	—
Altitude	2,000 m maximum (at 25 °C ambient temperature)	—
Pollution Degree	2	—

NI PCI-5152



Note To ensure that the NI PCI-5152 cools effectively, make sure that the chassis in which it is used has active cooling that provides at least some airflow across the PCI card cage. To maximize airflow and extend the life of the device, leave any adjacent PCI slots empty. Refer to the *Maintain Forced Air Cooling Note to Users* included in the NI PCI-5152 kit for important cooling information. The NI PCI-5152 is intended for indoor use only.

Specification	Value	Comments
Operating Temperature	0 °C to +45 °C. Meets IEC-60068-2-1 and IEC-60068-2-2.	—
Storage Temperature	−40 °C to +70 °C. Meets IEC-60068-2-1 and IEC-60068-2-2.	—
Operating Relative Humidity	10% to 90%, noncondensing. Meets IEC-60068-2-56.	—
Storage Relative Humidity	5% to 95%, noncondensing. Meets IEC-60068-2-56.	—
Storage Shock	50 g, half-sine, 11 ms pulse. Meets IEC-60068-2-27. Test profile developed in accordance with MIL-PRF-28800F.	—
Storage Vibration	5 Hz to 500 Hz, 2.46 g _{rms} . Meets IEC-60068-2-64. Test profile exceeds requirements of MIL-PRF-28800F, Class B.	—
Altitude	2,000 m maximum (at 25 °C ambient temperature)	—
Pollution Degree	2	—

Safety, Electromagnetic Compatibility, and CE Compliance

Safety

This product is designed to meet the requirements of the following standards of safety for electrical equipment for measurement, control, and laboratory use:

- IEC 61010-1, EN 61010-1
- UL 61010-1, CSA 61010-1



Note For UL and other safety certifications, refer to the product label or visit ni.com/certification, search by model number or product line, and click the appropriate link in the Certification column.

Electromagnetic Compatibility

This product is designed to meet the requirements of the following standards of EMC for electrical equipment for measurement, control, and laboratory use:

- EN 61326 EMC requirements; Minimum Immunity
- EN 55011 Emissions; Group 1, Class A
- CE, C-Tick, ICES, and FCC Part 15 Emissions; Class A



Note For EMC compliance, operate this device with RG223/U or equivalent shielded cable. Operate according to product documentation.

CE Compliance

This product meets the essential requirements of applicable European Directives, as amended for CE marking, as follows:

- 73/23/EEC; Low-Voltage Directive (safety)
- 89/336/EEC; Electromagnetic Compatibility Directive (EMC)



Note Refer to the Declaration of Conformity (DoC) for this product for any additional regulatory compliance information. To obtain the DoC for this product, visit ni.com/certification, search by model number or product line, and click the appropriate link in the Certification column.

Waste Electrical and Electronic Equipment (WEEE)



EU Customers At the end of their life cycle, all products must be sent to a WEEE recycling center. For more information about WEEE recycling centers and National Instruments WEEE initiatives, visit ni.com/environment/weee.htm.

Physical

Front Panel Connectors

Label	Function	Connector Type
CH 0	Analog input	BNC female
CH 1	Analog input	BNC female
TRIG	External Trigger	BNC female
PFI 0	Sample Clock Input, Reference Clock Input Digital Trigger Input/Output	SMB jack
PFI 1	Reference Clock Output, Digital Trigger Input/Output	SMB jack

Dimensions and Weight

NI PXI-5152

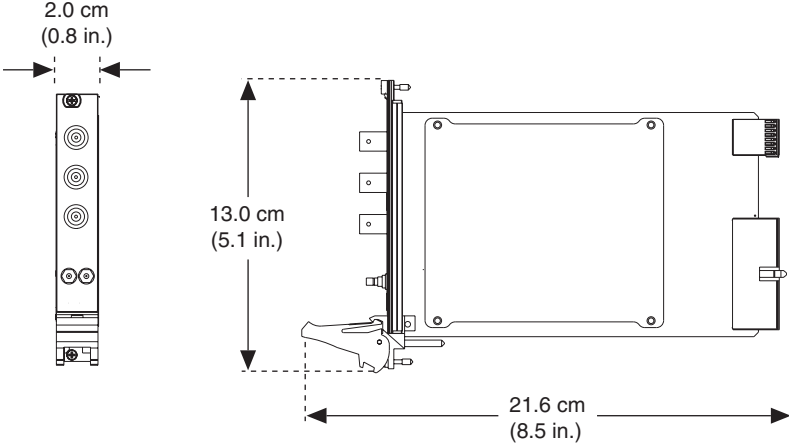
Specification	Value
Dimensions	<p data-bbox="337 296 682 387">3U, One slot, PXI/cPCI Module 21.6 × 2.0 × 13.0 cm (8.5 × 0.8 × 5.1 in.)</p>  <p>The technical drawing illustrates the NI PXI-5152 module from three perspectives. The front view on the left shows a vertical stack of components with a width dimension of 2.0 cm (0.8 in.). The side view in the center shows the module's height of 13.0 cm (5.1 in.). The top view on the right shows the module's length of 21.6 cm (8.5 in.).</p>
Weight	462 g (16.3 oz)

NI PCI-5152

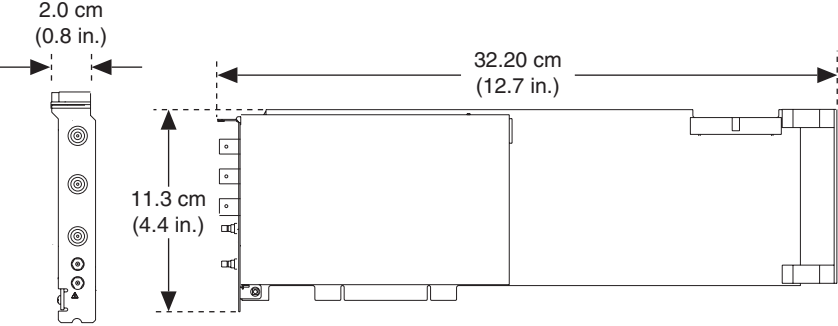
Specification	Value
Dimensions	<p data-bbox="350 215 588 274">32.20 × 2.0 × 11.3 cm (12.7 × 0.8 × 4.4 in.)</p>  <p>The diagram shows a side view of the NI PCI-5152 module. It is a long, thin rectangular component. On the left side, there is a vertical edge with several circular features. Dimension lines indicate the following measurements: a width of 2.0 cm (0.8 in.) across the top edge, a height of 11.3 cm (4.4 in.) from the bottom edge to the top edge of the main body, and a total length of 32.20 cm (12.7 in.) from the left edge to the right edge. The right side of the module has a vertical edge with several rectangular features.</p>
Weight	445 g (15.7 oz)

Where to Go for Support

The National Instruments Web site is your complete resource for technical support. At ni.com/support you have access to everything from troubleshooting and application development self-help resources to email and phone assistance from NI Application Engineers.

A Declaration of Conformity (DoC) is our claim of compliance with the Council of the European Communities using the manufacturer's declaration of conformity. This system affords the user protection for electronic compatibility (EMC) and product safety. You can obtain the DoC for your product by visiting ni.com/certification. If your product supports calibration, you can obtain the calibration certificate for your product at ni.com/calibration.

National Instruments corporate headquarters is located at 11500 North Mopac Expressway, Austin, Texas, 78759-3504. National Instruments also has offices located around the world to help address your support needs. For telephone support in the United States, create your service request at ni.com/support and follow the calling instructions or dial 512 795 8248. For telephone support outside the United States, contact your local branch office:

Australia 1800 300 800, Austria 43 662 457990-0,
Belgium 32 (0) 2 757 0020, Brazil 55 11 3262 3599,
Canada 800 433 3488, China 86 21 5050 9800,
Czech Republic 420 224 235 774, Denmark 45 45 76 26 00,
Finland 385 (0) 9 725 72511, France 33 (0) 1 48 14 24 24,
Germany 49 89 7413130, India 91 80 41190000, Israel 972 3 6393737,
Italy 39 02 413091, Japan 81 3 5472 2970, Korea 82 02 3451 3400,
Lebanon 961 (0) 1 33 28 28, Malaysia 1800 887710,
Mexico 01 800 010 0793, Netherlands 31 (0) 348 433 466,
New Zealand 0800 553 322, Norway 47 (0) 66 90 76 60,
Poland 48 22 3390150, Portugal 351 210 311 210, Russia 7 495 783 6851,
Singapore 1800 226 5886, Slovenia 386 3 425 42 00,
South Africa 27 0 11 805 8197, Spain 34 91 640 0085,
Sweden 46 (0) 8 587 895 00, Switzerland 41 56 2005151,
Taiwan 886 02 2377 2222, Thailand 662 278 6777,
Turkey 90 212 279 3031, United Kingdom 44 (0) 1635 523545

National Instruments, NI, ni.com, and LabVIEW are trademarks of National Instruments Corporation. Refer to the *Terms of Use* section on ni.com/legal for more information about National Instruments trademarks. Other product and company names mentioned herein are trademarks or trade names of their respective companies. For patents covering National Instruments products, refer to the appropriate location: **Help»Patents** in your software, the `patents.txt` file on your CD, or ni.com/patents.