

# Owner's Manual & Safety Instructions

**Save This Manual** Keep this manual for the safety warnings and precautions, assembly, operating, inspection, maintenance and cleaning procedures. Write the product's serial number in the back of the manual near the assembly diagram (or month and year of purchase if product has no number). Keep this manual and the receipt in a safe and dry place for future reference.

17d

# CENTRALPNEUMATIC®

## benchtop blast cabinet



Visit our website at: <http://www.harborfreight.com>  
Email our technical support at: [productsupport@harborfreight.com](mailto:productsupport@harborfreight.com)

**ITEM 62454**

When unpacking, make sure that the product is intact and undamaged. If any parts are missing or broken, please call 1-888-866-5797 as soon as possible.

Copyright© 2014 by Harbor Freight Tools®. All rights reserved.  
No portion of this manual or any artwork contained herein may be reproduced in any shape or form without the express written consent of Harbor Freight Tools. Diagrams within this manual may not be drawn proportionally. Due to continuing improvements, actual product may differ slightly from the product described herein.  
Tools required for assembly and service may not be included.

### **⚠ WARNING**






**Read this material before using this product.  
Failure to do so can result in serious injury.  
SAVE THIS MANUAL.**

# Table of Contents

Safety .....	2	Maintenance .....	12
Specifications .....	6	Parts List and Diagram .....	14
Setup .....	7	Warranty .....	16
Operation.....	10		

# CENTRALPNEUMATIC®

## WARNING SYMBOLS AND DEFINITIONS

	This is the safety alert symbol. It is used to alert you to potential personal injury hazards. Obey all safety messages that follow this symbol to avoid possible injury or death.
	Indicates a hazardous situation which, if not avoided, will result in death or serious injury.
	Indicates a hazardous situation which, if not avoided, could result in death or serious injury.
	Indicates a hazardous situation which, if not avoided, could result in minor or moderate injury.
	Addresses practices not related to personal injury.

## IMPORTANT SAFETY INSTRUCTIONS

### INSTRUCTIONS PERTAINING TO A RISK OF FIRE, ELECTRIC SHOCK, OR INJURY TO PERSONS

**WARNING** – When using tools, basic precautions should always be followed, including the following:

#### General

To reduce the risks of electric shock, fire, and injury to persons, read all the instructions before using the tool.

#### Work Area

- Keep the work area clean and well lighted.**  
Cluttered benches and dark areas increase the risks of electric shock, fire, and injury to persons.
- Do not operate the tool in explosive atmospheres, such as in the presence of flammable liquids, gases, or dust.**  
The tool is able to create sparks resulting in the ignition of the dust or fumes.
- Keep bystanders, children, and visitors away while operating the tool.** Distractions are able to result in the loss of control of the tool.

# Personal Safety

1. **Stay alert. Watch what you are doing and use common sense when operating the tool. Do not use the tool while tired or under the influence of drugs, alcohol, or medication.** A moment of inattention while operating the tool increases the risk of injury to persons.
2. **Dress properly. Do not wear loose clothing or jewelry. Contain long hair. Keep hair, clothing, and gloves away from moving parts.** Loose clothes, jewelry, or long hair increases the risk of injury to persons as a result of being caught in moving parts.
3. **Avoid unintentional starting. Be sure the trigger is released before connecting to the air supply.** Do not connect the tool to the air supply with the switch on.

4. **Do not overreach. Keep proper footing and balance at all times.** Proper footing and balance enables better control of the tool in unexpected situations.



5. **Use safety equipment.** A dust mask, non-skid safety shoes and a hard hat must be used for the applicable conditions.



6. **Always wear eye protection.** Wear ANSI-approved safety goggles.



7. **Always wear hearing protection when using the tool.** Prolonged exposure to high intensity noise is able to cause hearing loss.

# Tool Use and Care


1. **Use clamps or another practical way to secure and support the workpiece to a stable platform.** Holding the work by hand or against the body is unstable and is able to lead to loss of control.
2. **Do not force the tool.** Use the correct tool for the application. The correct tool will do the job better and safer at the rate for which the tool is designed.
3. **Do not use the tool if the switch does not turn the tool on or off.** Any tool that cannot be controlled with the switch is dangerous and must be repaired.
4. **Disconnect the tool from the air source before making any adjustments, changing accessories, or storing the tool.** Such preventive safety measures reduce the risk of starting the tool unintentionally. Turn off and detach the air supply, safely discharge any residual air pressure, and release the throttle and/or turn the switch to its off position before leaving the work area.

5. **Store the tool when it is idle out of reach of children and other untrained persons.** A tool is dangerous in the hands of untrained users.
6. **Maintain the tool with care.**
7. **Check for misalignment or binding of moving parts, breakage of parts, and any other condition that affects the tool's operation.** If damaged, have the tool serviced before using. Many accidents are caused by poorly maintained tools. There is a risk of bursting if the tool is damaged.
8. **Use only accessories that are identified by the manufacturer for the specific tool model.** Use of an accessory not intended for use with the specific tool model, increases the risk of injury to persons.

## Service

1. *Tool service must be performed only by qualified repair personnel.*
2. **When servicing a tool, use only identical replacement parts. Use only authorized parts.**

## Air Source





1.  **Never connect to an air source that is capable of exceeding 200 psi.** Over pressurizing the tool may cause bursting, abnormal operation, breakage of the tool or serious injury to persons. Use only clean, dry, regulated compressed air at the rated pressure or within the rated pressure range as marked on the tool. Always verify prior to using the tool that the air source has been adjusted to the rated air pressure or within the rated air-pressure range.
2. **Never use oxygen, carbon dioxide, combustible gases or any bottled gas as an air source for the tool.** Such gases are capable of explosion and serious injury to persons.



**SAVE THESE INSTRUCTIONS.**

## Symbols and Specific Safety Instructions

### Symbol Definitions

Symbol	Property or statement	Symbol	Property or statement
<b>PSI</b>	Pounds per square inch of pressure		WARNING marking concerning Risk of Hearing Loss. Wear hearing protection.
<b>ft-lb</b>	Foot-pounds of torque		WARNING marking concerning Risk of Respiratory Injury. Wear NIOSH-approved dust mask/respirator.
<b>NPT</b>	National pipe thread, tapered		WARNING marking concerning Risk of Explosion.
	WARNING marking concerning Risk of Eye Injury. Wear ANSI-approved eye protection.		

### Specific Safety Instructions

1. The warnings and precautions discussed in this manual cannot cover all possible conditions and situations that may occur. It must be understood by the operator that common sense and caution are factors which cannot be built into this product, but must be supplied by the operator.
2. Obey the manual for the air compressor used to power this tool.
3. Install an in-line shutoff valve to allow immediate control over the air supply in an emergency, even if a hose is ruptured.

### Assembly Precautions

1. Assemble only according to these instructions. Improper assembly can create hazards.
2. Wear ANSI-approved safety goggles and heavy-duty work gloves during assembly.
3. Keep assembly area clean and well lit.
4. Keep bystanders out of the area during assembly.
5. Do not assemble when tired or when under the influence of drugs or medication.

# Silicosis and Aluminum Oxide Warnings

**WARNING!** Abrasive blasting with sand containing crystalline silica can cause serious or fatal respiratory disease. Exposure to crystalline silica may cause silicosis (a serious lung disease), cancer and death. Exposure to aluminum oxide (a dust generated from material removing processes) can result in eye, skin and breathing irritation. Always use a NIOSH (National Institute for Occupational Safety and Health) approved respirator and safety goggles. Avoid skin exposure. Proper ventilation in the work area is required. Read and understand the 10 recommended measures below to reduce crystalline silica exposures in the workplace and prevent silicosis and silicosis related deaths.

**NIOSH recommends the following measures to reduce crystalline silica exposures in the workplace and prevent silicosis and silicosis-related deaths:**

1. Prohibit silica sand (or other substances containing more than 1% crystalline silica) as an abrasive blasting material and substitute less hazardous materials.
2. Conduct air monitoring to measure worker exposures.
3. Use containment methods such as blast-cleaning machines and cabinets to control the hazard and protect adjacent workers from exposure.
4. Practice good personal hygiene to avoid unnecessary exposure to silica dust.
5. Wear washable or disposable protective clothes at the work site. Shower and change into clean clothes before leaving the work site to prevent contamination of cars, homes and other work areas.
6. Use respiratory protection when source controls cannot keep silica exposures below the NIOSH REL.
7. Provide periodic medical examinations for all workers who may be exposed to crystalline silica.
8. Post signs to warn workers about the hazard and to inform them about required protective equipment.
9. Provide workers with training that includes information about health effects, work practices and protective equipment for crystalline silica.
10. Report all cases of silicosis to State health departments and to OSHA or the Mine Safety and Health Administration (MSHA).

## Vibration Precautions

This tool vibrates during use. Repeated or long-term exposure to vibration may cause temporary or permanent physical injury, particularly to the hands, arms and shoulders. To reduce the risk of vibration-related injury:

1. Anyone using vibrating tools regularly or for an extended period should first be examined by a doctor and then have regular medical check-ups to ensure medical problems are not being caused or worsened from use. Pregnant women or people who have impaired blood circulation to the hand, past hand injuries, nervous system disorders, diabetes, or Raynaud's Disease should not use this tool. If you feel any symptoms related to vibration (such as tingling, numbness, and white or blue fingers), seek medical advice as soon as possible.
2. Do not smoke during use. Nicotine reduces the blood supply to the hands and fingers, increasing the risk of vibration-related injury.
3. Use tools with the lowest vibration when there is a choice.
4. Include vibration-free periods each day of work.
5. Grip tool as lightly as possible (while still keeping safe control of it). Let the tool do the work.
6. To reduce vibration, maintain tool as explained in this manual. If abnormal vibration occurs, stop immediately.



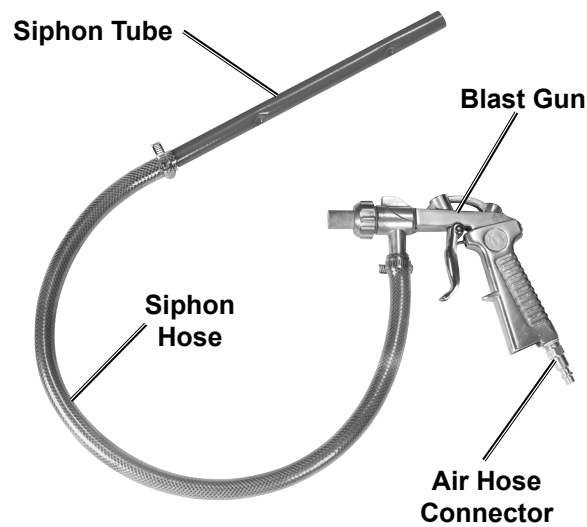
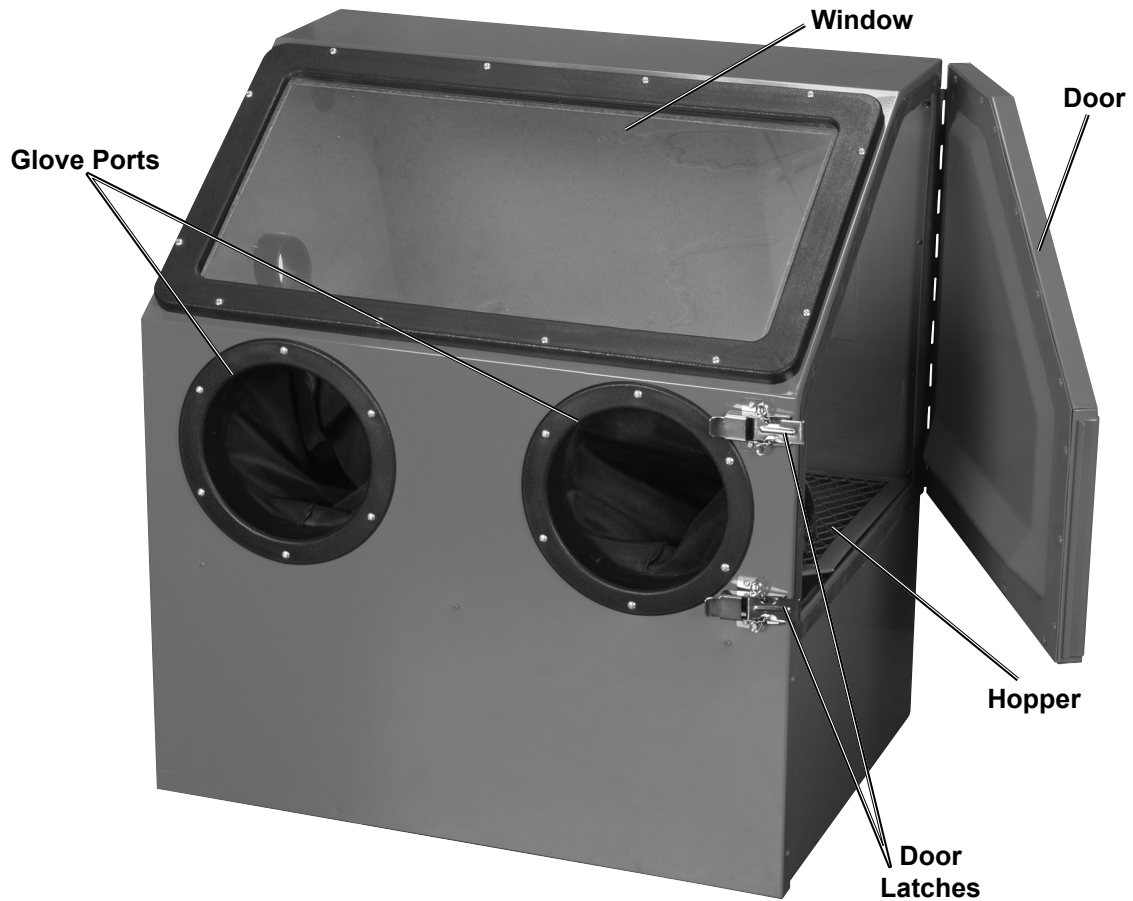
**SAVE THESE INSTRUCTIONS.**

## Functional Description

## Specifications

Average Air Consumption	10 CFM @ 100 PSI
Maximum Working Pressure	100 PSI
Air Inlet	1/4" -18 NPT
Included Nozzles	.18", .19", .22", .27"

## Components and Controls



SAFETY

SETUP

OPERATION

MAINTENANCE

## Initial Tool Setup / Assembly



Read the **ENTIRE IMPORTANT SAFETY INFORMATION** section at the beginning of this manual including all text under subheadings therein before set up or use of this product.

**Note:** For additional information regarding the parts listed in the following pages, refer to the Assembly Diagram near the end of this manual.

1. Remove any protective film from the outside of the Window (23), and any other parts.
2. Remove the protective backing from one of the included Window Liners (22) and adhere it to the inside of the Window (23).
3. Slide one end of the Siphon Hose (8) onto the Siphon Tube (12) and the other end onto the Blast Gun (7).
4. Insert the Siphon Tube through the corner opening of the Grate (14) so that it is resting in the Hopper (13).

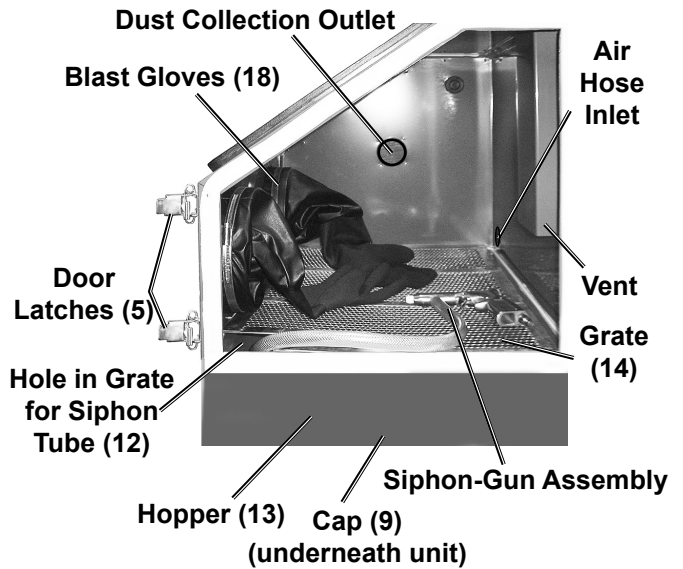


Figure A: Cabinet Setup

## Ceramic Nozzle Installation

1. Loosen the Locking Ring and remove the old Ceramic Nozzle.
2. Place the long end of the new Ceramic Nozzle into the Locking Ring.
3. Place the Locking Ring with Ceramic Nozzle onto the end of the Blast Gun, and thread the Locking Ring on securely by hand.

**Note:** By changing to the next larger size of Nozzle, production can increase significantly. Larger size Nozzles produce a larger cleaning pattern, requiring higher air pressure and greater air flow.

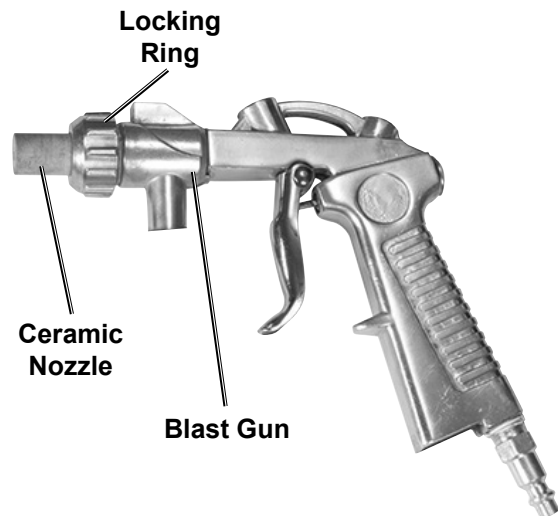


Figure B: Blast Gun Detail

# CENTRALPNEUMATIC®

# Air Supply

## ⚠️ WARNING



### TO PREVENT SERIOUS INJURY FROM EXPLOSION:

Use only clean, dry, regulated, compressed air to power this tool.  
Do not use oxygen, carbon dioxide, combustible gases,  
or any other bottled gas as a power source for this tool.

1. Incorporate a filter, regulator with pressure gauge, dryer, in-line shutoff valve, and quick coupler for best service, as shown on Figure C on page 9 and Figure D on page 9. **An in-line shutoff ball valve is an important safety device because it controls the air supply even if the air hose is ruptured. The shutoff valve should be a ball valve because it can be closed quickly.**
2. Attach an air hose to the compressor's air outlet. Connect the air hose to the air inlet of the tool. Other components, such as a coupler plug and quick coupler, will make operation more efficient, but are not required.
3. Turn the tool's throttle or switch to the off position; refer to Operation section for description of controls.
4. Close the in-line shutoff valve between the compressor and the tool.
5. Turn on the air compressor according to the manufacturer's directions and allow it to build up pressure until it cycles off.
6. Adjust the air compressor's output regulator so that the air output is enough to properly power the tool, but the output will not exceed the tool's maximum air pressure at any time. Adjust the pressure gradually, while checking the air output gauge to set the right pressure range.
7. Inspect the air connections for leaks. Repair any leaks found.
8. If the tool will not be used at this time, turn off and detach the air supply, safely discharge any residual air pressure, and release the throttle and/or turn the switch to its off position to prevent accidental operation.

**Note:** An oiler system should not be used with this tool. The oil will mix with the material being propelled, causing tool to clog.

**Note:** This air tool may be shipped with a protective plug covering the air inlet. Remove this plug before set up.

## ⚠️ WARNING! TO PREVENT SERIOUS INJURY FROM ACCIDENTAL OPERATION:

**Do not install a female quick coupler on the tool.**

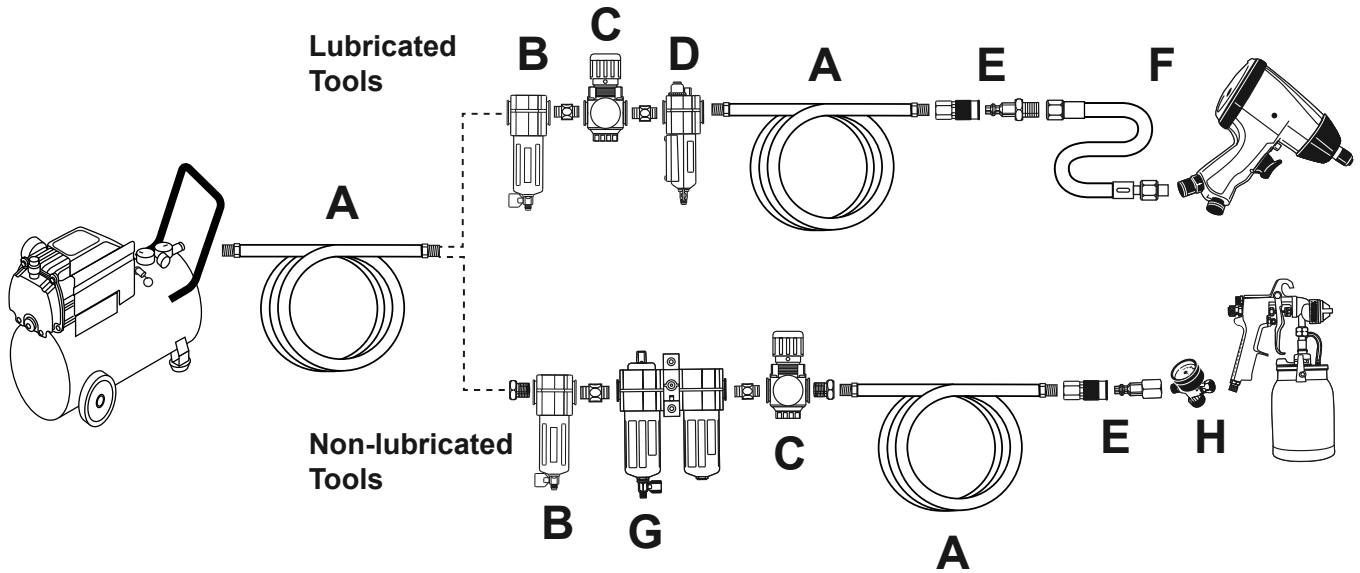
Such a coupler contains an air valve that will allow the air tool to retain pressure and operate accidentally after the air supply is disconnected.

**Note:** Air flow, and therefore tool performance, can be hindered by undersized air supply components. The air hose must be long enough to reach the work area with enough extra length to allow free movement while working.

**Note:** Residual air pressure should not be present after the tool is disconnected from the air supply. However, it is a good safety measure to attempt to discharge the tool in a safe fashion after disconnecting to ensure that the tool is disconnected and not powered.

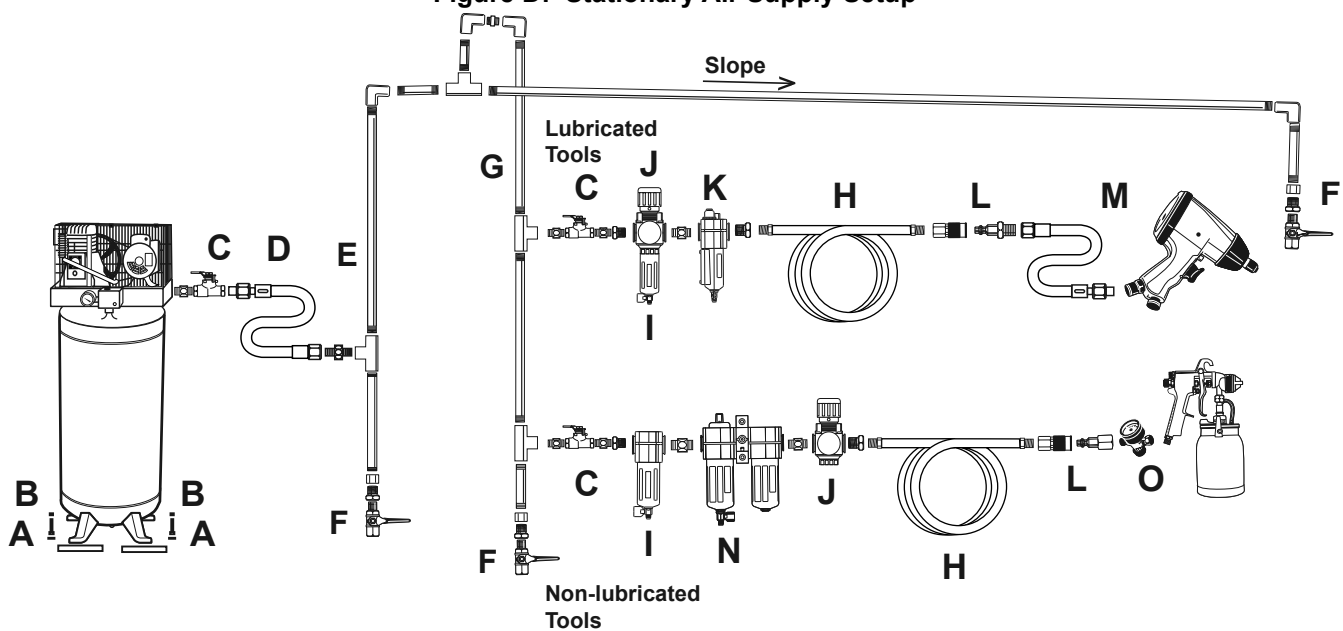


**Figure C: Portable Air Supply Setup**



	Description	Function
A	Air Hose	Connects air to tool
B	Filter	Prevents dirt and condensation from damaging tool or workpiece
C	Regulator	Adjusts air pressure to tool
D	Lubricator (optional)	For air tool lubrication
E	Coupler and Plug	Provides quick connection and release
F	Leader Hose (optional)	Increases coupler life
G	Air Cleaner / Dryer (optional)	Prevents water vapor from damaging workpiece
H	Air Adjusting Valve (optional)	For fine tuning airflow at tool

**Figure D: Stationary Air Supply Setup**



	Description	Function
A	Vibration Pads	For noise and vibration reduction
B	Anchor Bolts	Secures air compressor in place
C	Ball Valve	Isolates sections of system for maintenance
D	Isolation Hose	For vibration reduction
E	Main Air Line - 3/4" minimum recommended	Distributes air to branch lines
F	Ball Valve	To drain moisture from system
G	Branch Air Line - 1/2" minimum recommended	Brings air to point of use
H	Air Hose	Connects air to tool
I	Filter	Prevents dirt and condensation from damaging tool or workpiece
J	Regulator	Adjusts air pressure to tool
K	Lubricator (optional)	For air tool lubrication
L	Coupler and Plug	Provides quick connection and release
M	Leader Hose (optional)	Increases coupler life
N	Air Cleaner / Dryer (optional)	Prevents water vapor from damaging workpiece
O	Air Adjusting Valve (optional)	For fine tuning airflow at tool

SAFETY

SETUP

OPERATION

MAINTENANCE

## Operating Instructions



Read the **ENTIRE IMPORTANT SAFETY INFORMATION** section at the beginning of this manual including all text under subheadings therein before set up or use of this product.

Inspect tool before use, looking for damaged, loose, and missing parts.  
If any problems are found, do not use tool until repaired.

## Tool Set Up

### **⚠️ WARNING**

**TO PREVENT SERIOUS INJURY FROM ACCIDENTAL OPERATION:**

Turn off the tool, detach the air supply, safely discharge any residual air pressure in the tool, and release the trigger before performing any inspection, maintenance, or cleaning procedures.

**TO PREVENT SERIOUS INJURY:**

Do not adjust or tamper with any control or component in a way not specifically explained within this manual. Improper adjustment can result in tool failure or other serious hazards.

1. Remove the cover on the left side of the Cabinet and install a dust collection system (sold separately) to the Flange opening to remove media dust while blasting.
2. Fill the Hopper about 1/2 full with fine abrasive material. To prevent clogging, do not overfill.

If not using a dust collection system, check that the cover is in place over the opening on the left side of the Cabinet.

**WARNING!** Do not use sand or abrasives that contain crystalline silica. Abrasive blasting with sand containing crystalline silica can cause serious or fatal respiratory disease. See "Silicosis and Aluminum Oxide Warnings" on page 5.

## Workpiece and Work Area Set Up

1. Designate a work area that is clean and well-lit. The work area must not allow access by children or pets to prevent distraction and injury.
2. Route the air hose along a safe route to reach the work area without creating a tripping hazard or exposing the air hose to possible damage. The air hose must be long enough to reach the work area with enough extra length to allow free movement while working.

# CENTRALPNEUMATIC®

# General Operating Instructions

1. Connect the air compressor hose to the Hose Inlet Fitting.
  2. Turn on the vacuum of the dust collection system (if equipped, sold separately).
- Note:** When using a vacuum dust collector, clean the filter periodically to maintain adequate suction and effectiveness of the vacuum.
3. Open the Door of the Blast Cabinet and place the workpiece in the center of the Cabinet.
  4. Close the door and secure the Door Latches.
  5. Set the compressor's air pressure between 90 and 100 PSI.
  6. Place your hands into the Gloves inside the Cabinet. Make sure your fingers are in the proper positions and that you can easily move your hands and grip objects.
  7. Hold the workpiece in one hand, positioning your fingers so that the glove is not in the way of the area you will be blasting. While working, reposition your grip as needed to ensure that all areas of the workpiece will be contacted with the blast material.
  8. Grip the Blasting Gun with the other hand and point the nozzle at the bottom of the Cabinet.
  9. Squeeze the trigger.
  10. Check that the abrasive media is flowing through the suction hose with no leaks. Release the trigger and correct any leaks if needed. Otherwise begin blasting the workpiece.

**WARNING!** Do not aim the nozzle at your fingers or the Blast Gloves. If Gloves are punctured or you feel air blowing in the Glove, replace them immediately. Do not use a damaged or punctured Glove.

11. If the tool requires more force to accomplish the task, verify that the tool receives sufficient, unobstructed airflow (CFM) and increase the pressure (PSI) output of the regulator up to the maximum air pressure rating of this tool.

**CAUTION! TO PREVENT INJURY FROM TOOL OR ACCESSORY FAILURE:**

**Do not exceed the tool's maximum air pressure rating.**

If the tool still does not have sufficient force at maximum pressure and sufficient airflow, then a larger tool may be required.

12. When finished, or to check the progress of your blasting:
  - a. Release the trigger, lay the workpiece on the Grate of the Cabinet and remove your hands from the gloves.
  - b. Turn off the compressor and dust collection system (if equipped). Wait for the air inside the Cabinet to clear.
  - c. Open the Cabinet door and remove the workpiece. If the workpiece needs more blasting, resume from step 4 of these operating instructions.
13. To prevent accidents, release the trigger, detach the air supply, then squeeze and release the trigger once more to safely discharge any residual air pressure in the tool. Empty the Hopper of blast media (see User-Maintenance Instructions section on page 12). Clean external surfaces of the tool with a clean, dry cloth. Then store the tool indoors out of children's reach.

# CENTRALPNEUMATIC®

## User-Maintenance Instructions



Procedures not specifically explained in this manual must be performed only by a qualified technician.

### **WARNING**

#### **TO PREVENT SERIOUS INJURY FROM ACCIDENTAL OPERATION:**

Turn off the tool, detach the air supply, safely discharge any residual air pressure in the tool, and release the trigger before performing any inspection, maintenance, or cleaning procedures.

#### **TO PREVENT SERIOUS INJURY FROM TOOL FAILURE:**

Do not use damaged equipment. If abnormal noise, vibration, or leaking air occurs, have the problem corrected before further use.

## Cleaning, Maintenance, and Lubrication

**Note:** These procedures are in addition to the regular checks and maintenance explained as part of the regular operation of the air-operated tool.

#### 1. **Daily - Air Supply Maintenance:**


Every day, maintain the air supply according to the component manufacturers' instructions. Drain the moisture filter regularly. Performing routine air supply maintenance will allow the tool to operate more safely and will also reduce wear on the tool.

#### 2. After use, empty the Hopper of blast media:

**CAUTION!** Wear ANSI-approved Safety Goggles and NIOSH-approved dust mask/respirator when emptying the abrasive media.

- a. Place a container (sold separately), which is large enough to hold all the blast media, under the mouth of the Hopper.
- b. Turn the Hopper Hook on the Hopper Square to open the Hopper and allow all the abrasive media to flow into the container.
- c. Close the Hopper Square.

# Troubleshooting

Problem	Possible Causes	Likely Solutions
Decreased output.	<ol style="list-style-type: none"> <li>1. Not enough air pressure and/ or air flow.</li> <li>2. Obstructed trigger.</li> <li>3. Blocked air inlet screen (if equipped).</li> <li>4. Air leaking from loose housing.</li> <li>5. Mechanism contaminated.</li> <li>6. Abrasive media level too low.</li> <li>7. Lubrication being used.</li> </ol>	<ol style="list-style-type: none"> <li>1. Check for loose connections and make sure that air supply is providing enough air flow (CFM) at required pressure (PSI) to the tool's air inlet. <b>Do not exceed maximum air pressure.</b></li> <li>2. Clean around trigger to ensure free movement.</li> <li>3. Clean air inlet screen of buildup.</li> <li>4. Make sure housing is properly assembled and tight.</li> <li>5. Have qualified technician clean and lubricate mechanism. Install in-line filter in air supply as stated in Setup: Air Supply on page 8.</li> <li>6. Add more abrasive media to the Hopper.</li> <li>7. An oiler system should not be used with this tool. The oil will mix with the material being propelled, causing tool to clog.</li> </ol>
Housing heats during use.	Worn parts.	Have qualified technician inspect internal mechanism and replace parts as needed.
Severe air leakage. (Slight air leakage is normal, especially on older tools.)	<ol style="list-style-type: none"> <li>1. Cross-threaded housing components.</li> <li>2. Loose housing.</li> <li>3. Damaged valve or housing.</li> <li>4. Dirty, worn or damaged valve.</li> </ol>	<ol style="list-style-type: none"> <li>1. Check for incorrect alignment and uneven gaps. If cross-threaded, disassemble and replace damaged parts before use.</li> <li>2. Tighten housing assembly. If housing cannot tighten properly, internal parts may be misaligned.</li> <li>3. Replace damaged components.</li> <li>4. Clean or replace valve assembly.</li> </ol>
Abrasive media not effective.	Abrasive media has become worn down from use.	Replace abrasive media.
Abrasive media does not fire from Blasting Gun.	<ol style="list-style-type: none"> <li>1. Lubrication being used.</li> <li>2. Abrasive media size is too large for Nozzle.</li> <li>3. Abrasive media too moist and is sticking together.</li> </ol>	<ol style="list-style-type: none"> <li>1. An oiler system should not be used with this tool. The oil will mix with the material being propelled, causing tool to clog.</li> <li>2. Replace Nozzle with a nozzle large enough to handle abrasive media size or use finer media.</li> <li>3. Replace media with dry, fresh media. Incorporate an air drier on the air supply.</li> </ol>
 <p><b>Follow all safety precautions whenever diagnosing or servicing the tool. Disconnect air supply before service.</b></p>		

SAFETY

SETUP

OPERATION

MAINTENANCE

**PLEASE READ THE FOLLOWING CAREFULLY**

THE MANUFACTURER AND/OR DISTRIBUTOR HAS PROVIDED THE PARTS LIST AND ASSEMBLY DIAGRAM IN THIS MANUAL AS A REFERENCE TOOL ONLY. NEITHER THE MANUFACTURER OR DISTRIBUTOR MAKES ANY REPRESENTATION OR WARRANTY OF ANY KIND TO THE BUYER THAT HE OR SHE IS QUALIFIED TO MAKE ANY REPAIRS TO THE PRODUCT, OR THAT HE OR SHE IS QUALIFIED TO REPLACE ANY PARTS OF THE PRODUCT. IN FACT, THE MANUFACTURER AND/OR DISTRIBUTOR EXPRESSLY STATES THAT ALL REPAIRS AND PARTS REPLACEMENTS SHOULD BE UNDERTAKEN BY CERTIFIED AND LICENSED TECHNICIANS, AND NOT BY THE BUYER. THE BUYER ASSUMES ALL RISK AND LIABILITY ARISING OUT OF HIS OR HER REPAIRS TO THE ORIGINAL PRODUCT OR REPLACEMENT PARTS THERETO, OR ARISING OUT OF HIS OR HER INSTALLATION OF REPLACEMENT PARTS THERETO.

**Parts List**

Part	Description	Qty
1	Body	1
2	Foam Gasket	1
3	Door	1
4	Vent Baffle	1
5	Door Latch	2
6	Door Edge Trim	1
7	Blast Gun	1
8	Siphon Hose	1
9	Cap	1
10	Connector	1
11	Rubber Washer	1
12	Siphon Tube	1

Part	Description	Qty
13	Hopper	1
14	Grate	1
15	Nut	1
16	Glove Port	2
17	Glove Clamp	2
18	Blast Glove	2
19	Rubber Tube	1
20	Rubber Plug	1
21	Rubber Trim	1
22	Window Liner	3
23	Window	1
24	Window Frame	1

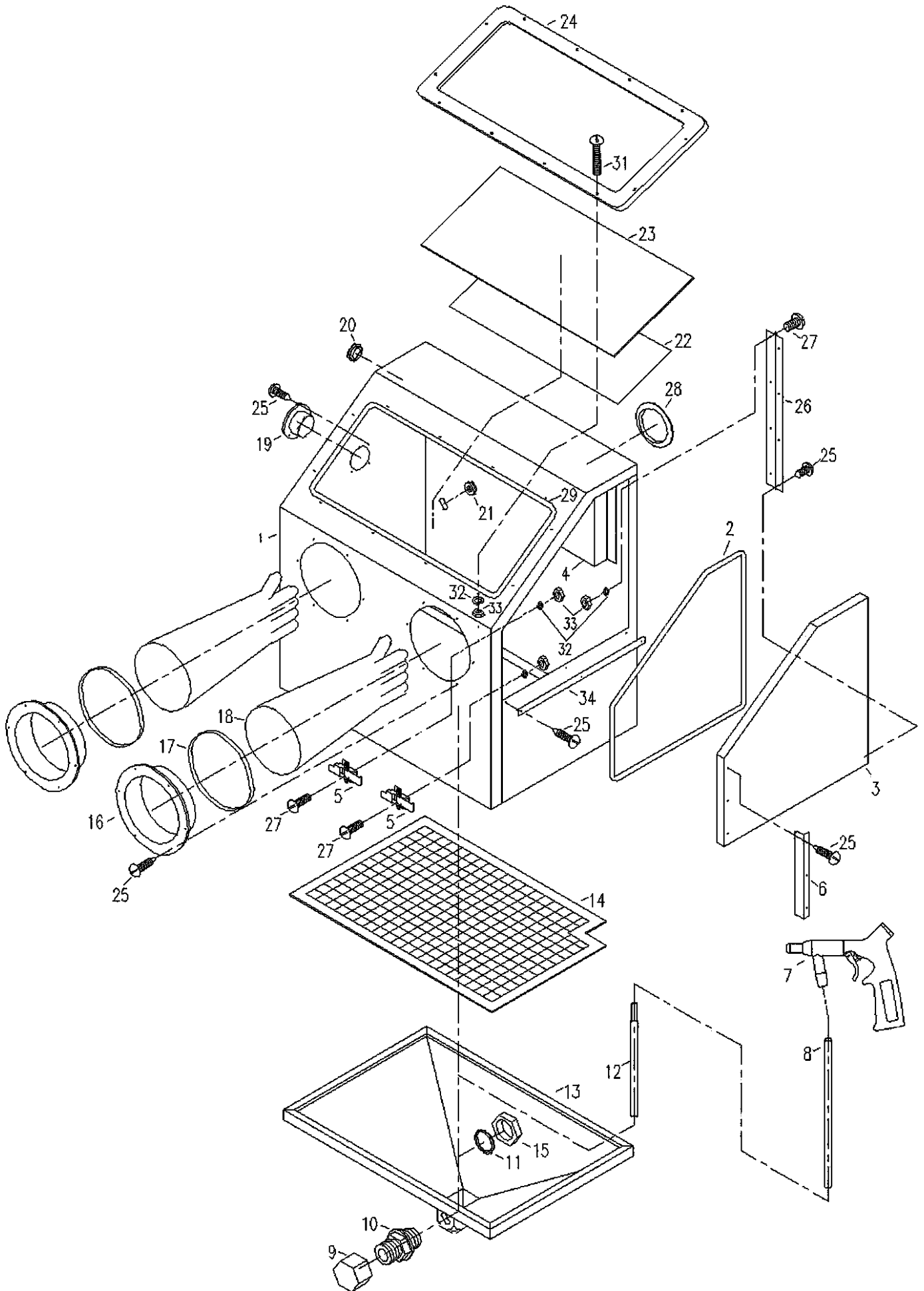
Part	Description	Qty
25	Pan Screw	26
26	Hinge	1
27	Bolt	8
28	Rubber Trim	1
29	Foam Gasket	1
31	Bolt	12
32	Spring Washer	20
33	Nut	20
34	Brace	1
35	Siphon Hose Clamp (not shown)	2
36	Ceramic Tip 3 pc. Set (not shown)	1 set

**Record Product's Serial Number Here:** \_\_\_\_\_

**Note:** If product has no serial number, record month and year of purchase instead.

**Note:** Some parts are listed and shown for illustration purposes only, and are not available individually as replacement parts.

# Assembly Diagram



SAFETY

SETUP

OPERATION

MAINTENANCE

## Limited 90 Day Warranty

Harbor Freight Tools Co. makes every effort to assure that its products meet high quality and durability standards, and warrants to the original purchaser that this product is free from defects in materials and workmanship for the period of 90 days from the date of purchase. This warranty does not apply to damage due directly or indirectly, to misuse, abuse, negligence or accidents, repairs or alterations outside our facilities, criminal activity, improper installation, normal wear and tear, or to lack of maintenance. We shall in no event be liable for death, injuries to persons or property, or for incidental, contingent, special or consequential damages arising from the use of our product. Some states do not allow the exclusion or limitation of incidental or consequential damages, so the above limitation of exclusion may not apply to you. THIS WARRANTY IS EXPRESSLY IN LIEU OF ALL OTHER WARRANTIES, EXPRESS OR IMPLIED, INCLUDING THE WARRANTIES OF MERCHANTABILITY AND FITNESS.

To take advantage of this warranty, the product or part must be returned to us with transportation charges prepaid. Proof of purchase date and an explanation of the complaint must accompany the merchandise. If our inspection verifies the defect, we will either repair or replace the product at our election or we may elect to refund the purchase price if we cannot readily and quickly provide you with a replacement. We will return repaired products at our expense, but if we determine there is no defect, or that the defect resulted from causes not within the scope of our warranty, then you must bear the cost of returning the product.

This warranty gives you specific legal rights and you may also have other rights which vary from state to state.

# CENTRALPNEUMATIC®

3491 Mission Oaks Blvd. • PO Box 6009 • Camarillo, CA 93011 • 1-888-866-5797