

Treker

4200 NT/ST, 4400 NT/ST, 4210/4410 ST Light Utility Vehicles



21107

4400ST Treker



23531

4410ST Treker

700-108M Operator's Manual



Read the Operator's manual entirely. When you see this symbol, the subsequent instructions and warnings are serious - follow without exception. Your life and the lives of others depend on it!

© Copyright 2007 Printed 10/09/07

Cover photo may show optional equipment not supplied with standard unit.



Section 1: Introduction	1	Section 5: Options and Accessories	27
Safety First	1	Trekker Options	27
Using This Manual	1	Front Guards	27
Terminology	1	Tires	27
Definitions	1	Accessories	28
Application	1	Section 6: Maintenance	29
Models Covered	1	General Maintenance	29
Getting Acquainted with your Trekker	1	Securing Vehicle for Maintenance	29
Owner Assistance	2	Torque Values	29
Serial Number Plate	2	Tire Maintenance	30
Section 2: Important Safety Information	3	Jacking the Vehicle	30
Look For The Safety Alert Symbol	3	Shock Absorber Adjustment	30
Be Aware of Signal Words	3	Electrical System	31
Safe Operating Procedures	5	Battery	31
Safety Decals	7	Adding Water to the Battery	32
Section 3: Pre-Delivery and Check List	16	Charging the Battery	32
Pre-Delivery Certificate	16	Jump Starting the Battery	32
Vehicle Information	16	Fuel System	33
Dealer Service and Inspection List	16	Engine Maintenance	34
Dealer Test Ride List	17	General Information	34
Dealer Delivery To Customer List	17	High Altitude Carburetor Kit	34
Customer Acceptance List	17	Drive Belt Replacement	35
Section 4: Operating Instructions	18	Driven Pulley Maintenance	35
Operator Responsibilities	18	Engine Air Filter Maintenance	36
Pre-Start Check List	18	Engine Air Filter Handling	37
General Operation	18	CVT Snorkel Filter Maintenance	38
Indicating Lights and Gauges	18	Spark Arrester	38
Switches	19	4210/4410 ST Park Brake Adjustment	39
Choke	20	Maintenance Schedule	40
Floor Pedals	20	Section 7: Lubrication	41
Shift Selector and Park Brake	20	Engine Oil	41
Instructions for 4200/4400 NT & ST	20	Case Oil	43
Instructions for 4210/4410 ST	20	Rear Trans-axle Case	43
Fuel Gauge	21	Center Transfer Case	44
Seat Belts	21	Front Differential Case	44
Cup Holders	22	Brake Fluid	45
Glove Box Enclosure	22	Section 8: Seasonal Storage	46
Cargo Box Operation	22	Section 9: Body Repair	47
Instructions for 4200/4400 NT & ST	22	Section 10: Specifications and Capacities	49
Instructions for 4210/4410 ST	23	Section 11: Features and Benefits	51
Towing the Trekker	23	4200/4400 NT Series	51
Cargo Box / Flat Bed Set-Up	24	4200/4400 ST Series	51
Engine Performance	24	4210/4410 ST Series	52
Fuel Quality	24	Section 12: Troubleshooting	53
Incomplete Combustion	24	Section 13: Appendix	57
Cold Weather Operation	24	Torque Values Chart	57
Traveling Tips From the Trail Masters	25	Tire Inflation Chart	57
		Land Pride Limited Warranty	59

© Copyright 2007 All rights Reserved

Land Pride provides this publication "as is" without warranty of any kind, either expressed or implied. While every precaution has been taken in the preparation of this manual, Land Pride assumes no responsibility for errors or omissions. Neither is any liability assumed for damages resulting from the use of the information contained herein. Land Pride reserves the right to revise and improve its products as it sees fit. This publication describes the state of this product at the time of its publication, and may not reflect the product in the future. The illustrations in this manual are not intended for safe and proper assembly or disassembly of equipment. The illustrations are intended for ordering parts only.

Land Pride is a registered trademark.
 Weather Pro G is a registered trademark of Spartech Plastic
 All other brands and product names are trademarks or registered trademarks of their respective holders.

Printed in the United States of America.



Section 1: Introduction

Land Pride welcomes you to its growing family of new product owners. Treker series trucks are light utility vehicles that have been designed with care and built by skilled workers using quality materials. Proper set-up, maintenance and safe operating practices will help you get years of satisfactory use from this vehicle.

Safety First

Land Pride is fully aware of the need for safe operating procedures around all of our equipment. We hope you will make a sincere effort to put safety above all other priorities. The Trekers are designed and built for work, recreation and enjoyment; however, improper and irresponsible operation could result in serious injury or death. Since this is an off-road vehicle, operators will seldom see the road safety and warning signs they are accustomed to seeing on highways and public streets. This places additional responsibility on the driver to operate this vehicle well within the safe operational limits and capabilities of the unit.

This manual has been prepared to instruct you in the safe and responsible operation of your Treker. Please read and abide by all safety alert information about this vehicle. If you do not understand any part of this manual, contact your local dealer for additional information and clarification. As the operator of this piece of equipment, you are in complete control. Only you can prevent an accident from happening!

Using This Manual

- Prior to any vehicle operation it is absolutely essential that you read and comprehend each section in this manual to develop an understanding of your vehicle and safety practices. After reviewing this manual, store it in a dry and easily accessible place for future reference.
- The Operator's Section is designed to help familiarize you with safety, assembly, operation, adjustments, troubleshooting and maintenance. Read this manual and follow the recommendations to help ensure safe and efficient operation.
- The information contained within this manual was current at the time of printing. Some parts may change slightly to assure you of the best performance.
- To order a new Operator's or Parts Manual contact your authorized dealer. Manuals can also be downloaded, free-of-charge from our website at www.landpride.com or printed from the Land Pride Service & Support Center by your dealer.

Terminology

Right-hand and left-hand as used in this manual are determined by facing the direction the vehicle will travel while in use unless otherwise stated.

Definitions

The following terms are used throughout this manual.

IMPORTANT: A special point of information related to its preceding topic. Land Pride's intention is that this information should be read and noted before continuing.

NOTE: A special point of information that the operator must be aware of before continuing.

Application

Models Covered

4200NT 4x2 and 4200ST 4x2
4400NT 4x4 and 4400ST 4x4
4210ST 4x2 and 4410ST 4x4

Getting Acquainted with your Treker

The Treker line of light utility vehicles is designed by Land Pride exclusively for off-road use. They are not designed for, nor are they properly equipped to be safely operated or licensed for use on public streets and highways. These vehicles are designed to carry two to three people and a limited amount of gear or cargo comfortably and safely over rough or difficult off road terrain.

The narrow stance NT series comes with either two or four wheeled traction drive and is designed to carry two passengers with 550 lbs. in the 10.5 cu.ft. dumping cargo box down very narrow and tight trails. The Treker NT will fit in the back of most full to mid-sized pickups and is capable of traversing most ATV trails. The stable but narrow stance of the NT series Trekers makes them highly desirable for orchard, vineyard, nursery, landscaping, hunting, and recreational applications.

The wider stance ST series also comes with either two or four wheeled traction drive but is a heavier payload hauler with the capacity for two full sized passengers on the 4200 and 4400 models and three passengers on the 4210 and 4410 models equipped with a bench seat. All ST's are capable of hauling 800 lbs. of cargo in their 15.9 cu.ft. capacity dumping cargo boxes. The wider stance, longer wheelbase, and higher payload on the ST series Trekers make them a strong and stable workhorse for ranches, farms, and construction sites.

Both series have an automotive steering wheel with easy handling rack-and-pinion steering. All models have four wheeled independent suspension, Mc Pherson Struts, large diameter hi-flotation tires, and high center-frame ground clearances that add up to excellent stability and smooth ride over tough terrain. The 4400 and 4410 series 4x4s feature our Command Track four wheeled drive system with over-running clutches on the front differential for unexcelled traction, easy handling and minimal disturbance to the turf. The 4210 4x2 and 4410 4x4 models also feature Auto-Lock rear differentials with

Section 1: Introduction

over-running clutches and sealed torque converters for absolute maximum traction capability in wet or slippery conditions. The Treker 4400NT is also available with the Auto-Lock rear differential and sealed torque converter as an option package.

Driving a Treker is as easy as driving a new pickup with an automatic transmission. A simple forward and reverse shifter provides direction control. A neutral start feature and keyed 12volt electronic ignition make for safe and easy starting. We have even provided a manual choke control with spring-loaded return for quicker cold weather starting. The infinitely variable torque converter drive system means there is no clutching. You just shift into either forward or reverse and step on the throttle pedal to go at speeds up to 25 mph. All Trekers are powered by highly reliable and proven 20 hp. Honda engines that are EPA certified and meet California Air Resources Board (CARB) certification standards.

Braking is accomplished by simply depressing the automotive style brake pedal located on the floorboard. This activates the rear automotive type hydraulic drum brakes and front mounted disc brakes. A lever action parking brake control is mounted on the center console located between operator and passenger seat on the 4400 and 4200 series. Depressing the top mounted button on the park brake control lever will release the park brake. Seat belts are available for all models and are standard on the 4210 and 4410 series.

The park brakes on the 4210 and 4410 series is incorporated in the dash-mounted shifter so that when you put these units in Park you simultaneously set the park brake. All models come with a very strong 4 post accessory bar that provides extra protection against low hanging limbs and briars as well as providing a mounting system for optional windshields, canopy tops, and weather enclosures. The 4 post accessory bar also provides a mounting base for optional cargo racks and accessories such as gun and bow racks, back screens, tree stands, and camping or fishing gear and tool holders. A standard rear receiver enables quick installation of a hitch to pull small trailers full of supplies, tools, gear, or game.

Owner Assistance

The safety video should be viewed by the owner and the Warranty Registration card should be filled out by the dealer at the time of purchase. The owner should also receive a copy of the safety video upon purchasing the vehicle as well as have participated in a short drivers training course with the dealer. This information is necessary to provide you with quality customer service.

The parts on your Treker Light Utility Vehicle have been specially designed and should only be replaced with genuine Land Pride parts.

If customer service or repair parts are required contact a Land Pride vehicle dealer. They have trained personnel, genuine repair parts and equipment specially designed to repair Land Pride products.

Serial Number Plate

Refer to Figure 1:

Always use serial and model number when ordering parts from your Land Pride dealer. The serial-number plate is located on the driver's side just left of the rear tail light as shown in figure 1 below.



**Serial Number Plate
Figure 1**

Record your vehicle model number (4200ST, 4400ST, 4200NT, 4400NT, 4210ST or 4410ST) and serial number here for quick reference:

Model Number: _____

Serial Number: _____

Your Land Pride dealer wants you to be satisfied with your new vehicle. If you do not understand any part of this manual or are not satisfied with the service received, please take the following actions.

1. Discuss the matter with your dealership service manager. Make sure they are aware of any problems so they can assist you.
2. If you are still unsatisfied, seek out the owner or general manager of the dealership.
3. For further assistance write to:

Product Support

Land Pride Service Department
1525 East North Street
P.O. Box 5060
Salina, Ks. 67402-5060

E-mail address
lpservicedept@landpride.com

Section 2: Important Safety Information

IMPORTANT: Read and understand all pages in this manual thoroughly before operating your vehicle.

These are common practices that may or may not be applicable to the products described in this manual.

Look For The Safety Alert Symbol

The SAFETY ALERT SYMBOL indicates there is a potential hazard to personal safety involved and extra safety precaution must be taken. When you see this symbol, be alert and carefully read the message that follows it. In addition to design and configuration of equipment, hazard control and accident prevention are dependent upon the awareness, concern, prudence and proper training of personnel involved in the operation, transport, maintenance and storage of equipment.



Be Aware of Signal Words

A signal words designate a degree or level of hazard seriousness. The signal words are:

DANGER

DANGER indicates an imminently hazardous situation which, if not avoided, will result in serious or death injury. This signal word is limited to the most extreme situations, typically for vehicle components that, for functional purposes, cannot be guarded.

WARNING

WARNING indicates a potentially hazardous situation which, if not avoided, could result in death or serious injury, and includes hazards that are exposed when guards are removed. It may also be used to alert against unsafe practices.

CAUTION

CAUTION indicates a potentially hazardous situation which, if not avoided, may result in minor or moderate injury. It may also be used to alert against unsafe practices.

For Your Protection

- ▲ Thoroughly read and understand the instructions given in this manual before operation. Refer to the "Safety Label" section, read all instructions noted on the decals.
- ▲ Do not allow anyone to operate this equipment who has not fully read and comprehended this manual and who has not been properly trained in the safe operation of the equipment.

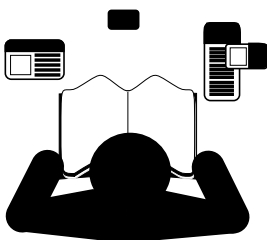

Before Operating

- ▲ This Treker Light Utility Vehicle is not to be driven on public roads.
- ▲ Do not operate this vehicle under the influence of alcohol or drugs.
- ▲ Always inspect the vehicle before operating it. See "Pre-Start Check List" on page 18.

- ▲ Do not operate this machine unless all safety shields are in place and all badly worn, broken or missing parts have been properly replaced.
- ▲ Wear appropriate protective gear and clothing such as safety helmet, goggles, gloves, coveralls, etc., when conditions warrant.
- ▲ No driver under age of 16.

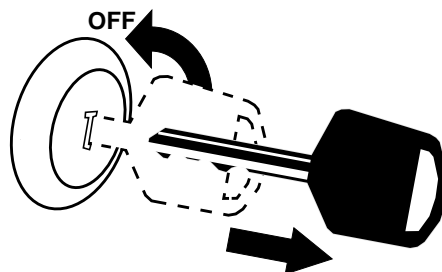

Table of Contents

Section 2: Important Safety Information

These are common practices that may or may not be applicable to the products described in this manual.

Practice Safe Maintenance

- ▲ Understand procedure before doing work. Use proper tools and equipment. Refer to this manual for additional information.
- ▲ Work in a clean, dry area.
- ▲ Place the vehicle in neutral, set parking brake, turn off engine and remove key before performing maintenance. Chock wheels if you must perform maintenance on a slope.

- ▲ Make sure all moving parts have stopped and all system pressure is relieved.
- ▲ Allow the engine to cool completely.
- ▲ Disconnect battery ground cable (-) before servicing or adjusting electrical systems or before welding.

- ▲ Inspect all parts. Make sure parts are in good condition and installed properly.
- ▲ Remove build-up of grease, oil or debris.
- ▲ Remove all tools and unused parts from the Treker before operation.

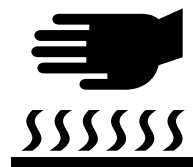
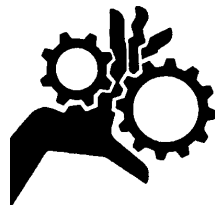
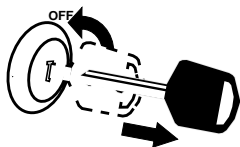

Prepare for Emergencies

- ▲ Be prepared if a fire starts.
- ▲ Keep a first aid kit and fire extinguisher handy.
- ▲ Keep emergency numbers for doctor, ambulance, hospital and fire department near phone.

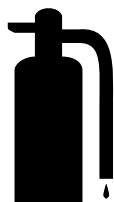
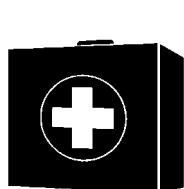

Wear Protective Equipment

- ▲ Wear protective clothing and equipment.
- ▲ Wear clothing and equipment appropriate for the job. Avoid loose-fitting clothing.
- ▲ Because prolonged exposure to loud noise can cause hearing impairment or hearing loss, it is best to wear suitable hearing protection such as earmuffs or earplugs.
- ▲ Because operating equipment safely requires your full attention, avoid wearing radio headphones while operating machinery.
- ▲ It is the discretion of the operator and passenger to wear Seat Belts when available.

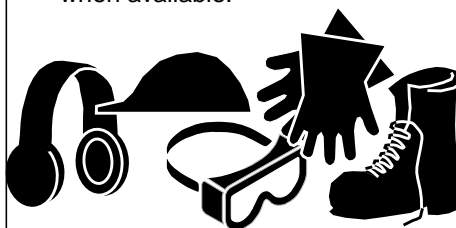

Tire Safety

Tire changing can be dangerous and should be performed by trained personnel using correct tools and equipment.

- ▲ When inflating tires, use a clip-on chuck and extension hose long enough for you to stand to one side—not in front of or over tire assembly. Use a safety cage if available.
- ▲ When removing and installing wheels, use wheel-handling equipment adequate for weight involved.



Section 2: Important Safety Information

Safe Operating Procedures

The safe operation of any machinery is a big concern to all consumers. Your Treker has been designed with many built-in safety features. However, no one should operate this vehicle before carefully reading this Operator's Manual. Also read all instructions noted on the safety decals.



WARNING

Most accidents with off road vehicles occur when traveling up, down, or across the face of a slope. Refer to operation instructions and safety video for proper operation procedures.

- ▲ Be familiar with all functions of this vehicle.
- ▲ Keep all bystanders away from this vehicle during operation.
- ▲ Do not allow anyone to operate this vehicle who has not fully read and comprehended this manual and who has not been properly trained in the safe operation of this vehicle.
- ▲ Do not operate a vehicle with damaged or defective parts. Repair all damages and defective parts before putting vehicle back in to service.
- ▲ Do not allow anyone under 16 years of age to operate this vehicle.
- ▲ Operator must always use both hands on the steering wheel.
- ▲ Riders may, without knowing it, place their foot on the accelerator pedal while bracing themselves against a rough ride. This makes it impossible to slow down the vehicle until the passenger removes his foot from the pedal. Inform the passenger to keep his foot off the accelerator and always slow down before the ride gets rough.
- ▲ Operator and passenger are responsible for deciding if their situation warrants using seat belts if so equipped.
- ▲ Do not use cargo tail gate as a seat.
- ▲ Do not use cargo bed as a working platform.
- ▲ The optional cargo power lift is designed to dump cargo only. Do not use it to lift other objects.
- ▲ No riders allowed except in factory designed and supplied seating and no more than one person in a bucket seat and three people in a bench seat. Do not use cargo bed for carrying people. Maximum vehicle occupancy including driver is one person per seat position.
- ▲ Operate vehicle from driver's seat only.
- ▲ Do not leave vehicle unattended with engine running.
- ▲ Do not dismount a moving vehicle as serious injury or death could occur.
- ▲ Always operate vehicle with belt guard installed. Do not leave pulleys and belts exposed.
- ▲ Wear snug-fitting clothing to avoid entanglement with moving parts.
- ▲ Keep hands, feet, long hair, clothing and jewelry away from moving parts and obvious pinch points to avoid getting caught.
- ▲ Some conditions may warrant extra safety gear to be worn such as safety helmets and/or goggles.
- ▲ Keep hands, arms, feet and all bodily appendages safely inside the confines of the vehicle. Always be aware of and avoid tree limbs and brush that have a potential of hitting and/or poking individuals riding the vehicle. Serious body harm could result.
- ▲ Do not touch engine, engine exhaust pipe and/or muffler while they are hot.
- ▲ Use extreme caution when driving through dry grass, brush and other fire hazard materials. Never stop or park over combustible materials. Keep grass and brush from collecting on and around engine and muffler parts.
- ▲ Battery fumes are explosive. A spark will ignite battery fumes. Wear a face shield when charging or jumping a battery. Follow all battery safety rules outlined in this manual.
- ▲ Avoid battery acid spills. Do not get battery acid on eyes, face, or other body parts. Flush eyes and other body parts immediately with water for at least 15 minutes if battery acid has gotten on them.
- ▲ Avoid pinch point hazards. Cargo bed and seat platform hinge creating pinch points.
- ▲ Do not operate this vehicle on highways, public roads, or where it may be a hazard to faster moving traffic.
- ▲ Never attempt wheelies, jumps, or other stunts. Never drive recklessly. Always operate your vehicle at a safe speed that will allow you to maintain control.
- ▲ Never use vehicle for racing and never modify the engine to exceed 25 MPH vehicle speed.
- ▲ Never modify any parts on the vehicle without authorization. Unauthorized modifications will void warranty to all parts directly and indirectly affected by the modification.
- ▲ Avoid sudden stops, starts and turns.
- ▲ Be aware of cargo shifting when stopping or moving. Make sure all cargo is properly secured and tied down. Injury could result from loose cargo.
- ▲ Always make sure the vehicle pathway is clear of all objects when backing up. Know location of persons around vehicle and especially location of small children. Take extra precautions when rear view is hindered by cargo.
- ▲ Do not exceed total payload capacity of this vehicle.
- ▲ Do not use the vehicle as an anchor device.

Table of Contents

Section 2: Important Safety Information

- ▲ Do not mount a receiver hitch type carrier platform to the vehicle.
- ▲ Do not pull a trailer or implement exceeding 1,000 pounds towing capacity and 100 pounds tongue weight. Loss of control may result.
- ▲ Do not attach an implement, trailer or other device to the hitch that will produce negative tongue weight.
- ▲ Follow all towing instructions in this manual when towing the Treker behind another vehicle. Do not tow the vehicle faster than 25 MPH. See "Towing the Treker" on page 23.
- ▲ Beware, tow ropes, cables and chains can break when pulling another vehicle or object causing serious injury or death to anyone in line with the whipping action created when they break. Never jerk when pulling, always ease into a pull gently. Always stay clear of the tow line. Never be in line with the tow line.
- ▲ Reduce speed and payload on hilly, rough, wet, slick or unstable ground.
- ▲ Reduce speed when loaded with cargo. Heavy cargo load takes longer to stop.
- ▲ Always make turns at a speed that will maintain control of vehicle. Never make turns at full speed. Reduce speed when turning empty and reduce speed even more when turning loaded. The heavier the cargo load, the slower the turn should be.
- ▲ The Four-Post Accessory Bar is not certified ROPS (Roll Over Protection System). Always avoid rollovers.
- ▲ Do not exceed front cargo rack capacity of 160 lbs. and rear cargo box payload capacity of 450 lbs. for NT Series and 850 lbs. for ST Series.
- ▲ Do not load Four-Post Accessory Bar with heavy equipment. Rollover could result from such loading.
- ▲ Do not operate vehicle while drinking or under the influence of alcohol or drugs.
- ▲ Always park on level ground, stop engine, set park brake (see "Shift Selector and Park Brake" on page 20) and remove ignition key before leaving the vehicle. Chock tires if condition warrants.
- ▲ Use extreme caution when cresting hills or when visibility is limited. Proceed slowly until you are sure trail conditions immediately ahead are safe.
- ▲ Keep front wheels straight when cresting hills or going over bumps.
- ▲ Do not stop, start suddenly or over accelerate on hills. Loss of control and rollover could result.
- ▲ Use extreme caution when descending hills, running on loose slippery surfaces, or when towing at maximum capacity. Towing, braking and tractive capabilities are greatly diminished.
- ▲ Do not operate vehicle on slopes over 15°.
- ▲ Avoid changing direction or making sharp steering corrections on slopes or rollover may occur.
- ▲ If this vehicle begins to tip when crossing a slope, turn the front wheels downhill to regain stability and control.
- ▲ When crossing a slope on soft terrain, turn the front wheels slightly uphill and maintain a constant speed to maintain a straight line of travel.
- ▲ When descending hills or slopes apply steady pressure to the foot brake to avoid potential of freewheeling or runaway.
- ▲ Never allow vehicle to coast or free wheel in neutral or loss of control may result.
- ▲ If your vehicle loses power and stops on a hill, immediately engage the foot brake and back slowly down the hill maintaining a straight downhill line of travel. Do not attempt to turn the vehicle sideways on the hill or a rollover could result.
- ▲ When traveling at night always use your headlights and reduce speed according to visibility, trail and terrain conditions.
- ▲ Avoid water crossings when possible and never cross a body of water where depth is unknown. Loss of power will occur if the drive belt becomes submerged or wet. Unnecessary crossing of streams and waterways erodes shore line and damages water-born habitat. If you must cross, do it at a point where banks are not steep and proceed at a slow and steady speed. Do not travel in water that is higher than the bottom wheel lug nuts. Water higher than the bottom wheel lug nut can damage the brake system and get the drive belt wet stalling the vehicle. However, *intermittent* stream crossings where depth of water briefly comes into contact with bottom of floorboards is acceptable. See "Going Out on the Trail" Note 7 on page 25.
- ▲ Front bumper, Brush Guards and cargo box are not designed as pusher bars. Do not attempt to push other vehicles or implements or damage may result.
- ▲ When refueling use a UL approved nonmetallic container that has no screen or filter. Set the container on the ground before fueling to eliminate static discharge and do not use Methanol fuel.
- ▲ Do not smoke or use electrical devices including cell phones while refueling.
- ▲ Always maintain proper tire inflation. See "Tire Maintenance" on page 30.
- ▲ Always disconnect the negative battery terminal before making adjustments to the vehicle electrical system or welding on this vehicle.
- ▲ Always check wheel lug nut torque values two hours after initial operation and two hours after each tire repair and/ or replacement. Routinely check lug nut torque valves every 100 hours of operation. See "Wheel Lug Nuts" on page 29.
- ▲ Support this vehicle securely before working beneath. Chock the wheels to prevent the vehicle from rolling.
- ▲ Do not shift trans-axle unless this vehicle is fully stopped and the engine is at idle or damage may occur.

Table of Contents

Section 2: Important Safety Information

Safety Decals

1. Your Treker Light Utility Vehicle comes equipped with all safety decals in place. They were designed to help you safely operate this vehicle and to serve as a reminder to keep safety uppermost in your mind. Read and follow decal directions.
2. Keep all safety decals clean and legible.
3. Replace all damaged or missing decals. Order new safety decals through your Land Pride dealer.
4. Some new equipment installed during repair requires safety labels to be affixed to the replaced component as specified

by Land Pride. When ordering new parts or components, also request corresponding safety decals.

5. Refer to this section for proper label placement. Install new decals as follows
 - a. Clean the area on which the decal is to be placed.
 - b. Spray soapy water on the surface where the decal is to be placed.
 - c. Peel backing from decal. Press firmly on surface, being careful not to cause air bubbles under decal.
 - d. Squeeze out air bubbles with the edge of a credit card.

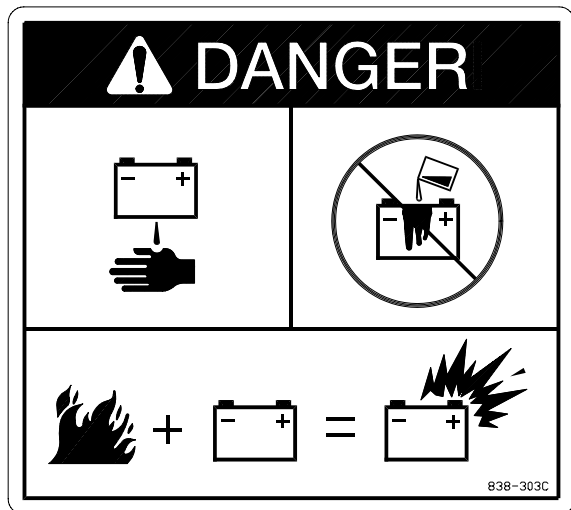

838-303C

Danger: Battery



**4200/4400 NT Series
Battery Label Location**

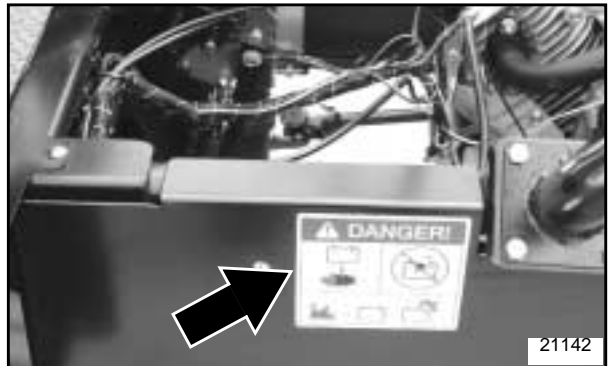

**4200/4400 ST Series
Battery Label Location**



**4210/4410 ST Series
Battery Label Location**

Table of Contents

Section 2: Important Safety Information



818-543C

Danger: Guard Missing

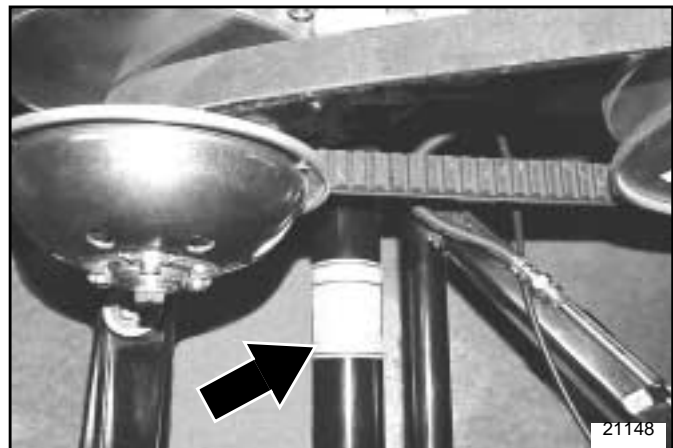

818-045C

Warning: Pinch Point or Crushing Hazard



4200/4400 NT & ST Series



4210/4410 ST Series

Table of Contents

Section 2: Important Safety Information

 **WARNING**

To prevent serious injury or death:

- Read and understand Operator's Manual before using and review annually.
- Do not operate without proper training or instructions.
- Operate only with guards installed and in good condition.
- Keep away from moving parts.
- NEVER operate with passenger – except in seat or seats provided (one person per seat position), passengers affect balance and steering and increase risk of losing control.
- Support vehicle securely before working beneath.
- Keep arms, legs, loose clothing and other appendages inside vehicle at all times.
- Do not operate vehicle in a dangerous manner. When ascending or descending hills – travel slowly, travel straight up and down, and avoid turning if possible.
- Use caution and slow down when approaching wet, loose, slippery surfaces or unfamiliar terrain.
- Avoid sudden stops, starts, turns or direction so as not to shift your load, endanger passengers, or lose control of the vehicle.
- Under all day or night travel conditions: operate this vehicle at speeds that will permit it to be brought to a stop in a safe manner.
- Prior to each use: inspect tires, engine oil level, brakes steering mechanism and overall vehicle condition. If any problem exists, DO NOT OPERATE vehicle until safe operation can be restored.
- DO NOT EXCEED PAYLOAD recommendations and avoid loads which can not be centered and secured.
- This vehicle is built for off-road use only at speeds NOT TO EXCEED 25 mph. Any attempt to make unauthorized modifications of the original manufacturer's design will make the modifying party immediately and totally responsible, henceforth, for meeting compliance with all applicable Federal, State and Local laws, guidelines and regulations.

Si no lee ingles, pida ayuda a alguien que si lo lea para que le traduzca las medidas de seguridad.

838-486C REV. A

838-486C

Warning: General Utility Vehicle



4210ST & 4410ST Trekers



4200/4400 NT & ST Trekers

Table of Contents

Section 2: Important Safety Information



WARNING

- **VEHICLE ROLLOVER** could cause severe injury or death.
This cab frame is not designed or intended to provide rollover protection.

838-532C

838-532C

Warning: Cab Rollover Protection



4200/4400 NT & ST Series



4210/4410 ST Series



CAUTION

Exceeding rated current of 12V 20A
can damage electrical system.
POWER SOURCE MAX. 12V 20A

838-492C

838-492C

Caution: Maximum Power Source



4200/4400 NT & ST Series



4210/4410 ST Series

Table of Contents

Section 2: Important Safety Information

 WARNING				
				
USE AN APPROVED MOTORCYCLE HELMET AND PROTECTIVE GEAR WHEN WARRANTED	NEVER USE ON PUBLIC ROADS, STREETS OR HIGHWAYS	NEVER CARRY PASSENGERS, EXCEPT IN SEAT PROVIDED	NEVER USE WITH DRUGS OR ALCOHOL	NO DRIVER UNDER AGE OF 16
Improper use can result in SEVERE INJURY or DEATH.				
<small>838-491C</small>				

838-491C

Warning: Improper Use



4200/4400 NT & ST Series



4210/4410 ST Series

Table of Contents

Section 2: Important Safety Information



838-489C

Warning: Rollover Hazard



4200/4400 NT & ST Series



4210/4410 ST Series

Table of Contents

Section 2: Important Safety Information



838-490C

Caution: Stop Engine



4200/4400 NT & ST Series



4210/4410 ST Series

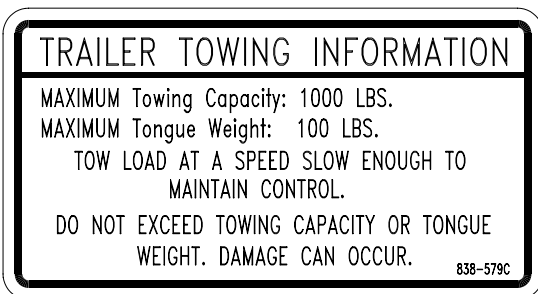

838-579C

Trailer Towing Information

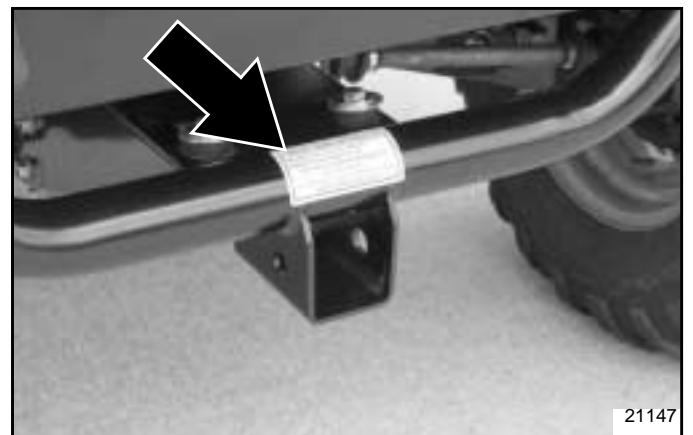

Table of Contents

Section 2: Important Safety Information

⚠ WARNING

OVER-LOADING can cause loss of control. Loss of control can result in severe injury or death.

4200NT CURB WEIGHT: 860 LBS.

TOTAL PAYLOAD CAPACITY: 950 LBS ACCESSORIES, PASSENGERS + CARGO

TOTAL BOX PAYLOAD CAPACITY: 550 LBS

GROSS VEHICLE WEIGHT (GVW): 1810 LBS.

NEVER exceed the Maximum Vehicle Load Rating.

838-581C REV. B

838-581C

4200NT Series (Narrow Tread Width)

⚠ WARNING

OVER-LOADING can cause loss of control. Loss of control can result in severe injury or death.

4400NT CURB WEIGHT: 985 LBS.

TOTAL PAYLOAD CAPACITY: 950 LBS ACCESSORIES, PASSENGERS + CARGO

TOTAL BOX PAYLOAD CAPACITY: 550 LBS

GROSS VEHICLE WEIGHT (GVW): 1935 LBS.

NEVER exceed the Maximum Vehicle Load Rating.

838-662C REV. A

838-662C

4400NT Series (Narrow Tread Width)

⚠ WARNING

OVER-LOADING can cause loss of control. Loss of control can result in severe injury or death.

4X2 ST CURB WEIGHT: 925 LBS.

TOTAL PAYLOAD CAPACITY: 1300 LBS ACCESSORIES, PASSENGERS + CARGO

TOTAL BOX PAYLOAD CAPACITY: 900 LBS

GROSS VEHICLE WEIGHT (GVW): 2225 LBS.

NEVER exceed the Maximum Vehicle Load Rating.

838-570C REV. C

838-570C

4200/4210 ST Series (Standard Tread Width)

⚠ WARNING

OVER-LOADING can cause loss of control. Loss of control can result in severe injury or death.

4X4 ST CURB WEIGHT: 1050 LBS.

TOTAL PAYLOAD CAPACITY: 1300 LBS ACCESSORIES, PASSENGERS + CARGO

TOTAL BOX PAYLOAD CAPACITY: 900 LBS

GROSS VEHICLE WEIGHT (GVW): 2350 LBS.

NEVER exceed the Maximum Vehicle Load Rating.

838-663C REV. A

838-663C

4400/4410 ST Series (Standard Tread Width)



4200/4400 NT & ST Series



4210/4410 ST Series

Section 2: Important Safety Information



838-508C

Warning: Before Filling Tank with Gasoline

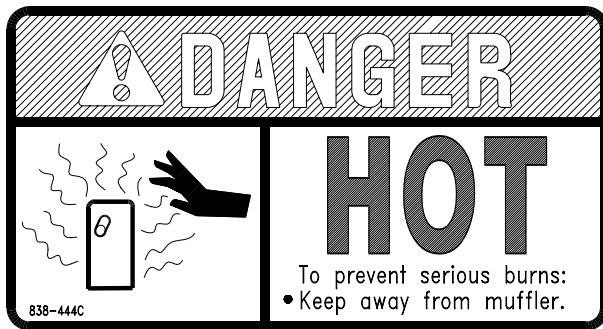

838-444C

Danger: Muffler hot

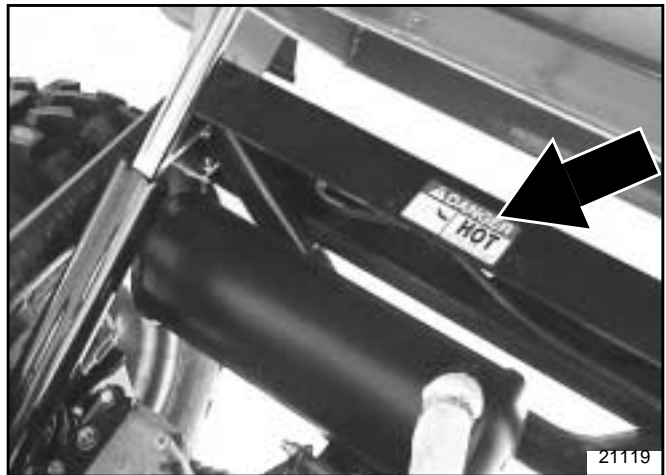

Warning Label Included with Seat

Warning: Check Seat mounting





Section 3: Pre-Delivery and Check List

Each vehicle must undergo a Pre-Delivery Inspection by the Dealer. Listed below is an example of the checklist that is included with the Warranty Registration that is to be submitted to Land Pride upon Retail Sale. The Pre-Delivery Certificate and Warranty Registration must be submitted to Land Pride in order to activate the vehicle warranty.

Pre-Delivery Certificate

The dealer is required to complete Land Pride's "Certificate of Light Utility Vehicle Pre-Delivery" form before customer may take possession of the vehicle. The information must be filled in and check list checked off or initialed by individuals performing the checks.

Dealership's name, signatures of individuals filling in the form, seller's signature, customer's signature and signing dates are also required before the form is returned to Land Pride. Below is a list of the information found in the form that is required to be completed and checked off.

Vehicle Information

Model No. _____

Date _____

Serial No. _____

Engine Serial No. _____

Dealer Service and Inspection List

- Fully charge battery. Check battery voltage to verify that it is fully charged.
- Connect negative battery cable. (Negative battery cable is disconnected before leaving the factory and is to be disconnected after initial dealer set-up to prevent battery discharge while setting on the dealer lot.)
- Check tire pressure to make sure front and rear tires have a minimum of 7 psi. See "Tire Inflation Chart" on page 30.
- Make sure wheel lug bolts/nuts are tightened to 90 Newton meters/(65ft. lbs.).
- Check master cylinder to make sure it is filled.
- Check engine oil level at the dipstick. Add SAE 10W30 oil if oil is below the full mark on the dipstick. Do not overfill.
- Check engine for correct RPM. Set to factory specification if needed. (See page 49)
- Check Tie Rods for tightness.
- Check choke control. It should move and return freely.
- Step on foot brake to make sure there is plenty of pedal and that brakes hold pressure and do not bleed off. Add brake fluid and bleed brakes if required.
- Make sure seats and seat belts are properly fastened to the frame if so equipped.
- Make sure all safety decals are in place.
- Check headlights to make sure they are working and are properly mounted.
- Check tail lights and brake lights to make sure they are working and are properly mounted.

- Inspect air cleaner element. Make certain it is clean and in place.
- Inspect the fuel tank to make sure it is properly installed and that there are no leaks.

NOTE: Vehicles are shipped from the factory with about a quart of fuel in the tank.

- Check fuel level in the tank. If needed, add gasoline with a fuel stabilizer to perform initial starting operations. See "Fuel System" instructions on page 33 before adding fuel.
- Inspect fuel lines to make sure they are properly installed and that there are no leaks.
- Check steering by executing a full lock to lock turn in each direction.
- Check park brake to make sure it will engage, hold and release.
- Make sure neutral start feature is working by trying to start the unit while the shifter is located in the forward and reverse positions.
- Check throttle control to make sure it moves and returns freely.
- Check choke control to make sure it moves and returns freely.
- Check Rear Trans-axle oil level at the oil plug. Add Land Pride special formulated gear lube noted on page 43 if oil is low.
- Check overall appearance for cleanliness and for body and molding damage.

Table of Contents

Section 3: Pre-Delivery and Check List

Dealer Test Ride List

- Check engine for starting, accelerating, running and idling smoothly.
- Check steering response. There should be no free-play.
- Check forward, neutral and reverse shifting response. Also check neutral start response.
- Check park brake to make sure it engages, holds and disengages.
- Make sure rocker switches are all working.
- Make sure throttle is responsive and returns freely.
- Make sure suspension ride is satisfactory and stable.
- Make sure there are no fuel or petroleum leaks.
- Make sure the foot brake has a firm engagement and that stopping is straight.
- Make sure there are no bad rattles or vibrations.

Dealer Delivery To Customer List

- Warranty registration form is complete.
- Owner's Manual has been delivered to and reviewed by the customer.
- Engine Manual has been delivered to and reviewed by the customer.
- Warranty Policy limits and requirements have been explained to the customer.
- Customer has reviewed the safety video.
- Location and functions of vehicle controls have been explained.
- Fuel transportation and storage procedures have been explained.
- Fluid fill and lubrication points have been located and explained to the customer.
- Customer has completed the driving course.
- Information on the safety decals have been reviewed with the customer.

Customer Acceptance List

Customer initials required where accepted as successfully completed.

- Customer has reviewed and understands Land Pride warranty policy.
- Customer has inspected the vehicle and it meets customer's satisfaction.
- Customer understands the importance of following the owner's manual instructions.
- Customer has completed the Land Pride safety training course.



Section 4: Operating Instructions

Operator Responsibilities



WARNING

It is the operator's responsibility to have read this manual thoroughly and to know how to operate this vehicle safely in all situations. See "Section 2: Important Safety Information" starting on page 3.

Pre-Start Check List

- Lubricate the vehicle as indicated in the Lubrication portion of "**Section 7: Lubrication**" starting on page 41.
- Check tire pressure as indicated in the "**Tire Inflation Chart**" on page 30.
- Make sure wheel lug bolts/nuts are tightened to 65ft. lbs.
- All nuts, bolts, screws and fasteners should be checked. Refer to the Torque Value Chart in "**Section 13: Appendix**" starting on page 57.
- Turn on headlights to make sure battery has a charge and electrical lighting circuit is working.
- Check tail lights and brake lights.
- Step on foot brake to make sure there is plenty of pedal and that brakes hold pressure and do not bleed off. Add brake fluid as indicated in "**Brake Fluid**" on page 45 and bleed brakes if required.
- Check park brake to make sure it will engage, hold and release.
- Check steering by executing a full lock to lock turn in each direction.
- Check to make sure neutral start feature is working by trying to start the unit while the shifter is located in the forward and reverse positions. (Unit should not start.)
- Check engine oil level at the dipstick. Add oil as indicated in "**Engine Oil**" on page 41 if oil is at or below the add mark on the dipstick. Do not overfill or plug fouling will occur.
- Check differential oil level at the differential oil plug. Add gear lube as indicated in "**Case Oil**" on page 43.
- Check fuel level to make sure there is at least 1/8 of a tank of gas prior to performing initial starting operations.
- Make sure low engine idle speed is set between 1250 and 1350 rpm and that maximum engine static speed does not exceed 3800 rpm. **Modifying or adjusting the carburetor to increase vehicle speed above factory set specification is a safety violation and could result in voiding the warranty.**

General Operation



DANGER

Avoid injury or death from entanglement in the rotating drive belt. All shields must be in place and secure when operating. Keep all persons away from rotating driveline.

Start Treker following starting procedures displayed at the gearshift lever and as noted below.

1. Set park brake and shift selector.
 - **Models 4200 & 4400:** Pull firmly up on the park brake lever with your hand until the lever is tight. Set shift selector in neutral.
 - **Models 4210 & 4410:** Set shift selector in Park.
2. Pull choke fully out and hold when engine is cold.
3. Turn ignition key fully clockwise and hold until engine starts.
4. Release ignition key to run position and choke to normal operating position immediately after engine starts.
5. Turn ignition key counterclockwise to stop engine.

Operating a Treker is as easy as operating a car with an automatic transmission. A simple forward and reverse shifter provides direction control. A neutral start feature and keyed 12 volt electronic ignition makes for safe and easy starting. A manual choke control under the seat assist quick cold weather starting. The infinitely variable torque converter drive system means there is no clutching. Shift into either forward or reverse when the vehicle is stopped and step on the throttle pedal to go at speeds up to 25 mph. Never shift while the vehicle is moving. The unit will only start when the shift lever is in neutral or park and dash mounted indicator light is on.

Braking is accomplished by simply depressing the automotive style brake pedal located on the floorboard. This activates the rear automotive type hydraulic drum brakes and front hydraulic disc brakes. A push button lever action parking brake is mounted on the center console between the bucket seats on models 4200 & 4400. The park brake is incorporated in the shift selector on models 4210 & 4410. A dash mounted park brake indicator light will remain on until the park brake is disengaged.

Indicating Lights and Gauges

Refer to Figure 4-1:

- #1 **Hour Meter:** Indicates number of hours vehicle has run to the nearest 1/10 of an hour.
- #2 **Park Brake Light:** Indicates park brake is on when illuminated. Do not move vehicle with park brake light on. See note below.

NOTE: Park Brake light was made functional on models beginning with S/N 418339 and up.

- #3 **4-Wheel Drive Light:** Indicates 4-wheel drive is activated when illuminated.
- #4 **Neutral Light:** Indicates Gear Shift is in neutral when illuminated.

Section 4: Operating Instructions

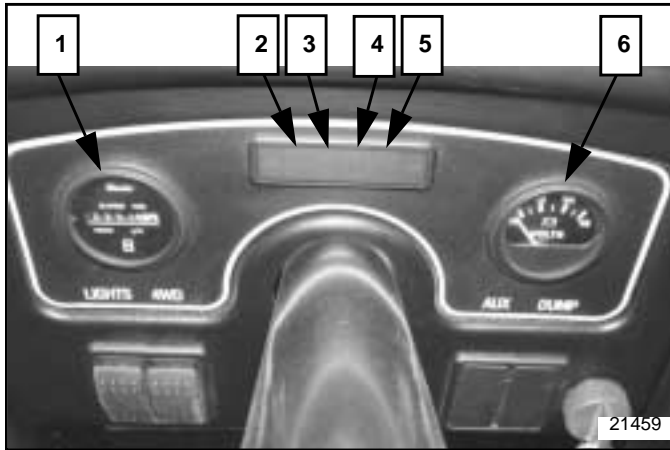

Figure 4-1

#5 Oil Light: Indicates low oil pressure when illuminated. Stop engine immediately. Check oil level and add if low. See your authorized Land Pride dealer if oil light stays on and engine is full of oil. It is normal for the oil light to come on whenever the ignition switch is turned on and will stay on until the engine is running.

#6 Volt Meter: Indicates battery is charging. Check battery if volt meter registers a charge that is lower than normal. See your authorized Land Pride dealer if battery is good and volt meter still register low charge.

Switches

Refer to Figure 4-2, Figure 4-3 and Figure 4-4:

#7 Power Plug Outlet: Located on the dash is a power plug outlet for connecting 12 volt accessories such as a cell phone or light.

#8 Ignition Switch: Starts and stops the engine. Vertical position is off. Turn switch key clockwise to start engine. See “General Operation” on page 18 for correct vehicle starting procedures.

#9 Dump Switch: Optional electric cylinder raises and lowers the cargo box. Press top of switch and hold to raise cargo box. Press bottom of switch and hold to lower cargo box. Release switch at any position to stop cargo box. Release switch immediately if Power Bed Lift Cylinder makes a ratchet noise.

IMPORTANT: The Power Bed Lift is protected by an internal clutch in both directions and will make a loud “ratchet” noise indicating end of travel has been reached or Power Bed Lift is overloaded. Release the switch immediately when this noise is heard.

#10 Auxiliary Switch Slot: 12 volt on/off accessory with switch may be installed at this location.

#11 Light Switch: Turns on head and tail lights. Press top of switch to turn on lights and bottom of switch to turn off lights.

#12 4-Wheel Drive Switch: Engages the 4-wheel drive system. Press top of switch to engage 4-wheel drive and bottom of switch to disengage 4-wheel drive. The 4-wheel drive system should be used only when required to get through a difficult situation.

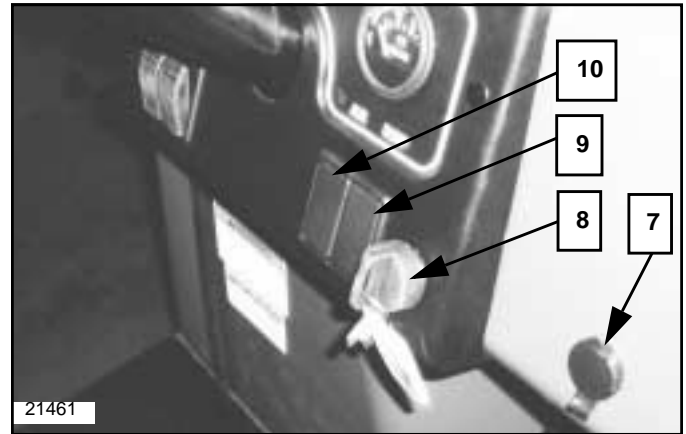

4200/4400 NT & ST Treker
Figure 4-2

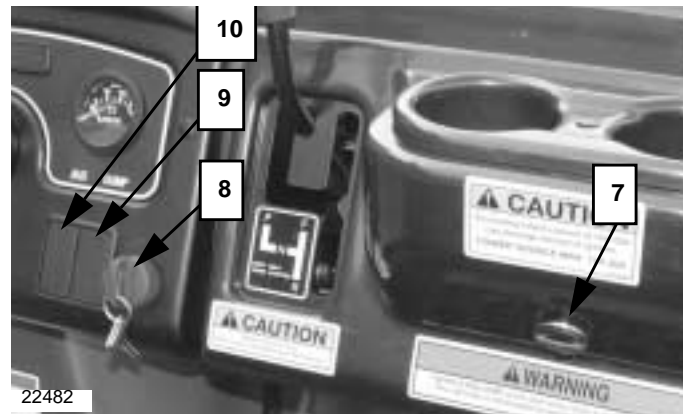

4210ST & 4410ST Treker
Figure 4-3

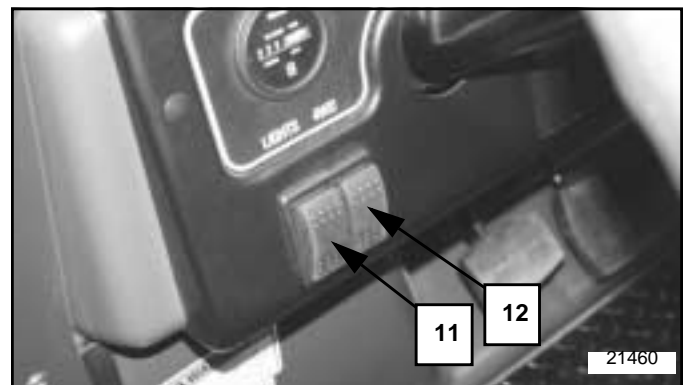

Figure 4-4

Section 4: Operating Instructions

Choke

Refer to Figure 4-5:

- #13 Choke Control:** Located under the driver's seat. Used to choke the engine when starting. Pull on knob to starting a cold engine. Release knob after engine has started. Do not choke an engine that is hot from operating, engine flooding may result.

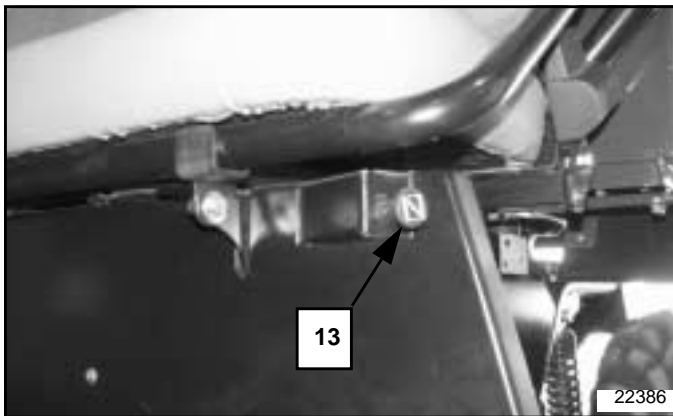

Figure 4-5

Floor Pedals

Refer to Figure 4-6:

- #14 Brake Pedal:** Applying pressure to the brake pedal instead of the accelerator pedal with your foot will slow down and/or stop the vehicle. Riding or resting your foot on the pedal unnecessary will wear the brakes out prematurely.
- #15 Accelerator Pedal:** Changes engine rpm and vehicle ground speed. Press down on the accelerator pedal with your foot to increase speed and let up on the pedal to decrease speed. Vehicle should not move when engine is idling. Adjust engine idle speed if vehicle moves while accelerator pedal is not being depressed.

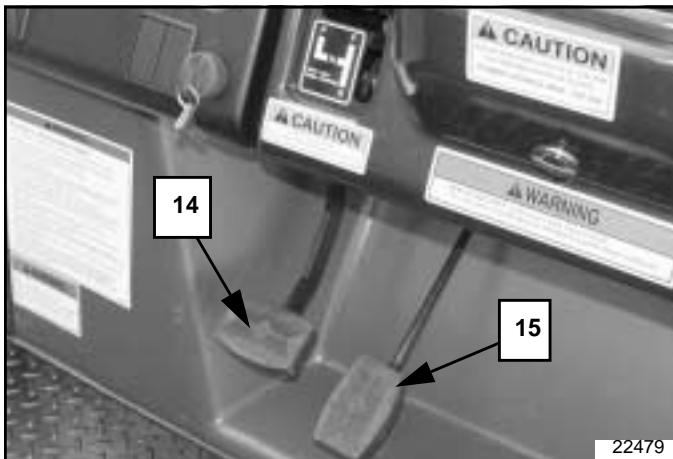
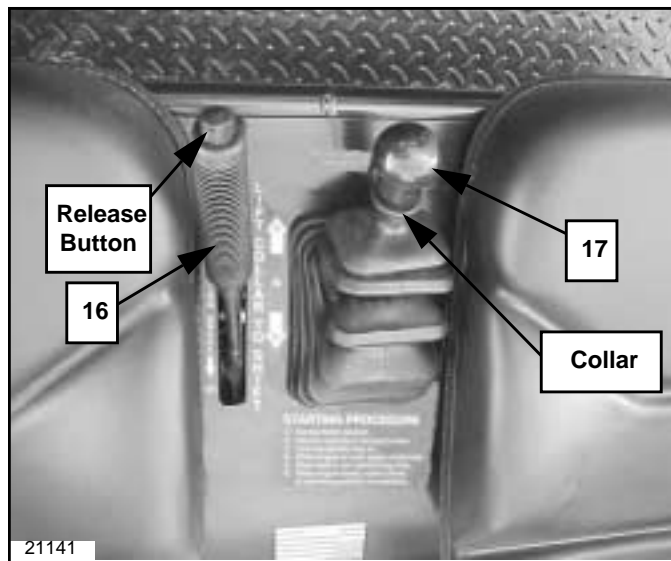

Figure 4-6

Shift Selector and Park Brake Instructions for 4200/4400 NT & ST

Refer to Figure 4-7:

- #16 Park Brake Lever:** Sets and releases the park brakes. Do not drive vehicle with park brake lever set. Indicator light will illuminate indicating park brake is engaged.
- Set park brakes: Depress the brake pedal down with your foot and hold. Firmly pull-up on the park brake lever until the lever is tight.
 - Release park brakes: Depress the brake pedal down with your foot and hold. Pull-up on the park brake lever, depress the release button and push the lever all the way down before letting up on the button.
- #17 Shift Selector:** Changes trans-axle gears from neutral to forward or reverse. Always start engine in neutral.
- Pull up on shift selector collar and push lever all the way forward to place trans-axle in forward gear.
 - Pull up on shift selector collar and move lever to center position to place trans-axle in neutral.
 - Pull up on shift selector collar and pull lever all the way back to place trans-axle in reverse gear.



4200/4400 NT & ST Treker
Figure 4-7

Instructions for 4210/4410 ST

Refer to Figure 4-8:

- #18 Shift Selector & Park Brake Control:** Sets and releases the park brake and changes trans-axle gears from neutral to forward or reverse. Always start engine in park or neutral.

Section 4: Operating Instructions

- To release the park brake and place trans-axle in neutral, move shift selector up and over to the left and then pull straight down to neutral position.
- From neutral, move the shift selector over to the right and up to place trans-axle in forward gear.
- From neutral, move the shift selector over to the right and down to place trans-axle in reverse gear.
- Make a full stop by letting up on the accelerator pedal and applying the brakes before returning shift selector to park or switching from reverse to forward and forward to reverse.

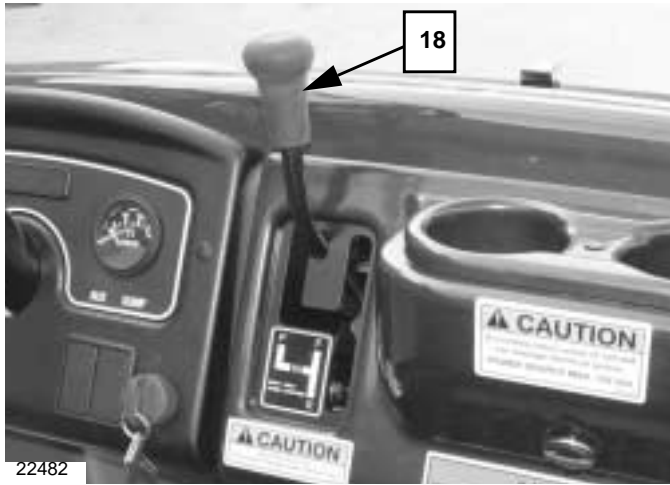

22482
4210ST & 4410ST Treker (Shift Selector Shown in Park)
Figure 4-8

Fuel Gauge

Refer to Figure 4-9:

- #19 **Fuel Gauge:** The fuel gauge, located on the gas tank, displays approximately how much fuel you have in the fuel tank. Always park the vehicle on level ground to get an accurate reading. The fuel tank is empty when the fuel gauge needle points to E and full when the needle points to F.

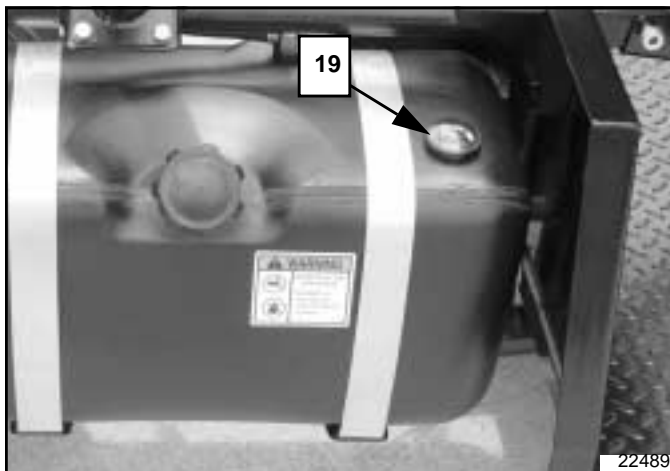

22489
Figure 4-9

Seat Belts

Seat belts are available for all models and are standard on the 4210 and 4410 series. It is the responsibility of the operator and passenger to decide if their situation warrants using seat belts. Make sure seats and seat belts are properly fastened to the frame if so equipped.

WARNING

Lap belts should fit snugly and as low around the hips as possible. Wearing seat belts high around the waist greatly increases the chances of that person being injured in a dangerous situation.

WARNING

Never use a lap belt for more than one person and never buckle the lap belt to a buckle designed to receive the other lap belt.

Seat Belt Components

Refer to Figure 4-10:

- #20 **Lap Belt:** The lap belt is the belt that extends from the retractor when pulled across your lap to be buckled. It is located on the left side of the driver's seat and right side of the passenger's seat.
- #21 **Buckle:** Both operator and passenger buckles are located between the two seats. It secures the lap belt in place.

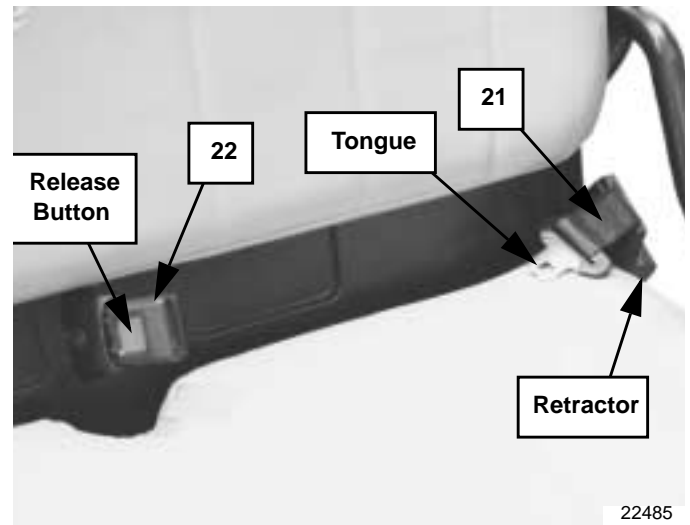

Figure 4-10

Seat Belt Operation

Pull the lap belt across your hips and insert its tongue into the buckle until you hear it snap. Release the lap belt by pressing the release button in the center of the buckle. Guide the lap belt to its original position as it retracts to keep it aligned and to prevent its tongue from striking and damaging surfaces on the vehicle.

Section 4: Operating Instructions

Cup Holders

Refer to Figure 4-11:

Cup holders are standard on the 4210ST & 4410ST Trekers. A velcro tab located between the cups secures the cup holder to the dash. They may be removed from the dash for cleaning.



4210ST & 4410 ST Treker
Figure 4-11

Glove Box Enclosure

Refer to Figure 4-12:

The 4210ST & 4410ST Trekers are factory equipped with a keyed twist lock enclosure and may be purchased as an accessory for the 4200ST & 4400ST Trekers. Unlock glove box by inserting key and rotating clockwise 90 degrees to the position shown. Rotate twist lock clockwise another 90 degrees to open. To close, push glove box lid shut. To lock while shut, rotate key 90 degrees counterclockwise and remove. Key can be removed in locked and unlocked positions.



4210ST & 4410 ST Treker
Figure 4-12

Cargo Box Operation



CAUTION

Always load front of cargo box first and back last. Never load back with more weight than the front. Always secure cargo box in the down position to prevent accidental flipping of cargo box while loading and during travel.



DANGER

Make sure area behind cargo box is clear of personnel before raising the cargo box. Bodily harm can result from being pinched between the cargo box and another object or from a load dumping and/or rolling onto a bystander.

Instructions for 4200/4400 NT & ST

Refer to Figure 4-13 & Figure 4-14:

Models 4200 & 4400 Treker vehicles are shipped from factory stocked with a Bed Latch Lock-Up Arm and a Bed Latch Lock-Down. Secure cargo box down by raising lever on Bed Latch Lock-Down and catching its loop over a hook located on the cargo box. Then return the lever to its down position. Adjust nuts on latch loop to tighten or loosen its grip.

Raise cargo box by first releasing Bed Latch Lock-Down and then raise Cargo box manually until latch pin is caught behind spring loaded catch. Lower cargo box by first lifting cargo box up, release spring loaded catch and then lower cargo box gently. Remember, always secure cargo box when in down position with Bed Latch Lock-Down.

Bed Latch Lock-Up Arm can be replaced with an electrical actuated Power Bed Lift. See "Electric Dump" on page 28.

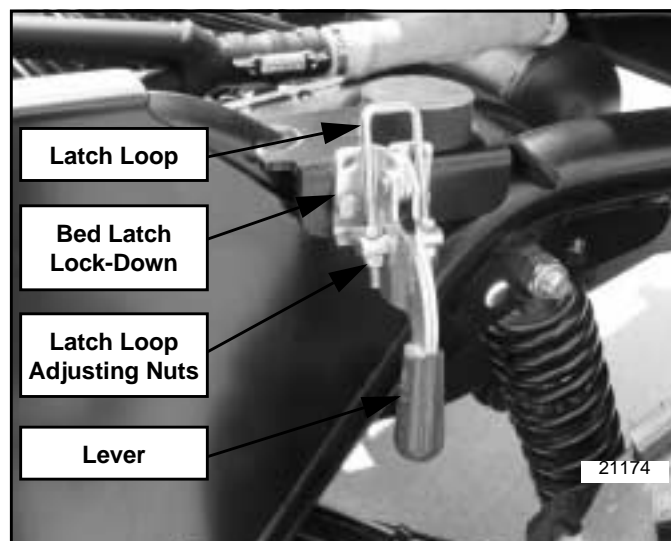

Figure 4-13

Section 4: Operating Instructions

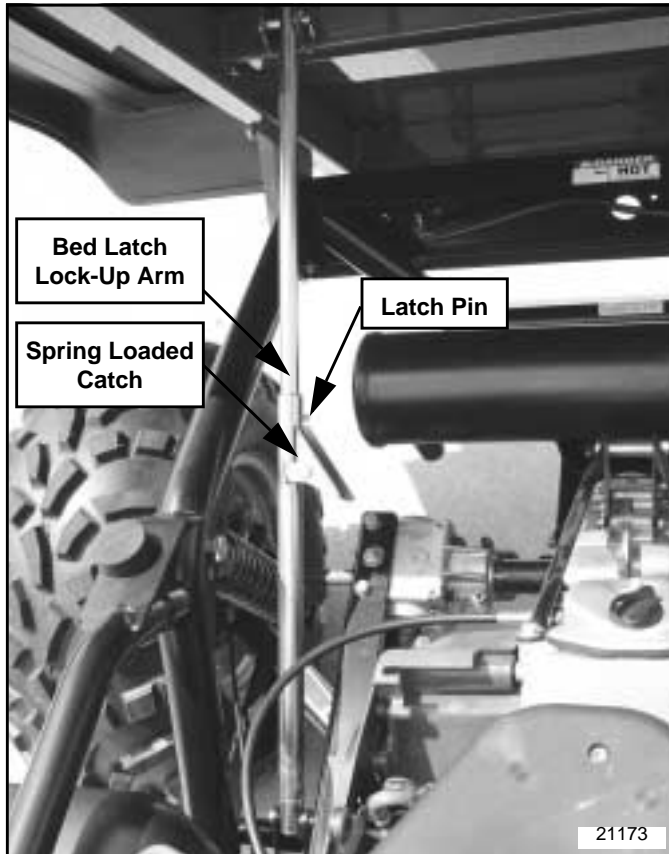

Figure 4-14

Instructions for 4210/4410 ST

Refer to Figure 4-15 & Figure 4-16:

Model 4410 Treker vehicles are shipped from factory stocked with a Bed Latch Lock-Up Arm and a Bed Latch Lock-Down System.

Release the cargo box lock-down position by pulling up on one or both of the bed latch release handles located on both sides of the vehicle. Continue pulling up on the release handle to tilt the bed up until the Bed Latch Lock-Up Arm locks into the arm locking slot.

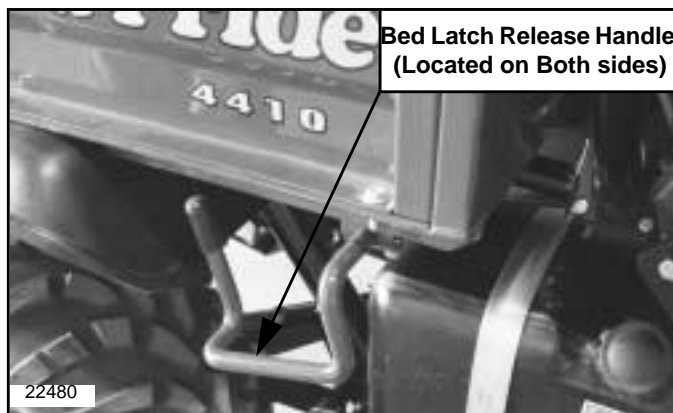

4210ST & 4410ST Cargo Box Latch Release
Figure 4-15

Refer to Figure 4-16:

Lower cargo box by raising the cargo box just enough to remove pressure on the Bed Latch Lock-Up Arm and then pull up on the arm near the arm locking slot to release its catch. Remove hand from the arm and Lower the box gently to the Treker frame. Make certain the bed lock-down hooks have caught.

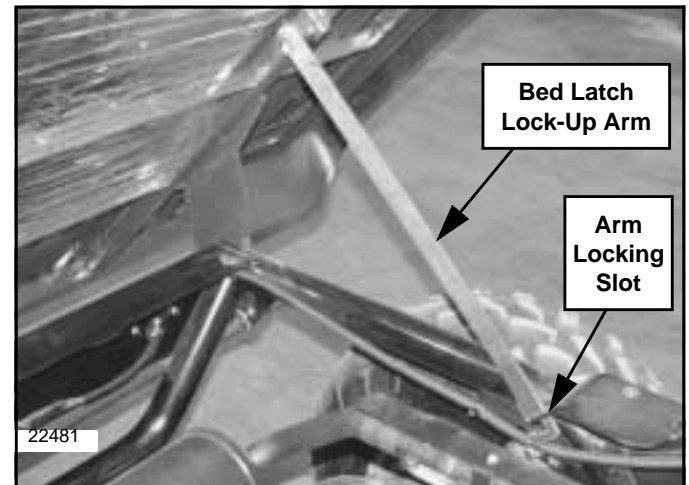

4210ST & 4410ST Cargo Box Lock-Up Arm
Figure 4-16

Towing the Treker

The Treker is capable of being towed behind a tractor or another vehicle as long as the certain precautions are followed:

- The ignition switch must be turned off.
- The gear selector must be locked in neutral position.
- The park brake must be off.
- The vehicle must be towed with a rigid tow-bar that is designed to tow the gross weight of the Treker. See "Section 10: Specifications and Capacities" on page 49 for vehicle gross weight.
- Tow-bar must be securely attached to the Treker at a location that will not damage the vehicle or come loose from the vehicle.
- Owner/user takes on all responsibility and liability resulting from attaching the tow-bar to the Treker and to the vehicle towing the Treker.
- Do not allow anyone to ride in the Treker while it is being towed.
- Do not tow a trailer or vehicle behind the Treker that is being towed.
- Do not tow vehicle at speeds over 25 mph. The vehicle is designed to travel up to 25 mph. Higher speeds may result in damage to the Treker, vehicle towing the Treker and personnel.
- Slow down when turning to prevent loss of control and rollovers.
- Obey all state and local laws for towing vehicles.

Section 4: Operating Instructions

Cargo Box / Flat Bed Set-Up

Refer to Figure 4-17 & Figure 4-18:

The cargo box on the **4210ST** and **4410ST** is factory standard with removal tail gate and side panels for changing the cargo box into a flatbed.

1. Pull cotter pin and remove cable pin on both sides.
2. Unbolt fastener securing the gate hinge bracket on both sides.
3. Pull gate release lever back on both sides and remove gate from the cargo box.
4. Unbolt side panel and front panel fasteners on one side and remove side panel.
5. Unbolt the other side panel and front panel fasteners and remove side panel.
6. Replace cable pin, cotter pin and fasteners in side panels for storage.

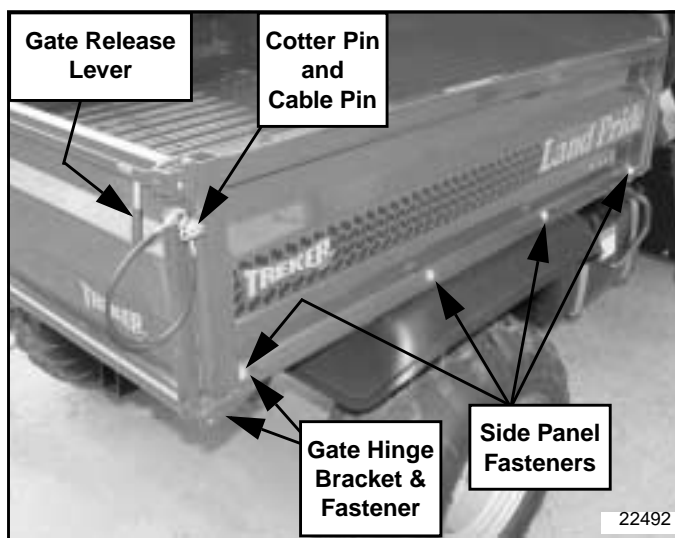

4210ST & 4410ST Cargo Box
Figure 4-17

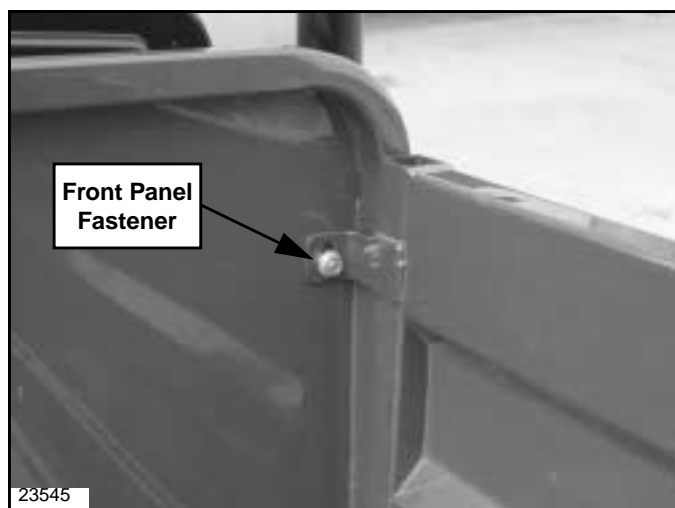

4210ST & 4410ST Cargo Box
Figure 4-18

Engine Performance

All small gas engines need fuel, air, and spark in exactly the right proportions in order to run properly at peak performance. Bad or stale fuel, a fouled spark plug, a wet or corroded spark plug wire, a gummed up carburetor, a wet or dirty air filter, a low oil situation, incomplete fuel combustion, carburetor icing, high oil situation (gas in the oil reservoir), and low engine temperature are all causes of small gas engine failure or diminished performance.

Fuel Quality

The normal shelf life of gasoline from the time it leaves the refinery is about 30 days. Some fuels treated with oxygen inhibitors can be stored for up to two months. Unused gas that is stored too long can oxidize and break down causing the formation of gum and varnish deposits in carburetors, needle valves, jets and venturis. This stops or chokes off the flow of the proper fuel/air mixture.

Draining the tank or running the engine till the tank is empty can result in dried out gaskets that, when dry, will crack and leak. Also, emptying metal fuel tanks and storage containers can result in corroded containers and contaminated fuel.

Land Pride highly recommends using a fuel stabilizer or oxygen inhibitor such as STA-BIL. Products of this type keep gasoline fresh and usable for up to 15 months.

Incomplete Combustion

Incomplete combustion is when the fuel is not fully burned in the engine combustion chamber. This condition can occur when an engine is started but is not allowed to run long enough to reach full operating temperature. Cold weather can accelerate this condition. Also, fouled spark plugs, wet electrical circuits and/or a plugged air filter will prevent fuel from being fully burned.

Unburned fuel pools on top of the piston and seeps down the cylinder walls into the oil reservoir. Often the oil dipstick will show an oil over-fill condition as fuel accumulates in the reservoir.

The oil reservoir filling up with gas can foul the spark plugs. If left unchecked, the oil will become so diluted with gasoline that it can no longer function as a lubricant. It is extremely important to change the oil and oil filter often whenever there is a high frequency of gas getting into the oil reservoir. Failure to do this can result in premature wear on the cylinder walls and piston rings.

Also, replace fouled spark plugs, regap weak plugs, check electrical system for capability of delivering a strong spark and clean the air filter when dirty.

Cold Weather Operation

Small gasoline engines must get up to operating temperature before they will operate properly. Most air

Section 4: Operating Instructions

cooled engines draw a large volume of air through their intake fan. In sub-zero temperatures or freezing weather it can become almost impossible for an engine to reach normal operating temperature unless the intake air is restricted or warmer air is fed into the carburetor. Land Pride offers a cold weather kit that directs air warmed from the exhaust manifold into the carburetor.

Chokes, throttle cables, and other mechanical linkages are also subject to freezing and sticking in cold weather. Products like WD-40 or dry graphite lubricants can be invaluable in keeping these items working freely. Whenever possible, park your Treker in a warm dry environment just to allow time for the linkages to dry out.

Traveling Tips From the Trail Masters

At Land Pride we want you to get maximum working and recreational enjoyment out of your utility vehicle whether you are using one of our All-Terrain Runabouts or one of our terrain hugging Treker utility trucks. If your work project or recreational adventure is going to take you on an extended ride deep into the wilderness or way out on the prairie, you'll need to seriously consider some of the following tips from experienced pros about safety, gear, clothing, supplies and driving techniques.

Preparation and Planning

Do a complete equipment check as follows:

1. Make sure you have plenty of fuel and oil to make the trip and then some.
2. Make sure your tires have proper inflation, your lug bolts are tight and that you have a spare and the tools to change, repair and inflate a tire. Consider adding a puncture sealant to your tires as a preventative measure.
3. Check for any loose or missing parts and definitely make those needed repairs before going anywhere. It is especially important that you check steering, braking, throttle, electrical and engine components thoroughly.

Plan Your Route

1. Plan your route, destination and rendezvous points before starting out.
2. Don't go it alone if at all possible. Taking someone else along reduces the potential for loss of life or major injury to inclement weather, animal attacks, or accidents. Besides, it's more fun when you have someone to share the adventure with.
3. Obtain trail or area maps of your travel routes to and from your destination. Communicate your travel plans to responsible friends and or proper authorities. Plan rendezvous points at conspicuous landmarks along your route just in case you run into unexpected trouble on the trail.

4. Make sure you take a weather radio and two-way communication devices such as cell phones or long range-two way radios. It is also good to have ground flares, a flare gun, a smoke canister, emergency strobe light, a reflecting mirror, matches for a signal fire and a compass.

Plan Your Gear

1. Check the short and long range weather forecast and take protective gear and clothing to cover all contingencies. It doesn't have to snow for you to fall victim to hypothermia or exposure. Take or wear appropriate eye and head protection, gloves, boots, a long sleeve shirt, long pants, a jacket, rain gear, dry socks and a full change of dry clothing.
2. Plan your gear and gear up for the best and worst of environmental conditions.
3. Pack a first aid kit, sunblocker, lip balm, insect repellent, personal medications, water, tarp or tent, flash light, survival knife, binoculars, camera, tool kit, rope, duct tape, tow strap, winch or come-along, eating, utensils, cooking utensils and high energy trail food.
4. Tie and lash down your gear and supplies securely. Keep the bulk of the weight centered and mounted as low as possible on the vehicle in order to maintain a low center of gravity for safe and stable off-road travel.

Going Out on the Trail

1. When it's time to hit the trail "take it all in" but do it safely!
2. Make sure you brief your passenger on proper safety procedures like keeping hands, arms, feet and other bodily appendages inside the vehicle. Passengers should only be transported in factory supplied seating.
3. Operator and passenger are responsible for deciding if their situation warrants using Seat Belts.
4. Avoid operating on excessively steep hills and especially on hills that are steeper than 15 degrees. Avoid crossing slopes if possible and don't make sharp uphill steering corrections or a rollover could result. If your vehicle starts to tip over on a slope turn the front wheels quickly down hill to regain stability and control. The best way to climb most hills is to drive straight up while maintaining a steady ground speed and constant engine rpm. The best way to descend most hills is straight down while using steady pressure on the brakes without locking them up. Locking up the brakes in a steep downhill situation can result in loss of traction, steering and control. When you must cross a slope on soft terrain, keep the front wheels turned slightly uphill and maintain a constant speed and a straight line of travel.
5. Driving too fast, being inattentive and turning too sharply on slippery surfaces can result in rollovers and accidents almost quicker than any other ground

Section 4: Operating Instructions

condition we know of. Snow cover, wet trails, loose gravel and frozen ground can all contribute to this dangerous condition. In these conditions maintain sharp focus on the trail ahead. Don't make sharp turns and avoid the need for hard braking if at all possible. If you do start to slide turn the front wheels in the direction of the skid to regain control.

6. Avoid paved surfaces. Land Pride vehicles are designed exclusively for off-road use only. We understand that occasionally operators have to cross public roads or right of ways to gain access to work or recreation sites, but don't get in the way of faster traffic and cross quickly and safely.
7. Land Pride Vehicles with shielded torque converters are capable of making **intermittent** stream crossings where the depth of the water briefly comes into contact with the bottom of the floorboards, but you must keep these considerations in mind; You must know how deep the water is and the strength of the current. Cross where you have a gradual incline for entry and exit and the bottom is fairly clean and free of obstacles. Maintain a slow steady speed disturbing the stream bed as little as possible. If you submerge a non-sealed torque converter and drive belt, you will lose forward momentum and power. If you submerge the engine or the whole vehicle, do not attempt to start the vehicle but take it to your nearest dealer immediately. After intermittent stream or shallow water crossings, dry out the brake linings and drive belt by slightly accelerating the engine rpm while riding the brakes momentarily until full drive power and braking are restored. It will also be necessary on vehicles with CVT Enclosures to remove the CVT drain cap to drain any water that may have entered the enclosure through its vents. Replace cap once all water is drained.
8. Backing up in an off-road situation might seem a simple thing to do to a novice, but having to back down a hill is a very dangerous situation. If you are on level ground always look behind you and back up slowly. If you find yourself having to back down a hill, apply the brakes very lightly. Hard braking can cause total loss of control and a rollover situation. Try to back straight down the hill without turning. Turning in this situation can also cause a rollover.
9. Whenever possible, park your vehicle on a level surface, set the park brake and remove the key. If you do have to park on a hillside make sure you chock the rear wheels on the downhill side to prevent a roll away. It's a good idea to keep your spare key stashed separately.
10. Never operate a vehicle under the influence of drugs or alcohol. When you're driving off-road vehicles you need to keep your senses keen and capable of quick reaction, sharp perception and good balance.
11. Working or recreation in the deep wilderness or on the prairies can be personally rewarding and very enjoyable to those who truly love and understand nature and the outdoors. Good judgement, maturity, proper preparation and planning can turn these adventures into great experiences you'll talk about for a lifetime. Share these adventures with young people whenever you can and show them how to do it properly. Don't let anyone under 16 operate this vehicle. They just aren't mature and experienced enough to take on the serious responsibility of operating a vehicle in the off-road environment without the benefit of an experienced adult with them. Remember, the only one who can prevent and avoid an accident is the operator in control and that's you!

Section 5: Options and Accessories

Treker Options

Front Guards

Refer to Figure 5-1:

The standard bumper is the most economical bumper available for the 4200/4400 NT & ST and 4210/4410 ST Trekers. It can be unbolted from the Treker to add the optional Brush Guard.



4200/4400 NT & ST Treker
Figure 5-1

Refer to Figure 5-2:

The Brush Guard shown in Figure 5-2 offers more protection for the body and is required when adding on a front cargo rack, winch, or roller hawse accessory. It is available for the 4200/4400 NT & ST Trekers.

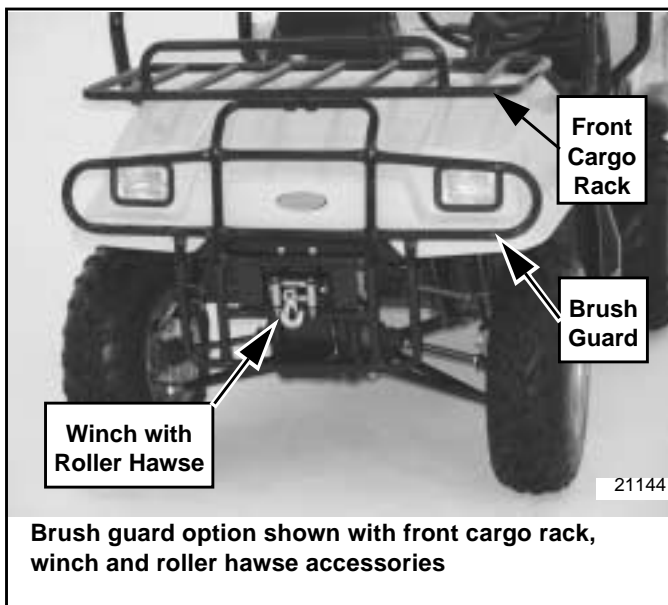

Brush guard option shown with front cargo rack, winch and roller hawse accessories

4200/4400 NT & ST Treker
Figure 5-2

Refer to Figure 5-3:

The extra heavy duty Brush Guard with front hitch receiver as shown in Figure 5-3 is available for the 4210ST & 4410ST Trekers. The hitch receiver on the extra heavy duty Brush Guard is removable for adding a winch and roller hawse accessory. A front cargo rack (not shown) can be mounted to the Brush Guard. Make certain you order the rack that fits your Brush Guard.

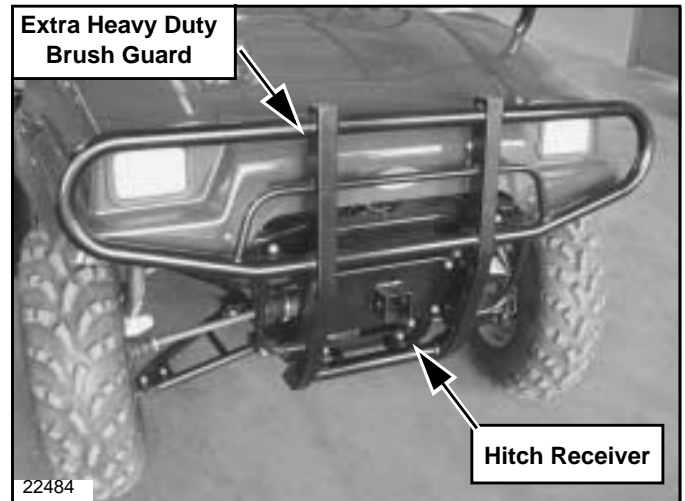

4210ST & 4410ST Series Treker
Figure 5-3

Tires

Refer to Figure 5-4:

There are two types of tires available for your Land Pride Treker. See Figure 5-4. The All Terrain Tire is a good tire to choose when traction is your first priority. This tire is a tough tire for going over rough terrain. The Turf Tire is a good selection when one wants to preserve the terrain being traveled over. Golf courses, parks and other maintained areas make the Turf Tire an excellent choice.



Figure 5-4

Section 5: Options and Accessories

Accessories

A variety of accessory equipment has been designed to complement your needs and make your Land Pride Treker a very functional and useful vehicle. See your nearest Land Pride Dealer for all available accessories. Accessories available are: (Some items not immediately available.)

- 2,000 lb. Winch
- Roller Hawse
- Rear Tire Chains
- Front Tire chains
- Grab Light
- Gun or Tool Rack
- Fifth Wheel Trailer
- Front Bumper
- Front Brush Guard
- Front Rack
- Front Basket
- Rear hitch
- Back Screen
- Back Screen Head Rest
- Electric Dump
- Mud Flaps
- Bedliner Mat
4200 & 4400 Series Only
- 60" Show Blade
- Canopy - Black or Gray
- Fiberglass Canopy -
Red, Yellow or Green
- Windshield Kit
- Soft Cab Enclosure
with Soft Doors
- Hard Cab Enclosure with
Hard Doors (ST only)
- Front Boot Guards
- Rear Boot Guards
- Skid Plate
- Dual Seat Belts
4200 & 4400 Series Only
- 3rd Seat Belt
For Bench Seats on
4210 & 4410 Series Only
- Glove Box Enclosure
4200ST & 4400ST Only
- Electric Spin Spreader

Electric Dump

Bed Latch Lock-Up Arm can be replaced with an electrical actuated dump kit. There are two Electric Dump Kits available. One fits ST Series Treker and the other fits NT Series Treker. Descriptions with part number are listed below. See you nearest Land Pride dealer for additional information.

Treker ST Series

Electric Dump ST (S/N 418339+)701-071A

Electric Dump ST (S/N 418338-)701-044A

Treker NT Series

Electric Dump NT (S/N 418339+)701-072A

Electric Dump NT (S/N 418338-)701-045A

Electric Spin Spreader

Refer to Figure 5-1:

The Land Pride Electric Spin Spreader is a highly versatile full component package designed to plant or spread seeds. It can then be used to spread prilled or granulated fertilizer, lime, gypsum, and other soil conditioning amendments at distances ranging from 4 ft. to 20 ft. The combination spin spreader/planter portion of this system can also be used in the off-season to spread sand or salt for winter icing or slick snow conditions.

The combination of maximum versatility and narrow to wide spread pattern makes the Electric Spin Spreader an excellent choice for applications in wild game food plots, hunting clubs, hunting resorts, ranches, farms, game preserves, landscaping, hobby farming, smaller nurseries, and gardens.

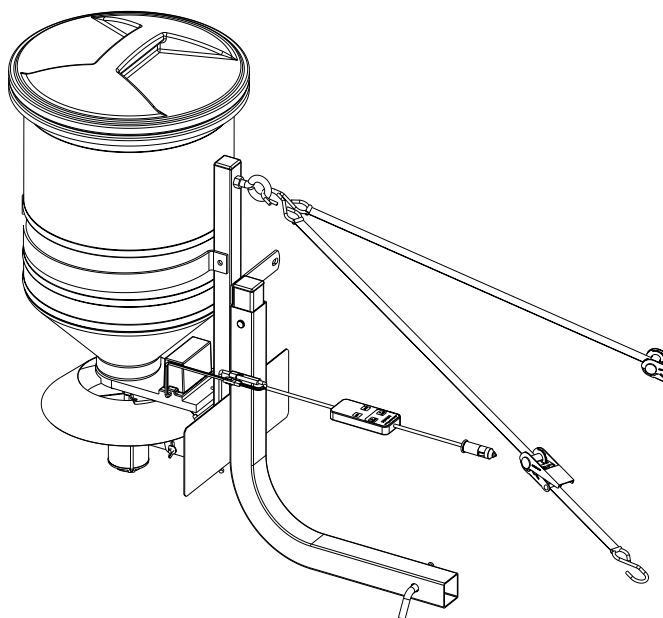

23921

Figure 5-1

The Land Pride Electric Spin Spreader can be attached to any vehicle equipped with a 2" receiver hitch and 12 volt accessory receptacle. Description and part number are listed below. See you nearest Land Pride dealer for additional information.

ELECTRIC SPIN SPREADER 701-130A

Section 6: Maintenance

General Maintenance

WARNING

Read and observe all safety warnings in this manual and in the engine service manual.

WARNING

Except when checking or changing components, always keep protective shields on for safety as well as for cleanliness.

WARNING

Keep engine clean of oil, grease, trash and debris which can cause engine overheating, fires and belt wear. Clean only after the engine has completely cooled. Wear gloves to protect hands from cuts, puncture wounds and burns.

WARNING

DO NOT have engine running when servicing or making adjustments to the vehicle. Shut engine off, place transmission in gear, set park brake and remove ignition switch key for maximum safety.

DANGER

Repairs or maintenance specifically requiring engine power should be performed by trained personnel only. Transmission gear should be set in neutral with tires properly chocked or with drive tires properly supported off the floor. Enclosed areas should be properly ventilated to prevent carbon monoxide poisoning.

DANGER

Exercise extreme caution when working with and around the belt drive. Make certain the engine cannot be accidentally started. Shut engine off and remove ignition switch key for maximum safety. Repairs or maintenance requiring engine power should be performed by trained personnel only.

Regular maintenance is the best prevention for costly downtime or expensive, premature repair. The following pages contain suggested maintenance information and schedules which the operator should follow on a routine basis.

Remain alert for unusual noises, they could be signaling a problem. Visually inspect the vehicle for any abnormal wear or damage. A good time to detect potential problems is while performing scheduled maintenance service. Correcting the problem as quickly as possible is the best insurance.

Some repairs require the assistance of a trained service mechanic and should not be attempted by unskilled personnel. Consult your Land Pride dealer when assistance is needed.

Securing Vehicle for Maintenance

Before servicing the vehicle the following procedure must be met to secure the vehicle:

1. Park vehicle on a level surface. **Don't work under or around a vehicle parked on an incline.**
2. Make the following gear and park brake selections:
 - a. **4200/4400 NT & ST Trekers:**
 - Set shift selector in forward gear.
 - Set park brake.
 - b. **4210ST & 4410ST Trekers.**
 - Set shift selector in Park.
3. Turn ignition switch off and remove switch key.
4. Chock front and back side of the wheels not being raised off the ground when jacking a vehicle or when ground surface slopes.
5. Always use jack stands to support the vehicle when working under the vehicle.
6. Always secure cargo box in the up position when working under the cargo box.

Torque Values

Wheel Lug Nuts

WARNING

Particular attention must be given to tightening the wheel lug nuts. Failure to correctly torque these items may result in the loss of a wheel, which can cause personal injury and damage to the vehicle.

Torque Values		
	FT -lbs.	Nm
Wheel lug nuts	65 - 75	88.14 - 101.7

Always check wheel lug nut torque values two hours after initial operation and two hours after each tire repair and/or replacement. Routinely check lug nut torque valves every 100 hours of operation. See "Maintenance Schedule" on page 40.

Engine Torques

For engine torque values, see engine owner's manual.

All Other Torques

For all other torques refer to "Torque Values Chart" page 57.

Section 6: Maintenance

Tire Maintenance

Use only tires recommended by Land Pride.

It is important for your safety and the safety of others that the tires have correct air pressure. Check air pressure in all four tires before each use. Visually inspect tires for loss of air throughout each day of operation. See Tire Inflation Chart below for correct tire pressure.

Tire Inflation Chart	
Tire	Inflation PSI
Front Tires	7
Rear Tires	7*

* Tire pressure may be increased to accommodate additional cargo load. Maximum tire pressure is noted on tire side wall.

Jacking the Vehicle

DANGER

For your safety and safety of others, a jacked vehicle must be supported properly with jack stands before working under and around it. Also the wheels on the ground must be chocked on both sides to prevent the vehicle from rolling forward or backward.

IMPORTANT: Use a hydraulic jack, floor jack, or scissor type jack to lift the vehicle. Do not use a handyman jack or bumper jack and don't jack against the bumper, body, front 4-wheel drive transfer case, rear trans-axle, or axles.

1. Secure vehicle for maintenance. See "**Securing Vehicle for Maintenance**" on page 29.
2. Loosen the lug nuts on a wheel being removed approximately 1/2 turn counterclockwise while it is still on the ground.
3. See important note above. Place proper jack under vehicle as follows:
 - c. **Front tires:** Refer to Figure 6-1. Place jack under body frame where the A-Frame struts attach to the body.
 - d. **Rear tires:** Refer to Figure 6-2. Center the jack under the receiver hitch.
4. Jack vehicle only high enough to do the work intended.
5. Support the vehicle securely with jack stands before working under or around the vehicle.
6. Work may now be performed on the vehicle. Be sure to properly torque all bolts that were loosened. Wheel bolts should be torqued after the vehicle is lowered to the ground.

7. Lower the vehicle by first jacking the vehicle up high enough to remove the jack stands. Then carefully lower the jack until the vehicle is on the ground.
8. Remove wheel chocks.

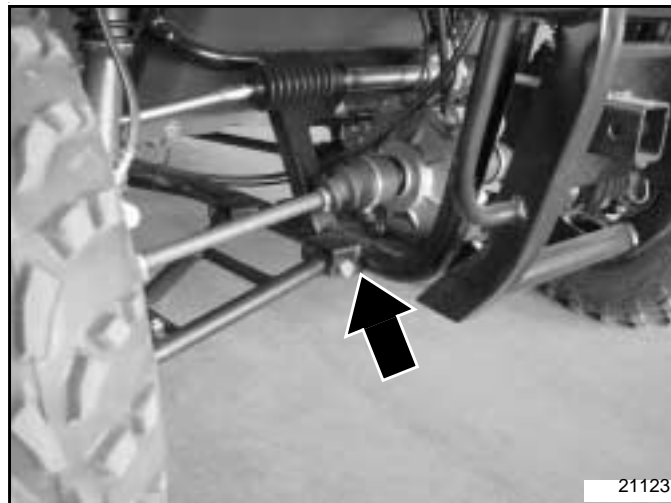

Figure 6-1



Figure 6-2

Shock Absorber Adjustment

Traveling fast or carrying heavy loads may cause shock absorbers to bottom-out making the ride rough. The mounting position of the rear shocks is adjustable to increase or decrease firmness of ride. Typically, they are set soft for slow speeds and light loads. Fast speeds and heavy loads require a firmer setting.

Section 6: Maintenance

Adjust rear shock absorber position as follows:

1. Refer to “**Jacking the Vehicle**” instructions to jack the vehicle up before repositioning the rear shocks.
2. Refer to Figure 6-3. Locate the shock absorber top three mounting holes.
3. Remove the locknut and hex bolt securing the shock absorber to the vehicle frame.
4. Reposition the rear shocks backwards or forwards to change load carrying capabilities as follows:
 - a. Repositioning the shock backwards increases ride firmness and load carrying capabilities.
 - b. Repositioning the shock forwards makes the ride softer.
5. Lower the vehicle as outlined in “**Jacking the Vehicle**” instructions.

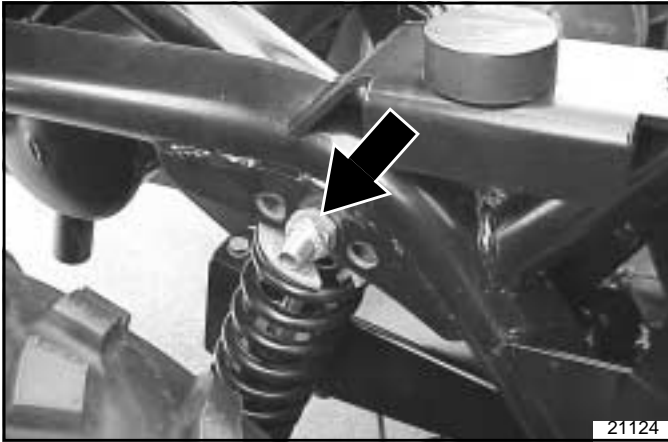

Figure 6-3

Electrical System

The electrical system is protected by fuses located in the fuse box. On the ST Treker the fuse box is located on the vehicle's left side panel behind the driver's seat. On the NT Treker it is located on the fire wall behind the passenger's seat. The lid is attached with velcro. Remove lid by pulling out at the top two corners. On the the lid is a diagram illustrating the required fuses and their locations. Fuses may be purchased through your nearest Land Pride Dealer.

Common circuit failures are shorts, corroded or dirty terminals, loose connections, defective wire insulation or broken wires. Switches, solenoids and ignition components can also not function, causing a short or open circuit.

Before attempting any fault diagnosis of the electrical system, use a test light or voltmeter to check the battery voltage. If the battery voltage is satisfactory, check the cleanliness and tightness of the terminals and ground connections. A general understanding of electrical servicing and use of basic test equipment is necessary for troubleshooting and repair.

Major overhaul or repair of the starting motor and alternator should be performed by trained technicians only.

Battery

WARNING

Acid can cause serious injury to skin and eyes. Avoid skin contact with battery acid and always wear eye protection when checking the battery. Flush area with clean water and call a physician immediately. Acid will also damage clothing.

WARNING

Incorrect battery cable connections can damage vehicle's electrical system and cause battery cables to spark. Sparks around a battery can result in a battery gas explosion and personal injury.

- Always **disconnect** negative (black) battery cable before disconnecting positive (red) cable.
- Always **reconnect** positive (red) battery cable to the positive (+) post before reconnecting negative (black) cable to the negative (-) post.

WARNING

Keep battery terminals from touching any metal parts when removing or installing the battery. Do not allow metal tools to short between battery terminals and metal vehicle parts. Sparks can cause a battery gas explosion which will result in personal injury.

WARNING

Do not allow an open flame near the battery when charging. Hydrogen gas forms inside the battery. This gas is both toxic and flammable and may cause an explosion if exposed to a flame.

The battery is located in the engine compartment on the 00 Sereis and under the seat on the 10 Series Trekers. It may be either a maintenance-free sealed battery or a maintenance-free battery with removable vent caps. Inspect your battery and know which battery you have. Water cannot be added to sealed batteries as the vent caps are not removable.

Land Pride recommends a maintenance-free battery size BCI group U1/U1R. The battery should also have a minimum of 300 cold cranking AMPs and 375 cranking AMPs at 32°F. The battery support is designed to hold a larger automotive style battery. Simply reposition the J-hooks to the higher holes when installing a larger battery. Always follow the battery manufacturer's maintenance, safety, storing and charging specifications.

Section 6: Maintenance

Adding Water to the Battery



CAUTION

Do not overfill battery with water. Electrolytes may overflow and damage paint, wiring or structure. Use soap and water to clean the battery. Be careful not to get soap and water into the battery. Use baking soda mixed in water to clean corrosion off the terminals.

There should be no need to add water throughout the normal life of a maintenance-free battery. However, abnormal electrical system conditions or high ambient temperatures may boil off more water than normal. It is best to check the water level once a year in batteries that have removable vent caps. Water level in each cell should be up to the level indicator. If not, add water. Distilled water should be used to fill each cell in the battery. However, tap water may be used if tap water is not hard or does not have high mineral or alkali content. Do not overfill. Have the charging system checked by your local Land Pride dealer if the battery requires water every few months.

Charging the Battery

Batteries that are severely discharged may not take or indicate a charge immediately. Some automatic chargers need a minimum voltage before they will start charging and some will not indicate a charging condition at the meter until the battery reaches a minimum charge. Consult your charger manual to determine how your charger works.

When recharging batteries, please follow these important safety precautions:

1. Secure vehicle for maintenance. See "**Securing Vehicle for Maintenance**" on page 29.
2. Read the charger manufacturer's instructions.
3. Leave the battery charger unplugged until its cables are connected to the battery.
4. Choose the correct battery charger to properly charge the battery.
5. Put on protective eye wear, rubber gloves, work clothes and remove all jewelry.
6. Don't charge a frozen battery. Allow the battery to warm up to about 60 deg. F before charging.
7. Charge batteries in a well ventilated area.
8. Never smoke while charging a battery.
9. If applicable, remove the vent caps and check the battery's water level. **If the water level is low**, follow instructions for "**Adding Water to the Battery**" on page 32.
10. If applicable, reinstall vent caps before charging.
11. Set the charger to 12 volts.
12. Plug in and turn on the charger.
13. Don't wiggle the connections to check contact while the charger is turned on or plugged in.
14. Choose the lowest amperage setting initially. Once the charger is on and the battery is charging you may want to choose a higher amp setting to reduce charging time.

Jump Starting the Battery

The battery will discharge if the lights or any other electrical equipment is left on after the engine has stopped running. Also, the battery will discharge if the lights or power plug outlet is used over a prolong period while the engine is idling.

The engine can be jump-started with a booster battery. Follow procedures listed below when jump-starting.

Prepare Vehicle to Jump-Start

1. Use only a 12-volt battery to jump-start the Treker. Higher voltages can damage the starter motor and other electrical components. Do not use a 24 volt battery or two 12-volt batteries connected in series.
2. Do not disconnect the vehicle's battery that needs a jump-start. Disconnecting the battery can damage the vehicle's electrical system.
3. Park the second vehicle close to the vehicle needing a boost without touching the two vehicles together. Set parking brake on both vehicles.
4. Turn off all ignition switches, electric switches, light switches and set parking brakes on both vehicles.

Connecting Jumper Cables

Refer to Figure 6-4 on page 33:

1. Inspect battery terminals for corrosion. Remove excess corrosion before connecting jumper cables.
2. Connect one end of the red jumper cable to the positive (+) terminal on the dead battery.
3. Connect the other end of the red jumper cable to the positive (+) terminal on the booster battery.
4. Connect one end of the black jumper cable to the negative (-) terminal on the booster battery.



WARNING

Make connection in step 5 below to a metal surface away from the battery. Never connect to the negative (-) post of the dead battery or to a metal surface near the battery. Sparking near the battery can result in a battery gas explosion and personal injury.

5. Connect the other end of the black jumper cable to a metal surface on the vehicle that has the dead battery.
6. Inspect jumper cables to make certain they are not in the way of moving or rotating components. Reposition any cables that will be in the way.

Section 6: Maintenance



DANGER

Make certain everyone is clear of all moving and rotating components before starting either vehicle.

Refer to Figure 6-4:

- Start the live vehicle and run it at a moderate speed for a few minutes to charge the dead battery.
- After waiting a few minutes, start the dead vehicle. It should start within several tries. If the vehicle does not start, then the problem might be something other than the battery.

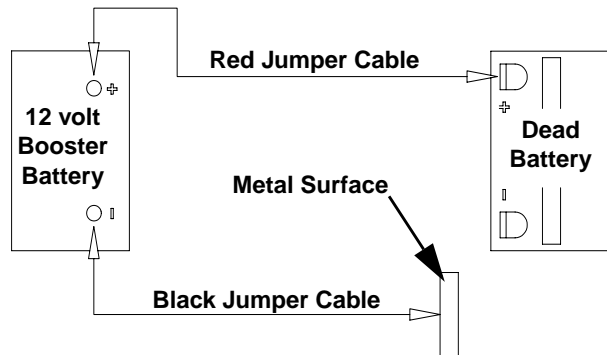

Figure 6-4

Disconnecting Jumper Cables

Refer to Figure 6-4:

- Let both vehicles run for several minutes to charge up the dead battery before removing the jumper cables.
- Disconnect the black jumper cable from the metal surface on the vehicle that had the dead battery.
- Disconnect the other end of the black jumper cable from the negative post on the booster battery.
- Disconnect the red jumper cable from the positive (+) post on the booster battery.
- Disconnect the other end of the red jumper cable from the positive (+) post on the dead battery.
- Drive the vehicle that had the dead battery for a while to recharge the battery or recharge the battery with a battery charger. Follow all battery charger instructions when recharging a battery with a battery charger.

Fuel System



DANGER

- Observe safe fuel handling precautions.
- Do not smoke while handling fuel.
- Do not fill tank with engine running or while engine is hot. Allow the engine to cool before filling. Spilling fuel over the engine, muffler, or a hot object may result in a fire or explosion.

- Allow engine to cool before servicing the fuel system.
- Clean up any gasoline spills immediately.
- Keep fuel away from open flame or spark.
- Store the vehicle away from open flame or spark if there is fuel in the tank.
- Use extra caution when handling gasoline and other fuels. They are flammable and vapors are explosive. A fire or explosion from gasoline can burn you and others and can damage property.
- Refuel outdoors preferably, or in well ventilated areas.
- Never attempt to start engine when there is a strong odor of gasoline fumes present. Locate and correct cause.
- Store gasoline in an approved container and keep it out of children's reach.
- Never buy more than a 30 day supply of gasoline.
- Do not fill gasoline containers inside a vehicle, on a truck, or on a trailer. Interior carpets and plastic truck bed liners insulate the container and slow loss of static charge.
- When practical, remove equipment from the truck or trailer and refuel the equipment with its wheels on the ground. If this is not possible, then refuel the equipment on the truck or trailer using a portable container and not a gasoline dispenser nozzle. If a gasoline dispenser nozzle must be used, keep the nozzle in contact with the rim of the fuel tank or container opening at all times until fueling is complete.
- Gasoline is a poison harmful or fatal if swallowed.
- Long-term exposure to vapors can cause serious injury and illness.
- Avoid prolonged breathing of vapors.
- Keep face away from nozzle and gas tank opening.
- Keep gas away from eyes and skin.

The fuel tank is located on the ST Series behind the passengers seat and on the NT Series behind the driver's seat. Total fuel capacity is 4 gallons for NT Series and 8 gallons for ST Series.

When filling the fuel tank, set park brake, turn off engine and remove ignition key. Clean dirt from around fuel tank cap, remove cap and begin filling. When finished, screw the cap back on securely and wipe up any spilled gasoline. Use regular unleaded gasoline with an octane rating of 87 or higher.

IMPORTANT: Never use methanol, gasoline containing methanol and/or gasohol containing more than 10% ethanol. These fuels can damage the vehicle's fuel system. Do not mix oil with gasoline.

Using a fuel stabilizer/conditioner in the vehicle can provide benefits such as:

- Keeps gasoline fresh during storage of 90 days or less. The fuel tank should be emptied for longer storage.

Section 6: Maintenance

2. Cleans the engine during operation.
3. Eliminates gum-like varnish build-up in the fuel system.

IMPORTANT: Do not use fuel additives containing methanol or ethanol.

Add the correct amount of gas stabilizer/conditioner to the gas. Follow the gas stabilizer/conditioner manufacturer's directions for best results.

Fuel Filter Maintenance

Refer to Figure 6-5

The fuel filter (Land Pride Part No. 831-031C) is installed in the fuel line between the fuel tank and engine. Check it every 100 hours for excessive water accumulation or sediment and replace if necessary. Otherwise replace after every 300 hours of operation or annually, whichever occurs first. Also check fuel tank and fuel line for cracks and leaks every 100 hours.



Figure 6-5

1. Secure vehicle for maintenance. See "**Securing Vehicle for Maintenance**" on page 29.
2. Following all Fuel Safety Cautions and Warnings, remove clamps securing the fuel filter and remove fuel filter for inspection.
3. Check fuel filter for sediment and water accumulation. Check fuel lines for cracks and leaks.
4. Replace damaged fuel lines with new ones.
5. Replace fuel filter when sediment or excessive water is present.
6. Reattach fuel filter to fuel line with arrow on the filter pointing in the same direction fuel flows in the line. Fuel flows towards the engine.
7. Install hose clamps around fuel filter.
8. Start vehicle and inspect for fuel leaks along fuel line and fuel filter.

9. Shut off the vehicle. Remove blocks securing cargo box up and lower cargo box.
10. Remove wheel chocks if used.

Emptying the Fuel Tank



DANGER

Never siphon a fuel tank by sucking on a hose with your mouth. Fuel vapors and gas are harmful to your lungs and can permanently damage them. Always use a siphon pump.

The fuel tank will need emptying when preparing for long term storage or replacing a damaged one.

1. Secure vehicle for maintenance. See "**Securing Vehicle for Maintenance**" on page 29.
2. Follow all Fuel Safety Cautions, Warnings and Dangers.
3. Remove gas cap and siphon fuel through the gas fill opening with a siphon pump into an approved gas container. Make sure the container or containers are capable of holding all the gas. Do not dump fuel on the ground.

Engine Maintenance

General Information

Detailed instructions and recommendations for break-in and regular maintenance are specified in the engine operator's manual. Engine warranty is backed by the engine manufacturer. Please refer to engine manufacturer's manual for engine servicing, lubricating oil levels, oil quality and viscosity recommendations, bolt torques, etc. Special attention should be paid to applicable data that is not duplicated here.

High Altitude Carburetor Kit

IMPORTANT: The air-fuel mixture in carburetors modified for high elevation is too lean when operating at elevations below 5,000 feet. Operating engines with modified carburetors below 5,000 feet can result in engine overheating and serious engine damage. Return carburetor to original factory specifications when operating at low elevations.

Treker vehicles shipped from the factory are stocked with carburetors designed to operate efficiently between 0 and 4,999 feet. Carburetor change over kits for different altitudes may be purchased from your nearest Land Pride Dealer as follows:

<u>Elevation</u>	<u>Carburetor Kit No.</u>
0'-4999'	99201-ZG8-1050
5,000'-7,999'	99201-ZG8-1020
8,000' & up	99201-ZG8-1000

Section 6: Maintenance

Drive Belt Replacement

Replace drive belt when it shows signs of severe cuts, tears, excessive weather checking and cracking or burns caused by slipping. Slight raveling of belt covering does not indicate failure. Trim ravelings with a sharp knife.

Inspect belt pulley grooves and flanges for wear. A new belt, or one in good condition, should never run against bottom of pulley groove except when engine is idling. Replace pulley when this is the case, otherwise belt will lose power and slip excessively.

Never pry a belt to get it on a pulley as this will cut or damage the fibers of the belt covering.

Keep oil and grease away from belts and never use belt dressings. Any of these will destroy the belt composition in a very short time.

CAUTION

Securely support cargo box in the up position to prevent injury when working under the cargo box.

CAUTION

Make certain to keep fingers from getting caught between belt and pulley when rotating belt over pulley.

Refer to Figure 6-8:

1. Secure vehicle for maintenance. See "**Securing Vehicle for Maintenance**" on page 29.

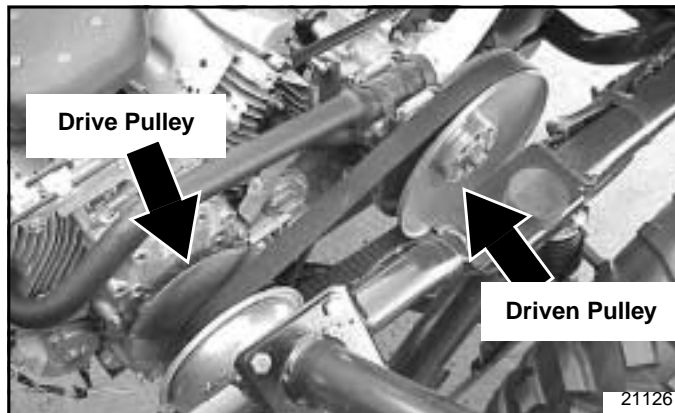

Figure 6-6

2. Remove hardware securing drive belt cover and remove cover.
3. Hand squeeze the belt together between the drive pulley and driven pulley to force the belt into the driven pulley. This should open the driven pulley side walls allowing room to remove the belt.
4. Remove belt by rolling it off over the drive pulley and then lifting it up off the driven pulley.
5. Reinstall new belt by placing it over the driven pulley and then rolling it over the variable pulley.

6. Reinstall belt cover and fasteners.
7. Reconnect battery negative cable.
8. Remove blocks securing cargo box up and lower cargo box.

Driven Pulley Maintenance

Refer to Figure 6-6:

The driven pulley should be inspected for wear at the wear buttons to prevent damage to the pulley and pulley compression spring.

Refer to Figure 6-7:

1. Secure vehicle for maintenance. See "**Securing Vehicle for Maintenance**" on page 29.
2. Fully enclosed CVT belts only: Remove screws securing drive belt cover. Pull cover back to inspect.
3. Check wear buttons on the driven pulley every 100 hours or less for wear. Wear buttons should be at least 1/16" above the aluminum hub as shown.

DANGER

Do not replace wear buttons without contacting your nearest Land Pride vehicle dealer for help. The compression spring can cause bodily injury if replacement is done incorrectly.

4. Replace all wear buttons if any are below the 1/16" height requirement. Make certain you contact your nearest Land Pride vehicle dealer for help on replacing the wear buttons.

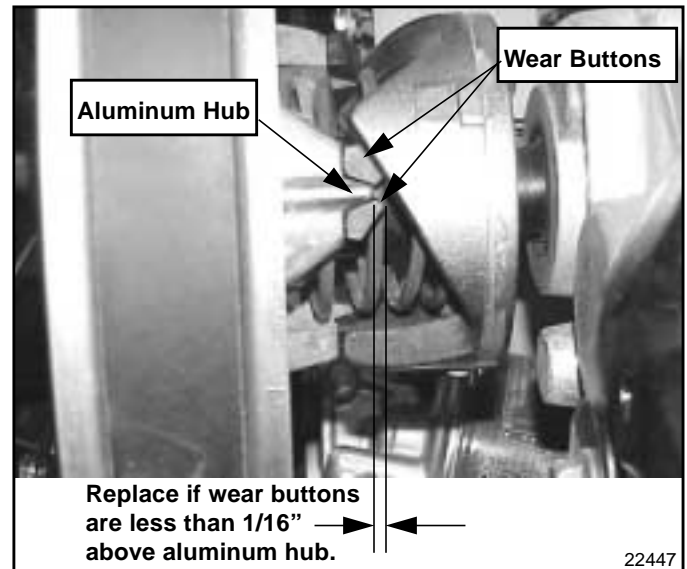

Figure 6-7

Wear Button Replacement Kit

Part No.	Part Description
700-344A	DRIVEN PULLEY BUTTON KIT (Kit contains 6 new buttons)

Section 6: Maintenance

Engine Air Filter Maintenance

Refer to Figures 6-8, 6-9, 6-10 & 6-11:

NOTE: Do not operate engine with a damaged air filter or without an air filter element. Dirt will enter the engine causing a dust ingested engine failure.

NOTE: Do not block air intake to the canister such as setting an object on the platform in front of the air intake opening.

1. Replace filter elements with Land Pride filter element No. 839-323C every 300 hours or every year, (whichever comes first). **Service more frequently when used in dusty conditions.**
2. Release retaining clips and remove filter element. Clean canister with a damp cloth.
3. Before installing a new filter element, inspect it by placing a bright light inside and rotate the element slowly, looking for any holes or tears in the paper. Also check gaskets for cuts or tears. Do not attempt to use a damaged element which will allow abrasive particles to enter the engine.
4. Install the new filter element with open end first.
5. Reinstall canister access cover. Make sure it seals all around the canister body before tighten retaining clips.
6. Check all fittings and clamps periodically for tightness. Inspect hoses for holes or cracks.
7. Periodically check engine intake hose for signs of ingested dust. Locate and repair source of ingested dirt.
8. Never operate a machine without an air filter installed.

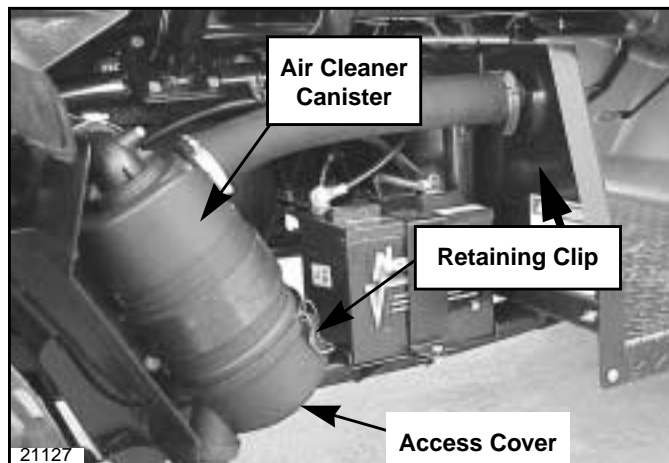

4200NT & 4400NT (Location - Right Side)
Figure 6-8

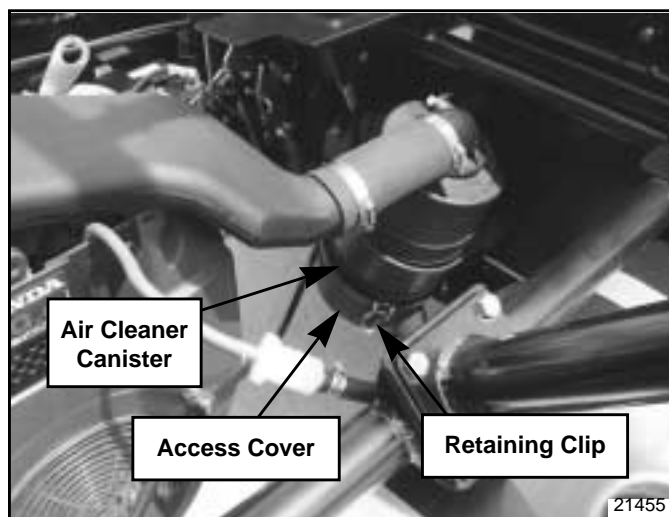

4200ST & 4400ST (Location - Behind Fire Wall)
Figure 6-10

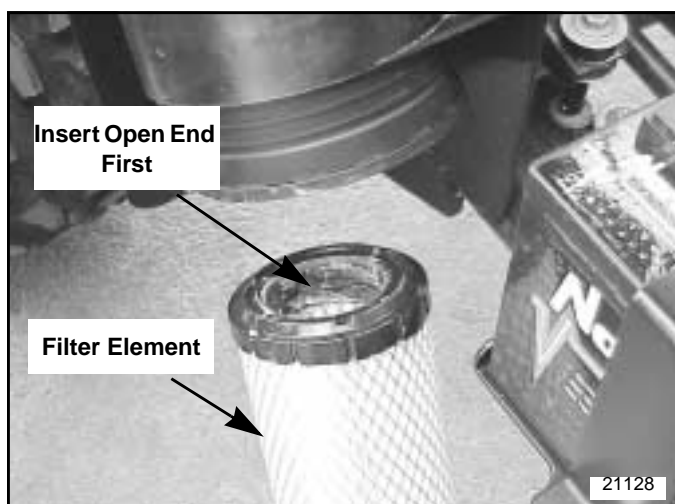

NT Series Shown
Figure 6-8

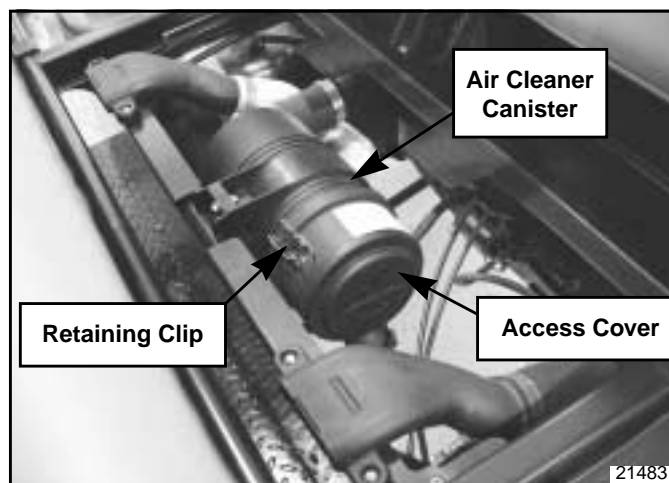

4210ST & 4410ST (Location - Under Hinged Seat)
Figure 6-11

Section 6: Maintenance

Engine Air Filter Handling

Refer to Figure 6-8 and Figure 6-8:

A specially designed dry filter is standard equipment on the Treker and supplies clean combustion air to the engine.

Prevent costly and non-warrantable premature engine damage by maintaining the vehicle air filter properly. Many engine failures are due to improper handling of the air filter. Dust and dirt that gets past the air filter will damage engine cylinder, piston and bearings in a few hours.

Prevent costly and non-warrantable premature engine failure by avoiding the following common mishandling:

- Over servicing
- Improper installation
- Damaged air filtering system
- Incorrect air filter element

Over Servicing

Over servicing occurs when an air filter element is inspected and/or replaced too often. Dust and dirt can fall off the filter element onto the canister where it can be sucked into the intake system. Only a few grams of dirt getting into an engine during each filter inspection can prematurely produce a dust ingested engine failure. A partially dirty air filter element is not harmful to the engine.

The air filter element should be changed before it becomes too dirty and restricts air flow to the engine hindering its performance. Replace the air filter element immediately should this happen. Engines that do not get proper amounts of air will draw in excessive amounts of gas causing premature engine failure.

The frequency of the air filter needing changing is largely determined by driving conditions. Dusty conditions will require more frequent servicing.

A dirty filter element should always be replaced with a new element. Improper cleaning procedures can get dust on the inside of the filter causing dirt ingestion and engine failure. **The air filter warranty expires upon cleaning or servicing a used filter in any manner. Land Pride does not warranty a dust ingested engine failure if a used air filter element has been cleaned or serviced in any manner.**

Improper Installation

Improper installation occurs when dust leaks past the seals. The filter element must be aligned within the canister and properly seated on both ends to prevent dirt from entering the engine.

Damaged Air Filtering System

A damaged air filtering system occurs from mishandling of the filter element and driving the vehicle in areas that could damage the canister.

Banging and/or bumping the filter element against a solid object such as a tire or blowing the element with air can damage the seals and/or force dust and dirt particles through the filter media creating a hole for dirt to pass through to the engine.

Driving the vehicle carelessly over rough terrain, jutting sticks, heavy brush and severe rocks can damage the air cleaner canister. Periodically inspect the outside of the air cleaner canister for external damage and replace if necessary.

Incorrect Air Filter Element

The air filter must remain intact to block passage of dirt and foreign particles. It must be of sufficient size and construction to withstand stresses, caused by rapid cycling of air volume demanded by the engine, without cracking or tearing under fatigue and pressure. Its filter elements must have the correct media composition, filter area, micron size and dimensions to properly filter the air of dirt while at the same time passing sufficient air to the engine.

Land Pride and the engine manufacturers have carefully selected a reliable filter designed to fit the needs of the Treker engines. Always specify a Land Pride filter part number 839-323C.

Always use genuine Land Pride filters. **Failure to use original equipment replacement parts is an alteration and will not be considered for warranty in the event of a dust ingested engine failure.**

Section 6: Maintenance

CVT Snorkel Filter Maintenance

Only vehicles with fully enclosed CVT covers require filter maintenance. CVT covers with open backs do not have a filter.

Refer to Figure 6-12:

1. Inspect filter at every oil change by removing the filter from the CVT air intake snorkel opening and inspect for dirtiness and damage.
2. Wash filter element if it is dirty in warm soapy water. Rinse and let dry before reinstalling. Replace if torn or cut.

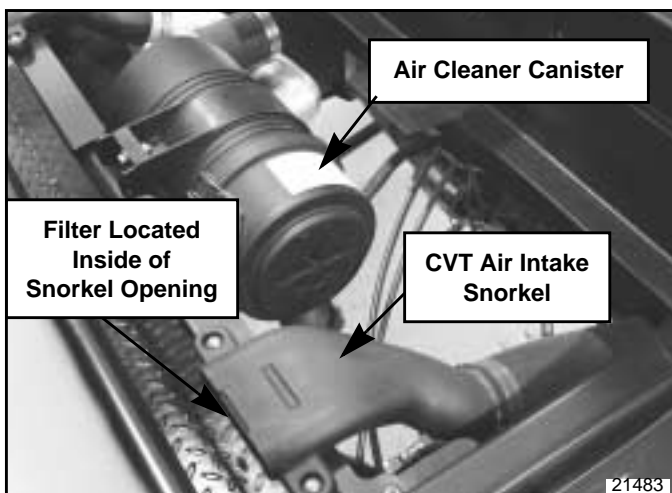

4210ST & 4410ST Shown
Figure 6-12

Spark Arrester

Refer to Figure 6-13 and Figure 6-14:

! DANGER

The spark arrester does not stop all fire emitting sparks from escaping the muffler. Use extreme caution when driving through dry grass, brush and other fire hazard materials. Never stop or park the vehicle over combustible materials.

! WARNING

The muffler is very hot and will burn upon contact. Allow time to cool before servicing the spark arrester.

! CAUTION

To maintain efficiency, the spark arrester must be serviced every 100 hours.

! CAUTION

Be careful not to damage the spark arrester screen when cleaning.

The spark arrester is mounted on the end of the muffler tail pipe and is designed to suppress sparks from escaping the muffler while they are still glowing.

Spark Arrester Maintenance Schedule

- Inspect every 100 hours for carbon build-up and screen damage.
- Clean whenever carbon build-up is visible or whenever lost of engine power is detected.
- Replace when damaged.

Spark Arrester Maintenance Procedure

1. Remove spark arrester mounting screw and remove spark arrester from muffler exhaust pipe.
2. Remove carbon deposits from spark arrester screen with a wire bristle brush. Be careful not to damage the spark arrester screen.
3. Inspect the spark arrester for holes or breaks in the screen and replace if damaged.
4. Reattach spark arrester to muffler with mounting screw.

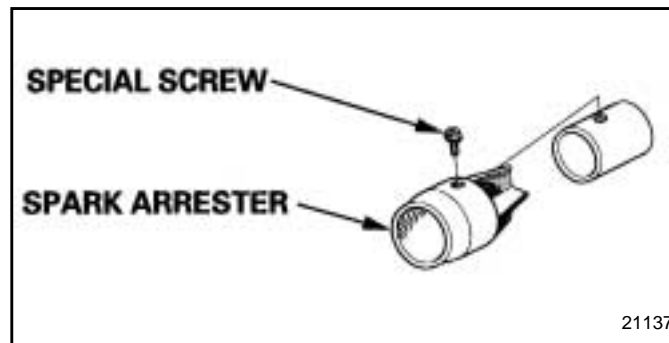

Spark Arrester Mounting
Figure 6-13

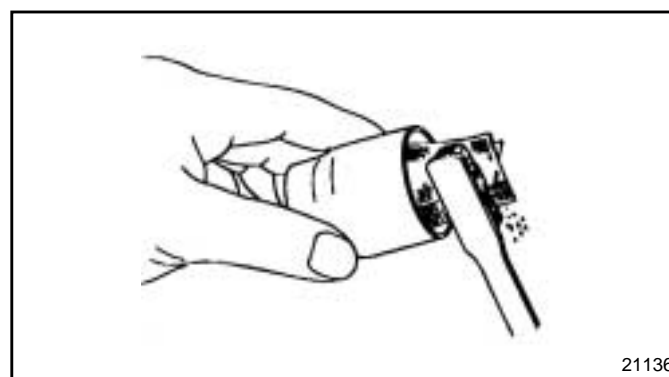

Cleaning Spark Arrester
Figure 6-14

Section 6: Maintenance

4210/4410 ST Park Brake Adjustment

The Park Brake Assembly is factory shimmed to the correct gap and should not require adjusting. Make adjustments only if the park brake pads do not hold when the gear shift selector is in park or if the brake pads drag on the disc when out of park. Have your nearest Land Pride Service Center replace brake pads and/or shims if the following adjustments are not satisfactory.

Refer to Figure 6-15:

The park brake calipers are located on the right side of the rear trans-axle case.

IMPORTANT: If the park brake lever is not properly adjusted, the brake pads can drag resulting in excessive brake wear and decreased engine power. When adjusted properly, the park brake lever (#4) will be located in its ball detent position when the gear shift selector is in neutral.

IMPORTANT: Make certain the wheels are chocked and the cargo box is securely supported in the up position before working on the Park Brake calipers.

1. Park vehicle on a level surface. **Don't work under or around a vehicle parked on an incline.**
2. Set shift selector in park.
3. Chock front and back of rear wheels.
4. Secure cargo box in the up position.
5. Change shift selector to neutral.
6. Turn ignition switch off and remove switch key.
7. Remove cotter pin (#1) and linchpin (#2).
8. Loosen jam nut (#3).
9. Allow the park brake lever (#4) to seat itself in the ball detents.
10. Adjust yoke (#7) in or out until the yoke linchpin hole aligns with brake lever (#4) linchpin hole.
11. Reinsert linchpin (#2).
12. Insert cotter pin (#1) and secure in place by bending one leg out.
13. Tighten jam nut (#3) against yoke (#7).
14. Check the park brake's ability to hold and release by:
 - a. Placing the shift selector in park and check to make sure the brake pads (#5) are seated tight against the rotary disc (#6). The vehicle should not move with the shift selector in this position.
 - b. Return shift selector to neutral and check to make sure the park brake pads (#5) do not make contact with the rotary disc (#6).
 - c. If the park brake still does not work properly, have your nearest Land Pride service center inspect the brakes before continuing to use the vehicle.
15. Set shift selector in park, lower cargo box and remove wheel chocks.

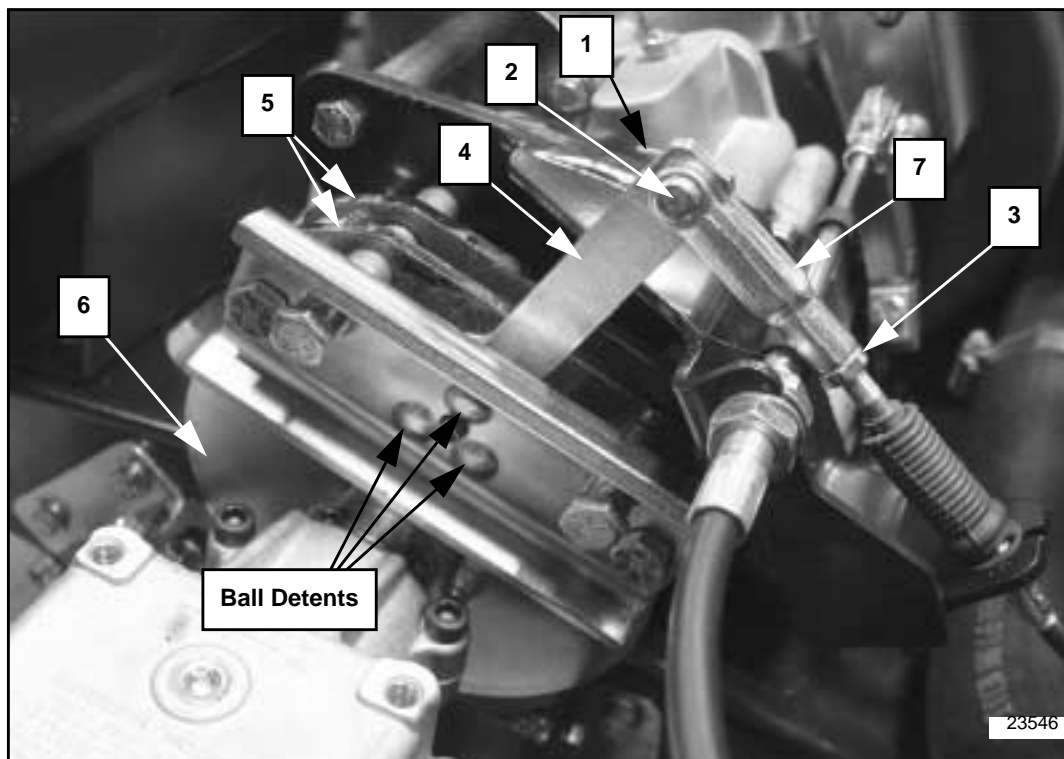

Park Brake Calipers
Figure 6-15

Table of Contents

Section 6: Maintenance

Maintenance Schedule

Maintenance Operation	Daily	Every 100 Hrs.	Every 300 Hrs.	Every 500 Hrs.	Every 6 Mos.	Every Year	Refer to Page
Check Engine Oil level (9)	X						41
Check Tire Pressure	X						30
Inspect All Nuts and Bolts for Tightness	X						29
Check and Clean Area Around Engine Air Intake	X						36
Check Fuel Line Hoses, Clamps, & Tank for Leaks	X					X	34
Clean Spark Arrester (1)		X					38
Check Wheel Lug Nuts (Torque 65 to 75 Ft. lbs.) (2)		X					29
Check Master Cylinder Brake Fluid Level		X					45
Check Battery Charge and Water Level		X					31
Check In-line Fuel Filter (10)		X			X		34
Check CVT Snorkel Filter (3) & (4)		X			X		38
Change Engine Oil (3), (4) & (9)		X			X		41
Change Engine Oil Filter (3), (4) & (9)		X			X		42
Check & Regap Spark Plugs (.028 to .031 in.) (9)		X			X		
Check Rear Trans-axle Case Fluid Level (7)		X			X		43
Check Center Transfer Case Fluid Level (7)		X			X		44
Check Front Differential Case Fluid Level (7)		X			X		44
Check Driven Pulley Wear Buttons		X					35
Inspect Drum Brakes (6)			X				
Inspect Parking Brake (6)			X				
Replace Air Cleaner Filter Element (5)			X			X	36
Replace Spark Plugs (9)			X			X	
Check and Adjust engine idle Speed (6) & (9)			X			X	
Check Valve Clearance (6) & (9)			X			X	
Replace In-line Fuel Filter			X			X	34
Clean Combustion Chamber (8) & (9)				X		X	
Clean Battery and Terminals						X	31
Check Drive Belt and Pulleys						X	35

Reference Notes for above Maintenance Operation:

- (1) Clean spark arrester whenever loss of engine power is noticed or every 100 hours (whichever comes first).
- (2) Check tightness after first 2 hours of initial operation and after removal for repair and replacement.
- (3) Make first engine oil and filter change after the first month of operation or at 20 hours of operation (whichever comes first).
- (4) Service every 100 hours or 6 months (whichever comes first).
- (5) Replace air cleaner filter element if damaged, every 300 hours or ever season (whichever comes first). Replace more frequently when used in dusty conditions.
- (6) Have a Land Pride dealer perform this service every year or every 300 hours (whichever comes first).
- (7) Change every year or every 400 hours (whichever comes first). Change immediately if contaminated with water.
- (8) Have a Land Pride dealer perform this service every year or every 500 hours (whichever comes first).
- (9) See also your Honda Engine Owner's Manual.
- (10) Replace fuel filter immediately if excessive water accumulation or sediment is found.

Section 7: Lubrication

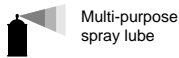

Multi-purpose
spray lube



Multi-purpose
grease lube



Multi-purpose
oil lube



Intervals at which
lubrication is required

Engine Oil

A general description for engine oil maintenance, recommendations and capacities is provided below. See Engine Operator's Manual for a detailed description.

IMPORTANT:

Running engine low on oil can cause engine damage and void engine warranty.

Overfilling engine of oil can cause loss of power, engine damage and void engine warranty.

Maintenance Schedule

- Check oil level after each use.
- Make first oil change after the first month of operation or at 20 hours of operation (whichever comes first).
- Make all subsequent oil changes every 6 months or every 100 hours of operation (whichever comes first).

Level Check

Refer to Figure 7-1:

Check engine oil daily with dipstick located at the engine left front side as follows:

1. Park vehicle on a level surface, set park brake, turn off ignition switch and remove switch key.
2. Allow enough time for engine oil to settle before checking oil level with the dipstick.
3. Remove dipstick and wipe clean.
4. Fully insert dipstick and remove. Check oil level shown on dipstick.
5. If oil level on dipstick is low, remove filler cap located top of rear valve cover and fill with recommended oil. Repeat steps 2, 3 and 4 until oil level on dipstick indicates full. **Do not overfill or plug fouling and power loss will occur.**
6. Replace filler cap and dipstick.

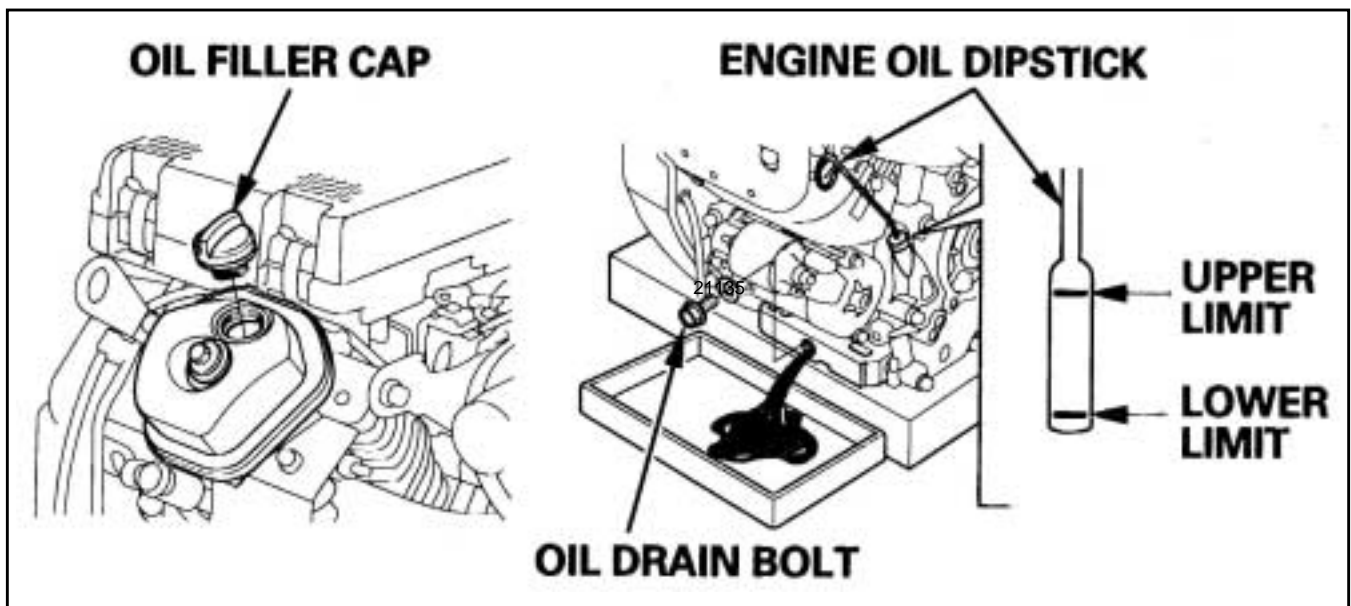

Engine Oil Fill, Drain and Check Locations
Figure 7-1

Section 7: Lubrication

Oil And Filter Change

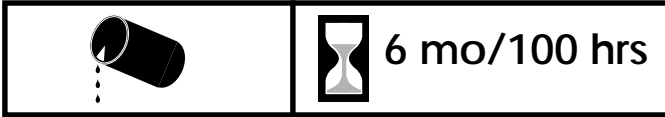

Refer to Figure 7-1 on page 41:

See also "Section 10: Specifications and Capacities" on page 49.

Filler cap location: Top of rear valve cover

Dipstick location: Front left side of engine

Drain plug location: Front bottom center of engine

Type of Lubrication: SAE 10W30

Engine Oil Capacity: 1.5 US qts. with filter replacement,
1.1 US qts. without filter replacement.

Quantity: Fill oil to upper limit mark on dipstick.

Refer to Figure 7-2 and Figure 7-3:

Warm oil drains quickly and completely. Therefore, drain used engine oil while engine is still warm as follows:

1. Park vehicle on a level surface, set park brake, turn off ignition switch and remove switch key.
2. Place a suitable container below engine to catch used oil. Remove filter access cover and drain plug to allow oil to drain out.
3. Remove oil filter with a filter wrench and let remaining oil drain out. Discard oil filter.
4. Clean engine filter base.
5. Coat new filter O-ring with clean engine oil and install filter to engine filter base.
6. Hand tighten oil filter until O-ring seats. Finish tightening by turning in the filter the specified turning angle or torque with a torque wrench.

Turning Angle: 7/8 turn

Torque: 22 N.m (2.2 kgf.m, 16 lb-ft)

7. Reinstall and tighten drain plug securely.
8. Dispose of used motor oil and filter in a manner that is compatible with the environment. Do not throw used oil in the trash, pour it on the ground, or down a drain.
9. Fill engine with 1.5 US quarts of 10W30 oil. Do not overfill. See "Level Check" on page 41.
10. Replace filler cap, start engine and check oil filter for leaks.
11. Stop engine and check oil level as outlined in section titled "Engine Oil Level Check" on page 41.

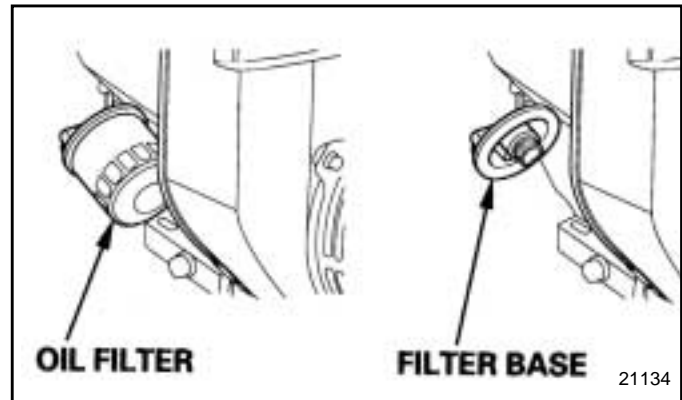

Oil Filter Location
Figure 7-2

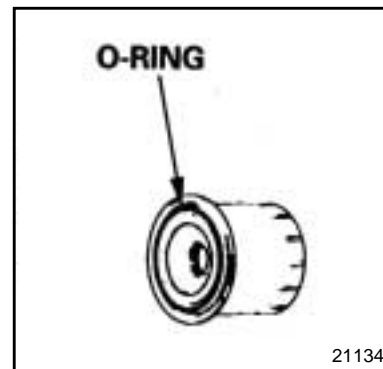

Oil Filter O-Ring
Figure 7-3

Section 7: Lubrication

Case Oil

A general description of maintenance, recommendations and capacities for the trans-axle case, center transfer case and front differential case are provided below.

Maintenance Schedule

- Check case housing for damage and possible oil leakage after each use.
- Check oil level every 6 months or every 100 hours (whichever comes first).
- Change oil once a year or every 400 hours (whichever comes first).

Level Check

Oil must be drained and refilled with proper quantities to insure correct oil level in the front differential case. Check rear trans-axle case and center transfer case oil at the fill plug with a clean rod. The rod should be long enough so that it will not fall pass the fill opening.

1. Park vehicle on a level surface, set park brake, turn off ignition switch and remove switch key.
2. Remove fill cap and measure from top of fill hole to oil level in case. This should be approximately 4 1/2" for

rear trans-axle case, 2" for center transfer case and 1/4" from bottom of fill opening for front differential case.

3. Add correct lubrication if needed. (**Don't overfill**)
4. Replace fill cap and tighten securely.

Oil Change

Warm oil drains quickly and completely. Drain used oil while it is still warm as follows:

1. Park vehicle on a level surface, set park brake, turn off ignition switch and remove switch key.
2. Place a suitable container below housing to catch used oil. Remove fill cap and drain plug.
3. Allow used oil to drain completely and then reinstall drain plug and tighten securely.
4. Dispose of used oil in a manner that is compatible with the environment. Do not throw used oil in the trash, pour it on the ground, or down a drain.
5. Fill gear cases per capacities in "Section 10: Specifications and Capacities" on page 49.
6. Replace fill cap and tighten securely.

Rear Trans-axle Case

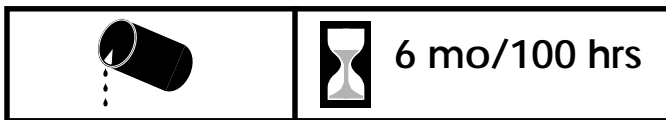

Refer to Figure 7-4:

See also "Section 10: Specifications and Capacities" on page 49.

NOTE: Running trans-axle or driveline gearboxes low on oil can damage seals, bearings and gears voiding the warranty for the trans-axle and gearboxes.

Fill cap location: Top center rear side (See arrow)

Drain plug location: At bottom left side (see arrow)

Type of lubrication: Mobil 424

Trans-axle case oil capacity: 20 oz.

Quantity: Fill to center line of output shaft.

(Approximately 4 1/2" from the top of the fill opening to the top of oil level.)

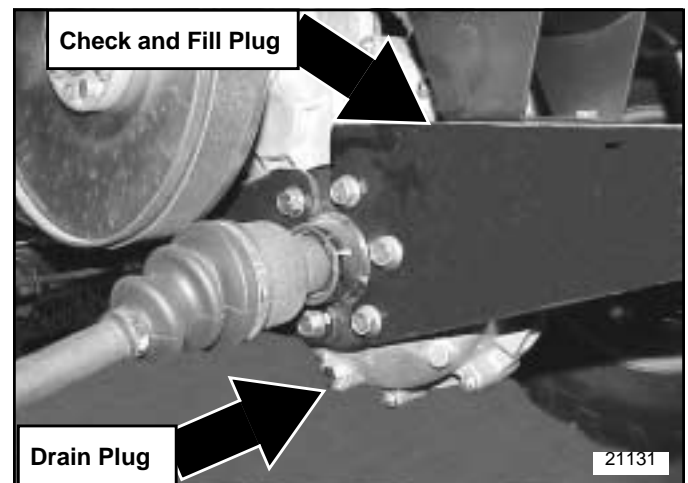

Rear Trans-axle
Figure 7-4

Section 7: Lubrication

Center Transfer Case

(4-Wheel Units Only)

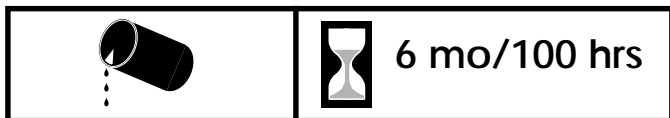

Refer to Figure 7-5:

See also "Section 10: Specifications and Capacities" on page 49.

Fill cap location: Top center (See arrow)

Drain plug location: Bottom Hex socket screw

Type of lubrication: 80/90 Gear Lube

Center transfer case oil capacity: 6 oz.

Quantity: Fill to center line of output shaft.
(Approximately 2" from the top of the fill opening to the top of oil level.)

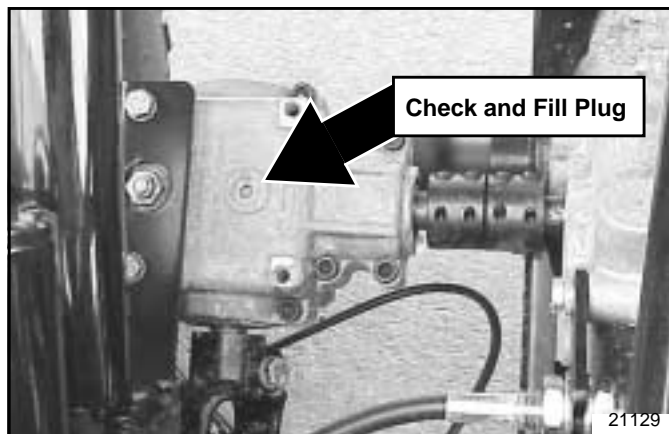

Center Transfer Case
Figure 7-5

Check and Fill Plug

Oil should be 1/4" below to level with plug opening.

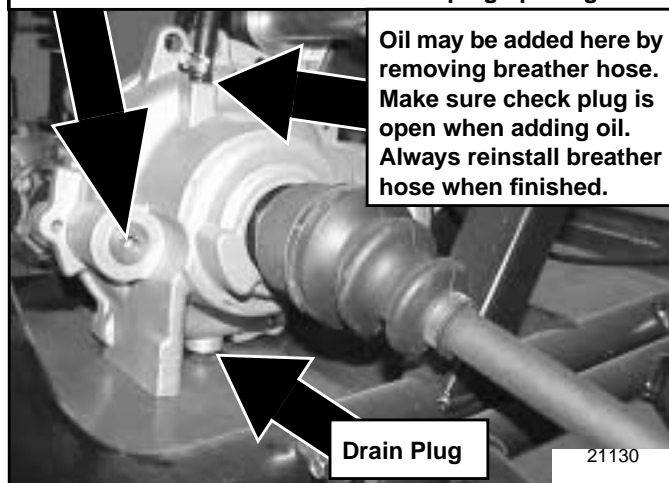

Front Differential Case
Figure 7-6

Front Differential Case

(4-Wheel Units Only)

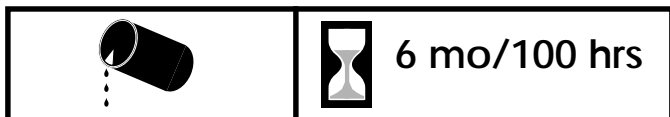

Refer to Figure 7-6 & Figure 7-7:

See also "Section 10: Specifications and Capacities" on page 49.

IMPORTANT: Differential may not function properly and/or become damaged if wrong oil is installed.

Fill plug location: Left front side (See large arrow)

Drain plug location: Bottom center (see large arrow)

Type of lubrication: Mobil 424

Front differential Case oil capacity: **5 oz.**

(Approximately 1/4" from bottom of fill opening to top of fill opening.)

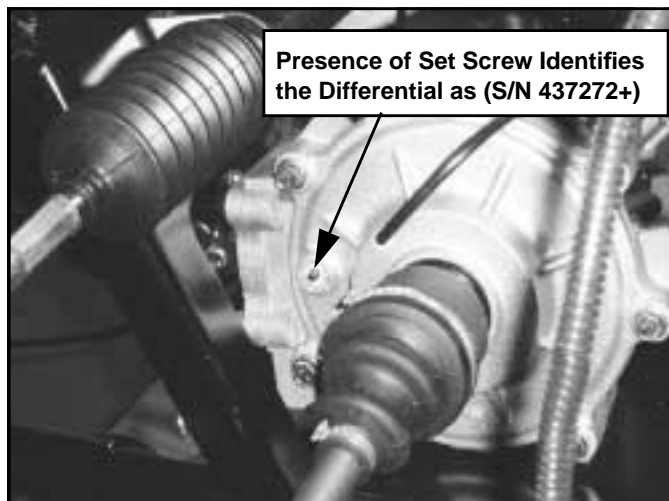

Front Differential Case (S/N 437242+)
Figure 7-7

Section 7: Lubrication

Brake Fluid

Brake Fluid Maintenance Schedule

- Check fluid reservoir monthly.
- Fill reservoir immediately if low or if brakes begin to fade.

Brake Fluid Visual Check and Fill

Refer to Figure 7-8:

The master cylinder fluid reservoir is attached to the body frame on the driver's side of the vehicle under the front hood. Visually inspect the fill line located high on the reservoir by turning the steering wheel to the left to expose oil reservoir and looking under the driver's side wheel well. Remove cap and add DOT 3 fluid to the reservoir through the wheel well with a squeeze bottle and tube inserted into the reservoir.

Brake Fluid Type and Fill Location

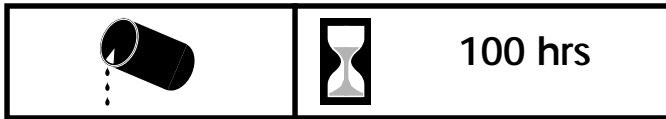

See also "Section 10: Specifications and Capacities" on page 49

Fill cap location: Located on the driver's side of vehicle under front hood. (see Figure 7-8)

Type of fluid: DOT 3

Quantity: Fill to line on reservoir.

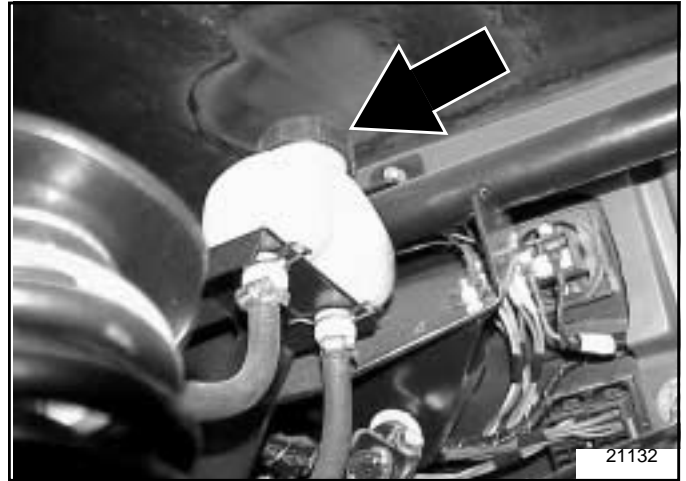

Master Cylinder Reservoir
Figure 7-8



Section 8: Seasonal Storage

Engine Preparation for Storage



CAUTION

Fuel vapors are flammable and explosive. Do not store a vehicle with fuel in the tank in a building where fumes can reach a spark or an open flames (i.e. plug-in sockets, light switches, light fixtures, power tools, welders, pilot lights and stoves).

Engine exhaust fumes contain carbon monoxide. Do not run a vehicle inside a building any longer than what it takes to move it. Serious illness or death may result from prolonged exposure to carbon monoxide.

1. Take vehicle out of gear, set park brake and run engine outside for 15 minutes minimum. Then shut vehicle off and remove ignition key.
2. Drain oil from crankcase while engine is still warm.
3. Change oil filter. Refer to page 42.
4. Refill with fresh oil of proper viscosity. Refer to page 41.
5. Replace fuel filter if needed. Refer to page 34.
6. Prepare fuel system as follows:
 - Short term storage (90 days or less):
 - a. Siphon most of the fuel from the tank.
 - b. Add fuel stabilizer to the tank per manufacturers recommendation.

IMPORTANT: Do not use fuel additives containing methanol or ethanol.

- c. Fill fuel tank with fresh fuel to prevent water condensation build-up.
- d. Run engine to circulate fresh fuel throughout engine components.

Long term storage (over 90 days):

- a. Siphon most of the fuel from the tank.
- b. Run engine until it stops from lack of fuel.

NOTE: Gasoline evaporates if left in carburetor for long periods, forming gum and varnish deposits in the carburetor. These deposits will cause engine flooding and loss of power.

- c. Remove spark plugs and pour a tablespoon of engine oil into each spark plug hole. Install plugs, but do not reconnect plug leads.
 - d. Crank engine with starter at least a dozen revolutions to distribute oil over cylinder walls and valve mechanism.
7. Clean exterior surface of engine. Spread a light film of oil over any exposed metal surfaces of engine that are subject to corrosion.

8. Clean dirt and chaff from cylinders and fins, blower housing and muffler.
9. Check oil fill cap and fuel tank cap to make certain they are securely in place.

Vehicle Storage Preparation

1. Perform separate engine preparations listed previously before storing the vehicle.
2. Store vehicle in a clean, dry place.
3. Always set park brake, leave vehicle in gear and remove ignition key when parking the vehicle.
4. Before working around or on the vehicle, allow it to cool.
5. Remove all dirt and trash.
6. Clean and touch up all scrapes per "Section 9: Body Repair" on page 46.
7. Check thoroughly for any worn or damaged parts that need replacing including decals and order them from your Land Pride Dealer.
8. Thoroughly lubricate the vehicle according to lubrication instructions.
9. Block vehicle up to take weight off the tires.

NOTE: Do not deflate tires.

10. Clean battery and battery post. Check battery electrolyte level. Protect battery from freezing temperatures. Occasionally recharging battery during storage will extend battery life.
11. Secure a waterproof cover over the vehicle if stored outside.

Vehicle Removal From Storage Preparation

1. Remove waterproof cover if used.
2. Clean vehicle, removing trash and dirt accumulation.
3. Install all safety shields and review safety precautions listed in this manual.
4. Reconnect spark plug leads to spark plugs.
5. Check engine oil level.
6. Check trans-axle oil level. If 4-wheel drive, check 4-wheel transfer case and front differential oil level.
7. Charge battery.
8. Fill fuel tank with fresh gasoline.
9. Run vehicle at half speed for 5 minutes, checking operation of steering control levers.
10. Stop engine and check for oil leaks, loose fittings and overall condition of the vehicle.
11. Tighten any bolts that may have loosened.
12. Check and inflate tires to correct air pressure.

Section 9: Body Repair

Introduction

Land Pride Treker bodies are constructed of ABS with WeatherPro G[™] Color Cap. Scuffs, light scratches and deep gouges are in most situations repairable. Land Pride recommends that you use a professional body shop to restore your vehicle's body. For your consideration, we have provided below a list of recommended tools, materials and steps suggested for repairing the WeatherPro G[™] Color Cap body.

NOTE: Land Pride does not supply the required tools, paint and materials needed to repair the vehicle body. All tools, paint and materials should be purchased locally.

Light Scuff

Required Tools and Materials (See note above)

- 1,000 rpm buffing tool, DeWalt #849
- Meguiars buffing compound #8432
- Meguiars polish #8232 (optional)
- Meguiars maroon cutting pad #W-7006
- Meguiars tan polishing pad #W-9006 (optional)
- Meguiars backing plate #W-64
- Soft clean cotton cloths

Steps to Repair

13. Clean entire area of repair. Clean water is fine for this purpose. **Do not use solvent** as this will damage the body surface.
14. Install cutting pad #7006 on buffer (maroon pad).
15. Spread compound on area of repair, use about as much as it takes to cover a half-dollar coin, this is a good starting point.
16. Set buffing tool to lowest possible speed on dial, do not buff at a high speed as this will heat and warp material.
17. Buff damage area until surface scuff disappears. A second and third application of compound may be required. Keep buffer moving over surface, this will help keep the surface cool. Clean compound residue off surface after each buffing operation. Do not continue to buff compound until dry, or buff the surface when dry. When all scuff marks have been buffed out the surface may still appear a little dull, if so, proceed to #6.
18. Install polish on surface as in step #3.
19. Spread #8232 polish on surface as in step #3.
20. Polish to a high luster or as required to match surrounding material.
21. Wipe clean with **soft clean** cloth; any dirt on cloth will mar surface.

Scratch

Required Tools and Materials (See note to left)

- 1,000 rpm buffing tool, DeWalt #849
- Meguiars buffing compound #8432
- Meguiars polish #8232 (optional)
- Meguiars maroon cutting pad #W-7006
- Meguiars tan polishing pad #W-9006 (optional)
- Meguiars backing plate #W-64
- Soft clean cotton cloths
- 3M interface sanding pad #05774
- Air Vantage finishing sander with 6-inch hook and loop pad
- 3M-P800 sanding film #00970

Steps to Repair

1. Clean entire area of repair. Clean water is fine for this purpose. **Do not use solvent** as this will damage the body surface.
2. Install interface-sanding pad onto finishing sander. Attach sanding film to Interface pad. (Take care in centering sanding pad and film on sander.)
3. Sand surface using about 45 P.S.I. air pressure at tool inlet, do not sand at a high pad speed, because speed causes the sanding film to load with dust and heats the body surface. Proper sander pad speed is based on cut and travel speed of pad, and downward pressure applied by the operator. To clean sanding pad surface, run sander face at 90 degrees on the edge of a piece of cardboard. This cleaning operation will help keep the sanding film clean and run cooler. Continue to sand surface until original scratch damage is no longer visible. Wipe the surface with a cloth then inspect to be sure the entire original scratch has been fully sanded away (very important).
4. Install cutting pad #7006 on buffer (maroon pad).
5. Spread compound #8432 on area of repair, use about as much as it takes to cover a half-dollar coin, this is a good starting point.
6. Set buffing tool to lowest possible speed on dial, do not buff at a high speed as this will heat and warp material.
7. Buff sanded area until surface scuff disappears.
8. A second and third application of compound may be required. Keep buffer moving over surface, this will help keep the surface cool. Clean compound residue off surface after each buffing operation. Do not continue to buff compound until dry.
9. Buff the surface of the body when dry. When all scuff marks have been buffed out the surface may still appear a little dull, if so, proceed to #10.
10. Install polishing pad #W-9006 on buffer (tan pad).

Section 9: Body Repair

11. Spread #8232 polish on surface as in step #3.
12. Polish to a high luster or as required to match surrounding material.
13. Wipe clean with ***soft clean*** cloth; any dirt on cloth will mar surface.

Deep Gouge

Required Tools and Materials (See note on page 46)

- 1,000 rpm buffing tool, DeWalt #849
- Evercoat Body Filler Easy Sand
- Sanding Pad
- DuPont Full-Thane Primer 421-15
- DuPont 3939 Cleaner
- DuPont Sealer 42470
- DuPont Chroma Base/ Clear Coat Paint System
- HVLP Paint Sprayer

Steps to Repair

1. Sand damaged area with 500-grit paper to remove raised edges and to create abraded surface for proper adhesion.
2. Fill damaged area with Evercoat body filler (2-part system) and allow to completely dry.
3. Sand down high spots with 500-grit paper. If recesses are still visible due to filler shrinkage, apply second skim coat and again allow to dry completely, then sand surface flush with surrounding area.
4. Apply DuPont Full-Thane Primer 421-15 over body filler.
5. Once primer is completely dry, clean surface with DuPont 3939 Cleaner and again allow surface to dry completely.
6. Apply 42470 Sealer over body filler.
7. Apply color-matched paint system with HVLP paint sprayer according to supplier's recommendations to meet WeatherPro G's surface finish, i.e. DuPont's two part Base/ Clear coat system.

Table of Contents

Section 10: Specifications and Capacities



4200/4400 ST & NT Series

Engine	Honda GX620K1	Body Cowling	ABS Composite
Engine Type	4 stroke - air cooled	Floorboards	Steel Safety Plate
Horse Power	20	Frame Construction	Tube & Channel
Displacement	614 cc	Frame. Suspension	Independent A-arms MacPherson Struts
Cylinders	2	Rear Suspension	Independent trailing arms Coil/over Adjustable Shocks
Valving	OHV	Fenders	Front: Integral Rear: Bed Mounted
Lubrication	Pressurized	Front Bumper	Optional
Engine Oil Type	SAE 10W30	Front Brush Guard	Optional
Engine Oil Capacity	1.5 US qts. with filter change 1.1 US qts. without filter change	Seating	Buckets - 2
Engine Idle rpm	1250 rpm min. to 1350 rpm max.	4-Post Acc.Bar	Standard
Max. Engine Static rpm	3800 rpm to 4000 rpm max.	Rear Hitch	2" receiver
Max. Torque	32.5 lb@2500	Approximate Curb Weight	4200NT: 860 lbs. 4200ST: 925 lbs. 4400NT: 985 lbs. 4400ST: 1050 lbs.
Cooling	Air	Base Unit Total Payload*	NT: 950 lbs. ST: 1300 lbs.
ACG Output	12V/20A	Gross Vehicle Weight	4200NT: 1810 lbs. 4200ST: 2225 lbs. 4400NT: 1935 lbs. 4400ST: 2350 lbs.
Ignition	Keyed	Rear Cargo Box Capacity	NT: 550 lbs. ST: 950 lbs.
Battery	300 cca	Maximum Tongue Weight	100 lbs.
Spark Arrestor	Standard	Max. Towing Capacity	1200 lbs.
Headlights	Standard	Wheel Base	NT: 70" ST: 76"
Tail Lights	Standard	Tread Center Front	NT: 41.5" ST: 46.5"
Fuel Capacity	NT: 4 gallon ST: 8 gallon	Tread Center Rear	NT: 42" ST: 47.5"
Fuel Type	Unleaded fuel with 87 min. octane (Methanol fuel not allowed)	Width at front tires	NT: 50" ST: 54"
Rear Trans-axle Case Oil Capacity and Type	20 oz. US Mobil 424	Width at rear tires	NT: 50.5" ST: 58"
Center Transfer Case Oil Capacity and Type	6 oz. US 80/90 Gear Lube	Height	With AT Tires: 71" With Turf Tires: 70"
Front Differential Case Oil Capacity and Type	5 oz. US Mobil 424	Length	NT: 104" ST: 116"
Trans-axle	Shielded CVT (Constantly Variable Transmission)	Floorboard Height	AT Tires: 14" Turf Tires: 13"
Gear Selection	Forward/Neutral/Reverse with Neutral Start	Min. Ground Clearance	9 1/2"
Max. Speed	25 mph	Tire Size (Front)	25x8-12 All-Terrain Tread 23x8.5-12 Turf
Brakes	Front: Hydraulic Disc Rear: Hydraulic Drum	Tire Size (Rear)	25x11-12 All-Terrain Tread 23x10.5-12 Turf
Brake oil	DOT 3	Tire Pressure (Front)	7 psi
Steering	Rack & Pinion	Tire Pressure (Rear)	7 psi**
Steering Wheel Dia.	15"	Optional Front Cargo Rack Capacity	160 lbs.

* Base unit does not include optional cargo racks.

** Tire pressure may be increased to accommodate additional cargo load. Max.tire pressure is noted on tire side wall.

Table of Contents

Section 10: Specifications and Capacities

4210/4410 ST Series

Engine	Honda GX620K1	Floorboards	Steel Safety Plate
Engine Type	4 stroke - air cooled	Frame Construction	Tube & Channel
Horse Power	20	Frame. Suspension	Independent A-arms MacPherson Struts
Displacement	614 cc	Rear Suspension	Independent trailing arms Coil/over Adjustable Shocks
Cylinders	2	Fenders	Front: Integral Rear: Bed Mounted
Valving	OHV	Front Bumper	Standard
Lubrication	Pressurized	Front Brush Guard	Optional
Engine Oil Type	SAE 10W30	Seating	2- Bucket seats or 1- Bench Seat
Engine Oil Capacity	1.5 US qts. with filter change 1.1 US qts. without filter change	Seat Belts	2- Standard with an optional 3rd Belt
Engine Idle rpm	1250 rpm min. to 1350 rpm max.	4-Post Acc.Bar	Standard
Max. Engine Static rpm	3800 rpm to 4000 rpm max.	Rear Hitch	2" receiver
Max. Torque	32.5 lb@2500	Front Hitch	2" receiver available with front Brush Guard option
Cooling	Air	Approximate Curb Weight	4210ST: 925 lbs. 4410ST: 1234 lbs.
ACG Output	12V/20A	Base Unit Total Payload*	1300 lbs.
Ignition	Keyed	Gross Vehicle Weight	4210ST: 2225 lbs. 4410ST: 2534 lbs.
Battery	300 cca	Rear Cargo Box Capacity	950 lbs.
Spark Arrestor	Standard	Maximum Tongue Weight	100 lbs.
Headlights	Standard	Max. Towing Capacity	1200 lbs.
Tail Lights	Standard	Wheel Base	76"
Fuel Capacity	8 gallon	Tread Center Front	46.5"
Fuel Type	Unleaded fuel with 87 min. octane (Methanol fuel not allowed)	Tread Center Rear	47.5"
Rear Trans-axle Case Oil Capacity and Type	20 oz. US Mobil 424	Width at front tires	54"
Center Transfer Case Oil Capacity and Type	6 oz. US 80/90 Gear Lube	Width at rear tires	58"
Front Differential Case Oil Capacity and Type	5 oz. US Mobil 424	Height	With AT Tires: 71" With Turf Tires: 70"
Trans-axle	Enclosed CVT (Constantly Variable Transmission)	Length	120"
Gear Selection	Park/Neutral/Forward/Reverse with Park/Neutral Start & Integral Park Brake	Floorboard Height	AT Tires: 14" Turf Tires: 13"
Max. Speed	25 mph	Min. Ground Clearance	9 1/2"
Brakes	Front: Hydraulic Disc Rear: Hydraulic Drum	Tire Size (Front)	25x8-12 All-Terrain Tread 23x8.5-12 Turf
Brake oil	DOT 3	Tire Size (Rear)	25x11-12 All-Terrain Tread 23x10.5-12 Turf
Steering	Rack & Pinion	Tire Pressure (Front)	7 psi
Steering Wheel Dia.	15"	Tire Pressure (Rear)	7 psi**
Body Cowling	ABS Composite	Optional Front Cargo Rack Capacity	160 lbs.

* Base unit does not include optional cargo racks.

** Tire pressure may be increased to accommodate additional cargo load. Max.tire pressure is noted on tire side wall.



Section 11: Features and Benefits

4200/4400 NT Series

Features	Benefits
20hp Honda OHV V-Twin Engine	For Proven Power & Dependability.
4-Wheeled Independent Suspension	For Soft Ride & Excellent Stability.
Rack & Pinion Automotive Type Steering	For Easy Handling & Quick Response.
Four Post Accessory Bar	Offers Accessory Mounting Capabilities & Added Protection from Limbs & Branches.
9 1/2" Minimum Ground Clearance	For Traversing Rough Terrain.
950 lb. Total Payload	For Great Cargo and Gear Hauling Capabilities.
4-Wheeled Automotive Style Braking	For Maximum Stopping Power & Control.
Constantly Variable Transmission	For Rapid Response & Easy Shifting.
Large Open Operators Platform	For Maximum Operator & Passenger Comfort.
4 Gallon Fuel Tank	For Extended Operating Range.
50.5" Wheel Stance	For Excellent Narrow Trail Capability & Loading Into Full Or Midsize Pickups.
Dumping Cargo Bed	For Maximum Productivity.
High Back Bucket Seats	For Added Passenger & Operator Comfort.
Wide Range Of Accessories	To Meet Individual Customer Needs.
Warranty	One year against manufacturing defects. Two years manufactured engine warranty.

4200/4400 ST Series

Features	Benefits
20hp Honda OHV V-Twin Engine	For Proven Power & Dependability.
4-Wheeled Independent Suspension	For Soft Ride & Excellent Stability.
Rack & Pinion Automotive Type Steering	For Easy Handling & Quick Response.
Four Post Accessory Bar	Offers Accessory Mounting Capabilities & Added Protection from Limbs & Branches.
9 1/2" Minimum Ground Clearance	For Traversing Rough Terrain.
1,300 lb. Total Payload	For Maximum Cargo and Gear Hauling Capabilities.
4-Wheeled Automotive Style Braking	For Maximum Stopping Power & Control.
Constantly Variable Transmission	For Rapid Response & Easy Shifting.
Large Open Operators Platform	For Maximum Operator & Passenger Comfort.
8 Gallon Fuel Tank	For Extended Operating Range.
56" Wheel Stance	For Maximum Stability.
Dumping Cargo Bed	For Maximum Productivity.
High Back Bucket Seats	For Added Passenger & Operator Comfort.
Wide Range Of Accessories	To Meet Individual Customer Needs.
Warranty	One year against manufacturing defects. Two years manufactured engine warranty.

Table of Contents

Section 11: Features and Benefits

4210/4410 ST Series

Features	Benefits
20hp Honda OHV V-Twin Engine	For Proven Power & Dependability.
4-Wheeled Independent Suspension	For Soft Ride & Excellent Stability.
Rack & Pinion Automotive Type Steering	For Easy Handling & Quick Response.
Four Post Accessory Bar	Offers Accessory Mounting Capabilities & Added Protection from Limbs & Branches.
9 1/2" Minimum Ground Clearance	For Traversing Rough Terrain.
1,300 lb. Total Payload	For Maximum Cargo and Gear Hauling Capabilities.
4-Wheeled Automotive Style Braking	For Maximum Stopping Power & Control.
Constantly Variable Transmission	For Rapid Response & Easy Shifting.
Large Open Operators Platform	For Maximum Operator & Passenger Comfort.
8 Gallon Fuel Tank	For Extended Operating Range.
56" Wheel Stance	For Maximum Stability.
Dumping Cargo Bed	For Maximum Productivity.
High Back Bucket Seats	For Added Passenger & Operator Comfort.
Full Bench Seat	More Spacious Seating.
Wide Range Of Accessories	To Meet Individual Customer Needs.
Enclosed CVT	For enhanced stream crossing capability.
Auto-Lock Differential	For maximum traction capability.
Overrunning Clutch	For environmental friendly traction and easy handling.
Seat Belts	For extra measure of safety.
Heavy Duty Brush Guard	For added body protection.
Front Receiver	For added versatility.
High Mounted Air Intake	For enhanced stream crossing capability.
Dash Mounted Cup Holders	For added convenience.
Locking Deep Well Glove Box	For added security and convenience.
Dash Mounted Shifter with Integral Park Brake	For added convenience.
Cargo Box with Integral Lift/latch Handles	For added convenience.
Removable Cargo Box Sides	For added versatility.
Warranty	One year against manufacturing defects. Two years manufactured engine warranty.



Symptoms	Probable Causes	Suggested Remedies
Battery is dead	Key switch is not in the off position.	Switch key to off position. Disconnect and recharge battery.
	Battery is worn out or defective.	Replace battery.
	Starter solenoid is shorted.	Replace starter solenoid.
Battery will not charge up	Battery connections are loose or corroded.	Clean and tighten battery connections.
	Battery fluid level is low.	Add distilled water to battery cell.
	Battery cell is dead.	Turn key switch on and pull rope start to start engine. Replace battery as soon as possible.
	Battery is worn out or defective.	
Brakes are sticking (won't release)	Master cylinder linkage is out of adjustment.	Adjust master cylinder linkage.
	Master cylinder return spring is broken.	Replace master cylinder return spring.
	Ground debris in brake linkage.	Clean debris from brake linkage.
Brakes don't function	Master cylinder oil level is low.	Add brake fluid to the master cylinder.
	Brake line is broken.	Replace brake line.
	Brake line has air in it.	Bleed brake line and add brake fluid.
	Master cylinder is defective.	Replace master cylinder.
Electrical System does not work	Electrical fuse is blown or missing.	Replace electrical fuse.
	Battery connections are loose or corroded.	Clean and tighten battery connections.
	Battery is worn out or defective.	Replace battery.
	Ignition switch is defective.	Replace ignition switch.
Engine backfires	Spark plug is fouled.	Replace or clean spark plug.
	Fuel solenoid is stuck.	See Honda Engine Manual.
	Air intake restrictor upstream of air cleaner is missing or incorrectly installed.	Replace or correctly install air intake restrictor.
	Throttle cable is defective or out of adjustment.	Clean and oil throttle cable. Replace worn or damaged cable.
Engine knocks	Engine speed is set too low.	Adjust engine idle screw.
	Fuel is stale or dirty.	Replace fuel with new fuel.

Table of Contents

Section 12: Troubleshooting

Symptoms	Probable Causes	Suggested Remedies
Engine loses power	Throttle cable is sticking.	Clean and oil throttle cable. Replace worn or damaged cable.
	Choke cable is sticking.	Clean and oil choke cable. Replace worn or damaged cable.
	Spark plugs are defective.	Replace spark plugs.
	Spark plugs are fouled.	Clean spark plugs or replace.
	Fuel supply is restricted.	Check for dirt in fuel tank.
	Fuel line is plugged, pinched, or kinked.	Clean or replace fuel line.
	Fuel leaks into the crankcase.	Clean or replace fouled spark plugs. Verify choke position is not stuck on.
	Engine oil level is high.	Drain excess oil, check for gas in the oil. Change if gas is present.
	Fuel octane is incorrect.	Use unleaded 87 minimum octane.
	Throttle cable is faulty or out of adjustment.	Adjust or replace throttle cable.
	Air cleaning element is plugged.	Replace or clean air cleaner with air.
	Engine is overheating.	See Symptoms for engine overheating.
Engine overheats	Engine cooling fins are plugged.	Allow engine to cool. Clean cooling fins with high pressure air.
	Engine oil level is low.	Add specified engine oil.
	Carburetor air intake tube is plugged.	Clean air intake tube.
	Air cleaning element is plugged or missing.	Replace or clean air cleaner with air.
Engine runs unevenly	Electrical connections are loose.	Reattach electrical connections.
	Engine cooling fins are plugged.	Allow engine to cool. Clean cooling fins with high pressure air.
	Throttle cable is sticking.	Clean and oil throttle cable. Replace worn or damaged cable.
	Choke cable is sticking.	Clean and oil choke cable. Replace worn or damaged cable.
	Fuel is stale or dirty.	Replace fuel with new fuel.
	Fuel line is plugged.	Clean fuel line.
	Fuel type is incorrect.	Use unleaded 87 minimum octane. (Methanol not allowed).
	Fuel leaks into the crankcase.	Clean or replace fouled spark plugs. Verify choke position is not stuck on.
	Spark Plug wiring is defective.	Replace spark plug wiring.
	Spark plug is defective.	Replace spark plugs.
	Spark plug is fouled.	Clean spark plugs or replace.
	Carburetor is not adjusted correctly.	Adjust carburetor.
Air cleaner is plugged.	Replace or clean air cleaner with air.	

Table of Contents

Section 12: Troubleshooting

Symptoms	Probable Causes	Suggested Remedies
Engine starts in gear	Neutral switch is adjusted incorrectly.	Adjust neutral switch to be engaged with shift selector in neutral.
	Shifter link is out of adjustment.	With shift selector in neutral, adjust shifter link at engine to be in neutral position.
Engine stops running	Gas tank is empty.	Refill gas tank.
	Spark Plug wiring is defective.	Replace spark plug wiring.
	Ignition switch is defective.	Replace ignition switch.
	Battery is worn out or defective.	Replace battery.
	Crankshaft is broke.	Replace broken crankshaft.
Gear Shift is malfunctioning	Foot feed throttle spring is loose or broken.	Reattach disconnected foot feed spring. Replace defective spring.
	Throttle cable is sticking.	Clean and oil throttle cable. Replace worn or damaged cable.
	Engine idle return spring is loose or broken.	Reattach disconnected engine idle spring. Replace defective spring.
	Engine idle set too high.	Readjust engine idle. (1250 to 1350 RPM)
	Governor spring is loose or broken.	Reattach disconnected governor spring. Replace defective spring.
	Drive Clutch does not disengaged.	Clean drive clutch by blowing air through it.
	Gear shift jumps out of gear.	With shift selector in neutral, adjust shifter link at engine to be in neutral position.
Park brake doesn't work	(4200/4400 NT & ST Series only) Not depressing the floor brake pedal before setting the park brake.	Depress floor brake pedal with your foot before setting the park brake.
	Park brake cable is not adjusted correctly.	Adjust park brake cable at the rear wheel drums.
	Park brake cable is broken.	Replace park brake cable.
	Park brake cable is jammed with debris.	Clean debris from park brake cable.
	(4200/4400 NT & ST Series only) Push button on top of park brake lever is damaged.	Replace push button assembly.
	(4210ST & 4410ST Series only) Caliper not adjusted correctly.	Adjust screw on park brake caliper.

Table of Contents

Section 12: Troubleshooting

Symptoms	Probable Causes	Suggested Remedies
Starter cranks slowly	Battery power is low.	Recharge battery.
	Battery connections are loose or corroded.	Clean and tighten battery connections.
	Battery is worn out or defective.	Replace battery.
	Harness connections are loose.	Reconnect harness connections.
	Harness pin connections are bent.	Straighten harness pins.
	Harness is defective.	Replace harness.
	Ignition switch is defective.	Replace ignition switch.
	Starter is defective.	Replace starter.
	Engine oil is too heavy.	Replace with SAE 10W30 oil.
Starter does not work	Neutral switch is not engaged.	Adjust neutral switch to be engaged with shift selector in neutral.
	Neutral switch is defective.	Replace neutral switch.
	Battery power is low.	Recharge battery.
	Battery connections are loose or corroded.	Clean and tighten battery connections.
	Battery is worn out or defective.	Replace battery.
	Harness connections are loose.	Reconnect harness connections.
	Harness pin connections are bent.	Straighten harness pins.
	Harness is defective.	Replace harness.
	Ignition switch is defective.	Replace ignition switch.
Starter is defective.	Replace starter switch.	
Steering does not track correctly	Improper tire inflation.	Inflate all tires to correct tire pressure.
	Tie rods not adjusted correctly.	Adjust tie rods to make front tire center line spread 1/8" to 3/16" less than rear tire center line spread.
	Damaged frame steering or suspension parts.	Inspect thoroughly.
Steering play is excessive	Pinion shaft is improperly attached.	Realign pinion shaft.
	Pinion shaft is loose.	Tighten pinion shaft bolts.
	Tie rod ends are loose.	Align and tighten tie rod ends.
Vehicle speed does not reach 25 MPH	Throttle cable housing is set too close to engine preventing proper cable movement.	Reposition cable housing toward seats until all cable slack is removed between cable housing and engine.
	Carburetor is icing up.	Install cold weather kit.
Vehicle loses ground speed without loosing engine speed	Normal condition when climbing grades as the CVT will downshift automatically allowing the engine to run in it's horsepower band.	None required.
	Drive belt is wet and slips.	Rev engine in neutral for one minute.
	Drive belt is worn.	Replace drive belt.

Table of Contents

Section 13: Appendix



Torque Values Chart													
Bolt Size (Inches)	Bolt Head Identification						Bolt Size (Metric)	Bolt Head Identification					
	 Grade 2		 Grade 5		 Grade 8			 Class 5.8		 Class 8.8		 Class 10.9	
in-tpi ¹	N ·	ft-lb	N ·	ft-lb	N ·	ft-lb	mm x	N ·	ft-lb	N ·	ft-lb	N ·	ft-lb
1/4" - 20	7.4	5.6	11	8	16	12	M 5 X 0.8	4	3	6	5	9	7
1/4" - 28	8.5	6	13	10	18	14	M 6 X 1	7	5	11	8	15	11
5/16" - 18	15	11	24	17	33	25	M 8 X 1.25	17	12	26	19	36	27
5/16" - 24	17	13	26	19	37	27	M 8 X 1	18	13	28	21	39	29
3/8" - 16	27	20	42	31	59	44	M10 X 1.5	33	24	52	39	72	53
3/8" - 24	31	22	47	35	67	49	M10 X 0.75	39	29	61	45	85	62
7/16" - 14	43	32	67	49	95	70	M12 X 1.75	58	42	91	67	125	93
7/16" - 20	49	36	75	55	105	78	M12 X 1.5	60	44	95	70	130	97
1/2" - 13	66	49	105	76	145	105	M12 X 1	90	66	105	77	145	105
1/2" - 20	75	55	115	85	165	120	M14 X 2	92	68	145	105	200	150
9/16" - 12	95	70	150	110	210	155	M14 X 1.5	99	73	155	115	1215	160
9/16" - 18	105	79	165	120	235	170	M16 X 2	145	105	225	165	315	230
5/8" - 11	130	97	205	150	285	210	M16 X 1.5	155	115	240	180	335	245
5/8" - 18	150	110	230	170	325	240	M18 X 2.5	195	145	310	230	405	300
3/4" - 10	235	170	360	265	510	375	M18 X 1.5	220	165	350	260	485	355
3/4" - 16	260	190	405	295	570	420	M20 X 2.5	280	205	440	325	610	450
7/8" - 9	225	165	585	430	820	605	M20 X 1.5	310	230	650	480	900	665
7/8" - 14	250	185	640	475	905	670	M24 X 3	480	355	760	560	1050	780
1" - 8	340	250	875	645	1230	910	M24 X 2	525	390	830	610	1150	845
1" - 12	370	275	955	705	1350	995	M30 X 3.5	960	705	1510	1120	2100	1550
1-1/8" - 7	480	355	1080	795	1750	1290	M30 X 2	1060	785	1680	1240	2320	1710
1 1/8" - 12	540	395	1210	890	1960	1440	M36 X 3.5	1730	1270	2650	1950	3660	2700
1 1/4" - 7	680	500	1520	1120	2460	1820	M36 X 2	1880	1380	2960	2190	4100	3220
1 1/4" - 12	750	555	1680	1240	2730	2010	¹ in-tpi = nominal thread diameter in inches-threads per ² N · m = newton-meters ³ ft-lb= foot pounds ⁴ mm x pitch = nominal thread diameter in millimeters x						
1 3/8" - 6	890	655	1990	1470	3230	2380							
1 3/8" - 12	1010	745	2270	1670	3680	2710							
1 1/2" - 6	1180	870	2640	1950	4290	3160							
1 1/2" - 12	1330	980	2970	2190	4820	3560							

Torque tolerance + 0%, -15% of torquing values. Unless otherwise specified use torque values listed above.

Tire Inflation Chart	
Tire	Inflation PSI
Front Tires	7
Rear Tires	7*

* Tire pressure may be increased to accommodate additional cargo load. Maximum tire pressure is noted on tire side wall.

Table of Contents

Section 13: Appendix

Notes

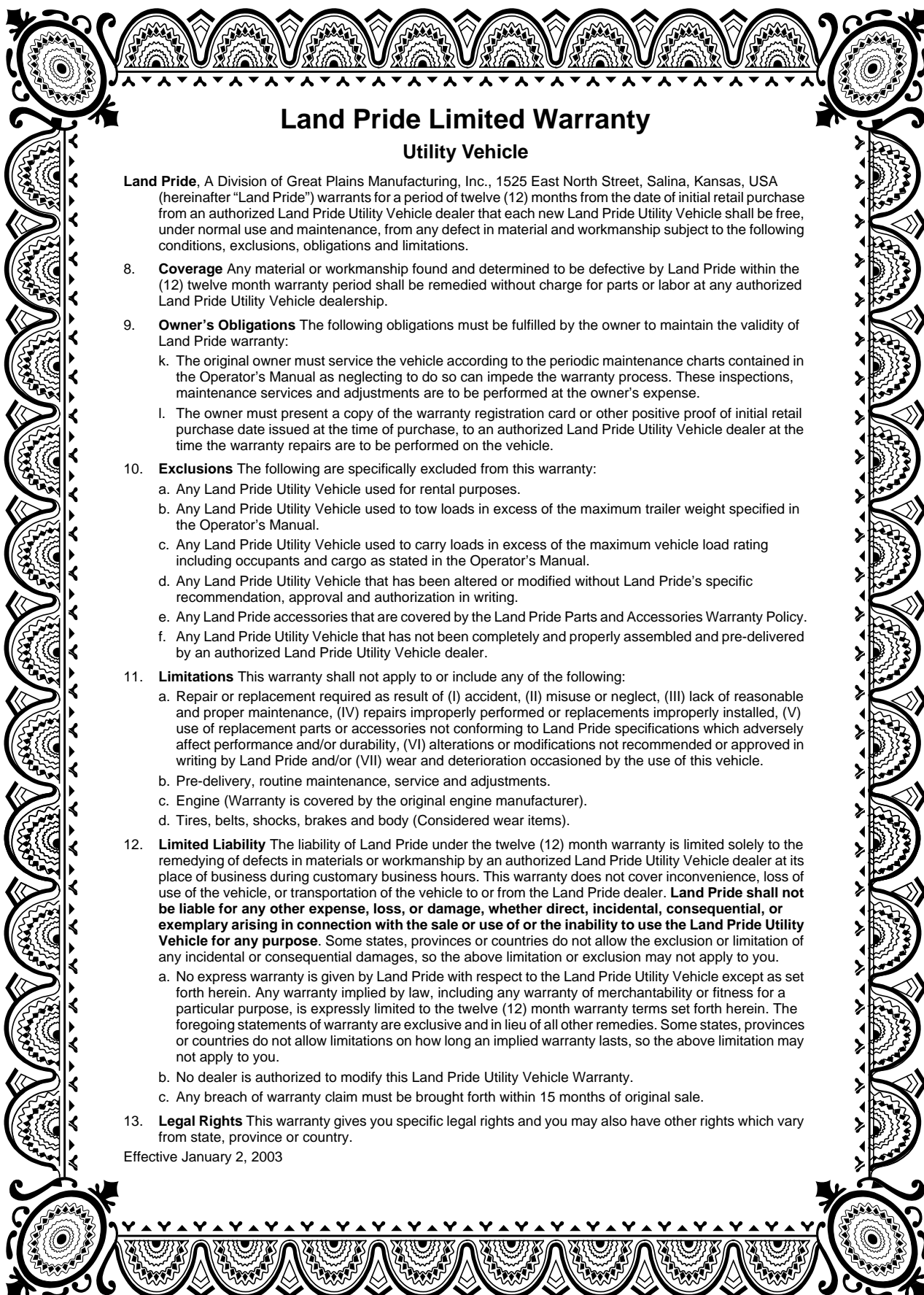

Land Pride Limited Warranty

Utility Vehicle

Land Pride, A Division of Great Plains Manufacturing, Inc., 1525 East North Street, Salina, Kansas, USA (hereinafter "Land Pride") warrants for a period of twelve (12) months from the date of initial retail purchase from an authorized Land Pride Utility Vehicle dealer that each new Land Pride Utility Vehicle shall be free, under normal use and maintenance, from any defect in material and workmanship subject to the following conditions, exclusions, obligations and limitations.

8. **Coverage** Any material or workmanship found and determined to be defective by Land Pride within the (12) twelve month warranty period shall be remedied without charge for parts or labor at any authorized Land Pride Utility Vehicle dealership.
9. **Owner's Obligations** The following obligations must be fulfilled by the owner to maintain the validity of Land Pride warranty:
 - k. The original owner must service the vehicle according to the periodic maintenance charts contained in the Operator's Manual as neglecting to do so can impede the warranty process. These inspections, maintenance services and adjustments are to be performed at the owner's expense.
 - l. The owner must present a copy of the warranty registration card or other positive proof of initial retail purchase date issued at the time of purchase, to an authorized Land Pride Utility Vehicle dealer at the time the warranty repairs are to be performed on the vehicle.
10. **Exclusions** The following are specifically excluded from this warranty:
 - a. Any Land Pride Utility Vehicle used for rental purposes.
 - b. Any Land Pride Utility Vehicle used to tow loads in excess of the maximum trailer weight specified in the Operator's Manual.
 - c. Any Land Pride Utility Vehicle used to carry loads in excess of the maximum vehicle load rating including occupants and cargo as stated in the Operator's Manual.
 - d. Any Land Pride Utility Vehicle that has been altered or modified without Land Pride's specific recommendation, approval and authorization in writing.
 - e. Any Land Pride accessories that are covered by the Land Pride Parts and Accessories Warranty Policy.
 - f. Any Land Pride Utility Vehicle that has not been completely and properly assembled and pre-delivered by an authorized Land Pride Utility Vehicle dealer.
11. **Limitations** This warranty shall not apply to or include any of the following:
 - a. Repair or replacement required as result of (I) accident, (II) misuse or neglect, (III) lack of reasonable and proper maintenance, (IV) repairs improperly performed or replacements improperly installed, (V) use of replacement parts or accessories not conforming to Land Pride specifications which adversely affect performance and/or durability, (VI) alterations or modifications not recommended or approved in writing by Land Pride and/or (VII) wear and deterioration occasioned by the use of this vehicle.
 - b. Pre-delivery, routine maintenance, service and adjustments.
 - c. Engine (Warranty is covered by the original engine manufacturer).
 - d. Tires, belts, shocks, brakes and body (Considered wear items).
12. **Limited Liability** The liability of Land Pride under the twelve (12) month warranty is limited solely to the remedying of defects in materials or workmanship by an authorized Land Pride Utility Vehicle dealer at its place of business during customary business hours. This warranty does not cover inconvenience, loss of use of the vehicle, or transportation of the vehicle to or from the Land Pride dealer. **Land Pride shall not be liable for any other expense, loss, or damage, whether direct, incidental, consequential, or exemplary arising in connection with the sale or use of or the inability to use the Land Pride Utility Vehicle for any purpose.** Some states, provinces or countries do not allow the exclusion or limitation of any incidental or consequential damages, so the above limitation or exclusion may not apply to you.
 - a. No express warranty is given by Land Pride with respect to the Land Pride Utility Vehicle except as set forth herein. Any warranty implied by law, including any warranty of merchantability or fitness for a particular purpose, is expressly limited to the twelve (12) month warranty terms set forth herein. The foregoing statements of warranty are exclusive and in lieu of all other remedies. Some states, provinces or countries do not allow limitations on how long an implied warranty lasts, so the above limitation may not apply to you.
 - b. No dealer is authorized to modify this Land Pride Utility Vehicle Warranty.
 - c. Any breach of warranty claim must be brought forth within 15 months of original sale.
13. **Legal Rights** This warranty gives you specific legal rights and you may also have other rights which vary from state, province or country.

Effective January 2, 2003



Corporate Office: P.O. Box 5060
Salina, Kansas 67402-5060 USA
www.landpride.com
