

**767 AIRPLANE CHARACTERISTICS FOR AIRPORT PLANNING
LIST OF ACTIVE PAGES**

Page	Date	Page	Date	Page	Date
Original 1 to 90	Preliminary April 1979	182	June 2010		
Rev A 1 to 96	Preliminary July 1980	214-219	June 2010		
Rev B 1 to 106	July 1981	3	May 2011		
Rev C 1 to 106	April 1983				
Rev D 1 to 126	December 1983				
Rev E 1 to 204	January 1986				
Rev F 1 to 176	February 1989				
Rev G 1 to 200	December 2003				
Rev H 1 to 268	September 2005 All Pages				

TABLE OF CONTENTS

<u>SECTION</u>	<u>TITLE</u>	<u>PAGE</u>
1.0	SCOPE AND INTRODUCTION	1
1.1	Scope	2
1.2	Introduction	3
1.3	A Brief Description of the 767 Family of Airplanes	4
2.0	AIRPLANE DESCRIPTION	7
2.1	General Characteristics	8
2.2	General Dimensions	15
2.3	Ground Clearances	19
2.4	Interior Arrangements	23
2.5	Cabin Cross-Sections	30
2.6	Lower Cargo Compartments	32
2.7	Door Clearances	37
3.0	AIRPLANE PERFORMANCE	45
3.1	General Information	46
3.2	Payload/Range for Long-Range Cruise	47
3.3	F.A.R. Takeoff Runway Length Requirements	57
3.4	F.A.R. Landing Runway Length Requirements	93
4.0	GROUND MANEUVERING	103
4.1	General Information	104
4.2	Turning Radii	105
4.3	Clearance Radii	108
4.4	Visibility from Cockpit in Static Position	109
4.5	Runway and Taxiway Turn Paths	110
4.6	Runway Holding Bay	115
5.0	TERMINAL SERVICING	117
5.1	Airplane Servicing Arrangement - Typical Turnaround	118
5.2	Terminal Operations - Turnaround Station	123
5.3	Terminal Operations - En Route Station	129
5.4	Ground Servicing Connections	132
5.5	Engine Start Pneumatic Requirements - Sea Level	139
5.6	Ground Pneumatic Power Requirements	144
5.7	Conditioned Air Flow Requirements	147
5.8	Ground Towing Requirements	151

TABLE OF CONTENTS (CONTINUED)

<u>SECTION</u>	<u>TITLE</u>	<u>PAGE</u>
6.0	JET ENGINE WAKE AND NOISE DATA	153
6.1	Jet Engine Exhaust Velocities and Temperatures	154
6.2	Airport and Community Noise	177
7.0	PAVEMENT DATA	181
7.1	General Information	182
7.2	Landing Gear Footprint	185
7.3	Maximum Pavement Loads	188
7.4	Landing Gear Loading on Pavement	191
7.5	Flexible Pavement Requirements - U.S. Army Corps of Engineers Method (S-77-1)	198
7.6	Flexible Pavement Requirements - LCN Method	201
7.7	Rigid Pavement Requirements - Portland Cement Association Design Method	204
7.8	Rigid Pavement Requirements - LCN Conversion	207
7.9	Rigid Pavement Requirements - FAA Method	211
7.10	ACN/PCN Reporting System: Flexible and Rigid Pavements	214
8.0	FUTURE 767 DERIVATIVE AIRPLANES	225
9.0	SCALED 767 DRAWINGS	227

1.0 SCOPE AND INTRODUCTION

1.1 Scope

1.2 Introduction

1.3 A Brief Description of the 767 Family of Airplanes

1.0 SCOPE AND INTRODUCTION

1.1 Scope

This document provides, in a standardized format, airplane characteristics data for general airport planning. Since operational practices vary among airlines, specific data should be coordinated with the using airlines prior to facility design. Boeing Commercial Airplanes should be contacted for any additional information required.

Content of the document reflects the results of a coordinated effort by representatives from the following organizations:

- Aerospace Industries Association
- Airports Council International - North America
- Air Transport Association of America
- International Air Transport Association

The airport planner may also want to consider the information presented in the "Commercial Aircraft Design Characteristics – Trends and Growth Projections," available from the US AIA, 1250 Eye St., Washington DC 20005, for long-range planning needs. This document is updated periodically and represents the coordinated efforts of the following organizations regarding future aircraft growth trends:

- International Coordinating Council of Aerospace Industries Associations
- Airports Council International - North American and World Organizations
- Air Transport Association of America
- International Air Transport Association

1.2 Introduction

This document conforms to NAS 3601. It provides characteristics of the Boeing Model 767 airplane for airport planners and operators, airlines, architectural and engineering consultant organizations, and other interested industry agencies. Airplane changes and available options may alter model characteristics; the data presented herein reflect typical airplanes in each model category.

For additional information contact:

Boeing Commercial Airplanes
P.O. Box 3707
Seattle, Washington 98124-2207
U.S.A.

Attention: Manager, Airport Technology
Mail Code 20-93

1.3 A Brief Description of the 767 Family of Airplanes

The 767 is a twin-engine family of airplanes designed for medium to long range flights. It is powered by advanced high bypass ratio engines. Characteristics unique to the 767 include:

- Advanced aerodynamics
- Stronger and lighter materials
- Two-crew cockpit with digital flight deck systems
- High bypass ratio engines
- Twin-aisle seating
- Extended range operations

767-200, -200ER

The 767-200 can carry up to 216 passengers and baggage over 3,900 nautical miles. The 767-200ER, with the center fuel tanks can also carry 216 passengers and baggage on routes over 5,200 nautical miles. Seating arrangement varies with airline option. Both airplane models have identical outside dimensions.

767-300, -300ER

The 767-300 and -300ER are 21 feet 1 inch longer than the 767-200. The additional length enables the airplane to carry more passengers. The -300ER is also fitted with center fuel tanks for additional range. Except for the longer fuselage, the -300 and the -300ER have dimensions identical to the -200 and -200ER.

The -300 and -300ER can be fitted with an optional mid-cabin door to facilitate loading and unloading of passengers. This arrangement also allows alternate passenger accommodations, up to and including maximum passenger capacity (exit limit).

767-300 Freighter

The 767-300 Freighter is equipped with a main deck cargo door that enables it to load cargo containers and/or pallets on the main deck. The main deck can accommodate either a manual cargo handling system or a powered transfer system (General Market Freighter). The 767-300 Freighter does not have windows and doors, except for the left entry door for crew access.

767-400ER

The 767-400ER is 21 feet longer than the 767-300. The -400ER is equipped with a new-generation wing design and new engines to enable it to achieve long range operations along with the additional payload.

Military Derivatives

The 767-200 airplane is also delivered for military uses. These derivatives are not mentioned in this document because they are equipped with special equipment used for special missions. Some of the external dimensions may be similar to the standard 767-200 airplane such that some of the data in this document can be used.

Extended Range Operations (ETOPS)

The 767 can be equipped with special features to enable it to fly extended range operations in remote areas. This feature is standard on the 767-400ER.

767 Engines

The 767 is offered with a variety of engines. These engines are high bypass ratio engines which are more economical to maintain and are more efficient. See Table 1.3.1 for engine applicability.

Cargo Handling

The lower lobe cargo compartments can accommodate a variety of containers and pallets now used in narrow-body and wide-body airplanes. The optional large forward cargo door (standard on the 767-200ER, 767-300ER, 767-300 Freighter, and 767-400ER) allow loading of 96- by 125-in (2.44 by 3.18 m) pallets and also split-engine carriage kits. In addition, bulk cargo is loaded in the aft cargo compartment and the forward cargo compartment where space permits.

Ground Servicing

The 767 has ground service connections compatible with existing ground service equipment, and no special equipment is necessary.

Document Applicability

This document contains data pertinent to all 767 airplane models (767-200/200ER/300/300ER/300 Freighter/400ER).

ENGINE MODEL (2 EACH)	RATED SLST THRUST PER ENGINE	MAXIMUM DESIGN TAXI WEIGHT – 1,000 LB (1,000 KG)					
		767-200	767-200ER	767-300	767-300ER	767-300 FREIGHTER	767-400ER
JT9D-7R4D	48,000 LB (21,772 KG)	284.0 (128.8) 302.0 (137.0) 312.0 (141.5) 317.0 (143.8)	337.0 (152.9) 347.0 (157.4) 352.2 (159.8)	347.0 (157.4) 352.0 (159.7)	NOT AVAILABLE	NOT AVAILABLE	NOT AVAILABLE
CF6-80A	48,000 LB (21,772 KG)						
JT9D-7R4E	50,000 LB (22,680 KG)						
CF6-80A2	50,000 LB (22,680 KG)						
PW4052	50,200 LB (22,770 KG)	302.0 (137.0) 312.0 (141.5) 317.0 (143.8)	337.0 (152.9) 347.0 (157.4) 352.2 (159.8) 381.0 (172.8) 388.0 (176.0) 396.0 (179.6)	NOT AVAILABLE	NOT AVAILABLE		
CF6-80C2-B2	52,500 LB (23,814 KG)						
CF6-80C2-B4	57,900 LB (26,263 KG)	NOT AVAILABLE	NOT AVAILABLE	NOT AVAILABLE	381.0 (172.8) 388.0 (176.0) 401.0 (181.9) 409.0 (185.5) 413.0 (187.3)	381.0 (172.8) 388.0 (176.0) 401.0 (181.9) 409.0 (185.5) 413.0 (187.3)	
PW4056	56,750 LB (25,741 KG)						
PW4060	60,000 LB (27,216 KG)						
CF6-80C2-B6	61,500 LB (27,896 KG)		NOT AVAILABLE	337.0 (152.9) 347.0 (157.4) 352.2 (159.8) 381.0 (172.8) 388.0 (176.0) 396.0 (179.6)	347.0 (157.4) 352.0 (159.7)	NOT AVAILABLE	
RB211-524G	58,000 LB (26,308 KG)						
RB211-524H	60,600 LB (27,488 KG)		NOT AVAILABLE	NOT AVAILABLE	NOT AVAILABLE	451.0 (204.6)	
CF6-80C2-B8F	60,600 LB (27,488 KG)		NOT AVAILABLE	NOT AVAILABLE	NOT AVAILABLE	451.0 (204.6)	
CF6-80C2-B7F1	60,600 LB (27,488 KG)	NOT AVAILABLE	NOT AVAILABLE	NOT AVAILABLE	451.0 (204.6)		
PW4062	60,600 LB (27,488 KG)	NOT AVAILABLE	NOT AVAILABLE	NOT AVAILABLE	451.0 (204.6)		

NOTES:

- ENGINE/TAXI WEIGHT COMBINATIONS SHOWN ARE AS DELIVERED OR AS OFFERED BY BOEING COMMERCIAL AIRPLANES. CERTAIN ENGINES MAY NOT YET BE CERTIFICATED.
- CONSULT WITH USING AIRLINE FOR ACTUAL OR PLANNED ENGINE/WEIGHT COMBINATION.
- SEE SECTION 2.1 GENERAL CHARACTERISTICS FOR DETAILS ON SELECTED AIRPLANES.

1.3.1 BRIEF DESCRIPTION – ENGINE/WEIGHT COMBINATIONS

MODEL 767

D6-58328

2.0 AIRPLANE DESCRIPTION

2.1 General Characteristics

2.2 General Dimensions

2.3 Ground Clearances

2.4 Interior Arrangements

2.5 Cabin Cross Sections

2.6 Lower Cargo Compartments

2.7 Door Clearances

2.0 AIRPLANE DESCRIPTION

2.1 General Characteristics

Maximum Design Taxi Weight (MTW). Maximum weight for ground maneuver as limited by aircraft strength and airworthiness requirements. (It includes weight of taxi and run-up fuel.)

Maximum Design Takeoff Weight (MTOW). Maximum weight for takeoff as limited by aircraft strength and airworthiness requirements. (This is the maximum weight at start of the takeoff run.)

Maximum Design Landing Weight (MLW). Maximum weight for landing as limited by aircraft strength and airworthiness requirements.

Maximum Design Zero Fuel Weight (MZFW). Maximum weight allowed before usable fuel and other specified usable agents must be loaded in defined sections of the aircraft as limited by strength and airworthiness requirements.

Spec Operating Empty Weight (OEW). Weight of structure, powerplant, furnishing systems, unusable fuel and other unusable propulsion agents, and other items of equipment that are considered an integral part of a particular airplane configuration. Also included are certain standard items, personnel, equipment, and supplies necessary for full operations, excluding usable fuel and payload.

Maximum Structural Payload. Maximum design zero fuel weight minus operational empty weight.

Maximum Seating Capacity. The maximum number of passengers specifically certificated or anticipated for certification.

Maximum Cargo Volume. The maximum space available for cargo.

Usable Fuel. Fuel available for aircraft propulsion.

CHARACTERISTICS	UNITS	MODEL 767-200 (1)			
MAX DESIGN	POUNDS	284,000	302,000	312,000	317,000
TAXI WEIGHT	KILOGRAMS	128,820	136,985	141,521	143,789
MAX DESIGN	POUNDS	282,000	300,000	310,000	315,000
TAKEOFF WEIGHT	KILOGRAMS	127,913	136,078	140,614	142,882
MAX DESIGN	POUNDS	257,000	270,000	270,000	272,000
LANDING WEIGHT	KILOGRAMS	116,573	122,470	122,470	123,377
MAX DESIGN ZERO	POUNDS	242,000	248,000	248,000	250,000
FUEL WEIGHT	KILOGRAMS	109,769	112,491	112,491	113,398
SPEC OPERATING	POUNDS	174,110	177,000	176,550	176,650
EMPTY WEIGHT (2)	KILOGRAMS	78,975	80,286	80,082	80,127
MAX STRUCTURAL	POUNDS	67,890	71,000	71,450	73,350
PAYLOAD	KILOGRAMS	30,794	32,205	32,409	33,271
SEATING	ONE-CLASS	FAA EXIT LIMIT = 255 (3)			
CAPACITY	MIXED CLASS	216 - 18 FIRST + 198 ECONOMY			
MAX CARGO	CUBIC FEET	3,070	3,070	3,070	3,070
- LOWER DECK	CUBIC METERS	86.9	86.9	86.9	86.9
USABLE FUEL	US GALLONS	12,140	16,700	16,700	16,700
	LITERS	45,955	63,217	63,217	63,217
	POUNDS	81,338	111,890	111,890	111,890
	KILOGRAMS	36,894	50,753	50,753	50,753

- NOTES: (1) SPEC WEIGHT FOR TYPICAL ENGINE/WEIGHT CONFIGURATION SHOWN
SEE TABLE 1.3.1 FOR COMBINATIONS AVAILABLE. CONSULT WITH AIRLINE FOR SPECIFIC
WEIGHTS AND CONFIGURATIONS.
- (2) TYPICAL OPERATING EMPTY WEIGHT SHOWN. ACTUAL WEIGHT WILL
DEPEND ON SPECIFIC AIRLINE CONFIGURATION.
- (3) 290 WITH SECOND OVERWING EXIT DOOR.

2.1.1 GENERAL CHARACTERISTICS

MODEL 767-200

CHARACTERISTICS	UNITS	767-200ER (1)					
MAX DESIGN	POUNDS	337,000	347,000	352,200	381,000	388,000	396000
TAXI WEIGHT	KILOGRAMS	152,861	157,397	159,755	172,819	175,994	179,623
MAX DESIGN TAKEOFF WEIGHT	POUNDS	335,000	345,000	351,000	380,000	387,000	395000
	KILOGRAMS	151,954	156,490	159,211	172,365	175,540	179,169
MAX DESIGN	POUNDS	278,000	278,000	278,000	285,000	285,000	300000
LANDING WEIGHT	KILOGRAMS	126,099	126,099	126,099	129,274	129,274	136,078
MAX DESIGN ZERO	POUNDS	253,000	253,000	253,000	260,000	260,000	260000
FUEL WEIGHT	KILOGRAMS	114,759	114,759	114,759	117,934	117,934	117,934
SPEC OPERATING	POUNDS	181,130	181,250	181,350	181,500	181,610	181610
EMPTY WEIGHT (2)	KILOGRAMS	82,159	82,214	82,259	82,327	82,377	82,377
MAX STRUCTURAL	POUNDS	71,870	71,750	71,650	78,500	78,390	78,390
PAYLOAD	KILOGRAMS	32,600	32,545	32,500	35,607	35,557	35,557
SEATING	ONE-CLASS	FAA EXIT LIMIT = 255 (3)					
CAPACITY	MIXED CLASS	216 - 18 FIRST + 198 ECONOMY					
MAX CARGO	CUBIC FEET	3,070	3,070	3,070	3,070	3,070	3,070
- LOWER DECK	CUBIC METERS	86.9	86.9	86.9	86.9	86.9	86.9
USABLE FUEL	US GALLONS	16,700	20,540	20,540	24,140	24,140	24140
	LITERS	63,216	77,752	77,752	91,380	91,380	91,380
	POUNDS	111,890	137,618	137,618	161,738	161,738	161,738
	KILOGRAMS	50,752	62,422	62,422	73,363	73,363	73,363

- NOTES: (1) SPEC WEIGHT FOR TYPICAL ENGINE/WEIGHT CONFIGURATION SHOWN SEE TABLE 1.3.1 FOR COMBINATIONS AVAILABLE. CONSULT WITH AIRLINE FOR SPECIFIC WEIGHTS AND CONFIGURATIONS.
- (2) TYPICAL OPERATING EMPTY WEIGHT SHOWN. ACTUAL WILL DEPEND ON SPECIFIC AIRLINE CONFIGURATION.
- (3) 290 WITH SECOND OVERWING EXIT DOOR.

2.1.2 GENERAL CHARACTERISTICS
MODEL 767-200ER

D6-58328

CHARACTERISTICS	UNITS	767-300 (1)	
MAX DESIGN TAXI WEIGHT	POUNDS	347,000	352,000
	KILOGRAMS	157,397	159,665
MAX DESIGN TAKEOFF WEIGHT	POUNDS	345,000	350,000
	KILOGRAMS	156,490	158,758
MAX DESIGN LANDING WEIGHT	POUNDS	300,000	300,000
	KILOGRAMS	136,078	136,078
MAX DESIGN ZERO FUEL WEIGHT	POUNDS	278,000	278,000
	KILOGRAMS	126,099	126,099
SPEC OPERATING EMPTY WEIGHT (2)	POUNDS	186,380	189,750
	KILOGRAMS	84,541	86,069
MAX STRUCTURAL PAYLOAD	POUNDS	91,620	88,250
	KILOGRAMS	41,558	40,230
SEATING CAPACITY	ONE-CLASS	FAA EXIT LIMIT 290 (3)	
	TWO-CLASS	261 - 24 FIRST + 237 ECONOMY	
MAX CARGO - LOWER DECK	CUBIC FEET	4,030	4,030
	CUBIC METERS	114.1	114.1
USABLE FUEL	US GALLONS	16,700	16,700
	LITERS	63,216	63,216
	POUNDS	111,890	111,890
	KILOGRAMS	50,753	50,753

- NOTES: (1) SPEC WEIGHT FOR TYPICAL ENGINE/WEIGHT CONFIGURATION SHOWN SEE TABLE 1.3.1 FOR COMBINATIONS AVAILABLE. CONSULT WITH AIRLINE FOR SPECIFIC WEIGHTS AND CONFIGURATIONS.
- (2) TYPICAL OPERATING EMPTY WEIGHT SHOWN. ACTUAL WEIGHT WILL DEPEND ON SPECIFIC AIRLINE CONFIGURATION.
- (3) 299 WITH MID-CABIN TYPE A DOOR.

2.1.3 GENERAL CHARACTERISTICS

MODEL 767-300

CHARACTERISTICS	UNITS	767-300ER (1)				
MAX DESIGN	POUNDS	381,000	388,000	401,000	409,000	413,000
TAXI WEIGHT	KILOGRAMS	172,819	175,994	181,891	185,519	187,334
MAX DESIGN	POUNDS	380,000	387,000	400,000	407,000	412,000
TAKEOFF WEIGHT	KILOGRAMS	172,365	175,540	181,437	184,612	186,880
MAX DESIGN	POUNDS	300,000	300,000	320,000	320,000	320,000
LANDING WEIGHT	KILOGRAMS	136,078	136,078	145,150	145,150	145,150
MAX DESIGN ZERO	POUNDS	278,000	278,000	288,000	295,000	295,000
FUEL WEIGHT	KILOGRAMS	126,099	126,099	130,635	133,810	133,810
SPEC OPERATING	POUNDS	193,840	193,940	195,040	198,440	198,440
EMPTY WEIGHT (2)	KILOGRAMS	87,924	87,970	88,469	90,011	90,011
MAX STRUCTURAL	POUNDS	84,160	84,060	92,960	96,560	96,560
PAYLOAD	KILOGRAMS	38,174	38,129	42,166	43,799	43,799
SEATING	ONE-CLASS	FAA EXIT LIMIT = 290 (3)				
CAPACITY	MIXED CLASS	261 - 24 FIRST + 237 ECONOMY				
MAX CARGO	CUBIC FEET	4,030	4,030	4,030	4,030	4,030
- LOWER DECK	CUBIC METERS	114.1	114.1	114.1	114.1	114.1
USABLE FUEL	US GALLONS	24,140	24,140	24,140	24,140	24,140
	LITERS	91,380	91,380	91,380	91,380	91,380
	POUNDS	161,740	161,740	161,740	161,740	161,740
	KILOGRAMS	73,364	73,364	73,364	73,364	73,364

- NOTES: (1) SPEC WEIGHT FOR TYPICAL ENGINE/WEIGHT CONFIGURATION SHOWN
SEE TABLE 1.3.1 FOR COMBINATIONS AVAILABLE. CONSULT WITH AIRLINE FOR SPECIFIC WEIGHTS AND CONFIGURATIONS.
- (2) TYPICAL OPERATING EMPTY WEIGHT SHOWN. ACTUAL WEIGHT WILL DEPEND ON SPECIFIC AIRLINE CONFIGURATION.
- (3) 299 WITH SECOND OVERWING EXIT DOOR.

2.1.4 GENERAL CHARACTERISTICS

MODEL 767-300ER

D6-58328

12 SEPTEMBER 2005

CHARACTERISTICS	UNITS	767-300 FREIGHTER (1)					
		CF6-80C2F		PW 4000		RB211-524	
MAX DESIGN	POUNDS	409,000	413,000	409,000	413,000	409,000	413,000
TAXI WEIGHT	KILOGRAMS	185,519	187,334	185,519	187,334	185,519	187,334
MAX DESIGN	POUNDS	408,000	412,000	408,000	412,000	408,000	412,000
TAKEOFF WEIGHT	KILOGRAMS	185,066	186,880	185,066	186,880	185,066	186,880
MAX DESIGN	POUNDS	326,000	326,000	326,000	326,000	326,000	326,000
LANDING WEIGHT	KILOGRAMS	147,871	147,871	147,871	147,871	147,871	147,871
MAX DESIGN ZERO	POUNDS	309,000	309,000	309,000	309,000	309,000	309,000
FUEL WEIGHT	KILOGRAMS	140,160	140,160	140,160	140,160	140,160	140,160
SPEC OPERATING	POUNDS	188,000	188,000	188,100	188,100	190,000	190,000
EMPTY WEIGHT (2)	KILOGRAMS	85,275	85,275	85,321	85,321	86,183	86,183
MAX STRUCTURAL	POUNDS	121,000	121,000	120,900	120,900	119,000	119,000
PAYLOAD	KILOGRAMS	54,885	54,885	54,839	54,839	53,978	53,978
MAX CARGO	(3) UP TO 24 TYPE A PALLETS AND 2 SPECIAL CONTOURED PALLETS						
- MAIN DECK	(4) UP TO 14 M-1 PALLETS AND 2 SPECIAL CONTOURED PALLETS						
MAX CARGO	CUBIC FEET	4,030	4,030	4,030	4,030	4,030	4,030
- LOWER DECK	CUBIC METERS	114.1	114.1	114.1	114.1	114.1	114.1
USABLE FUEL	US GALLONS	24,140	24,140	24,140	24,140	24,140	24,140
	LITERS	91,380	91,380	91,380	91,380	91,380	91,380
	POUNDS	161,740	161,740	161,740	161,740	161,740	161,740
	KILOGRAMS	73,364	73,364	73,364	73,364	73,364	73,364

- NOTES: (1) SPEC WEIGHT FOR TYPICAL ENGINE/WEIGHT CONFIGURATION SHOWN
SEE TABLE 1.3.1 FOR COMBINATIONS AVAILABLE. CONSULT WITH AIRLINE FOR SPECIFIC WEIGHTS AND CONFIGURATIONS.
- (2) TYPICAL OPERATING EMPTY WEIGHT SHOWN. ACTUAL WEIGHT WILL DEPEND ON SPECIFIC AIRLINE CONFIGURATION.
- (3) 767-300 FREIGHTER - SEE SEC 2.4.6 FOR PALLET DETAILS.
- (4) 767-300 GENERAL MARKET FREIGHTER - SEE SEC 2.4.6 FOR PALLET DETAILS

2.1.5 GENERAL CHARACTERISTICS

MODEL 767-300 FREIGHTER

CHARACTERISTICS	UNITS	767-400ER (1)	
		GE ENGINES	PW ENGINES
MAX DESIGN TAXI WEIGHT	POUNDS	451,000	451,000
	KILOGRAMS	204,570	204,570
MAX DESIGN TAKEOFF WEIGHT	POUNDS	450,000	450,000
	KILOGRAMS	204,116	204,116
MAX DESIGN LANDING WEIGHT	POUNDS	350,000	350,000
	KILOGRAMS	158,757	158,757
MAX DESIGN ZERO FUEL WEIGHT	POUNDS	330,000	330,000
	KILOGRAMS	149,685	149,685
SPEC OPERATING EMPTY WEIGHT (1)	POUNDS	227,400	229,000
	KILOGRAMS	103,147	103,872
MAX STRUCTURAL PAYLOAD	POUNDS	102,600	101,000
	KILOGRAMS	46,538	45,813
SEATING CAPACITY (1)	ONE-CLASS	409 ALL ECONOMY	
	TWO-CLASS	296 - 24 FIRST + 272 ECONOMY	
	THREE-CLASS	243 - 16 FIRST + 36 BUSINESS + 189 ECONOMY	
MAX CARGO - LOWER DECK (2)	CUBIC FEET	4,905	4,905
	CUBIC METERS	138.9	138.9
USABLE FUEL	US GALLONS	24,140	24,140
	LITERS	91,370	91,370
	POUNDS	161,738	161,738
	KILOGRAMS	73,363	73,363

- NOTES: (1) SPEC WEIGHT FOR BASELINE CONFIGURATION OF 296 PASSENGERS.
CONSULT WITH AIRLINE FOR SPECIFIC WEIGHTS AND CONFIGURATIONS.
- (2) FWD CARGO = 20 LD-2 CONTAINERS AT 120 CU FT EACH
AFT CARGO = 18 LD-2 CONTAINERS AT 120 CU FT EACH
BULK CARGO = 345 CU FT

2.1.6 GENERAL CHARACTERISTICS
MODEL 767-400ER

D6-58328

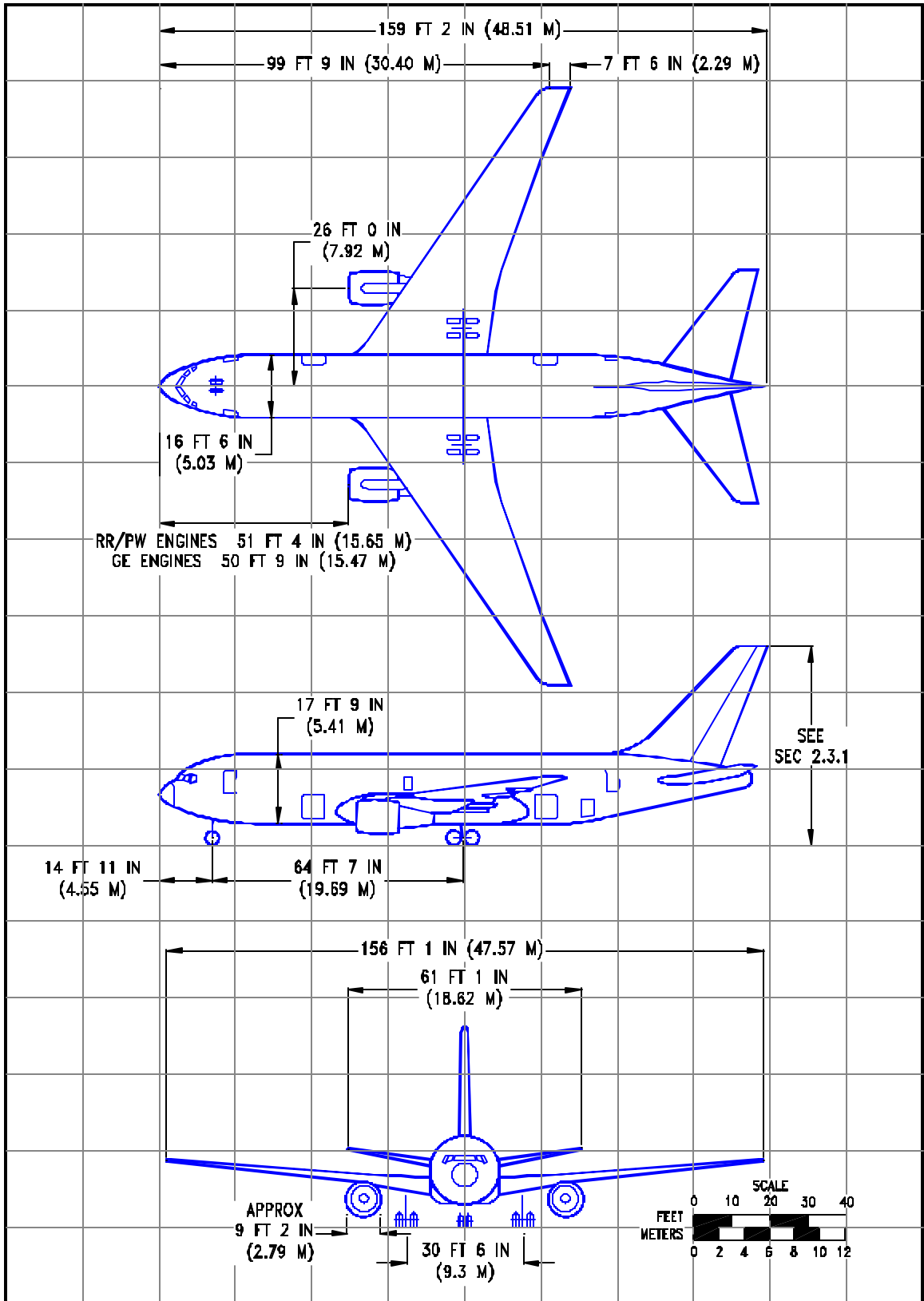

2.2.1 GENERAL DIMENSIONS
 MODEL 767-200, -200ER

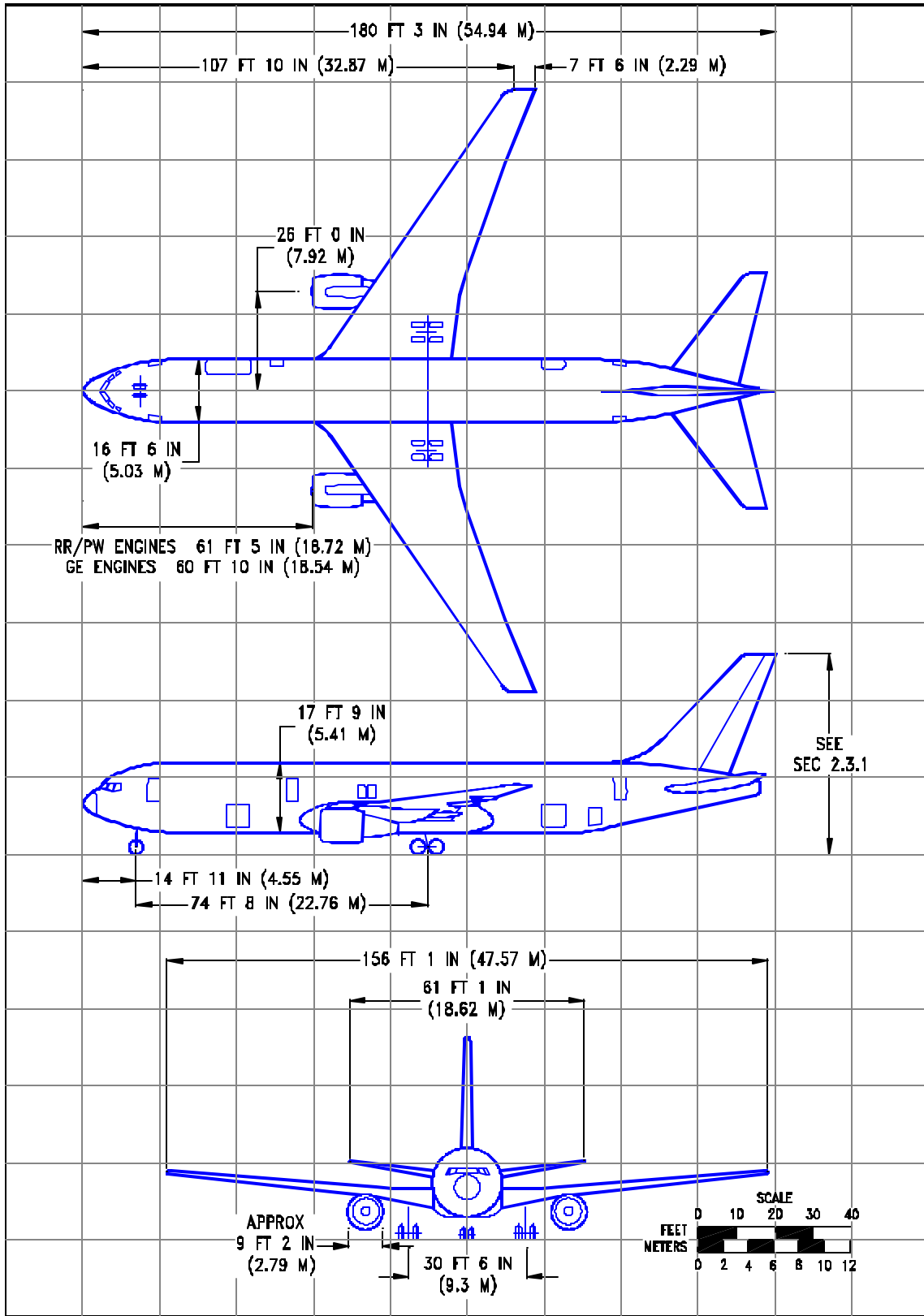

2.2.2 GENERAL DIMENSIONS
 MODEL 767-300, -300ER

D6-58328

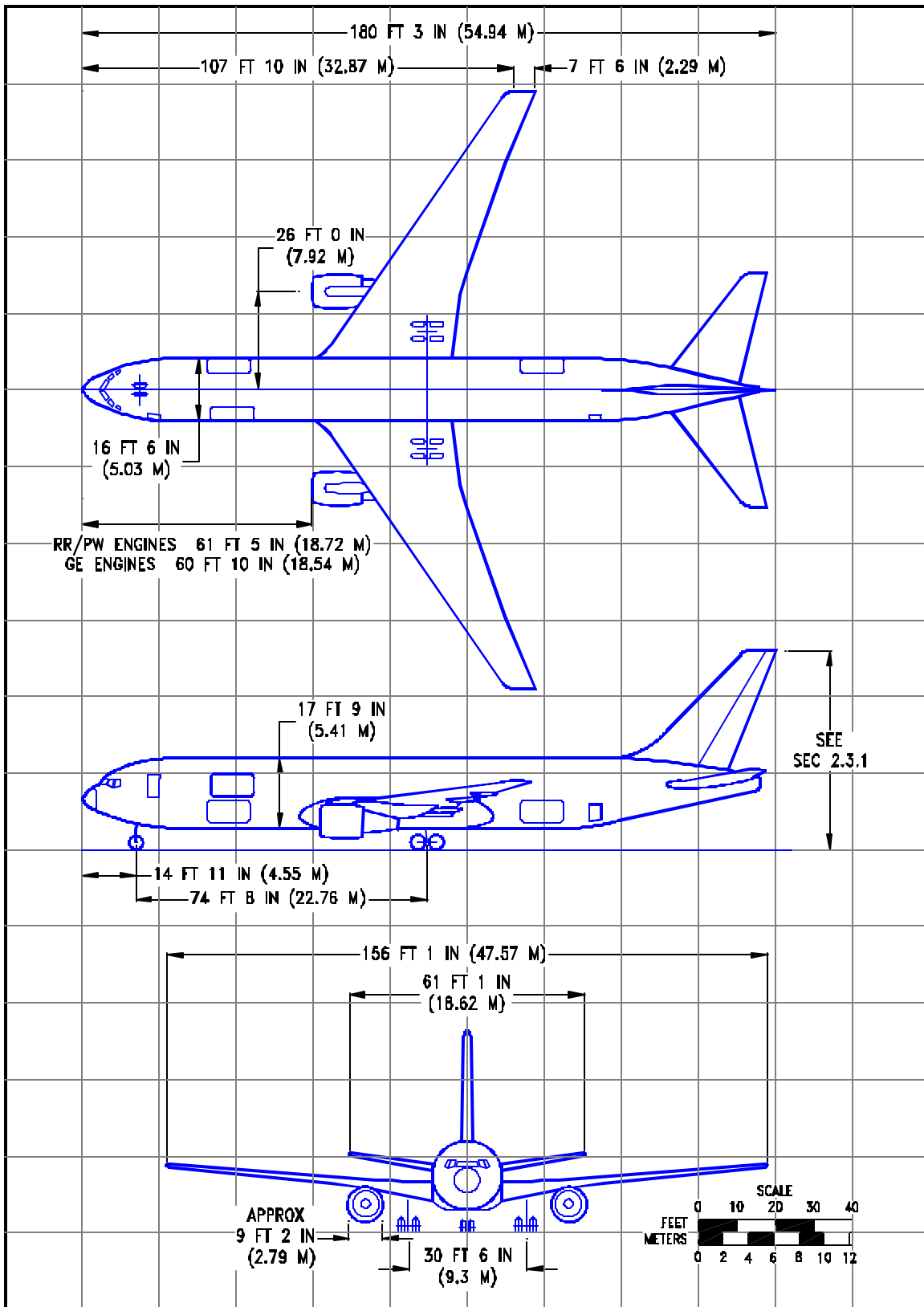

2.2.3 GENERAL DIMENSIONS
MODEL 767-300 FREIGHTER

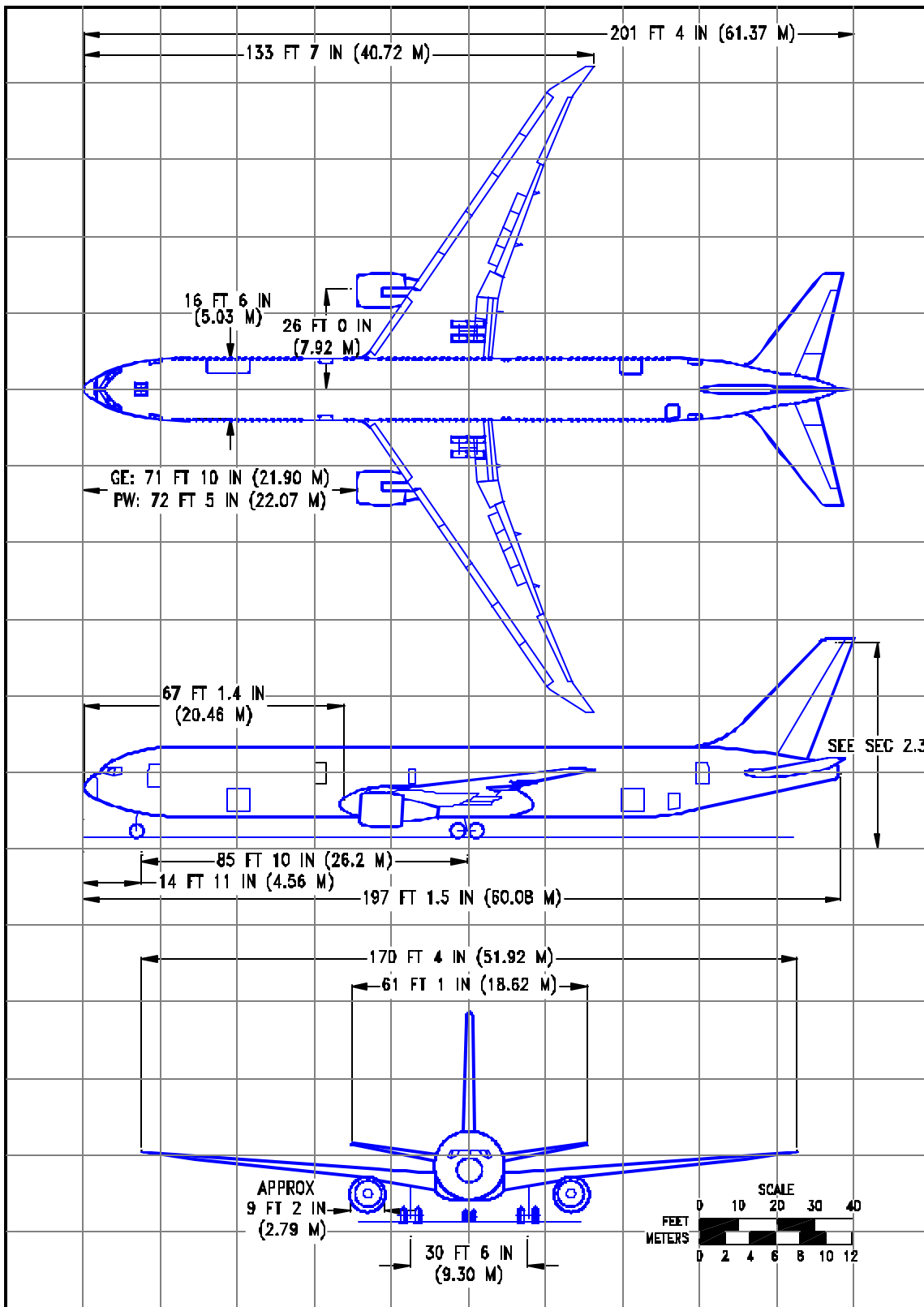

2.2.4 GENERAL DIMENSIONS
 MODEL 767-400ER

D6-58328

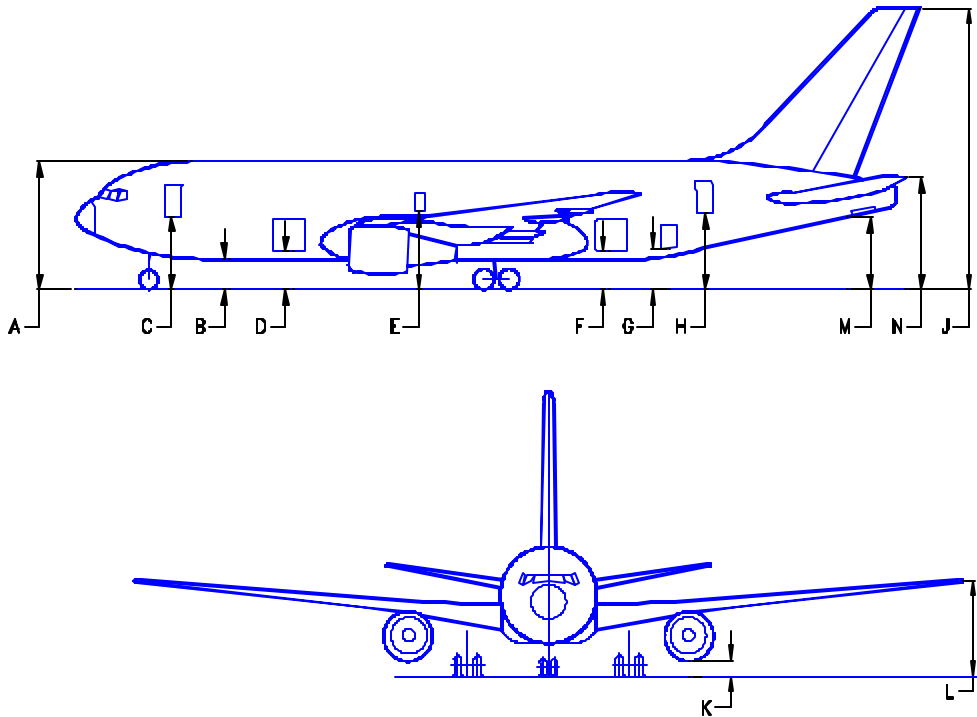

	MINIMUM*		MAXIMUM*	
	FEET - INCHES	METERS	FEET - INCHES	METERS
A	23 - 6	7.16	24 - 6	7.47
B	5 - 8	1.73	6 - 9	2.06
C	13 - 5	4.09	14 - 8	4.47
D	7 - 5	2.26	8 - 3	2.51
E	15 - 1	4.60	15 - 1	4.60
F	7 - 5	2.26	8 - 3	2.51
G	7 - 6	2.29	8 - 6	2.59
H	13 - 4	4.06	14 - 6	4.42
J	51 - 2	15.60	52 - 11	16.13
K	2 - 8	0.81	3 - 7	1.09
L	16 - 3	4.95	18 - 3	5.56
M	12 - 9	3.89	14 - 3	4.34
N	19 - 6	5.94	21 - 7	6.58

- NOTES: 1. VERTICAL CLEARANCES SHOWN OCCUR DURING MAXIMUM VARIATIONS OF AIRPLANE ATTITUDE. COMBINATIONS OF AIRPLANE LOADING AND UNLOADING ACTIVITIES THAT PRODUCE THE GREATEST POSSIBLE VARIATIONS IN ATTITUDE WERE USED TO ESTABLISH THE VARIATIONS SHOWN.
2. DURING ROUTINE SERVICING, THE AIRPLANE REMAINS RELATIVELY STABLE, PITCH AND ELEVATION CHANGES OCCURRING SLOWLY.
- * NOMINAL DIMENSIONS

2.3.1 GROUND CLEARANCES
MODEL 767-200, -200ER.

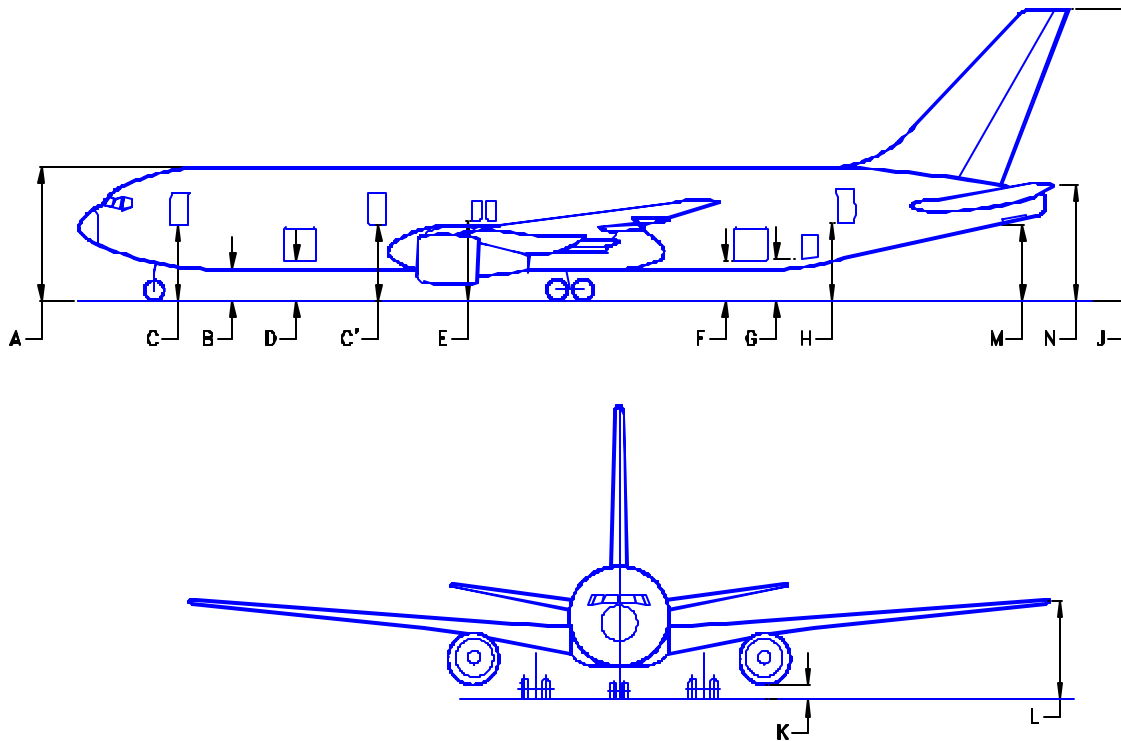

	MINIMUM*		MAXIMUM*	
	FEET - INCHES	METERS	FEET - INCHES	METERS
A	23 - 7	7.19	24 - 7	7.49
B	5 - 10	1.78	6 - 10	2.08
C	13 - 7	4.14	14 - 9	4.50
C'	13 - 8	4.16	14 - 8	4.47
D	7 - 6	2.29	8 - 5	2.57
E	15 - 1	4.60	15 - 8	4.77
F	7 - 2	2.18	8 - 3	2.51
G	7 - 3	2.21	8 - 6	2.59
H	13 - 1	3.99	14 - 5	4.39
J	50 - 6	15.39	52 - 7	16.03
K	1 - 10	0.56	3 - 8	1.12
L	16 - 1	4.90	17 - 11	5.46
M	12 - 2	3.71	14 - 1	4.29
N	19 - 2	5.84	21 - 3	6.48

NOTES: 1. VERTICAL CLEARANCES SHOWN OCCUR DURING MAXIMUM VARIATIONS OF AIRPLANE ATTITUDE. COMBINATIONS OF AIRPLANE LOADING AND UNLOADING ACTIVITIES THAT PRODUCE THE GREATEST POSSIBLE VARIATIONS IN ATTITUDE WERE USED TO ESTABLISH THE VARIATIONS SHOWN.

2. DURING ROUTINE SERVICING, THE AIRPLANE REMAINS RELATIVELY STABLE, PITCH AND ELEVATION CHANGES OCCURRING SLOWLY.

* NOMINAL DIMENSIONS

2.3.2 GROUND CLEARANCES

MODEL 767-300, -300ER

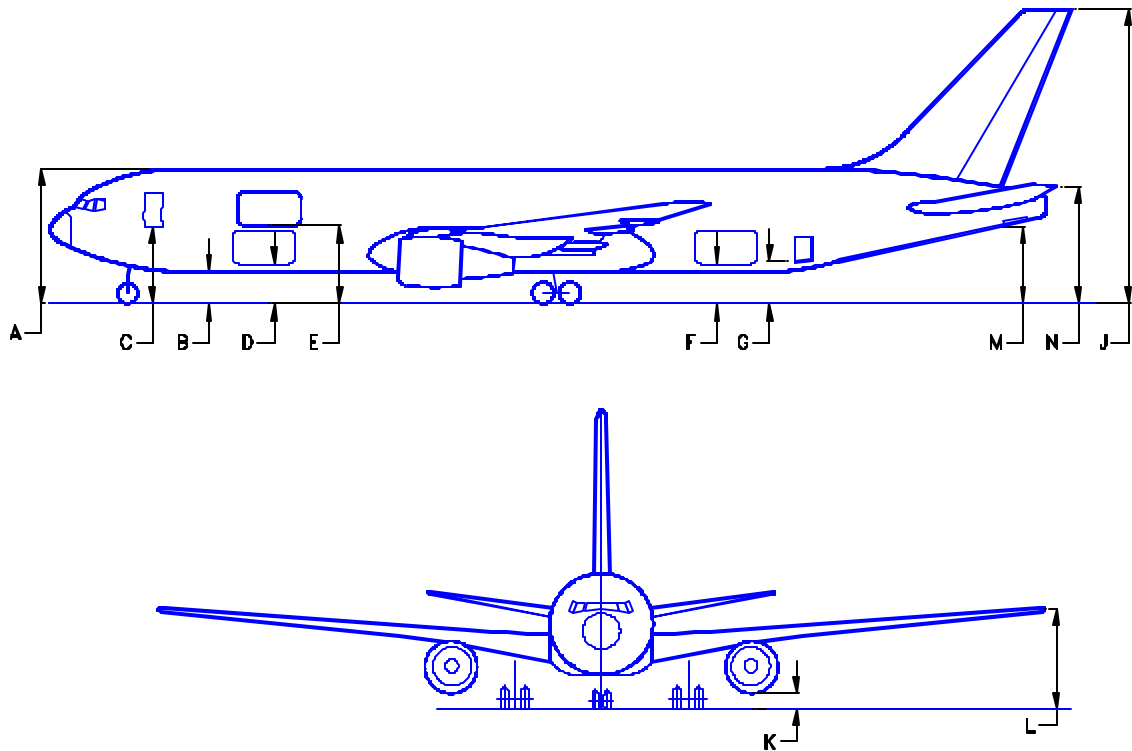

	MINIMUM*		MAXIMUM*	
	FEET - INCHES	METERS	FEET - INCHES	METERS
A	23 - 6	7.16	24 - 7	7.49
B	5 - 10	1.78	6 - 10	2.08
C	13 - 6	4.11	14 - 9	4.50
D	7 - 5	2.26	8 - 5	2.57
E	13 - 8	4.16	14 - 8	4.47
F	7 - 5	2.26	8 - 4	2.54
G	7 - 5	2.26	8 - 7	2.62
J	50 - 8	15.44	52 - 11	16.13
K	1 - 10	0.56	3 - 7	1.09
L	16 - 3	4.95	18 - 3	5.56
M	12 - 3	3.73	14 - 4	4.37
N	19 - 4	5.89	21 - 7	6.58

- NOTES: 1. VERTICAL CLEARANCES SHOWN OCCUR DURING MAXIMUM VARIATIONS OF AIRPLANE ATTITUDE. COMBINATIONS OF AIRPLANE LOADING AND UNLOADING ACTIVITIES THAT PRODUCE THE GREATEST POSSIBLE VARIATIONS IN ATTITUDE WERE USED TO ESTABLISH THE VARIATIONS SHOWN.
2. DURING ROUTINE SERVICING, THE AIRPLANE REMAINS RELATIVELY STABLE, PITCH AND ELEVATION CHANGES OCCURRING SLOWLY.
- * NOMINAL DIMENSIONS

2.3.3 GROUND CLEARANCES
MODEL 767-300 FREIGHTER

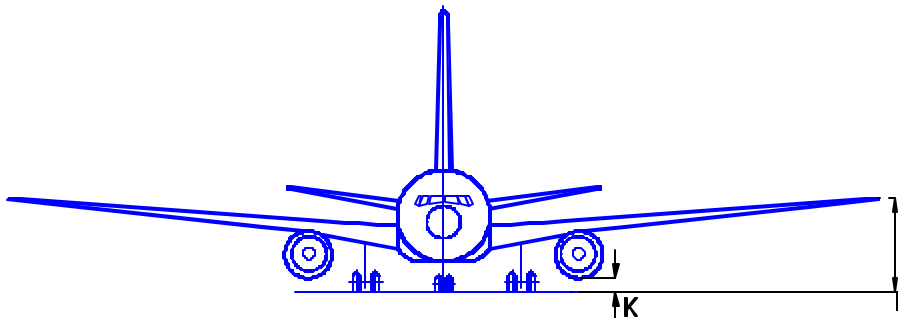
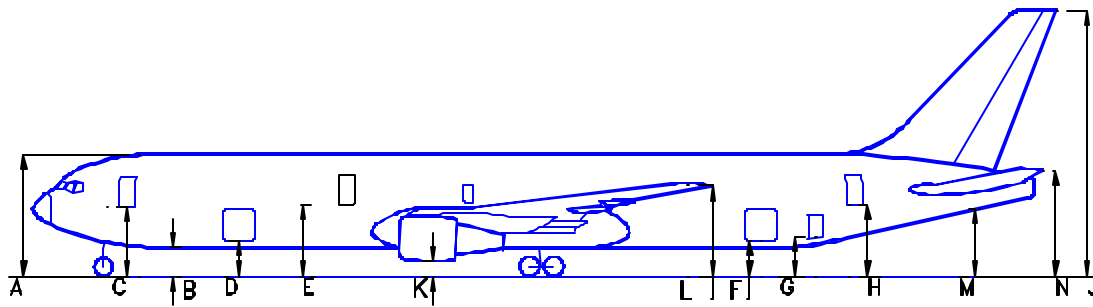

	MINIMUM*		MAXIMUM*	
	FEET - INCHES	METERS	FEET - INCHES	METERS
A	23-8	7.22	24-6	7.46
B	5-11	1.81	6-9	2.05
C	13-7	4.13	14-5	4.39
D	7-10	2.38	8-7	2.61
E	14-6	4.41	15-1	4.59
F	9-8	2.96	10-6	3.20
G	10-1	3.07	10-11	3.33
H	16-1	4.91	17-0	5.18
J	54-9	16.68	55-10	17.01
K	3-11	1.21	4-5	1.36
L	19-11	6.08	21-4	6.51
M	16-4	4.89	17-1	5.22
N	23-5	7.12	24-5	7.45

NOTES: VERTICAL CLEARANCES SHOWN OCCUR DURING MAXIMUM VARIATIONS OF AIRPLANE ATTITUDE. COMBINATIONS OF AIRPLANE LOADING AND UNLOADING ACTIVITIES THAT PRODUCE THE GREATEST POSSIBLE VARIATIONS IN ATTITUDE WERE USED TO ESTABLISH THE VARIATIONS SHOWN.

DURING ROUTINE SERVICING, THE AIRPLANE REMAINS RELATIVELY STABLE, PITCH AND ELEVATION CHANGES OCCURRING SLOWLY.

* NOMINAL DIMENSIONS

2.3.4 GROUND CLEARANCES

MODEL 767-400ER.

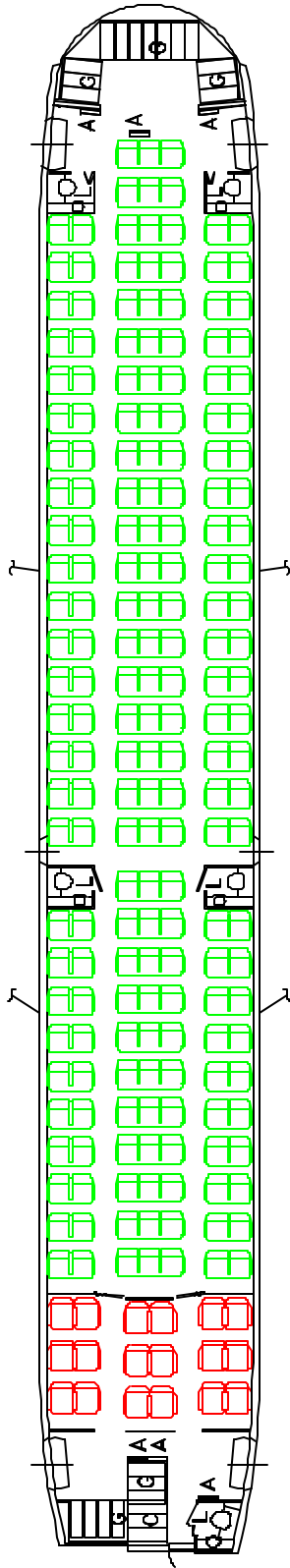

- 216 SEATS
- 18 FIRST CLASS AT 38-IN (0.97 M) PITCH
 - 198 ECONOMY CLASS AT 34-IN (0.86 M) PITCH

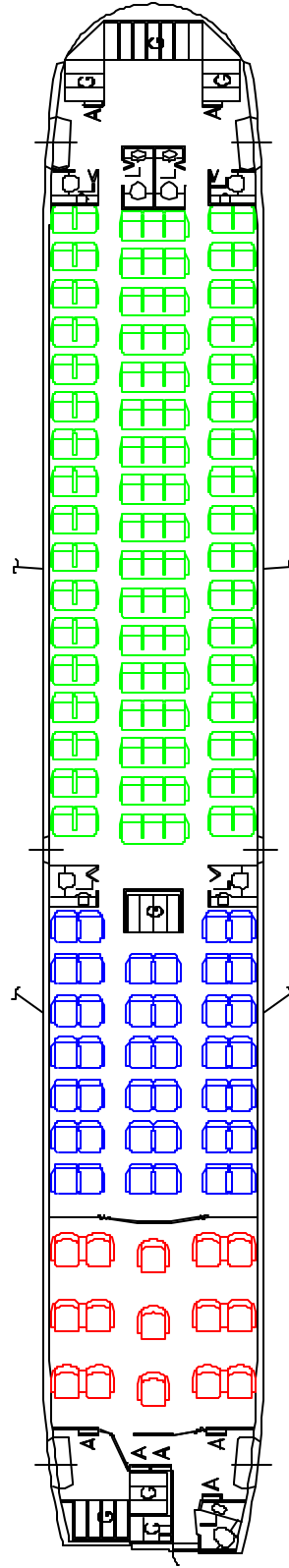

- 174 SEATS
- 15 FIRST CLASS AT 60-IN (1.53 M) PITCH
 - 40 BUSINESS CLASS AT 38-IN (0.97 M) PITCH
 - 119 ECONOMY CLASS AT 34-IN (0.86 M) PITCH

[A] ATTENDANT
 [C] CLOSET
 [G] GALLEY
 [L] LAVATORY

2.4.1 INTERIOR ARRANGEMENTS – MIXED CLASS CONFIGURATIONS
 MODEL 767-200, -200ER

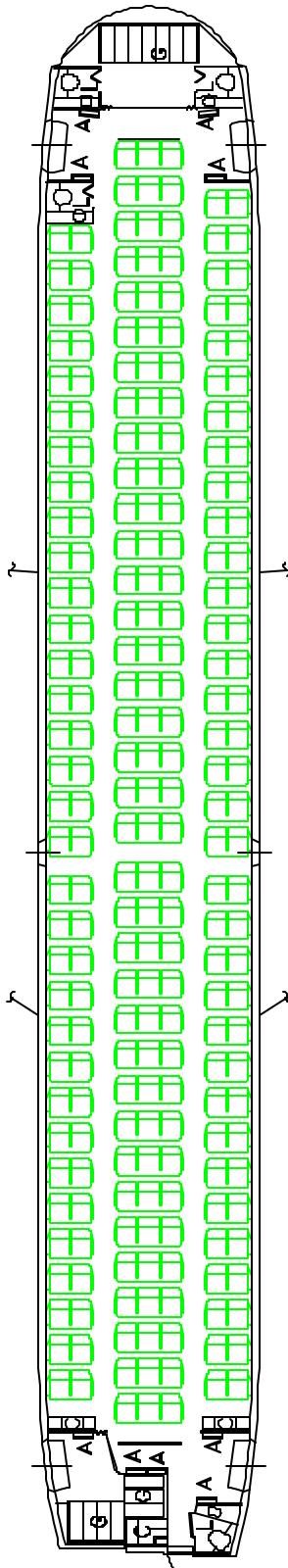

242 SEATS
 ● 242 ECONOMY CLASS AT 32-IN (0.81 M) PITCH

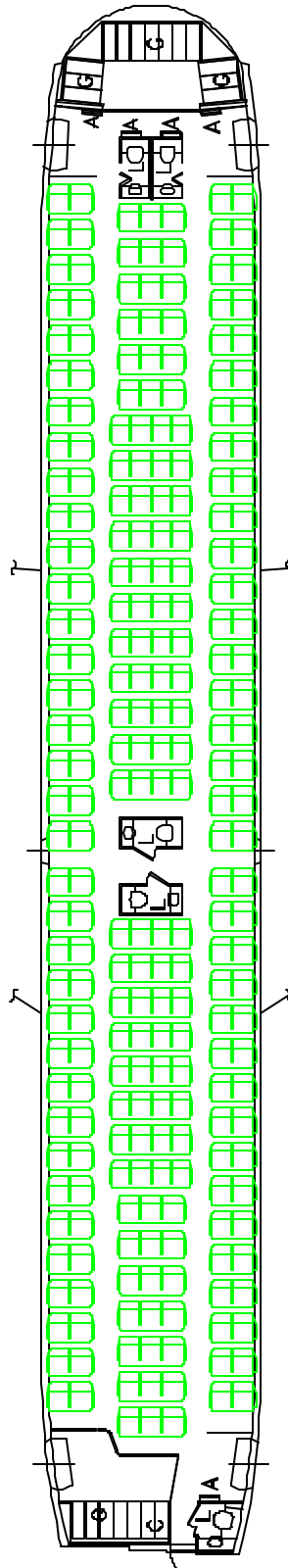

245 SEATS
 ● 245 ECONOMY CLASS AT 31-IN (0.79 M) PITCH

- A ATTENDANT
- G GALLEY
- L LAVATORY

2.4.2 INTERIOR ARRANGEMENTS – ALL-ECONOMY CLASS CONFIGURATIONS
 MODEL 767-200, -200ER

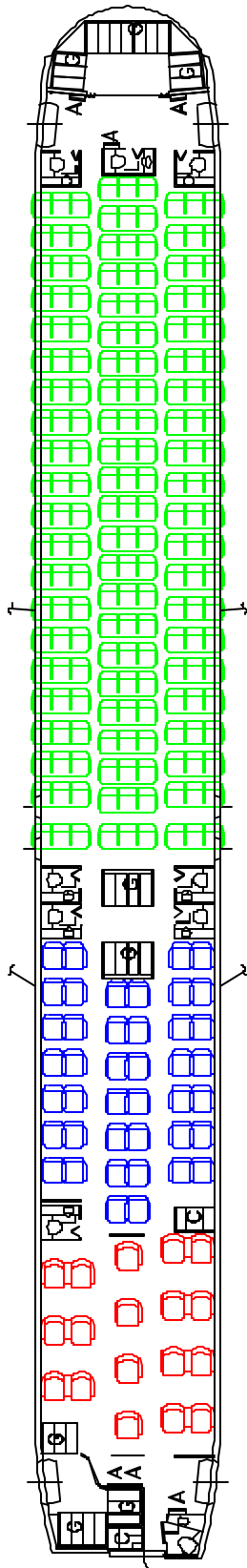

- 210 SEATS**
- 18 FIRST CLASS AT 60-IN (1.52 M) PITCH
 - 42 BUSINESS CLASS AT 38-IN (0.97 M) PITCH
 - 150 ECONOMY CLASS AT 34-IN (0.86 M) PITCH

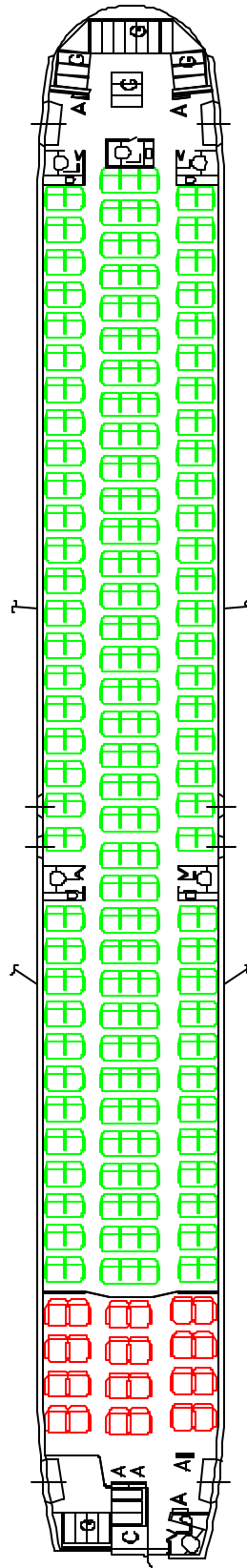

- 261 SEATS**
- 24 FIRST CLASS AT 38-IN (0.97 M) PITCH
 - 237 ECONOMY CLASS AT 34-IN (0.86 M) PITCH

A ATTENDANT
 C CLOSET
 G GALLEY
 L LAVATORY

2.4.3 INTERIOR ARRANGEMENTS – MIXED CLASS CONFIGURATIONS
 MODEL 767-300, -300ER

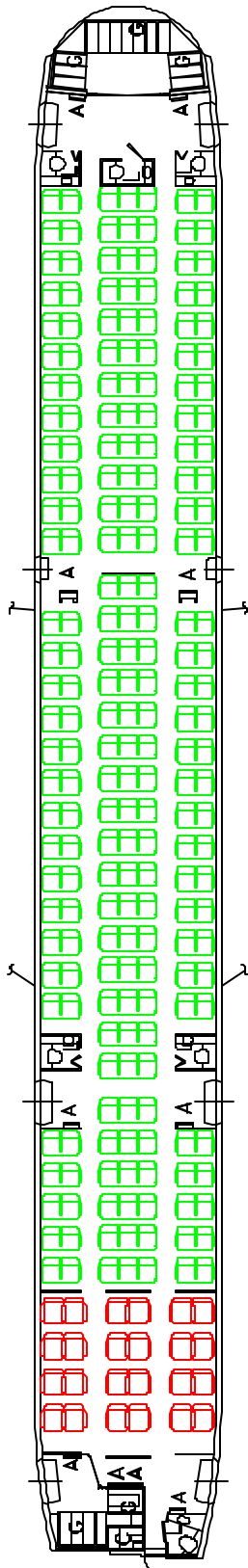

- 248 SEATS**
- 24 FIRST CLASS AT 38-IN (0.97 M) PITCH
 - 224 ECONOMY CLASS AT 34-IN (0.86 M) PITCH

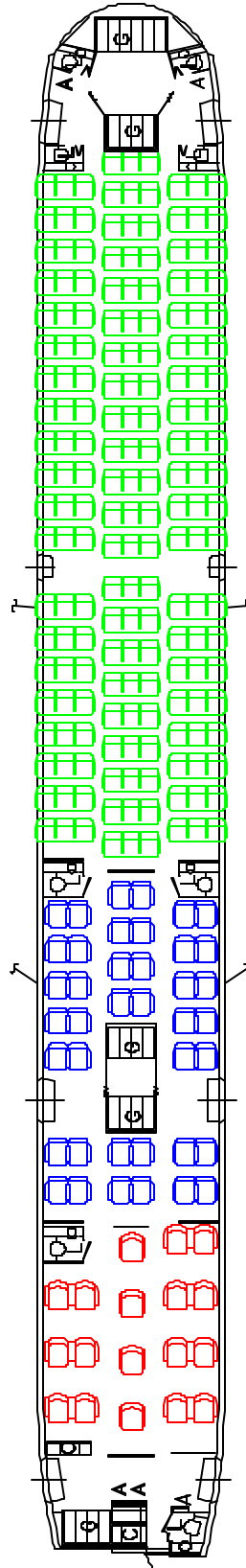

- 204 SEATS**
- 18 FIRST CLASS AT 60-IN (1.52 M) PITCH
 - 40 BUSINESS CLASS AT 38-IN (0.97 M) PITCH
 - 146 ECONOMY CLASS AT 34-IN (0.86 M) PITCH

- A** ATTENDANT
- C** CLOSET
- G** GALLEY
- L** LAVATORY

2.4.4 INTERIOR ARRANGEMENTS – MIXED CLASS CONFIGURATIONS
 MODEL 767-300, -300ER (TYPE A DOOR OPTION)

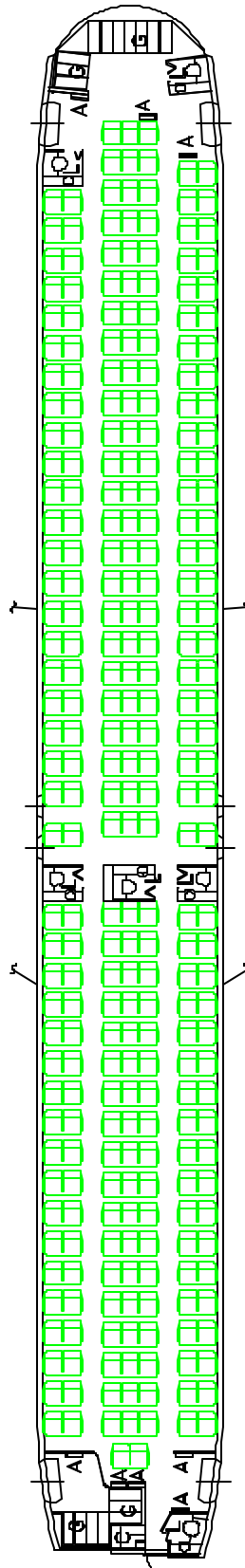

290 SEATS
 ● 290 ECONOMY CLASS AT 31-IN TO 32-IN (0.97 TO 0.81 M) PITCH

A	ATTENDANT
C	CLOSET
G	GALLEY
L	LAVATORY

2.4.5 INTERIOR ARRANGEMENTS – ALL-ECONOMY CLASS CONFIGURATION
 MODEL 767-300, -300ER

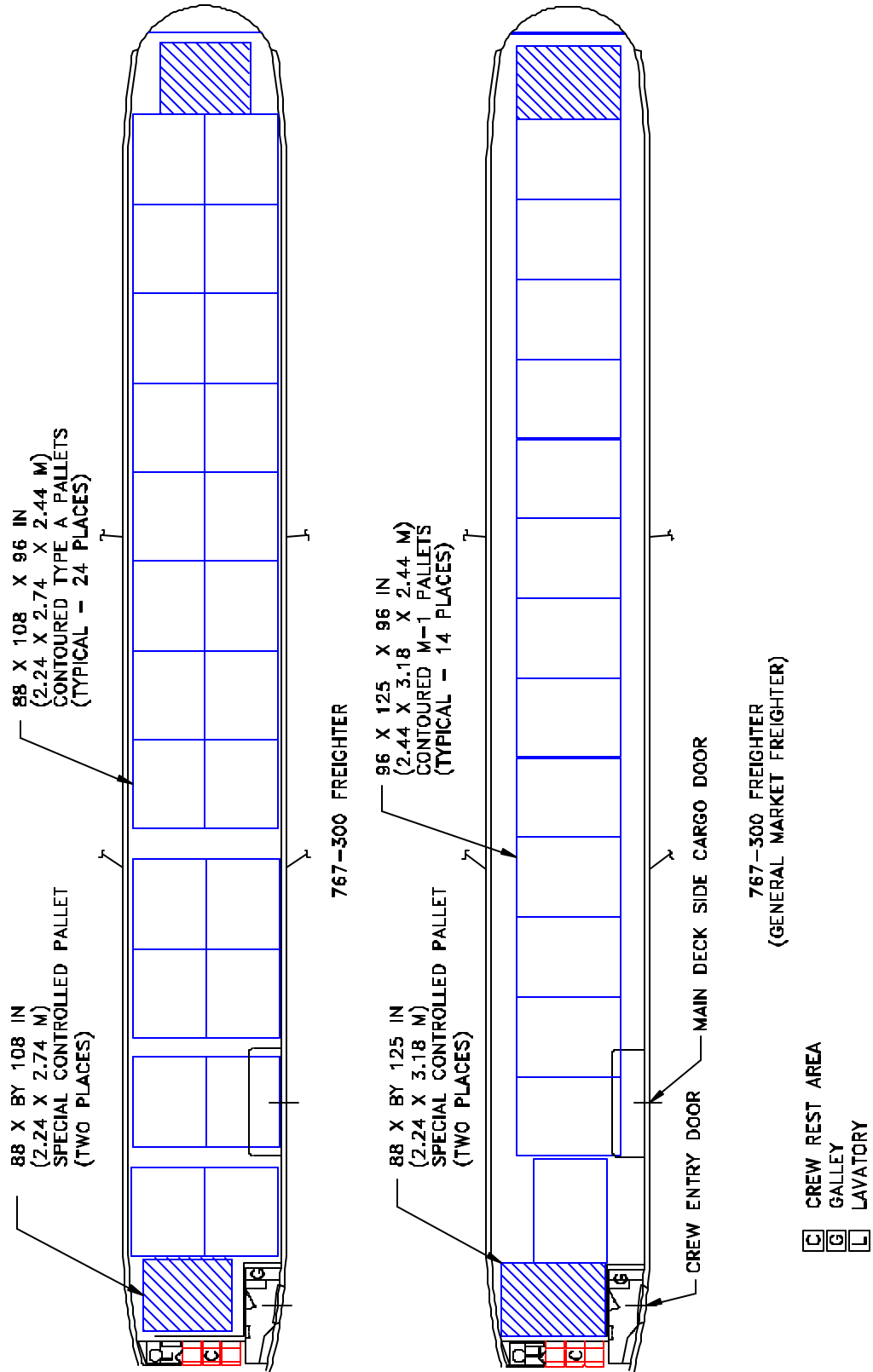

2.4.6 INTERIOR ARRANGEMENTS – MAIN DECK CARGO CONDIGURATION
 MODEL 767-300 FREIGHTER

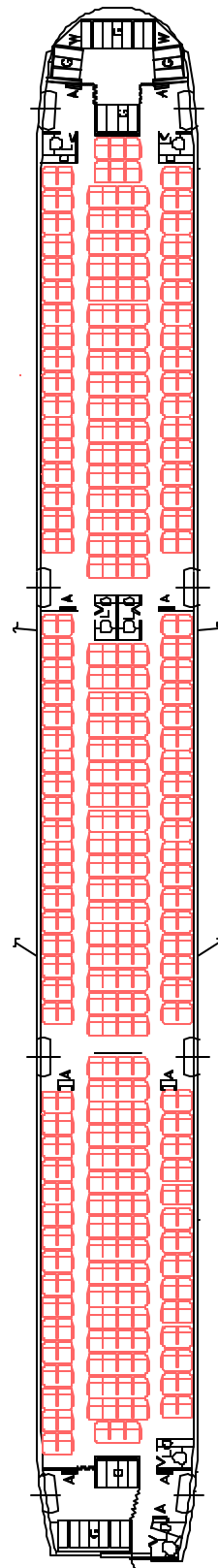
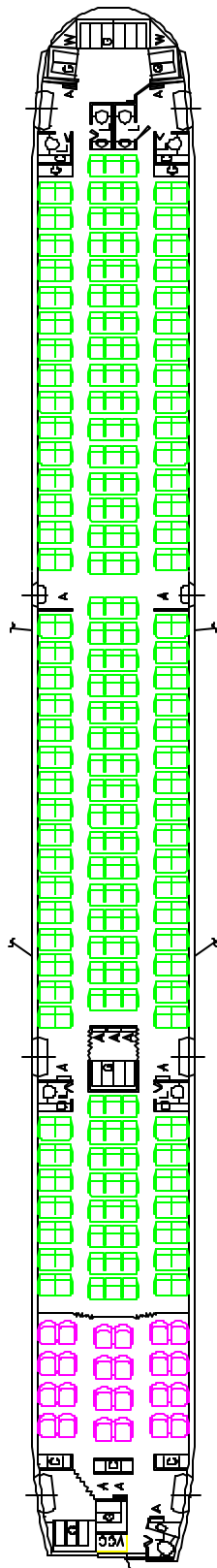
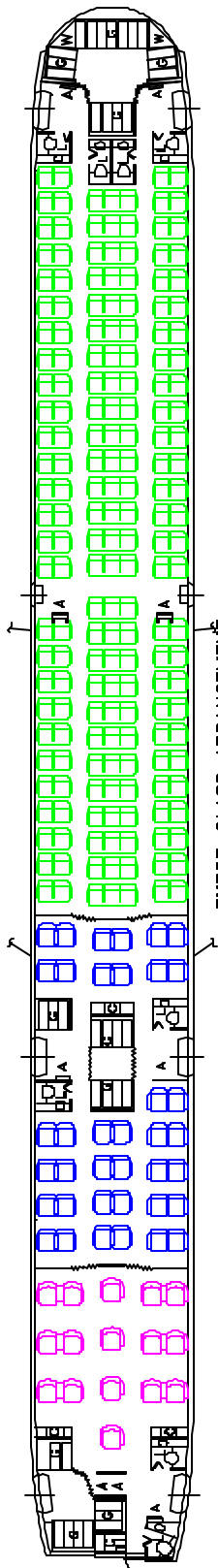

- A ATTENDANT'S SEAT
- G GOAT CLOSET
- G GALLEY
- W WARDROBE CLOSET
- L LAVATORY
- VGG VIDEO CONTROL CENTER

2.4.7 INTERIOR ARRANGEMENTS
MODEL 767-400ER

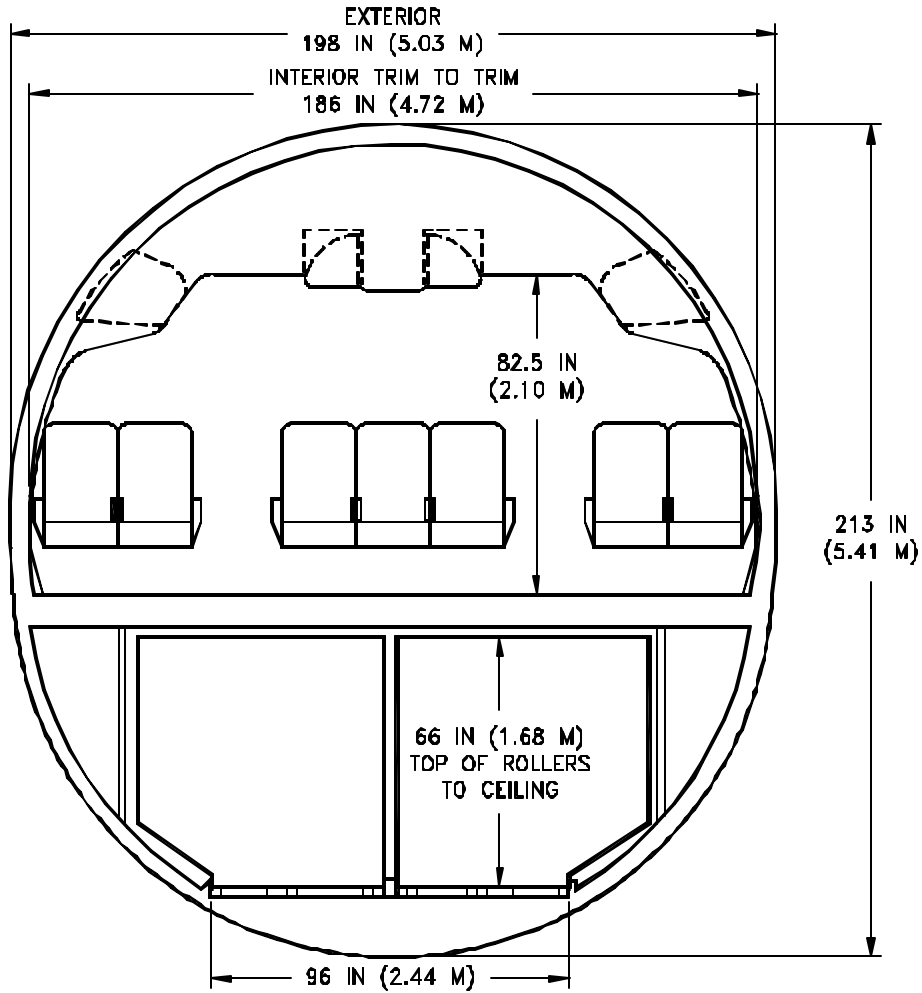

LOOKING AFT

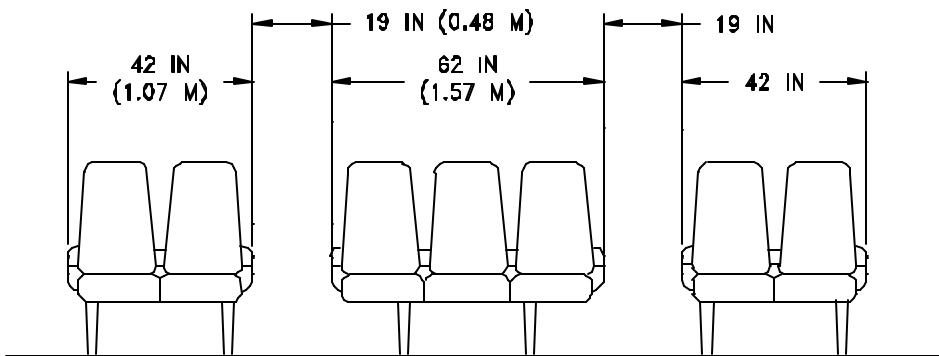

ECONOMY CLASS SEATING

2.5.1 CABIN CROSS-SECTIONS - ECONOMY CLASS SEATS

MODEL 767-200, -200ER, -300, -300ER, -400ER

D6-58328

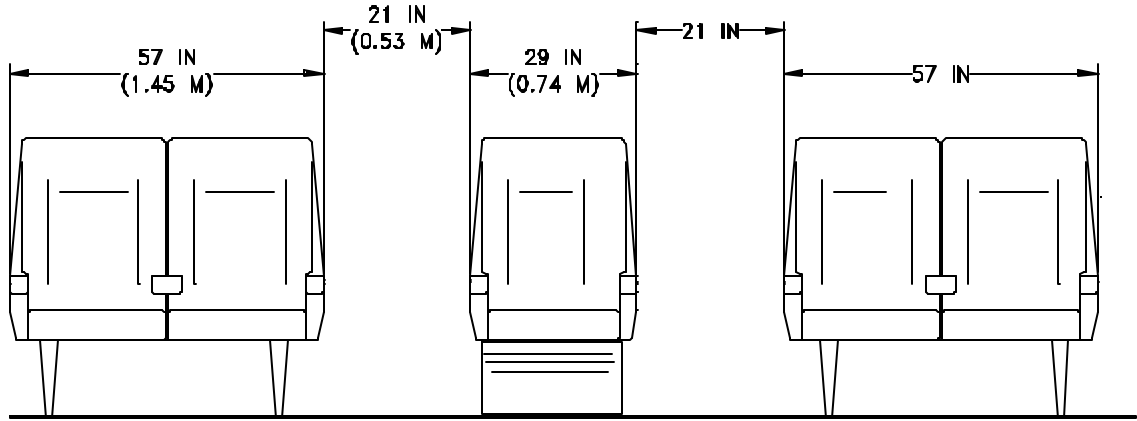

PREMIUM SLEEPER SEATS

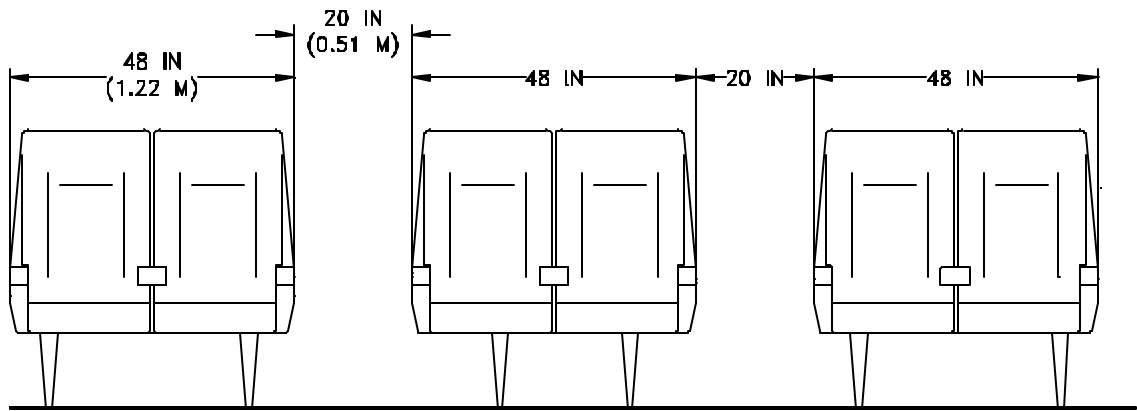

BUSINESS CLASS SEATING
SIX-ABREAST

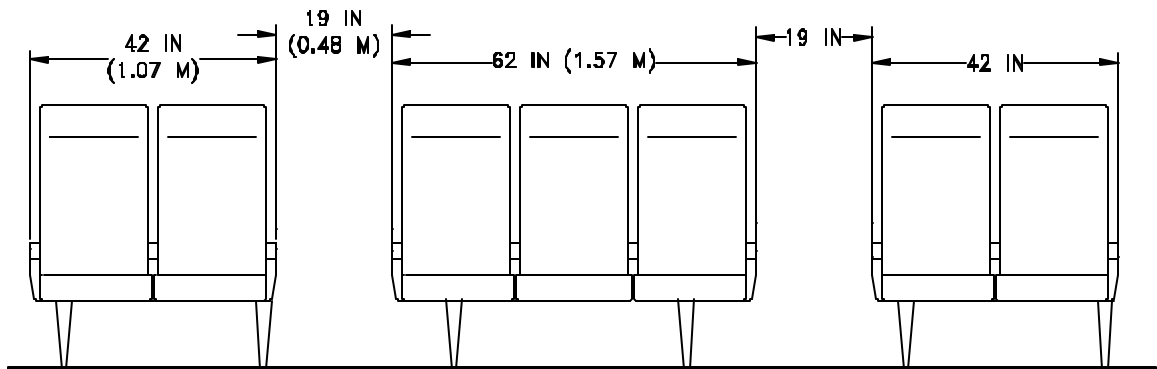

PREMIUM ECONOMY CLASS SEATING
SEVEN-ABREAST

2.5.2 CABIN CROSS-SECTIONS - ALTERNATE SEATING ARRANGEMENTS

MODEL 767-200, -200ER, -300, -300ER, -400ER

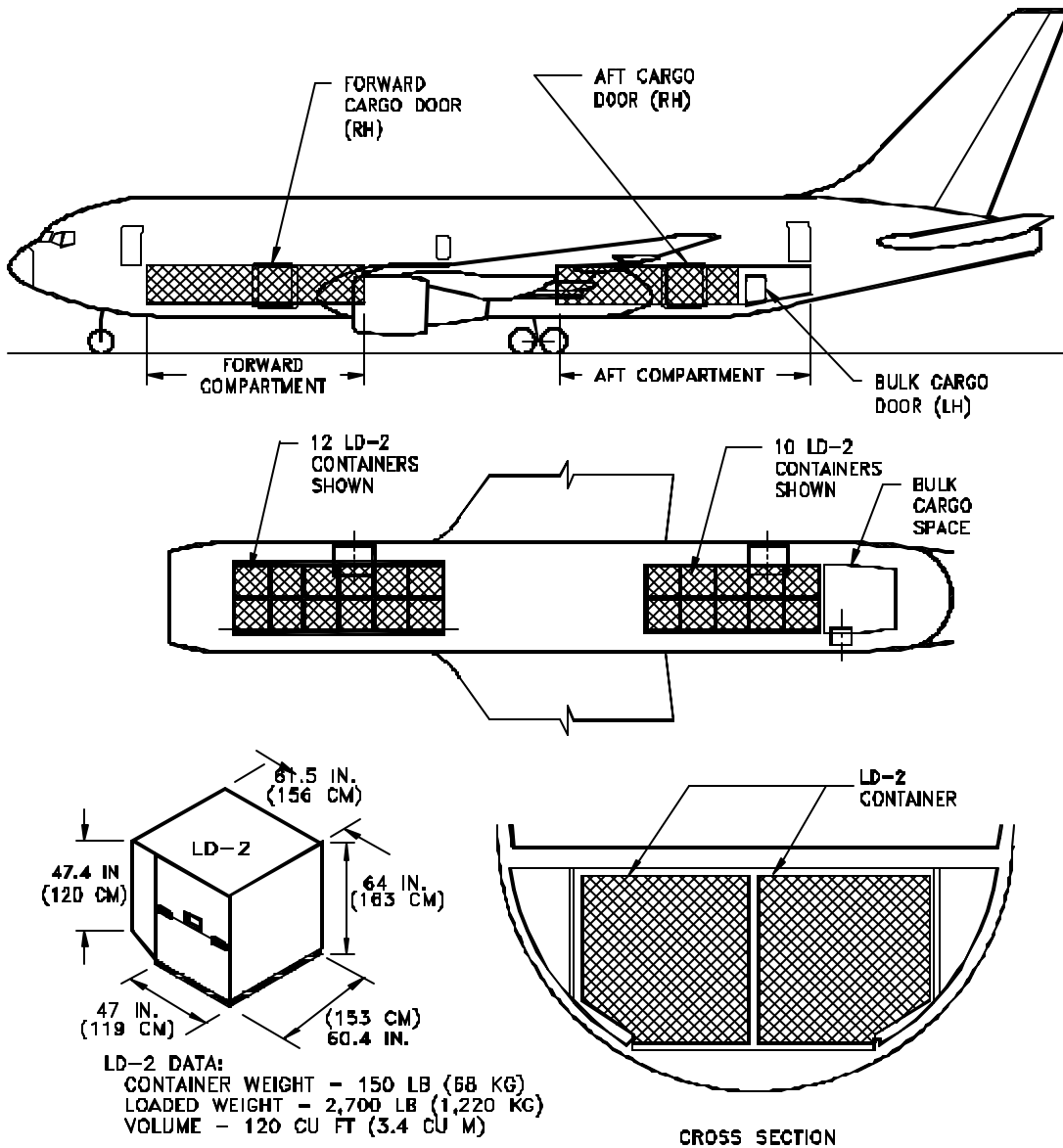

		FWD COMPARTMENT	AFT COMPARTMENT		TOTAL
		12 LD-2 CONTAINERS	10 LD-2 CONTAINERS	BULK CARGO	
VOLUME	CUBIC FEET	1,440	1,200	430	3,070
	CUBIC METERS	40.78	33.98	12.18	86.94

STRUCTURAL WEIGHT LIMIT

SEVEN-ABREAST SEATING	POUNDS	33,750	27,000	6,450	67,200
	KILOGRAMS	15,309	12,247	2,926	30,481
EIGHT-ABREAST SEATING	POUNDS	21,600	18,000	6,450	46,050
	KILOGRAMS	9,798	8,165	2,926	20,888

2.6.1 LOWER CARGO COMPARTMENTS – LD-2 CONTAINERS AND BULK CARGO

MODEL 767-200, -200ER

D6-58328

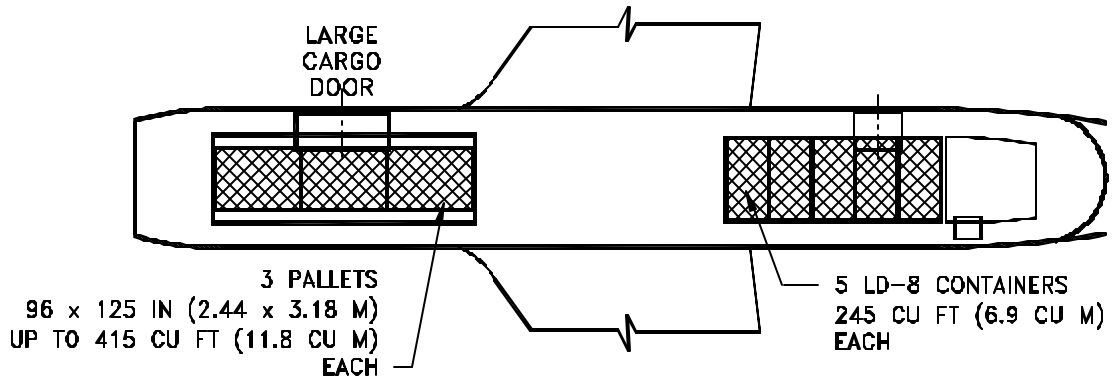
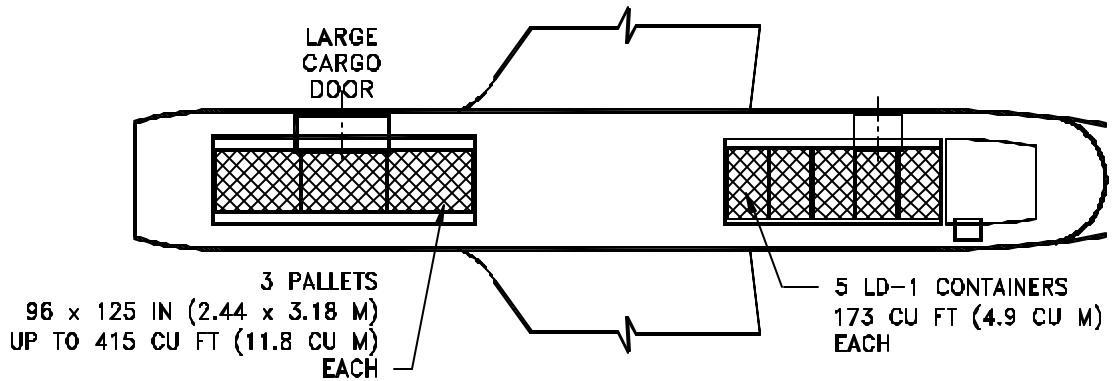
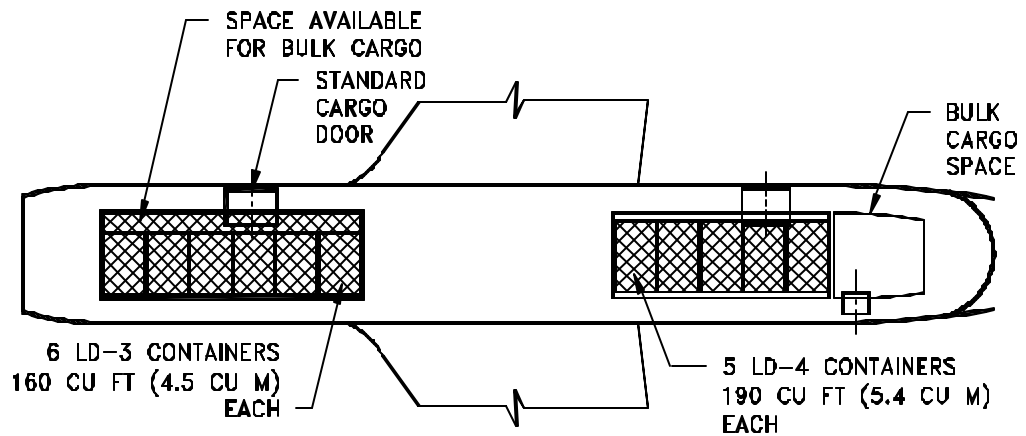

2.6.2 LOWER CARGO COMPARTMENTS – ALTERNATE ARRANGEMENTS

MODEL 767-200, -200ER

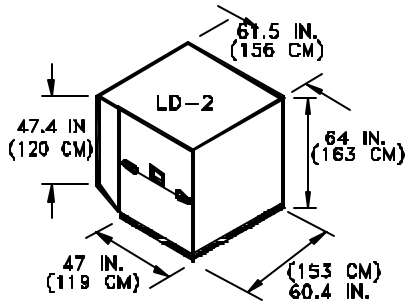
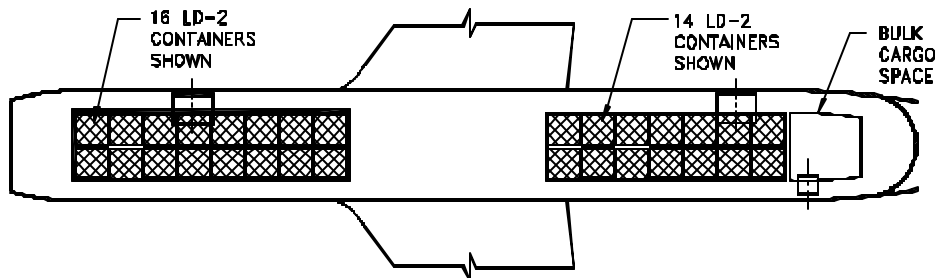
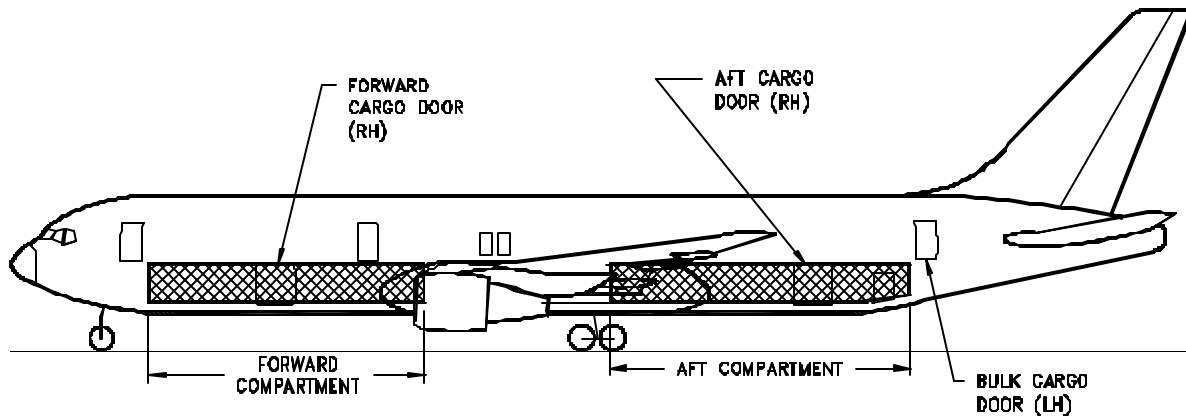

LD-2 DATA:
 CONTAINER WEIGHT - 150 LB (68 KG)
 LOADED WEIGHT - 2,700 LB (1,220 KG)
 VOLUME - 120 CU FT (3.4 CU M)

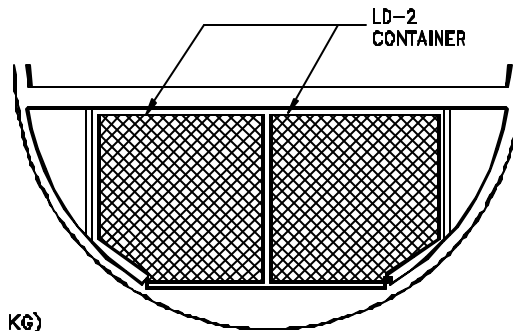

CROSS SECTION

		FWD COMPARTMENT	AFT COMPARTMENT		TOTAL
		16 LD-2 CONTAINERS	14 LD-2 CONTAINERS	BULK CARGO	
VOLUME	CUBIC FEET	1,920	1,680	430	4,030
	CUBIC METERS	54.4	47.6	12.2	114.2

STRUCTURAL WEIGHT LIMIT

SEVEN-ABREAST SEATING	POUNDS	45,000	37,800	6,450	89,250
	KILOGRAMS	20,412	17,146	2,926	40,483
EIGHT-ABREAST SEATING	POUNDS	28,800	25,200	6,450	60,450
	KILOGRAMS	13,063	11,431	2,926	27,420

2.6.3 LOWER CARGO COMPARTMENTS – LD-2 CONTAINERS AND BULK CARGO
 MODEL 767-300, -300ER, -300 FREIGHTER

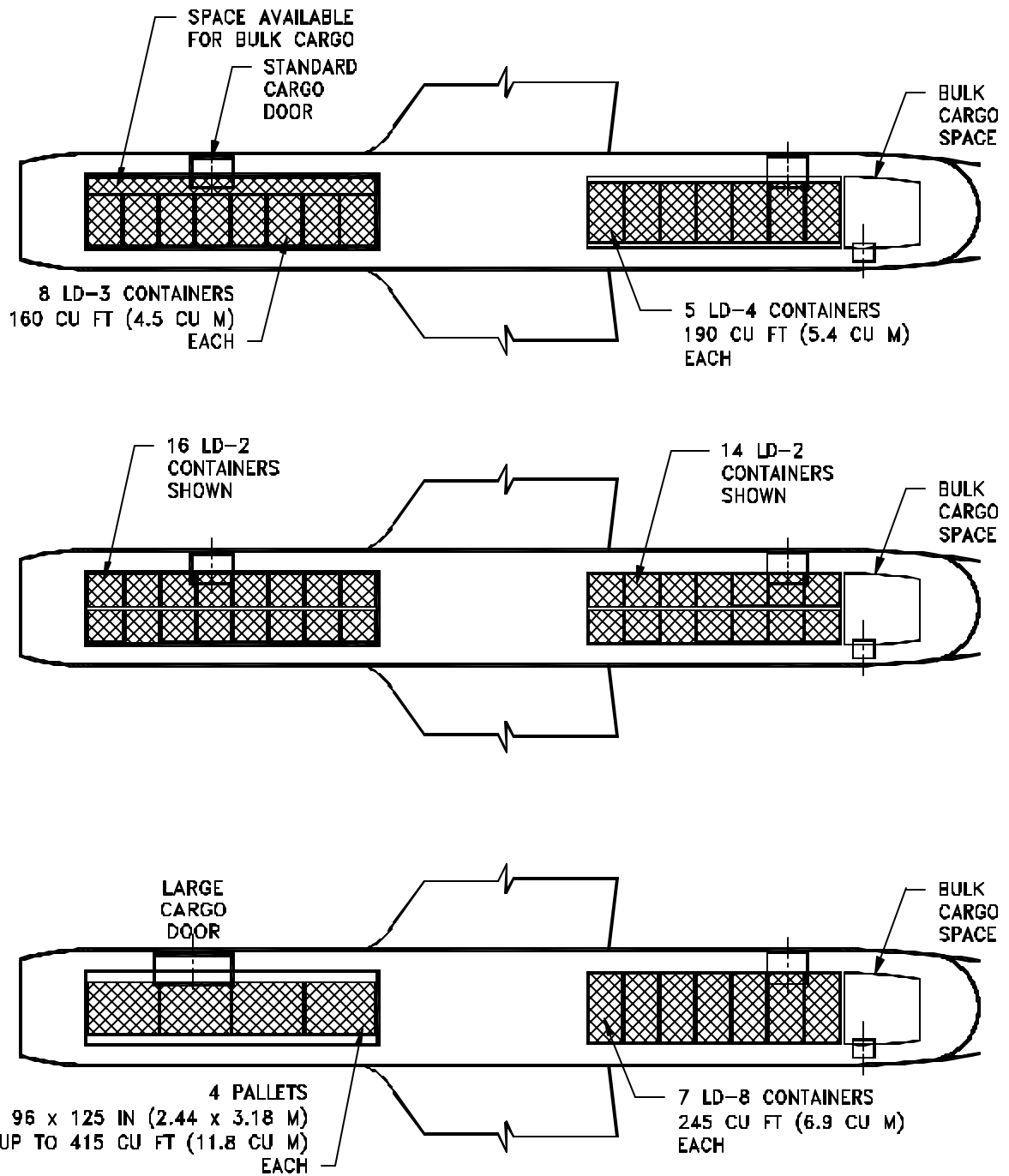

2.6.4 LOWER CARGO COMPARTMENTS – LD-2 CONTAINERS AND BULK CARGO
 MODEL 767-300, -300ER, -300 FREIGHTER

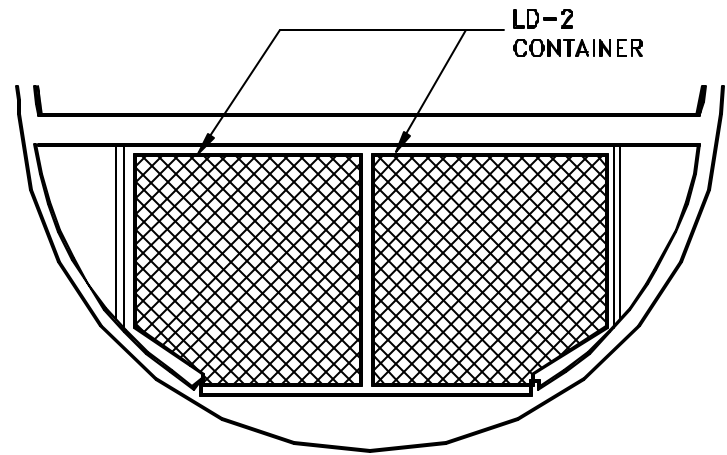
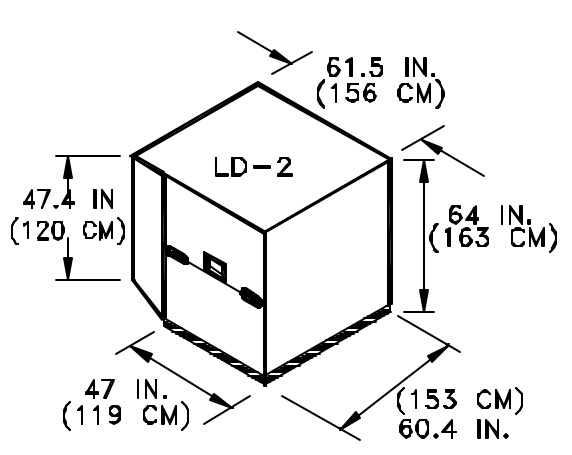
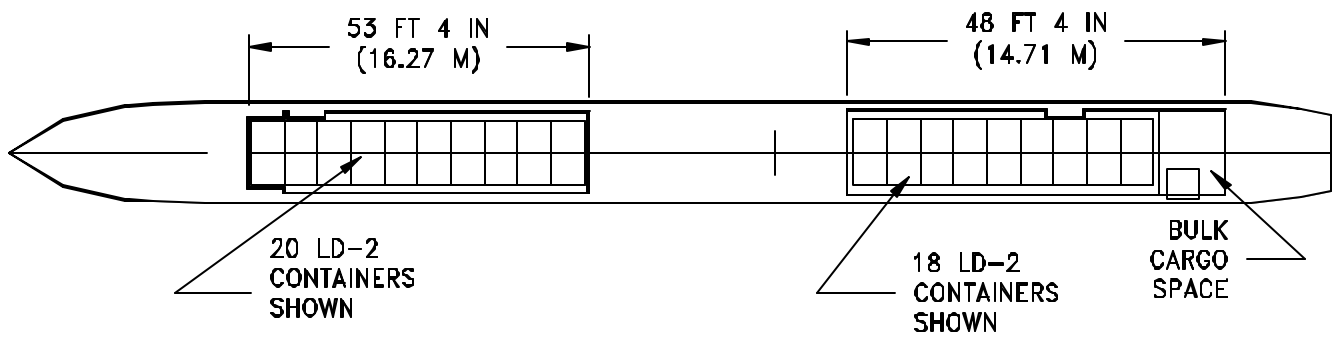
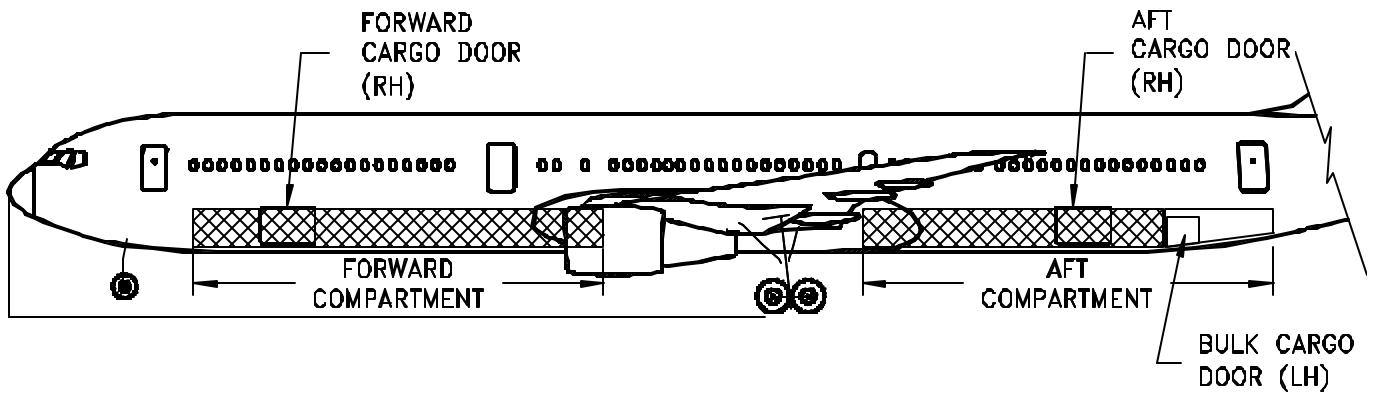

2.6.5 LOWER CARGO COMPARTMENTS - CONTAINERS AND BULK CARGO
 MODEL 767-400ER

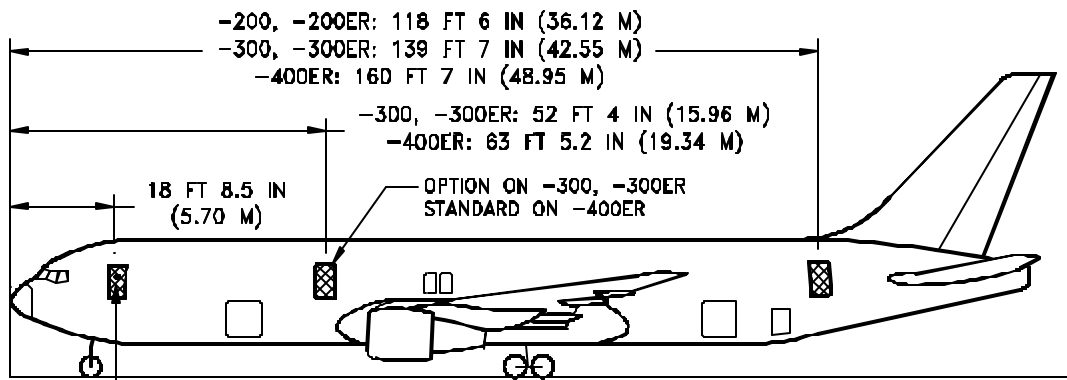

PASSENGER DOOR
 LH SIDE TWO OR THREE PLACES
 FWD LH SIDE ONLY ON -300 FREIGHTER
 42 BY 74 IN
 (1.07 BY 1.88 M)

SERVICE DOOR
 RH SIDE TWO OR THREE PLACES
 42 X 72 IN
 (1.07 BY 1.83 M)

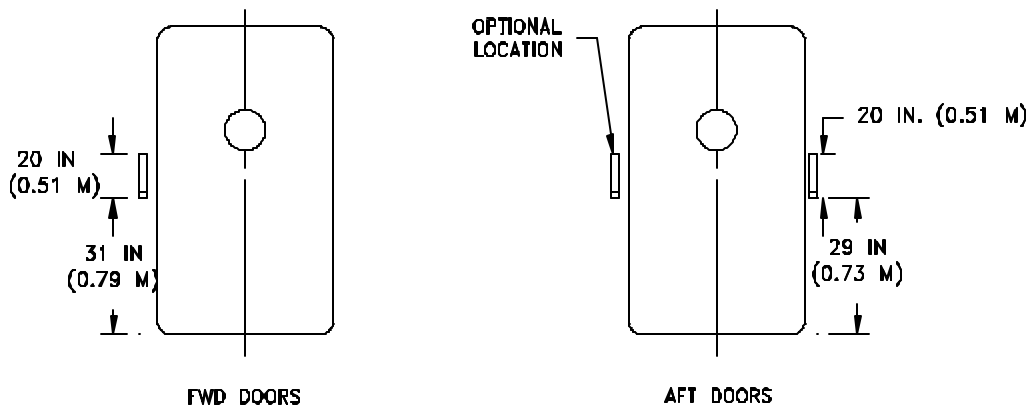
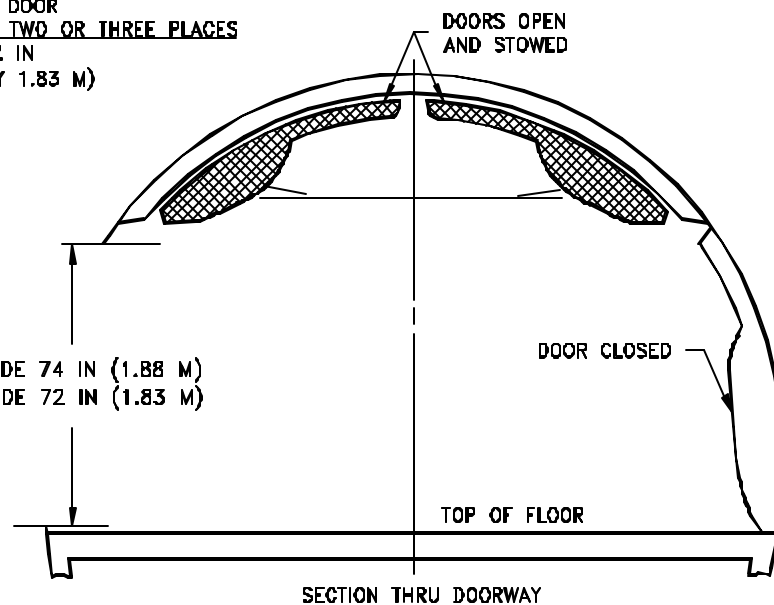

DOOR HANDLE LOCATIONS--LH EXTERIOR VIEW SHOWN--RH IS OPPOSITE

2.7.1 DOOR CLEARANCES - PASSENGER AND SERVICE DOORS
 MODEL 767-200, -200ER, -300, -300ER, -300 FREIGHTER, -400ER

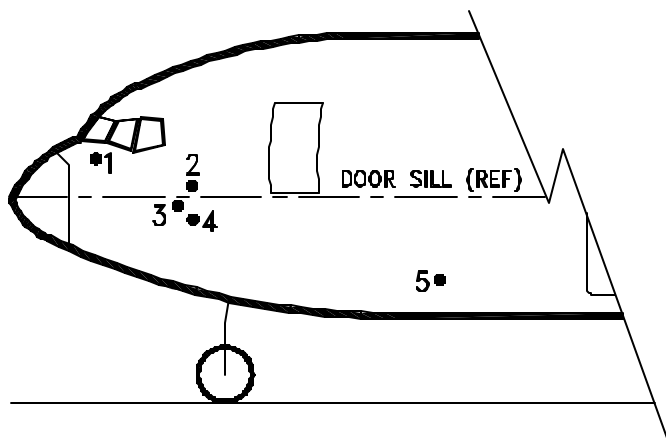

LEFT SIDE VIEW

NO	SENSOR	AFT OF NOSE		ABOVE DOOR SILL		BELOW DOOR SILL	
		FT-IN	M	FT-IN	M	FT-IN	M
1	TOTAL AIR TEMPERATURE (LH SIDE ONLY)	4-3	1.39	2-4	0.71	-	-
2	PITOT STATIC PROBE (LH AND RH SIDES)	9-0	2.74	1-0	0.30	-	-
3	ANGLE OF ATTACK (LH AND RH SIDES)	8-3	2.51	-	-	0-2	0.05
4	PITOT STATIC PROBES (LH AND RH SIDES)	9-0	2.74	-	-	0-6	0.15
5	FLUSH STATIC PORT (LH AND RH SIDES)	31-0	9.45	-	-	5-0	1.52

2.7.2 DOOR CLEARANCES - LOCATIONS OF PROBES AND SENSORS NEAR MAIN ENTRY DOOR NO 1

MODEL 767-200, -200ER, -300, -300ER, -300 FREIGHTER, -400ER

D6-58328

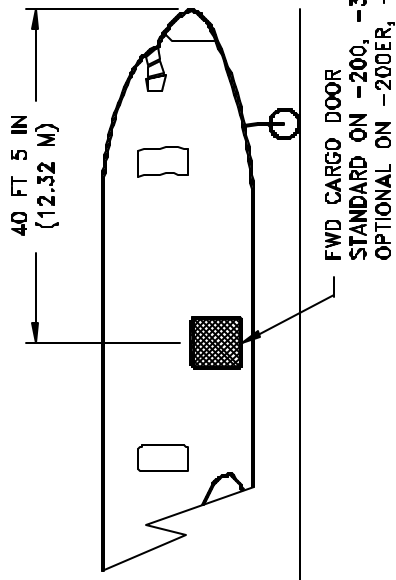

NOTE: CARGO DOORS ARE DESIGNED TO OPEN IN 40 KNOT WINDS FROM ANY DIRECTION DURING GROUND OPERATIONS.
CARGO DOORS ARE DESIGNED TO WITHSTAND 65 KNOT WINDS FROM ANY DIRECTION WHEN AIRPLANE IS NOT MOVING (STATIC)

[1] 67 IN. (1.70 M) IN DOORWAY AREA ONLY
66 IN. (1.68 M) INSIDE REST OF COMPARTMENT

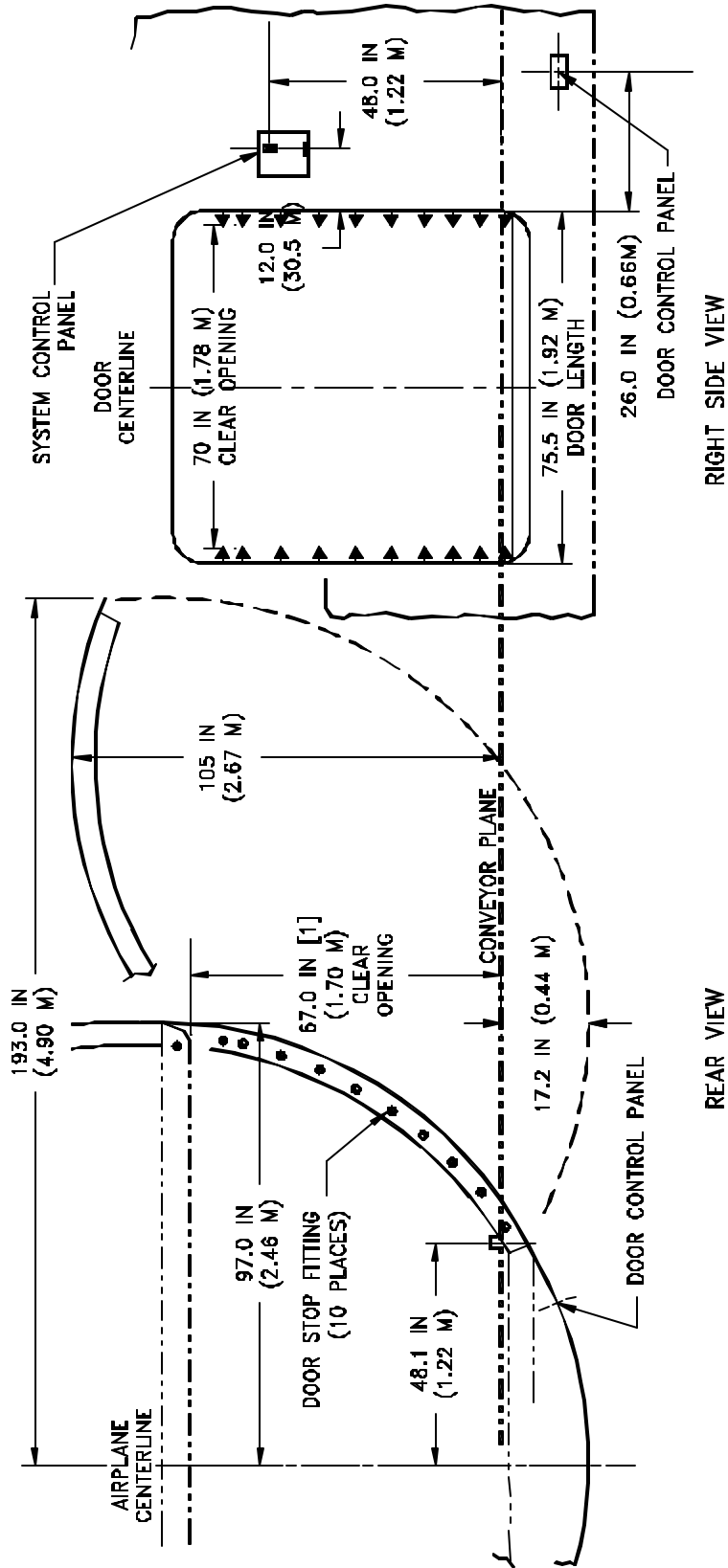

2.7.3 DOOR CLEARANCES – STANDARD FORWARD CARGO DOOR
MODEL 767-200, -200ER, -300, -300ER

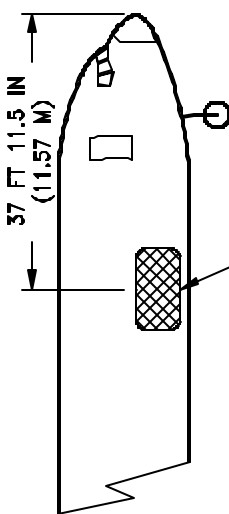

LARGE FORWARD CARGO DOOR
 STANDARD ON -200ER, -300ER, -300 FREIGHTER
 OPTIONAL ON -200, -300
 STANDARD ON 767-400ER

NOTE: CARGO DOORS ARE DESIGNED TO OPEN IN 40 KNOT WINDS FROM ANY DIRECTION DURING GROUND OPERATIONS.
 CARGO DOORS ARE DESIGNED TO WITHSTAND 65 KNOT WINDS FROM ANY DIRECTION WHEN AIRPLANE IS NOT MOVING (STATIC)
 [1] 67 IN. (1.70 M) IN DOORWAY AREA ONLY
 66 IN. (1.68 M) INSIDE REST OF COMPARTMENT

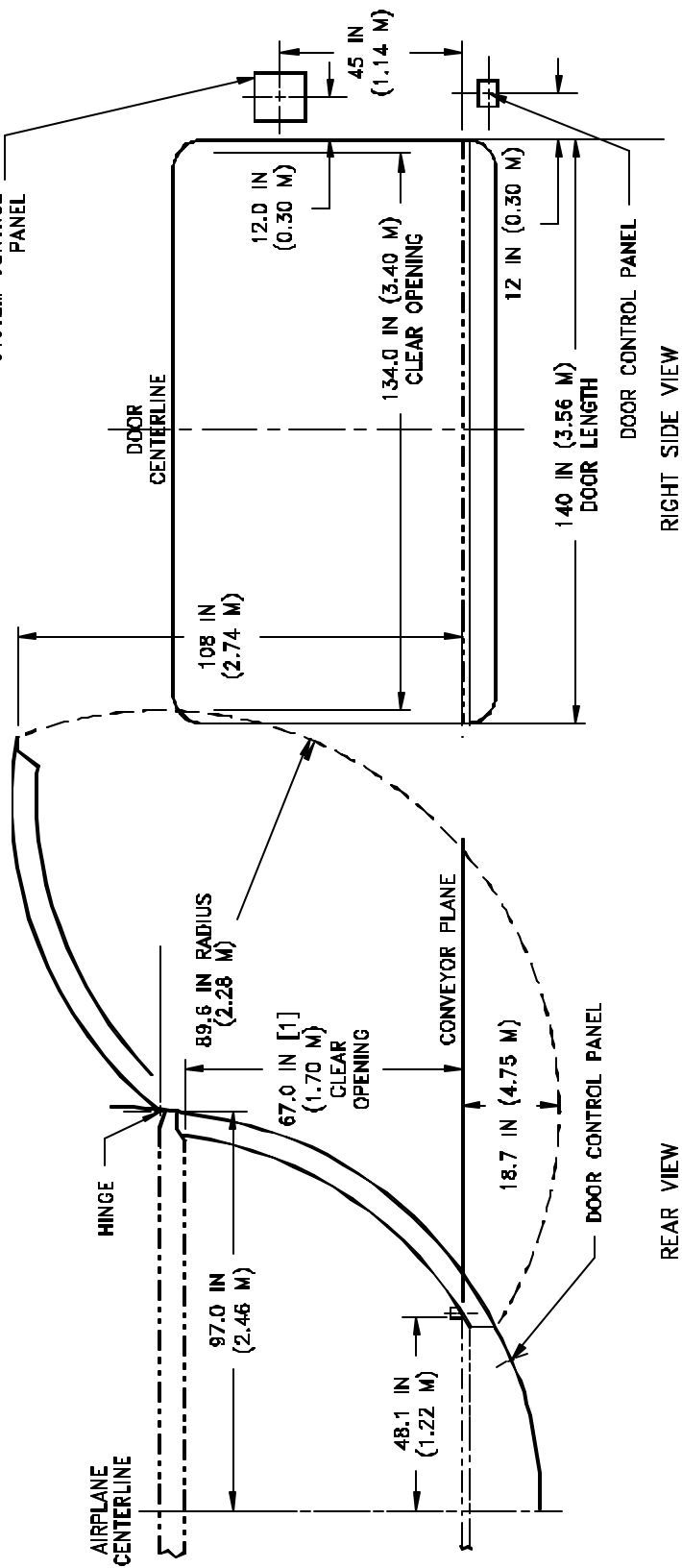

2.7.4 DOOR CLEARANCES – LARGE FORWARD CARGO DOOR
 MODEL 767-200, -200ER, -300, -300ER, -300 FREIGHTER, -400ER

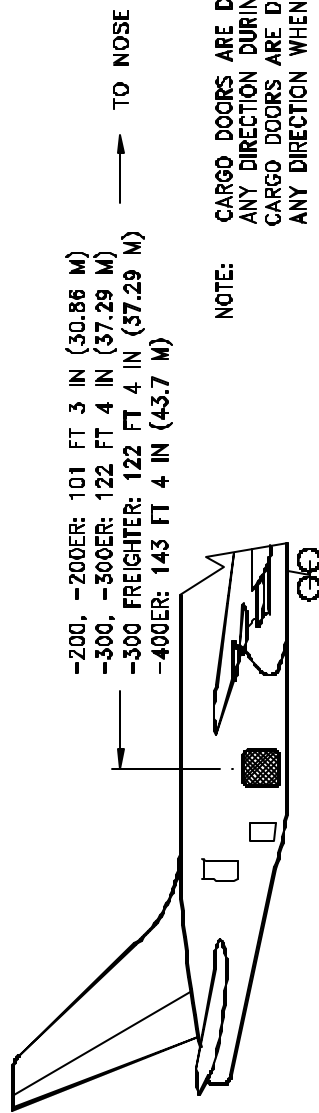

NOTE: CARGO DOORS ARE DESIGNED TO OPEN IN 40 KNOT WINDS FROM ANY DIRECTION DURING GROUND OPERATIONS.
 CARGO DOORS ARE DESIGNED TO WITHSTAND 65 KNOT WINDS FROM ANY DIRECTION WHEN AIRPLANE IS NOT MOVING (STATIC)

[1] 67 IN. (1.70 M) IN DOORWAY AREA ONLY
 56 IN. (1.68 M) INSIDE REST OF COMPARTMENT

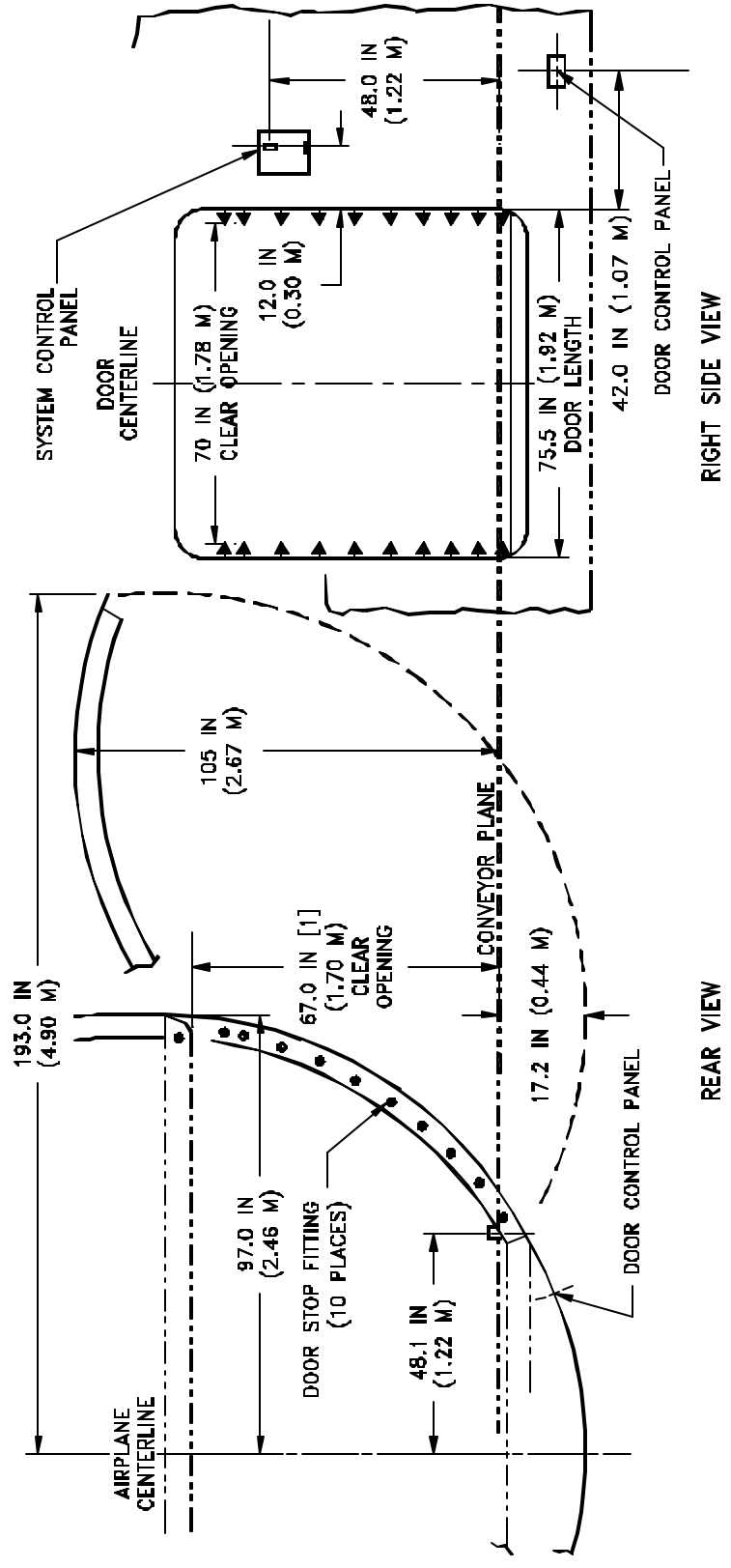

2.7.5 DOOR CLEARANCES - AFT CARGO DOOR

MODEL 767-200, -200ER, -300, -300ER, -300 FREIGHTER, -400ER

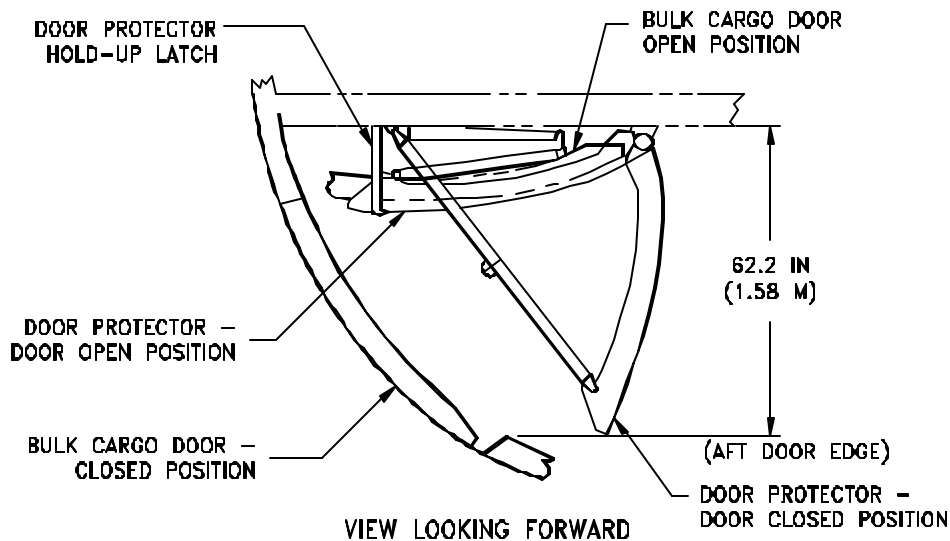
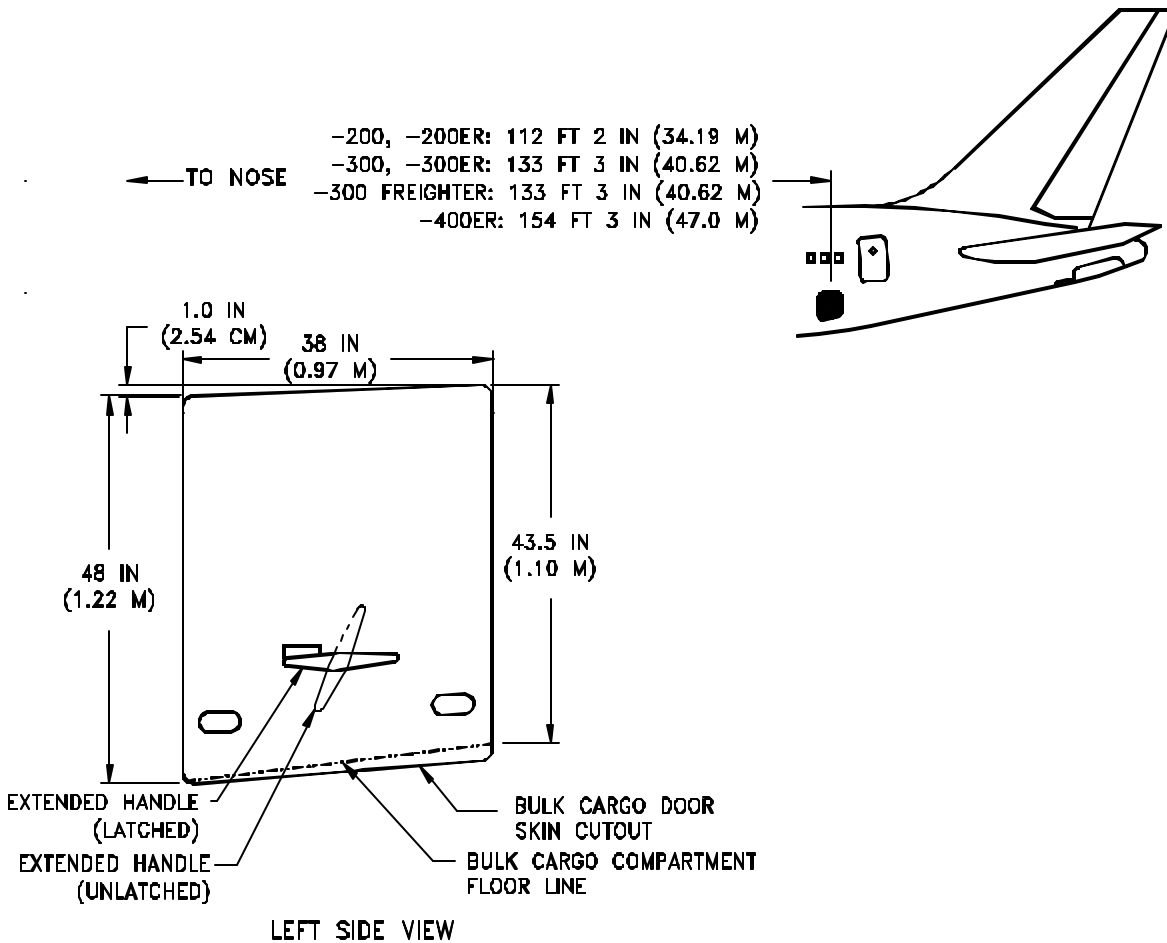

2.7.6 DOOR CLEARANCES - BULK CARGO DOOR

MODEL 767-200, -200ER, -300, -300ER, -300 FREIGHTER, -400ER

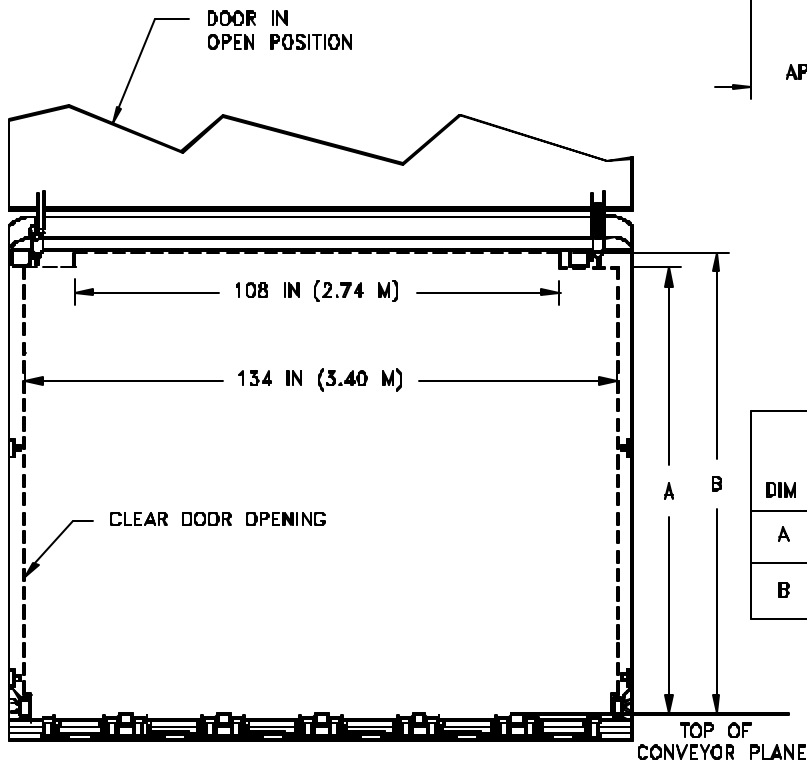
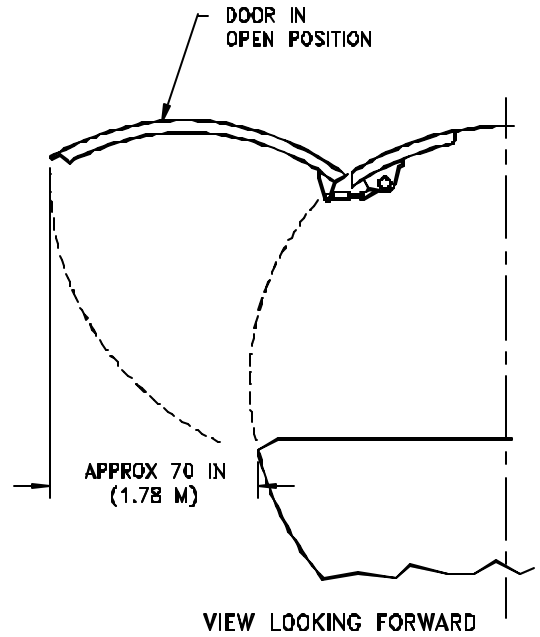
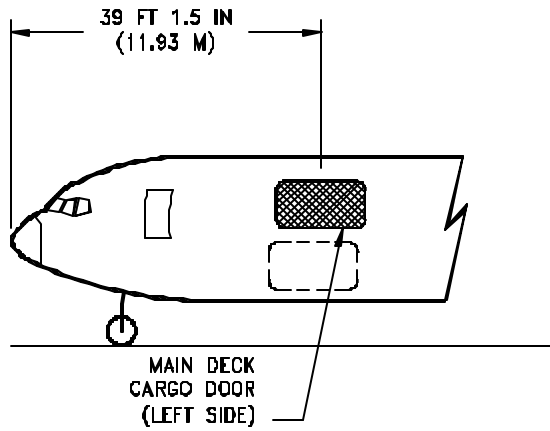

DIM	FREIGHTERS WITH POWERED CARGO HANDLING SYSTEM	FREIGHTERS WITH MANUAL CARGO HANDLING SYSTEM
A	100.70 IN (2.56 M)	103.70 IN (2.63 M)
B	100.00 IN (2.54 M)	103.00 IN (2.62 M)

LEFT SIDE VIEW

2.7.7 DOOR CLEARANCES – MAIN DECK CARGO DOOR
MODEL 767--300 FREIGHTER

THIS PAGE INTENTIONALLY LEFT BLANK

3.0 AIRPLANE PERFORMANCE

3.1 General Information

3.2 Payload/Range

3.3 F.A.R. Takeoff Runway Length Requirements

3.4 F.A.R. Landing Runway Length Requirements

3.0 AIRPLANE PERFORMANCE

3.1 General Information

The graph in Section 3.2 provides information on operational empty weight (OEW) and payload, trip range, brake release gross weight, and fuel limits for a typical 767-200, -200ER, -300, -300ER, -300 Freighter, and -400ER airplanes. To use this graph, if the trip range and zero fuel weight (OEW + payload) are known, the approximate brake release weight can be found, limited by fuel quantity.

The graphs in Section 3.3 provide information on F.A.R. takeoff runway length requirements with typical engines at different pressure altitudes. Maximum takeoff weights shown on the graphs are the heaviest for the particular airplane models with the corresponding engines. Standard day temperatures for pressure altitudes shown on the F.A.R. takeoff graphs are given below:

PRESSURE ALTITUDE		STANDARD DAY TEMP	
FEET	METERS	°F	°C
0	0	59.0	15.00
2,000	610	51.9	11.04
4,000	1,219	44.7	7.06
6,000	1,829	37.6	3.11
8,000	2,438	30.5	-0.85
10,000	3,048	23.3	-4.81

The graph in Section 3.4 provides information on landing runway length requirements for different airplane weights and airport altitudes. The maximum landing weights shown are the heaviest for the particular airplane model.

NOTES:

- 0.80 MACH AT 35,000 AND 39,000 FT (10,668 AND 11,887 METERS)
- ATA DOMESTIC RESERVES
- STANDARD DAY
- TAKEOFF WEIGHTS ARE 2,000 LB (970 KG) LESS THAN TAXI WEIGHTS
- CONSULT USING AIRLINE FOR SPECIFIC OPERATING PROCEDURE PRIOR TO FACILITY DESIGN

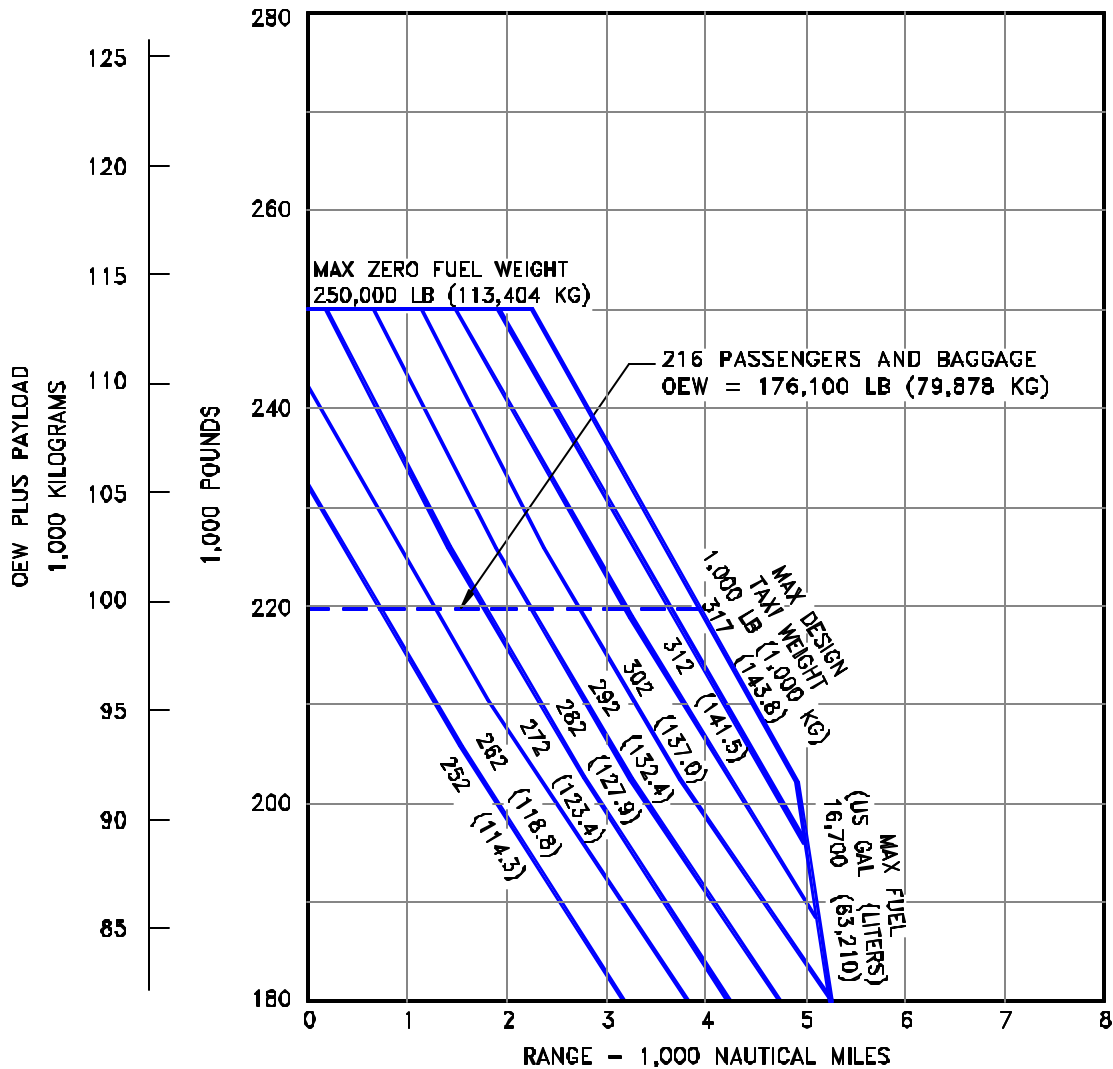

3.2.1 PAYLOAD/RANGE FOR LONG-RANGE CRUISE

MODEL 767-200

NOTES:

- 0.80 MACH AT 35,000 AND 39,000 FT (10,668 AND 11,887 METERS)
- ATA DOMESTIC RESERVES
- ◆ STANDARD DAY
- TAKEOFF WEIGHTS ARE 1,000 LB (454 KG) LESS THAN TAXI WEIGHTS
- ◆ CONSULT USING AIRLINE FOR SPECIFIC OPERATING PROCEDURE PRIOR TO FACILITY DESIGN

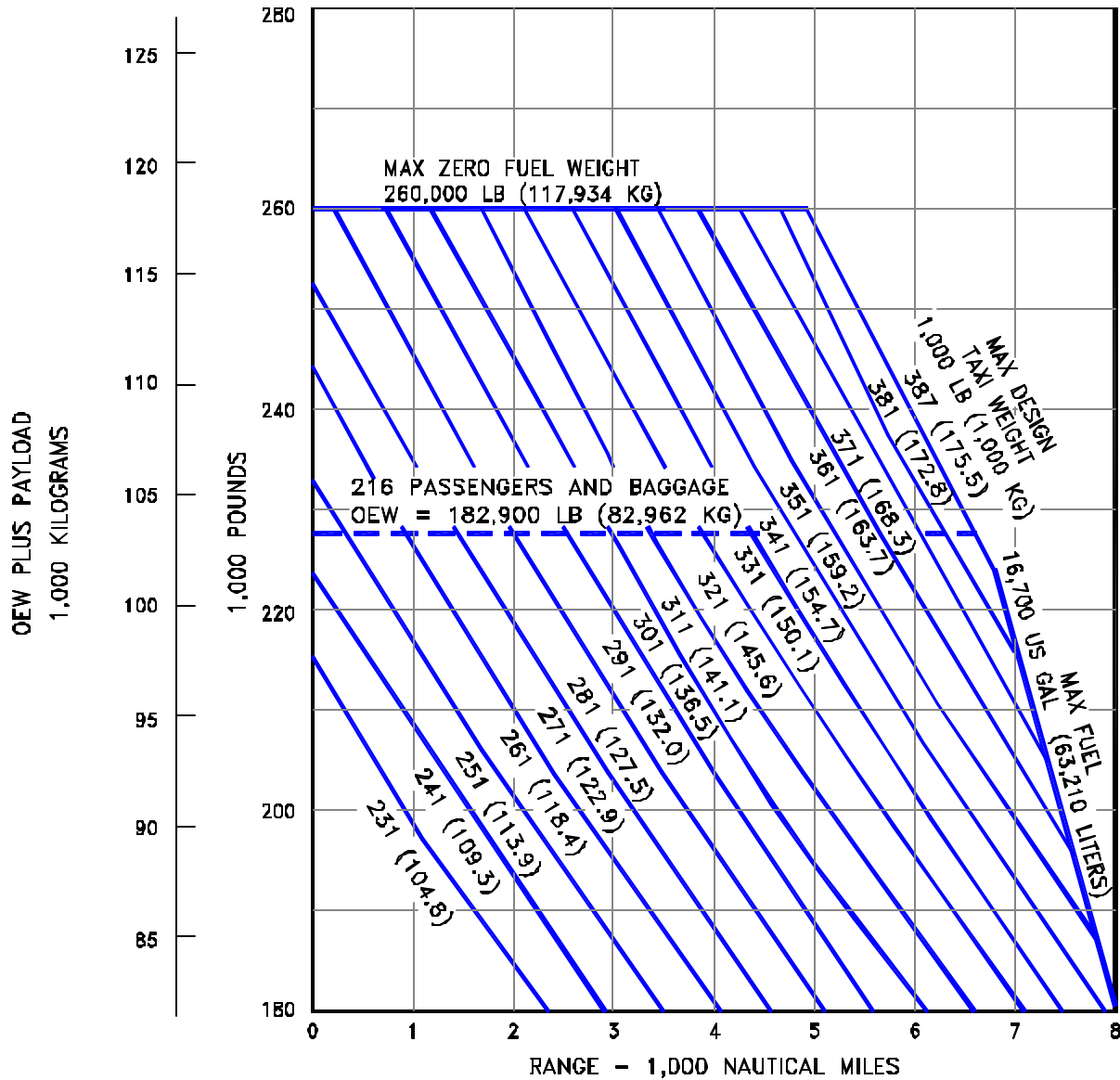

3.2.2 PAYLOAD/RANGE FOR LONG-RANGE CRUISE

MODEL 767-200ER

D6-58328

NOTES:

- 0.80 MACH AT 35,000 AND 39,000 FT (10,668 AND 11,887 METERS)
- ATA DOMESTIC RESERVES
- STANDARD DAY
- TAKEOFF WEIGHTS ARE 2,000 LB (907 KG) LESS THAN TAXI WEIGHTS
- CONSULT USING AIRLINE FOR SPECIFIC OPERATING PROCEDURE PRIOR TO FACILITY DESIGN

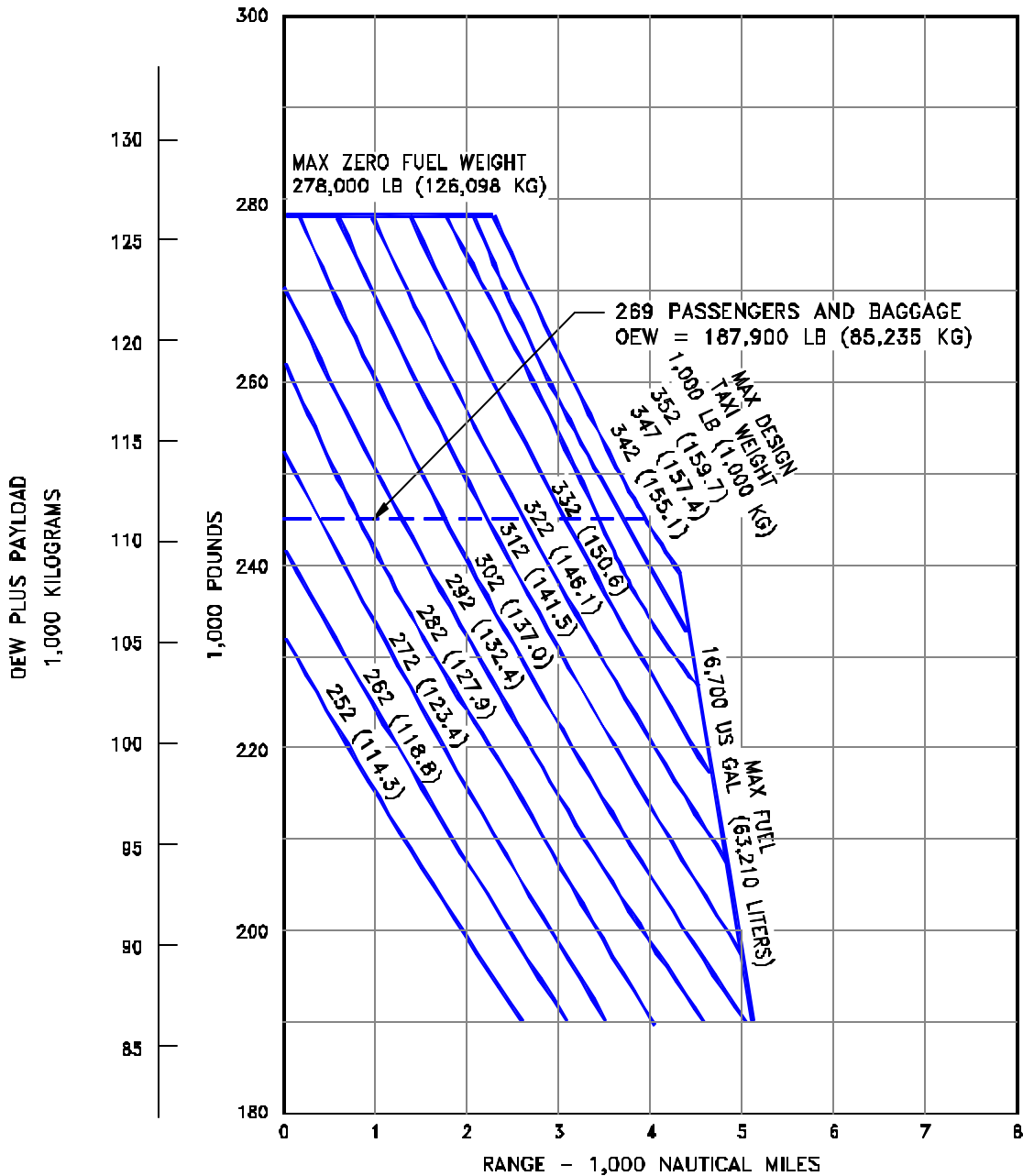

3.2.3 PAYLOAD/RANGE FOR LONG-RANGE CRUISE

MODEL 767-300

NOTES:

- 0.80 MACH AT 35,000 AND 39,000 FT (10,668 AND 11,887 METERS)
- ATA DOMESTIC RESERVES
- STANDARD DAY
- TAKEOFF WEIGHTS ARE 1,000 LB (454 KG) LESS THAN TAXI WEIGHTS
- CONSULT USING AIRLINE FOR SPECIFIC OPERATING PROCEDURE PRIOR TO FACILITY DESIGN

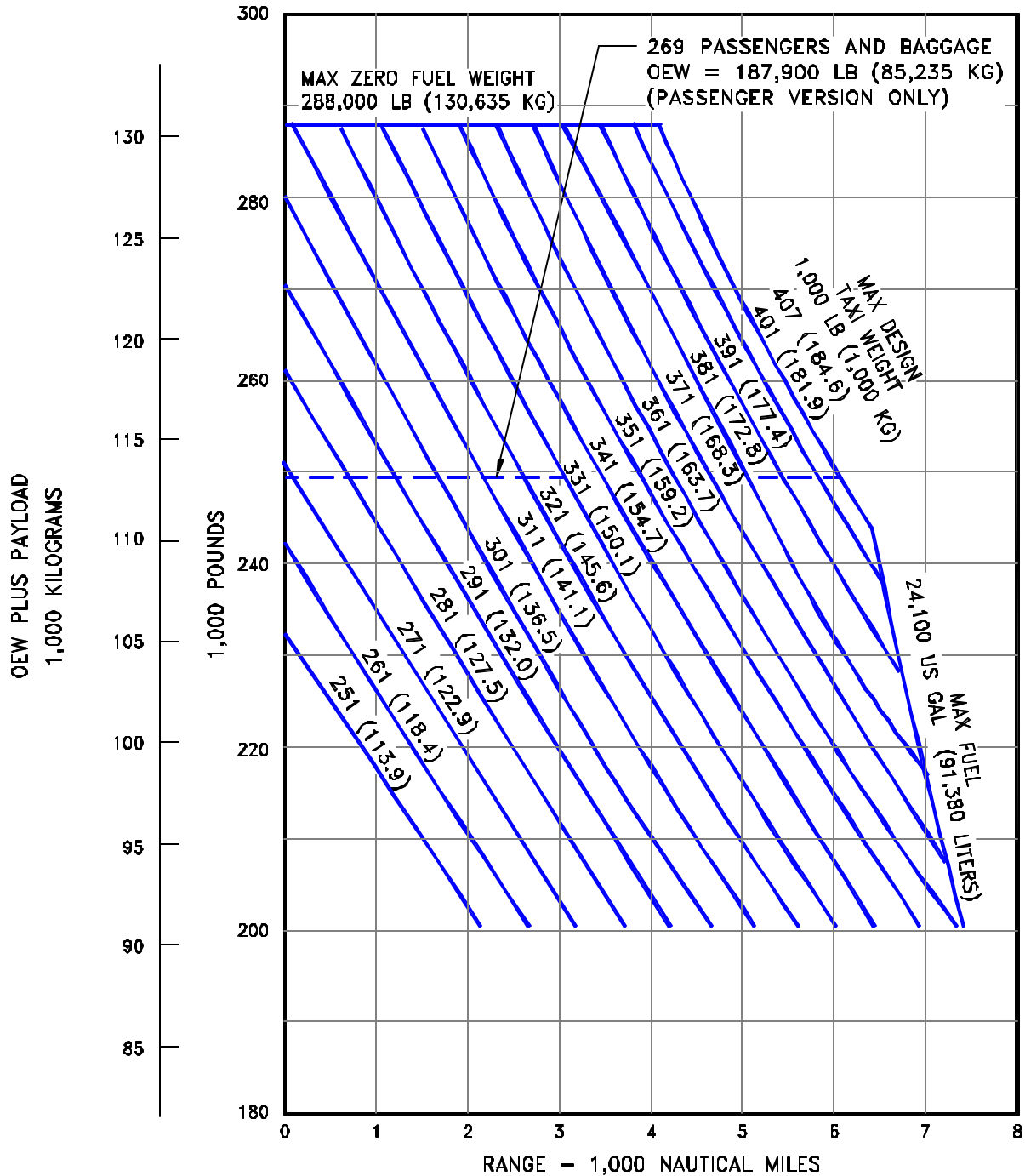

3.2.4 PAYLOAD/RANGE FOR LONG-RANGE CRUISE

MODEL 767-300ER-300 FREIGHTER

D6-58328

NOTES:

- 0.80 MACH AT 35,000 AND 39,000 FT (10,668 AND 11,887 METERS)
- ATA DOMESTIC RESERVES
- STANDARD DAY
- TAKEOFF WEIGHTS ARE 1,000 LB (454 KG) LESS THAN TAXI WEIGHTS
- CONSULT USING AIRLINE FOR SPECIFIC OPERATING PROCEDURE PRIOR TO FACILITY DESIGN

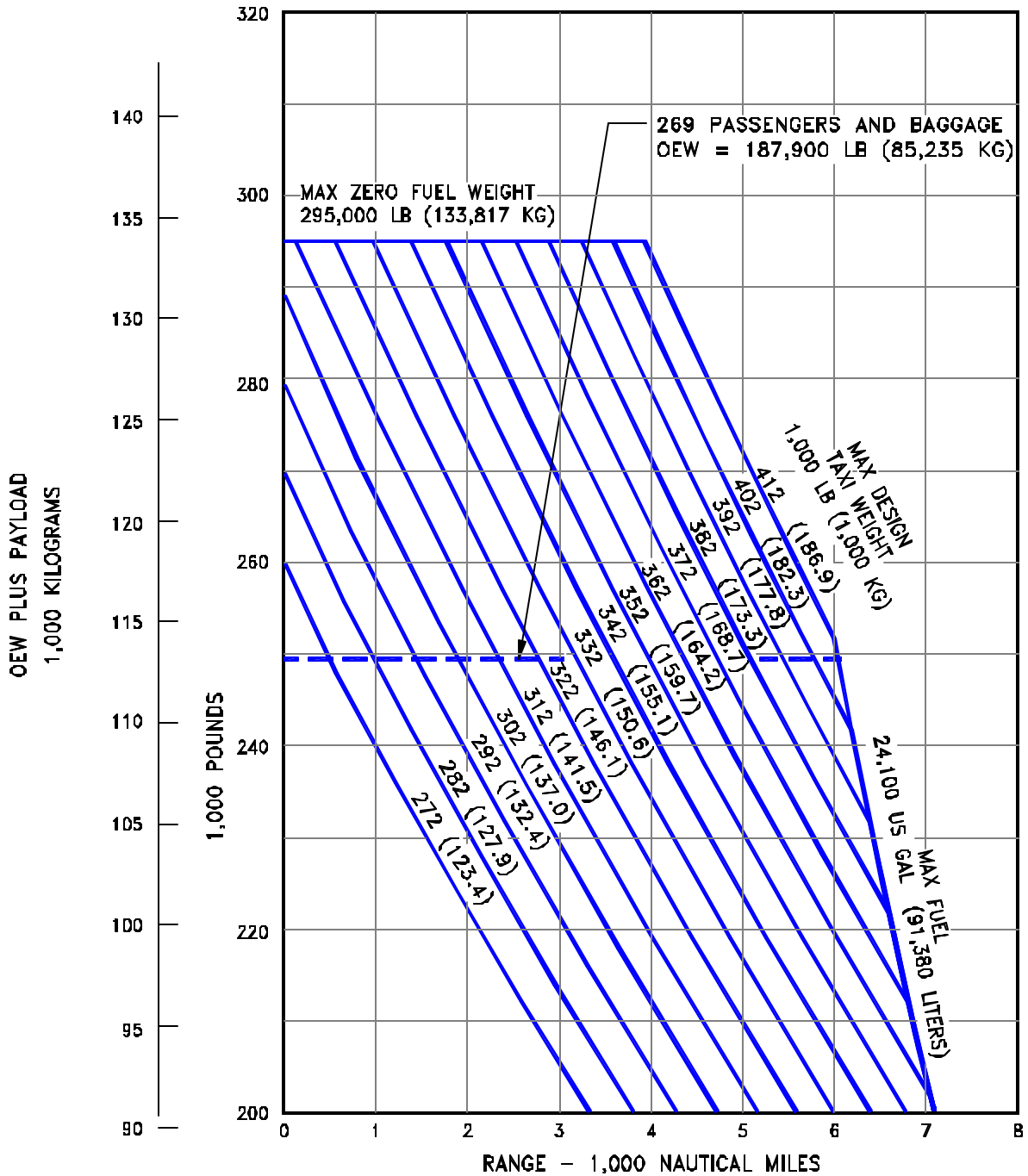

3.2.5 PAYLOAD/RANGE FOR LONG-RANGE CRUISE

MODEL 767-300ER (CF6-80C2B7F1 ENGINES)

NOTES:

- 0.80 MACH AT 35,000 AND 39,000 FT (10,668 AND 11,887 METERS)
- ATA DOMESTIC RESERVES
- STANDARD DAY
- TAKEOFF WEIGHTS ARE 1,000 LB (454 KG) LESS THAN TAXI WEIGHTS
- CONSULT USING AIRLINE FOR SPECIFIC OPERATING PROCEDURE PRIOR TO FACILITY DESIGN

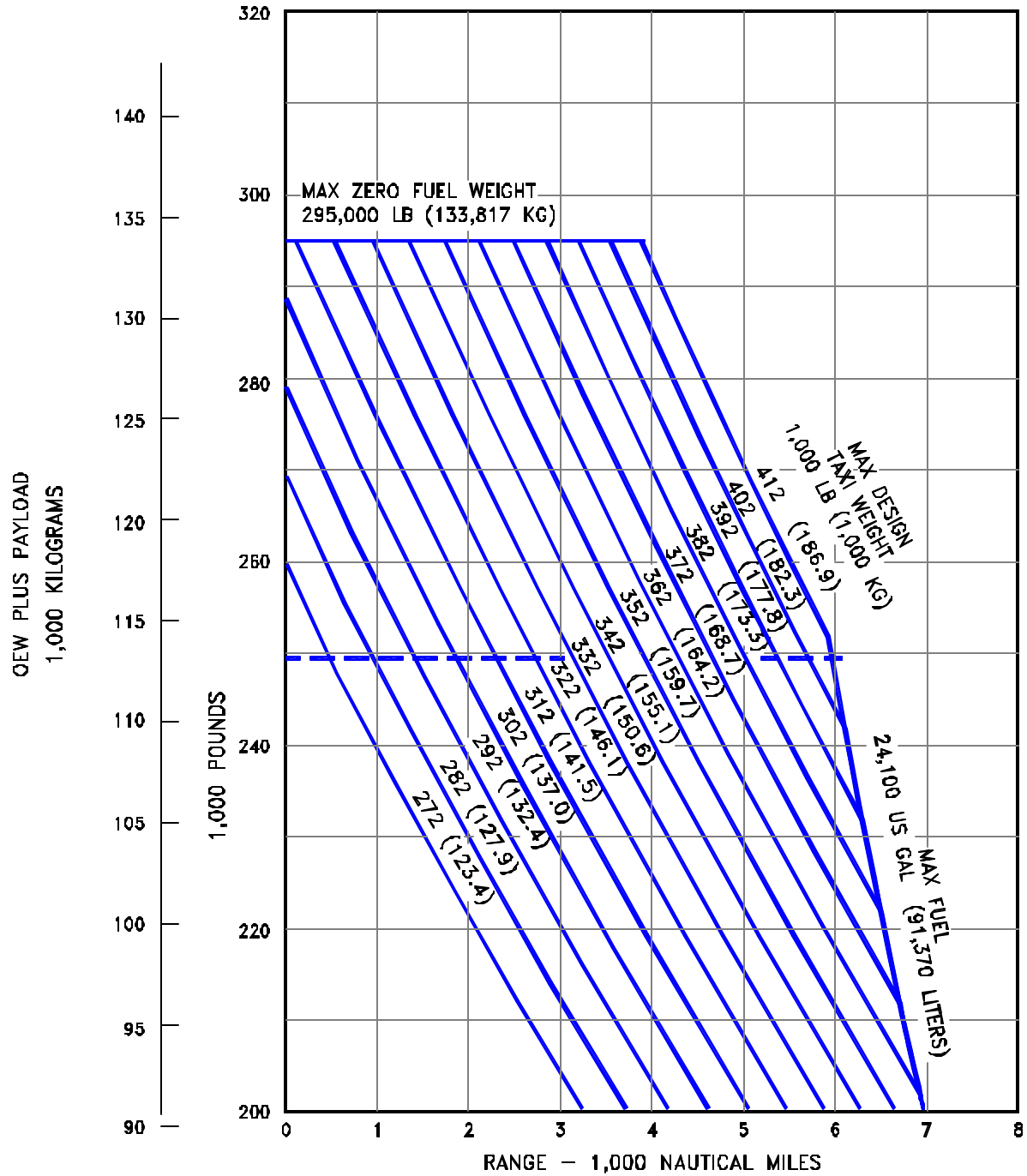

3.2.6 PAYLOAD/RANGE FOR LONG-RANGE CRUISE

MODEL 767-300ER (PW4062 ENGINES)

D6-58328

NOTES:

- 0.80 MACH AT 35,000 AND 39,000 FT (10,668 AND 11,887 METERS)
- ATA DOMESTIC RESERVES
- STANDARD DAY
- TAKEOFF WEIGHTS ARE 1,000 LB (454 KG) LESS THAN TAXI WEIGHTS
- CONSULT USING AIRLINE FOR SPECIFIC OPERATING PROCEDURE PRIOR TO FACILITY DESIGN

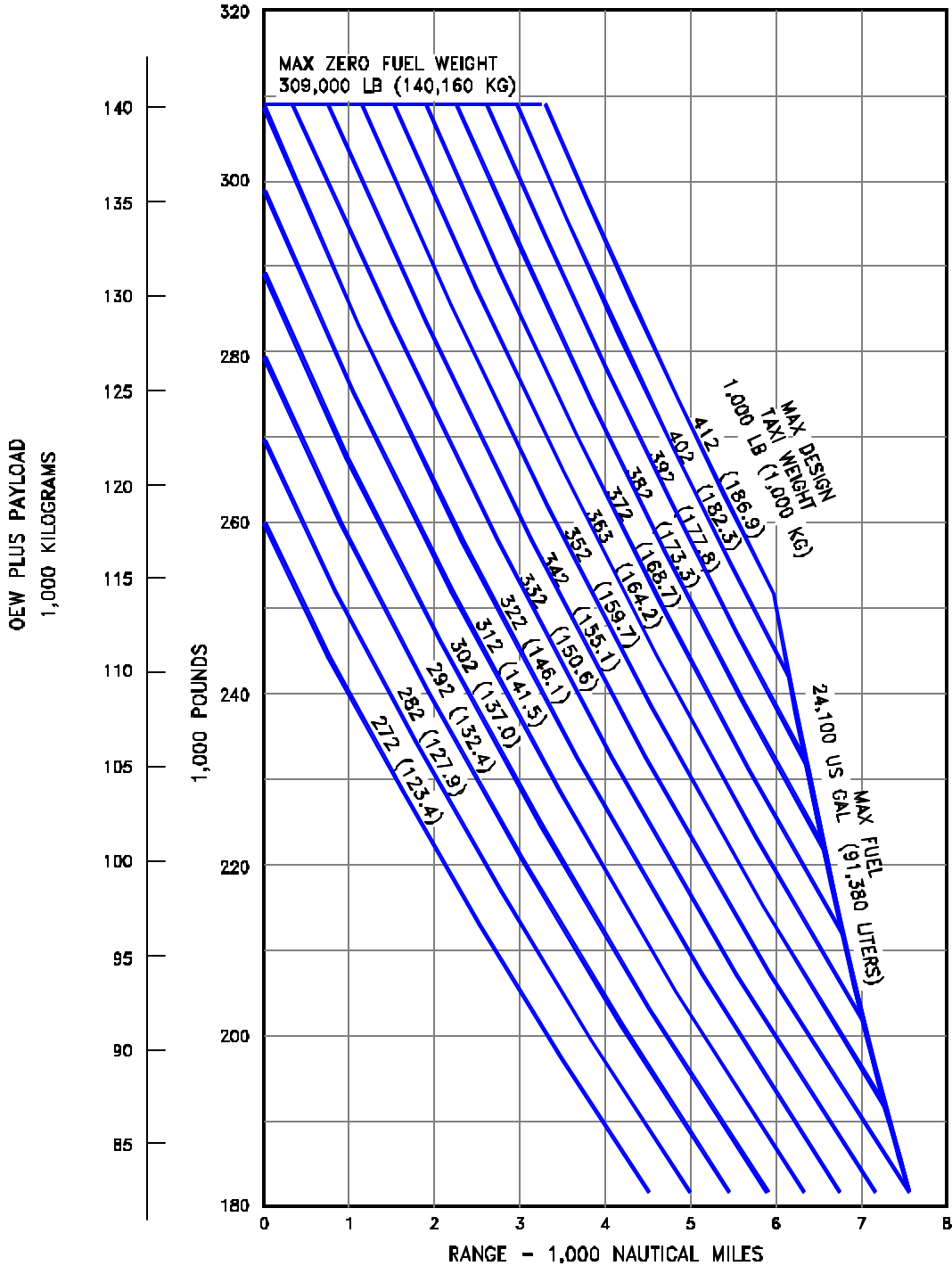

3.2.7 PAYLOAD/RANGE FOR LONG-RANGE CRUISE
 MODEL 767-300 FREIGHTER (CF6-80C2B7F1 ENGINES)

NOTES:

- 0.80 MACH AT 35,000 AND 39,000 FT (10,668 AND 11,887 METERS)
- ATA DOMESTIC RESERVES
- STANDARD DAY
- TAKEOFF WEIGHTS ARE 1,000 LB (454 KG) LESS THAN TAXI WEIGHTS
- CONSULT USING AIRLINE FOR SPECIFIC OPERATING PROCEDURE PRIOR TO FACILITY DESIGN

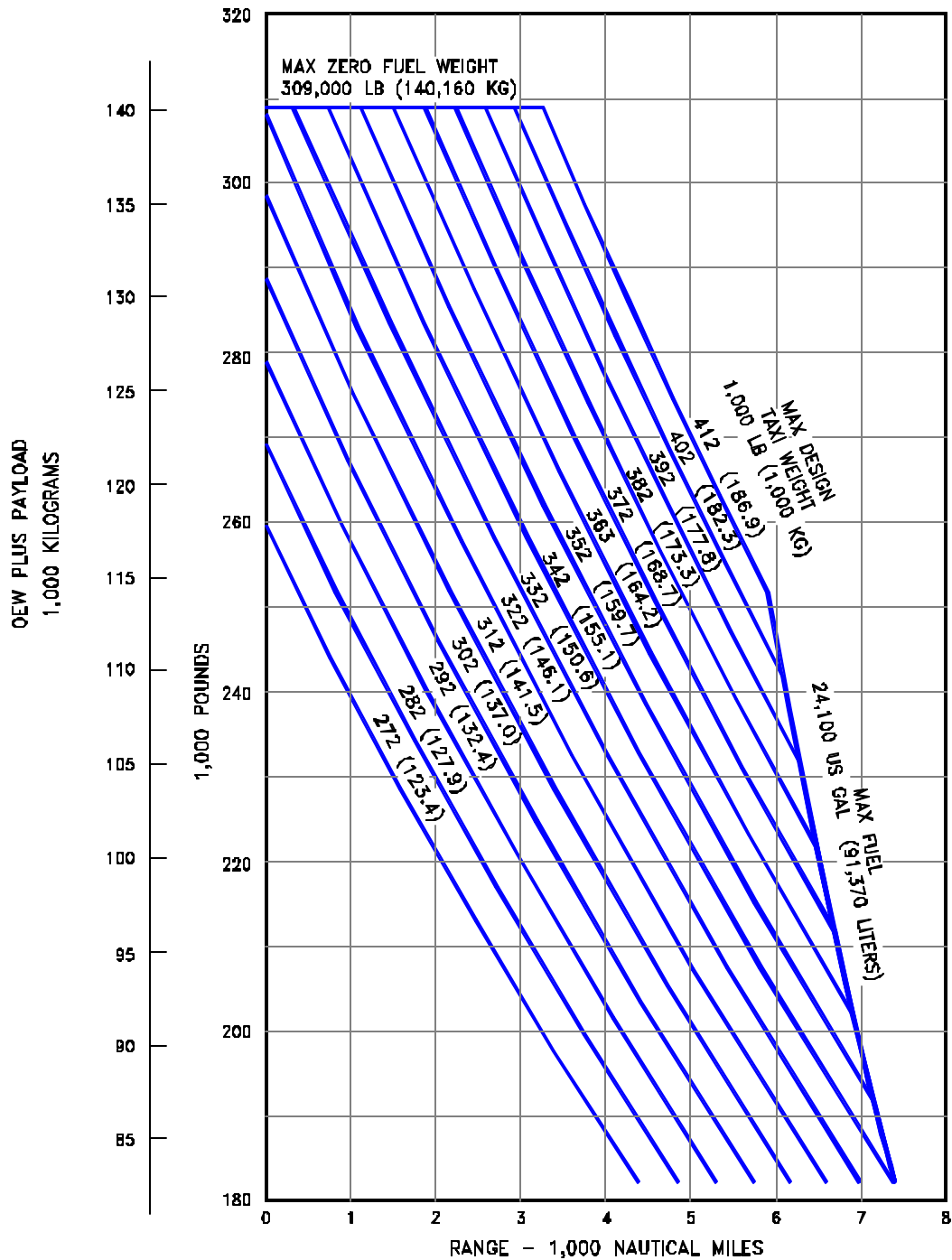

3.2.8 PAYLOAD/RANGE FOR LONG-RANGE CRUISE
 MODEL 767-300 FREIGHTER (PW4062 ENGINES)

D6-58328

NOTES:

- CF6-80C2B8F ENGINES
- 31-35-39,000 FT STEP CRUISE
- CRUISE MACH = 0.80
- TYPICAL MISSION RULES
- STANDARD DAY
- 200 NMI ALTERNATE
- NOMINAL PERFORMANCE
- TAKEOFF WEIGHTS ARE 1000 LB LESS THAN CORRESPONDING TAXI WEIGHTS
- CONSULT USING AIRLINES FOR SPECIFIC OPERATING PROCEDURES PRIOR TO FACILITY DESIGN

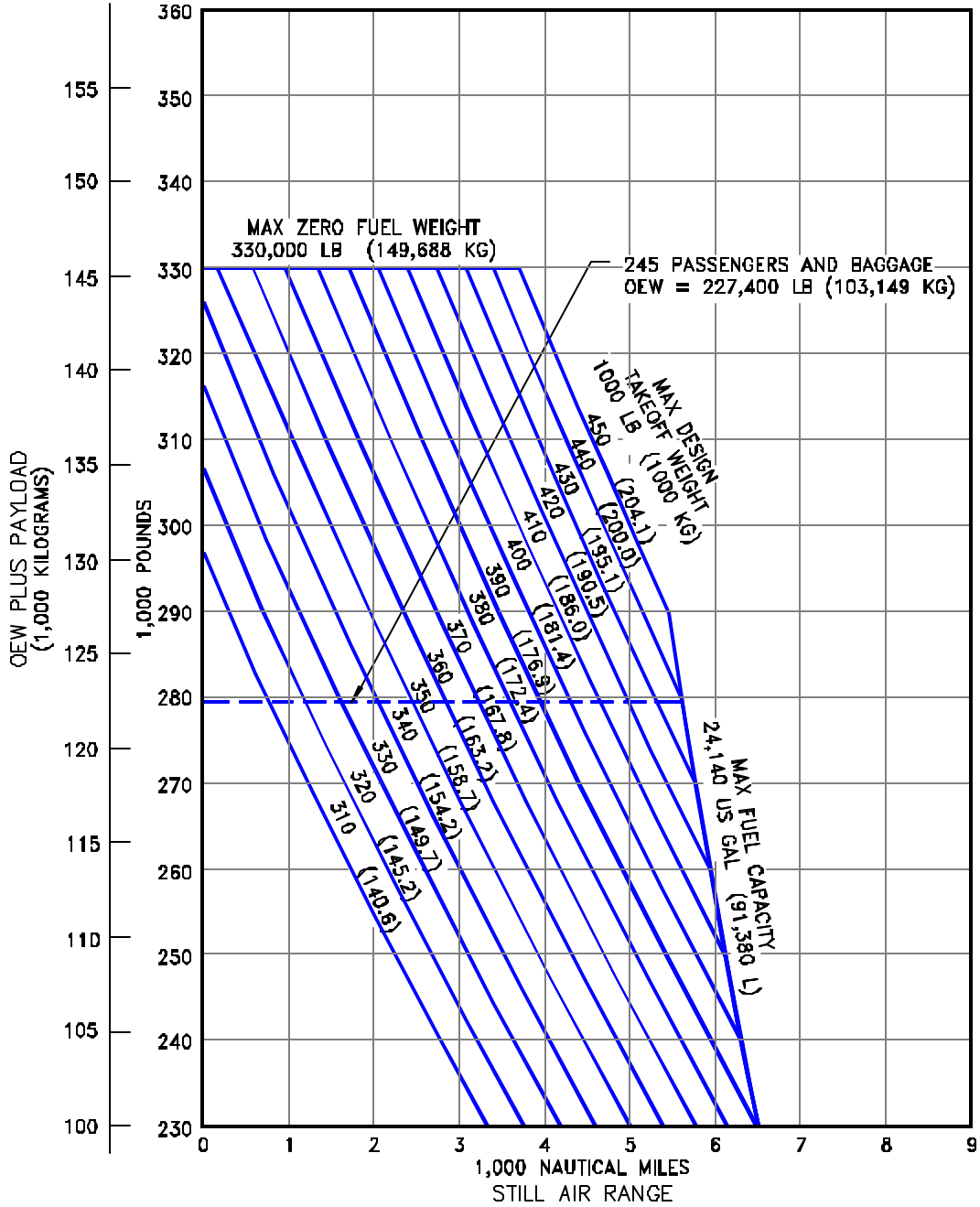

3.2.9 PAYLOAD/RANGE FOR LONG-RANGE CRUISE

MODEL 767-400ER (CF6-80C2B8 ENGINES)

NOTES:

- PW4062 ENGINES
- 31-35-39,000 FT STEP CRUISE
- CRUISE MACH = 0.80
- TYPICAL MISSION RULES
- STANDARD DAY
- 200 NMI ALTERNATE
- NOMINAL PERFORMANCE
- TAKEOFF WEIGHTS ARE 1000 LB LESS THAN CORRESPONDING TAXI WEIGHTS
- CONSULT USING AIRLINES FOR SPECIFIC OPERATING PROCEDURES PRIOR TO FACILITY DESIGN

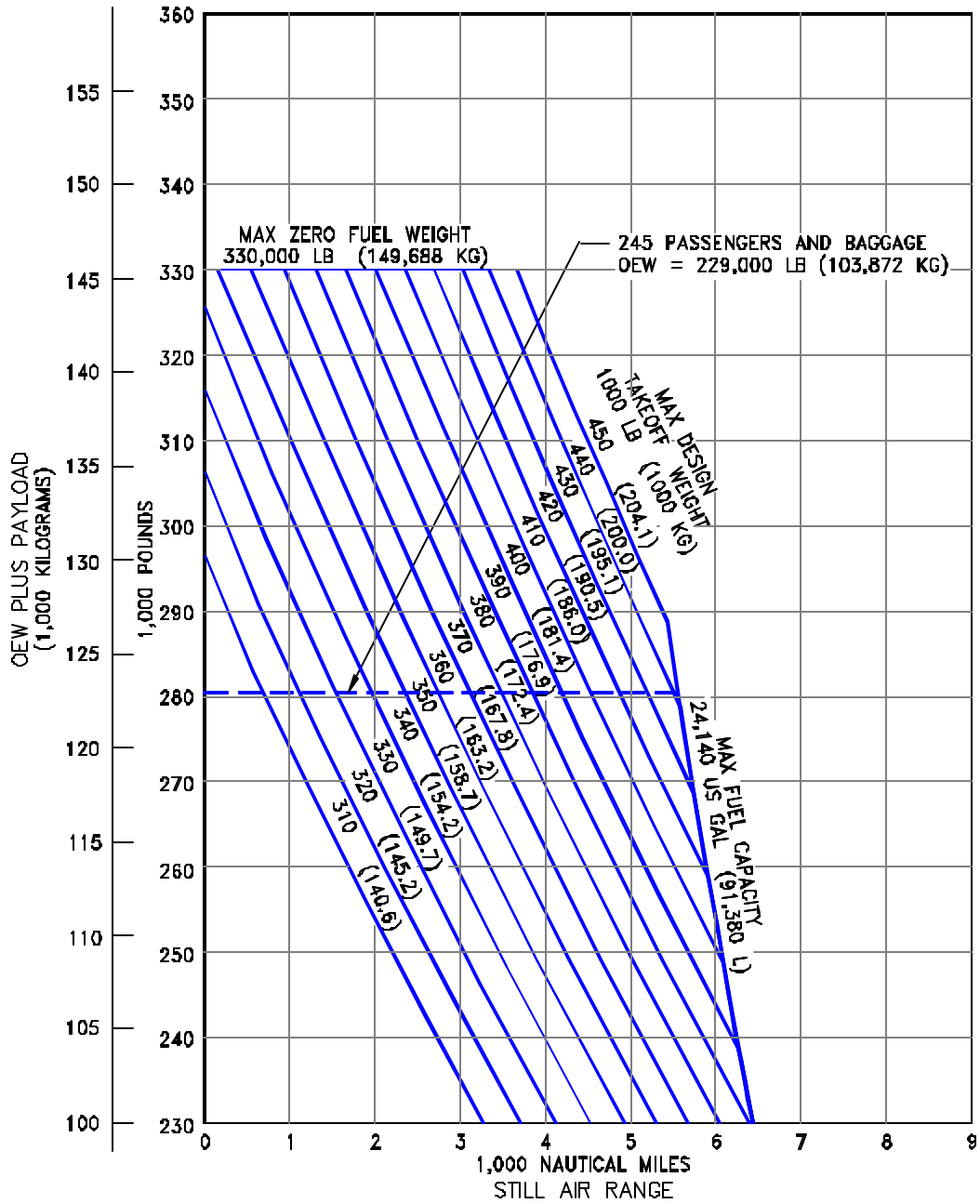

3.2.10 PAYLOAD/RANGE FOR LONG-RANGE CRUISE

MODEL 767-400ER (PW4062 ENGINES)

NOTES:

- JT9D-7R4D/7R4E, CF6-80A/80A2 ENGINES
- ZERO RUNWAY GRADIENT
- ZERO WIND
- AIR CONDITIONING OFF
- CONSULT USING AIRLINE FOR SPECIFIC OPERATING PROCEDURE PRIOR TO FACILITY DESIGN

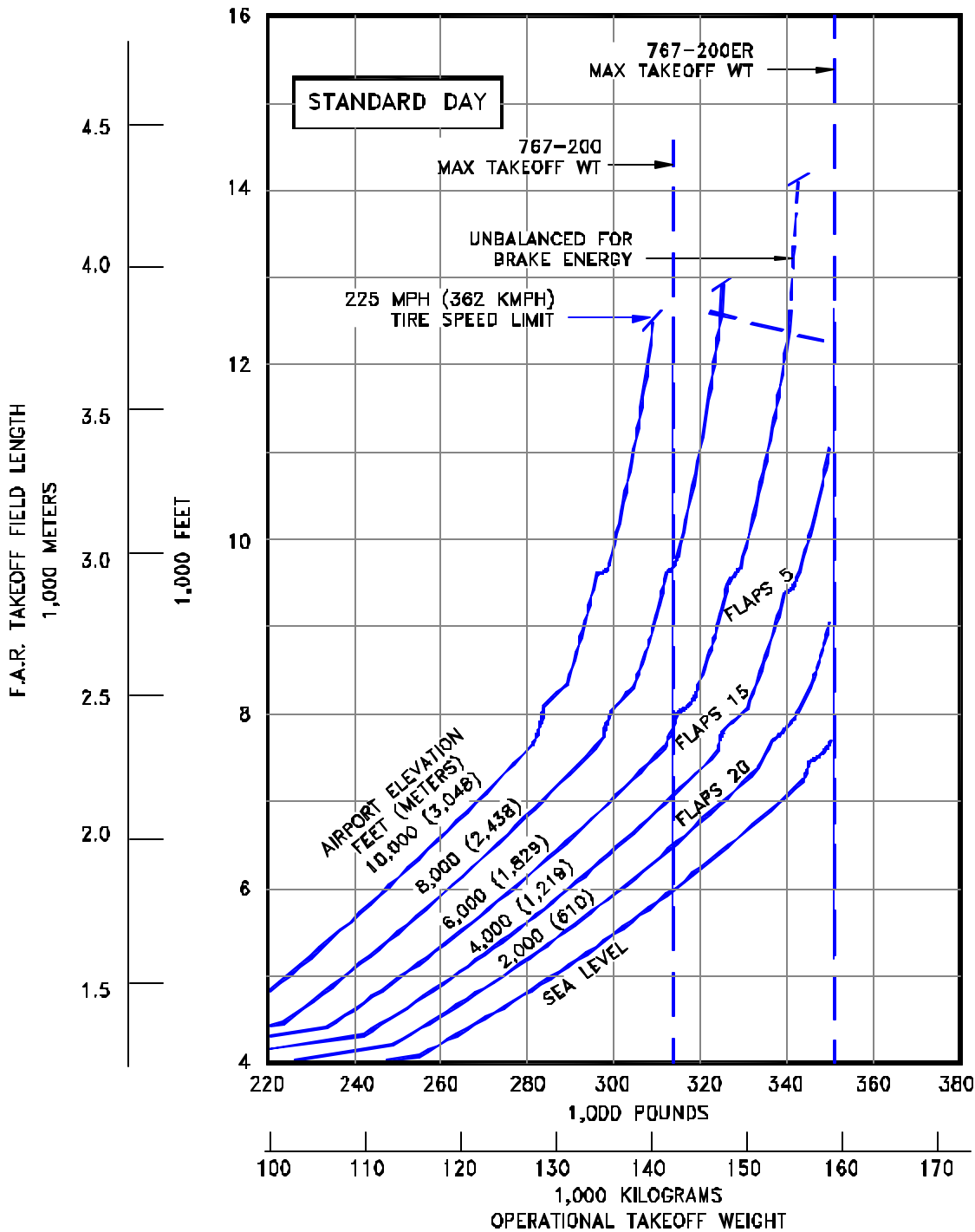

3.3.1 F.A.R. TAKEOFF RUNWAY LENGTH REQUIREMENTS - STANDARD DAY

MODEL 767-200, -200ER (JT9D-7R4D/7R4E , CF6-80A/80A2 ENGINES)

NOTES:

- JT9D-7R4D/7R4E, CF6-80A/80A2 ENGINES
- ZERO RUNWAY GRADIENT
- ZERO WIND
- AIR CONDITIONING OFF
- CONSULT USING AIRLINE FOR SPECIFIC OPERATING PROCEDURE PRIOR TO FACILITY DESIGN

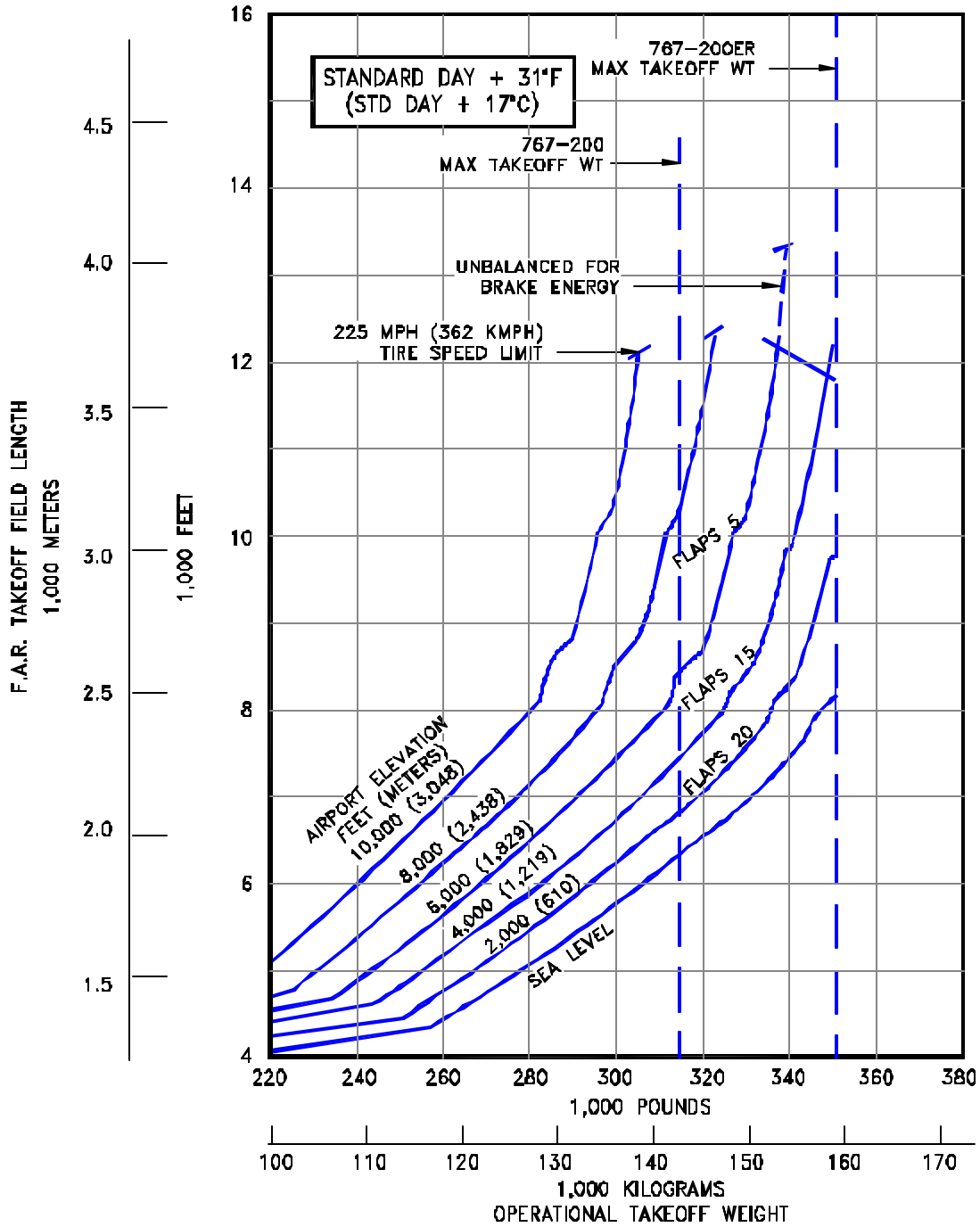

3.3.2 F.A.R. TAKEOFF RUNWAY LENGTH REQUIREMENTS

STANDARD DAY +31°F (STD + 17°C)

MODEL 767-200, -200ER (JT9D-7R4D/7R4E, CF6-80A/80A2 ENGINES)

NOTES:

- CF6-80C2B2, PW4052 ENGINES
- ZERO RUNWAY GRADIENT
- ZERO WIND
- AIR CONDITIONING OFF
- CONSULT USING AIRLINE FOR SPECIFIC OPERATING PROCEDURE PRIOR TO FACILITY DESIGN

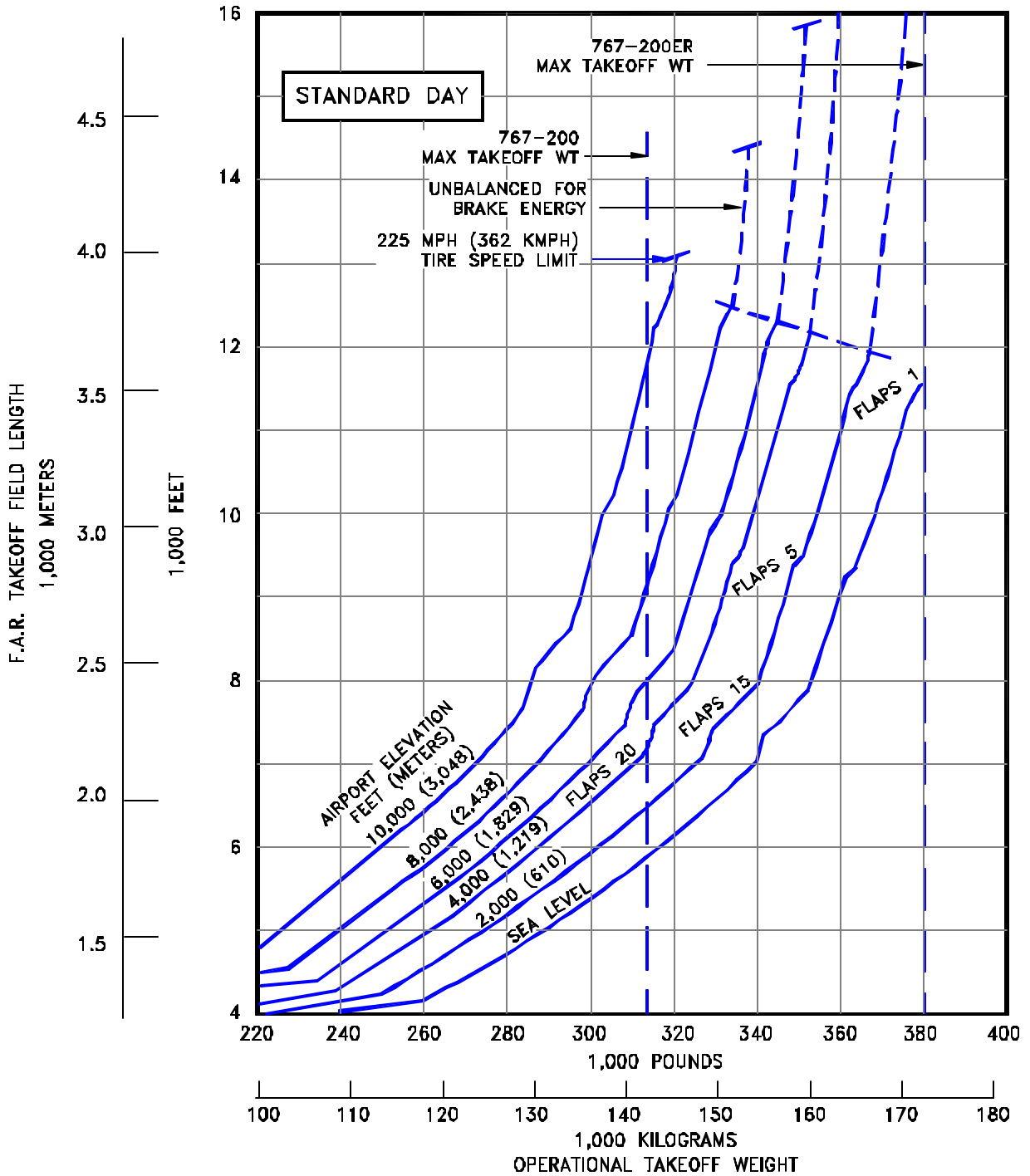

3.3.3 F.A.R. TAKEOFF RUNWAY LENGTH REQUIREMENTS - STANDARD DAY

MODEL 767-200, -200ER (CF6-80C2B2, PW4052 ENGINES)

NOTES:

- CF6-80C2B2, PW4052 ENGINES
- ZERO RUNWAY GRADIENT
- ZERO WIND
- AIR CONDITIONING OFF
- CONSULT USING AIRLINE FOR SPECIFIC OPERATING PROCEDURE PRIOR TO FACILITY DESIGN

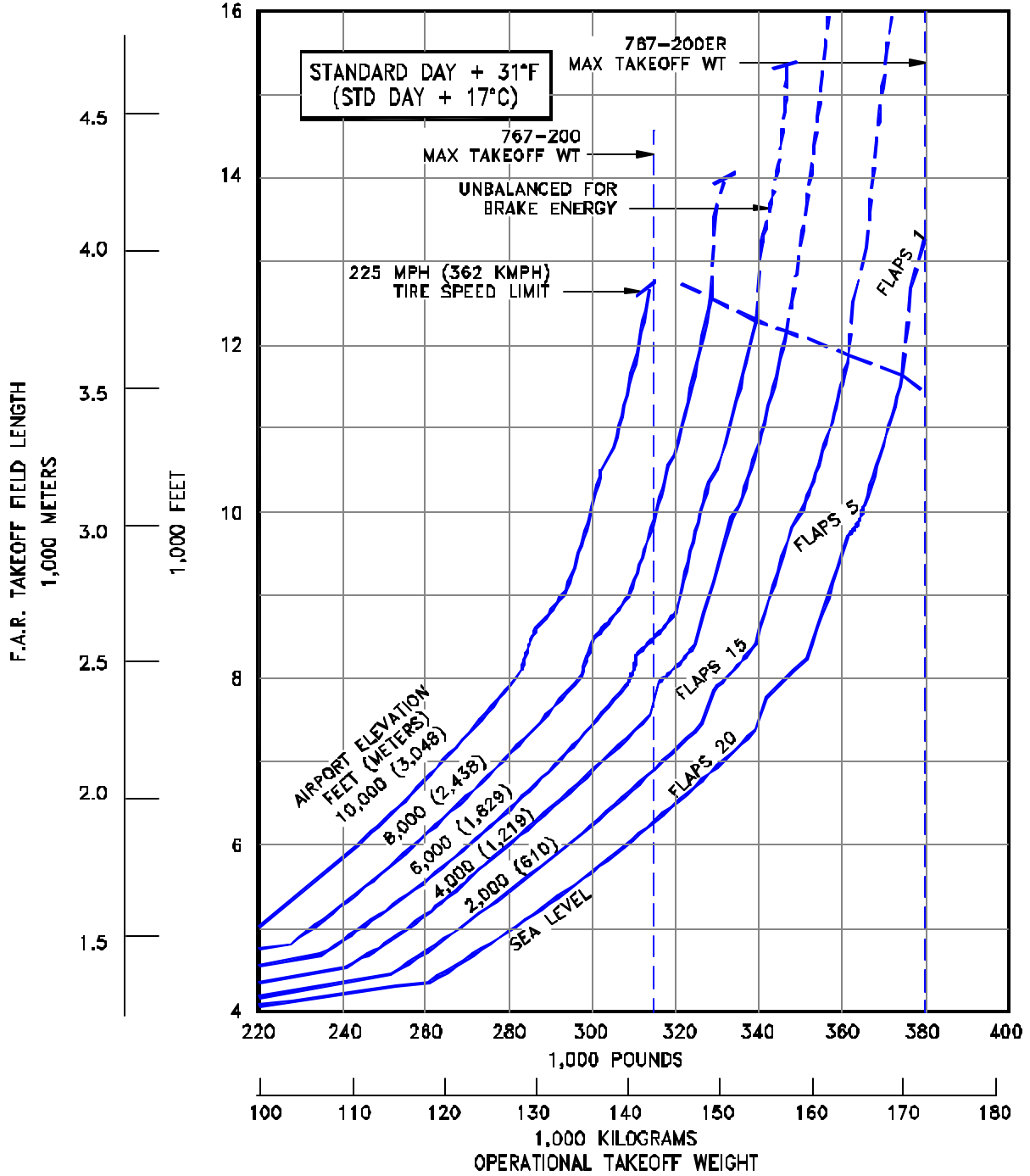

3.3.4 F.A.R. TAKEOFF RUNWAY LENGTH REQUIREMENTS

STANDARD DAY +31°F (STD + 17°C)

MODEL 767-200, -200ER (CF6-80C2B2, PW4052 ENGINES)

NOTES:

- CF6-80C2B4, PW4056, RB211-524G ENGINES
- ZERO RUNWAY GRADIENT
- ZERO WIND
- AIR CONDITIONING OFF
- CONSULT USING AIRLINE FOR SPECIFIC OPERATING PROCEDURE PRIOR TO FACILITY DESIGN

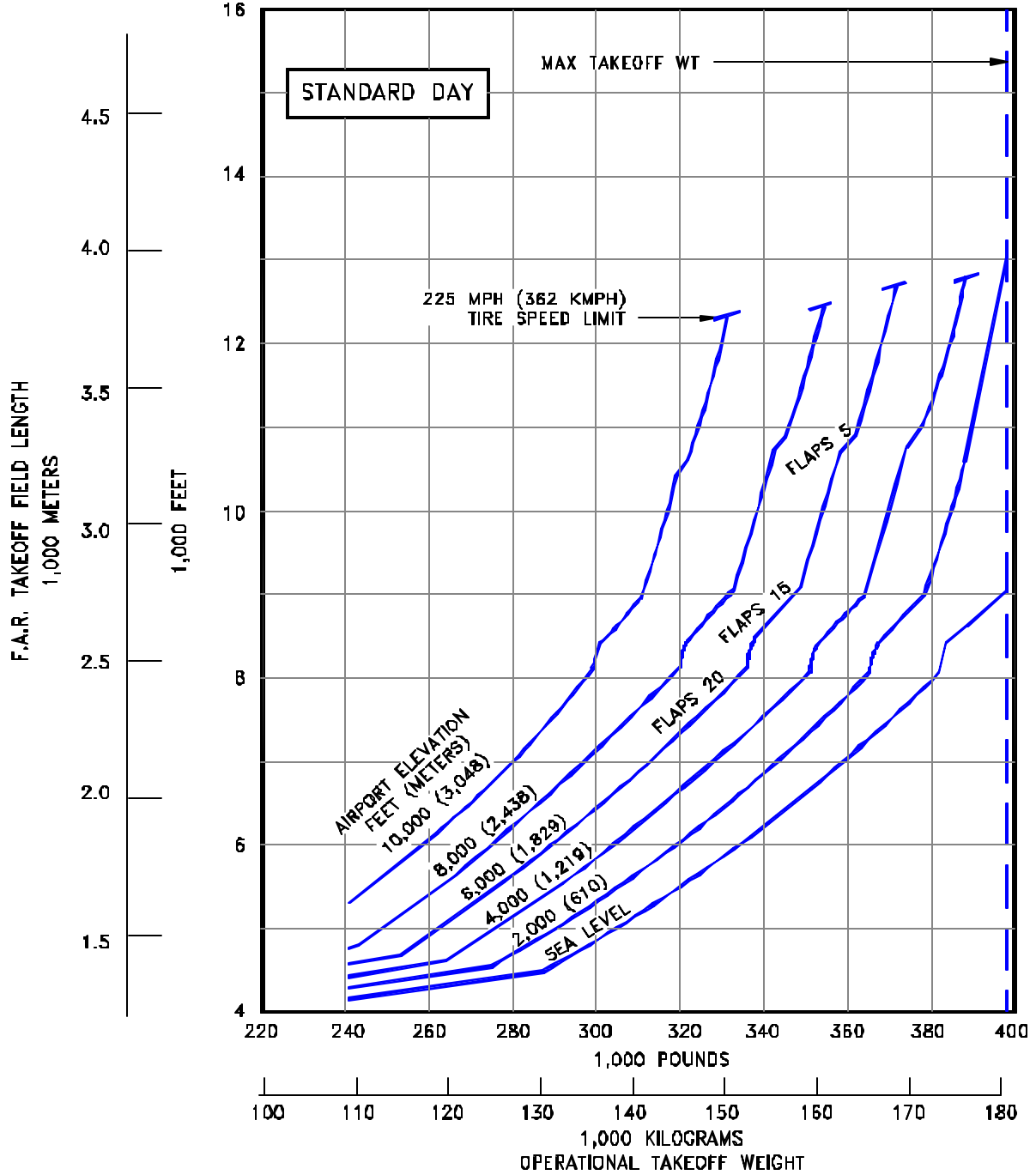

3.3.5 F.A.R. TAKEOFF RUNWAY LENGTH REQUIREMENTS - STANDARD DAY

MODEL 767-200ER (CF6-80C2B4, PW4056, RB211-524G ENGINES)

NOTES:

- CF6-80C2B4, PW4056, RB211-524G ENGINES
- ZERO RUNWAY GRADIENT
- ZERO WIND
- AIR CONDITIONING OFF
- CONSULT USING AIRLINE FOR SPECIFIC OPERATING PROCEDURE PRIOR TO FACILITY DESIGN

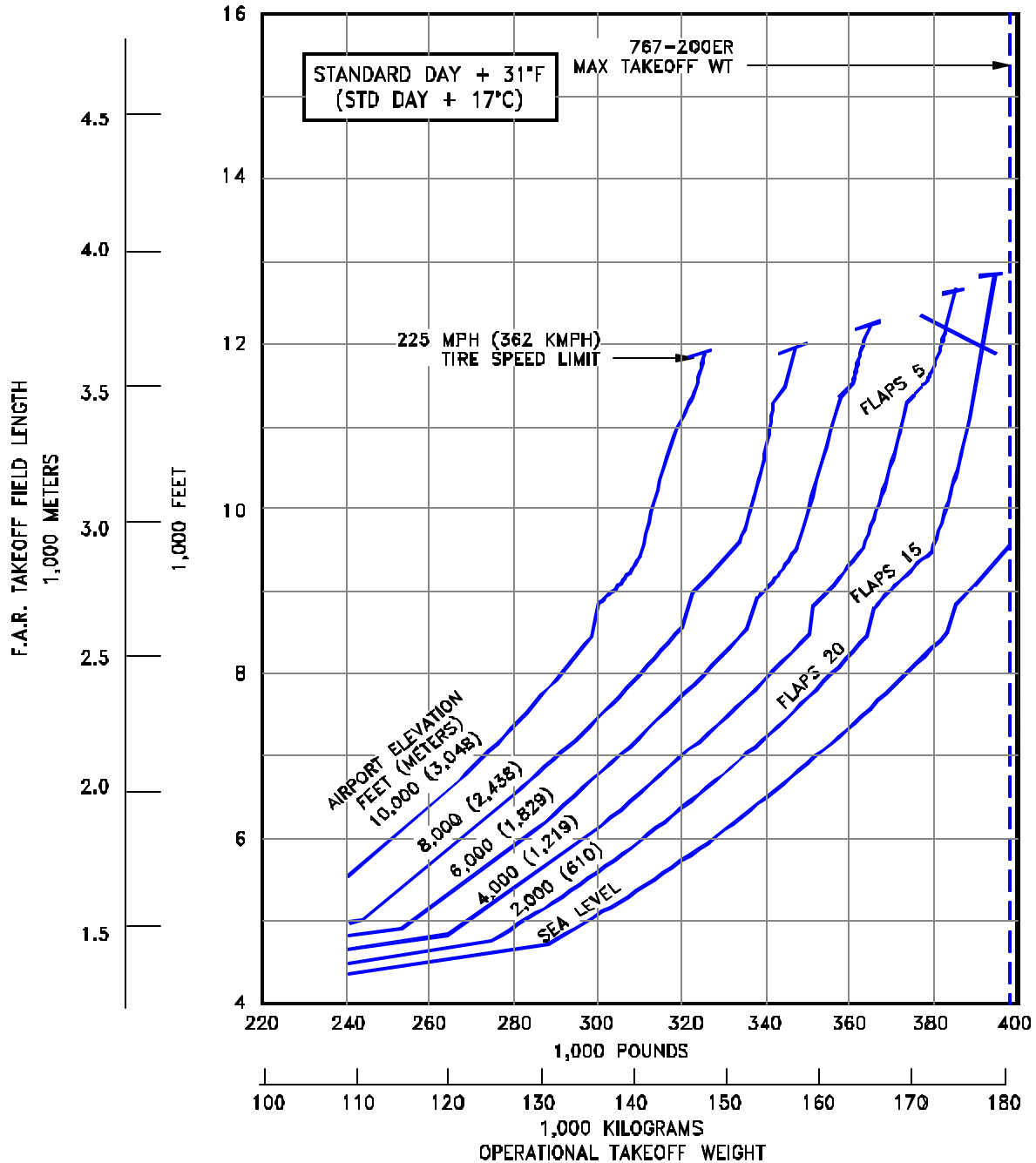

3.3.6 F.A.R. TAKEOFF RUNWAY LENGTH REQUIREMENTS

STANDARD DAY + 31°F (STD + 17°C)

MODEL 767-200ER (CF6-80C2B4, PW4056, RB211-524G ENGINES)

NOTES:

- CF6-80A/80A2 ENGINES
- ZERO RUNWAY GRADIENT
- ZERO WIND
- AIR CONDITIONING OFF
- CONSULT USING AIRLINE FOR SPECIFIC OPERATING PROCEDURE PRIOR TO FACILITY DESIGN

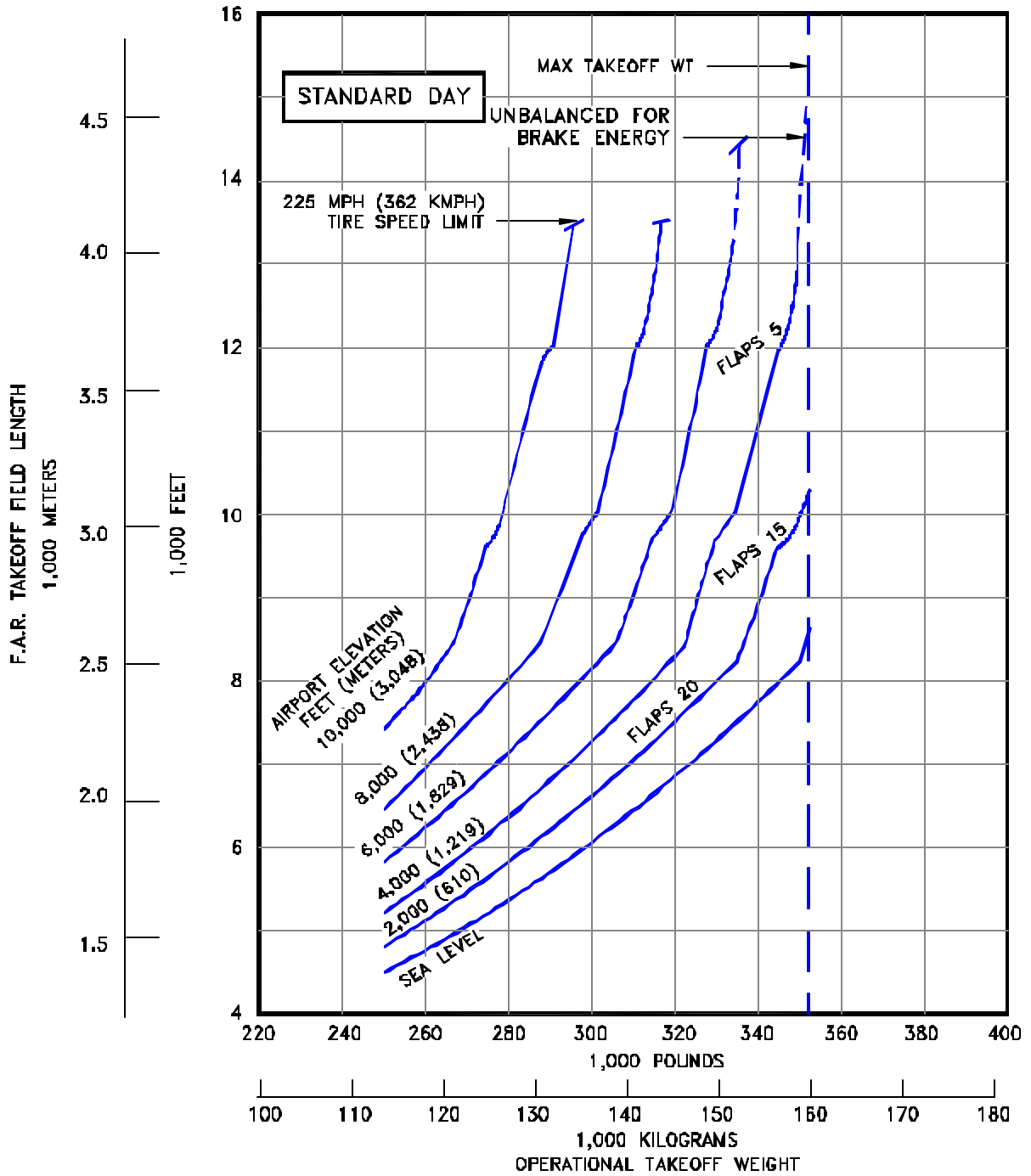

3.3.7 F.A.R. TAKEOFF RUNWAY LENGTH REQUIREMENTS - STANDARD DAY
 MODEL 767-300 (CF6-80A/80A2 ENGINES)

NOTES:

- CF6-80A/80A2 ENGINES
- ZERO RUNWAY GRADIENT
- ZERO WIND
- AIR CONDITIONING OFF
- CONSULT USING AIRLINE FOR SPECIFIC OPERATING PROCEDURE PRIOR TO FACILITY DESIGN

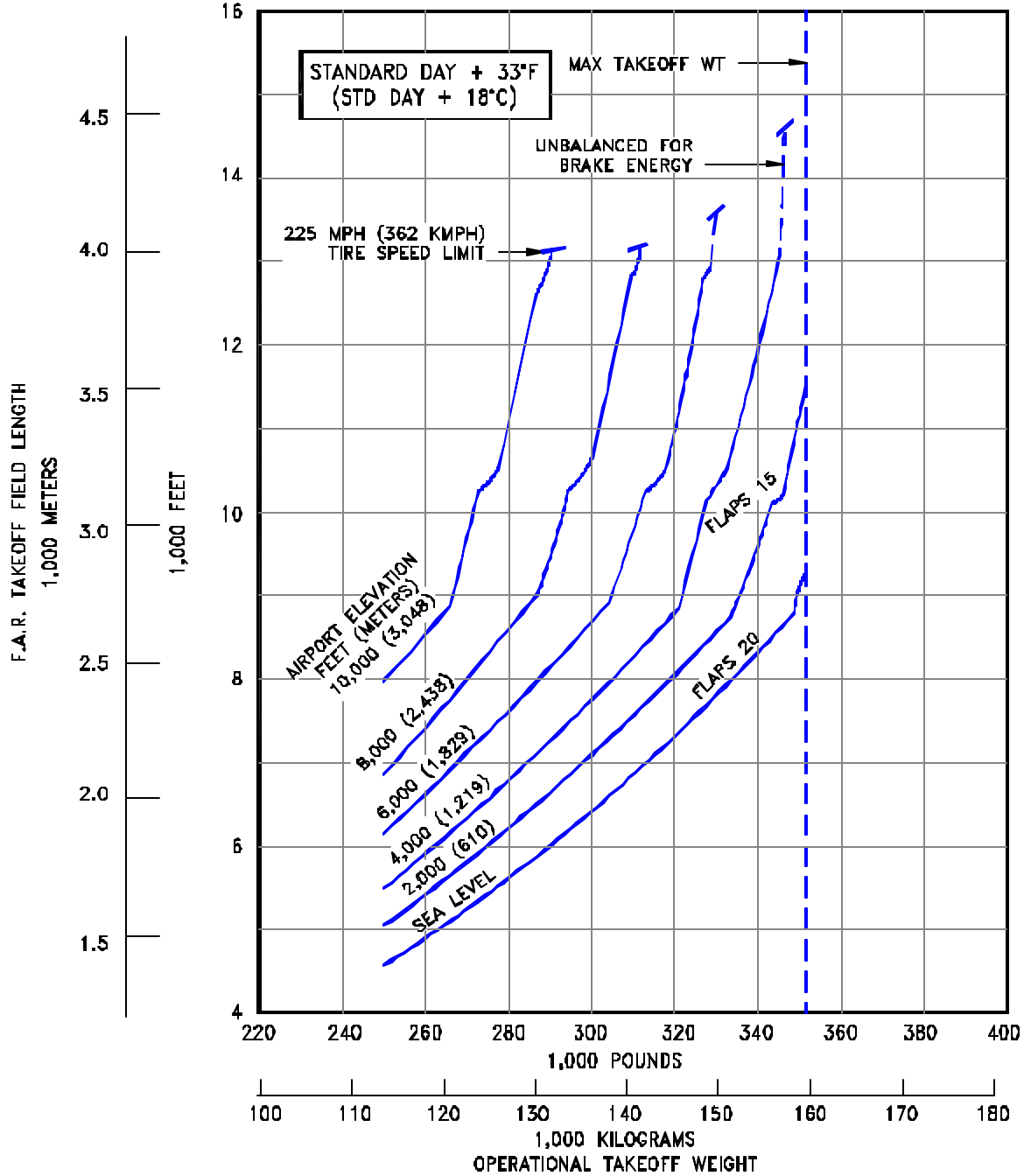

3.3.8 FAA TAKEOFF RUNWAY LENGTH REQUIREMENTS

STANDARD DAY + 33°F (STD + 18°C)

MODEL 767-300 (CF6-80A/80A2 ENGINES)

NOTES:

- JT9D-74RD/74RE ENGINES
- ZERO RUNWAY GRADIENT
- ZERO WIND
- AIR CONDITIONING OFF
- CONSULT USING AIRLINE FOR SPECIFIC OPERATING PROCEDURE PRIOR TO FACILITY DESIGN

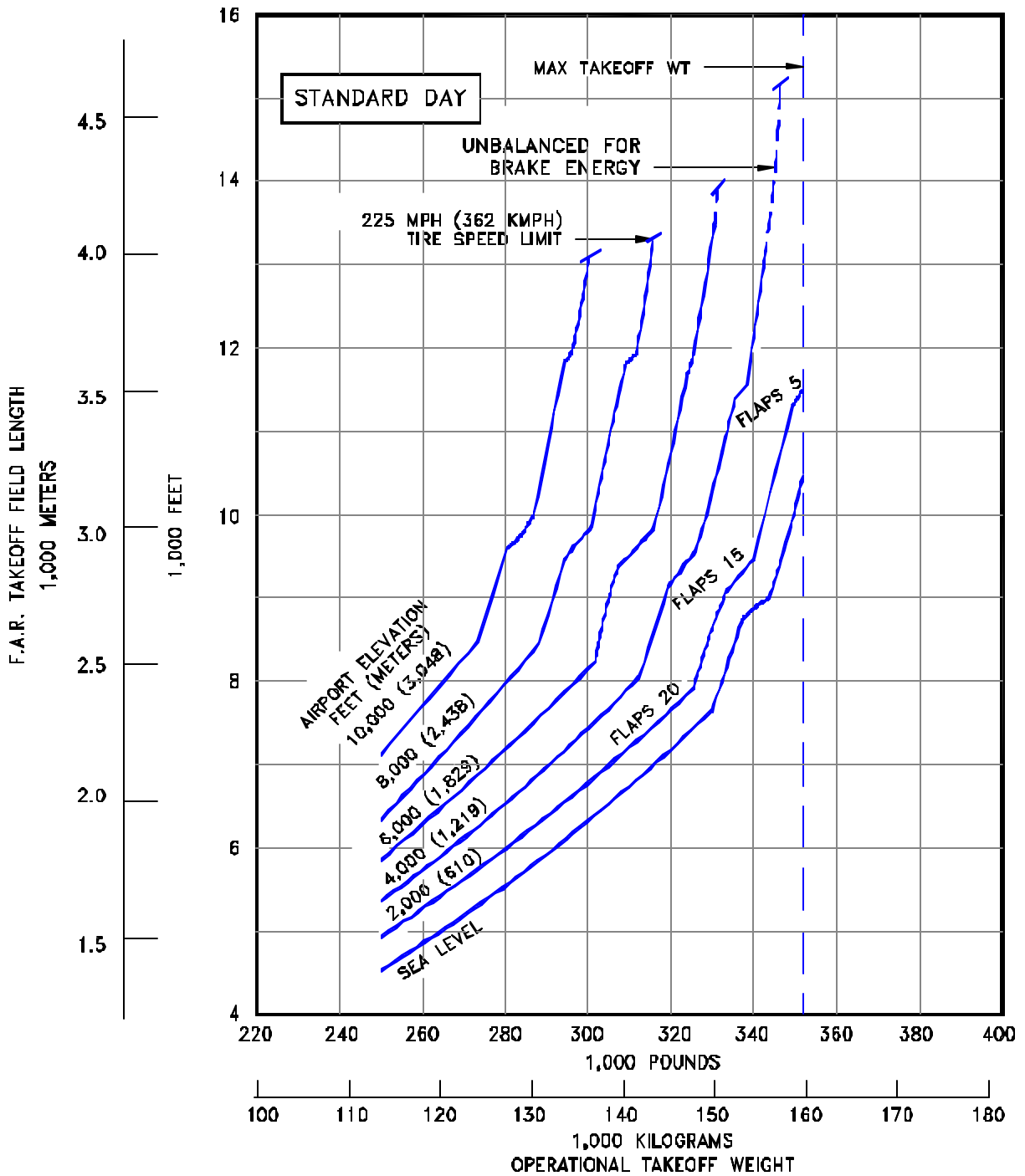

3.3.9 F.A.R. TAKEOFF RUNWAY LENGTH REQUIREMENTS - STANDARD DAY

MODEL 767-300 (JT9D-7R4D/7R4E ENGINES)

NOTES:

- JT9D-7R4D/7R4E ENGINES
- ZERO RUNWAY GRADIENT
- ZERO WIND
- AIR CONDITIONING OFF
- CONSULT USING AIRLINE FOR SPECIFIC OPERATING PROCEDURE PRIOR TO FACILITY DESIGN

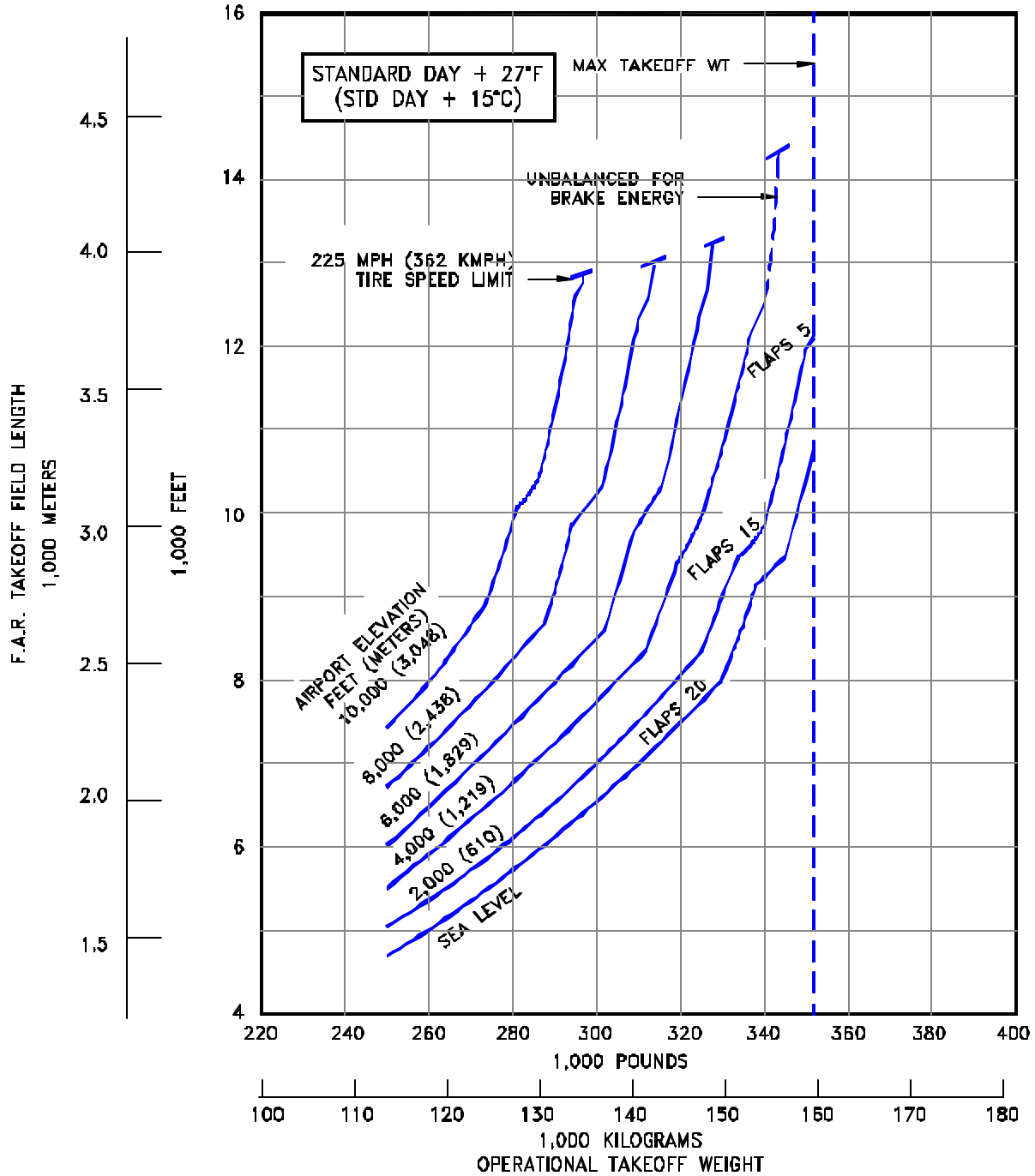

3.3.10 F.A.R. TAKEOFF RUNWAY LENGTH REQUIREMENTS

STANDARD DAY + 27°F (STD + 15°C)

MODEL 767-300 (JT9D-7R4D/7R4E ENGINES)

NOTES:

- CF6-80C2-B2, PW4052 ENGINES
- ZERO RUNWAY GRADIENT
- ZERO WIND
- AIR CONDITIONING OFF
- CONSULT USING AIRLINE FOR SPECIFIC OPERATING PROCEDURE PRIOR TO FACILITY DESIGN

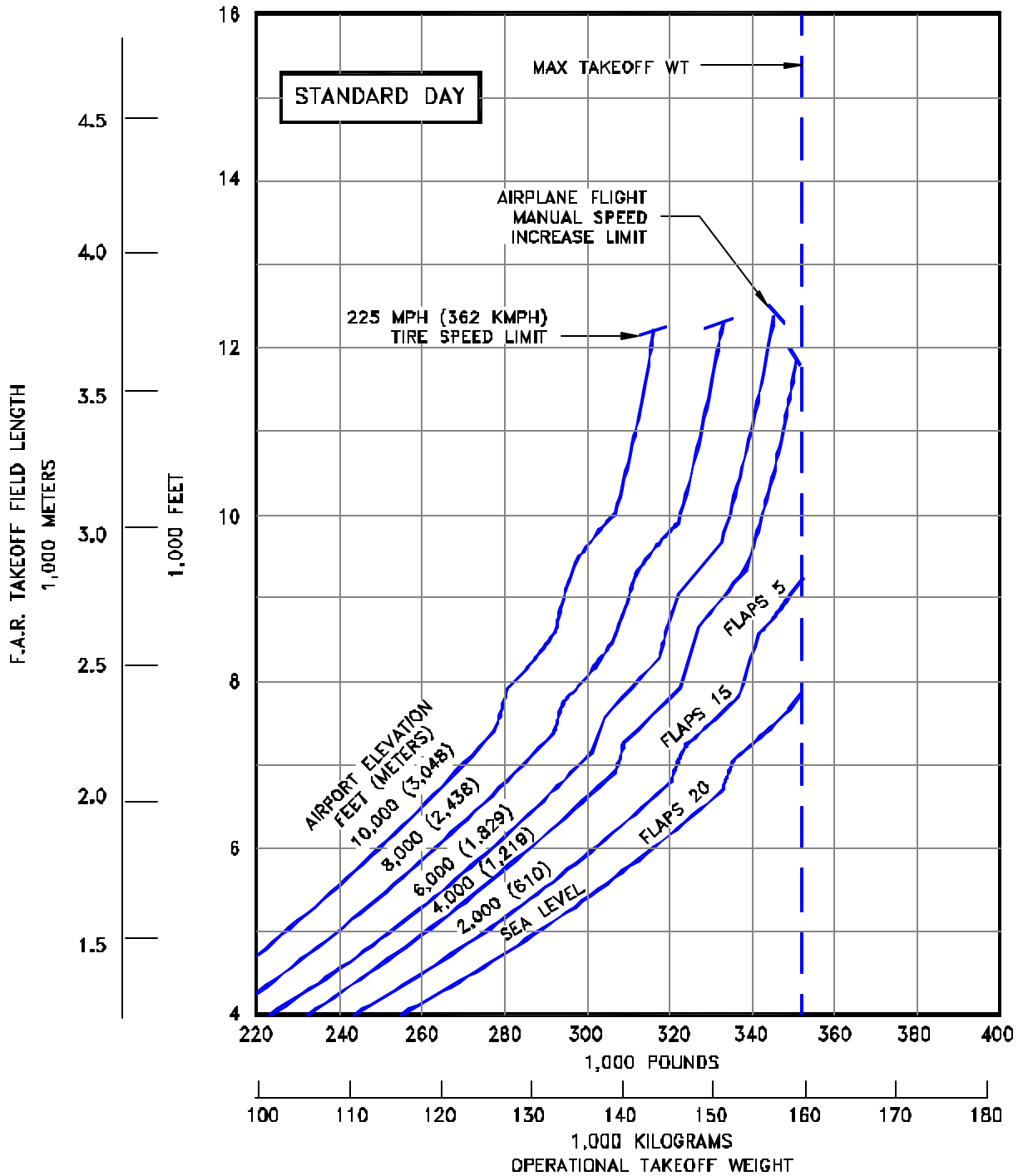

3.3.11 F.A.R. TAKEOFF RUNWAY LENGTH REQUIREMENTS - STANDARD DAY
 MODEL 767-300 (CF6-80C2B2, PW4052 ENGINES)

NOTES:

- CF6-80C2B2, PW4052 ENGINES
- ZERO RUNWAY GRADIENT
- ZERO WIND
- AIR CONDITIONING OFF
- CONSULT USING AIRLINE FOR SPECIFIC OPERATING PROCEDURE PRIOR TO FACILITY DESIGN

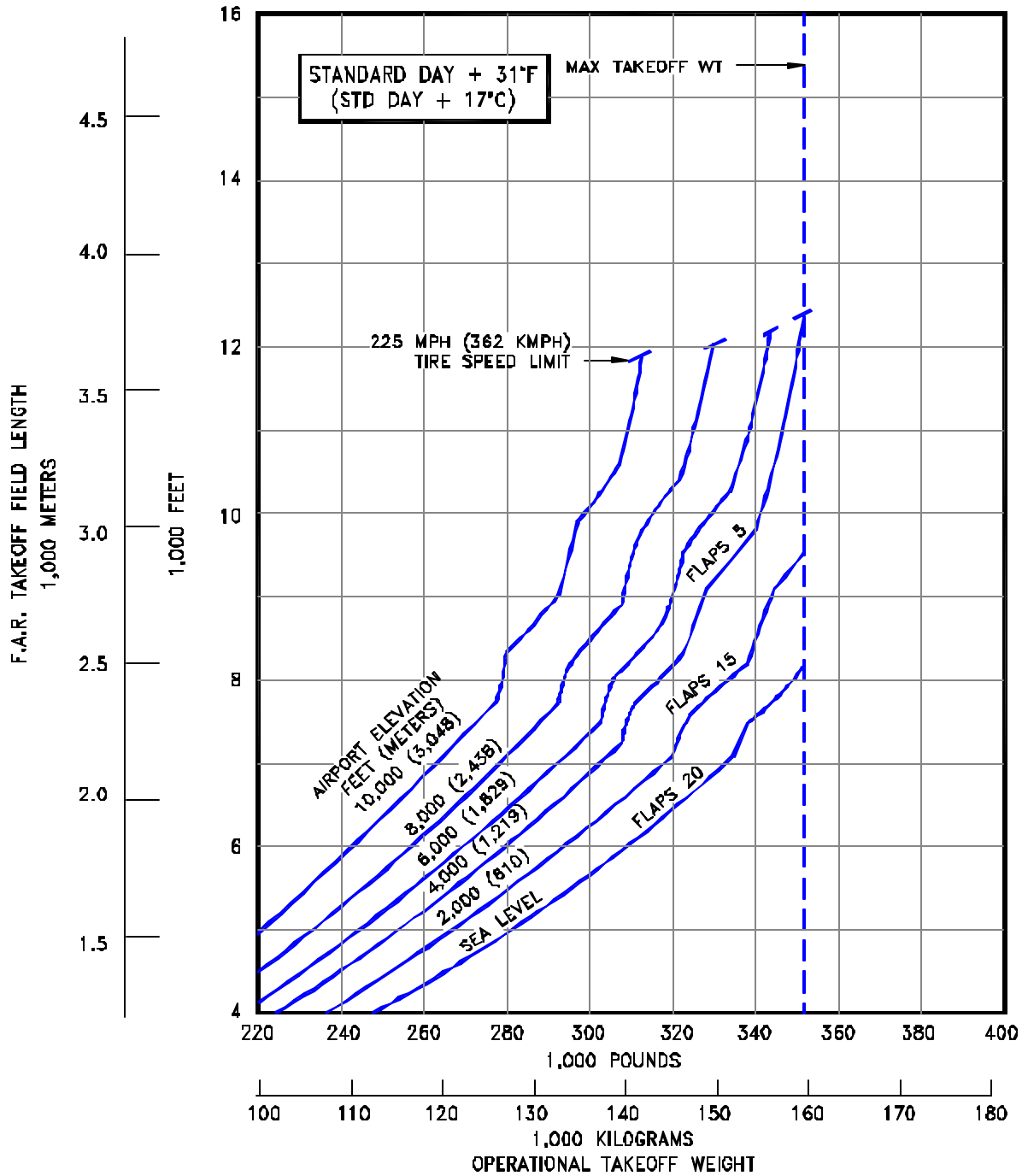

3.3.12 F.A.R. TAKEOFF RUNWAY LENGTH REQUIREMENTS

STANDARD DAY + 31°F (STD + 17°C)

MODEL 767-300 (CF6-80C2B2, PW4052 ENGINES)

D6-58328

NOTES:

- CF6-80C2B4, PW4056, RB211-524G ENGINES
- ZERO RUNWAY GRADIENT
- ZERO WIND
- AIR CONDITIONING OFF
- CONSULT USING AIRLINE FOR SPECIFIC OPERATING PROCEDURE PRIOR TO FACILITY DESIGN

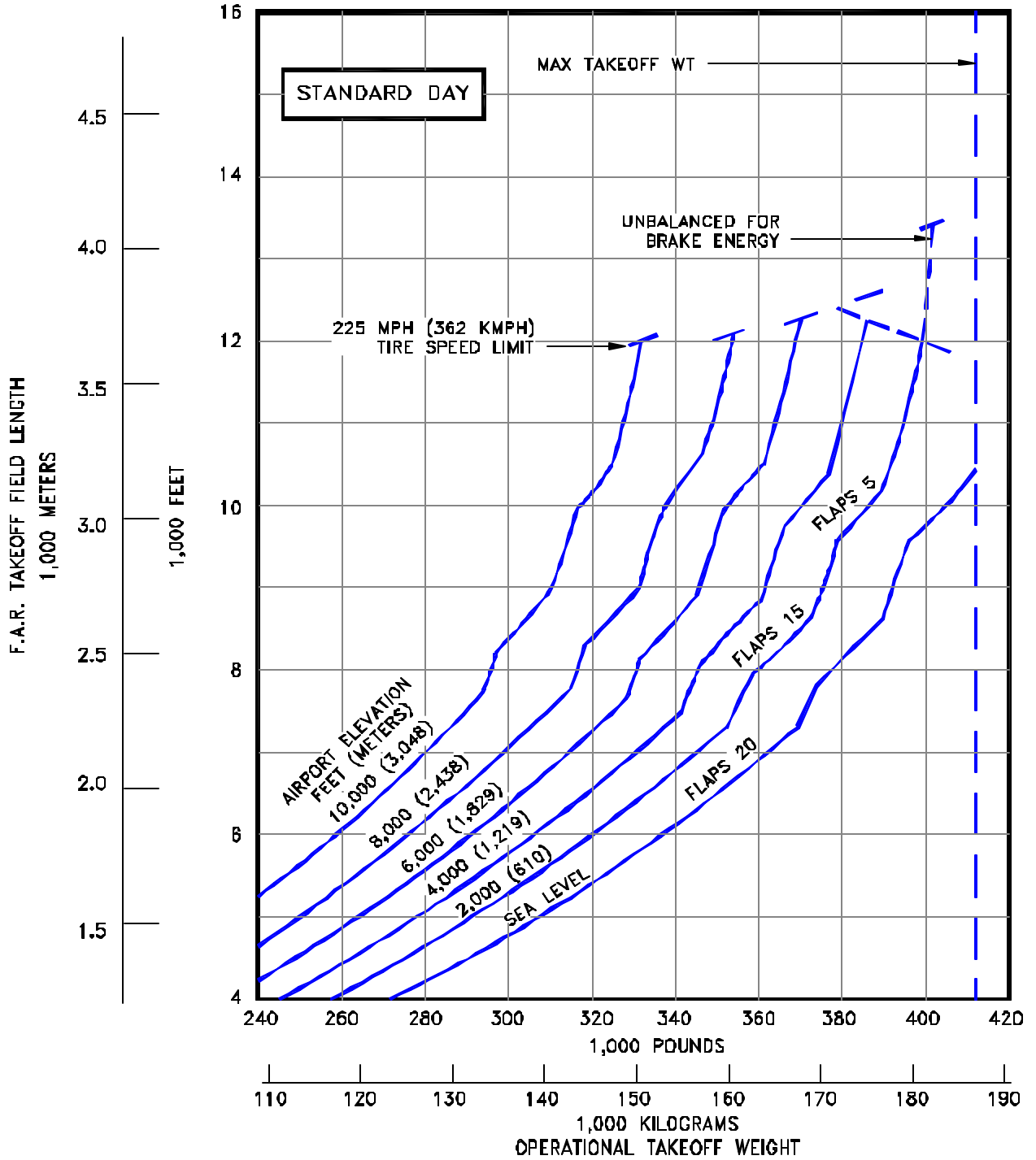

3.3.13 F.A.R. TAKEOFF RUNWAY LENGTH REQUIREMENTS - STANDARD DAY
 MODEL 767-300ER, -300 FREIGHTER (CF6-80C2B4, PW4056, RB211-524G ENGINES)

NOTES:

- CF6-80C2B4, PW4056, RB211-524G ENGINES
- ZERO RUNWAY GRADIENT
- ZERO WIND
- AIR CONDITIONING OFF
- CONSULT USING AIRLINE FOR SPECIFIC OPERATING PROCEDURE PRIOR TO FACILITY DESIGN

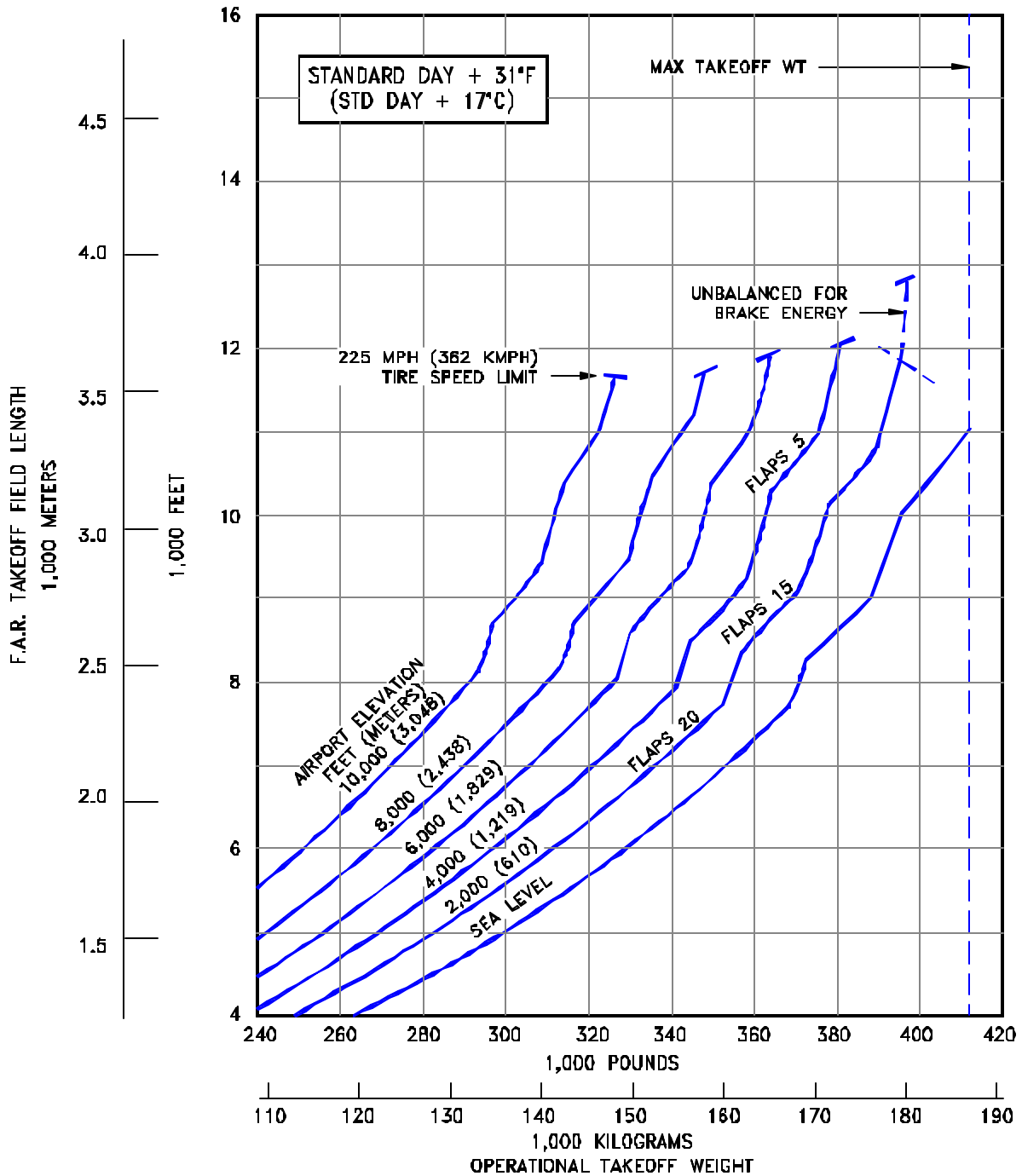

3.3.14 F.A.R. TAKEOFF RUNWAY LENGTH REQUIREMENTS

STANDARD DAY + 31°F (STD + 17°C)

MODEL 767-300ER, -300 FREIGHTER (CF6-80C2B4, PW4052, RB211-524G ENGINES)

D6-58328

NOTES:

- CF6-80C2B6, PW4060, RB211-524H ENGINES
- ZERO RUNWAY GRADIENT
- ZERO WIND
- AIR CONDITIONING OFF
- CONSULT USING AIRLINE FOR SPECIFIC OPERATING PROCEDURE PRIOR TO FACILITY DESIGN

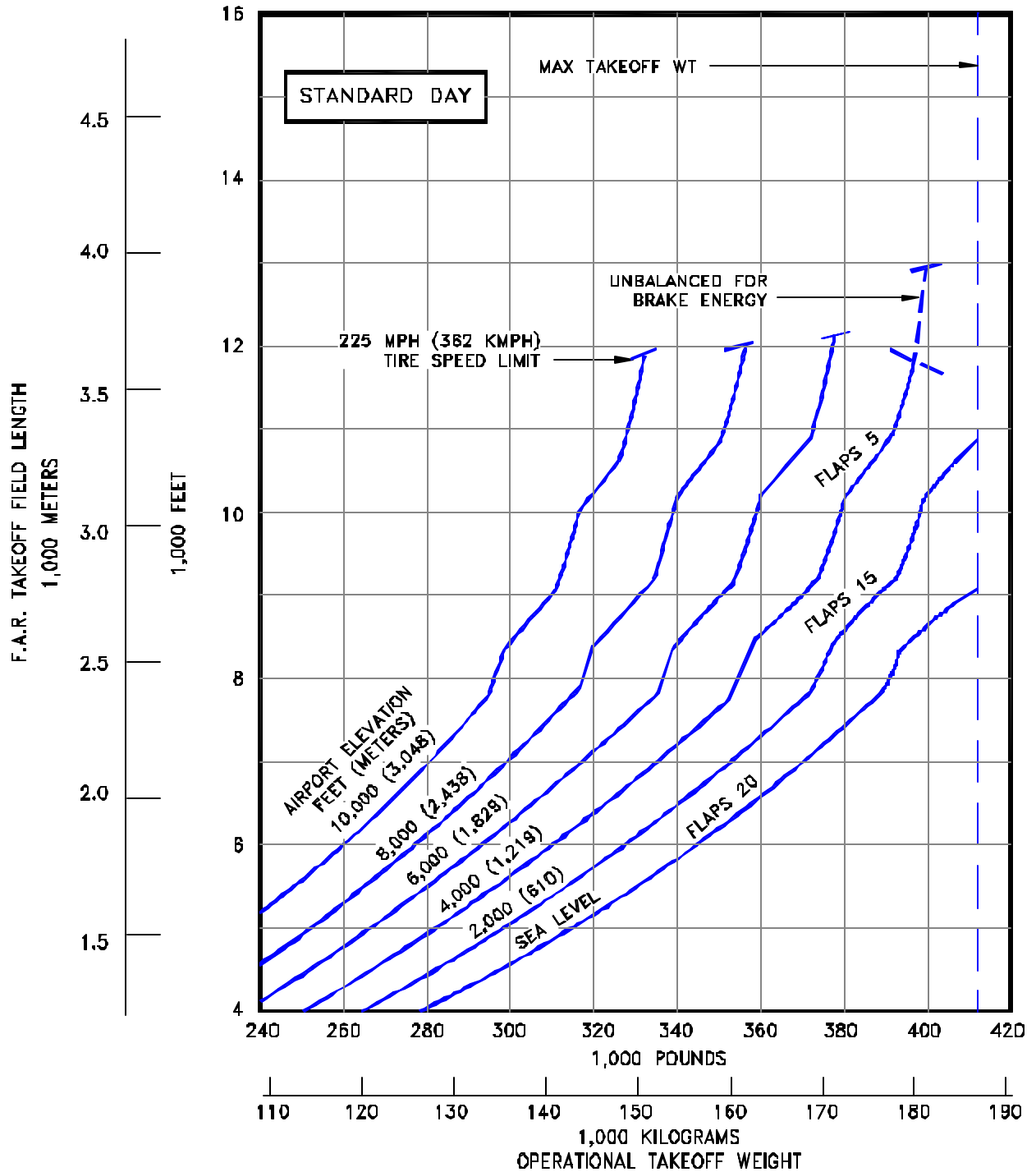

3.3.15 F.A.R. TAKEOFF RUNWAY LENGTH REQUIREMENTS - STANDARD DAY

MODEL 767-300ER, -300 FREIGHTER (CF6-80C2B64, PW4060, RB211-524H ENGINES)

NOTES:

- CF6-80C2B6, PW4060, RB211-524H ENGINES
- ZERO RUNWAY GRADIENT
- ZERO WIND
- AIR CONDITIONING OFF
- CONSULT USING AIRLINE FOR SPECIFIC OPERATING PROCEDURE PRIOR TO FACILITY DESIGN

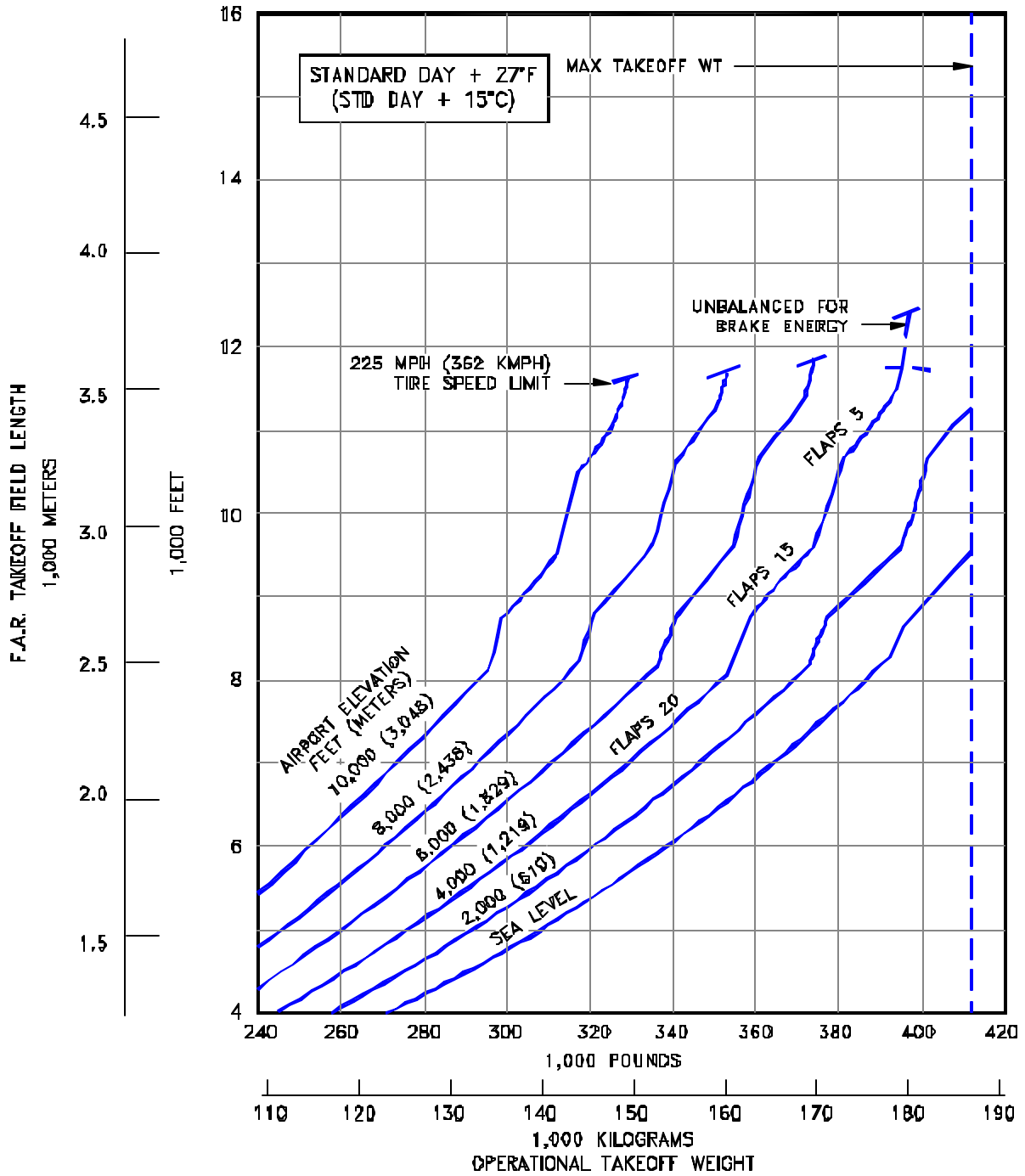

3.3.16 F.A.R. TAKEOFF RUNWAY LENGTH REQUIREMENTS

STANDARD DAY + 27°F (STD + 15°C)

MODEL 767-300ER, -300 FREIGHTER (CF6-80C2B6, PW4060, RB211-524H ENGINES)

NOTES:

- CF6-80C2B7F ENGINES
- ZERO RUNWAY GRADIENT
- ZERO WIND
- AIR CONDITIONING OFF
- CONSULT USING AIRLINE FOR SPECIFIC OPERATING PROCEDURE PRIOR TO FACILITY DESIGN

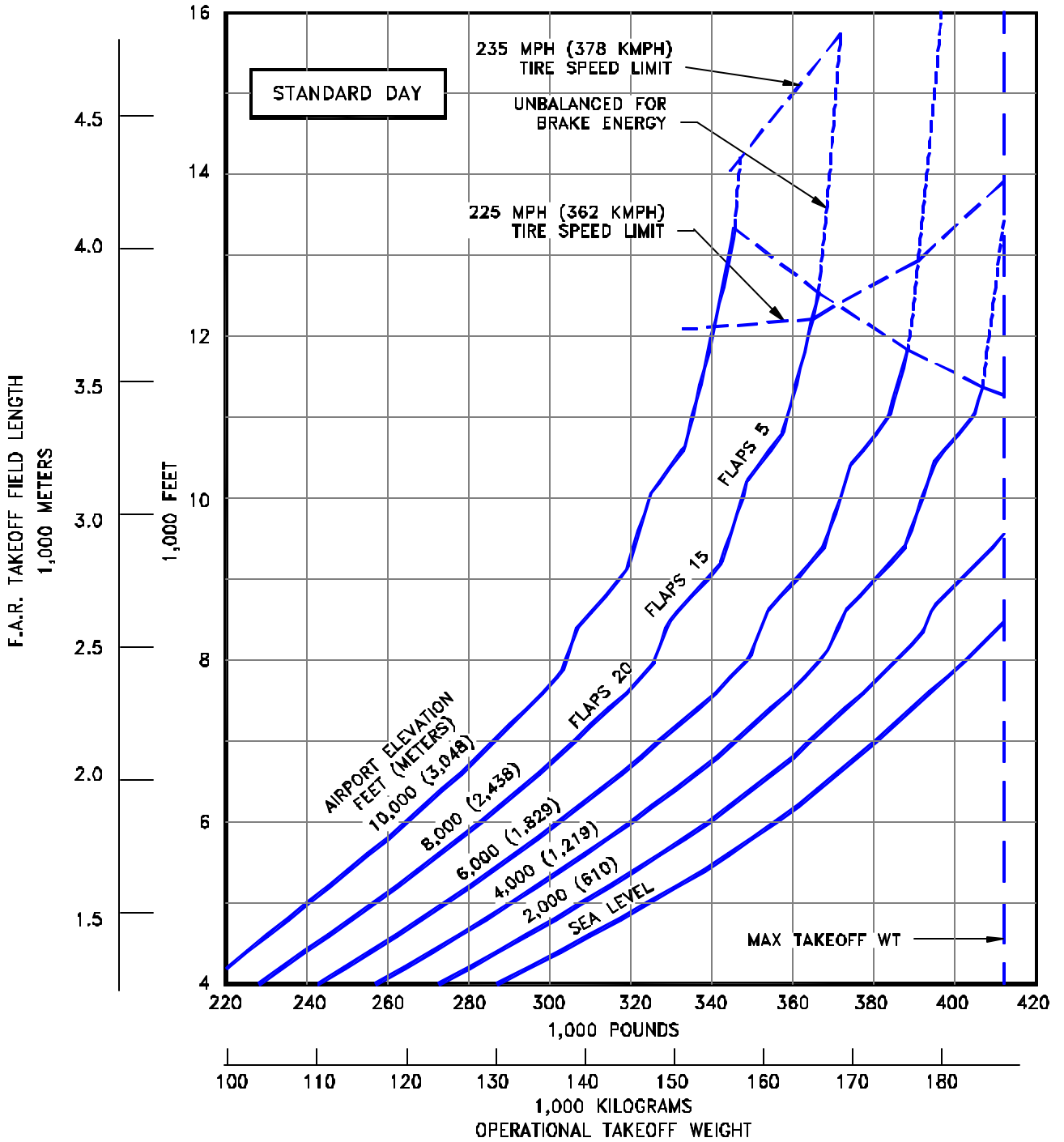

3.3.17 F.A.R. TAKEOFF RUNWAY LENGTH REQUIREMENTS - STANDARD DAY
 MODEL 767-300ER (CF6-80C2B7F ENGINES)

NOTES:

- CF6-80C2B7F ENGINES
- ZERO RUNWAY GRADIENT
- ZERO WIND
- AIR CONDITIONING OFF
- CONSULT USING AIRLINE FOR SPECIFIC OPERATING PROCEDURE PRIOR TO FACILITY DESIGN

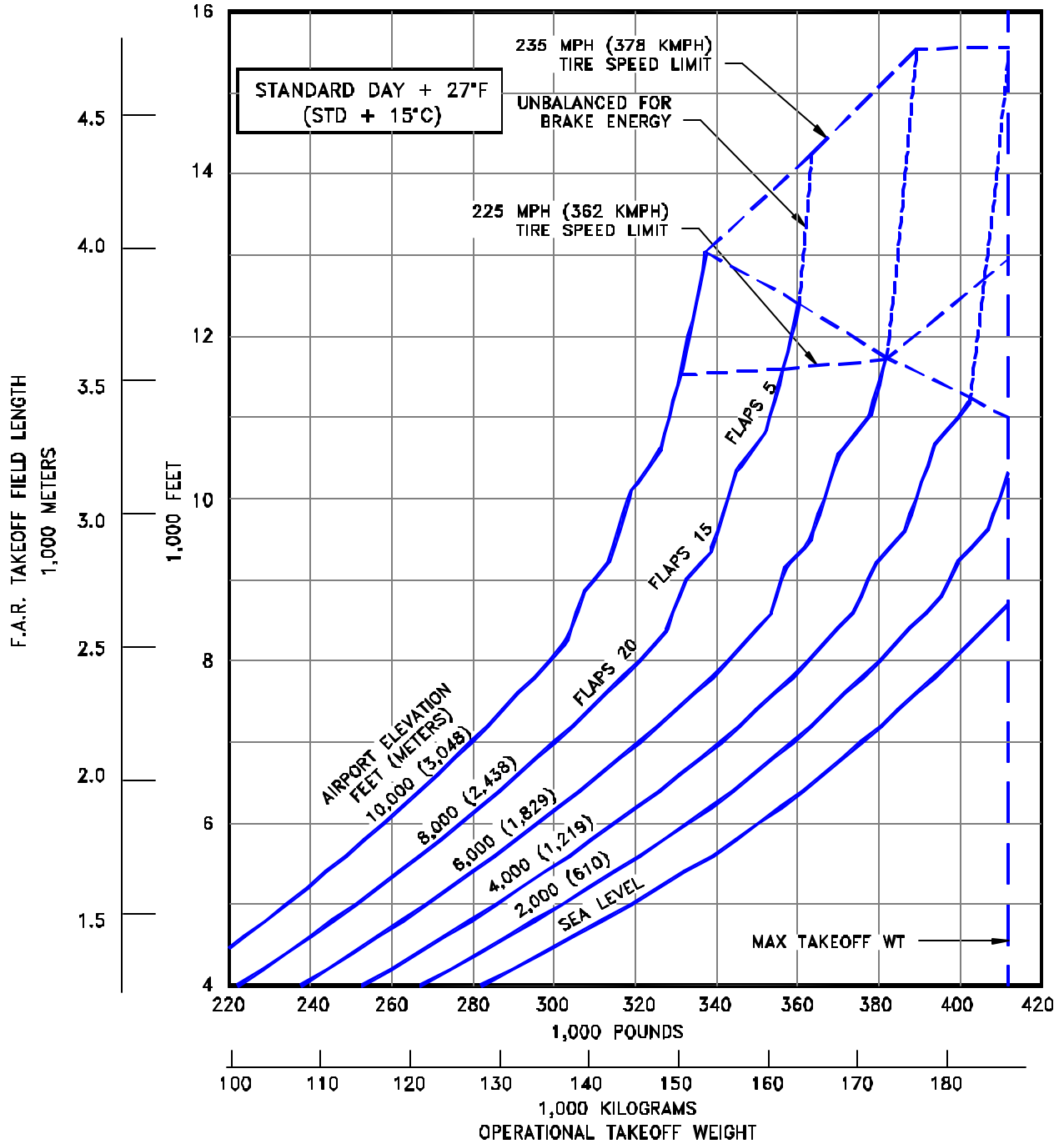

3.3.18 F.A.R. TAKEOFF RUNWAY LENGTH REQUIREMENTS

STANDARD DAY + 27°F (STD + 15°C)
 MODEL 767-300ER (CF6-80C2B7F ENGINES)

NOTES:

- PW4062 ENGINES
- ZERO RUNWAY GRADIENT
- ZERO WIND
- AIR CONDITIONING OFF
- CONSULT USING AIRLINE FOR SPECIFIC OPERATING PROCEDURE PRIOR TO FACILITY DESIGN

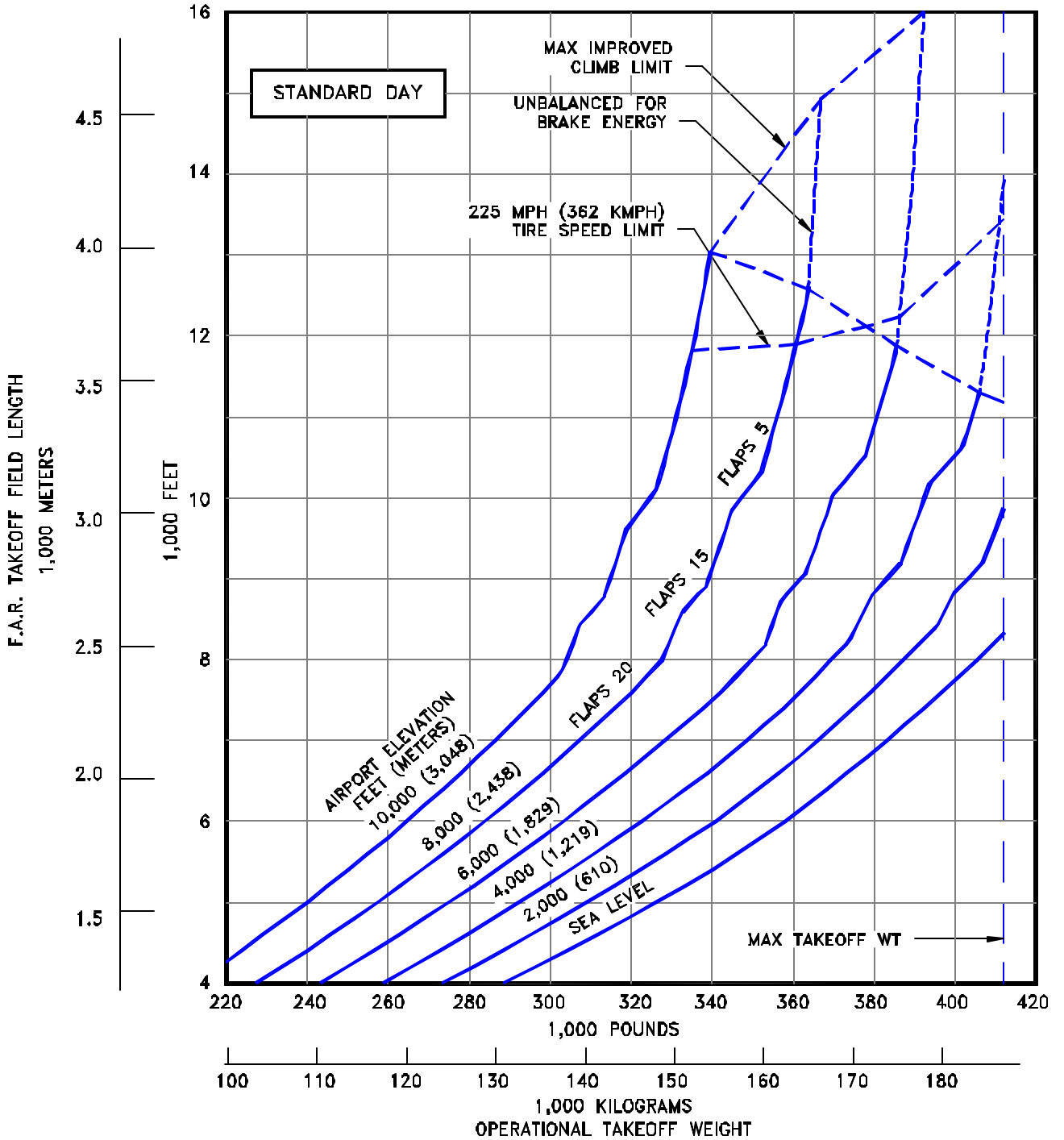

3.3.19 F.A.R. TAKEOFF RUNWAY LENGTH REQUIREMENTS - STANDARD DAY
 MODEL 767-300ER (PW4062 ENGINES)

NOTES:

- PW4062 ENGINES
- ZERO RUNWAY GRADIENT
- ZERO WIND
- AIR CONDITIONING OFF
- CONSULT USING AIRLINE FOR SPECIFIC OPERATING PROCEDURE PRIOR TO FACILITY DESIGN

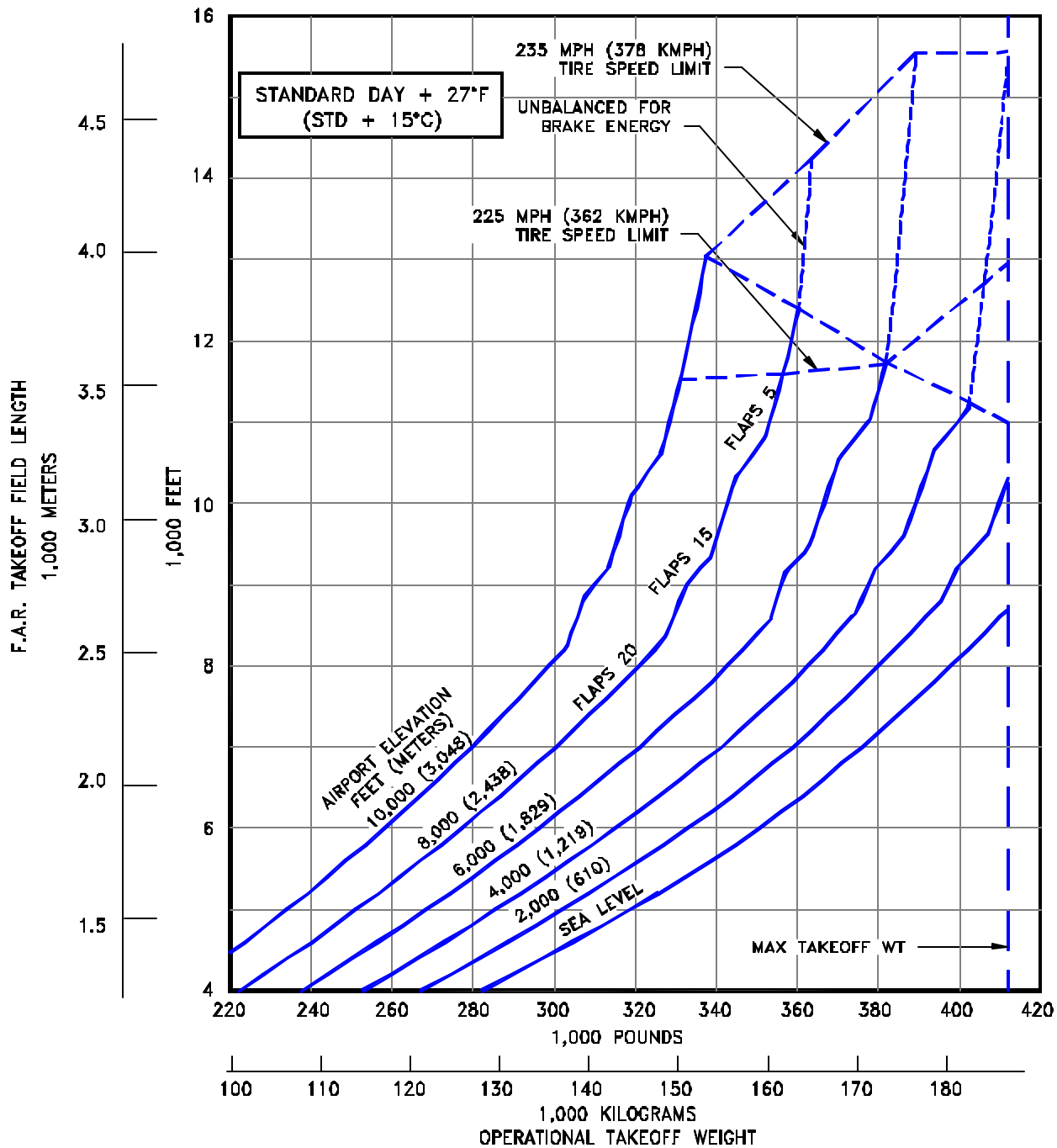

3.3.20 F.A.R. TAKEOFF RUNWAY LENGTH REQUIREMENTS

STANDARD DAY + 27°F (STD + 15°C)

MODEL 767-300ER (PW4062 ENGINES)

D6-58328

NOTES:

- CF6-80C2B7F ENGINES
- ZERO RUNWAY GRADIENT
- ZERO WIND
- AIR CONDITIONING OFF
- CONSULT USING AIRLINE FOR SPECIFIC OPERATING PROCEDURE PRIOR TO FACILITY DESIGN

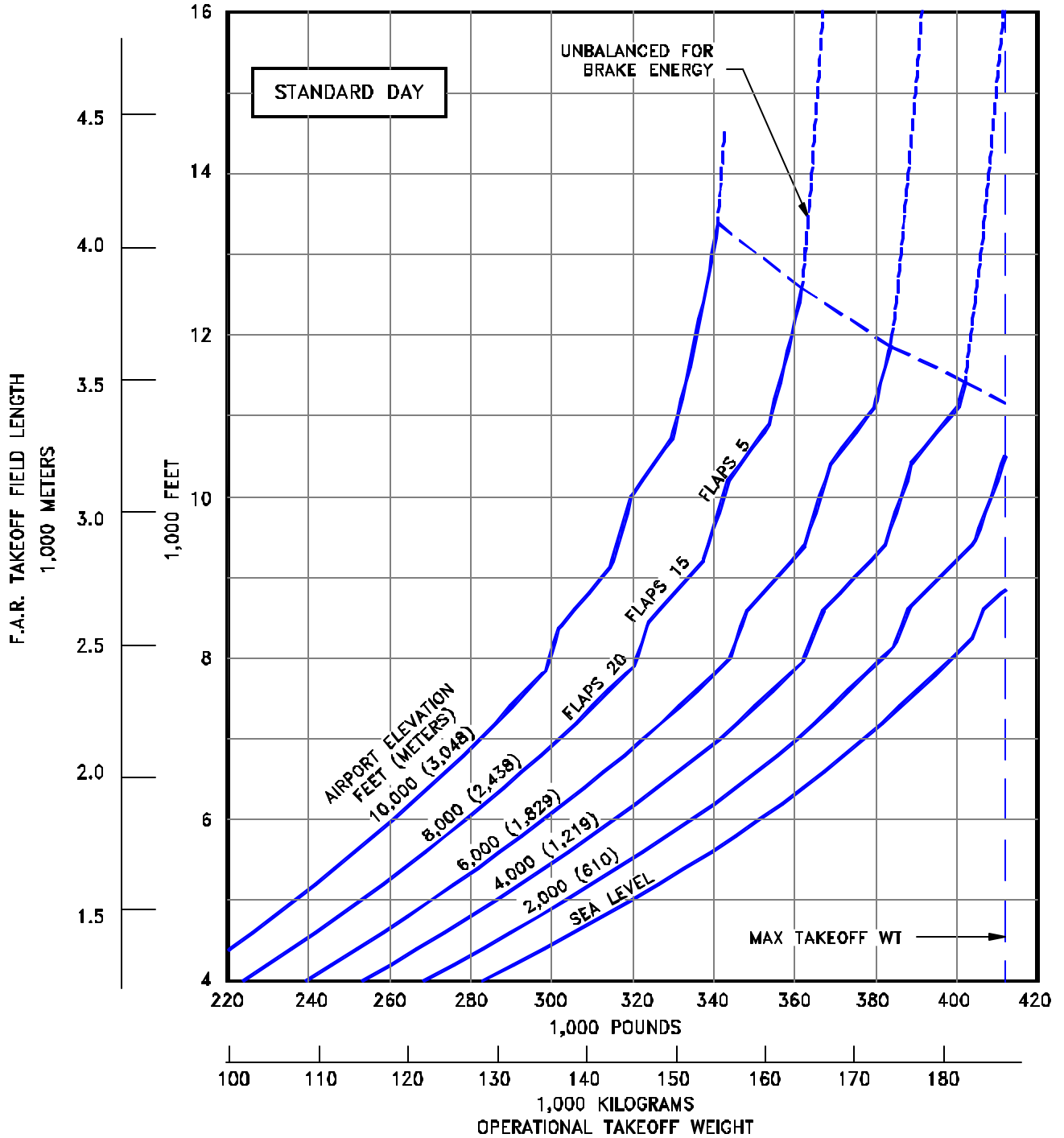

3.3.21 F.A.R. TAKEOFF RUNWAY LENGTH REQUIREMENTS - STANDARD DAY
 MODEL 767-300 FREIGHTER (CF6-80C2B7F ENGINES)

NOTES:

- CF6-80C2B7F ENGINES
- ZERO RUNWAY GRADIENT
- ZERO WIND
- AIR CONDITIONING OFF
- CONSULT USING AIRLINE FOR SPECIFIC OPERATING PROCEDURE PRIOR TO FACILITY DESIGN

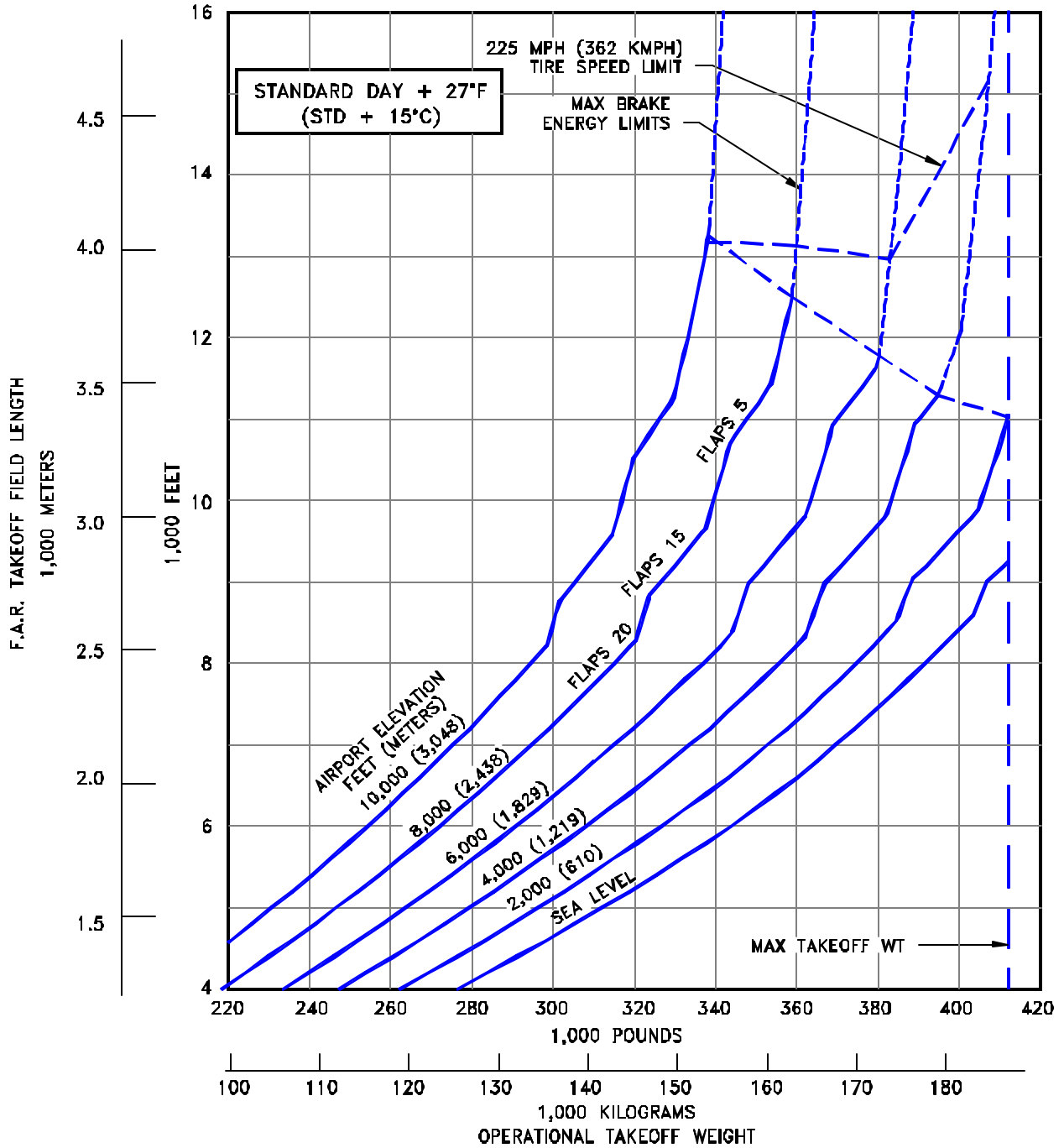

3.3.22 F.A.R. TAKEOFF RUNWAY LENGTH REQUIREMENTS

STANDARD DAY + 27°F (STD + 15°C)

MODEL 767-300 FREIGHTER (CF6-80C2B7F ENGINES)

NOTES:

- PW4062 ENGINES
- ZERO RUNWAY GRADIENT
- ZERO WIND
- AIR CONDITIONING OFF
- CONSULT USING AIRLINE FOR SPECIFIC OPERATING PROCEDURE PRIOR TO FACILITY DESIGN

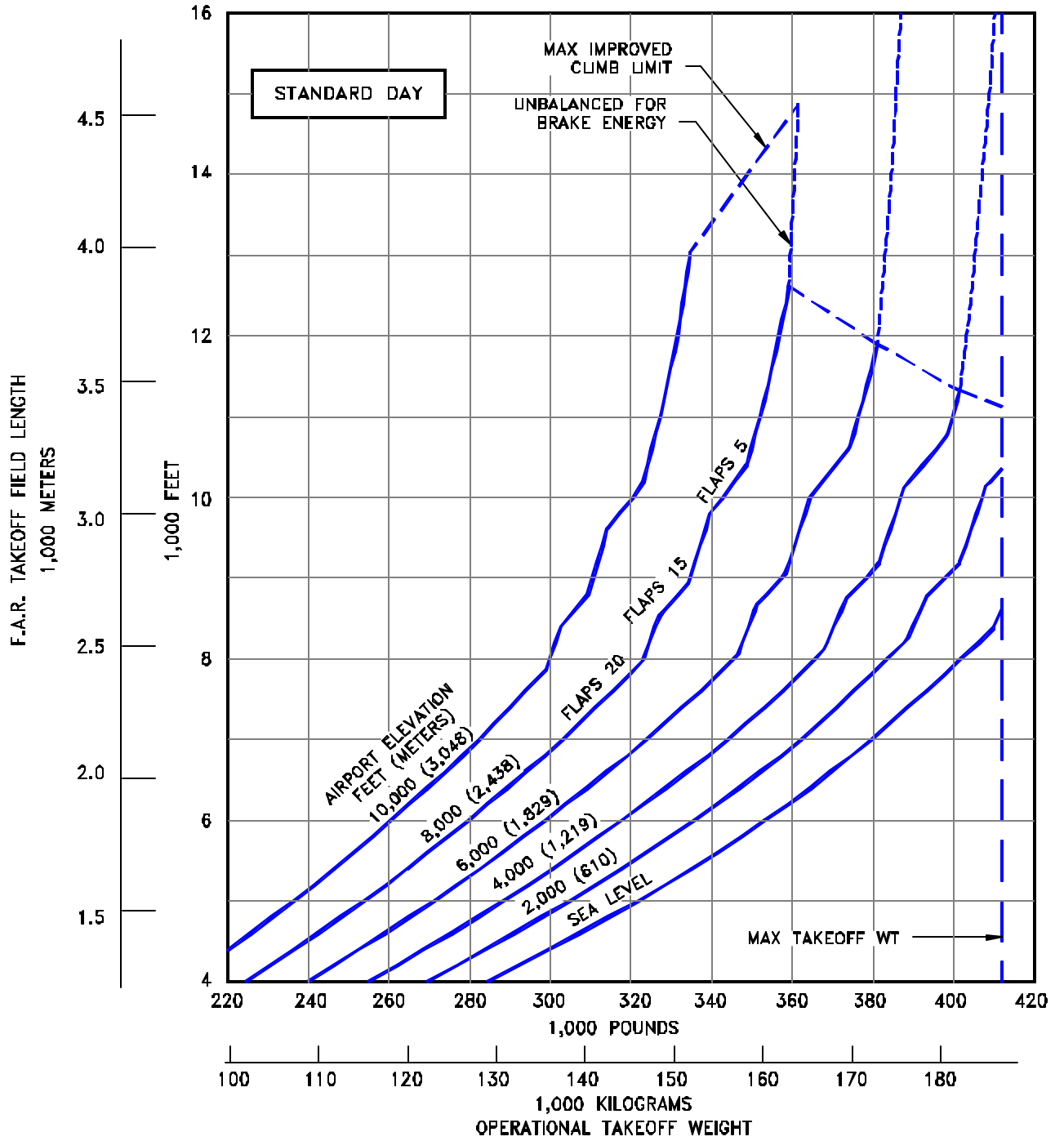

3.3.23 F.A.R. TAKEOFF RUNWAY LENGTH REQUIREMENTS - STANDARD DAY
 MODEL 767-300 FREIGHTER (PW4062 ENGINES)

NOTES:

- PW4062 ENGINES
- ZERO RUNWAY GRADIENT
- ZERO WIND
- AIR CONDITIONING OFF
- CONSULT USING AIRLINE FOR SPECIFIC OPERATING PROCEDURE PRIOR TO FACILITY DESIGN

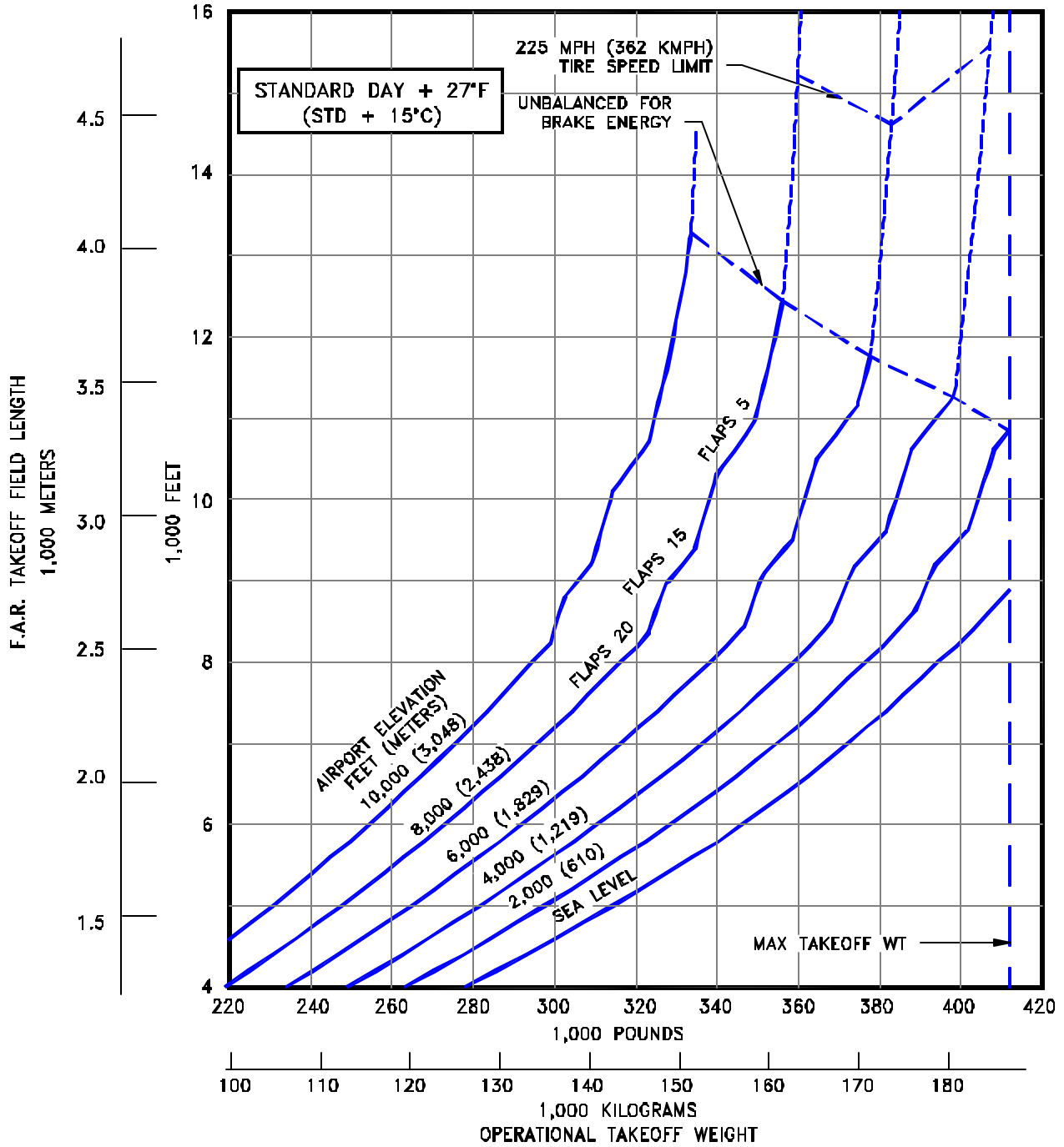

3.3.24 F.A.R. TAKEOFF RUNWAY LENGTH REQUIREMENTS

STANDARD DAY + 27°F (STD + 15°C)

MODEL 767-300 FREIGHTER (PW4062 ENGINES)

D6-58328

NOTES:

- CF6-80C2B8F ENGINES
- NO ENGINE AIRBLEED FOR AIR CONDITIONING
- ZERO WIND, ZERO RUNWAY GRADIENT
- DRY RUNWAY SURFACE
- CONSULT USING AIRLINE FOR SPECIFIC OPERATING PROCEDURE PRIOR TO FACILITY DESIGN

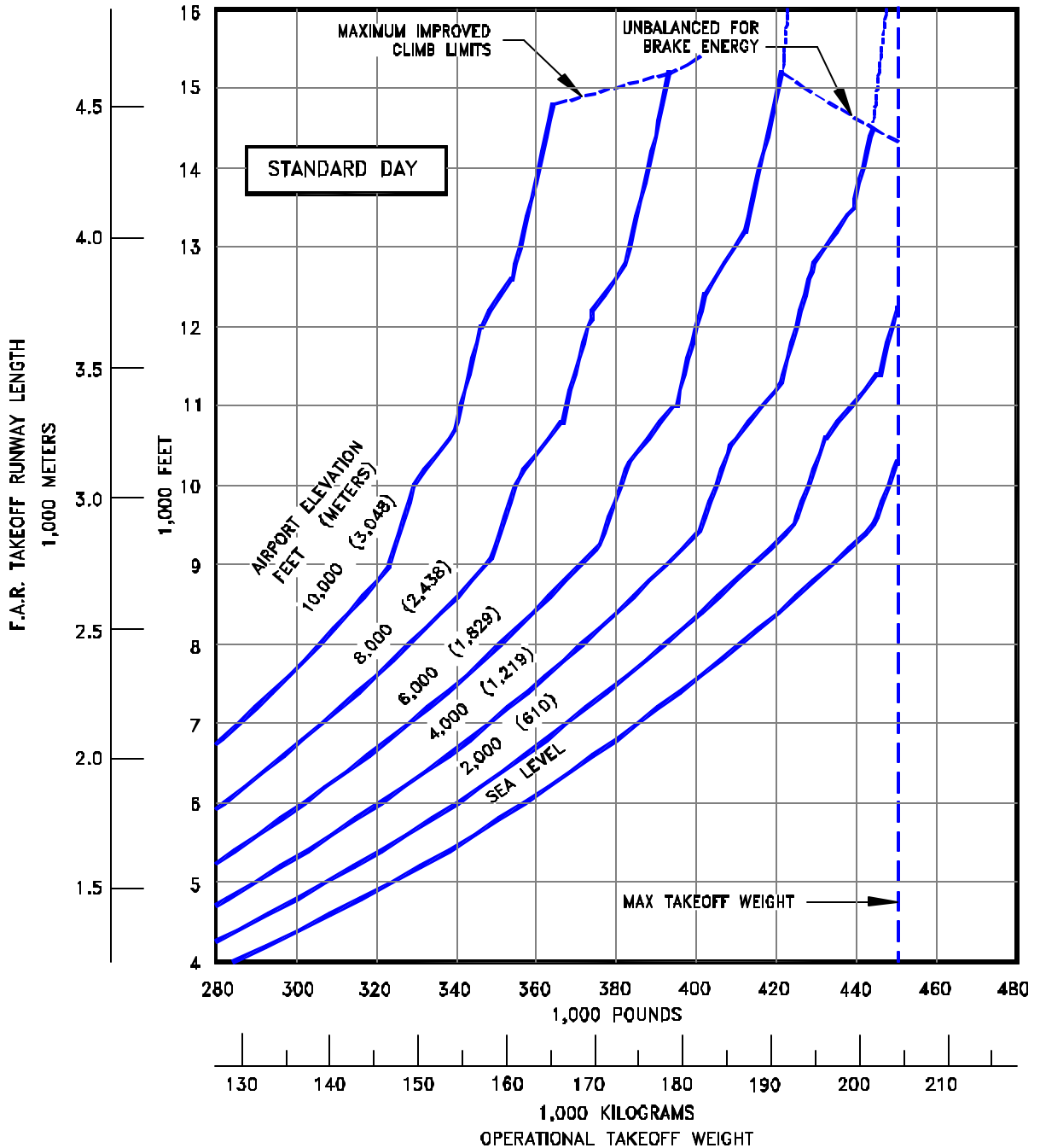

3.3.25 F.A.R. TAKEOFF RUNWAY LENGTH REQUIREMENTS - STANDARD DAY,
 DRY RUNWAY SURFACE
 MODEL 767-400ER (CF6-80C2B8F ENGINES)

NOTES:

- CF6-80C2B8F ENGINES
- NO ENGINE AIRBLEED FOR AIR CONDITIONING
- ZERO WIND, ZERO RUNWAY GRADIENT
- DRY RUNWAY SURFACE
- CONSULT USING AIRLINE FOR SPECIFIC OPERATING PROCEDURE PRIOR TO FACILITY DESIGN

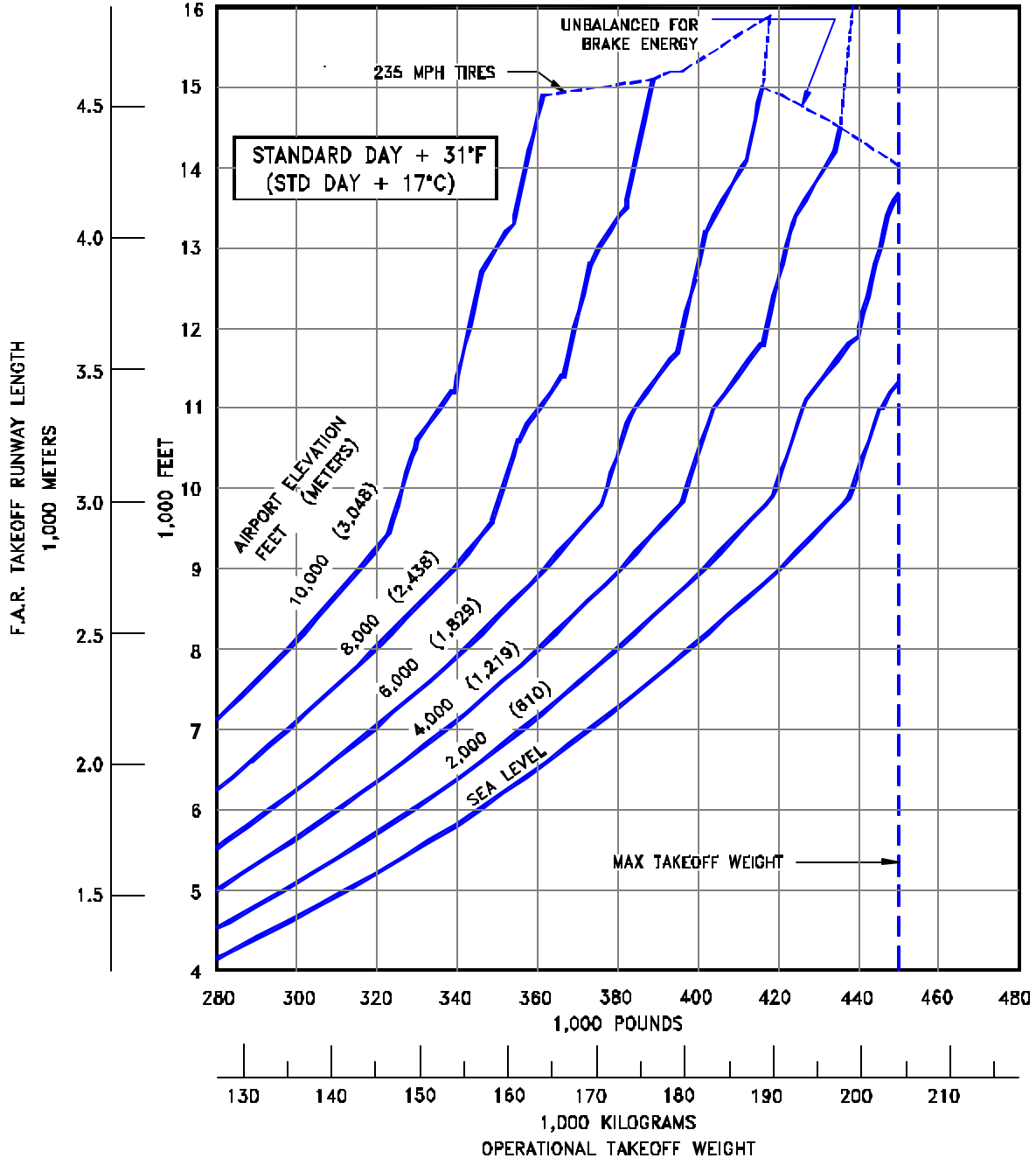

3.3.26 F.A.R. TAKEOFF RUNWAY LENGTH REQUIREMENTS

STANDARD DAY + 31°F (STD + 17°C), DRY RUNWAY SURFACE
 MODEL 767-400ER (CF6-80C2B8F ENGINES)

NOTES:

- CF6-80C2B8F ENGINES
- NO ENGINE AIRBLEED FOR AIR CONDITIONING
- ZERO WIND, ZERO RUNWAY GRADIENT
- WET SMOOTH RUNWAY SURFACE
- CONSULT USING AIRLINE FOR SPECIFIC OPERATING PROCEDURE PRIOR TO FACILITY DESIGN

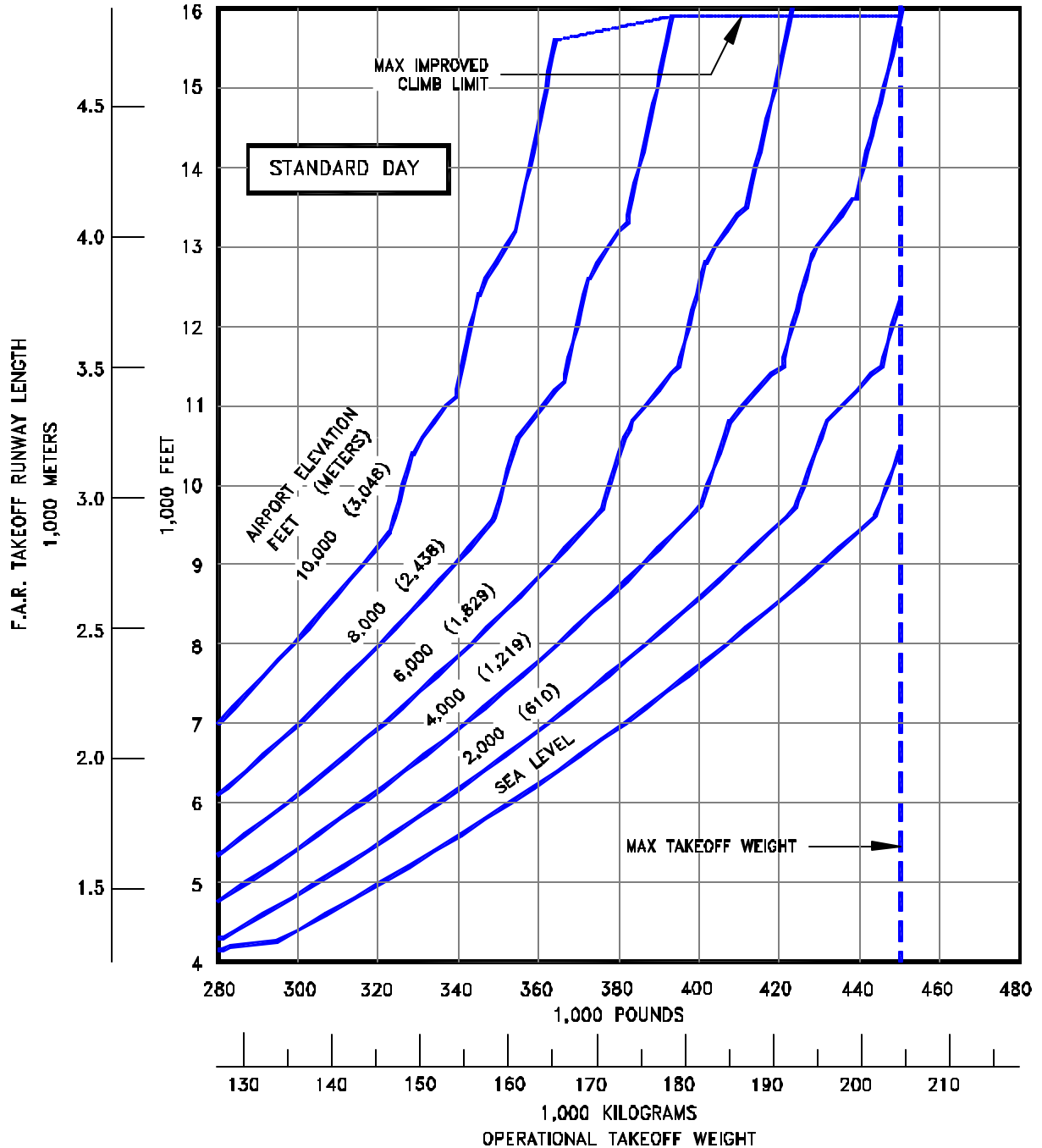

3.3.27 F.A.R. TAKEOFF RUNWAY LENGTH REQUIREMENTS - STANDARD DAY,
 WET SMOOTH RUNWAY SURFACE
 MODEL 767-400ER (CF6-80C2B8F ENGINES)

NOTES:

- CF6-80C2B8F ENGINES
- NO ENGINE AIRBLEED FOR AIR CONDITIONING
- ZERO WIND, ZERO RUNWAY GRADIENT
- WET SMOOTH RUNWAY SURFACE
- CONSULT USING AIRLINE FOR SPECIFIC OPERATING PROCEDURE PRIOR TO FACILITY DESIGN

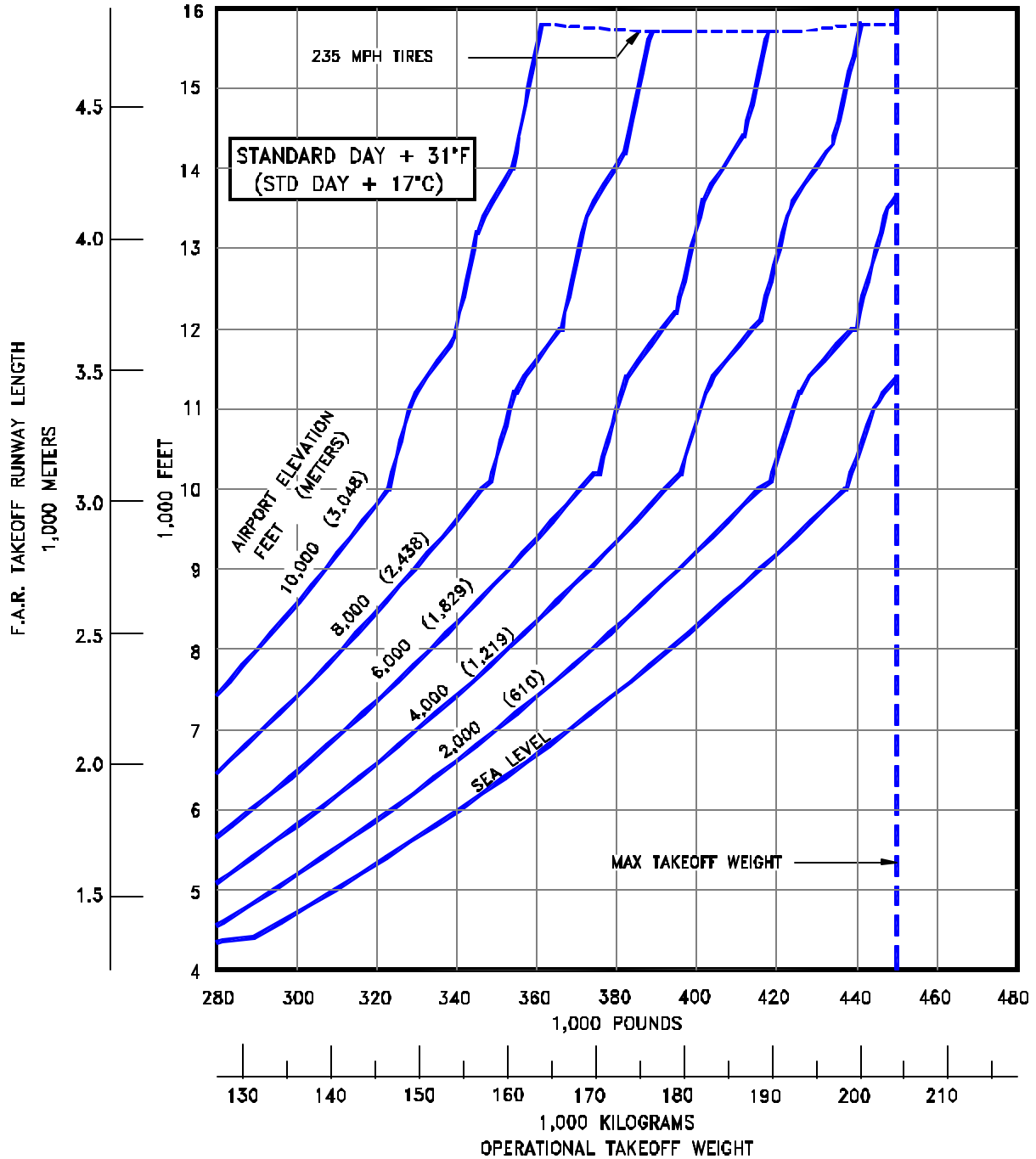

3.3.28 F.A.R. TAKEOFF RUNWAY LENGTH REQUIREMENTS

STANDARD DAY + 27°F (STD + 15°C), WET SMOOTH RUNWAY SURFACE
 MODEL 767-400ER (CF6-80C2B8F ENGINES)

NOTES:

- CF6-80C2B7F1 ENGINES
- NO ENGINE AIRBLEED FOR AIR CONDITIONING
- ZERO WIND, ZERO RUNWAY GRADIENT
- DRY RUNWAY SURFACE
- CONSULT USING AIRLINE FOR SPECIFIC OPERATING PROCEDURE PRIOR TO FACILITY DESIGN

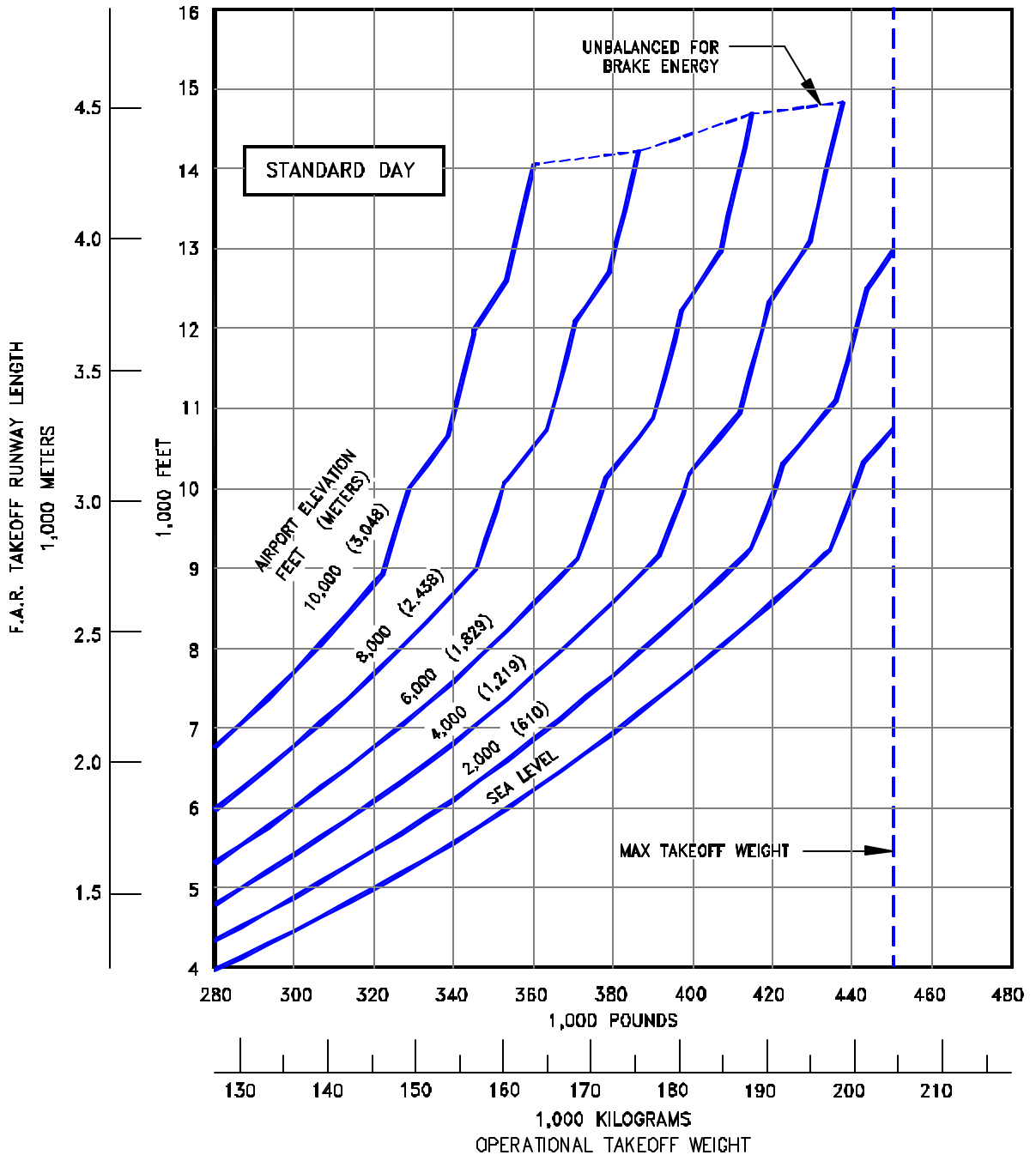

3.3.29 F.A.R. TAKEOFF RUNWAY LENGTH REQUIREMENTS - STANDARD DAY,
 DRY RUNWAY SURFACE
 MODEL 767-400ER (CF6-80C2B7F1 ENGINES)

NOTES:

- CF6-80C2B7F1 ENGINES
- NO ENGINE AIRBLEED FOR AIR CONDITIONING
- ZERO WIND, ZERO RUNWAY GRADIENT
- DRY RUNWAY SURFACE
- CONSULT USING AIRLINE FOR SPECIFIC OPERATING PROCEDURE PRIOR TO FACILITY DESIGN

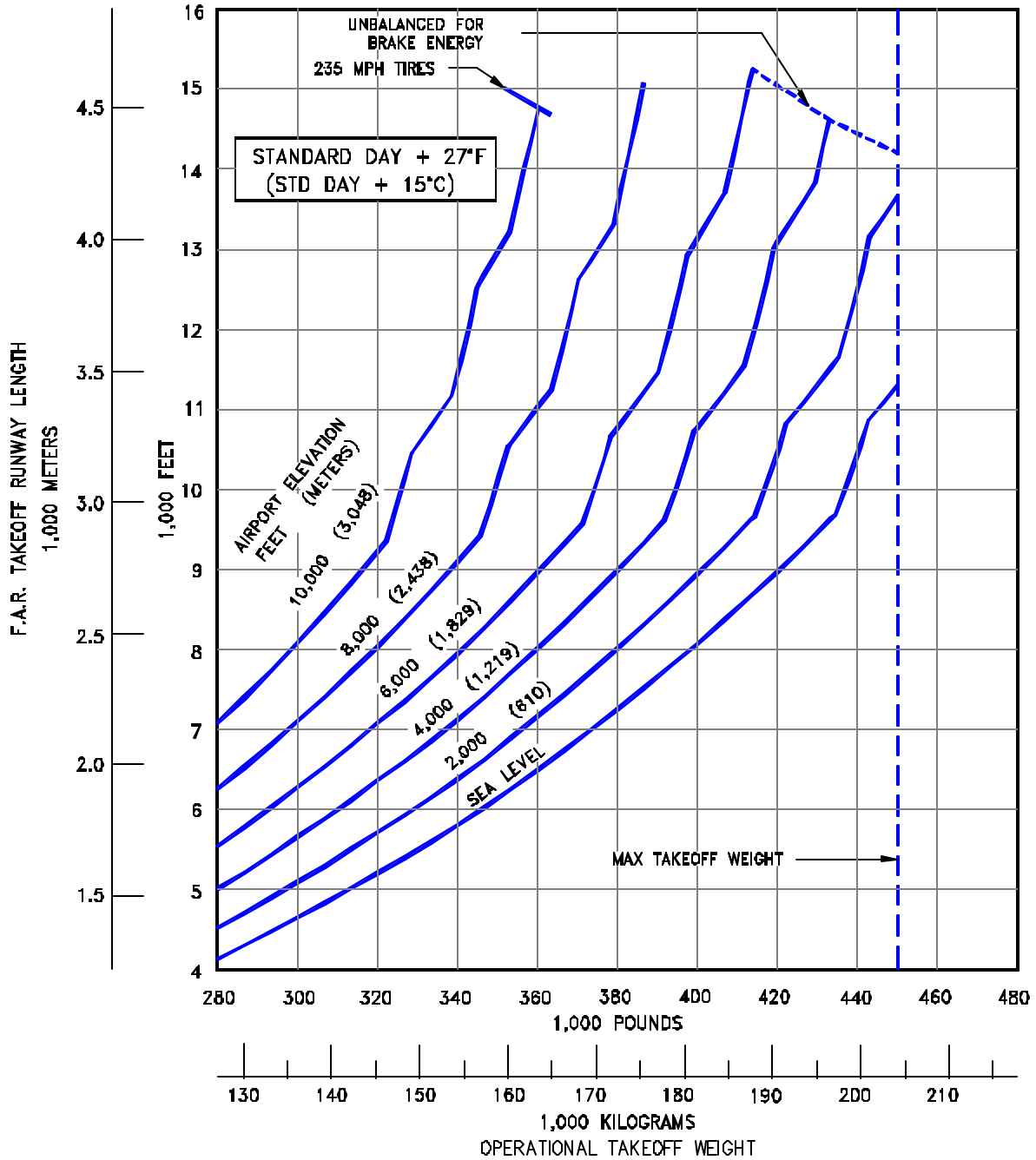

3.3.30 F.A.R. TAKEOFF RUNWAY LENGTH REQUIREMENTS

STANDARD DAY + 27°F (STD + 15°C), DRY RUNWAY SURFACE
 MODEL 767-400ER (CF6-80C2B7F1 ENGINES)

NOTES:

- CF6-80C2B7F1 ENGINES
- NO ENGINE AIRBLEED FOR AIR CONDITIONING
- ZERO WIND, ZERO RUNWAY GRADIENT
- WET SMOOTH RUNWAY SURFACE
- CONSULT USING AIRLINE FOR SPECIFIC OPERATING PROCEDURE PRIOR TO FACILITY DESIGN

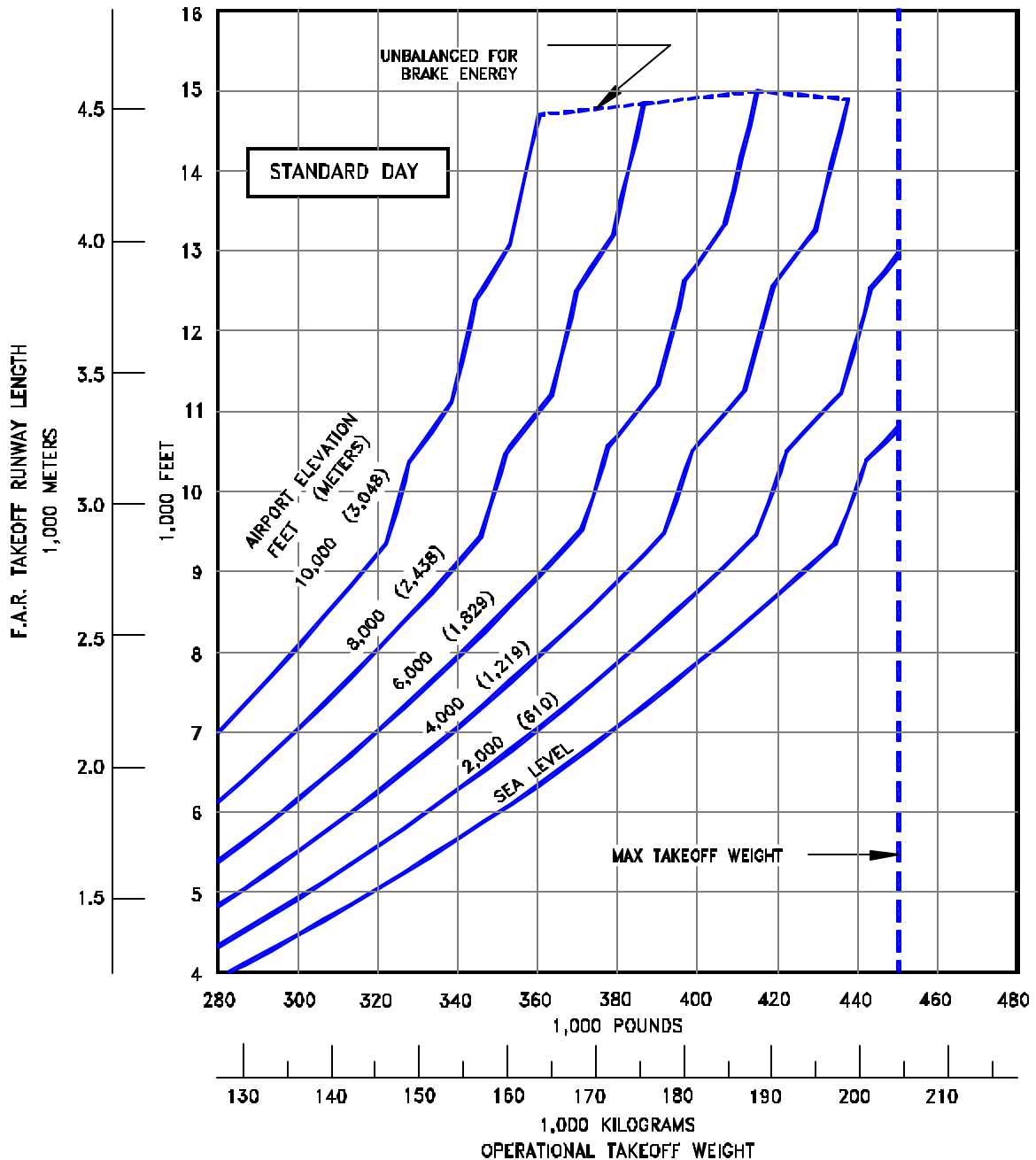

3.3.31 F.A.R. TAKEOFF RUNWAY LENGTH REQUIREMENTS - STANDARD DAY, WET SMOOTH RUNWAY SURFACE
 MODEL 767-400ER (CF6-80C2B7F1 ENGINES)

NOTES:

- CF6-80C2B7F1 ENGINES
- NO ENGINE AIRBLEED FOR AIR CONDITIONING
- ZERO WIND, ZERO RUNWAY GRADIENT
- WET SMOOTH RUNWAY SURFACE
- CONSULT USING AIRLINE FOR SPECIFIC OPERATING PROCEDURE PRIOR TO FACILITY DESIGN

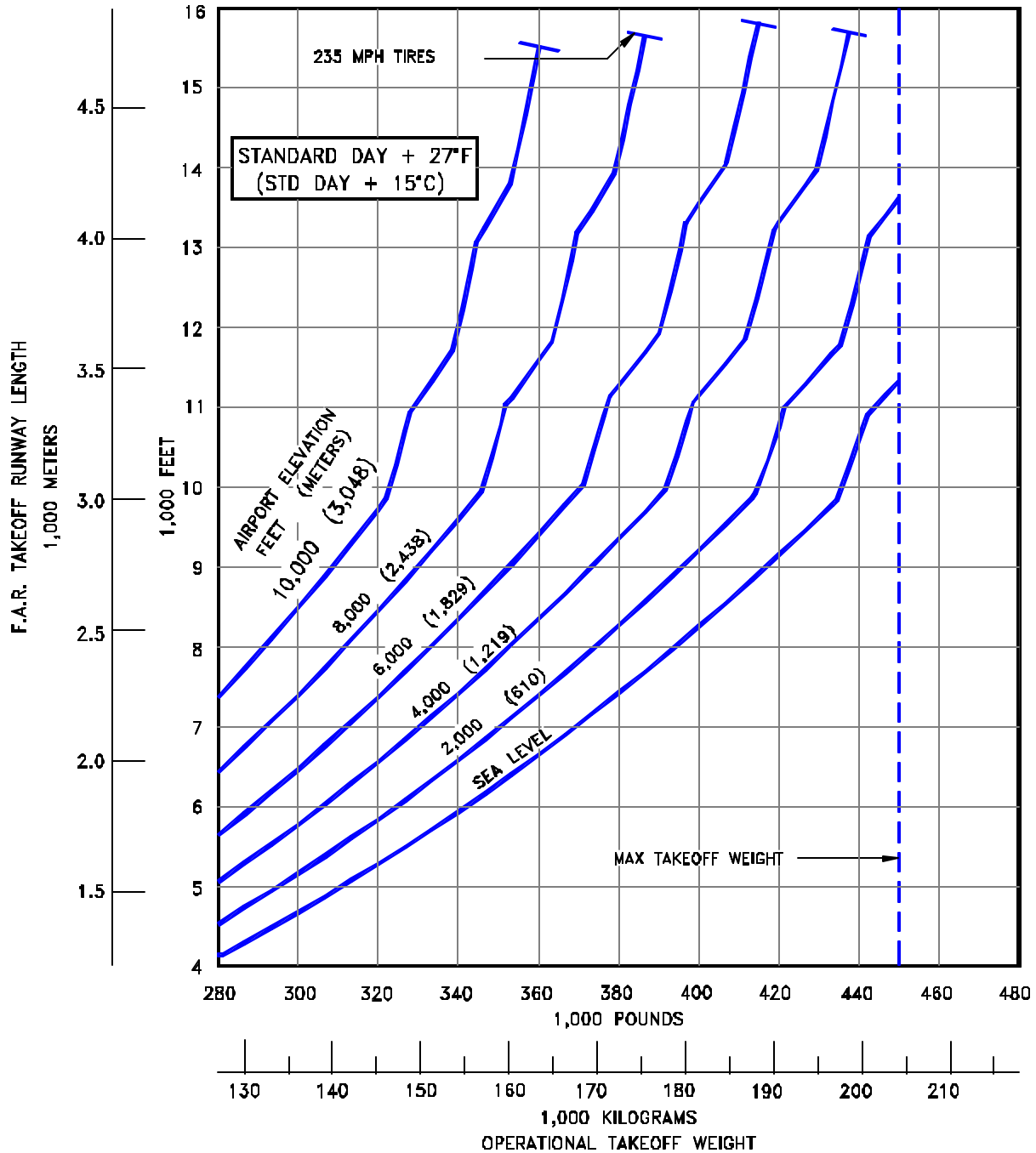

3.3.32 F.A.R. TAKEOFF RUNWAY LENGTH REQUIREMENTS

STANDARD DAY + 27°F (STD + 15°C), WET SMOOTH RUNWAY SURFACE
 MODEL 767-400ER (CF6-80C2B7F1 ENGINES)

NOTES:

- PW 4062 ENGINES
- NO ENGINE AIRBLEED FOR AIR CONDITIONING
- ZERO WIND, ZERO RUNWAY GRADIENT
- DRY RUNWAY SURFACE
- CONSULT USING AIRLINE FOR SPECIFIC OPERATING PROCEDURE PRIOR TO FACILITY DESIGN

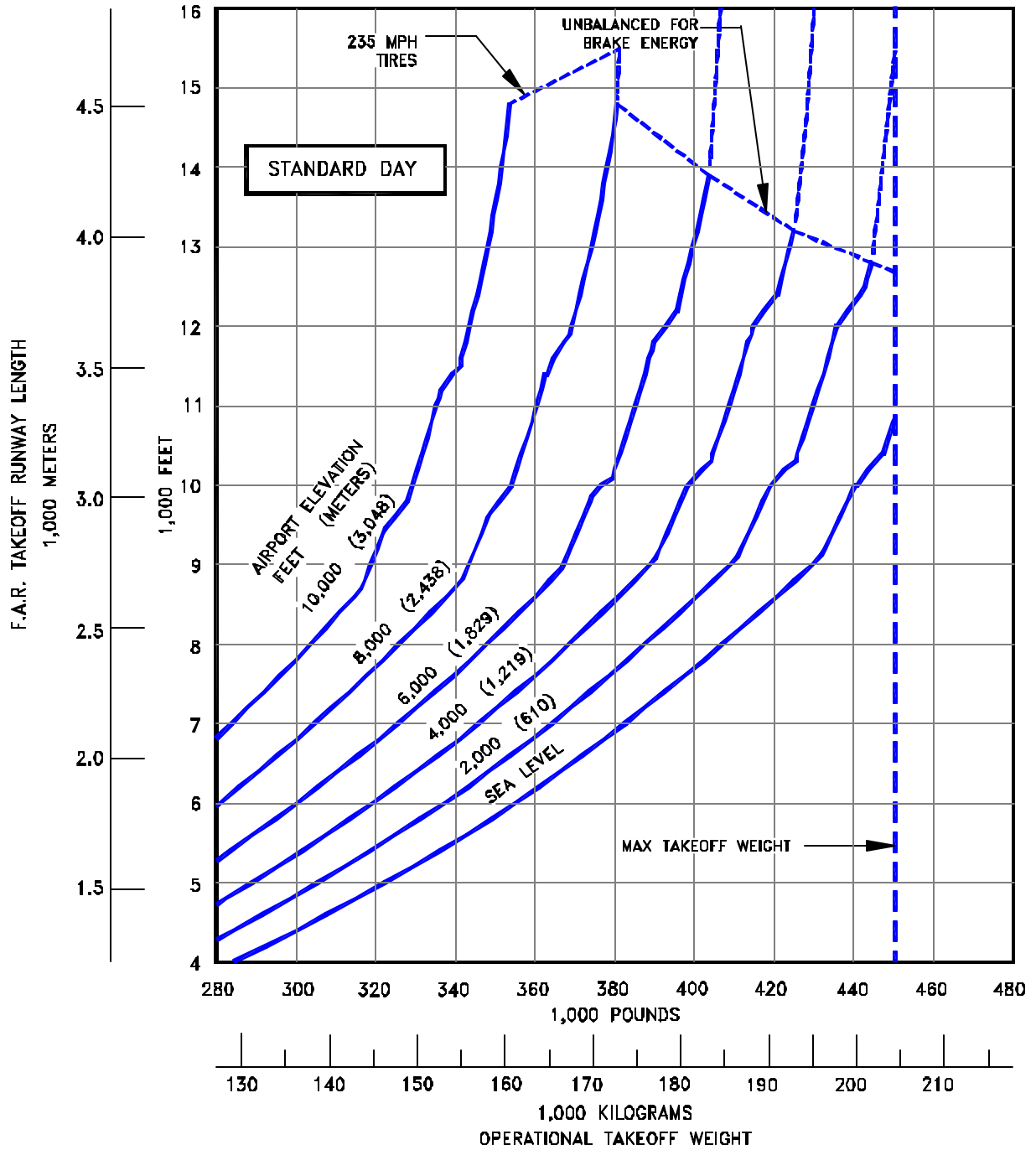

3.3.33 F.A.R. TAKEOFF RUNWAY LENGTH REQUIREMENTS - STANDARD DAY, DRY RUNWAY SURFACE
 MODEL 767-400ER (PW4062 ENGINES)

NOTES:

- PW 4062 ENGINES
- NO ENGINE AIRBLEED FOR AIR CONDITIONING
- ZERO WIND, ZERO RUNWAY GRADIENT
- DRY RUNWAY SURFACE
- CONSULT USING AIRLINE FOR SPECIFIC OPERATING PROCEDURE PRIOR TO FACILITY DESIGN

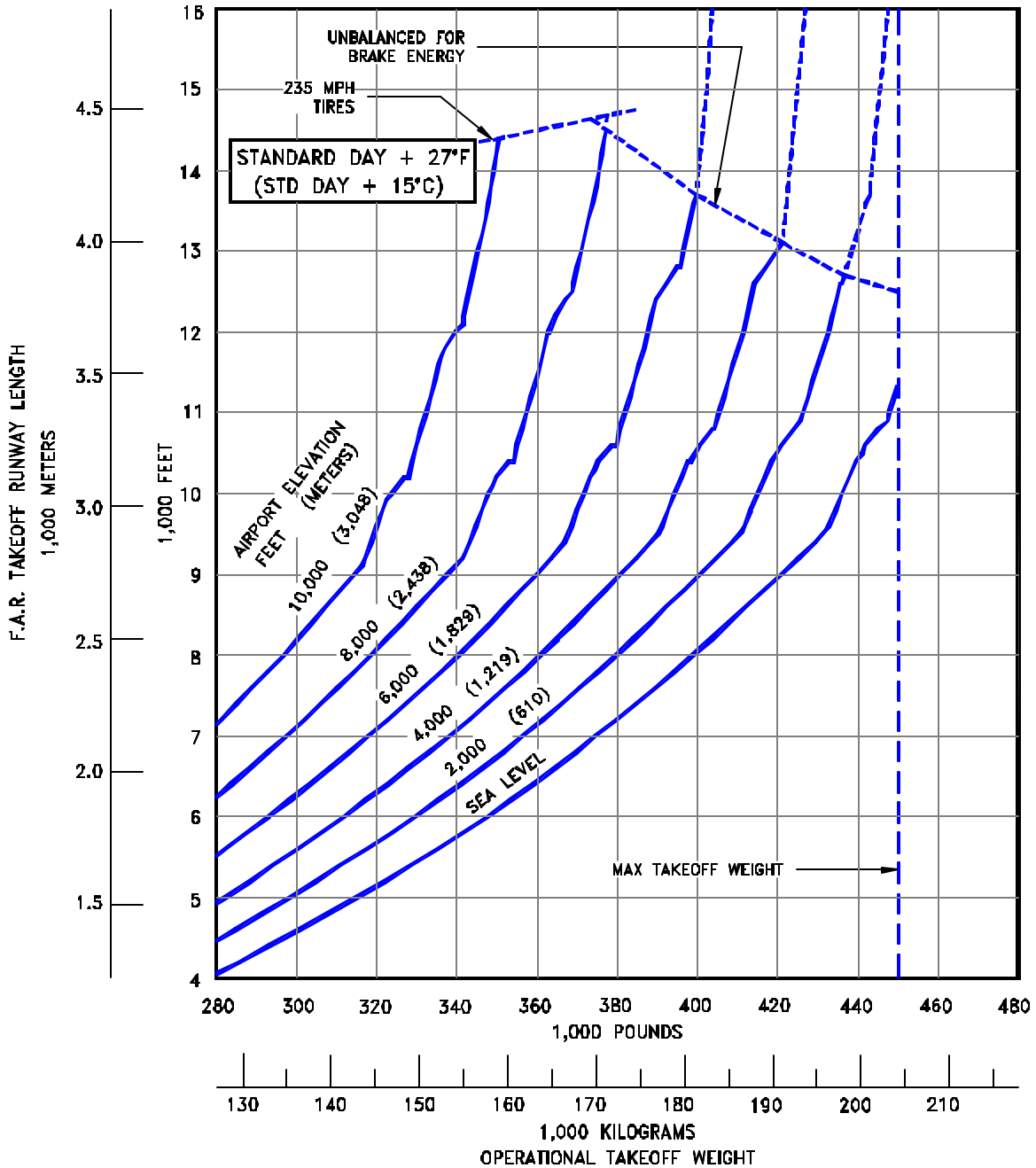

3.3.34 F.A.R. TAKEOFF RUNWAY LENGTH REQUIREMENTS

STANDARD DAY + 27°F (STD + 15°C), DRY RUNWAY SURFACE

MODEL 767-400ER (PW4062 ENGINES)

NOTES:

- PW4062 ENGINES
- NO ENGINE AIRBLEED FOR AIR CONDITIONING
- ZERO WIND, ZERO RUNWAY GRADIENT
- WET SMOOTH RUNWAY SURFACE
- CONSULT USING AIRLINE FOR SPECIFIC OPERATING PROCEDURE PRIOR TO FACILITY DESIGN

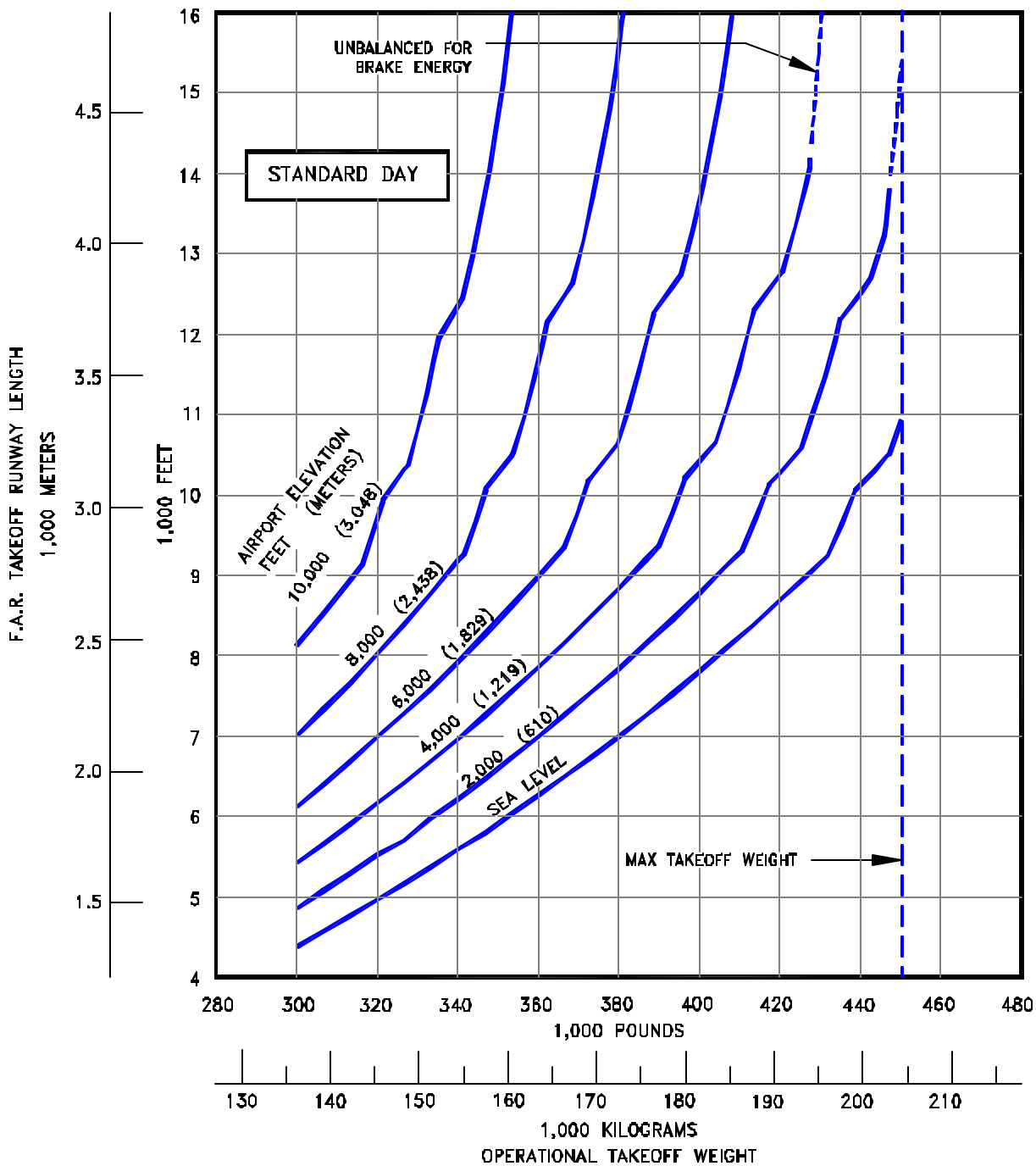

3.3.35 F.A.R. TAKEOFF RUNWAY LENGTH REQUIREMENTS - STANDARD DAY, WET SMOOTH RUNWAY SURFACE
 MODEL 767-400ER (PW4062 ENGINES)

NOTES:

- PW 4062 ENGINES
- NO ENGINE AIRBLEED FOR AIR CONDITIONING
- ZERO WIND, ZERO RUNWAY GRADIENT
- WET SMOOTH RUNWAY SURFACE
- CONSULT USING AIRLINE FOR SPECIFIC OPERATING PROCEDURE PRIOR TO FACILITY DESIGN

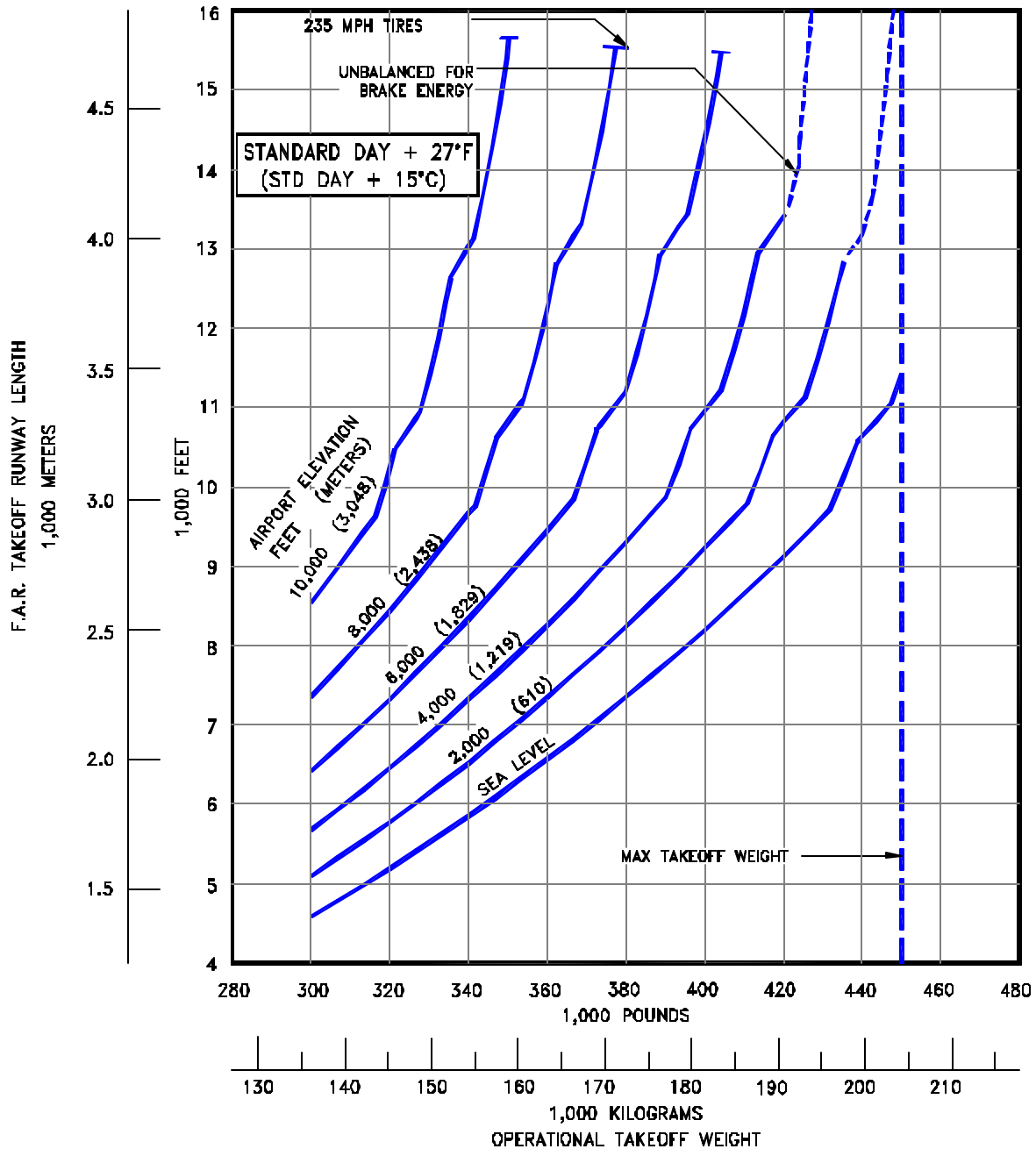

3.3.36 F.A.R. TAKEOFF RUNWAY LENGTH REQUIREMENTS

STANDARD DAY + 27°F (STD + 15°C), WET SMOOTH RUNWAY SURFACE

MODEL 767-400ER (PW4062 ENGINES)

NOTES:

- NO REVERSE THRUST
- ANTI-SKID ON
- AUTO SPEED BRAKES
- ZERO WIND, ZERO RUNWAY SLOPE
- CONSULT USING AIRLINE FOR SPECIFIC OPERATING PROCEDURE PRIOR TO FACILITY DESIGN

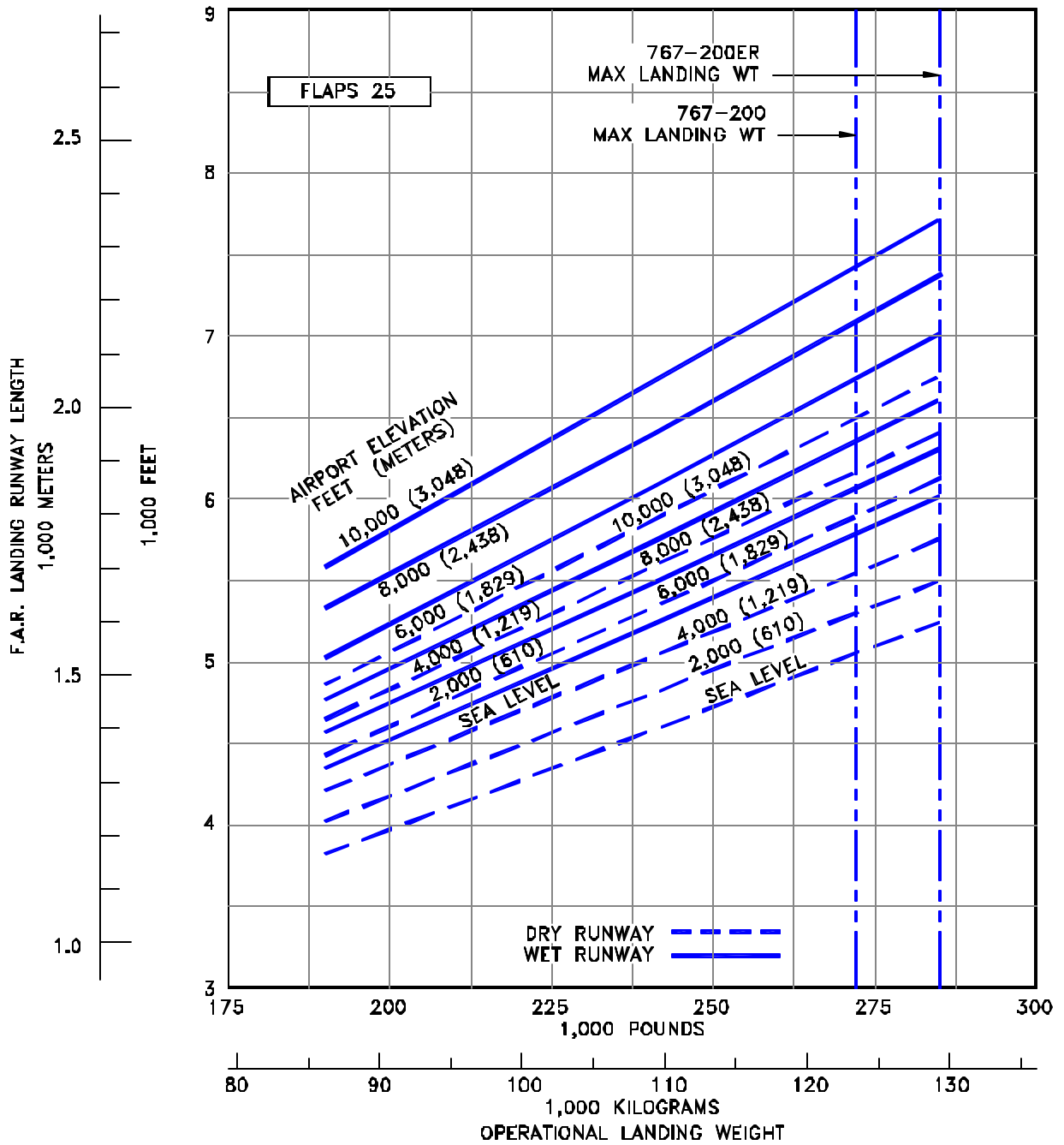

3.4.1 FAA LANDING RUNWAY LENGTH REQUIREMENTS - FLAPS 25
MODEL 767-200, -200ER

NOTES:

- NO REVERSE THRUST
- ANTI-SKID ON
- AUTO SPEED BRAKES
- ZERO WIND, ZERO RUNWAY SLOPE
- CONSULT USING AIRLINE FOR SPECIFIC OPERATING PROCEDURE PRIOR TO FACILITY DESIGN

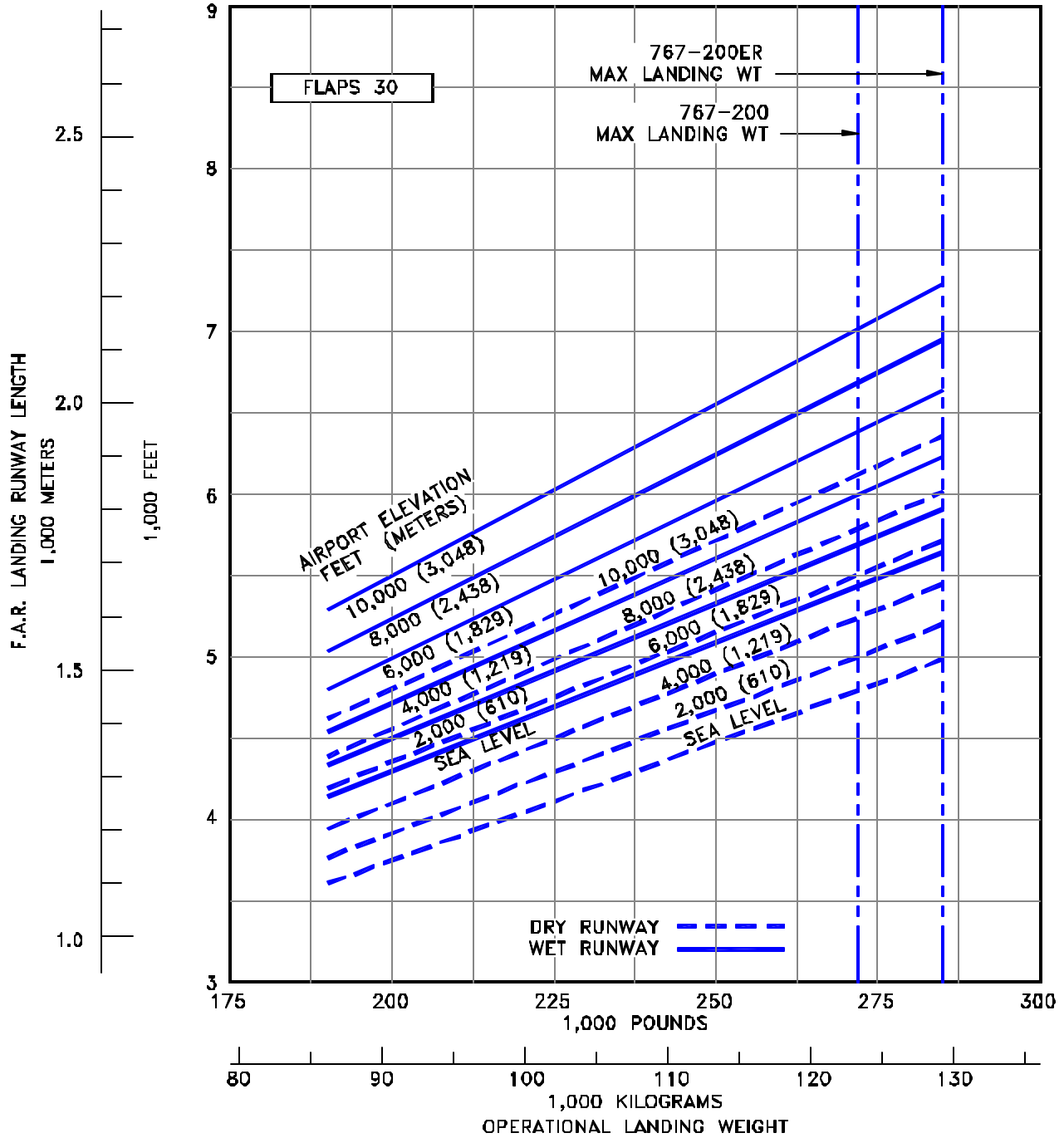

3.4.2 FAA LANDING RUNWAY LENGTH REQUIREMENTS - FLAPS 30
MODEL 767-200, -200ER

NOTES:

- NO REVERSE THRUST
- ANTI-SKID ON
- AUTO SPEED BRAKES
- ZERO WIND, ZERO RUNWAY SLOPE
- CONSULT USING AIRLINE FOR SPECIFIC OPERATING PROCEDURE PRIOR TO FACILITY DESIGN

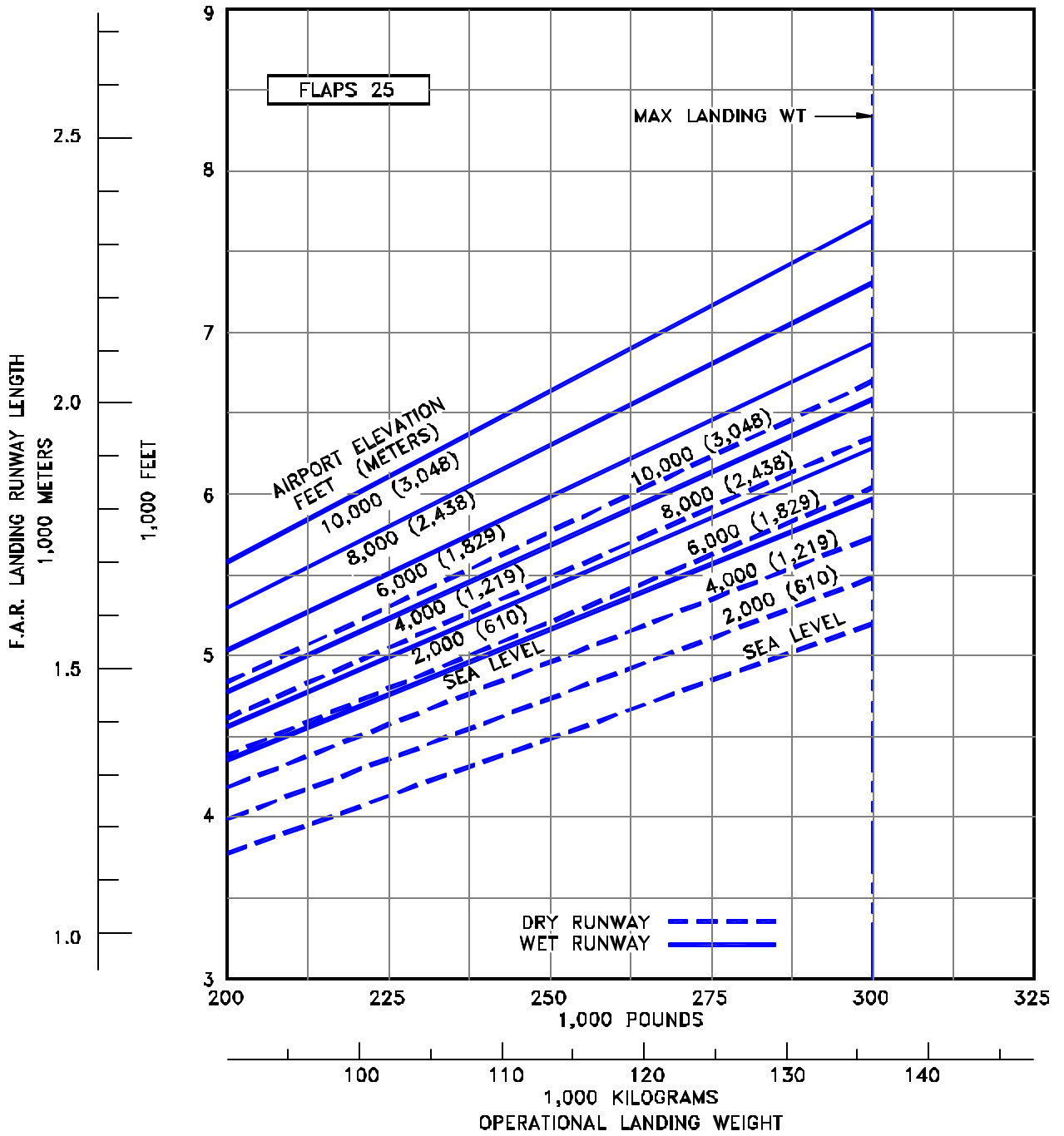

3.4.3 FAA LANDING RUNWAY LENGTH REQUIREMENTS - FLAPS 25

MODEL 767-300

NOTES:

- NO REVERSE THRUST
- ANTI-SKID ON
- AUTO SPEED BRAKES
- ZERO WIND, ZERO RUNWAY SLOPE
- CONSULT USING AIRLINE FOR SPECIFIC OPERATING PROCEDURE PRIOR TO FACILITY DESIGN

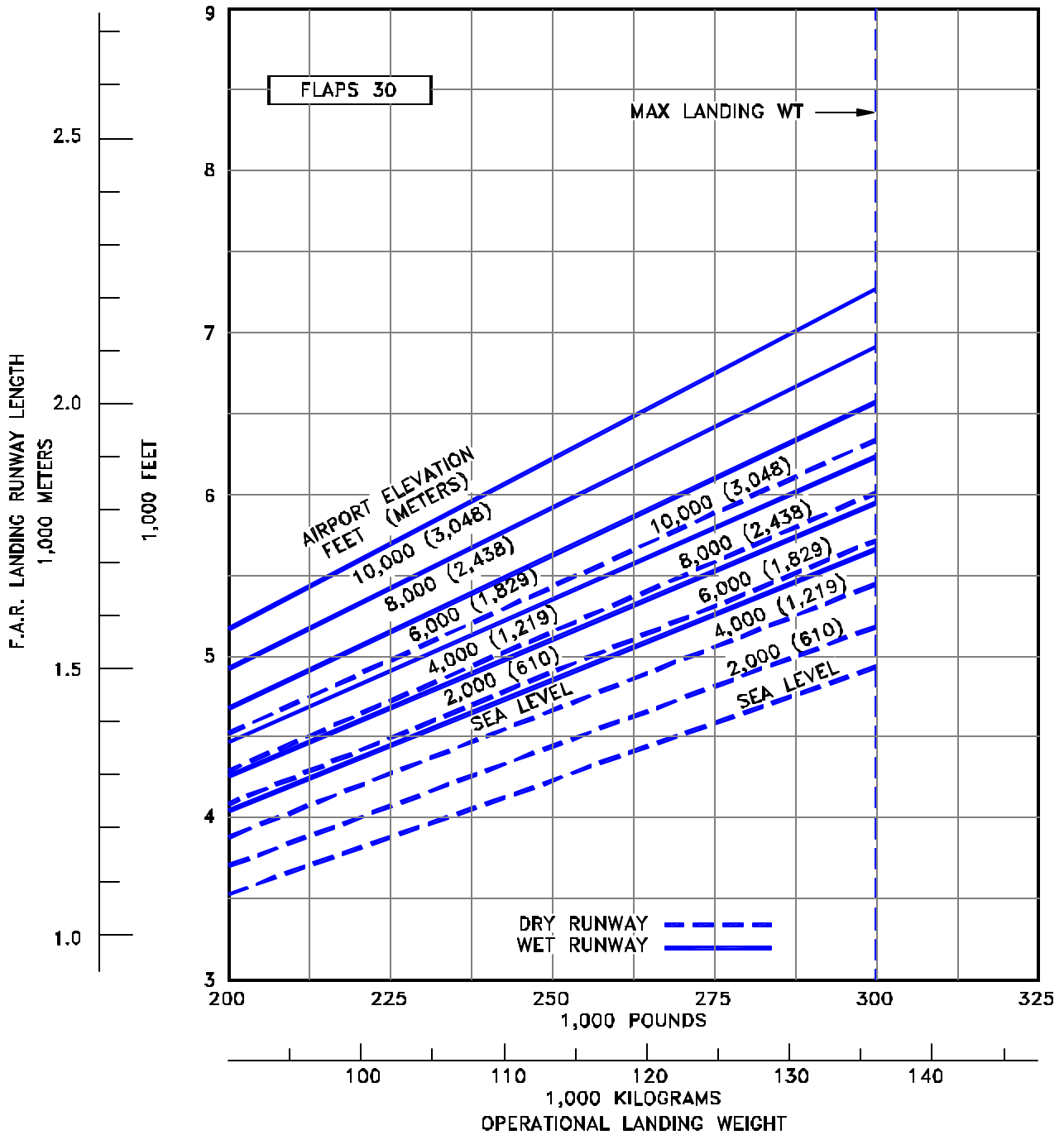

3.4.4 FAA LANDING RUNWAY LENGTH REQUIREMENTS - FLAPS 30
 MODEL 767-300

NOTES:

- NO REVERSE THRUST
- ANTI-SKID ON
- AUTO SPEED BRAKES
- ZERO WIND, ZERO RUNWAY SLOPE
- CONSULT USING AIRLINE FOR SPECIFIC OPERATING PROCEDURE PRIOR TO FACILITY DESIGN

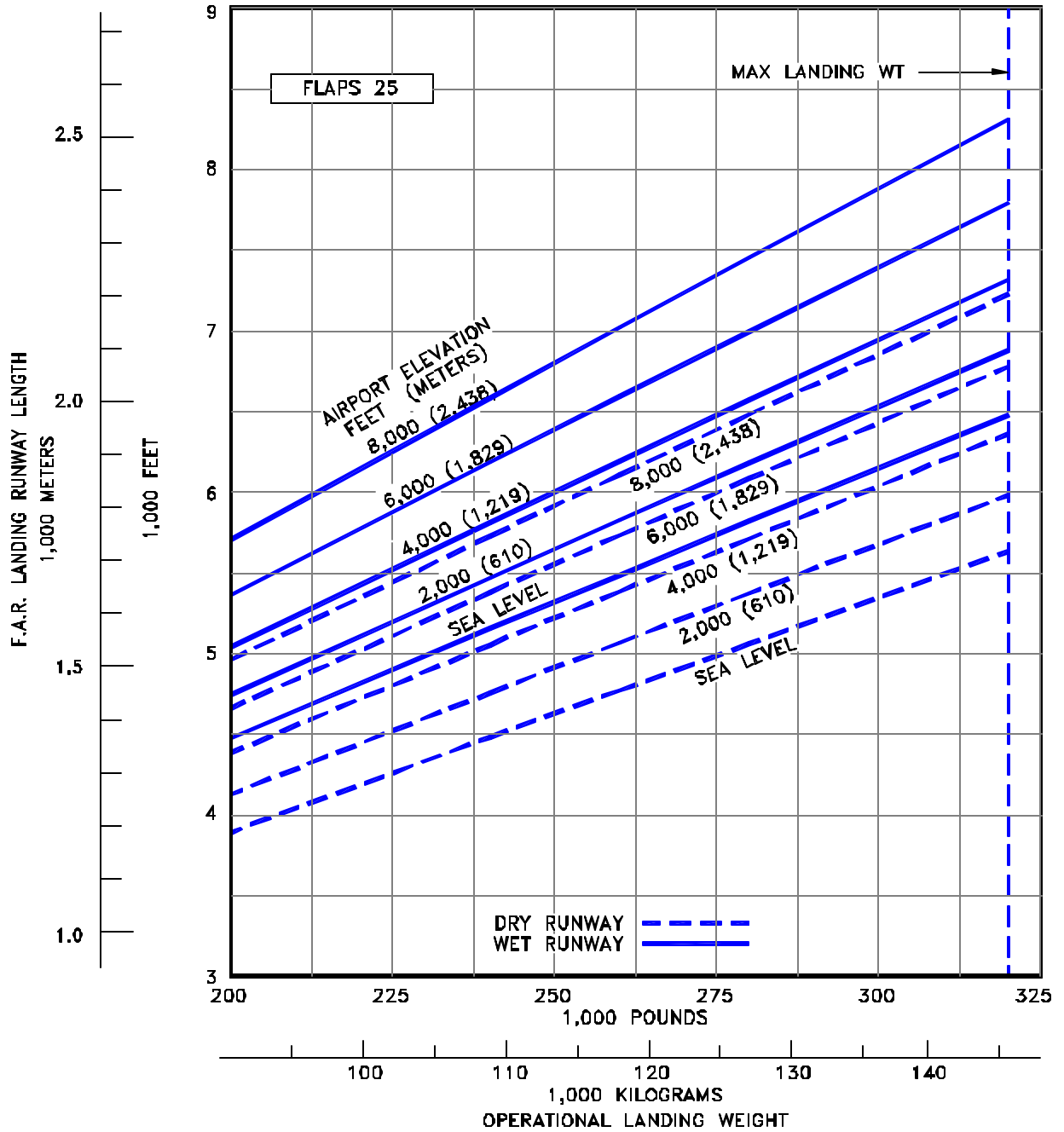

3.4.5 FAA LANDING RUNWAY LENGTH REQUIREMENTS - FLAPS 25

MODEL 767-300ER

NOTES:

- NO REVERSE THRUST
- ANTI-SKID ON
- AUTO SPEED BRAKES
- ZERO WIND, ZERO RUNWAY SLOPE
- CONSULT USING AIRLINE FOR SPECIFIC OPERATING PROCEDURE PRIOR TO FACILITY DESIGN

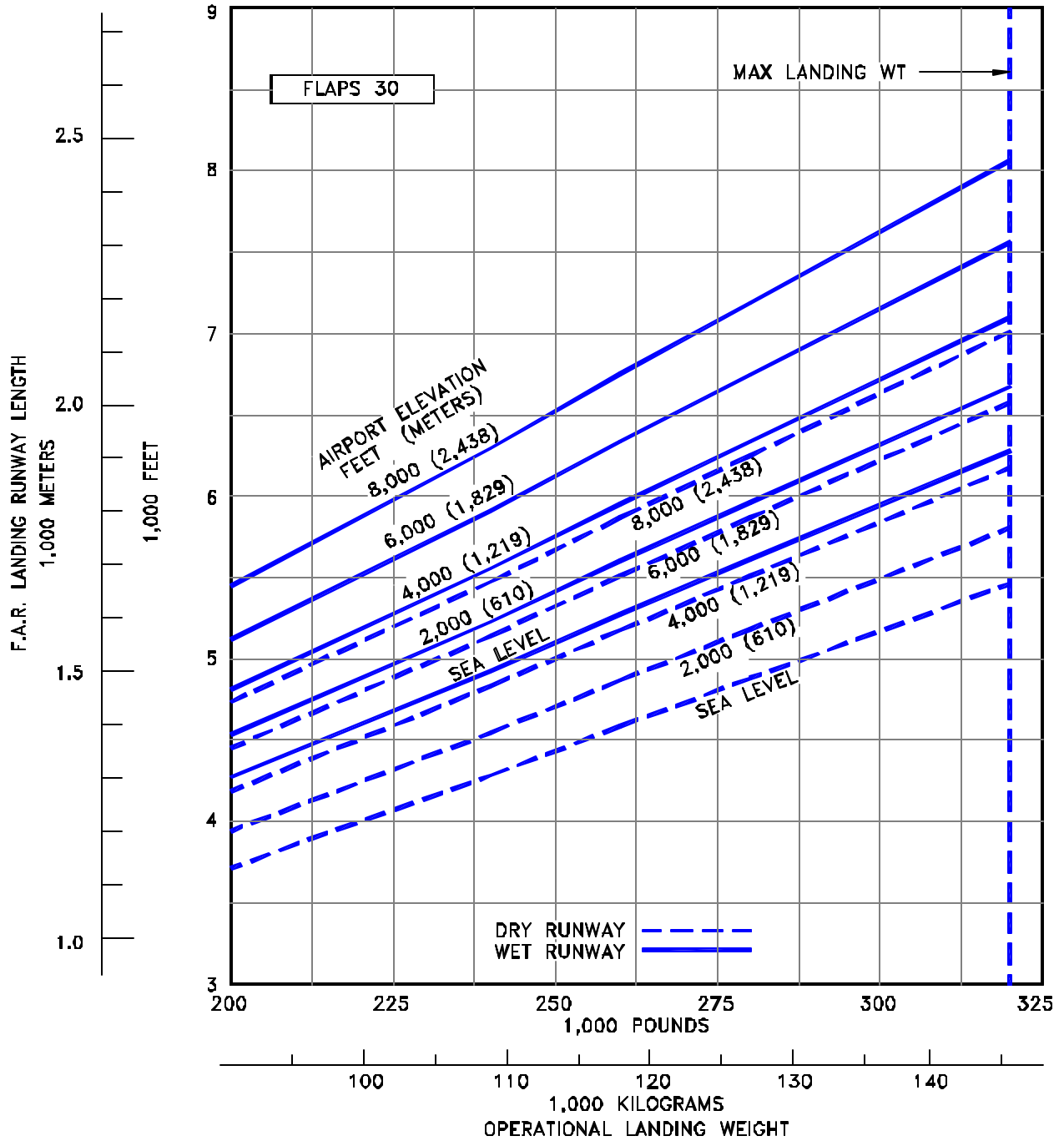

3.4.6 FAA LANDING RUNWAY LENGTH REQUIREMENTS - FLAPS 30
 MODEL 767-300ER

NOTES:

- NO REVERSE THRUST
- ANTI-SKID ON
- AUTO SPEED BRAKES
- ZERO WIND, ZERO RUNWAY SLOPE
- CONSULT USING AIRLINE FOR SPECIFIC OPERATING PROCEDURE PRIOR TO FACILITY DESIGN

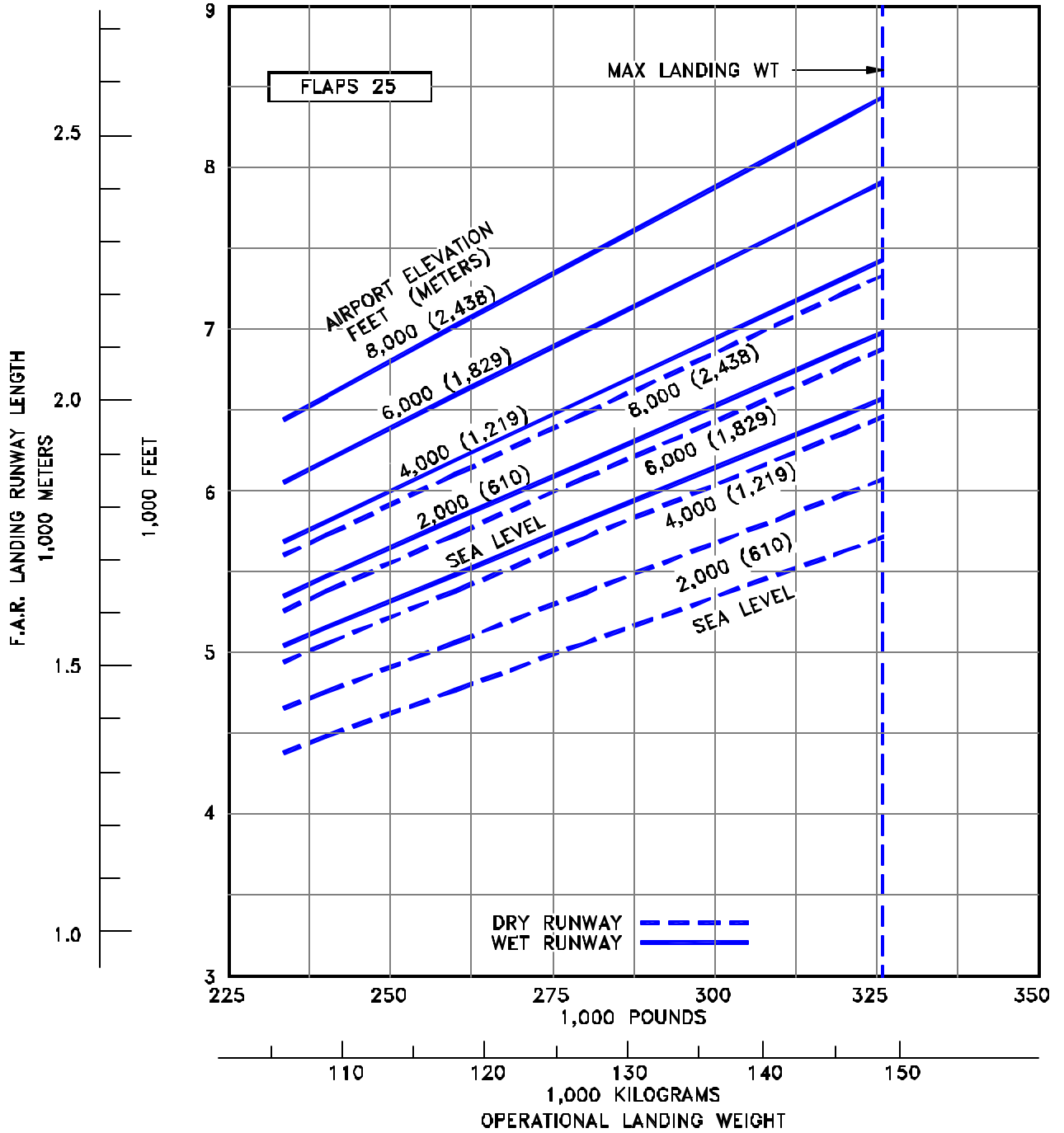

3.4.7 FAA LANDING RUNWAY LENGTH REQUIREMENTS - FLAPS 25
 MODEL 767-300 FREIGHTER

NOTES:

- NO REVERSE THRUST
- ANTI-SKID ON
- AUTO SPEED BRAKES
- ZERO WIND, ZERO RUNWAY SLOPE
- CONSULT USING AIRLINE FOR SPECIFIC OPERATING PROCEDURE PRIOR TO FACILITY DESIGN

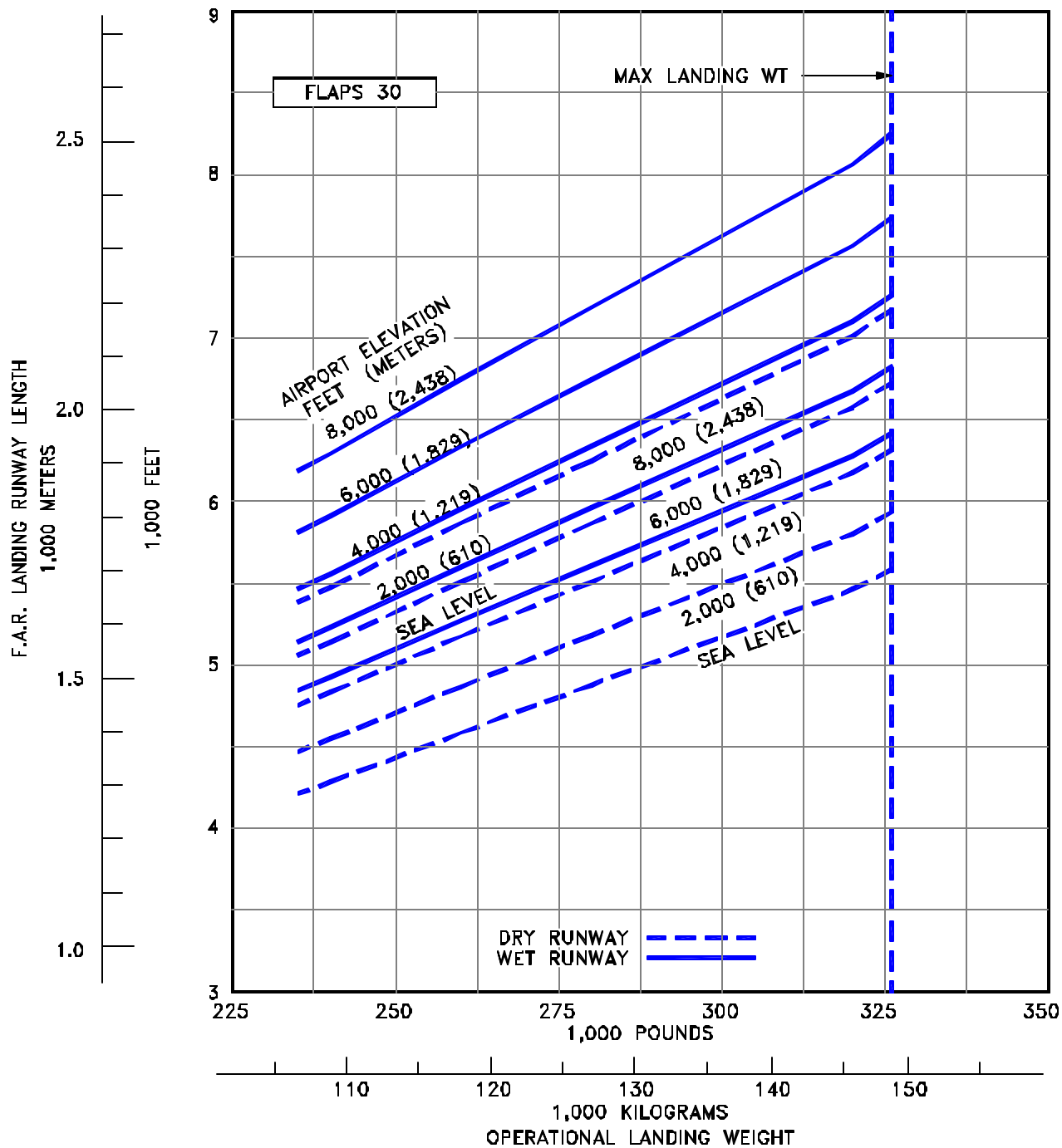

3.4.8 FAA LANDNG RUNWAY LENGTH REQUIREMENTS - FLAPS 30
 MODEL 767—300 FREIGHTER

NOTES:

- STANDARD DAY
- NO REVERSE THRUST
- ANTI-SKID OPERATIVE
- AUTO SPEED BRAKES
- ZERO WIND
- ZERO SLOPE
- CONSULT USING AIRLINE FOR SPECIFIC OPERATING PROCEDURE PRIOR TO FACILITY DESIGN

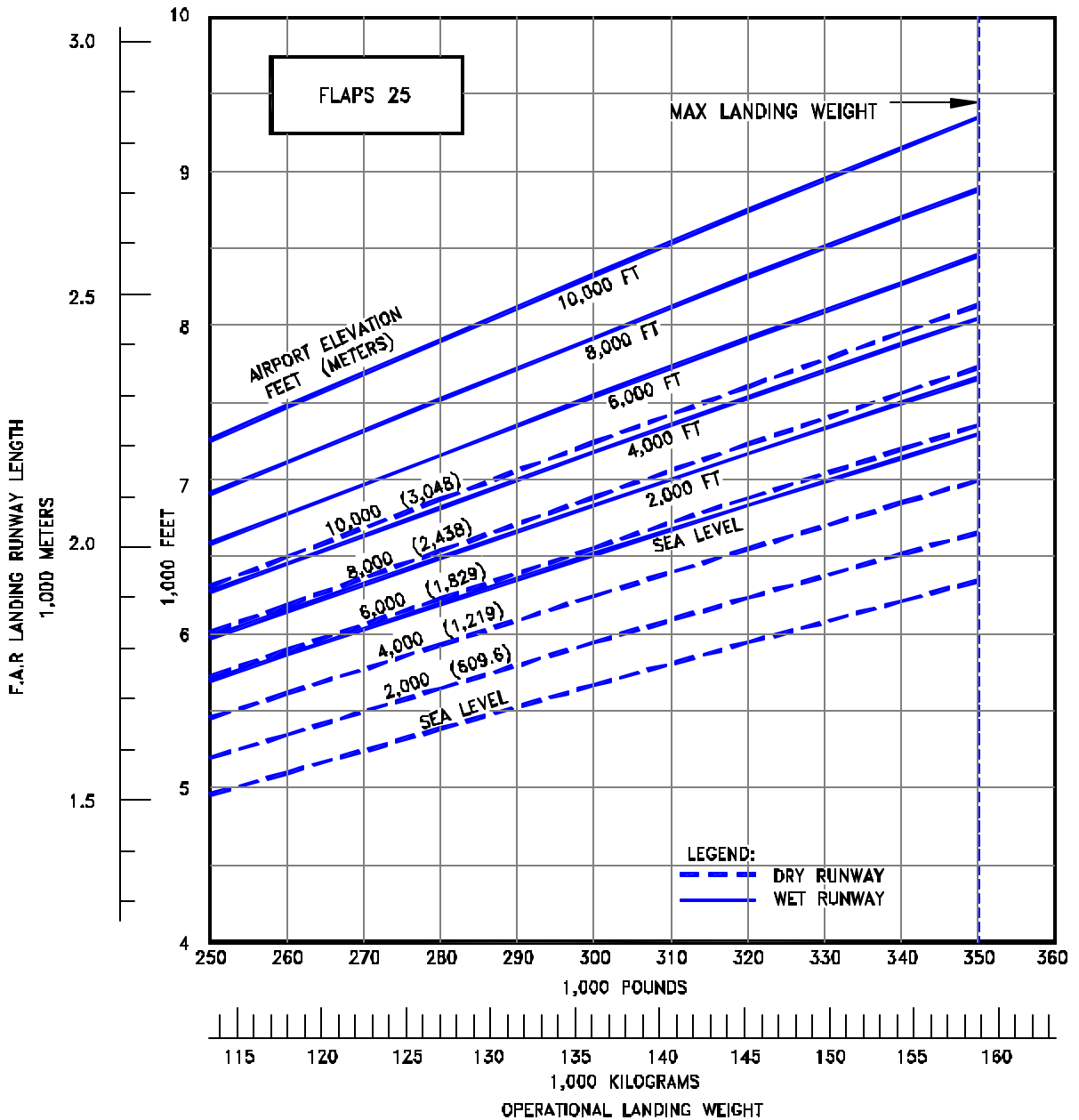

3.4.9 FAA LANDING RUNWAY LENGTH REQUIREMENTS - FLAPS 25
 MODEL 767-400ER

NOTES:

- STANDARD DAY
- NO REVERSE THRUST
- ANTI-SKID OPERATIVE
- AUTO SPEED BRAKES
- ZERO WIND
- ZERO SLOPE
- CONSULT USING AIRLINE FOR SPECIFIC OPERATING PROCEDURE PRIOR TO FACILITY DESIGN

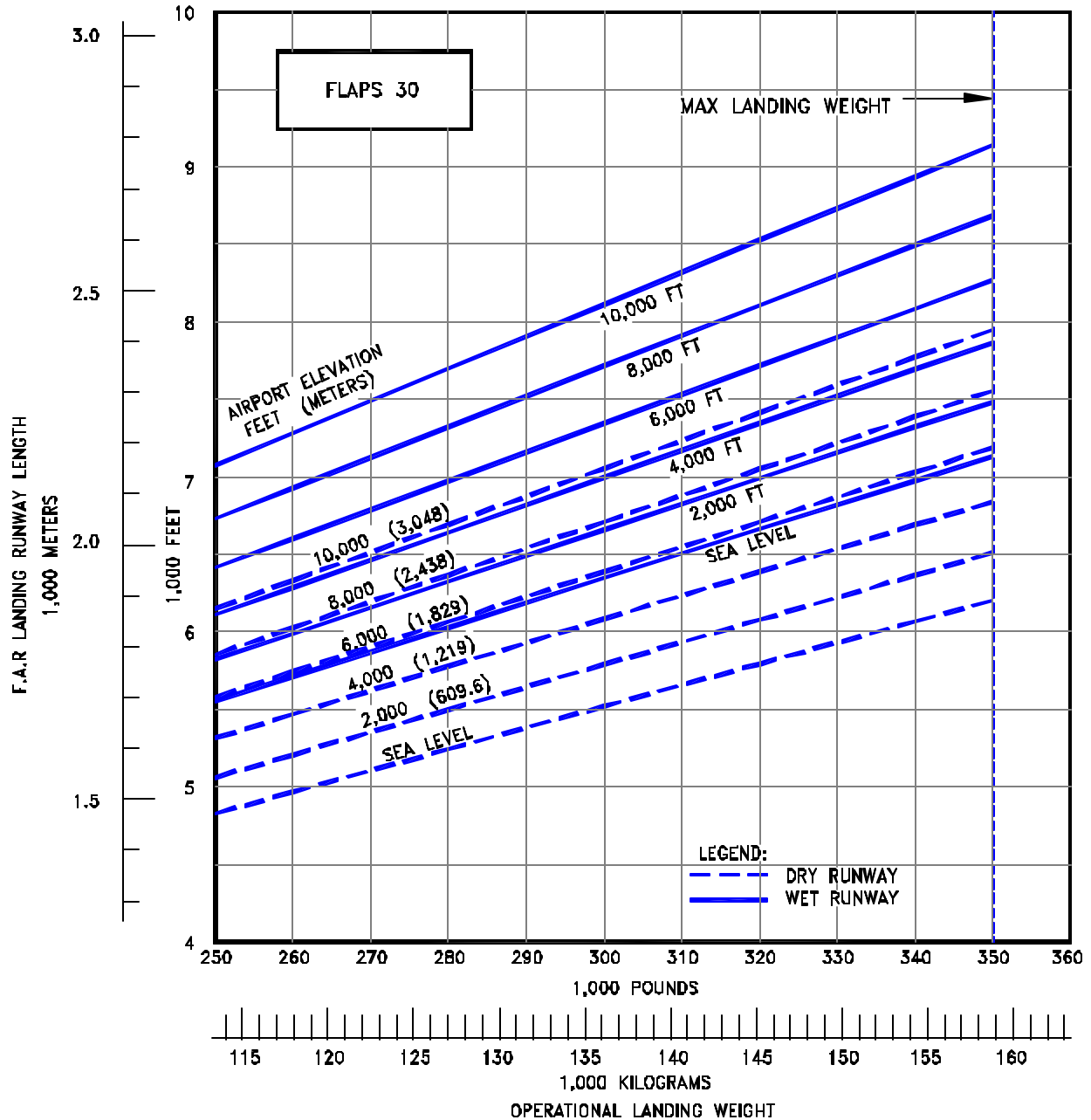

3.4.10 FAA LANDING RUNWAY LENGTH REQUIREMENTS - FLAPS 30
 MODEL 767-400ER

D6-58328

4.0 GROUND MANEUVERING

4.1 General Information

4.2 Turning Radii

4.3 Clearance Radii

4.4 Visibility From Cockpit in Static Position

4.5 Runway and Taxiway Turn Paths

4.6 Runway Holding Bay

4.0 GROUND MANEUVERING

4.1 General Information

This section provides airplane turning capability and maneuvering characteristics.

For ease of presentation, these data have been determined from the theoretical limits imposed by the geometry of the aircraft, and where noted, provide for a normal allowance for tire slippage. As such, they reflect the turning capability of the aircraft in favorable operating circumstances. These data should be used only as guidelines for the method of determination of such parameters and for the maneuvering characteristics of this aircraft.

In the ground operating mode, varying airline practices may demand that more conservative turning procedures be adopted to avoid excessive tire wear and reduce possible maintenance problems. Airline operating procedures will vary in the level of performance over a wide range of operating circumstances throughout the world. Variations from standard aircraft operating patterns may be necessary to satisfy physical constraints within the maneuvering area, such as adverse grades, limited area, or high risk of jet blast damage. For these reasons, ground maneuvering requirements should be coordinated with the using airlines prior to layout planning.

Section 4.2 shows turning radii for various nose gear steering angles. Radii for the main and nose gears are measured from the turn center to the outside of the tire.

Section 4.3 provides data on minimum width of pavement required for 180° turn.

Section 4.4 shows the pilot's visibility from the cockpit and the limits of ambinoocular vision through the windows. Ambinoocular vision is defined as the total field of vision seen simultaneously by both eyes.

Section 4.5 shows approximate wheel paths of a 767 on runway to taxiway, and taxiway to taxiway turns.

Section 4.6 illustrates a typical runway holding bay configuration.

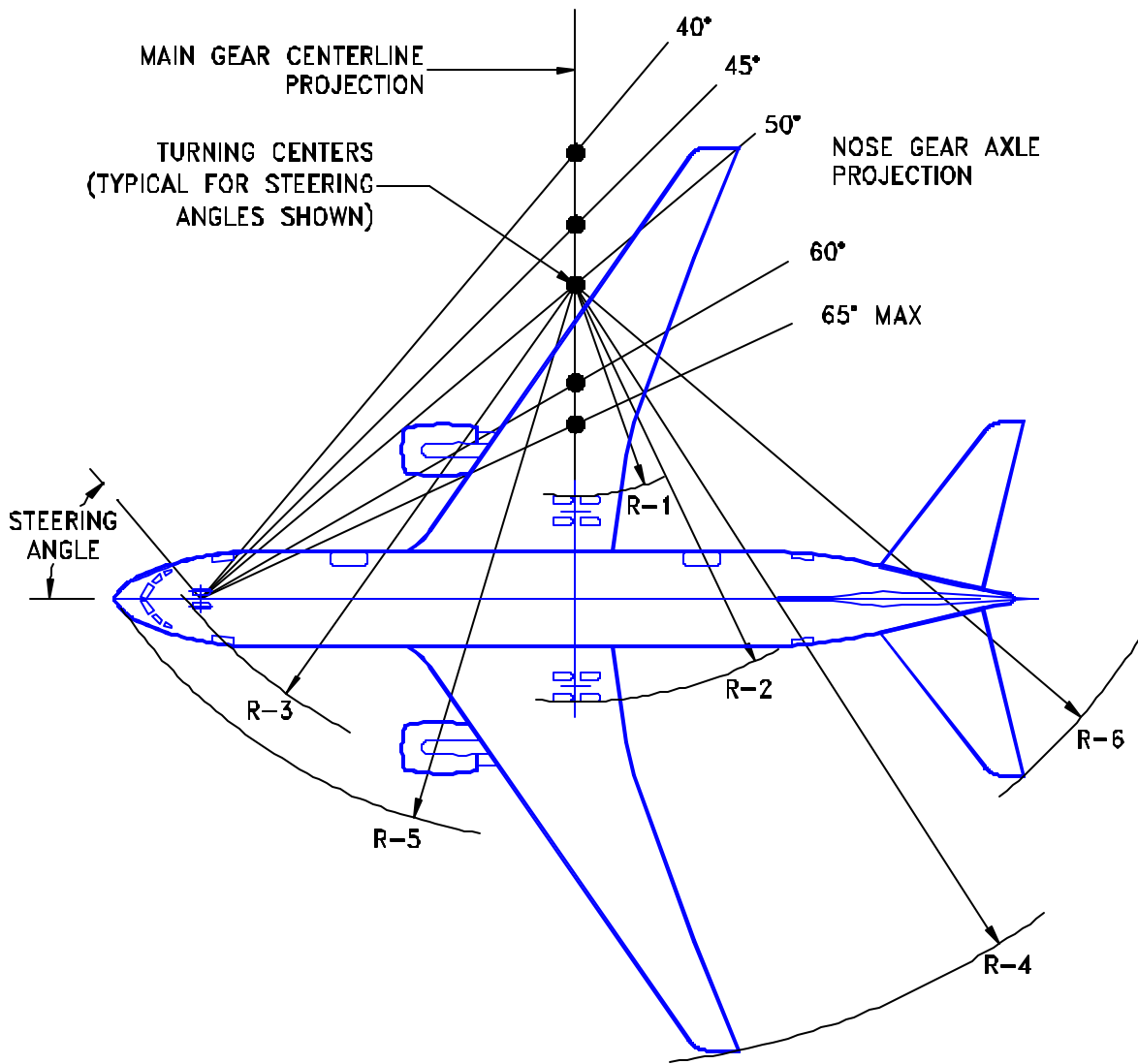

NOTES: * ACTUAL OPERATING TURNING RADII MAY BE GREATER THAN SHOWN.
 * CONSULT WITH AIRLINE FOR SPECIFIC OPERATING PROCEDURE

STEERING ANGLE (DEG)	R-1 INNER GEAR		R-2 OUTER GEAR		R-3 NOSE GEAR		R-4 WING TIP		R-5 NOSE		R-6 TAIL	
	FT	M	FT	M	FT	M	FT	M	FT	M	FT	M
30	94.0	28.7	129.7	39.5	130.8	39.9	192.1	58.5	137.3	41.8	161.8	49.3
35	74.4	22.7	110.1	33.6	114.3	34.8	172.7	52.6	121.8	37.1	144.8	44.1
40	59.1	18.0	94.8	28.9	102.1	31.1	157.6	48.0	110.7	33.7	132.1	40.3
45	46.7	14.2	82.4	25.1	93.0	28.3	145.4	44.3	102.4	31.2	122.2	37.3
50	36.4	11.1	72.1	22.0	86.0	26.2	135.2	41.2	96.2	29.3	114.3	34.8
55	27.4	8.3	63.1	19.2	80.5	24.5	126.5	38.6	91.5	27.9	107.8	32.9
60	19.4	5.9	55.1	16.8	76.2	23.2	118.7	36.2	87.8	26.8	102.4	31.2
65 (MAX)	12.3	3.7	48.0	14.6	72.9	22.2	111.8	34.1	85.0	25.9	97.8	29.8

4.2.1 TURNING RADII - NO SLIP ANGLE

MODEL 767-200, -200ER

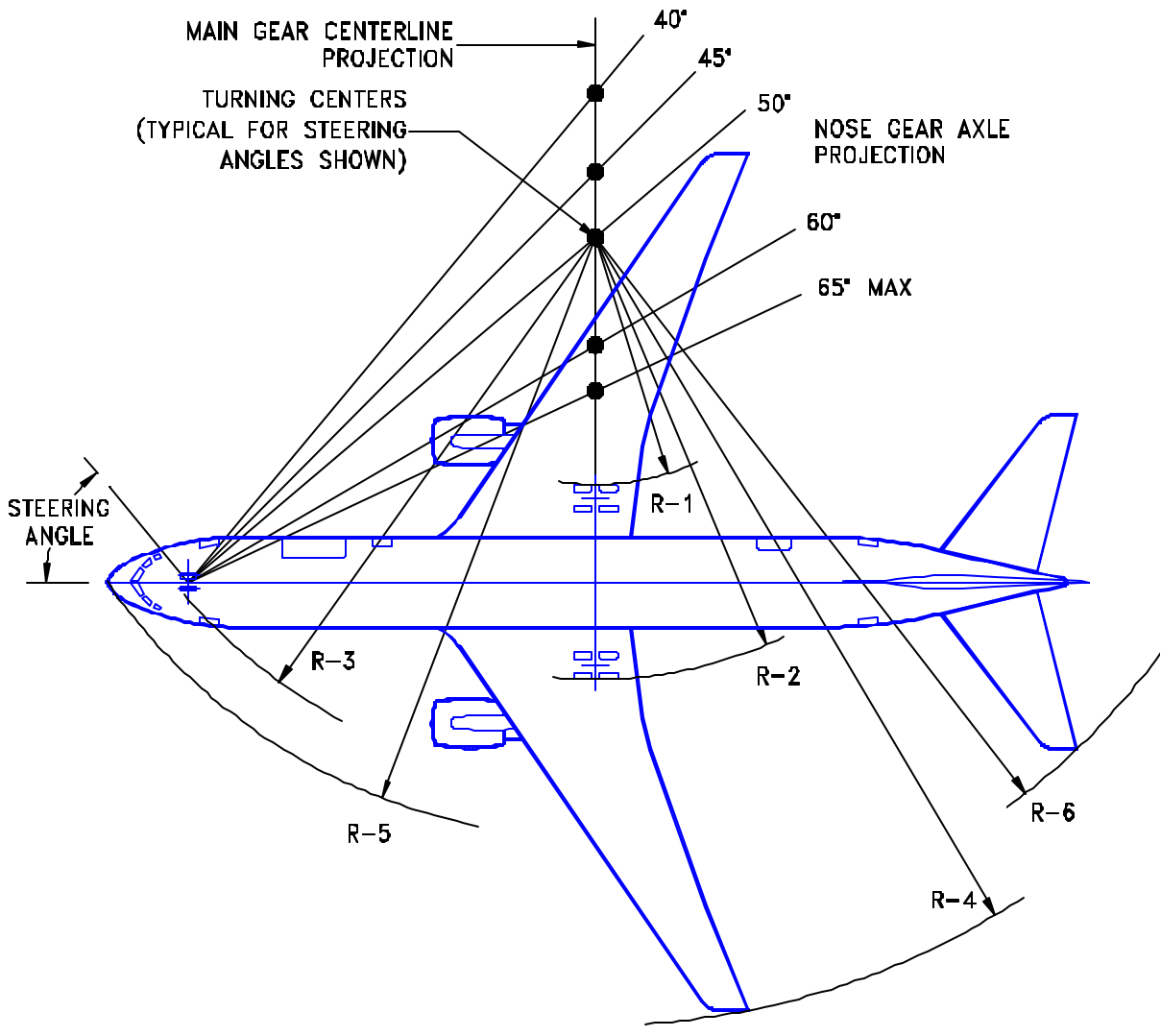

NOTES: *ACTUAL OPERATING TURNING RADII MAY BE GREATER THAN SHOWN.
 * CONSULT WITH AIRLINE FOR SPECIFIC OPERATING PROCEDURE

STEERING ANGLE (DEG)	R-1 INNER GEAR		R-2 OUTER GEAR		R-3 NOSE GEAR		R-4 WING TIP		R-5 NOSE		R-6 TAIL	
	FT	M	FT	M	FT	M	FT	M	FT	M	FT	M
30	111.5	34.0	147.3	44.9	151.0	46.0	209.4	63.8	157.4	48.0	181.8	55.4
35	88.8	27.1	124.6	38.0	131.9	40.2	186.9	57.0	139.3	42.5	162.2	49.4
40	71.1	21.7	106.9	32.6	117.9	35.9	169.5	51.7	126.3	38.5	147.6	45.0
45	56.8	17.3	92.6	28.2	107.3	32.7	155.4	47.4	116.7	35.6	136.2	41.5
50	44.8	13.6	80.6	24.6	99.2	30.2	143.5	43.8	109.3	33.3	127.2	38.8
55	34.4	10.5	70.2	21.4	92.8	28.3	133.4	40.7	103.7	31.6	119.8	36.5
60	25.2	7.7	61.0	18.6	87.9	26.8	124.4	37.9	99.4	30.3	113.6	34.6
65 (MAX)	16.9	5.2	52.7	16.1	84.1	25.6	116.4	35.5	96.1	29.3	108.4	33.1

4.2.2 TURNING RADII - NO SLIP ANGLE
 MODEL 767-300, -300ER, -300 FREIGHTER

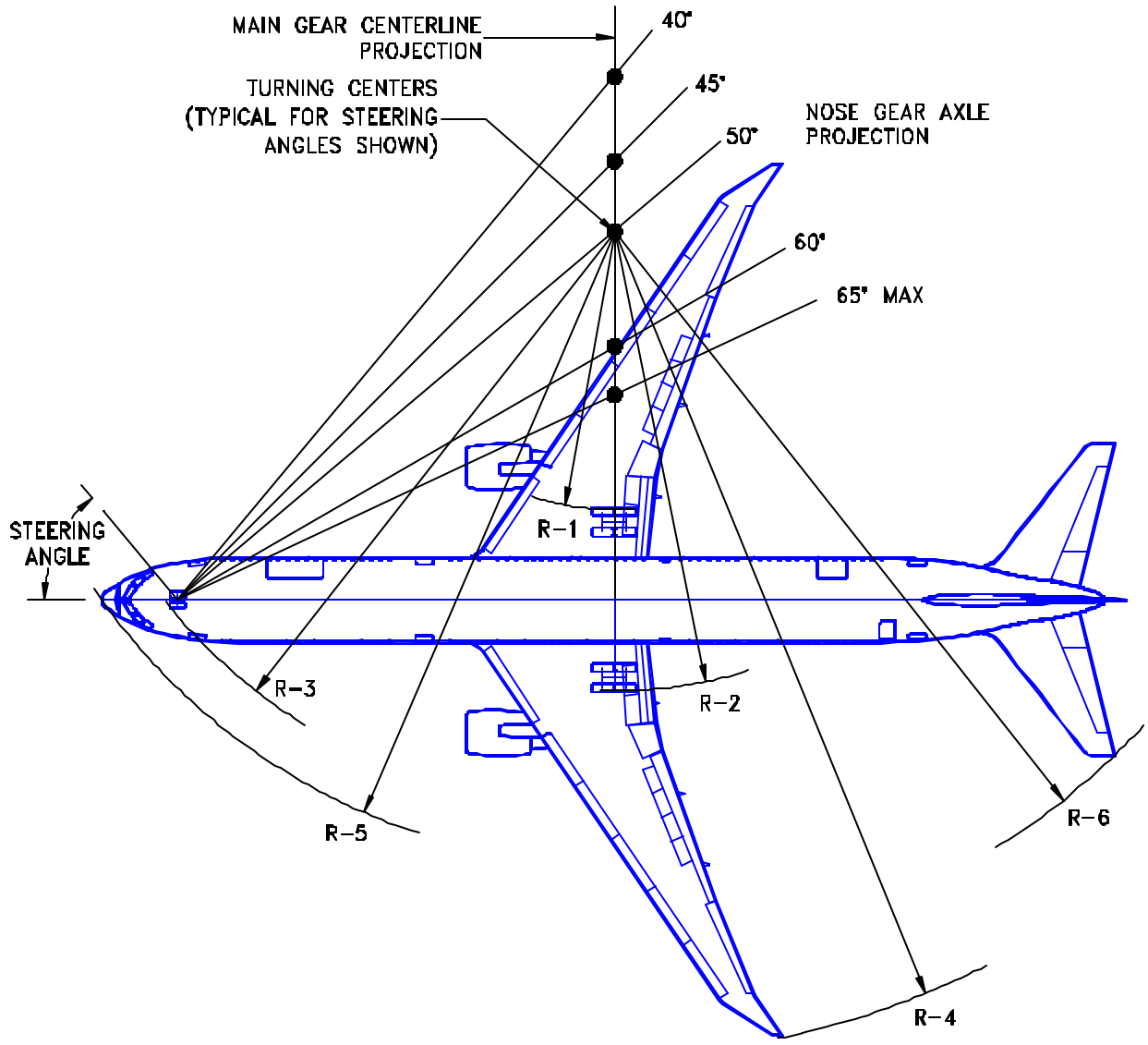

NOTES: *ACTUAL OPERATING TURNING RADII MAY BE GREATER THAN SHOWN.
 * CONSULT WITH AIRLINE FOR SPECIFIC OPERATING PROCEDURE

STEERING ANGLE (DEG)	R1 INNER GEAR		R2 OUTER GEAR		R3 NOSE GEAR		R4 WING TIP		R5 NOSE		R6 TAIL	
	FT	M	FT	M	FT	M	FT	M	FT	M	FT	M
30	130.5	39.8	166.3	50.7	173.0	52.7	236.0	71.8	179.3	54.7	203.4	62.0
35	104.5	31.8	140.3	42.8	151.1	46.0	210.3	63.9	158.4	48.3	180.9	55.1
40	84.2	25.7	120.0	36.6	135.0	41.1	190.3	57.8	143.4	43.7	164.1	50.0
45	67.8	20.7	103.6	31.6	122.8	37.4	174.1	52.9	132.2	40.3	151.1	46.1
50	54.0	16.5	89.8	27.4	113.5	34.6	160.6	48.7	123.7	37.7	140.8	42.9
55	42.1	12.8	77.9	23.7	106.3	32.4	149.0	45.2	117.1	35.7	132.4	40.4
60	31.6	9.6	67.4	20.5	100.6	30.7	138.7	42.0	112.1	34.2	125.4	38.2
65 (MAX)	22.1	6.7	57.9	17.6	96.2	29.3	129.5	39.2	108.2	33.0	119.6	36.5

4.2.3 TURNING RADII - NO SLIP ANGLE MODEL 767-400ER

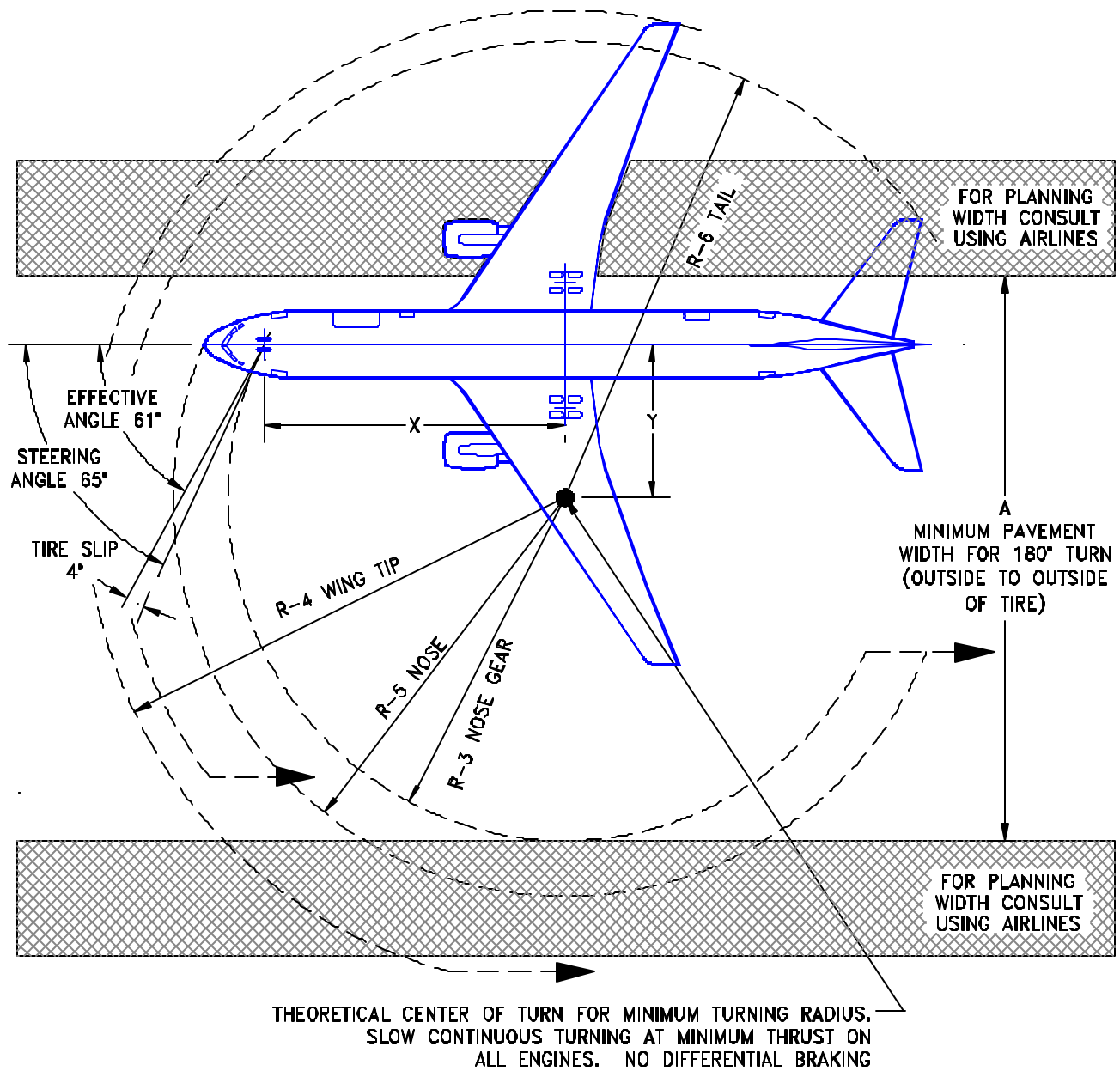

NOTES: * TIRE SLIP ANGLE APPROXIMATE FOR 61° STEERING ANGLE
* CONSULT USING AIRLINE FOR SPECIFIC OPERATING PROCEDURE

MODEL	EFFECTIVE STEERING ANGLE (DEG)	X		Y		A		R3		R4		R5		R6	
		FT	M	FT	M	FT	M	FT	M	FT	M	FT	M	FT	M
-200, -200ER	61	64.6	19.7	35.8	10.9	129.2	39.4	75.5	23.0	117.3	35.8	87.2	26.6	101.4	30.9
-300, -300ER, -300F	61	74.7	22.8	41.4	12.6	146.3	44.6	87.0	26.5	122.7	37.4	98.7	30.1	112.5	34.3
-400ER	61	85.7	26.1	47.5	14.5	165.1	50.3	99.6	30.4	136.8	41.7	111.3	33.9	124.2	37.9

4.3 CLEARANCE RADII

MODEL 767-200, -200ER, -300, -300ER, -300 FREIGHTER -400ER

D6-58328

NOT TO BE USED FOR LANDING
APPROACH VISIBILITY

NOT TO SCALE

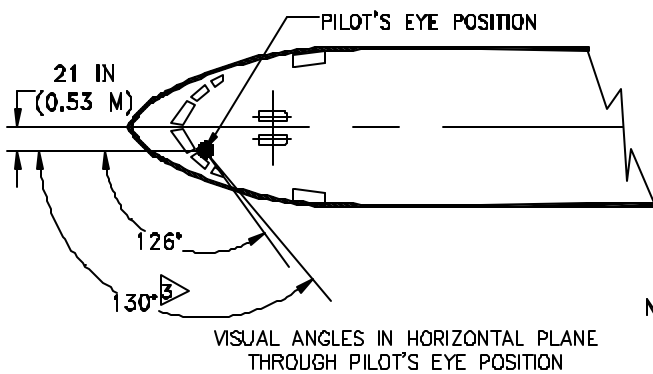
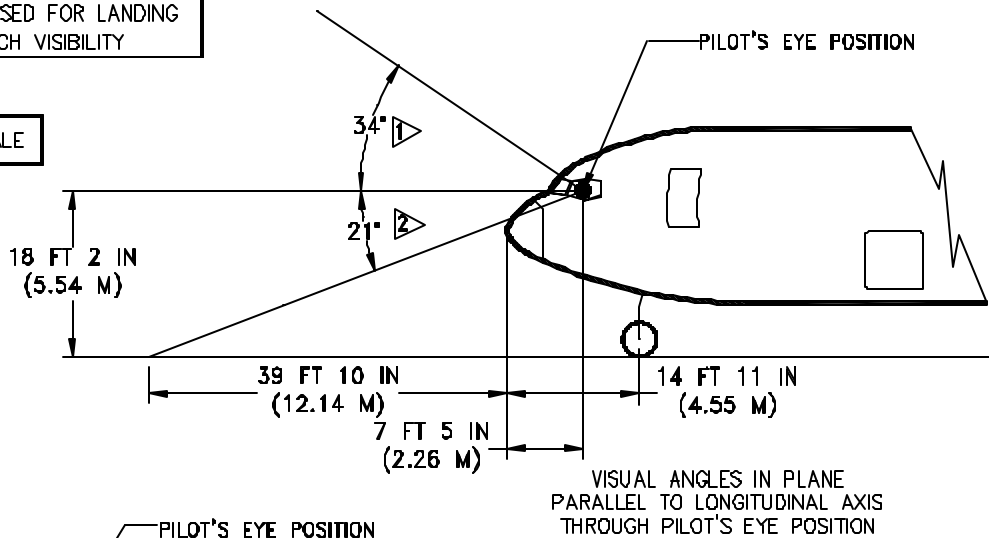

NOTES: HEAD ROTATED ABOUT POINT
3.3 IN (0.08 M) AFT OF PILOT'S
EYE POSITION

- 1 UPWARD VISION THROUGH MAIN WINDOW
- 2 DOWNWARD VISION THROUGH MAIN WINDOW
- 3 WITH HEAD MOVED 5 IN (0.13 M) OUTBOARD

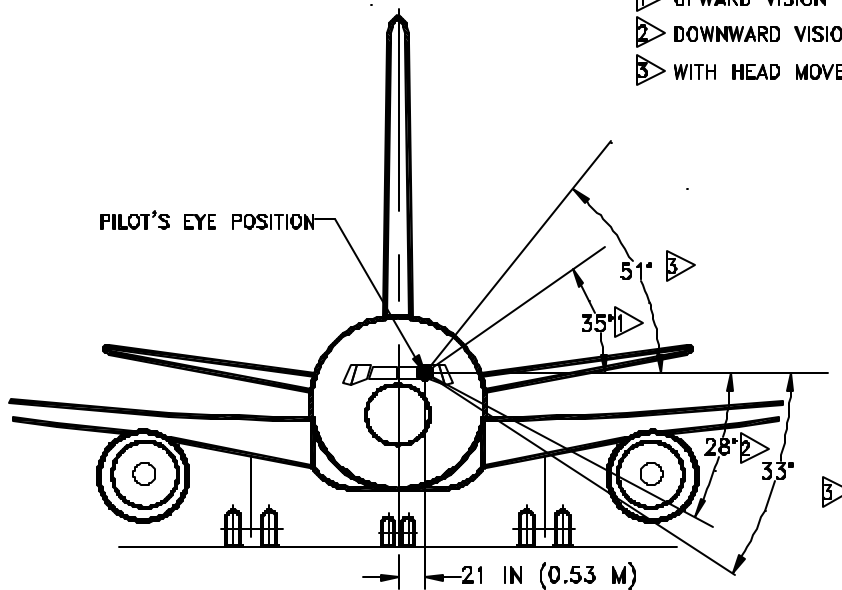

4.4 VISIBILITY FROM COCKPIT IN STATIC POSITION

MODEL 767-200, -200ER, -300, -300ER, -300 FREIGHTER, -400ER

NOTE

BEFORE DETERMINING THE SIZE OF THE INTERSECTION FILLET, CHECK WITH THE AIRLINES REGARDING THE OPERATING PROCEDURES THAT THEY USE AND THE AIRCRAFT TYPES THAT ARE EXPECTED TO SERVE THE AIRPORT

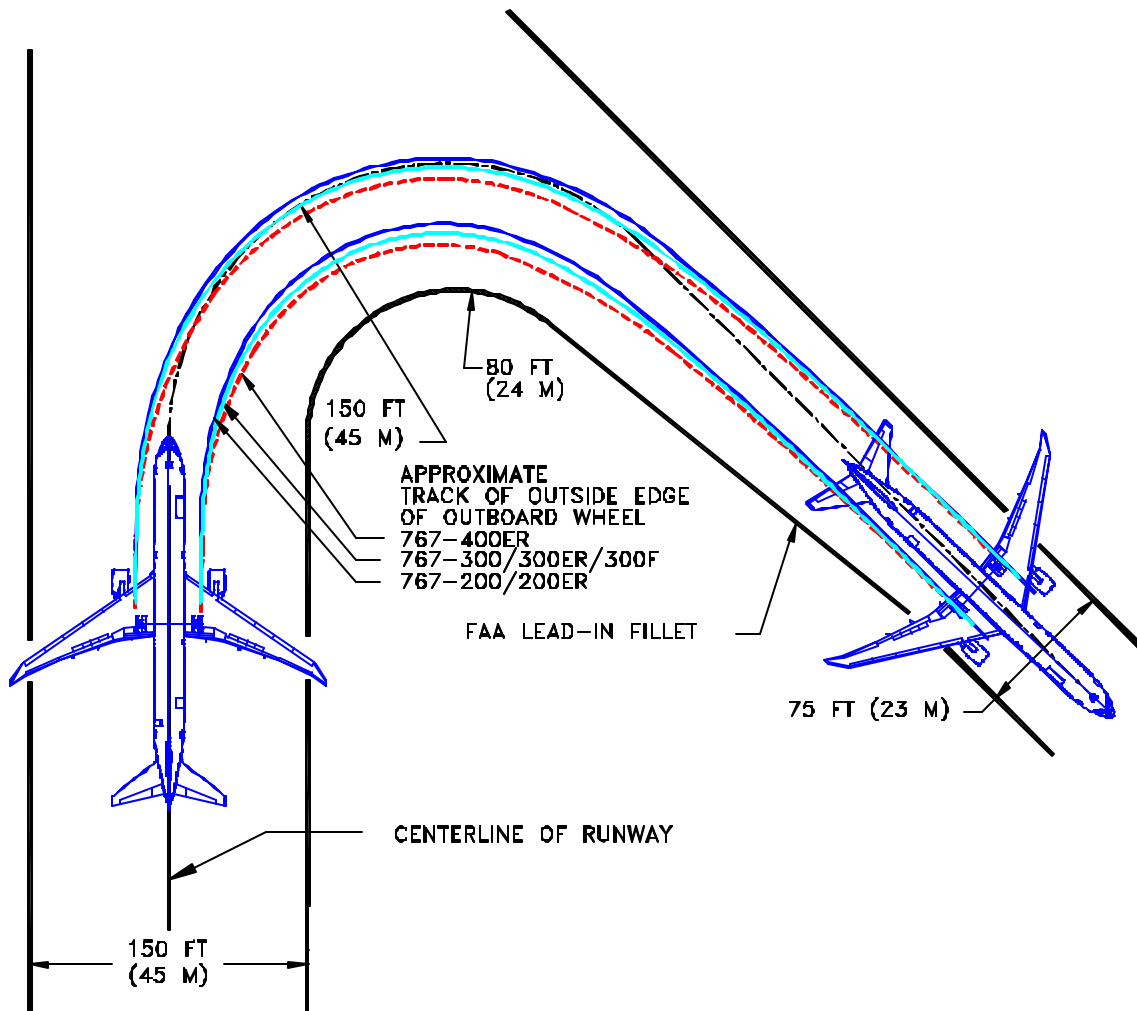

NOSE GEAR TRACKS
CENTERLINE OF TURNS

4.5.1 RUNWAY AND TAXIWAY TURNPATHS - RUNWAY-TO-TAXIWAY,
MORE THAN 90-DEGREE TURN

MODEL 767-200, -200ER, -300, -300ER, -300 FREIGHTER, -400ER

D6-58328

NOTE

BEFORE DETERMINING THE SIZE OF THE INTERSECTION FILLET, CHECK WITH THE AIRLINES REGARDING THE OPERATING PROCEDURES THAT THEY USE AND THE AIRCRAFT TYPES THAT ARE EXPECTED TO SERVE THE AIRPORT

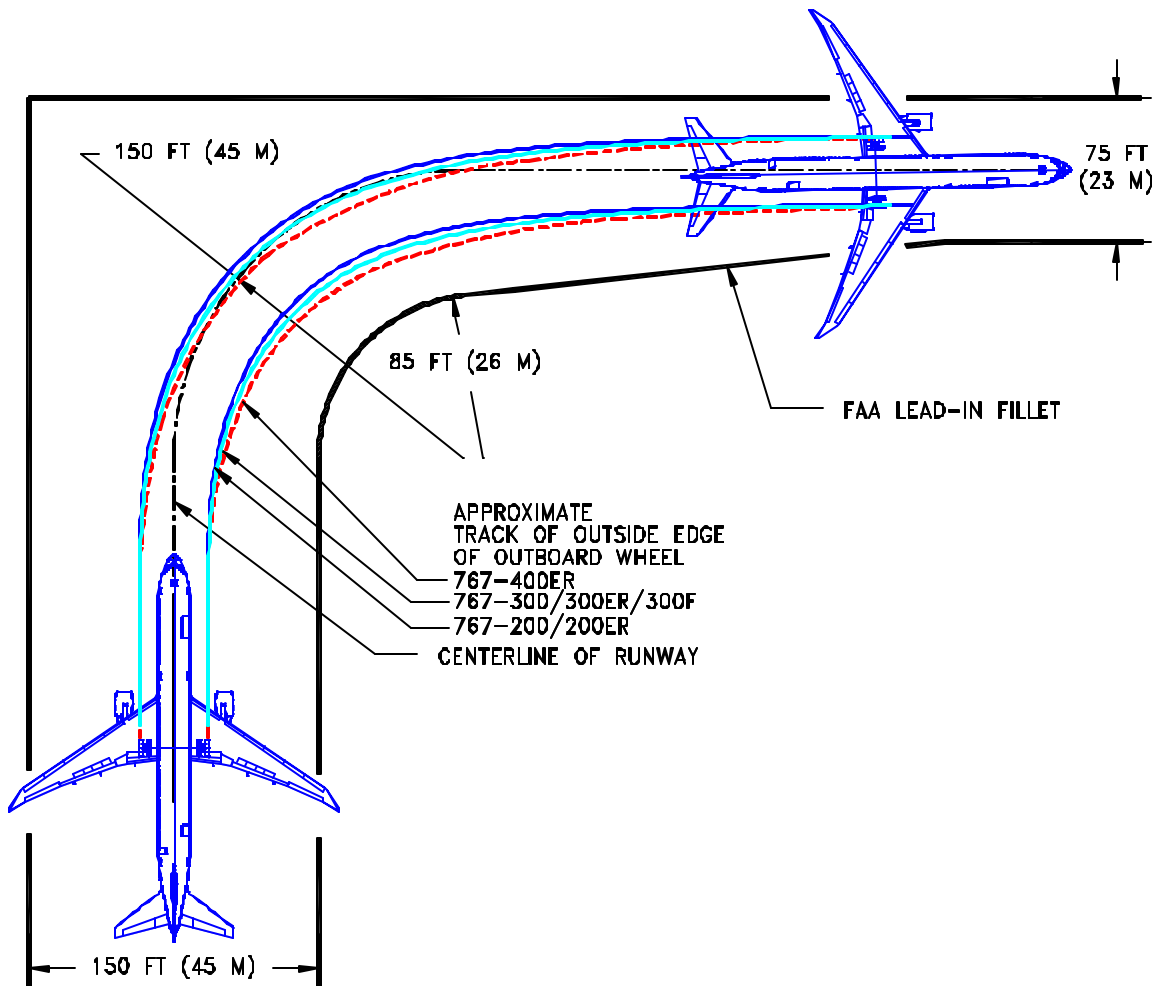

NOSE GEAR TRACKS
CENTERLINE OF TURNS

4.5.2 RUNWAY AND TAXIWAY TURNPATHS - RUNWAY-TO-TAXIWAY, 90-DEGREE TURN
MODEL 767-200, -200ER, -300, -300ER, -300 FREIGHTER, -400ER

NOTE

BEFORE DETERMINING THE SIZE OF THE INTERSECTION FILLET, CHECK WITH THE AIRLINES REGARDING THE OPERATING PROCEDURES THAT THEY USE AND THE AIRCRAFT TYPES THAT ARE EXPECTED TO SERVE THE AIRPORT

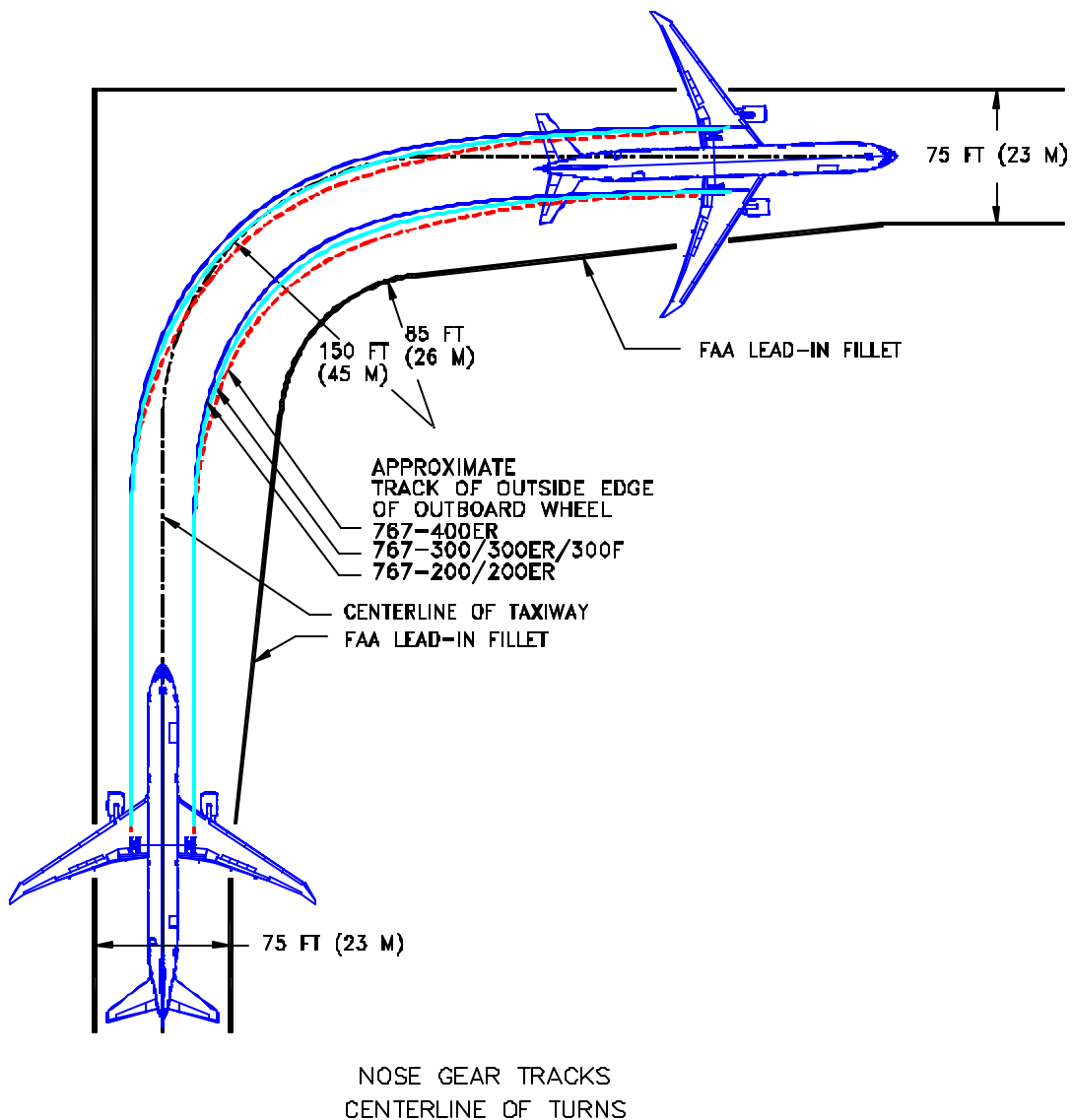

4.5.3 RUNWAY AND TAXIWAY TURNPATHS - TAXIWAY-TO-TAXIWAY, 90-DEGREE TURN, NOSE GEAR TRACKS CENTERLINE

MODEL 767-200, -200ER, -300, -300ER, -300 FREIGHTER, -400ER

NOTE

BEFORE DETERMINING THE SIZE OF THE INTERSECTION FILLET, CHECK WITH THE AIRLINES REGARDING THE OPERATING PROCEDURES THAT THEY USE AND THE AIRCRAFT TYPES THAT ARE EXPECTED TO SERVE THE AIRPORT

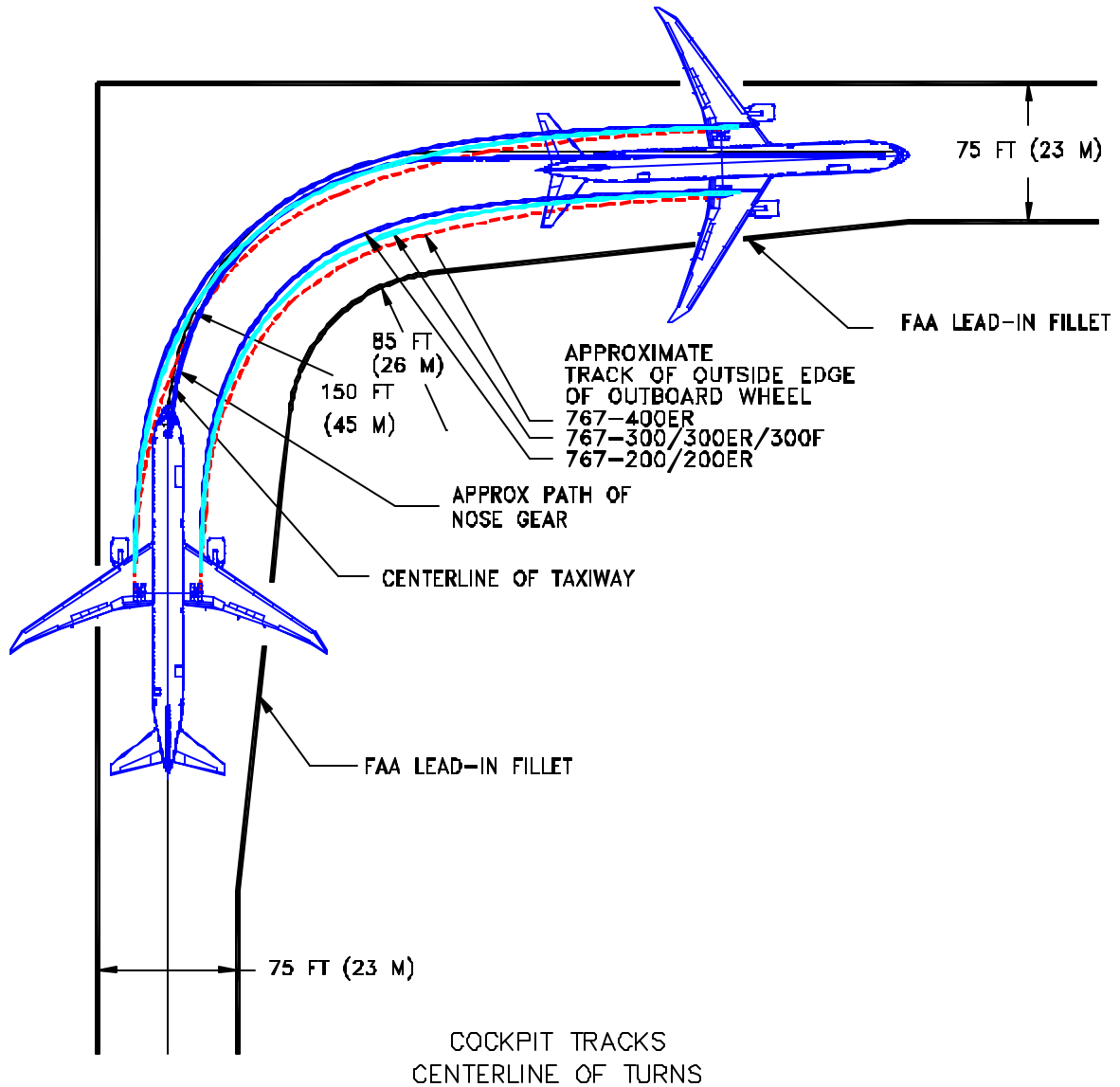

4.5.4 RUNWAY AND TAXIWAY TURNPATHS - TAXIWAY-TO-TAXIWAY, 90-DEGREE TURN, COCKPIT TRACKS CENTERLINE

MODEL 767-200, -200ER, -300, -300ER, -300 FREIGHTER, -400ER

NOTE

BEFORE DETERMINING THE SIZE OF THE INTERSECTION FILLET, CHECK WITH THE AIRLINES REGARDING THE OPERATING PROCEDURES THAT THEY USE AND THE AIRCRAFT TYPES THAT ARE EXPECTED TO SERVE THE AIRPORT

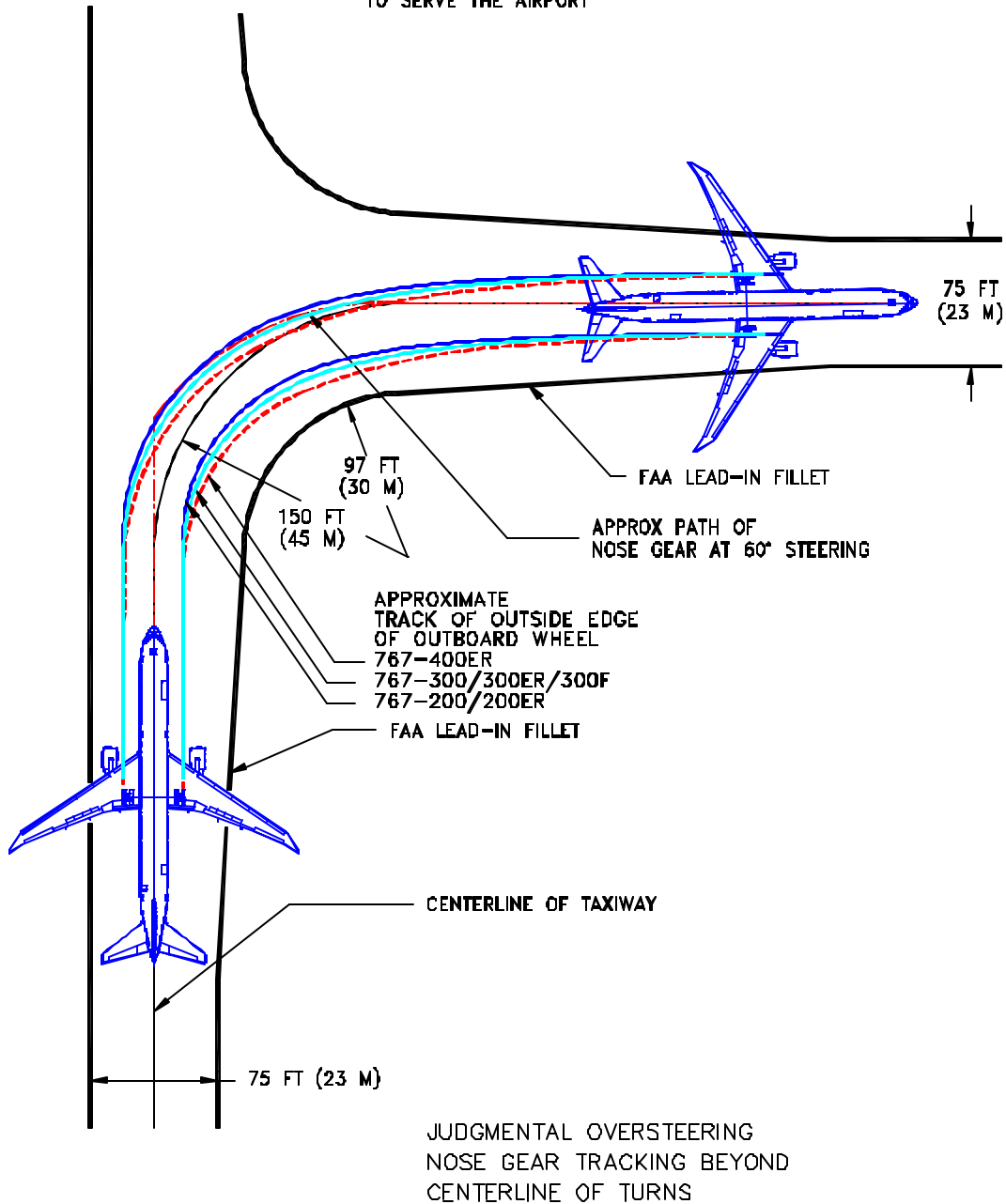

4.5.5 RUNWAY AND TAXIWAY TURNPATHS - TAXIWAY-TO-TAXIWAY, 90-DEGREE TURN, JUDGMENTAL OVERSTEERING

MODEL 767-200, -200ER, -300, -300ER, -300 FREIGHTER, -400ER

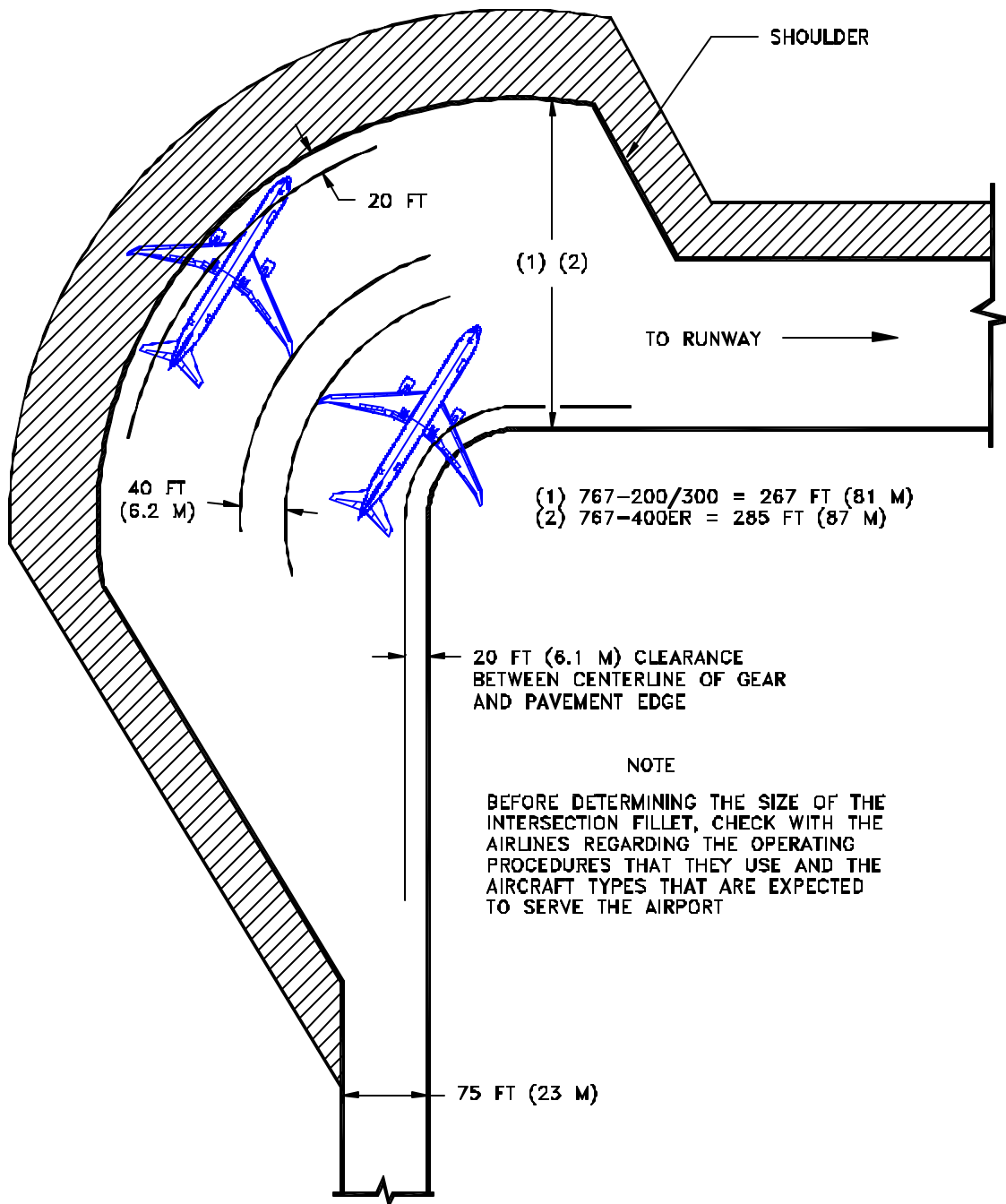

4.6 RUNWAY HOLDING BAY

MODEL 767-200, -200ER, -300, -300ER, -300 FREIGHTER, -400ER

THIS PAGE INTENTIONALLY LEFT BLANK

5.0 TERMINAL SERVICING

- 5.1 Airplane Servicing Arrangement - Typical Turnaround**
- 5.2 Terminal Operations - Turnaround Station**
- 5.3 Terminal Operations - En Route Station**
- 5.4 Ground Servicing Connections**
- 5.5 Engine Starting Pneumatic Requirements**
- 5.6 Ground Pneumatic Power Requirements**
- 5.7 Conditioned Air Requirements**
- 5.8 Ground Towing Requirements**

5.0 TERMINAL SERVICING

During turnaround at the terminal, certain services must be performed on the aircraft, usually within a given time, to meet flight schedules. This section shows service vehicle arrangements, schedules, locations of service points, and typical service requirements. The data presented in this section reflect ideal conditions for a single airplane. Service requirements may vary according to airplane condition and airline procedure.

Section 5.1 shows typical arrangements of ground support equipment during turnaround. As noted, if the auxiliary power unit (APU) is used, the electrical, air start, and air-conditioning service vehicles would not be required. Passenger loading bridges or portable passenger stairs could be used to load or unload passengers.

Sections 5.2 and 5.3 show typical service times at the terminal. These charts give typical schedules for performing service on the airplane within a given time. Service times could be rearranged to suit availability of personnel, airplane configuration, and degree of service required.

Section 5.4 shows the locations of ground service connections in graphic and in tabular forms. Typical capacities and service requirements are shown in the tables. Services with requirements that vary with conditions are described in subsequent sections.

Section 5.5 shows typical sea level air pressure and flow requirements for starting different engines. The curves are based on an engine start time of 90 seconds.

Section 5.6 shows air conditioning requirements for heating and cooling (pull-down and pull-up) using ground conditioned air. The curves show airflow requirements to heat or cool the airplane within a given time at ambient conditions.

Section 5.7 shows air conditioning requirements for heating and cooling to maintain a constant cabin air temperature using low pressure conditioned air. This conditioned air is supplied through an 8-in (20.3 cm) ground air connection (GAC) directly to the passenger cabin, bypassing the air cycle machines.

Section 5.8 shows ground towing requirements for various ground surface conditions.

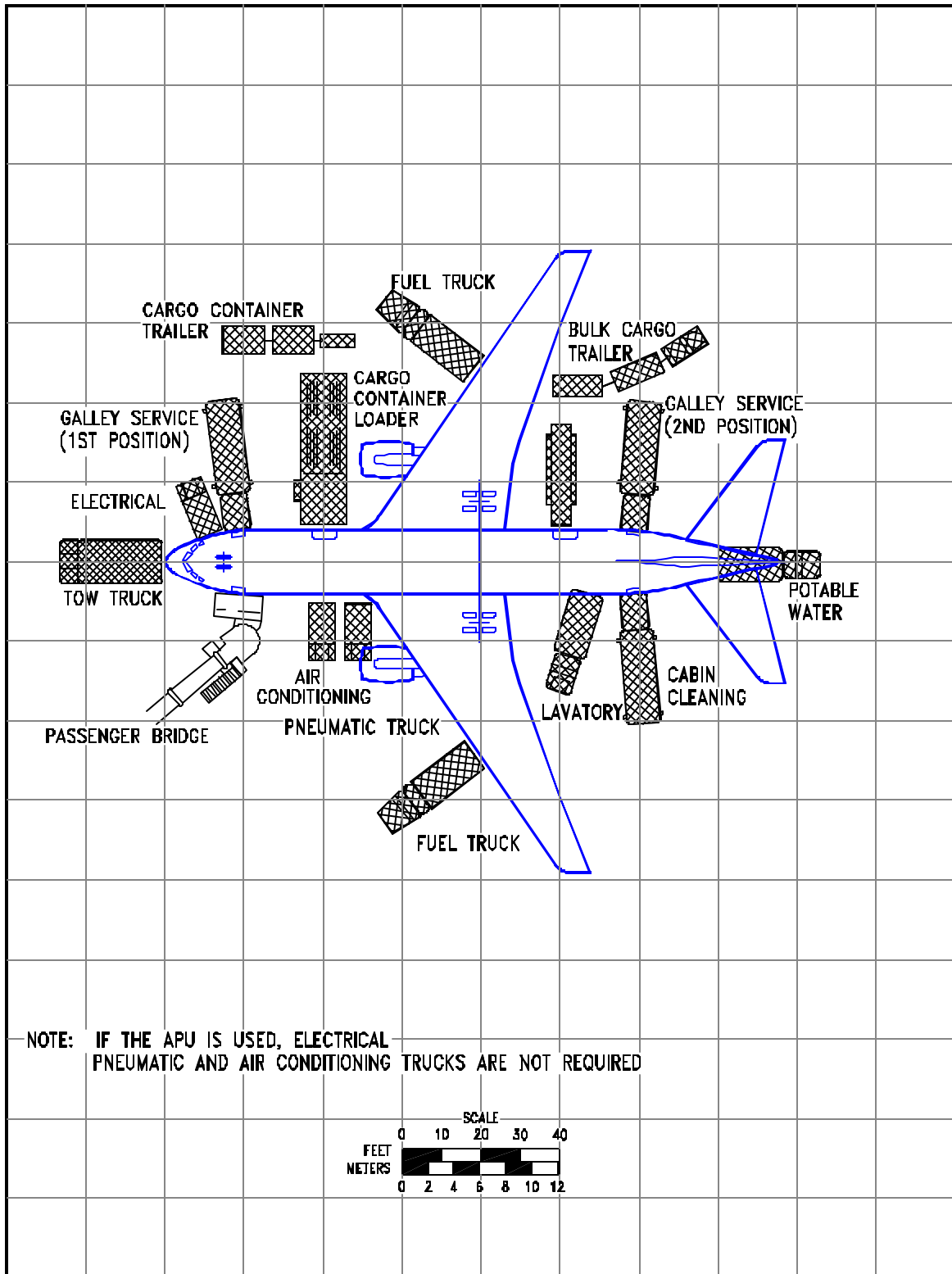

5.1.1 AIRPLANE SERVICING ARRANGEMENT - TYPICAL TURNAROUND
 MODEL 767-200, -200ER

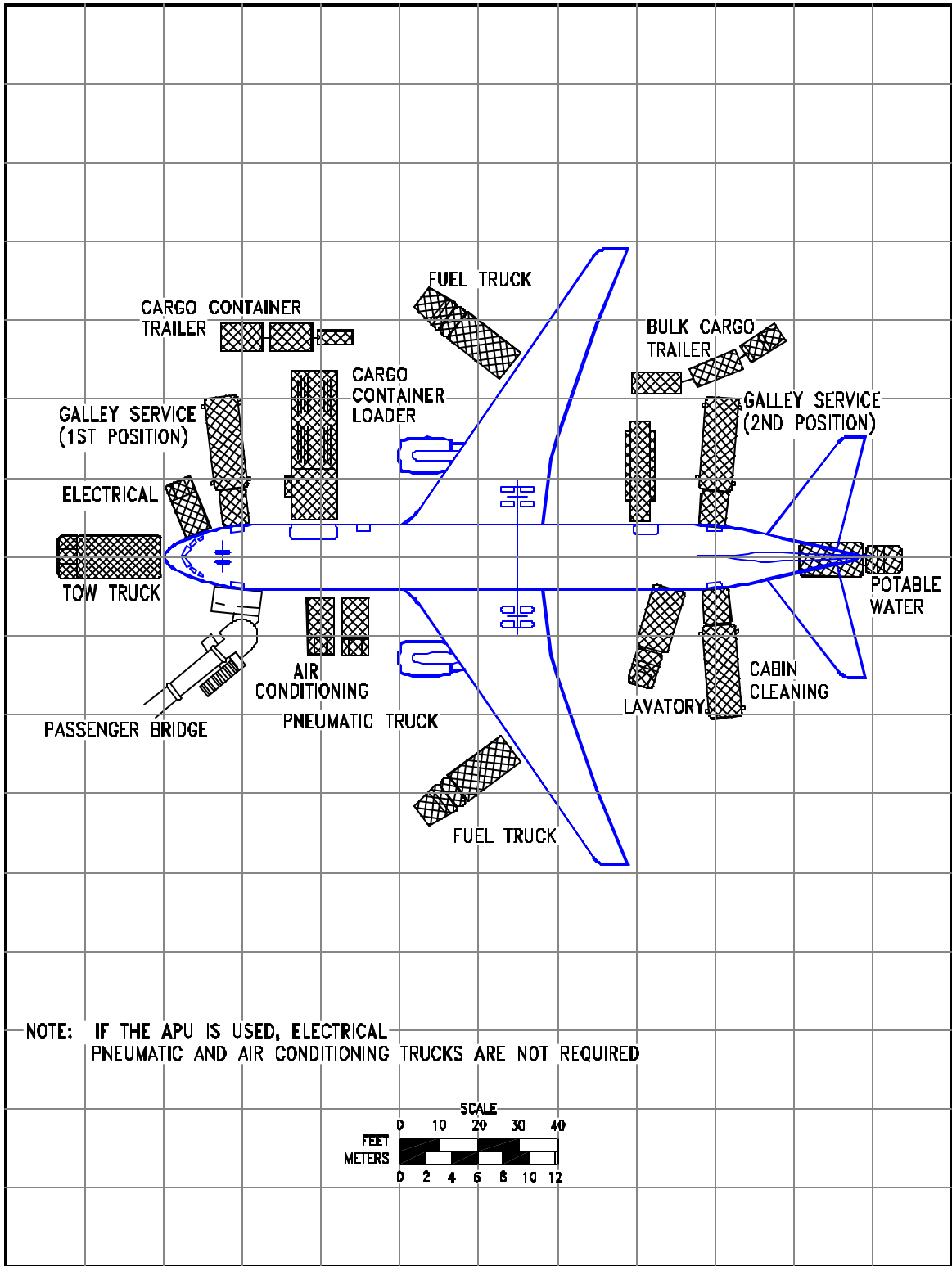

5.1.2 AIRPLANE SERVICING ARRANGEMENT - TYPICAL TURNAROUND
MODEL 767-300, -300ER

D6-58328

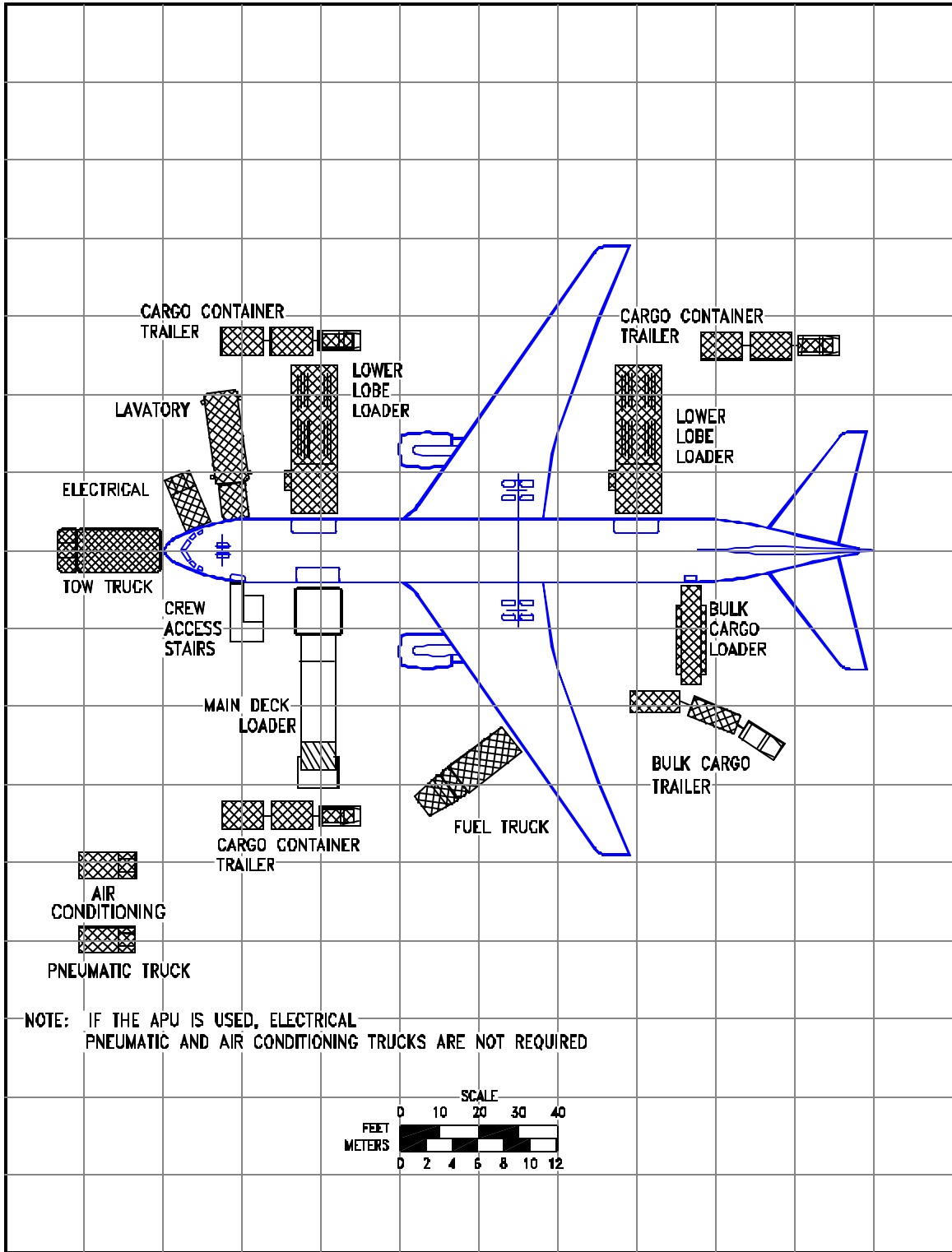

5.1.3 AIRPLANE SERVICING ARRANGEMENT - TYPICAL TURNAROUND
MODEL 767-300 FREIGHTER

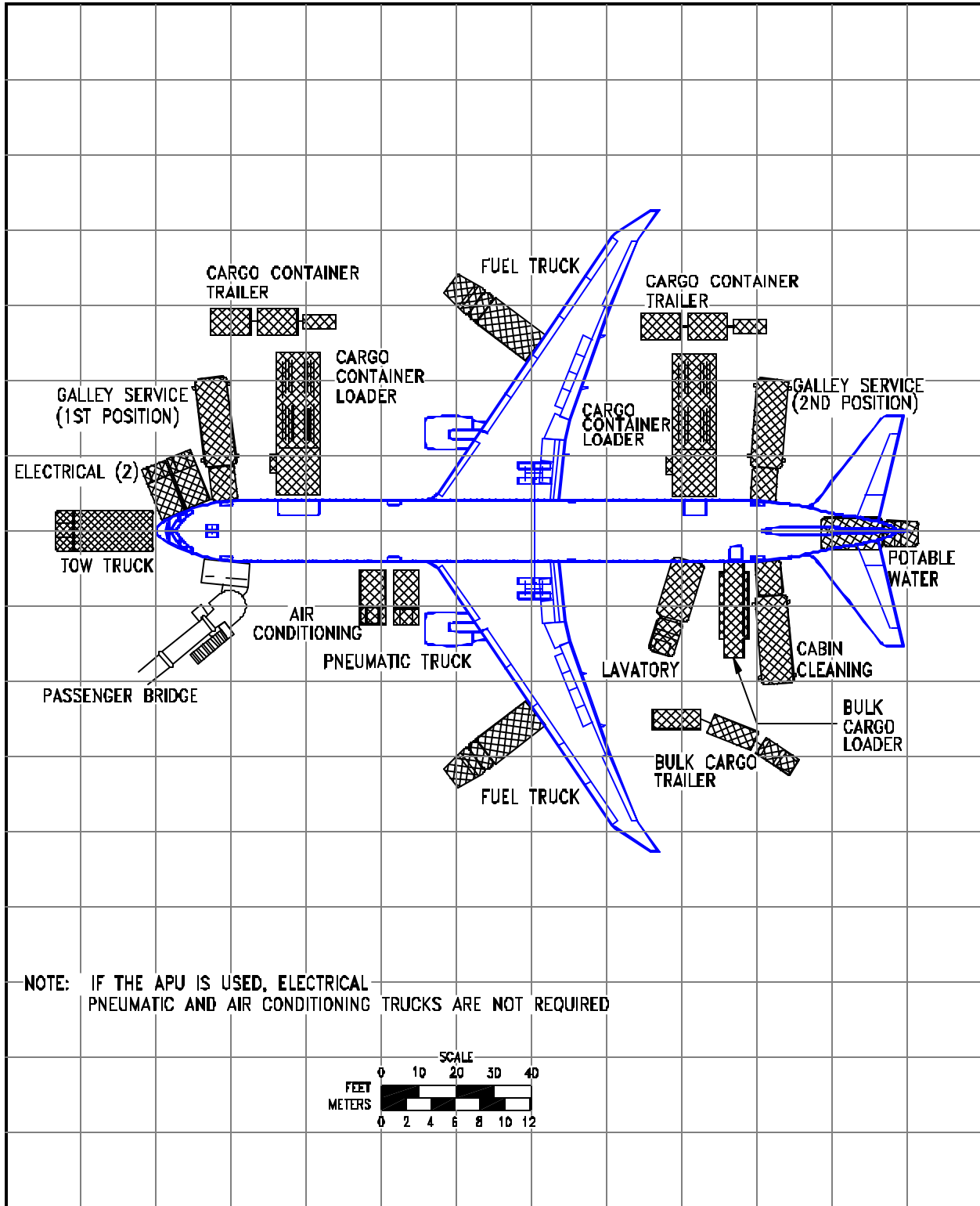

5.1.4 AIRPLANE SERVICING ARRANGEMENT - TYPICAL TURNAROUND
 MODEL 767-400ER

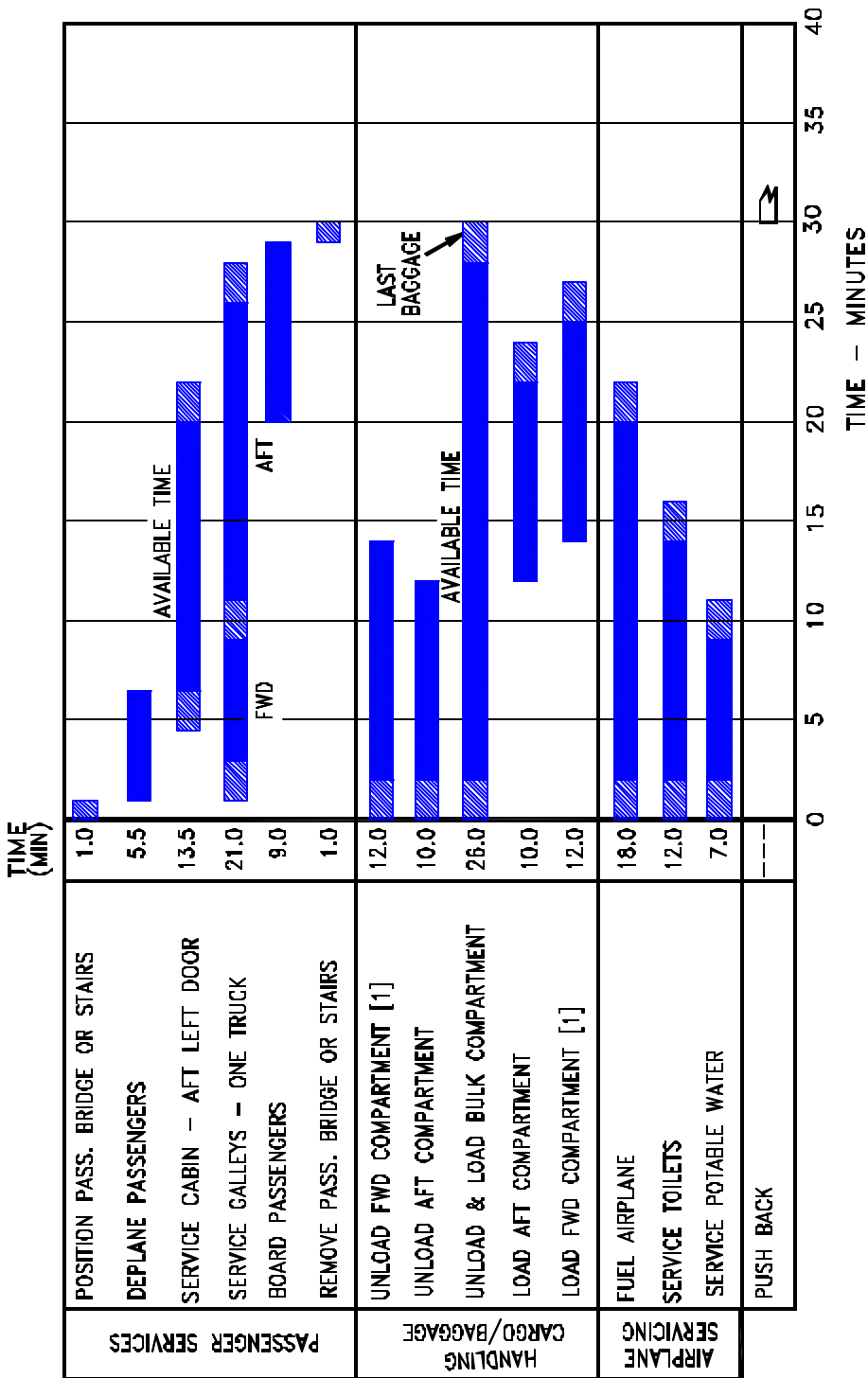

- 216 PASSENGERS DEPLANE & BOARD VIA DOOR L1
 - DEPLANE & BOARDING TIMES BASED ON RATES OF 25 & 20 PASSENGERS PER MINUTE, RESPECTIVELY
 - LOWER LOBE - 10 LD-2 CONTAINERS AFT
12 LD-2 CONTAINERS FWD
 - FUEL - WITH 2,000 GAL (7,571 LITERS) OF RESERVE FUEL, MAX FUEL OF 14,700 GAL (55,645 LITERS) AT 800 GPM (3,028 LPM) ADDED
 - 2 NOZZLE FUELING AT 50 PSI (3.5 KG/SQ CM); ACTUAL FUELING TIME MAY VARY DEPENDING ON FLOW RATE AND NOZZLE PRESSURE
 - POSITION/REMOVE EQUIPMENT
- [1] WITH OPTIONAL WIDE CARGO DOOR, THREE FULL PALLETS, LOAD & UNLOAD TIME ESTIMATED TO BE 6 MINUTES

5.2.1 TERMINAL OPERATIONS - TURNAROUND STATION
MODEL 767-200

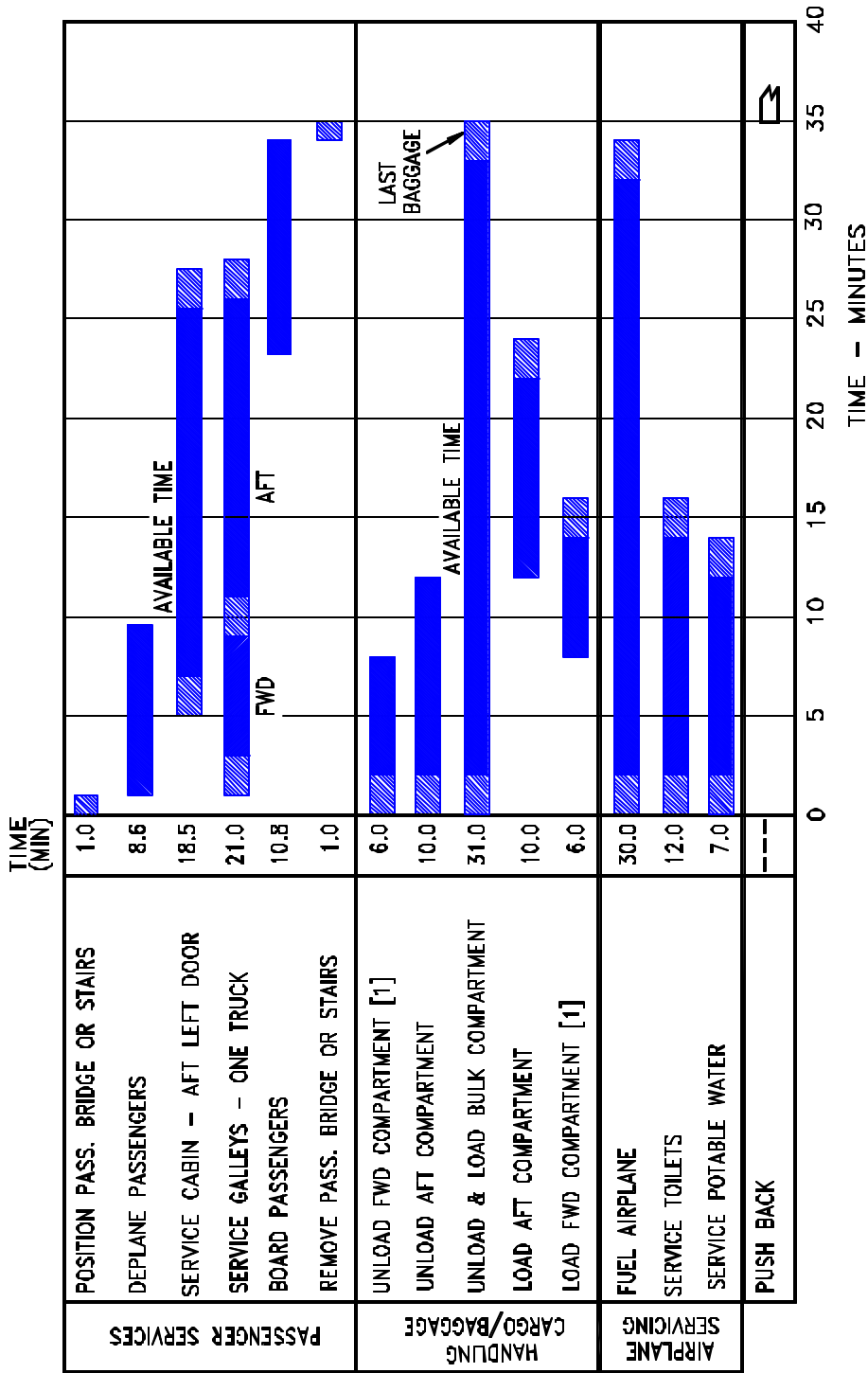

- 216 PASSENGERS DEPLANE & BOARD VIA DOOR L1
 - DEPLANE & BOARDING TIMES BASED ON RATES OF 25 & 20 PASSENGERS PER MINUTE, RESPECTIVELY
 - LOWER LOBE - 10 LD-2 CONTAINERS AFT
3 FULL PALLETS FWD
 - MAINTENANCE CHECK PRIOR TO ETOPS FLIGHT
CAN EXTEND TURNAROUND CONSIDERABLY
DEPENDING ON AIRLINE PRACTICE
 - FUEL - WITH 2,000 GAL (7,571 LITERS) OF RESERVE FUEL, MAX FUEL OF 18,450 GAL (69,841 LITERS) ADDED; 14,700 GAL (55,645 LITERS) AT 800 GPM (3,028 LPM) AND THEN 3,750 GAL (14,195 LITERS) AT 310 GPM (1,173 LPM)
 - POSITION/REMOVE EQUIPMENT [1] WITH 12 LD-2 CONTAINERS
LOAD & UNLOAD TIME ESTIMATED TO BE 12 MINUTES
- NOTE: 2 NOZZLE FUELING AT 50 PSI (3.5 KG/SQ CM);
ACTUAL FUELING TIME MAY VARY DEPENDING
ON FLOW RATE AND NOZZLE PRESSURE

5.2.2 TERMINAL OPERATIONS - TURNAROUND STATION
MODEL 767-200ER

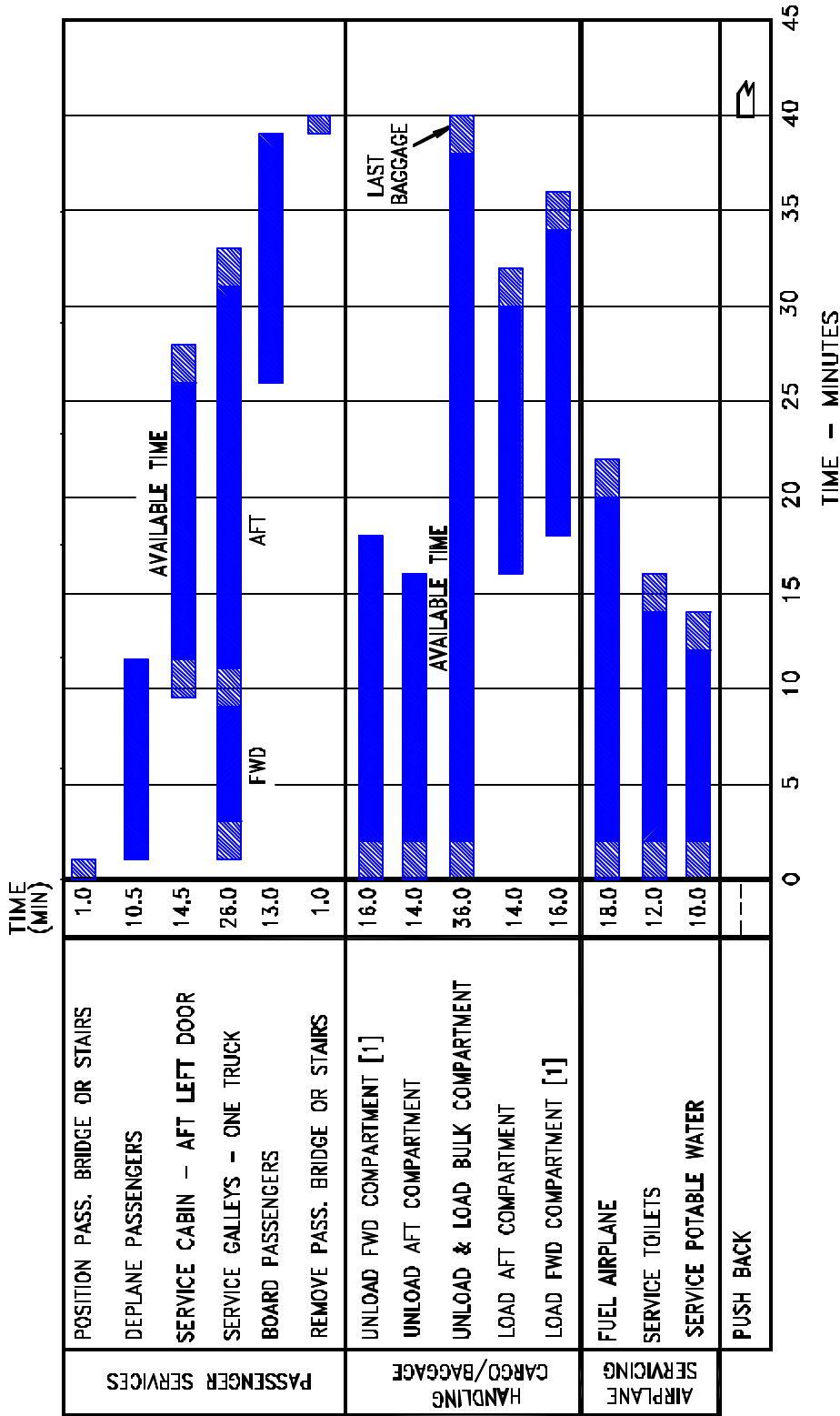

- 261 PASSENGERS DEPLANE & BOARD VIA DOOR L1
- DEPLANE & BOARDING TIMES BASED ON RATES OF 25 & 20 PASSENGERS PER MINUTE, RESPECTIVELY
- LOWER LOBE - 14 LD-2 CONTAINERS AFT
16 LD-2 CONTAINERS FWD
- FUEL - WITH 2,000 GAL (7,571 LITERS) OF RESERVE FUEL, MAX FUEL OF 14,700 GAL (55,645 LITERS) AT 800 GPM (3,028 LPM) ADDED
- NOTE: 2 NOZZLE FUELING AT 50 PSI (3.5 KG/SQ CM); ACTUAL FUELING TIME MAY VARY DEPENDING ON FLOW RATE AND NOZZLE PRESSURE
- POSITION/REMOVE EQUIPMENT [1] WITH OPTIONAL WIDE CARGO DOOR, FOUR FULL PALLETS, LOAD & UNLOAD TIME ESTIMATED TO BE 8 MINUTES

5.2.3 TERMINAL OPERATIONS - TURNAROUND STATION
MODEL 767-300

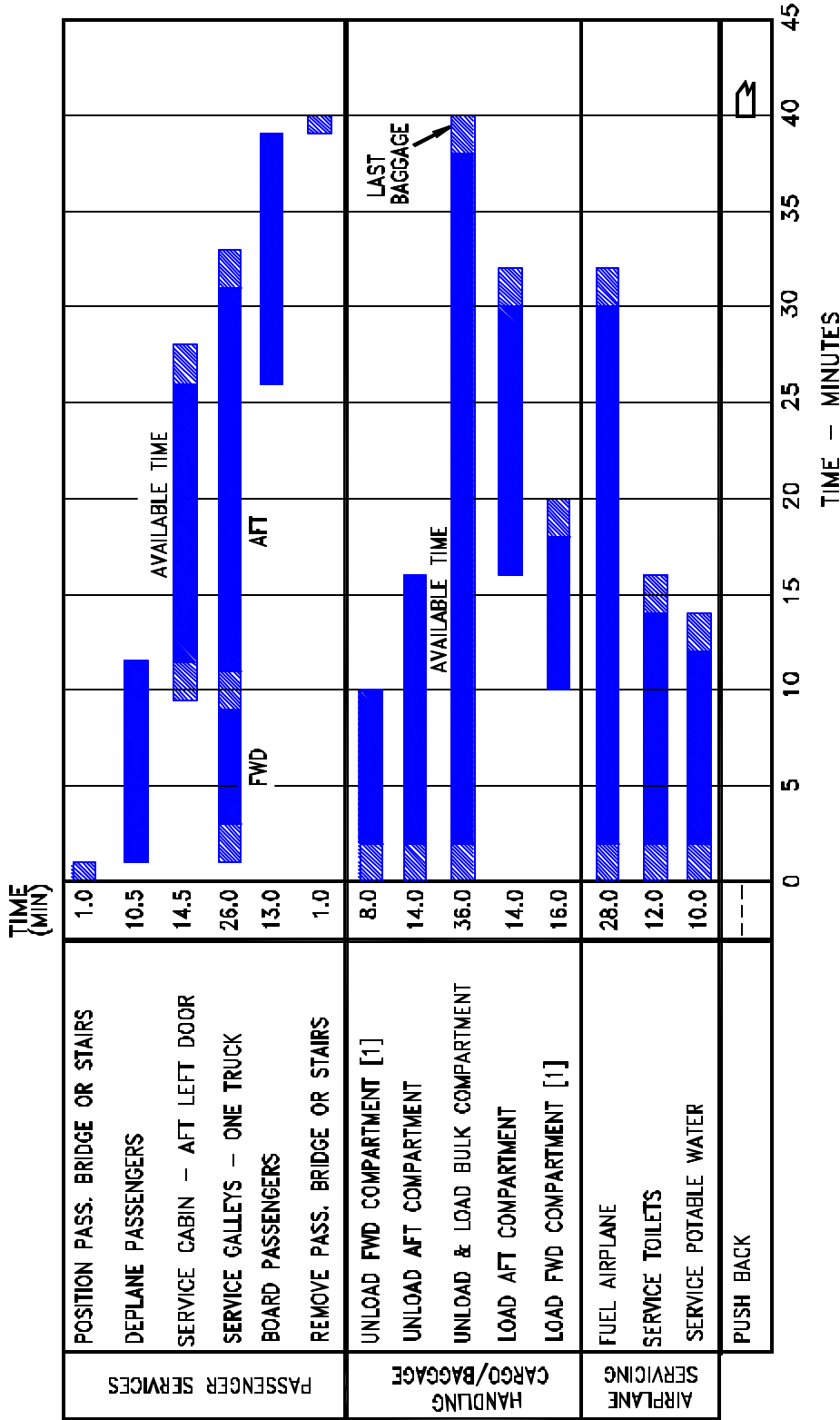

5.2.4 TERMINAL OPERATIONS - TURNAROUND STATION
MODEL 767-300ER

- 261 PASSENGERS DEPLANE & BOARD VIA DOOR L1
 - DEPLANE & BOARDING TIMES BASED ON RATES OF 25 & 20 PASSENGERS PER MINUTE, RESPECTIVELY
 - LOWER LOBE - 14 LD-2 CONTAINERS AFT
4 FULL PALLETS FWD
 - MAINTENANCE CHECK PRIOR TO ETOPS FLIGHT CAN EXTEND TURNAROUND CONSIDERABLY DEPENDING ON AIRLINE PRACTICE
 - FUEL - WITH 2,000 GAL (7,571 LITERS) OF RESERVE FUEL, MAX FUEL OF 24,149 GAL (83,809 LITERS) ADDED; 16,700 GAL (63,210 LITERS) AT 1,000 GPM (3,785 LPM) AND THEN 5,440 GAL (20,593 LITERS) AT 470 GPM (1,779 LPM)
 - POSITION/REMOVE EQUIPMENT [1] WITH 16 LD-2 CONTAINERS LOAD & UNLOAD TIME ESTIMATED TO BE 6 MINUTES
- NOTE: 2 NOZZLE FUELING AT 50 PSI (3.5 KG/SQ CM); ACTUAL FUELING TIME MAY VARY DEPENDING ON FLOW RATE AND NOZZLE PRESSURE

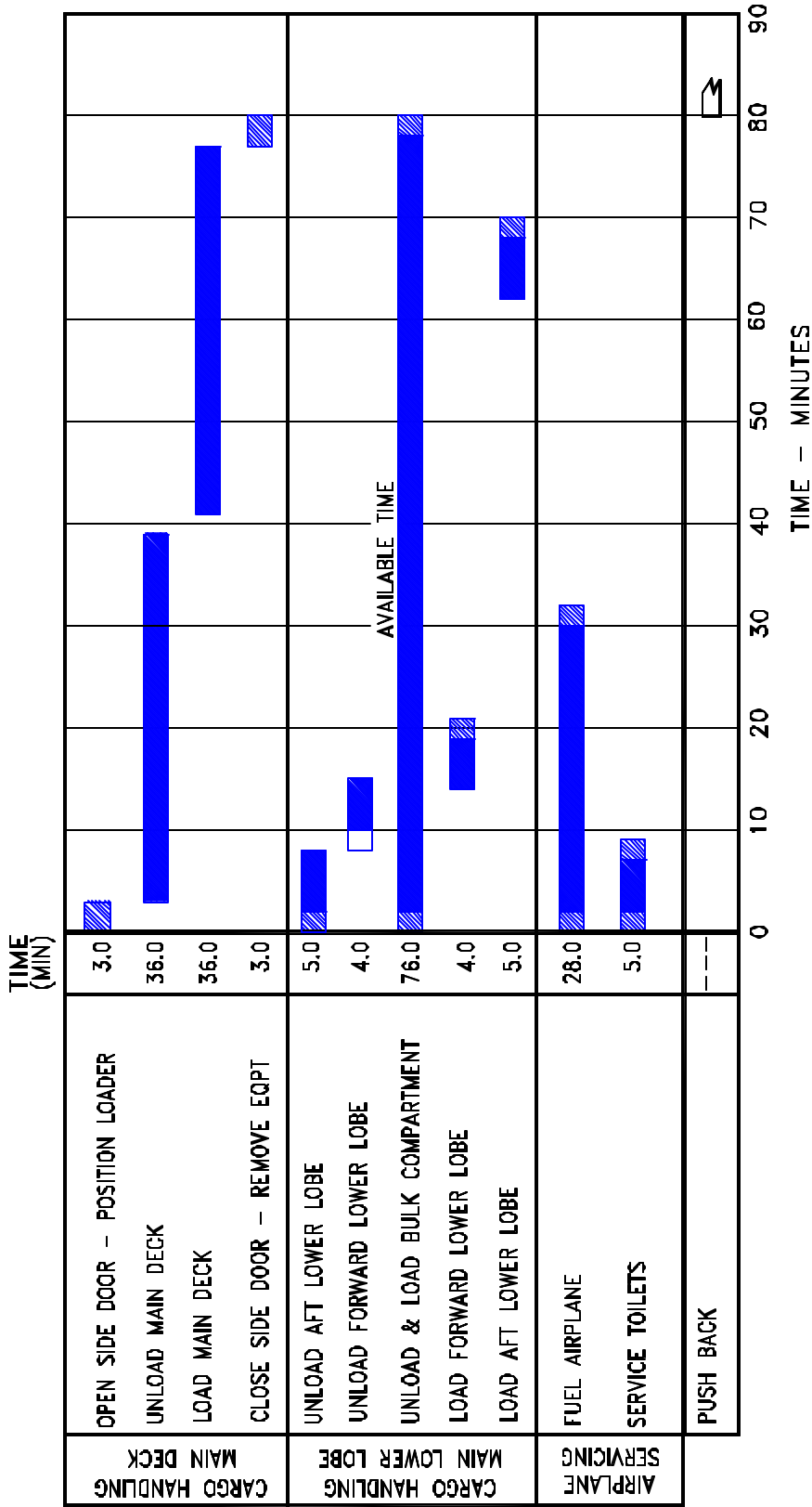

NOTES:

1. MAIN DECK CARGO - 24 88 X 125 IN (224 X 318 CM) CONTAINERS/PALLETS. 100 PERCENT CARGO EXCHANGE - 1.5 MINUTES PER CONTAINER/PALLET
2. AFT LOWER LOBE - 5 CONTAINERS: 3 LD-7/LD-9s, 2LD-2s FORWARD LOWER LOBE - 4 CONTAINERS: 4 LD-7/LD-9s 1.0 MINUTE PER CONTAINER, LOWER LOBE
3. FUELING WITH 2 NOZZLES AT 50 PSI (3.5 KG/SQ CM); TOTAL AIRPLANE FUEL ADDED = 22,140 GAL (83,809 L) REFUELING FROM A RESERVE LEVEL OF 2,000 GAL (7,571 L)

5.2.5 TERMINAL OPERATIONS - TURNAROUND STATION
 MODEL 767-300 FREIGHTER

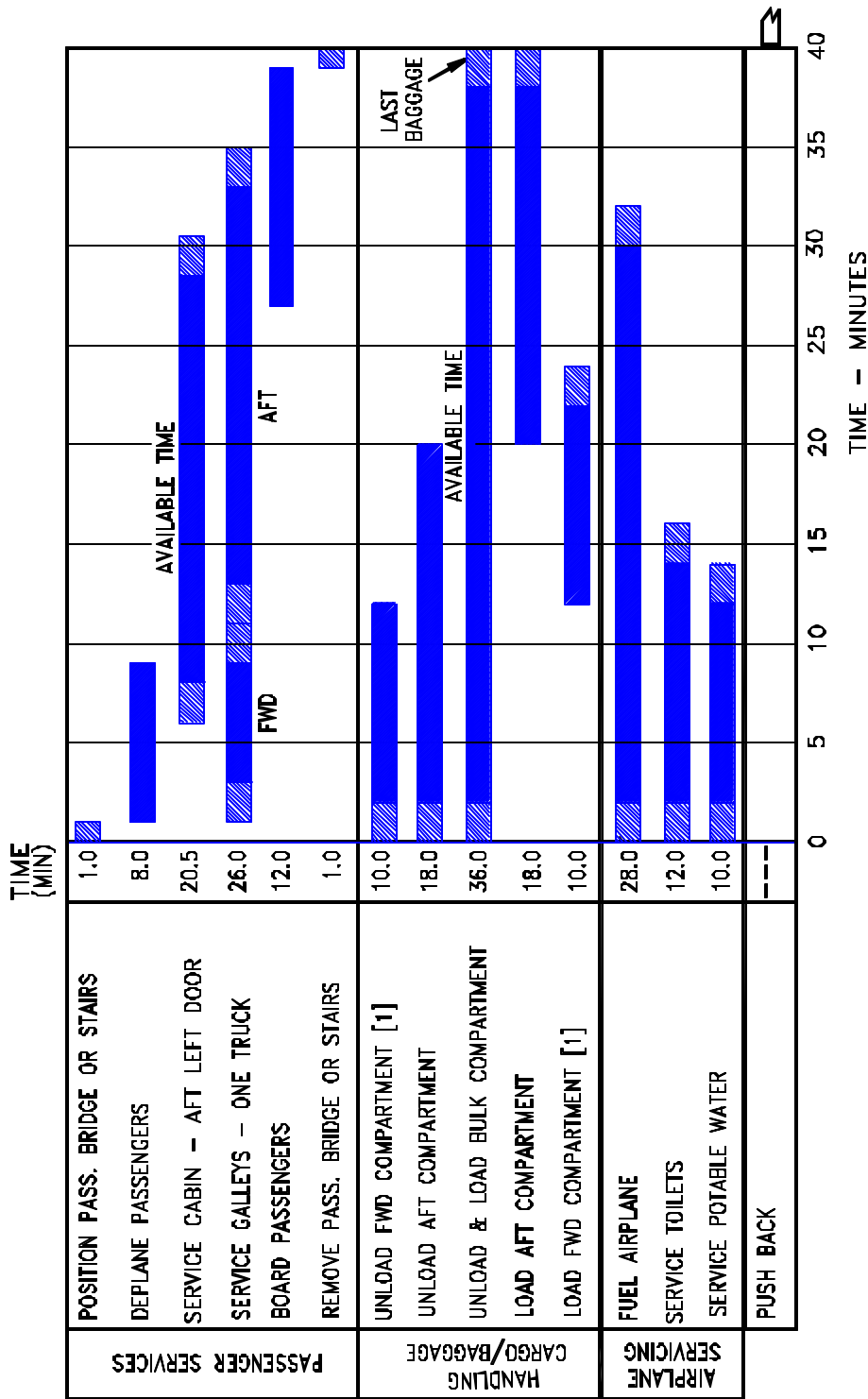

- 304 PASSENGERS DEPLANE & BOARD VIA DOOR L1
- FUEL - WITH 2,000 GAL (7,571 LITERS) OF RESERVE FUEL, MAX FUEL OF 24,140 GAL (83,809 LITERS) ADDED; 16,700 GAL (632,169 LITERS) AT 1,000 GPM (3,785 LPM) AND THEN 5,440 GAL (20,593 LITERS) AT 470 GPM (1,779 LPM)
- DEPLANE & BOARDING TIMES BASED ON RATES OF 25 & 20 PASSENGERS PER MINUTE, RESPECTIVELY
- LOWER LOBE - 18 LD-2 CONTAINERS AFT 5 FULL PALLETS FWD
- POSITION/REMOVE EQUIPMENT [1] WITH 20 LD-2 CONTAINERS LOAD OR UNLOAD TIME ESTIMATED TO BE 20 MINUTES

NOTE: 2 NOZZLE FUELING AT 50 PSI (3.5 KG/SQ CM); ACTUAL FUELING TIME MAY VARY DEPENDING ON FLOW RATE AND NOZZLE PRESSURE

MAINTENANCE CHECK PRIOR TO ETOPS FLIGHT CAN EXTEND TURNAROUND CONSIDERABLY DEPENDING ON AIRLINE PRACTICE

5.2.6 TERMINAL OPERATIONS - TURNAROUND STATION

MODEL 767-400ER

5.3.1 TERMINAL OPERATIONS - EN ROUTE STATION
 MODEL 767-200, -200ER

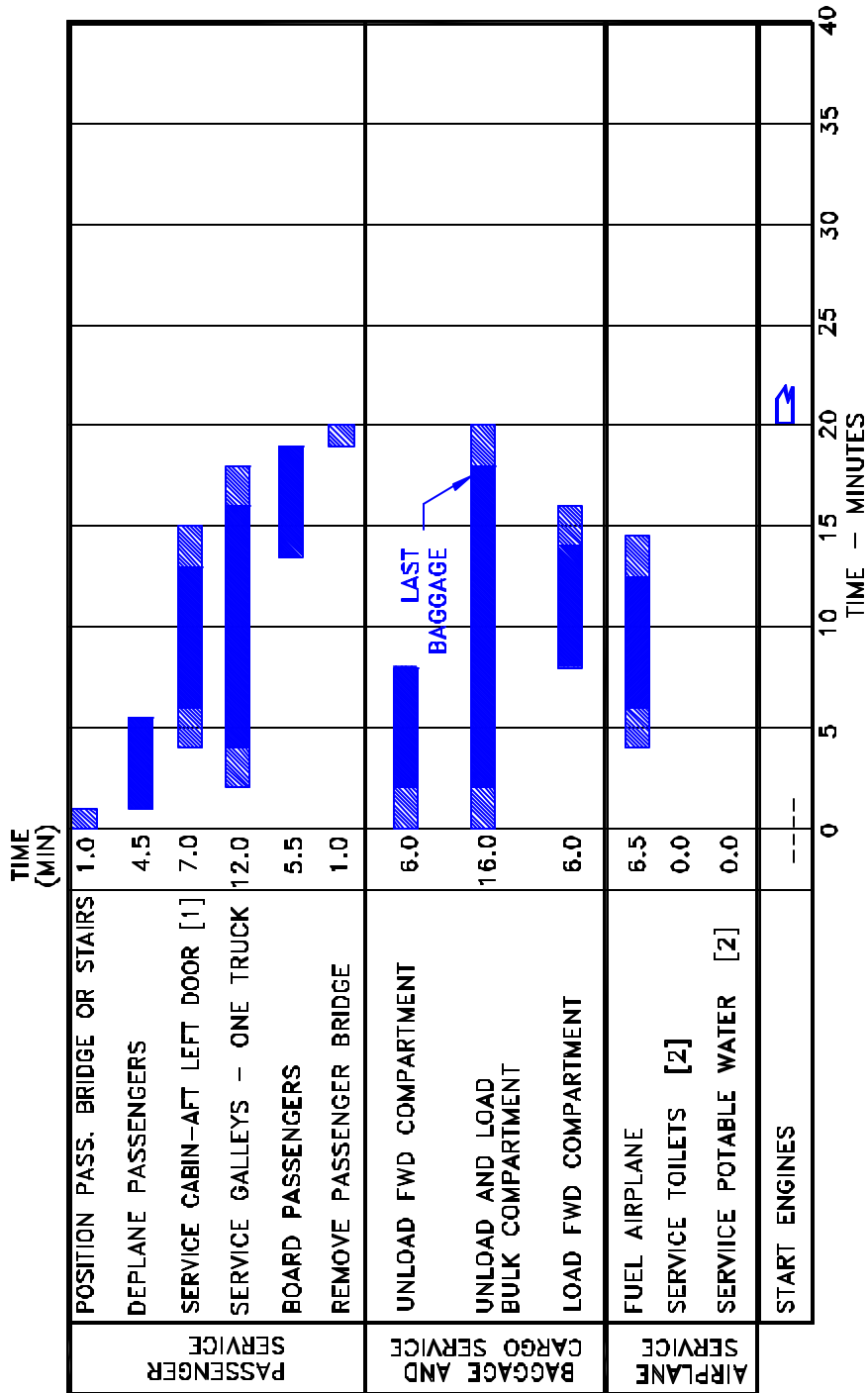

- POSITION/REMOVE EQUIPMENT
- PASSENGERS DEPLANE & BOARD VIA DOOR L1
- 50% PASSENGER TRANSFER - 108 PASSENGERS
- DEPLANE & BOARDING TIMES BASED ON RATES OF 25 & 20 PASSENGERS PER MINUTE, RESPECTIVELY
- LOWER LOBE - 6 LD-2 CONTAINERS FWD
- FUEL - WITH 5,000 GAL (18,927 LITERS) ADDED AT 800 GPM (3,028 LPM)
- NOTE: 2 NOZZLE FUELING AT 50 PSI (3.5 KG/SQ CM) ACTUAL FUELING TIME MAY VARY DEPENDING ON FLOW RATE AND NOZZLE PRESSURE
- [1] CABIN SERVICE RESTRICTED TO MINOR PICKUP
- [2] NO POTABLE WATER OR TOILET SERVICE

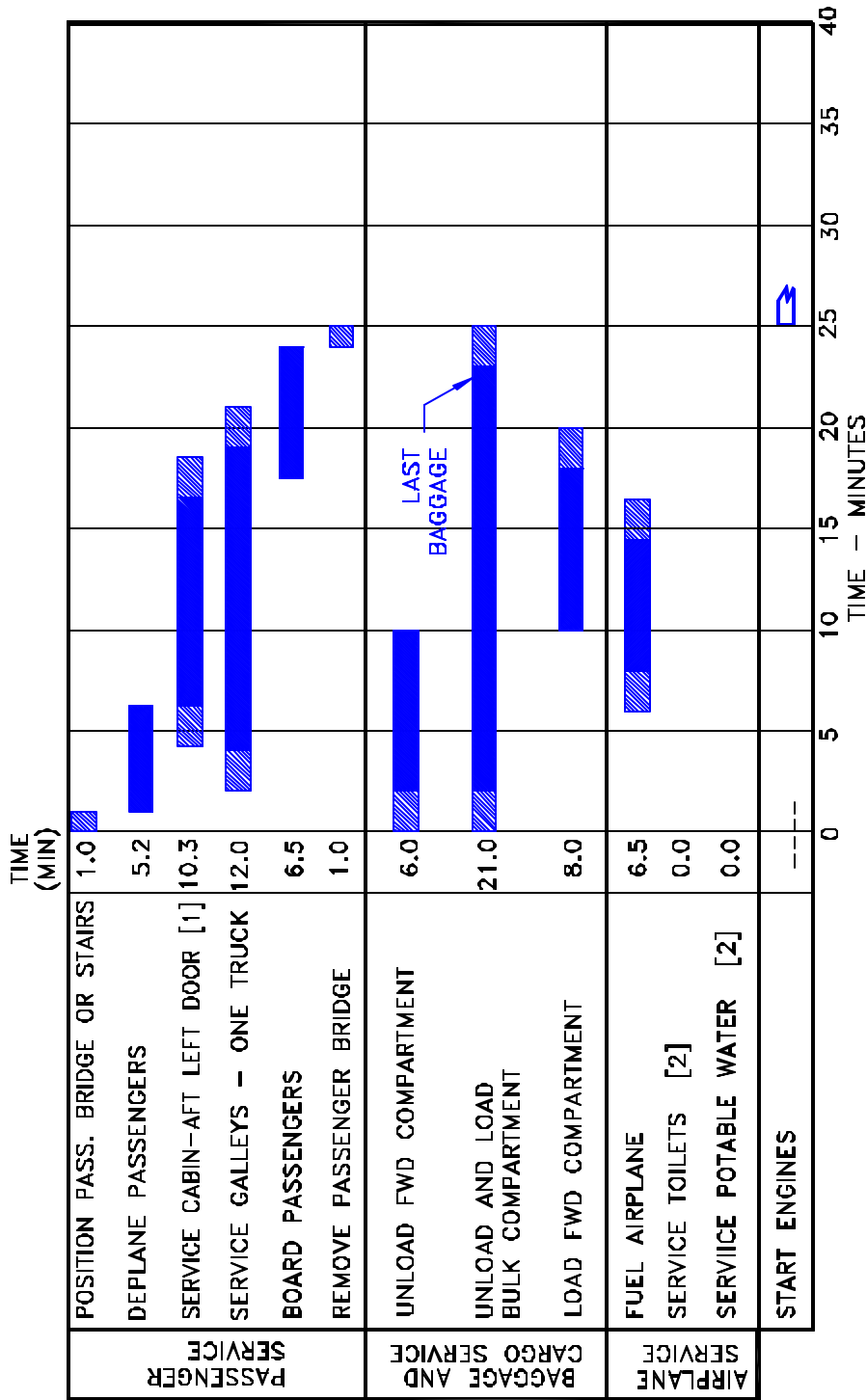

- FUEL - WITH 5,000 GAL (18,927 LITERS) ADDED AT 800 GPM (3,028 LPM)
- POSITION/REMOVE EQUIPMENT
- PASSENGERS DEPLANE & BOARD VIA DOOR L1
- 50% PASSENGER TRANSFER - 130 PASSENGERS
- DEPLANE & BOARDING TIMES BASED ON RATES OF 25 & 20 PASSENGERS PER MINUTE, RESPECTIVELY
- LOWER LOBE - 6 LD-2 CONTAINERS FWD
- FUEL - WITH 5,000 GAL (18,927 LITERS) ADDED AT 800 GPM (3,028 LPM)
- NOTE: 2 NOZZLE FUELING AT 50 PSI (3.5 KG/SQ CM) ACTUAL FUELING TIME MAY VARY DEPENDING ON FLOW RATE AND NOZZLE PRESSURE
- [1] CABIN SERVICE RESTRICTED TO MINOR PICKUP
- [2] NO POTABLE WATER OR TOILET SERVICE

5.3.2 TERMINAL OPERATIONS - EN ROUTE STATION
MODEL 767-300, -300ER

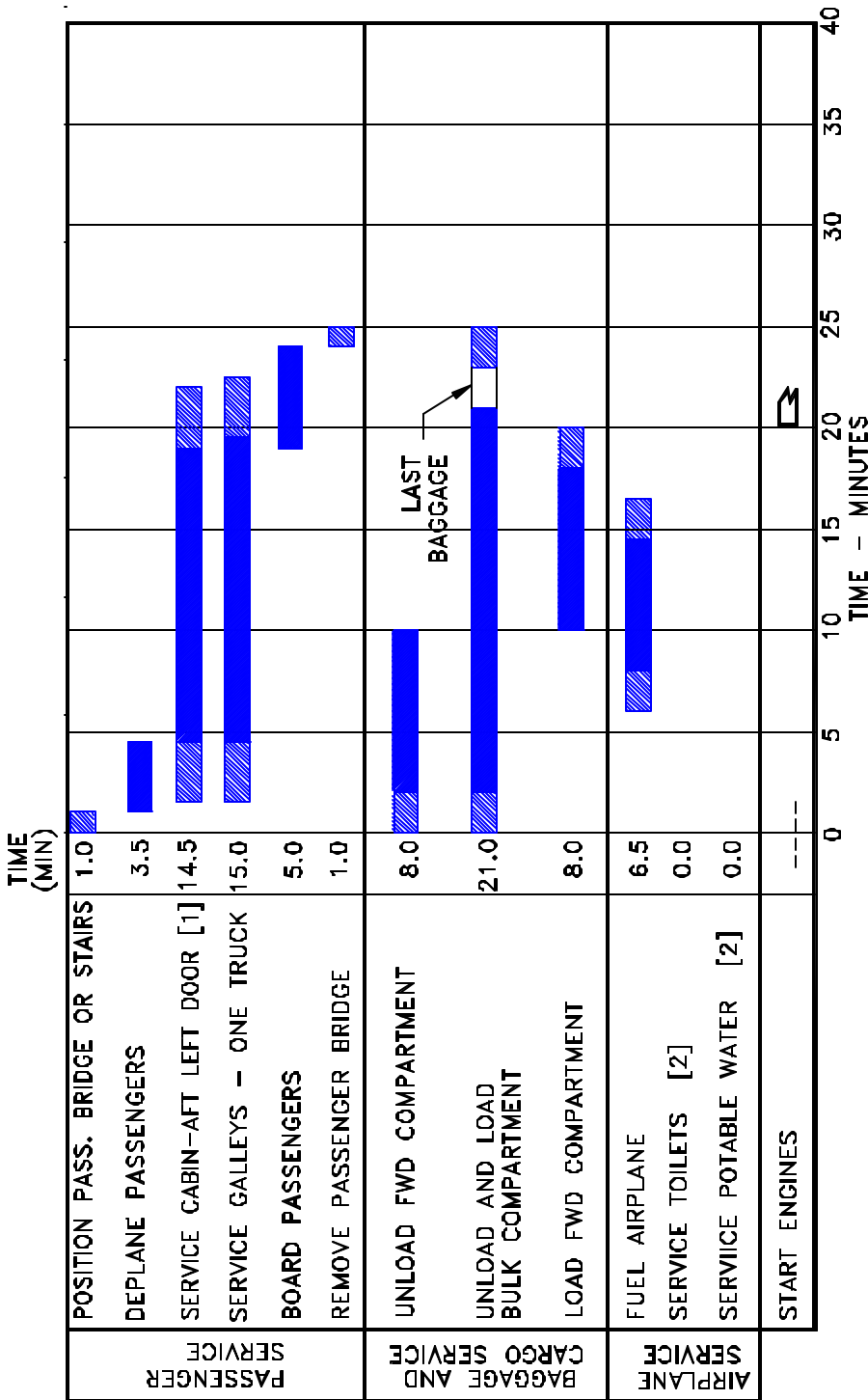

● FUEL - WITH 5,000 GAL (19,927 LITERS) ADDED AT 800 GPM (3,028 LPM)
 NOTE: 2 NOZZLE FUELING AT 50 PSI (3.5 KG/SQ CM) ACTUAL FUELING TIME MAY VARY DEPENDING ON FLOW RATE AND NOZZLE PRESSURE
 [1] CABIN SERVICE RESTRICTED TO MINOR PICKUP
 [2] NO POTABLE WATER OR TOILET SERVICE

■ POSITION/REMOVE EQUIPMENT
 ● PASSENGERS DEPLANE & BOARD VIA DOOR L1
 ● 50% PASSENGER TRANSFER
 ● DEPLANE & BOARDING TIMES BASED ON RATES OF 25 & 20 PASSENGERS PER MINUTE, RESPECTIVELY
 ● LOWER LOBE -- 8 LD-2 CONTAINERS FWD

5.3.3 TERMINAL OPERATIONS - EN ROUTE STATION
 MODEL 767-400ER

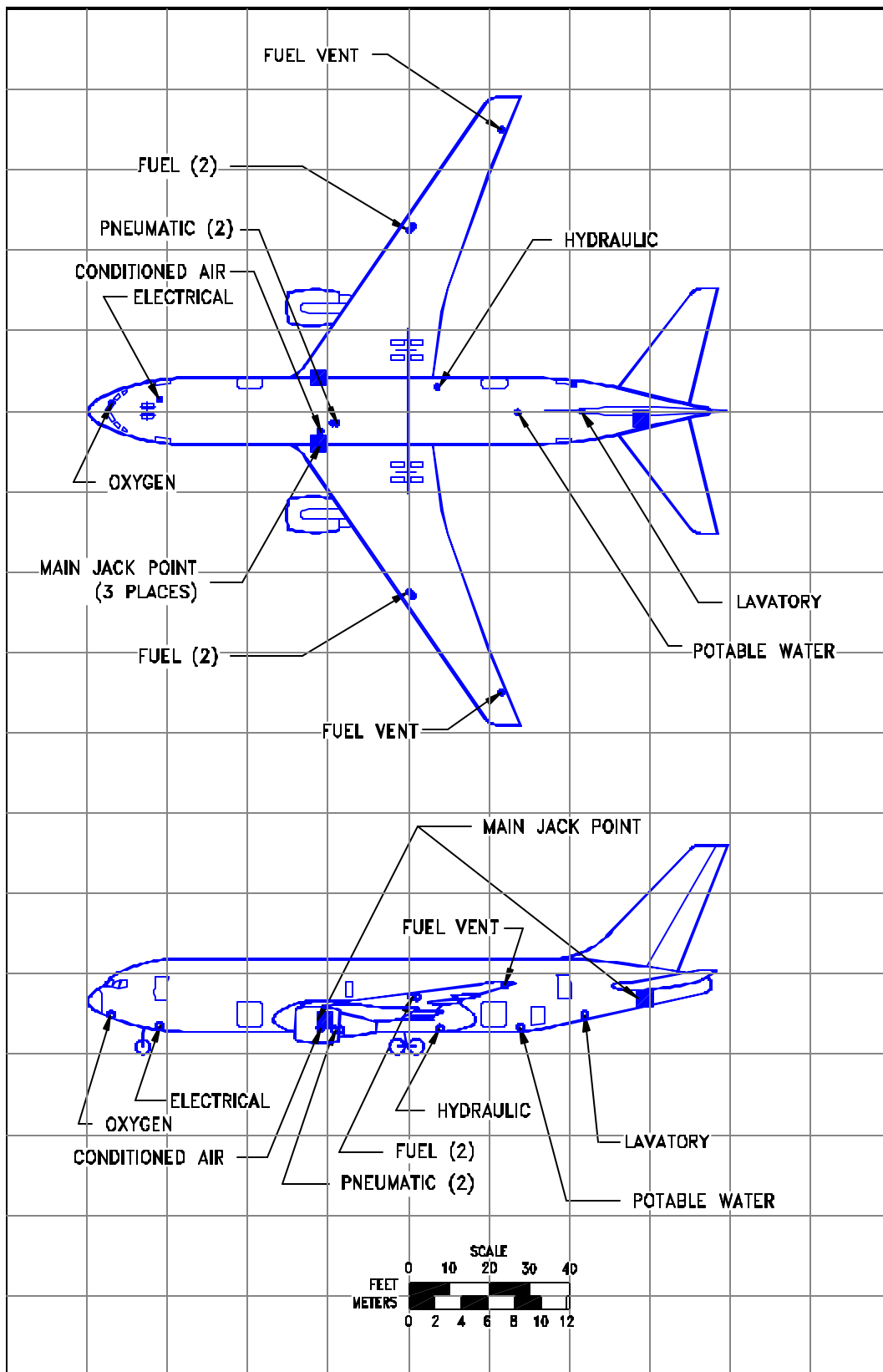

5.4.1 GROUND SERVICING CONNECTIONS
 MODEL 767-200, -200ER

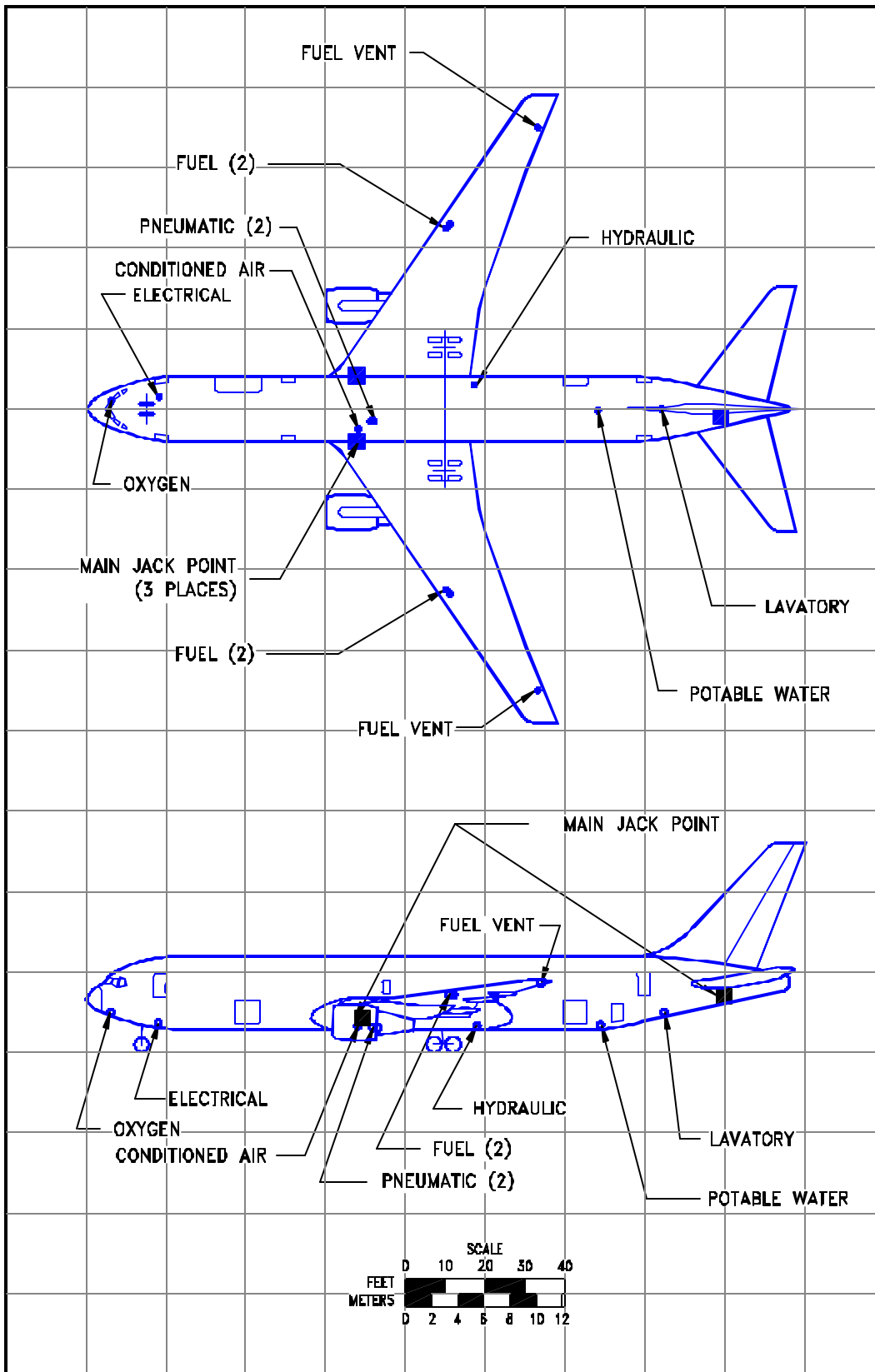

5.4.2 GROUND SERVICING CONNECTIONS
 MODEL 767-300, -300ER

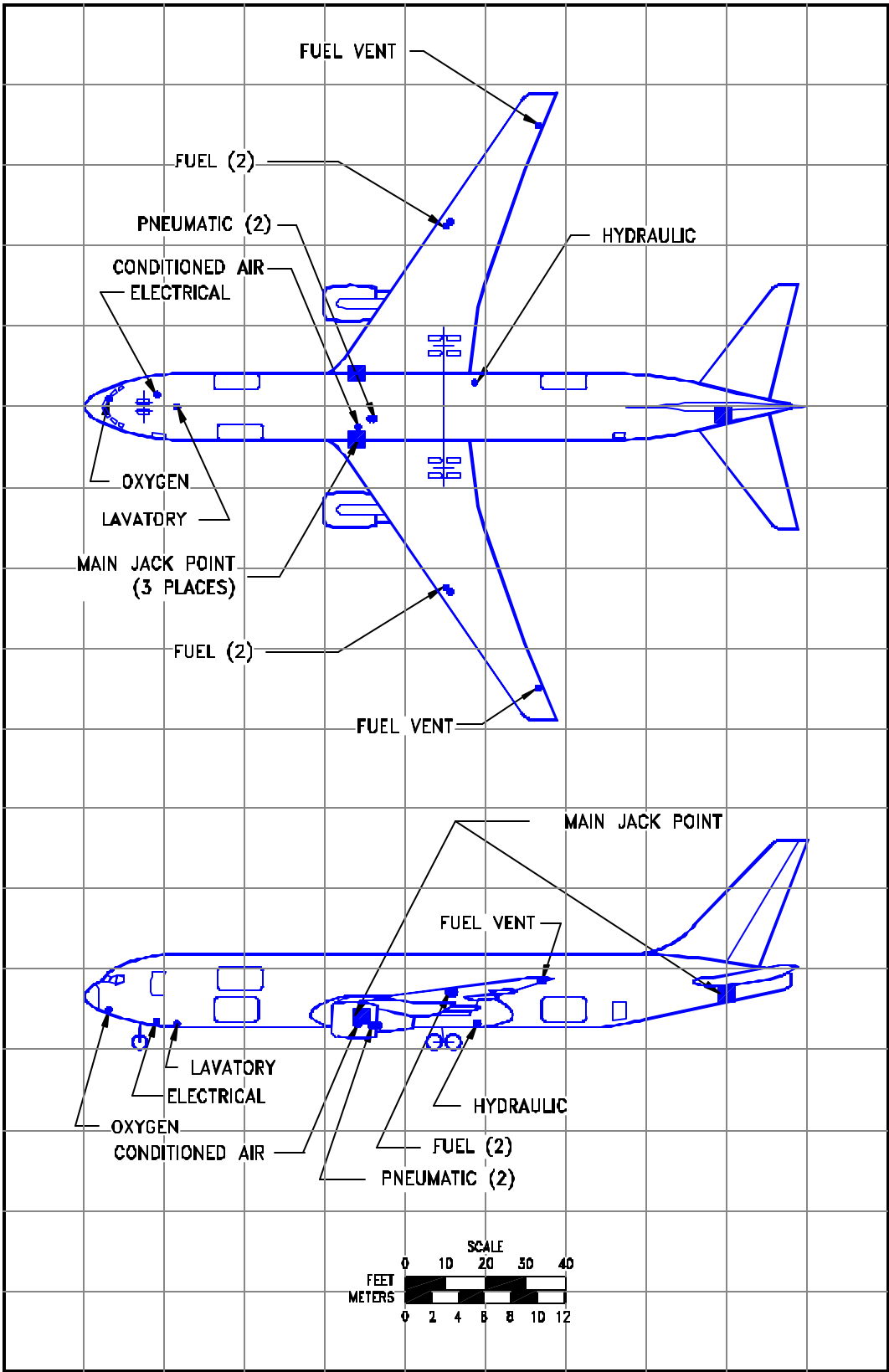

5.4.3 GROUND SERVICING CONNECTIONS
MODEL 767-300 FREIGHTER

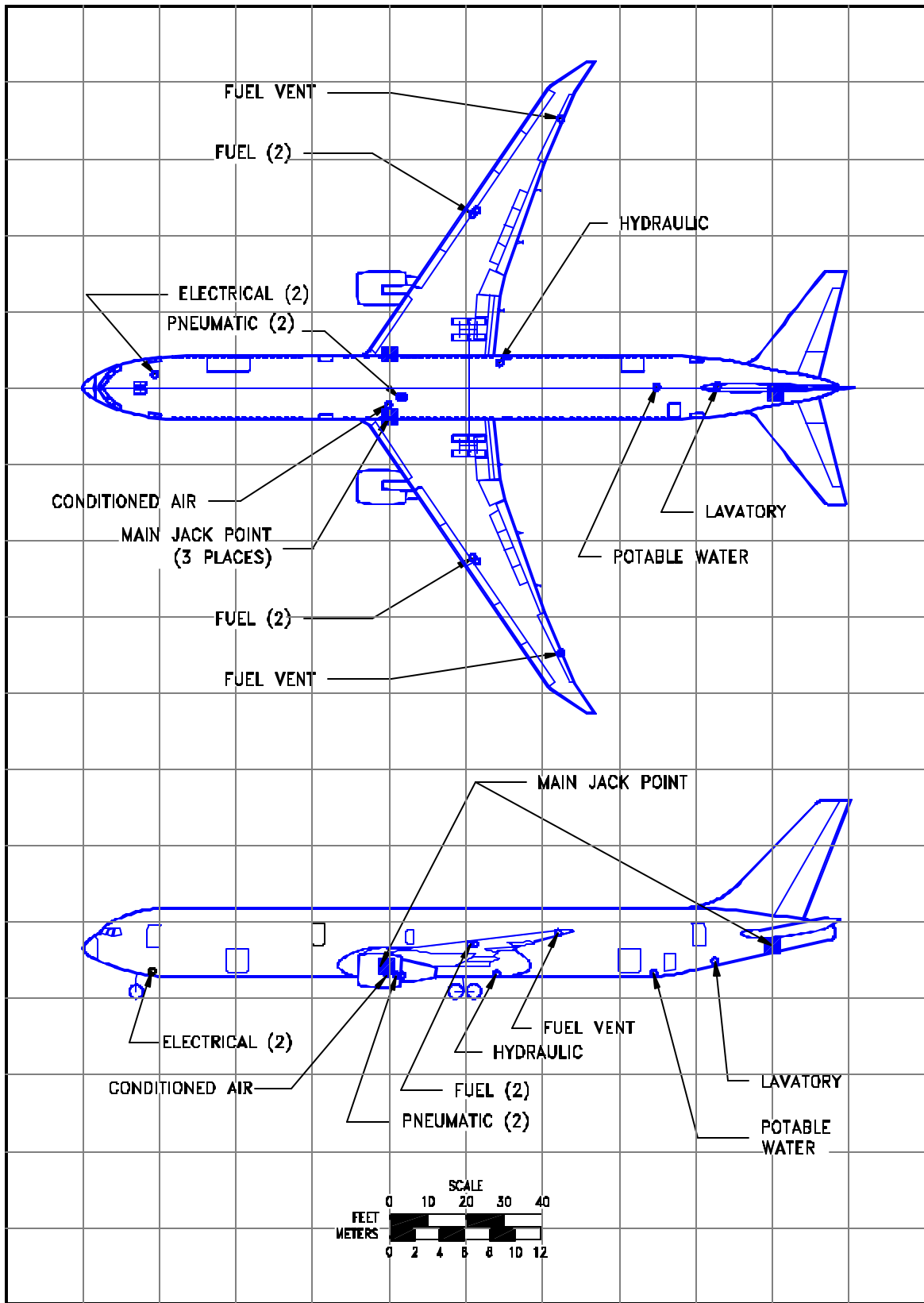

5.4.4 GROUND SERVICING CONNECTIONS
 MODEL 767-400ER

SYSTEM	MODEL	DISTANCE AFT OF NOSE		DISTANCE FROM AIRPLANE CENTERLINE				MAX HT ABOVE GROUND	
		FT	M	LH SIDE		RH SIDE		FT	M
				FT	M	FT	M		
CONDITIONED AIR ONE 8-IN (20.3 CM) PORT	-200, -200ER,	58	17.7	5	1.5	-	-	7	2.1
	-300, -300ER, -300 F	68	20.8	5	1.5	-	-	7	2.1
	-400ER	79	24.1	5	1.5	-	-	7	2.1
ELECTRICAL TWO CONNECTIONS 90 KVA , 200/115 V AC 400 HZ, 3-PHASE EACH	ALL	18	5.5	-	-	3	0.9	7	2.1
FUEL TWO UNDERWING PRESSURE CONNECTORS ON EACH WING	-200	80	24.4	45	13.7	45	13.7	15	4.5
	-200ER	81	24.7	46	14.0	46	14.0	15	4.5
	-300	90	27.4	45	13.7	45	13.7	15	4.5
	-300ER -300 F	91	27.7	46	14.0	46	14.0	15	4.5
	-400ER	101	30.8	45	13.7	45	13.7	14	4.3
		102	31.1	46	14.0	46	14.0	15	4.5
FUEL VENTS	-200	103	31.4	70	21.3	70	21.3	17	5.2
	-200ER								
	-300	113	34.4	70	21.3	70	21.3	17	5.2
	-300ER -300 F								
	-400ER	124	37.8	70	21.3	70	21.3	17	5.2
TOTAL TANK CAPACITY: -200, -300, -300 FREIGHTER 16,700 U.S. GAL (63,210 L)									
-200ER 20,450 U.S. GAL (77,410 L)									
-300ER, -400ER 24,140 U.S. GAL (91,370 L)									
MAX FUEL RATE: 1,000 GPM (3,970 LPM)									
MAX FILL PRESSURE: 55 PSIG (3.87 KG/CM ²)									

5.4.5 GROUND SERVICING CONNECTIONS AND CAPACITIES

MODEL 767-200, -200ER, -300, -300ER, -300 FREIGHTER, -400ER

SYSTEM	MODEL	DISTANCE AFT OF NOSE		DISTANCE FROM AIRPLANE CENTERLINE				MAX HT ABOVE GROUND	
		FT	M	LH SIDE		RH SIDE		M	FT
				FT			FT		
HYDRAULIC ONE SERVICE CONNECTION TOTAL SYSTEM CAPACITY = 80 GAL (303 L) FILL PRESSURE = 150 PSIG (10.55 KG/CM ²)	-200, -200ER,	87	26.5	-	-	6	1.8	7	2.1
	-300, -300ER, -300 F	97	29.6	-	-	6	1.8	7	2.1
	-400ER	108	32.9	-	-	6	1.8	7	2.1
LAVATORY BOTH FORWARD AND AFT TOILETS ARE SERVICED THROUGH ONE SERVICE PANEL THREE SERVICE CONNECTIONS : DRAIN – ONE 4 IN (10.2 CM) FLUSH – TWO 1 IN (2.5 CM) TOILET FLUSH REQUIREMENTS: FLOW – 10 GPM (38 LPM) PRESSURE 30 PSIG (2.11 KG/SC CM) TOTAL SERVICE TANK REQUIREMENTS: WASTE – 140 US GAL (530 L) FLUSH – 50 US GAL (189 L) PRECHARGE – 12 US GAL (45 L)	-200, -200ER,	123	37.5	0	0	0	0	10	3.0
	-300, -300ER	144	43.9	0	0	0	0	10	3.0
	-400ER	165	50.3	0	0	0	0	10	3.0
OXYGEN CREW SYSTEM USES REPLACEABLE CYLINDERS PASSENGER SYSTEM USES SELF-CONTAINED OXYGEN GENERATION UNITS	ALL ALL	6	1.8	-	-	2	0.6	10	3.0
PNEUMATIC TWO 3-IN(7.6-CM) PORTS	-200,	61	18.6	3	0.9	-	-	7	2.1
	-200ER,	62	18.9	3	0.9	-	-	7	2.1
	-300,	71	21.6	3	0.9	-	-	7	2.1
	-300ER, -300 F	72	21.9	3	0.9	-	-	7	2.1
	-400ER	82	25.0	3	0.9	-	-	7	2.1
		83	25.3	3	0.9	-	-	7	2.1

5.4.6 GROUND SERVICING CONNECTIONS AND CAPACITIES

MODEL 767-200, -200ER, -300, -300ER, -300 FREIGHTER, -400ER

SYSTEM	MODEL	DISTANCE AFT OF NOSE		DISTANCE FROM AIRPLANE CENTERLINE				MAX HT ABOVE GROUND	
		FT	M	LH SIDE		RH SIDE		FT	M
				FT	M	FT	M		
POTABLE WATER ONE SERVICE CONNECTION (BASIC)	-200, -200ER	107	32.6	0.3	0.1	-	-	7	2.1
OPTIONAL LOCATION	-200,	121	36.8	-	-	8	2.4	18	5.5
ONE SERVICE CONNECTION (BASIC)	-300, -300ER, -300 F	128	39.0	0.3	0.1	-	-	7	2.1
	-400ER	149	44.4	0.3	0.1	-	-	7	2.1
FORWARD DRAIN PANEL	ALL	46	14.0	0.3	0.1	-	-	7	2.1
TANK CAPACITY 102 U.S. GAL (386 L)	-200, -300								
149 U.S. GAL (564 L)	-200ER -300ER -400ER								
FILL PORT – ¾ IN (1.9 CM) MAX FILL PRESSURE = 25 PSIG (1.76 KG/SQ CM)									

5.4.7 GROUND SERVICING CONNECTIONS AND CAPACITIES

MODEL 767-200, -200ER, -300, -300ER, -300 FREIGHTER, -400ER

D6-58328

NOTES:

- ALTITUDE = SEA LEVEL
- GARRETT STARTER MODEL ATS200-58
- USE OF TWO GROUND CONNECTIONS IS ASSUMED
- PROVIDES MINIMUM ENGINE STARTING REQUIREMENTS

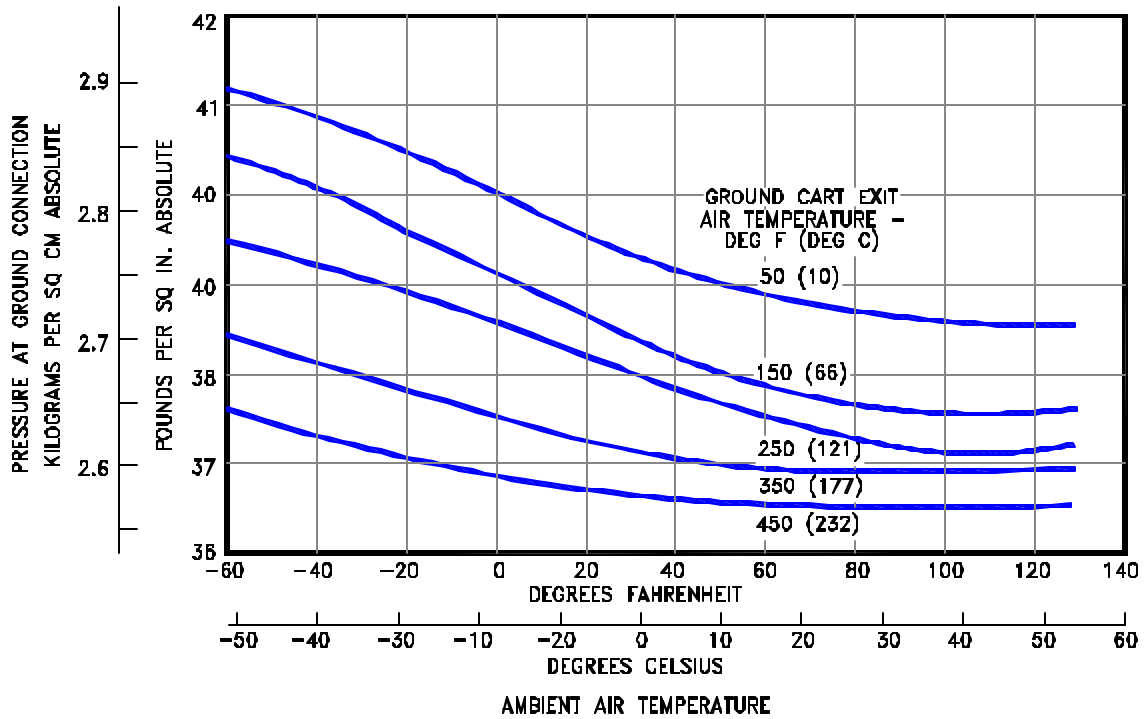
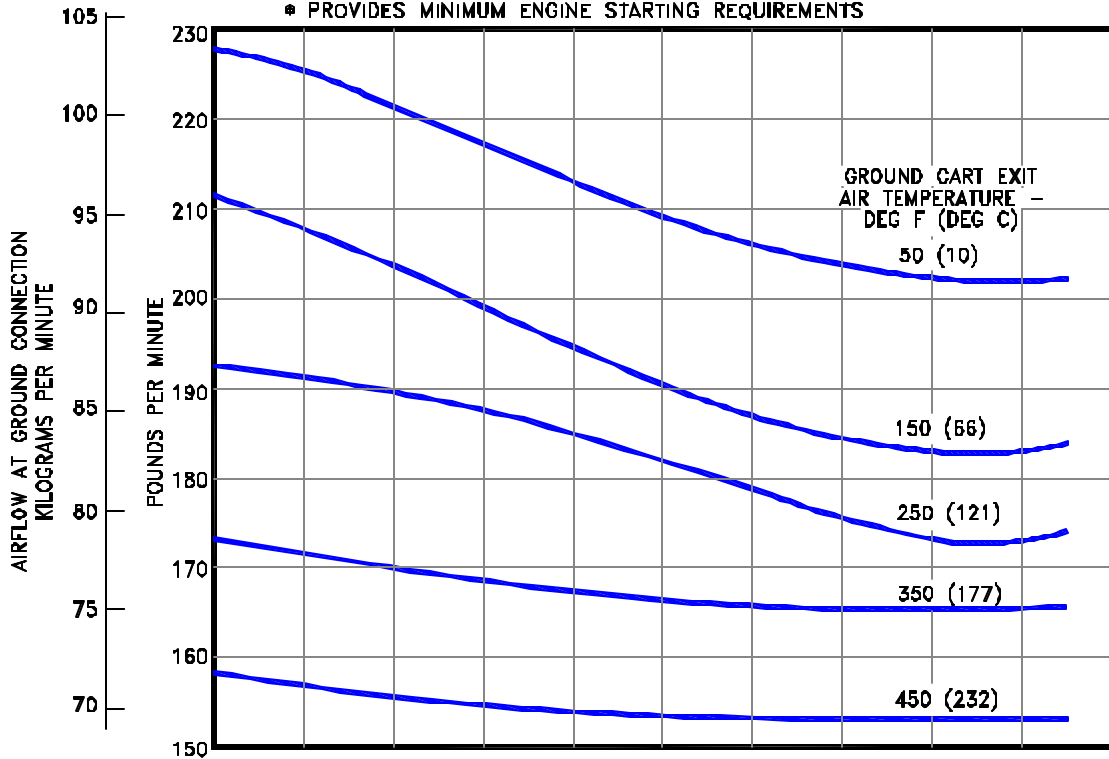

5.5.1 ENGINE START PNEUMATIC REQUIREMENTS - SEA LEVEL

MODEL 767-200, -200ER, -300, -300ER, -300 FREIGHTER, -400ER (GE ENGINES)

NOTES:

- ALTITUDE = SEA LEVEL
- HAMILTON STANDARD STARTER MODEL PS700-5
- USE OF TWO GROUND CONNECTIONS IS ASSUMED
- PROVIDES MINIMUM ENGINE STARTING REQUIREMENTS

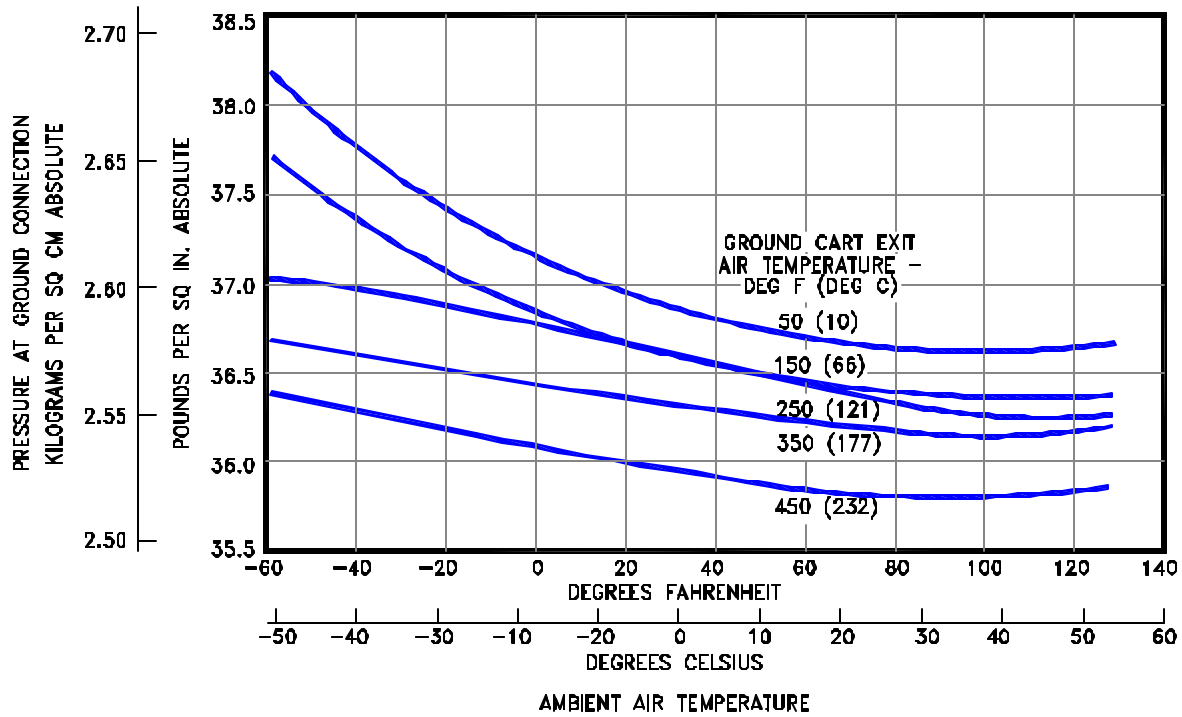
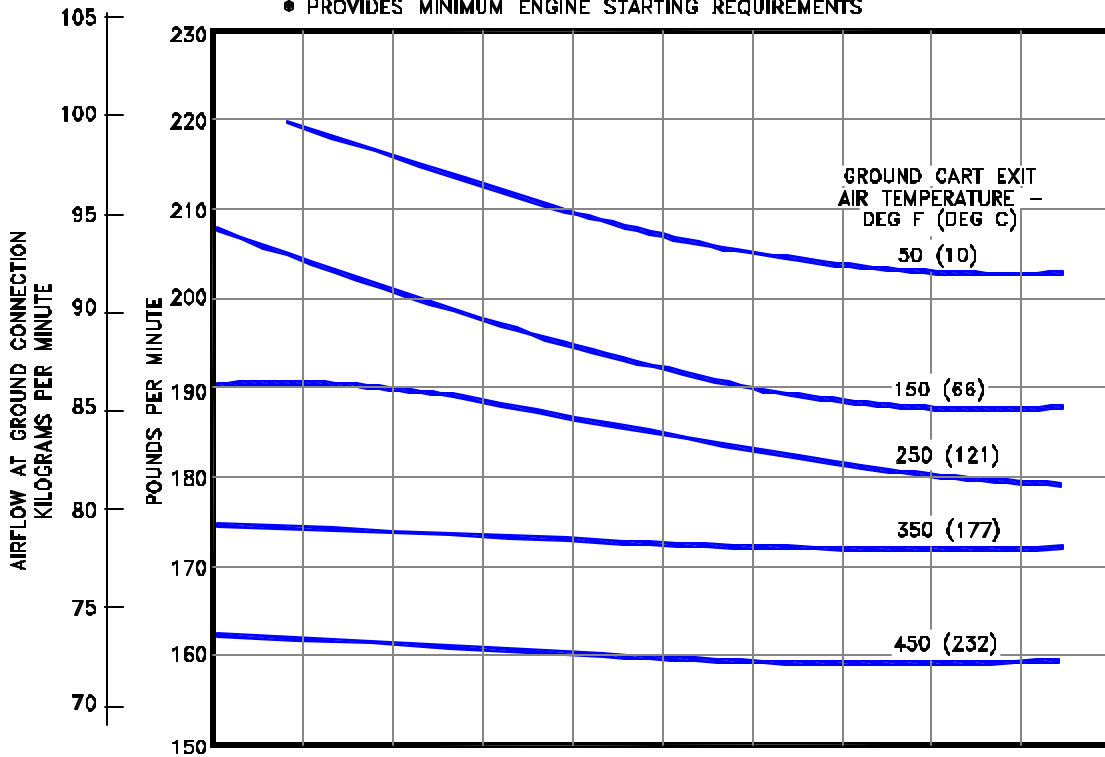

5.5.2 ENGINE START PNEUMATIC REQUIREMENTS - SEA LEVEL

MODEL 767-200, -200ER, -300, -300ER, -300 FREIGHTER, -400ER (PRATT & WHITNEY ENGINES)

NOTES:

- ◆ ALTITUDE = SEA LEVEL
- ◆ GARRETT STARTER MODEL ATS100-350L
- ◆ USE OF TWO GROUND CONNECTIONS IS ASSUMED
- ◆ PROVIDES MINIMUM ENGINE STARTING REQUIREMENTS

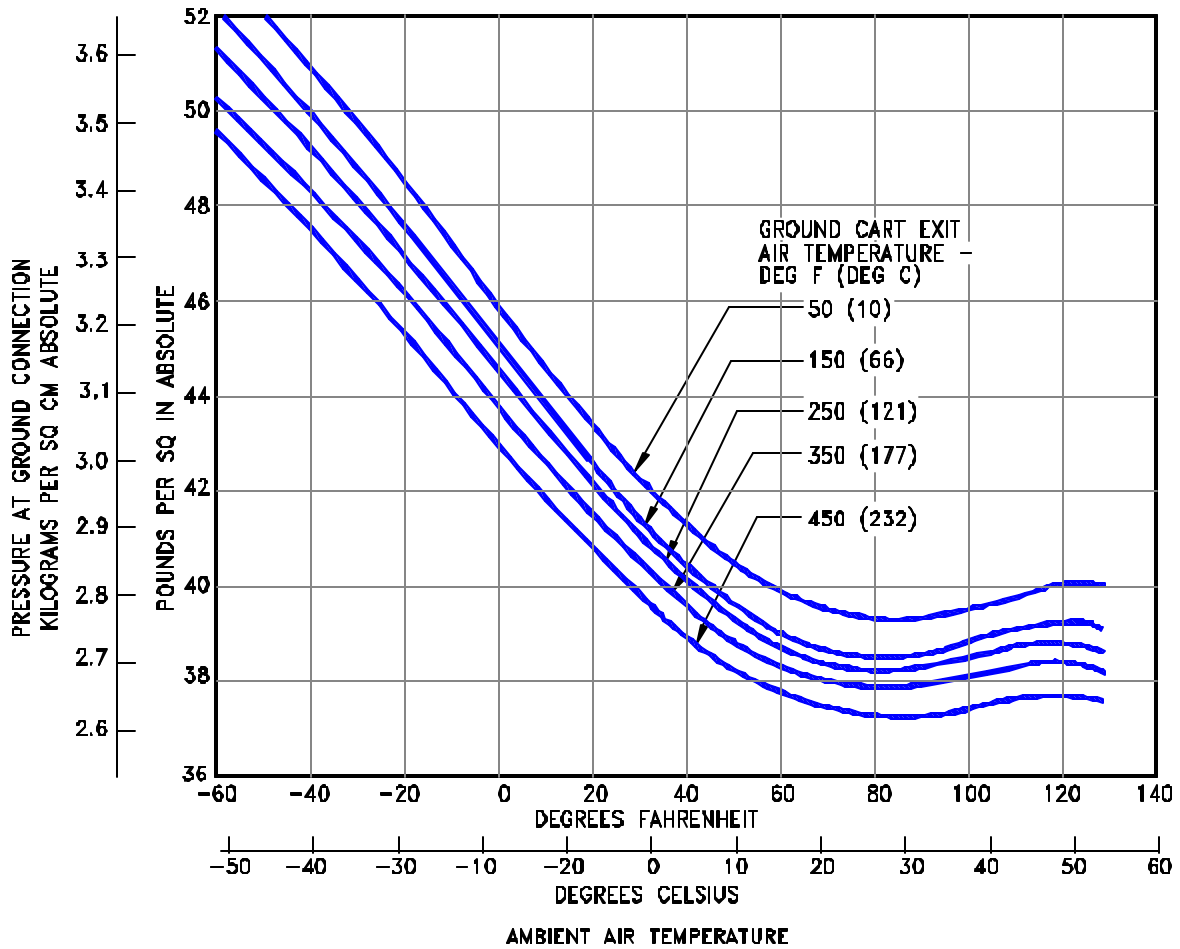
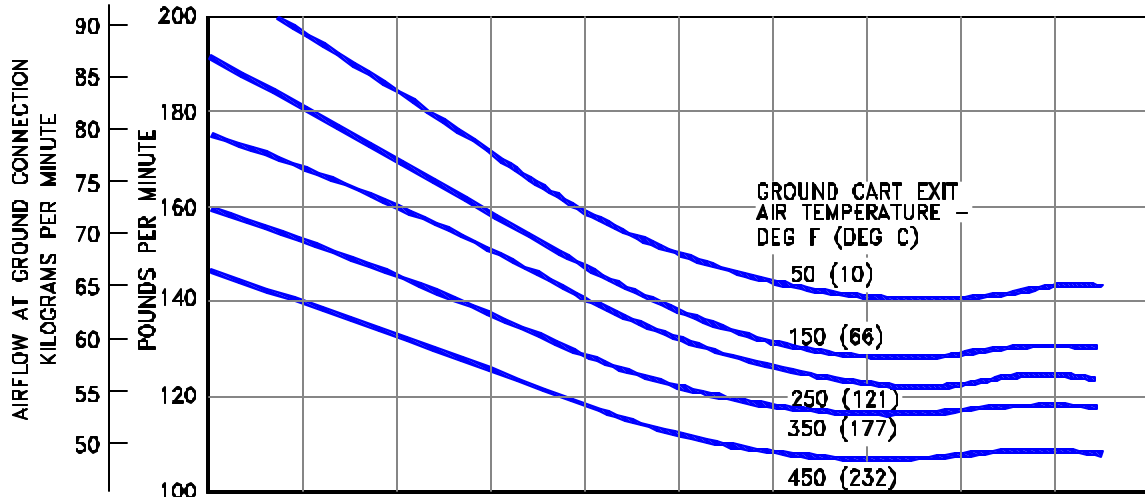

5.5.3 ENGINE START PNEUMATIC REQUIREMENTS - SEA LEVEL

MODEL 767-200, -200ER, -300, -300ER, -300 FREIGHTER, -400ER (GENERAL ELECTRIC ENGINES)

NOTES:

- ◆ ALTITUDE = SEA LEVEL
- ◆ HAMILTON STANDARD STARTER MODEL PS600-B
- ◆ USE OF TWO GROUND CONNECTIONS IS ASSUMED
- ◆ PROVIDES MINIMUM ENGINE STARTING REQUIREMENTS

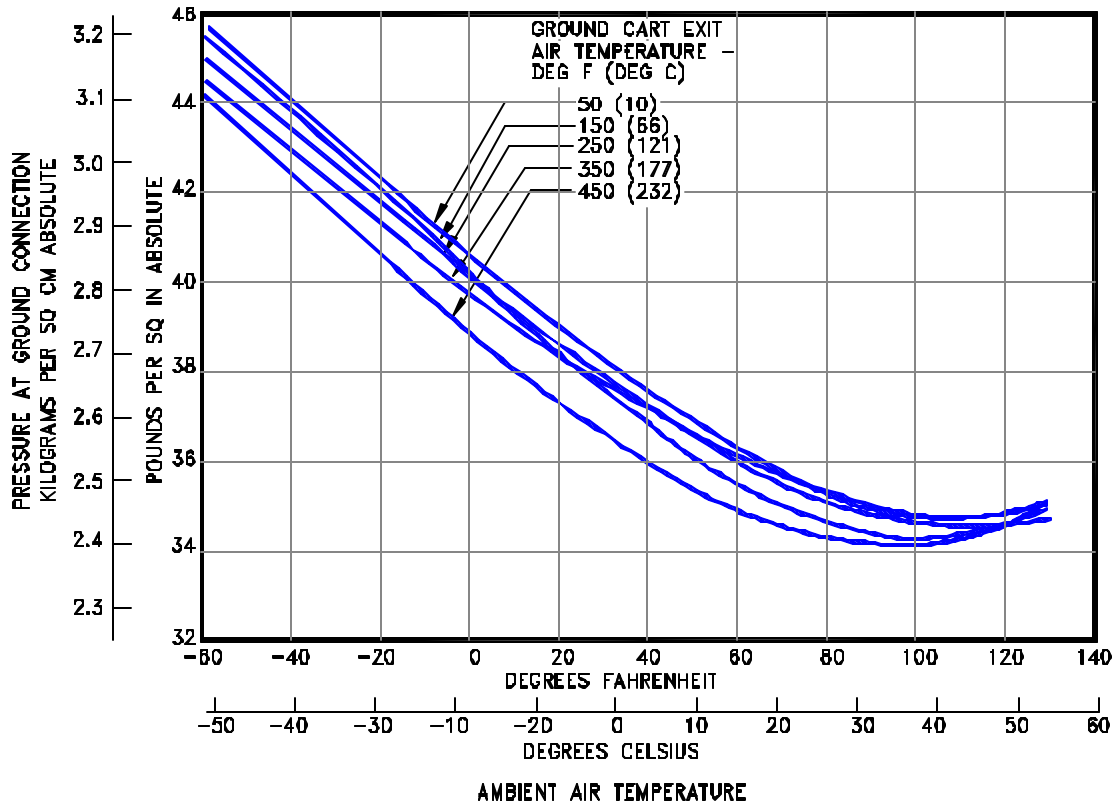
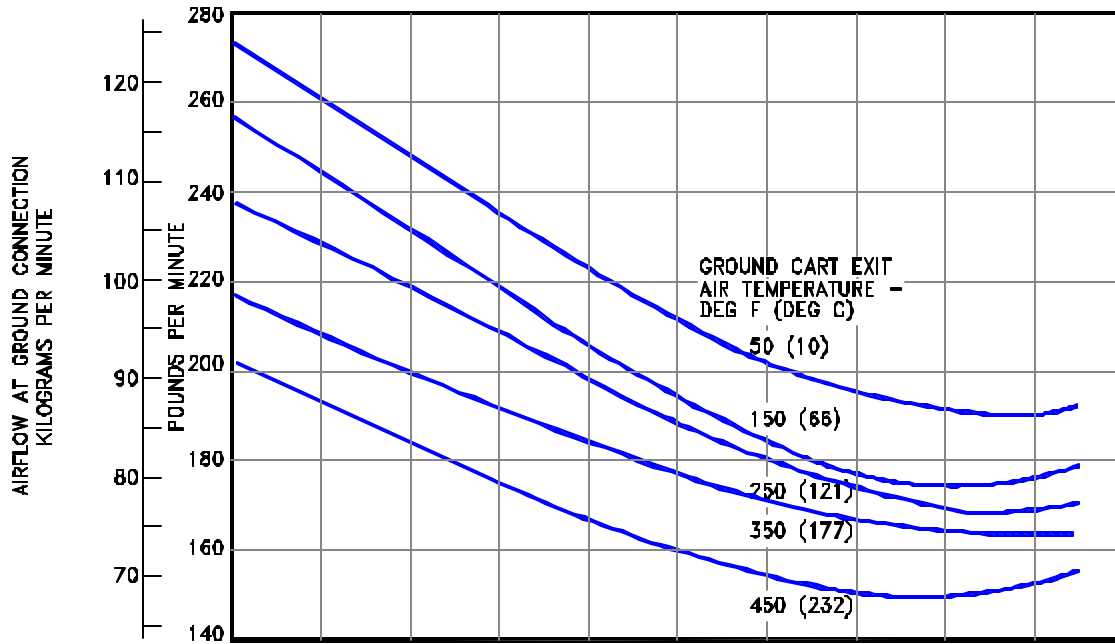

5.5.4 ENGINE START PNEUMATIC REQUIREMENTS - SEA LEVEL

MODEL 767-200, -200ER, -300, -300ER, -300 FREIGHTER, -400ER (GENERAL ELECTRIC ENGINES)

- NOTES:
- ALTITUDE = SEA LEVEL
 - HAMILTON STANDARD STARTER MODEL PS600-3
 - USE OF TWO GROUND CONNECTIONS IS ASSUMED PROVIDES MINIMUM ENGINE STARTING REQUIREMENTS

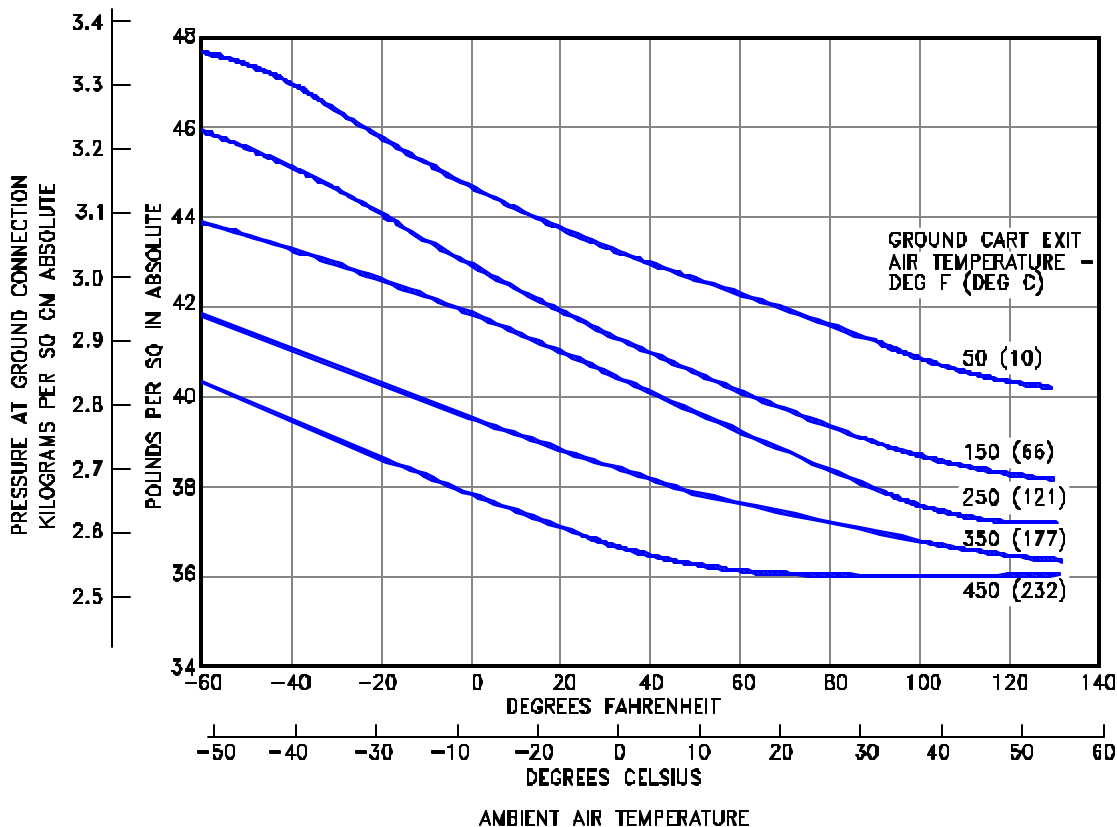
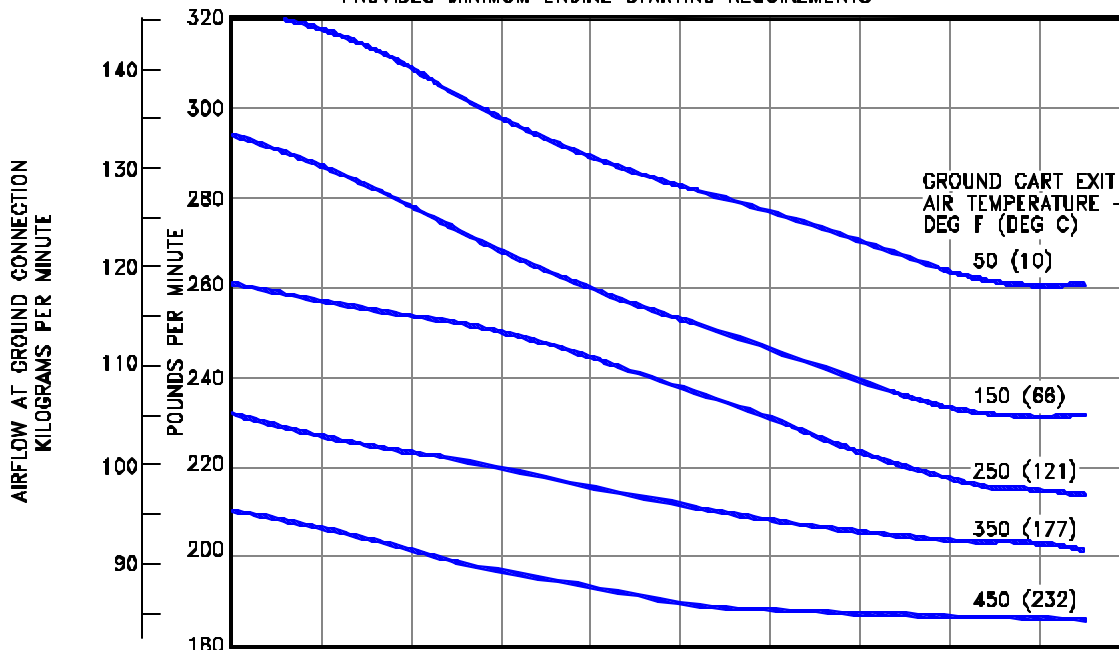

5.5.5 ENGINE START PNEUMATIC REQUIREMENTS - SEA LEVEL

MODEL 767-200, -200ER, -300, -300ER, -300 FREIGHTER (ROLLS ROYCE ENGINES)

HEATING (PULL-UP)

- * CABIN INITIALLY AT 0°F (-17.8°C)
- * NO OCCUPANTS OR OTHER HEAT LOAD
- * AIR TEMPERATURE AT GROUND CONNECTION 300°F (149°C)

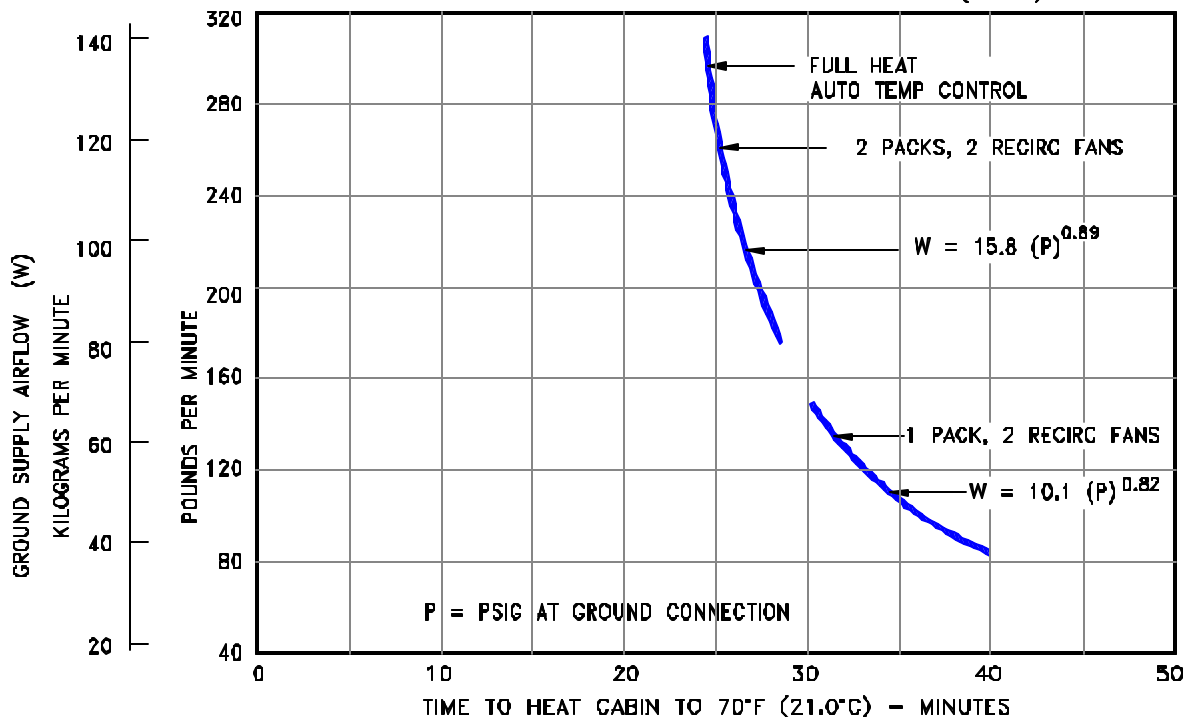

COOLING (PULL-DOWN)

- * CABIN INITIALLY AT 103°F (39°C)
- * NO OCCUPANTS, NO GALLEY OR ELECTRICAL HEAT LOAD
- * AMBIENT TEMPERATURE AT 103°F (39°C)
- * SOLAR HEAT LOAD 11,400 BTU/HR (2,870 KCAL/HR)
- * AIR TEMPERATURE AT GROUND CONNECTION 450°F (232°C)

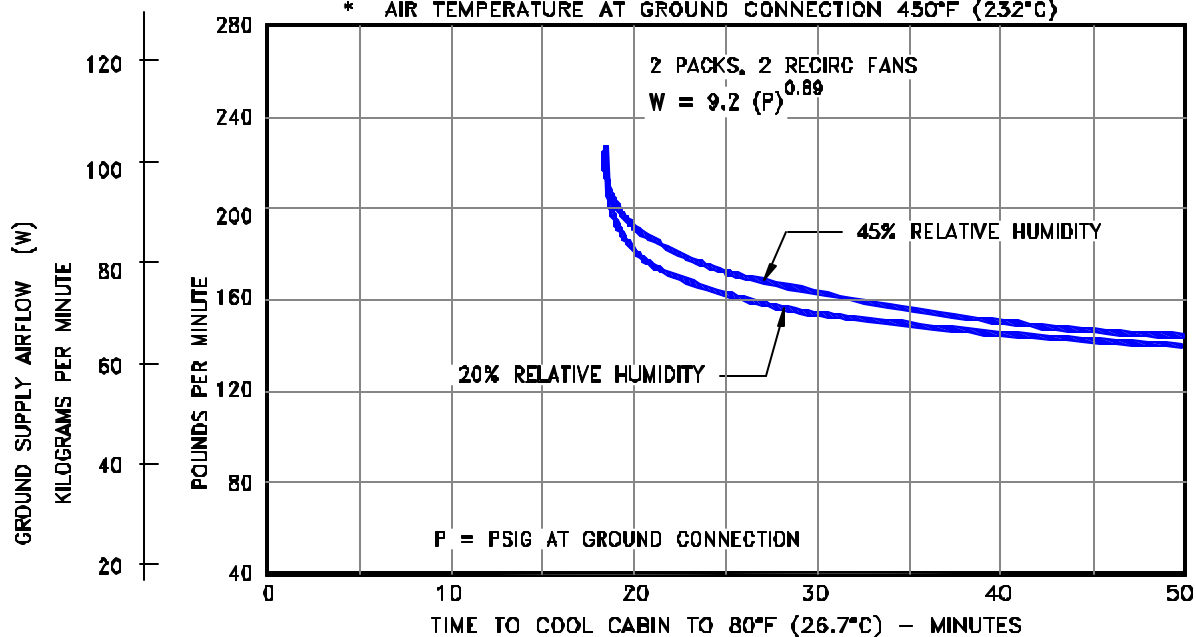

5.6.1 GROUND PNEUMATIC POWER REQUIREMENTS - HEATING AND COOLING
MODEL 767-200, -200ER

HEATING (PULL-UP)

- * CABIN INITIALLY AT 0°F (-17.8°C)
- * NO OCCUPANTS OR OTHER HEAT LOAD
- * AIR TEMPERATURE AT GROUND CONNECTION 300°F (149°C)

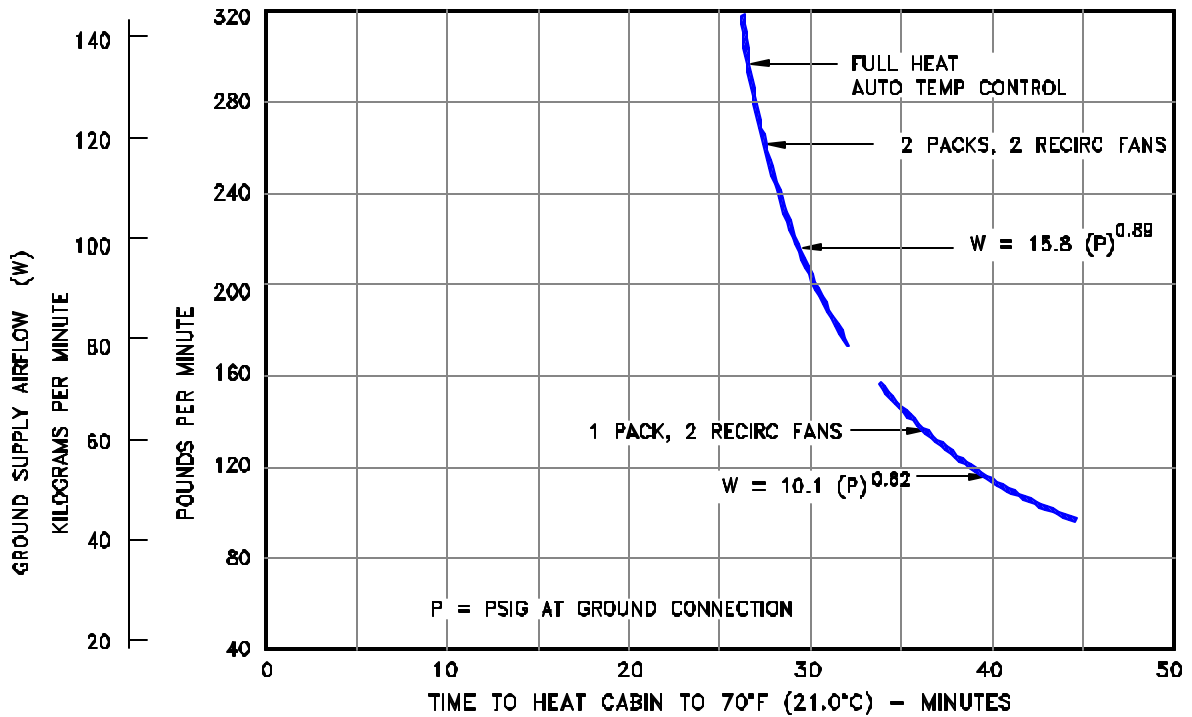

COOLING (PULL-DOWN)

- * CABIN INITIALLY AT 103°F (39°C)
- * NO OCCUPANTS, NO GALLEY OR ELECTRICAL HEAT LOAD
- * AMBIENT TEMPERATURE AT 103°F (39°C)
- * SOLAR HEAT LOAD 11,400 BTU/HR (2,870 KCAL/HR)
- * AIR TEMPERATURE AT GROUND CONNECTION 450°F (232°C)

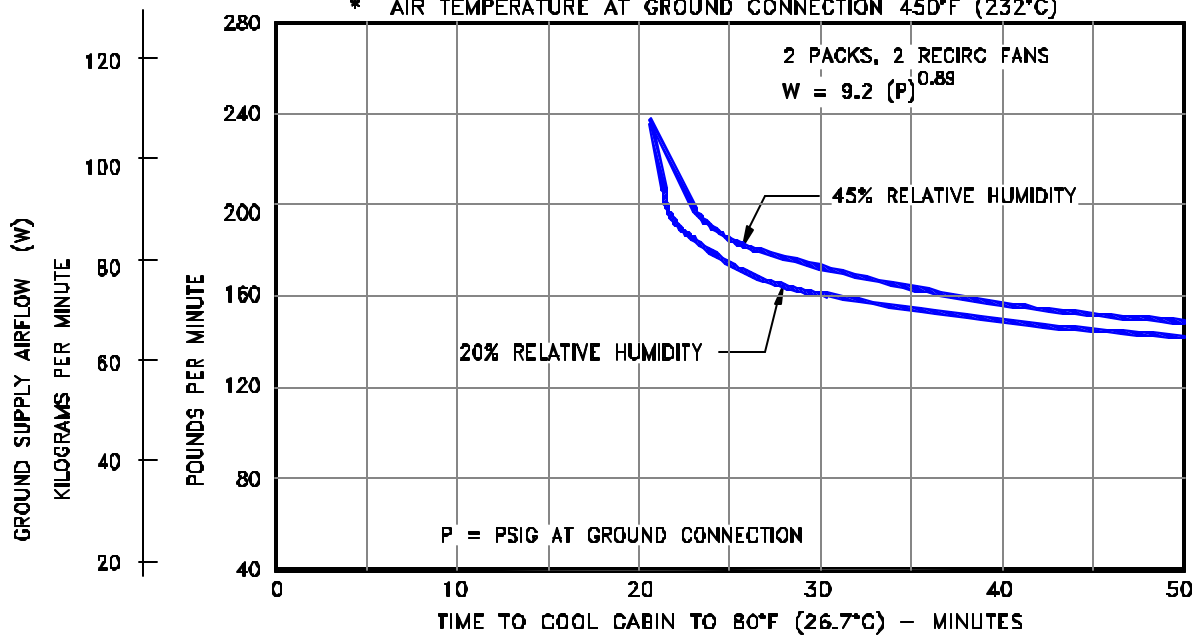

5.6.2 GROUND PNEUMATIC POWER REQUIREMENTS - HEATING AND COOLING

MODEL 767-300, -300ER

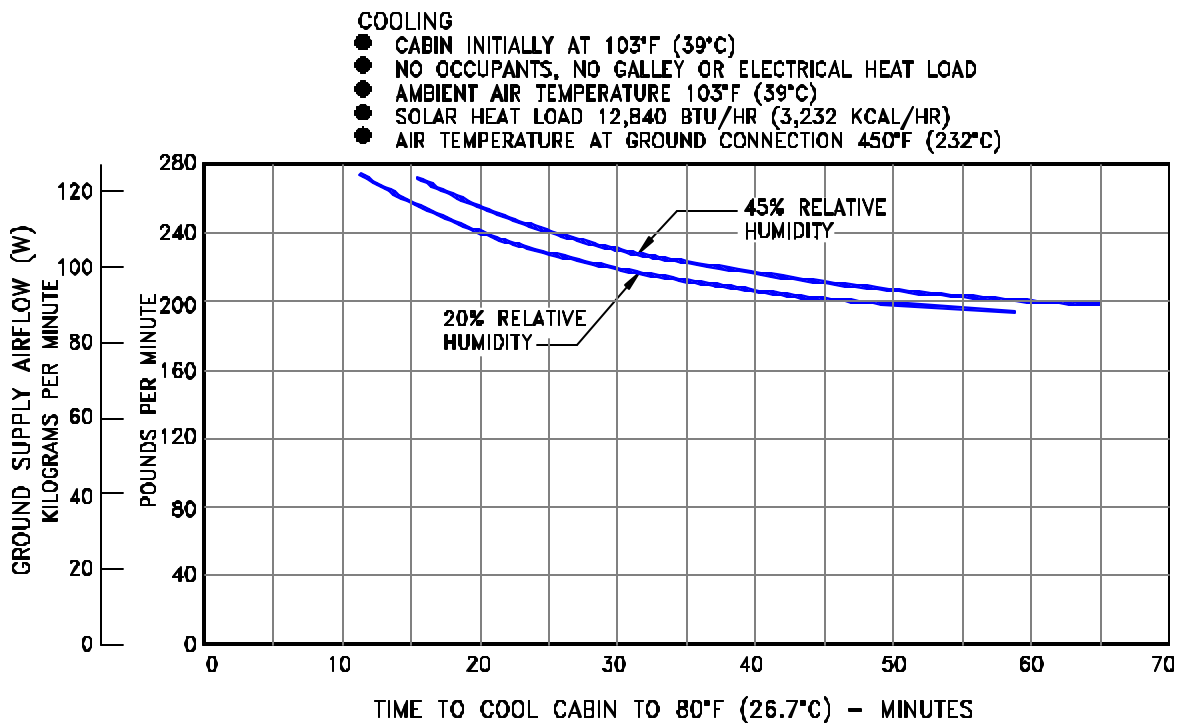
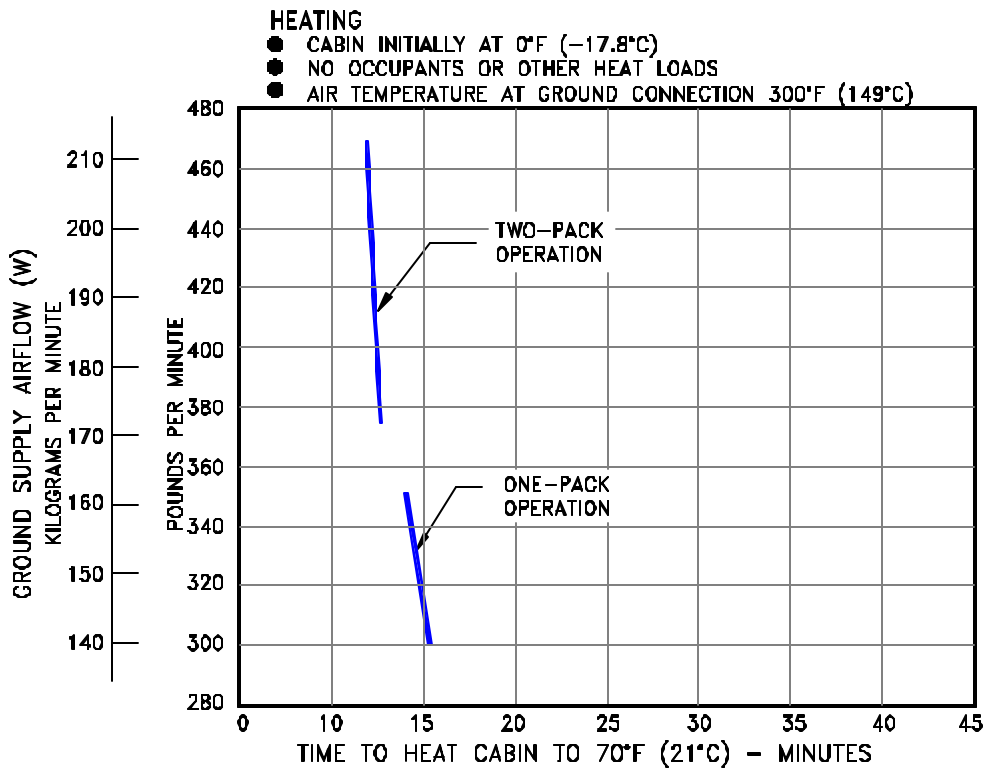

5.6.3 GROUND PNEUMATIC POWER REQUIREMENTS - HEATING AND COOLING
 MODEL 767-400ER

D6-58328

CONDITION	AMBIENT TEMPERATURE	SOLAR LOAD	ELECTRICAL LOAD	OCCUPANTS	CABIN TEMPERATURE
①	0°F (-17.8°C)	0	45 BTU/MIN (11.3 KCAL/MIN)	0	75°F (23.9°C)
②	-20°F (-29.0°C)	0		0	75°F (23.9°C)
③ ④	-40°F (-40.0°C)	0		0	75°F (23.9°C)
⑤ ⑥	103°F (39.0°C)	169.5 BTU/MIN (42.7 KCAL/MIN)	837 BTU/MIN (160.5 KCAL/MIN)	216	75°F (23.9°C)
⑦	103°F (39.0°C)			216	80°F (26.7°C)

NOTE: ALL DOORS AND HATCHES CLOSED ON ALL CONDITIONS

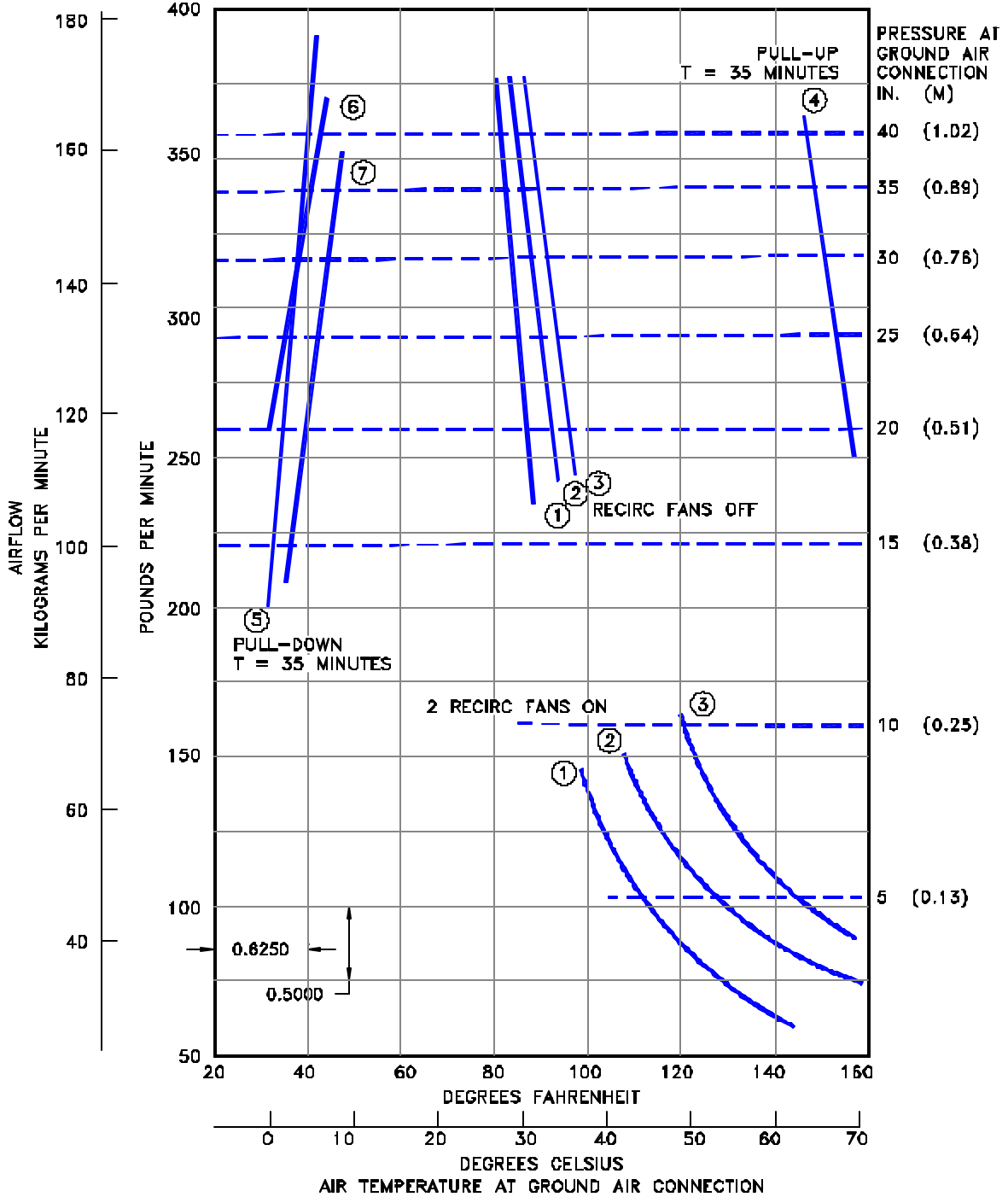

5.7.1 CONDITIONED AIR FLOW REQUIREMENTS – STEADY STATE MODEL 767-200, -200ER

CONDITION	AMBIENT TEMPERATURE	SOLAR LOAD	ELECTRICAL LOAD	OCCUPANTS	CABIN TEMPERATURE
①	0°F (-17.8°C)	0	45 BTU/MIN (11.3 KCAL/MIN)	0	75°F (23.9°C)
②	-20°F (-29.0°C)	0		0	75°F (23.9°C)
③ ④	-40°F (-40.0°C)	0		0	75°F (23.9°C)
⑤ ⑥	103°F (39.0°C)	214 BTU/MIN (53.9 KCAL/MIN)	803 BTU/MIN (201.5 KCAL/MIN)	268	75°F (23.9°C)
⑦	103°F (39.0°C)			268	80°F (26.7°C)

NOTE: ALL DOORS AND HATCHES CLOSED ON ALL CONDITIONS

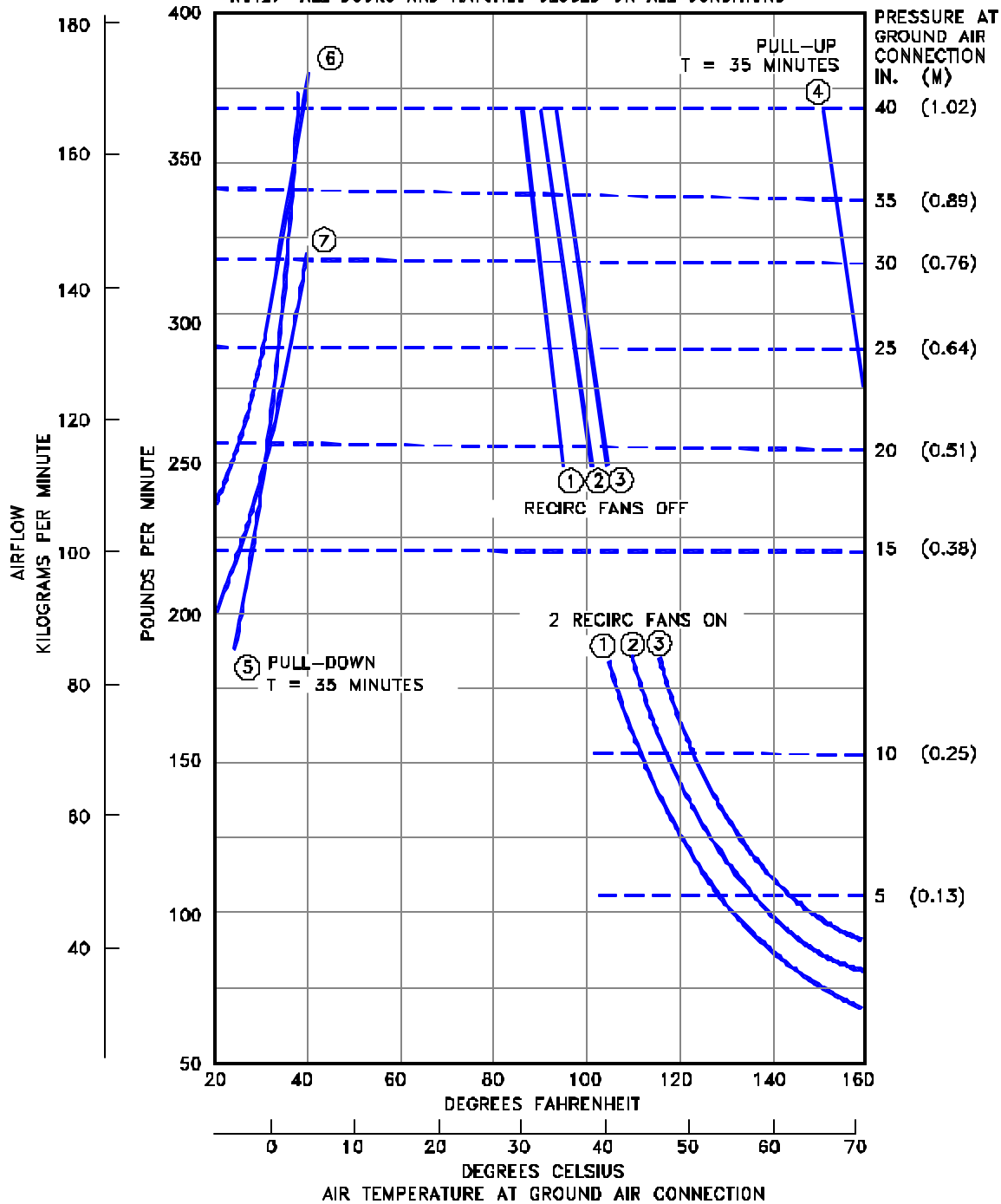

5.7.2 CONDITIONED AIR REQUIREMENTS – STEADY STATE

MODEL 767-300, -300ER, -300 FREIGHTER

COOLING (1), (2)

- ALL EXTERIOR DOOR AND WINDOWS CLOSED
- OUTSIDE TEMPERATURE 103°F (39°C)
- FULL SOLAR AND ELECTRICAL HEAT LOADS
- RECIRCULATION FANS OFF
- CHILLERS ON
- 216 OCCUPANTS
- CABIN TEMPERATURE MAINTAINED AT 75°F (24°C)

- ① IFE ON
- ② IFE OFF

HEATING (3)

- ALL EXTERIOR DOORS AND WINDOWS CLOSED
- OUTSIDE TEMPERATURE -40°F (-40°C)
- NO SOLAR OR ELECTRICAL HEAT LOADS
- RECIRCULATION FANS OFF
- CHILLERS OFF
- NO OCCUPANTS
- CABIN TEMPERATURE MAINTAINED AT 75°F (24°C)

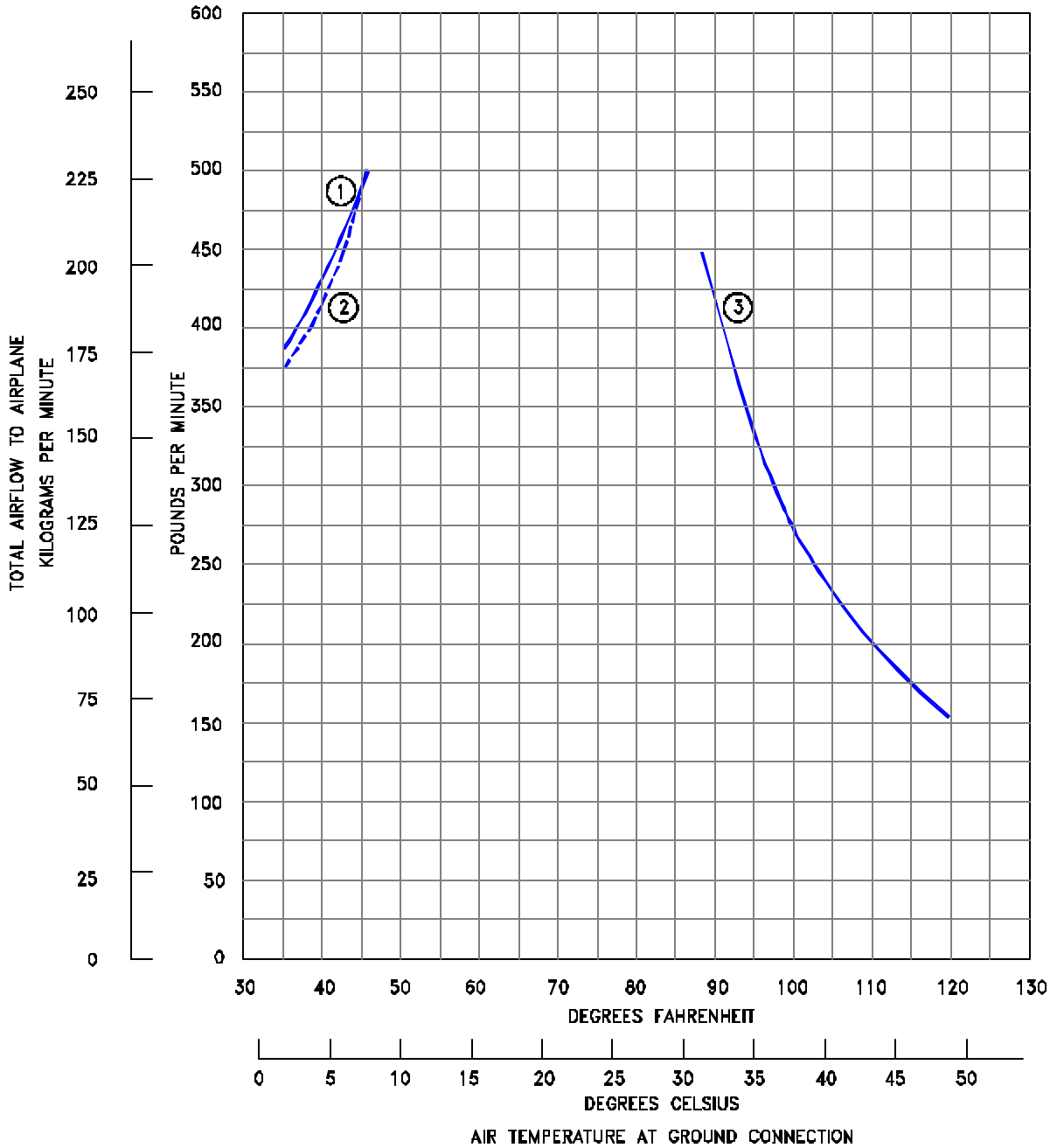

5.7.3 CONDITIONED AIR REQUIREMENTS

MODEL 767-400ER

NOTE:

THE GRAPH ON THIS PAGE SHOWS THE STATIC PRESSURE GAGE AT THE CONNECTOR AS A FUNCTION OF AIRFLOW. THIS GRAPH IS USED IN CONJUNCTION WITH THE GRAPH IN SECTION 5.7.1 TO DETERMINE THE AIRFLOW AND PRESSURE REQUIREMENTS WHEN USING A CONDITIONED AIR GROUND SOURCE.

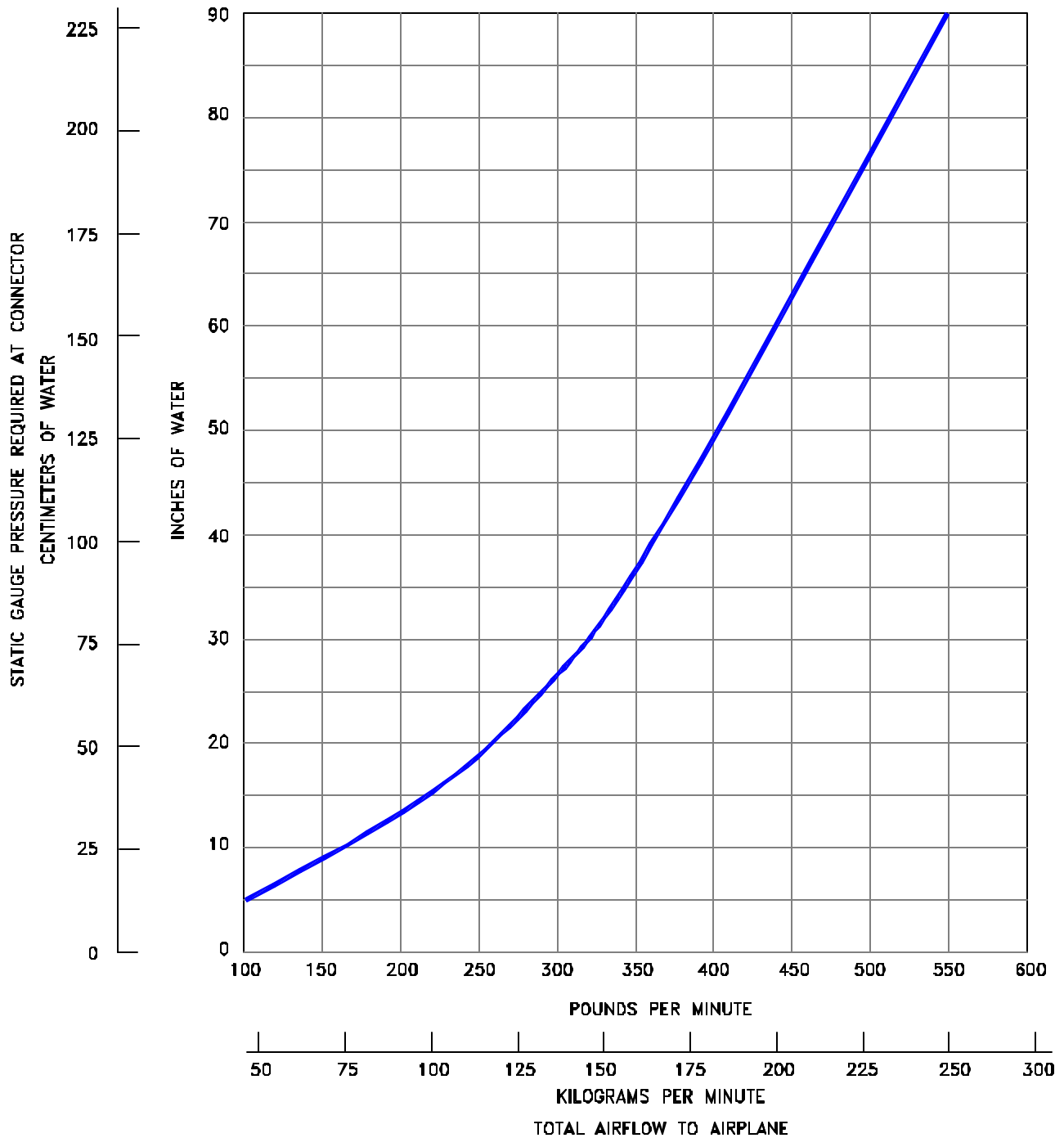

5.7.4 CONDITIONED AIR FLOW PRESSURE REQUIREMENTS
MODEL 767-400ER

D6-58328

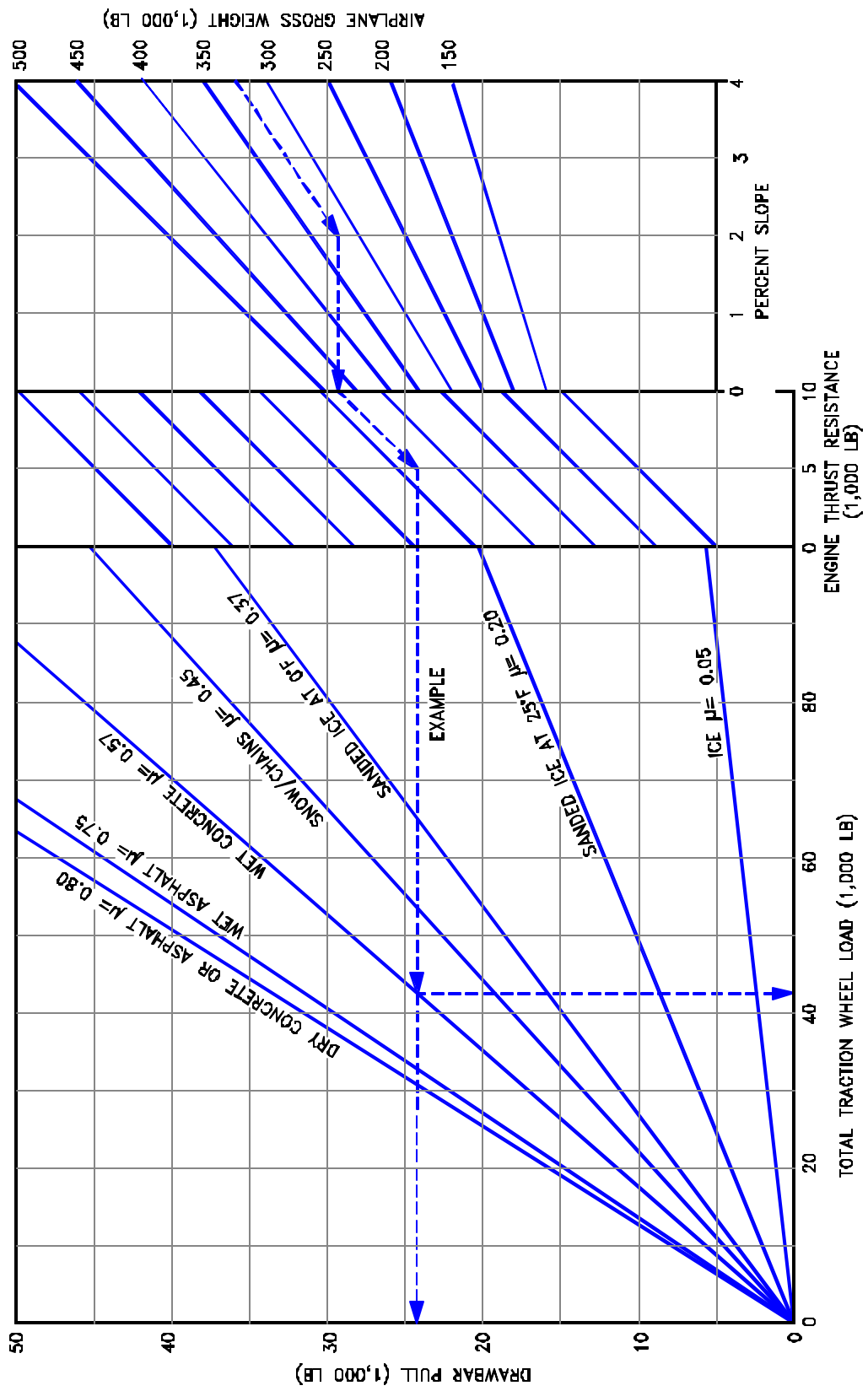

EXAMPLE: A 767-300ER WEIGHING 325,000 LB BEING PUSHED UP A 2% SLOPE ON WET CONCRETE AGAINST TWO ENGINES AT IDLE THRUST (APPROX 5,000 LB OF THRUST) WILL REQUIRE APPROX 24,300 LB OF DRAWBAR PUSH AND A WHEEL TRACTION LOAD OF APPROX 42,700 LB

NOTES:
 1. STRAIGHT-LINE TOW
 2. UNUSUAL BREAKAWAY CONDITIONS NOT SHOWN
 3. COEFFICIENTS OF FRICTION (μ) ARE ESTIMATED FOR RUBBER-TIRED TOW VEHICLES

5.8.1 GROUND TOWING REQUIREMENTS - ENGLISH UNITS
 MODEL 767-200, -200ER, -300, -300ER, -300 FREIGHTER, -400ER

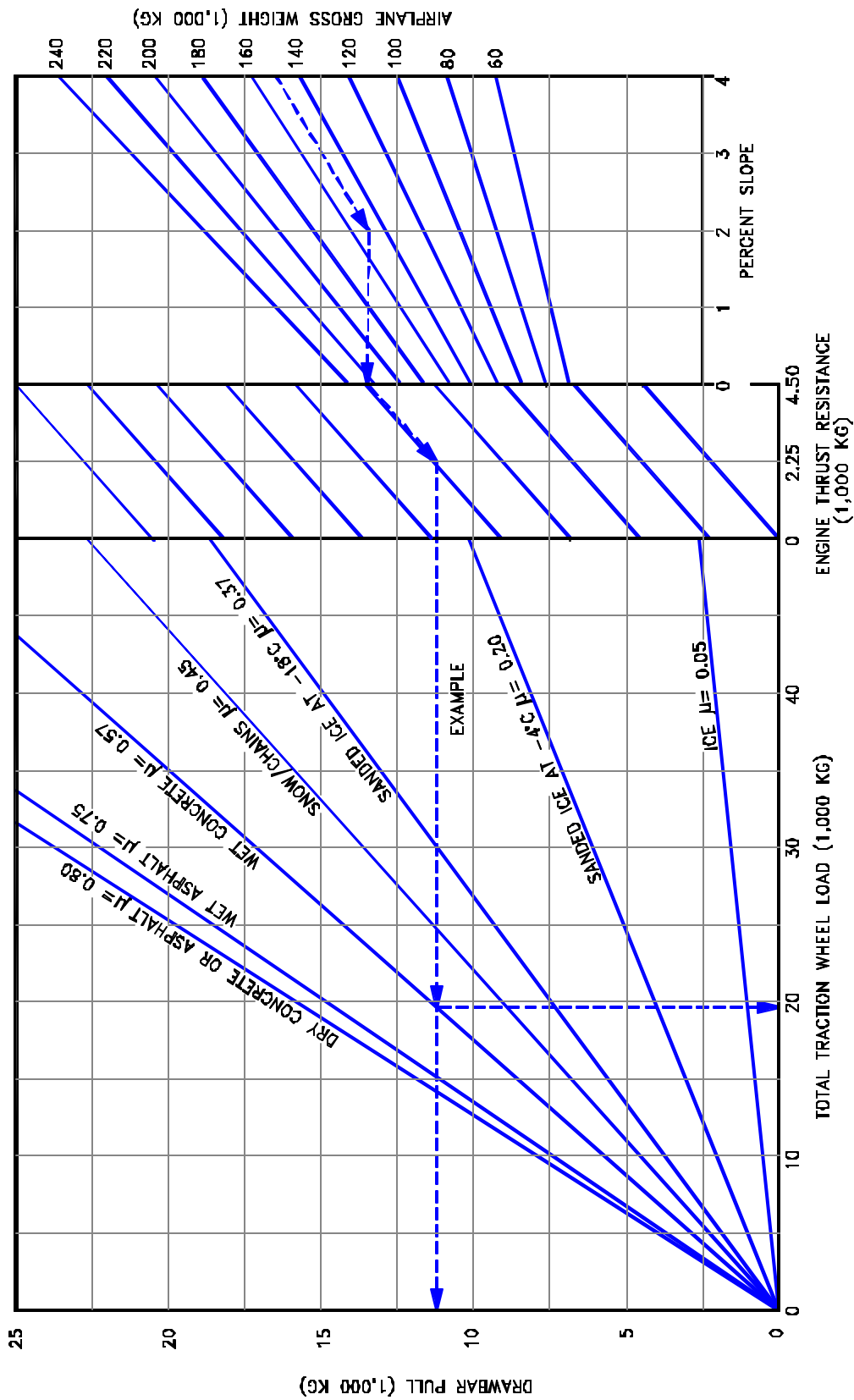

EXAMPLE: A 767-300ER WEIGHING 150,000 KG BEING PUSHED UP A 2% SLOPE ON WET CONCRETE AGAINST TWO ENGINES AT IDLE THRUST (APPROX .2250 KG OF THRUST) WILL REQUIRE APPROX 11,200 KG OF DRAWBAR PUSH AND A WHEEL TRACTION LOAD OF APPROX 19,750 KG

- NOTES:
1. STRAIGHT-LINE TOW
 2. UNUSUAL BREAKAWAY CONDITIONS NOT SHOWN
 3. COEFFICIENTS OF FRICTION (μ) ARE ESTIMATED FOR RUBBER-TIRED TOW VEHICLES

5.8.2 GROUND TOWING REQUIREMENTS - METRIC UNITS
 MODEL 767-200, -200ER, -300, -300ER, -300 FREIGHTER, -400ER

6.0 JET ENGINE WAKE AND NOISE DATA

6.1 Jet Engine Exhaust Velocities and Temperatures

6.2 Airport and Community Noise

6.0 JET ENGINE WAKE AND NOISE DATA

6.1 Jet Engine Exhaust Velocities and Temperatures

This section shows exhaust velocity and temperature contours aft of the 767-200, -300, -400ER airplane. The contours were calculated from a standard computer analysis using three-dimensional viscous flow equations with mixing of primary, fan, and free-stream flow. The presence of the ground plane is included in the calculations as well as engine tilt and toe-in. Mixing of flows from the engines is also calculated. The analysis does not include thermal buoyancy effects which tend to elevate the jet wake above the ground plane. The buoyancy effects are considered to be small relative to the exhaust velocity and therefore are not included.

The graphs show jet wake velocity and temperature contours for representative engines. The results are valid for sea level, static, standard day conditions. The effect of wind on jet wakes is not included. There is evidence to show that a downwind or an upwind component does not simply add or subtract from the jet wake velocity, but rather carries the whole envelope in the direction of the wind. Crosswinds may carry the jet wake contour far to the side at large distances behind the airplane.

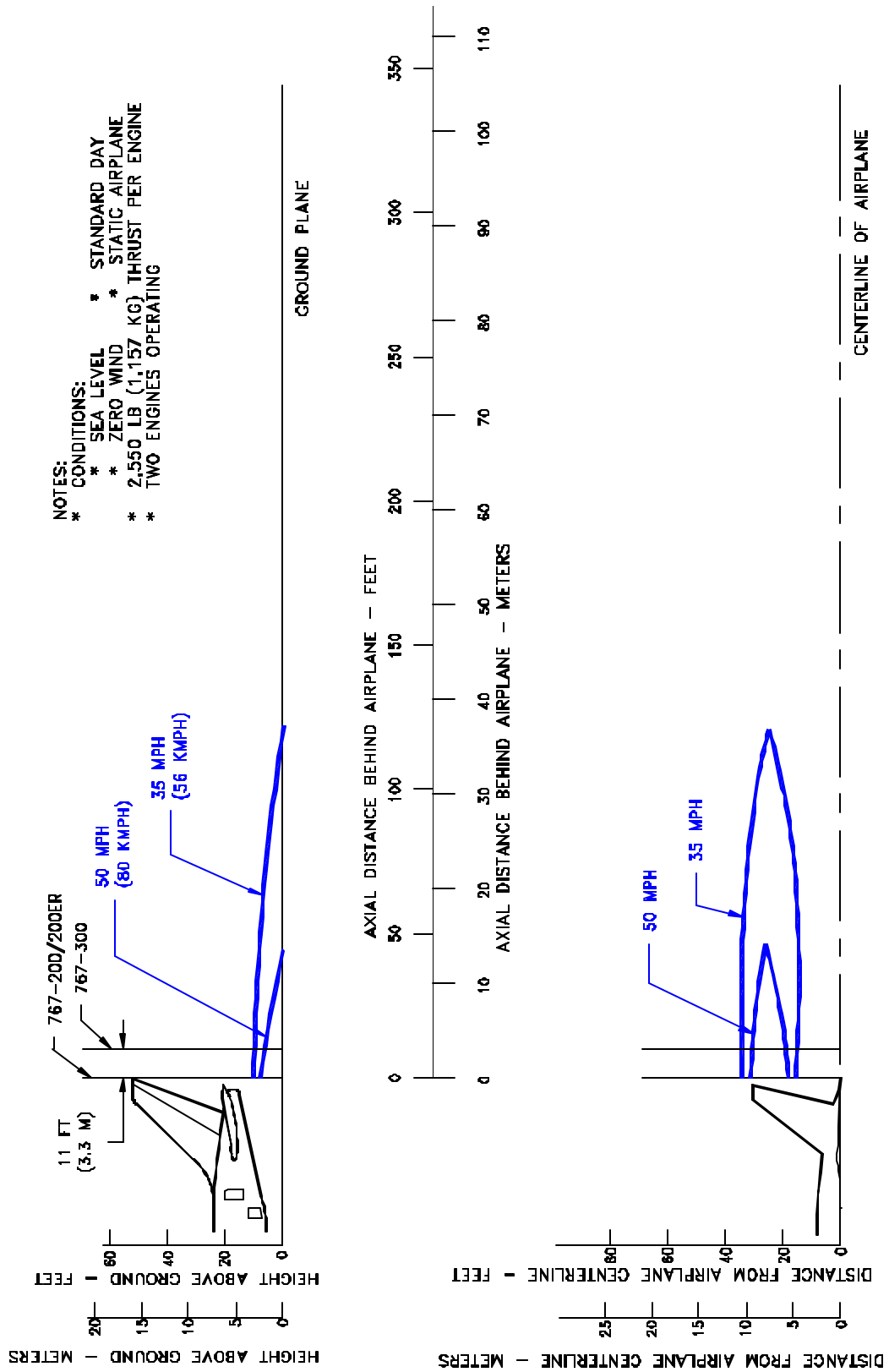

**6.1.1 PREDICTED JET ENGINE EXHAUST VELOCITY CONTOURS
 - IDLE THRUST**
 MODEL 767-200, -200ER, -300 (JT9D-7R4D, -7R4E ENGINES)

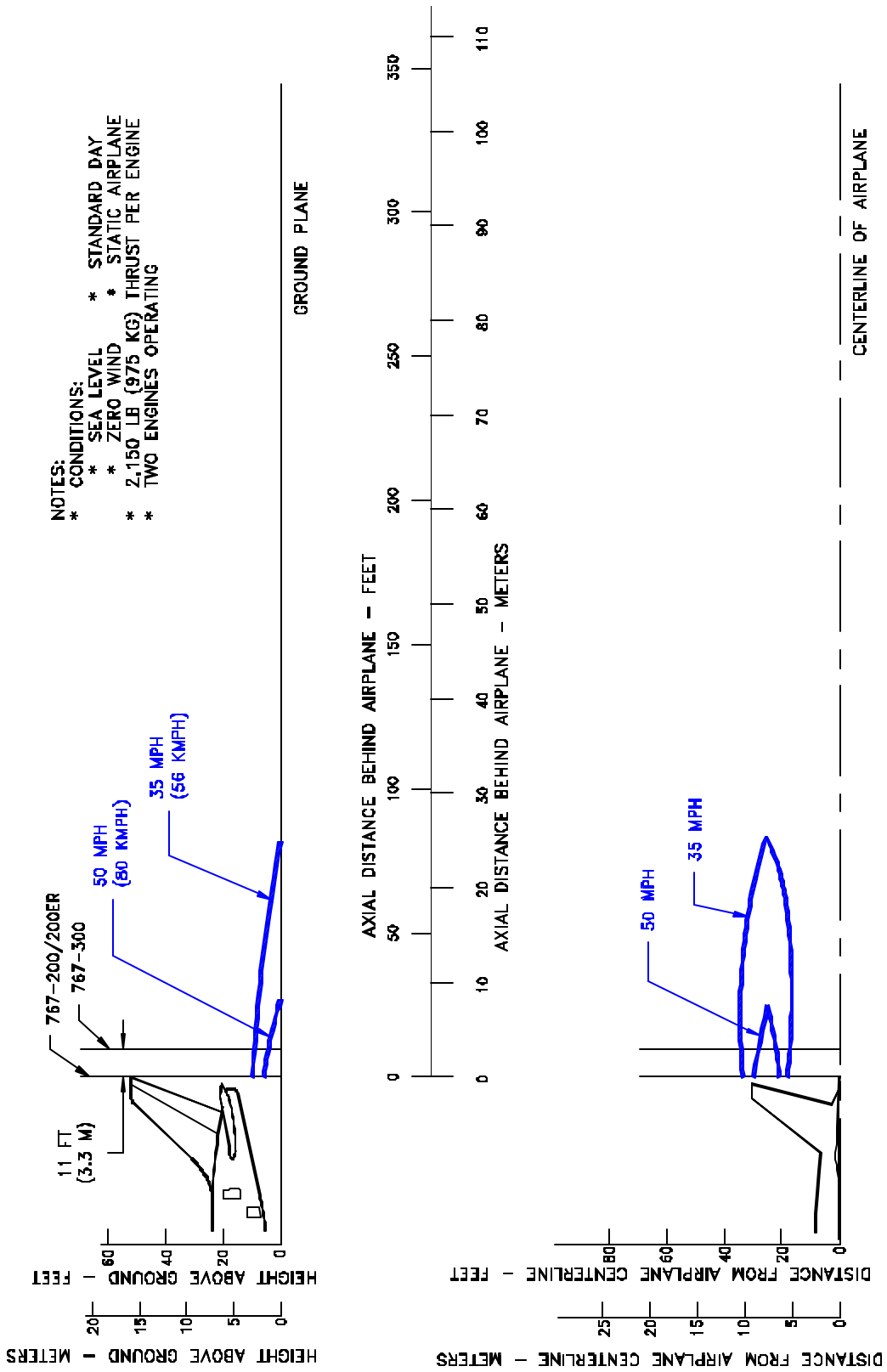

6.1.2 PREDICTED JET ENGINE EXHAUST VELOCITY CONTOURS - IDLE THRUST

MODEL 767-200, -200ER, -300 (CF6-80A, -80A2 ENGINES)

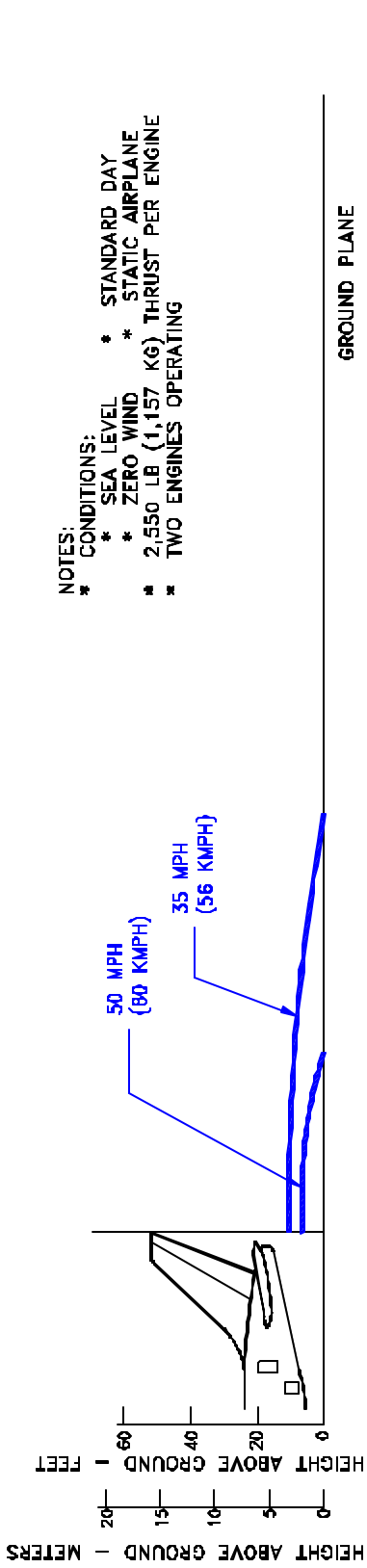

- NOTES:
 * CONDITIONS:
 * SEA LEVEL * STANDARD DAY
 * ZERO WIND * STATIC AIRPLANE
 * 2,550 LB (1,157 KG) THRUST PER ENGINE
 * TWO ENGINES OPERATING

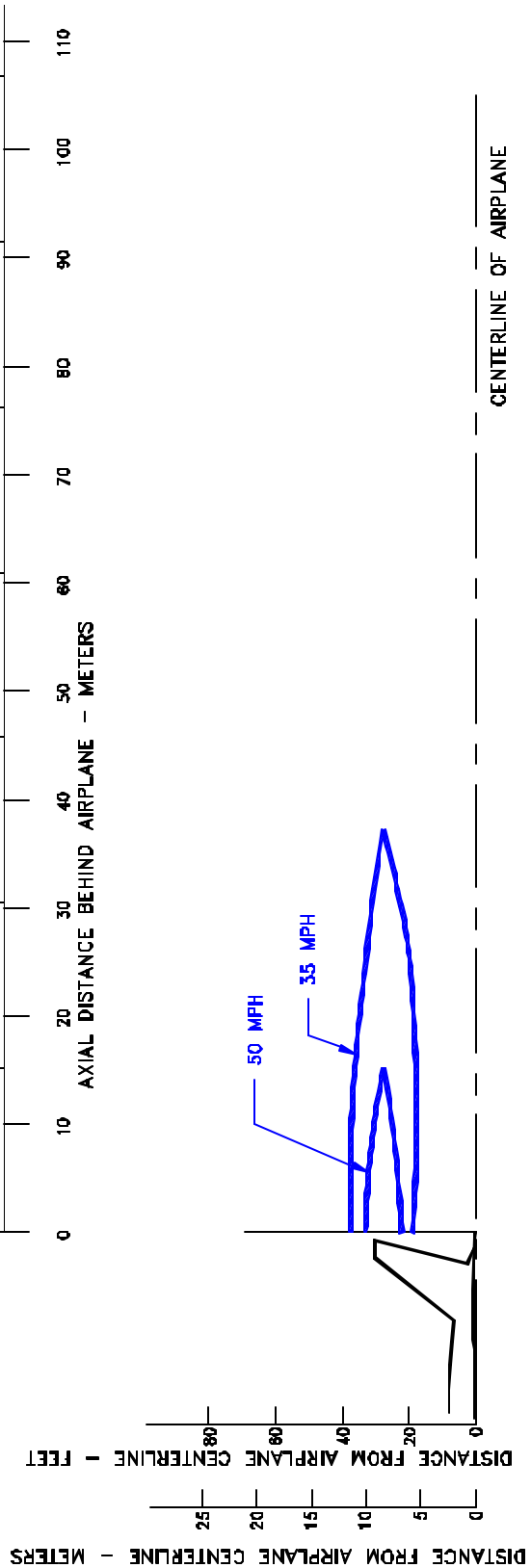

**6.1.3 PREDICTED JET ENGINE EXHAUST VELOCITY CONTOURS
 - IDLE THRUST**

MODEL 767-300, -300ER, -300 FREIGHTER (PW4000, CF6-80C2 SERIES ENGINES)

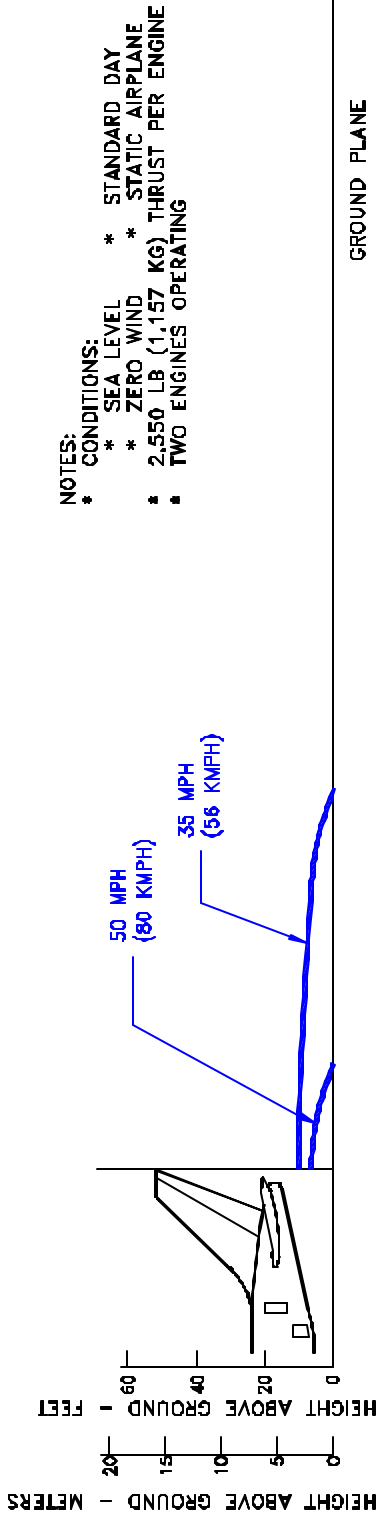

NOTES:
 * CONDITIONS:
 * SEA LEVEL * STANDARD DAY
 * ZERO WIND * STATIC AIRPLANE
 * 2,550 LB (1,157 KG) THRUST PER ENGINE
 * TWO ENGINES OPERATING

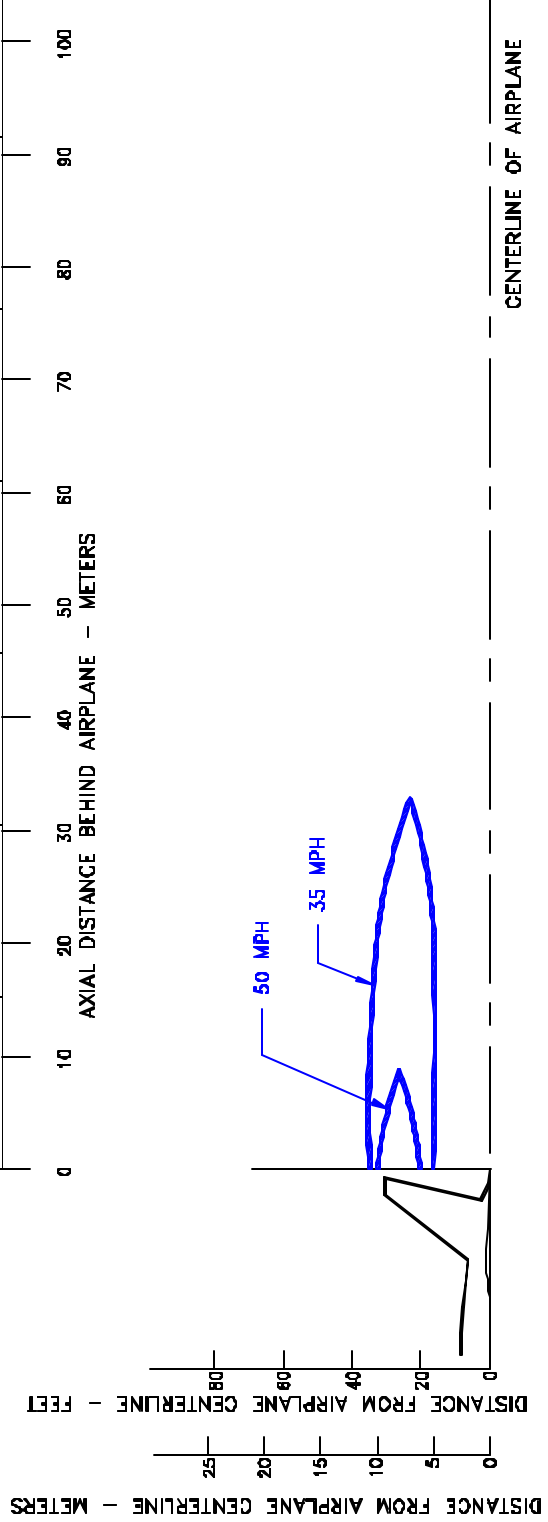

6.1.4 PREDICTED JET ENGINE EXHAUST VELOCITY CONTOURS
 - IDLE THRUST
 MODEL 767-300, -300ER, -300 FREIGHTER (RB211-524 ENGINES)

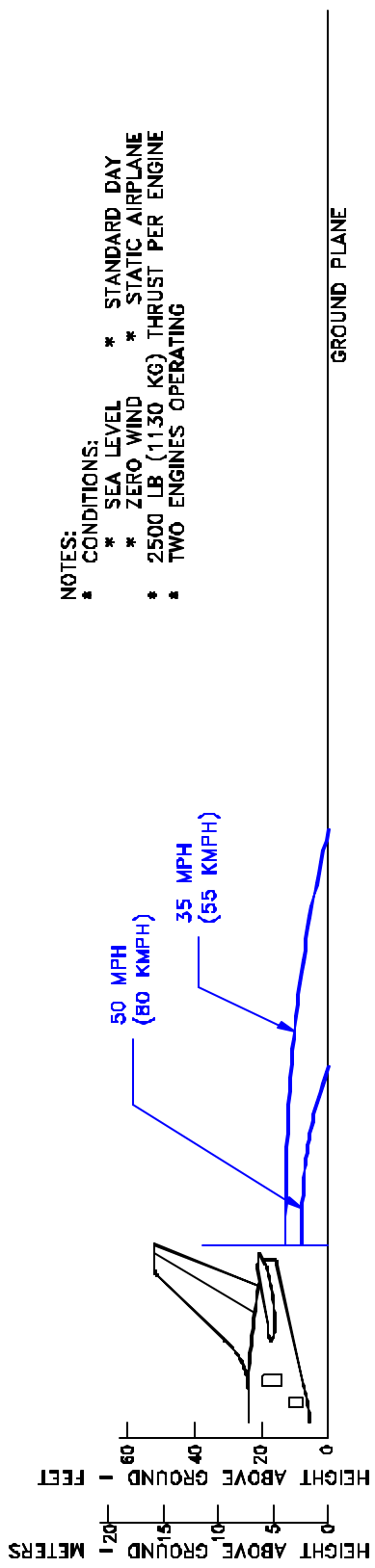

- NOTES:
- * CONDITIONS:
 - * SEA LEVEL * STANDARD DAY
 - * ZERO WIND * STATIC AIRPLANE
 - * 2500 LB (1130 KG) THRUST PER ENGINE
 - * TWO ENGINES OPERATING

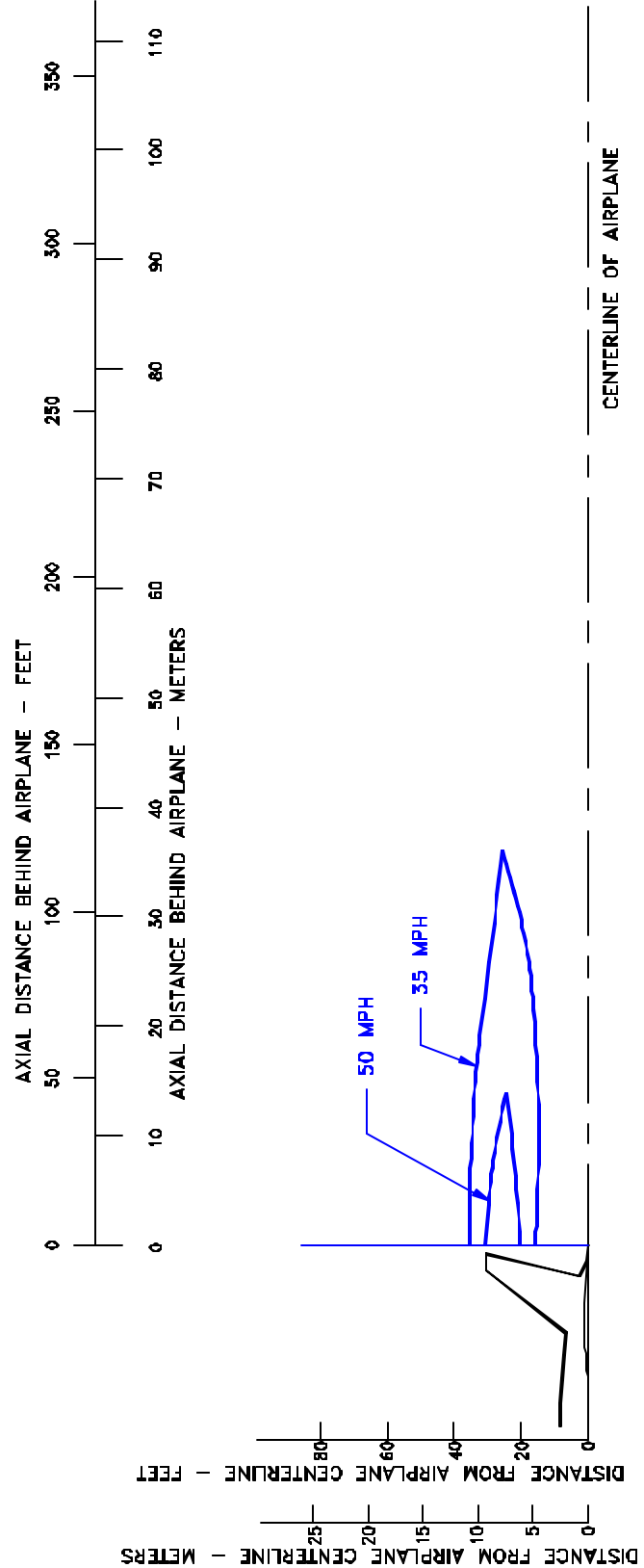

6.1.5 PREDICTED JET ENGINE EXHAUST VELOCITY CONTOURS
- IDLE THRUST
MODEL 767-400ER (ALL ENGINES)

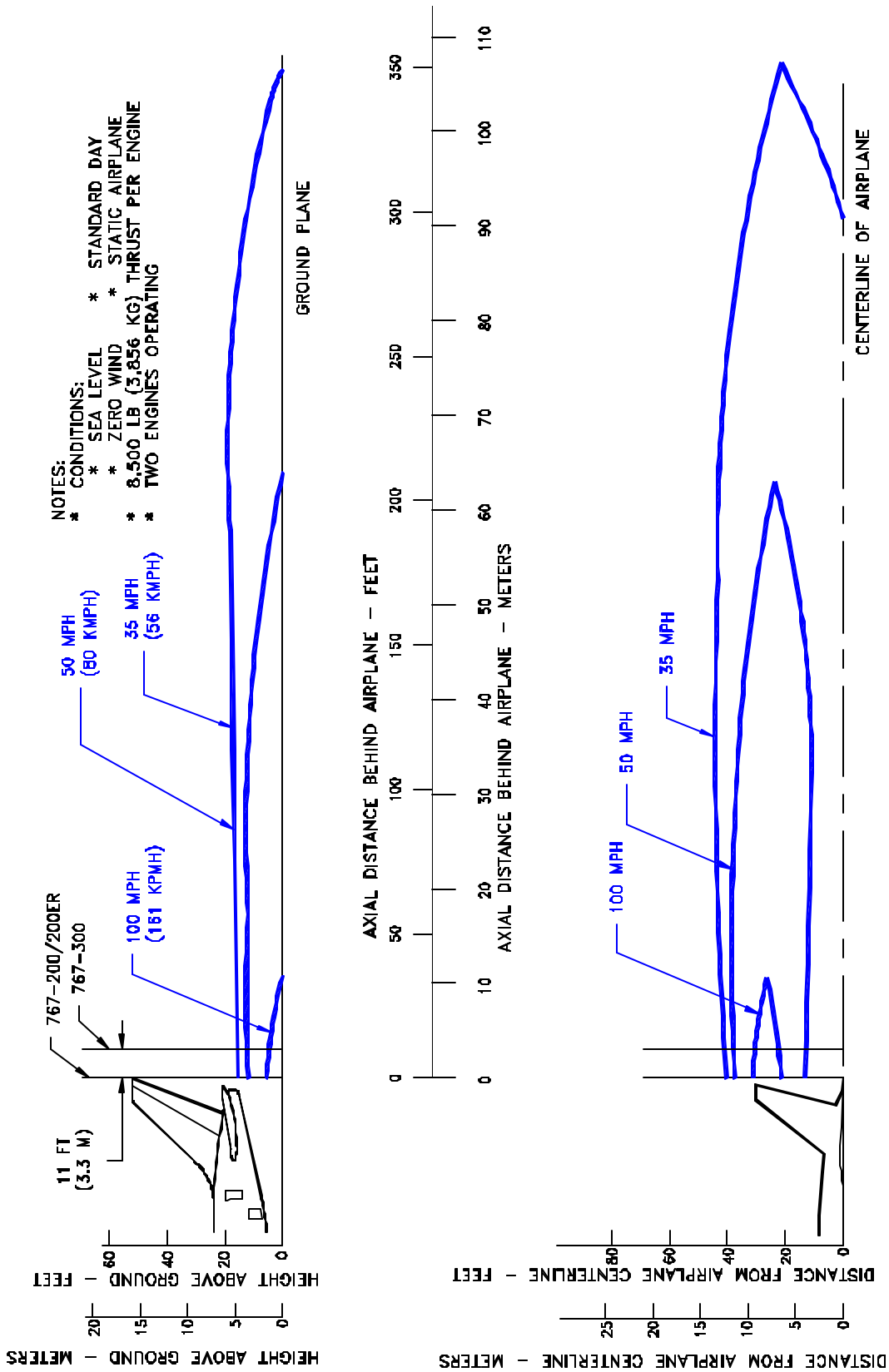

**6.1.6 PREDICTED JET ENGINE EXHAUST VELOCITY CONTOURS
- LOW BREAKAWAY THRUST**

MODEL 767-200, -200ER, -300 (JT9D-7R4D, -7R4E ENGINES)

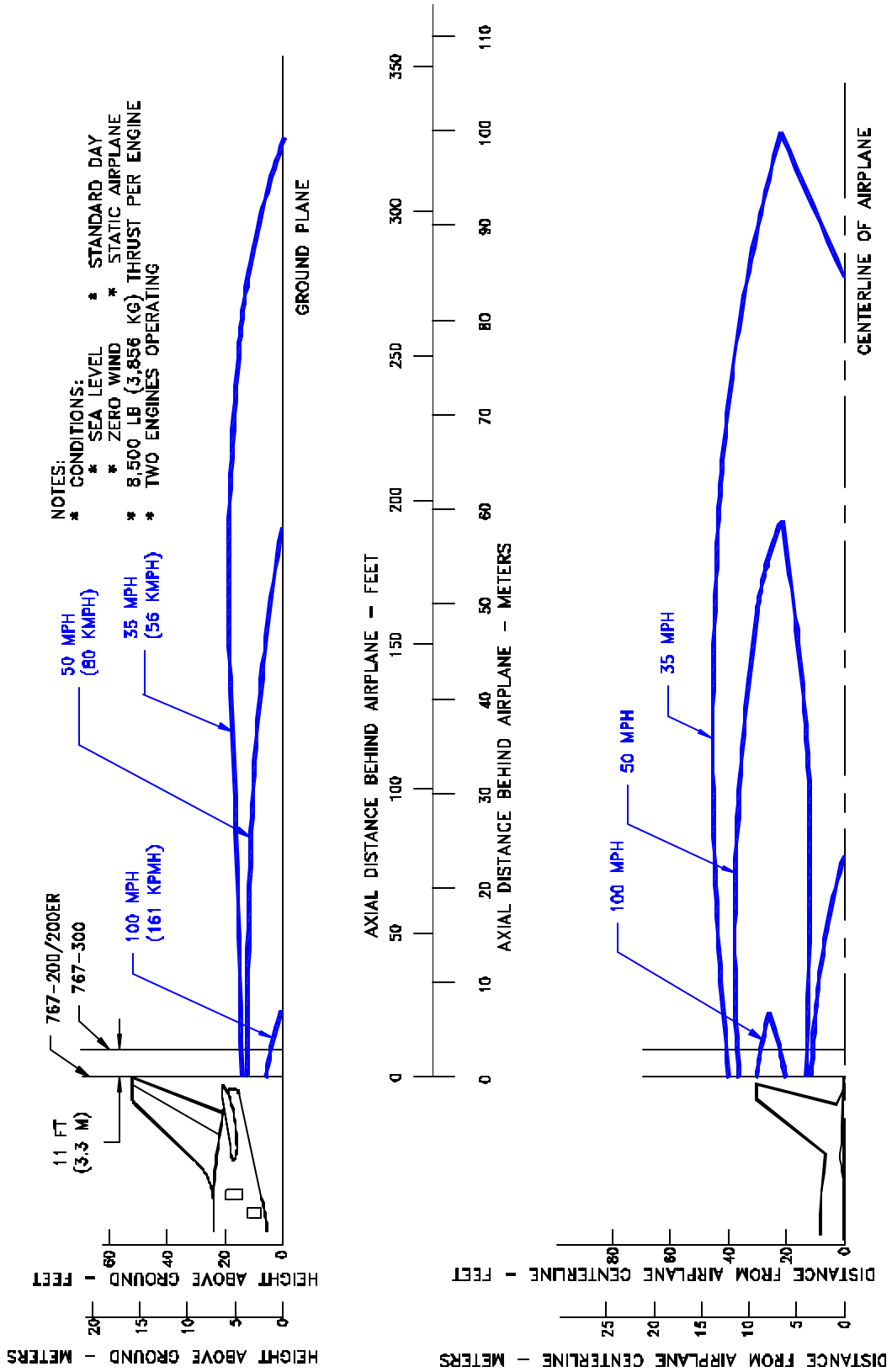

6.1.7 PREDICTED JET ENGINE EXHAUST VELOCITY CONTOURS
- LOW BREAKAWAY THRUST
MODEL 767-200, -200ER, -300 (CF6-80A, -80A2 ENGINES)

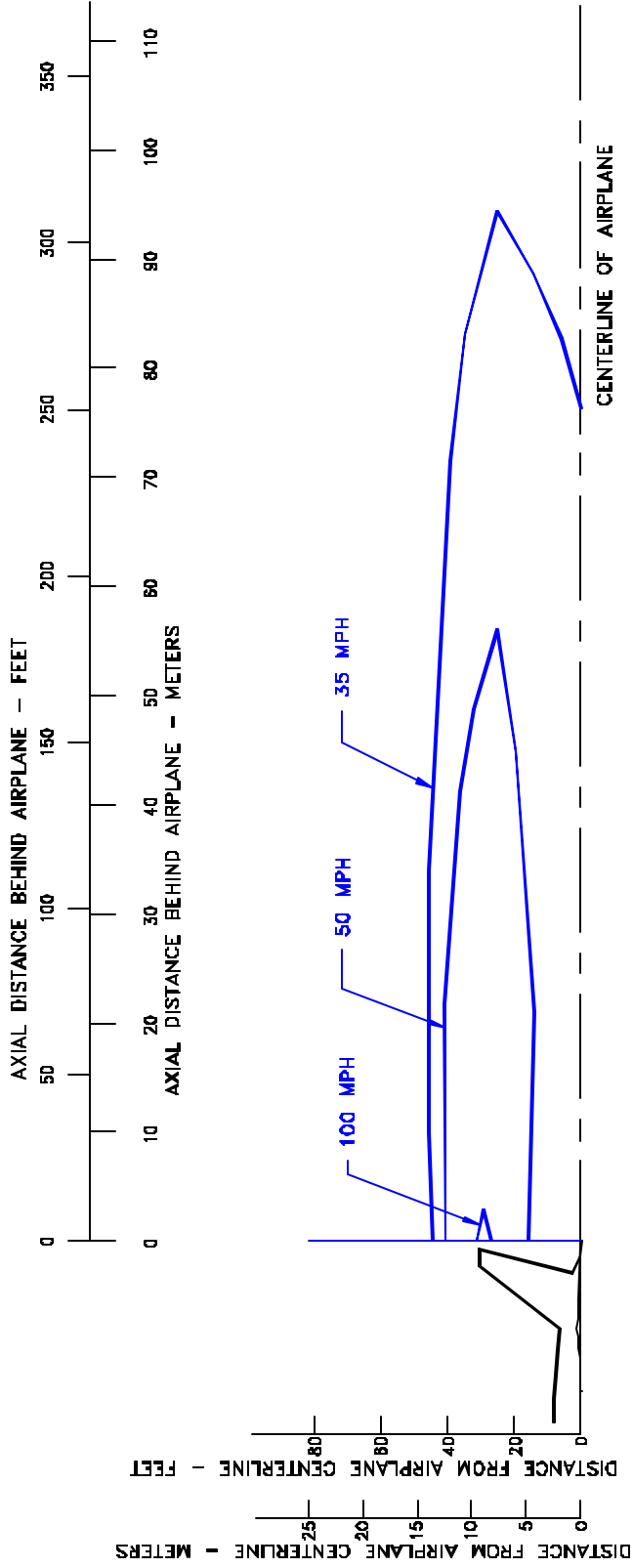
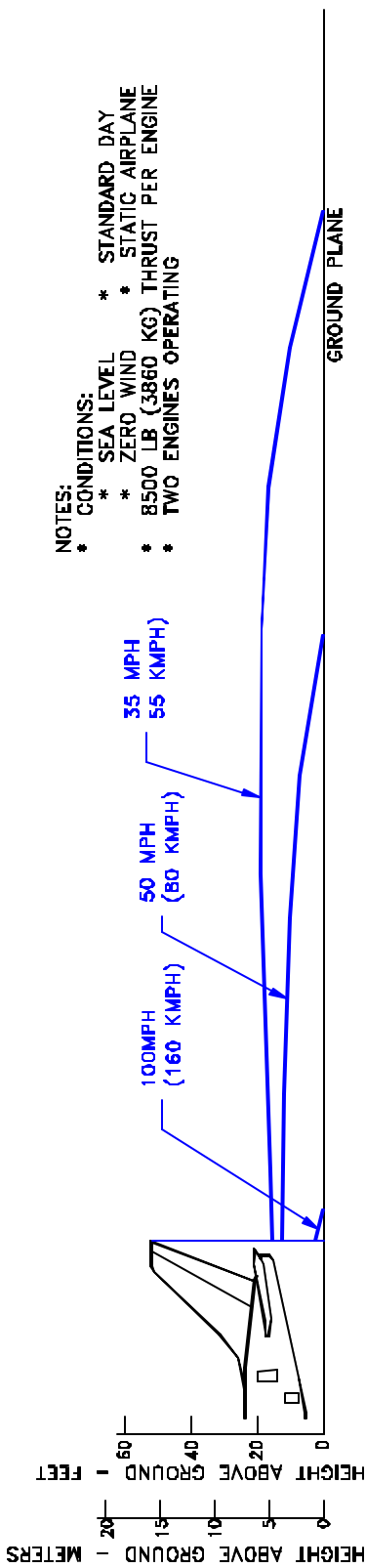

6.1.8 PREDICTED JET ENGINE EXHAUST VELOCITY CONTOURS
- LOW BREAKAWAY THRUST
MODEL 767-400ER (ALL ENGINES)

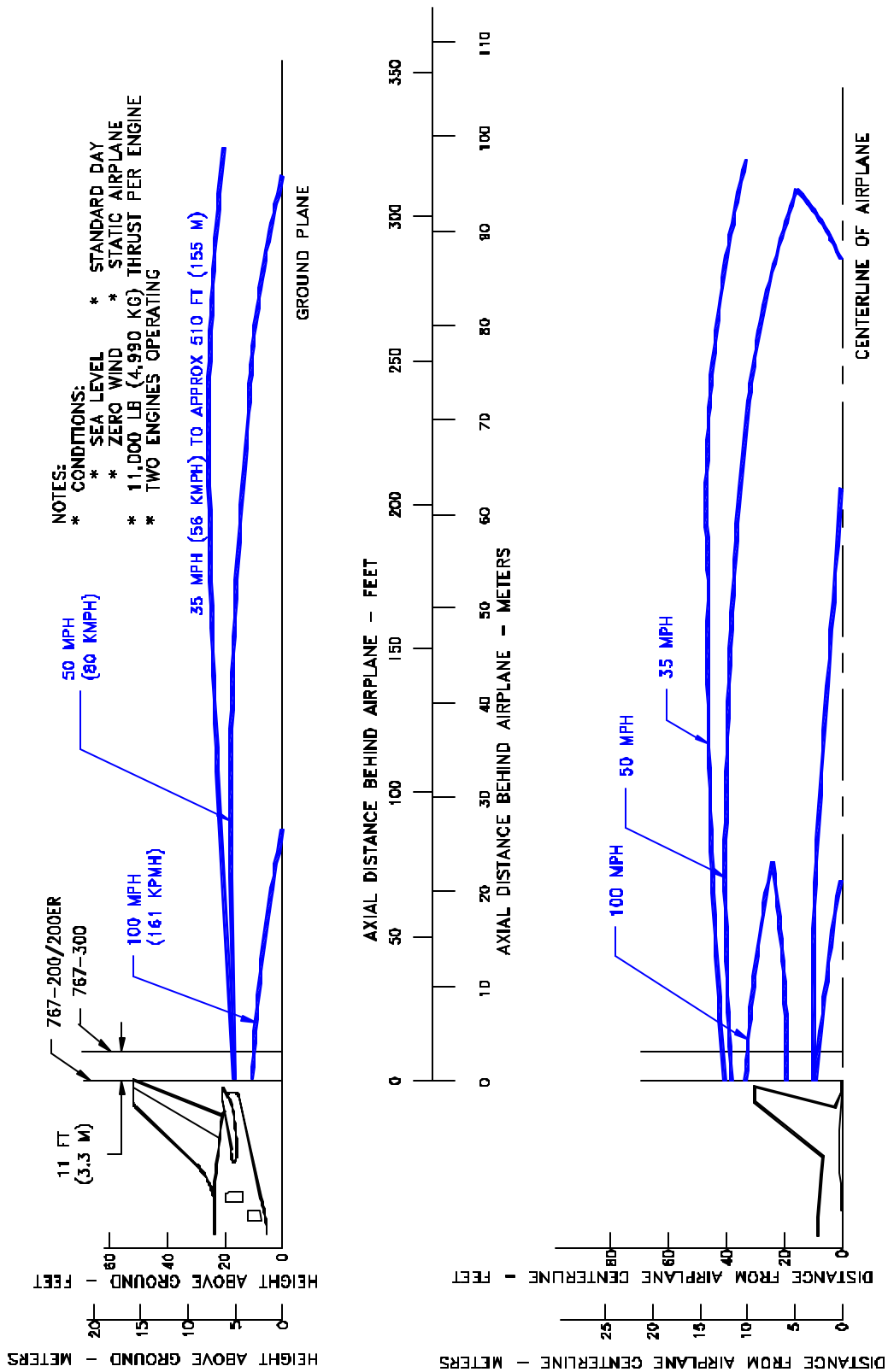

**6.1.9 PREDICTED JET ENGINE EXHAUST VELOCITY CONTOURS
- HIGH BREAKAWAY THRUST**

MODEL 767-200, -200ER, 300, -300ER, -300 FREIGHTER (ALL ENGINES)

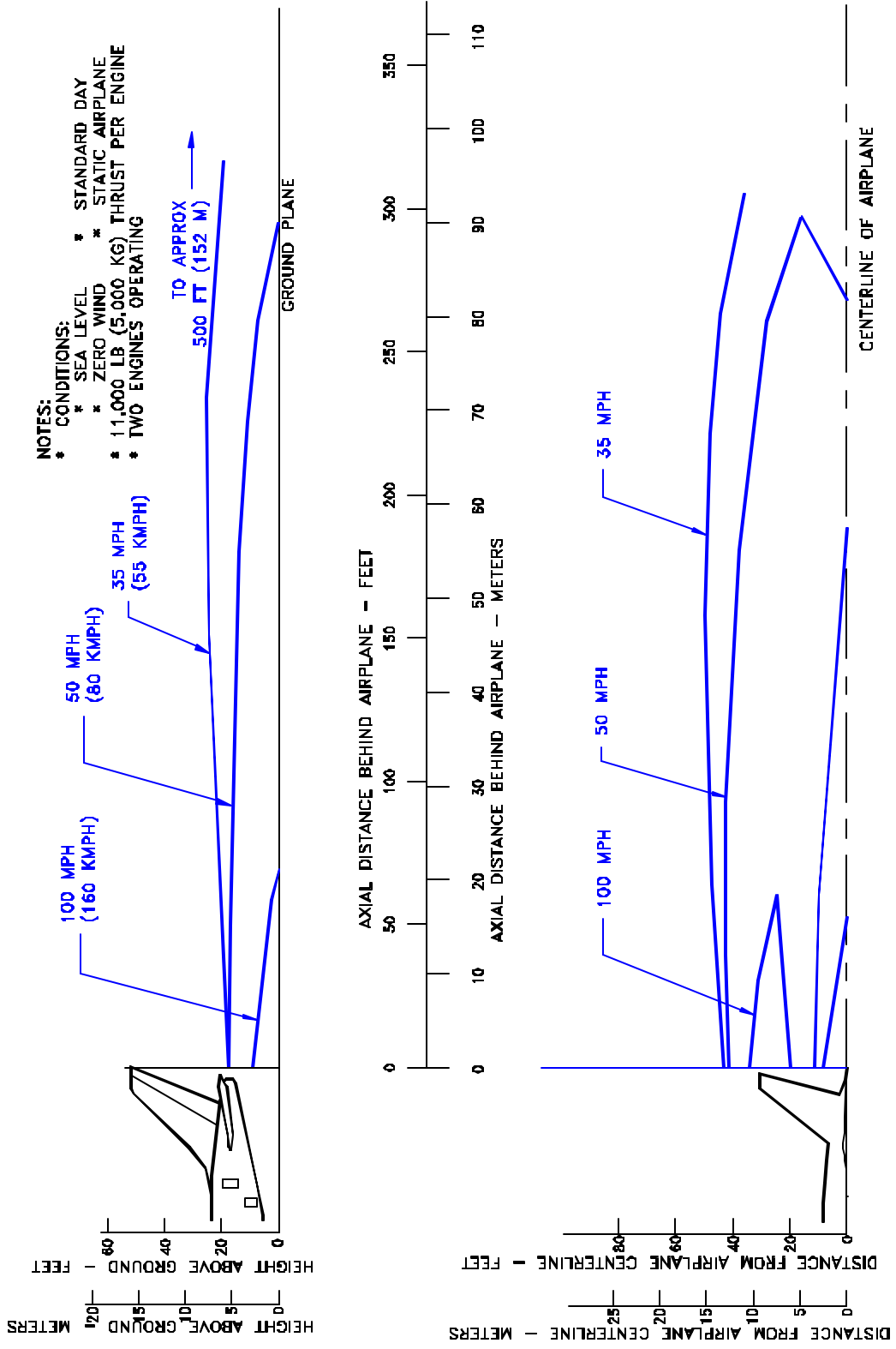

6.1.10 PREDICTED JET ENGINE EXHAUST VELOCITY CONTOURS
- HIGH BREAKAWAY THRUST
MODEL 767-400ER (ALL ENGINES)

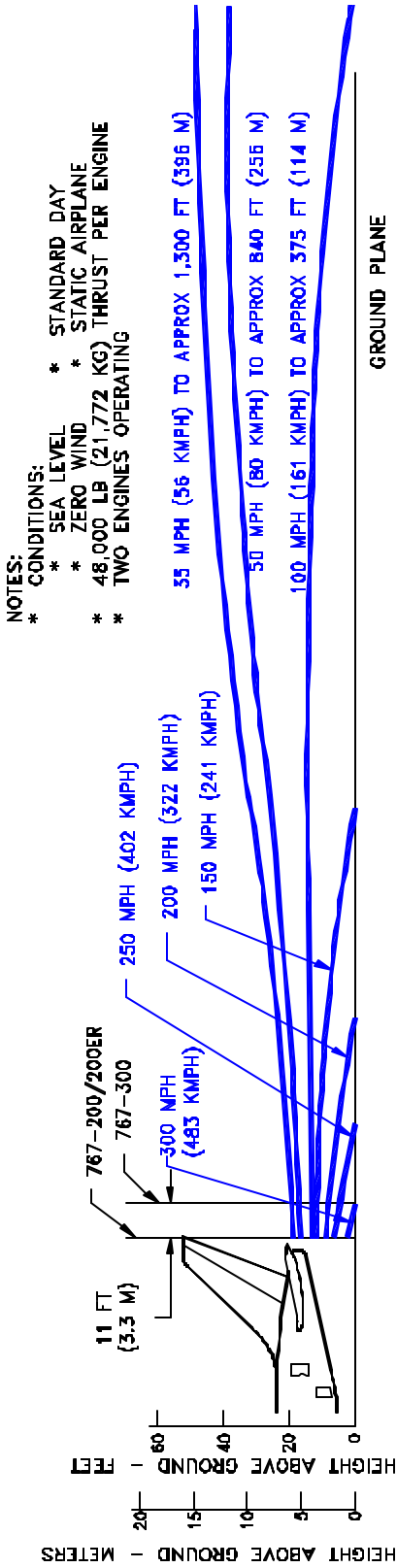

NOTES:
 * CONDITIONS:
 * SEA LEVEL * STANDARD DAY
 * ZERO WIND * STATIC AIRPLANE
 * 48,000 LB (21,772 KG) THRUST PER ENGINE
 * TWO ENGINES OPERATING

55 MPH (56 KMPH) TO APPROX 1,500 FT (396 M)
 50 MPH (80 KMPH) TO APPROX 840 FT (256 M)
 100 MPH (161 KMPH) TO APPROX 375 FT (114 M)

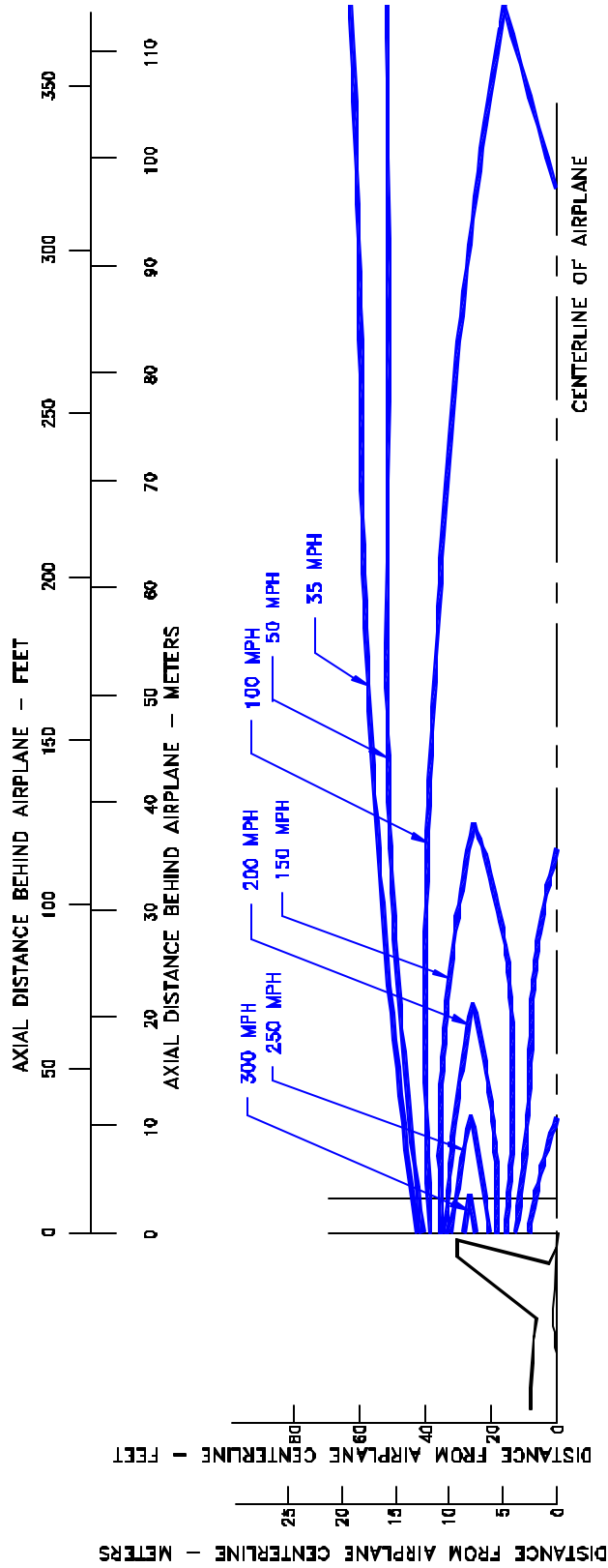

6.1.11 PREDICTED JET ENGINE EXHAUST VELOCITY CONTOURS
- TAKEOFF THRUST
 MODEL 767-200, -200ER, -300 (JT9D-7R4D, -7R4E ENGINES)

- NOTES:
 * CONDITIONS:
 * SEA LEVEL * STANDARD DAY
 * ZERO WIND * STATIC AIRPLANE
 * 48,000 LB (21,772 KG) THRUST PER ENGINE
 * TWO ENGINES OPERATING

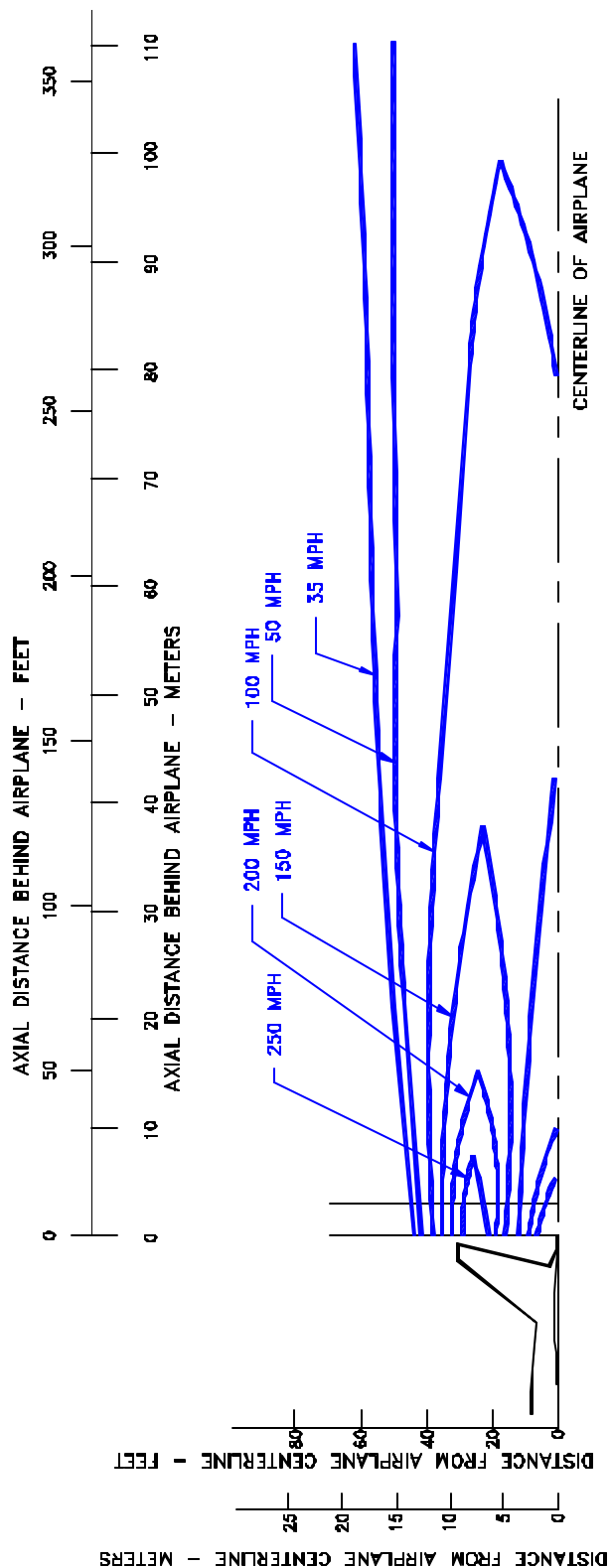
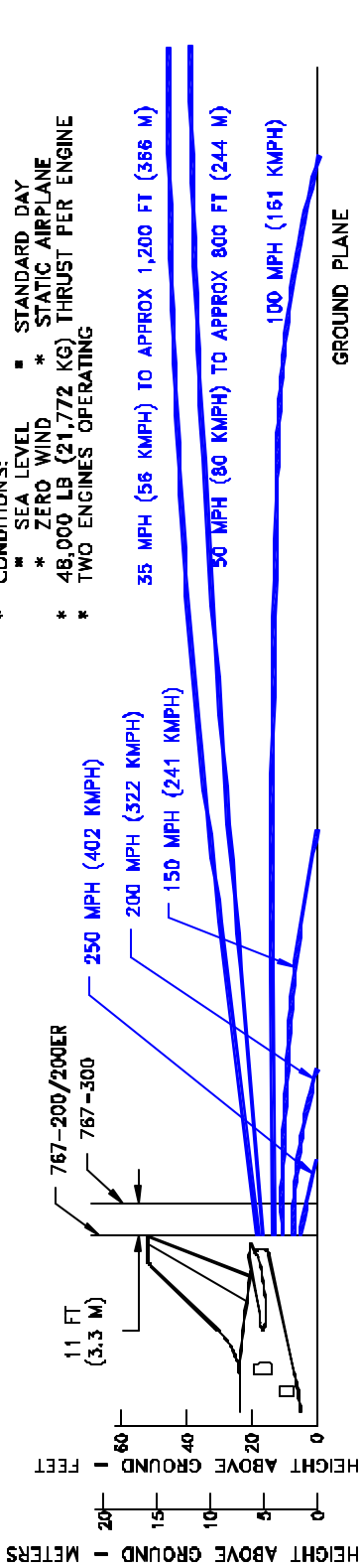

6.1.12 PREDICTED JET ENGINE EXHAUST VELOCITY CONTOURS
- TAKEOFF THRUST
 MODEL 767-200, -200ER, -300 (CF6-80A, -80A2 ENGINES)

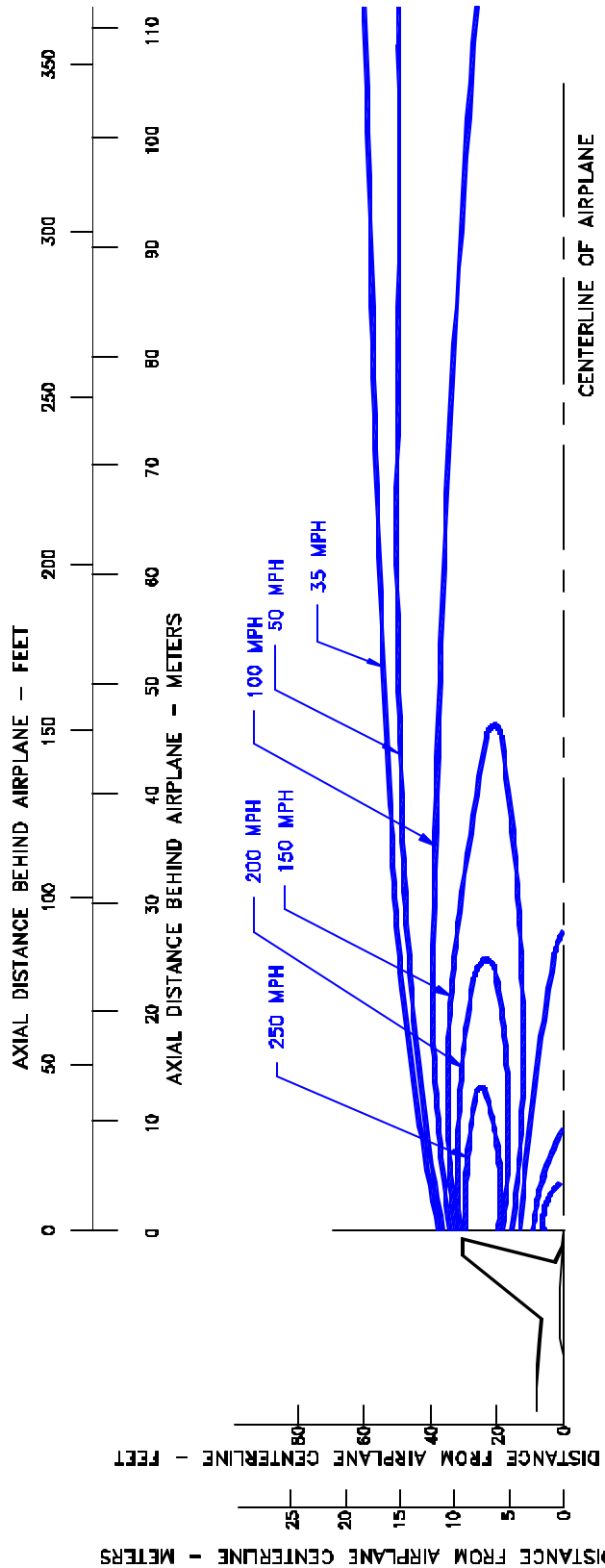
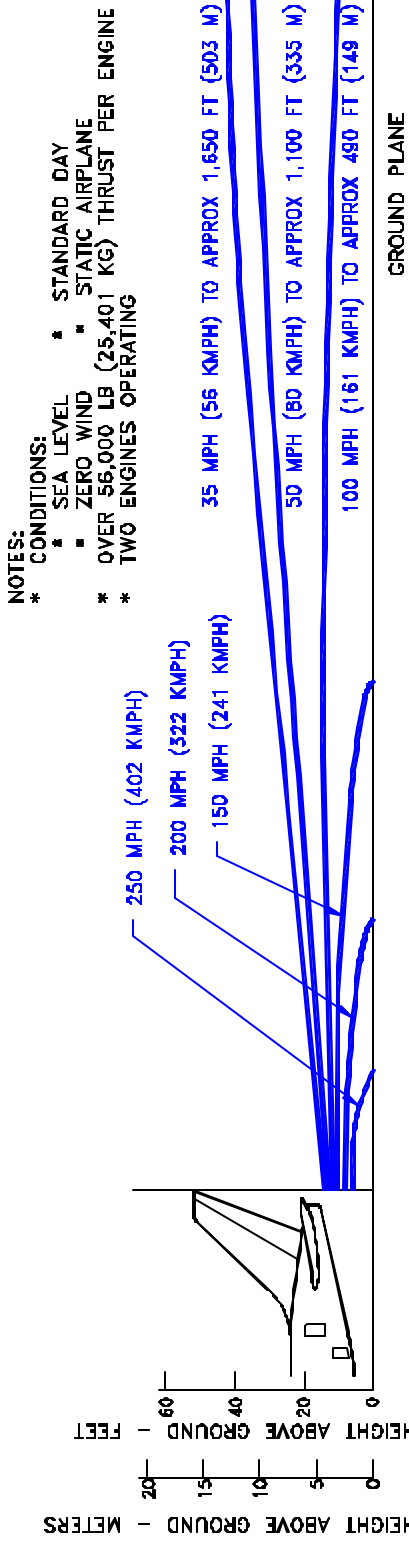

**6.1.13 PREDICTED JET ENGINE EXHAUST VELOCITY CONTOURS
- TAKEOFF THRUST**
MODEL 767-300ER, -300 FREIGHTER (PW4056, CF6-80C2 ENGINES)

- NOTES:
 * CONDITIONS:
 * SEA LEVEL * STANDARD DAY
 * ZERO WIND * STATIC AIRPLANE
 * OVER 56,000 LB (25,401 KG) THRUST PER ENGINE
 * TWO ENGINES OPERATING

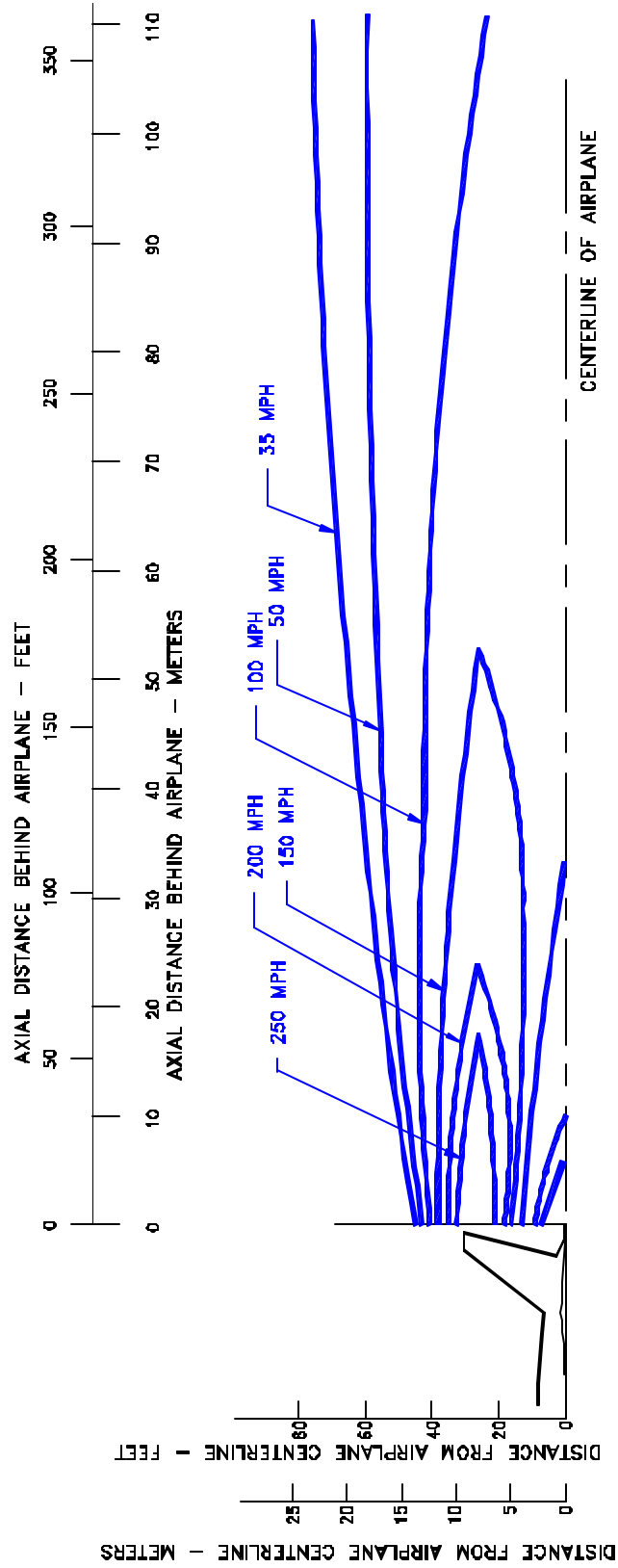
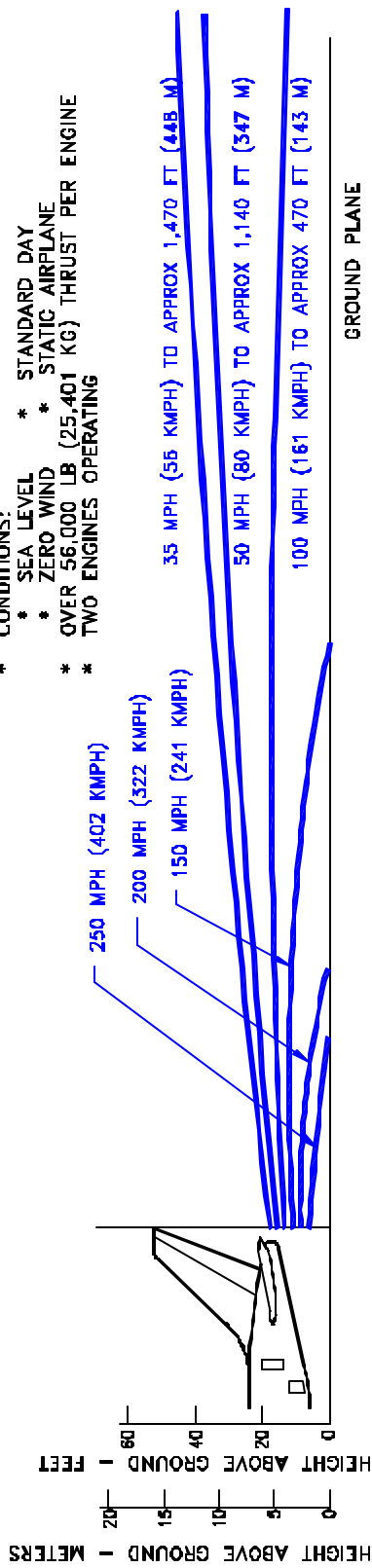

6.1.14 PREDICTED JET ENGINE EXHAUST VELOCITY CONTOURS
 - TAKEOFF THRUST
 MODEL 767-300, -300ER, -300 FREIGHTER (RB211-524 ENGINES)

NOTE:
 * CONDITIONS:
 * SEA LEVEL * STANDARD DAY
 * ZERO WIND * STATIC AIRPLANE
 * 56,000 LB (25,400 KG) THRUST PER ENGINE
 * TWO ENGINES OPERATING

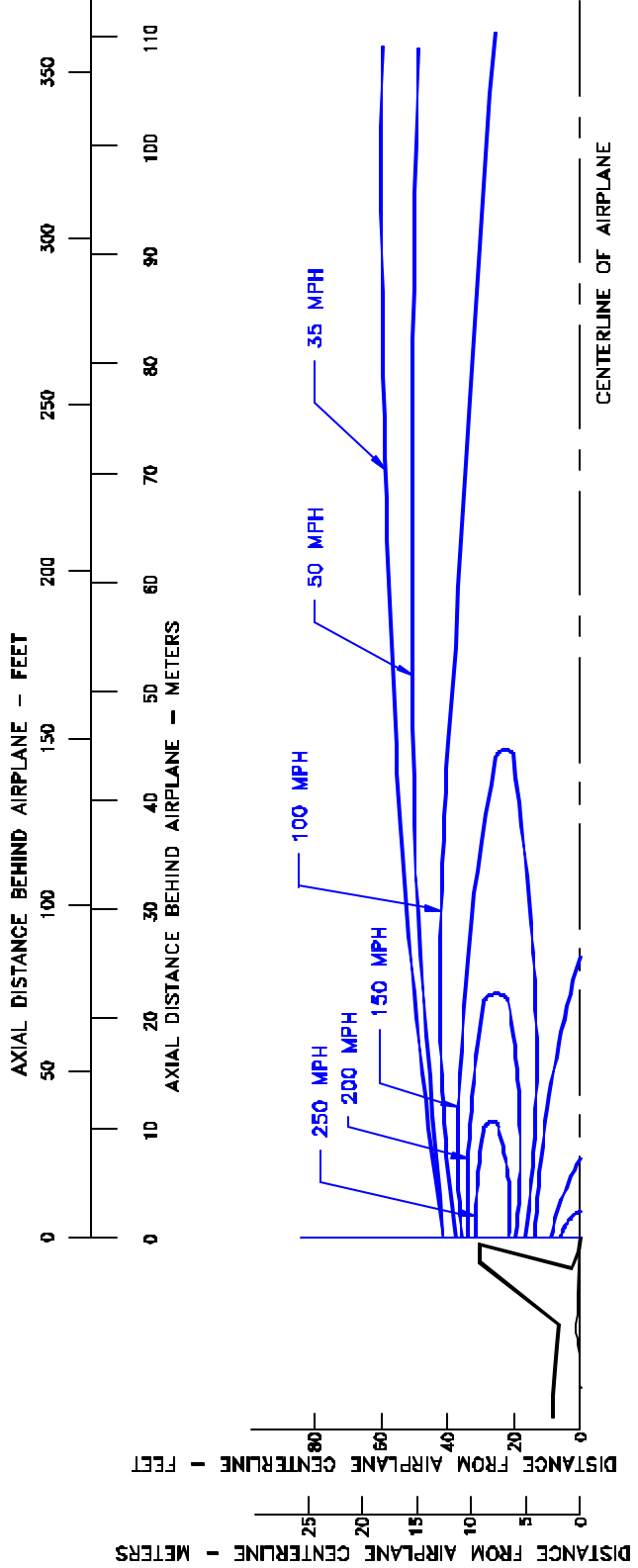
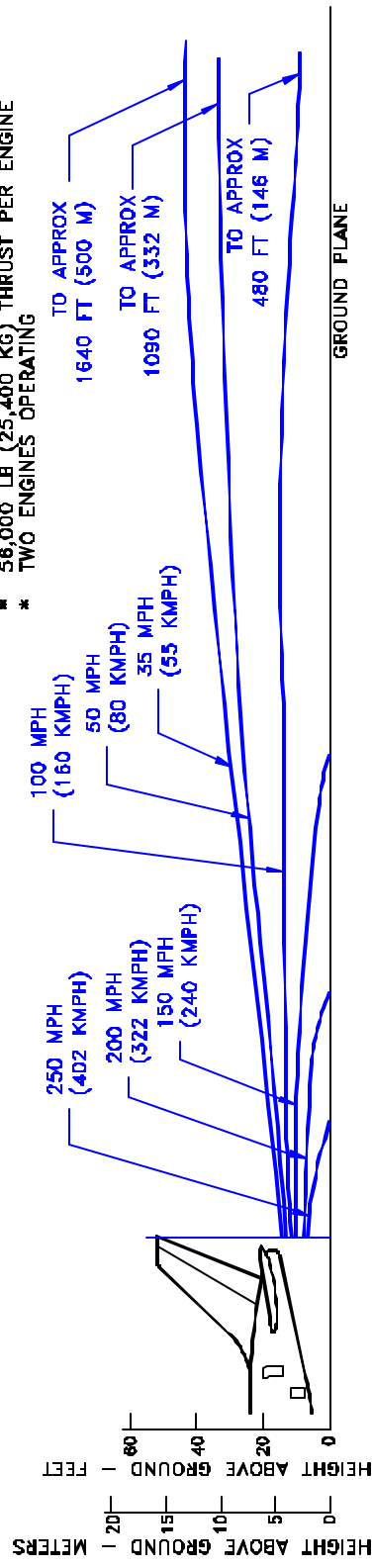

6.1.15 PREDICTED JET ENGINE EXHAUST VELOCITY CONTOURS
 - TAKEOFF THRUST
 MODEL 767-400ER (ALL ENGINES)

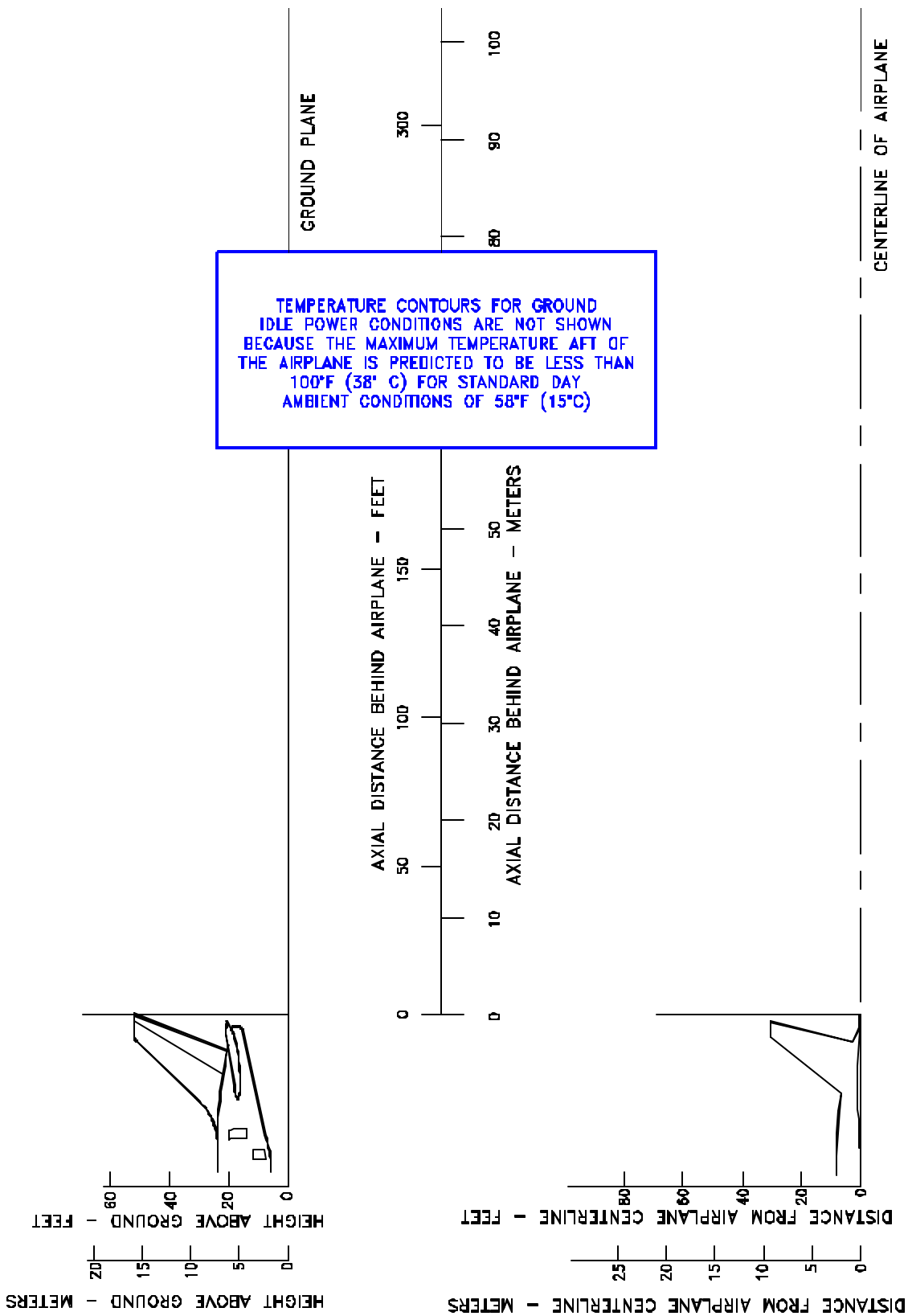

**6.1.16 PREDICTED JET ENGINE EXHAUST TEMPERATURE CONTOURS
 - IDLE THRUST**

MODEL 767—200, -200ER, -300, -300ER, -300 FREIGHTER, -400ER (ALL ENGINES)

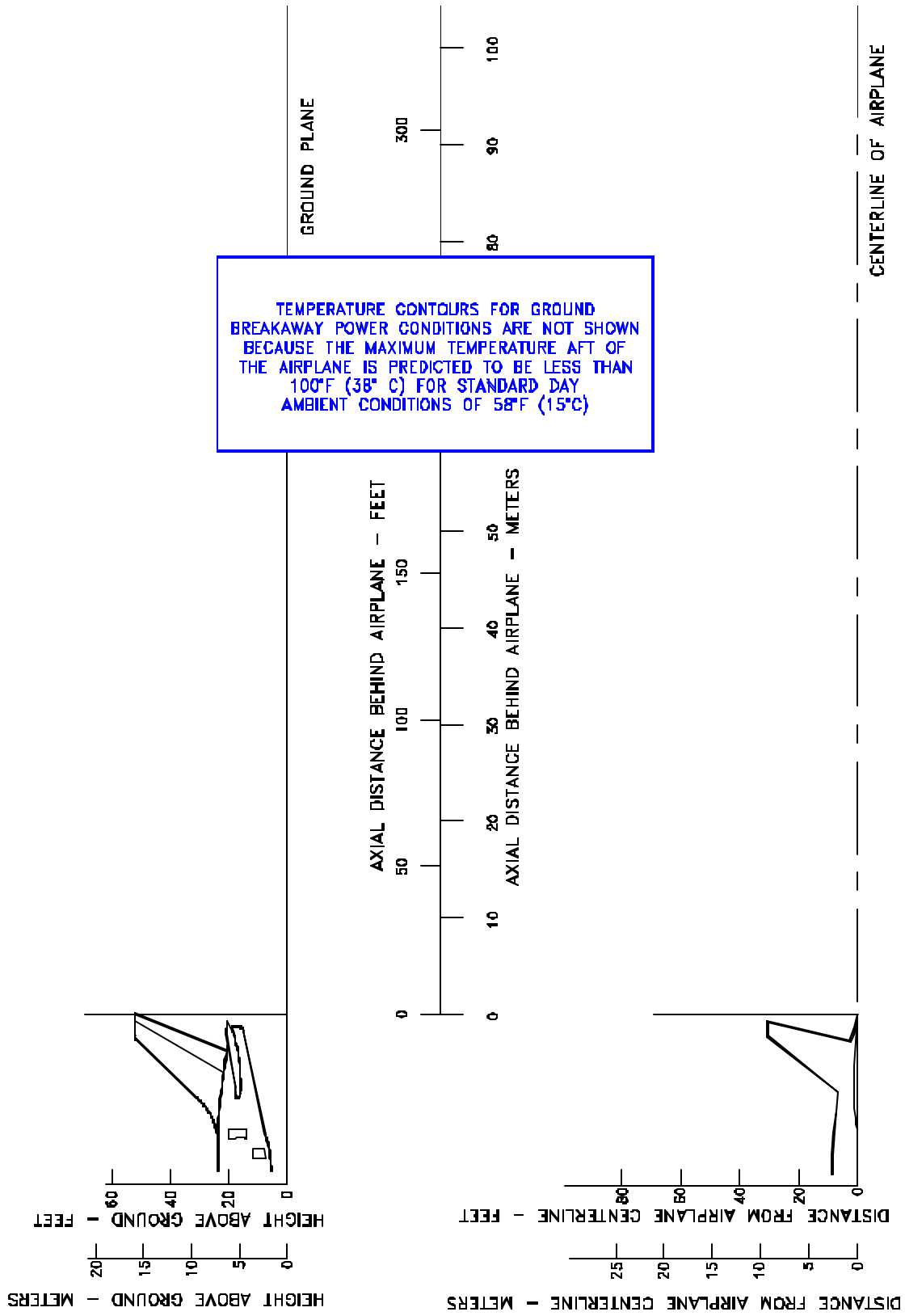

**6.1.17 PREDICTED JET ENGINE EXHAUST TEMPERATURE CONTOURS
 - BREAKAWAY THRUST**

MODEL 767—200, -200ER, -300, -300ER, -300 FREIGHTER, -400ER (ALL ENGINES)

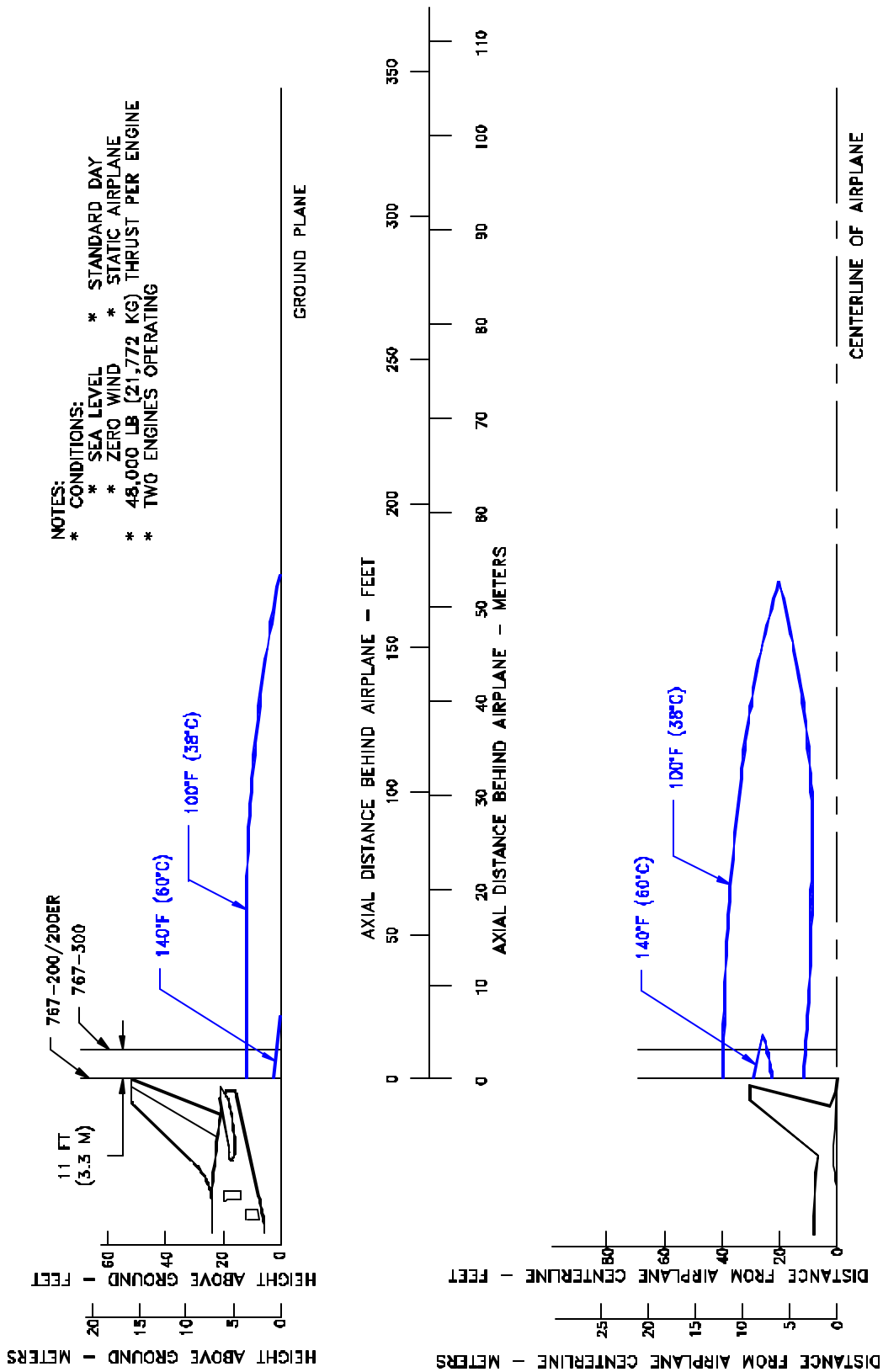

6.1.18 PREDICTED JET ENGINE EXHAUST TEMPERATURE CONTOURS - TAKEOFF THRUST
 MODEL 767-200, -200ER, -300 (JT9D-7R4E, -7R4E ENGINES)

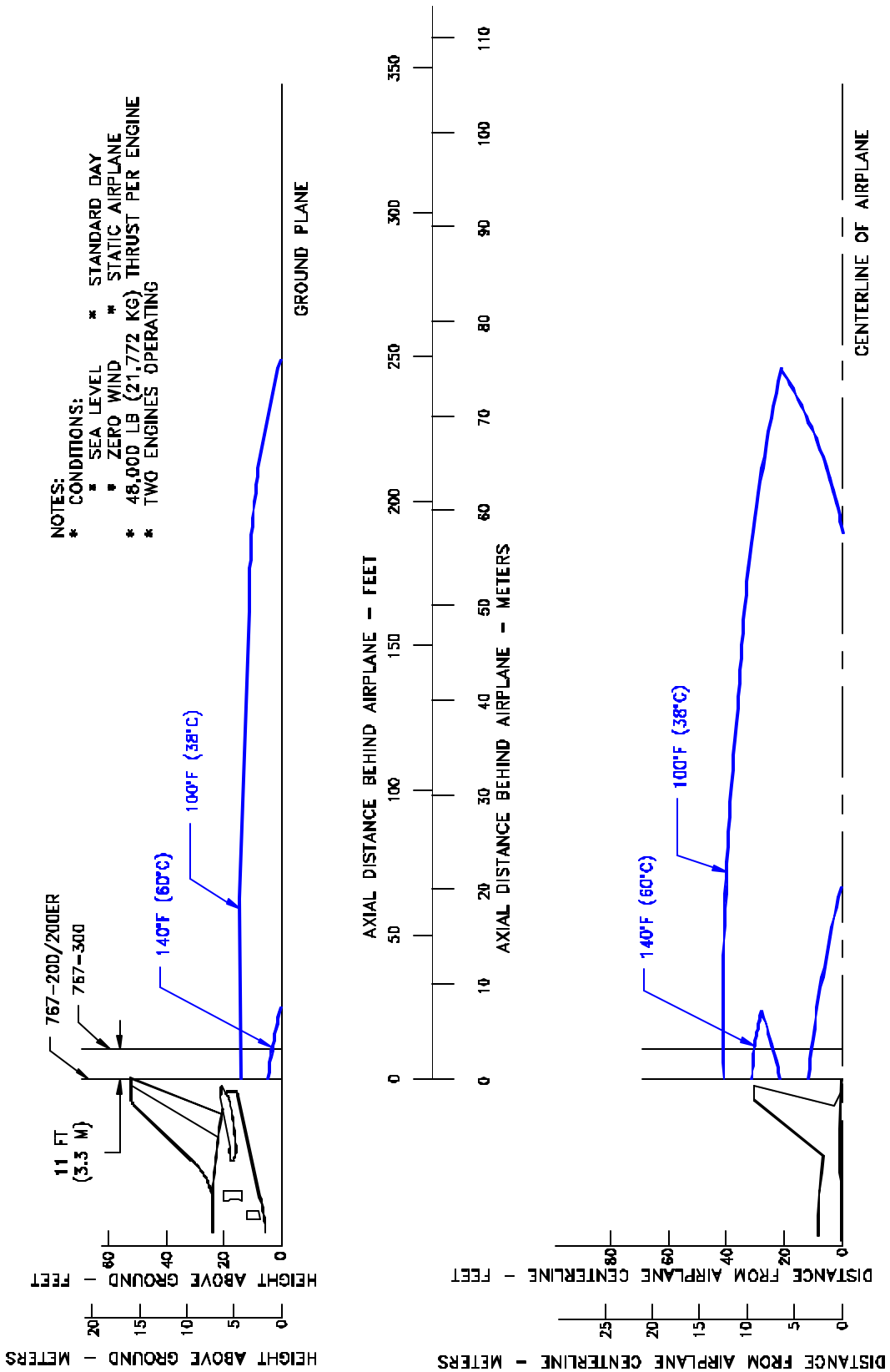

**6.1.19 PREDICTED JET ENGINE EXHAUST TEMPERATURE CONTOURS
 - TAKEOFF THRUST**
 MODEL 767-200, -200ER, -300 (CF6-80A, -80A2 ENGINES)

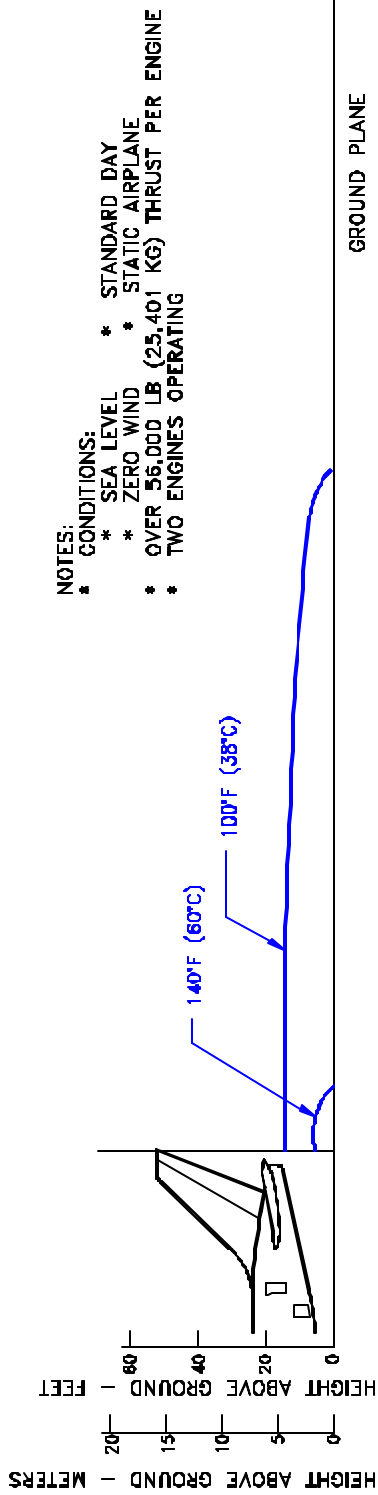

- NOTES:
- * CONDITIONS:
 - * SEA LEVEL
 - * ZERO WIND
 - * OVER 56,000 LB (25,401 KG) THRUST PER ENGINE
 - * TWO ENGINES OPERATING
 - * STANDARD DAY
 - * STATIC AIRPLANE

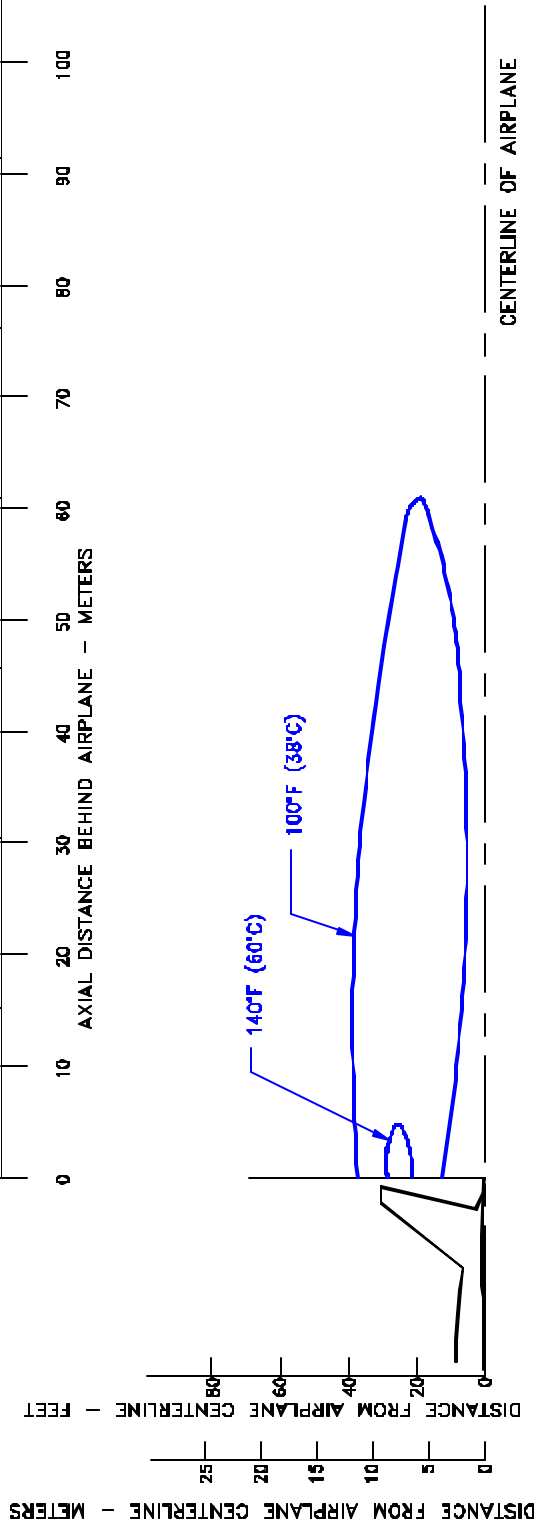

6.1.20 PREDICTED JET ENGINE EXHAUST TEMPERATURE CONTOURS - TAKEOFF THRUST

MODEL 767-300ER, -300 FREIGHTER (PW4000, CF6-80C2 ENGINES)

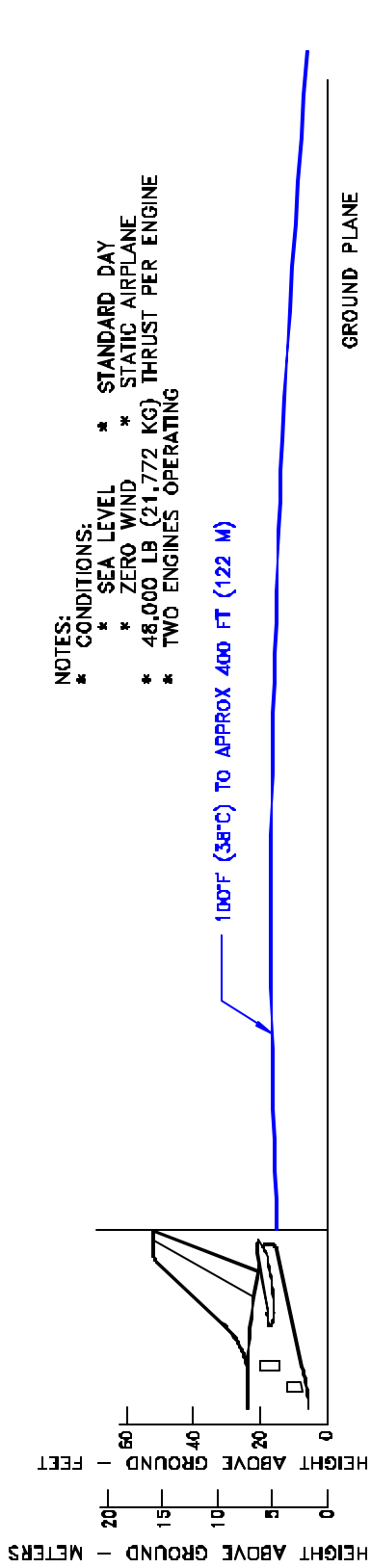

- NOTES:
- * CONDITIONS:
 - * SEA LEVEL
 - * STANDARD DAY
 - * ZERO WIND
 - * STATIC AIRPLANE
 - * 48,000 LB (21,772 KG) THRUST PER ENGINE
 - * TWO ENGINES OPERATING

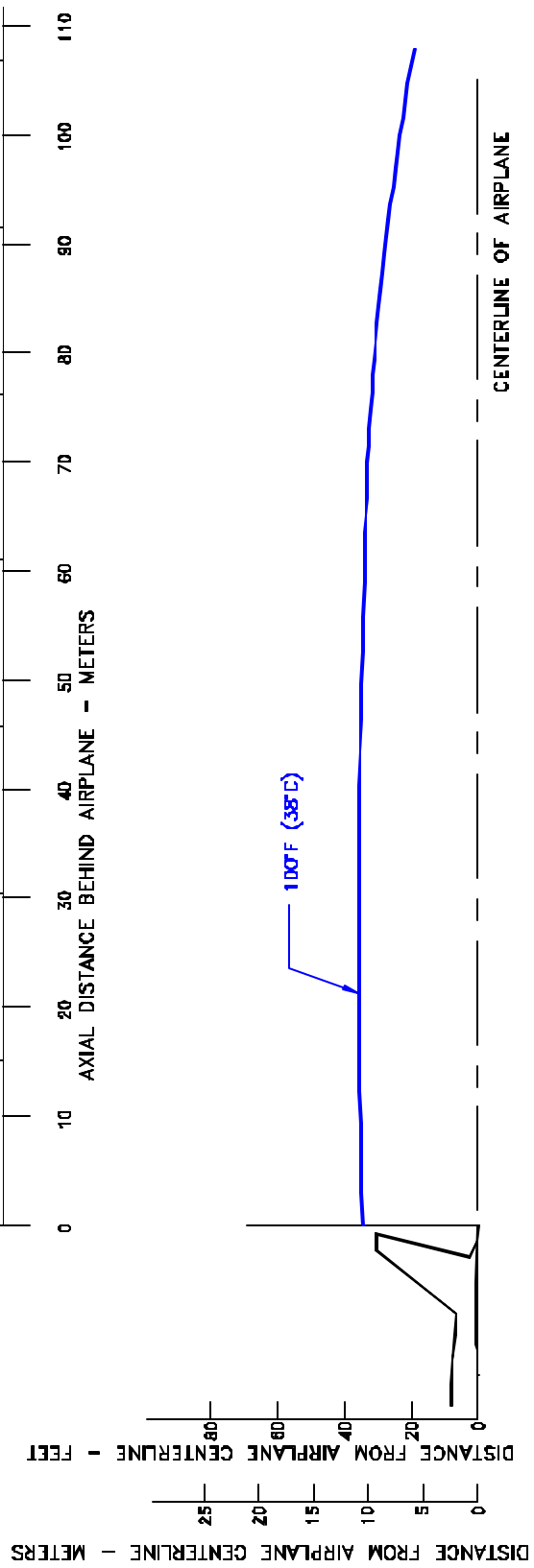

6.1.21 PREDICTED JET ENGINE EXHAUST TEMPERATURE CONTOURS
- TAKEOFF THRUST
MODEL 767-300, -300ER, -300 FREIGHTER (RB211-524 ENGINES)

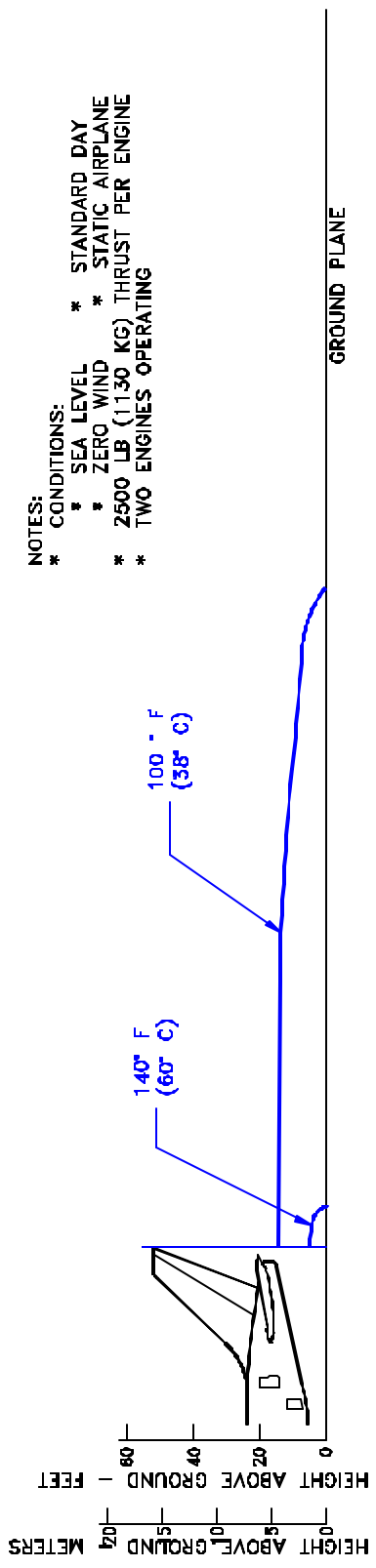

NOTES:
 * CONDITIONS:
 * SEA LEVEL * STANDARD DAY
 * ZERO WIND * STATIC AIRPLANE
 * 2500 LB (1130 KG) THRUST PER ENGINE
 * TWO ENGINES OPERATING

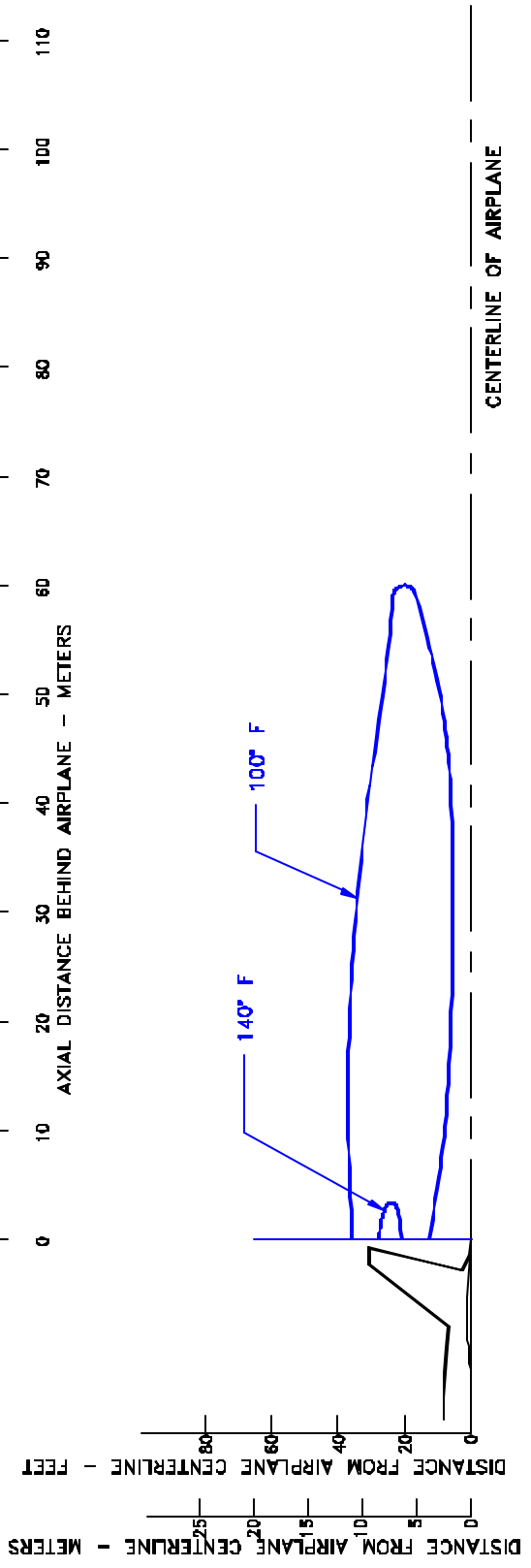
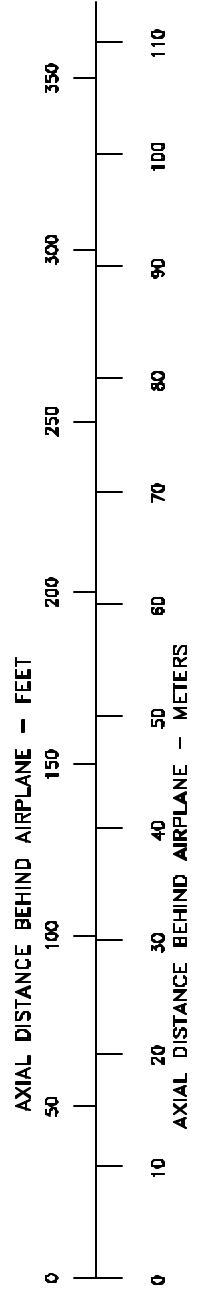

6.1.22 PREDICTED JET ENGINE EXHAUST TEMPERATURE CONTOURS
 - TAKEOFF THRUST
 MODEL 767-400ER (ALL ENGINES)

6.2 Airport and Community Noise

Airport noise is of major concern to the airport and community planner. The airport is a major element in the community's transportation system and, as such, is vital to its growth. However, the airport must also be a good neighbor, and this can be accomplished only with proper planning. Since aircraft noise extends beyond the boundaries of the airport, it is vital to consider the impact on surrounding communities. Many means have been devised to provide the planner with a tool to estimate the impact of airport operations. Too often they oversimplify noise to the point where the results become erroneous. Noise is not a simple subject; therefore, there are no simple answers.

The cumulative noise contour is an effective tool. However, care must be exercised to ensure that the contours, used correctly, estimate the noise resulting from aircraft operations conducted at an airport.

The size and shape of the single-event contours, which are inputs into the cumulative noise contours, are dependent upon numerous factors. They include the following:

1. Operational Factors
 - (a) Aircraft Weight - Aircraft weight is dependent on distance to be traveled, en route winds, payload, and anticipated aircraft delay upon reaching the destination.
 - (b) Engine Power Settings-The rates of ascent and descent and the noise levels emitted at the source are influenced by the power setting used.
 - (c) Airport Altitude-Higher airport altitude will affect engine performance and thus can influence noise.

2. Atmospheric Conditions-Sound Propagation

- (a) Wind - With stronger headwinds, the aircraft can take off and climb more rapidly relative to the ground. Also, winds can influence the distribution of noise in surrounding communities.
- (b) Temperature and Relative Humidity - The absorption of noise in the atmosphere along the transmission path between the aircraft and the ground observer varies with both temperature and relative humidity.

3. Surface Condition-Shielding, Extra Ground Attenuation (EGA)

- (a) Terrain - If the ground slopes down after takeoff or up before landing, noise will be reduced since the aircraft will be at a higher altitude above ground. Additionally, hills, shrubs, trees, and large buildings can act as sound buffers.

All these factors can alter the shape and size of the contours appreciably. To demonstrate the effect of some of these factors, estimated noise level contours for two different operating conditions are shown below. These contours reflect a given noise level upon a ground level plane at runway elevation.

Condition 1

Landing

Takeoff

Maximum Structural Landing Weight
 10-knot Headwind
 3^o Approach
 84 °F
 Humidity 15%

Maximum Gross Takeoff Weight
 Zero Wind
 84 °F
 Humidity 15%

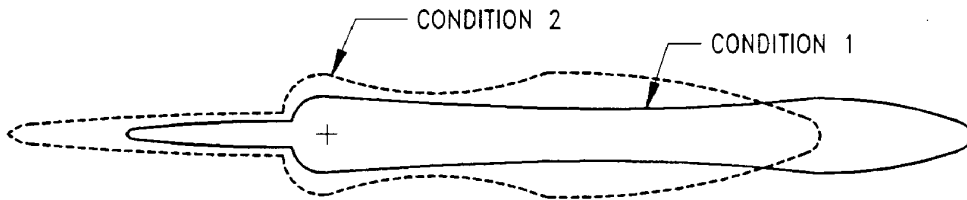

Condition 2

Landing:

Takeoff:

85% of Maximum Structural Landing Weight
 10-knot Headwind
 3^o Approach
 59 °F
 Humidity 70%

80% of Maximum Gross Takeoff Weight
 10-knot Headwind
 59 °F
 Humidity 70%

As indicated from these data, the contour size varies substantially with operating and atmospheric conditions. Most aircraft operations are, of course, conducted at less than maximum gross weights because average flight distances are much shorter than maximum aircraft range capability and average load factors are less than 100%. Therefore, in developing cumulative contours for planning purposes, it is recommended that the airlines serving a particular city be contacted to provide operational information.

In addition, there are no universally accepted methods for developing aircraft noise contours or for relating the acceptability of specific zones to specific land uses. It is therefore expected that noise contour data for particular aircraft and the impact assessment methodology will be changing. To ensure that the best currently available information of this type is used in any planning study, it is recommended that it be obtained directly from the Office of Environmental Quality in the Federal Aviation Administration in Washington, D.C.

It should be noted that the contours shown herein are only for illustrating the impact of operating and atmospheric conditions and do not represent the single-event contour of the family of aircraft described in this document. It is expected that the cumulative contours will be developed as required by planners using the data and methodology applicable to their specific study.

7.0 PAVEMENT DATA

7.1 General Information

7.2 Landing Gear Footprint

7.3 Maximum Pavement Loads

7.4 Landing Gear Loading on Pavement

7.5 Flexible Pavement Requirements - U.S. Army Corps of Engineers Method S-77-1

7.6 Flexible Pavement Requirements - LCN Conversion

7.7 Rigid Pavement Requirements - Portland Cement Association Design Method

7.8 Rigid Pavement Requirements - LCN Conversion

7.9 Rigid Pavement Requirements - FAA Method

7.10 ACN/PCN Reporting System - Flexible and Rigid Pavements

7.0 PAVEMENT DATA

7.1 General Information

A brief description of the pavement charts that follow will help in their use for airport planning. Each airplane configuration is depicted with a minimum range of six loads imposed on the main landing gear to aid in interpolation between the discrete values shown. All curves for any single chart represent data based on rated loads and tire pressures considered normal and acceptable by current aircraft tire manufacturer's standards. Tire pressures, where specifically designated on tables and charts, are at values obtained under loaded conditions as certificated for commercial use.

Section 7.2 presents basic data on the landing gear footprint configuration, maximum design taxi loads, and tire sizes and pressures.

Maximum pavement loads for certain critical conditions at the tire-to-ground interface are shown in Section 7.3, with the tires having equal loads on the struts.

Pavement requirements for commercial airplanes are customarily derived from the static analysis of loads imposed on the main landing gear struts. The chart in Section 7.4 is provided in order to determine these loads throughout the stability limits of the airplane at rest on the pavement. These main landing gear loads are used as the point of entry to the pavement design charts, interpolating load values where necessary.

The flexible pavement design curves (Section 7.5) are based on procedures set forth in Instruction Report No. S-77-1, "Procedures for Development of CBR Design Curves," dated June 1977, and as modified according to the methods described in ICAO Aerodrome Design Manual, Part 3, Pavements, 2nd Edition, 1983, Section 1.1 (The ACN-PCN Method), and utilizing the alpha factors approved by ICAO in October 2007. Instruction Report No. S-77-1 was prepared by the U.S. Army Corps of Engineers Waterways Experiment Station, Soils and Pavements Laboratory, Vicksburg, Mississippi. The line showing 10,000 coverages is used to calculate Aircraft Classification Number (ACN).

The following procedure is used to develop the curves, such as shown in Section 7.5:

1. Having established the scale for pavement depth at the bottom and the scale for CBR at the top, an arbitrary line is drawn representing 6,000 annual departures.
2. Values of the aircraft gross weight are then plotted.
3. Additional annual departure lines are drawn based on the load lines of the aircraft gross weights already established.
4. An additional line representing 10,000 coverages (used to calculate the flexible pavement Aircraft Classification Number) is also placed.

All Load Classification Number (LCN) curves (Sections 7.6 and 7.8) have been developed from a computer program based on data provided in International Civil Aviation Organization (ICAO) document 9157-AN/901, Aerodrome Design Manual, Part 3, "Pavements", First Edition, 1977. LCN values are shown directly for parameters of weight on main landing gear, tire pressure, and radius of relative stiffness (t) for rigid pavement or pavement thickness or depth factor (h) for flexible pavement.

Rigid pavement design curves (Section 7.7) have been prepared with the Westergaard equation in general accordance with the procedures outlined in the Design of Concrete Airport Pavement (1955 edition) by Robert G. Packard, published by the American Concrete Pavement Association, 3800 North Wilke Road, Arlington Heights, Illinois 60004-1268. These curves are modified to the format described in the Portland Cement Association publication XP6705-2, Computer Program for Airport Pavement Design (Program PDILB), 1968, by Robert G. Packard.

The following procedure is used to develop the rigid pavement design curves shown in Section 7.7:

1. Having established the scale for pavement thickness to the left and the scale for allowable working stress to the right, an arbitrary load line is drawn representing the main landing gear maximum weight to be shown.
2. Values of the subgrade modulus (k) are then plotted.
3. Additional load lines for the incremental values of weight on the main landing gear are drawn on the basis of the curve for $k = 300$, already established.

The ACN/PCN system (Section 7.10) as referenced in ICAO Annex 14, "Aerodromes," First Edition, July 1990, provides a standardized international airplane/pavement rating system replacing the various S, T, TT, LCN, AUW, ISWL, etc., rating systems used throughout the world. ACN is the Aircraft Classification Number and PCN is the Pavement Classification Number. An aircraft having an ACN equal to or less than the PCN can operate on the pavement subject to any limitation on the tire pressure. Numerically, the ACN is two times the derived single-wheel load expressed in thousands of kilograms, where the derived single wheel load is defined as the load on a single tire inflated to 181 psi (1.25 MPa) that would have the same pavement requirements as the aircraft. Computationally, the ACN/PCN system uses the PCA program PDILB for rigid pavements and S-77-1 for flexible pavements to calculate ACN values. The method of pavement evaluation is left up to the airport with the results of their evaluation presented as follows:

PCN	PAVEMENT TYPE	SUBGRADE CATEGORY	TIRE PRESSURE CATEGORY	EVALUATION METHOD
	R = Rigid F = Flexible	A = High B = Medium C = Low D = Ultra Low	W = No Limit X = To 254 psi (1.75 MPa) Y = To 181 psi (1.25 MPa) Z = To 73 psi (0.5 MPa)	T = Technical U = Using Aircraft

Section 7.10.1 shows the aircraft ACN values for flexible pavements. The four subgrade categories are:

- Code A - High Strength - CBR 15
- Code B - Medium Strength - CBR 10
- Code C - Low Strength - CBR 6
- Code D - Ultra Low Strength - CBR 3

Section 7.10.2 shows the aircraft ACN values for rigid pavements. The four subgrade categories are:

- Code A - High Strength, $k = 550 \text{ pci (150 MN/m}^3\text{)}$
- Code B - Medium Strength, $k = 300 \text{ pci (80 MN/m}^3\text{)}$
- Code C - Low Strength, $k = 150 \text{ pci (40 MN/m}^3\text{)}$
- Code D - Ultra Low Strength, $k = 75 \text{ pci (20 MN/m}^3\text{)}$

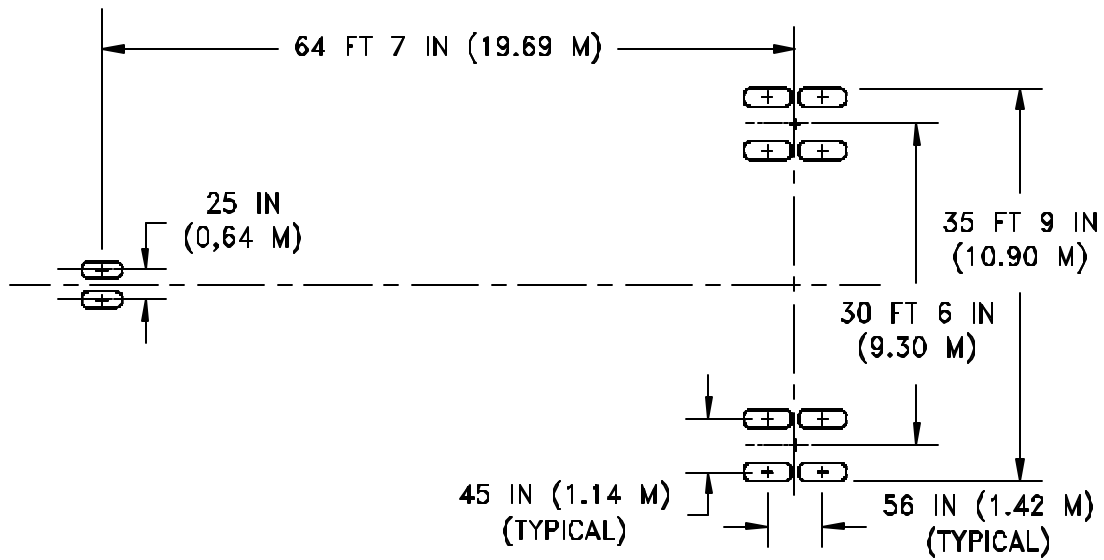

	UNITS	MODEL 767-200	MODEL 767-200ER			
MAXIMUM DESIGN TAXI WEIGHT	LB	284,000 – 317,000	337,000 – 347,000	352,200	381,000	388,000 – 396,000
	KG	128,820 – 143,788	152,861 – 157,397	159,755	172,819	175,994 - 179,623
PERCENT OF WEIGHT ON MAIN		SEE SECTION 7.4.1	SEE SECTION 7.4.2		SEE SECTION 7.4.3	
NOSE GEAR TIRE SIZE		H37 x 14-15 22PR	H37 x 14-15 22PR			
NOSE GEAR TIRE PRESSURE	PSI	145	155	155	180	185
	KG/CM ²	10.19	10.90	10.90	12.66	13.01
MAIN GEAR TIRE SIZE		H45 x 17-20 26PR (1)	H46 x 18-20 28PR	H46 x 18-20 28PR		H46 x 18-20 32PR
MAIN GEAR TIRE PRESSURE	PSI	190 (1)	175 (2)	183 (2)	190	
	KG/CM ²	13.36 (1)	12.30 (2)	12.87 (2)	13.36	

NOTES:

- (1) OPTIONAL TIRE: H46 x 18-20 26PR AT 175 PSI (12.30 KG/SQ CM) OR H46 x 18-20 26PR H/D AT 155 PSI (10.9 KG/SQ CM) OR 175 PSI (12.30 KG/SQ CM)
- (2) OPTIONAL TIRE PRESSURE: 190 PSI (13.36 KG/SQ CM)

7.2.1 LANDING GEAR FOOTPRINT

MODEL 767-200, -200ER

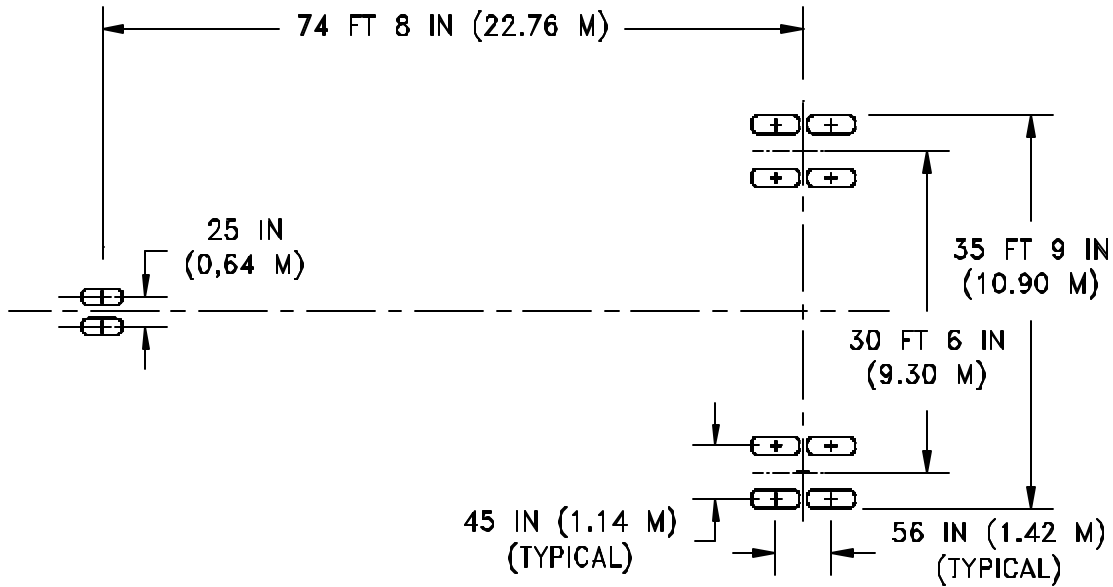

	UNITS	MODEL 767-300		MODEL 767-300ER		MODEL 767-300ER, -300 FREIGHTER
MAXIMUM DESIGN TAXI WEIGHT	LB	317,000 - 340,000	352,000	381,000	388,000	401,000 - 413,000
	KG	143,789 - 154,221	159,665	172,820	175,994	181,908 - 187,339
PERCENT OF WEIGHT ON MAIN		SEE SECTION 7.4.4		SEE SECTION 7.4.5		SEE SECTION 7.4.6
NOSE GEAR TIRE SIZE		H37 x 14-15 22PR		H37 x 14-15 22PR		H37 x 14-15 22PR
NOSE GEAR TIRE PRESSURE	PSI	150	145	150	165	170
	KG/CM ²	10.55	10.19	10.55	11.60	11.95
MAIN GEAR TIRE SIZE		H46 x 18-20 28PR		H46 x 18-20 28PR	H46 x 18-20 32PR	H46 x 18-20 32PR
MAIN GEAR TIRE PRESSURE	PSI	175 (1)	195	175	190	200
	KG/CM ²	12.30 (1)	13.71	12.30	13.36	14.06

NOTES:

(1) OPTIONAL TIRE PRESSURE: 190 PSI (13.36 KG/SQ CM)

7.2.2 LANDING GEAR FOOTPRINT

MODEL 767-300, -300ER, -300 FREIGHTER

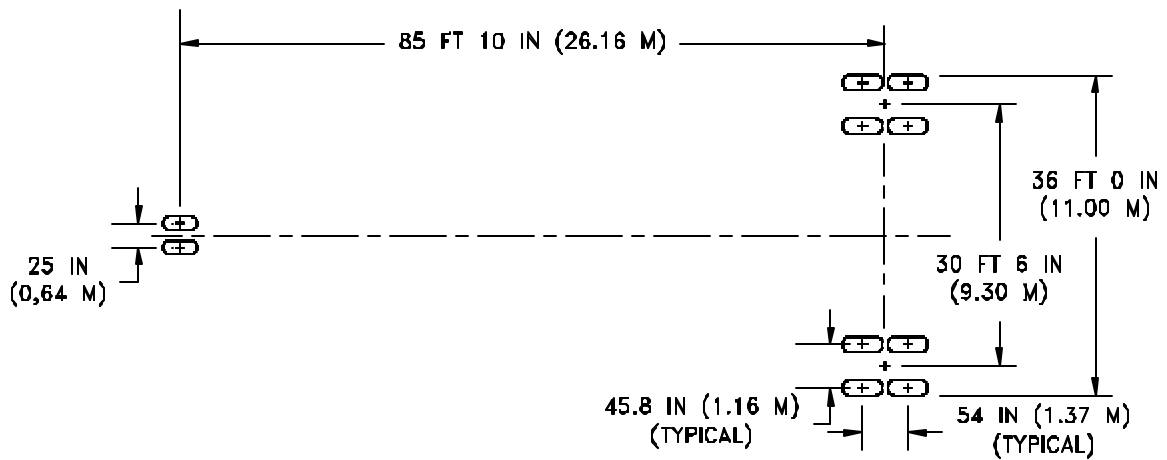

	UNITS	767-400ER
MAXIMUM DESIGN TAXI WEIGHT	LB	451,000
	KG	204,570
PERCENT OF WEIGHT ON MAIN GEAR		SEE SECTION 7.4
NOSE GEAR TIRE SIZE	IN.	H37 x 14 - 15 24PR
NOSE GEAR TIRE PRESSURE	PSI	185
	KG/CM ²	13.01
MAIN GEAR TIRE SIZE	IN.	50 x 20 R22 32 PR
MAIN GEAR TIRE PRESSURE	PSI	215
	KG/CM ²	15.11

7.2.3 LANDING GEAR FOOTPRINT
MODEL 767-400ER

V (NG) = MAXIMUM VERTICAL NOSE GEAR GROUND LOAD AT MOST FORWARD CENTER OF GRAVITY

V (MG) = MAXIMUM VERTICAL MAIN GEAR GROUND LOAD AT MOST AFT CENTER OF GRAVITY

H = MAXIMUM HORIZONTAL GROUND LOAD FROM BRAKING

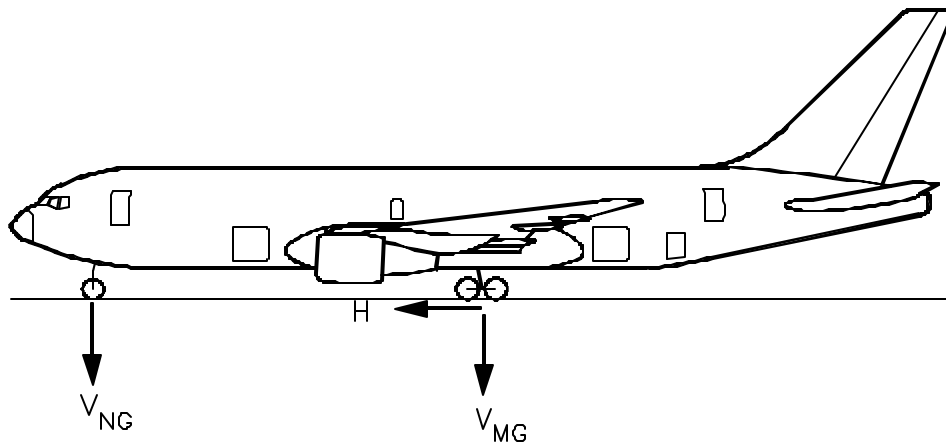

NOTE: ALL LOADS CALCULATED USING AIRPLANE MAXIMUM DESIGN TAXI WEIGHT

MODEL	UNIT	MAXIMUM DESIGN TAXI WEIGHT	V (NG)		V (MG) PER STRUT	H PER STRUT	
			STATIC AT MOST FWD C.G.	STATIC + BRAKING 10 FT/SEC ² DECEL	MAX LOAD AT STATIC AFT C.G.	STEADY BRAKING 10 FT/SEC ² DECEL	AT INSTANTANEOUS BRAKING (U= 0.8)
767-200	LB	284,000	39,100	56,500	133,300	44,100	106,600
	KG	128,821	17,736	25,628	60,464	20,003	48,353
767-200	LB	302,000	39,900	58,600	141,700	46,900	113,400
	KG	136,985	18,098	26,581	64,274	21,274	51,437
767-200	LB	312,000	40,200	59,700	146,400	48,400	117,100
	KG	141,521	18,234	27,080	66,406	21,954	53,116
767-200	LB	317,000	40,600	60,400	146,300	49,200	117,000
	KG	143,789	18,416	27,397	66,361	22,317	53,070
767-200ER	LB	337,000	42,700	63,800	158,100	52,300	126,500
	KG	152,861	19,368	28,939	71,713	23,723	57,380
767-200ER	LB	347,000	43,200	65,200	160,700	53,900	128,600
	KG	157,397	19,595	29,574	72,892	24,449	58,332
767-200ER	LB	352,200	43,300	65,100	162,200	54,700	129,800
	KG	159,756	19,641	29,529	73,573	24,812	58,876
767-200ER	LB	381,000	51,500	74,900	178,800	59,200	143,000
	KG	172,819	23,360	33,974	81,103	26,853	64,864
767-200ER	LB	388,000	52,400	76,100	180,000	60,200	144,000
	KG	175,994	23,768	34,518	81,647	27,306	65,317
767-200ER	LB	396,000	44,640	70,510	179,810	61,500	143,850
	KG	179,623	20,248	31,983	81,561	27,896	65,249

7.3.1 MAXIMUM PAVEMENT LOADS

MODEL 767-200, -200ER

D6-58328

$V_{(NG)}$ = MAXIMUM VERTICAL NOSE GEAR GROUND LOAD AT MOST FORWARD CENTER OF GRAVITY

$V_{(MG)}$ = MAXIMUM VERTICAL MAIN GEAR GROUND LOAD AT MOST AFT CENTER OF GRAVITY

H = MAXIMUM HORIZONTAL GROUND LOAD FROM BRAKING

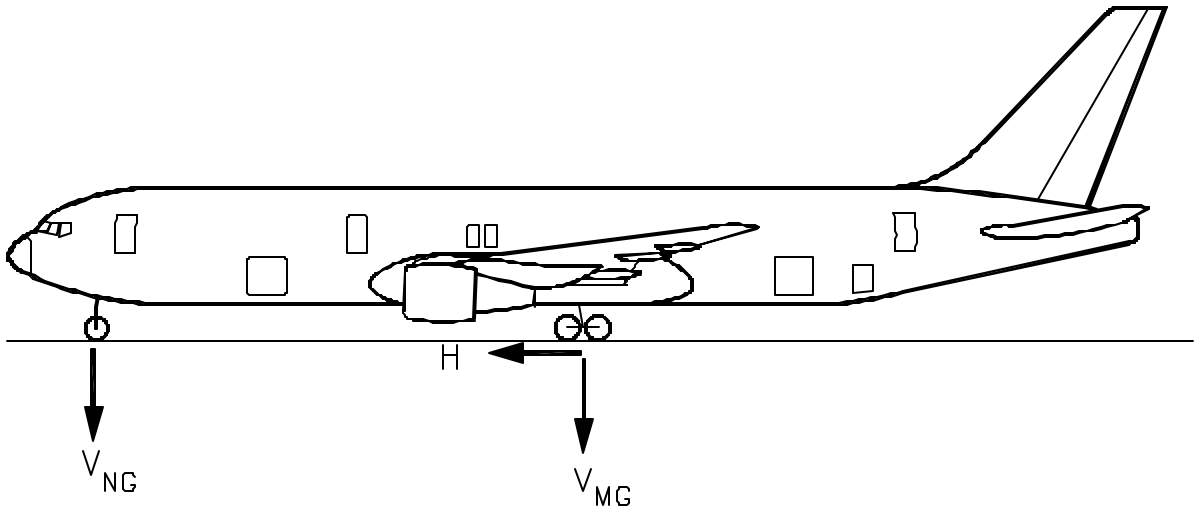

NOTE: ALL LOADS CALCULATED USING AIRPLANE MAXIMUM DESIGN TAXI WEIGHT

MODEL	UNIT	MAXIMUM DESIGN TAXI WEIGHT	$V_{(NG)}$		$V_{(MG)}$ PER STRUT MAX LOAD AT STATIC AFT C.G.	H PER STRUT	
			STATIC AT MOST FWD C.G.	STATIC + BRAKING 10 FT/SEC ² DECEL		STEADY BRAKING 10 FT/SEC ² DECEL	AT INSTANTANEOUS BRAKING ($u=0.8$)
767-300	LB	317,200	41,100	58,300	150,600	49,300	120,500
	KG	143,880	18,643	26,444	68,311	22,362	54,658
767-300	LB	347,000	41,000	59,600	160,100	53,900	128,100
	KG	157,397	18,597	27,034	72,620	24,449	58,105
767-300	LB	352,000	41,000	60,000	162,400	54,700	129,900
	KG	159,665	18,597	27,216	73,664	24,812	58,922
767-300ER	LB	381,000	46,600	66,800	177,900	59,200	142,300
	KG	172,819	21,137	30,300	80,694	26,853	64,546
767-300ER	LB	388,000	40,200	60,700	180,100	60,200	144,100
	KG	175,994	18,234	27,533	81,692	27,306	65,363
767-300ER, FREIGHTER	LB	401,000	48,200	69,500	186,300	62,300	149,100
	KG	181,891	21,863	31,525	84,504	28,259	67,631
767-300ER, FREIGHTER	LB	409,000	48,200	69,900	188,200	63,500	150,600
	KG	185,520	21,863	31,706	85,366	28,803	68,311
767-300ER, FREIGHTER	LB	413,000	44,330	67,660	190,800	64,140	152,640
	KG	187,334	20,108	30,690	86,546	29,093	69,237

7.3.2 MAXIMUM PAVEMENT LOADS

MODEL 767-300, -300ER, -300 FREIGHTER

$V_{(NG)}$ = MAXIMUM VERTICAL NOSE GEAR GROUND LOAD AT MOST FORWARD CENTER OF GRAVITY

$V_{(MG)}$ = MAXIMUM VERTICAL MAIN GEAR GROUND LOAD AT MOST AFT CENTER OF GRAVITY

H = MAXIMUM HORIZONTAL GROUND LOAD FROM BRAKING

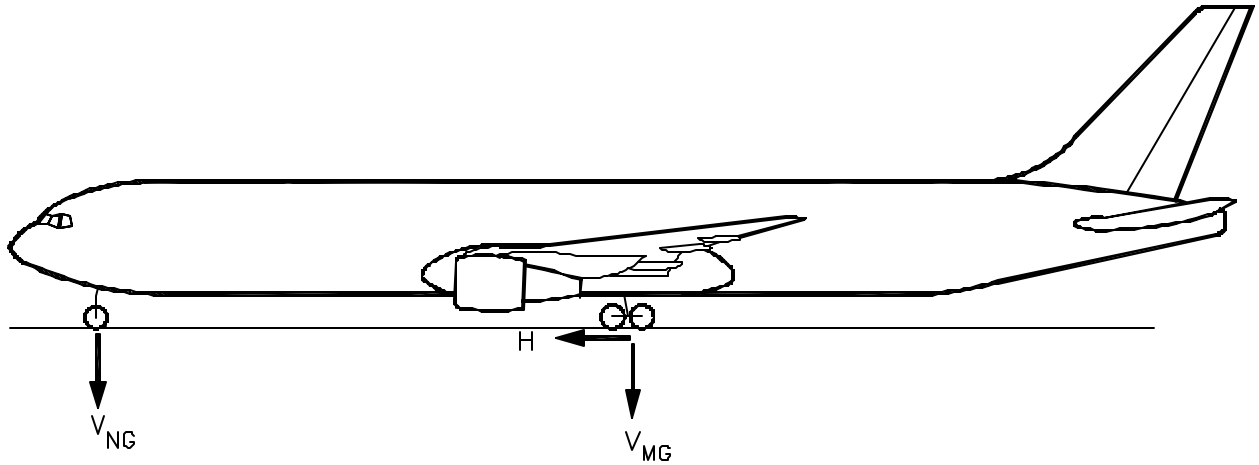

NOTE: ALL LOADS CALCULATED USING AIRPLANE MAXIMUM DESIGN TAXI WEIGHT

MODEL	UNIT	MAXIMUM DESIGN TAXI WEIGHT	$V_{(NG)}$		$V_{(MG)}$ PER STRUT	H PER STRUT	
			STATIC AT MOST FWD C.G.	STATIC + BRAKING 10 FT/SEC ² DECEL	MAX LOAD AT STATIC AFT C.G.	STEADY BRAKING 10 FT/SEC ² DECEL	AT INSTANTANEOUS BRAKING ($\mu=0.8$)
767-400ER	LB	451,000	37,600	59,650	211,850	70,050	169,500
	KG	204,570	17,055	27,057	96,093	31,774	76,884

7.3.3 MAXIMUM PAVEMENT LOADS

MODEL 767-400ER

D6-58328

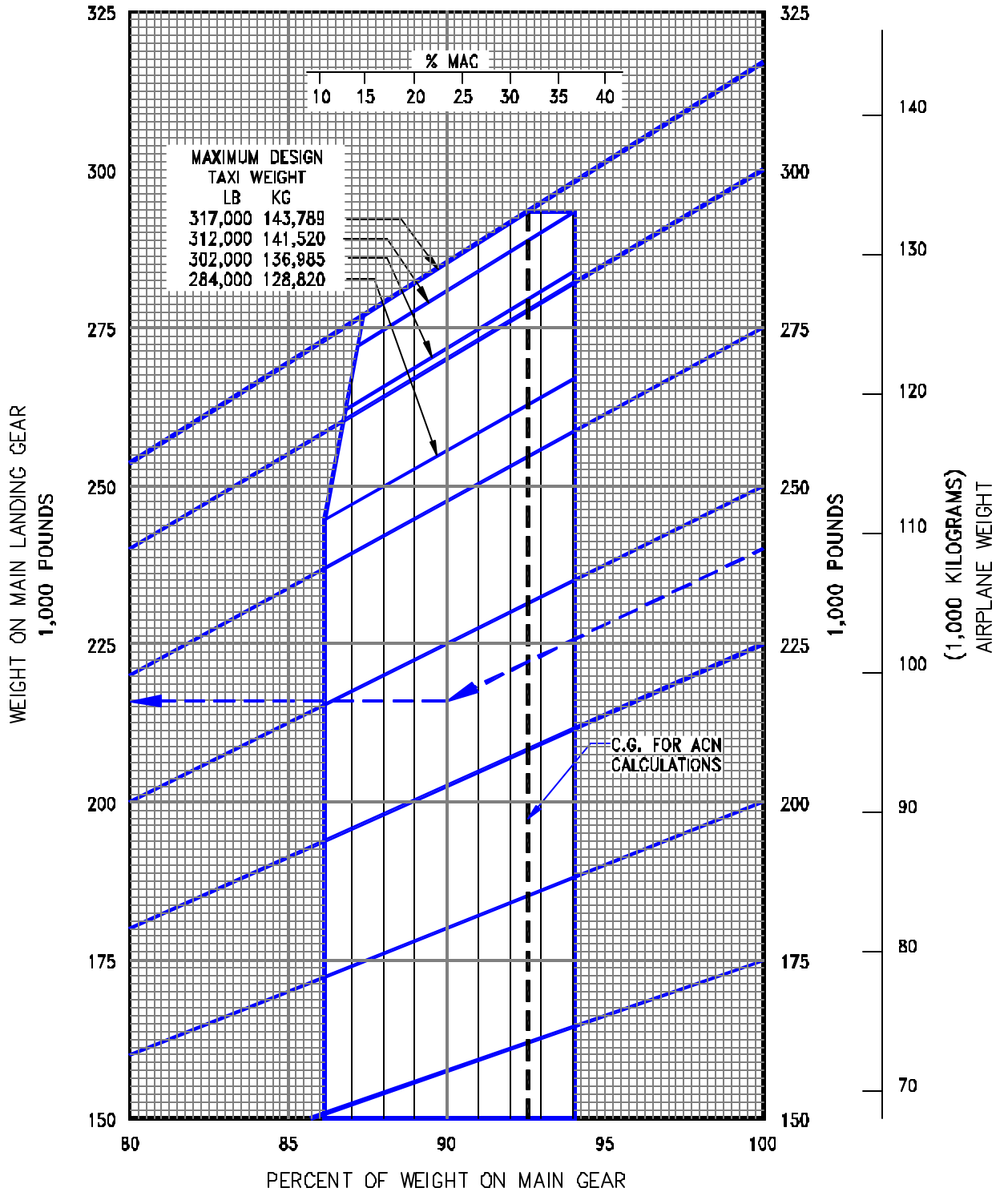

7.4.1 LANDING GEAR LOADING ON PAVEMENT

MODEL 767-200 AT 284,000 TO 317,000 LB (128,820 TO 143,789 KG) MTW

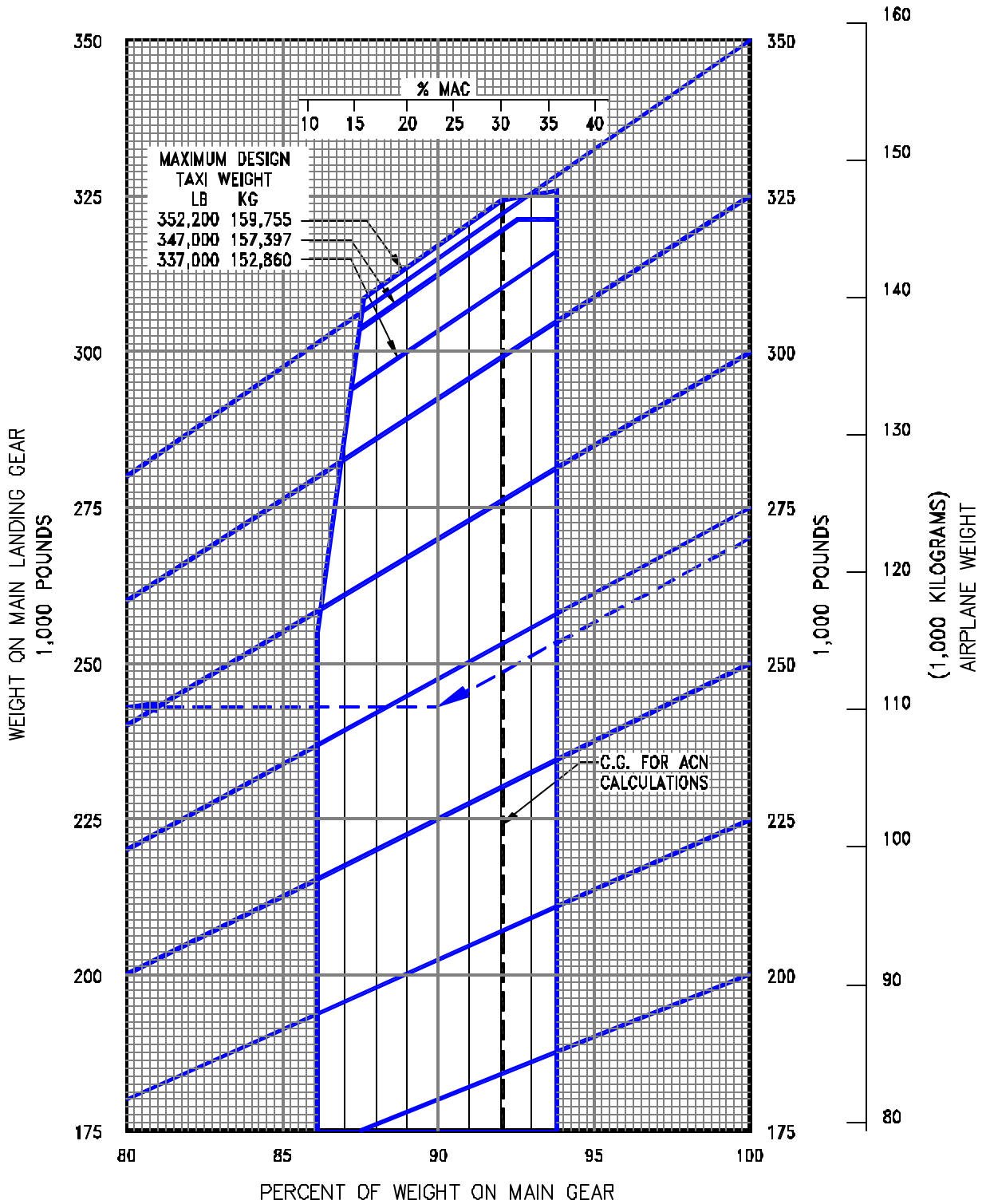

7.4.2 LANDING GEAR LOADING ON PAVEMENT

MODEL 767-200, -200ER AT 337,000 TO 352,200 LB (152,860 TO 159,755 KG) MTW

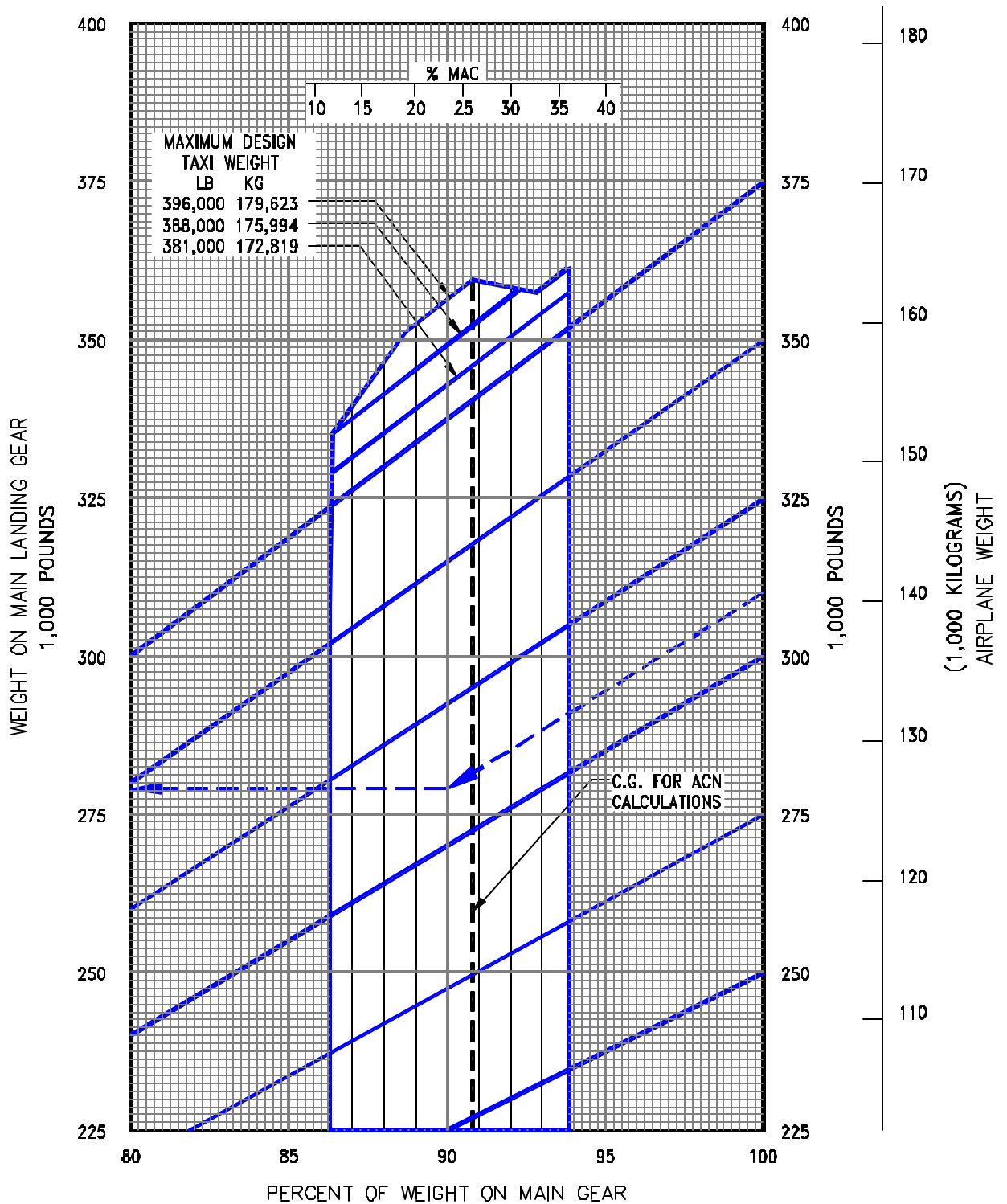

7.4.3 LANDING GEAR LOADING ON PAVEMENT

MODEL 767-200ER AT 381,000 TO 396,000 LB (172,819 TO 179,623 KG) MTW

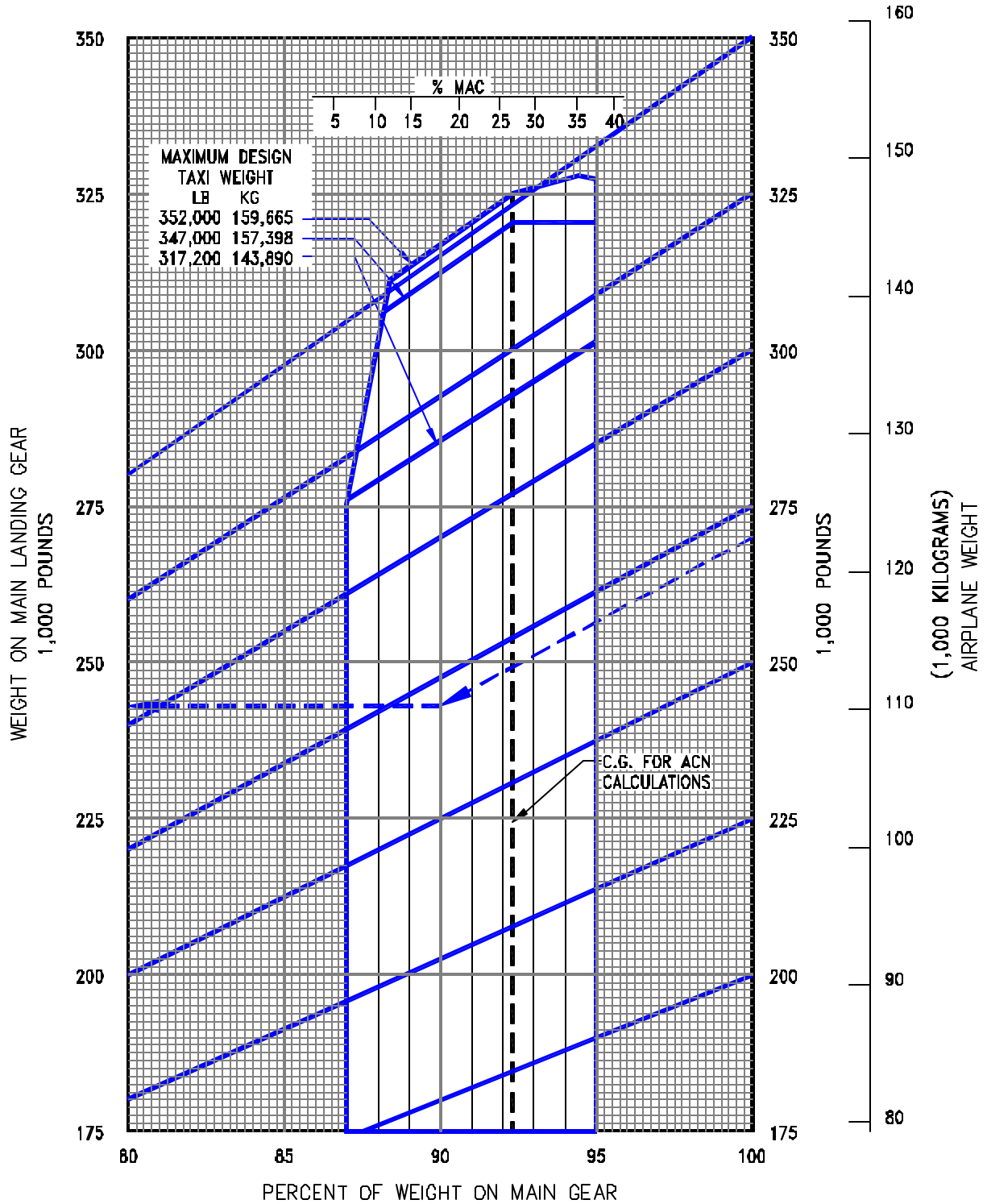

7.4.4 LANDING GEAR LOADING ON PAVEMENT

MODEL 767-300 AT 317,200 TO 352,000 LB (143,890 TO 159,665 KG) MTW

D6-58328

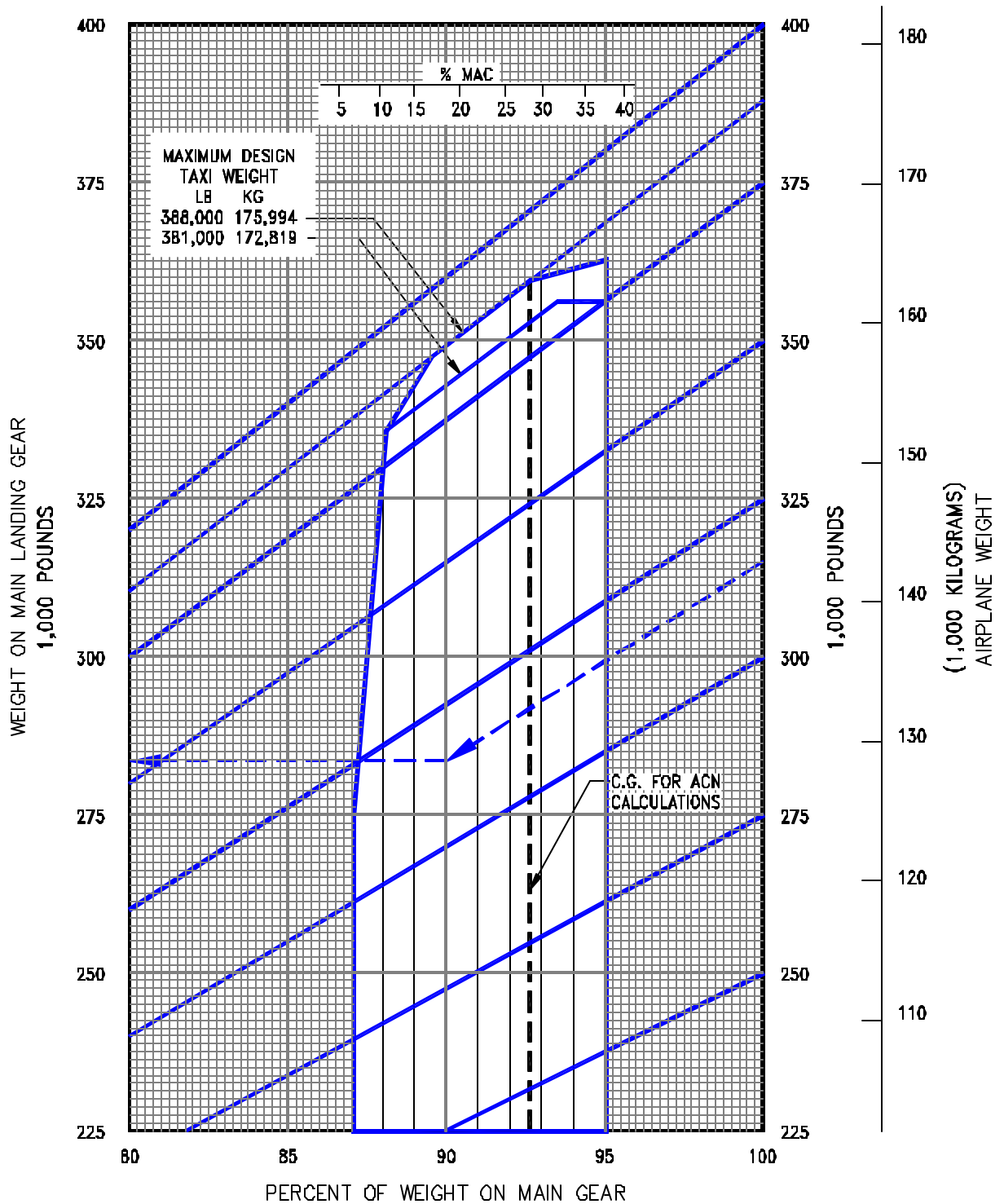

7.4.5 LANDING GEAR LOADING ON PAVEMENT

MODEL 767-300ER AT 381,000 TO 388,000 LB (172,819 TO 175,994 KG) MTW

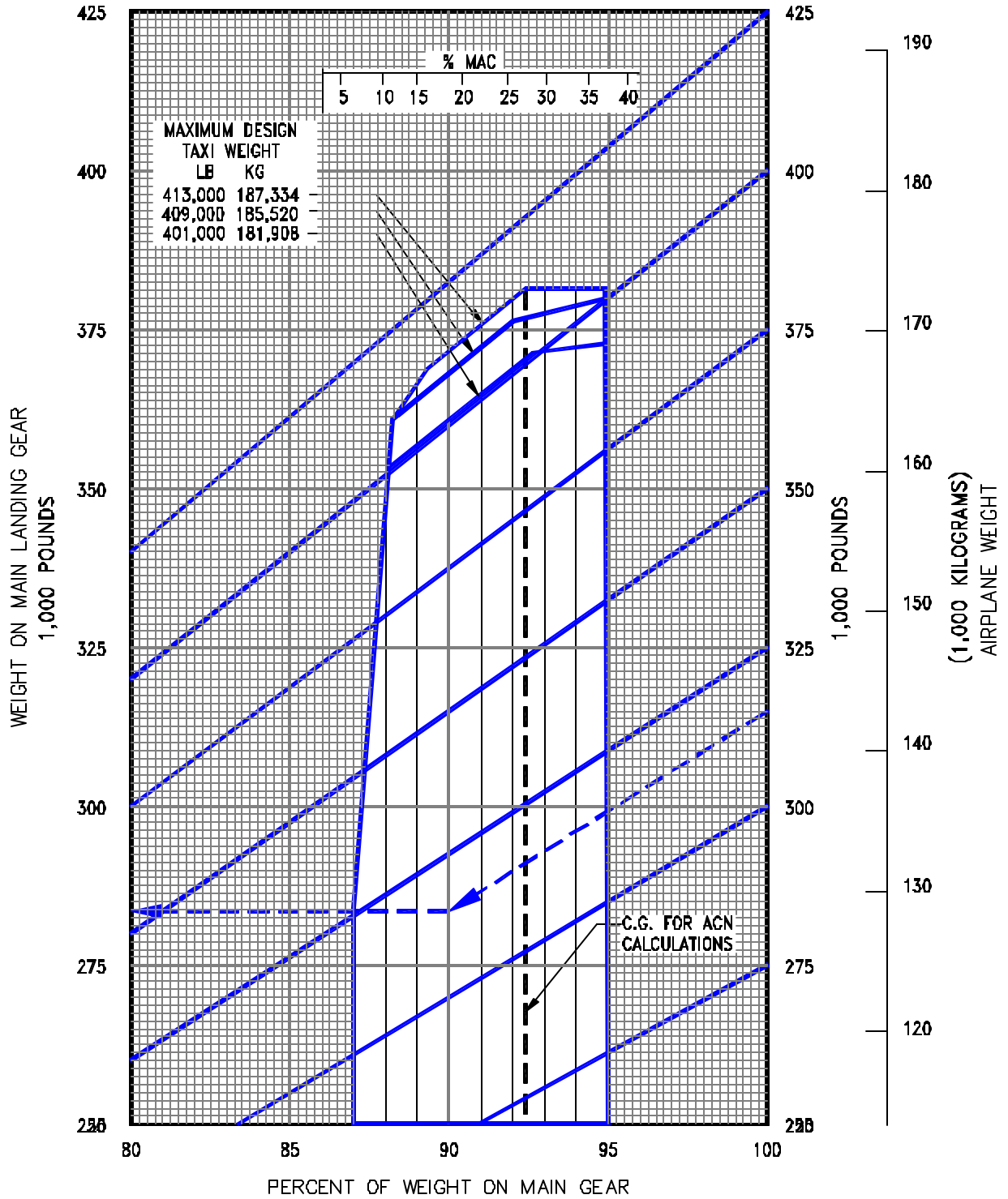

7.4.6 LANDING GEAR LOADING ON PAVEMENT

MODEL 767-300ER, -300 FREIGHTER AT 401,000 TO 413,000 LB (181,908 TO 187,334 KG) MTW

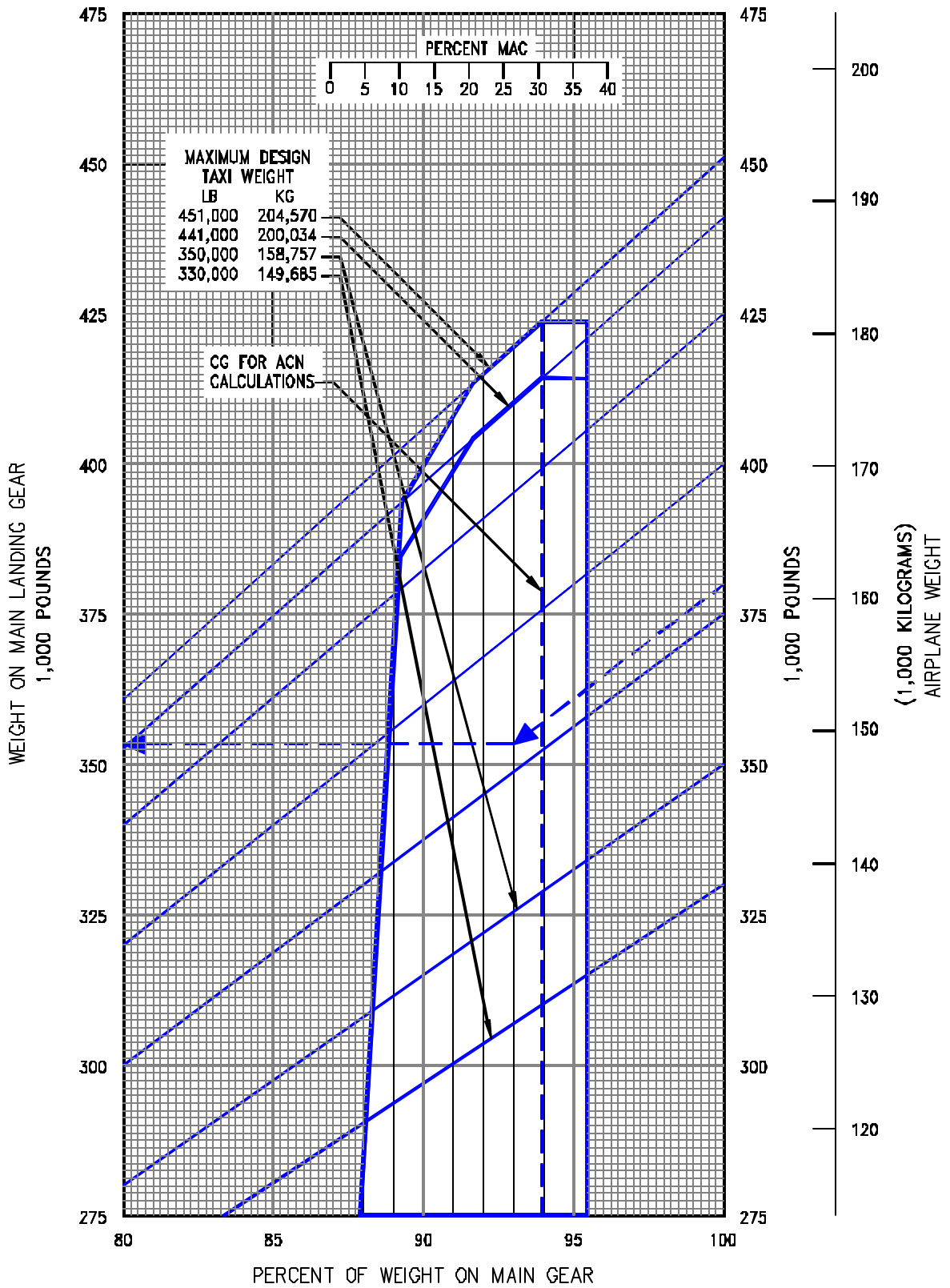

7.4.7 LANDING GEAR LOADING ON PAVEMENT
MODEL 767-400ER

7.5 Flexible Pavement Requirements - U.S. Army Corps of Engineers Method (S-77-1)

The following flexible-pavement design chart presents the data of six incremental main-gear loads at the minimum tire pressure required at the maximum design taxi weight.

In the example shown in 7.5.1, for a CBR of 30 and an annual departure level of 3,000, the required flexible pavement thickness for an airplane with a main gear loading of 376,300 pounds is 12.0 inches.

The line showing 10,000 coverages is used for ACN calculations (see Section 7.10).

The FAA design method uses a similar procedure using total airplane weight instead of weight on the main landing gears. The equivalent main gear loads for a given airplane weight could be calculated from Section 7.4.

NOTES: TIRES - H46 X 18-20 - 32PR
 PRESSURE CONSTANT AT 200 PSI (14.06 KG/SQ CM)

CALIFORNIA BEARING RATIO, CBR

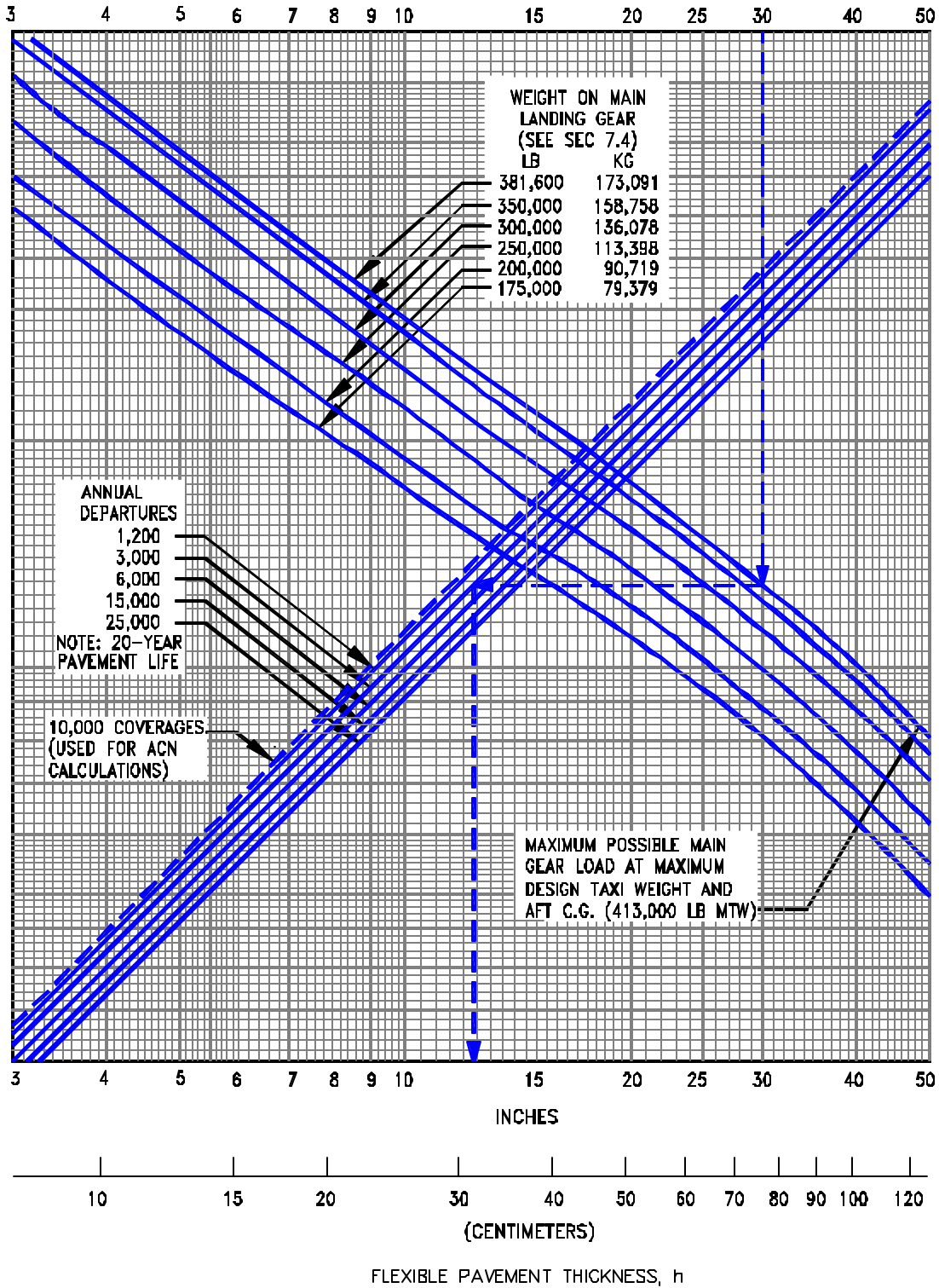

7.5.1 FLEXIBLE PAVEMENT REQUIREMENTS - U.S. ARMY CORPS OF ENGINEERS DESIGN METHOD (S-77-1)

MODEL 767-200, -200ER, -300, -300ER, -300 FREIGHTER

NOTE: TIRES - 50 X 20R22 - 32PR

CALIFORNIA BEARING RATIO, CBR

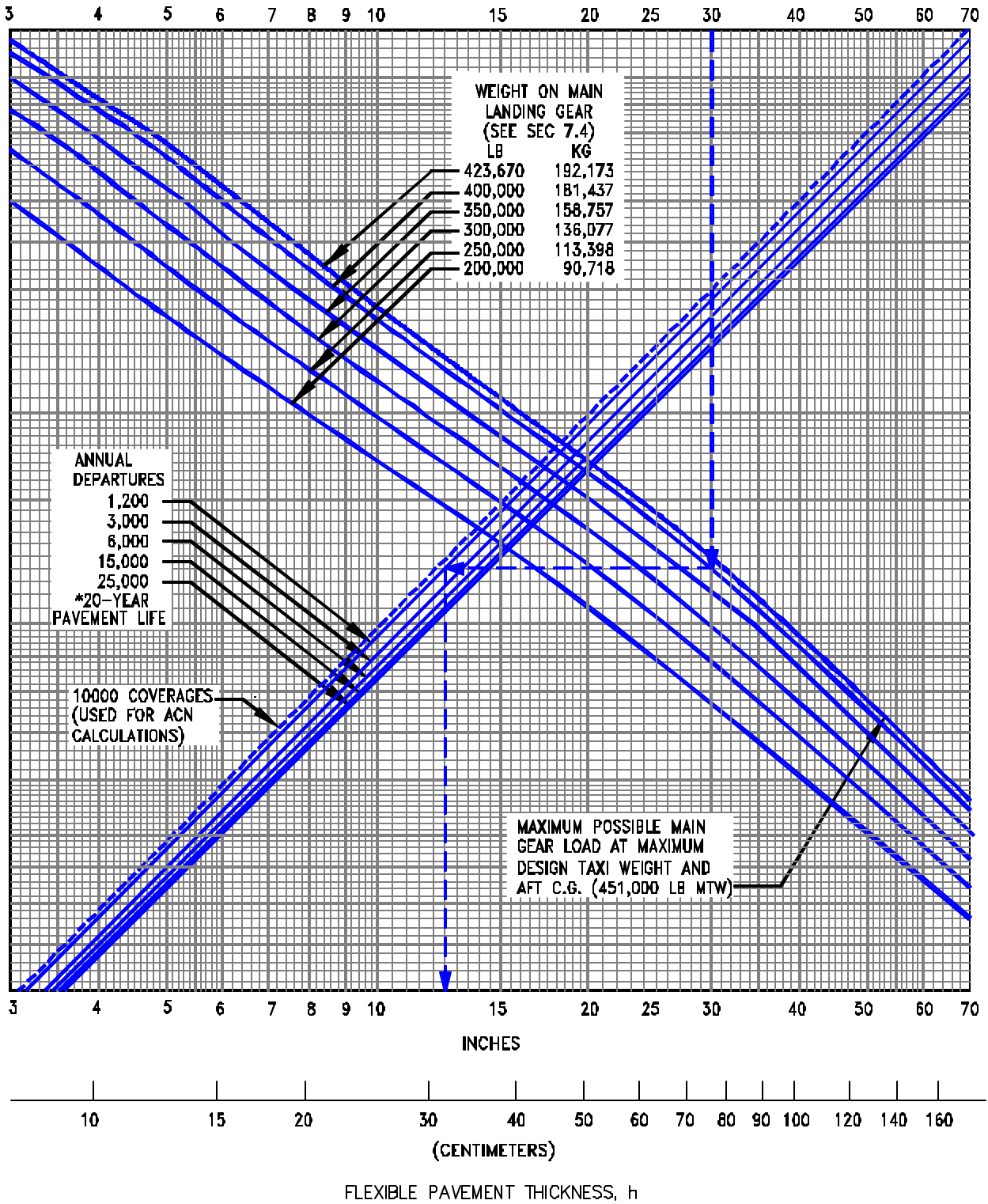

7.5.2 FLEXIBLE PAVEMENT REQUIREMENTS - U.S. ARMY CORPS OF ENGINEERS DESIGN METHOD (S-77-1)

MODEL 767-400ER

D6-58328

7.6 Flexible Pavement Requirements - LCN Method

To determine the airplane weight that can be accommodated on a particular flexible pavement, both the Load Classification Number (LCN) of the pavement and the thickness must be known.

In the example shown in 7.6.1, flexible pavement thickness is shown at 30 in. with an LCN of 75. For these conditions, the apparent maximum allowable weight permissible on the main landing gear is 250,000 lb for an airplane with 200-psi main gear tires.

Note: If the resultant aircraft LCN is not more than 10% above the published pavement LCN, the bearing strength of the pavement can be considered sufficient for unlimited use by the airplane. The figure 10% has been chosen as representing the lowest degree of variation in LCN that is significant (reference: ICAO Aerodrome Manual, Part 2, "Aerodrome Physical Characteristics," Chapter 4, Paragraph 4.1.5.7v, 2nd Edition dated 1965).

NOTES:
 * TIRES - H46 X 18-20 ZB PR OR 32PR
 * EQUIVALENT SINGLE-WHEEL LOADS ARE DERIVED FROM ICAO AERODROME MANUAL, PART 2 PAR. 4.1.3

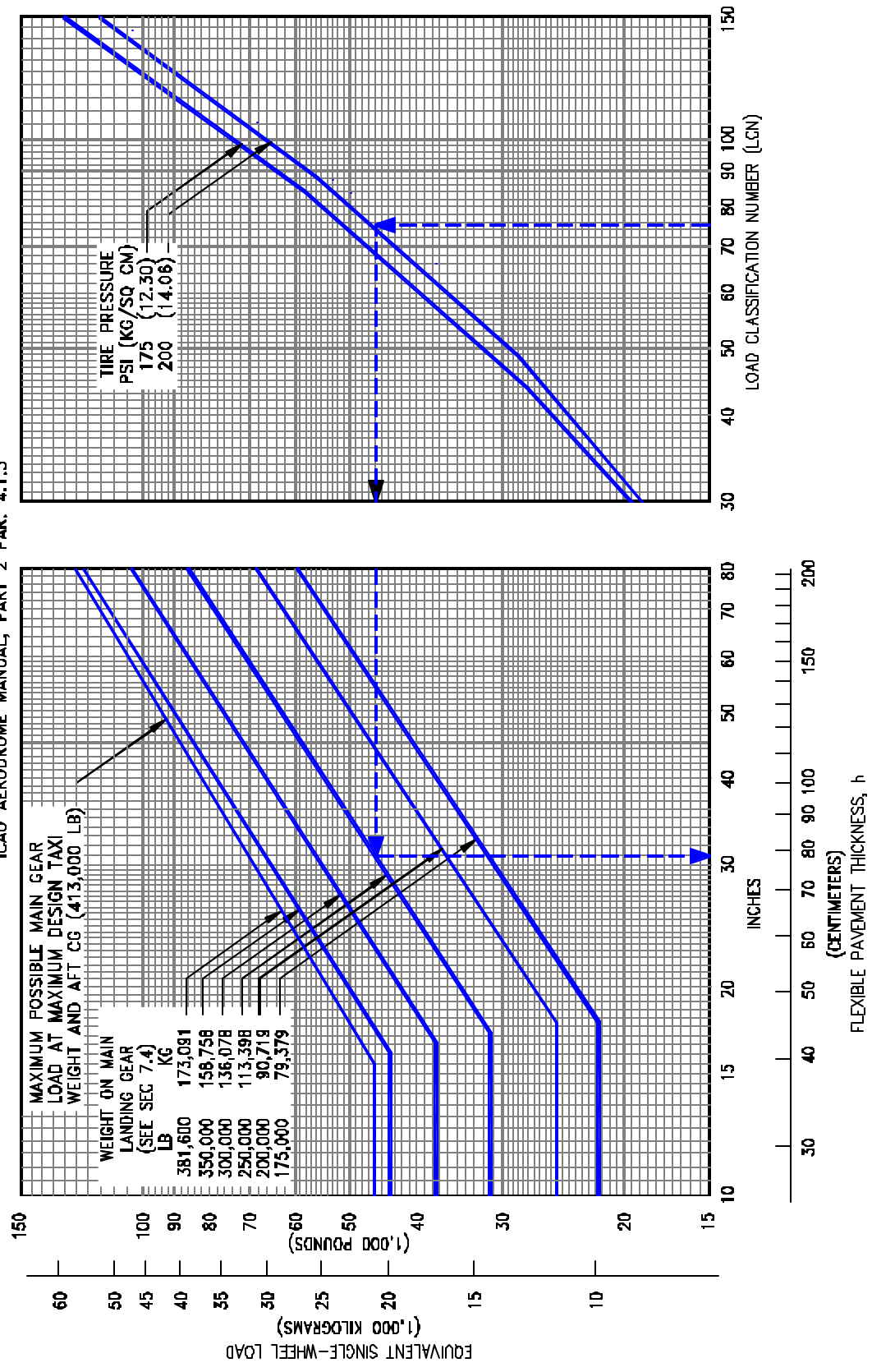

7.6.1 FLEXIBLE PAVEMENT REQUIREMENTS - LCN METHOD
 MODEL 767-200, -200ER, -300, -300ER, -300 FREIGHTER

- NOTES:
- * TIRES - 50 X 20 R22 - 32PR AT 215 PSI (15.11 KG/SQ CM)
 - * EQUIVALENT SINGLE-WHEEL LOADS ARE DERIVED FROM ICAO AERODROME MANUAL, PART 2 PAR. 4.1.3

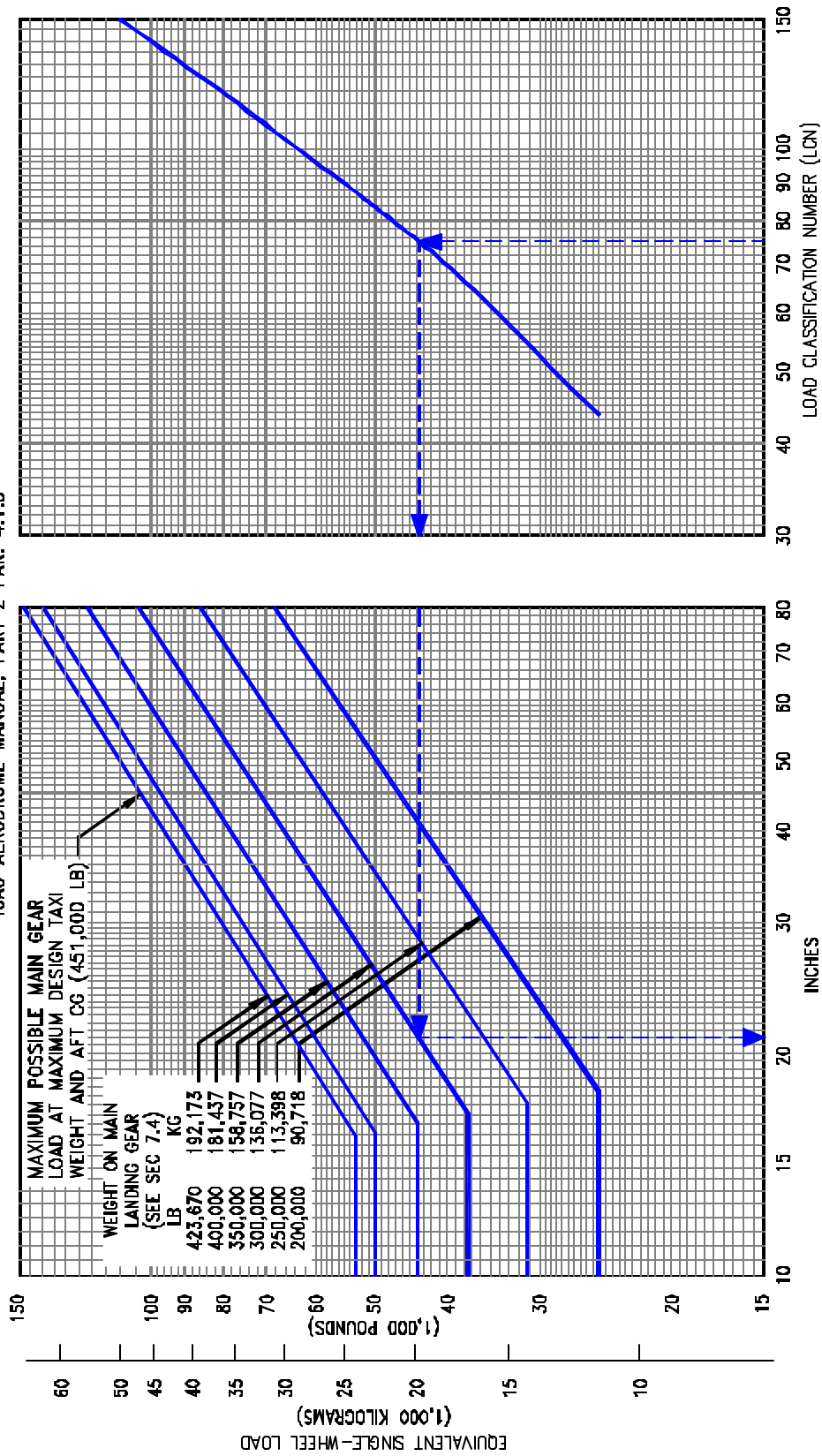

7.6.2 FLEXIBLE PAVEMENT REQUIREMENTS - LCN METHOD
 MODEL 767-400ER

7.7 Rigid Pavement Requirements - Portland Cement Association Design Method

The Portland Cement Association method of calculating rigid pavement requirements is based on the computerized version of "Design of Concrete Airport Pavement" (Portland Cement Association, 1955) as described in XP6705-2, "Computer Program for Airport Pavement Design" by Robert G. Packard, Portland Cement Association, 1968.

The following rigid pavement design chart presents the data for six incremental main gear loads at the minimum tire pressure required at the maximum design taxi weight.

In the example shown in 7.7.1, for an allowable working stress of 550 psi, a main gear load of 300,000 lb, and a subgrade strength (k) of 300, the required rigid pavement thickness is 9.4 in.

NOTES: TIRES - H46 X 18-20 - 32PR
 PRESSURE CONSTANT AT 200 PSI (14.06 KG/SQ CM)

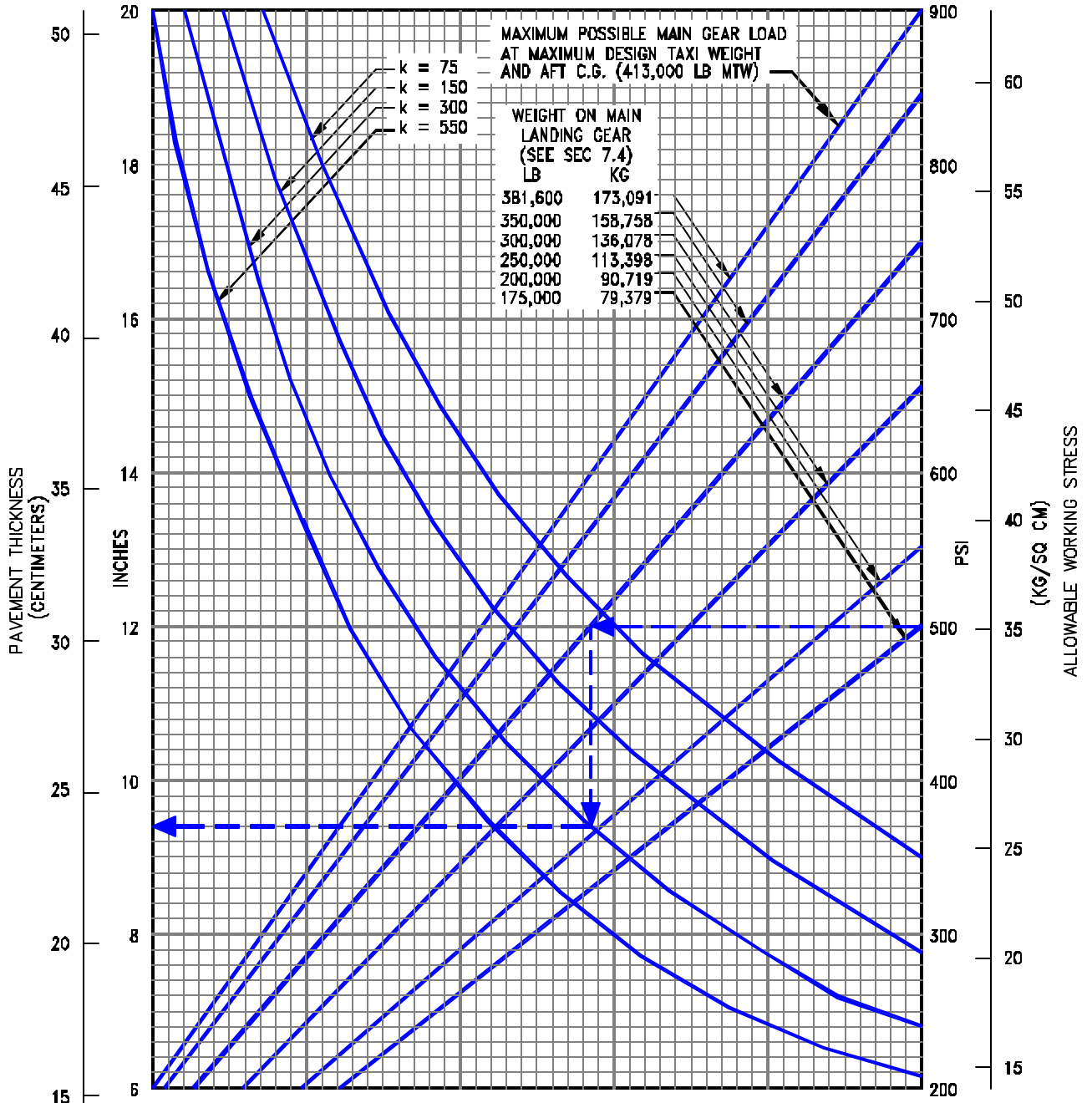

NOTE:
 THE VALUES OBTAINED BY USING THE
 MAXIMUM LOAD REFERENCE LINE AND
 ANY VALUE OF k ARE EXACT.
 FOR LOADS LESS THAN MAXIMUM, THE CURVES
 ARE EXACT FOR $k = 300$ BUT DEVIATE
 SLIGHTLY FOR OTHER VALUES OF k .

REFERENCES:
 "DESIGN OF CONCRETE AIRPORT
 PAVEMENT" AND "COMPUTER
 PROGRAM FOR AIRPORT PAVEMENT
 DESIGN - PROGRAM PDILB"
 PORTLAND CEMENT ASSOCIATION.

7.7.1 RIGID PAVEMENT REQUIREMENTS - PORTLAND CEMENT ASSOCIATION DESIGN METHOD
 MODEL 767-200, -200ER, -300, -300ER, -300 FREIGHTER

NOTE: TIRES - 50 X 20 R22 - 32PR

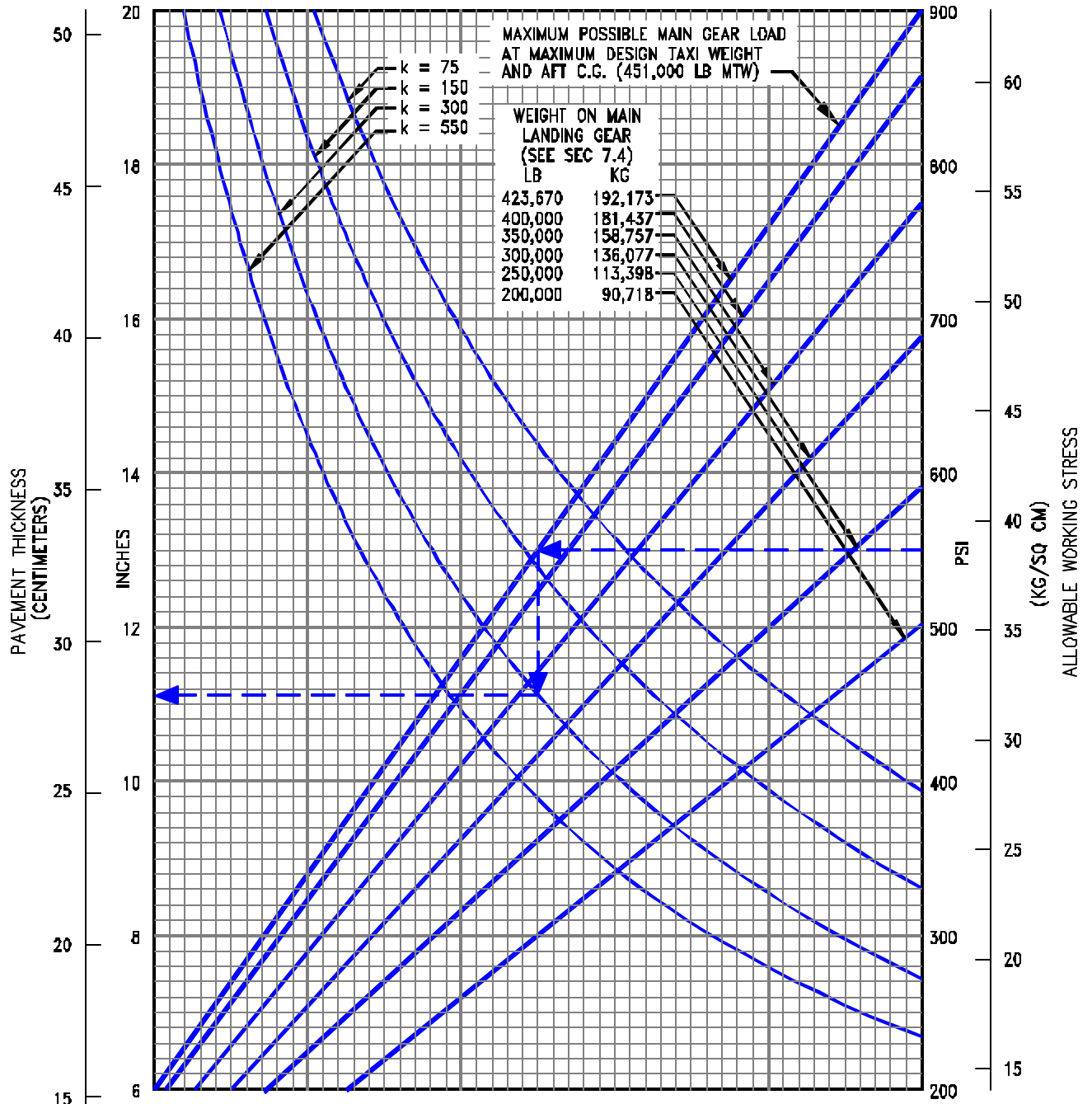

NOTE:
 THE VALUES OBTAINED BY USING THE MAXIMUM LOAD REFERENCE LINE AND ANY VALUE OF *k* ARE EXACT. FOR LOADS LESS THAN MAXIMUM, THE CURVES ARE EXACT FOR *k* = 300 BUT DEVIATE SLIGHTLY FOR OTHER VALUES OF *k*.

REFERENCES:
 "DESIGN OF CONCRETE AIRPORT PAVEMENT" AND "COMPUTER PROGRAM FOR AIRPORT PAVEMENT DESIGN - PROGRAM PDILB"
 PORTLAND CEMENT ASSOCIATION.

7.7.2 RIGID PAVEMENT REQUIREMENTS - PORTLAND CEMENT ASSOCIATION DESIGN METHOD
 MODEL 767-400ER

D6-58328

7.8 Rigid Pavement Requirements - LCN Conversion

To determine the airplane weight that can be accommodated on a particular rigid pavement, both the LCN of the pavement and the radius of relative stiffness (l) of the pavement must be known.

In the example shown in 7.8.2, for a rigid pavement with a radius of relative stiffness of 60 with an LCN of 80, the apparent maximum allowable weight permissible on the main landing gear is 250,000 lb for an airplane with 200-psi main tires.

Note: If the resultant aircraft LCN is not more than 10% above the published pavement LCN, the bearing strength of the pavement can be considered sufficient for unlimited use by the airplane. The figure 10% has been chosen as representing the lowest degree of variation in LCN that is significant (reference: ICAO Aerodrome Manual, Part 2, "Aerodrome Physical Characteristics," Chapter 4, Paragraph 4.1.5.7v, 2nd Edition dated 1965).

RADIUS OF RELATIVE STIFFNESS (l)
VALUES IN INCHES

$$l = \sqrt[4]{\frac{Ed^3}{12(1-\mu^2)k}} = 24.1652 \sqrt[4]{\frac{d^3}{k}}$$

WHERE: E = YOUNG'S MODULUS OF ELASTICITY = 4 x 10⁶ psi
k = SUBGRADE MODULUS, LB PER CU IN
d = RIGID PAVEMENT THICKNESS, IN
μ = POISSON'S RATIO = 0.15

d	k = 75	k = 100	k = 150	k = 200	k = 250	k = 300	k = 350	k = 400	k = 500	k = 550
6.0	31.48	29.29	26.47	24.63	23.30	22.26	21.42	20.71	19.59	19.13
6.5	33.42	31.10	28.11	26.16	24.74	23.63	22.74	21.99	20.80	20.31
7.0	35.33	32.88	29.71	27.65	26.15	24.99	24.04	23.25	21.99	21.47
7.5	37.21	34.63	31.29	29.12	27.54	26.31	25.32	24.49	23.16	22.61
8.0	39.06	36.35	32.84	30.56	28.91	27.62	26.57	25.70	24.31	23.73
8.5	40.87	38.04	34.37	31.99	30.25	28.90	27.81	26.90	25.44	24.84
9.0	42.66	39.70	35.88	33.39	31.57	30.17	29.03	28.07	26.55	25.93
9.5	44.43	41.35	37.36	34.77	32.88	31.42	30.23	29.24	27.65	27.00
10.0	46.17	42.97	38.83	36.13	34.17	32.65	31.41	30.38	28.73	28.06
10.5	47.89	44.57	40.27	37.48	35.44	33.87	32.58	31.52	29.81	29.10
11.0	49.59	46.15	41.70	38.81	36.70	35.07	33.74	32.63	30.86	30.14
11.5	51.27	47.72	43.12	40.12	37.95	36.26	34.89	33.74	31.91	31.16
12.0	52.94	49.26	44.51	41.43	39.18	37.43	36.02	34.83	32.94	32.17
12.5	54.58	50.80	45.90	42.71	40.40	38.60	37.14	35.92	33.97	33.17
13.0	56.21	52.31	47.27	43.99	41.60	39.75	38.25	36.99	34.98	34.16
13.5	57.83	53.81	48.63	45.25	42.80	40.89	39.34	38.05	35.99	35.14
14.0	59.43	55.30	49.97	46.50	43.98	42.02	40.43	39.10	36.98	36.11
14.5	61.01	56.78	51.30	47.74	45.15	43.14	41.51	40.15	37.97	37.07
15.0	62.58	58.24	52.62	48.97	46.32	44.25	42.58	41.18	38.95	38.03
15.5	64.14	59.69	53.93	50.19	47.47	45.35	43.64	42.21	39.92	38.98
16.0	65.69	61.13	55.23	51.40	48.61	46.45	44.69	43.22	40.88	39.92
16.5	67.22	62.55	56.52	52.60	49.75	47.53	45.73	44.23	41.83	40.85
17.0	68.74	63.97	57.80	53.79	50.87	48.61	46.77	45.23	42.78	41.77
17.5	70.25	65.38	59.07	54.97	51.99	49.68	47.80	46.23	43.72	42.69
18.0	71.75	66.77	60.34	56.15	53.10	50.74	48.82	47.22	44.65	43.60
19.0	74.72	69.54	62.83	58.47	55.30	52.84	50.84	49.17	46.50	45.41
20.0	77.65	72.26	65.30	60.77	57.47	54.91	52.83	51.10	48.33	47.19
21.0	80.55	74.96	67.73	63.03	59.61	56.95	54.80	53.00	50.13	48.95
22.0	83.41	77.62	70.14	65.27	61.73	58.98	56.75	54.88	51.91	50.68
23.0	86.23	80.25	72.51	67.48	63.82	60.98	58.67	56.74	53.67	52.40
24.0	89.03	82.85	74.86	69.67	65.89	62.95	60.57	58.58	55.41	54.10
25.0	91.80	85.43	77.19	71.84	67.94	64.91	62.46	60.41	57.13	55.78

**7.8.1 RADIUS OF RELATIVE STIFFNESS
(REFERENCE: PORTLAND CEMENT ASSOCIATION)**

NOTES: * TIRES - H46 X 18-20 28PR OR 32PR
 * EQUIVALENT SINGLE-WHEEL LOADS ARE DERIVED FROM ICAD AERODROME MANUAL, PART 2 PAR 4.1.3, DATED 1965.

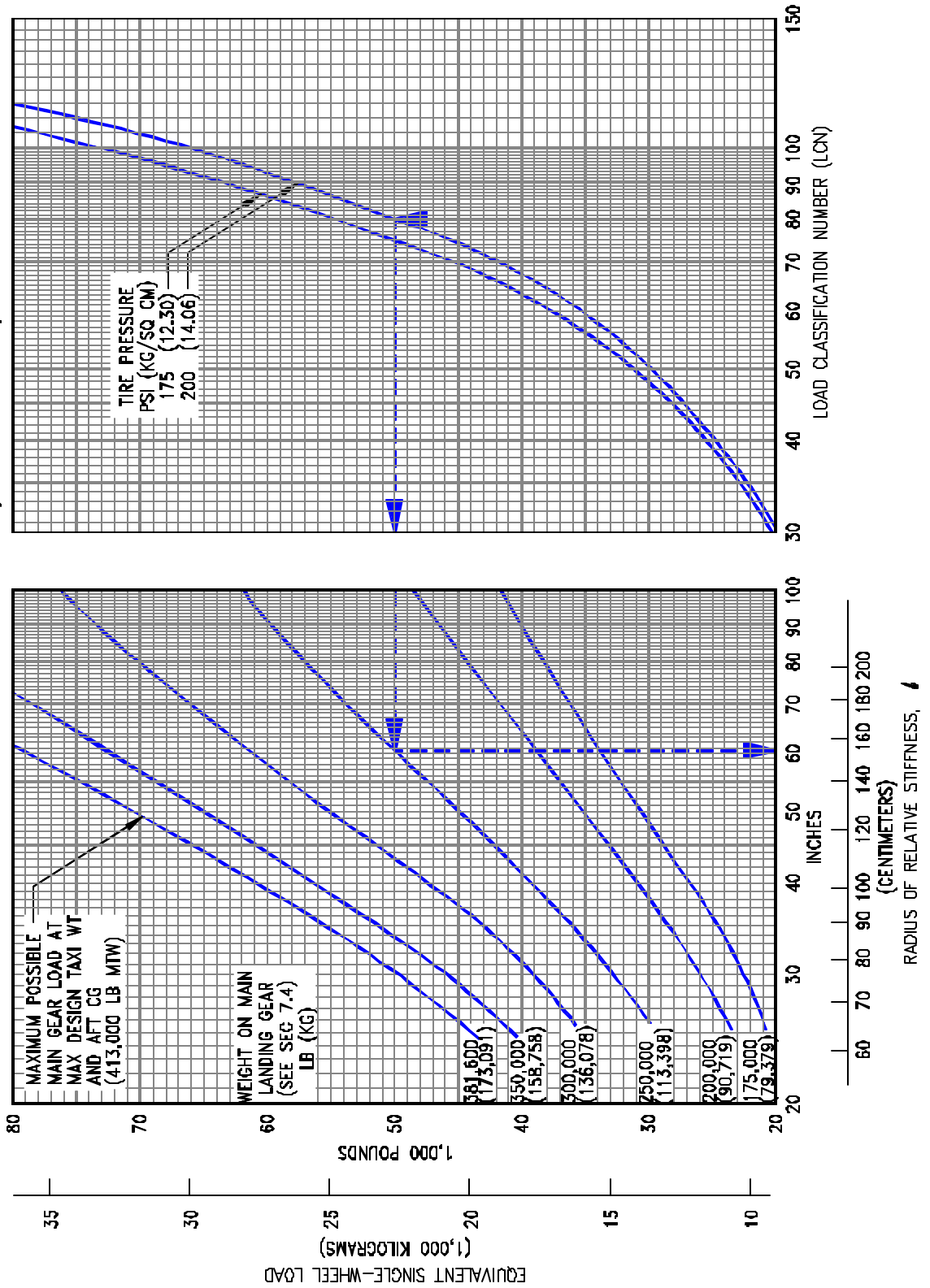

7.8.2 RIGID PAVEMENT REQUIREMENTS - LCN CONVERSION
 MODEL 767-200, -200ER, -300, -300ER, -300 FREIGHTER

NOTES: * TIRES - 50 X 20 R22 - 32PR AT 215 PSI (15.11 KG/SQ CM)
 * EQUIVALENT SINGLE-WHEEL LOADS ARE DERIVED FROM ICAO AERODROME MANUAL, PART 2 PAR 4.1.3, DATED 1965.

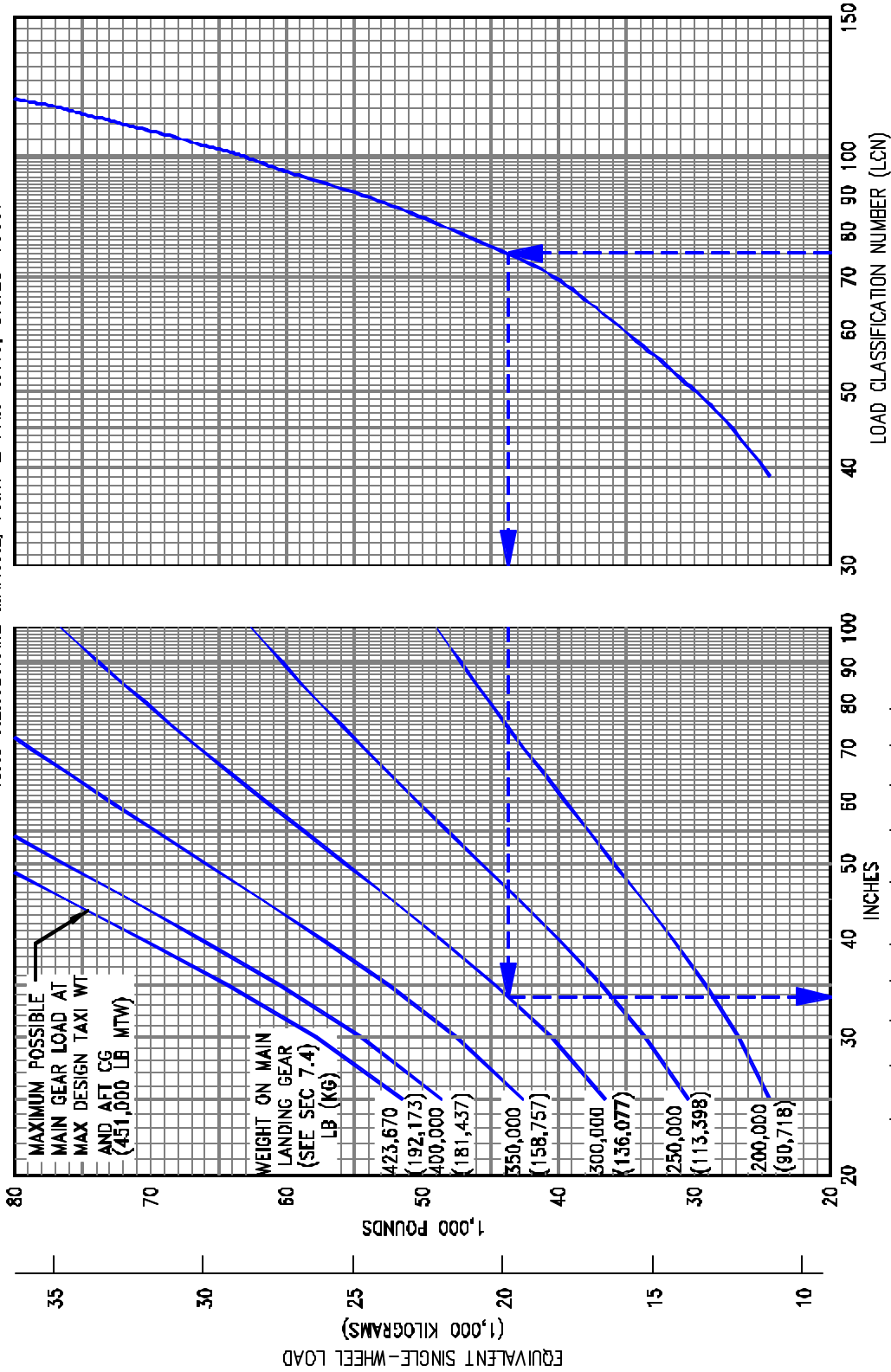

7.8.3 RIGID PAVEMENT REQUIREMENTS - LCN CONVERSION
 MODEL 767-400ER

7.9 Rigid Pavement Requirements - FAA Design Method

The following rigid-pavement design chart presents data on six incremental main gear loads at the minimum tire pressure required at the maximum design taxi weight.

In the example shown in 7.9.1, the pavement flexural strength is shown at 700 psi, the subgrade strength is shown at $k = 300$, and the annual departure level is 6,000. For these conditions, the required rigid pavement thickness for an airplane with a main gear loading of 350,000 pounds is 12.4 inches.

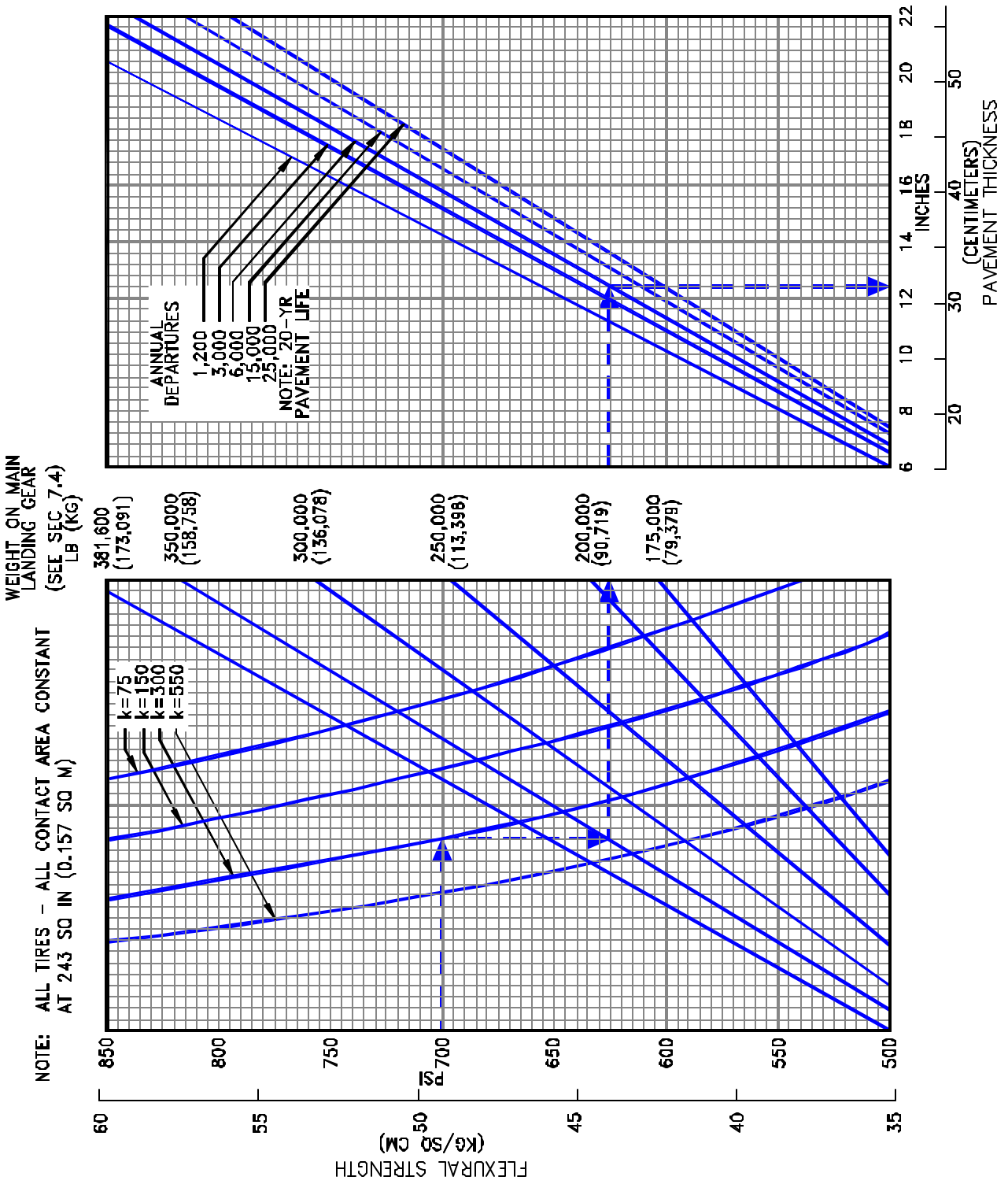

7.9.1 RIGID PAVEMENT REQUIREMENTS - FAA METHOD
 MODEL 767-200, -200ER, -300, -300ER, -300 FREIGHTER

D6-58328

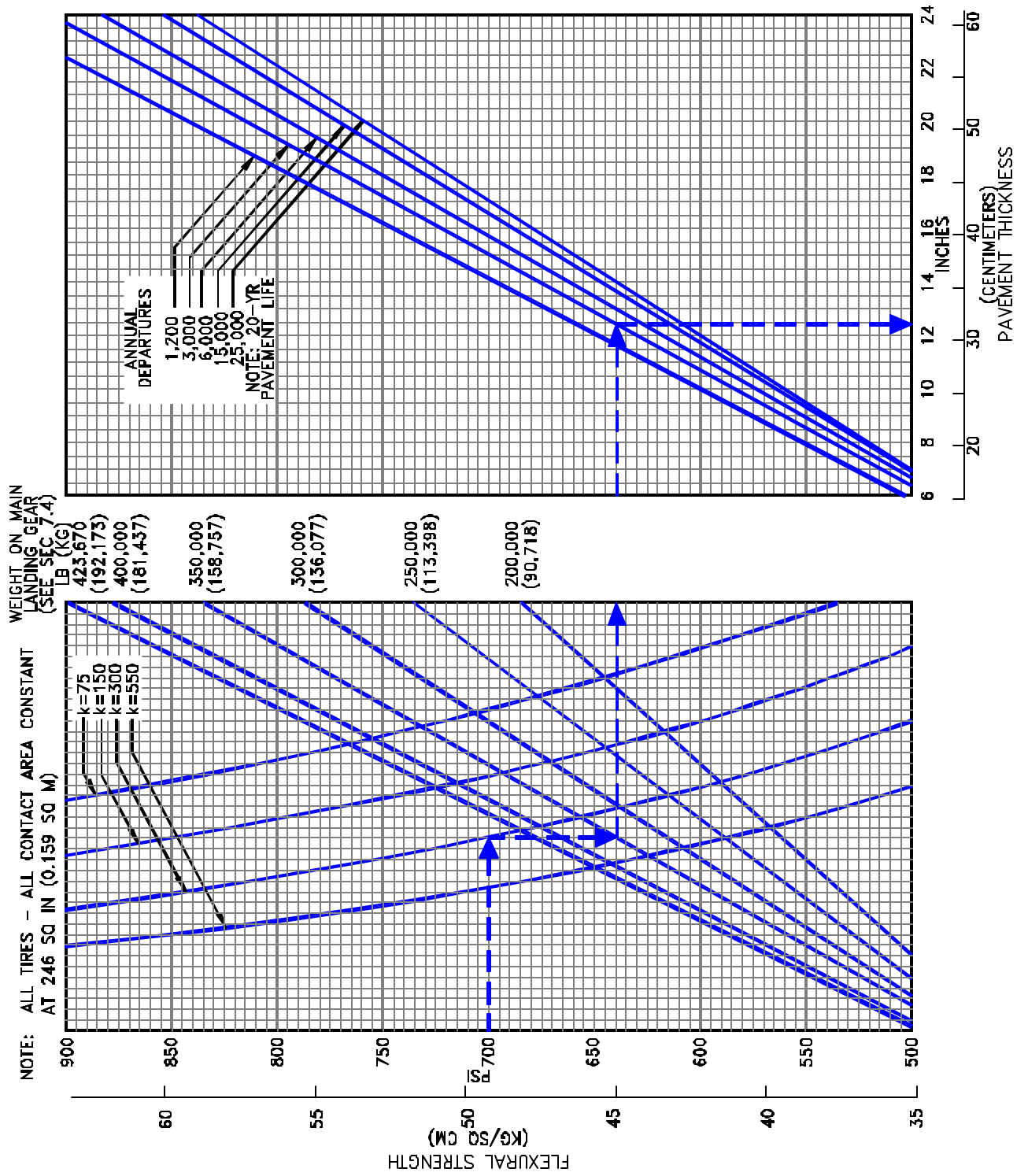

7.9.2 RIGID PAVEMENT REQUIREMENTS - FAA METHOD
 MODEL 767-400ER

7.10 ACN/PCN Reporting System - Flexible and Rigid Pavements

To determine the ACN of an aircraft on flexible or rigid pavement, both the aircraft gross weight and the subgrade strength category must be known. In the chart in 7.10.1, for an aircraft with gross weight of 260,000 lb on a low subgrade strength (Code C), the flexible pavement ACN is 32.4. Referring to 7.10.6, the same aircraft, the same gross weight, and on a low subgrade rigid pavement has an ACN of 35.5.

Note: An aircraft with an ACN equal to or less than the reported PCN can operate on that pavement subject to any limitations on the tire pressure. (Ref.: Amendment 35 to ICAO Annex 14 Aerodrome, Eighth Edition, March 1983.)

The following table provides ACN data in tabular format similar to the one used by ICAO in the “Aerodrome Design Manual Part 3, Pavements.” If the ACN for an intermediate weight between taxi weight and empty fuel weight of the aircraft is required, Figures 7.10.1 through 7.10.10 should be consulted.

AIRCRAFT TYPE	MAXIMUM TAXI WEIGHT MINIMUM WEIGHT (1) LB (KG)	LOAD ON ONE MAIN GEAR LEG (%)	TIRE PRESSURE PSI (MPa)	ACN FOR RIGID PAVEMENT SUBGRADES – MN/m ²				ACN FOR FLEXIBLE PAVEMENT SUBGRADES – CBR			
				HIGH 150	MEDIUM 80	LOW 40	ULTRA LOW 20	HIGH 15	MEDIUM 10	LOW 6	ULTRA LOW 3
767-200	317,000(143,787)	46.15	190 (1.31)	39	46	55	63	40	44	52	71
	181,000(82,100)			17	19	22	25	17	18	20	25
767-200ER	396,000(179,623)	45.41	190 (1.31)	44	52	62	71	45	50	60	80
	182,000(82,600)			17	18	21	25	17	18	20	25
767-300	352,000(159,665)	46.14	195(1.34)	40	47	57	66	42	46	55	75
	190,000(86,200)			18	20	24	28	19	20	22	29
767-300ER 737-300F	413,000(187,334)	46.2	200(1.38)	40	47	57	66	42	46	55	75
	198,000(89,811)			18	20	24	28	19	20	22	29
767-400ER	451,000(204,570)	46.98	215(1.48)	58	68	80	91	56	63	77	99
	229,000(103,900)			24	27	32	37	24	26	29	38

(1) Minimum weight used solely as a baseline for ACN curve generation.

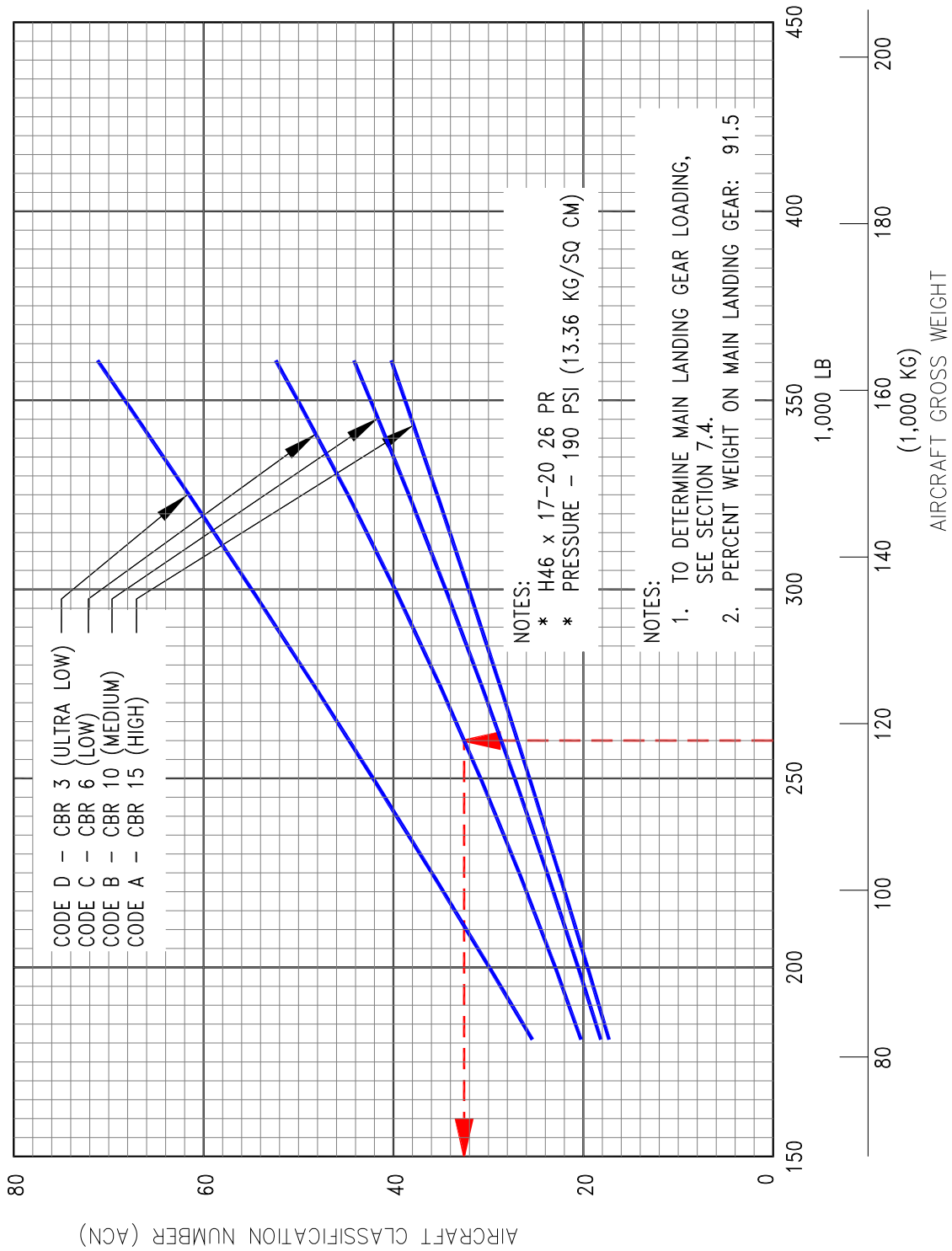

7.10.1 AIRCRAFT CLASSIFICATION NUMBER - FLEXIBLE PAVEMENT
 MODEL 767-200

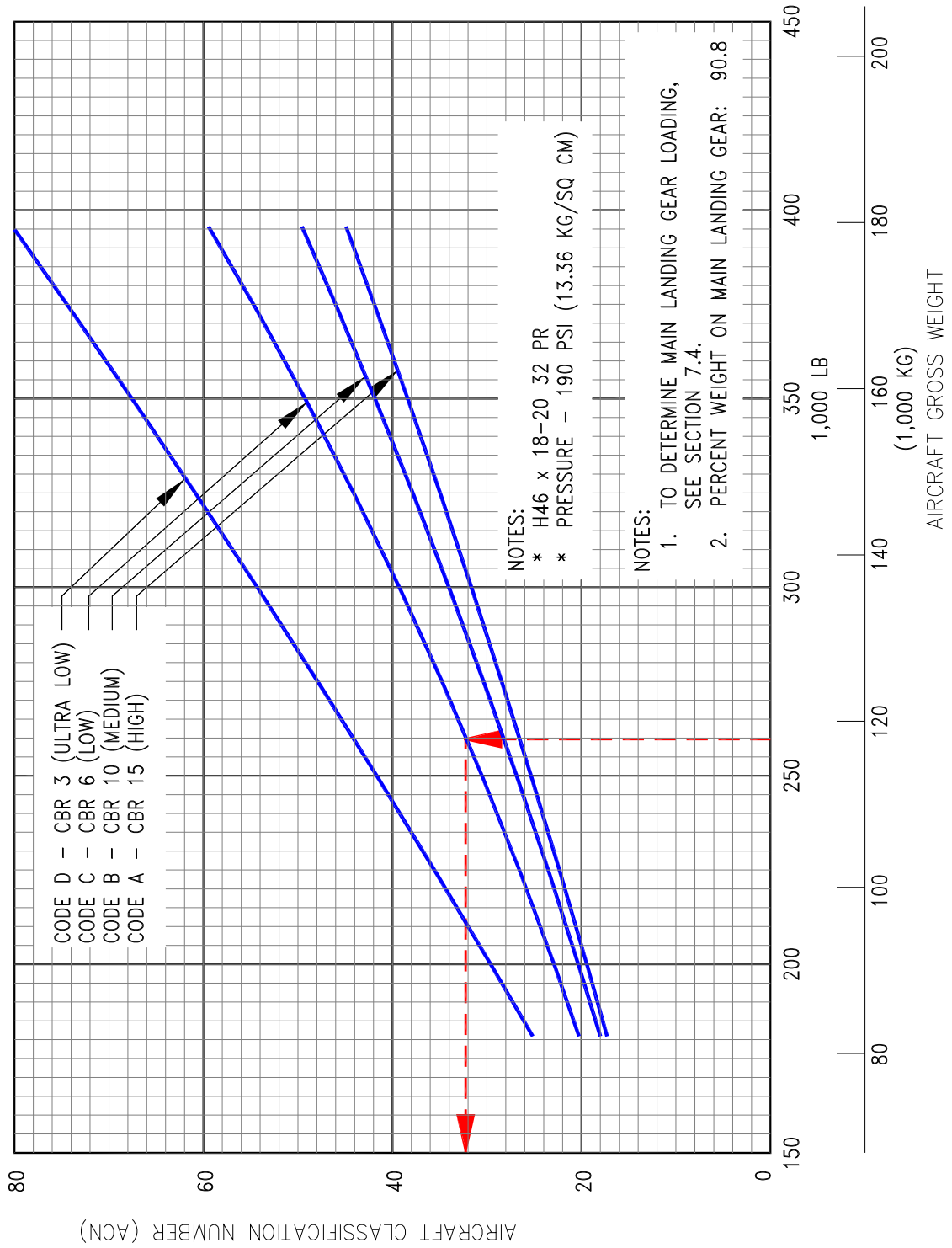

7.10.2 AIRCRAFT CLASSIFICATION NUMBER - FLEXIBLE PAVEMENT
MODEL 767--200ER

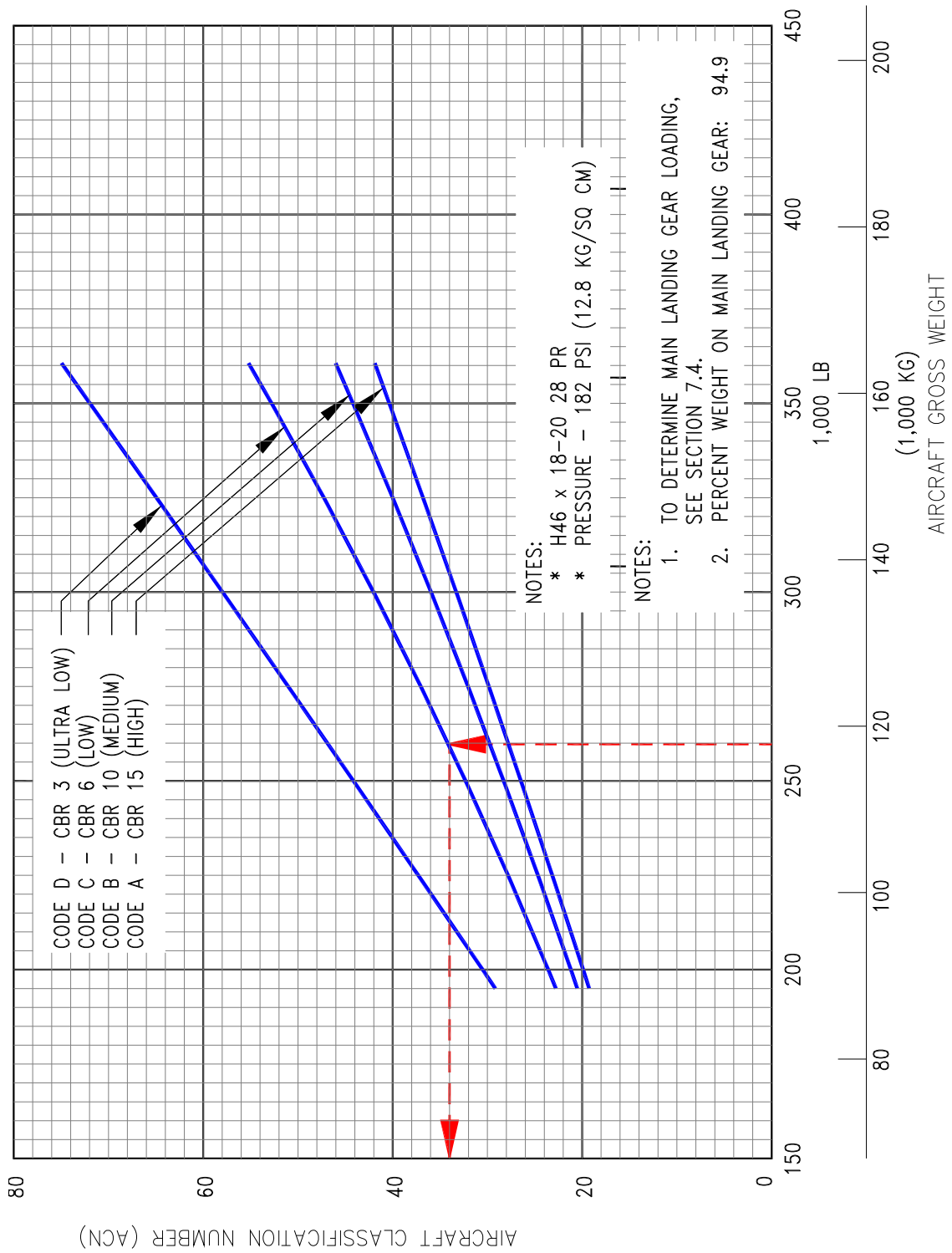

7.10.3 AIRCRAFT CLASSIFICATION NUMBER - FLEXIBLE PAVEMENT
 MODEL 767-300

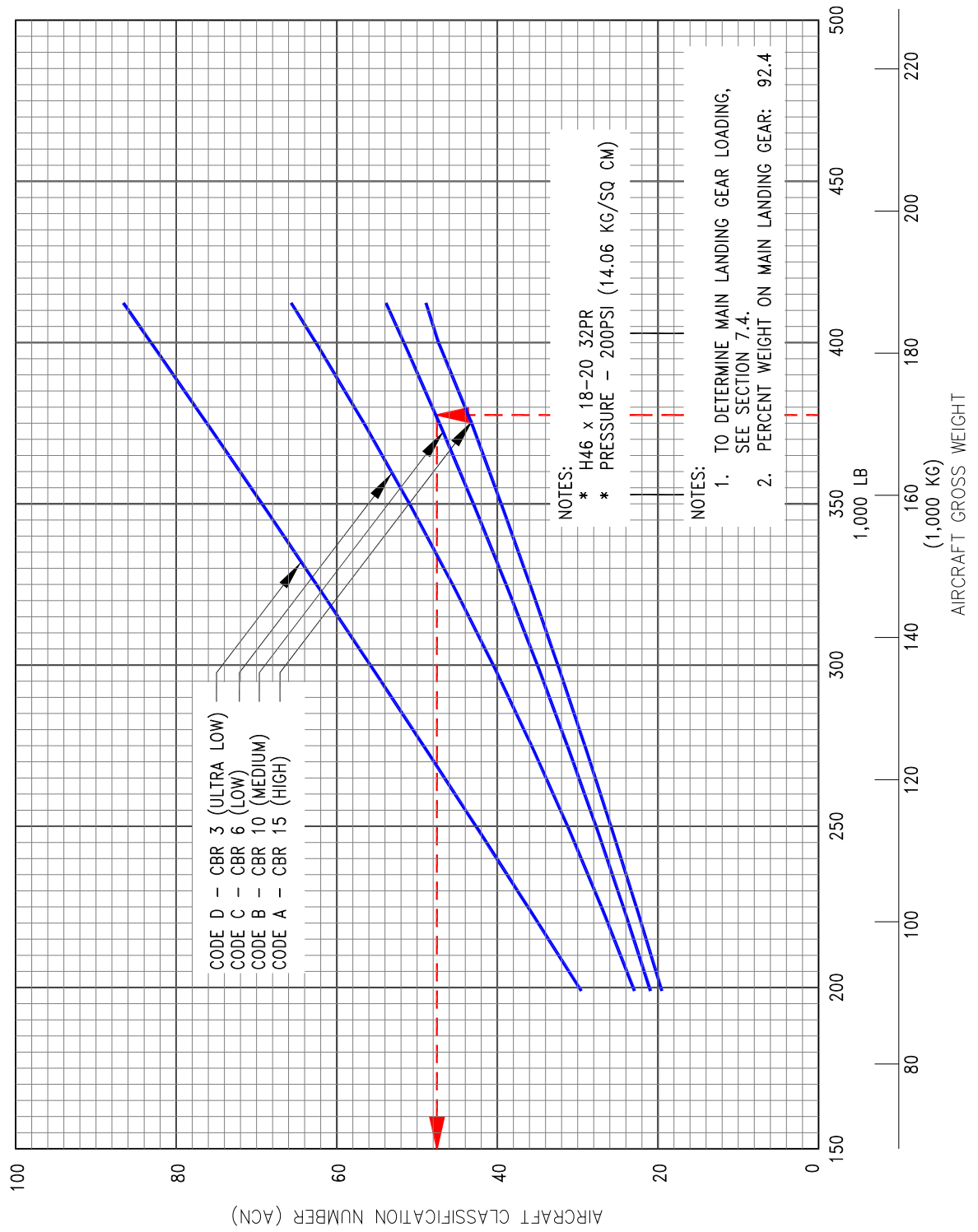

7.10.4 AIRCRAFT CLASSIFICATION NUMBER - FLEXIBLE PAVEMENT
 MODEL 767-300ER, -300 FREIGHTER

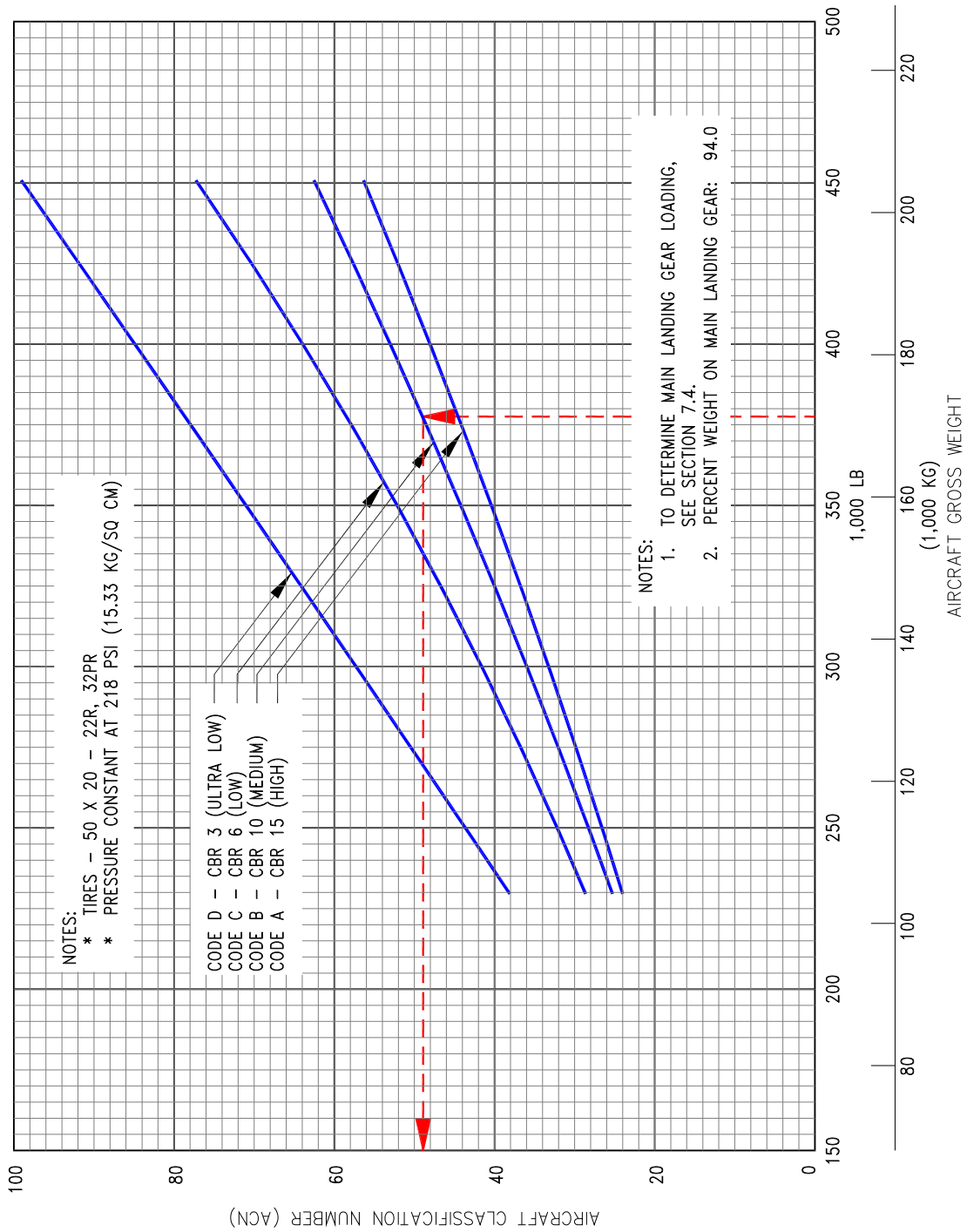

7.10.5 AIRCRAFT CLASSIFICATION NUMBER - FLEXIBLE PAVEMENT
 MODEL 767-400ER

NOTES:
 * H45 X 17-20 26 PR
 * PRESSURE - 190 PSI (13.36 KG/CM SQ)

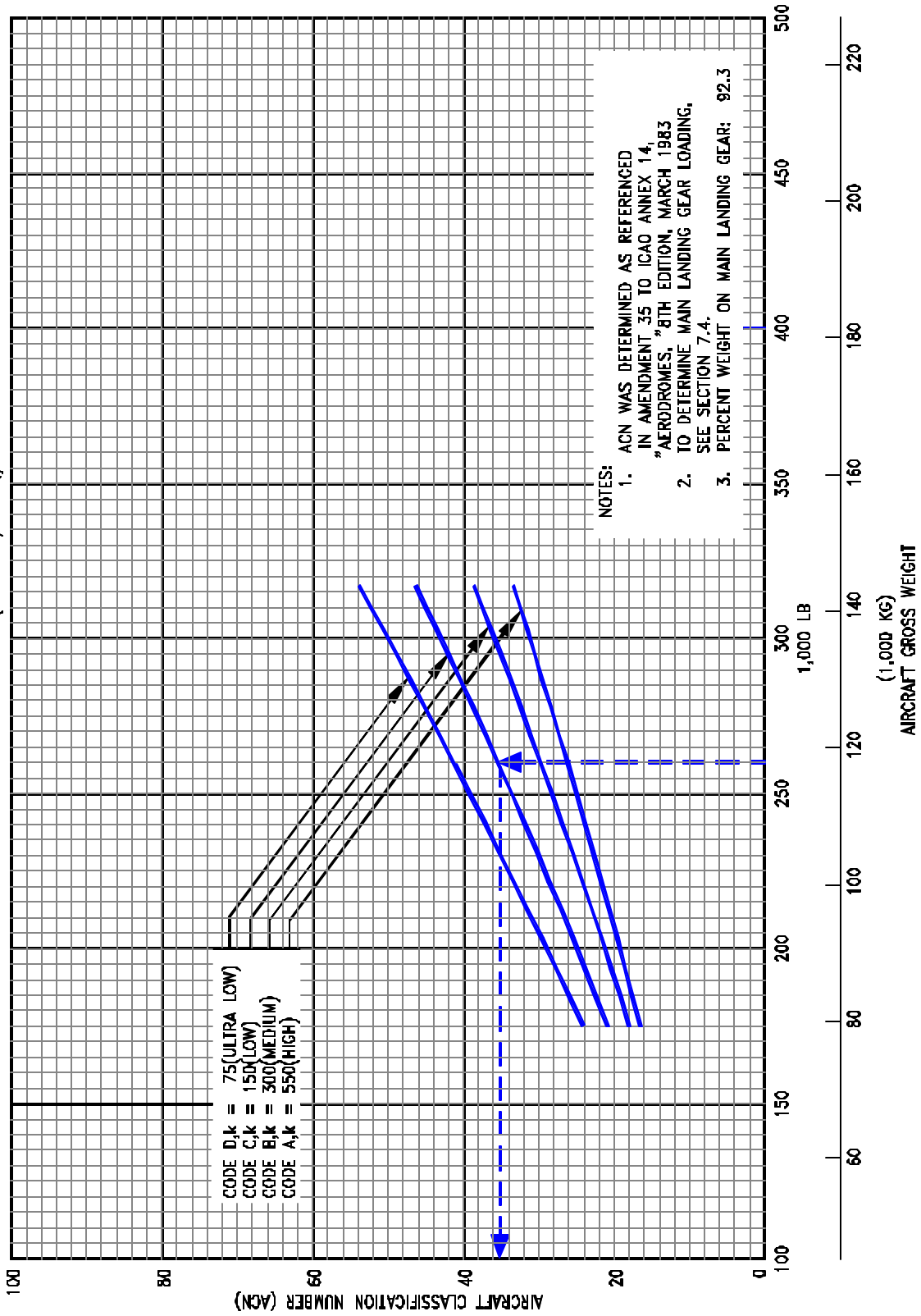

NOTES:
 1. ACN WAS DETERMINED AS REFERENCED IN AMENDMENT 35 TO ICAO ANNEX 14, "AERODROMES," 8TH EDITION, MARCH 1983.
 2. TO DETERMINE MAIN LANDING GEAR LOADING, SEE SECTION 7.4.
 3. PERCENT WEIGHT ON MAIN LANDING GEAR: 92.3

7.10.6 AIRCRAFT CLASSIFICATION NUMBER - RIGID PAVEMENT
 MODEL 767-200

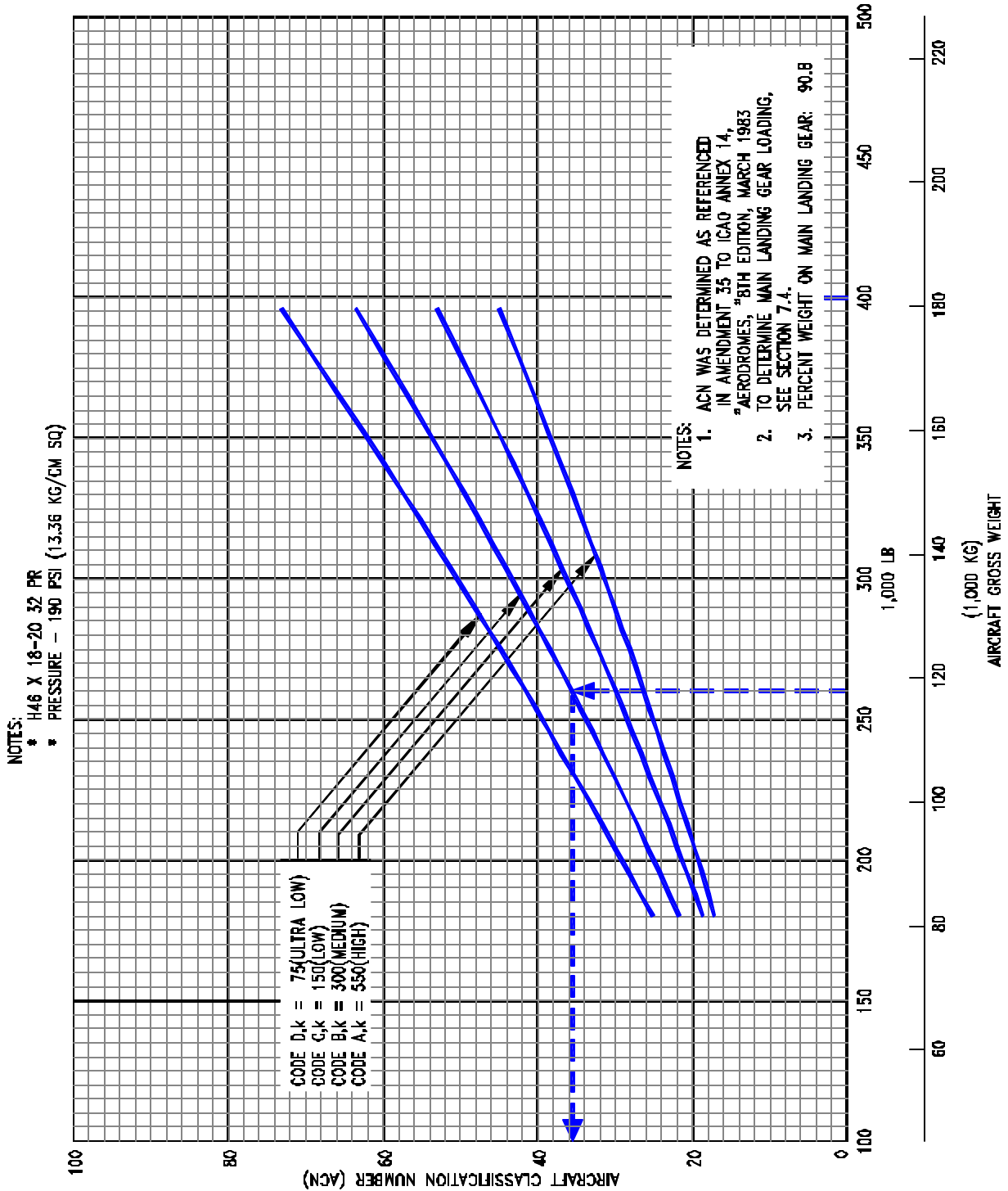

7.10.7 AIRCRAFT CLASSIFICATION NUMBER - RIGID PAVEMENT
 MODEL 767-200ER

NOTES:
 * H46 X 18-20 28 PR
 * PRESSURE - 195PSI (13.71 KG/CM SQ)

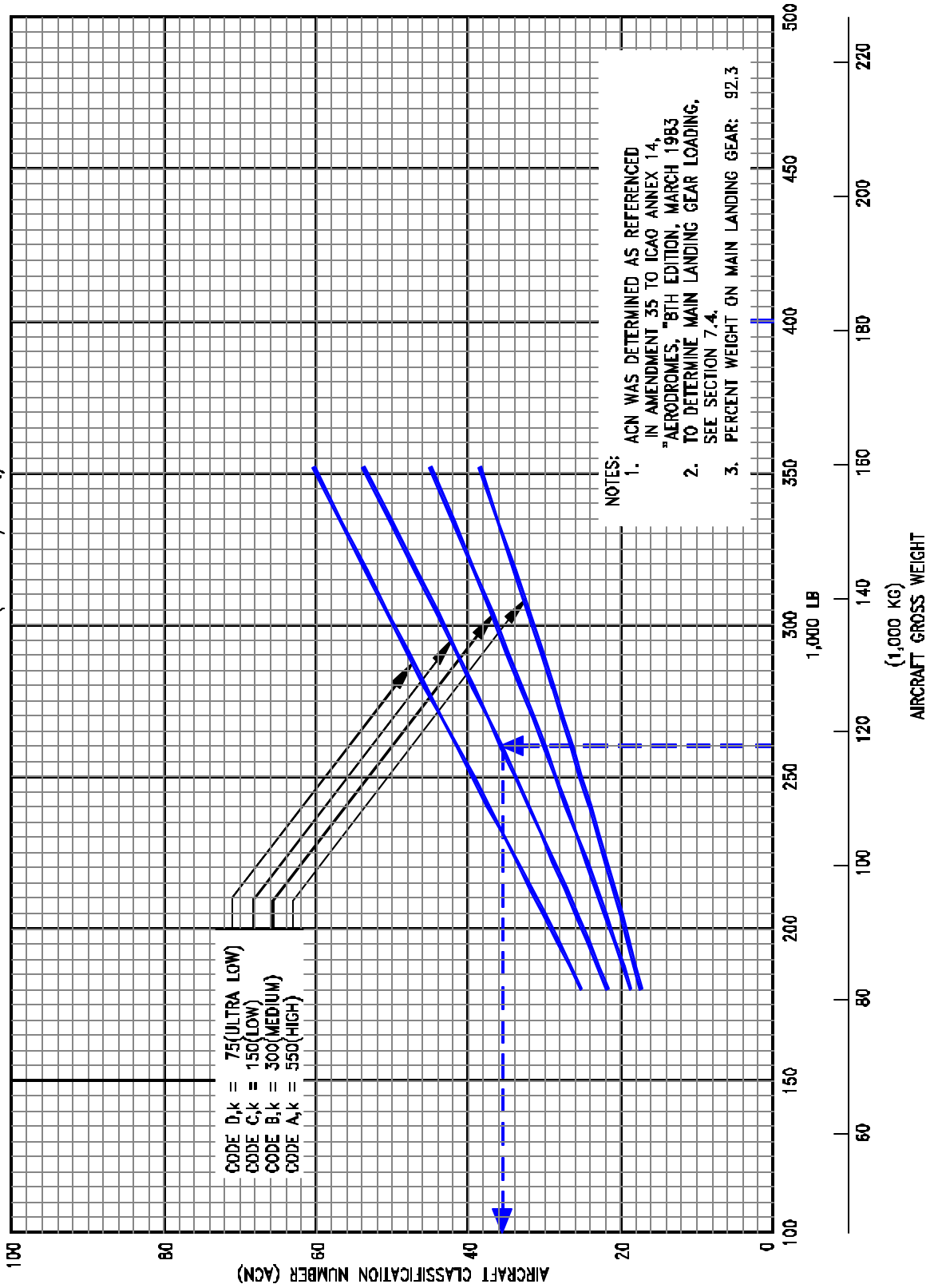

7.10.8 AIRCRAFT CLASSIFICATION NUMBER - RIGID PAVEMENT
 MODEL 767-300

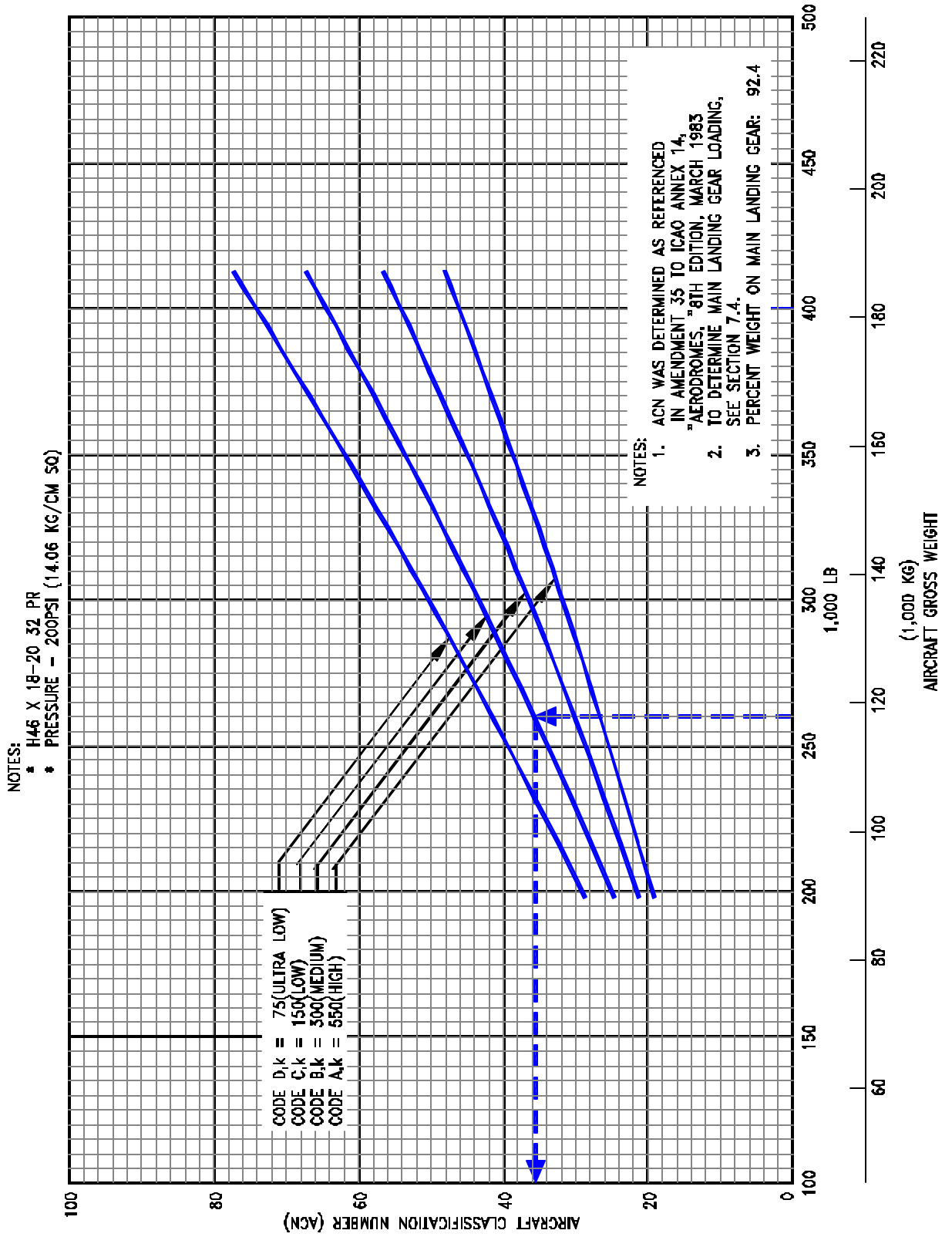

7.10.9 AIRCRAFT CLASSIFICATION NUMBER - RIGID PAVEMENT
 MODEL 767-300ER, -300 FREIGHTER

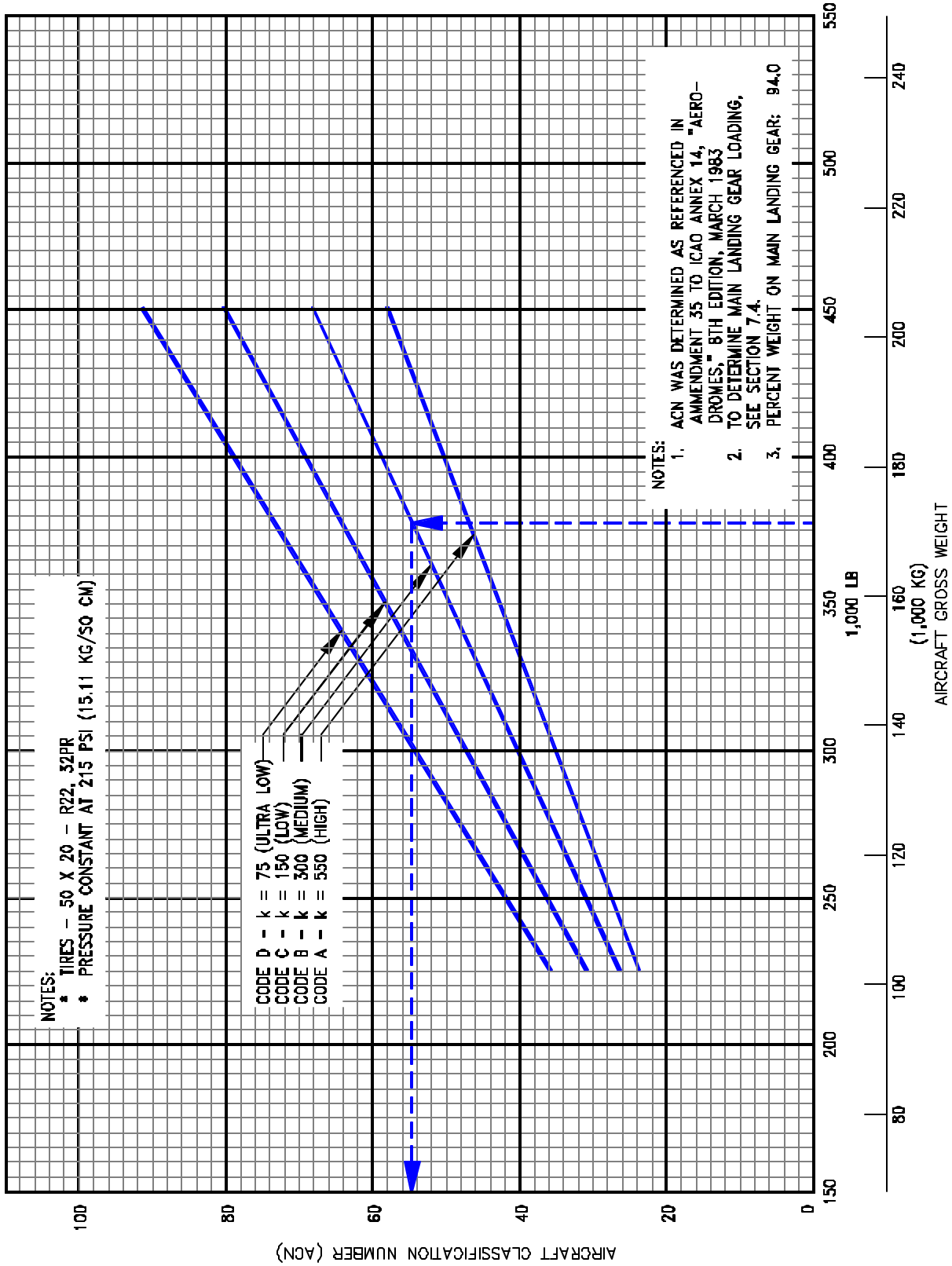

7.10.10 AIRCRAFT CLASSIFICATION NUMBER - RIGID PAVEMENT
 MODEL 767-400ER

8.0 FUTURE 767 DERIVATIVE AIRPLANES

8.0 FUTURE 767 DERIVATIVE AIRPLANES

Several derivatives are being studied to provide additional capabilities of the 767 family of airplanes. Future growth versions could require additional passenger or cargo capacity or increased range or both. Whether these growth versions could be built would depend entirely on airline requirements. In any event, impact on airport facilities will be a consideration in the configuration and design.

9.0 SCALED 767 DRAWINGS

9.1 – 9.5 Model 767-200, -200ER

9.6 – 9.10 Model 767-300, -300ER

9.11 – 9.15 Model 767-300 Freighter

9.16 – 9.20 Model 767-400ER

9.0 SCALED DRAWINGS

The drawings in the following pages show airplane plan view drawings, drawn to approximate scale as noted. The drawings may not come out to exact scale when printed or copied from this document. Printing scale should be adjusted when attempting to reproduce these drawings. Three-view drawing files of the 767-200, -200ER, -300, -300ER, -300 Freighter, -400ER, along with other Boeing airplane models, can be downloaded from the following website:

<http://www.boeing.com/airports>

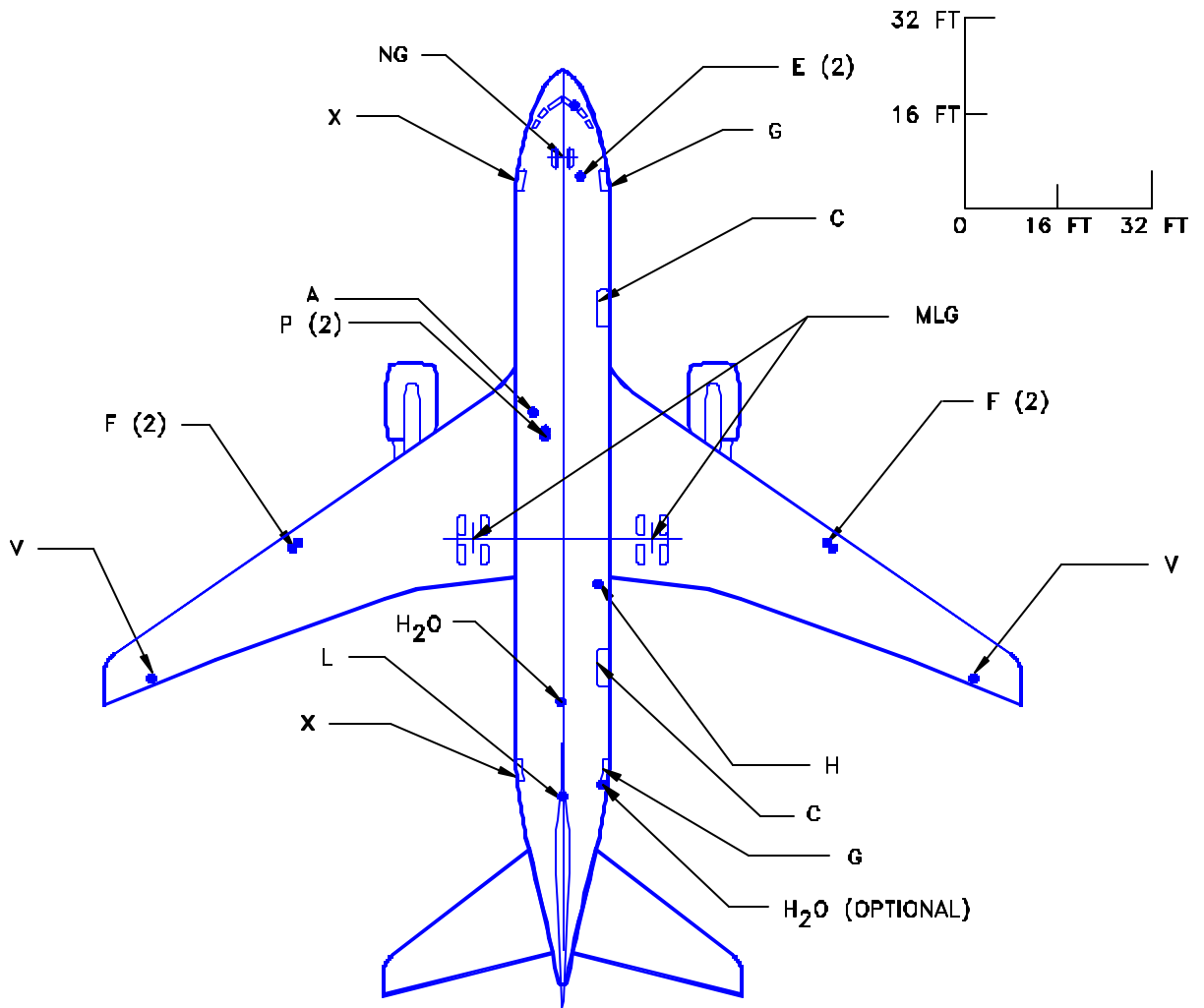

LEGEND

- A CONDITIONED AIR
- C CARGO DOOR
- E ELECTRICAL
- F FUEL
- G GALLEY SERVICE DOOR
- H HYDRAULIC
- H₂O POTABLE WATER
- L LAVATORY
- MLG MAIN LANDING GEAR
- NG NOSE GEAR
- P PNEUMATIC
- V FUEL VENT
- X PASSENGER DOOR

NOTE: FOR TURNING RADIUS DATA
SEE SECTIONS 4.2 AND 4.3

NOTE: WHEN PRINTING THIS DRAWING, MAKE SURE TO ADJUST FOR PROPER SCALING

9.1.1 SCALED DRAWING - 1 IN. = 32 FT
MODEL 767-200, -200ER

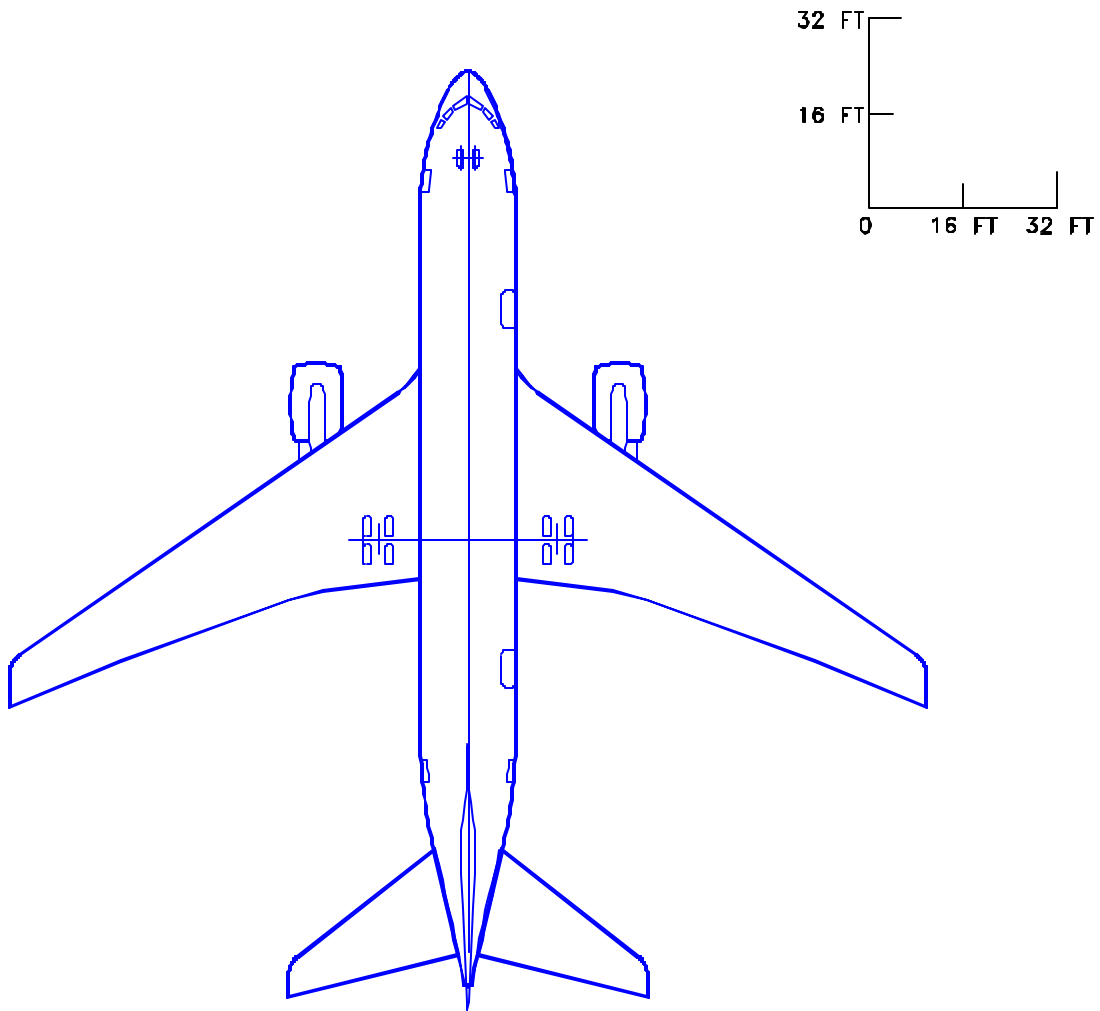

NOTE: WHEN PRINTING THIS DRAWING, MAKE SURE TO ADJUST FOR PROPER SCALING

9.1.2 SCALED DRAWING - 1 IN. = 32 FT
MODEL 767-200, -200ER

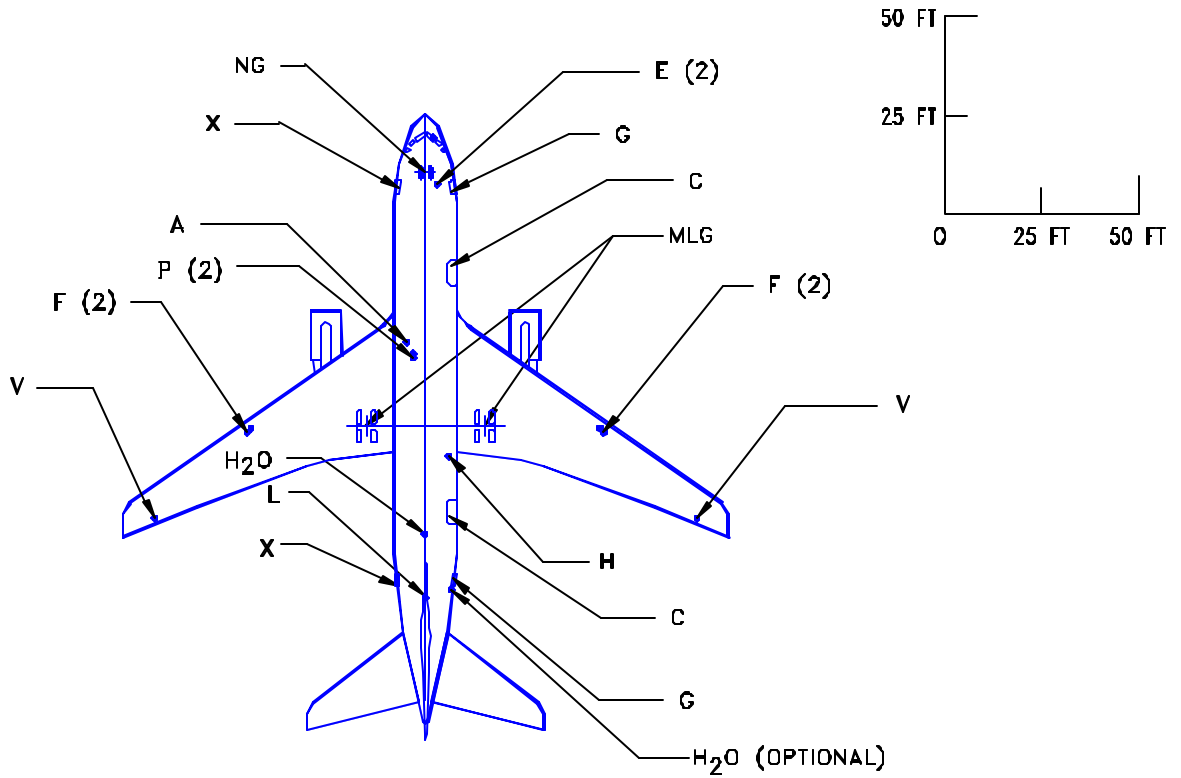

LEGEND

- A CONDITIONED AIR
- C CARGO DOOR
- E ELECTRICAL
- F FUEL
- G GALLEY SERVICE DOOR
- H HYDRAULIC
- H₂O POTABLE WATER
- L LAVATORY
- MLG MAIN LANDING GEAR
- NG NOSE GEAR
- P PNEUMATIC
- V FUEL VENT
- X PASSENGER DOOR

NOTE: FOR TURNING RADIUS DATA
SEE SECTIONS 4.2 AND 4.3

NOTE: WHEN PRINTING THIS DRAWING, MAKE SURE TO ADJUST FOR PROPER SCALING

9.2.1 SCALED DRAWING - 1 IN. = 50 FT
MODEL 767-200, -200ER

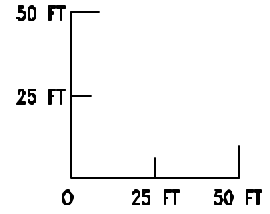
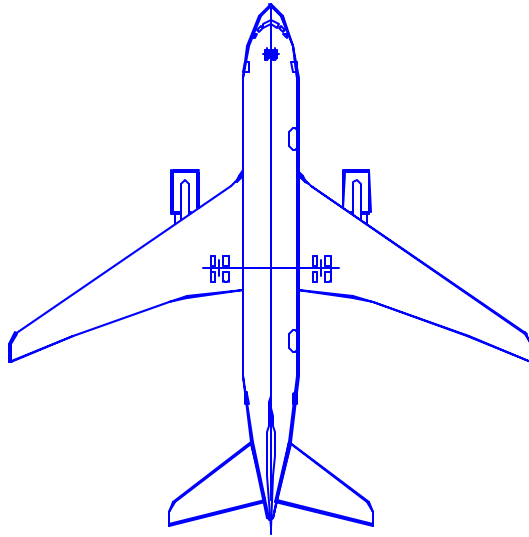

NOTE: WHEN PRINTING THIS DRAWING, MAKE SURE TO ADJUST FOR PROPER SCALING

9.2.2 SCALED DRAWING - 1 IN. = 50 FT
MODEL 767-200, -200ER

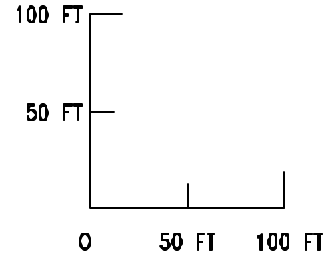
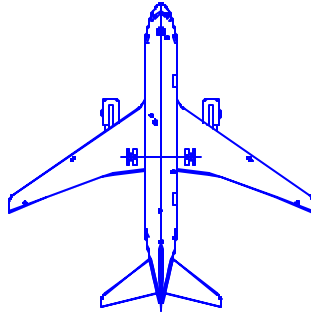

NOTE:
SEE SEC 9.1.1
LOCATIONS AND IDENTIFICATIONS
OF SERVICE POINTS

LEGEND

A CONDITIONED AIR
C CARGO DOOR
E ELECTRICAL
F FUEL
G GALLEY SERVICE DOOR
H HYDRAULIC
H₂O POTABLE WATER
L LAVATORY
MLG MAIN LANDING GEAR
NG NOSE GEAR
P PNEUMATIC
V FUEL VENT
X PASSENGER DOOR

NOTE: FOR TURNING RADIUS DATA
SEE SECTIONS 4.2 AND 4.3

NOTE: WHEN PRINTING THIS DRAWING, MAKE SURE TO ADJUST FOR PROPER SCALING

9.3.1 SCALED DRAWING - 1 IN = 100 FT
MODEL 767-200, -200ER

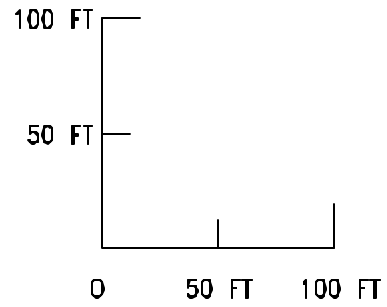
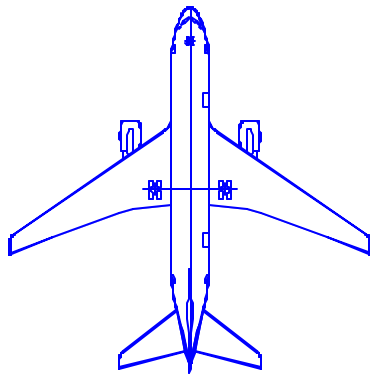

NOTE: WHEN PRINTING THIS DRAWING, MAKE SURE TO ADJUST FOR PROPER SCALING

9.3.2 SCALED DRAWING - 1 IN = 100 FT
MODEL 767-200, -200ER

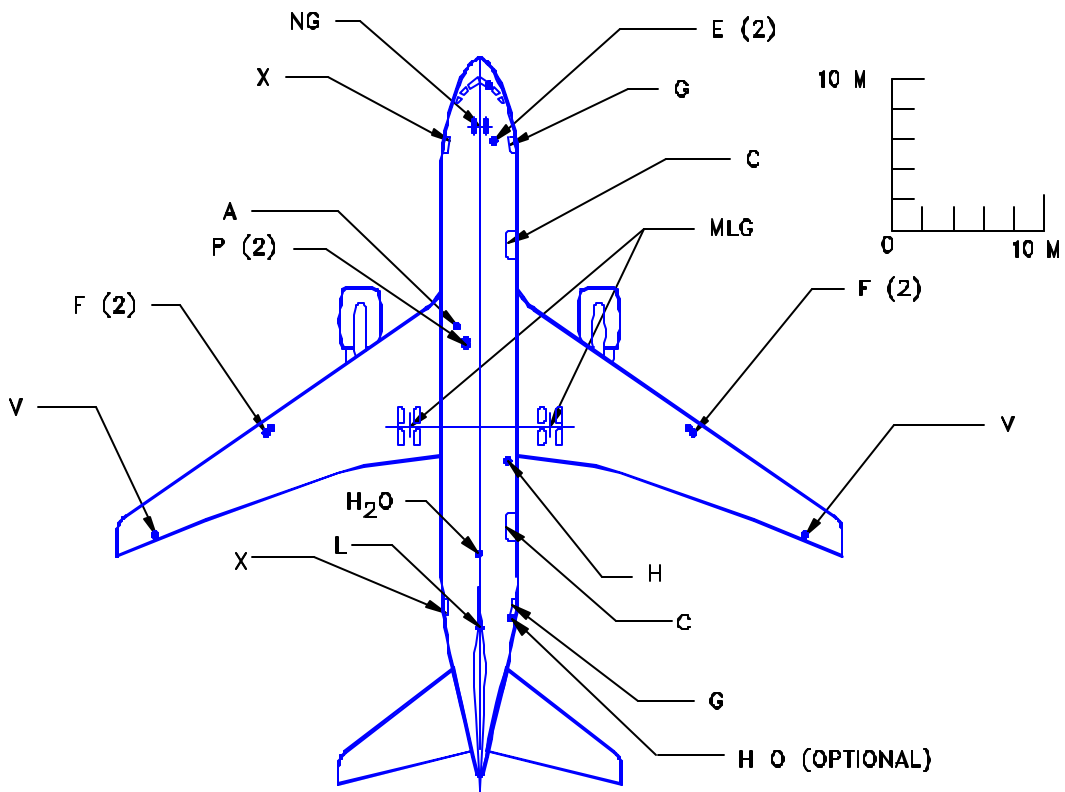

LEGEND

- A CONDITIONED AIR
- C CARGO DOOR
- E ELECTRICAL
- F FUEL
- G GALLEY SERVICE DOOR
- H HYDRAULIC
- H₂O POTABLE WATER
- L LAVATORY
- MLG MAIN LANDING GEAR
- NG NOSE GEAR
- P PNEUMATIC
- V FUEL VENT
- X PASSENGER DOOR

NOTE: FOR TURNING RADIUS DATA
SEE SECTIONS 4.2 AND 4.3

NOTE: WHEN PRINTING THIS DRAWING, MAKE SURE TO ADJUST FOR PROPER SCALING

9.4.1 SCALED DRAWING - 1:500
MODEL 767-200, -200ER

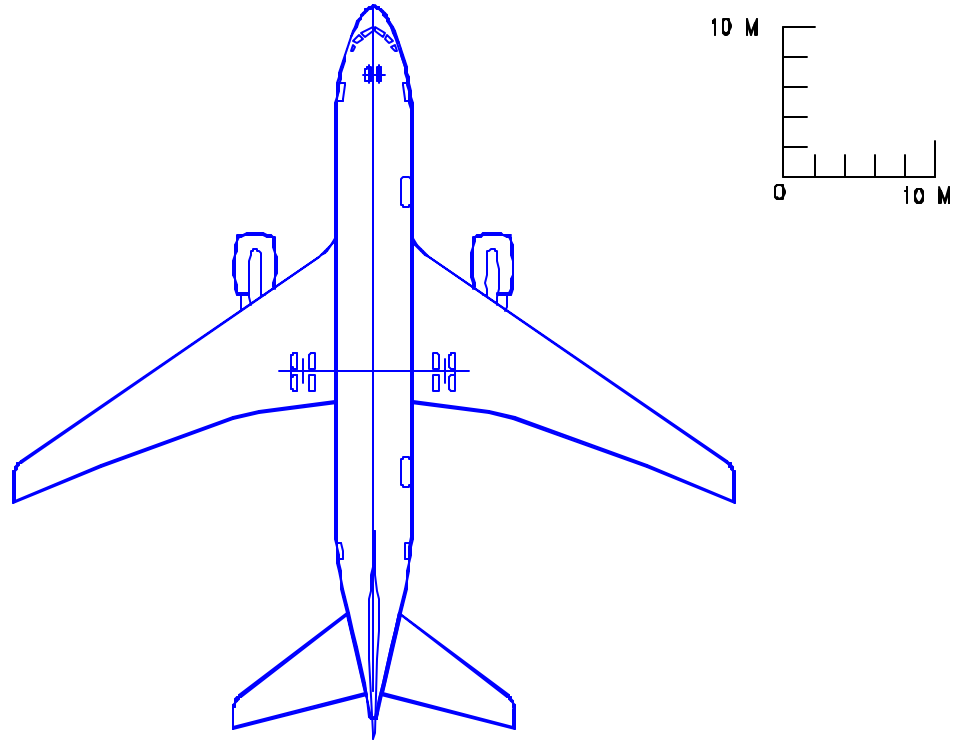

NOTE: WHEN PRINTING THIS DRAWING, MAKE SURE TO ADJUST FOR PROPER SCALING

9.4.2 SCALED DRAWING - 1:500
MODEL 767-200, -200ER

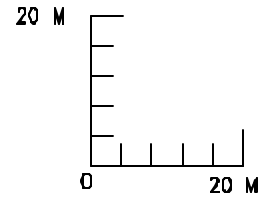
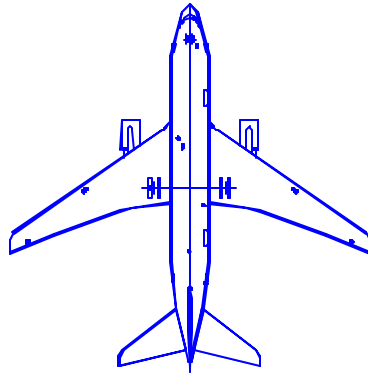

NOTE:

SEE SEC 9.1.1
LOCATIONS AND IDENTIFICATIONS
OF SERVICE POINTS

LEGEND

A CONDITIONED AIR
C CARGO DOOR
E ELECTRICAL
F FUEL
G GALLEY SERVICE DOOR
H HYDRAULIC
H₂O POTABLE WATER
L LAVATORY
MLG MAIN LANDING GEAR
NG NOSE GEAR
P PNEUMATIC
V FUEL VENT
X PASSENGER DOOR

NOTE: FOR TURNING RADIUS DATA
SEE SECTIONS 4.2 AND 4.3

NOTE: WHEN PRINTING THIS DRAWING, MAKE SURE TO ADJUST FOR PROPER SCALING

9.5.1 SCALED DRAWING - 1:1000
MODEL 767-200, -200ER

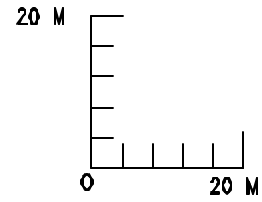
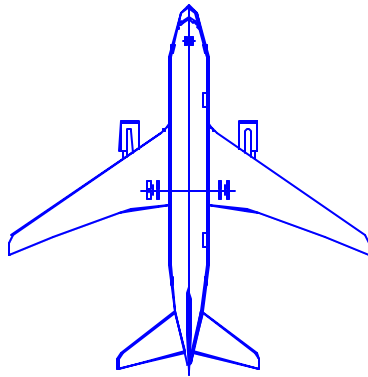

NOTE: WHEN PRINTING THIS DRAWING, MAKE SURE TO ADJUST FOR PROPER SCALING

9.5.2 SCALED DRAWING - 1:1000
MODEL 767-200, -200ER

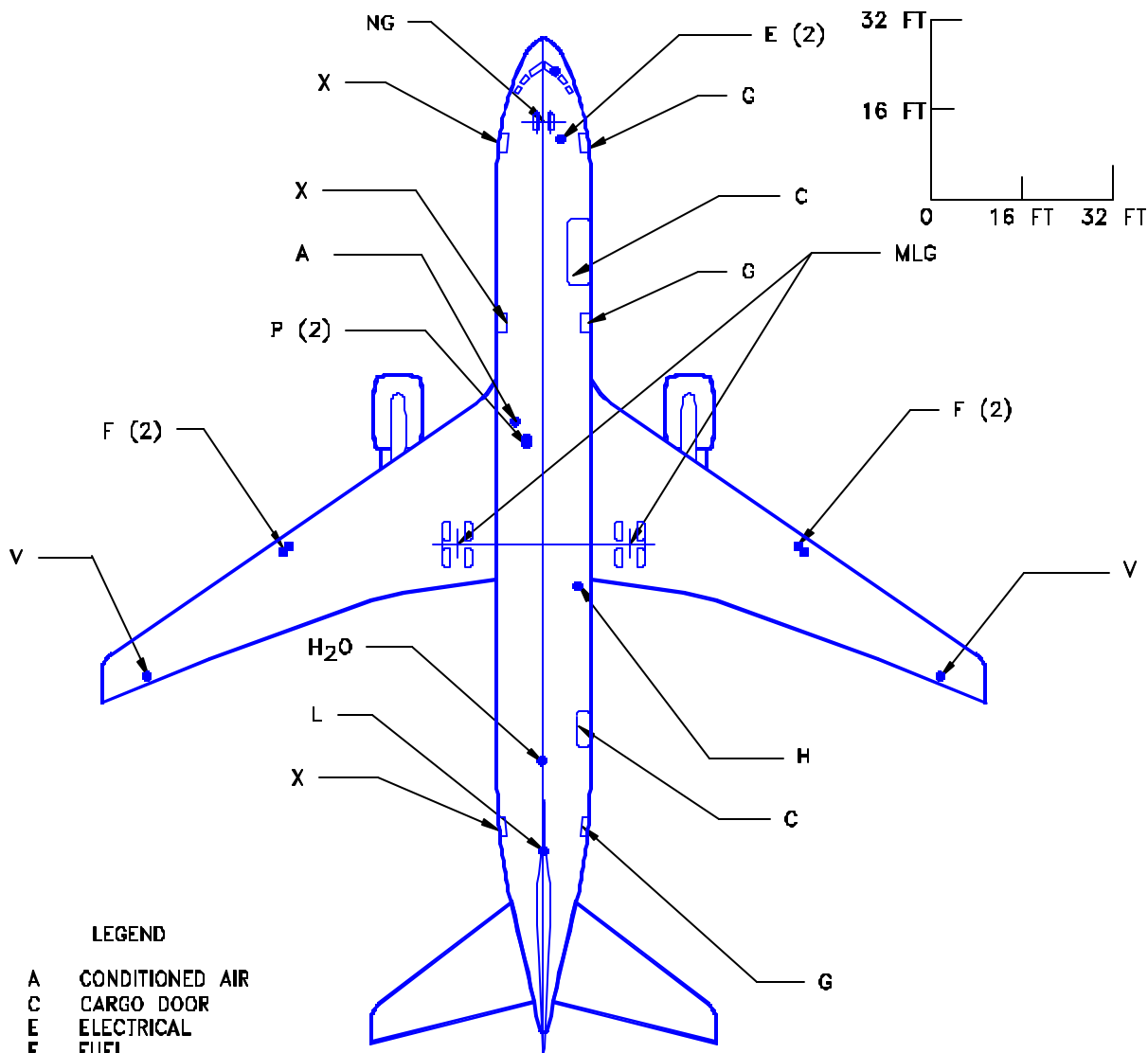

LEGEND

- A CONDITIONED AIR
- C CARGO DOOR
- E ELECTRICAL
- F FUEL
- G GALLEY SERVICE DOOR
- H HYDRAULIC
- H₂O POTABLE WATER
- L LAVATORY
- MLG MAIN LANDING GEAR
- NG NOSE GEAR
- P PNEUMATIC
- V FUEL VENT
- X PASSENGER DOOR

NOTE: FOR TURNING RADIUS DATA
SEE SECTIONS 4.2 AND 4.3

NOTE: WHEN PRINTING THIS DRAWING, MAKE SURE TO ADJUST FOR PROPER SCALING

9.6.1 SCALED DRAWING - 1 IN. = 32 FT
MODEL 767-300, -300ER

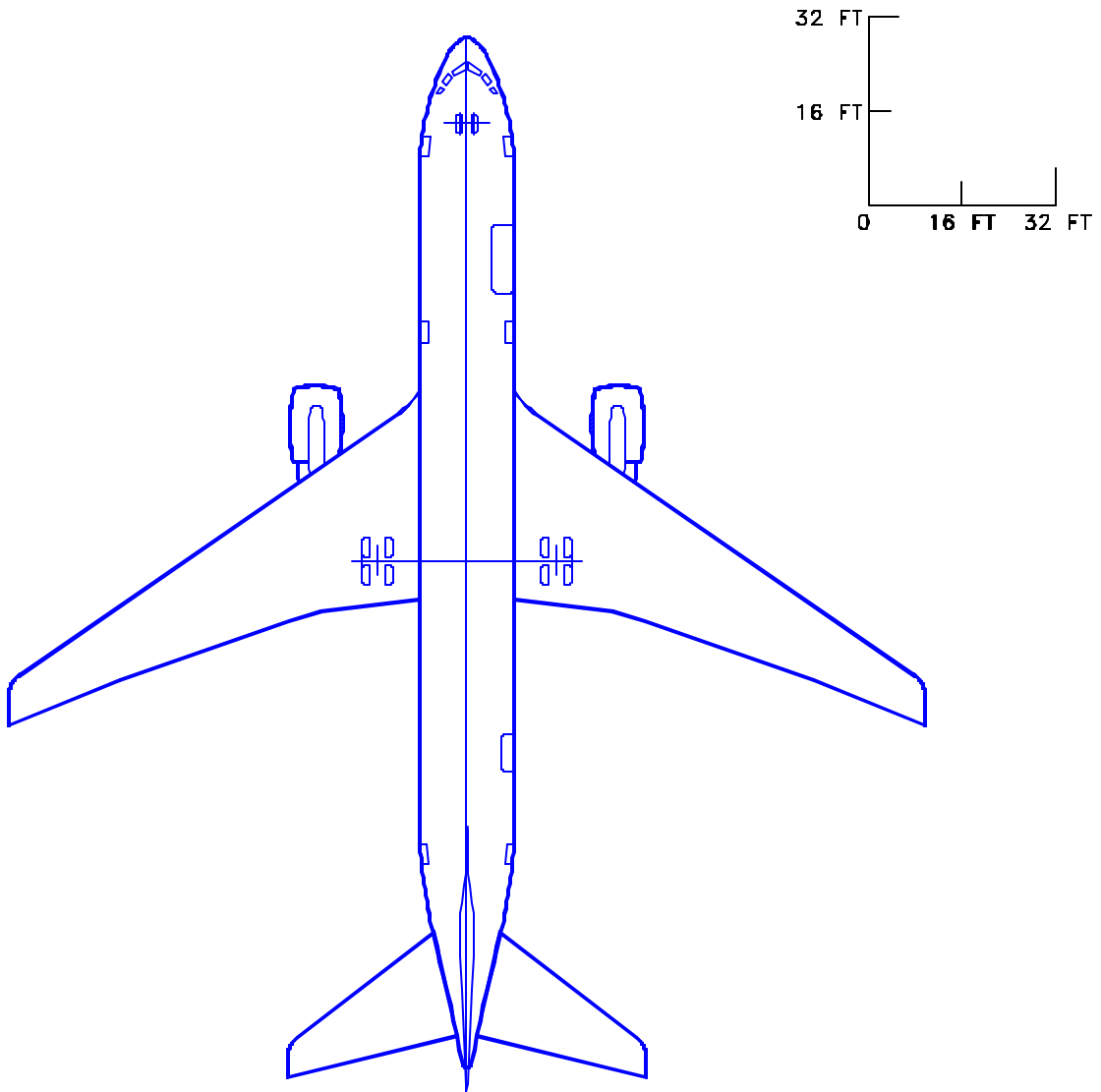

NOTE: WHEN PRINTING THIS DRAWING, MAKE SURE TO ADJUST FOR PROPER SCALING

9.6.2 SCALED DRAWING - 1 IN. = 32 FT
MODEL 767-300, -300ER

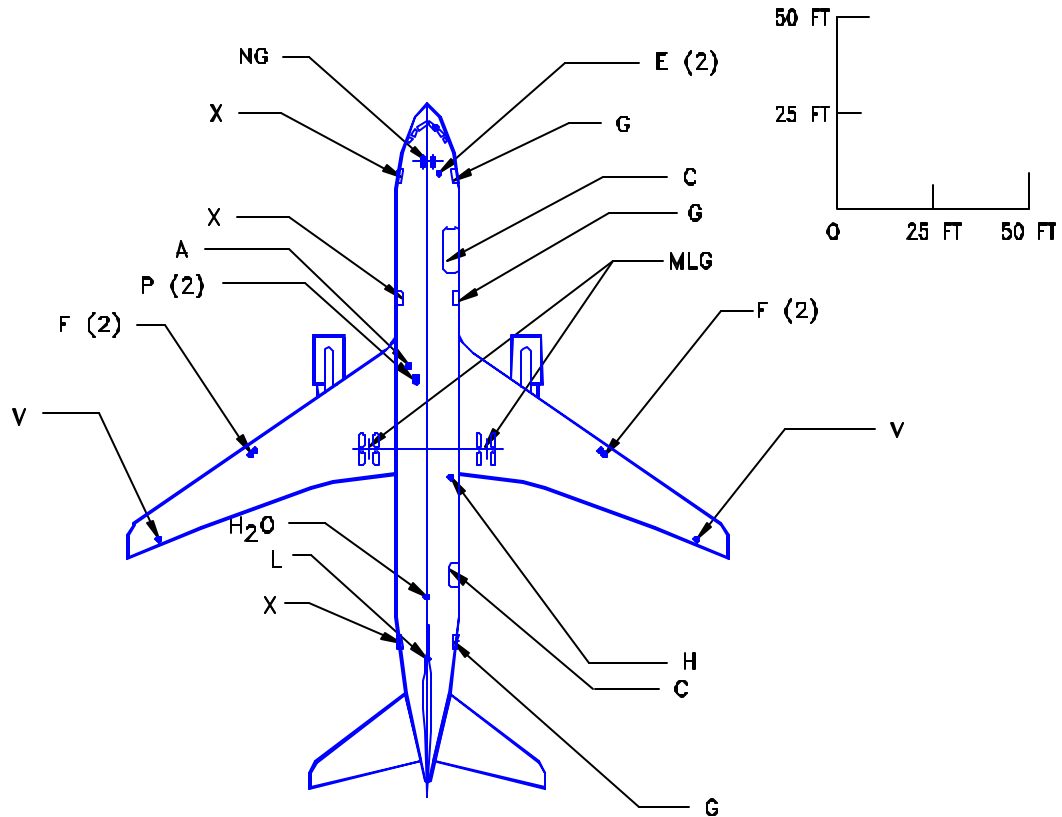

LEGEND

- A** CONDITIONED AIR
- C** CARGO DOOR
- E** ELECTRICAL
- F** FUEL
- G** GALLEY SERVICE DOOR
- H** HYDRAULIC
- H₂O** POTABLE WATER
- L** LAVATORY
- MLG** MAIN LANDING GEAR
- NG** NOSE GEAR
- P** PNEUMATIC
- V** FUEL VENT
- X** PASSENGER DOOR

NOTE: FOR TURNING RADIUS DATA
SEE SECTIONS 4.2 AND 4.3

NOTE: WHEN PRINTING THIS DRAWING, MAKE SURE TO ADJUST FOR PROPER SCALING

9.7.1 SCALED DRAWING - 1 IN. = 50 FT
MODEL 767-300, -300ER

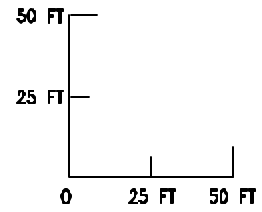
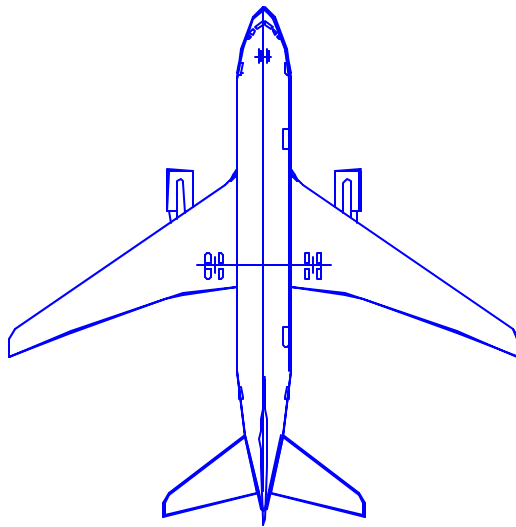

NOTE: WHEN PRINTING THIS DRAWING, MAKE SURE TO ADJUST FOR PROPER SCALING

9.7.2 SCALED DRAWING - 1 IN. = 50 FT
MODEL MODEL 767-300, -300ER

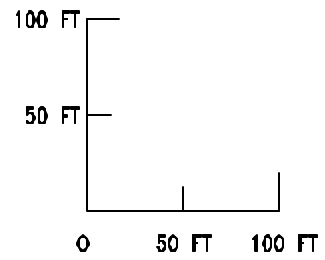
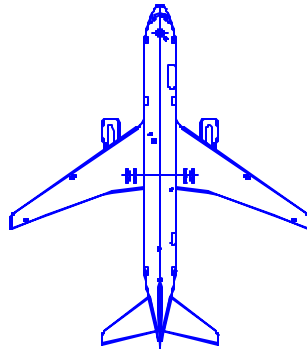

NOTE:

SEE SEC 9.6.1
LOCATIONS AND IDENTIFICATIONS
OF SERVICE POINTS

LEGEND

- A CONDITIONED AIR
- C CARGO DOOR
- E ELECTRICAL
- F FUEL
- G GALLEY SERVICE DOOR
- H HYDRAULIC
- H₂O POTABLE WATER
- L LAVATORY
- MLG MAIN LANDING GEAR
- NG NOSE GEAR
- P PNEUMATIC
- V FUEL VENT
- X PASSENGER DOOR

NOTE: FOR TURNING RADIUS DATA
SEE SECTIONS 4.2 AND 4.3

NOTE: WHEN PRINTING THIS DRAWING, MAKE SURE TO ADJUST FOR PROPER SCALING

9.8.1 SCALED DRAWING - 1 IN = 100 FT
MODEL 767-300, -300ER

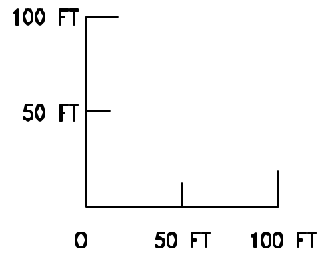
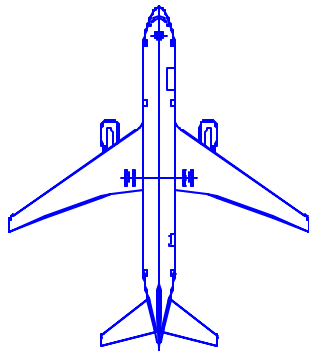

NOTE: WHEN PRINTING THIS DRAWING, MAKE SURE TO ADJUST FOR PROPER SCALING

9.8.2 SCALED DRAWING - 1 IN = 100 FT
MODEL 767-300, -300ER

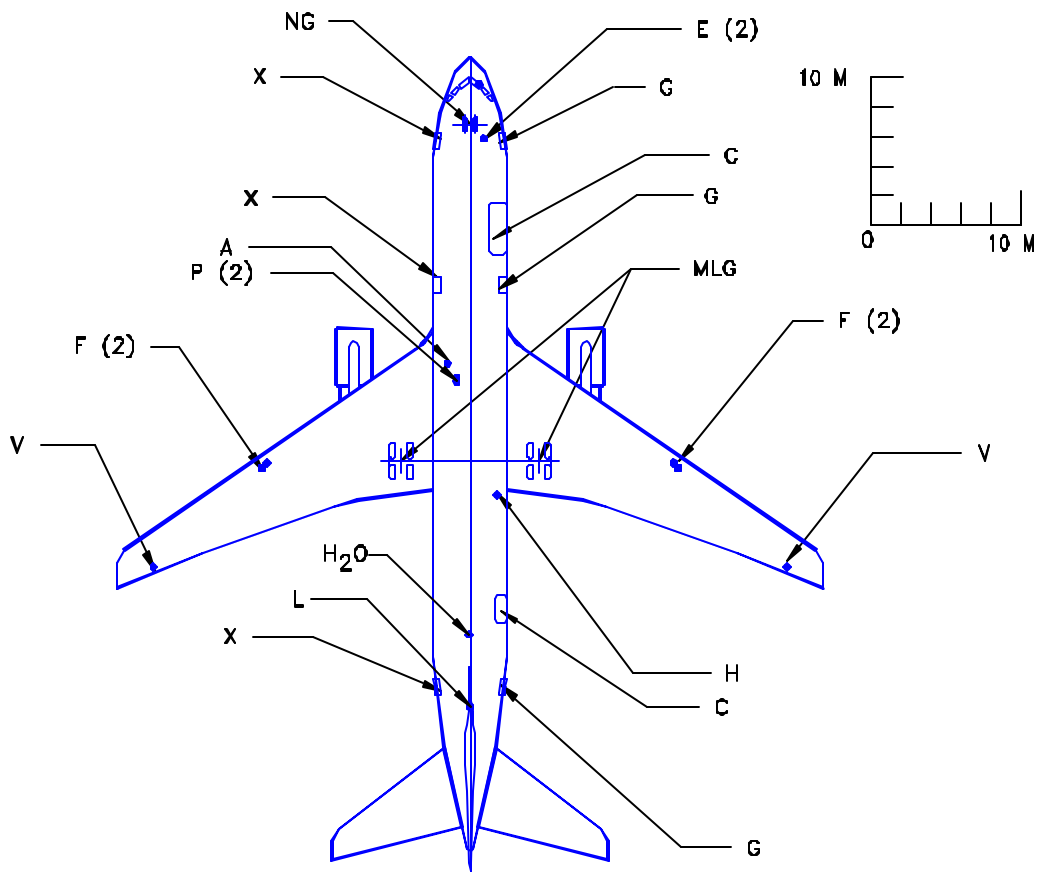

LEGEND

- A CONDITIONED AIR
- C CARGO DOOR
- E ELECTRICAL
- F FUEL
- G GALLEY SERVICE DOOR
- H HYDRAULIC
- H₂O POTABLE WATER
- L LAVATORY
- MLG MAIN LANDING GEAR
- NG NOSE GEAR
- P PNEUMATIC
- V FUEL VENT
- X PASSENGER DOOR

NOTE: FOR TURNING RADIUS DATA
SEE SECTIONS 4.2 AND 4.3

NOTE: WHEN PRINTING THIS DRAWING, MAKE SURE TO ADJUST FOR PROPER SCALING

9.9.1 SCALED DRAWING - 1:500
MODEL 767-300, -300ER

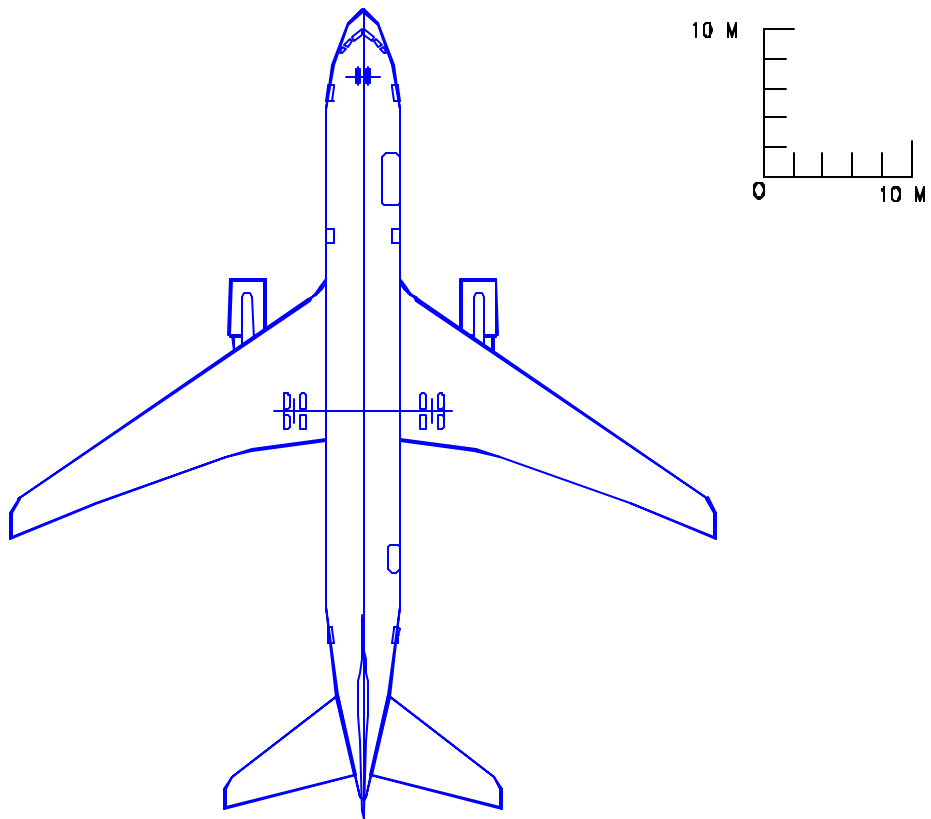

NOTE: WHEN PRINTING THIS DRAWING, MAKE SURE TO ADJUST FOR PROPER SCALING

9.9.2 SCALED DRAWING - 1:500
MODEL 767-300, -300ER

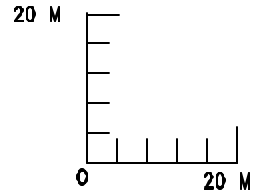
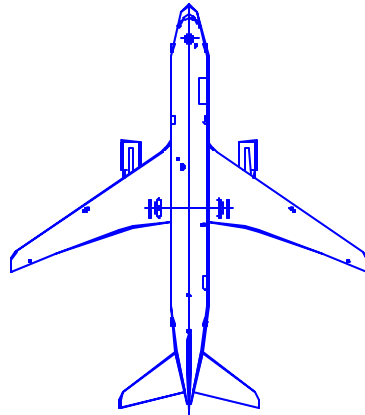

NOTE:

**SEE SEC 9.6.1
LOCATIONS AND IDENTIFICATIONS
OF SERVICE POINTS**

LEGEND

- A** CONDITIONED AIR
- C** CARGO DOOR
- E** ELECTRICAL
- F** **FUEL**
- G** GALLEY SERVICE DOOR
- H** HYDRAULIC
- H₂O** POTABLE WATER
- L** LAVATORY
- MLG** MAIN LANDING GEAR
- NG** NOSE GEAR
- P** PNEUMATIC
- V** FUEL VENT
- X** PASSENGER DOOR

**NOTE: FOR TURNING RADIUS DATA
SEE SECTIONS 4.2 AND 4.3**

NOTE: WHEN PRINTING THIS DRAWING, MAKE SURE TO ADJUST FOR PROPER SCALING

9.10.1 SCALED DRAWING - 1:1000
MODEL 767-300, -300ER

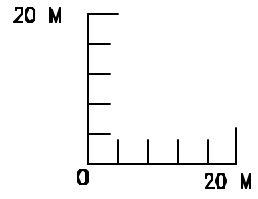
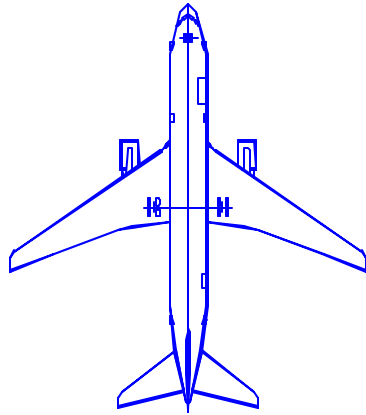

NOTE: WHEN PRINTING THIS DRAWING, MAKE SURE TO ADJUST FOR PROPER SCALING

9.10.2 SCALED DRAWING - 1:1000
MODEL 767-300, -300ER

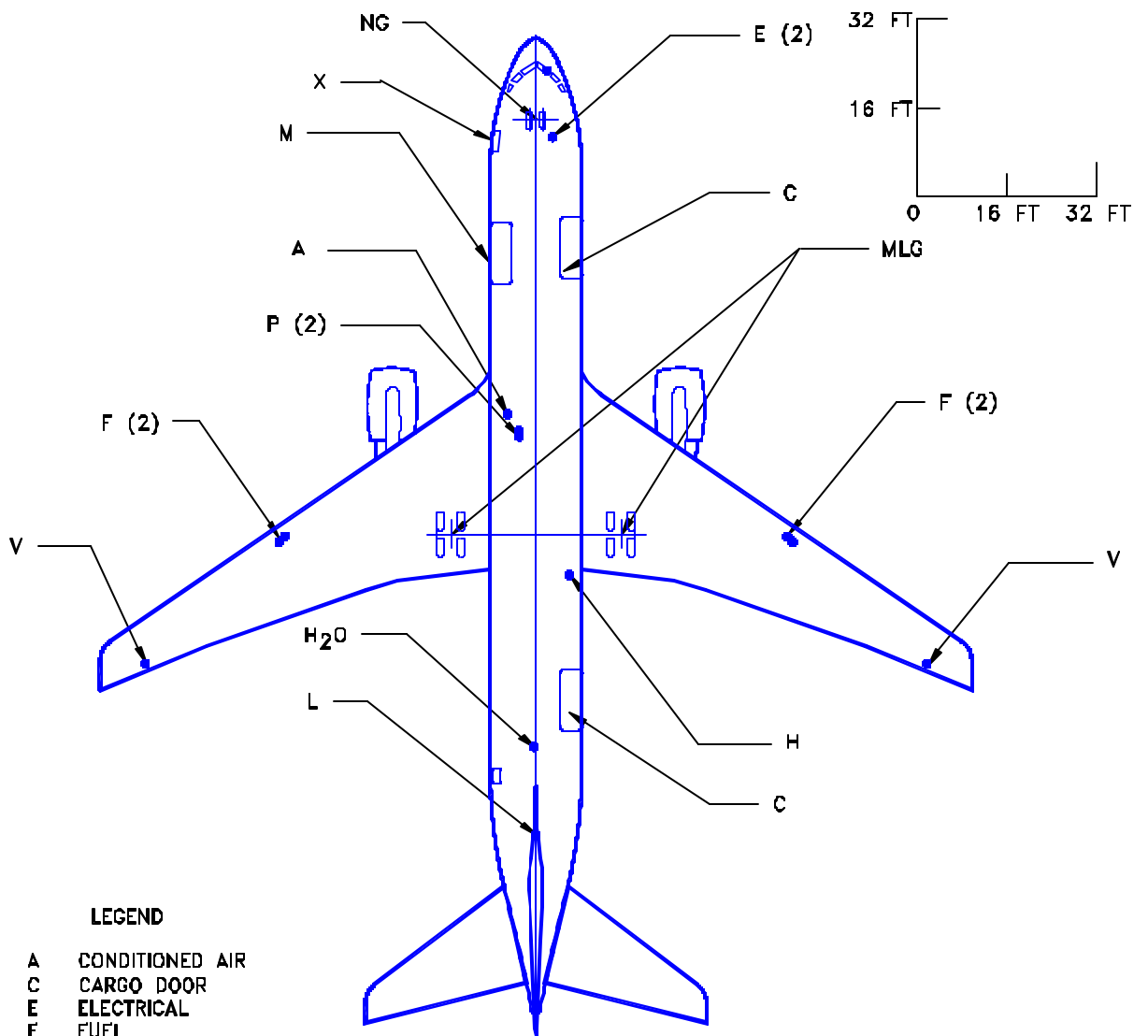

LEGEND

- A CONDITIONED AIR
- C CARGO DOOR
- E ELECTRICAL
- F FUEL
- H HYDRAULIC
- H₂O POTABLE WATER
- L LAVATORY
- M MAIN DECK CARGO DOOR
- MLG MAIN LANDING GEAR
- NG NOSE GEAR
- P PNEUMATIC
- V FUEL VENT
- X CREW ENTRY DOOR

NOTE: FOR TURNING RADIUS DATA
SEE SECTIONS 4.2 AND 4.3

NOTE: WHEN PRINTING THIS DRAWING, MAKE SURE TO ADJUST FOR PROPER SCALING

9.11.1 SCALED DRAWING - 1 IN. = 32 FT
MODEL 767-300 FREIGHTER

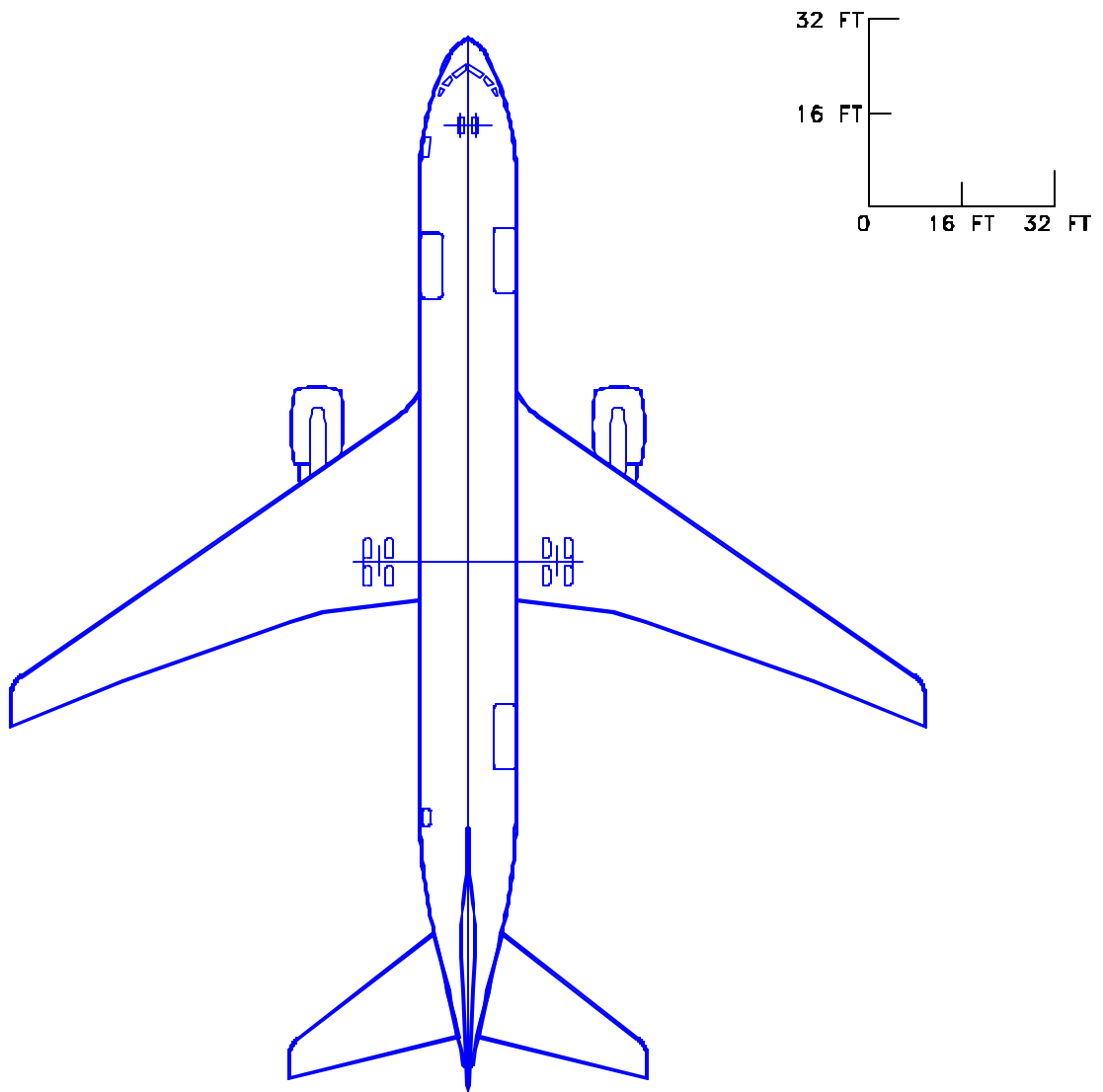

NOTE: WHEN PRINTING THIS DRAWING, MAKE SURE TO ADJUST FOR PROPER SCALING

9.11.2 SCALED DRAWING - 1 IN. = 32 FT
MODEL 767-300 FREIGHTER

D6-58328

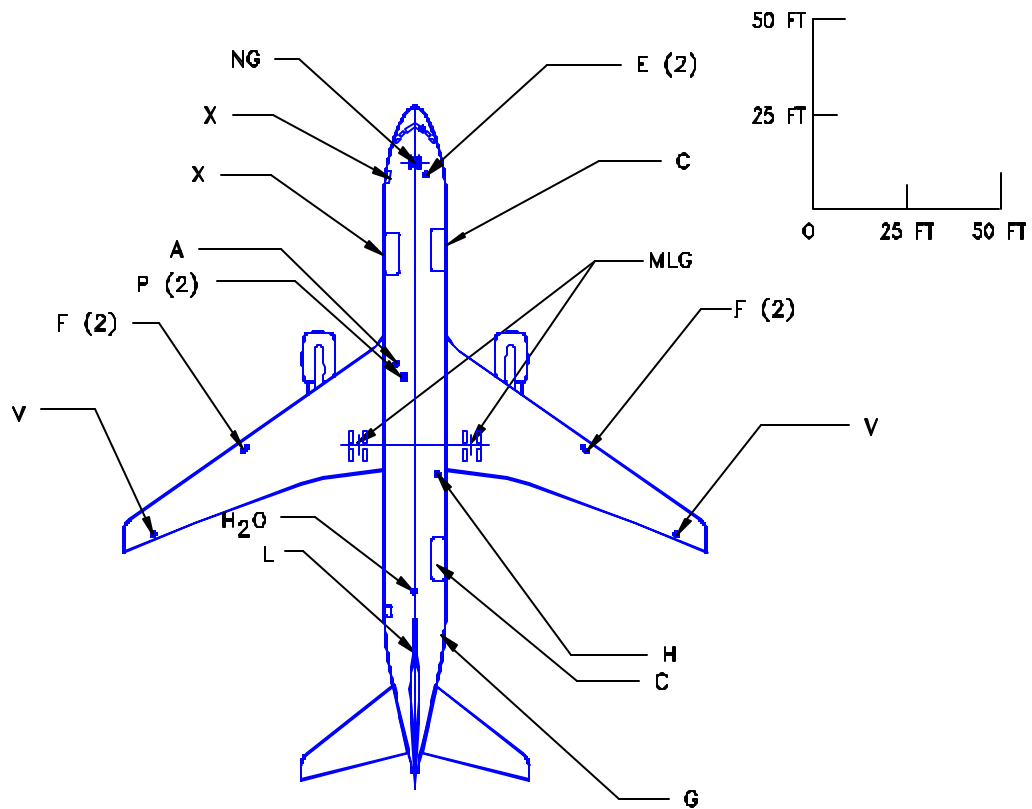

LEGEND

- A CONDITIONED AIR
- C CARGO DOOR
- E ELECTRICAL
- F FUEL
- H HYDRAULIC
- H₂O POTABLE WATER
- L LAVATORY
- M MAIN DECK CARGO DOOR
- MLG MAIN LANDING GEAR
- NG NOSE GEAR
- P PNEUMATIC
- V FUEL VENT
- X CREW ENTRY DOOR

NOTE: FOR TURNING RADIUS DATA
SEE SECTIONS 4.2 AND 4.3

NOTE: WHEN PRINTING THIS DRAWING, MAKE SURE TO ADJUST FOR PROPER SCALING

9.12.1 SCALED DRAWING - 1 IN. = 50 FT
MODEL 767-300 FREIGHTER

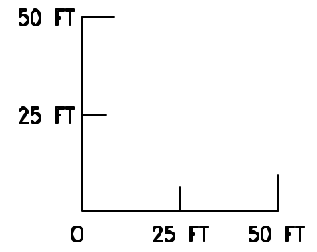
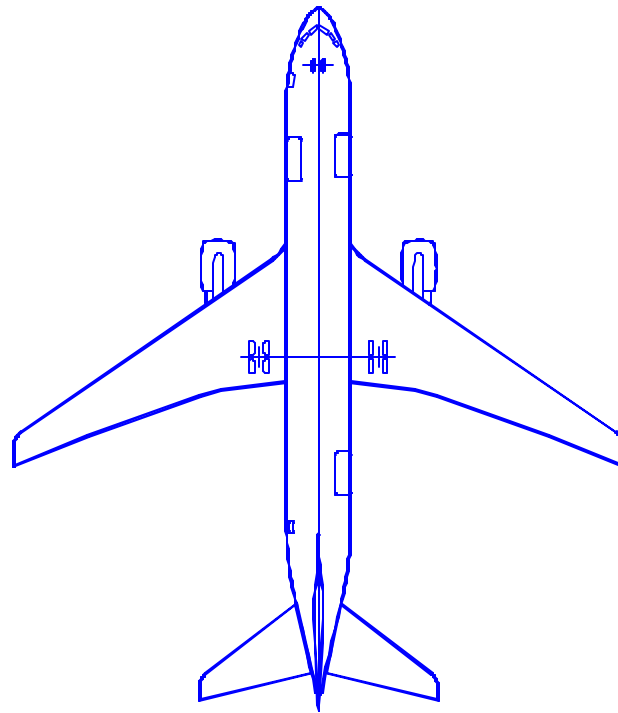

NOTE: WHEN PRINTING THIS DRAWING, MAKE SURE TO ADJUST FOR PROPER SCALING

9.12.2 SCALED DRAWING - 1 IN. = 50 FT
MODEL 767-300 FREIGHTER

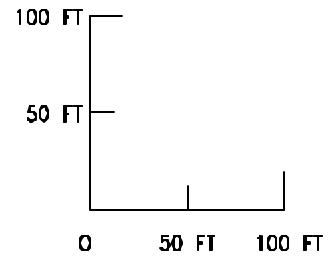
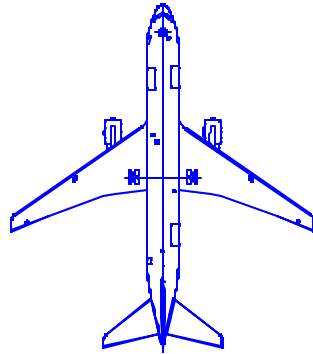

NOTE:

SEE SEC 9.11.1
LOCATIONS AND IDENTIFICATIONS
OF SERVICE POINTS

LEGEND

- A CONDITIONED AIR
- C CARGO DOOR
- E ELECTRICAL
- F FUEL
- H HYDRAULIC
- H₂O POTABLE WATER
- L LAVATORY
- M MAIN DECK CARGO DOOR
- MLG MAIN LANDING GEAR
- NG NOSE GEAR
- P PNEUMATIC
- V FUEL VENT
- X CREW ENTRY DOOR

NOTE: FOR TURNING RADIUS DATA
SEE SECTIONS 4.2 AND 4.3

NOTE: WHEN PRINTING THIS DRAWING, MAKE SURE TO ADJUST FOR PROPER SCALING

9.13.1 SCALED DRAWING - 1 IN = 100 FT
MODEL 767-300 FREIGHTER

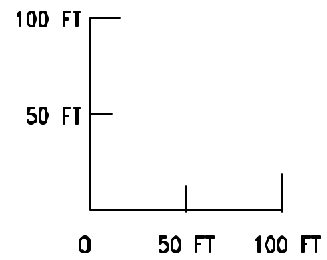
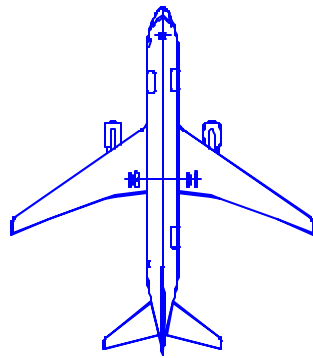

NOTE: WHEN PRINTING THIS DRAWING, MAKE SURE TO ADJUST FOR PROPER SCALING

9.13.2 SCALED DRAWING - 1 IN = 100 FT
MODEL 767-300 FREIGHTER

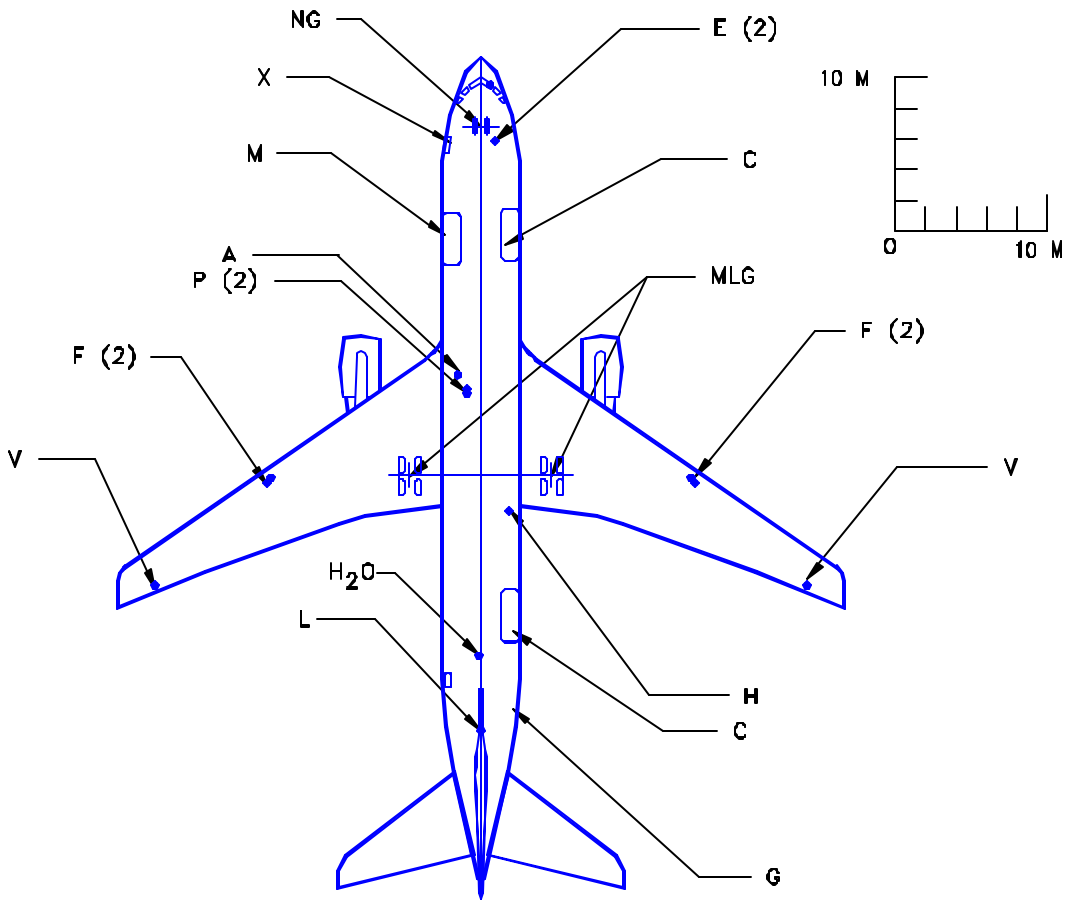

LEGEND

- A CONDITIONED AIR
- C CARGO DOOR
- E ELECTRICAL
- F FUEL
- H HYDRAULIC
- H₂O POTABLE WATER
- L LAVATORY
- M MAIN DECK CARGO DOOR
- MLG MAIN LANDING GEAR
- NG NOSE GEAR
- P PNEUMATIC
- V FUEL VENT
- X CREW ENTRY DOOR

NOTE: FOR TURNING RADIUS DATA
SEE SECTIONS 4.2 AND 4.3

NOTE: WHEN PRINTING THIS DRAWING, MAKE SURE TO ADJUST FOR PROPER SCALING

9.14.1 SCALED DRAWING - 1:500
MODEL 767-300 FREIGHTER

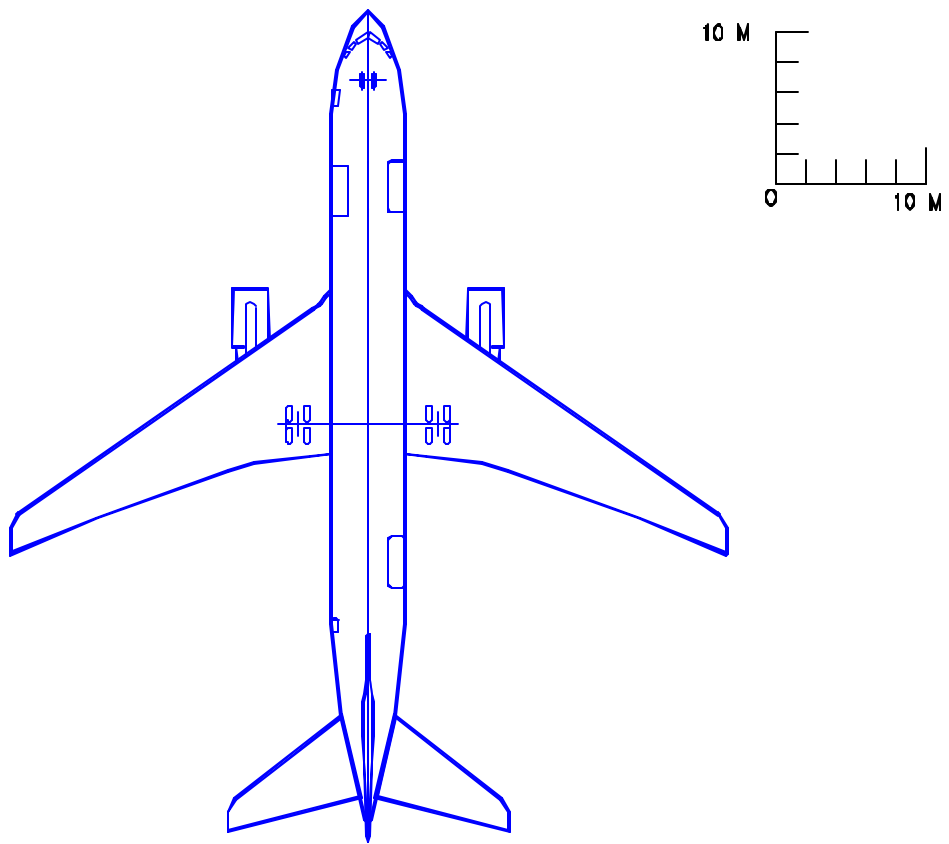

NOTE: WHEN PRINTING THIS DRAWING, MAKE SURE TO ADJUST FOR PROPER SCALING

9.14.2 SCALED DRAWING - 1:500
MODEL 767-300 FREIGHTER

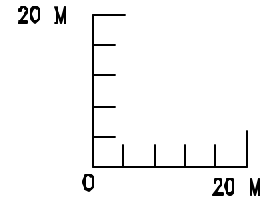
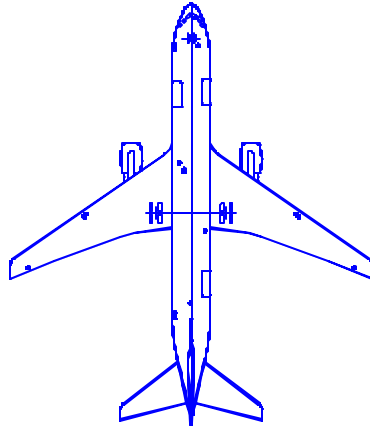

NOTE:

SEE SEC 9.11.1
LOCATIONS AND IDENTIFICATIONS
OF SERVICE POINTS

LEGEND

A CONDITIONED AIR
C CARGO DOOR
E ELECTRICAL
F FUEL
H HYDRAULIC
H₂O POTABLE WATER
L LAVATORY
M MAIN DECK CARGO DOOR
MLG MAIN LANDING GEAR
NG NOSE GEAR
P PNEUMATIC
V FUEL VENT
X CREW ENTRY DOOR

NOTE: FOR TURNING RADIUS DATA
SEE SECTIONS 4.2 AND 4.3

NOTE: WHEN PRINTING THIS DRAWING, MAKE SURE TO ADJUST FOR PROPER SCALING

9.15.1 SCALED DRAWING - 1:1000
MODEL 767-300 FREIGHTER

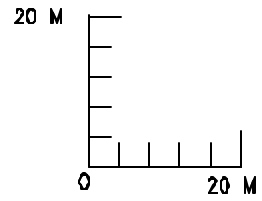
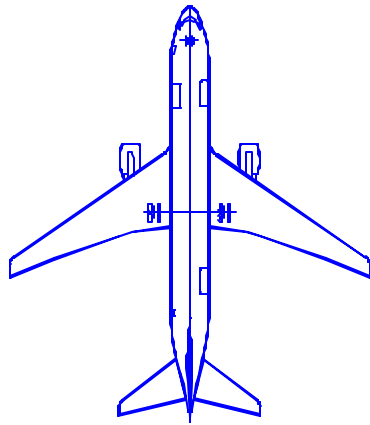

NOTE: WHEN PRINTING THIS DRAWING, MAKE SURE TO ADJUST FOR PROPER SCALING

9.15.2 SCALED DRAWING - 1:1000
MODEL 767-300 FREIGHTER

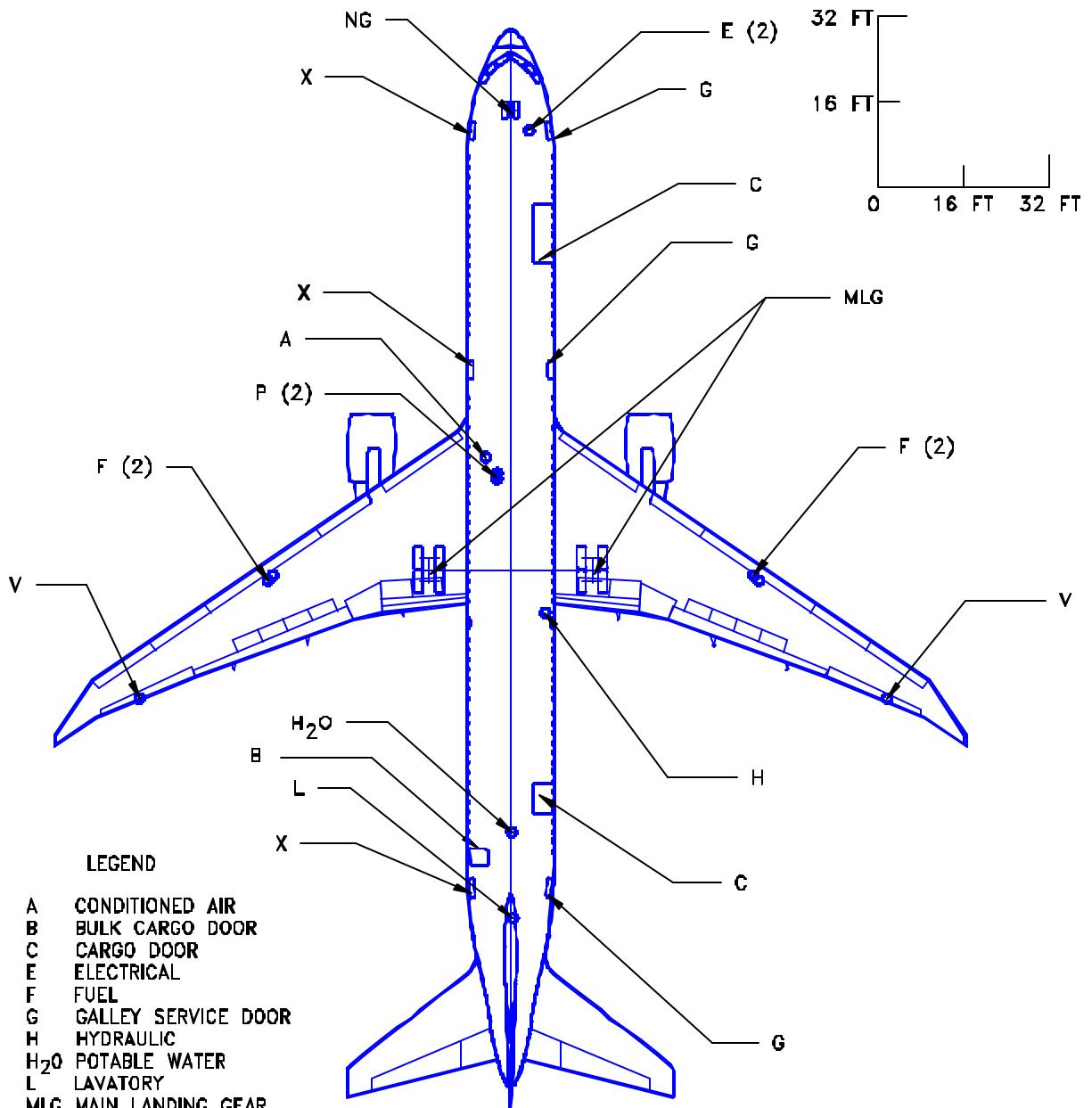

LEGEND

- A CONDITIONED AIR
- B BULK CARGO DOOR
- C CARGO DOOR
- E ELECTRICAL
- F FUEL
- G GALLEY SERVICE DOOR
- H HYDRAULIC
- H₂O POTABLE WATER
- L LAVATORY
- MLG MAIN LANDING GEAR
- NG NOSE GEAR
- P PNEUMATIC
- V FUEL VENT
- X PASSENGER DOOR

NOTE: FOR TURNING RADIUS DATA
SEE SECTIONS 4.2 AND 4.3

NOTE: WHEN PRINTING THIS DRAWING, MAKE SURE TO ADJUST FOR PROPER SCALING

9.16.1 SCALED DRAWING - 1 IN. = 32 FT
MODEL 767-400ER

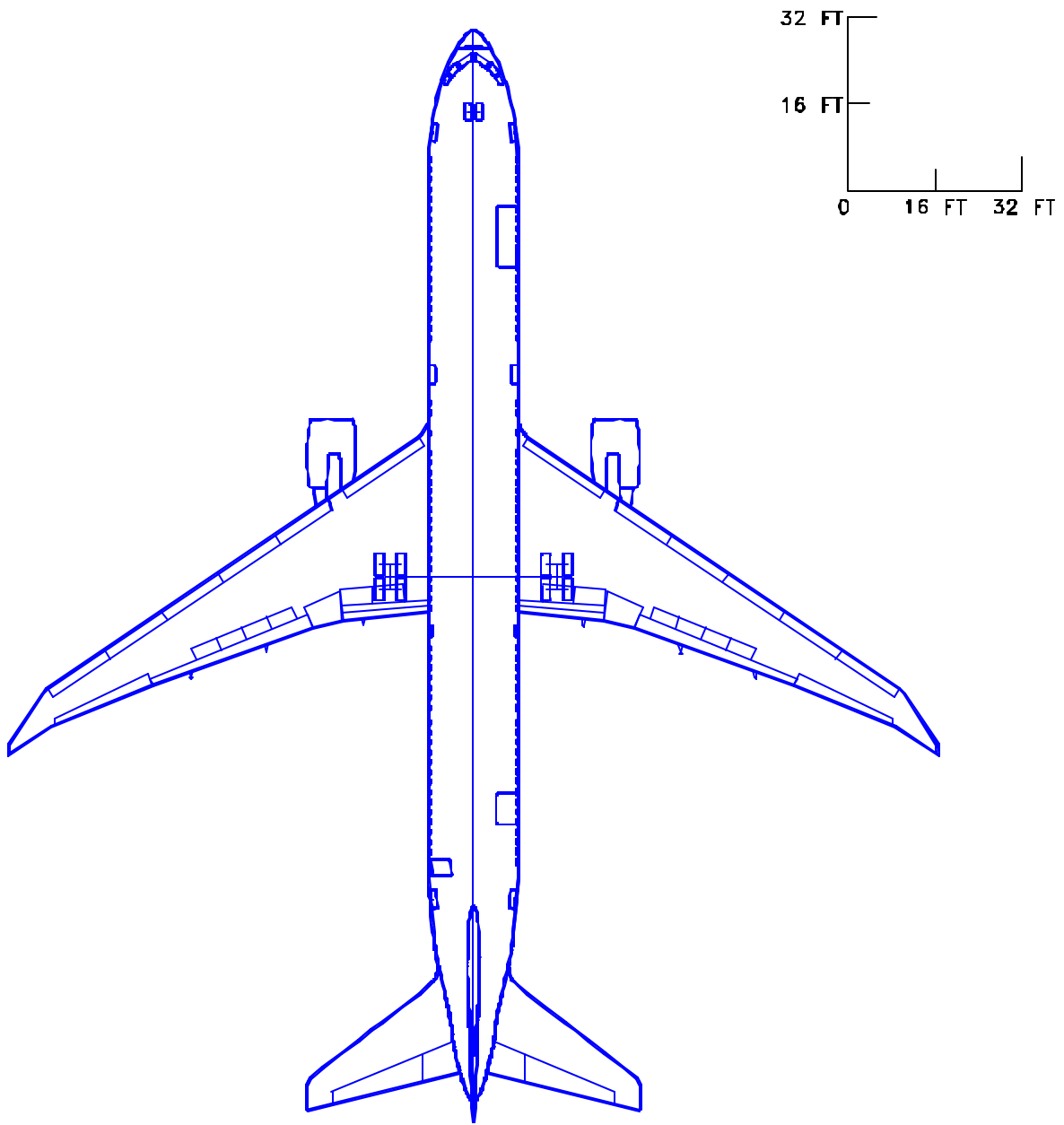

NOTE: WHEN PRINTING THIS DRAWING, MAKE SURE TO ADJUST FOR PROPER SCALING

9.16.2 SCALED DRAWING - 1 IN. = 32 FT
MODEL 767-400ER

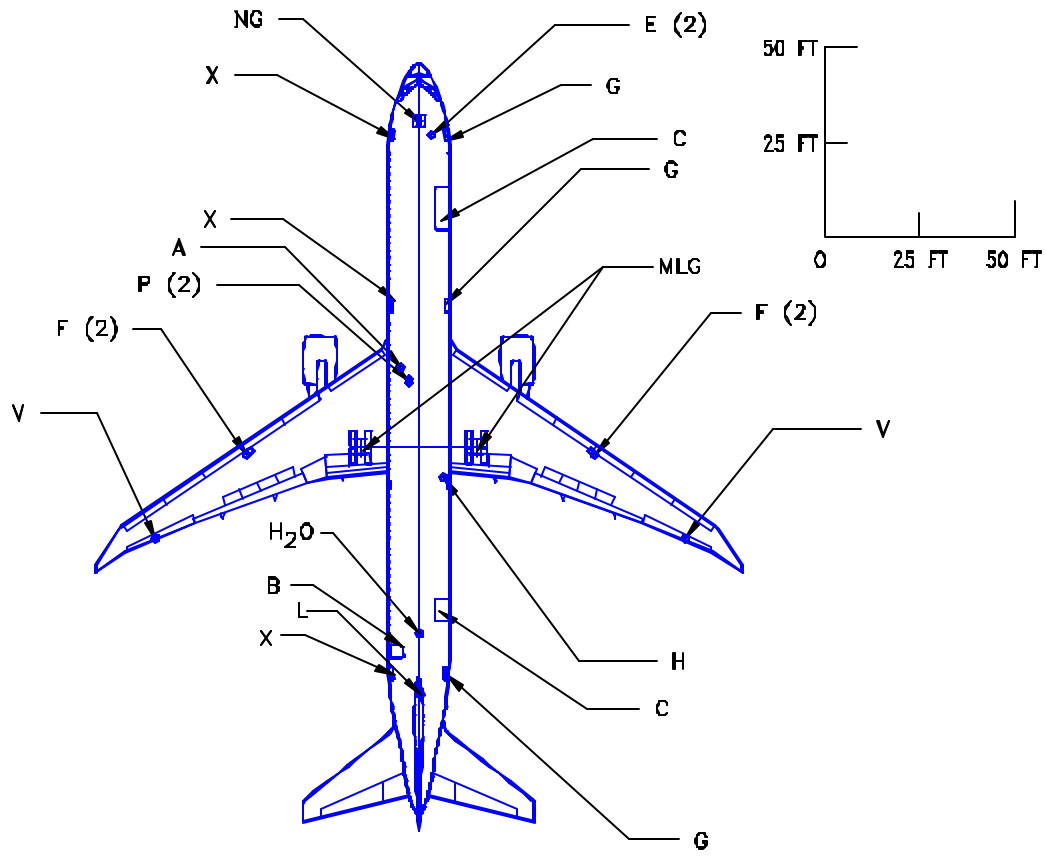

LEGEND

- A CONDITIONED AIR
- B BULK CARGO DOOR
- C CARGO DOOR
- E ELECTRICAL
- F FUEL
- G GALLEY SERVICE DOOR
- H HYDRAULIC
- H₂O POTABLE WATER
- L LAVATORY
- MLG MAIN LANDING GEAR
- NG NOSE GEAR
- P PNEUMATIC
- V FUEL VENT
- X PASSENGER DOOR

NOTE: FOR TURNING RADIUS DATA
SEE SECTIONS 4.2 AND 4.3

NOTE: WHEN PRINTING THIS DRAWING, MAKE SURE TO ADJUST FOR PROPER SCALING

9.17.1 SCALED DRAWING - 1 IN. = 50 FT
MODEL 767-400ER

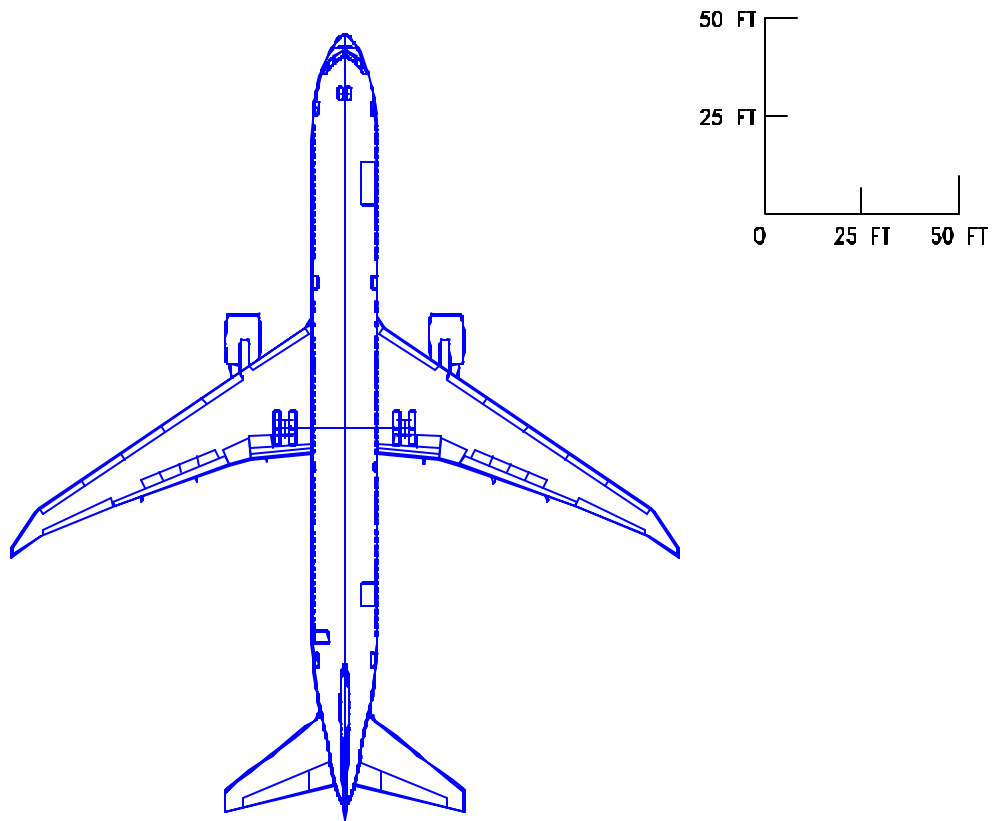

NOTE: WHEN PRINTING THIS DRAWING, MAKE SURE TO ADJUST FOR PROPER SCALING

9.17.2 SCALED DRAWING - 1 IN. = 50 FT
MODEL 767-400ER

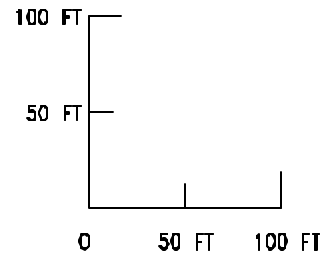
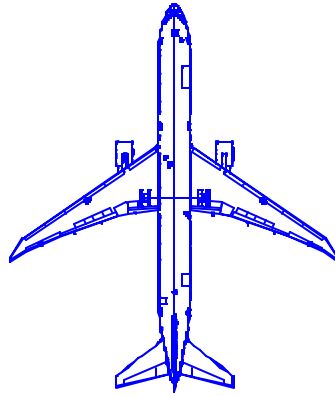

NOTE:

SEE SEC 9.16.1
LOCATIONS AND IDENTIFICATIONS
OF SERVICE POINTS

LEGEND

- A CONDITIONED AIR
- B BULK CARGO DOOR
- C CARGO DOOR
- E ELECTRICAL
- F FUEL
- G GALLEY SERVICE DOOR
- H HYDRAULIC
- H₂O POTABLE WATER
- L LAVATORY
- MLG MAIN LANDING GEAR
- NG NOSE GEAR
- P PNEUMATIC
- V FUEL VENT
- X PASSENGER DOOR

NOTE: FOR TURNING RADIUS DATA
SEE SECTIONS 4.2 AND 4.3

NOTE: WHEN PRINTING THIS DRAWING, MAKE SURE TO ADJUST FOR PROPER SCALING

9.18.1 SCALED DRAWING - 1 IN = 100 FT
MODEL 767-400ER

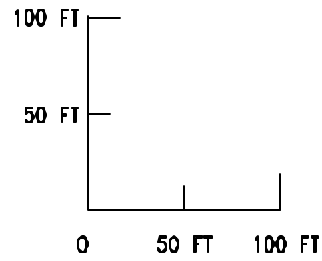
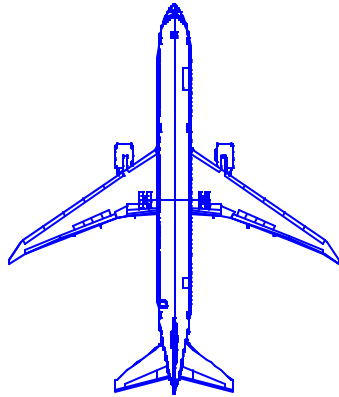

NOTE: WHEN PRINTING THIS DRAWING, MAKE SURE TO ADJUST FOR PROPER SCALING

9.18.2 SCALED DRAWING - 1 IN = 100 FT
MODEL 767-400ER

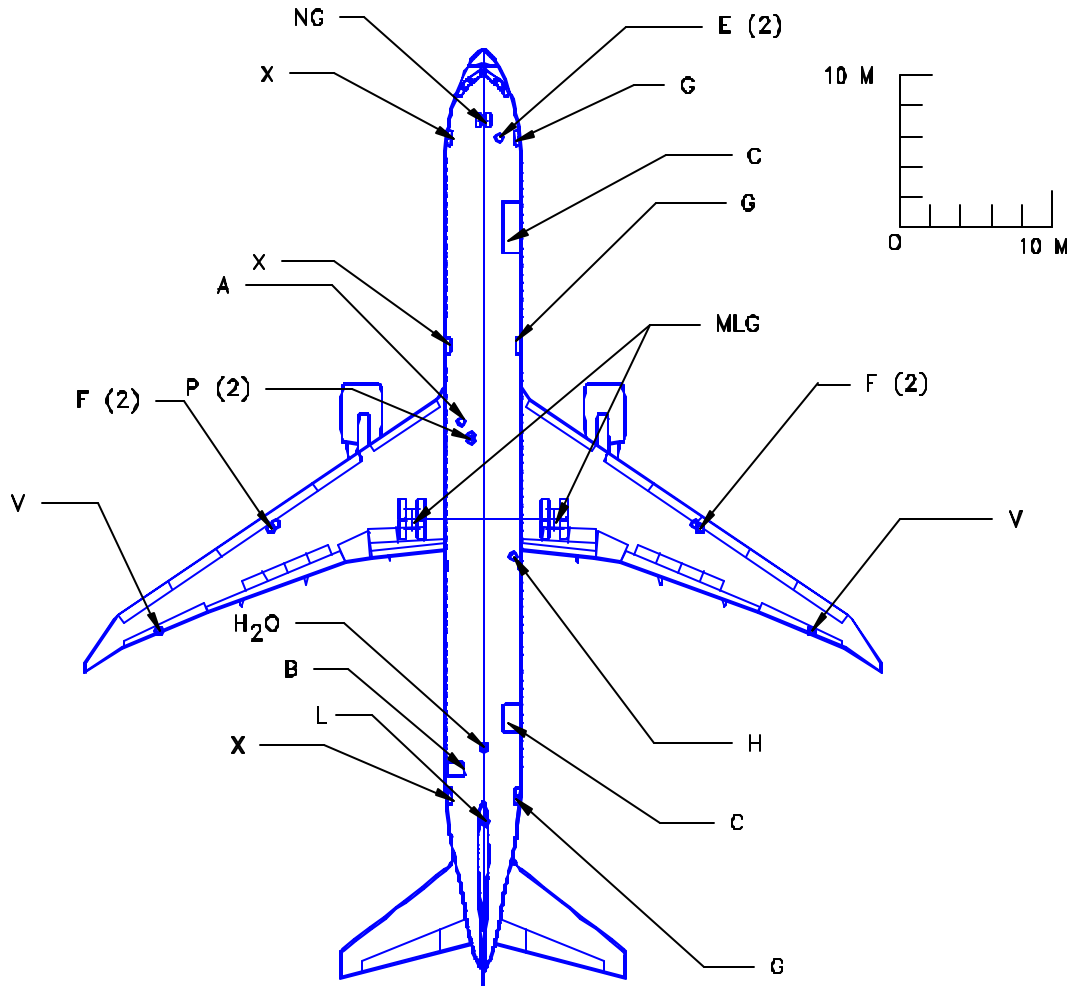

LEGEND

- A CONDITIONED AIR
- B BULK CARGO DOOR
- C CARGO DOOR
- E ELECTRICAL
- F FUEL
- G GALLEY SERVICE DOOR
- H HYDRAULIC
- H₂O POTABLE WATER
- L LAVATORY
- MLG MAIN LANDING GEAR
- NG NOSE GEAR
- P PNEUMATIC
- V FUEL VENT
- X PASSENGER DOOR

NOTE: FOR TURNING RADIUS DATA
SEE SECTIONS 4.2 AND 4.3

NOTE: WHEN PRINTING THIS DRAWING, MAKE SURE TO ADJUST FOR PROPER SCALING

9.19.1 SCALED DRAWING - 1:500
MODEL 767-400ER

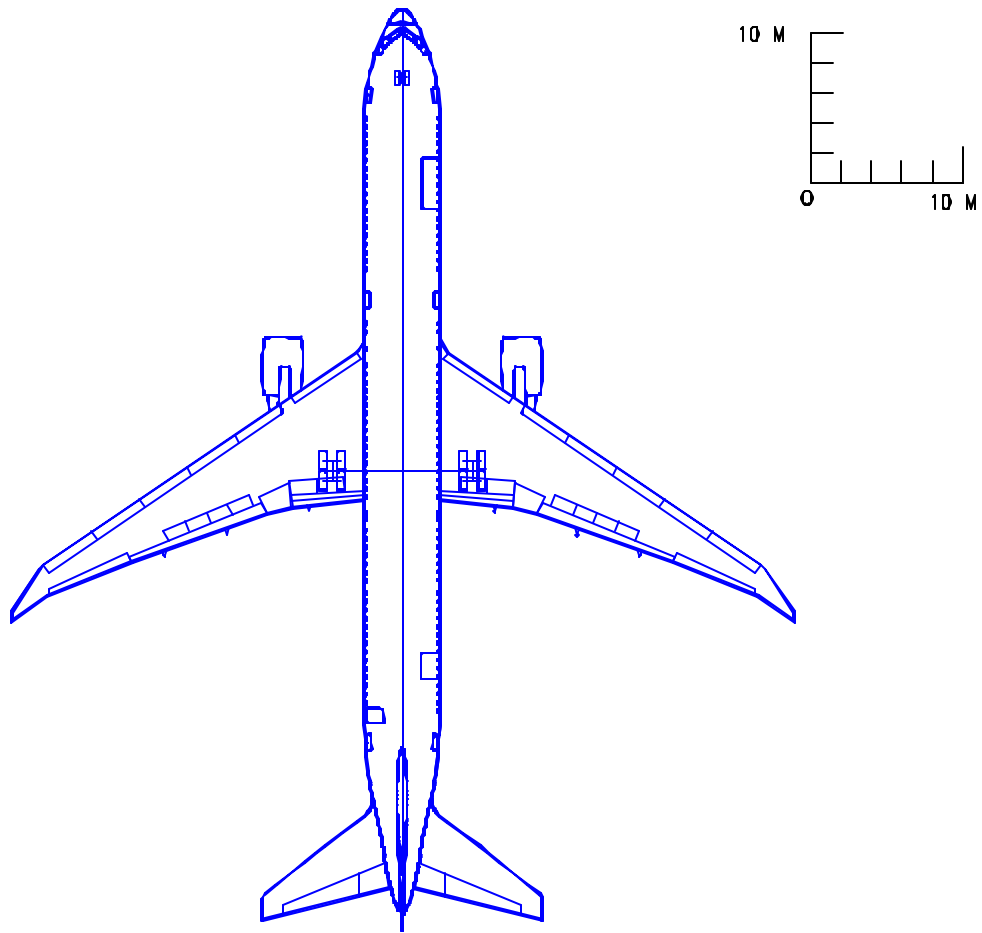

NOTE: WHEN PRINTING THIS DRAWING, MAKE SURE TO ADJUST FOR PROPER SCALING

9.19.2 SCALED DRAWING - 1:500
MODEL 767-400ER

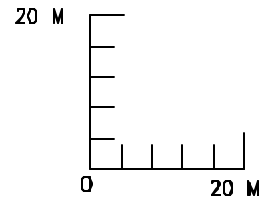
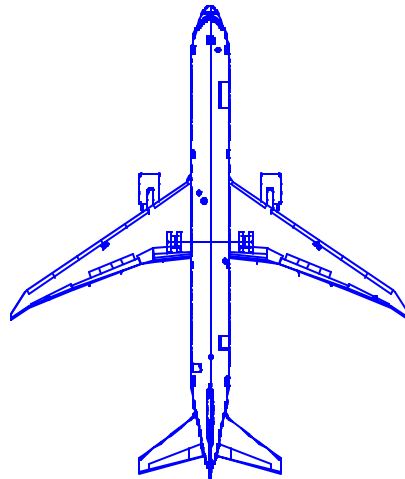

NOTE:
SEE SEC 9.16.1
LOCATIONS AND IDENTIFICATIONS
OF SERVICE POINTS

LEGEND

- A CONDITIONED AIR
- B BULK CARGO DOOR
- C CARGO DOOR
- E ELECTRICAL
- F FUEL
- G GALLEY SERVICE DOOR
- H HYDRAULIC
- H₂O POTABLE WATER
- L LAVATORY
- MLG MAIN LANDING GEAR
- NG NOSE GEAR
- P PNEUMATIC
- V FUEL VENT
- X PASSENGER DOOR

NOTE: FOR TURNING RADIUS DATA
SEE SECTIONS 4.2 AND 4.3

NOTE: WHEN PRINTING THIS DRAWING, MAKE SURE TO ADJUST FOR PROPER SCALING

9.20.1 SCALED DRAWING - 1:1000
MODEL 767-400ER

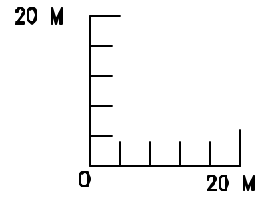
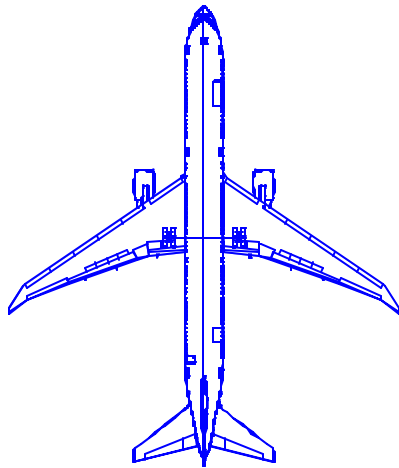

NOTE: WHEN PRINTING THIS DRAWING, MAKE SURE TO ADJUST FOR PROPER SCALING

9.20.2 SCALED DRAWING - 1:1000
MODEL 767-400ER