

Leica Viva Series

Technical Reference Manual



Version 5.0
English

- when it has to be **right**

Leica
Geosystems

Introduction

Purchase

Congratulations on the purchase of a Leica SmartWorx Viva instrument.



To use the product in a permitted manner, please refer to the detailed safety directions in the CS10/CS15 User Manual, the GS10/GS15 User Manual, the GS25 User Manual, the TS11 User Manual, the TS15 User Manual, the Leica TS12 Robotic User Manual and the Leica MS50/TS50/TM50 User Manual.

Product identification

The type and serial number of your product are indicated on the type plate. Enter the type and serial number in your manual and always refer to this information when you need to contact your agency or Leica Geosystems authorised service workshop.

Type: _____

Serial No.: _____

Symbols

The symbols used in this manual have the following meanings:

Type	Description
	Important paragraphs which must be adhered to in practice as they enable the product to be used in a technically correct and efficient manner.

Trademarks



- Windows is a registered trademark of Microsoft Corporation in the United States and other countries
 - CompactFlash and CF are trademarks of SanDisk Corporation
 - Bluetooth® is a registered trademark of Bluetooth SIG, Inc.
 - SD Logo is a trademark of SD-3C, LLC.
- All other trademarks are the property of their respective owners.



Validity of this manual

- This manual applies to SmartWorx Viva. For the Lite version of SmartWorx Viva, some functionality described in this manual is not available.
- This manual applies to the Leica Viva Series. Differences between GPS and TPS are marked and described.

Available documentation

Name	Description/Format		
CS10/CS15 User Manual	All instructions required to operate the product to a basic level are contained in the User Manual. Provides an overview of the product together with technical data and safety directions.	-	✓
GS10/GS15 User Manual	All instructions required to operate the product to a basic level are contained in the User Manual. Provides an overview of the product together with technical data and safety directions.	-	✓
TS11 User Manual	All instructions required to operate the product to a basic level are contained in the User Manual. Provides an overview of the product together with technical data and safety directions.	-	✓

Name	Description/Format		
GS25 User Manual	All instructions required to operate the product to a basic level are contained in the User Manual. Provides an overview of the product together with technical data and safety directions.	-	✓
TS15 User Manual	All instructions required to operate the product to a basic level are contained in the User Manual. Provides an overview of the product together with technical data and safety directions.	-	✓
TS12 Robotic User Manual	All instructions required to operate the product to a basic level are contained in the User Manual. Provides an overview of the product together with technical data and safety directions.	-	✓
TS12 Lite User Manual	All instructions required to operate the product to a basic level are contained in the User Manual. Provides an overview of the product together with technical data and safety directions.	-	✓

Name	Description/Format		
Viva GNSS Getting Started Guide	Describes the general working of the product in standard use. Intended as a quick reference field guide.	-	✓
Viva TPS Getting Started Guide	Describes the general working of the product in standard use. Intended as a quick reference field guide.	-	✓
Viva Series Technical Reference Manual	Overall comprehensive guide to the product and application functions. Included are detailed descriptions of special software/hardware settings and software/hardware functions intended for technical specialists.	-	✓

Refer to the following resources for all Leica Viva Series documentation/software:

- the SmartWorx Viva USB documentation card
- <https://myworld.leica-geosystems.com>

Table of Contents

In this manual	Chapter	Page
	1 Configurable Keys	19
	1.1 Hot Keys	19
	1.2 Favourites Key	20
	2 TPS Settings	21
	2.1 Leica TPS Favourites	21
	2.2 Check Point	23
	2.3 Joystick	24
	2.4 Turn Instrument to Hz/V	25
	2.5 Orientation With Compass	26
	2.6 Using the Digital Camera	27
	3 GPS Settings	28
	3.1 Leica GPS Favourites	28
	4 Main Menu	30
	4.1 Main Menu Functions	30
	4.2 Go to Work!	31
	4.3 Jobs & Data	31
	4.4 Instrument	33
	4.5 User	34
	4.6 Icons	35
	5 Jobs & Data - Jobs	42
	5.1 Overview	42
	5.2 Creating a New Job	42
	5.3 Job Properties and Editing a Job	47
	5.4 Choosing a Job	51
	5.5 Managing Job Codes	51
	6 Jobs & Data - Data	54
	6.1 Overview	54
	6.2 Accessing Data Management	54
	6.3 Point Management	57
	6.3.1 Creating a New Point	57
	6.3.2 Editing a Point	59
	6.3.3 Mean Page	62
	6.4 Line/Area Management	65
	6.4.1 Overview	65
	6.4.2 Creating a New Line/Area	65
	6.4.3 Editing a Line/Area	68
	6.5 Data Log	70
	6.6 Point Sorting and Filters	71
	6.6.1 Sorting and Filters for Points, Lines and Areas	71
	6.6.2 Point, Line and Area Code Filter	74
	6.6.3 Stakeout Filter	75
	6.7 Scan Viewer	76
	7 Codelists	78
	7.1 Overview	78
	7.2 Accessing Codelist Management	78
	7.3 Creating/Editing a Codelist	79

7.4	Managing Codes	80
7.4.1	Accessing Codes	80
7.4.2	Creating/Editing a Code	81
7.5	Managing Code Groups	82
8	Coordinate Systems	84
8.1	Overview	84
8.2	Accessing Coordinate System Management	85
8.3	Coordinate Systems - Creating and Editing	86
8.4	Transformations	87
8.4.1	Accessing Transformation Management	87
8.4.2	Creating/Editing a Transformation	88
8.5	Ellipsoids	89
8.5.1	Accessing Ellipsoid Management	89
8.5.2	Creating/Editing an Ellipsoid	89
8.6	Projections	90
8.6.1	Accessing Projection Management	90
8.6.2	Creating/Editing a Projection	92
8.7	Geoid Models	92
8.7.1	Overview	92
8.7.2	Accessing Geoid Model Management	93
8.7.3	Creating a New Geoid Model from the Data Storage Device / Internal Memory	94
8.8	CSCS Models	94
9	Jobs & Data - Create control data	95
10	Jobs & Data - Import data	99
10.1	Overview	99
10.2	Importing Data in ASCII/GSI Format	100
10.3	Importing Data in LandXML Format	103
10.4	Importing Alignment Data	104
10.5	Importing Data in DXF Format	108
10.6	Importing DTM Data	109
11	Jobs & Data - Export & copy data	111
11.1	Overview	111
11.2	Exporting Data from a Job to an ASCII Format	112
11.3	Exporting Data from a Job to a Custom Format	114
11.4	Exporting Data in DXF Format	115
11.5	Exporting Data in XML Format	119
11.6	Exporting Data using Stylesheets	121
11.7	Exporting Data in FBK/RW5/RAW Format	122
11.8	Copy Data Between Jobs	124
12	Instrument - TPS settings	126
12.1	Measure mode & target	126
12.1.1	Measure & Target Settings	126
12.1.2	Targets	129
12.1.3	Creating/Editing a Target	130
12.2	Prism search settings	131
12.3	Atmospheric corrections	134
12.4	Level bubble & compensator	136
12.5	Offsets & Quality Control	137
12.6	Lights / Lights & accessories	139

13	Instrument - GPS settings	143
13.1	RTK rover wizard	143
	13.1.1 Overview	143
	13.1.2 Creating a New RTK Profile	144
	13.1.3 Loading an Existing RTK Profile	144
	13.1.4 Editing an Existing RTK Profile	145
13.2	Satellite tracking	145
13.3	Antenna heights	148
	13.3.1 Rover Antenna Heights	148
	13.3.2 Antennas	149
	13.3.3 Creating/Editing an Antenna	150
13.4	Quality control	151
13.5	Raw data logging	156
14	Antenna Heights	158
14.1	Overview	158
14.2	Mechanical Reference Planes, MRP	159
14.3	Determining Antenna Heights	160
	14.3.1 Pillar Setup	160
	14.3.2 Tripod Setup	162
	14.3.3 Pole Setup	163
14.4	SmartStation Setup	164
15	Connections.. - GPS connection wizard	165
15.1	Starting the GPS Connection Wizard	165
15.2	Connection to GS10/GS15/GS08plus/GS12/GS25	166
16	Connections.. - TPS connection wizard	168
16.1	Starting the TPS Connection Wizard	168
16.2	Connection Using Cable	169
16.3	Connection Using Bluetooth	169
16.4	Connection Using Internal Radio	171
16.5	Connection To Leica Legacy and Third Party Total Stations	171
17	Connections.. - CS connection wizard	174
17.1	Starting the CS Connection Wizard	174
17.2	Connection Using TCPS	176
17.3	Connection Using Cable	177
18	Connections.. - Internet wizard	178
19	Connections.. - All other connections	179
19.1	Accessing Configuration Connections	179
19.2	CS Internet / GS Internet / TS Internet	180
19.3	GPS Rover / Base Sensor	182
19.4	ASCII Input	183
	19.4.1 Configuration of an ASCII Input Connection	183
	19.4.2 Configuration of a Command to the Device	185
19.5	GPS Hidden Pt	186
19.6	Export Job	190
19.7	RTK Rover	192
	19.7.1 Configuration of a Rover Real-Time Connection	192
	19.7.2 Configuration with Digital Cellular Phone and Radio	201
	19.7.3 Configuration of GGA Message Sending for Reference Network Applications	202

19.8	Base RTK 1 / Base RTK 2	203
19.8.1	Configuration of a Reference Real-Time Connection	203
19.9	NMEA 1 / NMEA 2	206
19.10	Remote (OWI)	211
19.11	PPS Output	212
19.12	Event Input 1/Event Input 2	214
19.13	Total Station	216
19.14	GSI Output	217
19.15	Field Controller Connection	222
19.16	GeoCom Connection	223
20	Connections.. - All other connections, Cntrl.. Key	225
20.1	Digital Cellular Phones	225
20.1.1	Overview	225
20.1.2	Configuring a GSM Connection	225
20.1.3	Configuring a CDMA Connection	227
20.2	Modems	229
20.3	Radios for GPS Real-Time	230
20.4	Radios for Remote Control	233
20.5	RS232	234
20.6	Internet	234
20.7	Configuring the Stations to Dial	237
20.7.1	Accessing Dial-up Connection List	237
20.7.2	Creating / Editing a Station to Dial	238
20.8	Configuring the Server to Connect	239
20.8.1	Accessing Server to Connect	239
20.8.2	Creating / Editing a Server	240
21	Configuration of Devices	241
21.1	Devices	241
21.1.1	Overview	241
21.1.2	Digital Cellular Phones	241
21.1.3	Modems	242
21.1.4	Radios for Real-Time	243
21.1.5	Radios for Remote Control	243
21.1.6	RS232	243
21.1.7	USB	244
21.1.8	Hidden Point Measurement Devices	244
21.1.9	GPRS / Internet Devices	245
21.2	Accessing Devices / GPRS Internet Devices	245
21.3	Creating/Editing a Device	247
22	Instrument - Instrument status info	250
22.1	Status Functions	250
22.2	Battery & memory	251
22.3	Satellite tracking	252
22.4	RTK data link status	254
22.5	Current GPS position	259
22.6	Raw data logging	261
22.7	Connection status	263
22.7.1	Connection Status	263
22.7.2	Internet	263
22.7.3	ASCII Input	264
22.7.4	RTK Data Link Status	264
22.7.5	Remote (OWI)	264

	22.7.6	Event Input 1/Event Input 2	265
	22.8	Internet connection status	266
	22.9	TPS current station info	266
23		Instrument - Base settings	268
	23.1	Satellite tracking	268
	23.2	Base raw data logging	270
24		Instrument - TPS camera settings	272
25		User - Work settings	272
	25.1	ID templates	272
		25.1.1 Accessing ID Template Configuration	272
		25.1.2 Creating/Editing an ID Template	274
	25.2	Coding & linework	276
	25.3	My Survey Screen	279
	25.4	Hot keys & favourites	283
	25.5	Prompt before storing	285
26		Coding	286
	26.1	Overview	286
	26.2	Thematical Coding	287
		26.2.1 Thematical Coding with Codelist	287
		26.2.2 Thematical Coding without Codelist	290
	26.3	Free Coding	290
		26.3.1 Free Coding Using a Codelist	290
		26.3.2 Free Coding with Direct Input	291
	26.4	Quick Coding	292
	26.5	SmartCodes	293
		26.5.1 Overview	293
		26.5.2 Configuring SmartCodes	293
		26.5.3 Code Block	295
	26.6	Code and Attribute Mismatch	297
		26.6.1 Code Mismatch	297
		26.6.2 Attribute Mismatch	298
	26.7	Code Information	299
27		Linework	300
	27.1	Overview	300
	27.2	Performing Linework using the Linework Field	300
	27.3	Performing Linework with Thematical Coding	301
28		User - Working style wizard	304
	28.1	Overview	304
	28.2	Accessing the Working Style Wizard	304
	28.3	Choosing a Different Working Style	305
	28.4	Creating a New Working Style	305
	28.5	Editing a Working Style	306
29		User - System settings	307
	29.1	Regional settings	307
	29.2	SmartWorx options	313
	29.3	Screen & audio	314
	29.4	Admin settings	315

30	User - Tools & other utilities	317
30.1	Transfer user objects	317
30.2	Uploading System Files	319
30.3	Load licence keys	320
30.4	Ftp data transfer	321
30.5	Format memory devices	324
30.6	View contents of ASCII files	325
30.7	Leica Exchange	325
30.7.1	Overview	325
30.7.2	Configuring Leica Exchange	327
30.7.3	Sending Data	329
30.7.4	Getting Data	330
30.7.5	Data Transfer Status	331
30.7.6	In the Office	332
31	User - Check & Adjust	333
31.1	Overview	333
31.2	Details on Instrument Errors	334
31.3	Accessing the Check & Adjust Wizard	337
31.4	Combined Adjustment (l, t, i, c, ATR and tele camera)	338
31.5	Tilting Axis Adjustment (a)	341
31.6	Compensator Adjustment (l, t)	343
31.7	Viewing the Current Values	344
31.8	Configuring Check & Adjust	345
31.9	Adjusting the Circular Level of the Instrument and Tribrach	345
31.10	Adjusting the Circular Level of the Prism Pole	346
31.11	Inspecting the Laser Plummet of the Instrument	346
31.12	Servicing the Tripod	347
32	User - About Leica Viva	348
33	Camera & Imaging	349
33.1	Overview	349
33.2	Instrument - TPS camera settings	350
33.3	Taking an Image	352
33.3.1	Overview	352
33.3.2	Outside of Applications	352
33.3.3	Within Applications	355
33.3.4	Screenshot	359
33.3.5	Panoramic Imaging	360
33.4	Image Management	362
33.5	Sketching	364
33.5.1	Sketching on Images	364
33.5.2	Field Sketching	365
33.6	Exporting Images	367
34	TPS Functions	368
34.1	EDM	368
34.2	Prism Search Methods	368
34.2.1	Automatic aiming	368
34.2.2	PowerSearch	369
34.3	Follow Moving Prisms - Lock	370
34.4	RCS	371
34.5	EGL	371

34.6	Illumination	372
34.7	Connection to Other Total Stations	373
34.7.1	Leica Legacy Total Stations	373
34.7.2	Topcon	374
34.7.3	Sokkia	374
34.7.4	Nikon	375
35	Calculator	376
35.1	Accessing the Calculator	376
35.2	Configuring the Calculator	376
35.3	Using the Calculator	377
35.3.1	RPN Mode	377
35.3.2	Standard Mode	378
35.3.3	Description of Softkeys	379
36	NTRIP via Internet	382
36.1	Configuring Access to the Internet	382
36.2	Using the NTRIP Service with a Real-Time Rover	384
37	MapView Interactive Display Feature	387
37.1	Overview	387
37.2	Accessing MapView	387
37.3	Configuring MapView	387
37.4	MapView Components	390
37.4.1	Screen Area	390
37.4.2	Keys, Softkeys and Toolbar	392
37.4.3	Point Symbols	393
37.5	Selecting Points, Lines and Areas	393
37.6	Context Menu	394
37.7	Viewing Results	396
38	Tap Map	398
39	Applications - General	402
40	COGO	403
40.1	Overview	403
40.2	Accessing COGO	404
40.3	Configuring COGO	405
40.4	COGO Calculation - Inverse Method	408
40.4.1	Selecting the Inverse Method	408
40.4.2	Point to Point and Current Position to Point	410
40.4.3	Point to Line and Current Position to Line	412
40.4.4	Point to Arc and Current Position to Arc	414
40.5	COGO Calculation - Traverse Method	417
40.6	COGO Calculation - Intersection Method	421
40.6.1	Selecting the Intersection Method	421
40.6.2	Intersection with Double Bearing	423
40.6.3	Intersection with Double Distance	425
40.6.4	Intersection with Bearing - Distance	428
40.6.5	Intersection with By Points	430
40.6.6	Intersection with TPS Observation - TPS Observation	432
40.7	COGO Calculation - Line/Arc Calculations Method	434
40.7.1	Selecting the Line/Arc Method	434
40.7.2	Arc Calculation	436

40.7.3	Calculate Line Offset Point and Calculate Line Base Point	439
40.7.4	Segment an Arc	442
40.7.5	Segment a Line	442
40.8	COGO Calculation - Area Division	443
40.8.1	Selecting the Division Method	443
40.8.2	Choosing an Area to be Divided	447
40.8.3	Dividing an Area	448
40.8.4	Results of the Area Division	449
40.9	COGO Calculation - Shift, Rotate & Scale	451
40.9.1	Selecting the Shift, Rotate & Scale Method and the Points to be Moved	451
40.9.2	Manually Entered	455
40.9.3	Matching Points	459
40.10	COGO Calculation - Angle Method	462
40.11	COGO Calculation - Horizontal Curve Method	463
40.12	COGO Calculation - Triangle Method	465
40.13	Selecting a Result from Previous COGO Inverse Calculations	466
40.14	Modifying Values for Azimuths, Distances and Offsets	467
41	Determine Coordinate System	470
41.1	Overview	470
41.2	Selecting the Transformation Method	471
41.3	The Normal Method	473
41.3.1	Configuring the Normal Method	473
41.3.2	Determining a New Coordinate System	474
41.3.3	Modifying a Coordinate System	481
41.3.4	Matching Points: Selecting/ Editing a Pair of Matching Points	482
41.3.5	Transformation Results for Onestep and Twostep	483
41.3.6	Transformation Results for Classic 3D	484
41.4	The One Point Localisation Method	485
41.4.1	Determining a New Coordinate System	485
41.4.2	Computing Required Azimuth	493
41.4.3	Computing the Grid Scale Factor	494
41.4.4	Computing the Height Scale Factor	495
42	QuickGrid	496
42.1	Selecting the Transformation Method	496
42.2	Determining a New Coordinate System	499
43	Reference Line	502
43.1	Overview	502
43.2	Accessing Reference Line	506
43.3	Configuring Reference Line	508
43.4	Defining the Reference Line	515
43.4.1	Overview	515
43.4.2	Defining the Line	516
43.4.3	Defining a Segment of a Line	520
43.4.4	Defining Reference Line Slopes	520
43.5	Measuring to a Reference Line	522
43.6	Staking to a Reference Line	526
43.7	Gridstaking to a Reference Line	532

44	Reference Plane & Grid Scan	535
44.1	Overview	535
44.2	Accessing Reference Plane & Grid Scan	539
44.3	Creating a Reference Plane From Previously Stored Points	540
44.4	Selecting a Reference Plane from a Job	543
44.5	Configuring Reference Plane & Grid Scan	544
44.6	Editing a Reference Plane	546
44.7	Measuring Points to a Reference Plane	549
44.8	Grid Scan on Plane	550
44.9	Grid Scan on Surface	553
45	Roads - General	556
45.1	Overview	556
45.2	Jobs & Design Data	558
45.2.1	Accessing Roads Applications	558
45.2.2	Working with a DTM Job	560
45.2.3	Design Data	560
45.2.4	Viewing and Editing the Design Data	563
45.3	Configuring Roads Applications	569
45.3.1	Configuration Settings	569
45.3.2	Road Line - Info Page	583
45.3.3	Road Local Line - Info Page	585
45.3.4	Road Surface Grade - Info Page	588
45.3.5	Road Manual Slope, Local Manual Slope and Slope - Info Page	591
45.3.6	Road Crown - Info Page	594
45.3.7	Road Layer - Info Page	596
45.3.8	Road DTM - Info Page	599
45.3.9	Rail - Info Page	600
45.3.10	Tunnel - Info Page	602
45.3.11	Workflow for Height (aim to stake ht)	603
45.4	Working with Shifts	604
45.5	Tasks	608
45.6	Understanding Terms and Expressions	609
45.6.1	Road - Basic Terms	609
45.6.2	Road - Horizontal and Vertical Geometry Elements	610
45.6.3	Road - Basic Elements for Stake and Check Measurements	610
45.6.4	Road - Stake Offset and Stake Height Difference	612
45.6.5	Road - Chainage or Station Equations	613
45.6.6	Road - Working Corridor	615
45.6.7	Road - Extension of the Centreline	615
45.6.8	Road/Rail - Working with Heights	616
45.6.9	Rail - Working with a Single Track	616
45.6.10	Rail - Working with Multiple Tracks	618
45.6.11	Rail - Check Elements and Stakeout Elements	619
45.6.12	Rail - Working with Offsets	620
45.6.13	Tunnel - Basic Terms	620
45.6.14	Tunnel - Elements for Stake Out and Check Measurements	621
45.6.15	Tunnel - Shifts	623

46	Roads - Alignment Editor	625
46.1	Basic Terms	625
46.2	Starting Alignment Editor	626
46.2.1	Accessing Alignment Editor	626
46.2.2	Creating a New Alignment	626
46.2.3	Modifying an Existing Alignment	627
46.2.4	Importing Alignment Data	628
46.2.5	Alignment Editor Menu	629
46.3	Configuring Alignment Editor	630
46.4	Edit Horizontal Alignments Using Elements	632
46.4.1	Overview	632
46.4.2	Editing the Start Point	633
46.4.3	Inserting/Editing an Element in a Horizontal Alignment	633
46.5	Edit Horizontal Alignments Using PIs	639
46.5.1	Overview	639
46.5.2	Inserting/Editing a PI in a Horizontal Alignment	640
46.6	Edit Vertical Alignments Using Elements	642
46.6.1	Overview	642
46.6.2	Editing the Start Point	643
46.6.3	Inserting/Editing an Element in a Vertical Alignment	643
46.7	Edit Vertical Alignments Using PIs	647
46.7.1	Overview	647
46.7.2	Inserting/Editing a PVI in a Vertical Alignment	647
46.8	Edit Cross Section Templates	649
46.8.1	Overview	649
46.8.2	Creating/Editing a Cross Section Template	649
46.8.3	Add/Edit a Layer	651
46.9	Edit Cross Section Assignments	653
46.9.1	Overview	653
46.9.2	Creating/Editing a Cross Section Assignment	654
46.10	Edit Chainage Equation	655
46.10.1	Overview	655
46.10.2	Creating/Editing a Chainage Equation	655
46.11	Convert to job	656
47	Roads - Road	657
47.1	Creating a New Road Job	657
47.2	Defining the Work	658
47.2.1	Defining the Method and the Task	658
47.2.2	Selecting a Line	664
47.2.3	Advanced Slope Settings	666
47.3	Staking/Checking the Road	672
47.3.1	The Stake/Check Screen	672
47.3.2	Measuring Points by Chainage and Offset	677
47.3.3	Measuring Lines Relative to a Centreline	678
47.3.4	Measuring Local Lines without Centrelines	679
47.3.5	Indefinite Triangle	679
47.3.6	Measuring Surface Grades	680
47.3.7	Measuring Manual Slopes, Local Manual Slopes and Design Slopes	681
47.3.8	Measuring Road Crowns	682
47.3.9	Measuring Road Layers	682
47.3.10	Measuring Digital Terrain Models (DTM)	683

47.4	The Tools Menu	683
47.4.1	Overview	683
47.4.2	Use heights from DTM	684
47.4.3	Apply current chainage	685
47.4.4	Get current angle to alignment	685
47.4.5	Stake individual point	686
47.4.6	COGO Road - Alignment Information	686
47.4.7	Additional Layer Information	688
47.4.8	Box / base definition	689
47.4.9	Get current slope	691
47.4.10	Manual Slope	693
47.4.11	Reset slope to design	693
47.4.12	Shift reference line	693
47.4.13	Re-initialise search	695
47.4.14	Stake intersection point	696
48	Roads - Rail	699
48.1	Creating a New Rail Job	699
48.1.1	Overview	699
48.1.2	Installing all necessary Software	699
48.1.3	Importing the Track Design with Leica Geo Office	700
48.1.4	Loading the Track Design onto the Instrument	706
48.2	Defining the Work	706
48.3	Staking/Checking the Track	708
48.3.1	The Stake/Check Screen	708
48.3.2	Offset Library	716
48.3.3	Working with Pendular Displacements	717
48.4	The Tools Menu	717
48.4.1	Overview	717
48.4.2	Use heights from DTM	717
48.4.3	Apply current chainage	718
48.4.4	Stake individual point	719
48.4.5	Second point of cant	719
48.4.6	COGO Rail	720
49	Roads - Tunnel	721
49.1	Creating a New Tunnel Job	721
49.1.1	Preparing Design Data	721
49.1.2	Tunnel Centreline	721
49.1.3	Design Profiles	722
49.1.4	Data Transfer to Instrument	723
49.2	Defining the Work	723
49.3	Staking/Checking the Tunnel	727
49.3.1	Overview	727
49.3.2	Stake face	734
49.3.3	Stake profile and Check profile	738
49.3.4	Scan profile	739
49.4	The Tools Menu	742
49.4.1	Profile Viewer	742
49.4.2	Stake face auto	743

50	Scanning	746
50.1	Accessing Scanning	746
50.2	Defining a Scan	746
50.3	Configuring Scanning	750
50.4	Starting a Scan	751
51	Sets of Angles	752
51.1	Overview	752
51.2	Sets of Angles	753
51.2.1	Accessing Sets of Angles	753
51.2.2	Configuring Sets of Angles	754
51.2.3	Creating New Point Groups	757
51.2.4	Managing Existing Point Groups	761
51.2.5	Measuring the Sets	762
51.2.6	Managing Results	766
51.3	Monitoring	770
52	Setup	772
52.1	Overview	772
52.2	Accessing Setup	773
52.3	Configuring Setup	773
52.4	Set Station Point	777
52.5	Enter Station Information	778
52.6	Setup Reminder	779
52.7	Setup Methods	780
52.7.1	Set orientation and Known backsight	780
52.7.2	Multiple backsights	783
52.7.3	Transfer height	785
52.7.4	Resection	785
52.7.5	Orientate to line	786
52.8	Setup Results	787
52.9	Finding a Target Point	791
53	Stakeout	792
53.1	Overview	792
53.2	Accessing Stakeout	793
53.3	Configuring Stakeout	794
53.4	Staking Out	799
53.5	Stakeout Difference Limit Exceeded	803
53.6	Staking Out a DTM or Points & DTM	804
54	Seismic Stakeout	806
54.1	Overview	806
54.2	Accessing Stakeout	806
54.3	Configuring Stakeout	809
54.4	Staking Out	811
55	Base Menu - Start base	813
55.1	Start base over known point	813
55.2	Start base over last setup	814
55.3	Start base over any point	815

56	Survey - General	816
56.1	Surveying Points	816
	56.1.1 Post-Processed Kinematic and Static Operations	816
	56.1.2 Real-Time Rover Operations	817
56.2	Adding Annotations	819
56.3	Timed Measurements	820
56.4	Initialisation for Real-Time Rover Operations	821
	56.4.1 Accessing Initialisation for Real-Time Rover Operations	821
	56.4.2 Initialise while Moving	821
	56.4.3 Initialise while Static	822
	56.4.4 Initialise on Known Point	822
57	Survey - General	823
58	Survey - Auto Points	825
58.1	Overview	825
58.2	Configuring Auto Points	825
58.3	Measuring Auto Points	831
58.4	Offset Points of Auto Points	834
	58.4.1 Overview	834
	58.4.2 Configuring Offset Points	836
59	Survey Cross Section	839
59.1	Overview	839
59.2	Accessing Survey Cross Section	840
59.3	Creating/Editing a Cross Section Template	841
59.4	Surveying Cross Sections	843
59.5	Configuring Survey Cross Section	845
60	Survey - Hidden Points	847
60.1	Overview	847
60.2	Hidden Point Methods	848
	60.2.1 Bearing & Distance	848
	60.2.2 Using 2 Bearings	848
	60.2.3 Using 2 Distances	849
	60.2.4 Chainage & Offset	850
	60.2.5 Backwards Bearing & Distance	850
60.3	Hidden Point Measurements	851
60.4	Hidden Point Results	853
60.5	Computing an Azimuth	854
	60.5.1 Using the Sun	854
	60.5.2 Using Auxiliary Point	855
60.6	Computing Horizontal Distances from Slope Distances	856
60.7	Hidden Point Measurement Including Heights	858
61	Hidden Point	860
61.1	Overview	860
61.2	Accessing Hidden Point and Measuring	861
61.3	Configuring Hidden Point	863
62	Survey - Remote Point	865
62.1	Overview	865
62.2	Accessing Remote Point	865
62.3	Configuring Remote Point	867

63	Traverse	868
63.1	Overview	868
63.2	Accessing Traverse	868
63.3	Creating/Editing a Traverse	869
63.4	Selecting an Existing Traverse	870
63.5	Traverse Data	871
63.6	Configuring Traverse	872
63.7	Traverse Methods	874
	63.7.1 Starting Traverse	874
	63.7.2 Continuing an Existing Traverse	875
	63.7.3 Closing Traverse	876
	63.7.4 Creating a Control Point from Backsight by Azimuth	878
63.8	Traverse Point Results	878
63.9	Traverse Results	881
63.10	Traverse Adjustment	882
	63.10.1 Accessing Traverse Adjustment	882
	63.10.2 Adjustment Results	884
64	Volumes & Surfaces	886
64.1	Overview	886
64.2	Accessing Volumes & Surfaces	886
64.3	Configuring Volumes & Surfaces	887
64.4	Calculating Volumes	888
	64.4.1 Create a New Surface by Measuring New Points	888
	64.4.2 Create a New Surface by Using Grid Scan	890
	64.4.3 Create a New Surface from Previously Stored Points	890
	64.4.4 Choosing an Existing Surface	892
	64.4.5 Selecting the Surface Task	892
	64.4.6 Boundary Definition	893
	64.4.7 Compute Volumes	895
65	QuickVolume	898
65.1	Overview	898
65.2	Accessing Volume Calculations	898
65.3	Volume Calculations	898
Appendix A	Menu Tree	900
Appendix B	Internal Memory	905
Appendix C	Directory Structure of the Memory Device	906
Appendix D	Pin Assignments and Sockets	908
D.1	GS08plus	908
D.2	GS10	908
D.3	GS14	910
D.4	GS15	910
D.5	GS25	912
D.6	CS10/CS15	914
D.7	TS11/TS15/TS12 Lite	915
D.8	MS50/TS50/TM50	915
D.9	TPS1200+	916
Appendix E	Cables	917
E.1	GPS Cables	917
E.2	TPS Cables	920

Appendix F	NMEA Message Formats	922
F.1	Overview	922
F.2	Symbols Used for Describing the NMEA Formats	922
F.3	GGA - Global Positioning System Fix Data	924
F.4	GGK - Real-Time Position with DOP	925
F.5	GGK(PT) - Real-Time Position with DOP, Trimble Proprietary	926
F.6	GGQ - Real-Time Position with CQ	927
F.7	GLL - Geographic Position Latitude/Longitude	928
F.8	GNS - GNSS Fix Data	928
F.9	GSA - GNSS DOP and Active Satellites	929
F.10	GSV - GNSS Satellites in View	930
F.11	LLK - Leica Local Position and GDOP	931
F.12	LLQ - Leica Local Position and Quality	932
F.13	RMC - Recommended Minimum Specific GNSS Data	933
F.14	VTG - Course Over Ground and Ground Speed	934
F.15	ZDA - Time and Date	935
Appendix G	AT Commands	936
Appendix H	Event Input Notify Message Format	938
Appendix I	PPS Output Notify Message Format	939
Appendix J	Glossary	942
J.1	A	942
J.3	C	943
J.4	D	951
J.7	G	952
J.8	H	955
J.9	I	956
J.14	N	957
J.15	O	959
J.16	P	960
J.19	S	960
J.20	T	963
J.22	V	968
J.23	W	968
Index		940

1 Configurable Keys

1.1 Hot Keys



Hot keys are found on the TS and on the CS15 model only. The CS10 model does not have any hotkeys.

Description

Two levels of hot keys exist:

- The first level is the keys **F7, F8, ..., F12** and **F13**, the user definable Smartkey.
- The second level is the combination of Fn and **F7, F8, ..., F12**.

Functionality



Hot keys provide a shortcut for quickly and directly carrying out functions or starting applications assigned to the keys. The assignment of functions and applications to hot keys is user configurable.

Use

- The first level is accessed by pressing **F7, F8, ..., F12** or **F13**, the user definable Smartkey, directly.
- The second level is accessed by pressing Fn first followed by **F7, F8, ... F12**.
- Hot keys can be pressed at any time. It is possible that a function or application assigned to a hot key cannot be executed in certain situations.

Define hot key step-by-step

This step-by-step description shows how to assign the **Coding & linework settings** screen to the **F7** key and to the first line of the **My GPS Favourites** or **My TPS Favourites** menu.

Step	Description
1.	Select Main Menu: User\Work settings\Hot keys & favourites.
2.	Hot Keys & Favourites For hot keys/Fn hot keys select F7: User - Coding & linework settings. For favourites select 1: User - Coding & linework settings.
3.	OK
4.	OK
5.	Press F7 to access Coding & linework settings. OR GPS Press the favourites key  and 1 to access Coding & linework settings. TPS Press Fn, the favourites key  and 1 to access Coding & linework settings.

User definable Smartkey

The user definable Smartkey is located next to the right hand fine drives. It enables fast and comfortable recording of measurements. Being equipped with a soft touch key located in the instruments turning axis allows highest precision measurements. All functions and application programs that can be assigned to the hot keys can be assigned to the user definable Smartkey including **<None>**.

1.2



Favourites Key

Description

GPS

- Fn  opens the **My GPS Favourites** menu.
- The  key alone opens the **Leica GPS Favourites** menu.

TPS

- Fn  opens the **My TPS Favourites** menu.
- The  key alone opens **Leica TPS Favourites**.



The following chapter is about the **My GPS Favourites** and **My TPS Favourites** menus only. Refer to **Leica TPS Favourites** for more information about **Leica TPS Favourites**.

Functionality of the favourites menu

The **My GPS Favourites** and **My TPS Favourites** menus can be configured to contain the most used functions or applications. The favourites menu cannot be accessed while in a configuration screen.

Selecting an option in the menu carries out the function or starts the application assigned to the option.

My favourites menu

The following screen is an example of what a **My GPS Favourites** or **My TPS Favourites** menu can look like. The softkeys and their order is fixed. The functions and applications which are assigned to the individual places in the menu can differ depending on the configuration.

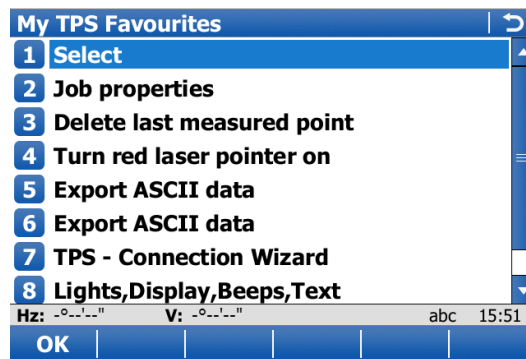

Key	Description
OK	To execute the selected function.
Fn Quit	To exit the screen.

Define favourites menu step-by-step

Defining the favourites menu is the same process as for defining the hot keys. Refer to "1.1 Hot Keys".

2 TPS Settings TPS

2.1 Leica TPS Favourites

Description Frequently used settings can be accessed and changed quickly. The change is applied immediately. The workflow is not interrupted.
This screen displays the possible settings to change to.



Changes made on this screen are stored in the active working style.

Access Tap the target aiming icon or select .

Leica TPS Favourites The appearance of the screen changes, depending on whether the instrument is equipped with motorisation, ATR, reflectorless EDM or PowerSearch.

To change to the displayed setting do one of the following:

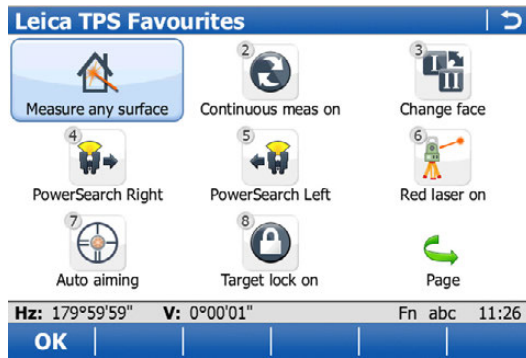

- Tap on the icon on the touch screen.
- Highlight a field and press .
- Highlight a field and press .
- Highlight a field and press **OK**.
- Press the number next to the function.



Key	Description
OK	To apply the selected setting, or to access the selected function.
Fn Quit	To exit the screen.

Description of options

Icon	Description
Measure any surface	To measure to any surface (reflectorless). Automatically sets Target aiming: Manual .
Measure to prism	To measure to prisms.
Continuous meas on	To set the measure mode to continuous.
Continuous meas off	To set the measure mode to the previous non-continuous mode.
Change face	To change the face of the telescope.
PowerSearch right	Prisms are searched for with PowerSearch in the PS window when this icon is used.

Icon	Description
	 If this icon is selected and reflectorless measurements is still set, then this setting is changed to measurements to prisms.
PowerSearch left	To start PowerSearch right in anti-clockwise direction.
Red laser on	To turn the red laser of the reflectorless EDM on.
Red laser off	To turn the red laser of the reflectorless EDM off.
Auto aiming	To set Target aiming: Automatic.
Manual aiming	To set Target aiming: Manual.
Target lock on	To set Target aiming: LOCK.
Target lock off	To set Target aiming to the previous non-lock setting.
Joystick	To turn the instrument using the arrow keys. Refer to Joystick.
Turn to Hz/V	To turn the instrument to a specific entered position. Refer to Turn Instrument to Hz/V.
Check point	To check a point or the instrument orientation. Refer to Check Point.
Compass	To turn the instrument using compass readings. Refer to Orientation With Compass.
Bluetooth connection	To define Bluetooth connections.
Camera	To begin the camera function of the CS field controller. Refer to "2.6 Using the Digital Camera".
Panoramic image	To generate a panoramic image. Refer to "33.3.5 Panoramic Imaging".  Panoramic images can only be generated with motorized instruments with overview camera.
Sketch pad	To create a sketch on a virtual piece of paper. Refer to "33.5.2 Field Sketching".
Start Active Assist	To connect to the Active Assist service.
End Active Assist	To disconnect from the Active Assist service.

Description

This screen is used to check if a measured point is identical to a point already stored in the job, or if the instrument's orientation to a backsight point is still correct.

Access

In **Leica TPS Favourites** click **Check point**.

Check Point

Check Point | ↩

Point ID: 1016

Target height: 0.0000 m

Target: Leica Round Prism

Δ azimuth: 29.6400g

Δ hz dist: ----m

Δ height: ----m

Hz: 50.0001g V: 100.0000g abc 17:11

Store | Dist | More | Last

Key	Description
Dist	To measure a distance.
Store	To store the point and return to Main Menu .
Positn	To position to the selected point. For Target aiming: Automatic the instrument does an ATR search. For Target aiming: LOCK the instrument tries to lock on to a prism.
More	To display additional information.
Last	To recall the point ID of the last checked point.
Fn Quit	To exit the screen.

Description of fields

Field	Option	Description
Point ID	Selectable list	Point ID to be checked. If a stored point was checked, the point ID for that point is remembered and recalled when Last is pressed.
Target height	Editable field	The last used prism height is suggested. An individual prism height can be typed in.
Target	Selectable list	Target names as configured in the Targets screen.
Δ azimuth	Display only	Difference between calculated azimuth and current orientation.
Δ hz dist	Display only	Difference between calculated and current distance.
Δ height	Display only	Difference between calculated and current height.
Current azimuth	Display only	Current orientation.
Horiz distance	Display only	Current distance between station and backsight point.

Field	Option	Description
Height difference	Display only	Current height difference between station and backsight point.
Calc'd azimuth	Display only	Calculated azimuth between station and backsight point.
Calc'd hz dist	Display only	Calculated horizontal distance between station and backsight point.
Calc'd Δheight	Display only	Calculated height difference between station and backsight point.

2.3

Joystick

Description

The instrument can be turned using the keyboard arrow keys on the instrument or field controller, or the arrow keys displayed on the touch screen. When this screen is accessed, the EGL is turned on automatically. When leaving the screen, the EGL is turned off.

Access

In **Leica TPS Favourites** click **Joystick**.

Move by Joystick

Use the arrow keys to start the telescope movement. Press an arrow key again to speed up the movement. Press any of the other arrow keys while the instrument turns to stop the movement. Press **OK** to stop the instrument movement.

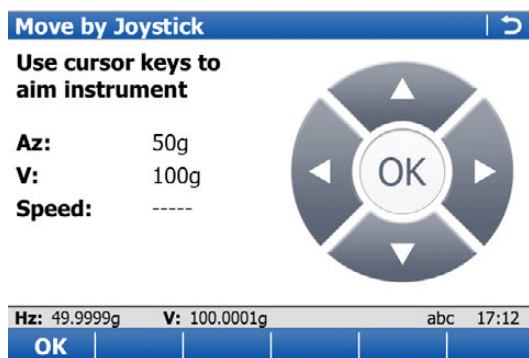

Key	Description
OK	To return to Main Menu .
Fn Quit	To exit the screen.

Description of fields

Field	Option	Description
Speed	----, Very slow , Slow , Medium and Fast	Displays the rotating speed of the instrument. Press the same arrow key to change the speed.

Description

This screen is used when the instrument is remote controlled and the telescope is to be turned to a certain direction.

Access

In **Leica TPS Favourites** click **Turn to Hz/V**.

Turn Instrument to Hz/V, Absolute page

Key	Description
OK	To return to Main Menu . The instrument turns to the prism.
Page	To change to another page on this screen.
Fn Quit	To exit the screen.

Description of fields

Field	Option	Description
Azimuth	Editable field	Oriented horizontal direction for the instrument to turn to.
Angle right	Editable field	Displays the horizontal angle difference between the backsight point and the current telescope position.
V angle	Editable field	Vertical direction for the instrument to turn to.

Next step

Page changes to the **Relative** page.

Turn Instrument to Hz/V, Relative page

The values are added to the current telescope position to calculate the new direction for the telescope to turn to.

Description of fields

Field	Option	Description
ΔHz	Editable field	Angular difference for the horizontal angle to turn to.
ΔV	Editable field	Angular difference for the vertical angle to turn to.

Next step

Press **OK**. The instrument turns to the prism.

For **Target aiming: Automatic** an ATR measurement is performed. If no prism was found, the instrument turns to the position typed in.

For **Target aiming: Lock** the instrument locks on the prism and the LOCK icon is displayed. If no prism was found, the instrument turns to the position typed in.

2.5

Orientation With Compass

Description

Using a conventional magnetic compass while remotely controlling the instrument, it is possible to determine the direction towards which the instrument should turn to perform a target search to locate the prism.



Access

In **Leica TPS Favourites** press **Comps**.



The instrument must be connected to a radio to be remote controlled with the field controller.

Orientation with compass step-by-step

Step	Description
1.	Set up the instrument.
2.	Start the Survey application.
3.	Turn the telescope until H_z: 0.0000 .
4.	Look through the telescope with H_z: 0.0000 to select an object which is easily recognisable.
5.	Standing at the instrument, point the compass to the selected object. Turn the rotating dial until the "N" lines up with the north end of the compass needle.  The compass dial must not be turned once the "N" is lined up with the north end of the compass needle.
6.	Go to the prism. From the prism aim the "N" of the compass towards the instrument. Read the horizontal angle as pointed to by the north end of the compass needle.
7.	In Leica TPS Favourites click on the Compass icon.
8.	Orientation With Compass Compass reading: The horizontal angle read from the compass while aiming to the instrument. V angle: If the compass works as a clinometer, those values can also be used.  The horizontal and vertical angle reads from the compass are always displayed in degree regardless of the system settings.
9.	OK to return to the survey screen. The instrument turns to the prism. For Target aiming: Automatic an ATR measurement is performed. If no prism was found, the instrument turns to the position typed in. For Target aiming: Lock the instrument locks on the prism and the LOCK icon is displayed. If no prism was found, the instrument turns to the position typed in.

**Taking a picture
step-by-step**

Step	Description
1.	Aim the camera to the desired target.
2.	Check the view at the display.
3.	Press OK or click Capture to take the picture.  Capture changes to Save .
4.	Press OK again or click Save to open the Save As dialog.
5.	Click Discard to reject the picture.

3 GPS Settings GPS

3.1 Leica GPS Favourites

Description Frequently used settings can be accessed and changed quickly. The change is applied immediately. The workflow is not interrupted.
This screen displays the possible settings to change to.



Changes made on this screen are stored in the active working style.

Access Tap the position status icon or select .

Leica GPS Favourites The appearance of the screen changes, depending on the RTK settings defined. To change to the displayed setting do one of the following:

- Tap on the icon on the touch screen.
- Highlight a field and press .
- Highlight a field and press .
- Highlight a field and press **OK**.
- Press the number next to the function.

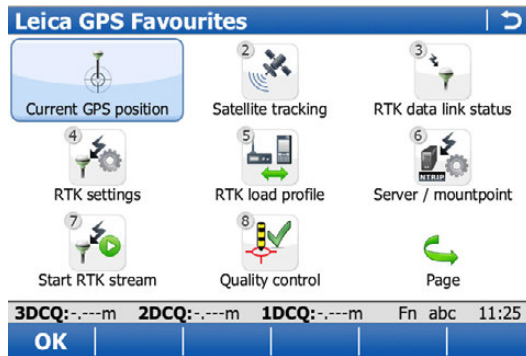

Key	Description
OK	To apply the selected setting, or to access the selected function. Once leaving a screen, the system returns to the screen from where this screen was accessed..
Fn Quit	To exit the screen.

Description of options

Icon	Description
Current GPS position	To open the status screen Current GPS Position . Refer to "22.5 Current GPS position".
Satellite tracking	To open the status screen Satellite Tracking . Refer to "22.3 Satellite tracking".
RTK data link status	Available when RTK is configured. Opens the status screen RTK Data Link Status or RTK Data Link Status (RTK1)/RTK Data Link Status (RTK2) . Refer to "22.4 RTK data link status".
RTK settings	To open the configuration screen RTK Rover Settings or RTK base settings (RTK1)/RTK base settings (RTK2) . Refer to "19.7 RTK Rover" and "19.8 Base RTK 1 / Base RTK 2".
Load RTK profile	To load an existing profile via the RTK Rover Wizard . Refer to "13.1 RTK rover wizard".

Icon	Description
Radio ch. / dial-up	To open the configuration screen Radio Configuration . Refer to "20.3 Radios for GPS Real-Time".
Start RTK stream	To start streaming RTK data.
Stop RTK stream	To stop streaming RTK data.
Quality control	To open the configuration screen GNSS Quality Control Settings . Refer to "13.4 Quality control".
Raw data logging	To open the status screen Raw Data Logging Status . Refer to "22.6 Raw data logging".
Bluetooth connection	To define Bluetooth connections.
Camera	To begin the camera function of the CS field controller. Refer to "2.6 Using the Digital Camera".
Sketch pad	To create a sketch on a virtual piece of paper. Refer to "33.5.2 Field Sketching".
Start Active Assist	To connect to the Active Assist service.
End Active Assist	To disconnect from the Active Assist service.

4

Main Menu

4.1

Main Menu Functions

Main Menu



Key	Description
OK	To select the highlighted option and to continue with the subsequent screen.
Map	To open Tap Map . Refer to "38 Tap Map".
Fn Mode	To switch between GPS and TPS mode.
Fn Exit	To close Leica SmartWorx Viva software.

Description of the main menu functions

Main menu function	Description	Refer to chapter
Go to Work!	To select and start an application.	"4.2 Go to Work!"
Jobs & Data	To manage jobs and data, as well as import and export. Available in SmartWorx when operating an RTK rover or a TPS.	"4.3 Jobs & Data"
Instrument	To access settings regarding GPS and instrument connections as well as status information.	"4.4 Instrument"
User	To make settings regarding the software and the display as well as other useful tools. Available in SmartWorx when operating an RTK rover or a TPS.	"4.5 User"

4.2

Go to Work!

Description

The **Go to Work!** menu contains all loaded applications. Selecting an option in the menu starts the application. Configurations and measurements that can be performed depend on the application.



The menu can be displayed as drop-down menu or as icon menu. To change between both options go to **User\System Settings\SmartWorx options**. Change to the **General** page and check or uncheck **Use drop down menus in the main menu**.

Go to Work!

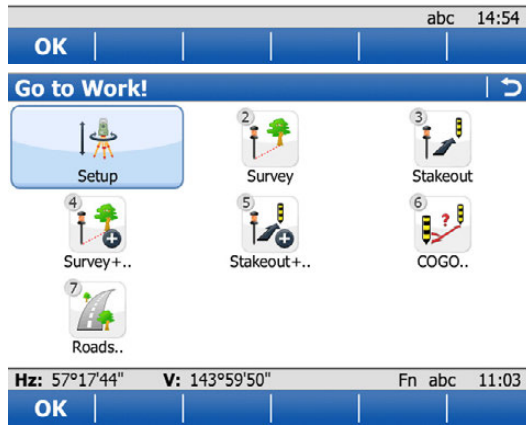
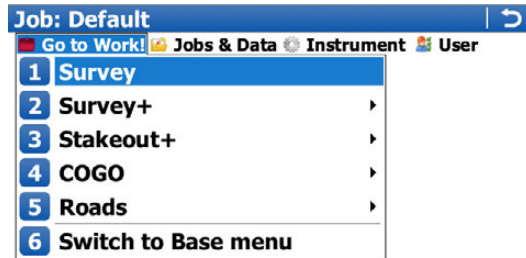

Key	Description
OK	To start the highlighted application or to open a submenu.

Next step

Refer to **Applications - General** for information on the applications.

4.3

Jobs & Data

Description

Jobs & Data is available in SmartWorx when operating an RTK rover or a TPS. It is used to:

- Create a new job.
- Select a job.
- View job properties.
- View and edit data.
- Import data.
- Export and copy data.



The menu can be displayed as drop-down menu or as icon menu. To change between both options go to **User\System Settings\SmartWorx options**. Change to the **General** page and check or uncheck **Use drop down menus in the main menu**.

Jobs & Data

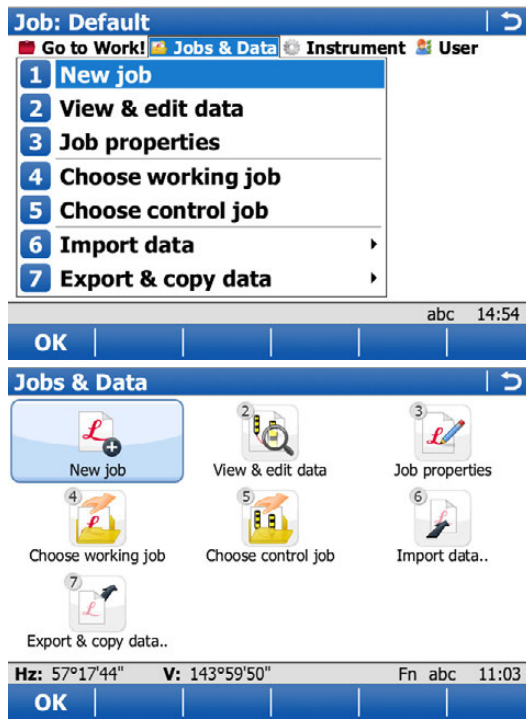

Key	Description
OK	To select the highlighted option and to continue with the subsequent screen.

Next step

New job	Refer to chapter 5.2.
View & edit data	Refer to chapter 6.
Create control data	Refer to chapter 9.
Job properties	Refer to chapter 5.3.
Choose working job	Refer to chapter 5.4.
Choose control job	Refer to chapter 5.4.
Import data	Refer to chapter 10.
Export & copy data	Refer to chapter 11.

Description

Instrument is used to:

- Configure parameters related to the instrument.
- Configure parameters related to the interfaces.
- Check status information.



The menu can be displayed as drop-down menu or as icon menu. To change between both options go to **User\System Settings\SmartWorx options**. Change to the **General** page and check or uncheck **Use drop down menus in the main menu**.

Instrument

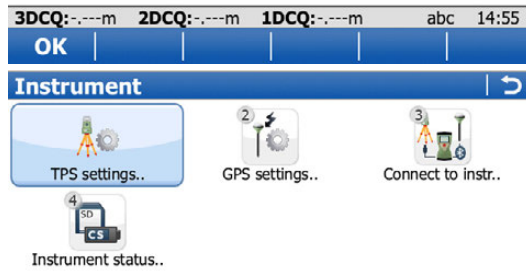
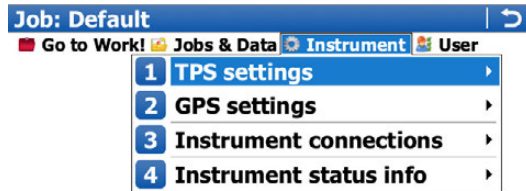

Key	Description
OK	To select the highlighted option and to continue with the subsequent screen.

Next step

GPS settings	Refer to chapter 13.
TPS settings	Available for TPS. Refer to chapter 13.
Base settings	Available in SmartWorx when operating an RTK base. Refer to chapter 22.
Connections..	
• GPS connection wizard	Refer to chapter 13.1.
• TPS connection wizard	Available for TPS. Refer to chapter 13.
• All other connections	Refer to chapter 19.
Base connections	Available in SmartWorx when operating an RTK base. Refer to chapter 22.
Instrument status info	Available in SmartWorx when operating an RTK rover or a TPS. Refer to chapter 22.
Base status info	Available in SmartWorx when operating an RTK base. Refer to chapter 22.

Description

User is available in SmartWorx when operating an RTK rover or a TPS. It is used:

- To configure user favourite settings for the survey and the instrument.
- For functionality which is not directly related to surveying data, such as loading firmware or licence keys, format data storage devices and viewing ASCII files.



The menu can be displayed as drop-down menu or as icon menu. To change between both options go to **User\System Settings\SmartWorx options**. Change to the **General** page and check or uncheck **Use drop down menus in the main menu**.

User

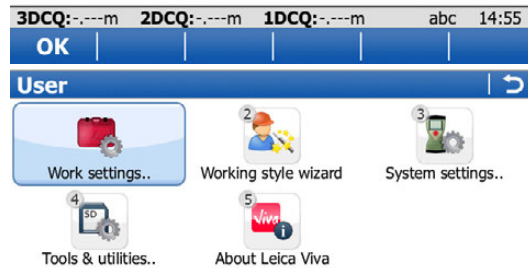

Key	Description
OK	To select the highlighted option and to continue with the subsequent screen.

Next step

Work settings	Refer to chapter 25.
Working style wizard	Refer to chapter 28.
System settings	Refer to chapter 29.
Tools & other utilities	Refer to chapter 30.

Description

The screen icons display the status information of the instrument.



The icons provide information related to basic instrument functions. The icons that appear depend upon which instrument is used and the current instrument configuration.

TPS specific icons









Icon	Description
Automatic aiming 	Displays the current automatic aiming or PowerSearch settings.
Prism 	Displays the selected prism.
Measure mode 	Displays the selected measurement mode. The red laser icon will display when the red laser is active.
Compensator level and Instrument face I or II 	Displays the compensator is off or out of range icons, or the instrument face I or II icon.

GNSS specific icons









Icon	Description
Position status 	Displays the status of the current position. As soon as this icon becomes visible the instrument is in a stage where practical operation can commence.
Number of visible satellites 	Displays the number of theoretically visible satellites above the configured cut-off angle according to the current almanac.
Contributing satellites 	Displays the number of satellites that are contributing to the currently computed position solution. The number of contributing satellites can differ from the number of visible satellites. This difference can be because satellites cannot be viewed, or because the observations to these satellites are considered too noisy to be used.
Real-time device 	Displays the real-time device configured to be used.
Real-time status 	Displays the status of the real-time device configured to be used.

Automatic aiming











Icon	Description
	The instrument is in Auto Aiming mode using ATR.
	The instrument is in manual aiming mode

Icon	Description
	The instrument is in target lock mode, however not following a prism at current. Lock Status: Unlocked.
	The instrument is in target lock mode, following a prism at current. Lock Status: Locked.
	The Visibility setting in Measure & Target Settings is set to Rain & fog . This setting ensures better performance under unfavourable visibility conditions.
	The Visibility setting in Measure & Target Settings is set to Sun & reflections . This setting ensures better performance under sunny conditions with reflexions.
	The instrument is in prediction or locking on the fly is activated. The instrument will lock towards a prism coming into the field of view and follow this prism.
	The prediction time has elapsed. The instrument beeps and the EGL is blinking. The instrument will lock towards a prism coming into the field of view and follow this prism.
	Searching for the prism using Auto aiming .
	Searching for the prism using PowerSearch .



Prism

Icon	Description
	Leica circular prism
	Leica 360° prism
	Leica mini prism
	Leica mini 0
	Leica mini 360°
	Leica Machine Automation power prism MPR122
	Leica reflective tape or HDS target.
	Reflectorless
	User defined prism





Measure mode

Icon	Description
	No active distance measurement
	Distance measurement active
	Measure mode Single
	Measure mode Single (fast)
	Measure mode Continuous
	Measure mode Averaging
	Measure mode Continuous+
	Measure mode Long range (>4km)
	Measure mode Long range avg
	Red laser is turned on

Compensator level and instrument face I or II

Icon	Description
	Compensator is turned off.
	Compensator is turned on, but is out of range.
	The current face of the instrument is shown, if the compensator and the Hz-correction are turned on.

Position status





Icon	Description
	Navigation position available
	Code solution available
	Fixed position available
	xRTK fixed position available
	Precise mode



Icon	Description
	The ticks indicate that an ambiguity check is being made.

Number of visible satellites







Icon	Description
	The number of visible satellites.



Contributing satellites

Icon	Description
When a position status icon is displayed then	
	the number of satellites currently used for the position computation are shown.
If no position is currently available then	
	<ul style="list-style-type: none"> the L1, L2 and L5 values (GPS only) show how many satellites are being tracked. OR the sum and G (GPS), R (GLONASS), E (Galileo) or B (BeiDou) values show how many satellites are being tracked.
	
	





-  The number of contributing satellites can differ from the number of visible satellites. This may be either because satellites cannot be viewed or the observations to these satellites are considered to be too noisy to be used in the position solution.
-  The number of contributing GLONASS satellites could be zero if five or more GPS satellites are used for the position computation. The processing algorithm automatically selects the best possible set of satellite combinations for the position computation. A position computation with R = 0 is certainly within the specified reliability.

Real-time device













Icon	Description
	Radio
	Digital cellular phone/modem
	Internet
	SBAS/WAAS/EGNOS/MSAS/GAGAN
	CTR16
	NTRIP





Icon	Description
	RS232
 	Caution

Real-time status



Icon	Description
	An arrow pointing down indicates a real-time rover configuration. The arrow flashes when real-time messages are received.
	An arrow pointing up indicates a real-time base configuration. The arrow flashes when real-time messages are received.
	Sending/receiving data
	Raw data logging active
	Synchronization active

Current active instrument



Icon	Description
	TS instrument
	TS with cable
	GS rover instrument
	GS rover with cable
	TS and GS rover connected via cable. The instrument in the foreground is used first.
	TS and GS rover connected via Bluetooth. The instrument in the foreground is used first.
	GS base with active Bluetooth connection
	CS with GS05 used
	TS and CS used
	GS25 used
	GS25 with cable connection
	GS base and GS25 connected via cable

Icon	Description
	GS12 rover instrument
	GS12 rover connected via cable
	GS12 base
	Caution. Connection between CS and GS via Bluetooth.





Camera

Icon	Description
	To capture an image with the camera
	Image capture in progress

Internet online status

Icon	Description
	Instrument is online in the Internet.
	Internet not connected.

Leica Exchange service

Icon	Description
	Logged into Leica Exchange.
	Data upload in progress.
	Data download in progress.
	Exchanging new data.
	Data transfer problem.

Active Assist service

Icon	Description
	Active Assist is active. Leica technical support can gain remote access to the instrument.

Data management

Icon	Description
	To access data management where lines/areas can be opened/closed.
	At least one line is open.
	At least one area is open.
	At least one line and one area are open.

Memory storage

Icon	Description
	Internal memory. Sufficient memory space available.
	CompactFlash card is inserted and can be removed. Sufficient memory space available.
	Secure Digital Memory card is inserted and can be removed. Sufficient memory space available.
	USB stick is inserted and can be removed. Sufficient memory space available.
	The memory device is inserted and cannot be removed. It is strongly recommended not to remove the memory device to avoid loss of data.
	Memory device full

Battery

Icon	Description
	A CS internal battery is inserted and in use. Sufficient power available.
	A GS internal battery is inserted and in use. Sufficient power available.
	A TS internal battery is inserted and in use. Sufficient power available.
	Power level is getting low.
	Power level is getting low.
	Battery empty.

5 Jobs & Data - Jobs

5.1 Overview

Description	Jobs <ul style="list-style-type: none">• structure surveying projects.• contain all points, lines, areas and codes that are measured/recorded and stored.• can be downloaded to LGO for post-processing or for data transfer to a further program.• can be uploaded from LGO, for example, for (real-time) stakeout operations.• can be stored on the data storage device or, if fitted, the internal memory.
Type of jobs	<ul style="list-style-type: none">• Data jobs. Explained in this chapter.• DTM files. Refer to "53.6 Staking Out a DTM or Points & DTM".• Road alignment files.
Default job	A job called Default is available on the instrument after: formatting the memory device, inserting a previously formatted data storage device or deleting all jobs from Job properties .
Working job	The working job is the one data is stored to. One job is always considered the working job. After formatting the memory device, the job Default is used until a user-defined job is created and selected. When a job becomes the working job, then the sort and filter settings of this job are saved in the SystemRAM. If the data storage device is formatted then these last used sort and filter settings are used for the job Default .

5.2 Creating a New Job

Access Select **Main Menu: Jobs & Data\New job**.

New Job, General

The screenshot shows the 'New Job' screen with the following elements:

- Header: **New Job** with a back arrow.
- Navigation tabs: General (selected), Codelist, CAD files, Coord system, Averaging.
- Fields:
 - Name:** Job
 - Description:** Two empty text boxes.
 - Creator:** Empty text box.
 - Device:** CF card (dropdown menu).
- Checkbox: Use with System1200
- Status bar: 3DCQ:--m 2DCQ:--m 1DCQ:--m Fn abc 17:37
- Bottom navigation: Store, Page

Key	Description
Store	To store the settings.
Page	To change to another page on this screen.
Fn Quit	To exit the screen.

Description of fields

Field	Option	Description
Name	Editable field	A unique name for the new job. The name can be up to 16 characters long and include spaces. Input required.
Description	Editable field	Two lines for a detailed description of the job, for example, work to be performed or the classes contained in the job. Input optional.
Creator	Editable field	The person's name who is creating the job. Input optional.
Device	Selectable list	The device on which the new job will be stored. Depending on the instrument options, this may be a display only field.
Use with System1200	Check box	When this box is checked, the job can be used on System 1200 instruments. The setting of this check box is remembered until changed manually.

Next step

Page changes to the **Codelist** page.

New Job, Codelist page

Description of fields

Field	Option	Description
Codelist	Selectable list	Choosing a codelist copies the codes to the job.

Next step

Page changes to the **CAD files** page.

New Job, CAD files page

New Job		
File	Format	Use
DXF_Road	dxf	No
Plot	dxf	No
Plot_dxf	Leica	No

3DCQ:--m	2DCQ:--m	1DCQ:--m	Fn abc	13:58
Store		Attach	More	Page

Key	Description
Store	To store the settings. Selected and attached CAD files will be available in the job as background maps.
Unit	To change between the options in the Unit column. Available when the Unit column is visible after using the More key.  The default value for the units depends on the selection in Regional Settings, Distance page. If the regional settings units are inches or miles, then the default cad file units are feet. If the regional settings are kilometer, then the default settings for cad files are meters.

Key	Description
Attach	To attach a CAD file from the \DATA folder of any data storage device. The new job and the CAD file need not be on the same data storage device. The setting in the Use column will be updated. CAD heights are supported.
More	To display information about the format, size, source and units.
Page	To change to another page on this screen.
Fn Quit	To exit the screen.

Description of columns

Column	Description
File	The name of the CAD files available in the \DATA directory of any data storage device.
Format	The format of the CAD file: dxf, shp or Leica for CAD files that are already attached to other jobs and converted to Leica format.
Size (MB)	The size of the CAD file in megabytes.
Source	The memory device where the CAD file is stored.
Unit	The units used for the CAD file.
Use	If set to Yes , the file is attached to the job when Store is pressed.

Next step

Page changes to the **Coord system** page.

New Job, Coord system page

Description of fields

Field	Option	Description
Coord system	Selectable list	Choosing a coordinate system attaches it to the job. If it is not known which coordinate system to use, select Coord system: WGS 1984 .
All other fields on this screen are display only fields. They depend on the transformation type of the selected coordinate system.		

Next step

GPS **Page** changes to the **Averaging** page.

TPS **Page** changes to the **Scale** page.

New Job, Averaging page

In order to check measurements, the same point can be measured more than once. If activated, an average or an absolute difference is calculated.

Description of fields

Field	Option	Description
Mode		Defines the averaging principles for multiple measured points. The selection determines the availability of the subsequent fields for setting the acceptable averaging limits or absolute differences.

Field	Option	Description
	Average Absolute differences Off	Computes the average for the position and the height. Points exceeding the defined limits are marked with ! in Edit Point: Mean page. Computes the absolute differences between two points selected from a list of measured points which are all stored with the same point ID. Averaging is turned off. No other fields are available.
Method	Weighted No weighting	The method used for computing the average. Available for Mode: Average . Calculates a weighted average Calculates an arithmetic average.
Points to use	Selectable list	The type of points which will be taken into account for averaging or absolute differences. Available for Mode: Average and Mode: Absolute differences .
Limit in position and Limit in height	Editable field	The acceptable difference for the position and height components. Available for Mode: Average .
From Easting to Cartesian Z	Editable fields	The acceptable absolute differences for each coordinate component. Available for Mode: Absolute differences .

Next step

Store creates a new job.

New Job, Scale page TPS

The geometric distance correction (geometric ppm) is derived from the map projection distortion (map projection ppm), the height above reference datum correction (height ppm) and an individual correction (individual ppm).

The calculation of the map projection ppm follows the formula for the Transversal Mercator Projection. The individual factors are: the scale factor of the line of projection central meridian, Gauss-Krüger = 1.0, UTM = 0.9996, etc. and the offset from the line of projection.

The calculation of the height ppm is derived from the height of the instrument station above the reference datum. Normally this is the height above mean sea level MSL.

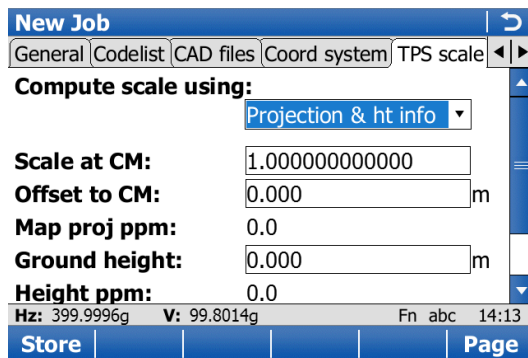

Key	Description
Store	To store the settings.

Key	Description
SF/ppm	To change between entering the scale factor or the ppm. Only available for Compute scale using:SF/GeoPPM .
ppm=0	To set Geometric ppm: 0.0 .
Page	To change to another page on this screen.
Fn Quit	To exit the screen.

Description of fields

Field	Option	Description
Compute scale using	Projection & ht info	To enter all values for determining the geometric ppm.
	SF/GeoPPM	To enter only the scale factor or the geometric ppm value.
	Stn & coord system	To automatically calculate the ppm/scale factor from the coordinate system and station position.
Scale at CM	Editable field	The scale at the central meridian. Available for Compute scale using: Projection & ht info .
Offset to CM	Editable field	The offset to the central meridian. Available for Compute scale using: Projection & ht info .
Map proj ppm	Display only	The map projection ppm value. If this value cannot be calculated, then ----- is displayed and is also ignored in the calculation of the geometric ppm value. Available for Compute scale using: Projection & ht info and Compute scale using: Stn & coord system .
Ground height	Editable field	The height of the instrument station above the reference datum. Available for Compute scale using: Projection & ht info .
Height ppm	Display only	The height ppm value calculated from the height coordinates of the current station stored in the internal memory. If this value cannot be calculated, then ----- is displayed and is also ignored in the calculation of the geometric ppm value. Available for Compute scale using: Projection & ht info and Compute scale using: Stn & coord system .
User entered ppm	Editable field	The individual ppm value. Available for Compute scale using: Projection & ht info and Compute scale using: SF/GeoPPM .
Geometric ppm	Display only	For Projection & ht info : Geometric ppm = Map proj ppm + User entered ppm + height ppm value calculated from Ground height. For Stn & coord system : Geometric ppm = Map proj ppm + Height ppm.

Field	Option	Description
User entered scale factor	Editable field	The user entered scale factor. Compute scale using: SF/GeoPPM.

Additional calculation method for the geometric ppm value

The geometric ppm value can also be calculated by a resection calculation. The scale factor from the resection is used for **User entered ppm**.

Individual ppm=(s-1)*106.s=1+ppm*10⁻⁶. The **Geometric ppm** value is calculated with the following:

- **Scale at CM: 1,**
- **Offset to CM: 0,**
- **Map proj ppm: 0** and
- **Ground height: 0.**

Automatic calculation of the geometric ppm value

When **Compute scale using: Stn & coord system**:

- the ppm values for Map Proj ppm, Height ppm and Geometric ppm are automatically calculated. The coordinates of the current instrument station stored in the internal memory are used, which are based on the currently active coordinate system.
- each time an application is accessed, the geometric ppm value is automatically calculated. The coordinates of the current instrument station stored in the internal memory are used (these coordinates may have been updated), which are based on the currently active coordinate system (this coordinate system may have changed). This way, the user is always working with the correct geometric ppm value.
- when the **<None>** coordinate system is chosen, then the geometric ppm value cannot be automatically calculated. A message will appear, allowing the user to either manually enter the ppm values or accept ppm values of 0.

Next step

Page changes to the **Averaging** page.

5.3 Job Properties and Editing a Job

Description In the **Job Properties:**, the settings for a job can be viewed and changed.

Access Select **Main Menu: Jobs & Data\Job properties**.

Job Properties:, General page The fields on this page are identical with the fields in **New Job, General**. Refer to "5.2 Creating a New Job".

Job Properties: Default [↩]

General | Codelist | CAD files | Coord system | Averaging

Name: Default

Description: -----

Creator: -----

Device: CF card

Size (kB): 55

3DCQ:-:---m 2DCQ:-:---m 1DCQ:-:---m abc 10:13

Store | Data.. | Page

Key	Description
Store	To store the settings.
Data..	To view, edit and delete points, lines and areas stored with the job. Points, lines and areas are shown on separate pages. Selected sort and filter settings apply.
Page	To change to another page on this screen.
Fn Log..	To view, edit and delete points, lines and areas stored with the job. Points, lines and areas are sorted by time in one list.
Fn Quit	To exit the screen.

Next step

Page changes to the **Codelist** page.

Job Properties:, Codelist page

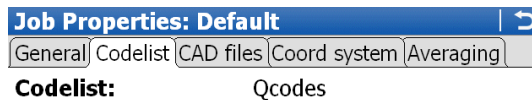

Key	Description
Store	To store the settings.
Import	To add additional codes from a new codelist to the job. The name of this codelist is copied to the job.
Codes..	To view codes currently stored in the job. Refer to "5.5 Managing Job Codes".
Data..	To view, edit and delete points, lines and areas stored with the job. Points, lines and areas are shown on separate pages. Selected sort and filter settings apply.
Page	To change to another page on this screen.
Fn Log..	To view, edit and delete points, lines and areas stored with the job. Points, lines and areas are sorted by time in one list.
Fn Export	To copy codes from the job to an existing or new codelist.
Fn Quit	To exit the screen.

Description of fields

Field	Option	Description
Codelist	<None>	No codes are stored in the job. This default setting can be changed. Choosing a codelist copies the codes to the job.

Field	Option	Description
	Display only	Codes are stored in the job. If codes had been copied from a codelist in the internal memory, the name of the codelist is displayed. If codes have been typed in, then the name of the working job is displayed.

Next step

Page changes to the **CAD files** page.

Job Properties: CAD files page

Job Properties: Default	
General	Codelist
CAD files	Coord system
Averaging	
Maps	View
Simple DXF 1_dxf	Yes

3DCQ:-:---m	2DCQ:-:---m	1DCQ:-:---m	abc	10:15
Store	Add	Rmove	View	Page

Key	Description
Store	To store the settings.
Add	To select a CAD file to be added to the job properties. The screen that opens is very similar to New Job, CAD files page. Refer to "5.2 Creating a New Job" for a description of the screen. Only the files that are currently not attached to the job are displayed in the CAD Files screen. The files listed are all dxf, shp files and mpl files from the \Data directory on a data storage device or in the internal memory. If an mpl file is selected, then this file, including all related files, is copied to the appropriate job folder.
Rmove	To delete the highlighted Map file from the job.  If deleted accidentally, the file must be attached again.
View	To change the setting in the View column.
Page	To change to another page on this screen.
Fn Layers..	To change to the CAD layers screen. On this screen, it is possible to make layers from the CAD file visible or invisible for MapView.
Fn Log..	To view, edit and delete points, lines and areas stored with the job. Points, lines and areas are sorted by time in one list.
Fn Quit	To exit the screen.

Description of columns

Column	Description
Maps	The name of the CAD files that can be used. The files displayed are the converted Leica Map files (*.mpl) within the job. The original file extension is added to the file name with an underscore, for example example_dxf.
View	If set to Yes , the map is visible as background maps in MapView.

Next step

IF you want to change to	THEN
another page	Page changes to the Coord system page and the Averaging page and for TPS also to the Scale page. The functionality on all pages is identical with the creation of a new job. Refer to "5.2 Creating a New Job" If the coordinate system of the working job is edited, and Use auto coordinate system has been selected in the RTK Rover Wizard , a message will display requesting confirmation to deactivate auto coordinate system.
the CAD Layers page	press Fn Layrs... Refer to "CAD Layers".

CAD Layers

CAD Layers	
Layer	Visible
C200203009	Hidden
E400200309	Visible
E500200309	Selectable
F800200309	Hidden
H900200309	Visible
T040200309	Selectable

Hz: 177°30'24"	V: 90°00'02"	Fn abc	10:15
Store		State	All

Key	Description
Store	To store the settings.
State	To change between the options in the Visible column of the highlighted layer.  Shapefiles are not displayed on this screen. Shape files are only displayed in Job Properties :, CAD files page.
All	To make all layers have the same state as the currently highlighted layer.
Fn Quit	To exit the screen.

Description of columns

Column	Description
Layer	The name of the layer. For dxf files, all layers are listed, no matter if the layer is filled or empty.
Visible	The state of the layer: <ul style="list-style-type: none"> • Hidden These layers are not shown on the Map page and their positions are not used when zooming to extents. Nothing in these layers can be selected. • Visible These layers are shown on the Map page and their positions are used when zooming to extents. Nothing in these layers can be selected. Empty dxf layers can be set to visible. • Selectable These layers are shown on the Map page and their positions are used when zooming to extents. Objects on these layers are available to be selected.

5.4

Choosing a Job

Access

- For a working job, where measured points are stored to, select **Main Menu: Jobs & Data\Choose working job**.
- For a control job with control points, select **Main Menu: Jobs & Data\Choose control job**.

Choose working job

Listed are all data jobs stored on the data storage device or in the internal memory depending on the current device.

Choose working job (SD card) ↩	
Name	Date
COGO EXC V3	11.11.2005
Cad	18.03.2010
Default	10.03.2010
fixpoint job	11.11.2005
measure job	29.02.2008

3DCQ:--m	2DCQ:--m	1DCQ:--m	Fn abc	13:46	
OK	New..	Edit..	Delete	Data..	USB

Key	Description
OK	To select the highlighted job and to return to the screen from where this screen was accessed.
New..	To create a job. Refer to "5.2 Creating a New Job".
Edit..	To edit the highlighted job. Refer to "5.3 Job Properties and Editing a Job".
Delete	To delete the highlighted job, including all map files from attached CAD files.
CF card, SD card or Intrnl	To change between viewing jobs stored on another data storage device or internal memory.

5.5

Managing Job Codes

Description

Available for jobs which have a codelist attached. To view, edit, group and sort all codes currently stored in the job. The functionality of this screen is mainly the same as for **Main Menu: Jobs & Data\New job, Codelist**. For simplicity, the functionality which is different for **Main Menu: Jobs & Data\Job properties, Codelist** is explained here. Refer to "7.4 Managing Codes" for information on **Main Menu: Jobs & Data\New job, Codelist**.

Access step-by-step

Step	Description
1.	Select Main Menu: Jobs & Data\Job properties . OR Select Main Menu: Jobs & Data\Choose working job or Choose control job. Edit.. to access Job Properties: .
2.	Page until the Codelist page is active.
3.	Codes.. to access Job Codes .

Job Codes

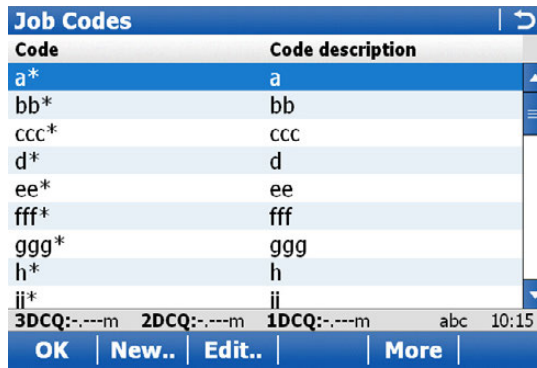

Key	Description
OK	To return to the previous screen.
New..	To create a new code. Refer to "7.4.2 Creating/Editing a Code".
Info	To edit the highlighted code. Accesses Edit Code where new attributes can be added to a code and line styles can be changed.
More	To display information about the code group, the code type, the code description and the quick codes if available.
Fn Group	To access Code Groups . To view, create, activate and deactivate code groups. Refer to "7.5 Managing Code Groups".
Fn Sort	To access Sort Codes . To sort codes by code name, code description, quick code or last used.
Fn Quit	To exit the screen.

Next step

IF	THEN
the job codes do not need to be changed	OK closes the screen.
a new job code is to be created	New... Refer to "7.4.2 Creating/Editing a Code".
an existing job code is to be edited	highlight the job code and Info .

Edit Code

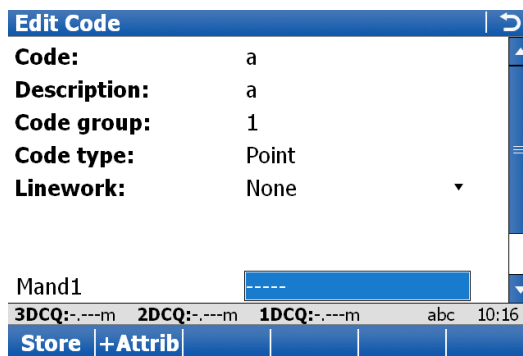

Key	Description
Store	To store the code including any newly created attributes.
+Attrib	To add a new attribute to a code.

Key	Description
Name or Value	Available for attributes for which an attribute name can be typed in. To highlight the field of the attribute name or the field for the attribute value. The name of the attribute can be edited and an attribute value can be typed in.
Fn Quit	To exit the screen.

The behaviour of this screen varies with the type of code to be edited. The differences are explained in the table.

Type of code	Description
Point codes and Free codes	New attributes can be added with +Attrib.
Line codes and Area codes	<ul style="list-style-type: none"> • New attributes can be added with +Attrib. • The line style can be changed. This new line style is stored to the code. It can be decided whether to update the line style of all previously stored lines/areas with this code in this job.

6 Jobs & Data - Data

6.1 Overview

Description Data management is the administration of data stored in the working job, including

- viewing data and related information.
- editing data.
- creating new data.
- deleting existing data.
- filtering existing data.

6.2 Accessing Data Management



Access Select **Main Menu: Jobs & Data\View & edit data.**

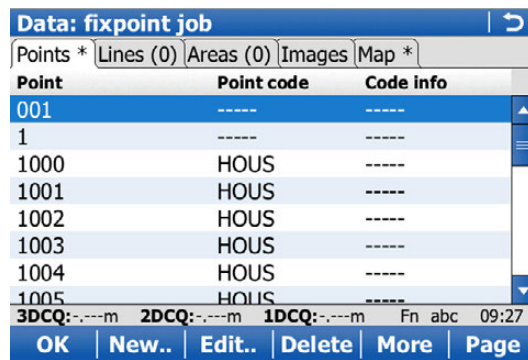

The objects listed on the pages belong to the working job. The objects listed and their order depend on the active sort and filter settings. An active filter for a page is indicated by * to the right of the name of the page. Refer to "6.6 Point Sorting and Filters" for information about sort and filter settings.

**Data:,
Points page**



Key	Description
OK	To close the screen and return to the screen from where this screen was accessed.
New..	To create a point.
Edit..	To edit the highlighted point.
Delete	To delete the highlighted point.
More	To display information about the codes and code information if stored with any point, the 3D coordinate quality, the class, Easting, Northing and Elevation, the time and the date of when the point was stored, and the flag for Linework.  The order in which the Easting and Northing columns are shown depends on the Grid format configured to be used in Regional Settings, Coords page.  The Easting, Northing and Elevation values are shown in the unit configured in Regional Settings, Distance page.
Page	To change to another page on this screen.
Fn Log..	To view points, lines, areas and free codes stored with the job sorted by time. Refer to "6.5 Data Log".
Fn Filter..	To define sort and filter settings. Refer to "6.6 Point Sorting and Filters".

Key	Description
Fn Quit	To exit the screen.

Next step

Page changes to the **Lines** and **Areas** page.

Data: Lines and Areas page

The explanations given for the softkeys are valid for both pages.

The number in brackets next to the name of the page indicate the number of open lines/areas. Example: Lines (2)/Areas (2) means that two lines/areas are open.

Data: fixpoint job		
Points *	Lines (0)	Areas (0) Map *
Line	Start time	Open
Line0001	14:26:57	No

Hz: -----g	V: -----g	abc	16:31
OK	New..	Edit..	Open More Page

Key	Description
OK	To close the screen and return to the screen from where this screen was accessed.
New..	To create a line/area. After storing the new line/area, all existing lines and areas which are open are closed. Refer to "6.3.1 Creating a New Point".
Edit..	To edit the highlighted line/area.
Close and Open	To change between the options in the Open column of the highlighted line/area. Only available for the current working job.
More	To display information about the codes if stored with any line/area, the start time, the end time of when the last point was added to the line/area, the length of the line, the perimeter and the area of the area.
Page	To change to another page on this screen.
Fn Delete	To delete the highlighted line/area.
Fn Filter..	To define sort and filter settings. Refer to "6.6 Point Sorting and Filters".
Fn Quit	To exit the screen.

Description of columns

Column	Description
Line or Area	The listed lines/areas already stored in the working job.
Open	The status of a line/area. <ul style="list-style-type: none"> Yes The line/area is open. Measured points are assigned to the line/area.

Column	Description
	<ul style="list-style-type: none"> • No The line/area is closed. Measured points are not assigned to the line/area. Close and Open change between the options.

Next step

IF the line/area	THEN
which was last used is to be opened	press a hot key configured to reopen last used line/area. This hot key can be used at any time. Refer to "1.1 Hot Keys" for information on hot keys.
is to be viewed	Page until the Map page is active.



For information on camera and images refer to "33.4 Image Management".

Data:, Scans page

Key	Description
OK	To close the screen and return to the screen from where this screen was accessed.
View	To open Scan Viewer for scans that show Yes in the Display column. Scan Viewer is a perspective display of the 3D-point clouds. To cancel the loading of the selected scan(s) pressing ESC.
Display	To change the setting in the Display column for the highlighted scan.
More	To display information about the date, the time, the status, the number of surface points and the number of boundary points.
Page	To change to another page on this screen.
Fn Delete	To delete the highlighted scan.
Fn All or Fn None	To change the setting in the Display column for all scans at once.
Fn Quit	To exit the screen.

6.3

6.3.1

Point Management

Creating a New Point

Access

In **Data**, **Points** page, press **New...**

New Point, Coords page

New Point | ↻

Coords | Code

Point ID:

Easting: m

Northing: m

Elevation: m

Hz: -----g V: -----g abc 16:31

Store | **Coord** | | | | **Page**

Key	Description
Store	To store the new point entered and all associated information.
Coord	To view other coordinate properties.
North or South	Available for local geodetic or WGS 1984 geodetic coordinates when Local latitude or WGS84 latitude is highlighted. Changes between North and South latitude.
East or West	Available for local geodetic or WGS 1984 geodetic coordinates when Local longitude or WGS84 longitude is highlighted. Changes between East and West longitude.
Page	To change to another page on this screen.
Fn Ell Ht or Fn Elev	Available for local coordinates. Changes between the ellipsoidal and the orthometric height.
Fn IndivID or Fn Run	For an individual name independent of the ID template or to change back to the next ID from the configured ID template.
Fn Quit	To exit the screen.

Description of fields

Field	Option	Description
Point ID	Editable field	The name of the new point. The configured point ID template is used. The ID can be changed in the following ways: <ul style="list-style-type: none">To start a new sequence of point IDs, type over the point ID.For an individual name independent of the ID template Fn IndivID. Fn Run changes back to the next ID from the configured ID template.
Coordinate fields	Editable field	Negative geodetic coordinates are interpreted as being of the opposite hemisphere or other side of the central meridian. For example, entering -25 °N will be stored as 25 °S, entering -33 °E will be stored as 33 °W.

Next step

Page changes to the **Code** page.

New Point, Code page

The settings for **Code & attributes** in **Main Menu: User\Work settings\Coding & linework** determine the availability of the subsequent fields and softkeys.

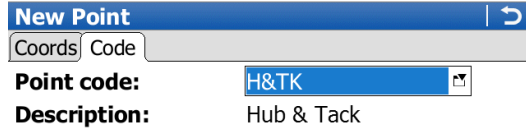

Key	Description
Store	To store the new point entered and all associated information.
+Attrib	To create additional attributes for this point code.
Name or Value	Available for attributes for which an attribute name can be typed in. To highlight the field of the attribute name or the field for the attribute value. The name of the attribute can be edited and an attribute value can be typed in.
Last	To recall the last used attribute values which were stored with this point code.
Default	To recall the default attribute values for the selected code.
Page	To change to another page on this screen.
Fn Quit	To exit the screen.

Description of fields

Field	Option	Description
Point code	Selectable list	When the check box Use a list box to view codes is checked in Coding & Linework Settings : The codes from the job codelist are used. All point codes of the job codelist can be selected. The description of the code is shown as a display only field. The attributes are shown as display only, editable fields or selectable lists depending on their definition.
	Editable field	When the check box Use a list box to view codes is not checked in Coding & Linework Settings : Codes for points can be typed in but not selected from a codelist. A check is performed to see if a point code of this name already exists in the job. If so, an information message is displayed. If Suggested attributes: Last used in Coding & Linework Settings , the according attributes are also shown.

Field	Option	Description
Attribute	Editable field	When the check box Use a list box to view codes is checked: Up to 20 attribute values are available. When the check box Use a list box to view codes is not checked: Up to eight attribute values are available.

Next step

Store stores the new point entered and all associated information. The properties stored with the point are:

- Class: **Ctrl**
- Sub class: **Fixed (Pos & Ht)**
- Source: **User entered**
- Instrument source: GPS



It may happen that a point with the same point ID exists in the job. If the codes and/or attribute values of the new and the existing point do not match, a screen opens where they can be corrected.

6.3.2

Editing a Point

Access

In **Data:, Points** page highlight a point to be edited. Press **Edit...**

Edit Point:, Coords page

The visible pages on this screen depend on the properties of the point being edited.

It is possible to edit the point ID and for points of **Class: Ctrl** and **Class: Est** also the coordinates. Other point-related data is shown in display only fields.

Changing the point ID of a point, applies this new point ID to all other points with the same original name, regardless of their class.

Points of **Class: Ref** cannot be renamed.

Changing coordinates of a point which has been previously used in other applications, for example COGO, or hidden point measurements does not update the application results.

An edited point retains the creation value for **Time**.

Key	Description
Store	To store the changes.
Coord	To view other coordinate properties.
Prev	To display the previous point in the list of points displayed in Data:, Points page. Available unless the beginning of the list is reached.

Key	Description
Next	To display the next point in the list of points displayed in Data:, Points page. Available unless the end of the list is reached.
More	To display information about class, sub class, 3D coordinate quality, time and date of when point was stored, instrument source, source and the flag for Linework if available.
Page	To change to another page on this screen.
Fn Ell Ht or Fn Elev	Available for local coordinates. Changes between the ellipsoidal and the orthometric height. Changing the height type does not edit the point.
Fn Quit	To exit the screen.

Next step

Page changes to the next page.

Edit Point:, Obs page

Available when the edited point is **Class: Meas.**

For GPS points

The name of the real-time base station from where the GPS/GNSS point was measured, the name of antenna used to measure the point and the baseline values, are shown in display only/observations fields.

For TPS points

It is possible to edit the reflector height. The name of the station from where the point was measured is shown in a display only field.

 Changing the reflector height recalculates the point height.

The distance variables **ΔHz**, **ΔV**, **Δ slope dist** are shown in a display only field, whenever a measurement has been taken in both faces.

More displays the horizontal angle or the azimuth from the point to the instrument.

Next step

Page changes to the next page.

Edit Point:, RTK info page

Available for GNSS points which were recorded in real-time mode, however not for average or mean points.

All fields are display only fields and cannot be edited.

The information is obtained from **System settings** and data coming across with the real-time information and the Ntrip connection.

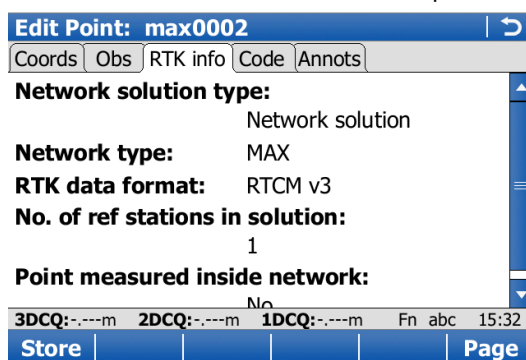

Description of fields

Field	Option	Description
Network solution type	Single baseline	Displayed when Use RTK network is not checked in RTK Rover Settings, RTK network page.
	Network solution	Displayed when Use RTK network is checked in RTK Rover Settings, RTK network page.
Network type	FKP, VRS, MAX, i-MAX	The type of reference network selected in RTK Rover Settings . Refer to "RTK Rover Settings, RTK network page".
	Nearest	If Network type: Nearest is selected in RTK Rover Settings , a singlebase solution is calculated and the number of base stations equals 1.
RTK data format	Display only	Refer to "RTK Rover Settings, General page".
No. of ref stations in solution	Display only	<ul style="list-style-type: none"> For single-baseline solutions, this number is always 1. For VRS and i-MAX, this number is always 1 since it is not possible to derive the number of base stations contributing to the VRS or i-MAX corrections from the data format. For network solutions, this information is derived from the content of the data format. Only RTCM v3 and Leica 4G are able to provide this number.
Mountpoint	Display only	The Ntrip server sending out real-time data. Available for network RTK with Ntrip. The information is available for all Ntrip connections independent from the Network type used. The information is derived from the Connection Settings , either manually defined or selected from the NTRIP Source Table .
Point measured inside network	Display only	Available for network RTK with Ntrip and MAX and data format RTCM v3 or Leica 4G .
User ID	Display only	Available for single baseline RTK, network RTK with/without Ntrip.

Next step

Page changes to the next page.

Edit Point:, Code page

Available when the edited point is **Class: Meas**.

The point code and code information can be edited. All point codes in the job can be selected.

The description of the code is shown as a display only field.

The attributes are shown as display only, editable fields or selectable lists depending on their definition.

The attribute values shown depend on the setting in **Coding & Linework Settings**.

Suggested attributes: Last used shows the last used attribute values which are stored for this point code in the active codelist. **Suggested attributes: Default values** shows the default attribute values for this point code if existing.

 It may happen that a point with the same point ID exists in the job. If the codes and/or attribute values of the new and the existing point do not match, a screen opens where they can be corrected.

Next step

Page changes to the next page.

**Edit Point:,
Annots page**

Available when the edited point is **Class: Nav** or **Class: Meas** and no offset point.

The comments to be stored with the point can be edited.

Next step

Page changes to the next page.

**Edit Point:,
Mean page**

Available when the edited point is **Class: Avge**.

Refer to "6.3.3 Mean Page" for a detailed description.

6.3.3

Mean Page

Description

In order to check measurements, the same point can be measured more than once. These measured points are assigned the class **Meas**. The various measured coordinate triplets for one point can be recorded using the same point ID. If the averaging mode is activated, an average is calculated when more than one measured coordinate triplet is available for the same point ID.

The averaged point is given the class **Avge**. It is checked if the deviations of each single point are within the limits configured in **Job Properties:, Averaging** page.

After averaging, the **Mean** page becomes available in **Edit Point:** and accessible from the Survey application. Available functionality on the **Mean** page depends on the selected averaging mode.

Averaging

Defining the averaging mode and configuring the limits

The averaging mode and the limits are configured in **Job Properties:, Averaging** page. Refer to "5.3 Job Properties and Editing a Job".

Description of averaging modes

Averaging mode	Description
Average	<p>When more than one measured coordinate triplet is recorded for the same point, the average for the position and the height is computed. Depending on the selected averaging method, the average will be computed weighted or arithmetic (no weighting). The class Avge is assigned to the averaged point.</p> <p>The horizontal and height distances from the measured points to the average are computed and displayed on the Mean page.</p> <p>A check is performed that the differences in position and height, between the averaged point and the point being stored, do not exceed the defined limits.</p>
Absolute differences	<p>What is described for Average also applies for Absolute differences. Additionally, the absolute difference between two points selected from a list of measured points with the same point ID, is checked to be within the defined limits.</p>

Averaging mode	Description
Off	Averaging functionality is turned off. With more than one measured coordinate triplet recorded for the same point, no average for the position and the height is computed.

Averaging with position only or height only points

Position only points, height only points and points with full coordinate triplets are handled in the averaging.

Access step-by-step

The **Mean** page can be accessed if

Mode: Average or **Mode: Absolute differences** is configured in **Job Properties:, Averaging** page.

AND

more than one measured coordinate triplet is recorded for the same point using the same point ID.

Access within data management

Step	Description
1.	In Data:, Points page highlight a point to be edited.
2.	Edit.. to access Edit Point:, Mean page.

Access within Survey

From within the Survey application, the **Mean** page is accessible when the RTK Rover interface is active.

In **Survey, Points** page, press Fn **Avg** or Fn **Abs** to access **Edit Point:, Mean** page.

Edit Point:, Mean page

All measured coordinate triplets recorded using the same point ID are shown.

Edit Point: 2				
Use	Time	dPos	dHt	!
----	17:22:47	----	----	!
Auto	09:48:22	0.0000	0.0000	!

3DCQ:0.382m	2DCQ:0.196m	1DCQ:0.329m	abc	09:48	
Store	Use	Edit..	Delete	More	Page

Key	Description
Store	To store the changes.
Use	To change between the options in the Use column for the highlighted coordinate triplet. To include or exclude this triplet in or from the calculation of the average.
Edit..	To view and edit the highlighted measured coordinate triplet. It is possible to edit the point ID and the antenna height without impact on all other classes of the point with the same original name. The coordinates are updated. A change in codes must be an overall change for the average point.

Key	Description
	Example: One of the measured coordinate triplets has a wrong point ID and should not be included in the average. By editing the point ID, the point is renamed and no longer contributes to the average.
Delete	To delete the highlighted coordinate triplet. The average is recomputed.
More	To change between time and date of when the point was stored and the 3D coordinate quality.
Page	To change to another page on this screen.
Fn Diff	Available for Mode: Absolute differences and Yes is set in the Use column for exactly two measurements. To display the absolute coordinate differences when a local coordinate system is active. Differences exceeding the defined limit are indicated by ! .

Description of columns

Column	Description
Use	<p>The use of a measured coordinate triplet in the averaging.</p> <ul style="list-style-type: none"> • Auto The coordinate triplet is included in the averaging computation if within the averaging limit defined in Job Properties::Averaging page. • Yes The coordinate triplet is always included in the averaging computation even if it would fall outside the averaging limit defined in Job Properties::Averaging page. • No The coordinate triplet is never included in the averaging computation. • ---- The coordinate triplet cannot be included in the averaging computation. Automatically set by the system. <p>Use changes between the options.</p>
Time	The time the measured coordinate triplet was stored.
Date	The date the measured coordinate triplet was stored. The format is as defined in Regional Settings, Time page.
dPos	The horizontal distance from the measured coordinate triplet to the average. dPos : ---- indicates unavailable information, for example for a height only point.
dHt	The height distance from the measured coordinate triplet to the average. dHt : ---- indicates unavailable information, for example for a position only point.
!	Available for measured coordinate triplets with Auto or Yes in the Use column if Mode: Average . Indicates an exceeding of the limits.

Next step

Store stores the changes.

6.4

Line/Area Management

6.4.1

Overview

Description

A line/area consists of points and can be created/edited in **Data**, **Lines** and **Areas** page. The individual points are measured within any application. All points can be used except auxiliary points. Points can be simultaneously assigned to one or more lines and/or areas.

A line/area can have

- a style for display in MapView.
- a code independent of the point code of the points comprising the line/area.



Points are assigned to a line/area when the line/area is open. Refer to "6.2 Accessing Data Management" for information on how to open a line/area.

6.4.2

Creating a New Line/Area



The functionality of all screens and fields are similar for the creation of both lines and areas. The descriptions for lines can be applied for areas.

Access

In **Data**, **Lines** page, press **New...**

New Line, General page

New Line | ↻

General Code

Line ID: Line0002

Points to store: All points ▼

Style: ▼

Colour: ▼

3DCQ:0.381m 2DCQ:0.197m 1DCQ:0.326m abc 09:49

Store Page

Key	Description
Store	To store the new line entered and all associated information.
Page	To change to another page on this screen.
Fn IndivID or Fn Run	For an individual name independent of the ID template or to change back to the next ID from the configured ID template.
Fn Quit	To exit the screen.

Description of fields

Field	Option	Description
Line ID	Editable field	The name of the new line. The configured ID template for lines is used. The ID can be changed in the following ways: <ul style="list-style-type: none">• To start a new sequence of line IDs, type over the line ID.• For an individual name independent of the ID template Fn IndivID. Fn Run changes back to the next ID from the configured ID template.

Field	Option	Description
Points to store	Selectable list	The type of points which are used to form the line during a survey.
Style	Selectable list	The line style in which lines/areas are represented in MapView and LGO. For Line code: <None> on the Code page a line style can be selected from a selectable list. Otherwise the line style as defined for the selected line code is shown.
Colour	Selectable list	A colour in which the line will be displayed.

Next step

Page changes to the **Code** page.

New Line, Code page

The settings for **Code & attributes** in **Main Menu: User\Work settings\Coding & line-work** determine the availability of the subsequent fields and softkeys.

 The value for **Start time** with which the line is stored is the time when **Store** was pressed. The same value is assigned to the value for **End time** until a point is added to the line.

Key	Description
Store	To store the new line entered and all associated information. Any existing lines and areas which are open are closed.
+Attrib	To create additional attributes for this line code.
Name or Value	Available for attributes for which an attribute name can be typed in. To highlight the field of the attribute name or the field for the attribute value. The name of the attribute can be edited and an attribute value can be typed in.
Last	To recall the last used attribute values which were stored with this line code.
Default	To recall the default attribute values for the selected code.
Page	To change to another page on this screen.
Fn Quit	To exit the screen.

Description of fields

Field	Option	Description
Line code	Selectable list	<p>The line code to be stored with the point.</p> <p>When the check box Use a list box to view codes is checked in Coding & Linework Settings: All line codes of the job codelist can be selected. The description of the code is shown as a display only field.</p> <p>The line style is shown as defined for the selected line code. It is the style in which lines/areas are represented in MapView and LGO. For Line code: <None>, it can be changed.</p> <p>The attributes are shown as display only, editable fields or selectable lists depending on their definition.</p>
	Editable field	<p>When the check box Use a list box to view codes is not checked in Coding & Linework Settings: Codes for lines can be typed in but not selected from a codelist.</p> <p>A check is performed to see if a line code of this name already exists in the job. If so, the line style and colour are copied from the existing code and shown as display only. If Suggested attributes: Last used in Coding & Linework Settings, the according attributes are also shown.</p>
Attribute	Editable field	<p>When the check box Use a list box to view codes is checked: up to 20 attribute values are available.</p> <p>When the check box Use a list box to view codes is not checked: up to eight attribute values are available.</p>

Next step

Store stores the new line entered and all associated information.

Creating lines/areas most efficiently

IF the task is to create	THEN
multiple lines/areas with subsequent line/area IDs	use the hot key/favourites menu function Linework - Create new line (quick)/Linework - Create new area (quick) . Pressing the hot key or selecting the function from the  My GPS Favourites menu creates and immediately stores the new line/area. For the line/area ID, the line/area ID template as defined in ID Templates is used. The code and attributes are taken over from the last created line/area.
lines/areas with certain codes	use quick coding. The job codelist must contain quick codes for lines/areas. By typing the quick code a new line/area is created and immediately stored with that line/area code and attributes. For the line/area ID, the line/area ID template as defined in ID Templates is used.



The functionality of all screens and fields are similar for the creation of both lines and areas. The descriptions for lines can be applied for areas.

Access

In **Data:**, **Lines** page, press **Edit...**

Edit Line, General page

Key	Description
Store	To store the changes.
More	To display End time and End date .
Page	To change to another page on this screen.
Fn Quit	To exit the screen.

Description of fields

Field	Option	Description
Line ID	Editable field	The name of the line can be edited. A line cannot be renamed to an already existing line ID.
Points to store	Selectable list	The type of points which are used to form the line during a survey can be edited.
Style	Editable field	The line style in which lines/areas are represented in MapView and LGO.
Colour	Editable field	A colour in which the line will be displayed.
Number of points	Display only	The number of points contained within the line.
Length	Display only	The sum of the distances between the points in the sequential order in which they are stored for the line. This length can be a horizontal grid distance or a geodetic distance on the WGS 1984 ellipsoid.
Start date and Start time	Display only	The time/date when the line was created. An edited line retains the creation value for Start time .
End date and End time	Display only	The time/date when the last point was added to the line. This can be different to the time the point was created. The values do not change after deleting the last added point or after editing unless an additional point is added to the line.

Next step

Page changes to the **Points** page.

Edit Line, Points page

All points belonging to the line are listed. The point that was added last to the line is at the top of the list.

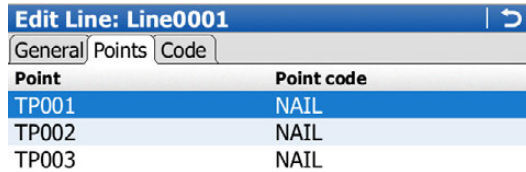

Edit Line: Line0001	
Point	Point code
TP001	NAIL
TP002	NAIL
TP003	NAIL



3DCQ:0.396m	2DCQ:0.199m	1DCQ:0.342m	abc	09:49	
Store	Add	Edit..	Remov	More	Page

Key	Description
Store	To store the changes.
Add	To add an existing point from the working job to the line. A new point is added above the point which was highlighted when the key was pressed. The value for End time on the General page changes when a point was added to the line.
Edit..	To edit the highlighted point.
Remov	To remove the highlighted point from the line. The point itself is not deleted.
More	To display information about the point codes if stored with the line, the time and the date of when the line was stored, the 3D coordinate quality, the class and the flag for Linework.
Page	To change to another page on this screen.
Fn Quit	To exit the screen.

Next step

Page changes to the **Code** page.

Edit Line, Code page

The line code can be edited. All line codes can be selected. For **Line code:None**, the line style can be changed.

The description of the code is shown as a display only field.

The attributes are shown as display only, editable fields or selectable lists depending on their definition.

Next step

Store stores the changes.

Description

A list of all objects and free codes in the working job is displayed in order of time.

Access step-by-step**Access within data management**

In **Data: Points** page, press Fn **Log..** to access **Data Log**.

Access within job management

In **Job Properties: General** page, press Fn **Log..** to access **Data Log**.

Data Log

In the column **Data record**, all points, lines and areas as well as free codes stored within the working job are displayed. They are always sorted by time with the most recent record at the top. For lines and areas, the value for **Start time** is relevant.

Data record	Record type
1016	Point
1011	Point
1010	Point
1016	Point
1011	Point
1010	Point
1016	Point
1016	Point
1011	Point

3DCQ:0.426m 2DCQ:0.218m 1DCQ:0.366m abc 09:50

OK | New.. | Edit.. | Delete | More

Key	Description
OK	To close the screen.
New..	To insert a free code below/before the currently highlighted object or record. The functionality of inserting a free code is identical to the functionality of entering a free code during a survey.
Edit..	To edit the highlighted object or free code. The functionality of editing a free code is identical to the functionality of entering a free code during a survey. Refer to "26.3 Free Coding".
Delete	To delete the highlighted object or free code.
More	To display information about the type of data recorded, the time and the date of when it was stored or for lines and areas when they were created and the codes if stored with any object.
Fn Quit	To exit the screen.

Next step

OK returns to the screen from where **Data Log** was accessed.

6.6

Point Sorting and Filters

6.6.1

Sorting and Filters for Points, Lines and Areas

Description

The sort settings define the order of the objects in the working job. The filter settings define the objects to be viewed.

Three types of filters are available:

Point filter: An active point filter shows selected points in **Data: Points** page.
Line filter: An active line filter shows selected lines in **Data: Lines** page.
Area filter: An active area filter shows selected areas in **Data: Areas** page.



For information on camera and images refer to "33.4 Image Management".



The sort and filter settings are stored in the job. They are remembered after turning off the instrument.

When a job becomes active, then the sort and filter settings of this job are saved in the internal memory. If the data storage device is formatted then these last used sort and filter settings are used for the job **Default**.

When a new job is created, the sort and filter settings from what was the working job are copied to the new job.



Changing the working job influences the sort and filter settings for the objects. The settings are changed to those of the selected job.



An active filter for an object is indicated in **Data:** by * located on the right side of the page name.

Access

In **Data:** on the **Points, Lines** or **Areas** page, press Fn **Filter..** to access **Sorts & Filters**.

Sorts & Filters, Points page

The available fields on this screen depend on the selected setting for **Filter by**.

Sorts & Filters | ↻
Points | Lines | Areas
Sort by: Backward time
Filter by: Highest class

3DCQ:0.465m 2DCQ:0.244m 1DCQ:0.396m abc 09:50
OK | Stake.. | Page

Key	Description
OK	To close the screen and return to the screen from where this screen was accessed. The selected sort and filter settings are applied.
Codes..	Available for Filter by: Point code . To define the code filters. Refer to "6.6.2 Point, Line and Area Code Filter".
Stake..	To filter points for the Stakeout application. Refer to "6.6.3 Stakeout Filter".
Page	To change to another page on this screen.
Fn Quit	To exit the screen.

Description of fields

Field	Option	Description
Sort by	Ascending point ID, Descending point ID, Forward time or Backward time	Always available. The method points are sorted by.
Filter by	<p>No filter</p> <p>Highest class</p> <p>Range of point IDs</p> <p>Pt ID wildcard</p> <p>Time</p> <p>Class</p> <p>Instrument</p> <p>Coordinate type</p> <p>Point code</p> <p>Box around point</p> <p>Individual line</p> <p>Individual area</p>	<p>Always available. The method the points are filtered by.</p> <p>Shows all points.</p> <p>Shows points of highest class.</p> <p>Shows points with point IDs between the entered start and end ID. The points are left aligned and sorted by the first digit.</p> <p>Shows points with point IDs matching the wildcard.</p> <p>Shows points which were recorded within a defined time window.</p> <p>Shows points of the selected class.</p> <p>Shows points originating from the selected instrument or software program type.</p> <p>Shows points of the selected type of coordinates.</p> <p>Shows points with selected codes attached.</p> <p>Shows points within the defined radius from a particular point. The radius is the horizontal distance.</p> <p>Shows points forming a selected line. This can be useful, for example, during stakeout.</p> <p>Shows points forming a selected area. This can be useful, for example, during stakeout.</p>
Start ID	Editable field	Available for Filter by: Range of point IDs . The first point to be displayed.
End ID	Editable field	Available for Filter by: Range of point IDs . The last point to be displayed.
Wildcard	Editable field	Available for Filter by: Pt ID wildcard . * and ? are supported. * indicates an undefined number of unknown characters. ? indicates a single unknown character.
Start date	Editable field	Available for Filter by: Time . The date of the first point to be displayed.
Start time	Editable field	Available for Filter by: Time . The time of the first point to be displayed.
End date	Editable field	Available for Filter by: Time . The date of the last point to be displayed.
End time	Editable field	Available for Filter by: Time . The time of the last point to be displayed.

Field	Option	Description
Control (Ctrl), Adjusted (Adj), Reference (Ref), Average (Avge), Measured (Meas), Navigated (Nav), Estimated (Est), None	Show or Hide	Available for Filter by: Class . Defined classes are shown or hidden.
View	Highest triplet All triplets	Available for Filter by: Class . The coordinate triplets of the highest class are shown. All classes for one coordinate triplet are shown.
Instrument	All, TPS, GPS, LEICA Geo Office, Level, Controller, Third party SW or Unknown	Available for Filter by: Instrument . Points originating from this instrument type are shown.
Type	WGS84 only or Local only	Available for Filter by: Coordinate type . Points from the chosen coordinate type are shown.
Point ID	Selectable list	Available for Filter by: Box around point . The point to which the radius is applied. Opening the selectable list opens Data: . Refer to "6.2 Accessing Data Management".
Radius	Editable field	Available for Filter by: Box around point . The radius of the circle within which the points are shown.
Line ID	Selectable list	Available for Filter by: Individual line . Opening the selectable list opens Data: . Refer to "6.2 Accessing Data Management".
Area ID	Selectable list	Available for Filter by: Individual area . Opening the selectable list opens Data: . Refer to "6.2 Accessing Data Management".

Next step

Page changes to the **Lines** page.

Sorts & Filters, Lines and Areas page

Sorts & Filters
↩

Points
Lines
Areas

Sort by: Backward end time ▼

Filter by: No filter ▼

3DCQ:0.514m
2DCQ:0.269m
1DCQ:0.438m
abc
09:50

OK
Page

Key	Description
OK	To close the screen and return to the screen from where this screen was accessed. The selected sort and filter settings are applied.
Codes..	Available for Filter by: Code / code group . To select the line codes to be used.
Page	To change to another page on this screen.
Fn Quit	To exit the screen.

Description of fields

Field	Option	Description
Sort by	Ascending line ID, Descending line ID, Forward start time, Backward start time, Forward end time, Backward end time	Always available. The method the lines are sorted by.
Filter by	No filter Code / code group	Always available. The method by which the lines are filtered. Shows all lines. Shows lines with selected codes attached.

Next step

OK closes the screen.

6.6.2

Point, Line and Area Code Filter



For each object, a code filter exists. The point, line and area code filters are independent from each other. The functionality is identical. For simplicity, the point code filter is explained.

Access step-by-step

Step	Description
1.	In Sorts & Filters select Filter by: Point code .
2.	Codes.. to access Point Code Filter .

Point Code Filter

This screen shows the point codes from the working job and codes currently used as filter. Point codes are sorted according to the settings in **Sort Codes**.

Point Code Filter	
Code	Activated
H&TK	Yes
NAIL	Yes
CLNE	Yes
EPAV	Yes
ESHD	Yes
TRED	Yes
FWBD	Yes
BUSH	Yes
FHYD	Yes

3DCQ:0.643m 2DCQ:0.330m 1DCQ:0.552m abc 09:51

OK | Group | Use | None

Key	Description
OK	To close the screen and return to the screen from where this screen was accessed.
Group	To activate and deactivate code groups. Accesses Code Groups . Any code group that has been previously deactivated are displayed as deactivated here. Codes belonging to a deactivated code group are not displayed in Point Code Filter .
Use	To activate and deactivate the filter for the highlighted code.
None or All	To deactivate or activate all point codes.
Fn Sort	To define the order of the codes. Accesses Sort Codes .
Fn Quit	To exit the screen.

6.6.3

Stakeout Filter

Description

The settings on this screen define a filter for the Stakeout application. The Stakeout filter can be applied to show points which are already staked or points that are still to be staked.



The stakeout filter acts in addition to any other filter set in **Sorts & Filters**. For example, points still to be staked out with a particular code can be filtered.

Access

In **Sorts & Filters, Points** page, press **Stake..** to access **Stakeout Filter**.

Stakeout Filter

Stakeout Filter | ↻

View: ▾

3DCQ:0.696m 2DCQ:0.358m 1DCQ:0.597m abc 09:51

Key	Description
OK	To close the screen and return to the screen from where this screen was accessed.
Reset	To reset the staked flag for all points of the currently working job.
Fn Quit	To exit the screen.

Description of fields

Field	Option	Description
View	All points	Shows all points.
	Points to stake	Shows points not yet staked out.
	Staked points	Shows points which are already staked out.

Description

The Scan Viewer is available on MS50.
 The Scan Viewer is a point cloud viewer. One or more scans can be viewed.
 The Scan Viewer respectively the **Scans** tab in the data management is available as soon as a scan is available in the data job.
 Scan Viewer provides a perspective display of the 3D point clouds which allows for a better overall understanding of the measured data.
 The displayed data can be navigated in.

Access

Step	Description
1.	In Data: , Scans page, highlight one scan and press Display to set Yes in the Display column.  To set Yes in the Display column for all scans. press Fn All .
2.	Press View .

Scan Viewer

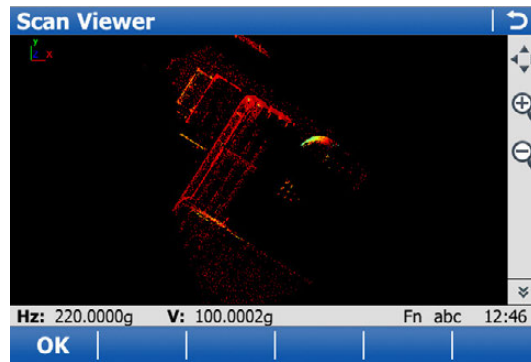











Key	Description
OK	To return to Data: , Scans page.
Fn Config..	To configure Scan Viewer. Refer to "Scan View Settings".
Fn Quit	To exit the screen.

Scan View Settings

Description of fields

Field	Option	Description
Background colour	Selectable list	A colour in which the background will be displayed.
Point cloud colour	Intensity	The point cloud is colored according to the intensity value of the received EDM signal.
	Single colour	A point cloud gets a single colour. If several scans are available, each point cloud gets a different colour. A colour table is defined in the background, from which the colours are picked for each point cloud.
	RGB	The point cloud is coloured according to the RGB (red, green, blue) values from the panoramic image. If a panoramic image has been taken when defining a scan, the RGB values are available.

Toolbar icons

Icon	Description
	To scroll the Scan Viewer toolbar.
	The fit icon fits all displayable data using the largest possible scale.
	To zoom into the map.  Pressing ESC stops the zooming process.
	To zoom out of the map.  Pressing ESC stops the zooming process.
	To zoom into the point cloud in real-time by tapping the screen and moving the stylus up. To zoom out move the stylus down the screen.
	To rotate the point cloud in 3D. The rotation point is the closest point of the scan to the centre of the 3D viewer.
	To toggle between pre-defined perspective views zoomed fit: top view, front view and side view.
	To change the pixel size of a single scan point displayed in the viewer.

7 Codelists

7.1 Overview



It is recommended to create a codelist in LGO. A codelist can be transferred from LGO to the internal memory of the instrument using the data storage device.

Steps from creating to using a codelist

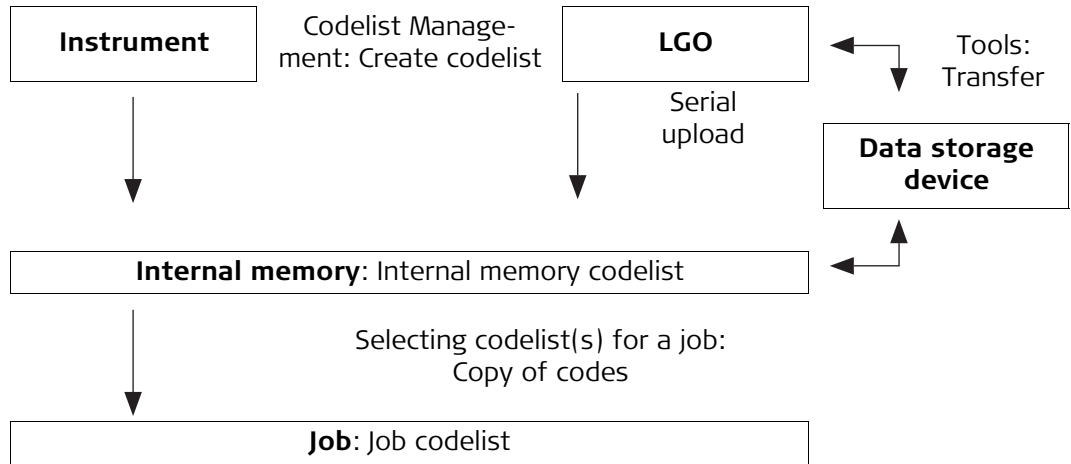

The creating, editing and managing of codelists is explained in this chapter. In order to use a codelist on the instrument, it must be transferred from the data storage device to the internal memory.

7.2 Accessing Codelist Management

Access

Step	Description
1.	Go to Job Properties :, Codelist page when creating a new job or editing an existing working or control job.
2.	Open the selectable list for Codelist .

Codelists

Listed are all codelists stored in the internal memory.

Codelists	
Name	Date
<None>	----
123	19.03.2010
Qcodes	06.10.2004

3DCQ:7.648m	2DCQ:4.961m	1DCQ:5.821m	Fn abc	13:30
OK	New..	Edit..	Delete	More

Key	Description
OK	To return to the screen from where this screen was accessed. The codes from the highlighted codelist are copied to the working job.
New..	To create a codelist. Refer to "7.3 Creating/Editing a Codelist".
Edit..	To edit the highlighted codelist. Refer to "7.3 Creating/Editing a Codelist".

Key	Description
Delete	To delete the highlighted codelist.
More	To display information about the creator and the date of when the codelist was created.
Fn Quit	To exit the screen.

7.3 Creating/Editing a Codelist

Access In **Codelists** press **New..** or **Edit...**

New Codelist or Edit Codelist

New Codelist | ↻

Name:

Description:

Creator:

3DCQ:6.835m 2DCQ:3.752m 1DCQ:5.713m abc 10:40

Store | **Codes..**

Key	Description
Store	To store the codelist.
Codes..	To access Codes where codes can be created, edited or deleted and code groups can be accessed.
Fn Quit	To exit the screen.

Description of fields

Field	Option	Description
Name	Editable field	A unique name for the codelist. The name can be up to 16 characters long and include spaces. Input required.
Description	Editable field	A detailed description of the codelist. This description can be, for example, work to be performed. Input optional.
Creator	Editable field	The person's name who is creating the codelist. Input optional.

7.4

Managing Codes

7.4.1

Accessing Codes

Description

Managing codes includes

- creating new codes
- viewing codes with their related information
- editing codes
- deleting existing codes.

Access step-by-step

Step	Description
1.	In Codelists , highlight the codelist of the codes which are to be managed.
2.	Edit.. to access Edit Codelist .
3.	Codes.. to access Codes .

Codes

Codes from currently active code groups are shown.

The listed codes belong to

the codelist selected from the internal memory when this screen was accessed through **New job\Codelist**

OR

to the job codelist when this screen was accessed through **Job properties\Codelist**.

The * indicates codes which have attributes attached.

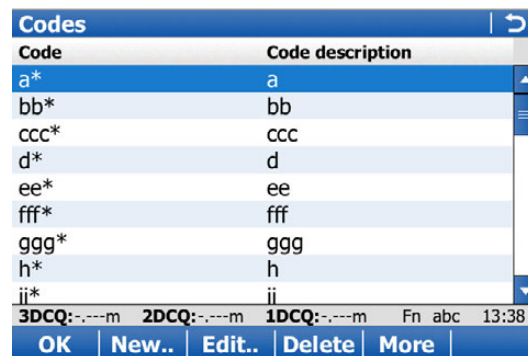

Code	Code description
a*	a
bb*	bb
ccc*	ccc
d*	d
ee*	ee
fff*	fff
ggg*	ggg
h*	h
jj*	jj

3DCQ:---m 2DCQ:---m 1DCQ:---m Fn abc 13:38

OK | New.. | Edit.. | Delete | More

Key	Description
OK	To close the screen and return to the screen from where this screen was accessed.
New..	To create a new code. Refer to "7.4.2 Creating/Editing a Code".
Edit..	To edit the highlighted code. Refer to "7.4.2 Creating/Editing a Code".
Delete	To delete the highlighted code.
More	To display information about the code description, the quick codes if available, the code groups and the code type.
Fn Group	To view, create, delete, activate and deactivate code groups. Refer to "7.5 Managing Code Groups".
Fn Sort	To sort codes by code name, code description, quick code or the last use.



The values for code groups, codes and attributes are case sensitive. For example, the code group Tree is not the same as the code group TREE.



Attribute names that have already been typed in cannot be edited in a job codelist.



A new code can also be created within an application. In this case, the new code is added to the job codelist.

New Code or Edit Code

New Code	
Code:	123
Description:	-----
Code group:	1 <input type="checkbox"/>
Code type:	Point ▼
Linework:	None ▼

3DCQ:6.835m 2DCQ:3.752m 1DCQ:5.713m abc 10:41
 Store +Attrib

Key	Description
Store	To add the new code and any associated attributes to the codelist in the internal memory.
+Attrib	To add a new editable field for an attribute of attribute type normal and of value type text.
Name or Value	Available for attributes for which an attribute name can be typed in. To highlight the field of the attribute name or the field for the attribute value. The name of the attribute can be edited and the attribute value to be used as the default attribute value can be typed in.
Fn Quit	To exit the screen.

Description of fields

Field	Option	Description
Code	Editable field	A unique name for the new code. The name can be up to 16 characters long and include spaces. Input required.
Description	Editable field	A detailed description of the code. This description can be, for example, the full designation if Code is an abbreviation. Input optional.
Code group	Selectable list	The code group to which the code is to be assigned.
Code type	Selectable list	Defines the use of the code. It can be used as thematical code for points, lines or areas or as a free code. Makes a code unique. A code can have the same value with different types within the same codelist. For example a code OAK can be of type Point, Line, Area and/or Free .

Field	Option	Description
Linework	Selectable list	Only available for Code type: Point . To allow a new line or new area to be opened whenever the point code is newly selected. This functionality is also available when creating codelists with LGO Codelist Management.
	None	Select this option to disable the functionality. All other code settings on the instrument are not affected when this option is set.
	Begin line	When a point code is newly selected, a new line is opened and the point being stored is added to the line. When the same point code remains selected, a new line is not opened. The point being stored is added to the current line.
	Begin area	The behaviour for opening a new area is the same as the behaviour for opening a new line.
Style	Selectable list	Available for Code type: Line and Code type: Area . The style in which lines/areas are represented in MapView and LGO.
Attribute	Editable field	Up to twenty attributes can be created.  Attributes of attribute type mandatory or fixed and of value type real or integer must be created in LGO.

7.5

Managing Code Groups

Access

In **Codes**, press Fn **Group**.

Code Groups

The listed code groups belong to the codelist selected from the internal memory when this screen was accessed through **New job\Codelist**

OR

to the job codelist when this screen was accessed through **Job properties\Codelist**.

Codes from currently active code groups are shown.

Code Groups		↩
Code group	Activated	
1	Yes	

3DCQ:6.835m	2DCQ:3.752m	1DCQ:5.713m	abc	10:42	
OK	New..	Edit..	Delete	Use	None

Key	Description
OK	To close the screen and return to the screen from where this screen was accessed.





Key	Description
New..	To create a new code group. In New Code Group type in a unique name for Name . Store stores the new code group typed in and returns to Code Groups .
Edit..	Available for codelists in the internal memory. To edit the highlighted code group. In Edit Code Group type in the changes for Name . Store stores the changes and returns to Code Groups .
Use	To activate and deactivate the highlighted code group. Codes belonging to a deactivated code group are not displayed in Codes .
None or All	To deactivate or activate all code groups.
Fn Quit	To exit the screen.

Description of columns

Column	Description
Code group	The name of the code group.
Activated	Use code group or not. The codes belonging to a deactivated code group cannot be selected from the selectable list for code selection. Use changes between the options.

8 Coordinate Systems

8.1 Overview

Description	<p>A coordinate system</p> <ul style="list-style-type: none">• consists of up to five elements.• allows the conversion from WGS 1984 geodetic or cartesian coordinates to, local cartesian, geodetic or grid coordinates and back.• can be attached to jobs.• can be manually defined.• can be computed in the field.• can be directly received from a reference network. Refer to "19.7.1 Configuration of a Rover Real-Time Connection".• can be downloaded to LGO.• can be uploaded from LGO.
Using coordinate systems on TPS	<p>Coordinate systems are used on TPS instruments to combine GPS data with TPS data.</p>
	<p>[TPS] An attached coordinate system is not used to reduce any measured distance on a TPS instrument.</p>
	<p>All GPS surveyed points are always stored as WGS 1984 geodetic coordinates regardless of the coordinate system being used. Using a different coordinate system converts the coordinates displayed on the screen, but does not convert and restore the coordinate values in the database DBX.</p>
	<p>[TPS] Points surveyed with a TPS instrument are always stored in local GRID coordinates regardless of the coordinate system being used.</p>
	<p>One coordinate system can be attached to a job at one time. This coordinate system remains attached to the job unless it is changed.</p>
Default coordinate systems	<p>The default coordinate system is WGS 1984. It cannot be deleted. It is not possible to create a coordinate system called WGS 1984. Additional default coordinate systems may be available for certain countries.</p>
Active coordinate system	<p>The active coordinate system is the one attached to the working job. One coordinate system is always considered as the active coordinate system.</p>
Automatic coordinate system (RTCM transformation parameters)	<p>When Use auto coordinate system is checked in the RTK Rover Wizard, the coordinate system is directly received from the reference network via RTCM correction data. Refer to "19.7.1 Configuration of a Rover Real-Time Connection".</p>
Coordinate systems when transferring jobs between GPS and TPS	<p>When transferring a job from GPS to TPS, or vice versa, the coordinate system stays attached to the job. It then appears like any other coordinate system on the instrument.</p>

Access

Step	Description
1.	Go to Job Properties , Coord system page when creating a new job or editing an existing working or control job.
2.	Open the selectable list for Coord system .

Coordinate Systems

Listed are all coordinate systems stored in the database DBX. Any unavailable information is shown as -----.

Coordinate Systems	
Name	Type
CH1903	Classic 3D
None (WGS84)	-----

3DCQ:5.442m	2DCQ:3.220m	1DCQ:4.387m	abc	09:51
OK	New..	Edit..	Delete	More

Key	Description
OK	To select the highlighted coordinate system and to return to the previous screen. With a data storage device inserted, the selected coordinate system will be attached to the working job.
New..	To create a coordinate system manually. Refer to "8.3 Coordinate Systems - Creating and Editing".
Edit..	To edit the highlighted coordinate system. Refer to "8.3 Coordinate Systems - Creating and Editing".
Delete	To delete the highlighted coordinate system. Deletion is not possible if the highlighted coordinate system is active and its source is RTCM.
More	To display information about the type of transformation used, the type of heights computed, the number of control points used for the determination and the date of when the coordinate system was created.
Fn Set-D	Available unless a default coordinate system is highlighted. To turn the highlighted coordinate system into a user defined default coordinate system stored in the instrument.
Fn Default	To recall the deleted default coordinate systems.
Fn Quit	To exit the screen.



Coordinate systems can be defined by manual creation or determined by calculation. In this chapter, the manual creation of coordinate systems is explained. Refer to "41 Determine Coordinate System" for information on the determination by calculation.



Coordinate systems with a Classic 3D transformation can be defined by manual creation.



The type of transformation of the selected coordinate system determines which elements of a coordinate system can be edited. The name of the coordinate system, the method of residual distribution and the geoid model in use are always editable.



For coordinate systems with source RTCM, only the geoid model in use can be changed. However, if no projection is received with the automatic coordinate system, then the projection can also be defined.

Access

In **Coordinate Systems**, highlight a coordinate system. A copy of this coordinate system is taken for further configurations. Press **New..** or **Edit...**

New Coordinate System or Edit Coordinate System

Key	Description
Store	To store the coordinate system.
Fn Quit	To exit the screen.

Description of fields

Field	Option	Description
Name	Editable field	A unique name for the new coordinate system. The name can be up to 16 characters long and include spaces.
Residuals	1/distance , 1/distance² , 1/distance^{3/2}	Available for transformations with control points. Manually entered transformations do not have control points. The method by which residuals are distributed throughout the transformation area. The transformation results become more realistic and any strain is dispersed in the transformation. Distribute the residuals of the control points according to the distance between each control point and the newly transformed point.

Field	Option	Description
	Multiquadratic	Distributes the residuals using a multiquadratic interpolation approach.
Transformation	Selectable list	The type of transformation.
Pre Transform	Selectable list	Available when editing a coordinate system and for Twostep transformations. The name of a preliminary 3D transformation, which, together with the selected projection, is used to obtain preliminary grid coordinates for a final 2D transformation.
Ellipsoid	Selectable list	Available unless projection Type: Customised . The local coordinates are based on this ellipsoid.
Projection	Selectable list	The map projection.
Geoid model	Selectable list	The geoid model.
CSCS model	Selectable list	The Country Specific Coordinate System model.

8.4

Transformations

8.4.1

Accessing Transformation Management



Transformations cannot be accessed for coordinate systems with source RTCM. Refer to "Automatic coordinate system (RTCM transformation parameters)".

Access step-by-step

Step	Description
1.	In Coordinate Systems , highlight a coordinate system.
2.	Press New.. or Edit..
3.	Highlight Transformation .
4.	ENTER to access Transformations .

Transformations

Listed are all Classic 3D transformations stored in the database DBX. Any unavailable information is shown as -----.

Transformations	
Name	Height mode
<None>	-----
granit90-ortho	Orthometric

3DCQ:5.338m	2DCQ:3.181m	1DCQ:4.286m	abc	09:53
OK	New..	Edit..	Delete	More

Key	Description
OK	To select the highlighted transformation and to return to the previous screen.
New..	To create a new transformation. Refer to "8.4.2 Creating/Editing a Transformation".

Key	Description
Edit..	To edit the highlighted transformation. Refer to "8.4.2 Creating/Editing a Transformation".
Delete	To delete the highlighted transformation.
More	To display information about the type of heights computed and the number of control points used for the determination of the transformation.
Fn Set-D	To turn the highlighted transformation into a user-defined default transformation stored in the instrument.
Fn Quit	To exit the screen.

8.4.2 Creating/Editing a Transformation



Classic 3D transformations can be created.

Access

In **Transformations**, highlight a transformation. A copy of this transformation is taken for further configurations. Press **New..** or **Edit..**

New Transformation or Edit Transformation, General page

New Transformation | ↩

General Parameters Advanced

Name:

Type: Classic 3D

3DCQ:6.426m 2DCQ:3.478m 1DCQ:5.403m abc 09:53

Store Page

Key	Description
Store	To store the transformation.
Clear	To set the editable fields to 0. Available on the Parameters and the Advanced page.
Page	To change to another page on this screen.
Fn Quit	To exit the screen.

Description of fields

Field	Option	Description
Name	Editable field	A unique name for the new transformation. The name can be up to 16 characters long and include spaces.
Type	Display only	No other transformations than Classic 3D can be created.

Next step

Page changes to the **Parameters** page.

New Transformation or Edit Transformation, Parameters page

Enter the known values of the transformation parameters.

Next step
Page changes to the **Advanced** page.

New Transformation or Edit Transformation, Advanced page

Select at least a height mode and a transformation model.

Description of fields

Field	Option	Description
Height mode	Selectable list	The type of heights to be computed.
Model	Selectable list	The transformation model to be used. For Model: Molodensky-Badakus , additional editable fields are available.

Next step
Store stores the transformation.

8.5

Ellipsoids

8.5.1

Accessing Ellipsoid Management



Ellipsoids cannot be accessed for coordinate systems with source RTCM. Refer to "Automatic coordinate system (RTCM transformation parameters)".

Access step-by-step

Step	Description
1.	In Coordinate Systems , highlight a coordinate system.
2.	Press New.. or Edit...
3.	Highlight Ellipsoid .
4.	ENTER to access Ellipsoids .

8.5.2

Creating/Editing an Ellipsoid

Access

In **Ellipsoids**, highlight an ellipsoid. A copy of this ellipsoid is taken for further configurations. Press **New..** or **Edit...**

New Ellipsoid or Edit Ellipsoid

New Ellipsoid | ↩

Name:

Axis a: m

1/f:

3DCQ:5.452m 2DCQ:3.239m 1DCQ:4.386m abc 09:54

Store | | | | |

Key	Description
Store	To store the ellipsoid.
Fn Quit	To exit the screen.

Description of fields

Field	Option	Description
Name	Editable field	A unique name for the new ellipsoid. A name is mandatory, can be up to 16 characters long and include spaces.
Axis a	Editable field	The semi-major axis a.
1/f	Editable field	The reciprocal value of flattening f.

8.6

Projections

8.6.1

Accessing Projection Management



Projections cannot be accessed for coordinate systems with source RTCM. Refer to "Automatic coordinate system (RTCM transformation parameters)".

Access step-by-step

Step	Description
1.	In Coordinate Systems , highlight a coordinate system.
2.	Press New.. or Edit...
3.	Highlight Projection .
4.	ENTER to access Projections .

Projections

Listed are all projections stored in the database DBX. Any unavailable information is shown as -----.

Projections	
Name	Type
<None>	-----
Czech and Slovak	Customised
DK Bornholm	Customised
DK Jylland	Customised
DK S34 Bornholm	Customised
DK S34 Jylland	Customised
DK S34 Sjælland	Customised
DK Sjælland	Customised
Dutch	Customised
3DCQ:5.461m 2DCQ:3.248m 1DCQ:4.390m abc 09:54	
OK New.. Edit.. Delete	

Key	Description
OK	To select the highlighted projection and to return to the previous screen.
New..	To create a new projection. Refer to "8.6.2 Creating/Editing a Projection".
Edit..	To edit the highlighted projection. Refer to "8.6.2 Creating/Editing a Projection".
Delete	To delete the highlighted projection.
Fn Set-D	Available unless a default projection is highlighted. To turn the highlighted projection into a user-defined default projection stored in the instrument.
Fn Default	To recall the deleted default projections.
Fn Quit	To exit the screen.

Description of columns

Column	Option	Description
Type		The projection type. Refer to standard surveying literature for details on projections.
	Customised	Customised projection. Certain fixed projections which cannot be defined by any of the following options.
	Transverse Mercator	Transverse Mercator. Conformal projection onto a cylinder with its axis lying on the equatorial plane. The cylinder is tangential to a meridian.
	UTM	Universal Transverse Mercator. Transverse Mercator Projection with fixed zone-defining constants. The central meridian is selected automatically according to the selected zone number.
	Oblique Mercator	Oblique Mercator. Oblique Mercator Conformal projection onto a cylinder. The cylinder is tangent to any circle other than the equator or a meridian.
	Mercator	Mercator. Conformal projection onto a cylinder with its axis lying on a meridian plane. The cylinder is tangent to the sphere along the equator.
	Lambert 1 parallel	Lambert 1 Parallel. Conformal projection onto a cone, with its axis coinciding with the z-axis of the ellipsoid.
	Lambert 2 parallel	Lambert 2 Parallel. Conformal projection onto a cone, with its axis coinciding with the z-axis of the ellipsoid. The cone is secant to the sphere.
	Cassini	Soldner-Cassini. Projection onto a cylinder. It is not an equal area or conformal. The scale is true along the central meridian and along lines perpendicular to central meridian.
	Polar stereo	Polar Stereographic. Conformal azimuthal projection onto a plane. The point of projection is on the surface of the ellipsoid diametrically opposite of the origin which is the centre of the projection.
	Double stereo	Double Stereographic. Conformal azimuthal projection onto a plane. The point of projection is on the surface of the sphere diametrically opposite of the centre of the projection.
RSO	Rectified Skewed Orthomorphic. This is a special type of Oblique Mercator projection.	

8.6.2

Creating/Editing a Projection

Access

In **Projections**, highlight a projection. A copy of this projection is taken for further configurations. Press **New..** or **Edit..**

New Projection or Edit Projection

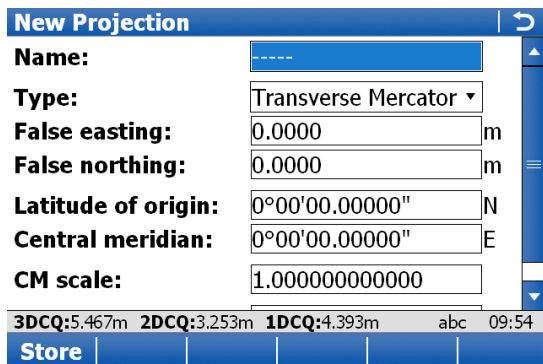

Key	Description
Store	To store the projection.
Fn Quit	To exit the screen.

Description of fields

Field	Option	Description
Name	Editable field	A unique name for the new projection. A name is mandatory, can be up to 16 characters long and include spaces.
Type	Selectable list	The projection type. The setting for determines the availability of the subsequent fields for the parameters of the projection. Refer to "8.6.1 Accessing Projection Management" for a description of the projection types.

8.7

Geoid Models

8.7.1

Overview

Use in the field

For use on the instrument in the field, geoid field files are created from the geoid model.

Create geoid models on the instrument

Geoid models can be created on the instrument in one of three ways:

1. The geoid field file is stored on a data storage device and can be used when the data storage device is inserted in the instrument. It is recommended for large geoid field files. This method is explained in this chapter.
2. The geoid field file is stored in the internal memory of the instrument. It is recommended for large geoid field files. This method is also explained in this chapter.
3. The geoid field file is transferred to the internal memory and can be used at any time. Refer to "30.1 Transfer user objects" for information on how to transfer geoid field files to the internal memory on the instrument.

Access step-by-step

Step	Description
1.	In Coordinate Systems , highlight a coordinate system.
2.	Press New.. or Edit..
3.	Highlight Geoid model .
4.	ENTER to access Geoid Models .

Geoid Models

Listed are all geoid models stored in the database DBX. Any unavailable information is shown as -----. For example, ----- would be shown if the geoid field file associated to the geoid model is not available on the data storage device / internal memory.

Geoid Models	
File	Source
<None>	-----

3DCQ:5.484m	2DCQ:3.266m	1DCQ:4.405m	abc	09:55
OK	Edit..	Delete	Intrnl	

Key	Description
OK	To select the highlighted geoid model and to return to the previous screen.
CF card	To create a new geoid model. The \DATA\GPS\GEOID directory on the data storage device is automatically scanned for geoid field files. Refer to "8.7.3 Creating a New Geoid Model from the Data Storage Device / Internal Memory".
Edit..	To view the highlighted geoid model. None of the fields can be edited. The geoid field file from which the geoid model was created must be stored in the internal memory or in the \DATA\GPS\GEOID directory on the data storage device.
Delete	To delete the highlighted geoid model. The geoid field file which was associated with this geoid model is then also deleted.
Fn Quit	To exit the screen.

8.7.3

Creating a New Geoid Model from the Data Storage Device / Internal Memory

Requirement

At least one geoid field file with the extension *.gem is in the \DATA\GPS\GEOID directory on the data storage device / internal memory.

Create geoid model step-by-step

Step	Description
1.	Listed in Geoid Models are all geoid models stored in the internal memory. OR Press CF card to scan the \DATA\GPS\GEOID directory on the data storage device.
2.	For each geoid field file on the data storage device or in the internal memory, one geoid model is automatically created. The names given to the geoid models are those names which were entered in LGO.  Existing geoid models are automatically overwritten by new models with the same name.
3.	The creation of a geoid model is finished.

8.8

CSCS Models

Use in the field

For use on the instrument in the field, CSCS field files are created from the CSCS model.



The creation of CSCS models on the instrument and the functionality of all screens and fields are similar to those for geoid models. Refer to " Requirement".
The directory on the data storage device / internal memory for CSCS field files with the extension *.csc is \DATA\GPS\CSCS.



All changes made effect the control job.

Access

Select **Main Menu: Jobs & Data\Create control data.**



Data.. displays the Data in the control job.

Create new point

This screen is similar to the **New Point** screen. Refer to "New Point, Coords page".

Key	Description
Next	To store the point and to remain in the screen. The point ID increments according to point ID template.

Methods for creating lines, arcs and polylines

Description of fields

Field	Option	Description
Method		Select one of the following options to create a line/arc/polyline.
	2 points and Line - 2 points	For lines/polylines. Uses two known points to define the reference line.
	Pt, brng, dist, grade and Line - Pt, brng, dist, grad	For lines/polylines. Defines the reference line using a known point, a distance, an azimuth and the gradient of the line. A new point is created at the end of the line.
	Pt, brng, dist, Δht and Line - Pt, brng, dist, Δht	For lines/polylines. The same as Pt, brng, dist, grade/Line - Pt, brng, dist, grad but uses the difference in height instead of the gradient. A new point is created at the end of the line.
	3 points and Arc - 3 points	For arcs/polylines. Defines the reference arc using three known points.
	2 points/radius and Arc - 2 points/radius	For arcs/polylines. Defines the reference arc with two known points and a known radius.

Create new line/arc

For all point fields, the MapView interactive display can be used to select the desired point.

Key	Description
Store	To store the line/arc to the control job.
Next	To store the line/arc and to remain in the screen. The line ID increments according to line ID template.
Survy..	To manually measure a point. Available when a point field is highlighted.
Page	To change to another page on this screen.
Fn IndivID and Fn Run	To change between entering an individual line ID different to the defined ID template and the running line ID according to the ID template.
Fn Quit	To exit the screen.

Description of fields

Field	Option	Description
Line ID	Editable field	The name of the new line. The configured ID template for lines is used. The ID can be changed in the following ways: <ul style="list-style-type: none"> To start a new sequence of line IDs, type over the line ID. For an individual name independent of the ID template Fn IndivID. Fn Run changes back to the next ID from the configured ID template.
Azimuth	Editable field	The azimuth of the line from the start point.
Δ height	Editable field	The difference in height from the start point to the end point of the line.
End point	Selectable list	The last point forming the line.
Grade	Editable field	The gradient of the line from the start point to the end point of the line.
Horiz distance	Editable field	The horizontal grid distance from the start point to the end point of the line.
Line length	Display only	For lines: The horizontal grid distance between the two points of the line. If the distance cannot be calculated, ----- is displayed. For arcs: The horizontal grid distance along the arc between the points. If the distance cannot be calculated, ----- is displayed.
Radius	Editable field	The radius of the arc.
Second point	Selectable list	The medium point forming the arc.
Start point	Selectable list	The first point forming the line.
Point ID	Editable field	The end point of the defined line. Available for creating a line with Method:Pt, brng, dist, Δht .

Next step

Page changes to the **Code** page. Refer to "New Line, Code page".

Create new polyline - Segment by segment



Step	Description
1.	In Create New Polyline select Segment by segment .
2.	Select the method to use for the first segment. Refer to "Methods for creating lines, arcs and polylines" for a description of methods.
3.	Type in the values for the first segment. Refer to "Create new line/arc" for a description of the input fields.
4.	Next to store the segment.
5.	Repeat step 2. to 4. until all segments are entered.
6.	Finish to store the polyline.

**Create new polyline
- Enter point IDs**

In **Create New Polyline** select **Enter point IDs**.

Key	Description
Store	To store the line to the control job.
Page	To change to another page on this screen.
Fn Config..	To access Screen & Audio Settings and change the text input. Available when Points in line is highlighted. Refer to "29.3 Screen & audio".
Fn IndivID and Fn Run	To change between entering an individual line ID different to the defined ID template and the running line ID according to the ID template.
Fn Quit	To exit the screen.

Description of fields

Field	Option	Description
Line ID	Editable field	<p>The name of the new line. The configured ID template for lines is used. The ID can be changed in the following ways:</p> <ul style="list-style-type: none"> To start a new sequence of line IDs, type over the line ID. For an individual name independent of the ID template Fn IndivID. Fn Run changes back to the next ID from the configured ID template.
Points in line	Editable field	<p>Enter a list of points from the control job and characters to define the line.</p> <p>Entering a dot between the points adds point-by-point to the polyline. Example: Entering 1.3.5 creates a polyline with the points 1, 3 and 5 in that order.</p> <p>Entering a minus between the points adds all points between the two points to the polyline, according to the point ID ordering. Example: Entering 1-5 creates a polyline with all points between 1 and 5.</p> <p> This can only be used with numeric point IDs.</p> <p>Entering () creates an arc between the points which are outside () through the point which is inside (). Example: Entering 1(3)5 creates a 3-point arc from 1 to 5 through 3 as the arc mid point.</p>
Line length	Display only	<p>The calculated 2D line length according to the selected points. Units according to distance in regional settings.</p> <p> The line length is shown in the unit configured in Regional Settings, Distance page.</p>

Extend existing polyline

Step	Description
1.	In Line to extend select the line to extend.
2.	OK.
3.	Continue as if creating a new polyline. Refer to "Create new polyline - Segment by segment".

Description

The data to import must be stored on the data storage device or in the internal memory.

Data can be imported to a job

- on the data storage device.
- on the internal memory.

Import formats

Format	Characteristic	Description
ASCII	Import variables	Point ID, grid coordinates, thematical codes. No free codes, no attributes.
	Format definition	Free format. Use and order of variables and delimiter can be defined during import.
	Units	As currently configured on the instrument
	Height	Orthometric or ellipsoidal
	Specialities	
	Local heights but no coordinates in file	Points are imported without coordinates but with local height and code if available.
	Coordinates but no heights in file	Points are imported without height but with coordinates and code if available.
No coordinates or heights in file	No import	
No point IDs in file	No import	
GS18 GSI16	Import variables	Point ID (WI 11), local coordinates (WI 81, WI 82, WI 83), thematical codes (WI 71). No free codes, no attributes. Example for GS18: 110014+00001448 81..01+00001363 82..01-00007748 83..01-00000000 71....+000sheep
	Format definition	Fixed format. Easting and Northing can be switched during import.
	Units	As defined in the GSI file
	Heights	Orthometric or ellipsoidal
	Specialities	
	Local heights but no coordinates in file	Points are imported without coordinates but with local height and code if available.
	Coordinates but no heights in file	Points are imported without height but with coordinates and code if available.
No coordinates or heights in file	No import	
No point IDs in file	No import	
DXF	Import variables	Block, point, line, arc, polyline. Local coordinates. No free codes, no attributes.
	Format definition	Fixed format (X/Y/Z).
	Units	Not predefined.

Format	Characteristic	Description
	Heights Specialities No coordinates or heights in file	Z value imported as orthometric. No import
MxGenio	-	-
LandXML	-	-
DTM data	Format definition	DXF file containing DTM data

Checks

Points are always imported with the class **Ctrl** and a coordinate quality of -----. Refer to "Appendix J Glossary".

While importing points to a job, checks are performed against point ID, class and coding of points already existing in the job.

10.2

Importing Data in ASCII/GSI Format

Requirements

At least one ASCII file with any file extension, is stored in the \DATA or \GSI directory of the data storage device.



Do not remove the data storage device while importing the data.

Access

Select **Main Menu: Jobs & Data\Import data\Import ASCII data.**

Import ASCII Data

Key	Description
OK	To import the data.
Config..	To define the format of the data to be imported.
View	To view the file from which data will be imported.
Fn Hts..	To define how heights and the Easting are imported.
Fn Quit	To exit the screen.

Description of fields

Field	Option	Description
From	Selectable list	Defines from which storage device the data are imported.
Data type to import	Selectable list	Defines if ASCII or GSI data are imported.

Field	Option	Description
From file	Selectable list	For Data type to import: ASCII data : All files in the \DATA directory on the data storage device can be selected. For Data type to import: GSI data : All files with extension *.gsi in the \GSI directory on the data storage device can be selected.
Header lines	Selectable list	This option allows up to ten header lines which can exist in an ASCII file to be skipped. Select the number of header lines.
To job	Selectable list Editable field	Available when Create new job on import is not checked. Choosing a job as destination for import makes this job the working job. Available when Create new job on import is checked. The name of the new job.
Create new job on import	Check box	When this box is checked and the file from which the data should be imported is selected the To job field displays a suggested jobname. The suggested jobname is the name of the file without the extension.
Create new job as	Selectable list	The new job can wither be a working job or a control job.
Device	Selectable list	The device on which the new job will be stored.

Next step

Config.. accesses, depending on selection for **Data type to import**, either **Configuration** or **Configuration (GSI)**.

Configuration

Configuration | ↻

Delimiter: Comma

Point ID position: 1

Easting position: 2

Northing position: 3

Height position: 4

Code position: None

Example: P,E,N,H,,,,,

3DCQ:0.020m 2DCQ:0.012m 1DCQ:0.017m abc 14:20

OK | Default

Key	Description
OK	To return to the previous screen.
Default	To recall the default import settings.
Fn Quit	To exit the screen.

Description of fields

Field	Option	Description
Delimiter	Selectable list	The separator between the import variables.

Field	Option	Description
Point ID position, Easting position, Northing position, Height position and Code position	None (not for Point ID position) and from 1 to 20	Select the positions of the particular variables. An example is shown at the bottom of the screen.
Multiple spaces between data	Yes No	Available for Delimiter: Space . For space delimited data having multiple spaces between the variables. For space delimited data having one space between the variables.
Number of lines/pt	Selectable list	Available for Delimiter: Line feed . The number of lines used to describe each point.

Next step

Step	Description
1.	OK leads back to Import ASCII Data .
2.	Fn Hts.. to access Define Ht Type & Easting Import .

Configuration (GSI)

Description of fields

Field	Option	Description
Switch WI81/WI82	Yes or No	All WI 81 data, normally Easting, is imported as Northing and all WI 82 data, normally Northing, is imported as Easting. This coordinate switch is necessary for "left handed" coordinate systems.
Definition of feet	Selectable list	The type of feet used in the GSI file.

Next step

Step	Description
1.	OK leads back to Import ASCII Data .
2.	Fn Hts.. to access Define Ht Type & Easting Import .

Define Ht Type & Easting Import

Description of fields

Field	Option	Description
Import as	Selectable list	The height type for the imported data.
Easting	Selectable list	The Easting can be imported as written in the ASCII file or it can be multiplied by -1. This change is required by some coordinate systems.

OK leads back to **Import ASCII Data**.

Requirements

At least one file in LandXML format with the file extension *.xml has to be stored in the \DATA directory of the data storage device.

 The file can contain points, lines, areas, alignments (Road/Rail/Tunnel jobs) and DTM's/PLA's.

Access

Select **Main Menu: Jobs & Data\Import data\Import XML data.**

Import XML Data

Key	Description
OK	To import the data.
Fn Quit	To exit the screen.

Description of fields

Field	Option	Description
From	Selectable list	Defines from which storage device the data are imported.
From file	Selectable list	All files with extension *.xml in the \DATA directory on the data storage device can be selected.
Import points, lines, areas, coord systems & point codes	Check box	When this box is checked, points, lines and areas are imported and a job can be selected.
Import alignments	Check box	When this box is checked, alignments are imported and a job can be selected.
Import DTM	Check box	When this box is checked, DTM's are imported and a new DTM job is created which can be selected.

Next step

OK start the import.

Requirements

The requirements depend on the file type:

- For MxGenio: At least one file in MxGenio format with the file extension *.txt is stored in the \DATA directory of the data storage device.
- For LandXML and Terramodel: At least one file in LandXML format with the file extension *.xml is stored in the \DATA directory of the data storage device.
- For DXF: At least one file in DXF format with the file extension *.dxf is stored in the \DATA directory of the data storage device.
- For Carlson: At least one file in Carlson format with the file extension *.cl is stored in the \DATA directory of the data storage device.

Access

Select **Main Menu: Jobs & Data\Import data\Import alignment data.**

Import Alignment Data

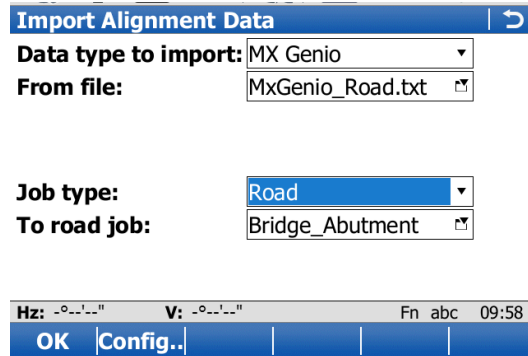

Key	Description
OK	To import the data.
Config..	To define the format of the data to be imported. Available for Data type to import: MX Genio , Data type to import: DXF and Data type to import: Carlson .
Fn Quit	To exit the screen.

Description of fields

Field	Option	Description
Data type to import	Selectable list	Defines if MX Genio, LandXML, DXF, Terramodel or Carlson data are imported.
From file	Selectable list	For Data type to import: MX Genio : All files with the extension *.txt in the \DATA directory on the data storage device can be selected. For Data type to import: LandXML : All files with the extension *.xml in the \DATA directory on the data storage device can be selected.  For cross section-based LandXML data, vertex connection definitions are mandatory. For Data type to import: DXF : All files with extension *.dxf in the \DATA directory on the data storage device can be selected.

Field	Option	Description
		For Data type to import: Terramodel : A Terramodel *.xml file in the \DATA directory on the data storage device can be selected. The file must contain the centreline. For Data type to import: Carlson : All Carlson centreline files with the extension *.cl in the \DATA directory on the data storage device can be selected.
Section file	Selectable list	For Data type to import: Terramodel : All ASCII cross-section files with the extension *.txt in the \DATA directory on the data storage device can be selected. For Data type to import: Carlson : All Carlson cross-section files with the extension *.sct in the \DATA directory on the data storage device can be selected.
Job type	Road and Rail	The type of job the data are converted to.
To road job or To rail job	Selectable list	When importing data, a new/empty rail or road job must be created for the data to be stored in.

Configuration

This screen is available for **Data type to import: MX Genio**, **Data type to import: DXF** and **Data type to import: Carlson**.

Key	Description
OK	To return to the previous screen.
Fn About	To display information about the program name, the version number, the date of the version, the copyright and the article number.
Fn Quit	To exit the screen.

Description of fields

Field	Option	Description
File linear units	Selectable list	The units used in the file to import.
Line prefix	Editable field	Available for Data type to import: DXF . The prefix to be used.  Line prefix can not be defined for Carlson data.

Next step



Step	Description
1.	OK leads back to Import Alignment Data .
2.	OK opens, depending on the selections made, a screen for the line, layer or track selection.

Import MX Genio Data, for Road jobs

Key	Description
OK	To start the import.
Centre	To set the highlighted line as centreline.
Use	To set Yes or No in the Use column for excluding/including the highlighted line from/to import.
Fn Quit	To exit the application.



Line selection is also possible on the **Map** page.

IF	THEN
a single line is to be selected	tap on the line.
multiple lines are to be selected	click the  icon, drag the stylus on the screen in a diagonal line to make a rectangular area.
the context menu is to be activated	hold down the supplied stylus anywhere on the map for 0.5 second. Refer to "37.6 Context Menu".  To deselect all objects for import, select Clear selected object .

Description of columns

Column	Description
Line name	Displays the name of all the lines in the layer.
CL	Shows CL for the line selected as centreline.
Use	For Yes : The selected line is used for the import. For No : The selected line is not used for the import.

Next step

OK start the import.

Define Track Design, MxGenio for Rail jobs

For MxGenio, only single track Rail jobs can be created.

Key	Description
OK	To start the import.
Ch CL	To select/deselect the highlighted line as external chainage centreline. The selection is optional.
T. CL	To select/deselect the highlighted line as track centreline. The selection is mandatory.
Rail L	To select/deselect the highlighted line as left rail. The selection is optional.

Key	Description
Rail R	To select/deselect the highlighted line as right rail. The selection is optional.
Fn Quit	To exit the application.

 Line selection/deselection is also possible on the **Map** page.

IF	THEN
a single line is to be selected/deselected	tap on the line.
the context menu is to be activated	hold down the supplied stylus anywhere on the map for 0.5 second. Refer to "37.6 Context Menu".



Description of columns

Column	Description
Line name	Displays the name of all the lines.
Use as	Displays a line selected as external chainage centreline, track centreline, left rail or right rail.

Next step

OK start the import.

Select Layers to Import, for DXF Road/Rail data, LandXML Road/Raildata, Terramodel Road data and Carlson Roaddata

Key	Description
OK	To start the import.
Edit..	<ul style="list-style-type: none"> For Road: To define the centerline and to turn lines on and off for the highlighted layer. For Rail: To define the external chainage centreline (optional), to define the track centerline (mandatory), to define the left rail (optional) and to define the right rail (optional). <p> By default, the longest stringline is set as the centreline.</p> <p> For DXF and LandXML data (Road and Rail), line selection, per layer, is also possible in Edit Layer, Map page.</p> <ul style="list-style-type: none"> To select a single line, tap on the line. For Road: To select multiple lines, click the  icon, drag the stylus on the screen in a diagonal line to make a rectangular area. To activate the context menu, hold down the supplied stylus anywhere on the map for 0.5 second. Refer to "37.6 Context Menu".
Use	To set Yes or No in the Use column for excluding/including the highlighted line from/to import.
Fn Quit	To exit the application.

Description of columns

Column	Description
Layer name	Displays the name of all layers available for importing.

Column	Description
Use	For Yes : The selected layer is used for the import. For No : The selected layer is not used for the import.

Next step
OK start the import.

10.5 Importing Data in DXF Format

Requirements At least one file in DXF format with the file extension *.dxf has to be stored in the \DATA directory of the data storage device.



Do not remove the data storage device while importing the data.

Access Select **Main Menu: Jobs & Data\Import data\Import DXF data.**

Import DXF Data

Key	Description
OK	To import the data.
Config..	To define the format of the data to be imported.
Fn Quit	To exit the screen.

Description of fields

Field	Option	Description
From	Selectable list	Defines from which storage device the data are imported.
From file	Selectable list	All files with extension *.dxf in the \DATA directory on the data storage device can be selected.
To job	Selectable list	Choosing a job as destination for import makes this job the working job.

Next step
Config.. accesses **Configuration.**

Description of fields

Field	Option	Description
Block prefix	Editable field	Optional prefix to imported blocks.
Point prefix	Editable field	Optional prefix to imported points.
Line prefix	Editable field	Optional prefix to imported lines.
File units	Selectable list	Choosing the unit for the DXF data to be imported.
Create points at the vertices of lines	Check box	Option if points will be created at vertices of the imported line/arc/polyline elements.
Convert white elements	Check box	Option if white coloured elements will be converted to black coloured elements.
Height to exclude	Selectable list	Height values inside the DXF file are considered invalid and will not be converted.
Apply height to 2D CAD data on import	Check box	When this box is checked, a height can be defined which is then applied to all imported 2D CAD points.
Height to apply	Editable field	Available when Apply height to 2D CAD data on import is checked. The height to apply to 2D CAD points.

Next step

OK leads back to **Import DXF Data**.

10.6

Importing DTM Data

Requirements

- At least one file in DXF format with the file extension *.dxf has to be stored in the \DATA directory of the data storage device.
- The DXF file must contain a 3D face layer.



Do not remove the data storage device while importing the data.

Access

Select **Main Menu: Jobs & Data\Import data\Import DTM data**.

Import DTM data

Import DTM Data | ↻

From: SD card

From dxf file: Simple DXF 1

To job: Simple DXF 1

Device: Internal memory



Key	Description
OK	To import the data.
Config..	To define the linear units of the data to be imported.
Fn Quit	To exit the screen.

Description of fields

Field	Option	Description
From	Selectable list	Defines from which storage device the data are imported.
From dxf file	Selectable list	All files with extension *.dxf in the \DATA directory on the data storage device can be selected.
To job	Selectable list	Choosing a job as destination for import makes this job the DTM job.
Device	Selectable list	Defines to which storage device the data are imported.

Next step

Config.. accesses **Configuration**.

Configuration

Description of fields

Field	Option	Description
File linear units	Selectable list	Choosing the unit for the DXF data to be imported.

Next step

OK leads back to **Import DXF Data**.

Description

Data can be exported

- to a file on the data storage device.
- to a file on the internal memory.

Export format

Format	Characteristic	Description
ASCII	Export variables	Point ID, grid coordinates, thematic codes, code description, up to four attributes and linework. No free codes.
	Format definition	Free format. Use and order of variables and delimiter can be defined during export.
	Units Height	As currently configured on the instrument Orthometric or ellipsoidal
Custom	Export variables	Refer to the online help of LGO.
	Format definition	Composed individually as format file using LGO. Refer to the online help of LGO for information on creating format files.
	Units	Defined within the format file.
	Coordinate conversion	All coordinate types are supported.
	Height	All height types are supported. If the desired height cannot be computed, the default value for the missing variable is output.
	Specialities:	
	Points in file outside of CPCS model	If the variable is missing, the default value is output.
	Points in file outside of geoid model	If the variable is missing, or a geoid separation is available, the default value is output.
DXF	Coordinate conversion	All points are converted to local grid position using the coordinate system.
	Height	Orthometric height and ellipsoidal height are supported.
	Specialities:	
	Points in file outside of CPCS model	Points outside of CPCS model are not exported.
	Points in file outside of geoid model	The ellipsoidal height is exported.
LandXML	Coordinate conversion	All points are converted to local grid position using the coordinate system.
	Height	Orthometric height and ellipsoidal height are supported.
	Specialities:	
	Points in file outside of CPCS model	LocalGrid position of the points outside of CPCS model is not exported.

Format	Characteristic	Description
	Points in file outside of geoid model	The ellipsoidal height is exported.
FBK/RAW5/RAW	Coordinate conversion Height Units	All points are converted to local grid position using the coordinate system. If a geoid model exists, then orthometric height is supported, otherwise ellipsoidal height is exported. Metre, US Ft or Int Feet, Gons, Dec Deg, DMS

11.2 Exporting Data from a Job to an ASCII Format

Description

The settings on this screen define the data that is converted and exported and what format is used.

Data is exported from the selected job. Currently active view, filter and sort settings are applied.

Access

Select **Main Menu: Jobs & Data\Export & copy data\Export ASCII data.**

Export ASCII Data

Key	Description
OK	To select the highlighted format file.
Config..	To define the format of the data to be exported.
Filter..	To define the order in which points, lines and areas are exported as well as which points are exported.
CrdSys.	To update the coordinate system in which the coordinates are exported.
Fn Quit	To exit the screen.

Description of fields

Field	Option	Description
Export to	Selectable list	Defines where the exported data are saved to.  For Export to: Internal memory the data is always exported to the \DATA directory.
Folder	Selectable list	The data can be exported to the \DATA or the root directory or to the folder where the selected job is located.

Field	Option	Description
Job	Selectable list	To select the job to export.
Coord system	Display only	The coordinate system currently attached to the selected job.
Output file to write	Editable field	The name of the file to which the data will be exported.

Next step

Config.. accesses **Configuration.**

Configuration

Key	Description
OK	To return to the previous screen.
Default	To recall the default import settings.
Fn Quit	To exit the screen.

Description of fields

Field	Option	Description
Delimiter	Selectable list	The separator between the import variables.
1st position to 8th position	None, Point ID, Easting, Northing, Elevation, Code, Code information, Code & code info, Description, Attribute 1 to Attribute 4 and Linework	Select the variable of the particular positions. An example is shown on the Export ASCII Data screen.

Description

The settings on this screen define the data that is converted and exported and what format is used.

Data is exported from the selected job. Currently active view, filter and sort settings are applied.

Requirements

At least one format file was created using LGO and transferred to the internal memory.

Access

Select **Main Menu: Jobs & Data\Export & copy data\Export custom data.**

Export Custom Data

Key	Description
OK	To select the highlighted format file.
Config..	To configure the default extension to be used.
Filter..	To define the order in which points, lines and areas are exported as well as which points are exported.
CrdSys.	To update the coordinate system in which the coordinates are exported.
Fn Quit	To exit the screen.

Description of fields

Field	Option	Description
Export to	Selectable list	Defines where the exported data are saved to.  For Export to: Internal memory the data is always exported to the \DATA directory.
Folder	Selectable list	Available for Export to: CF card , Export to: SD card and Export to: USB . The data can be exported to the \DATA, the \GSI or the root directory or to the folder where the selected job is located. Data must be stored to the \GSI directory to be read in a TPS instrument.
Job	Selectable list	To select the job to export.
Coord system	Display only	The coordinate system currently attached to the selected job.
Format file to use	Selectable list	The format files currently available in the internal memory.
Output file to write	Editable field	The name of the file to which the data will be exported.

General

Data can be exported to a DXF file in a data storage device or the internal memory.



Do not remove the data storage device while exporting the data.

Access

Select **Main Menu: Jobs & Data\Export & copy data\Export DXF Data.**

Export DXF data



Key	Description
OK	To accept the settings.
Config..	To define what is exported.
Fn Quit	To exit the screen.

Description of fields

Field	Option	Description
Folder	Selectable list	Defines if the data is exported to the \DATA directory or to the folder where the selected job is located.
Export to	Selectable list	Available for Folder: Data . Defines which data storage device the data is exported to.
	Display only	Available for Folder: Same as job . Displays the data storage device of the selected Job .
Job	Selectable list	To select the job to export.
Coord system	Display only	The coordinate system currently attached to the selected job.
File name	Editable field	The name of the file to which the data will be exported.

Next step

Config.. goes to **Configuration, Export** page.

Configuration, Export page

Configuration | ↻

Objects | DXF | Labels

Export points

Export lines

Export areas

Export images

3DCQ:----m 2DCQ:----m 1DCQ:----m Fn abc 12:17

OK | **Filter..** | **Page**

Key	Description
OK	To export the data.
Filter..	To define the order in which points, lines and areas are exported as well as which points are exported. Refer to "6.6.1 Sorting and Filters for Points, Lines and Areas".
Fn Quit	To exit the screen.

Description of fields

Field	Option	Description
Points	Check box	When this box is checked, points are exported.
Lines	Check box	When this box is checked, lines are exported.
Areas	Check box	When this box is checked, areas are exported.
Export images	Check box	When this box is checked, images are exported.

Next step

Page changes to the **DXF** page.



For information on camera and images refer to "33.6 Exporting Images".

Configuration, DXF page

Description of fields

Field	Option	Description
Export lines & areas	Selectable list	Defines if lines and areas are exported as Line or Polyline entities.
Symbol size	Editable field	Defines the size used for creation of the LGO symbols.
Dimensions	Selectable list	Defines if the data is exported as 2D or 3D.
Export to DXF layer	Selectable list	Defines the DXF layer.
Export LGO symbols	Check box	When this box is checked, the relevant symbols for LGO are also exported.

Next step

Page changes to the **Labels** page.

Configuration, Labels page

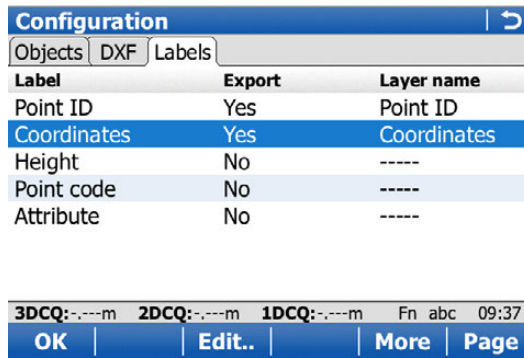

Key	Description
OK	To accept the settings.
Edit..	To define if the label is exported, its colour, the number of decimal places to use and what layer or block it is exported to.
More	To display information about the layer name, the colour and the decimals.
Page	To change to another page on this screen.
Fn About	To display information about the program name, the version number, the date of the version, the copyright and the article number.
Fn Quit	To exit the screen.

Description of columns

Column	Description
Label	The name of the label.
Export	Shows if the label is exported or not.
Layer name	The name of the layer that is exported which can be: <ul style="list-style-type: none"> Name of a user-defined layer If the label is exported to a user-defined layer. Same layer as point If the label is exported to the same layer as the point symbol. Block with point If the label is exported to a block with the point symbol. ----- The label is not exported.
Colour	The colour of the label.
Decimals	The number of decimals used.

Next step

Edit.. access **Labels**.

Description of fields

Field	Option	Description
First field on screen	Check box	When this box is checked, the chosen label types are exported.  All other fields on the screen are active and can be edited.
Colour	Selectable list	Defines the colour for the label.
Decimals	From 0 to 4	Available for the labels Coordinates and Height . Defines the number of decimal places for the label.
Export to	User defined Same layer as point Block with point	The label is exported to a user defined layer. The label is exported to the layer which the point symbols are exported to. The label is exported to a block with the point symbol and all other labels which are also set to be exported to Block with point . Only one block is created for a point and there can be one or more labels in this block.
Layer name	Selectable list	Available for Layer name: User defined is checked. The name of the layer.
Export code descriptions	Check box	Available when Point Code is highlighted in Configuration, Labels page. Defines if the code descriptions are exported with the point code.
Export attribute names	Check box	Available when Attribute is highlighted in Configuration, Labels page. Defines if the attribute names are exported with the attribute values.

Next step

OK returns to **Configuration**.

General

Data can be exported to a XML file in the.

- \DATA directory or
- same directory as the job is in

on the

- data storage device or
- internal memory.



Do not remove the data storage device while exporting the data.

Access

Select **Main Menu: Jobs & Data\Export & copy data\Export XML Data.**

Export XML Data

Key	Description
OK	To export the data.
Config..	To define what is exported.
Fn Quit	To exit the screen.

Description of fields

Field	Option	Description
Export to	Selectable list	Defines where the exported data are saved to.
Folder	Selectable list	The data can be exported to the \DATA directory or to the folder where the selected job is located.
Job type	Points/lines/areas, Road, Rail or Tunnel	The type of job to be exported. To use this option, select LandXML version: 1.2 and check Use Hexagon XML extension in Configuration, XML page.
Job	Selectable list	To select the job to export. The selectable list depends on the setting for Job type .
Coord system	Display only	The coordinate system currently attached to the selected job.
File name	Editable field	The name of the file to which the data will be exported.

Next step

Config.. accesses **Configuration, Export** page.

Configuration, Export page

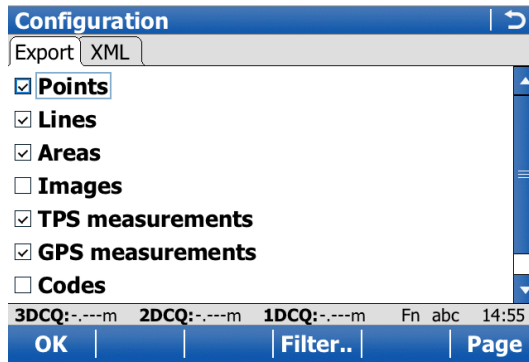

Key	Description
OK	To return to the previous screen.
Filter..	To set the sort and filter settings for export. Refer to "6.6.1 Sorting and Filters for Points, Lines and Areas".
Fn Quit	To exit the screen.

Description of fields

Field	Option	Description
Points	Check box	When this box is checked, points are exported.
Lines	Check box	When this box is checked, lines are exported.
Areas	Check box	When this box is checked, areas are exported.
Images	Check box	When this box is checked, all onboard, TPS and panoramic images are exported.
TPS measurements	Check box	When this box is checked, TPS observations are exported.
GPS measurements	Check box	When this box is checked, GPS observations are exported.
Codes	Check box	When this box is checked, point codes, line codes and area codes are exported.
Free codes	Check box	When this box is checked, the free code, free code description, free code group and the free code attributes, are all exported to the LandXML file associated to each exported point. Free code export works also when Use Hexagon XML extension is checked on the XML page.
Application results	Check box	When this box is checked, all application results such as stakeout and reference line are exported. They are only exported when Use Hexagon XML extension is checked on the XML page.

Next step

Page changes to the **XML** page.



For information on camera and images refer to "33.6 Exporting Images".

Description of fields

Field	Option	Description
Dimensions	Selectable list	Defines the dimension of the exported entities.
LandXML version	Selectable list	Defines the LandXML version of the file exported file.
Use Hexagon XML extension	Check box	Available for LandXML version: 1.2 . When this box is checked, a job type can be selected for the export in the Export XML Data screen.

11.6

Exporting Data using Stylesheets

Access

Select **Main Menu: Jobs & Data\Export & copy data\Export using stylesheets.**

Export Data Using Stylesheet

Key	Description
OK	To export the data.
Fn Quit	To exit the screen.

Description of fields

Field	Option	Description
Folder	Selectable list	The data can be exported to the \DATA directory or to the folder where the selected job is located.
Export to	Selectable list	Defines where the exported data is saved to.
Job type	Points/lines/areas, Road, Rail or Tunnel	The type of job to be exported.
Job	Selectable list	To select the job to export.
Coord system	Display only	The coordinate system currently attached to the selected job.
Stylesheet to use	Selectable list	The stylesheets currently available in the \CONVERT folder on the internal memory of the CS: My Device\Leica GeoSystems\SmartWorx Viva\Convert.
Description:	Display only	A detailed description of the stylesheet. This information is entered by the user in a variable within the stylesheet.
File name	Editable field	The name of the file to which the data will be exported. The file extension is defined by the user in a variable inside the stylesheet. Default is "txt" if the extension has not been defined.

General

Data can be exported to an AutoDesk FBK, TDS RAW, TDS RW5, Carlson RW5 or MicroSurvey RW5 file. The newly created file is stored in the \DATA directory of the data storage device or the internal memory.

The formatted FBK files can be imported directly into Autodesk products.

The created RW5 and RAW files can be processed with various survey office packages.

Although the export operation converts any job to an FBK/RW5/RAW file, the figure creation is based on existing lines and areas present in the job.

Point codes

Each point collected should have a point code.

IF you are creating	THEN
Autodesk FBK file	Point codes are used to match the Description Keys in Autodesk LDT and Civil 3D to each position located.
TDS RW5 file	Point codes are used to generate raw linework in TDS Foresight.
MicroSurvey RW5 file	Point codes are used to match the Description Keys in MicroSurvey CAD to each position located.

Line/Area ID

IF you are creating	THEN
Autodesk FBK file	The figure ID follows the user selection as defined in the configuration menu.
TDS RW5 file	The line and area IDs are not used when importing data into TDS Foresight.
MicroSurvey RW5 file	The line and area IDs are not used when importing data into MicroSurvey CAD 2005.



Do not remove the data storage device while exporting the data.

Access

Select **Main Menu: Jobs & Data\Export & copy data\Export FBK/RW5/RAW data.**

Export FBK/RW5/RAW data

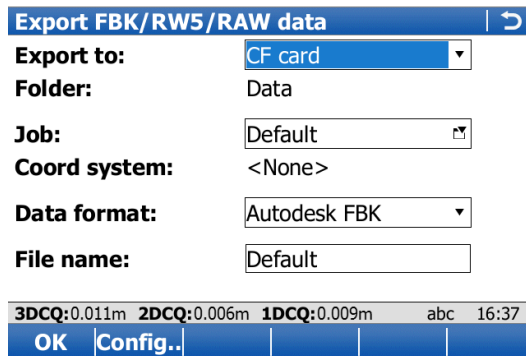

Key	Description
OK	To export the data.
Config..	To configure some format-specific options.
Fn Quit	To exit the application.

Description of fields

Field	Option	Description
Export to	Selectable list	Defines where the exported data are saved to.
Folder	Display only	The data can be exported to the \DATA directory or to the folder where the export job is located.
Job	Selectable list	To select the job to export.
Coord system	Display only	The coordinate system currently attached to the selected job.
Data format	Autodesk FBK, TDS RW5, TDS RAW, Carlson RW5 or Micro-Survey RW5	Ensure that this field is set properly.
File name	Editable field	Default is the name of the selected Job . It can be changed.  The extension designation (.FBK, .RW5 or .RAW) is added automatically.

Next step

Config.. to access the configuration screen.

Configuration for FBK, General page

Description of fields

Field	Option	Description
Use numerical pt ID	Check box	Available unless Data format: TDS RW5 .
Pt ID offset	Editable field	The point IDs are offset by this value.
Use angle right	Check box	Define if angle right values are exported.
Figure ID	Selectable list	Available for Data format: Autodesk FBK . For all other formats, the figure ID is set to point code only automatically.

Next step

Page changes to the **Objects** page.

Configuration for FBK, Objects page



Key	Description
OK	To return to Export FBK/RW5/RAW data .

Key	Description
All	To check all boxes at once.
Page	To change to another page on this screen.
Fn About	To display information about the application name, the version number, the date of the version, the copyright and the article number.
Fn Quit	To exit the application.

Description of fields

Field	Option	Description
All fields	Check box	To include points from an application, check a box.

Next step

OK returns to **Export FBK/RW5/RAW data**.

11.8 Copy Data Between Jobs

Description

This chapter explains the process of copying data from one job to another.



Important features:

- Points are copied as defined by the point filter settings.
- Points selected for copying can be viewed in a points listing. The point sort settings define the order of the points in the listing. The point filter settings define the points to be viewed in the listing.
- Only points are copied - observation data is not copied.
- When points are copied from one job to another:
 - the point codes and attached attributes are also copied.
 - the **Class** is retained.
 - the **Sub class** is retained.
 - the **Source** is changed to **Copied Point**.
 - the point coordinate quality is retained.
 - the **Instrument Flag** is retained.
 - the **Date** and **Time** is retained.

Access

Select **Main Menu: Jobs & Data\Export & copy data\Copied data between jobs**.

Copy Data Between Jobs

Copy Data Between Jobs | ↻

From job:

Coord system:

To job:

3DCQ:0.011m 2DCQ:0.006m 1DCQ:0.009m abc 16:30

OK | Filter.. | Data.. | CrdSys.

Key	Description
OK	To copy a selection of points.
Filter..	To define the point sort and/or point filter settings of points from the job. Refer to "6.6.1 Sorting and Filters for Points, Lines and Areas".
Data..	To view, edit and delete points, lines and areas stored with the job. Points, lines and areas are shown on separate pages. Selected sort and filter settings apply. Refer to "6 Jobs & Data - Data".
CrdSys.	To select a different coordinate system.
Fn Quit	To exit the screen.

Description of fields

Field	Option	Description
From job	Selectable list	Describes where the points are to be copied from.
Coord system	Display only	The coordinate system which is currently attached to the job.
To job	Selectable list	Describes where the points are to be copied to.

12

Instrument - TPS settings TPS

12.1

Measure mode & target

12.1.1

Measure & Target Settings

Description

The settings on this screen define the active EDM **E**lectronic **D**istance **M**easurement and ATR **A**utomatic **T**arget **R**ecognition settings.



Available options depend on the purchased model, for example with or without ATR.

Access

Select **Main Menu: Instrument\TPS settings\Measure mode & target.**

Measure & Target Settings

Description

- This screen has two pages - the **Survey** page and the **Setup** page.
- The **Survey** page and **Setup** page contain identical fields.
- The settings made in the **Survey** page are used by all applications and all measurements taken outside of the **Setup** application.
- The settings made in the **Setup** page are only used inside the Setup application.
- Any changes made to the **Measure & Target Settings**, for example via icons or hotkeys, while the Setup application is active, only affect the Setup **Measure & Target Settings**.
- Any changes made to the **Measure & Target Settings**, for example via icons or hotkeys, while the Setup application is not active, only affect the Survey **Measure & Target Settings**.
- When entering the Setup application, the Setup **Measure & Target Settings** are active.
- When leaving the Setup application, the Survey **Measure & Target Settings** are active.
- Both Survey and Setup **Measure & Target Settings** are part of the working styles.

Key	Description
OK	To accept changes and return to Main Menu .
Page	To change to another page on this screen.
Fn Test	To access the Measurement Signal Test screen.
Fn Quit	To exit the screen.

Description of fields

Field	Option	Description
Measure	Prism	All fields are set to the last used options. The infrared EDM exists for all instrument types and allows to measure the distance to a prism or a tape. For Target aiming: Automatic or Target aiming: Lock this option is automatically set.
	Any surface	To measure without reflector.
Measure mode	Single	Available for Measure: Prism . When a single measurement with high precision is required.
	Single (fast)	Available only for Measure: Prism . When a single measurement is required but the time to survey must be minimised. The highest accuracy is of less importance. Use this mode for example when performing, "typical" topographical surveys.
	Continuous	When continuous distance measurements are required. Use this mode for example when continually checking the positions of a moving prism pole.
	Continuous+	Available for Measure: Prism . This is the measurement mode for the interpolation of angle measurements in prism LOCK continuous mode. In difference to normal continuous mode, where angle measurements are only assigned to certain distance measurements, Continuous+ will perform a linear interpolation between the previous and following angle measurement, based upon the timestamp of the EDM measurement. Using this interpolation procedure, a higher accuracy for all dynamic applications, for example machine guidance, is possible. Use this mode for example with machine control applications.
	Averaging	Repeats measurements in standard measuring mode. The average distance of No. of distances and the standard deviation for the averaged distance are calculated. Use this mode for example when performing cadastral survey where rigid guidelines must be followed.
	Long range (>4km)	Available only for Measure: Prism . When long distances (> 4 km) to prisms are needed. Use this mode for example for triangulation measurements.
	Long range avg	Available for Measure: Prism . Whenever long distances (> 4 km) to prisms are needed but in addition, average values and standard deviations for multiple precise distance measurements are required.

Field	Option	Description
	Precise	Use this mode for example when performing triangulation measurements within a cadastral survey where rigid guidelines must be followed. Available for Measure: Prism on TS50/TM50. Fine measuring mode for highest precision measurements with prisms.
No. of distances		Available if Measure mode: Averaging or Measure mode: Long range avg. Input field for the maximum number of distances to be averaged from 2 to 999 distances.
Target	Selectable list	Target names as configured in the Targets screen.
Leica constant	Display only	The additive constant as stored for the selected prism in the SmartWorx Viva software.
Absolute constant	Display only	The true additive constant.
Target aiming	Manual Automatic Lock	Measurements are done without any automation. ATR search and/or ATR measurement are not performed. Positioning to static prisms. The ATR sensor is used for measurements to static prisms. If needed an ATR measurement or ATR search is performed after pressing Meas or Dist . Unavailable for SmartStation/TS12 Lite. The instrument locks onto and follows the moving prism. The ATR sensor is used to follow moving prisms and to find prisms after loss of lock. Depending on Measure single or continuous measurements are performed pressing Meas or Dist .
Visibility	Good Rain & fog Rain & fog always Sun & reflections Sun & rflctns always	If weather conditions are normal, then select this mode. To increase the instrument measuring ability during suboptimal weather conditions. This mode is automatically deactivated when the instrument is turned off. As for Rain & fog , however this mode stays active when the instrument is turned off. To increase the instrument measuring ability during incident solar radiation and reflections, for example safety vests. This mode has a considerable influence on the range (restriction 100 - 150 m). This mode is automatically deactivated when the instrument is turned off. As for Sun & reflections , however this mode stays active when the instrument is turned off.
Allow lock in on the fly	Check box	Available for Target aiming: Lock . For robotic instruments and the remote operation with CS10/CS15.

Field	Option	Description
		<p>When this box is checked, the instrument locks to a prism as soon as it enters the ATR field of view when previously locked to a prism and target lock was lost.</p> <p> A power search helps to lock to shaking prisms.</p> <p>Works on all prisms and tape targets.</p>
High dynamics at short range	Check box	<p>Available for Target aiming: Lock. For robotic instruments and the remote operation with TS15. When this box is checked, the performance improves for distances less than 20 m to the instrument. The instrument reacts faster to changes in prism speed and direction.</p>
Use precise target aiming	Check box	<p>Available for the 0.5" instruments of TS50/TM50. When this check box is checked, ATR measurements with higher accuracy are performed.</p>

12.1.2

Targets

Description

Each prism type has an absolute constant. Leica Geosystems prisms are predefined as defaults and can be selected. Additional prisms can be defined.

Default targets

Following default prisms are always available on the instrument:

Product Name	Name in list	Type	Leica constant	Absolute constant
GRZ4, GRZ122	Leica 360° Prism	Prism	+23.1 mm	-11.3 mm
GMP111-0	Leica Mini 0	Prism	0.0 mm	-34.4 mm
GRZ101	Leica Mini 360°	Prism	+30.0 mm	-4.4 mm
GMP101, GMP111	Leica Mini Prism	Prism	+17.5 mm	-16.9 mm
GZM29, GZM30, GZM31, CPR105	Leica Reflective Tape	Tape	+34.4 mm	0.0 mm
GPR1, GPR111, GPR113, GPR121, GPH1P	Leica Round Prism	Prism	0.0 mm	-34.4 mm
-	Reflectorless	RL	+34.4 mm	0.0 mm
MPR122  For Machine Control purposes only!	Leica HDS Target	Prism	+28.1 mm	-6.3 mm

Access

Open the selectable list for **Target** in **Measure & Target Settings**.

Targets

Targets		
Name	Leica constant	Abs constant
Leica 360° Prism	23.1mm	-11.3mm
Leica HDS Target	34.4mm	0.0mm
Leica Mini 0	0.0mm	-34.4mm
Leica Mini 360°	30.0mm	-4.4mm
Leica Mini Prism	17.5mm	-16.9mm
Leica Reflective Tape	34.4mm	0.0mm
Leica Round Prism	0.0mm	-34.4mm
Reflectorless	34.4mm	0.0mm

Hz: -:----g V: -:----g abc 10:10

OK | New.. | Edit.. | Delete | More

Key	Description
OK	To select the highlighted target and to return to the previous screen.
New..	To define a new target. Refer to "12.1.3 Creating/Editing a Target".
Edit..	To edit the highlighted target. It is not possible to edit default targets. Refer to "12.1.3 Creating/Editing a Target".
Delete	To delete the highlighted target. It is not possible to delete default targets.
More	To display information about the additive constant, the target type and the creator of the target.
Fn Default	To recall previously deleted default targets and to reset default targets to the default settings. User-defined targets are not affected.
Fn Quit	To exit the screen.

12.1.3 Creating/Editing a Target

Access

In **Targets**, highlight a target. All constants are copied from this target. Press **New..** or **Edit..**

New Target

New Target	
Name:	<input type="text" value="123"/>
Type:	<input type="text" value="Prism"/>
Leica constant:	<input type="text" value="0.0"/> mm
Absolute constant:	<input type="text" value="-34.4"/> mm
Creator:	<input type="text" value="-----"/>



Hz: -:----g V: -:----g abc 10:11

Store

Key	Description
Store	To store the target.
Fn Quit	To exit the screen.

Description of fields

Field	Option	Description
Name	Editable field	A significant name for the new target.

Field	Option	Description
Type	Prism, Tape or Undefined	The type of target to be defined.
Leica constant	Editable field	The additive constant as stored for the selected prism in the SmartWorx Viva software.  An additive constant of 0.0 mm has been defined for the Leica Geosystems standard targets GPR1, GPR111, etc. All entered or selected additive constant values are differences to this 0.0 mm based Leica Geosystems TPS prism system.
Absolute constant	Editable field	The true additive constant. The additive constant is always in mm.  The additive constants of non-Leica Geosystems prisms are often given in the true zero prism system. Use the following formula to convert the additive constant to the Leica Geosystems TPS prism system. This Leica constant must be entered into the Leica instrument. Formula: True zero constant - 34.4 mm = Leica constant. It is highly recommended to check the additive constant for non-Leica Geosystems prisms on a baseline with an appropriate procedure.
Creator	Editable field	A name of the creator or other comments can be entered.

12.2

Prism search settings

Description

The settings on this screen define

- the size of search windows for prisms to be searched in. The prisms can be searched with PowerSearch in the **PowerSearch window** or with ATR in the **Fine search window**.
- the behaviour of automatic prism search after the target is lost in lock mode.

Access

Select **Main Menu: Instrument\TPS settings\Prism search settings**.

Prism Search Settings, Target prediction page

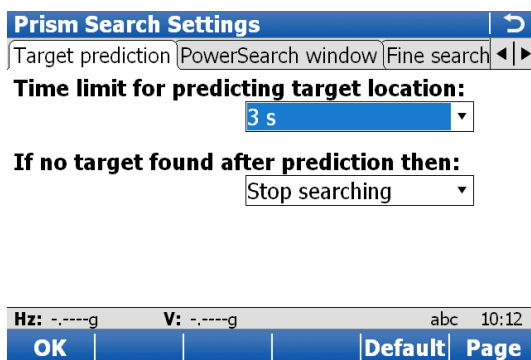

Prism Search Settings

Target prediction | PowerSearch window | Fine search

Time limit for predicting target location:
3 s

If no target found after prediction then:
Stop searching

Hz: ----- V: ----- abc 10:12

OK | Default | Page

Key	Description
OK	To accept changes and return to Main Menu .
Default	To recall the default settings.
Page	To change to another page on this screen.
Fn Quit	To exit the screen.

Description of fields

Field	Option	Description
Time limit for predicting target location	From 1 s to 5 s	If the target is lost when Target aiming: Lock the path of the prism is predicted for the selected number of seconds.
If no target found after prediction then	Stop searching	Perform no search after prediction.
	Start fine search	Perform search after prediction with ATR in a dynamic Fine search window .
	Start PowerSearch	Perform search after prediction with PowerSearch. Activate PowerSearch on the PowerSearch window page.
	Turn to last msd pt	If the target is lost when Target aiming: Lock , then the instrument turns back to the last stored point. The field of view is disabled while the instrument is repositioning.

Next step

Page changes to the **PowerSearch window** page.

Prism Search Settings, PowerSearch window page

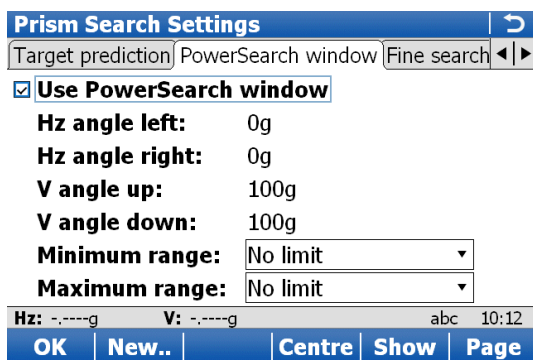

Key	Description
OK	To accept changes and return to Main Menu .
New..	To define new PowerSearch window.
Centre	To centre the PowerSearch window to the current position of the telescope.
Show	To position the telescope to corners of PowerSearch window.
Page	To change to another page on this screen.
Fn Quit	To exit the screen.

Description of fields

Field	Option	Description
Use PowerSearch window	Check box	If checked, PowerSearch searches in the defined window.
Hz angle left, Hz angle right, V angle up and V angle down	Display only	The left, right, upper and lower boundaries of the PowerSearch window.
Minimum range	No limit and from 25 m to 175 m	Minimum distance of the search range for the PS window to be defined.
Maximum range	From 25 m to 175 m and No limit	Maximum distance of the search range for the PS window to be defined.

Next step

Page changes to the **Fine search window** page.

Prism Search Settings, Fine search window page

Key	Description
OK	To accept changes and return to Main Menu .
Default	To recall the default settings.
Page	To change to another page on this screen.
Fn Quit	To exit the screen.

Description of fields

Field	Option	Description
Width of Hz search	Editable field	Horizontal extent of window.
Height of V search	Editable field	Vertical extent of window.

Next step

Page changes to another page on this screen.

Description

The settings on this screen define the atmospheric ppm and the refraction. For standard applications, the distance is corrected due to atmospheric influences. The geometrical correction and the projection distortions are set to 0.00. Heights are reduced with the standard refraction coefficient. Refer to the TS11 User Manual, the TS15 User Manual, the Leica TS12 Lite User Manual and the MS50/TS50/TM50 User Manual for information on calculations.

Access

Select **Main Menu: Instrument\TPS settings\Atmospheric corrections.**

Atmospheric Corrections, Atmospheric ppm page

The atmospheric distance corrections are derived from the dry air temperature, air pressure or elevation above mean sea level MSL, and the relative air humidity or wet bulb temperature.

The screenshot shows the 'Atmospheric Corrections' screen with the following fields:

- Atmospheric ppm:** 0.0
- Refraction:** (field is empty)
- Temperature:** 12.0 °C
- Pressure:** 1013.3 mbar
- Humidity:** 60.000 %

The bottom navigation bar contains the following elements:

- Hz: -.-g V: -.-g abc 10:13
- OK button
- Page button

Key	Description
OK	To accept changes and return to Main Menu .
Page	To change to another page on this screen.
Fn P<>E	To change Pressure to Elev above MSL and back.
Fn %<>T'	To change Humidity to Temp wet-bulb and back.
Fn ppm=0	To set Atmospheric ppm: 0.0 .
Fn Quit	To exit the screen.

Description of fields

Field	Option	Description
Temperature	Editable field	Sets the temperature.
Pressure or Elev above MSL	Editable field	Sets the atmospheric pressure or the elevation above mean sea level dependent on selection.
Humidity or Temp wet-bulb	Editable field	Sets the relative air humidity or the wet bulb temperature dependent on selection.
Atmospheric ppm	Editable field or display only	The atmospheric ppm is either set or calculated from the values in the previous fields.

Next step

Page changes to the **Refraction** page.

**Atmospheric Corrections,
Refraction page**

The refraction correction is taken into account during the calculation of the height difference.

Key	Description
OK	To accept changes and return to Main Menu .
Default	To recall the default settings.
Page	To change to another page on this screen.
Fn Quit	To exit the screen.

Description of fields

Field	Option	Description
Use refraction coefficient correction	Check box	If checked, refraction correction is applied to measurements.
Coefficient (k)	Editable field	Refraction coefficient to be used for calculation.

Next step

Page changes to another page.

Description

If raw data is to be displayed and recorded, the compensator and the horizontal correction can be deactivated.

 The graphical level bubble is displayed correctly for the situation when the first screen is aligned with two foot screws.

Access

Select **Main Menu: Instrument\TPS settings\Level bubble & compensator**.
OR

Tap  / .

Level Bubble & Compensator

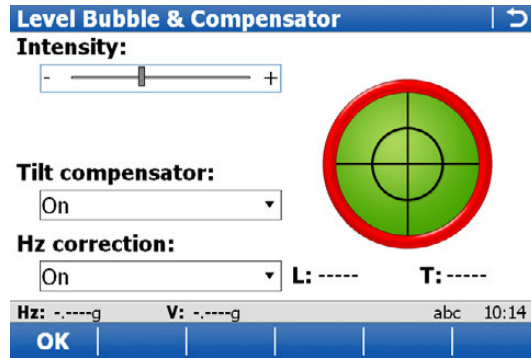

Key	Description
OK	To accept changes and return to Main Menu .
Fn Quit	To exit the screen.

Description of fields

Field	Option	Description
Intensity	Scroll bar	To adjust the intensity of the laser plummet.
Tilt compensator	On	Vertical angles are relative to plumb line. The horizontal angle is corrected for the transversal tilt errors if Hz correction: On .
	Off	Vertical angles are relative to vertical/standing axis.
	Always off	The mode stays always deactivated.
Hz correction	On	The horizontal angles are corrected for the line of sight, tilting axis and if Tilt compensator: On transversal tilt errors.
	Off	Horizontal angles are not corrected.
	Always off	The mode stays always deactivated.

Description

Quality control

The instrument can be configured to monitor sequentially stored measurements and to notify the user if the coordinates lie within a defined range of each other.

If configured, the X,Y coordinates of a point being stored can be compared to the coordinates of the last previously stored point. If the difference is less than the defined position tolerance then a warning is shown. It can now be decided whether to store the point or not.

If configured, backsight target points and resection target points which were measured during the setup procedure are then also checked in this manner.

Offsets

The offset values are applied to measured points. The Offset function allows offset points to be determined, for instance when the reflector cannot be set up directly on a point. Transverse, longitudinal and/or elevation offsets can be defined from the reflector position to the offset point. All of the displayed and recorded measurement data is in relation to the offset point.

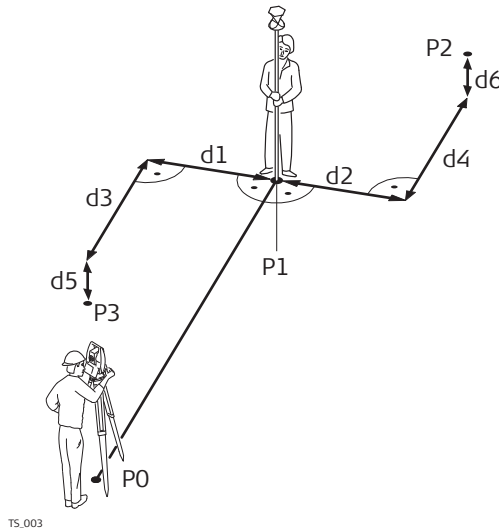

- P0 Station
- P1 Current position
- P2 Offset point
- P3 Offset point
- d1 Offset cross left
- d2 Offset cross right
- d3 Offset length towards instrument
- d4 Offset length away from instrument
- d5 Offset height down
- d6 Offset height up

Access

Select **Main Menu: Instrument\TPS settings\Offsets & Quality Control.**

Offsets & Quality Control, Target QC page

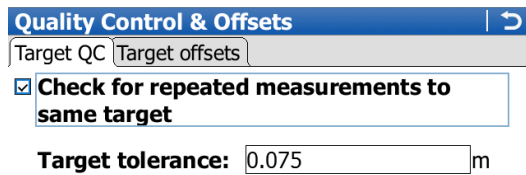

Key	Description
OK	To accept changes and return to Main Menu.
Page	To change to another page on this screen.
Fn Quit	To exit the screen.

Description of fields

Field	Option	Description
Check for repeated measurements to same target	Check box	If checked, target checking is activated.
Target tolerance	Editable field	The position tolerance. The units are defined by User\System settings\Regional settings .

Next step

Page changes to the **Target offsets** page.



If configured in a survey screen page, the offset values appear also in the survey screen page in Survey.

Offsets & Quality Control, Target offsets page

Quality Control & Offsets | ↻

Target QC Target offsets

Offset mode: Reset after storing ▾

Offset left/right: 0.000 m

Offset in/out: 0.000 m

Offset height: 0.000 m

Hz: -----g V: -----g Fn abc 15:18

OK | Offst=0 | Page

Key	Description
OK	To accept changes and return to Main Menu .
Offst=0	To set all offsets to 0.000.
Page	To change to another page on this screen.
Fn Quit	To exit the screen.

Description of fields

Field	Option	Description
Offset mode	Reset after storing	The offset values are reset to 0.000 after a point is measured with Store or Meas .
	Permanent	The offset values are applied to every measured point until reset or changed.
Offset left/right	Editable field	Sets cross offset of target point, perpendicular to the line of sight.
Offset in/out	Editable field	Sets length offset of target point, in the direction of the line of sight.
Offset height	Editable field	Sets height offset of target point.

Next step

Page changes to another page.

Description

The settings on this screen allow the lights on the instrument to be configured. For motorised instruments (TS15, TS12 Lite), the horizontal/vertical boundaries of a search window can be defined.

Access

For manual TPS instruments:
 Select **Main Menu: Instrument\TPS settings\Lights**.

For motorised TPS instruments:
 Select **Main Menu: Instrument\TPS settings\Lights & accessories**.

Instrument Lights

This screen is available for TPS instruments or TS11.

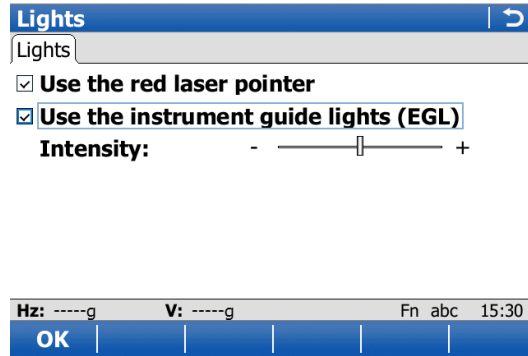

Key	Description
OK	To accept changes and return to Main Menu .
Fn Quit	To exit the screen.

Description of fields

Field	Option	Description
Use the red laser pointer	Check box	If checked, the red laser of the reflectorless EDM is turned on.
Use the instrument guide lights (EGL)	Check box	If checked, the Emitting Guide Light (EGL) is turned on. This field is only available if EGL is fitted.
Intensity	From 0 % to 100 %	To adjust the EGL/Laser Guide intensity using the left and right arrow keys.
Use the reticule light	Check box	If checked, the reticule illumination is turned on.
Intensity	From 0 % to 100 %	To adjust the reticule illumination intensity using the left and right arrow keys.

**Lights & Accessories,
Lights page**

This screen is available for motorised instruments.

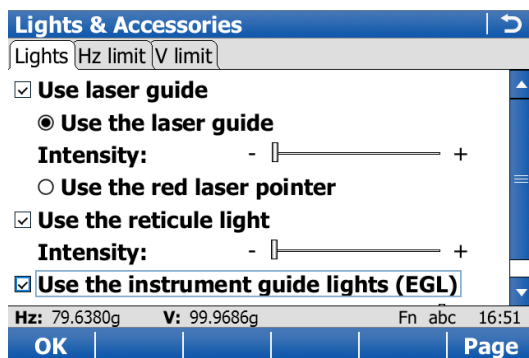

Key	Description
OK	To accept changes and return to Main Menu .
Page	To change to another page on this screen.
Fn Quit	To exit the screen.

Description of fields

Field	Option	Description
Use laser guide	Check box	When this box is checked, either the GUS74 or the red laser guide can be activated.
Use the laser guide	Check box	Available if the instrument has a GUS74. If checked, the GUS74 is turned on.
Intensity	From 0 % to 100 %	To adjust the GUS74 intensity using the left and right arrow keys.
Use the red laser pointer	Check box	If checked, the red laser of the reflectorless EDM is turned on.
Use the reticule light	Check box	If checked, the reticule illumination is turned on.
Intensity	From 0 % to 100 %	To adjust the reticule illumination intensity using the left and right arrow keys.
Use the instrument guide lights (EGL)	Check box	If checked, the Emitting Guide Light (EGL) is turned on. This field is only available if EGL is fitted.
Intensity	From 0 % to 100 %	To adjust the EGL/Laser Guide intensity using the left and right arrow keys.

Next step

Page changes to the **Hz limit** page.

**Lights & Accessories,
Hz limit page**

This screen is available for motorised instruments.

Key	Description
OK	To accept changes and return to Main Menu .
New..	To define new search window. Follow the instructions on the screen.
Show	To position the telescope to corners of the search window.
Page	To change to another page on this screen.
Fn Quit	To exit the screen.

Description of fields

Field	Option	Description
Limit Hz movement of instrument	Check box	When this box is checked, horizontal boundaries for the search window can be defined.
Hz begin and Hz end	Editable field	The boundaries of the search window as horizontal angles where the search begins/ends.

Next step

Page changes to the **V limit** page.

Lights & Accessories, V limit page

This screen is available for motorised instruments.

Key	Description
OK	To accept changes and return to Main Menu .
New..	To define new search window. Follow the instructions on the screen.
Show	To position the telescope to corners of the search window.
Page	To change to another page on this screen.
Fn Quit	To exit the screen.

Description of fields

Field	Option	Description
Limit V movement of instrument	Check box	When this box is checked, vertical boundaries for the search window can be defined.
Limit movement for	Selectable list	Limits can be set for eyepiece and/or lens.
V begin and V end	Editable field	The boundaries of the search window as vertical angles where the search begins/ends. For eyepiece and lens.

Lights & Accessories, Battery & charging page

This screen is available for MS50/TS50/TM50 on the CS when is connected to a MS50/TS50/TM50.

Key	Description
OK	To accept changes and return to Main Menu .
Fn Quit	To exit the screen.

Description of fields

Field	Option	Description
Main power source	Internal battery	Determines the power source to be used when internal and external battery are attached at the same time. Select this setting if an internal battery and an external power source are attached but the internal battery must be used first.

Field	Option	Description
	External power	Select this setting if: <ul style="list-style-type: none"> • an internal battery is attached but an external battery will be attached later. Then the external power source will be used as power source. • an external power source and an internal battery is attached but the external power source must be used.
Charge the internal battery when external power is connected	Check box	The internal battery is charged from the external power source, if attached.

13

Instrument - GPS settings GPS

13.1

RTK rover wizard

13.1.1

Overview

Description

Using this wizard, the settings for a real-time rover behaviour are defined at one glance. These settings are stored in an RTK profile.

Access

Select **Main Menu: Instrument\GPS settings\RTK rover wizard**.



If RTK profiles exist, the wizard starts with the screen shown in this section. Otherwise, the wizard starts the process of creating a new RTK profile. In this case refer to "13.1.2 Creating a New RTK Profile".

RTK rover wizard

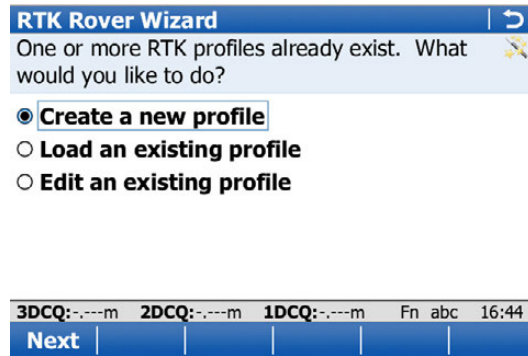

Key	Description
Next	To accept changes and to continue with the subsequent screen within the wizard.
Fn Quit	To exit the wizard.

Next step

IF you want to	THEN
create a new set of settings	select Create a new profile , press Next and continue with "13.1.2 Creating a New RTK Profile".
select a different set of settings	select Load an existing profile , press Next and continue with "13.1.3 Loading an Existing RTK Profile".
edit an existing set of settings	select Edit an existing profile , press Next and continue with "13.1.4 Editing an Existing RTK Profile".

13.1.2

Creating a New RTK Profile

RTK rover wizard,
Enter a name for the
new RTK profile.

Type in the name and a description for the new set of settings.

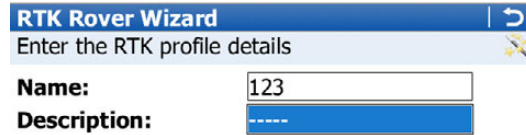

Key	Description
Next	To accept changes and to continue with the subsequent screen within the wizard.
Back	To return to the previous screen.
Fn Quit	To exit the wizard.

13.1.3

Loading an Existing RTK Profile

RTK rover wizard,
Choose an RTK
profile.

Select an existing RTK profile from the selectable list. Listed are profiles that match the instrument in use.



Key	Description
Next	To accept changes and to continue with the subsequent screen within the wizard.
Delete	Pressing this key deletes the RTK profile currently shown in the selectable list.
Back	To return to the previous screen.
Fn Quit	To exit the wizard.

13.1.4

Editing an Existing RTK Profile

RTK rover wizard, Choose an RTK profile.

Select the RTK profile to be edited from the selectable list. Listed are profiles that match the instrument in use.

Key	Description
Next	To accept changes and to continue with the subsequent screen within the wizard.
Delete	Pressing this key deletes the RTK profile currently shown in the selectable list.
Back	To return to the previous screen.
Fn Quit	To exit the wizard.

Description of fields

Field	Option	Description
Create a copy	Check box	Creates a copy before the editing process starts.

13.2

Satellite tracking GPS

Description

The settings on this screen define which satellite system, satellites and satellite signals are used by the instrument.

Access

Select **Main Menu: Instrument\GPS settings\Satellite tracking.**

Satellite Tracking Settings, Tracking page

Key	Description
OK	To accept changes.
Page	To change to another page on this screen.

Key	Description
Fn Quit	To exit the screen.

Description of fields

Field	Option	Description
GPS L5	Check box	Defines if the GPS L5 signal will be tracked.
Glonass	Check box	Defines if GLONASS satellite signals are accepted by the instrument when tracking satellites.
Galileo	Check box	Defines if Galileo satellite signals are accepted by the instrument when tracking satellites.
BeiDou	Check box	Defines if BeiDou satellite signals are accepted by the instrument when tracking satellites.
Show message & audio warning, when loss of lock occurs	Check box	Activates an acoustic warning signal and a message given by the instrument when satellites are lost.

Next step

Page changes to the **Advanced** page.

Satellite Tracking Settings, Advanced page

Key	Description
OK	To accept changes.
Hlth..	Available for Satellite health: User defined . To configure the satellites used in the survey.
Page	To change to another page on this screen.
Fn Quit	To exit the screen.

Description of fields

Field	Option	Description
Cut-off angle	Editable field	Sets the elevation in degrees below which satellite signals are not recorded and are not shown to be tracked. Recommended settings: <ul style="list-style-type: none"> For real-time: 10°. For purely post-processing applications: 15°.

Field	Option	Description
DOP limit	None, GDOP, HDOP, PDOP or VDOP	If activated, the limit defined in Limiting value is checked. GPS positions are unavailable when the limit is exceeded.
Limiting value	Editable field	The maximum acceptable DOP value. Available unless DOP limit: None .
L2C tracking	Automatic Always track	L2 signals which are flagged as unhealthy are not recorded or used for real-time computations. L2C signals are always tracked.
Satellite health	Automatic User defined	Sets the satellite tracking behaviour.  This setting is remembered when the instrument is turned off. It is stored as part of the configuration set. Incoming satellite signals are monitored by the instrument. Data from signals which are flagged as unhealthy is not recorded or used for real-time computations. Satellites must manually be included/excluded from data recording and real-time computations with Hlth...

Next step

Hlth.. changes to **Satellite Health**.

Satellite Health

This screen consists of the **GPS** page, **Glonass** page and the **Galileo** page. The explanations given for the softkeys are valid for all pages.

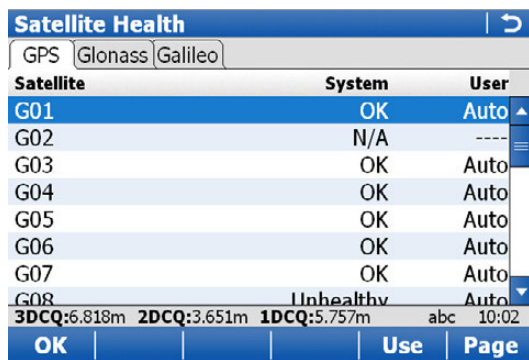

Satellite Health		
GPS	Glonass	Galileo
Satellite	System	User
G01	OK	Auto
G02	N/A	----
G03	OK	Auto
G04	OK	Auto
G05	OK	Auto
G06	OK	Auto
G07	OK	Auto
G08	Unhealthy	Auto
3DCQ:6.818m 2DCQ:3.651m 1DCQ:5.757m abc 10:02		
OK		Use Page

Key	Description
OK	To accept changes and return to the screen from where this screen was accessed.
Use	To change between the options in the column User .
Page	To change to another page on this screen.
Fn Quit	To exit the screen.

Description of columns

Column	Option	Description
Satellite	01 to 32	The Pseudo Random Noise number (GPS, 1 to 32), the Slot ID (GLONASS, 1 to 24) or the Space Vehicle number (Galileo, 1 to 30) of the satellites. There is a prefix G for GPS satellites, a prefix R for GLONASS satellites and a prefix E for Galileo satellites.
System RAM	OK, N/A or Unhealthy	Information on the satellite health taken from the almanac. N/A stands for not available.
User	Bad OK Auto	Excludes satellite from tracking. Includes satellite in tracking. Automatic satellite tracking when satellite is healthy.

Next steps

Step	Description
1.	Page changes to the Glonass page and to the Galileo page, where GLONASS satellites and Galileo satellites used in the survey can be configured.
2.	OK returns to Satellite Tracking .
3.	OK returns to Main Menu .

13.3

13.3.1

Antenna heights GPS

Rover Antenna Heights

Access

Select **Main Menu: Instrument\GPS settings\Antenna heights**.

Rover Antenna Heights

This screen consists of two pages:

- If a GS10/GS15/GS08plus/GS14 is selected, then no pages are available.
- If a GS05/GS06 is selected, then two page tabs are available - **Internal** and **External**. The internal settings are used when an external (connected by cable) antenna is NOT used. The external settings are used when an external (connected by cable) antenna is used.

Key	Description
OK	To return to the Main Menu .
Fn Quit	To exit the screen.

Description of fields for the External page

Field	Option	Description
Rover antenna	Selectable list	Leica Geosystems antennas are predefined as default and can be selected from the list. Default antennas contain an elevation-dependent correction model. New antenna correction models can be set up and transferred to the instrument using LGO. Open the list to define or edit additional antennas. Refer to "14 Antenna Heights".
Vertical offset	Display only	The vertical antenna offset for the selected antenna.
Antenna height when measuring points	Editable field	Sets the default antenna height for the current working style. This height is then also the default antenna height during the use of applications. The antenna height can still be changed during a survey. The initial value depends on the selected antenna. Unavailable for SmartStation. The height is added in the Setup and GPS Survey application.
Use offset for moving antenna	Check box	When unchecked, the moving antenna height is considered the same as the default antenna height.
Offset	Editable field	When the check box Use offset for moving antenna is checked: Sets the default antenna height for auto points and for the moving part of a track when logging raw observations.

13.3.2

Antennas

Description

Listed are antennas in the instrument's internal memory.

Access

Open the selectable list for **Rover antenna** in **Rover Antenna Heights**.

Antennas

Antennas	
Name	Creator
ADVNULLANTENNA	Default
AR25 LEIT	Default
AR25 Pillar	Default
AR25 Tripod	Default
AS05 Pillar	Default
AS05 Pole	Default
AS05 Tripod	Default
AS10 Pillar	Default
AS10 Pole	Default

3DCQ:6.834m 2DCQ:3.665m 1DCQ:5.768m abc 10:03

OK | New.. | Edit.. | Delete

Key	Description
OK	To select the highlighted antenna and to return to the previous screen.
New..	To define a new antenna. Refer to "13.3.3 Creating/Editing an Antenna".

Key	Description
Edit..	To edit the highlighted antenna. It is not possible to edit default antennas. Refer to "13.3.3 Creating/Editing an Antenna".
Delete	To delete the highlighted antenna. It is not possible to delete default antennas.
Fn Default	To recall previously deleted default antennas and to reset default antennas to the default settings. User-defined antennas are not affected.
Fn Quit	To exit the screen.

13.3.3

Creating/Editing an Antenna

Access

In **Antennas**, highlight an antenna. All offsets are copied from this antenna. Press **New..** or **Edit..**

New Antenna or Edit Antenna, General page

Key	Description
Store	To store the antenna.
Clear	To set the editable fields to 0. Available on the Parameters and the Advanced page.
Page	To change to another page on this screen.
Fn Quit	To exit the screen.

Description of fields

Field	Option	Description
Name	Editable field	A unique name for the new antenna.
Hz offset	Editable field	Horizontal offset of measurement reference point.
Vertical offset	Editable field	Vertical offset of measurement reference point.
L1 phase offset	Editable field	Offset of L1 phase centre.
L2 phase offset	Editable field	Offset of L2 phase centre.
Copy additional corrections	Check box	Allows additional corrections to be copied from the antenna which was highlighted before this screen was accessed.

Next step

Page changes to the **IGS** page.

New Antenna or Edit Antenna, IGS page

The combination of values typed in here provides a unique standardised ID for the antenna being used.

Description of fields

Field	Option	Description
IGS name	Editable field	The International GPS/GNSS Service name of the antenna.
Serial number	Editable field	The serial number of the antenna.
Setup number	Editable field	The setup number of the antenna. Identifies the version number of the current calibration.

Next step

Store stores the new antenna.

13.4

Quality control

Description

The settings on this screen define the limits for coordinate quality accepted for point occupations.

Access

Select **Main Menu: Instrument\GPS settings\Quality control**.

Quality Control, General page

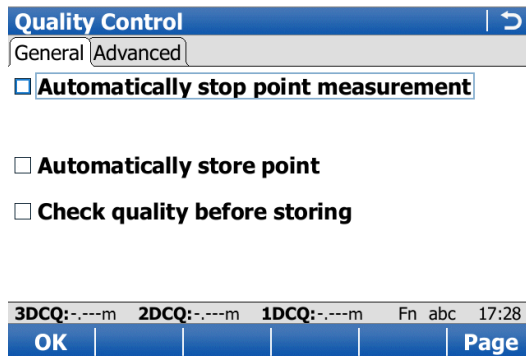

Key	Description
OK	To accept changes.
Param..	To configure the time interval after which a point occupation can be stopped automatically.
Page	To change to another page on this screen.
Fn Quit	To exit the screen.

Description of fields

Field	Option	Description
Automatically stop point measurement	Check box	Activates a selectable list for the stop criteria. Stops the measurements automatically when the parameter defined for Stop criteria reaches 100 %.

Field	Option	Description
Stop criteria		Defines the method used for Automatically stop point measurement . The setting determines the computation and value to be shown in the survey screen mask and in the status screen. Parameters for the selected method are defined with Param...
	Accuracy or Positions	Available when working with real-time device. Records observations between pressing Meas and Stop . Recommended for normal real-time applications. Refer to the diagram below.
	Instantaneous	Records the time tag when Meas is pressed. A coordinate is interpolated between the positions at the neighbouring two epochs to filter out effects of slight movement. Recommended when measuring positions of objects while the antenna is moving very fast. Example: Measuring the position of lampposts by driving in a car along the road and pressing Meas when the car is next to the lamppost. Refer to the diagram below.
	Stop & go indicator	Available when raw data logging is configured. The occupation time is based on a user defined baseline length, the number of satellites and the GDOP.
	Time, Observations or Number of satellites	Available when working without real-time device and when raw data are recorded for post-processing.
Automatically store point	Check box	Stores points automatically after stopping the point occupation. If Automatically stop point measurement and Automatically store point are checked, then points are recorded by pressing one button.
Check quality before storing	Check box	If activated, the limit defined in Tolerance is checked before storing a point. A warning signal is given when the limit is exceeded.
Check	Position only, Height only or Position & height	The type of coordinate quality to be checked before storing a point.
Tolerance	Editable field	The maximum acceptable coordinate quality.

Stop criteria: Accuracy or Positions

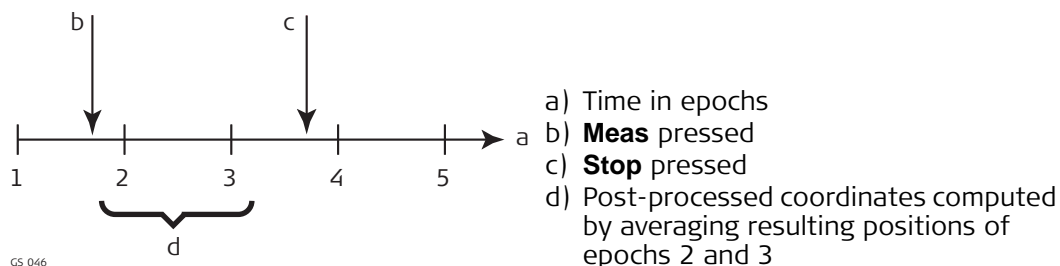

Stop criteria: Immediately

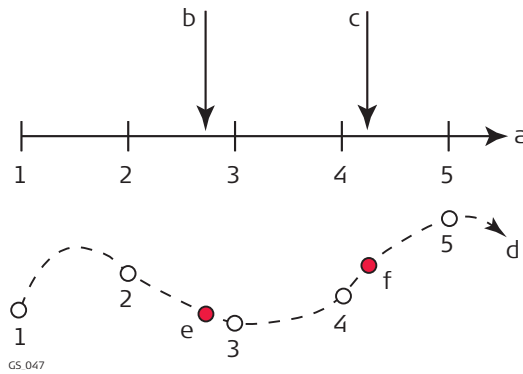

- a) Time in epochs
- b) **Meas** pressed and point coordinates interpolated based on epochs 2 and 3
- c) **Meas** pressed and point coordinates interpolated based on epochs 4 and 5
- d) Plan view
- e) **Meas** pressed and point coordinates interpolated based on epochs 2 and 3
- f) **Meas** pressed and point coordinates interpolated based on epochs 4 and 5

Next step

IF parameters for Stop criteria	THEN
are not to be configured	Page changes to the Advanced page.
are to be configured	Param.. changes to Parameters for Auto Stop or Real-Time Stop Criteria .

Quality Control, Advanced page

Description of fields

Field	Option	Description
Automatically start measuring point on entering survey	No	Starts point occupation when pressing Meas .
	Yes	Starts point occupation automatically when entering the survey screen. All subsequent points must be occupied by pressing Meas .
	Timed	Starts point occupation automatically at a certain time.

Next step

OK closes the screen.

Parameters for Auto Stop

The parameters shown on this screen depend on the setting for **Stop criteria**.

Parameters for Auto Stop | >

Enter the values to be used to automatically stop the point occupation:

Number of obs: 5
At logging rate: 1.00 s

3DCQ:--m 2DCQ:--m 1DCQ:--m Fn abc 15:48
OK | | | | |

Key	Description
OK	To accept changes.

Description of fields

Field	Option	Description
Time at point	Editable fields	Sets the required observation time for each point. Counting time starts when Meas is pressed. The instrument stops measuring when the set length of time is reached.
Number of obs	Editable fields	Sets the required number of observations that are to be recorded at each point. Counting observations starts when Meas is pressed. The instrument stops measuring when the set number of observations is reached.
At logging rate	Display only	Displays the rate at which static raw observations are logged as configured.
8+ satellites for, 7 satellites for, 6 satellites for, 5 satellites for and 4 satellites for	Editable field	Sets the required observation time depending on the number of satellites available. Counting time starts when Meas is pressed. The instrument stops measuring when the set length of time for a certain number of satellites is reached. Should the number of available satellites change during observation, the observations already recorded will be taken into account.
Baseline length	Selectable list	Used for the calculation of the occupation time for Stop criteria: Stop & go .
Extend occupation time by factor of	From 1.0 to 5.0	The factor extends the point occupation time recommended by SmartWorx Viva. It directly influences the occupation time shown in Time at point on the Survey screen.

Next step

Step	Description
1.	OK closes the screen.
2.	OK returns to the screen from where Parameters for Auto Stop was accessed.

Observation time depending on the number of satellites available

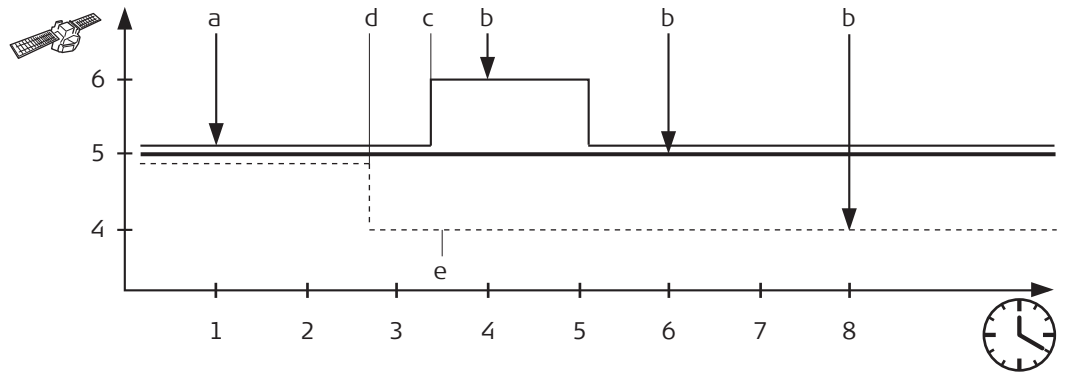

GS 048

- a) **Meas** is pressed. Counting time starts.
- b) Observation is stopped.
- c) 40 % for six satellites.
- d) 30 % for five satellites.
- e) 30 % for four satellites.

Thin line represents **6 satellites for: 3 min.**
 Bold line represents **5 satellites for: 5 min.**
 Dashed line represents **4 satellites for: 7 min.**

Real-Time Stop Criteria

The parameters shown on this screen depend on the setting for **Stop criteria**.

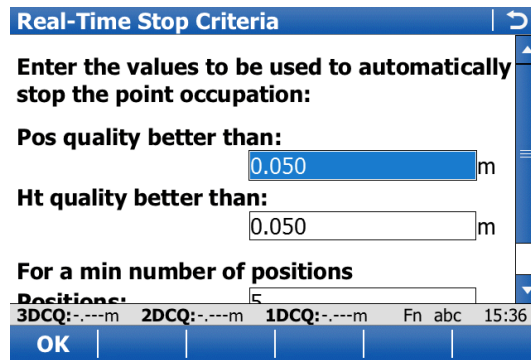

Key	Description
OK	To accept changes.
Fn Quit	To exit the screen.

Description of fields

Field	Option	Description
Pos quality better than and Ht quality better than	Editable field	Sets the maximum position and height qualities for each point occupation. Calculating the qualities starts when Meas is pressed. The instrument stops measuring when the position and height qualities are both less than the configured values.
Positions	Editable field	Raw data is logged for a minimum number of positions even when the Pos quality better than and Ht quality better than is already less than the specified maximum.

Field	Option	Description
Position update	Display only	Displays the value for GPS position update rate as configured in Instrument\Instrument status info: Position .
No. of positions	Editable field	Sets the number the positions which must be observed before the instrument stops measuring. Counting the number of positions starts when Meas is pressed.

Next step

OK closes the screen.

13.5

Raw data logging

Description

Logged raw observations are used for

- static and kinematic operations. With these operations, raw data is always post-processed in the office. Raw data must therefore be logged on both base and rover instruments.
- real-time operations
 - to check the work in the office by post-processing.

OR

to fill in gaps when a real-time position could not be calculated in the field, for example, due to problems with the real-time data reception from the reference station or the RTK network provider

Observations must be logged on all instruments which will be used for post-processing.

The settings on this screen define the logging of raw observations.

Access

- The licence for raw data logging is required to log GNSS raw data on the GS, CS or TS instrument.
- The licence for RINEX logging is required to log RINEX data on the GS or CS. RINEX data cannot be logged on the TS11/TS15/TS12 Lite.

The licence key can only be loaded from an SD card using the Webserver or myWorld@Leica Geosystems.

Select **Main Menu: Instrument\GPS settings\Raw data logging**.

Raw data logging settings

Raw Data Logging Settings | ↩

Log data for post-processing

Log data to: GS sensor ▼

Logging starts: Only within survey ▼

Log data when: Static ▼

Rate: 0.5s ▼

Data type: Leica format (MDB) ▼

3DCQ:7.017m 2DCQ:3.807m 1DCQ:5.895m abc 10:09

OK

Key	Description
OK	To accept changes.
Fn Quit	To exit the screen.

Description of fields

Field	Option	Description
Log data for post-processing	Check box	Activates raw data logging.
Log data to	Controller or GS sensor Controller TS instrument or GS sensor	For GS10/GS14/GS15/GS25, data can either be logged to the field controller or to the GS. For GS05/GS06/GS08plus/GS12 data can only be logged to the field controller. For SmartStation, data can either be logged to the TS11/TS15 or to the GS14/GS15.
Logging starts	Selectable list	Available for GS10/GS14/GS15/GS25 with Log data to: GS sensor . Data logging can start as soon as the instrument is turned on or only while in the Survey application. For GS05/GS06/GS08plus/GS12 data can only be logged with the Survey application.
Log data when	Static Static & kinematic Kinematic	Raw observation logging during static intervals when occupying a point. The instrument has to be stationary. For SmartStation, this is the only option available. Raw observation logging during static and moving intervals. For post-processed kinematic rover operations. Unavailable for SmartStation. Raw observation logging during moving intervals. For post-processed kinematic antenna operations. Unavailable for SmartStation.
Rate	From 0.05s to 300.0s	Rate at which raw observations are logged. For GS05/GS06/GS08plus/GS12 logging rates of 0.2s and slower are supported. Recommendations: <ul style="list-style-type: none"> • The maximum logging rate using Bluetooth on the field controller is 0.2 s. • For static operations with long baselines and over long time Rate: 15.0s or Rate: 30.0s. • For base stations for post-processed and real-time kinematic rovers, Rate at the base should be the same rate as at the rover. • For initialisation while static and occupying distinct points in kinematic chains Rate between 0.1s and 2.0s.
Data type	Selectable list	Unavailable for SmartStation. Available for Log data to: GS sensor . Data can be logged in the Leica proprietary MDB format or in RINEX. For GS05/GS06/GS08plus/GS12, this field is available for Log data when: Static .

Description

The height of the GNSS antenna above a point consists of three components:

- the vertical or slope height reading,
- the vertical offset,
- the vertical phase centre variations.

For most operations, pre-configured standard settings in the instrument can be used. They automatically take the vertical phase centre variations into account.

Vertical or slope height

Only vertical antenna heights measured to the **Mechanical Reference Plane** are accepted.

Measurements required

This table is an overview of required measurements depending on antennas, setup and accessories. All former Leica antenna types are supported.

IF the antenna is	AND the accessories are	AND the setup is	THEN the measurements required are
Leica antenna, for example GS15	standard Leica	tripod or tripod short	vertical height from height hook
Leica antenna, for example GS15	standard Leica	pole	none. Value is 2.00 m as indicated on the pole
Leica antenna, for example GS15	standard Leica	pillar	vertical height to the MRP.
Leica antenna, for example GS15	non-Leica	any	<ul style="list-style-type: none"> • vertical height to the MRP. • possibly vertical offset.
non-Leica antenna	standard Leica OR non-Leica	any	<ul style="list-style-type: none"> • vertical height to the MRP. • possibly vertical offset. • phase centre variations. • horizontal offset if a slope height reading.

Vertical phase centre variations

For Leica antennas:

Are handled automatically in the standard antenna records.

For non-Leica antennas:

Can be stored in a newly created antenna record.
OR
Antenna records including azimuth and elevation-dependent corrections must be created using LGO or imported using the ANTEX format.

The antenna calibrations to determine the phase centre variations of all Leica antennas were executed by Geo++® GmbH.

14.2

Mechanical Reference Planes, MRP

General

The **Mechanical Reference Plane**

- is where the antenna heights are measured to.
- is where the phase centre variations refer to.
- varies for different antennas.

GS15

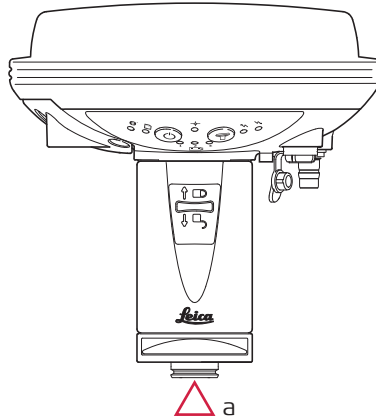

GS_031

a) The mechanical reference plane is the underside of the threaded metal insert.

GS08plus/GS12/ GS14

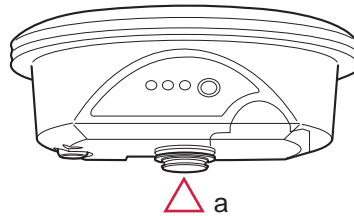

GS_127

a) The mechanical reference plane is the underside of the thread.

AS05/AS10

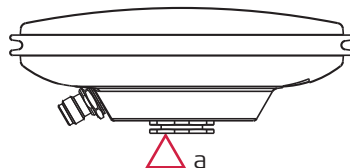

GS_032

a) The mechanical reference plane is the underside of the threaded metal insert.

14.3
14.3.1

Determining Antenna Heights
Pillar Setup



- One of the Leica standard antennas is used, for example GS15. All former Leica antenna types are supported.
- Leica standard accessories are used.

Pillar setup

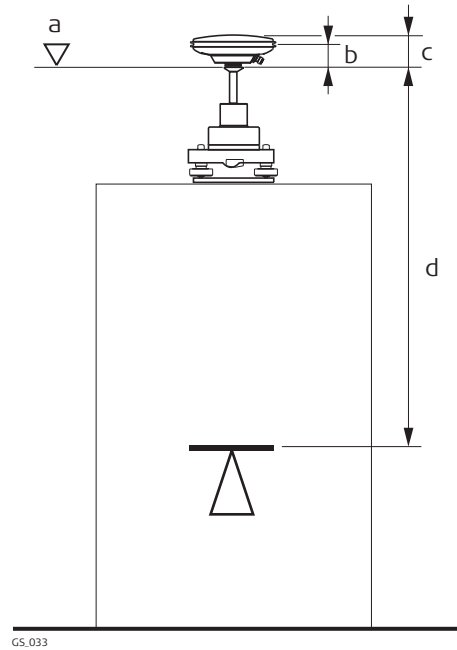

- a) Mechanical reference plane
- b) Vertical phase centre offset for L1
- c) Vertical phase centre offset for L2
- d) Vertical height reading

Vertical offset = 0

Vertical height reading

The vertical height reading is the height difference between the pillar benchmark and the mechanical reference plane of the antenna. Normally, it is determined indirectly by levelling.

Determine the antenna height step-by-step

Sometimes, it is difficult to measure to the MRP directly.

Step	Description
1.	Determine the height difference between the pillar benchmark and a surface on the carrier.
2.	Look up the height difference between this surface on the carrier and where the MRP of the antenna sits on the carrier.
3.	Add the values determined in step 1. and 2., to get the vertical height reading.
4.	For Leica standard antennas plus accessories, the vertical offset is 0.00 m.

Carrier and adapter dimensions

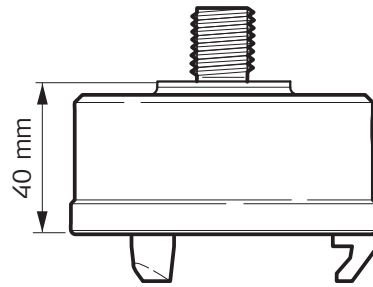

GS.038

GRT247 carrier, preferred for GS15 - **Tripod Short** setup

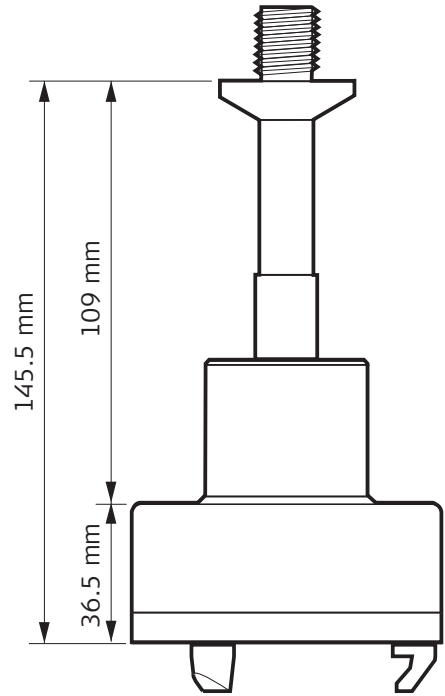

GS.036

GRT146 carrier - **Tripod** setup

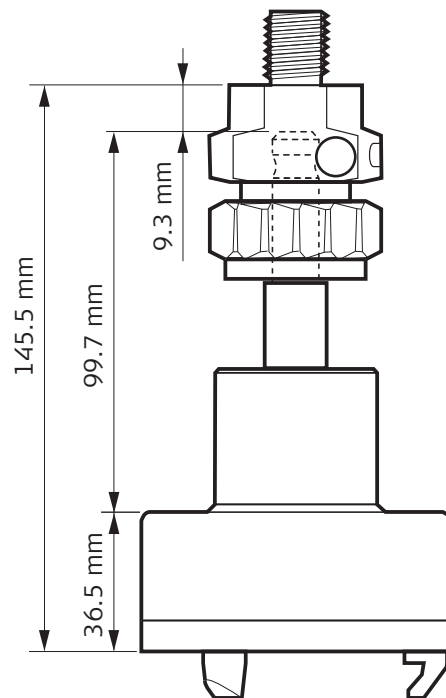

GS.037

GRT144 carrier with GAD31 screw-to-stub adapter - **Tripod** setup

Next step

- At the beginning of a survey, enter the vertical height reading into the instrument.
- The vertical offset of 0.00 m is stored in the antenna setup record for a pillar setup and will automatically be taken into account.
- Refer to **Overview** for the vertical phase centre variations.



For carriers other than those carriers shown in the diagram above, the dimensions must be determined.



Except for Leica standard antennas plus accessories, the vertical offset must be measured. This value must be entered in the antenna setup record.

14.3.2

Tripod Setup



- One of the Leica standard antennas is used, for example GS15. All former Leica antenna types are supported.
- Leica standard accessories are used.

Tripod setup

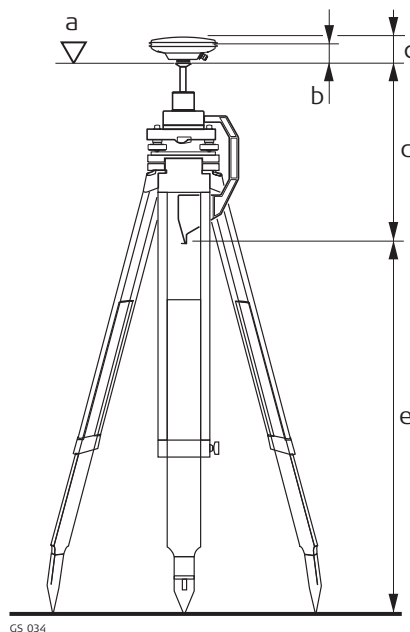

- a) Mechanical reference plane
- b) Vertical phase centre offset for L1
- c) Vertical phase centre offset for L2
- d) Vertical offset
- e) Vertical height reading

Vertical height reading

The vertical height reading is the height difference between the ground mark and the bottom end of the height hook. It is determined using the height hook.

Determine the antenna height step-by-step

Step	Description
1.	Determine the vertical height reading using the height hook.
2.	For Leica standard antennas plus accessories, the vertical offset is 0.36 m for a Tripod setup and 0.2545 m for a Tripod Short setup.

Next step

- Determine the antenna type.
- At the beginning of a survey, enter the vertical height reading into the instrument.
- The vertical offset is stored in the antenna setup record for all tripod setups and will automatically be taken into account. It does not need to be entered.
- Refer to **Overview** for the vertical phase centre variations.



For other than the carriers shown in the diagram above, the dimensions must be determined, the vertical offset must be adapted and entered into a new antenna record.



For other height measurement devices than the height hook, the dimensions must be determined and the vertical offset must be adapted.



For other than Leica standard antennas, the vertical offset must be measured. It must be entered in the antenna setup record.

14.3.3

Pole Setup



- One of the Leica standard antennas is used, for example GS15. All former Leica antenna types are supported.
- Leica standard accessories are used.

Pole setup

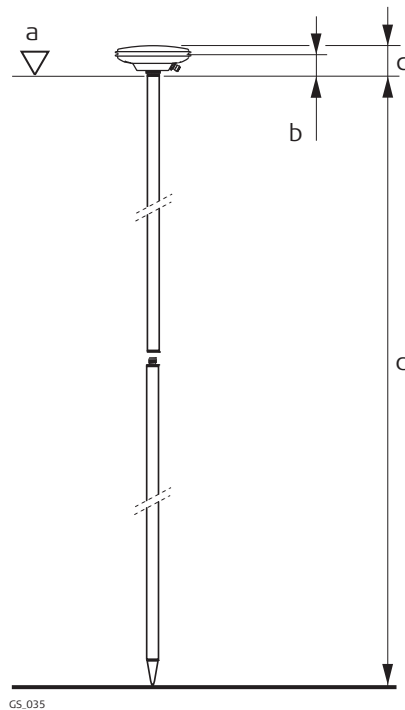

- a) Mechanical reference plane
- b) Vertical phase centre offset for L1
- c) Vertical phase centre offset for L2
- d) Vertical height reading, 2.00 m for the fully extended Leica telescopic pole.

Vertical offset = 0

Vertical height reading

The vertical height reading is the height difference between the bottom end and the top end of the pole. Usually, this height difference is a fixed value.

Next step

- At the beginning of a survey, enter the vertical height reading into the instrument. A standard rover configuration with a standard antenna setup record for a pole setup uses the value of 2.00 m already as default.
- The vertical offset of 0.00 m is stored in the antenna setup record for a pole setup and will automatically be taken into account. It does not need to be entered.
- Refer to **Overview** for the vertical phase centre variations.



For other than the Leica standard poles, the dimensions must be determined.



For other than Leica standard antennas, the vertical offset must be measured. It must be entered in the antenna setup record.



- For a SmartStation setup, select the SmartStation antenna in use. This configuration depends on both the used GS and the used TS instrument. The configuration will ensure the correct vertical offset is applied to the antenna heights.
- For a SmartStation setup, the antenna height value in the GPS survey screen must equal the value for **Instrument height**. **Instrument height** is seen in the preceding **Set Station Point**.
- Leica standard accessories are used.

SmartStation setup

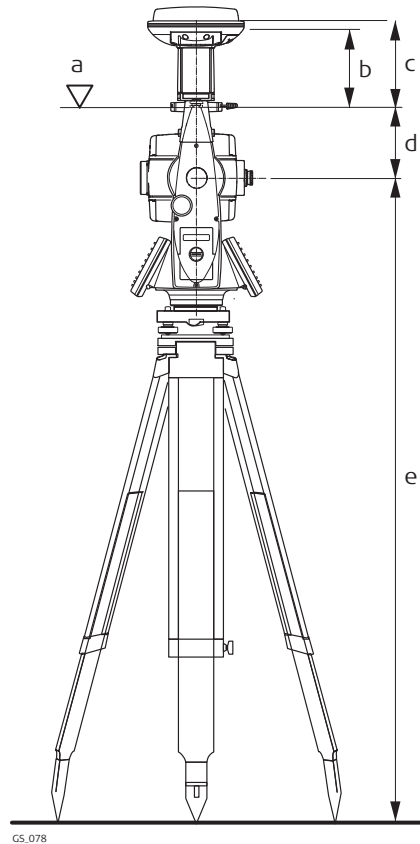

- a) Mechanical reference plane
- b) Vertical phase centre offset for L1
- c) Vertical phase centre offset for L2
- d) Vertical offset
- e) Instrument height reading

15

Connections.. - GPS connection wizard GPS

15.1

Starting the GPS Connection Wizard

Description

This chapter explains how the field controller can be connected with a GNSS antenna using a wizard.

Access

Select **Main Menu: Instrument\Connections..\GPS connection wizard.**

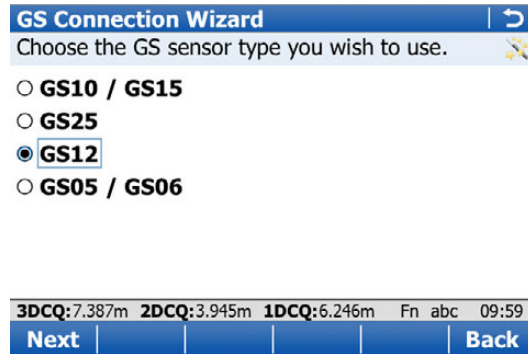
GS Connection Wizard - Step 1

Key	Description
Next	To confirm the settings and to continue to the next screen.
Back	To return to the previous screen.
Fn Quit	To exit the screen.

Next step

IF connecting a	THEN
GS10/GS15/GS08plus/ GS12/GS25	refer to "15.2 Connection to GS10/GS15/GS08plus/GS12/GS25".
GS05/GS06	follow the instruction on the screen.

GS Connection Wizard - Step 2

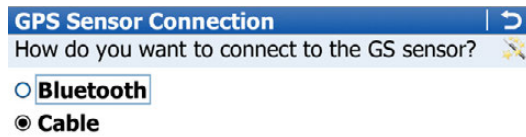

Key	Description
Next	To confirm the settings and to continue to the next screen.
Back	To return to the previous screen.
Fn Quit	To exit the screen.

Next step

Next changes to the next screen.

IF	THEN
connected via cable	follow the instructions on the screen.
connected via Bluetooth	the screen shown depends on whether a Bluetooth GPS connection has previously been configured or not.

GS Connection Wizard - Step 3

This screen is displayed if a Bluetooth connection has previously been configured.

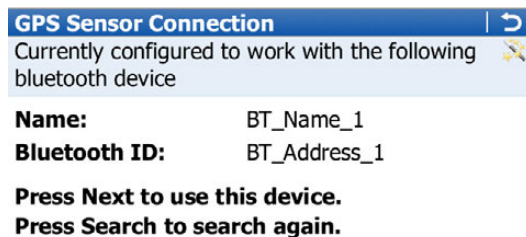

Key	Description
Next	To confirm the settings and to continue to the next screen.
Search	To search for a different GPS instrument.
Back	To return to the previous screen.
Fn Quit	To exit the screen.

Next step

Follow the instructions on the screen.

GS Connection Wizard - Step 3

This screen is displayed if a NO Bluetooth connection has previously been configured. Move the focus using the arrow keys or the stylus to select a Bluetooth device.

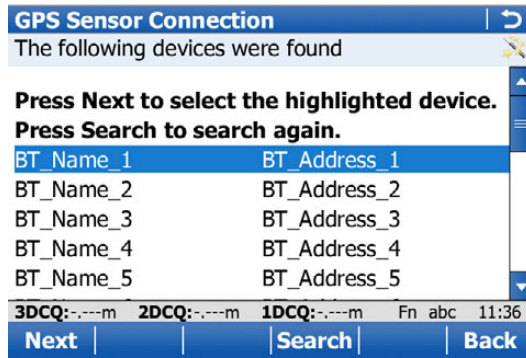

Key	Description
Next	To connect to the selected device and continue to the next screen.
Search	To search for a different total station.
Back	To return to the previous screen.
Fn Quit	To exit the screen.

Next step

Follow the instructions on the screen.

Description

This chapter explains how the field controller can be connected with a total station using a wizard.

Access

Select **Main Menu: Instrument\Connections..\TPS connection wizard**.

TPS Connection Wizard - Step 1

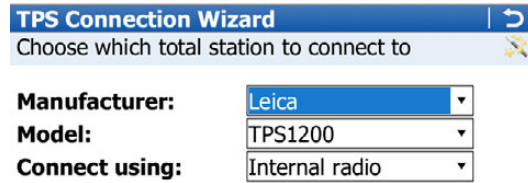

Key	Description
Next	To confirm the settings and to continue to the next screen.
Back	To return to the previous screen.
Fn Quit	To exit the screen.

Description of fields

Field	Option	Description
Manufacturer	Selectable list	The brand of the instrument.
Model	Selectable list	The instrument model. The Leica models TC1000 and TC1100 are not supported.
Connect using	Cable, Bluetooth or Internal radio Radio cap (CTR16)	How the instrument is connected. The options available depend on the selection for Model . The CTR16 can be only used on the CS15. To connect a CS15 to a TS with RH16 or TCPS29 attached. Offline configuration is possible if a Bluetooth address is known.

Next step

Next changes to the next screen.

IF	THEN
connected via cable	refer to Connection Using Cable .
connected via Bluetooth	refer to Connection Using Bluetooth .
connected via internal radio	refer to Connection Using Internal Radio .
connected via CTR16	refer to "16.3 Connection Using Bluetooth".

16.2

Connection Using Cable

Description

The connection settings must be specified.

TPS Connection Wizard - Step 2

TPS Connection Wizard | ↻

Connect cable to total station. Ensure same settings are made on the total station.

Baud rate: 115200 ▾

Parity: None ▾

Data bits: 8 ▾

Stop bit: 1 ▾

Flow control: None ▾

Hz: " " V: " " abc 14:52

Next | Default | Back

Key	Description
Next	To confirm the settings and to continue to the next screen.
Default	To return the fields back to their default values.
Back	To return to the previous screen.
Fn Quit	To exit the screen.

Description of fields

Field	Option	Description
Baud rate	From 1200 to 115200	Frequency of data transfer from instrument to device in bits per second.
Parity	None, Even or Odd	Error checksum at the end of a block of digital data.
Data bits	6, 7 or 8	Number of bits in a block of digital data.
Stop bit	1 or 2	Number of bits at the end of a block of digital data.
Flow control	None or RTS/CTS	Activates hardware handshake. When the instrument/device is ready for data, it asserts the Ready To Send line indicating it is ready to receive data. This line is read by the sender at the Clear To Send input, indicating it is clear to send the data.

Next step

Next and follow the instructions on the screen.

16.3

Connection Using Bluetooth

Description

The screen shown depends on whether a last used Bluetooth ID is available for the chosen instrument model.

TPS Connection Wizard - Step 2

This screen is displayed if the chosen instrument model has a previously used Bluetooth ID already stored.

For a CTR16 connection, the last total station which was connected via RH16 or TCPS29 and CTR16 is displayed.

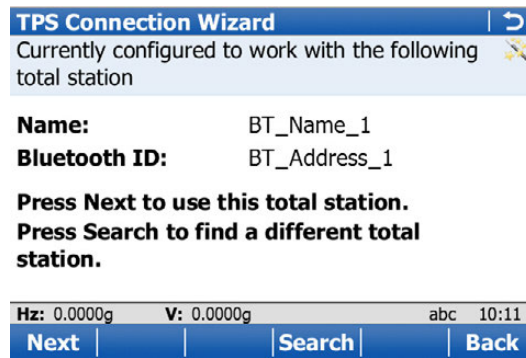

Key	Description
Next	To confirm the settings and to continue to the next screen.
Search	To search for a different total station. For a CTR16 connection also: To check if the radio used for the connection was changed.
Back	To return to the previous screen.
Fn Quit	To exit the screen.

Next step

Follow the instructions on the screen.

Total Station Connection - Step 2

This screen is displayed if the chosen instrument model has NO previous used Bluetooth ID already stored.

Move the focus using the arrow keys or the stylus to select a Bluetooth device.

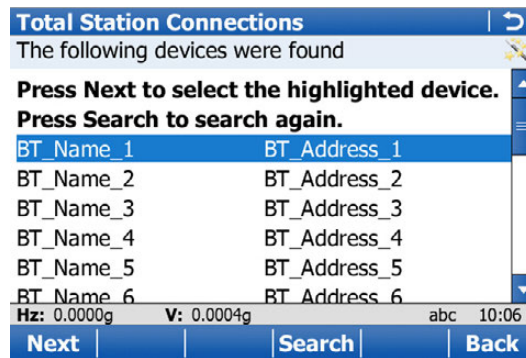

Key	Description
Next	To connect to the selected device and continue to the next screen.
Search	To search for a different total station.
Back	To return to the previous screen.
Fn Quit	To exit the screen.

Next step

Follow the instructions on the screen.

TPS Connection Wizard - Step 2

Description of fields

Field	Option	Description
Link number	Editable field	The assigned channel number.
Set as	Remote or Base	 The radio modules inside the field controller and the TPS instrument must be set to opposite settings. It is recommended to set the field controller to Remote and TPS instrument to Base .

Next step

Next and follow the instructions on the screen.



Once you begin working with the CS always work on the controller! Do not touch the total station software, excluding turning the laser pointer, laser plummet or guide lights on/off for some models.



Refer to "34.7 Connection to Other Total Stations" for supported functions.

Settings required

Before using any Leica Legacy or third party total station, please ensure that the following values are set **on the** TPS:

Instrument	Settings
Leica Legacy total station	<ol style="list-style-type: none"> Total station ppm/scale: <ul style="list-style-type: none"> Atmospheric ppm = 0 Geometric ppm = 0 or scale factor = 1 These settings ensure that the correct coordinates are calculated at the CS. It is still possible to apply the relevant atmospheric and geometric ppm/scale factor values. These values must then be set on the CS. Communication settings: <ul style="list-style-type: none"> The communication settings on the TPS must match the default parameters for that particular instrument type as seen on the CS. For TPS1000, TPS2000 and TPS1100 instruments: <ul style="list-style-type: none"> set the communication mode to GSI ensure the TPS is in the measurement screen when trying to connect.
Third party total station - Topcon	<ol style="list-style-type: none"> Total station ppm/scale: <ul style="list-style-type: none"> Atmospheric ppm = 0 Geometric ppm = 0 or scale factor = 1 Prism constant = 0 (non-motorised instruments only) The vertical angle on the total station must be set to zenith for all Topcon instruments. The angular unit on both the total station and controller must match These settings ensure that the correct coordinates are calculated at the CS. It is still possible to apply the relevant atmospheric and geometric ppm/scale factor values. These values must then be set on the CS.

Instrument	Settings
	<p>2. Communication settings:</p> <ul style="list-style-type: none"> The communication settings on the TPS must match the default parameters for that particular instrument type as seen on the CS. On motorised Topcon total stations, for example GTS800 and above, set the communication values through Prog\Ext. Link\Setting\RS232. For non-motorised instruments ensure that the total station is in the survey measurement screen when trying to connect. <p>3. External Link mode</p> <ul style="list-style-type: none"> To connect to motorised Topcon total stations, for example GTS800 and above, set the external link mode through Prog\Ext. Link\Execute. <p>4. Required cable:</p> <ul style="list-style-type: none"> TDS DB9 Data Cable (148 SCGTSSOKTOP – Topcon/Sokkia)
Third party total station - Sokkia	<p>1. Total station ppm/scale:</p> <ul style="list-style-type: none"> Atmospheric ppm = 0 Geometric ppm = 0 or scale factor = 1 Prism constant = 0 The vertical angle display setting must be the same on the CS and the total station <p>These settings ensure that the correct coordinates are calculated at the CS. It is still possible to apply the relevant atmospheric and geometric ppm/scale factor values. These values must then be set on the CS.</p> <p>2. Units:</p> <ul style="list-style-type: none"> For a Set 030R/220/010 instrument, the angle unit at the total station must be set to degrees, minutes, seconds. The angle setting at the CS does not matter. <p>3. Communication settings:</p> <ul style="list-style-type: none"> The communication settings on the TPS must match the default parameters for that particular instrument type as seen on the CS. For all Sokkia instruments ensure the TPS is in the measurement screen when trying to connect. On motorised Sokkia total stations, set additional total station communication values: Comms mode: RS232C, Checksum: No and Controller: 2 Way + Remote For the Sokkia SRX set Tilt correction: No to have an uninterrupted connection. On the total station go to Settings\Obs. Condition\Tilt crn: No. <p>4. Required cable:</p> <ul style="list-style-type: none"> TDS DB9 Data Cable (148 SCGTSSOKTOP – Topcon/Sokkia)

Instrument	Settings
Third party total station - Nikon	<p>1. Total station ppm/scale:</p> <ul style="list-style-type: none"> • Atmospheric ppm = 0 • Geometric ppm = 0 or scale factor = 1 • Prism constant = 0 • The angular unit on both the total station and controller must match <p>These settings ensure that the correct coordinates are calculated at the CS. It is still possible to apply the relevant atmospheric and geometric ppm/scale factor values. These values must then be set on the CS.</p> <p>2. Communication settings:</p> <ul style="list-style-type: none"> • The communication settings on the TPS must match the default parameters for that particular instrument type as seen on the CS. • For all Nikon instruments ensure the TPS is in the measurement screen when trying to connect. <p>3. Required cable:</p> <ul style="list-style-type: none"> • TDS DB9 Data Cable (148 CNTG Nikon)

Description

This chapter explains how to configure a total station for remote controlled from the CS.

Access

Select **Main Menu: Instrument\Connections..\CS connection wizard.**

**CS Connection Wizard,
Which software is running on the field controller?**

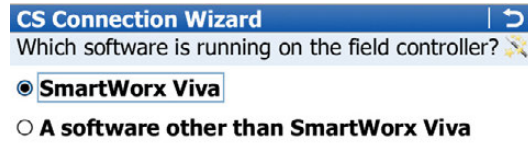

Key	Description
Next	To confirm the settings and to continue to the next screen.
Back	To return to the previous screen.
Fn Quit	To exit the wizard.

Next step

Independent of the selection made, **Next** changes to a screen where the connection type must be selected.

**CS Connection Wizard,
How do you want to connect to the field controller?**

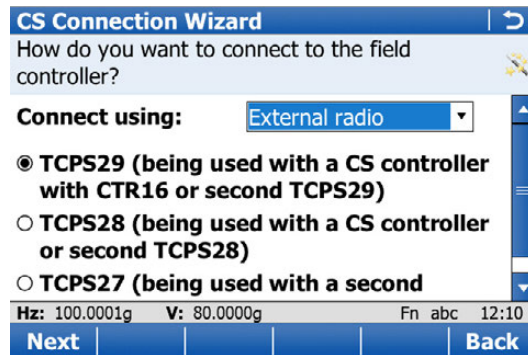

Key	Description
Next	To confirm the settings and to continue to the next screen.
Back	To return to the previous screen.
Fn Quit	To exit the wizard.

Description of fields

Field	Option	Description
Connect using	Radio handle, Bluetooth or External radio	How the instrument is connected. When External radio is selected, choose the type of External radio in use.
	Cable	For TS11/TS15: Serial cable connection. For MS50/TS50/TM50: USB cable connection. Select Cable for a USB cable connection. Use the cables GEV234 (Lemo - USB), GEV237 (Lemo - Lemo) or GEV261 (combined RS232/USB cable).
	Cable RS232	Available on MS50/TS50/TM50 to configure serial connection.
	WLAN	Available when A software other than SmartWorx Viva is checked in the previous screen. Requires configurations in WinCE.

Next step

Next changes to the next screen.

IF	THEN
connected via Radio-Handle	Next changes to the next screen. The RadioHandle is detected automatically, if it is plugged onto the TS. The name of the RadioHandle is then displayed. If the RadioHandle is not plugged onto the TS, then select the RadioHandle which will be used. Press Next .  The RH16 can only be connected to a CS15 equipped with a CTR16.
connected via TCPS27/TCPS28	Select the TCPS connected and press Next . Refer to "17.2 Connection Using TCPS".
connected via TCPS29	Select the TCPS connected. Further configurations are not required.
connected via cable	refer to "17.3 Connection Using Cable".
a MS50/TS50/TM50 is connected via cable and SmartWorx Viva is running on the field controller	the systems sets all the parameters to be able to connect to a CS via USB interface from port 1.
a MS50/TS50/TM50 is connected via cable and a software other than SmartWorx Viva is running on the field controller	<ul style="list-style-type: none"> for a serial connection refer to "17.3 Connection Using Cable". for a USB connection, the systems sets all the parameters to be able to connect to a CS via USB interface from port 1.
connected via Bluetooth	Next changes to the next screen. The Bluetooth connection is established automatically. Press Finish .
connected via WLAN	enabled and configure WLAN within WinCE. Next changes to the next screen. Press Finish .

TPS Radio Communication



This screen is valid for TCPS27 and TCPS28.

The channel on which the TCPS broadcasts can be changed. Changing channels changes the frequency at which the TCPS operates. This may be necessary to enable multiple pairs of TCPS to work simultaneously in the same area without interfering with each other.

TPS Radio Communication
↩

Radio type: TCPS

Link number:

Set as: Base ▼

Hz: 250.0000g
V: 340.0002g
Fn abc 15:03

OK
Default
Back

Key	Description
OK	To confirm the settings and to continue to the next screen.
Default	To return the fields back to their default values.
Back	To return to the previous screen.
Fn Quit	To exit the screen.

Description of fields

Field	Option	Description
Radio type	Display only	The type of protocol.
Link number	Editable field	The assigned channel number.
Set as	Remote or Base	The TCPS inside the field controller and the TS11/TS15 must be set to opposite settings. It is recommended to set the field controller to Remote and TS11/TS15 to Base .

Next step

OK and follow the instructions on the screen.

CS Connection Wizard - Connect the cable between the total station & CS. Ensure same settings are made on the CS.

Valid for TS11/TS15.

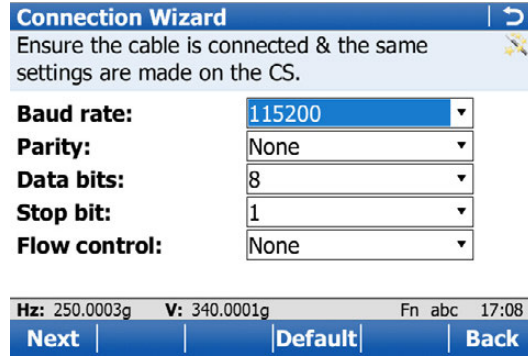

Key	Description
Next	To confirm the settings and to continue to the next screen.
Default	To return the fields back to their default values.
Back	To return to the previous screen.
Fn Quit	To exit the screen.

Description of fields

Field	Option	Description
Baud rate	From 1200 to 115200	Frequency of data transfer from instrument to device in bits per second.
Parity	None, Even or Odd	Error checksum at the end of a block of digital data.
Data bits	6, 7 or 8	Number of bits in a block of digital data.
Stop bit	1 or 2	Number of bits at the end of a block of digital data.
Flow control	None or RTS/CTS	Activates hardware handshake. When the instrument/device is ready for data, it asserts the Ready To Send line indicating it is ready to receive data. This line is read by the sender at the Clear To Send input, indicating it is clear to send the data.

Next step

Next and follow the instructions on the screen.

Description

This chapter explains how the field controller can be connected to the Internet using a wizard and without using RTK.

Access

Select **Main Menu: Instrument\Connections..\Internet wizard.**

The screen displayed varies.

IF	AND	THEN
the Internet wizard is started for the first time	a CS is used	the Internet device can be connected to the <ul style="list-style-type: none"> • Internal 3.5G modem • Bluetooth mobile phone
	a TS11/TS15/TS12 Lite/MS50/TS50/TM50 is used	the Internet device can be connected to a Bluetooth phone of type <ul style="list-style-type: none"> • GSM/GPRS/UMTS device • CDMA device
the Internet connection is configured	not connected	<ul style="list-style-type: none"> • the Internet connection can be edited. • the connection can be started.
the Internet connection is configured	connected	<ul style="list-style-type: none"> • the Internet connection can be edited. • the connection can be stopped.

Next step

Make a selection, press **Next** and follow the instructions on the screen.

Description

The instrument has various connections which can be configured to be used with different ports and devices. The configuration varies depending on the individual application.

Access

For RTK rover, TPS, TS11/TS15 and MS50/TS50/TM50:

- Select **Main Menu: Instrument\Connections..\All other connections.**

For RTK base:

- Select **Main Menu: Base connections\Connections..\All other connections.**

Connection Settings

The screen gives an overview of all connections with the currently assigned port and device.

For an RTK rover, this screen consists of the **CS connections** and the **GS connections** or **TS connections** page.

For a GS05/GS06/GS08plus/GS12, this screen consists of only one page.

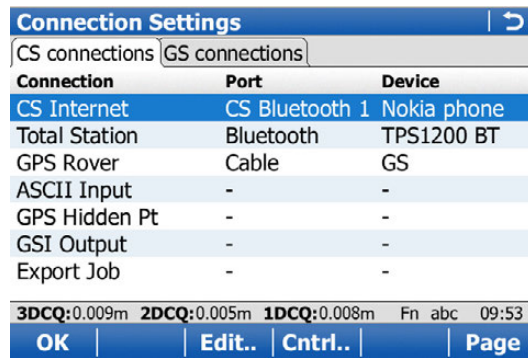

Key	Description
OK	To return to the screen from where this screen was accessed.
Edit..	To configure the parameters related to the highlighted connection. Refer to the sections on each individual connection in this chapter.
Cntrl..	Available for certain devices connected to certain connections. To configure additional parameters related to the highlighted device. For MS50/TS50/TM50: Available when the GeoCom connection is set to Cable (USB) and WLAN . To show the IP and the port for third party connections.
Fn Conect and Fn Disco	Available for a real-time connection configured to use an Internet connection. To connect/disconnect from the GPS reference data.

Description

The Internet connection

- allows accessing the Internet using the field controller (CS internal GSM) or the instrument plus a GPRS device.
- can be used together with the real-time connection to receive real-time data from, for example, an Ntrip Caster via Internet communication.

Refer to "36 NTRIP via Internet" for information about Ntrip.

The settings on this screen define the port and parameters required for accessing the Internet.

Access

For RTK rover:

- In **Connection Settings, CS connections** page, highlight **CS Internet. Edit...**
- In **Connection Settings, GS connections** page, highlight **GS Internet. Edit...**

For RTK base:

- In **Base Connection Settings**, select **GS Internet. Edit...**

For TPS:

- In **Connection Settings**, highlight **CS Internet. Edit...**

For TS11/TS15/TS12 Lite:

- In **Connection Settings**, highlight **TS Internet. Edit...**

Internet Connection, Internet page

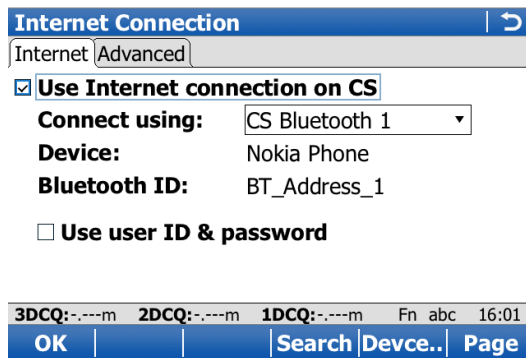

Key	Description
OK	To accept changes and return to the screen from where this screen was accessed.
Search	To search for all available Bluetooth devices. If more than one Bluetooth device is found a list of available devices is provided. Available if CS Bluetooth 1 or CS Bluetooth 2 are selected.
Devce..	To create, select, edit or delete a device. Refer to "21.2 Accessing Devices / GPRS Internet Devices". Available if the Internet connection is activated. For Connect using: CS 3.5G modem , a special screen opens to edit the CS 3.5G modem settings. Refer to "21.3 Creating/Editing a Device".
Page	To change to another page on this screen. Available if the Internet connection is activated.
Fn Quit	To exit the screen.

Description of fields

Field	Option	Description
Use Internet connection on CS, Use Internet connection on GS or Use Internet connection on TS	Check box	Activates the Internet connection.
Connect using	CS 3.5G modem CS RS232 port CS Bluetooth 1 and CS Bluetooth 2 CS 3.5G modem GS Port 1 GS Port 2 GS Port 3 TS Bluetooth 1 and TS Bluetooth 2	<p>The ports available for connection to the Internet.</p> <p>The internal GSM modem of the field controller.</p> <p>The RS232 port on the field controller.</p> <p>The Bluetooth ports on the field controller which will be used for the connection functionality.</p> <p>For GS10: The physical port P1 on the box. For GS15: The red LEMO port.</p> <p>For GS10: The physical port P2 on the box. For GS15: The black LEMO port.</p> <p>For GS10: The physical port P3 on the box. For GS15: The port for the slot devices.</p> <p>The Bluetooth ports on the TS11/TS15/TS12 Lite which will be used for the connection functionality.</p>
Device	Display only	The name of the selected device.
Use user ID & password for Internet connection	Check box	If checked, a user ID and a password can be typed in.
User ID	Editable field	Some providers ask for a user ID to allow connecting to the Internet via GPRS. Contact your provider if a user ID must be used. It is possible to show/hide the User ID.
Password	Editable field	Some providers ask for a password to allow connecting to the Internet via GPRS. Contact your provider if a password is required.

Next step

Page changes to the **Advanced** page.

Internet Connection, Advanced page

Description of fields

Field	Option	Description
Use static IP address	Check box	In order to get access to the Internet, an IP address is required. This IP address identifies the instrument in the Internet. This option should only be checked if a static IP address is available for the instrument.

Field	Option	Description
		The IP address to get access to the Internet is provided by the network provider permanently. Each time the instrument wants to access the Internet via the device the same IP address identifies the instrument. This behaviour is important if the instrument is used as a TCP/IP server.
IP address	Editable field	Available if Use static IP address is checked. To set the IP address.

Next step

OK returns to the screen from where **Internet Connection** was accessed.

19.3

GPS Rover / Base Sensor GPS

Description

To connect the field controller to the sensor (antenna) either on the base or on the rover side.

Access

For RTK rover:

- In **Connection Settings, CS connections** page, highlight **GPS Rover. Edit...**
- Select **Instrument\Connections..\GPS connection wizard.**

For RTK base:

- In **Base Connection Settings**, select **Base Sensor. Edit...**
- Select **Instrument\Base connections\Connect to base sensor.**

GPS Rover Connection / Connect to Base Sensor

GPS Connection | ↶

Sensor: GS10/15 sensor ▼

Connection using: Cable ▼

3DCQ:--m 2DCQ:--m 1DCQ:--m Fn abc 14:52

OK

Key	Description
OK	To accept changes and return to the screen from where this screen was accessed. When changing the sensor type, SmartWorx Viva must be shutdown and re-started before the sensor can be used.
Search	To search for all available Bluetooth devices. If more than one Bluetooth device is found a list of available devices is provided. Available for GS10/GS15/GS08plus/GS12/GS14/GS25 with Connection using: Use Bluetooth.
Fn Quit	To exit the screen.

Description of fields

Field	Option	Description
Sensor	Selectable list	Select the attached model.  GS08plus is only available if SmartWorx Viva LT is used on a CS10.
Connect using	Cable or Blue-tooth	How the instrument is connected. The options available depend on the selection for Sensor . The availability of the other fields depends on the selection made here.
Last used rover	Display only	For GS10/GS15/GS08plus/GS12/GS14/GS25: Available for RTK rover. The name of the selected Bluetooth device.
Last used base	Display only	For GS10/GS15/GS08plus/GS12/GS14/GS25: Available for RTK base. The name of the selected Bluetooth device.
Bluetooth ID	Display only	For GS10/GS15/GS08plus/GS12/GS14/GS25: The ID of the selected Bluetooth device.

19.4

ASCII Input

19.4.1

Configuration of an ASCII Input Connection

Description

The ASCII Input connection receives ASCII messages from third-party devices such as depth sounders, barometers, digital cameras, pipe detectors, Geiger counters, etc. The ASCII messages are stored as annotations together with the next manually measured point and/or auto point.

The settings on this screen define the port and the device to be used and the type of ASCII messages to be written to individual annotations.

Access

For RTK rover:

- In **Connection Settings, CS connections** page, highlight **ASCII Input. Edit...**

For TPS:

- In **Connection Settings**, highlight **ASCII Input. Edit...**

ASCII Input, ASCII input page

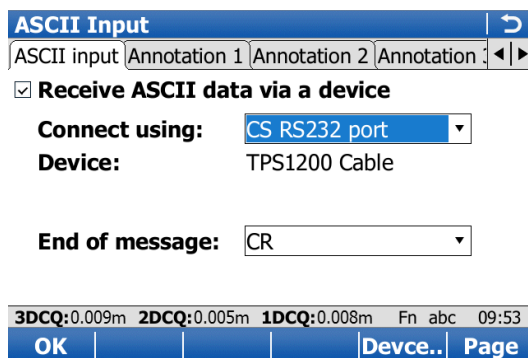

Key	Description
OK	To accept changes and return to the screen from where this screen was accessed.

Key	Description
Devce..	Available when Receive ASCII data via a device is checked. To create, select, edit or delete a device. Refer to "21.2 Accessing Devices / GPRS Internet Devices".
Page	To change to another page on this screen.
Fn Cmd..	To configure a message to be sent through the configured port to the device.
Fn Quit	To exit the screen.

Description of fields

Field	Option	Description
Receive ASCII data via a device	Check box	Activates the ASCII input connection.
Connect using	CS Bluetooth 1 and CS Bluetooth 2	The Bluetooth ports on the field controller which will be used for the connection functionality.
	CS RS232 port	The RS232 port on the field controller.
Device	Display only	The name of the device selected for ASCII input.
End of message	CR, LF or CR/LF	The character to be used to identify the end of the incoming ASCII message.

Next step

Page changes to the **Annotation 1/Annotation 2/Annotation 3/Annotation 4** page.

ASCII Input,
Annotation 1/
Annotation 2/
Annotation 3/
Annotation 4 page

Description of fields

Field	Option	Description
Store ASCII data to this annotation	Check box	If checked, ASCII messages are recorded with the selected annotation.
Message desc	Editable field	The description for the ASCII message being received. This description is then displayed in other screens, for example in the status screen.
Message ID	Display only	The message ID to identify a particular ASCII message coming from the device. The message is then saved to the annotation. The following characters can be used as filter: ^ To accept strings starting with the subsequent characters. For example, ^1 accepts 12 but not 21. \$ To accept strings ending with the preceding characters. For example, 1\$ accepts 21 but not 12. . To accept any character except newline. [] To accept a set of characters. For example, [0-9] accepts all numbers. Any characters to accept strings that include the characters at any position. For example 1 accepts 1234, 4321 or 2134 but not 2345.

Field	Option	Description
Prefix '@<Desc>@' when writing	Check box	Stores the description in Message desc as prefix to the ASCII message. This prefix helps to more easily identify the annotations registered with a point.

Next step

Page changes to another page on this screen.

19.4.2

Configuration of a Command to the Device

Access

For RTK rover:

- In **ASCII Input, ASCII input** page, Fn **Cmnd...**

Send Command to Device

Send Command to Device | ↩

Enter command to send to device & press
Send

Command:

3DCQ:0.010m 2DCQ:0.005m 1DCQ:0.008m Fn ABC 10:04

OK | Send | | |

Key	Description
OK	To accept changes and return to the screen from where this screen was accessed.
Send	To send the command to the device.
Fn Quit	To exit the screen.

Description of fields

Field	Option	Description
Command	Editable field	A message to be sent to the device through the configured port when the survey or stakeout application is accessed. This functionality, for example, allows the device to be started remotely. The last used command that was entered is remembered as part of the active working style.

Description

Hidden point measurement devices are used for measuring to points which cannot be directly measured with GPS, for example house corners or trees. The measurements made with a hidden point measurement device are directly transferred to the instrument for the calculation of the coordinates of the hidden point. They can also be entered manually.

The settings on this screen define the port, the device and estimated qualities to be used for the hidden point connection.

Access

For RTK rover:

- In **Connection Settings, CS connections** page, highlight **GPS Hidden Pt. Edit...**

Hidden Point Measurement

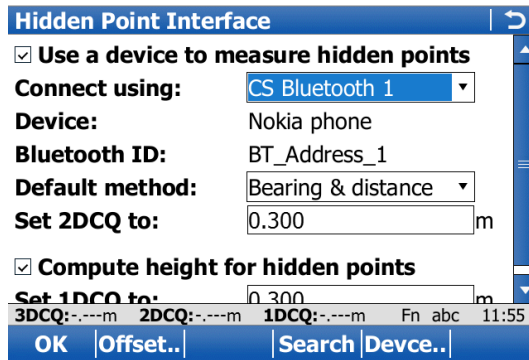

Key	Description
OK	To accept changes and return to the screen from where this screen was accessed.
Offset..	To configure the height and external angle offsets.
Search	Available when a Bluetooth port and device is selected. To search for all available Bluetooth devices. If more than one Bluetooth device is found a list of available devices is provided.
Devce..	To create, select, edit or delete a device. Refer to "21.2 Accessing Devices / GPRS Internet Devices".
Fn Quit	To exit the screen.

Description of fields

Field	Option	Description
Use a device to measure hidden points	Check box	To compute a hidden point with height. Activates the hidden point connection. If not checked, the measured values must be entered manually.
Connect using	CS Bluetooth 1 and CS Bluetooth 2 CS RS232 port	The Bluetooth ports on the field controller which will be used for the connection functionality. The RS232 port on the field controller.
Device	Display only	The name of the selected hidden point device.
Bluetooth ID	Display only	Available if CS Bluetooth 1 or CS Bluetooth 2 are selected. The Bluetooth ID of the hidden point device.

Field	Option	Description
Default method	Bearing & distance	The method which is suggested first when starting the Survey Hidden Points application. The distance and bearing from the known point to the hidden point are to be determined. An auxiliary point helps compute the bearing which might not be known. The auxiliary point can be measured in the direction from the known point to the hidden point.
	Using 2 bearings	The bearings from the known points to the hidden point are to be determined. Auxiliary points help compute the bearings which might not be known. Auxiliary points can be measured in the direction from the known points to the hidden point.
	Using 2 distances	The distances from the known points to the hidden points are to be determined. The location of the hidden point relative to the line between the two known points is to be defined.
	Chainage & offset	The chainage from one known point along the line between the two known points must be determined. The offset of the hidden point to the line between the two known points must be determined.
	Back brng & distance	The distance and the bearing from the hidden point to the known point are to be determined. An auxiliary point helps compute the bearing which might not be known. An auxiliary point can be measured in the direction from the hidden point to the known point.
Set 2DCQ to	Editable field	The estimated value for the position quality assigned to all hidden points. This value must be estimated because hidden point measurement devices do not output position qualities.
Compute height for hidden points	Check box	Select to compute a hidden point with height.
Set 1DCQ to	Editable field	Available when Compute height for hidden points is checked. The estimated value for the height quality assigned to all hidden points.

Next step

IF height and external angle/distance offsets	THEN
are not to be configured	OK closes the screen and returns to the screen from where Hidden Point Measurement was accessed.
are to be configured	Offset...

Hidden Point Device Offsets

Hidden Point Device Offsets | ↻

Distance offset: m

Height offset: ▾

Device height: m

Angle offset: ▾

Offset: g

3DCQ:0.009m 2DCQ:0.005m 1DCQ:0.008m Fn ABC 10:04

OK | | | | |

Key	Description
OK	To accept changes and to return to Hidden Point Measurement .
Fn Quit	To exit the screen.

Description of fields

Field	Option	Description
Distance offset	Editable field	The offset is automatically added to the measured distance.
Height offset	None	Available when Compute height for hidden points is checked in Hidden Point Measurement . No height offsets are used. The result is the delta height between the centre of the device and the aimed point.
	Device height	When measuring hidden points, the height of the hidden point measurement device can be typed in. This option should be used when the hidden point can be directly measured using the hidden point device.
	Device & target ht	When measuring hidden points, the height of the hidden point measurement device as well as the target height can be typed in. This option should be used when the hidden point cannot be directly measured with a hidden point device, but a target point can be used to calculate the position.
Device height	Editable field	The height of the hidden point measurement device. This height is the distance from the ground to the centre of the device.
Target height	Editable field	The distance from the hidden point to the aimed point.
Angle offset		Sets the default method for entering an angle offset. EAO is an offset angle between the North of the device being used and WGS 1984 geodetic North. EAOs are applied when measuring hidden points using a device capable of measuring azimuths.
	None	No EAO value is applied to the azimuth measurement received from the hidden point measurement device.

Field	Option	Description
	Permanent	Applies a default value for the offset angle. The value is changeable.
	New for each point	Offset angle values must be entered for each new hidden point.
Offset	Editable field	Available for Angle offset: Permanent . The default value for the offset angle.

Next step

Step	Description
1.	OK returns to Hidden Point Measurement .
2.	OK returns to the screen from where Hidden Point Measurement was accessed.

Diagram

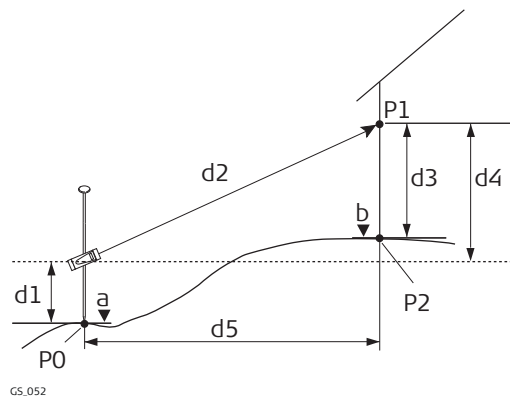

- P0 Known point
- P1 Target point
- P2 Hidden point
- a Height of P0
- b Height of P2 = $a + d1 + d4 - d3$
- d1 Device height: height of hidden point measurement device above P0
- d2 Slope distance
- d3 Device height: height of P1 above P2
- d4 Height difference between hidden point measurement device and P1
- d5 Horizontal distance

Distance offsets at hidden point measurement devices

A Leica DISTO is shown as an example

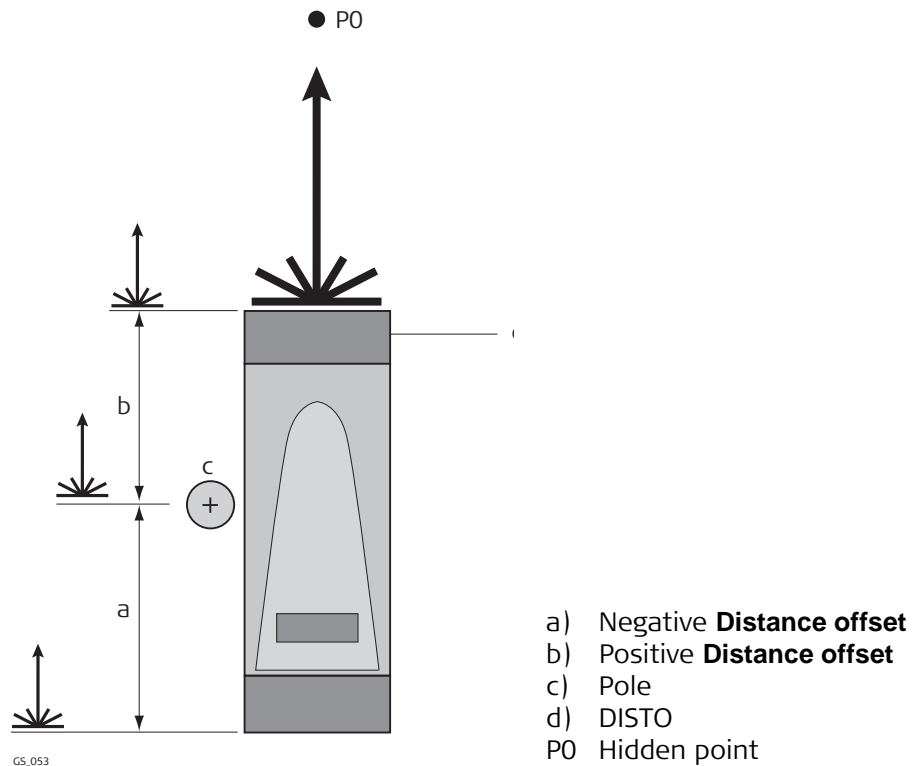

19.6

Export Job

Description

The Export Job connection allows data from a job to be exported from the instrument to another instrument.

The settings on this screen define the port and the device to which the data will be exported.

Access

For RTK rover:

- In **Connection Settings, CS connections** page, highlight **Export Job. Edit...**

For TPS and TS11/TS15/TS12 Lite:

- In **Connection Settings** highlight **Export Job. Edit...**

Export Job Connection

Export Job Interface

Export job to external device

Connect using: CS RS232 port

Device: TPS1200 Cable

3DCQ:0.009m 2DCQ:0.005m 1DCQ:0.008m Fn abc 09:53

OK | | | Devce..

Key	Description
OK	To accept changes and return to the screen from where this screen was accessed.

Key	Description
Search	Available when CS Bluetooth 1 or CS Bluetooth 2 are selected. To search for all available Bluetooth devices. If more than one Bluetooth device is found a list of available devices is provided.
Devce..	To create, select, edit or delete a device. Refer to "21.2 Accessing Devices / GPRS Internet Devices".
Fn Quit	To exit the screen.

Description of fields

Field	Option	Description
Export job to external device	Check box	Activates the connection.
Connect using	CS Bluetooth 1 / CS Bluetooth 2 or TS Bluetooth 1 / TS Bluetooth 2 CS RS232 port or Cable Radio handle	The Bluetooth ports on the field controller or the TS11/TS15/TS12 Lite which will be used for the connection functionality. The RS232 port on the field controller or the TS11/TS15/TS12 Lite. Hotshoe connection for RadioHandle. This port is located on top of Communication side cover.
Device	Display only	The device currently assigned to the selected port within the active working style. The device which is selected determines the availability of the next fields.
Job Number	Selectable list	Available if the Device is a Leica instrument. Select a job number to assign to the job.
Name	Editable field	Available if the Device is a Leica instrument. The name of the job.

19.7
19.7.1

RTK Rover GPS
Configuration of a Rover Real-Time Connection

Description The real-time connection allows real-time related parameters to be configured. These parameters include defining the real-time messages and the base to be used.

Access For RTK rover:

- In **Connection Settings, GS connections** page, highlight **RTK Rover. Edit...**

RTK Rover Settings, General page The available fields and keys on this screen depend on the selected settings.

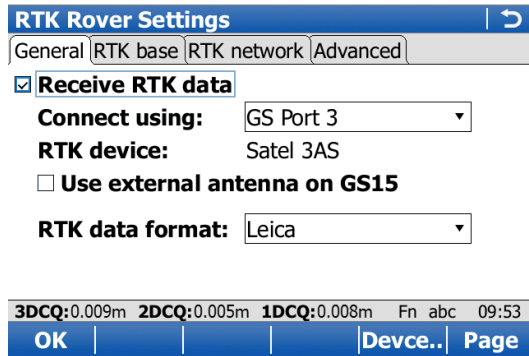

Key	Description
OK	To accept changes and return to the screen from where this screen was accessed.
Search	Available when connecting via Bluetooth. To search for all available Bluetooth devices. If more than one Bluetooth device is found a list of available devices is provided.
Devce..	To create, select, edit or delete a device. Refer to "21.2 Accessing Devices / GPRS Internet Devices". For Connect using: CS 3.5G modem , a special screen opens to edit the CS 3.5G modem settings. Refer to "21.3 Creating/Editing a Device".
Page	To change to another page on this screen.
Fn Quit	To exit the screen.

Description of fields

Field	Option	Description
Receive RTK data	Check box	If checked, the rover real-time connection is activated.
Connect using	CS 3.5G modem	The internal GSM modem of the field controller.
	CS RS232 port	The RS232 port on the field controller. Unavailable for GS08plus.
	CS Bluetooth 1 and CS Bluetooth 2	The Bluetooth ports on the field controller which will be used for the connection functionality.
	CS Internet 1, CS Internet 2 and CS Internet 3	The Internet ports on the field controller. If these ports are not assigned to a specific connection, then these ports are additional remote ports.

Field	Option	Description
	GS Port 1	For GS10: The physical port P1 on the box. For GS14/GS15: The red LEMO port.
	GS Port 2	For GS10: The physical port P2 on the box. For GS15: The black LEMO port.
	GS Port 3	For GS10: The physical port P3 on the box. For GS15: The slot for a device.
	GS Internet 1, GS Internet 2 and GS Internet 3	The Internet ports on the GS10/GS14/GS15. If these ports are not assigned to a specific connection, then these ports are additional remote ports.
	TS Bluetooth 1 and TS Bluetooth 2	The Bluetooth ports on the TPS which will be used for the connection functionality.
	TS Internet 1, TS Internet 2 and TS Internet 3	The Internet ports on the TPS. If these ports are not assigned to a specific connection, then these ports are additional remote ports.
	CS CGR radio	The CGR10/CGR15 that can be attached to the CS.
RTK device	Display only	The device currently assigned to the selected port within the active working style. The device which is selected determines the availability of the next fields.
RTK data format		<p> If a mountpoint was selected from a downloaded source table during the use of the RTK connection wizard, then the RTK format which is used with the NTRIP mountpoint is displayed.</p> <p>Leica The proprietary Leica real-time GPS data format supporting GPS L1/L2 and GLONASS L1/ L2. This format is recommended when working exclusively with Leica instruments.</p> <p>Leica 4G The proprietary Leica real-time GNSS data format supporting GPS L1/ L2/ L5, GLONASS L1/ L2 and Galileo E1/E5a/E5b/Alt-BOC. This format is recommended when working exclusively with Leica instruments.</p> <p>CMR/CMR+ CMR and CMR+ are compacted formats used to broadcast data for third-party instruments.</p> <p>RTCM 18,19 v2 Message according to RTCM version 2.x. Uncorrected carrier phase and pseudorange. Message 3 is also generated. Use for real-time operations where the ambiguities will be resolved at the rover. Accuracy at the rover: 1 - 5 cm rms after a successful ambiguity resolution.</p> <p>RTCM v3 Use RTCM when rover units from a different manufacturer are to be used. Message according to RTCM version 3. A new standard format for transmission of Global Navigation Satellite System correction information. Higher efficiency than RTCM v2.x. Supports real-time services with significantly reduced bandwidth.</p>

Field	Option	Description
		<p>Message types for real-time GNSS operation:</p> <ul style="list-style-type: none"> • 1001: L1-only GPS real-time observables • 1002: Extended L1-only GPS real-time observables • 1003: L1 & L2 GPS real-time observables • 1004: Extended L1 & L2 GPS real-time observables • 1005: Stationary real-time base station Antenna Reference Point • 1006: Stationary real-time base station ARP with antenna height • 1007: Antenna descriptor • 1008: Antenna descriptor and serial number • 1009: L1-only GLONASS real-time observables • 1010: Extended L1-only GLONASS real-time observables • 1011: L1 & L2 GLONASS real-time observables • 1012: Extended L1 & L2 GLONASS real-time observables <p>Network RTK Messages according to Master-Auxiliary Concept:</p> <ul style="list-style-type: none"> • 1014: Network Auxiliary Station Data message. This message contains details of the base stations in the network. For example, the master station and its coordinates, and the coordinate differences between the master and its auxiliaries. • 1015: Ionospheric Correction Differences message • 1016: Geometric Correction Differences message • 1021: Helmert / Abridged Molodensky transformation • 1022: Molodensky-Badekas transformation • 1023: Transformation Residual Message, ellipsoidal grid representation; CSCS/position & geoid/height residuals are supported • 1024: Transformation Residual Message, plane grid representation; CSCS/position & geoid/height residuals are supported • 1025: Projection types except LCC2SP, OM • 1026: Projection type Lambert Conic Conformal (LCC2SP) • 1027: Projection type Oblique Mercator (OM) • 1029: Unicode Text String message • 1032: Physical Reference Station Position message

Field	Option	Description
		<ul style="list-style-type: none"> • 1033: Receiver and Antenna Descriptor message • 1037: GLONASS Ionospheric Correction Differences message (phase). • 1038: GLONASS Geometric Correction Differences message (phase). • 1039: GLONASS Combined Geometric and Ionospheric Correction Differences message (phase). • 1068: GLONASS Ionospheric Correction Differences message (code). • 1069: GLONASS Geometric Correction Differences message (code). • 1070: GLONASS Combined Geometric and Ionospheric Correction Differences message (code). <p>Pseudorange and phase range values for L1 and L2. Depending on the type of instrument, the data for L1-only or for L1 and L2 are sent out.</p> <p>Accuracy at the rover:</p> <ul style="list-style-type: none"> • For L1-only: 0.25 - 1 m rms. • For L1 and L2: 1 - 5 cm rms after a successful ambiguity resolution.
	RTCM 1,2 v2	Message according to RTCM version 2.x. Differential and delta differential GPS corrections. Message 3 is also generated. Use for DGPS applications. Accuracy at the rover: 0.25 - 1 m rms.
	RTCM 9,2 v2	Message according to RTCM version 2.x. GPS partial correction set and delta differential GPS corrections. Message 3 is also generated. Use for DGPS applications with a slow data channel in the presence of interference. Accuracy at the rover: 0.25 - 1 m rms.
	RTCM 20,21 v2	Message according to RTCM version 2.x. Real-time carrier phase corrections and high accuracy pseudorange corrections. Message 3 is also generated. Use for real-time operations. Accuracy at the rover: 1 - 5 cm rms after a successful ambiguity resolution.
	RTCM 1,2,18,19 v2	Available for RTK base. Message according to RTCM version 2.x. Combination of RTCM 1,2 v2 and RTCM 18,19 v2 .
	RTCM 1,2,20,21 v2	Available for RTK base. Message according to RTCM version 2.x. Combination of RTCM 1,2 v2 and RTCM 20,21 v2 .
		The availability of the following options, depends on the selection made for SBAS tracking on the Advanced page.
	Automatic SBAS	SBAS satellites will be tracked and the SBAS service used will be automatically selected.

Field	Option	Description
	WAAS	Wide Area Augmentation System satellites will be tracked.
	WAAS (test)	To track Wide Area Augmentation System satellites while the system is still in test mode.
	EGNOS	European Geostationary Navigation Overlay System satellites will be tracked.
	EGNOS (test)	To track European Geostationary Navigation Overlay System satellites while the system is still in test mode.
	MSAS	MTSAT Satellite-based Augmentation System where MTSAT stands for Multi-functional Transport SATellite
	GAGAN	GPS Aided Geo Augmentation Navigation satellites will be tracked.
RTCM version	1.x, 2.1, 2.2 or 2.3	Available when the selected RTK data format is an RTCM version 2 format. The same version must be used at the reference and the rover.
Bits per byte	6 or 8	Defines the number of bits/byte in the RTCM message being received.
Use auto coordinate system	Check box	Available for RTK data format: RTCM v3 . To set an RTCM coordinate system received by a reference network as active coordinate system.
Receive RTK network information	Check box	Available for RTK data format: RTCM v3 . Activates an info message (RTCM message 1029).
Behaviour	Selectable list	Available for RTK data format: RTCM v3 .
	Log only	The info message will only be logged to a text file.
	Show only	The info message will only be shown by the instrument.
	Show & log	The info message will be shown by the instrument and logged to a text file.

Next step

Page changes to the **RTK base** page.

RTK Rover Settings, RTK base page

Description of fields

Field	Option	Description
Sensor at base	Selectable list	The instrument type used at the base. If the real-time data format contains information of the instrument type, certain corrections based on this information are applied in order to provide correct results. The real-time data formats Leica , Leica 4G , CMR/CMR+ and RTCM v3 contain this information. These corrections are important when third party instruments are used as reference.

Field	Option	Description
Antenna at base	Selectable list	The antenna used at the base. If the real-time data format contains information of the antenna, certain corrections based on this information are applied in order to provide correct results. The real-time data formats Leica , Leica 4G , CMR/CMR+ and RTCM v3 contain this information.  If the reference data is corrected by absolute antenna calibration values and a Leica standard antenna is being used on the rover, select ADVNULLANTENNA as base antenna.
RTK base is sending unique ID	Check box	If checked, an ID can be typed in.
RTK base ID	Editable field From 0 to 31 From 0 to 1023 From 0 to 4095	The special ID of the base station from which real-time data is to be received. The allowed minimum and maximum values vary. For RTK data format: Leica and RTK data format: CMR/CMR+ . For RTCM version: 2.x . For RTK data format: Leica 4G and RTK data format: RTCM v3 .

Next step

Page changes to the **RTK network** page.

RTK Rover Settings, RTK network page

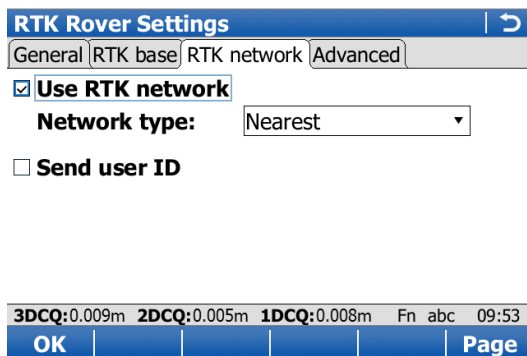

Key	Description
OK	To accept changes and return to the screen from where this screen was accessed.
Fn GGA..	To activate the sending of a GGA message for RTK network applications. Refer to "19.7.3 Configuration of GGA Message Sending for Reference Network Applications".
Page	To change to another page on this screen.
Fn Quit	To exit the screen.

Description of fields

Field	Option	Description
Use RTK network	Check box	If checked, an RTK network can be used.
Network type	<p>Nearest</p> <p>i-MAX</p> <p>MAX</p> <p>VRS</p> <p>FKP</p>	<p>Defines the type of reference network to be used. Refer to Leica GNSS Spider documentation for more detailed descriptions.</p> <p>The rover sends its position via NMEA GGA message to Leica GNSS Spider. From this position, Leica GNSS Spider determines the reference in a reference network that is closest to the rover. The corrections from that reference are sent to the rover. Supported for all real-time data formats.</p> <p>If this option is selected, an NMEA GGA message must be activated using Fn GGA...</p> <p>individualised Master-AuXiliary corrections. The rover sends its position via NMEA GGA message to Leica GNSS Spider where the Master-Auxiliary corrections are calculated. The corrections are also individualised by Leica GNSS Spider, which means it determines the best suitable corrections for that rover.</p> <p>If this option is selected, an NMEA GGA message can be activated using Fn GGA...</p> <p>Master-AuXiliary corrections</p> <p>The rover typically does not send its position to Leica GNSS Spider. Leica GNSS Spider calculates and sends Master-Auxiliary corrections to the rover.</p> <p>The rover individualises the corrections for its position, which means it determines the best suitable corrections. The corrections are sent in RTCM v3 with message types 1015/1016.</p> <p>If this option is selected, an NMEA GGA message can be activated using Fn GGA...</p> <p>Virtual Reference Station. If this option is selected, an NMEA GGA message must be activated using Fn GGA... Refer to "19.7.3 Configuration of GGA Message Sending for Reference Network Applications".</p> <p>Area correction parameters. Derived from German: FlächenKorrektur Parameter</p>
Send user ID	Check box	Activates the sending of a Leica proprietary NMEA message defining the user.
User ID 1 and User ID 2	Editable field	The specific user IDs to be sent as part of the Leica proprietary NMEA message. By default the serial number of the instrument is displayed.

Next step

Page changes to the **Advanced** page.

Description of fields

Field	Option	Description
Use prediction	Check box	To activate and deactivate the prediction of real-time observations between the data rate of the base. Available unless RTK data format: RTCM 1,2 v2 or RTK data format: RTCM 9,2 v2 .
Use height filter	Check box	To activate and deactivate the height filter for height smoothing.
Compute xRTK positions	Check box	To activate or deactivate a slightly less accurate RTK position type, typically 5 - 10 cm, automatically providing more availability for phase fixed positions with a reliability of 99%. Recommended when working in heavy canopy environments. Available for GS10/GS14/GS15/GS25.  For NMEA messages, positions measured with the x-RTK mode are flagged as fixed.
Glonass mode	Automatic	The instrument decides automatically if GLONASS observations are fixed or not. Available for GLONASS instruments. For GS05/GS06, the option Automatic is always used.
	Glonass fix	The GLONASS observations are fixed in an RTK solution.
	Glonass float	The GLONASS observations are not fixed in an RTK solution.
SBAS tracking		Allows a Space-Based Augmentation System to be configured to provide additional corrections in conjunction with GPS signals. Also commonly referred to as Satellite-Based Augmentation System , SBAS provides corrected time and distance measurements calculated by a network of ground relay stations and geostatic satellites. An SBAS can correct for problems such as atmospheric delays, poor satellite geometry and incorrect satellite positioning.
	Automatic SBAS	SBAS satellites will be tracked and the SBAS service used will be automatically selected.
	WAAS	Wide Area Augmentation System satellites will be tracked.
	WAAS (test)	To track Wide Area Augmentation System satellites while the system is still in test mode.
	EGNOS	European Geostationary Navigation Overlay System satellites will be tracked.
	EGNOS (test)	To track European Geostationary Navigation Overlay System satellites while the system is still in test mode.
	MSAS	MTSAT Satellite-based Augmentation System where MTSAT stands for Multi-functional Transport SATellite
	GAGAN	GPS Aided Geo Augmentation Navigation satellites will be tracked.

Next step

Page changes to another page on this screen.

Prediction

The following provides additional information on the prediction of real-time positions between the data rate of the base.

Access

In **RTK Rover Settings, Advanced** page.

Description

Prediction is the interpolation of real-time corrections between those corrections regularly transmitted by a reference at a defined data rate.

Advantages in using prediction

- Computation of real-time positions on the rover is independent from the transmission rate of the data from the base station.
- Positions computed with prediction have a reduced latency of around 20 ms.

Recommended settings for using prediction

The slower the data rate the more important it is to activate prediction.

Height smoothing

The following provides additional information on the height filter for height smoothing.

Access

In **RTK Rover Settings, Advanced** page.

Description

Height smoothing is a filter applied to all heights measured in the WGS84 or a local coordinate system or output via NMEA. The filter defaults are best suited for high dynamic variations in height up to 1 m/s as carried out by graders.

Height Smoothing with high dynamic GPS operations

All GPS computed positions are almost twice as accurate in plan than in height. For the position determination, satellites can appear in all four quadrants. For the height determination, satellites can appear in two quadrants. Having fewer quadrants, weakens the height position compared to the plan position.

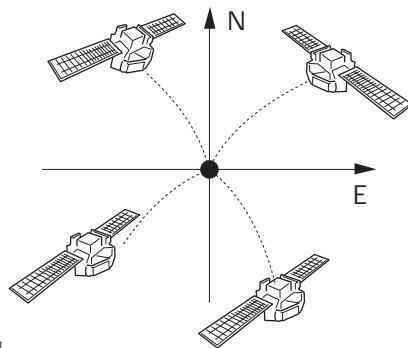

GS12_041

Position determination with satellites appearing in all four quadrants.

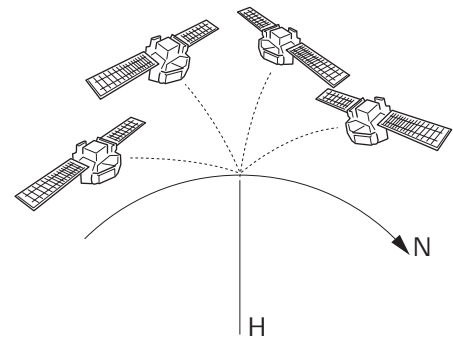

Height determination with satellites appearing in two quadrants.

In high dynamic GPS operations, this fact results in height variations of a few centimetres as shown in the blue curve in the following diagram. Some GPS monitoring applications require a stabilised height. By applying the filter, the height variations are smoothed and most of the noise in the height component is eliminated.

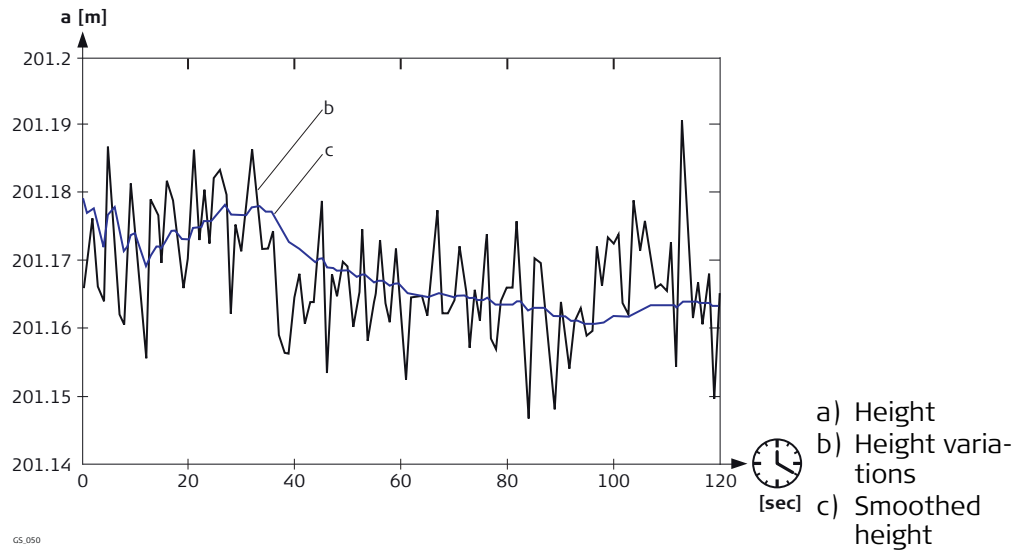

19.7.2

Configuration with Digital Cellular Phone and Radio

Description

An ideal real-time setup is to combine a radio and a digital cellular phone to get the best of both technologies. The radio can be used where the radio signals can be received, the advantage being that the radio data transmission is free. If the radio channel is broken, when the rover goes out of range or due to an obstruction, change to the digital cellular phone to complete the survey. This switch allows maximum productivity and minimal costs with real-time GPS.

Field procedure step-by-step

Step	Description
1.	Set up a base.
2.	On the base, attach a digital cellular phone to one port and a radio to another port.
3.	Configure both connections on the base.
4.	Start the base. Real-time data is transmitted on two ports simultaneously - using different devices.
5.	Set up a rover.
6.	On the rover, attach a digital cellular phone to one port and a radio to another port.
7.	Use two working styles to configure both connections on the rover.
8.	Start the rover using either the digital cellular phone connection or the radio connection.
9.	On the rover, change the working style in use in order to change between using digital cellular phone and radio. There is no need to return to the base.

Description

Most reference networks require an approximate position of the rover. For reference network applications, a rover dials into the reference network and submits its approximate position in form of an NMEA GGA message.
 By default, the instrument sends GGA messages with updated current positions automatically when a reference network is selected.
 Surveying regulations in some countries require that one certain position can be selected. This position is then sent to the reference network as GGA message through the real-time connection every five seconds.
 Refer to "F.3 GGA - Global Positioning System Fix Data" for information on GGA message format.

Access step-by-step In **RTK Rover Settings, RTK network** page, press Fn **GGA...**

Send GGA NMEA

Key	Description
OK	To accept changes and return to the screen from where this screen was accessed.
Coord	Available for GGA position: From job and GGA position: LAST/HERE Posn . To view other coordinate types. Local coordinates are available when a local coordinate system is active.
Last	Available for GGA position: LAST/HERE Posn . To use the same coordinates in the GGA message as when the instrument was last used in a reference network application. This functionality is possible when position coordinates from a previous reference network application are still stored in the internal memory.
Here	Available for GGA position: LAST/HERE Posn . To use the coordinates of the current navigation position in the GGA message.
Fn Ell Ht and Fn Elev	To change between the ellipsoidal and the orthometric height. Available for local coordinates.
Fn Quit	To exit the screen.

Description of fields

Field	Option	Description
GGA position	Automatic	The current rover position is sent to the reference network. The position is updated and sent every five seconds.

Field	Option	Description
	From job	A point from the working job can be selected in Point ID . The position of this point is sent to the reference network every five seconds.
	LAST/HERE Posn	The position last used in a reference network application or the current navigation position can be selected using Last or Here . The selected position is sent every five seconds.
	None	No GGA message is sent to the reference network.
Point ID	Selectable list	Available for GGA position: From job . The coordinates of this point are sent out in the GGA message.

19.8

19.8.1

Base RTK 1 / Base RTK 2 GPS

Configuration of a Reference Real-Time Connection



Unavailable for GS05/GS06.

Description

The real-time connection allows real-time related parameters to be configured. These parameters include defining the real-time messages, data rates and time slicing. Up to two real-time connections can be configured on the instrument.

Access

For RTK base:

- In **Base Connection Settings** highlight **Base RTK 1. Edit...**
- Two real-time devices can be attached to two different ports, for example a radio and a digital cellular phone. On the reference, the two devices can operate simultaneously. Highlight **Base RTK 2** and press **Edit..** to configure a second real-time connection.

RTK base settings (RTK1)/RTK base settings (RTK2), General page

The available fields and pages on this screen depend on the selected settings.

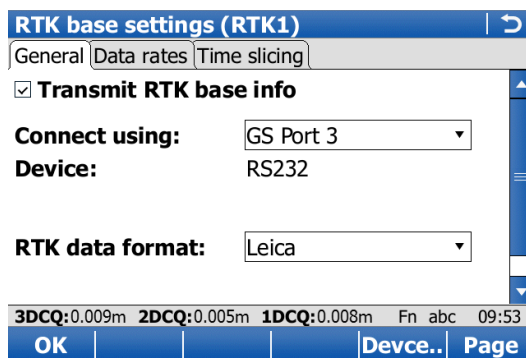

Key	Description
OK	To accept changes and return to the screen from where this screen was accessed.
Devce..	Available for Connect using: GS Port 1/GS Port 2/GS Port 3/GS radio/GS modem . To create, select, edit or delete a device. Refer to "21.2 Accessing Devices / GPRS Internet Devices".
Page	To change to another page on this screen.
Fn Quit	To exit the screen.

Description of fields

Field	Option	Description
Transmit RTK base info	Check box	Activates the base real-time connection.
Connect using	GS Port 1 GS Port 2 GS Port 3 GS Internet 1, GS Internet 2 and GS Internet 3 GS radio GS modem	For GS10: The physical port P1 on the box. For GS14/GS15: The red LEMO port. For GS08plus/GS12: Fixed to this setting. Streaming of RTK data through the CS is not allowed. For GS10: The physical port P2 on the box. For GS15: The black LEMO port. For GS10: The physical port P3 on the box. For GS15: The slot for a device. The internet ports on the GS10/GS14/GS15. If these ports are not assigned to a specific connection, then these ports are additional remote ports. Available for GS14. Available for GS14.
Device	Display only	The device currently assigned to the selected port within the active working style.
RTK data format	Leica, Leica 4G, CMR/CMR+, RTCM 18,19 v2, RTCM v3, RTCM 1,2 v2, RTCM 9,2 v2, RTCM 20,21 v2, RTCM 1,2,18,19 v2	Refer to "19.7.1 Configuration of a Rover Real-Time Connection" for information about these real-time data formats.  For GS08plus/GS12, the setting is fixed to RTCM v3 .
RTCM version	1.x, 2.1, 2.2 or 2.3	Available when the selected RTK data format is an RTCM version 2 format. The same version must be used at the reference and the rover.
Use external antenna on GS15	Check box	Available for Connect using: GS Port 3 . Allows external radio / GSM antenna on the GS15 to be used for slot devices.

Next step

Page changes to the **Data rates** page.

RTK base settings (RTK1)/RTK base settings (RTK2), Data rates page

 This page is unavailable for GS08plus/GS12.

Description

For all real-time data formats, parts of the message can be output at different rates. The settings on this screen define the output rates for the various parts of the selected real-time data format. The available fields on this screen depend on the selected setting for **RTK data format** in **RTK base settings (RTK1)/RTK base settings (RTK2)**.

Description of fields

Field	Option	Description
RTK data format	Display only	The selected data format.
Data	From 0.1s to 60.0s	Rates for the transmission of raw observations. The default settings are suitable for standard applications. They can be changed for special applications. A check is performed for permissible combinations.
Message type	Selectable list	The message type of RTCM v3 and Leica 4G Compact is suitable for standard applications.
Coords	From 10s to 120s	Rate for the transmission of reference coordinates.
Info	From 10s to 120s	Rate for the transmission of base station information such as point ID.
End of message	Nothing or CR	To add a Carriage Return at the end of the real-time message.
Messages to be streamed (local coords will be computed using coordinate system on the GS sensor)	Selectable list	Available for RTCM version: 2.3 . The messages sent within the coordinate message.
RTK base ID	Editable field From 0 to 31 From 0 to 1023 From 0 to 4095	An identification for a base station. It is converted into a compact format and sent out with real-time data in all real-time data formats. It is different from the point ID of the base station. An ID of the base station is required if working with several base stations in time slicing mode on the same frequency. In this case, the ID of the base station from which data is to be accepted must be typed in at the rover. The allowed minimum and maximum values vary. For Leica and CMR/CMR+ . For any RTCM version 2 format. For Leica 4G and RTCM v3 .

Next step

Page changes to the **Time slicing** page.

 This page is unavailable for GS08plus/GS12.

Description of fields

Field	Option	Description
Use time slicing	Check box	The possibility to send delayed real-time messages. This functionality is required when real-time messages from different base stations are sent on the same radio channel. Time slicing works for all device types.
Total base stations being used	2, 3 or 4	The number of base stations in use from where real-time messages are sent.
Time slot for this base	2, 3 or 4 The contents of the selectable list depend on the settings for Total base stations being used .	The time slot represents the actual time delay. The number of possible time slots is the number of base stations in use. The time delay equals 1 s divided by the total number of base stations. If two base stations are used, the time delay is 0.50 s. Therefore, the time slots are at 0.00 s and at 0.50 s. With three base stations, the time delay is 0.33 s. The time slots are at 0.00 s, 0.33 s and 0.66 s.

Next step

Page changes to another page on this screen.

19.9

NMEA 1 / NMEA 2 GPS



Unavailable for GS05/GS06/GS08plus/GS12.



For GS05/GS06/GS08plus/GS12, streaming of GGA messages is supported for RTK network operations.

Description

National **M**arine **E**lectronics **A**ssociation has developed a message standard related to the marine electronics industry. NMEA messages have been accepted as the standard for sharing specific data information between companies since the late 1970s. Refer to "Appendix F NMEA Message Formats" for a comprehensive description of each NMEA message.

The settings on this screen define the port, the device and the type of NMEA message to be used for the NMEA Out connection.

Up to two NMEA Out connections can be configured. Each NMEA Out connection can output different messages at different rates with different talker IDs. The output of NMEA messages on both ports is simultaneous.

The screens for the configuration of both NMEA connections are identical except for the title - **NMEA Output 1** and **NMEA Output 2**. For simplicity, the title **NMEA Output 1** is used in the following.

Access

For RTK rover:

- In **Connection Settings, GS connections** page, highlight **NMEA 1** or **NMEA 2**. **Edit...**

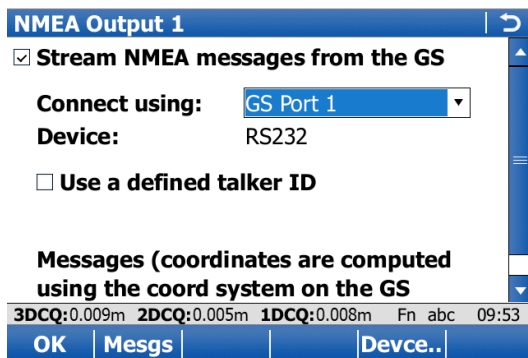

Key	Description
OK	To accept changes and return to the screen from where this screen was accessed.
Mesgs	To configure what NMEA messages are output, the rates and the output timing method. Refer to paragraph "NMEA Messages".
Devce..	To create, select, edit or delete a device.
Fn Quit	To exit the screen.

Description of fields

Field	Option	Description
Stream NMEA messages from the GS	Check box	Activates the output of NMEA.
Stream NMEA messages from the GS	Check box	Activates the output of NMEA.
Connect using	GS Port 1 GS Port 2 GS Port 3 GS BT	For GS10: The physical port P1 on the box. For GS15: The red LEMO port. For GS10: The physical port P2 on the box. For GS15: The black LEMO port. For GS10: The physical port P3 on the box. For GS15: The slot for a device. The Bluetooth port on the GS10/GS15.
Device	Display only	Usually, RS232 is used to transfer NMEA messages.
Use a defined talker ID	Check box	When this box is checked, a user-defined talker ID can be typed in. Otherwise, the NMEA Talker ID based on the NMEA standards v3.0 is used (default GP for GPS.)
Talker ID	Editable field	Available when Use a defined talker ID is checked. Appears at the beginning of each NMEA message.
Messages to be streamed (local coords will be computed using coordinate system on the GS sensor)	Display only	The NMEA messages currently selected for output.

Next step

IF NMEA messages	THEN
are not configured	OK closes the screen.
are to be configured	Mesgs.

NMEA Messages

This screen shows the messages that can be output, which messages are currently output, the output rates and the output timing method.

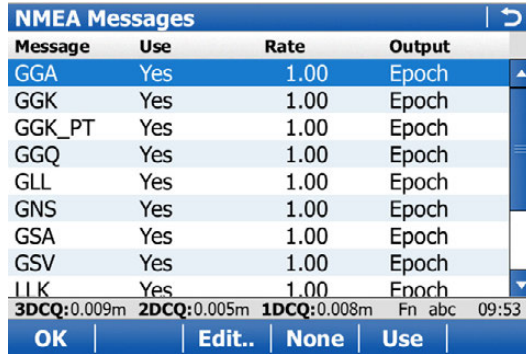

Key	Description
OK	To accept changes and return to the screen from where this screen was accessed.
Edit..	To configure how the currently highlighted message is output. Refer to paragraph "NMEA Message to Send".
All and None	To activate and deactivate the output for all messages.
Use	To activate and deactivate the output for the highlighted message.
Fn Quit	To exit the screen.

Next step

IF an NMEA message	THEN
is not to be configured	OK closes the screen.
is to be configured	highlight the message and Edit..

NMEA Message to Send

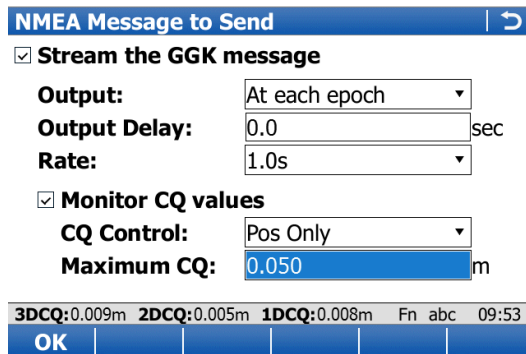

Key	Description
OK	To accept changes and return to the screen from where this screen was accessed.
Fn Quit	To exit the screen.

Description of fields

Field	Option	Description
Stream the NMEA message	Check box	When this box is checked, the selected NMEA message is output.
Output	At each epoch Immediately On point stored	<p>The NMEA message is created at the exact epoch of the screen update rate. It is sent out in the time interval as defined in Rate. With Output Delay, the output can also be delayed by a time after this epoch. Refer to paragraph "Diagram".</p> <p>The NMEA message is created as soon as the information is available. It is sent out in the time interval as defined in Rate.</p> <p>The NMEA message is sent on point storage.  If the time interval defined in Rate is shorter than the epochs of the screen update, then the internal computation of positions is changed to allow the specified rate of NMEA positions. The screen update remains unchanged.</p>
Output Delay	Editable field	<p>Available for Output: At each epoch. Delays the output of the NMEA message. The delay is applied from the epoch as defined in Rate. The time of delay can be a value up to Rate.</p> <p>This option is required if two or more instruments are being used to monitor the position of an object. The position of each instrument is being output as NMEA message back to a control station. If all instruments sent their position message at the same time, as would be the case with Output: Immediately, then the control station may not be able to cope with all the positional data messages. In this case, the output of the second instrument could be delayed. The control station would then receive the message from each instrument at a slightly different time.</p>
Point Type	All points Occupied pts only Auto pts only	<p>Available for Output: On point stored. Defines the type of points for which the NMEA message is sent.</p> <p>The NMEA message is sent when any type of point is stored.</p> <p>The NMEA message is sent when a manually measured point is stored.</p> <p>The NMEA message is sent when auto points are stored.</p>

Field	Option	Description
Rate	From 0.05s to 3600.0s	Available unless Output: On point stored . Defines the time intervals at which the NMEA messages are created. For GS05/GS06 logging rates > 5 Hz are supported.
Monitor CQ values	Check box	When this box is checked the CQ control can be defined.
CQ Control	Position only, Height only or Position & height	Available when Monitor CQ values is checked. Activates a control over the coordinate quality. If the coordinate quality of the position and/or height component exceeds the limit as defined in Maximum CQ , then NMEA messages are not output.
Maximum CQ	Editable field	Available when Monitor CQ values is checked. The limit for the coordinate quality up to which NMEA messages are output.

Next step

Step	Description
1.	OK returns to NMEA Messages .
2.	OK returns to the screen from where NMEA Messages was accessed.

Diagram

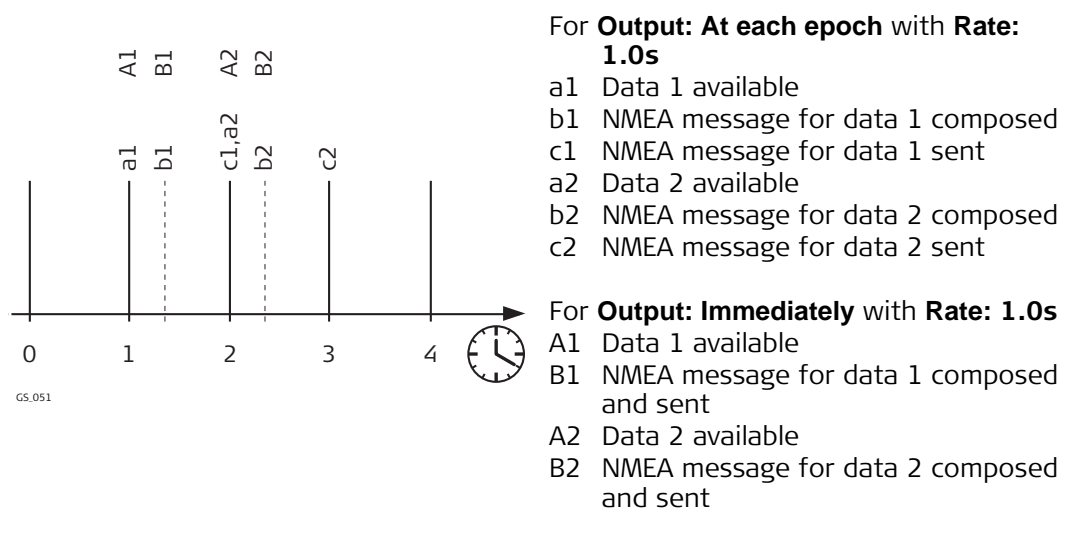



Unavailable for GS05/GS06/GS08plus/GS12.

Description

The remote connection allows:

- the instrument to be controlled using a device other than the field controller, for example a computer. **Outside World Interface** or Leica Binary 2 commands can be used to control the instrument through the remote port. Documentation for OWI and LB2 is available on request from the Leica Geosystems representative.
- a message log to be requested from a remote client via an OWI message. A message log contains a history of warning messages and message lines.
- the downloading of data directly from the instrument's memory device to LGO through a serial port on the computer. The CS does not need to be removed from the instrument.

The settings on this screen define the port and the device to be used for the remote control.



A port configured as a remote port can be used to output event input, meteo or tilt notification messages.



The OWI commands listed here are protected by a licence key. Refer to "30.3 Load licence keys" for information on how to type in the licence key. The corresponding LB2 commands are also protected. If these OWI commands have been activated by a licence key, it is indicated in **About Leica Viva**.

- | | | | | |
|-------|-----------|-------|-------|-------|
| • AHT | • DPM | • GLL | • POB | • RTK |
| • ANT | • GGA | • GNS | • POE | • TPV |
| • CNF | • GGK | • LLK | • POQ | • USR |
| • DCF | • GGK(PT) | • LLQ | • POS | |
| • DCT | • GGQ | • NET | • RMC | |

Access

For RTK rover:

- In **Connection Settings, GS connections** page, highlight **Remote (OWI). Edit...**

Remote (OWI) Connections

Remote (OWI) Interfaces		
Port	Connection	Device
GS Port 1	Remote (OWI)	RS232
GS Port 2	NMEA 2	-
GS Port 3	RTK Rover	Satel 3AS
GS BT	Remote (OWI)	-

3DCQ:0.009m	2DCQ:0.005m	1DCQ:0.008m	Fn abc	09:53
OK		Cntrl..	Devce..	

Key	Description
OK	To accept changes and return to the screen from where this screen was accessed.
Cntrl..	To configure additional parameters.
Devce..	Available unless an internet connection is used. To create, select, edit or delete a device. Refer to "21.2 Accessing Devices / GPRS Internet Devices".

Key	Description
Use	Available unless a connection is NMEA 1 , NMEA 2 or Remote (OWI) . To use the highlighted connection by Remote (OWI) .
Fn Quit	To exit the screen.

Description of columns

Column	Description
Port	The physical port on the instrument which will be used for the connection functionality.
Connection	The connection configured for the ports. Any port which is not configured is automatically assigned the remote connection.
Device	The hardware connected to the chosen port.

19.11

PPS Output GPS



The PPS output is an optional interface requiring a special port.

Description

PPS stands for **Pulse Per Second**. It is a pulse that is output at a specified interval time. This can be used to activate another device. Additionally, a notification message can be output through the GS25 ports P1, P2, P3, P4 or BT when a PPS output occurs. For example, in aerial photography, an aerial camera can be configured to take a photo each time it receives a pulse from the instrument.

The settings on this screen define the output port and parameters for the PPS option. This screen is available if the instrument is fitted with a PPS output port.



This option is only available on GS25.

Access

For RTK rover:

- In **Connection Settings, GS connections** page, highlight **PPS Output. Edit...**

PPS Output, PPS Output page

Key	Description
OK	To accept changes and return to the screen from where this screen was accessed.
Page	To change to another page on this screen.
Fn Quit	To exit the screen.

Description of fields

Field	Option	Description
Stream Puls Per Second from the GS	Check box	When this box is checked, the output of PPS is activated and relevant settings can be configured.
Rate	From 0.05s to 20.0s	The rate at which pulses are output.
Polarity	Negative edge and Positive edge	Measure the time from the negative edge or the positive edge of the pulse.
Restrict output by time accuracy	Check box	To restrict the PPS output by the accuracy of time. If the time accuracy is degraded below a defined value, for example, due to a lack of satellites, no PPS output is generated. When this box is checked, the observation of the time accuracy limit within which pulses are generated is activated.
Accuracy limit	Editable field	The time accuracy limit in nanoseconds. Available when Restrict output by time accuracy is checked.

Next step

Page changes to the **Notification** page.

PPS Output, Notification page

Key	Description
OK	To accept changes and return to the screen from where this screen was accessed.
Page	To change to another page on this screen.
Fn Quit	To exit the screen.

Description of fields

Field	Option	Description
Send notification on each PPS output	Check box	When this box is checked, the output of a notification message with each PPS output is activated. Refer to "Appendix I PPS Output Notify Message Format" for information on the message format.
Connect using	GS Port 1 , GS Port 2 or GS Port 3 GS BT	The ports on the GS25 used for the connection. The Bluetooth ports on the GS25 used for the connection.
Device	Display only	The hardware connected to the chosen port.
Notification	Selectable list	The message can be in ASCII or in binary format.

Next step

Page changes to another page on this screen.



The event input is an optional interface requiring a special port.

Description

The event input interface allows pulses which are sent from devices connected to the instrument to be recorded. These records can later be superimposed on the processed kinematic data and the positions where the events took place can be interpolated in LGO. Events logged during real-time operations can also be exported to an ASCII file using an appropriate format file. Additionally, a notification message can be output through the GS25 ports P1, P2, P3, P4 or BT providing information about when the event occurred. A port configured as a remote port can be used to output the notification message.

For example, in aerial photography, an aerial camera can be connected through the event input port. When the shutter opens, the position at which the event occurred is recorded.

The settings on this screen define the input port and parameters for the event input option. This screen is available if the instrument is fitted with a event input port.



This option is only available on GS25.

Event input 1/Event input 2, Event input page

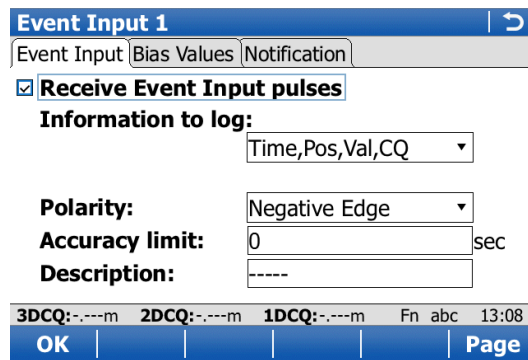

Key	Description
OK	To accept changes and return to the screen from where this screen was accessed.
Page	To change to another page on this screen.
Fn Quit	To exit the screen.

Description of fields

Field	Option	Description
Receive event input pulses	Check box	When this box is checked, the detection and logging of events being sent to the event ports is activated and relevant settings can be configured.
Information to log	Time,pos,vel,CQ, Time,pos,vel, Time,pos or Time	Time, position, velocity and coordinate quality can be recorded in various combinations.
Polarity	Negative edge or Positive edge	The polarity according to the device in use.

Field	Option	Description
Accuracy limit	Editable field	If two or more events take place during the time defined in s, the first event is recorded. Enter 0 to accept all events. The shortest recording time is 0.05 s.
Description	Editable field	Records up to four lines of data with the event record. Use the description to differentiate between the two event records if two event input ports are used at the same time.

Next step

Page changes to the **Bias values** page.

Event input 1/Event input 2, Bias values page

Key	Description
OK	To accept changes and return to the screen from where this screen was accessed.
Page	To change to another page on this screen.
Fn Quit	To exit the screen.

Description of fields

Field	Option	Description
External bias	Editable field	Sets a calibration value in ns according to the external event device and cable being used.
Enter user defined internal bias	Check box	When this box is checked, personal calibration values for the particular instrument can be configured. When this box is not checked, default calibration values for the particular instrument are used.
Internal bias	Editable field	Available when Enter user defined internal bias is checked. Sets the particular calibration value in ns for the instrument.

Next step

Page changes to the **Notification** page.

Event input 1/Event input 2, Notification page

Key	Description
OK	To accept changes and return to the screen from where this screen was accessed.
Page	To change to another page on this screen.
Fn Quit	To exit the screen.

Description of fields

Field	Option	Description
Send notification on each Event Input	Check box	When this box is checked, the output of a notification message with each event input is activated. Refer to "Appendix H Event Input Notify Message Format" for information on the message format.

Field	Option	Description
Connect using	GS Port 1, GS Port 2 or GS Port 3	The ports on the GS25 which are used for the connection.
	GS BT	The Bluetooth ports on the GS25 used for the connection.
Device	Display only	The hardware connected to the chosen port.
Notification	Selectable list	The message can be in ASCII or in binary format.

Next step

Page changes to another page on this screen.

19.13

Total Station TPS

Description

The settings on this screen define the communication of the field controller with Leica total stations and third-party instruments.

Access

For TPS:

- In **Connection Settings** highlight **Total Station. Edit...**

Total Station Connection

Total Station Connections	
Manufacturer:	Leica
Model:	TPS1200
Connect using:	Bluetooth
Name:	TPS1200
Bluetooth ID:	15894650

3DCQ:0.008m	2DCQ:0.004m	1DCQ:0.007m	Fn abc	09:48
OK		Search		

Key	Description
OK	To accept changes and return to the screen from where this screen was accessed.
Search	To search for all available Bluetooth devices. If more than one Bluetooth device is found a list of available devices is provided. Available if Connect using: Bluetooth is selected.
Cntrl..	Available for certain devices connected to certain connections. To configure additional parameters, for example changing the radio channel.
Default	To return the fields back to their default values.
Fn Quit	To exit the screen.

Description of fields

Field	Option	Description
Manufacturer	Selectable list	The brand of the instrument.
Model	Selectable list	The instrument model.

Field	Option	Description
Connect using	Cable, Bluetooth, Internal radio, External radio Radio cap (CTR16)	How the instrument is connected. The options available depend on the selection for Model . The availability of the other fields depends on the selection made here. To configure a connection between a CS15 with CTR16 and a TS with RH16.
Baud rate	From 1200 to 115200	Frequency of data transfer from instrument to device in bits per second.
Parity	None, Even or Odd	Error checksum at the end of a block of digital data.
Data bits	6, 7 or 8	Number of bits in a block of digital data.
Stop bit	1 or 2	Number of bits at the end of a block of digital data.
Flow control	None or RTS/CTS	Activates hardware handshake. When the instrument/device is ready for data, it asserts the Ready To Send line indicating it is ready to receive data. This line is read by the sender at the Clear To Send input, indicating it is clear to send the data.
Bluetooth ID and Name	Display only	The last connected total station using CTR16. If no information of a last total station is available, then ---- is displayed.

19.14

GSI Output TPS TS

Description

Each time a measured point is stored to the working job, GSI data is streamed through the configured port of the field controller.

Access

In **Connection Settings** highlight **GSI Output. Edit...**

GSI Output Connection

GSI Output Interface | ↻

Output GSI data to device

Connect using: CS Bluetooth 1 ▾

Device: Nokia phone

Bluetooth ID: BT_Address_1

GSI Format: GSI8 polar & crtsn ▾

3DCQ:0.009m 2DCQ:0.005m 1DCQ:0.008m Fn abc 09:53

OK | Search | Devce..

Key	Description
OK	To accept changes and return to the screen from where this screen was accessed.
Search	Available when CS Bluetooth 1 or CS Bluetooth 2 are selected. To search for all available Bluetooth devices. If more than one Bluetooth device is found a list of available devices is provided.
Devce..	To create, select, edit or delete a device.
Fn Quit	To exit the screen.

Description of fields

Field	Option	Description
Output GSI data to device	Check box	Activates the connection.
Connect using	CS RS232 port CS Bluetooth 1 and CS Bluetooth 2 TS Bluetooth 1 and TS Bluetooth 2 Cable Radio handle	The RS232 port on the field controller. The Bluetooth ports on the field controller which will be used. The Bluetooth ports on the TS11/TS15/TS12 Lite which can be used. The RS232 port on the TS11/TS15/TS12 Lite. Hotshoe connection for RadioHandle. This port is located on top of Communication side cover.
Device	Display only	The device currently assigned to the selected port.
GSI Format	GSI8 polar & crtsn GSI16 polar GSI16 cartesian Pt,N,E,Ht,Date Pt,E,N,Ht,Date Pseudo NMEA GGA GSI8 polar GSI16 polar 2	GSI Polar and Cartesian (8 data characters) (Point ID, Hz, V, SlopeDist, PPM, E, N, Elev.) GSI Polar (16 data characters) (Point ID, Hz, V, SlopeDist, PPM, reflector height) GSI Cartesian (16 data characters) (E, N, Elev, Reflector Height) Coordinate data (Northing BEFORE Easting) Coordinate data (Easting BEFORE Northing) Based on NMEA (National Marine Electronics Association), which is a standard for interfacing marine electronic devices. GSI Polar (8 data characters) (Point ID, Hz, V, SlopeDist, PPM) GSI Polar (16 data characters) (Point ID, Hz, V, SlopeDist, PPM)
Use RS232 GSI protocol	Check box	A protocol defines if the system expects a handshake or no handshake. If checked, a handshake is required. A data block is sent out from the instrument and a receipt confirmation is expected. This handshake requires that GeoCom Mode is activated.

Output format - GSI Format

GSI data is transmitted in blocks. Every block consists of several data words, refer to the examples in the following table. Every data word begins with a two character Word Index, the WI code, specifying the data type within this block. Each GSI8 word has in total 16 characters, consisting of 7 information characters followed by 8 data characters and finally the blank character ASCII code 32. The GSI16 block is like the GSI8 block, but begins with * and the data word contains 16 characters for large values such as UTM coordinates, alphanumeric codes, attributes or point IDs.

Example 1 shows a GSI8 block sequence with the words for point ID (11), Easting coordinate (81) and Northing coordinate (82). Example 2 shows a GSI16 block sequence with the words for point ID (11), horizontal (21) and vertical angle (22).

Type	GSI8 Polar&Cart	GSI16 Polar	GSI16 Cartesian
WI 11	Point ID	Point ID	Point ID
WI 21	Hz	Hz	-
WI 22	V	V	-
WI 31	SlopeDist	SlopeDist	-
WI 51	PPM Total/mm	PPM Total/mm	-
WI 81	East	-	East
WI 82	North	-	North
WI 83	Elev.	-	Elev.
WI 87	Refl. Ht	-	Refl. Ht

Example 1: GSI8

Each word has 16 characters of which 8 characters are used for the data block.

Word 1	Word 2	Word 3
110001+0000A110	81..00+00005387	82..00-00000992
110002+0000A111	81..00+00007586	82..00-00003031
110003+0000A112	81..00+00007536	82..00-00003080
110004+0000A113	81..00+00003839	82..00-00003080
110005+0000A114	81..00+00001241	82..00-00001344

Example 2: GSI16

Each word has 24 characters of which 16 characters are used for the data block.

Word 1	Word 2	Word 3
*110001+000000000PNC0055	21.002+0000000013384650	22.002+0000000005371500
*110002+000000000PNC0056	21.002+0000000012802530	22.002+0000000005255000
*110003+000000000PNC0057	21.002+0000000011222360	22.002+0000000005433800
*110004+000000000PNC0058	21.002+0000000010573550	22.002+0000000005817600
*110005+000000000PNC0059	21.002+0000000009983610	22.002+0000000005171400

GSI Word information

Pos.	Name	Description of values	Applicable for
1-2	Word Index (WI)		
3	No significance	.: No information.	WI 11, WI 21, WI 22, WI 31, WI 51, WI 81, WI 82, WI 83, WI 87
4	Automatic index information	.: No information. 0: Tilt compensator: Off 3: Tilt compensator: On	WI 21, WI 22

Pos.	Name	Description of values	Applicable for
5	Input mode	.: No information. 0: Measured values transferred from instrument 1: Manual input from keyboard 2: Measured value, Hz correction: On. 3: Measured value, Hz correction: Off. 4: Result calculated from functions	WI 21, WI 22, WI 31, WI 51, WI 81, WI 82, WI 83, WI 87
6	Units	.: No information. 0: Distance: Metre (m) , last digit 1 / 1000 m 1: Distance: US ft (ft) last digit 1 / 1000 ft 2: Angle: 400 gon 3: Angle: 360° dec 4: Angle: 360°" 5: Angle: 6400 mil 6: Distance: Metre (m) , last digit 1 / 10000 m 7: Distance: US ft (ft) last digit 1 / 10000 ft	WI 21, WI 22, WI 31, WI 81, WI 82, WI 83, WI 87
7	Sign	+: Positive value -: Negative value	WI 21, WI 22, WI 31, WI 51, WI 81, WI 82, WI 83, WI 87
8-15 8-23	Data	Data includes a sequence of 8 (16) numerical or alphanumerical characters.  Certain data blocks are allowed to carry more than one value for example ppm/mm. This data is automatically transferred with the according sign before each single value.	WI 11, WI 21, WI 22, WI 31, WI 51, WI 81, WI 82, WI 83, WI 87
16 24	Separating character	: Blank	WI 11, WI 21, WI 22, WI 31, WI 51, WI 81, WI 82, WI 83, WI 87

Output format - Pt,N,E,Ht,Date

Format

Point ID, Northing, Easting, Elevation, Date, Time <CR/LF>

Description of fields

The format settings are defined in **Regional Settings**.

Field	Description
Point ID	Text describing the point identification
Northing	The Northing coordinate.
Easting	The Easting coordinate.
Elevation	The height coordinate.
Date	The measurement/origination date.
Time	The measurement/origination time.
<CR/LF>	Carriage Return Line Feed

Example

2004,4997.635,6010.784,393.173,09/10/2001,16:34:12.2
 2005,4997.647,6010.765,393.167,09/10/2001,16:34:12.4
 2006,4997.657,6010.755,393.165,09/10/2001,16:34:12.7

**Output format -
Pt,E,N,Ht,Date**

Format

This output format is identical to the Pt,N,E,Ht,Date format except the order of the Easting and Northing variables are reversed.

**Output format -
Pseudo NMEA GGA**

Description

This output format is based on NMEA (**N**ational **M**arine **E**lectronics **A**ssociation), which is a standard for interfacing marine electronic devices.

Format

\$GPGGA,Time,Northing,N,Easting,E,1,05,1.0,Elevation,M,0.0,M,0.0,0001*99 <CR/LF >

Description of Fields

Field	Description
\$GPGGA	Sentence identification (header including talker identification). A Talker ID appears at the beginning of the header of each NMEA message.
Time	UTC time of position (hhmmss.ss)
Northing	The Northing coordinate (always output with 2 decimal places)
N	Fixed text (N)
Easting	The Easting coordinate (always output with 2 decimal places)
E	Fixed text (E)
GPS Quality Indicator	Fixed number (1=no real-time position, navigation fix)
Number of satellites	Number of satellites in use (00 to 12)
HDOP	Fixed number (1.0)
Elevation	The height coordinate (always output with 2 decimal places)
Elevation units	Elevation units (F or M). The format settings are defined in Regional Settings .
Height Geoid	Fixed number (0.0)
Height units	Fixed text (M)
Time since last DGPS update	Fixed number (0.0)
DGPS Base station ID	Fixed number (0.0001)
Checksum	Fixed number (*99)
<CR/LF >	Carriage Return Line Feed

Example

\$GPGGA,171933.97,7290747.02,N,3645372.06,E,1,05,1.0,1093609.54,F,0.0,M,0.0,0001*99
\$GPGGA,171934.20,7290747.02,N,3645372.06,E,1,05,1.0,1093609.54,F,0.0,M,0.0,0001*99
\$GPGGA,171934.45,7290747.03,N,3645372.06,E,1,05,1.0,1093609.54,F,0.0,M,0.0,0001*99



Fields are always separated by a comma. A comma is never placed before the Checksum field. When information for a field is not available, the position in the data string is empty.

Description

The Remote connection allows the TS11/TS15/TS12 Lite/MS50/TS50/TM50 instrument to be steered remotely from a field controller where SmartWorx Viva is running. The settings on this screen define the port and the device used for the remote connection.

Field Controller Connection

Field Controller Connection
↩

Allow field controller to connect to this instrument

Connect using: Cable

Device: RS232

Hz: 79.6427g V: 99.9685g Fn abc 11:41

OK			Devce..
----	--	--	---------

Key	Description
OK	To accept changes and return to the screen from where this screen was accessed.
Devce..	Available unless Connect using: Cable is selected on TS50. To create, select, edit or delete a device. Refer to "21.2 Accessing Devices / GPRS Internet Devices".
Fn Quit	To exit the screen.

Description of fields

Field	Option	Description
Allow field controller to connect to this instrument	Check box	When this box is checked, the remote connection is activated.
Connect using	Cable	For TS11/TS15/TS12 Lite: The RS232 port. For MS50/TS50/TM50: The cable USB port.
	Radio handle	Hotshoe connection for RadioHandle. This port is located on top of Communication side cover.
	Bluetooth	The Bluetooth port on the TS11/TS15/TS12 Lite which is used.
	Cable RS232	The RS232 port on the MS50/TS50/TM50.
Device	Display only	The device currently assigned to the selected port.

Next step

When the connection is established, keys are locked except **Meas, Dist, Store. Dist** and **Store** have the same functionality as on the CS or as on the TS11/TS15/TS12 Lite/MS50/TS50/TM50 when it is independently controlled.

SmartWorx Robotic Screen | ↻

The Total Station is now remotely controlled.

Hz: 200.0000g
V: 101.8672g
Slope distance: ----m

Hz: 200.0000g V: 101.8672g Fn abc 09:09
Meas | **Dist** | **Store** | | |

19.16

GeoCom Connection TS

Description

The GeoCOM Mode permits communication of the TS11/TS15/MS50/TS50/TM50 with a 3rd party device.
 ☞ TS12 Lite can not communicate with a 3rd party device.

GeoCom Connection

GeoCom Connection | ↻

Allow GeoCom communication with this instrument
Connect using: Cable ▾
Device: RS232

Hz: 79.6425g V: 99.9684g Fn abc 11:47
OK | | | **Devce..** |

Key	Description
OK	To accept changes and return to the screen from where this screen was accessed.
Devce..	Available unless Connect using: Cable is selected on TS50. To create, select, edit or delete a device. Refer to "21.2 Accessing Devices / GPRS Internet Devices".
Fn Quit	To exit the screen.

Description of fields

Field	Option	Description
Allow GeoCom communication with this instrument	Check box	When this box is checked, the GeoCOM mode is activated.
Connect using	Cable Radio handle TS Bluetooth 1 and TS Bluetooth 2	For TS11/TS15/TS12 Lite: The RS232 port. For MS50/TS50/TM50: The cable USB port. Hotshoe connection for RadioHandle. This port is located on top of Communication side cover. The Bluetooth ports on the TS11/TS15 which can be used.

Field	Option	Description
	Cable RS232	The RS232 port on the MS50/TS50/TM50.
	WLAN	The WLAN port on the MS50/TS50/TM50.
Device	Display only	The device currently assigned to the selected port.

20

Connections.. - All other connections, Cntrl.. Key

20.1

Digital Cellular Phones

20.1.1

Overview

Description

For digital cellular phones, information such as

- the base stations that can be contacted
 - the phone numbers of the base stations and
 - the type of protocol to be used
- can be defined.

Changing the base station to be dialled is of interest in two cases.

- Case 1: Two real-time base stations, each equipped with a digital cellular phone, are set up at two locations belonging to different network providers.
When leaving the area of one base, the station can be changed and the other base can be called.
- Case 2: Set up as in case 1.
Two separate fixes from each base for each point can be obtained, providing redundancy for future least squares adjustment operations.

Technologies

- CDMA Code Division Multiple Access is a high speed data transmission for effective and flexible use of available resources such as bandwidth. Users of a cellular phone network occupy the same frequency band. The signal is especially coded for each user.
- GSM **Global System for Mobile Communications** is a more efficient version of CDMA technology that uses smaller time slots but faster data transfer rates. It is the world's most commonly used digital network.

20.1.2

Configuring a GSM Connection

Access

For RTK rover and TPS:

- In **Connection Settings**, highlight a connection which has a digital cellular phone of GSM technology attached. **Cntrl...**

For RTK base:

- In **Base Connection Settings**, highlight a connection which has a digital cellular phone of GSM technology attached. **Cntrl...**

GSM Dial-Up Connection, Dial-up details page

Key	Description
OK	To accept changes and return to the screen from where this screen was accessed.

Key	Description
Near	To find the nearest base station with a digital cellular phone of GSM technology. Available when base stations to dial are already created in Dial-up Connection List . Coordinates of these stations must be known.
Page	To change to another page on this screen. Available if the Internet connection is activated.
Fn Cmd..	To send AT commands to the digital cellular phone.
Fn Clear	Available on the Sim codes page. To set the additional editable fields to 0.
Fn Quit	To exit the screen.

Description of fields

Field	Option	Description
GSM device	Display only	Available for RTK rover and TPS. The type of digital cellular phone highlighted when this screen was accessed.
Dial-up connection	Selectable list	Available for RTK rover and TPS. The digital cellular phone base station to be dialled. Opening the selectable list accesses Dial-up Connection List where new base stations can be created and existing base stations can be selected or edited. Refer to "20.7 Configuring the Stations to Dial".
Number	Display only	Available for RTK rover and TPS. The number of the digital cellular phone at the selected Dial-up connection as configured in Dial-up Connection List .
Protocol	Display only	Available for RTK rover and TPS. The configured protocol of the digital cellular phone at the selected Dial-up connection as configured in Dial-up Connection List .
APN	Editable field	Available for RTK base with Internet capable devices. The Access Point Name of a server from the network provider, which allows access to data services. Contact your provider to get the correct APN.

Next step

Page changes to the **Sim codes** page.

GSM Dial-Up Connection, Sim codes page

Description of fields

Field	Option	Description
PIN code	Editable field	To enter the Personal Identification Number of the SIM card.
PUK code	Editable field	If the PIN is locked for any reason, for example the wrong PIN was entered, input the Personal UnblockK ing code for access to the PIN.

Next step

Page changes to the **Advanced** page.

GSM Dial-Up Connection, Advanced page

Description of fields

Field	Option	Description
Network data rate	Selectable list	The network baud rate. For digital cellular phones of GSM technology that do not support autobauding choose the baud rate from the selectable list.
	Autobauding	Select this option for an automatic search of the network baud rate.
Use transparent mode	Check box	Define if the digital cellular phone uses Radio channel Protocol. Check for digital cellular phones that do use transparent mode. Uncheck for digital cellular phones that use RLP. Check with the network provider if the digital cellular phone uses transparent mode or not.
Manually select cell-phone network	Check box	Available for digital cellular phone devices unless they are in data mode. When this box is checked, the currently selected network provider is displayed and the Search key is available. Press Search for a list of all available networks and to select a specific network.

Next step

Page changes to another page on this screen.

20.1.3

Configuring a CDMA Connection

Access

For RTK rover and TPS:

- In **Connection Settings**, highlight a connection which has a digital cellular phone of CDMA technology attached. **Cntrl...**

For RTK base:

- In **Base Connection Settings**, highlight a connection which has a digital cellular phone of CDMA technology attached. **Cntrl...**

CDMA Connection

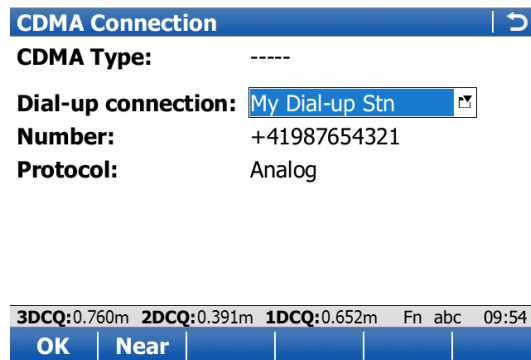

Key	Description
OK	To accept changes and return to the screen from where this screen was accessed.

Key	Description
Near	To find the nearest base station with a digital cellular phone of CDMA technology. Available when base stations to dial are already created in Dial-up Connection List . Coordinates of these stations must be known.
Fn Info	To provide information about the CDMA device being used, such as the manufacturer, the model and the electronic serial number.
Fn Reg	To register the settings of the CDMA digital cellular phone over the air. For US and Canada only. Available when the registration process must be done manually.
Fn Cmnd..	To send AT commands to the digital cellular phone.
Fn Quit	To exit the screen.

Description of fields

Field	Option	Description
CDMA Type	Display only	The type of digital cellular phone highlighted when this screen was accessed.
Dial-up connection	Selectable list	The digital cellular phone base station to be dialed. Opening the selectable list accesses Dial-up Connection List where new base stations can be created and existing base stations can be selected or edited. Refer to "20.7 Configuring the Stations to Dial".
Number	Display only	The number of the digital cellular phone at the selected Dial-up connection as configured in Dial-up Connection List .
Protocol	Display only	The configured protocol of the digital cellular phone at the selected Dial-up connection as configured in Dial-up Connection List .

Next step

Fn Info changes to **CDMA Information**.

CDMA Information

Description of fields

Field	Option	Description
Manufact	Display only	The manufacturer of the CDMA device being used.
Model	Display only	The model of the CDMA device being used.
ESN No.	Display only	Electronic Serial Number For registration purposes, send the electronic serial number to the network provider in order to receive the service programming code and the mobile directory number. These numbers must be typed in CDMA Registration .

Next step

Step	Description
1.	Press Print to print all information to a file CDMA Info.log in the \DATA directory on the data storage device.
2.	Press OK to return to CDMA Connection .
3.	For US and Canada only: Press Reg to access CDMA Registration .

CDMA Registration

The settings allow the CDMA digital cellular phone to be registered over the air.

Description of fields

Field	Option	Description
MSL/SPC	Display only	The S ervice P rogram C ode provided by the network provider.
MDN	Display only	The M obile D irectory N umber provided by the network provider
MSID/MIN	Display only	M obile S tation I dentity Number and M obile I dentification Number. Another 10-digit number to identify the mobile phone. Sometimes identical with the MDN.

Next step

OK to return to **CDMA Connection**.

20.2

Modems

Description

For modems, information such as

- the base stations that can be contacted and
- the phone numbers of the base stations can be controlled.

Changing the base station to be dialled is of interest in two cases.

- Case 1: Two real-time base stations, each equipped with a digital cellular phone, are set up at two locations belonging to different network providers. When leaving the area of one base, the station can be changed and the other base can be called.
- Case 2: Set up as in case 1. Two separate fixes from each base for each point can be obtained, providing redundancy for future least squares adjustment operations.

Access

For RTK rover and TPS:

- In **Connection Settings**, highlight a connection which has a modem attached. **Cntrl...**

For RTK base:

- In **Base Connection Settings**, highlight a connection which has a modem attached. **Cntrl...**

Modem Dial-up Connection

Modem Dial-up Connection ↻	
Modem:	Manufact ModelId
Dial-up connection:	My Dial-up Stn <input type="text"/>
Number:	+41987654321
Protocol:	Analog

3DCQ:0.008m 2DCQ:0.004m 1DCQ:0.007m Fn abc 09:54

OK	Near			
----	------	--	--	--

Key	Description
OK	To accept changes and return to the screen from where this screen was accessed.
Near	To find the nearest base station with a modem. Available when base stations to dial are already created in Dial-up Connection List . Coordinates of these stations must be known.
Fn Cmnd..	To send AT commands to the modem.
Fn Quit	To exit the screen.

Description of fields

Field	Option	Description
Modem	Display only	The type of modem highlighted when this screen was accessed.
Dial-up connection	Selectable list	The modem base station to be dialled. Opening the selectable list accesses Dial-up Connection List where new base stations can be created and existing base stations can be selected or edited. Refer to "20.7 Configuring the Stations to Dial".
Number	Display only	The number of the modem at the selected Dial-up connection as configured in Dial-up Connection List .
Protocol	Display only	The configured protocol of the modem at the selected Dial-up connection as configured in Dial-up Connection List .

20.3

Radios for GPS Real-Time

Description

For radios the channels on which the radio broadcasts can be changed. Changing channels changes the frequency at which the radio operates. Not all radios support channel changing.

Changing radio channels is of interest in three cases.

- Case 1: Two real-time base stations are set up at two locations, each broadcasting on a different channel. If the signal from one base station is jammed, the channel can be changed and the other base can be used.
- Case 2: Set up as in case 1. Two separate fixes for each point can be obtained, providing redundancy for future least squares adjustment operations.
- Case 3: One real-time base and one real-time rover are being used. If the signal is blocked due to radio interference, the channel at the base and the rover can be changed in order to work on a different frequency.

Requirements for channel changing

- Pacific Crest radios:
- channel changing must be activated by a Pacific Crest dealer.
 - A special licence might be required.
- Satellite radios: The radio must be in programming mode. This mode can be set by a Satellite dealer.



Channel changing may contravene radio broadcasting regulations in certain countries. Before operating with radios, check the regulations in force in the working area.



The number of channels available and the frequency spacing between channels depends on the radio used.



If channel changing is to be used, when configuring the base real-time connection, set **RTK base ID** in **RTK base settings (RTK1)/RTK base settings (RTK2), Data rates** page to a different ID for each base site. By doing so, the rover can recognise if the incoming real-time data after channel changing is being received from a different base station or if the original base station is using a new frequency. In the first case, the ambiguities are recomputed.

Access

For RTK rover and TPS:

- In **Connection Settings**, highlight a connection which has a radio attached. **Cntrl...**

For RTK base:

- In **Base Connection Settings**, highlight a connection which has a radio attached. **Cntrl...**

Radio Configuration

Key	Description
OK	To accept changes and return to the screen from where this screen was accessed.
Scan	To provide information such as the station ID, latency and the data format of incoming signals from base stations broadcasting on the same radio channel. This information can be used to select appropriate base stations to dial.
Fn Quit	To exit the screen.

Description of fields

Field	Option	Description
Radio type	Display only	The type of radio highlighted when this screen was accessed.
Channel	Editable field	The radio channel. The channel used must be within minimum and maximum allowed input values. The minimum and maximum allowed input values for a radio depend on the number of channels supported by the radio and the spacing between the channels.
Actual frequency	Display only	Available for Radio type: Satellite 3AS . Displays the actual frequency of the radio.

Field	Option	Description
Use different protocol	Check box	Available when a Satellite radio is selected as Radio type . When this box is checked, the Satellite radio can transmit data to and receive data from a Pacific Crest radio. The radio is configured accordingly online. The radio need not be connected to a PC and no configuration software is needed. When this box is not checked and OK is pressed the device switches to the standard Satel 3AS/3ASd mode.
Modulation type	Pac Crest GMSK or Pac Crest 4FSK	Defines the settings supported on Pacific Crest radios. Refer to the next table. Available when Use different protocol is checked.

**Settings for Modulation type: Pac Crest GMSK and
Modulation type: Pac Crest 4FSK**

Setting	Modulation type/Channels with channel spacing			
	Pac Crest GMSK/25 kHz	Pac Crest GMSK/12.5 kHz	Pac Crest 4FSK/25 kHz	Pac Crest 4FSK/12.5 kHz
Protocol Type	Transparent with EOT Timeout	Transparent with EOT Timeout	Transparent with EOT Timeout	Transparent with EOT Timeout
Link Rate	19200	9600	9600	4800
Modulation Type	4FSK	4FSK	GMSK	GMSK
Use Forward Error Correction	ON	ON	ON	ON

Next step

Scan to access **Scan for Base Station**.

Scan for Base Station

This screen provides information about the base stations, with specific types of devices attached, for example a radio, from which real-time corrections are being received. This information can also be useful for finding out if anyone else in the area is using a particular radio channel.

Scan for Base Station		
Stn Id	Latency(s)	RTK format
1	0.09	Leica 4G

3DCQ:7.273m	2DCQ:4.041m	1DCQ:6.047m	Fn ABC	17:10
OK	Chnl-1	Chnl+1		

Key	Description
OK	To select the highlighted base station and to continue with the subsequent screen.

Key	Description
Chnl-1 and Chnl+1	Available for scanning base stations with radios attached. To switch the radio to one channel lower/higher than the current channel. The base stations displayed change to those broadcasting on the new channel.

Description of columns

Column	Description
Station ID	Station ID of available base stations from which a signal is being received. For radios, the base station radios transmitting on the same channel will be listed.
Latency(s)	Time delay, in seconds and configured on the base, from when the base collects the data to when the data is transmitted.
RTK data format	Format of the data from the base station. Refer to "19.8.1 Configuration of a Reference Real-Time Connection" for more information about data formats.

20.4

Radios for Remote Control

Description

For radios the channels on which the radio broadcasts can be changed. Changing channels changes the frequency at which the radio operates. This change in frequency can be necessary to enable multiple pairs of radios to work simultaneously in the same area without interfering with each other.

Access

For TPS:

- In **Connection Settings**, highlight a connection which has an internal radio, a TCPS or a GFU attached. **Cntrl...**

Internal radio



Internal radio | ↻

Radio type: Internal radio
Link number: 1
Set as: Base ▾

3DCQ:0.010m 2DCQ:0.006m 1DCQ:0.008m Fn abc 10:25
 OK | | | Default

Key	Description
OK	To accept changes and return to the screen from where this screen was accessed.
Default	To change to the default radio settings.
Fn Save	To save the radio settings.
Fn Quit	To exit the screen.

Description of fields

Field	Option	Description
Radio type	Display only	The type of radio device selected for the connection.
Link number	Editable field	The assigned channel number.  The channel number for the field controller and the radio must be the same. The communication settings for the field controller and the radio must also be same.
Set as	Remote or Base	 The radio modules inside the field controller and the radio must be set to opposite settings. It is recommended to set the field controller to Remote and the radio to Base .

20.5

RS232

Description

RS232 is a standard serial communication method that is able to transfer data without the need for predefined time slots.

Access

For RTK rover and TPS:

- In **Connection Settings**, highlight a connection which has an RS232 device attached. **Cntrl...**

For RTK base:

- In **Base Connection Settings**, highlight a connection which has an RS232 device attached. **Cntrl...**

RS232 Connection

Displayed is the type of device highlighted when this screen was accessed.

20.6

Internet

Description

Internet

The Internet connection allows connection to the Internet to receive real-time data. A GPRS / Internet device must be attached to the instrument.

Requirements

For Internet

- Check **Use Internet connection on GS** in **Internet Connection**.
- An Internet port must be selected in **RTK base settings (RTK1)/RTK base settings (RTK2)** or **RTK Rover Settings**.

Access

For RTK rover:

- In **Connection Settings**, highlight a connection which has an Internet device attached. **Cntrl...**

For RTK base:

- In **Base Connection Settings**, highlight a connection which has an Internet device attached. **Cntrl...**

Internet Port Connection

Internet Port Connection | ↻

Internet port: GS Internet 1

Server to use: MyServer

NTRIP mountpoint: MAX-RTCM3

Press Source to get a list of mountpoints

3DCQ:0.008m 2DCQ:0.005m 1DCQ:0.007m Fn abc 10:35

OK | | | Source

Key	Description
OK	To accept changes and return to the screen from where this screen was accessed.
Fn Quit	To exit the screen.

Description of fields

Field	Option	Description
Internet port	Display only	The name of the Internet port attached to the connection that was highlighted when this page was accessed.
User type	Selectable list Client	How the instrument will operate in the Internet. Available for RTK base. Must be selected when using Ntrip as Internet application. Inside the Internet, Ntrip Clients and Ntrip Servers are considered as clients.
Server to use	Selectable list	The server to be accessed in the Internet. Opening the selectable list accesses Server to Connect where new servers can be created and existing servers can be selected or edited.
NTRIP mountpoint	Editable field	Mountpoints are the Ntrip servers sending out real-time data.

Next step

Select **Source** to access **NTRIP Source Table**.

Highlight a mountpoint about which more information is required. This information helps to configure the instrument to use the selected mountpoint as a base. Press **Info** to access **Mountpoint**.

Mountpoint, General page

Description of fields

Field	Option	Description
Identifier	Display only	The name of the selected Mountpoint.
Format	Display only	The real-time data format sent out by the Mountpoint.
Format details	Display only	Details about Format , for example the RTCM message types including update rates in seconds displayed in brackets.
Authentic		The type of password protection required for the authorisation to the Ntrip server.

Field	Option	Description
	None	If no password is required.
	Basic	If the password does not require encryption.
	Digest	If the password must be encrypted.
NMEA	Display only	Indicates if the Mountpoint must receive GGA NMEA data from the rover in order to compute VRS information.
Charges	Display only	Indicates if charges are currently made for the connection.
Carrier	Display only	The type of carrier message sent out.
System	Display only	The type of satellite system supported by the Mountpoint.

Next step

Page changes to the **Location** page.

**Mountpoint,
Location page**

Detailed information about the location of the Mountpoint is displayed.

Next step

Page changes to the **Miscell** page.

**Mountpoint,
Miscell page**

Description of fields

Field	Option	Description
Generator	Display only	The hard- or software generating the data stream.
Compress	Display only	The name of the compression / encryption algorithm.
Bitrate	Display only	The data speed in bits per second.
Info	Display only	Miscellaneous information if available.

Next step

OK to return to the previous screen.

20.7

20.7.1

Configuring the Stations to Dial GPS

Accessing Dial-up Connection List

Description

Dial-up Connection List allows new stations to be created, provides a list of base stations that can be dialed and allows existing stations to be edited. For digital cellular phones of any technology and for modems, the phone numbers of the device at the base station must be known. For a base station to be dialed, a name, the phone number and, if available, the coordinates can be configured. The configuration is possible for rover and base digital cellular phones and modems.

Access step-by-step

Step	Description
1.	In Connection Settings , highlight a connection which has a digital cellular phone of any technology or modem attached.
2.	Cntrl...
3.	Open the selectable list for Dial-up connection .

Dial-up Connection List

Dial-up Connection List	
Name	Number
<None>	-----
My Dial-up Stn	+41987654321

3DCQ:0.010m	2DCQ:0.005m	1DCQ:0.008m	Fn abc	10:11
OK	New..	Edit..	Delete	

Key	Description
OK	To select the highlighted station and to return to the screen from where this screen was accessed.
New..	To create a new station. Refer to "20.7.2 Creating / Editing a Station to Dial".
Edit..	To edit a station. Refer to "20.7.2 Creating / Editing a Station to Dial".
Delete	To delete the highlighted station.
Fn Quit	To exit the screen.

Description of columns

Column	Description
Name	Name of all available base stations.
Number	Phone number of the station to dial.

Access

In **Dial-up Connection List** press **New..** or **Edit..**

New Dial-up Connection

New Dial-up Connection	
Name:	Stn 01
Number:	+41123456789
Protocol:	Analog
Use coordinates:	Yes
WGS84 X:	100.000 m
WGS84 Y:	200.000 m
WGS84 Z:	1.941 m
3DCQ:0.009m 2DCQ:0.005m 1DCQ:0.008m Fn abc 10:09	
Store	Coord

Key	Description
Store	To return to the screen from where this screen was accessed.
Coord	To view other coordinate types.
Fn Quit	To exit the screen.

Description of fields

Field	Option	Description
Name	Editable field	A unique name for the new base station to be dialled. The name can be up to 16 characters long and include spaces. Input optional.
Number	Editable field	The number of the base station to dial. If the survey is to be undertaken across country borders it is necessary to input the phone number using standard international dialling codes. For example, +41123456789. Otherwise it can be input as a standard digital cellular phone number.
Protocol	Analog ISDN v.110 or ISDN v.120	Available for digital cellular phones of GSM technology. The configured protocol of the digital cellular phone of GSM technology. For conventional phone networks. For GSM networks.
Use coordinates	Selectable list	Select Yes to type in the approximate coordinates of the base station.

20.8
20.8.1

Configuring the Server to Connect GPS
Accessing Server to Connect

Description

Server to Connect allows new servers to be created, provides a list of servers that can be accessed in the Internet and allows existing servers to be edited.

Access step-by-step

Step	Description
1.	In Connection Settings , highlight a connection which has an Internet connection attached.
2.	Cntrl...
3.	Open the selectable list for Server name .

Server to Connect

Server to Connect	
Name	IP address
MyServer	www.myserver.com

3DCQ:6.734m	2DCQ:3.759m	1DCQ:5.588m	Fn abc	10:17
OK	New..	Edit..	Delete	More

Key	Description
OK	To select the highlighted server and to return to the screen from where this screen was accessed.
New..	To create a new server. Refer to "20.8.2 Creating / Editing a Server".
Edit..	To edit a server. Refer to "20.8.2 Creating / Editing a Server".
Delete	To delete the highlighted server.
More	To change between the IP Address and the TCP/IP Port of the server.
Fn Quit	To exit the screen.

Description of columns

Column	Description
Name	Name of all available servers.
IP address	IP addresses of all available servers.
TCP/IP port	TCP/IP Port numbers of all available servers.

Access

In **Server to Connect** press **New..** or **Edit...**

New Server,
General page

Key	Description
Store	To return to the screen from where this screen was accessed.
Page	To change to another page on this screen.
Fn Quit	To exit the screen.

Description of fields

Field	Option	Description
Name	Editable field	A unique name for the new server to be accessed. The name can be up to 16 characters long and include spaces.
Address	Editable field	Type in the host name or the IP address of the server to be accessed in the Internet.
Port	Editable field	The port of the Internet server through which the data is provided. Each server has several ports for various services.

Next step

Page changes to the **NTRIP** page.

New Server,
NTRIP page

Description of fields

Field	Option	Description
Use NTRIP	Check box	Check to activate Ntrip.
User ID	Editable field	A user ID is required to receive data from to the Ntrip Caster. Contact the Ntrip administrator for information.
Password	Editable field	A password is required to receive data from the Ntrip Caster. Contact the Ntrip administrator for information.

Next step

Store to store the settings.

21 Configuration of Devices

21.1 Devices

21.1.1 Overview

Description Before using any device, it is necessary to configure the interface with which it will be used. Refer to "19.1 Accessing Configuration Connections" for information on how to configure the interfaces.

Some devices can be used with different interfaces for different applications. For example:

- **GPS** A radio can be used to receive real-time base data but a second radio could also be used to output simultaneous NMEA messages.
- **TPS** A radio can be used for remote control with a TPS but also to send GeoCOM commands from a computer to a TPS.

21.1.2 Digital Cellular Phones

Description Digital cellular phones comprise of the technologies CDMA and GSM.

- Typical uses**
- To transmit real-time data.
 - To receive real-time data.
 - To download raw observations from a remote location.
 - To steer an instrument.

Example use

Step	Description
1.	Base and rover must both be equipped with a digital cellular phone.
2.	Ensure that the digital cellular phone at the base is on.
3.	The rover digital cellular phone contacts the selected base of which the phone number was pre-defined. Refer to "21.3 Creating/Editing a Device".
4.	One rover can dial in to the base digital cellular phone at a time.
5.	As soon as the base digital cellular phone is contacted, real-time data is sent to the rover digital cellular phone that has called.
	Several digital cellular phone numbers can be pre-defined on the rover. Dialling a different number dials that particular base station.

Requirements for using digital cellular phones

- Always required:
- AT command language must be supported by the digital cellular phone.
 - Working area must be covered by a digital cellular phone network.
 - The network operator must support data transmission.
- Sometimes required:
- SIM card. This SIM card is the same as is normally used in mobile phones. The SIM card must be enabled to transmit data. Contact the service provider to enable the SIM card.
 - **Personal Identification Number**
 - Registration

Supported digital cellular phones

Some digital cellular phones are predefined. Other digital cellular phones can be used. Their settings must be defined by creating a new digital cellular phone configuration. Refer to "21.3 Creating/Editing a Device". These digital cellular phones must be connected with a cable or Bluetooth. Refer to "Appendix E Cables" for information on cables. Please contact the local selling unit or dealer for further information.

Advantages

- Unlimited range of the data channel between base and rover.
- Free of jamming from other users.
- Cheaper in price in the initial costs of buying.

Disadvantages

Fees are charged for the time that the digital cellular phone network is being used.



Base and rover can both be equipped with a digital cellular phone and a radio. On the base, they operate simultaneously. On the rover, use the radio when within radio range of the base and the digital cellular phone when radio reception is not possible.

21.1.3

Modems

Typical uses

- To transmit NMEA messages.
- To download raw observations from a remote location.
- To transmit real-time data.

Example of use

Step	Description
1.	The base is equipped with a modem.
2.	The rover is equipped with a digital cellular phone.
3.	Ensure that the modem is switched on.
4.	The rover digital cellular phone contacts the selected base of which the phone number was pre-defined. Refer to "21.3 Creating/Editing a Device".
5.	One rover can dial in to the base modem at a time.
6.	As soon as the base modem is contacted, it sends its data to the rover digital cellular phone that has called.
	Several modem numbers can be pre-defined on the rover. Dialling a different number changes the base station.

Requirements for using modem

AT command language must be supported by the modem.

Supported modems

Some modems are predefined. Modems must be connected with a cable. Other modems can be used. Their settings must be defined by creating a new modem configuration. Refer to "21.3 Creating/Editing a Device".

21.1.4 Radios for Real-Time GPS

Typical uses

- To transmit real-time data.
- To receive real-time data.
- To steer an instrument.

Example of use

Step	Description
1.	Base and rover must both be equipped with radios using the same frequency range and the same data format.
2.	The base radio continuously sends out real-time data until the instrument is turned off, the configuration is changed or the radio is detached.
3.	The rover radio continuously receives real-time data until the instrument is turned off, the configuration is changed or the radio is detached.
4.	Several rovers can receive data from the same base at the same time.
	Several base radios can transmit real-time data simultaneously using different radio channels. Changing to a different radio channel on the rover changes the base from which real-time data is received.

Supported radios

Some radios are predefined.

Other radios can be used. Their settings must be defined by creating a new radio configuration. Refer to "21.3 Creating/Editing a Device". These radios must be connected with a cable.



Base and rover can both be equipped with a digital cellular phone and a radio. On the base, they operate simultaneously. On the rover, use the radio when within radio range of the base and the digital cellular phone when radio reception is not possible.

21.1.5 Radios for Remote Control TPS

Typical uses

- To remote control the TPS.
- To transmit data between a TPS and computer.

Supported radios

- The default radios used with TPS for remote control are the internal radio CTR16, the RadioHandle and the external radios TCPS. The TPS has to be set to the correct communication mode to send and receive data and commands via the radio.
- A Communication side cover must be fitted to the TPS when operating with the RadioHandle.

User defined radios

Other radios than the default radios can be used. Their settings must be defined by creating a new radio configuration. Refer to "21.3 Creating/Editing a Device". These radios must be connected with a cable. Refer to "Appendix E Cables" for information on cables.

21.1.6 RS232

Standard RS232

Standard RS232 is supported by default. The settings are:

Baud rate:	115200	Stop bits:	1
Parity:	None	Flow control:	None
Data bits:	8		

USB

USB is supported on the MS50/TS50/TM50. The USB interface on port 1 can be used to:

- connected to the CS via the USB interface.
- configure **GeoCom Connection** (cable). USB and serial interface are possible.
- configure **GSI Output Connection** (cable). USB and serial interface are possible.
- configure **Export Job Connection** (cable). USB and serial interface are possible.

If cable is selected (serial – RS232), then the USB interface is also available. If USB is selected, the serial interface is also available but with the default respectively previously set parameters.



The IP address of the RNDIS interface of the MS50/TS50/TM50 cannot be changed within SmartWorx Viva. Use Windows CE to change the IP address, for example when connecting two instruments via USB to the same PC.

21.1.8

Hidden Point Measurement Devices**Typical uses**

To measure

- distances (reflectorless distance measurements using laser technology)
- angles
- azimuths

to points which are not directly accessible with GPS, for example house corners or trees. If the device is connected to the instrument, the measurements taken with hidden point measurement devices are directly transferred. If the device is not connected, measurement can be typed in manually to calculate the coordinates of a hidden point.

Example of use

Step	Description
1.	An instrument must be a rover with or without real-time configuration.
2.	A hidden point measurement device is connected to the instrument via cable or Bluetooth.
3.	Hidden point measurements are configured and activated.
4.	Distances, angles and azimuths are measured to the hidden point with the hidden point measurement device.
5.	The measurements are directly transferred to the instrument and displayed in the appropriate fields.
	Hidden point measurement devices can be connected in addition to any of the other devices. They can be active at the same time. Changing of ports is not required.

Supported hidden point measurement devices

Some devices are predefined.

Hidden point measurement devices of the same type but with different settings must be defined by creating a new hidden point measurement device. Refer to "21.3 Creating/Editing a Device".

Description GPRS is a telecommunication standard for transmitting data packages using the Internet Protocol.
When using GPRS technology, charges are made based on the amount of transferred data and not, as per normal digital cellular phones, for the connection time.

Typical uses To access the Internet with an instrument in order to receive real-time data from the Internet.

Example use

Step	Description
	The following is an example use for receiving data from the Internet.
1	Rover must be equipped with a GPRS / Internet device.
2	The GPRS / Internet device accesses the Internet where the rover connects for example to Ntrip.
3	The rover receives real-time corrections via the Internet.

Requirements for using GPRS / Internet devices

- AT command language must be supported by the digital cellular phone.
- **Access Point Name** of a server from the network provider. The APN can be thought of as the home page of a provider supporting GPRS data transfer.
- SIM card. This SIM card is the same as is normally used in mobile phones. The SIM card must be enabled to transmit data. Contact the service provider to enable the SIM card.
- **Personal Identification Number**
- Registration

Supported GPRS / Internet devices

Some GPRS/Internet devices are predefined. Other GPRS capable devices can be used as long as they use AT commands. Their settings must be defined by creating a new device configuration. Refer to "21.3 Creating/Editing a Device". Please contact the local selling unit or dealer for further information.

Advantages

- Unlimited range of the data channel between base and rover.
- Free of jamming from other users.
- Fees are charged for the amount of data being transferred.

Description Allows devices to be created, edited, selected and deleted.

Access step-by-step

Step	Description
1.	For RTK rover and TPS: <ul style="list-style-type: none"> • Select Main Menu:Instrument\Connections..\All other connections. For RTK base: <ul style="list-style-type: none"> • Select Main Menu:Base connections\Connections..\All other connections.
2.	Highlight the appropriate interface based on the type of device to be configured. For example, highlight RTK Rover when a radio is to be configured.
3.	Edit...
4.	Activate the interface by checking the check box.
5.	Devce.. to access Devices.

Devices

This screen may consist of several pages and provides different devices for selection depending on which interface the screen was accessed from. The functionality described here is always the same.

Connection Settings		
CS connections	Rover connections	
Connection	Port	Device
CS Internet	-	-
GPS Rover	Cable	GS
ASCII Input	-	-
GPS Hidden Pt	-	-
Export Job	-	-

3DCQ:----m	2DCQ:----m	1DCQ:----m	abc	16:21
OK	Edit..			Page

Key	Description
OK	To select the highlighted device and return to the screen from where this screen was accessed.
New..	To create a new device. Refer to "21.3 Creating/Editing a Device".
Edit..	To edit the highlighted device. Refer to "21.3 Creating/Editing a Device".
Delete	To delete the highlighted device.
More	To display information about the type of device and the creator of the device.
Page	To change to another page on this screen.
Fn All or Fn Filter..	Available for Internet and Bluetooth devices. To list all devices or to hide devices which are not Internet or Bluetooth capable.
Fn Default	To recall previously deleted default devices and to reset default devices to the default settings.
Fn Quit	To exit the screen.

Description of columns

Column	Description
Name	Names of available devices.
Type	Type of device defined when creating the device.
Creator	The creator of the device. The creator can be either Default if the device is a default, or User if the device has been created.  If a Default device is edited by using Edit.. then its creator is still displayed as Default .

Description

Allows a new device to be configured or an existing device to be edited.

Access

In **Devices**, highlight a device of the same type as the device to be created, from the list. Press **New..** or **Edit..**

New Device or Edit Device

New Device | ↩

Name:

Type: Satel 2ASx

Baud rate:

Parity:

Data bits:

Stop bit:

Flow control:

Hz: 50.0001g V: 99.9999g abc 09:56

Store | | | | |

Edit Device: CS 3.5G modem | ↩

Name: CS 3.5G modem

Type: UMTS

Use this device for internet

Use UMTS network if available

3DCQ:-:---m 2DCQ:-:---m 1DCQ:-:---m Fn abc 16:38

Store | | | **AT Msg** | **Default** |

Key	Description
Store	To store the new device and to return to the screen from where this screen was accessed.
AT Msg	Available for digital cellular phones and modems. To configure communication commands.
Fn Quit	To exit the screen.

Description of fields

Field	Option	Description
Name	Editable field	Name of new device.
Type	Display only	Same device type as was highlighted when New.. or Edit.. was used.
Use this device for Internet (use GPRS)	Check box	Available for digital cellular phones and modems. Defines the device as an Internet capable device and adds it to the list in GPRS Internet Devices .
Use UMTS network if available	Check box	In case of using GSM only modems together with modems, which are UMTS capable, this option must be disabled.

Field	Option	Description
Baud rate	From 1200 to 230400	Frequency of data transfer from instrument to device in bits per second. Unavailable for CS 3.5G modem.
Parity	None, Even or Odd	Error checksum at the end of a block of digital data. Unavailable for CS 3.5G modem.
Data bits	6, 7 or 8	Number of bits in a block of digital data. Unavailable for CS 3.5G modem.
Stop bit	1 or 2	Number of bits at the end of a block of digital data. Unavailable for CS 3.5G modem.
Flow control	None or Flow control	Activates hardware handshake. When the instrument/device is ready for data, it asserts the Ready To Send line indicating it is ready to receive data. This line is read by the sender at the Clear To Send input, indicating it is clear to send the data. Unavailable for CS 3.5G modem.

Next step

IF the device is a	THEN
radio or device other than digital cellular phone or modem	Store to close the screen and to return to the screen from where this screen was accessed.
digital cellular phone or modem	AT Msg.

AT Msg

For **Use this device for Internet (use GPRS)** checked in **New Device** or **Edit Device**, this screen consists of two pages:

GSM/CSD page: The AT commands configure the devices for normal digital cellular phone/modem mode.

GPRS/Internet page: The AT commands configure the devices for GPRS/Internet mode. Please refer to the manual of the GPRS / Internet device for information about which AT commands must be entered or contact the supplier.

The following table lists the fields of both pages.

Description of fields

Field	Option	Description
Initialisation 1	Editable field	Initialisation sequence to initialise digital cellular phone/modem. When the device is used, between Initialisation 1 and Initialisation 2 , a check for the PIN is performed.
(continued)	Editable field	Allows the Initialisation 1 , Initialisation 2 or the Connect string to continue onto a new line.
Initialisation 2	Editable field	Initialisation sequence to initialise digital cellular phone/modem.
Dial	Editable field	Dialling string used to dial the phone number of the real-time base.

Field	Option	Description
Hang-up	Editable field	Hangup sequence used to end the network connection.
Escape	Editable field	Escape sequence used to switch to the command mode before using the hangup sequence.
Connect	Editable field	Dialling string used to dial into the Internet.

Next step

Store returns to **New Device** or **Edit Device**.

22

Instrument - Instrument status info

22.1

Status Functions



The Status functions for the GPS RTK base menu, the GPS rover menu and for TPS are similar. The functions are described in the same chapters, differences are outlined.

Description

The STATUS functions help using the instrument by showing the state of many instrument functions. All fields are display only fields. Unavailable information is indicated by -----.

Access

- For RTK base:
Select **Main Menu: Instrument\Base status info.**
- For RTK rover and TPS:
Select **Main Menu: Instrument\Instrument status info.**

Status Menu

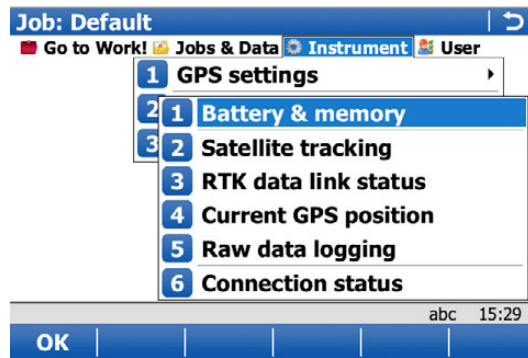

Key	Description
OK	To select the highlighted option and to continue with the subsequent screen.

Description of the Status functions

STATUS function	Description	Refer to chapter
Battery & memory	Information related to usage and status of battery and memory.	"22.2 Battery & memory"
Satellite tracking	<ul style="list-style-type: none"> • Information related to the satellites ordered by the elevation angle. • A skyplot shows satellite information in a graphical way. • Another page shows the date of the used almanacs, and, as shown on the skyplot, the number of satellites tracked and the number of satellites available above the cut-off elevation mask. 	"22.3 Satellite tracking"
RTK data link status	Information related to real-time data, for example the data link and the device used to transfer real-time data.	"22.4 RTK data link status"
Current GPS position	Information related to the current antenna position and the speed of the antenna.	"22.5 Current GPS position"
Raw data logging	Information related to logging of raw observations.	"22.6 Raw data logging"

STATUS function	Description	Refer to chapter
Connection status	<ul style="list-style-type: none"> Information related to the configuration and use of interfaces, ports and devices. Information related to the incoming data from active devices. 	"22.7 Connection status"
TPS TPS current station info	Information related to the current station set on the instrument.	"22.9 TPS current station info"

22.2

Battery & memory

Access

Besides the standard access from the **Instrument status info/Base status info** menu, access is also possible by tapping the battery icon.

Battery & Memory

This description is valid for all pages of the screen. For the **GPS base** page, the information that is displayed depends on the real-time message.

Leica/Leica 4G: Transfers precise values for all fields.

RTCM: Transfer of any of the information not part of the message.

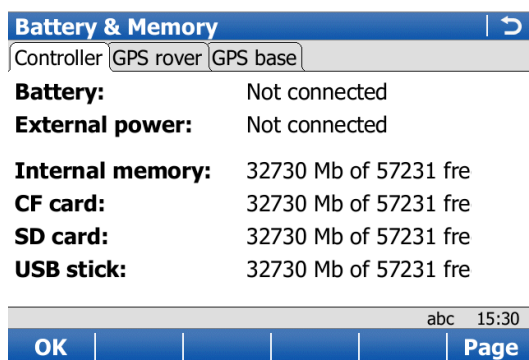

CMR/CMR+: Transfers general status information such as O.K. and Low.

For GS05/GS06/GS08plus, the **GPS rover** page is unavailable.



Key	Description
Page	To change to another page on this screen.
Fn Quit	To exit the screen.

Description of fields

Field	Description
Battery, Battery 1 or Battery 2	<p>The percentage of remaining power capacity for the battery is displayed numerically. If no information for a field is available, for example no battery is inserted, then 0% is displayed.</p> <p> On the MS50/TS50/TM50, if the battery gets charged (charging) is stated behind the percentage of the battery power level.</p> <p> When the battery is getting low on the TS, a warning message is displayed on the CS.</p>
External power	Shows if an external power supply is connected.

Field	Description
Internal memory, CF card, SD card or USB stick	The total/free memory for data storage on the data storage device. If no information for a field is available, for example no data storage device is inserted, then ----- is displayed.

22.3

Satellite tracking [GPS]

Description

This screen shows information related to the satellites ordered by the elevation angle.

Access

Besides the standard access from the **Instrument status info/Base status info** menu, access is also possible by tapping the number of visible satellites icon.

Satellite Tracking: RTK rover, GPS/Glonass/Galileo page

Sat	Elev	Azmth	S/N L1	S/N L2
G23	84	79	50	44
G13	60	225	48	40
G20	55	91	47	39
G04	48	298	47	39
G32	29	91	43	34
G25	28	167	43	32
G17	19	236	--	--
G31	12	34	41	29

3DCQ:0.015m 2DCQ:0.008m 1DCQ:0.013m abc 14:17

OK Base Hlth.. Page

Key	Description
OK	To return to the Main Menu .
Base / Rover	To change between the SNR values of rover and base.
Hlth..	To view the numbers of satellites categorised in good, bad and unavailable.
Page	To change to another page on this screen. The Galileo page is unavailable with GS08plus.
More	To display information about the SNR values for GPS satellites (if GPS L5 is checked in GPS settings/Satellite tracking) and Galileo satellites. Available on the Satellite tracking and GAL page.
Fn Quit	To exit the screen.

Description of columns

Column	Description
Sat	The Pseudo Random Noise number (GPS), the Slot number (GLONASS) or the Space Vehicle number (Galileo) of the satellites.
Elev	The elevation angle in degrees. The arrows indicate if the satellite is rising or falling.
Azmth	The azimuth of the satellite.
S/N 1, S/N 2 and S/N L5	The SNR on L1, L2 and L5 for GPS, on L1 and L2 for GLONASS and on E1, E5a, E5b and Alt-Boc for Galileo. If the signal is currently not being used in the position calculations, the number is shown in brackets. For GS05/GS06, S/N 2 is unavailable.

Next step

Page changes to another page on this screen.

**Satellite Tracking:
GPS,
Skyplot page**

Satellites below the **Cut-off angle** configured in **Satellite Tracking** are marked grey. The part of the skyplot between the 0° elevation and the cut-off angle is marked grey.

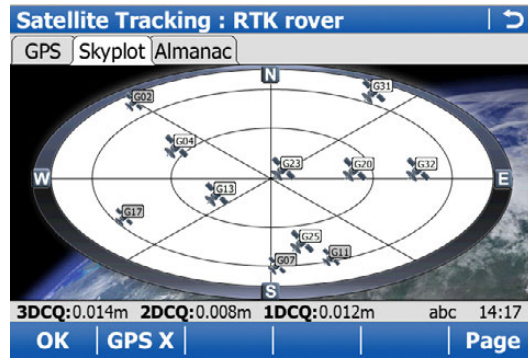

Key	Description
OK	To return to the Main Menu .
GPS ? / GPS ?	To hide or show the GPS satellites (shown by the prefix G).
GLO ? / GLO ?	To hide or show the GLONASS satellites (shown by the prefix R). Available when Glonass is activated in Satellite Tracking .
GAL ? / GAL ?	To hide or show the Galileo satellites (shown by the prefix E). Available when Galileo is activated in Satellite Tracking .
Page	To change to another page on this screen.
Fn Quit	To exit the screen.

Description of symbols

Symbol	Description
	Satellites above the Cut-off angle configured in Satellite Tracking .
	Satellites below the Cut-off angle configured in Satellite Tracking .

Next step

Page changes to the **Almanac** page.

**Satellite Tracking:
GPS,
Almanac page**

The almanac page shows the date of the used almanacs, and, as shown on the skyplot, the number of satellites tracked and the number of satellites available above the cut-off elevation mask.

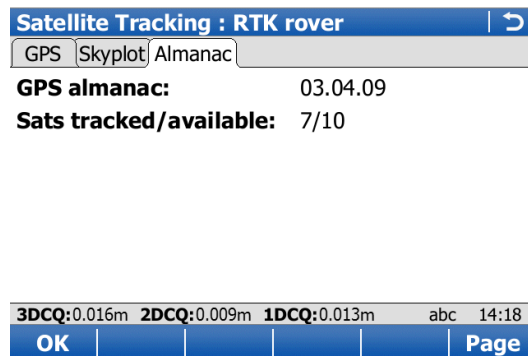

Key	Description
OK	To return to the Main Menu .
Page	To change to another page on this screen.

Next step

OK exits **Satellite Tracking**.

Satellite Tracking, RTK rover page

The information about the satellites at the base shown on this page is identical with the information shown for the rover.

Next step

OK exits **Satellite Tracking**.

22.4

RTK data link status GPS

Description

This screen shows information related to real-time data, for example the data link and the device used to transfer real-time data.

Access

Standard access from the **Instrument status info/Base status info** menu.

RTK Data Link Status, General page

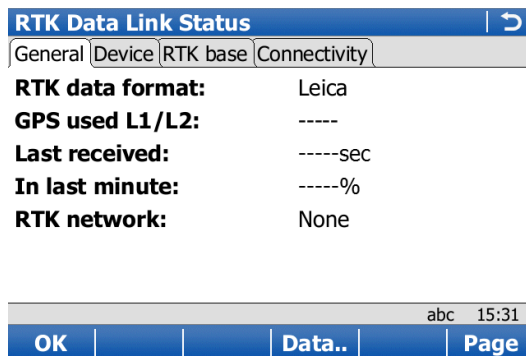

Key	Description
OK	To exit the screen.
Data..	To view the data being received. Depending on the RTK data format , the shown data differ.
Page	To change to another page on this screen.
Fn Quit	To exit the screen.

Description of fields

Field	Description
RTK data format	The received real-time data format message type.
GPS used L1/L2	The number of satellites on L1, L2 and L5 (when GPS L5 is activated in Satellite Tracking) being used in the current position solution.
GLO used L1/L2	Available if Glonass is activated in Satellite Tracking . The number of satellites on L1 and L2 being used in the current position solution.

Field	Description
GAL used E1/E5a	Available if Galileo is activated in Satellite Tracking . The number of satellites on E1 and E5a being used in the current position solution.
GAL used E5b/ABOC	Available if Galileo is activated in Satellite Tracking . The number of satellites on E5b and Alt-BOC being used in the current position solution.
Last data sent	Available for an RTK base. Seconds since the last message from the base was sent.
Last received	Available for an RTK rover. Seconds since the last message from the base was received.
In last minute	Available for an RTK rover. The percentage of real-time data received from the base compared with the data received from the antenna within the last minute. This percentage indicates how well the data link is working.
RTK network	Available for an RTK rover. The type of base network in use.
Stream NMEA messages from the GS	Available for an RTK rover in a base network. NMEA positions must be sent to a network. The type of NMEA message sent to the base network. If more than one message is sent at a time, then all types are shown separated by comma.

Next step

Page changes to the **Device** page.

RTK Data Link Status, Device page

The content of this page differs for each type of device in use.

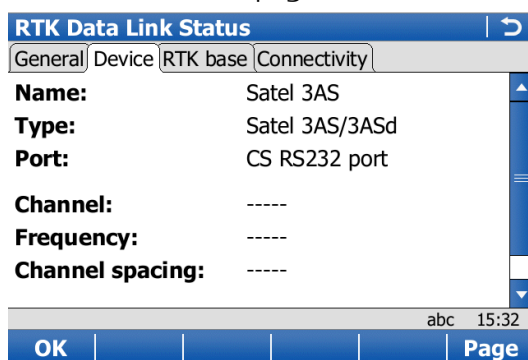

Key	Description
OK	To exit the screen.
Page	To change to another page on this screen.

For all devices available

Description of fields

Field	Description
Name	The name of the device.

For RS232

Description of fields

Field	Description
Type	The type of device.
Port	The port to which the device is connected.
Bluetooth	Available if device is connected via Bluetooth. Indicates the state of the connection.

For digital cellular phones and modems

Description of fields

Field	Description
Type	The type of device.
Port	The port to which the device is connected.
Firmware	The software version of the attached digital cellular phone.
Operator	The name of the network operator in which the digital cellular phone is operating.
Status	The current mode of the digital cellular phone. The options are Unknown, Detection and Registered.
Bluetooth	Available if device is connected via Bluetooth. Indicates the state of the connection. Unavailable for CS 3.5G modem.
Signal	Indication of received signal strength of the digital cellular phone network.

For radios

Description of fields

The available fields depend on the radio type.

Field	Description
Port	The port to which the device is connected.
Type	The type of device.
Channel	The radio channel.
Actual frequency	The current set frequency of the radio.
Central freq	The defined central frequency of the radio.
Firmware	The software version of the attached radio.
Signal	Indication of strength of received radio signal.

Next step

Page changes to the **RTK base** page.

**RTK Data Link
Status,
RTK base page**

As shown below, the name of the page changes depending on the type of base being used.

Name of page	Description
RTK base page	Base is a real base station.
Base (Nearest) page	Base is the closest to the rover determined by for example Leica GNSS Spider.
Base (i-MAX) page	Base information is individualised Master-Auxiliary corrections determined and sent by for example Leica GNSS Spider.
Base (MAX) page	Base information is Master-Auxiliary corrections determined and sent by for example Leica GNSS Spider.
Base (VRS) page	Base is a virtual base station.
Base (FKP) page	Base information is area correction parameters.

Description of fields

Field	Description
RTK base ID	An identification for a base station. The ID can be converted into a compact format to be sent out with real-time data in all real-time data formats. It is different from the point ID of the base station.
Antenna height	<ul style="list-style-type: none"> For RTK data format: Leica, RTK data format: Leica 4G, RTK data format: RTCM v3 or RTK data format: RTCM 9,2 v2/RTCM 1,2 v2 with RTCM version: 2.3: The antenna height at the base from the marker to the MRP. For RTK data format: CMR/CMR+ and RTK data format: RTCM 18,19 v2 or RTK data format: RTCM 18,19 v2 with RTCM version: 2.2: The antenna height at the base from the marker to the phase centre. For all other RTK data format: ---- is displayed because the data format does not include information about the antenna height.
Coords of	<p>The coordinates for the base station which are transferred depend on the active real-time data format.</p> <ul style="list-style-type: none"> For real-time messages which include antenna height and antenna type: Marker. For real-time messages which do not include antenna information: Phase Centre of L1.
Number of aux ref	The number of active auxiliary base stations from which data is received.
Antenna at base	The antenna used at the base.
Sensor type at base	The instrument type used at the base.

Next step

IF	THEN
other coordinate types are to be viewed	Coord. Local coordinates are available when a local coordinate system is active.
another page is to be accessed	Page.
this screen is to be quit	OK exits the screen.

RTK Data Link Status, Connectivity page

This screen shows the status real-time connectivity as dynamic troubleshooting screen. It shows the success of each of the steps in the connectivity to receive real-time corrections. If one step fails, the check box is unchecked. As each step is successfully completed, the check box will be checked.

Real-Time Input Data

The following provides additional information on the satellite data received via real-time message. Information of those satellites is displayed, which are used on both base and rover.

Access

Data.. on **RTK Data Link Status, General** page.

Real-Time Input Data | ↻

Sat PRN: G13
Sat Time: 12:25:21
Phase L1: 107951637.977cyc
Phase L2: 84118141.614cyc
Code L1: 20542512.847m
Code L2: 20542508.917m

3DCQ:0.020m 2DCQ:0.010m 1DCQ:0.017m abc 14:25

OK | Sat +

Key	Description
OK	To return to RTK Data Link Status .
Sat -	To display information about the satellite with the next smaller PRN.
Sat +	To display information about the satellite with the next larger PRN.

Description of fields

The data being received from the satellites and the layout of the screen depend on the active real-time data format.

Field	Description
Sat PRN	The PRN number (GPS), the Slot number (GLONASS) or the Space Vehicle number (Galileo) of the satellites shown with the prefix G (GPS), R (GLONASS) or E (Galileo).
Sat Time	The GPS time of the satellite.
Phase L1, Phase L2, Phase L5	The number of phase cycles from the antenna to the GPS satellite on L1, L2 and L5.
Phase L1, Phase L2	The number of phase cycles from the antenna to the GLONASS satellite on L1 and L2.
Phase E1, Phase E5a, Phase E5b, Phase AltBOC	The number of phase cycles from the antenna to the Galileo satellite on E1, E5a, E5b and Alt-BOC.
Msg 18 L1, Msg 18 L2	The uncorrected carrier phases for L1 and L2.
Msg 20 L1, Msg 20 L2	The carrier phase corrections for L1 and L2.
Code L1, Code L2, Code L5	The pseudorange from the antenna to the GPS satellite for L1, L2 and L5.
Code L1, Code L2	The pseudorange from the antenna to the GLONASS satellite on L1 and L2.

Field	Description
Code E1, Code E5a, Code E5b, Code AltBOC	The pseudorange from the antenna to the Galileo satellite on E1, E5a, E5b and Alt-BOC.
Msg 19 L1, Msg 19 L2	The uncorrected pseudoranges for L1 and L2.
Msg 21 L1, Msg 21 L2	The pseudorange corrections for L1 and L2.
PRC	Pseudorange corrections.
RRC	Rate of change of the corrections.
IODE	Issue Of Data Ephemeris. The identification number of the ephemeris for a satellite.

22.5

Current GPS position GPS

Description

This screen shows information related to the current antenna position and the speed of the antenna. For real-time rover configurations, the baseline vector is also shown. MapView shows the current position in a graphical format.

Access

Besides the standard access from the **Instrument status info/Base status info** menu, access is also possible by:

- Tapping the position Status icon.

Current GPS Position, Position page

Current GPS Position ↔	
Position	Baseline Speed Map
Local time:	14:25:49.0
Position latency:	0.00sec
WGS84 latitude:	47°24'31.72786"N
WGS84 longitude:	9°37'04.90872"E
WGS84 ellipsoid ht:	469.660m
Position quality:	0.009m
Height quality:	0.015m
3DCQ: 0.018m	2DCQ: 0.009m 1DCQ: 0.015m abc 14:25
OK	Coord Page

Key	Description
OK	To return to the Main Menu .
Coord	To see other coordinate types. Local coordinates are available when a local coordinate system is active.
Page	To change to another page on this screen.
Fn Config..	To determine how often positions are computed and the screen display is updated.
Fn Elev	To see height as elevation. Available when local grid coordinates are displayed.
Fn Ell Ht	To see height as ellipsoidal height. Available when local grid coordinates are displayed.
Fn Quit	To exit the screen.

Description of fields

Field	Description
Position latency	The latency of the computed position. Latency is mostly due to time required for data transfer and computation of position. Depends on the use of the prediction mode.
Position quality and Height quality	Available for phase fixed and code only solutions. The 2D coordinate and height quality of the computed position.
HDOP and VDOP	Available for navigated solutions.

Next step

IF	THEN
the instrument is a real-time rover	Page changes to the Baseline page.
the instrument is not configured for real-time	Page changes to the Speed page.
the instrument is a real-time base	OK exits Current GPS Position .

**Current GPS Position,
Baseline page**

Information on the baseline vector is displayed.

Next step

Page changes to the **Speed** page.

**Current GPS Position,
Speed page**

Description of fields

Field	Description
Horizontal speed	The speed over ground in the horizontal direction.
On bearing	Available for local coordinate systems. The bearing for the horizontal direction related to the North direction of the active coordinate system.
Vertical speed	The vertical component of the current velocity.

Next step

OK exits **Current GPS Position**.

Description

This screen shows information related to logging of raw observations.

Access

Standard access from the **Instrument status info/Base status info** menu.

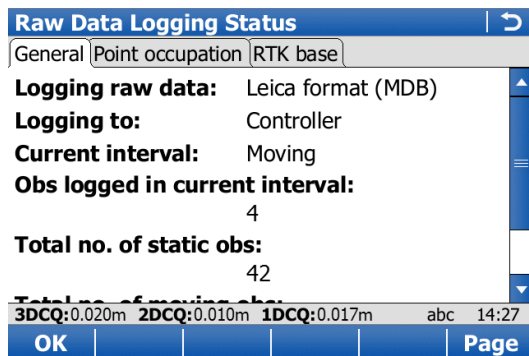
Raw Data Logging Status, General page

Key	Description
OK	To return to the Main Menu .
Page	To change to another page on this screen.
Fn Quit	To exit the screen.

Description of fields

Field	Description
Data format	Shows if raw data is saved and if so in which format.
Logging to	Shows where the data is saved.
Current interval	The type of current interval.
Obs logged in current interval	The number of observations logged in current interval.
Total no. of static obs	The number of static epochs recorded in the current job.
Total no. of moving obs	The number of moving epochs recorded in the current job.

Next step

Page changes to the **Point occupation** page.

Raw Data Logging Status, Point occupation page
Description of fields

Field	Description
Current Status	Shows if the instrument is moving or not.
GDOP	Current GDOP.
Logging rate	Rate at which raw observations are being recorded.
No. of moving obs	The number of logged moving raw observations. Reset as soon a new moving interval starts.

Field	Description
Logging data from more than 5 sats since	The time for how long five or more satellites are tracked on L1 and L2 without interruption. If less than five satellites were tracked, the counter is reset. The counter is not reset after Meas , Stop or Store .
Measurement completed	The percentage of collected data required for successful processing. It is a conservative estimate based on a 10 - 15 km baseline. The criteria used to display this value depend on the settings for Automatically stop point measurement , Stop criteria and Enter the values to be used to automatically stop the point occupation: in Main Menu: Instrument\GPS settings\Quality control .
Time to go	The estimated time in hours, minutes and seconds until the configured criteria for Stop criteria or Enter the values to be used to automatically stop the point occupation: is reached. The criteria used to display this value depend on the settings for Automatically stop point measurement , Stop criteria and Enter the values to be used to automatically stop the point occupation: in Main Menu: Instrument\GPS settings\Quality control .

Next step

Page changes to the **RTK base** page.

Raw Data Logging Status, RTK base page

As shown below, the name of the page changes depending on the type of base used.

Name of page	Description
RTK base page	Base is a real base station.
Base (Nearest) page	Base is the closest to the rover determined by for example Leica GNSS Spider.
Base (i-MAX) page	Base information is individualised Master-Auxiliary corrections determined and sent by for example Leica GNSS Spider.
Base (MAX) page	Base information is Master-Auxiliary corrections determined and sent by for example Leica GNSS Spider.
Base (VRS) page	Base is a virtual base station.
Base (FKP) page	Base information is area correction parameters.

Description of fields

Field	Option	Description
Logging static obs	A time in sec	The logging rate at the base. This information is shown if the real-time message format supports this information and raw observations are being logged at the base.
	-----	Raw observations are not being logged, or status information is not supported by RTK format.

Next step

OK exits **Raw Data Logging Status**.

22.7

22.7.1

Connection status

Connection Status

Description This screen gives an overview of all interfaces with the port and the devices currently assigned.

Access Standard access from the **Instrument status info/Base status info** menu.

Connection Status This screen consists of two pages, one for the field controller interfaces and one for the GS interfaces. For a GS05/GS06/GS08plus/GS12, the **GS connections** page is not shown.

The screenshot shows the 'Connection Status' screen with two tabs: 'CS connections' and 'GS connections'. The 'CS connections' tab is active, displaying a table with columns 'Connection', 'Port', and 'Device'. The table lists several connections: 'CS Internet', 'GPS Rover', 'ASCII Input', 'GPS Hidden Pt', and 'Export Job'. Below the table is a status bar showing '3DCQ:0.018m 2DCQ:0.009m 1DCQ:0.016m abc 14:28' and two buttons: 'OK' and 'Page'.

Connection	Port	Device
CS Internet	-	-
GPS Rover	Cable	GS
ASCII Input	-	-
GPS Hidden Pt	-	-
Export Job	-	-

Key	Description
OK	To return to the Main Menu .
Intfce	Available for configured interfaces being highlighted. To view information related to real-time data or the internet connection.
Devce..	To view the status of the attached device.
Page	To change to another page on this screen.
Fn Quit	To exit the screen.

22.7.2

Internet

Description This screen shows

- if the instrument is online on the Internet.
- for how long the instrument is online.
- the technology of data transfer.
- the amount of data received or sent since the instrument is online.

Access This screen is accessible for a configured and activated Internet interface.

- On the **Connection Status, CS connections** page, highlight **CS Internet.Intfce**.
- On the **Connection Status, GS connections** page, highlight **GS Internet. Intfce**.

22.7.3

ASCII Input GPS

Description

This screen shows the

- incoming ASCII data which is stored as an annotation.
- description of the incoming ASCII data for each annotation field.

Not used is shown for annotation fields which are not configured to receive incoming ASCII data.

Access

This screen is accessible for a configured and activated ASCII Input interface.

On the **Connection Status, CS connections** page, highlight **ASCII Input.Intfce**.

ASCII Input - Data

ASCII Input - Data abc 15:43

Annotation 1: Not used
Annotation 2: Not used
Annotation 3: Not used
Annotation 4: Not used

OK	Descr

Key	Description
OK	To exit the screen.
Data.. and Descr	To change between the given description for the incoming ASCII data or the last received ASCII data.

22.7.4

RTK Data Link Status GPS

Description

For information about this screen, refer to "22.4 RTK data link status".

Access

This screen is accessible for a configured RTK rover interface.

On the **Connection Status, GS connections** page, highlight **RTK Rover.Intfce**.

22.7.5

Remote (OWI) GPS

Description

This screen shows all available ports and the interfaces and devices configured to these ports.

Access

This screen is accessible for a configured and activated remote interface.

On the **Connection Status, GS connections** page, highlight **Remote (OWI) Connections**.

Remote (OWI)

Remote (OWI) Interfaces		
Port	Connection	Device
GS Port 1	Remote (OWI)	RS232
GS Port 2	Remote (OWI)	-
GS Port 3	Remote (OWI)	-
GS BT	Remote (OWI)	-

abc 15:44	
OK	Devce..

Key	Description
OK	To exit the screen.
Devce..	Available for some devices. To view status information about the devices.

Description of fields

Column	Description
Port	The physical port on the instrument which is being used for the interface functionality.
Connection	The interface configured for the ports.
Device	The hardware connected to the chosen port.

Next step

OK exits the screen.

22.7.6

Event Input 1/Event Input 2 GPS

Description

This screen shows the incoming data from the event input interface.

Access

This screen is accessible for a configured and activated event input interface.

On the **Connection Status, GS connections** page, highlight **Event Input 1** or **Event Input 2**.

Event input 1/Event input 2

Description of fields

Field	Description
Time	The local time of when the last event was available.
Event Count	The incrementing number of detected events. Counting starts as soon as the event input is configured and activated. To reset the counter to 0, press Reset .
Event Pulse Count	The incrementing number of detected pulses in the event input. Events which do not fulfil the requirements configured are counted as an event pulse but not as an event. This is, for example, the case when the time between two events is shorter than defined in Time . Counting starts as soon as the event input is configured and activated. To reset the counter to 0, press Reset .

Next step
OK exits the screen.

Diagram

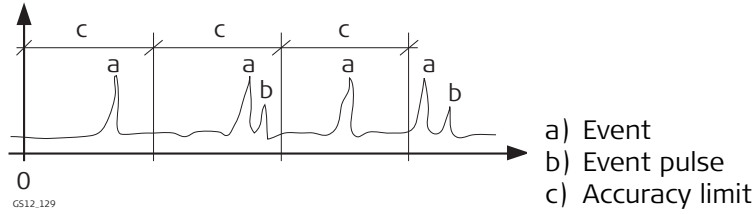

22.8 Internet connection status

Description

The information on this screen is valid for the CS or TS11/TS15/TS12 Lite. The information is invalid for the GS.
 The status of the device used for the Internet connection is displayed as well as the status of the Internet connection itself.

Access

Besides the standard access from the **Instrument status info** menu, access is also possible by tapping the Internet icon.

Internet Connection Status

For a description of the **Device**, refer to "22.4 RTK data link status".
 On the **Connectivity** page, all necessary steps for an Internet connection are displayed. A checked box indicates that this step has been accomplished successfully.

22.9 TPS current station info TPS

Access

Standard access from the **Instrument status info** menu.

TPS Current Station Info

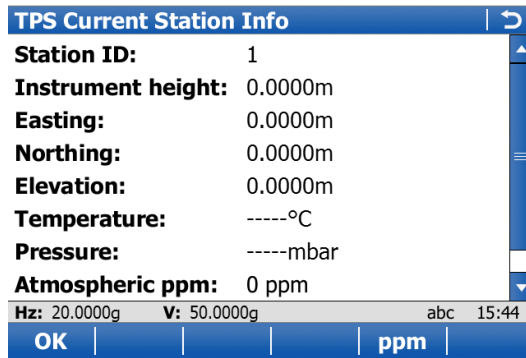

Key	Description
OK	To exit the screen.
Coord	To display other coordinate types.
ppm/SF	To switch between displaying the station scale factor and the station ppm.
Fn Quit	To exit the screen.

Description of fields

Field	Description
Station ID	Station ID of the current station setup.
Instrument height	Instrument height of the current station setup.
Easting	Easting value of the instrument position.
Northing	Northing value of the instrument position.
Local ellipsoid ht or Elevation	For a selected coordinate system, ellipsoidal height and elevation can be displayed.
Temperature	Temperature set on the instrument.
Pressure	Pressure set on the instrument.
Atmospheric ppm	Atmospheric ppm set on the instrument.
Station ppm	Ppm of the current station set up.
Station scale	Scale factor of the current station set up.

Description

The settings on this screen define which satellite system, satellites and satellite signals are used by the instrument.



Unavailable for GS05/GS06.



This screen contains the same settings as the RTK Rover **Satellite Tracking Settings** screen. Changes made to the settings here in RTK Base mode, will be reflected in the RTK Rover mode and vice versa.

Access

For RTK base:
Select **Main Menu: Instrument\Base settings\Satellite tracking.**

Satellite Tracking Settings, Tracking page

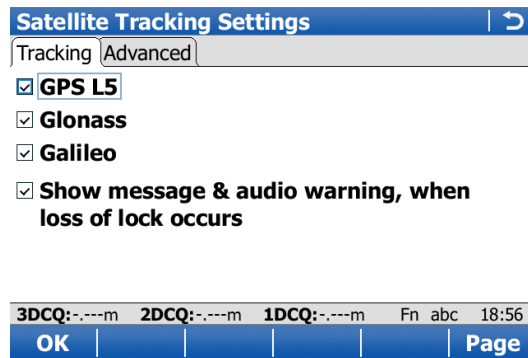

Key	Description
OK	To accept changes.
Page	To change to another page on this screen.
Fn Quit	To exit the screen.

Description of fields

Field	Option	Description
GPS L5	Check box	Defines if the GPS L5 signal will be tracked.
Glonass	Check box	Defines if GLONASS satellite signals are accepted by the instrument when tracking satellites.
Galileo	Check box	Defines if Galileo satellite signals are accepted by the instrument when tracking satellites.
BeiDou	Check box	Defines if BeiDou satellite signals are accepted by the instrument when tracking satellites.
Show message & audio warning, when loss of lock occurs	Check box	Activates an acoustic warning signal and a message given by the instrument when satellites are lost.

Next step

Page changes to the **Advanced** page.

Satellite Tracking
Settings,
Advanced page

Satellite Tracking | ↩

Tracking | Advanced

Cut-off angle: 10.000 °

DOP limit: None ▾

L2C tracking: Automatic ▾

Satellite health: Automatic ▾

3DCQ:6.876m 2DCQ:3.680m 1DCQ:5.809m abc 10:02

OK | | | | Page

Key	Description
OK	To accept changes.
Hlth..	Available for Satellite health: User defined . To configure the satellites used in the survey.
Page	To change to another page on this screen.
Fn Quit	To exit the screen.

Description of fields

Field	Option	Description
Cut-off angle	Editable field	Sets the elevation in degrees below which satellite signals are not recorded and are not shown to be tracked. Recommended settings: <ul style="list-style-type: none"> • For real-time: 10°. • For purely post-processing applications: 15°.
DOP limit	None, GDOP, HDOP, PDOP or VDOP	If activated, the limit defined in Limiting value is checked. GPS positions are unavailable when the limit is exceeded.
Limiting value	Editable field	The maximum acceptable DOP value. Available unless DOP limit: None .
L2C tracking	Automatic Always track	Automatic L2 signals which are flagged as unhealthy are not recorded or used for real-time computations. Always track L2C signals are always tracked.
Satellite health	Automatic User defined	Sets the satellite tracking behaviour.  This setting is remembered when the instrument is turned off. It is stored as part of the configuration set. Automatic Incoming satellite signals are monitored by the instrument. Data from signals which are flagged as unhealthy is not recorded or used for real-time computations. User defined Satellites must manually be included/excluded from data recording and real-time computations with Hlth...

Next step

Hlth.. changes to **Satellite Health**.

Satellite Health

This screen consists of the **GPS** page, **Glonass** page and the **Galileo** page. The explanations given for the softkeys are valid for all pages.

Satellite Health		
GPS	Glonass	Galileo
Satellite	System	User
G01	OK	Auto
G02	N/A	----
G03	OK	Auto
G04	OK	Auto
G05	OK	Auto
G06	OK	Auto
G07	OK	Auto
G08	Unhealthy	Auto
3DCQ:6.818m 2DCQ:3.651m 1DCQ:5.757m abc 10:02		
OK		Use Page

Key	Description
OK	To accept changes and return to the screen from where this screen was accessed.
Use	To change between the options in the column User .
Page	To change to another page on this screen.
Fn Quit	To exit the screen.

Description of columns

Column	Option	Description
Satellite	01 to 32	The Pseudo Random Noise number (GPS, 1 to 32), the Slot ID (GLONASS, 1 to 24) or the S pace V ehicle number (Galileo, 1 to 30) of the satellites. There is a prefix G for GPS satellites, a prefix R for GLONASS satellites and a prefix E for Galileo satellites.
System RAM	OK, N/A or Unhealthy	Information on the satellite health taken from the almanac. N/A stands for not available.
User	Bad OK Auto	Bad Excludes satellite from tracking. OK Includes satellite in tracking. Auto Automatic satellite tracking when satellite is healthy.

Next steps

Step	Description
1.	Page changes to the Glonass page and to the Galileo page, where GLONASS satellites and Galileo satellites used in the survey can be configured.
2.	OK returns to Satellite Tracking .
3.	OK returns to Main Menu .

23.2

Base raw data logging



Unavailable for GS05/GS06.

Description

Logged raw observations are used for

- static and kinematic operations. With these operations, raw data is always post-processed in the office. Raw data must therefore be logged on both base and rover instruments.
 - real-time operations
 - to check the work in the office by post-processing.
- OR
- to fill in gaps when a real-time position could not be calculated in the field, for example, due to problems with the real-time data reception from the reference station or the RTK network provider

Observations must be logged on all instruments which will be used for post-processing.

The settings on this screen define the logging of raw observations.

Access

For RTK base:

Select **Main Menu: Instrument\Base settings\Base raw data logging.**

Raw Data Logging Settings

Key	Description
OK	To accept changes.
Fn Quit	To exit the screen.

Description of fields

Field	Option	Description
Log base data for post processing	Check box	Activates raw data logging.
Rate	From 0.05s to 300.0s	Rate at which raw observations are logged. Recommendations: <ul style="list-style-type: none"> • For static operations with long baselines and over long time Rate: 15.0s or Rate: 30.0s. • For base stations for post-processed and real-time kinematic rovers, Rate at the base should be the same rate as at the rover.
Data type	Selectable list	Data can be logged in the Leica proprietary MDB format or in RINEX.



For information on camera and images refer to "33 Camera & Imaging".

25

User - Work settings

25.1

ID templates

25.1.1

Accessing ID Template Configuration

Description

ID templates are predefined templates for point, line or area numbers. ID templates save having to type in the ID for each object. They are useful when many points are collected quickly, for example in post-processed and real-time kinematic operations. The ID templates that are selected to be used suggest IDs for **Point ID**, **Line ID** and **Area ID** when points, lines and areas are to be surveyed.

Access

Select **Main Menu: User\Work settings\ID templates**.

ID Templates

Key	Description
OK	To accept changes and return to the screen from where this screen was accessed. The currently active working style is automatically updated, to include the selected ID template.
Fn Quit	To exit the screen.

Description of fields

Field	Option	Description
GPS points GPS	Selectable list	Sets the ID templates for manually occupied GPS points.
GPS auto points GPS	Selectable list	Sets the ID templates for GPS auto points. These points are automatically recorded at a specific rate.
TPS points TPS	Selectable list	Sets the ID templates for manually occupied TPS points.
TPS auto points TPS	Selectable list	Sets the ID templates for TPS auto points. These points are automatically recorded at a specific rate.
Auxiliary points	Selectable list	Sets the ID templates for auxiliary points. These points are used when trying to find a stakeout point.

Field	Option	Description
Lines	Selectable list	Sets the ID templates for lines.
Areas	Selectable list	Sets the ID templates for areas.

Next step

ENTER to open a selectable list and to access **ID Template Library**.

ID Template Library

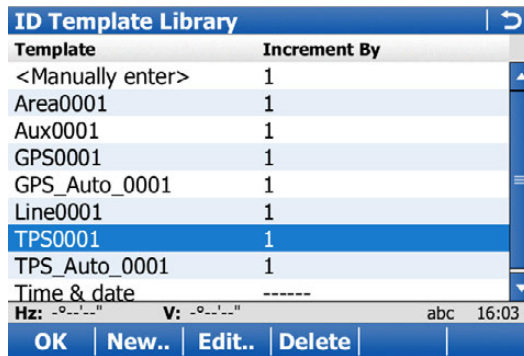

Key	Description
OK	To select the highlighted template.
New..	To create a new ID template.
Edit..	To edit the highlighted ID template.
Delete	To delete the highlighted ID template. It does not matter if the ID template is being used in a working style. The ID template will be rebuilt when that working style becomes active.
Fn Default	To recall deleted default ID templates.
Fn Quit	To exit the screen.

Description of columns

Column	Description
Template	The name of the ID template and the format of the ID object.
Increment	The amount by which the point ID is incremented.

Default ID templates

Some ID templates are implemented by default.

Default ID template	Description
<Manually enter>	The last point ID during a survey will be displayed. This ID is automatically incremented if it contains numerical characters. If this ID is overwritten, the auto increment starts from the new ID. The automatic incrementation can be turned off when editing this ID template.
Area0001	Suggested as ID for areas in default working styles. This ID is automatically incremented.
Aux0001	Suggested as ID for auxiliary points in default working styles. These points are used when trying to find a stakeout point. This ID is automatically incremented.

Default ID template	Description
GPS0001	Suggested as ID for GPS measured points in default working styles. This ID is automatically incremented.
GPS_Auto_0001	Suggested as ID for GPS auto points in default working styles. These points are automatically recorded at a specific rate. This ID is automatically incremented.
Line0001	Suggested as ID for lines in default working styles. This ID is automatically incremented.
TPS0001	Suggested as ID for TPS measured points in default working styles. This ID is automatically incremented.
TPS_Auto_0001	Suggested as ID for TPS auto points in default working styles. These points are automatically recorded at a specific rate. This ID is automatically incremented.
Date & time	The current local time and date is the ID.

25.1.2 Creating/Editing an ID Template

Access

In **ID Template Library**, highlight an ID template. A copy of this ID template is taken for further configurations. **New...**

New ID Template/ Edit ID Template

Key	Description
OK	To store the new ID template into the ID template library.
Fn Quit	To exit the screen.

Description of fields

Field	Option	Description
ID	Editable field	The name of the ID template and the format of the ID object. Any characters including spaces are allowed. Leading spaces are not accepted.
Increment	Selectable list	IDs are incremented numerically or alphanumerically.
Increment by	Editable field	The amount by which the point ID is incremented.

Field	Option	Description
Cursor position	Selectable list	The character position at which the cursor is placed when ENTER is pressed in Point ID , Line ID or Area ID when surveying points. Last Character means that the cursor is placed immediately to the right of the last character.

Examples for incrementation

For Increment: Numeric only

The rightmost numeric part is incremented within the point ID.

ID	Increment by	Next point ID	Notes
Point994	5	Point999 Point1004 ...	-
994point	5	999point 1004point ...	-
123point123	-10	123point113	Numbers on the right are incremented. Negative increments allowed.
Point11	-6	Point5 Point-1 Point-7 Point-13 ...	-
Abcdefghijklmn94	5	Abcdefghijklmno99 Point ID increment fail	Incrementation fails if next increment will result in more than 16 characters.
Abcdefghijklmno9	-5	Abcdefghijklmnop4 Point ID increment fail	Negative incrementing fails if next increment requires negative sign and will result in more than 16 characters.

For Increment: Alphanumeric

The rightmost character within the point ID is incremented regardless of whether that character is numeric or alphanumeric.

ID	Increment by	Next point ID	Notes
Point994	5	Point999 Point99E Point99J ...	-
994point	5	994poiny Point ID increment fail	Lower case alpha characters increment until z is reached. Then a new point ID must be entered.

ID	Increment by	Next point ID	Notes
Abcdef	-5	Abcdea AbcdeV ... AbcdeB Point ID increment fail	Lower case alpha characters decrement from lower to upper case until A is reached. Then a new point ID must be entered.
ABCDEB	5	ABCDEG ABCDEL ... Abcdez Point ID increment fail	Upper case alpha characters increment from upper to lower case until z is reached. Then a new point ID must be entered.

25.2

Coding & linework

Description

The settings on this screen define the method of coding. Refer to "26 Coding" for a complete description of coding.

Access

Select **Main Menu: User\Work settings\Coding & linework**.

Coding & linework settings, Code & attributes page

Key	Description
OK	To accept changes and return to Main Menu .
Page	To change to another page on this screen.
Fn Quit	To exit the screen.

Description of fields

Field	Option	Description
Use a list box to view codes	Check box	If checked, codes stored within the job codelist can be selected from a selectable list to code points, lines and areas. Otherwise, each code must be entered manually.
Suggested attributes	Default values	Determines the attribute values displayed under certain circumstances. This setting is applicable to both the storing and displaying of attribute values. When available, the default attribute values, as stored in the job, are displayed and stored.

Field	Option	Description
	Last used	When available, the last used attribute values as stored in the job are displayed and stored.
Prompt for mandatory attributes	Always prompt	A screen to enter mandatory attributes will always appear when codes being stored have one or more attributes of attribute type mandatory. Attributes of attribute type mandatory or fixed can only be created in LGO.
	Only if no value	A screen to enter mandatory attributes will only appear when codes being stored have one or more attributes of attribute type mandatory, without an attribute value. Attributes of attribute type mandatory must always be created in LGO.
	Code change only	A screen to type in mandatory attributes will only appear when a new code with a mandatory attribute was selected.

Next step

Page changes to the **Linework** page.

Coding & linework settings, Linework page

The flags for Linework are defined on this screen. A flag

- is stored as a property of a point.
- can be exported with a format file.
- is different to a code.

The flags defined on this screen are linked to the options available for **Linework** in a survey screen page of an application. The selection for **Linework** in a survey screen page determines the flag stored with a point. The availability of **Linework** in a survey screen page is configured in **My Survey Screen Settings**. Refer to "27 Linework" for information on Linework.

Description of fields

Field	Option	Description
Automatically create lines & areas when coding	Check box	If checked, lines and areas can be automatically created and opened using codes.
Use a stringing attribute	Check box	Available if Automatically create lines & areas when coding is checked. If checked, surveyed points that have the same code and attribute value for the Stringing attribute are strung together on one line.
Attribute	Selectable list	Available if Use a stringing attribute is checked. The attribute value used to determine which surveyed points are strung together on one line.
Begin line	Editable field	Opens a new line when the next point is stored. Any lines which are currently open are closed. The point can be stored with a point code.
3pt curve	Editable field	Stores the linework flag for a curve through the next three measured points and continues a line/area.

Field	Option	Description
Re-open last line	Editable field	Opens the last used line again.
End line	Editable field	Closes all open lines.
Cont line/area	Editable field	Indicates a line/area is open.
Start spline	Editable field	Stores the linework flag for beginning a spline and continues any open line/area.
End spline	Editable field	Stores the linework flag to stop a spline.
Cont spline	Editable field	Indicates a line/area is open with spline line type.
Begin area	Editable field	Opens a new area when the next point is stored. Any areas which are currently open are closed. The point can be stored with a point code.
Re-open last area	Editable field	Opens the last used area again.
Close area	Editable field	Closes all open areas.

Next step

Page changes to the **Quickcoding** page.

Coding & linework settings,
Quickcoding page

Description of fields

Field	Option	Description
Quickcoding	Never On Off	Prevents the use of quick coding completely. Allows the use of quick coding and activates it. Allows the use of quick coding, but keeps it deactivated.
Digits to use	1, 2 or 3	Sets the mostly used number of digits for the quick code. Quick codes with fewer digits can still be used. While typing a quick code during a survey, using ENTER after typing one or two digits of the quick code indicates the end of the input.
Store free code	After pt is stored or Before pt is stored	Determines if a free code measured with a quick code is stored before or after the point.

Next step

Page changes to another page on this screen.

Description

Display settings define the parameters shown on a page on the survey screen.

Four survey screen pages are definable.

- Page 1:** Always shown on the survey screen.
Page 2: Can be shown or hidden on the survey screen.
Page 3: Can be shown or hidden on the survey screen.
Page 4: Never shown on the survey screen. Reserved for applications.

The settings on this screen define the layout of the four survey screen pages.

Access

Select **Main Menu: User\Work settings\My Survey Screen**.

My Survey Screen Settings, TPS and GPS page

Key	Description
OK	To accept changes and return to Main Menu .
Config..	To configure the selected survey screen page.
Page	To change to another page on this screen.
Fn Quit	To exit the screen.

Description of fields

Field	Option	Description
Define	Page 1, 2, 3 or 4	Selected survey screen page.
Use in survey	Check box	Indicates if the survey screen page is shown or hidden as a page in Survey .

Next step

Highlight the survey screen page and **Config..** to access **Configure Page**.

Configure Page

Key	Description
OK	To accept changes and to return to previous screen.
Clear	To set all fields to Line space full .
Default	To recall the default settings.
Fn Quit	To exit the screen.

Description of fields

Field	Option	Description
Name	Editable field	The name of the page is shown as page name in Survey .
Show in the Survey application	Check box	Shows or hides the page as a page in Survey .
1st line	Display only	Fixed to Point ID .
2nd line to 16th line	<p>Angle right <input type="checkbox"/> TPS</p> <p>% completed <input type="checkbox"/> GPS</p> <p>Annotation 1 to Annotation 4</p> <p>Antenna height <input type="checkbox"/> GPS</p> <p>Attrib (free) 01 to Attrib (free) 20</p> <p>Attrib 01 to Attrib 20</p> <p>Automation <input type="checkbox"/> TPS</p> <p>Avg max #distances <input type="checkbox"/> TPS</p> <p>Azimuth <input type="checkbox"/> TPS</p>	<p>For each line, one of the following options can be selected.</p> <p>Displays the horizontal angle difference between the backsight point and the current telescope position.</p> <p>Display only field for the percentage of the time for which the point has been occupied based on the setting for Stop criteria in screen Quality Control. Appears in the page during the point occupation if Quality Control is checked.</p> <p>Editable field for comments to be stored with the point.</p> <p>Input field for antenna height for static observations.</p> <p>Display only field for attributes for free codes.</p> <p>Editable field for attributes for codes.</p> <p>Unavailable for SmartStation. Select automation type.</p> <p>Input field for maximum number of distance measurements in the averaging EDM mode.</p> <p>Display only field for the azimuth.</p>

Field	Option	Description
	Backsight pt ID <input type="text" value="TPS"/>	Display only field for the point ID of the backsight point.
	Code	Editable field for codes.
	Code (free)	Editable field for free codes.
	Code desc (free)	Display only field for the description of free codes.
	Code information	Editable field for additional information relating to the code, such as instructions to the CAD package to start a line and string number and curve information.
	Description	Display only field for the description of codes.
	Easting <input type="text" value="TPS"/>	Display only field for Easting coordinate of measured point.
	GDOP <input type="text" value="GPS"/>	Display only field for the current GDOP of the computed position.
	HDOP <input type="text" value="GPS"/>	Display only field for the current HDOP of the computed position.
	Elevation <input type="text" value="TPS"/>	Display only field for the height coordinate of the measured point.
	Height difference <input type="text" value="TPS"/>	Display only field for the height difference between station and reflector.
	Horiz distance <input type="text" value="TPS"/>	Display only field for horizontal distance.
	Humidity <input type="text" value="GPS"/>	Editable field for relative humidity to be stored with point.
	Hz angle <input type="text" value="TPS"/>	Display only field for the horizontal angle.
	Instrument height <input type="text" value="TPS"/>	Display only field for the instrument height.
	Line space full	Insert full line space.
	Line space half	Insert half line space.
	Linework	Selectable list with option for flagging a line/area.
	Local ellipsoid ht <input type="text" value="GPS"/>	Display only field for the elevation of the current GNSS position.
	Measure mode <input type="text" value="TPS"/>	Select EDM measurement mode.
	Measure <input type="text" value="TPS"/>	Select EDM type.
	Moving antenna ht <input type="text" value="GPS"/>	Input field for antenna height for moving observations.
	Msd PP obs <input type="text" value="GPS"/>	Display only field for the number of static observations recorded over the period of point occupation. Appears in the page when recording of static observations is configured.
	Northing <input type="text" value="TPS"/>	Display only field for Northing coordinate of measured point.
	Number of dists <input type="text" value="TPS"/>	Display only field for number of averaged distances measured with EDM mode averaging.

Field	Option	Description
	Offset left/right <input type="text"/> <small>TPS</small>	Input field for horizontal distance offset for measured point, perpendicular to the line of sight.
	Offset height <input type="text"/> <small>TPS</small>	Input field for height offset for measured point.
	Offset in/out <input type="text"/> <small>TPS</small>	Input field for horizontal distance offset, in the direction of line of sight.
	Offset mode <input type="text"/> <small>TPS</small>	Select offset mode.
	PDOP <input type="text"/> <small>GPS</small>	Display only field for the current PDOP of the computed position.
	PPM atmos <input type="text"/> <small>TPS</small>	Display only field for atmospheric ppm.
	PPM geometric <input type="text"/> <small>TPS</small>	Display only field for geometric ppm value.
	PPM total <input type="text"/> <small>TPS</small>	Display only field for the total ppm value.
	Point ID	Editable field for the point ID.
	Pressure <input type="text"/> <small>GPS</small>	Editable field for atmospheric pressure.
	Prism constant <input type="text"/> <small>TPS</small>	Display only field for additive constant of currently selected reflector.
	Quality 1D <input type="text"/> <small>GPS</small>	Display only field for the current height coordinate quality of computed position.
	Quality 2D <input type="text"/> <small>GPS</small>	Display only field for the current 2D coordinate quality of computed position.
	Quality 3D <input type="text"/> <small>GPS</small>	Display only field for the current 3D coordinate quality of computed position.
	RTK positions <input type="text"/> <small>GPS</small>	Display only field for the number of positions recorded over the period of point occupation. Appears in the page of real-time rover configurations.
	SD (last recorded) <input type="text"/> <small>TPS</small>	Display only field for the last recorded distance.
	Slope distance <input type="text"/> <small>TPS</small>	Display only field for measured slope distance.
	Station ID <input type="text"/> <small>TPS</small>	Display only field for current station ID.
	Station easting <input type="text"/> <small>TPS</small>	Display only field for current station Easting coordinates.
	Station height <input type="text"/> <small>TPS</small>	Display only field for current station height coordinates.
	Station northing <input type="text"/> <small>TPS</small>	Display only field for current station Northing coordinates.
	Std deviation <input type="text"/> <small>TPS</small>	Display only field of standard deviation in millimetres of averaged distances.
	Target <input type="text"/> <small>TPS</small>	Select a prism.
	Target height <input type="text"/> <small>TPS</small>	Input field for prism height.
	Temp dry <input type="text"/> <small>GPS</small>	Editable field for dry temperature to be stored with point.

Field	Option	Description
	Temp wet <input type="checkbox"/> GPS	Editable field for wet temperature to be stored with point.
	Time at point <input type="checkbox"/> GPS	Display only field for the time from when the point is occupied until point occupation is stopped. Appears in the page during the point occupation.
	Type	Display only field for the type of code, for example point code, line code or area code.
	V angle <input type="checkbox"/> TPS	Display only field for vertical angle.
	V angle display <input type="checkbox"/> TPS	Select vertical angle display.
	VDOP <input type="checkbox"/> GPS	Display only field for the current VDOP of the computed position.
	WGS84 ellipsoid ht <input type="checkbox"/> GPS	Display only field for the current GNSS position.
	WGS84 latitude <input type="checkbox"/> GPS	Display only field for the current GNSS position.
	WGS84 longitude <input type="checkbox"/> GPS	Display only field for the current GNSS position.

25.4

Hot keys & favourites

Description

The settings on this screen assign functions, screens or applications to each of the first and second level of hot keys, including the user definable Smartkey **F13**, and the favourites key.

Access

Select **Main Menu: User\Work settings\Hot keys & favourites**.

OR

Hold a hot key down for two seconds. This action is also possible after pressing Fn.

Hot Keys & Favourites, GPS Hot Keys/ TPS Hot Keys page

To configure the first level of hot keys.

This page is only available for CS15 models. CS10 models do not have hot keys.

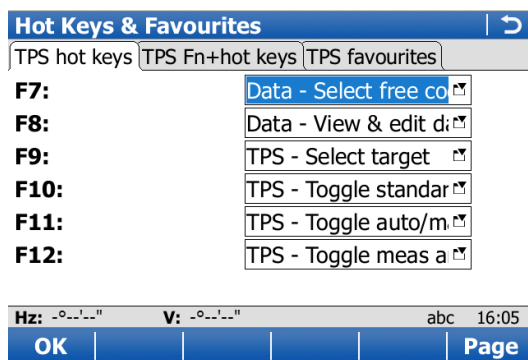

Key	Description
OK	To accept changes and return to Main Menu .
Page	To change to another page on this screen.
Fn Quit	To exit the screen.

Description of fields

Field	Option	Description
F7 to F12	Selectable list	All functions, screens or applications which can be assigned to the particular key.
F13	Selectable list	Available for MS50/TS50/TM50. All functions, screens or application programs which can be assigned to the user definable Smartkey.

Next step

Page changes to the **GPS Fn+hot keys/TPS Fn+hot keys** page.

Hot Keys & Favourites, GPS Fn+hot keys/TPS Fn+hot keys page

To configure the second level of hot keys.

This page is only available for CS15 models. CS10 models do not have hot keys.

The functionality on this page is identical to the one on the **GPS Hot Keys/TPS Hot Keys** page.

Next step

Page changes to the **GPS Fn+favourites/TPS Fn+favourites** page.

Hot Keys & Favourites, GPS Fn+favourites/TPS Fn+favourites page

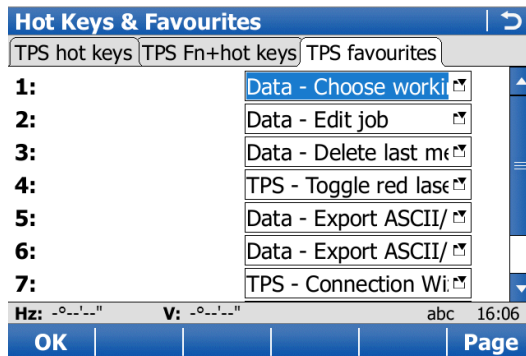

Key	Description
OK	To accept changes and return to Main Menu .
Page	To change to another page on this screen.
Fn Quit	To exit the screen.

Description of fields

Field	Option	Description
1 to 9	Selectable list	All functions, screens or applications which can be assigned to the individual lines in the user-defined menu.

Next step

Page changes to the first page on this screen.

Access

Select **Main Menu: User\Work settings\Prompt before storing**.

Prompt Before Storing, GPS and TPS page

Check a box if you want to be asked for input/selection when storing a point with **Store**.

Enter the Following

This screen is displayed when prompting is configured in **Prompt Before Storing** and when storing a point with **Store**.



Only the fields relating to the ticked check boxes in **Prompt Before Storing** are shown.

Description

A code is a description which can be stored by itself or with a point, line, or area. SmartWorx Viva coding is flexible with what types of codes can be stored and also how they are entered. Thematical and/or free codes can be stored to the system by;

- selecting codes from a codelist,
- entering a quick code combination,
- directly typing in the code, or
- selecting the code from a SmartCodes screen.



Quick coding and SmartCodes are both quick ways for a code to be selected, a point to be measured, and both code and point to be stored.



For coding, points, lines and areas have the same behaviour. In this chapter, the word object is used as a generic term for points, lines and areas.

Coding methods

Coding method	Characteristic	Description
Thematical	Use	To store a description together with an object inside an application or in Main Menu: Jobs & Data\ View & edit data.
	Selection of the codes	<ul style="list-style-type: none"> • For thematical coding with codelist: On a configured survey screen page, codes are selected from the job codelist in a selectable list. It is also possible to add thematical codes from the codelist to a SmartCodes screen for quick selection, or to select thematical codes using the quick coding method. The job codelist must contain thematical codes. • For thematical coding without codelist: On a configured survey screen page, codes are manually typed in.
	Recording of the codes	Together with the objects.
Free	Use	To store a description independent of an object at any time. A free code can be used to store a description related to an object, or additional descriptions such as the job name or temperature.
	Selection of the codes	<ul style="list-style-type: none"> • For free coding using a codelist: Pressing the configured hot key opens a selectable list with the free codes of the job codelist. It is also possible to select free codes using the quick coding method. The job codelist must contain free codes. • For free coding with direct input: Pressing the configured hot key opens a screen for alphanumeric input.

Coding method	Characteristic	Description
	Recording of the codes	Stored as time-related information. A time stamp is stored with each free code. Free codes selected using quick coding can be configured to be stored before or after the object.
Quick	<p>Use</p> <p>Selection of the codes</p> <p>Recording of the codes</p> <p></p> <p></p>	<p>Quick coding is the storing of an object plus a thematical or free code using a minimum number of keystrokes.</p> <p>Shortcuts must be assigned to codes in the job codelist. Quickcoding: On must be set in Coding & linework settings, Quickcoding page. Typing the shortcut searches for the assigned code. Point measurement begins.</p> <ul style="list-style-type: none"> For thematical codes: Together with the objects. With Automatically stop point measurement and Automatically store point both checked in Quality control, the points and codes are immediately stored. For free codes: Stored as time-related information before or after the points. A time stamp is stored with each free code. <p>Quick codes must be created in LGO.</p> <p>Characters that can be assigned to quick codes are:</p> <ul style="list-style-type: none"> 0 to 9 A to Z a to z

Configure coding

Refer to "25.2 Coding & linework" for information on configuring coding.

26.2

Thematical Coding

26.2.1

Thematical Coding with Codelist

Requirements

- The job codelist contains thematical codes for points, lines and/or areas.
- Use a list box to view codes** is checked in **Coding & Linework Settings**.
- A survey screen page with an editable field for codes must be configured.

Access

Open the selectable list for **Code** in a survey screen page of an application.

OR

Open the selectable list for a **Code/Point code** in **New Point, Code** page. The procedure is similar for lines and areas.

OR

Open the selectable list for **Point code** in **Edit Point:, Code** page. The procedure is similar for lines and areas.

OR

Open the selectable list for **Code (auto)** in **Survey, Auto** page, if configured.

Select Code

Select Code is shown as an example.

Depending on the setting for **Automatically create lines & areas when coding** in **Coding & Linework Settings, Linework** page, either;

- all point, line and area codes are available for selection, or
- only those point codes from the job codelist, which belong to an active code group, are available for selection.

Codes marked with * have attributes attached.

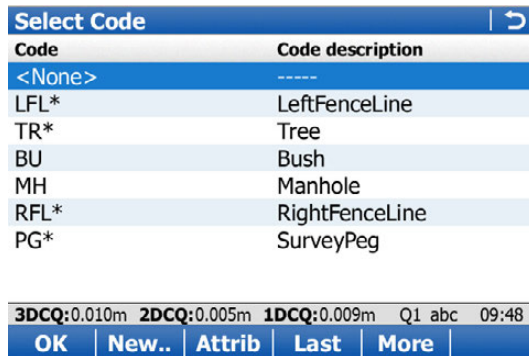

Key	Description
OK	To accept changes and to return to the screen from where this screen was accessed.
New..	To create a new code.
Attrib	Available unless creating/editing a point/line/area. To type in attribute values for the selected code and/or add new attributes for the selected code.
Last	Available if a code has been previously used in the working job. To select from a list of last used codes. The codes are sorted by time with the most recently used code at the top of the list.
More	To display information about the code description, the code group, the code type and the quick code if codes with quick codes exist in the job.
Fn Group	To view, create, delete, activate and deactivate code groups. Refer to "7.5 Managing Code Groups".
Fn Sort	To sort codes by code name, code description, quick code, in the order they were added to the codelist, or the last used.
Fn Quit	To exit the screen.

Next step

Highlight the desired code.

- If a point code is selected then any open line/area is closed. The measured point is stored with the selected code independently of any line/area.
- If a line code is selected then any open line is closed and a new line with the selected code is created. The line ID is defined by the configured line ID template. The measured point is assigned to that line. The line stays open until it is closed manually or another line code is selected.
- If an area code is selected then the behaviour is as for lines.

Attrib to access **Enter Attributes**.

Enter Attributes

If configured for the selected code, editable fields for attribute values are available. Any preconfigured attribute rules, for example, integer numbers only, a set range, or a selectable list, control what values can be entered. Type in the attribute values. Attribute values for attributes of type

- normal can be edited.
- fixed cannot be edited.

Enter Attributes | ↻

Point code: TR

Description: Tree

Diameter:

Attribute 2

3DCQ:0.008m 2DCQ:0.004m 1DCQ:0.007m Q1 abc 09:48

OK
+Attrib
Value
Last
Default

Key	Description
OK	To return to the screen from where this screen was accessed.
+Attrib	To add a new attribute of type normal and of value type text. Up to twenty attributes can be added. Attributes of type mandatory or fixed and of value type real or integer must be created in LGO.
Name or Value	Available for attributes for which an attribute name can be typed in. To highlight the field of the attribute name or the field for the attribute value. The name of the attribute can be edited and the attribute value to be used as the default attribute value can be typed in.
Last	To recall the last used attribute values for the selected code.
Default	To recall the default attribute values for the selected code.
Fn Quit	To exit the screen.

Next step

Press **OK**. The code and any associated attribute values are stored when the point is stored. If a point with the same point ID exists in the job, the codes, attribute names and attribute values of the new and existing points must be identical. Should they not be identical, a screen opens where the code or attribute mismatch can be corrected.

26.2.2

Thematical Coding without Codelist

Requirements

- **Use a list box to view codes** is NOT checked in **Coding & Linework Settings**.
 - A survey screen page with an editable field for codes must be configured.
 - A survey screen page with a selectable list for code types must be configured.
-

Access

A thematical code is typed in the field

Code in a survey screen page of an application.

OR

Code/Point code in **New Point, Code** page. The procedure is similar for lines and areas.

OR

Point code in **Edit Point:, Code** page. The procedure is similar for lines and areas.

OR

in the field **Code (auto)** in **Survey, Auto** page, if configured.

Survey, Code page

Type in a code and attribute values. Up to eight attributes can be added. This setting is configured in the survey screen page.

- If a point code is selected then any open line/area is closed. The measured point is stored with the selected code independently of any line/area.
- If a line code is selected then any open line is closed and a new line with the selected code is created. The line ID is defined by the configured line ID template. The measured point is assigned to that line. The line stays open until it is closed manually or another line code is selected.
- If an area code is selected then the behaviour is as for lines.

Next step

Press **Meas.**

26.3

Free Coding

26.3.1

Free Coding Using a Codelist

Requirements

- The job codelist contains free codes.
 - A hot key is configured to access the screen **Enter Free Code & Attributes** or the favourites menu is configured to display the option **Select free code from list**.
-

Access

Press a hot key configured to access the screen **Enter Free Code & Attributes**.

Refer to "1.1 Hot Keys" for information on hot keys.

OR

For GPS mode, press  and select **Select free code from list** to access the screen **Select Free Code**.

For TPS mode, press Fn  and select **Select free code from list** to access the screen **Select Free Code**.

Refer to "1.2 Favourites Key" for information on the  key.

Select Free Code

All free codes from the job codelist which belong to an active code group, are available for selection. Free codes marked with * have attributes attached.

Select Free Code	
Code	Code description
RE	Right edge of rd
LE	Left edge of rd
CL	Centre line

3DCQ:0.010m	2DCQ:0.005m	1DCQ:0.008m	Q1 abc	09:49
Store	New..	Attrib	Last	More

Key	Description
Store	To store the free code and any associated attribute values and to return to the screen from where this screen was accessed.
New..	To create a new code.
Attrib	To type in attribute values and/or add new attributes for the selected free code. Refer to "26.2.1 Thematical Coding with Codelist".
Last	Available if a free code has been previously used in the working job. To select from a list of last used free codes. The free codes are sorted by time with the most recently used code at the top of the list.
More	To display information about the code description, the code group and the quick code if codes with quick codes exist in the job.
Fn Group	To view, create, delete, activate and deactivate code groups. Refer to "7.5 Managing Code Groups".
Fn Sort	To sort codes by code name, code description, quick code or the last used.
Fn Quit	To exit the screen.

26.3.2

Free Coding with Direct Input

Requirements

A hot key is configured to access the screen **Enter Free Code & Attributes** or the favourites menu is configured to display the option **Enter free code**.

Access

Press a hot key configured to access the screen **Enter Free Code & Attributes**. Refer to "1.1 Hot Keys" for information on hot keys.

OR

For GPS mode, press  and select **Enter free code** to access the screen **Enter Free Code & Attributes**.

For TPS mode, press Fn  and select **Enter free code** to access the screen **Enter Free Code & Attributes**.

Refer to "1.2 Favourites Key" for information on the  key.

Enter Free Code & Attributes

Type in a code and attribute values. As soon as a free code is typed in, a codelist is created within the job. Up to eight attributes can be added. Refer to "26.3.1 Free Coding Using a Codelist" for a description of keys.

Next step

Press **Store**.

Requirements

- The job codelist contains quick codes for points, lines and/or areas.
- According to the user requirements, set **Store free code: Before pt is stored** or **Store free code: After pt is stored** in **Coding & Linework Settings, Quickcoding**.

Activate quick coding

The current setting for **Quickcoding** in the **Quickcoding** page determines how quick coding is activated. Quick coding can be activated at any time.

- For **Quickcoding: On**, Quick coding is active and can be used.
- For **Quickcoding: Off**, use a hot key, the  favourites menu or tap the quick coding icon.
- For **Quickcoding: Never**, change the setting manually.

Performing Quick coding

A screen must be active where points can be measured.

Type in the one, two or three digits of the quick code. The current setting for **Digits to use** in **Coding & Linework Settings, Quickcoding** page determines by how many keystrokes quick coding is executed.

Press ENTER to execute quick coding after less than the configured keystrokes. This action is possible after one keystroke for **Digits to use: 2** and one or two keystrokes for **Digits to use: 3**.

Press ESC to clear digits from the entry.

Only mandatory attribute values can be entered. For non-mandatory attributes, either the default or the last used attribute values are stored, depending on the setting for **Suggested attributes** in **Coding & Linework Settings, Code & attributes** page.

For point codes:

- The point code assigned to the quick code is searched for in the job codelist and point measurement begins.
- The point code and any associated attribute values are stored with the point.
- If a point with the same point ID exists in the job, the codes, attribute names and attribute values of the new and existing points must be identical. Should they not be identical, a screen opens where the code or attribute mismatch can be corrected.

For free codes:

- The free code assigned to the quick code is searched for in the job codelist and point measurement begins.
- The free code, associated attribute values and time related information are stored. The setting for **Store free code** in **Coding & Linework Settings, Quickcoding** page determines if the free code is stored before or after the point.

For line/area codes:

- The line/area code assigned to the quick code is searched for in the job codelist.
- A new line/area is created and immediately stored with that line/area code and attributes. For the line/area ID, the line/area ID template as defined in **ID Templates** is used.

26.5
26.5.1

SmartCodes
Overview

Description

SmartCodes is a quick way for a code to be selected and a point to be measured. All existing coding, linework, and point measurement functionality is retained.

26.5.2

Configuring SmartCodes

Access

In **Survey** press Fn **Config..** to access **Configuration**.

Configuration Smart-Codes page

The settings on this page activate the using of SmartCodes and define the method. All settings in this screen are stored within the currently active working style.

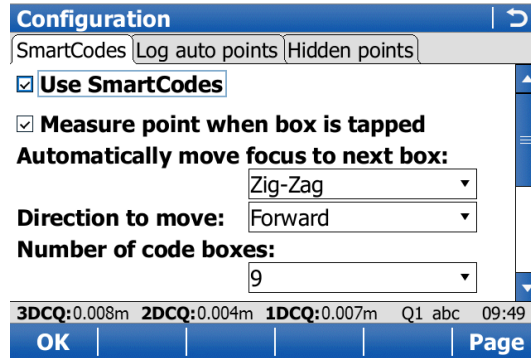

Key	Description
OK	To accept changes and return to the screen from where this screen was accessed.
Page	To change to another page on this screen.
Fn Quit	To exit the screen.

Description of fields

Field	Option	Description
Use Smart-Codes	Check box	If checked, using of SmartCodes is activated.  All other fields on the screen are active and can be edited.
Measure point when box is tapped	Check box	If checked, when one of the code boxes is tapped in Survey, SmartCodes page, then the code is selected and the point is measured.
Automatically move focus to next box	Not used	Method by which subsequent code box is selected after a point is stored. Nine code boxes are shown in the Survey, Smart-Codes page, but no automatic movement of the focus takes place.
	Zig-Zag	Each new code rotation through the block is started at the same end where the previous code rotation finished.
	Same direction	Each new code rotation through the block is started at the same end where the previous code rotation started.

Field	Option	Description
		Refer to "59 Survey Cross Section" for an explanation of Zig-Zag and Same direction .
Direction to move	<p>Forward</p> <p>Backward</p>	<p>Available for Automatically move focus to next box: Zig-Zag and Automatically move focus to next box: Same direction. The way of using the code boxes. This setting controls the order in which the code boxes will be rotated through automatically.</p> <p>The code boxes are used in the same way as defined in Survey, SmartCodes page.</p> <p>The code boxes are used in the reverse way as defined in Survey, SmartCodes page.</p>
Number of code boxes	From 1 to 9	Available for Automatically move focus to next box: Zig-Zag and Automatically move focus to next box: Same direction . Number of code boxes shown in Survey, SmartCodes page.
Show at bottom of screen	<p>Not used</p> <p>Point ID</p> <p>3D CQ</p> <p>2D CQ</p> <p>1D CQ</p> <p>Linework</p> <p>Antenna height <input type="text" value="GPS"/></p> <p>Target height <input type="text" value="TPS"/></p> <p>Hz <input type="text" value="TPS"/></p> <p>v <input type="text" value="TPS"/></p> <p>Horiz distance <input type="text" value="TPS"/></p> <p>Slope distance <input type="text" value="TPS"/></p> <p>Height difference <input type="text" value="TPS"/></p>	<p>Information shown in line 8 of Survey, Smart-Codes page.</p> <p>No survey screen page element is shown.</p> <p>The identifier for manually measured points. The configured point ID template is used.</p> <p>The current 3D coordinate quality of the computed position.</p> <p>The current 2D coordinate quality of the computed position.</p> <p>The current height coordinate quality of the computed position.</p> <p>The linework flag to be stored with the point. The options available depend on whether a line/area is currently open.</p> <p>The height of the antenna that is being used. Changing the antenna height here does not update the default antenna height as defined in the active working style.</p> <p>The height of the reflector that is being used. Changing the reflector height here does not update the default reflector height as defined in the active configuration set.</p> <p>The current horizontal angle of the measured point.</p> <p>The current vertical angle of the measured point.</p> <p>The current horizontal distance of the measured point.</p> <p>The current slope distance of the measured point.</p> <p>The current height difference between the station and the measured point.</p>

Field	Option	Description
Automatically create lines & areas when coding	Check box	If checked, lines and areas can be automatically created and opened using codes.
Use a stringing attribute	Check box	Available if Automatically create lines & areas when coding is checked. If checked, surveyed points that have the same code and attribute value for the Stringing attribute are strung together on one line.
Stringing attribute	Selectable list	Available if Use a stringing attribute is checked. The attribute value used to determine which surveyed points are strung together on one line.
Show code description instead of code	Check box	If checked, the code description is shown in the code boxes instead of the code.

26.5.3

Code Block

Requirements



- **Use SmartCodes** ticked in **Configuration, SmartCodes** page.

Survey, SmartCodes page

Key	Description
Meas	To start recording positions.
Codes..	To select a code to be assigned to the highlighted code block. Available when a code box is highlighted.
Page	To change to another page on this screen.

Description of fields

Field	Option	Description
Code block	Selectable list	The code block to be used.
Code box	-	A measured point is stored with the code assigned to the highlighted code box.

Field	Option	Description
		<p> When Stringing attribute is configured in Stringing attribute, SmartCodes page, an attribute value can be typed in below the code name of the highlighted code box. The attribute value can also be modified using the softkeys + and -.</p> <p> For Measure point when box is tapped being checked in Stringing attribute, SmartCodes page, tapping the code box with the supplied stylus automatically starts measuring the point. Selecting the code box by using the arrow keys will not start measuring the point.</p> <p> Lines/areas are automatically opened and closed using SmartCodes, as configured.</p>
Linework	Selectable list	Available for Show at bottom of screen: Linework . Select the linework flag to be stored with the point. Then move the focus on the line/area code box.

Next step

Highlight a code block and press **Codes..** to access **Select Code**.



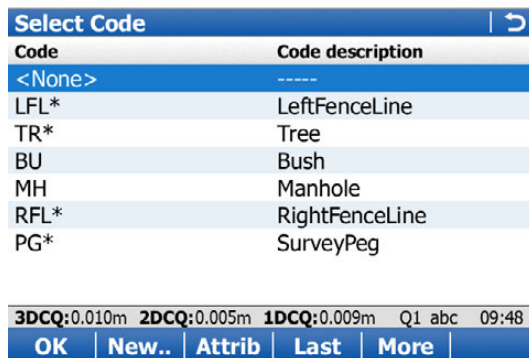

Select Code



Key	Description
OK	To accept changes and return to the screen from where this screen was accessed.
New..	To create a new code.
Attrib	To type in attribute values for the selected code and/or add new attributes for the selected code.
Last	Available if a code has been previously used in the working job. To select from a list of last used codes. The codes are sorted by time with the most recently used code at the top of the list.
More	To display information about the code description, the code group, the code type and the quick code if codes with quick codes exist in the job.
Fn Group	To view, create, delete, activate and deactivate code groups. Refer to "7.5 Managing Code Groups".
Fn Sort	To sort codes by code name, code description, quick code, in the order they were added to the codelist, or the last used.

Key	Description
Fn Quit	To exit the screen.

Copying a code block to a new job step-by-step

Step	Description
	Code blocks are stored in the job.
1.	Select Main Menu: Jobs & Data\ Job properties. OR Select Main Menu: Jobs & Data\Choose working job or Choose control job. Edit.. to access Job Properties:.
	Codelist: If codes had been copied from the internal memory codelist, the name of the codelist is displayed. If codes have been typed in, then the name of the job is displayed.
2.	Fn Export to copy codes and code blocks from the job to an existing or new codelist.
	Copying code blocks to an existing codelist overwrites the code blocks of the existing codelist.
3.	OK and Store to save the current job and return to Main Menu.
4.	Create a new job and assign the related codelist to the job.
	SmartCodes from the codelist are now available within the new job.

26.6

26.6.1

Code and Attribute Mismatch

Code Mismatch

Description

When storing a point with a code, it can happen that a point with the same point ID already exists in the job. If the codes of the new and the existing point do not match, a screen opens where the code can be corrected. One point cannot have different codes.

Point Code Mismatch

This screen opens automatically if the codes of the new and the existing point do not match. Highlight the code to be stored with the new point.

Point Code Mismatch ↶

Point ID: P101

New Code: TR

Description: Tree

Stored Code: LFL

Description: LeftFenceLine

3DCQ:0.010m
2DCQ:0.005m
1DCQ:0.008m
Q1 abc
09:53

Store
More

Key	Description
Store	To store the highlighted code and any associated attributes with the point being stored and to continue with the application or data management.
More	To display information about the code description, the code group and any attributes associated with the highlighted code.
Fn Quit	To exit the screen.

Description of fields

Field	Option	Description
New Code	Display only	The code for the point.
Stored Code	Display only	The code as stored for the existing point in the job.

26.6.2

Attribute Mismatch

Description

If a point with the same point ID exists in the job, the codes, attribute names and attribute values of the new and existing points must be identical. Should the attributes not be identical, a screen opens where the attribute mismatch can be corrected. One point cannot have different attribute information.



The name of the screen changes with pressing **Current** or **Stored**:

Pressing **Current**: **Attributes Being Stored**
 Pressing **Stored**: **Attributes Already Stored**

Attributes Already Stored/Attributes Being Stored

This screen opens automatically if the attribute names and/or values of the new and the existing point do not match.

Attributes Already Stored	
Point ID:	P101
Point code:	LFL
Description:	LeftFenceLine
Colour:	Beige

3DCQ:0.009m	2DCQ:0.005m	1DCQ:0.007m	Q1 abc	09:54
Store			Current	

Key	Description
Store	To store the selected attributes with the new/created point and to continue with the application or data management.
Current or Stored	To change between viewing the attribute names and values of the new/created point and those values stored for the existing point in the job.
Fn Quit	To exit the screen.

Description of fields

Field	Option	Description
Point code	Display only	<ul style="list-style-type: none"> For Attributes Already Stored: The code of the existing point in the job. For Attributes Being Stored: The code of the new point.
Attributes	Display only	<ul style="list-style-type: none"> For Attributes Already Stored: The attributes as stored for the existing point in the job. For Attributes Being Stored: The attributes of the new point.

Description	Code information is additional information with up to 40 alphanumeric characters. Code information relates to the code, such as instructions to the CAD package to start a line and string number and curve information. Code information can be used independently of a code being selected. Code information is stored when the measured point is stored.
Activating an editable field for code information	The editable field for code information can be selected to be used in any survey screen mask for GPS and TPS. To configure a survey screen mask select Main Menu: User\Work settings\My Survey Screen . Press Config.. and select Code information for one of the fields.
Using the code information editable field within applications	If the use of the Code information field is configured to be used in a survey screen mask, then the editable field is shown on that survey screen mask in any application. At any time, text can be typed into the field. This text is remembered and remains displayed after the point is stored. To recall entered text use the keys Prev and Next when the Code information is highlighted.
Viewing and editing code information	To view/edit code information, go to: <ul style="list-style-type: none"> • Data:, Points page. Use More until the code information is visible. • Edit Point:, Code page.
Exporting code information	To export code information select: <ul style="list-style-type: none"> • Main Menu: Jobs & Data\Export & copy data\Export ASCII data. Press Config.. to activate the export of code information. • Main Menu: Jobs & Data\Export & copy data\Export custom data. Configure a format file to export code information for entered points/lines/areas, points/lines/areas measured by GPS/TPS, GPS baselines or TPS measurements.

Description

Working with lines can be automated. Two ways of working are available. They are listed in this table. The two ways of working can be mixed.

Linework by	Description
Linework listbox	<p>The Auto page in Survey and any survey screen page, can be configured to show a field Linework with a selectable list. Any application can be configured to display a survey screen page and therefore have access to this Linework field.</p> <p>The selection from the selectable list determines</p> <ul style="list-style-type: none"> the action taken for a line/area, for example opening or closing a line. the linework flag stored with a point. <p>The linework flags</p> <ul style="list-style-type: none"> are configured in Coding & Linework Settings, Linework page. can be exported with a format file.
Coding	<p>Point, line or area codes can be selected in many applications.</p> <p>Selecting a point, line or area code closes any open line/area and opens a new line/area.</p> <p>Refer to "26 Coding" for more information.</p>



The linework flag can be used without thematical coding by using the linework field in the Survey screen page configuration.

The code can be linked to linework if it is configured as a point code to start a line/area, or it is a line or area code.

Quick coding can be used as described in "26.4 Quick Coding".

27.2**Performing Linework using the Linework Field**

The Survey application is used here to explain Linework.

Requirements

- A survey screen page with a selectable list for Linework must be configured.
- The linework flags must be defined in **Coding & Linework Settings, Linework** page.
- GPS** The rover menu must be used.

Access

Select **Main Menu: Go to Work!\Survey**.

Linework using the linework field step-by-step

Step	Description
1.	Go to the point to be measured.
2.	Select the linework flag to be stored with the point.
3.	Measure the point.
	Depending on the option selected for Linework , a line/area is opened, closed or reopened.
4.	Repeat steps 1. to 5. until all points for the linework are measured.
5.	Fn Quit to exit the Survey application.
6.	Use a format file to export the points including the linework flags.

Description

Linework and coding can be combined.

This combination can be useful, because coding, assigning linework flags and opening/closing lines/areas can all be done with one point observation.

Combining Linework and coding can only be configured if thematical point codes or if thematical point, line and area codes are available for selection. Thematical coding can be done with or without codelists.



Linework and coding can also be combined using SmartCodes. Refer to "26.5 Smart-Codes".

Configuration options

The configuration for the types of codes available and the configuration for coding with/without a codelist both have an influence on the following:

- The required configuration of a survey screen page.
- The behaviour of the fields configured for the survey screen page.
- The behaviour of the software.

The possible configurations and their influence on the coding related fields are shown in this table:

Configuration selected in the Coding & Linework Settings screen	Behaviour of the coding related fields depending on the configuration selected.		
	Code	Code type	Linework
Use a list box to view codes <input checked="" type="checkbox"/>	Selectable list	Display only	Selectable list
Automatically create lines & areas when coding <input checked="" type="checkbox"/>			
Use a list box to view codes <input checked="" type="checkbox"/>	Selectable list	Display only	Selectable list
Automatically create lines & areas when coding <input type="checkbox"/>			
Use a list box to view codes <input type="checkbox"/>	Editable field	Selectable list	Selectable list
Automatically create lines & areas when coding <input checked="" type="checkbox"/>			
Use a list box to view codes <input type="checkbox"/>	Editable field	Display only	Selectable list
Automatically create lines & areas when coding <input type="checkbox"/>			

Requirements

- A survey screen page must be configured with
 - a field for **Code**.
 - a selectable list for **Linework**.
 - a selectable list for **Code type** when using point, line and area codes without a codelist (**Use a list box to view codes** is unchecked).
This field is not required if only point codes are used, or when working with a codelist (**Use a list box to view codes** is checked).
- Configure in **Coding & Linework Settings, Code & attributes** page
 - **Automatically create lines & areas when coding** checked or not checked.
 - **Use a list box to view codes** checked or not checked.
- In **Coding & Linework Settings, Linework** page, define the linework flags.
-  The rover menu must be used.



The Survey application is used here to explain the combination of Linework and Coding.

Access

Select **Main Menu: Go to Work!\Survey**.

Survey, Survey page

This example is what a survey screen page configured for Linework and coding looks like.





The most important keys are explained.

The screenshot shows the Survey application interface. At the top, there is a title bar 'Survey: Job name' with a refresh icon. Below it are tabs for 'Survey', 'Code', 'Annot', and 'Map'. The main area contains several input fields: 'Point ID:' with a text box containing 'P1001', 'Code:' with a text box containing 'EL', 'Code type:' with a dropdown menu showing 'Line', 'Linework:' with a dropdown menu showing 'Begin line', and 'Antenna height:' with a text box containing '2.000' and a unit 'm'. At the bottom, there is a status bar with '3D CO: -----m', '3DCQ:0.010m', '2DCQ:0.006m', '1DCQ:0.008m', 'Fn abc', and '12:20'. Below the status bar are buttons for 'Meas', 'Near', 'HdnPt..', and 'Page'.

Key	Description
Meas <input type="button" value="GPS"/>	To start recording positions. The key changes to Stop .
Stop <input type="button" value="GPS"/>	To end recording of positions when enough data is collected. The key changes to Store .
Store <input type="button" value="GPS"/>	To store the point information. The key changes to Meas .
Meas <input type="button" value="TPS"/>	To measure and store distances and angles.
Stop <input type="button" value="TPS"/>	Available if Measure mode: Continuous and Dist was pressed. Stops the distance measurements. The key changes back to Meas .
Dist <input type="button" value="TPS"/>	To measure and display distances. Available unless Measure mode: Continuous and/or Log auto points checked, after the tracking or logging is started.
Store <input type="button" value="TPS"/>	To record data. If Measure mode: Continuous and/or Log auto points checked, records measured point and continues tracking.

Linework and Coding step-by-step

Step	Field	Description for thematical coding	
		Use a list box to view codes checked	Use a list box to view codes not checked
1.	Code	Select a code from the selectable list. Depending on the configuration only point codes, or also line and area codes are available for selection. <None> to store a point without code or to perform Linework without coding.	Type in a code. ----- to store a point without code or to perform Linework without coding.
2.	Code type	Point is displayed. This field is a display only field. It cannot be changed.	

Step	Field	Description for thematical coding	
		Use a list box to view codes checked	Use a list box to view codes not checked
3. 	Linework	<p>Select an option for the linework flag to be stored with the point. Refer to "27.2 Performing Linework using the Linework Field" for a description of the options.</p> <p>Select ----- to store a point without linework flag or to perform coding without Linework.</p>	
4.	-	 Press Meas , Stop and Store .	
	- - -	 Press Meas .	<ul style="list-style-type: none"> • The point is stored with the selected code. • The point is stored with the selected linework flag. • The choice of linework flags available for Linework is updated.

Description

The software has many configurable parameters and functions which can be set by the user to suit their preferred method of working. These preferred settings can be saved as a Working Style.
Using the **Working Style Wizard**, all the settings can be defined at once. Alternatively, all screens of this wizard can also be accessed individually from **User\Work settings** and **User\System settings**.

Default working style

A default working style exists on the instrument. It uses standard settings for most applications. The default working style can be edited or deleted. It is always possible to restore the default working style by formatting the internal memory.

User defined working styles

New working styles can be created. The working style wizard assists in editing working styles.

Edit outside the working style wizard

Parameters and functions can be edited without going through the working style wizard.

Access

Select **Main Menu: User\Working style wizard**.

Working Style Wizard

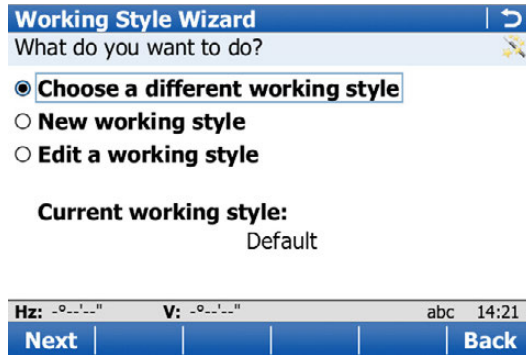

Key	Description
Next	To accept changes and to continue with the subsequent screen within the wizard.
Back	To return to the previous screen.
Fn Quit	To exit the wizard.

Next step

IF you want to	THEN
select a different set of settings	select New working style , press Next and continue with "28.3 Choosing a Different Working Style".
create a new set of settings	select Choose a different working style , press Next and continue with "28.4 Creating a New Working Style".
edit an existing set of settings	select Edit a working style , press Next and continue with "28.5 Editing a Working Style".

28.3

Choosing a Different Working Style

Working Style Wizard,
Choose the working style to use.

Select an existing working style from the selectable list.

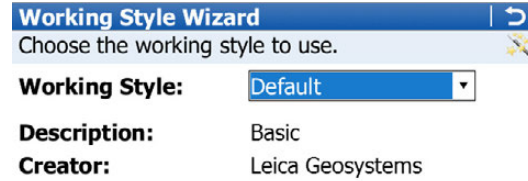

Working Style Wizard | ↻
Choose the working style to use. ✕
Working Style: Default ▾
Description: Basic
Creator: Leica Geosystems



Hz: -o-!-'' V: -o-!-'' abc 14:22
Next | Delete | Back

Key	Description
Next	To accept changes and to continue with the subsequent screen within the wizard.
Delete	To delete the highlighted working style.
Back	To return to the previous screen.

28.4

Creating a New Working Style

Working Style Wizard,
Enter the working style details.

Type in the name and a description for the new working style.



Working Style Wizard | ↻
Enter the working style details ✕
Name: 123
Description: -----
Creator: -----



Hz: -o-!-'' V: -o-!-'' abc 14:23
Next | Delete | Back | Fn Quit

Key	Description
Next	To accept changes and to continue with the subsequent screen within the wizard.
Back	To return to the previous screen.
Fn Quit	To exit the wizard.

Working Style Wizard,
Choose the working style to edit.

Select the working style to be edited from the selectable list.

Working Style Wizard | ↻

Choose the working style to edit. ✕

Working Style: Default ▾

Description: Basic

Creator: Leica Geosystems

Create a copy

Hz: -°-'-'' V: -°-'-'' abc 14:23

Next | Delete | Back

Key	Description
Next	To accept changes and to continue with the subsequent screen within the wizard.
Delete	To delete the working style currently shown in the selectable list immediately.
Back	To return to the previous screen.
Fn Quit	To exit the wizard.

Description of fields

Field	Option	Description
Create a copy	Check box	Creates a copy of the working style before the editing process starts.

Description

- The settings on this screen define
- the units for all types of measurement data displayed.
 - information related to some types of measurement data.
 - the order in which coordinates are displayed.
 - the instrument identification number.
 - the languages available on the instrument.

Access

Select **Main Menu: User\System settings\Regional settings.**

Regional Settings, Distance page

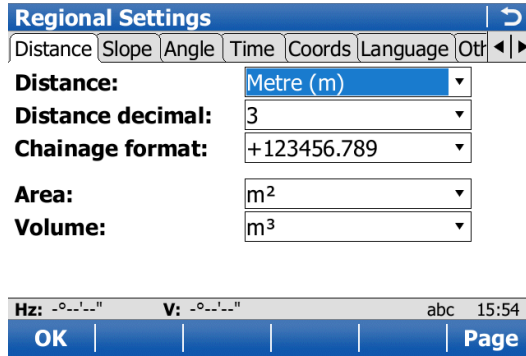

Key	Description
OK	To accept changes and return to Main Menu.
Page	To change to another page on this screen.
Fn Quit	To exit the screen.

Description of fields

Field	Option	Description
Distance	Metre (m)	The units shown for all distance and coordinate related fields. Metres [m]
	International ft (fi)	International feet [fi], storage in US feet
	Intl ft/inch (fi)	International feet [fi], inches and 1/8 inches (0' 00 0/8 fi), storage in US feet
	US ft (ft)	US feet [ft]
	US ft/inch (ft)	US feet, inches and 1/8 inches (0' 00 0/8 fi) [ft]
	US mile (mi)	US miles [mi]
Kilometre (km)	Kilometres [km]	
Distance decimal	From 0 to 4	The number of decimal places shown for all distance and coordinate related fields. This setting is for data display and does not apply to data export or storage. The available options depend on the selected Distance.
Chainage format	+123456.789	Selects display format for all chainage information fields. Default chainage display form.

Field	Option	Description
	+123+456.789 +1234+56.789 +123.4+56.789 PegN°+10.000	Separator between hundreds and thousands. Separators between tens and hundreds. Separator between tens and hundreds with additional decimal point. In this format, a peg distance is used to calculate a peg number and determine what additional value is shown next to it. For example, at chainage of 100 m and a peg distance of 20 m, the peg number equals 5 ($100/20 = 5$). Chainage 100 m = 5 + 0.000 Chainage 110 m = 5 + 10.000 Chainage -100 m = -5 - 0.000 Chainage -90 m = -4 - 10.000
Area	m², Intl acres (Ai), US acres (A), Hectares (ha), fi² or ft²	The units shown for all area-related fields.
Volume	m³, fi³, ft³ or yd³	The units shown for all volume-related fields.

Next step

Page changes to the **Slope** page.

Regional Settings, Slope page

OK

To accept changes and return to **Main Menu**.

Page

To change to another page on this screen.

Fn Quit

To exit the screen.

Description of fields

Field	Option	Description
All fields	h:v v:h %(v/h x 100) Elevation angle	The input and output format for grades. Horizontal by vertical distance. Vertical by horizontal distance. Percentage of vertical by horizontal distance. Elevation angle.

Next step

Page changes to the **Angle** page.

Description of fields

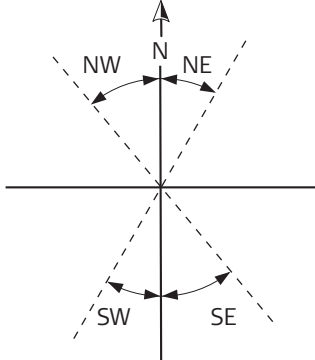
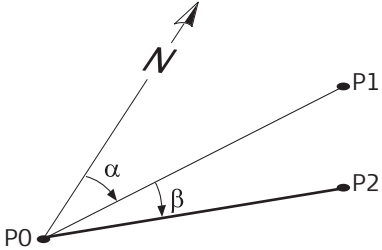
Field	Option	Description
Angle	400 gon, 360°", 360° dec or 6400 mil	The units shown for all angular and coordinate related fields.
Angle decimal	From 1 to 4 From 2 to 4 5 0.1", 1", 5", 10" or 60"	The number of decimal places shown for all angular and coordinate related fields. This setting is for data display and does not apply to data export or storage. Available for Angle: 6400 mil . Available for Angle: 400 gon and Angle: 360° dec . Available for MS50/TS50/TM50 and Angle: 400 gon or Angle: 360° dec . Unavailable for remote configuration. Available for Angle: 360°" .
Hz angle display	North azimuth, South azimuth, North anti-clockwise Bearing Angle right	Sets the reference direction as well as the direction from where and how azimuths are computed. The azimuth fields in other screens are called Azimuth . The azimuth fields in screens are called Bearing . NE, SW, SE and NW indicate the quadrant of the bearing.  GS_049 Displays the horizontal angle difference between the backsight point and the current telescope position. The azimuth fields in screens are called Angle right .  GS_128

Field	Option	Description
		P0 Instrument station P1 Backsight point P2 Point in direction of current telescope position α Azimuth β Angle right
GPS direction ref	True or Magnetic	Sets the North direction.
Declination	Editable field	Available for GPS direction ref: Magnetic . The value for the magnetic declination. It is considered when computing or using any azimuth values.
V angle display <input type="checkbox"/> TPS	Zenith angle Elevation angle Elevation angle %	V = 0 in zenith. V = 0 horizontal elevation angle. Vertical angles are positive above the horizon and negative below it. V = 0 horizontal. Vertical angles are expressed in % and are positive above the horizon and negative below it.
Hold V angle after a Dist measurement <input type="checkbox"/> TPS	Check box	If checked, the vertical angle is fixed after a distance measurement with Dist , whereas the horizontal angle is continuously updated with the telescope movement. If not checked, the vertical angle is continuously updated with the telescope movement.  The active prism height is applied in the calculation of remote point elevations. The prism height must be set to zero to display and record the elevation of the targeted remote point.

Next step

Page changes to the **Time** page.

Regional Settings, Time page

The time zone is read from WinCE.

Description of fields



Field	Option	Description
Time format	24 hour or 12 hour (am/pm)	How the time is shown in all time-related fields.
Current time	Display only	Shows an example of the selected time format.
Date format	Day.month.year, Month/day/year or Year/month/day	How the date is shown in all date-related fields.
Current date	Display only	Shows an example of the selected date format.

Next step

Page changes to the **Coords** page.

**Regional Settings,
Coords page**

Description of fields

Field	Option	Description
Grid format	Easting, northing or Northing, easting	The order in which grid coordinates are shown in all screens. The order in survey screen pages depends on the user settings.
Geodetic format	Latitude, longitude or Longitude, latitude	The order in which geodetic coordinates are shown in all screens. The order in survey screen pages depends on the user settings.
Switch Easting for CAD files and Switch Northing for CAD files	Check box	<p>When these boxes are checked, then the signs of the Easting and Northing coordinates of CAD files are changed so that the CAD file in MapView is mirrored. The setting applies to all applications, including Roads.</p> <p> The signs of the Easting/Northing coordinate only change for the display purposes. The signs are not changed in the data-base.</p> <p> When importing/exporting dxf data, the signs of the data are switched according to the setting.</p>

Next step

Page changes to the **Language** page.

**Regional Settings,
Language page**

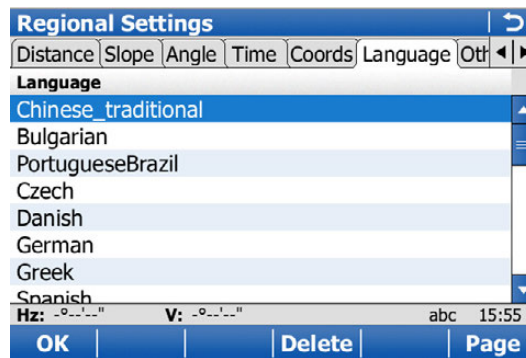

Key	Description
OK	To accept changes and return to Main Menu .
Delete	To delete the highlighted language.
Page	To change to another page on this screen.
Fn Quit	To exit the screen.

Description of columns

Column	Description
Language	The languages available on the instrument. Three languages can be stored on the instrument at one time - English and two others. English cannot be deleted.

Column	Description
	The selected language is used for the system software. If a language is not available for the system software, the English language is used instead. Applications are available in the languages that were loaded on the instrument when the application was installed.

Next step

Page changes to the **Others** page.

**Regional Settings,
Others page**

Description of fields

Field	Option	Description
Temperature	Celsius (°C) or Fahrenheit (°F)	The units shown for all temperature-related fields.
Pressure	mbar, mmHg, Inch Hg (inHg), hPa or psi	The units shown for all pressure-related fields. PSI = pounds per square inch.
Velocity unit	Km/h (kmh), Mph (mph) or Knots (kn)	The units shown for all velocity-related fields.

Next step

Page changes to the **Device ID** page.

**Regional Settings,
Device ID page**

Description of fields

Field	Option	Description
Device ID	Editable field	This number is used for the generation of the file names. Using format files, the instrument ID can be exported together with data from the instrument. By doing so, it can be identified which instrument was used for certain measurements. Sets a four-digit number as instrument identification number. By default the last four numbers of the serial number are used.

Next step

Page changes to another page on this screen.

Description The settings on this screen define the behaviour of the instrument for a general start up.

Access Select **Main Menu: User\System settings\SmartWorx options**.

Welcome to SmartWorx Viva! If a check box is checked, the corresponding screen is shown during start up. If all check boxes are unchecked, then, after turning on the instrument, the **Main Menu** is accessed immediately.

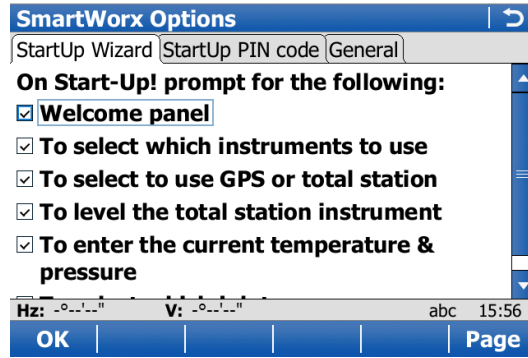

Key	Description
OK	To accept changes and return to Main Menu .
Fn Quit	To exit the screen.

Welcome to SmartWorx Viva!, StartUp PIN code page

If **Use PIN: Yes**, then, after turning on the instrument, a PIN code must be entered.

Description of fields

Field	Option	Description
Use PIN	Yes	PIN protection is activated and a PIN code must be entered at startup.
	No	PIN protection is not activated and no PIN code is required at startup.
New PIN	Editable field	Available if Use PIN: Yes The new PIN code that will be required at startup. PIN codes must be numerical only and 4 to 6 digits in length.

Next step

Page changes to the **General** page.

Welcome to SmartWorx Viva!, General page

If the check box for **Use drop down menus in the main menu** is checked, then menus will appear as drop down menus.

If the check box for **Use drop down menus in the main menu** is unchecked, then menus will appear as graphical menus.

Next step

OK to save the changes and return to the **Main Menu**.

Description

The settings on this screen allow the screen appearance to be configured, turn the notification beeps on and off and define the behaviour of the keys. The settings are stored on the field controller itself. If the field controller is exchanged, the settings stored on the new field controller apply.

Access

Select **Main Menu: User\System settings\Screen & audio.**

Screen & Audio Settings, Screen page

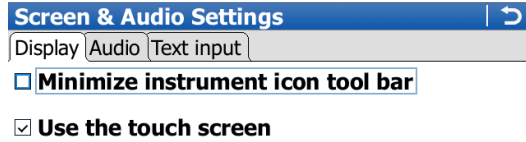

Key	Description
OK	To accept changes and return to Main Menu.
Calib	To calibrate the touch screen.
Page	To change to another page on this screen.
Fn Quit	To exit the screen.

Description of fields

Field	Option	Description
Minimise instrument icon tool bar	Check box	If checked, the icon tool bar on the top of the screen is minimised to one small icon on the top left. Tap this icon to make the full icon tool bar visible again.
Use the touch screen	Check box	If checked, the touch screen is turned on.

Next step

Page changes to the **Audio** page.

Screen & Audio Settings, Audio page

Description of fields

Field	Option	Description
Message sounds	Sounds only	A sound alert will be given when an information message appears.
	Sounds & voice	A sound and voice alert will be given when an information message appears.
Use Hz sector beeps with total stations	Check box	If checked, the horizontal sector beep is turned on. The instrument beeps when within 5 gon/4°30' of the defined sector, has a long and consistent beep within 0.5 gon/27' and no beep within 0.005 gon/16''.

Field	Option	Description
Hz sector angle	Editable field	Editable field for the sector angle for which a beep will sound.

Next step

Page changes to the **Text input** page.

Screen & Audio Settings, Text input page

Description of fields

Field	Option	Description
Data input method	Function keys, Mobile phone style or Pop-up keyboard	Alphanumeric input can either be through function or numeric keys. For the CS10 model, alphanumeric input can also be through an on-screen pop-up keyboard to be used with the stylus.
Default characters	Selectable list	Sets the set of extra characters available through Alpha or F1-F6 whenever an entry is made. The choices available depend on the character sets loaded on the instrument and the language configured to be used.

Next step

Page changes to another page on this screen.

29.4

Admin settings

Description

By the settings on this screen, access to certain areas of the system can be locked for other users, for example restricting them from creating a new working style.
To unlock the system, a correct password has to be entered. The number of attempts of password entries is not limited.

Access

Select **Main Menu: User\System settings\Admin settings**.

IF the system is	THEN
locked	the password must be typed in.
not locked	restriction settings can be set and a password can be defined. Refer to "Admin Settings Wizard, What do you want to do?".

Admin Settings Wizard, What do you want to do?

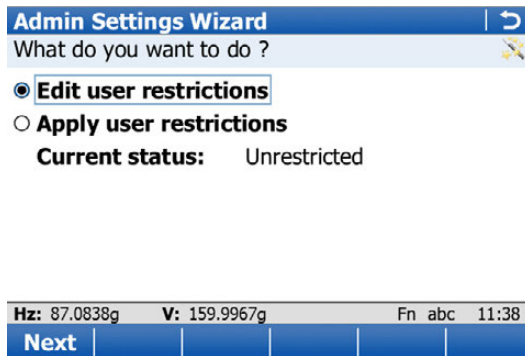

Key	Description
Next	To accept changes and to continue with the subsequent screen within the wizard.
Fn Quit	To exit the wizard.

Next step

IF you want to	THEN
lock settings	select Edit user restrictions , press Next and continue with "Admin Settings Wizard, Enter new admin password."
edit lock settings	select Edit user restrictions , press Next and follow the instructions on the screen. Then continue with "Admin Settings Wizard, Select the settings to be available."

**Admin Settings Wizard,
Enter new admin password.**

Description of fields

Field	Option	Description
Password	Editable field	Type in the password.

Next step

Page saves the password and changes the state of the system to **Restricted**.

**Admin Settings Wizard,
Select the settings to be available.**

Key	Description
Next	To accept changes and to continue with the subsequent screen within the wizard.
Edit..	To open the screen corresponding to the highlighted field. Shows the screen that will be hidden or displayed.
Back	To return to the previous screen.
Fn Quit	To exit the wizard.

**Admin Settings Wizard,
Do you want to apply user restrictions?**

Key	Description
Next	When Yes, apply user restrictions now is checked and this key is pressed, a password can be typed in. When No, just finish the wizard is checked, this key returns to the Main Menu .
Back	To return to the previous screen.

Description

This chapter describes the basic procedure for

- transferring objects between the data storage device and the internal memory.
- sending a job from the CS10/CS15 to the TS11/TS15/TS12 Lite and vice versa. Since the TS menu cannot be used when it is connected to the CS, the commands for sending the jobs from and to the TS must be operated from the CS only.

Refer to "Appendix C Directory Structure of the Memory Device" for information about file types and locations of files on the data storage device.

Access

Select **Main Menu: User\Tools & other utilities\Transfer user objects.**

Transfer User Objects



Key	Description
OK	To transfer an object and return to the screen from where this screen was accessed. For transfer between TS and CS, the job is transferred through Bluetooth, radio or cable.
Fn Quit	To exit the screen.

Description of fields

Field	Option	Description
Object to transfer	Selectable list	Listed are the objects that can be transferred. The available fields on the screen depend on the option selected.
From	CF card SD card USB Internal memory TS Internal memory TS SD card	Data storage device to transfer object from. Transfer from CS CompactFlash card. Transfer from CS Secure Digital Memory card. Transfer from CS USB. Transfer from the field controller. Transfer from TS internal memory. Transfer from TS Secure Digital Memory card.
To	Selectable list	Data storage device to transfer object to. Data storage device not selected in From .

Field	Option	Description
Job	Selectable list	To select the job to be transferred between memory devices or to/from TS.
Admin settings	Selectable list	To transfer the Admin settings defined.
Antenna	Selectable list	To select the antenna records to be transferred.
Codelist	Selectable list	To select the codelist to be transferred.
Working style	Selectable list	To select the configuration set to be transferred.
Coordinate system	Selectable list	To select the coordinate system to be transferred.
CSCS field file	Selectable list	To select the Country Specific Coordinate System to be transferred.
File	Display only	The dial-up list, the RTK Rover Wizard list, the server list to be transferred as a binary file. To select the custom templates stored on the data storage device in CONFIG\SKETCH_TEMPLATES.
Format file	Selectable list	To select the format files to be transferred.
Geoid field file	Selectable list	To select the Geoid Field File to be transferred.
Choose working job	Selectable list	To select the job to be transferred.
Rail job	Selectable list	To select the Rail job to be transferred. Available when the Roads application is loaded.
Road job	Selectable list	To select the Road job to be transferred. Available when the Roads application is loaded.
Tunnel job	Selectable list	To select the Tunnel job to be transferred. Available when the Roads application is loaded.
XSL Stylesheet	Selectable list	To select the stylesheets to be transferred.
Transfer for use with System1200	Check box	Available for jobs with To: CF card . When this box is checked, the job files are copied to the DBX folder, not to a subfolder.
Transfer all objects of the selected type	Check box	Available for some transfer object options. To transfer all objects.
Transfer all objects into a single VivaSystem.zip file	Check box	Available for Object to transfer: All objects . To zip all objects automatically during transfer.  Custom templates for the sketch pad are included.

Access

Select **Main Menu: User\Tools & other utilities\Load firmware & Apps.**

Load firmware & Apps

Load Firmware & Apps 

Object to transfer: Apps

From: CF card

App: <None>

Version: -----

Hz: _o_o_ V: _o_o_ abc 15:03

OK

Key	Description
OK	To upload an application, firmware or language and return to the screen from where this screen was accessed.
Delete	To delete an application or language.
Fn Quit	To exit the screen.

Description of fields

Field	Option	Description
Object to transfer	Apps	Application uploads are possible from the data storage device to the field controller. These files are stored in the \SYSTEM directory of the data storage device and use the extension *.a*.
	Firmware <input type="checkbox"/> GPS	Firmware uploads are possible from the data storage device to the field controller. These files are stored in the \SYSTEM directory of the active memory device and use the extension *.fw.  The firmware file for SmartWorx Viva includes the firmware of the CS 3.5G modem. However, the firmware of the CS 3.5G modem can also be loaded separately by using the stand-alone loader tool loader.exe. Refer to the CS10/CS15 User Manual and follow the CS firmware update instructions.
	Language	Language uploads are possible from the data storage device to the field controller. These files are stored in the \SYSTEM directory of the data storage device and use an extension that is individual to each language.
From	Selectable list	Upload from CompactFlash card, Secure Digital Memory card or USB stick.
App	Selectable list	List of application files stored on the card.
Firmware	Selectable list	List of firmware files stored on the card.
Language	Selectable list	List of language files stored on the card.

Field	Option	Description
Version	Display only	Version of the application/firmware/language file chosen.



In order to load the firmware to a GS05/GS06, the GS05/GS06 must be connected to the CS.



It is not possible to have more than three language files stored on the instrument. English is always available as the default language and cannot be deleted.



There is only one version of each application. The application will be installed in English and in any other language that is already loaded onto the instrument. If a new language is loaded after an application has been installed, the application will need to be reinstalled to become available in the new language.

30.3

Load licence keys

Description

A licence key can be used to activate applications and protected options and can be used to define the expiry date of the software maintenance. Refer to "32 User - About Leica Viva" to find out how to check the expiry date of the software maintenance.

A licence key file can be uploaded to the field controller. To upload a licence key file the file must be located on the \SYSTEM directory of the data storage device. Licence key files use the naming convention L_123456.key, where 123456 is the instrument serial number.



In order to upload the GS05/GS06 Glonass licence, the GS05/GS06 must be connected to the field controller.

To delete the GS05/GS06 Glonass licence from the GS05/GS06, upload the GS05/GS06 GPS licence.

Access

Select **Main Menu: User\Tools & other utilities\Load licence keys**.

OR

Select an application not yet activated.

Load Licence Keys

Load Licence Keys | ↻

Load key:

Key:

Hz: -°-'-'' V: -°-'-'' abc 15:03

OK | | | | |

Key	Description
OK	To accept changes and return to Main Menu or continue with the application.
Fn Delete	To delete all licence keys on the field controller.
Fn Quit	To exit the screen.

Description of fields

Field	Option	Description
Load key		The method used to input the licence key to activate the application or the protected options or the software maintenance.
	Upload key from file	The licence key file is uploaded from the data storage device. The licence key file must be stored in the \SYSTEM directory on the data storage device.
	Enter manually	Allows the licence key to be typed in manually.
Key	Editable field	Available for Load key: Enter manually . The licence key required to activate an application. Entry is not case sensitive.

30.4

Ftp data transfer

Description

This functionality is to transfer jobs, codelists and other Viva Series related files on the data storage device with a standard and simple FTP server.

FTP protocol is used to transfer between Viva Series, which runs SmartWorx Viva and has an Internet device connected, and the FTP server. The zip/unzip functionality is included. Licence keys can also be typed in manually in **Main Menu>User\Tools & other utilities\Load licence keys** or the first time the functionality is started.

Supported files

The following list shows the supported file extensions that will automatically move to the corresponding directory after downloading.

Supported file	File extension	Directory
Almanac file	Almanac.sys	DATA/GPS
Antenna file from GPS	List.ant	GPS
Application files	*.a*	SYSTEM
ASCII files for import/export to/from job	*.txt	DATA
Coordinate system file from GPS	Trfset.dat	DBX
CSCS field files	*.csc	DATA/GPS/CSCS
DXF files for import/export to/from job	*.dxf	DATA
Firmware files	*.fw	SYSTEM
Format files	*.fmt	CONVERT
Geoid field files	*.gem	DATA/GPS/GEOID
GSI files	*.gsi	GSI
GSM/Modem station list from GPS	*.fil	GPS
Language files	*.s*	SYSTEM
Licence file	*.key	SYSTEM
Report sheets created from applications	*.log	DATA
TPS working style files	*.xfg	CONFIG
System files	System.ram	SYSTEM
Custom ASCII file (SmartWorx Viva Export)	*.cst	DATA

Supported file	File extension	Directory
Comma separated variables, text file format (ASCII)	*.csv	DATA



Configure and connect the Internet interface before using this function.

Access

Select **Main Menu: User\Tools & other utilities\Ftp data transfer**.

Ftp Connection Details

Field to Office Configuration | ↩

Enter the office ftp connection details

Host:

TCP/IP port:

User ID:

Password:

```
3DCQ:-:---m 2DCQ:-:---m 1DCQ:-:---m Fn abc 13:57
Conect | | | | |
```

Key	Description
Conect	To connect to the FTP server entered.
Fn Quit	To exit the screen.

Description of fields

Field	Option	Description
Host	Editable field	In order to get access to the Internet, a host name is required. This host name identifies the instrument in the Internet.
TCP/IP port	Editable field	Port to be used. Any number between 0 and 65535 is valid.
User ID	Editable field	The User ID allows connection to the ftp site. If no value is typed in, then the instrument logs into the FTP server anonymously.
Password	Editable field	The password to get access to the ftp site.

Next step

Conect. Once the connection to the FTP server is established, the **Ftp Data Transfer, Field** page is displayed.

Ftp Data Transfer, Field page

The files and folders on the selected memory device of the instrument are displayed including their size. To get into the folders, highlight the folder and ENTER.

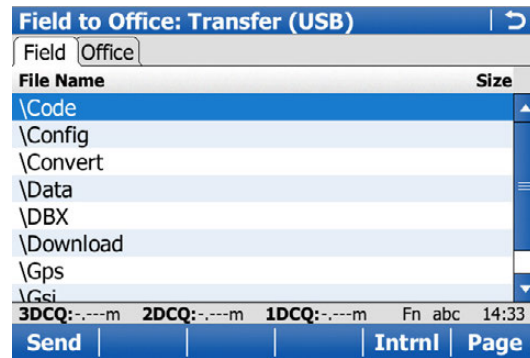

Key	Description
Send	To copy the file or folder to its corresponding directory on the ftp server. Files or folders bigger than 100 KB are zipped before sending.
Unzip	To unzip a file in the download directory. Available if a zip file is highlighted.
Import	To move a file from the \Download folder to the appropriate directory folder based on its file extension type. Available in the \Download folder when a file is highlighted. Unavailable for unrecognised files in the \Download folder. These files must stay in the \Download folder.
CF card, SD card, USB or Intrnl	To change between the data storage devices and the internal memory.
Fn Quit	To return to Main Menu and disconnect automatically from the FTP server.

Next step

Page changes to the **Office** page.

Ftp Data Transfer, Office page

The files located on the FTP server are displayed.

Whenever switching to this page, if the connection to the server was disconnected, then a refresh action is done or it reconnects to the server.

The most important keys are explained.

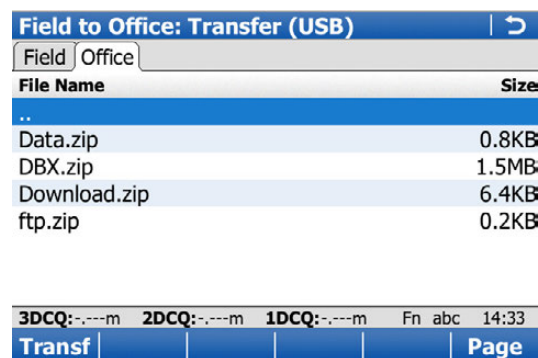

Key	Description
Transf	To download the highlighted file or folder list on the FTP server to the local download folder. If recognised by the system, downloaded files are moved automatically to the corresponding directories. If not, they are stored in the download folder. Zipped files are unzipped before storing in the download folder.
Page	To change to another page on this screen.
Fn Refrsh	To refresh the FTP directory.
Fn Quit	To return to Main Menu and disconnect automatically from the FTP server.

30.5

Format memory devices

Description

Allows the data storage device and the internal memory to be formatted. All data will be erased.



If the internal memory is formatted, all system data such as almanac, user-defined configuration sets, user-defined antennas, codelists, geoid field files and CSCS field files will be lost.

Access

Select **Main Menu: User\Tools & other utilities\Format memory devices**.

Format Memory Device

Key	Description
OK	To format a memory device and return to the screen from where this screen was accessed.
Fn Quit	To exit the screen.

Description of fields

Field	Option	Description
Memory device	Selectable list	The type of memory to be formatted.
	CF card	Formatting the CF card will delete all data currently stored on the CF card.

Field	Option	Description
	Internal memory	Formatting the Internal Memory will delete the following objects currently stored on the internal memory - Jobs, Admin Settings, Codelists, Coordinate Systems, Format Files, Geoid & CSCS field files, RTK Profiles, Sketch Templates & User Entered Antenna.
	SD card	Formatting the SD card will delete all data currently stored on the SD card.
	USB stick	Formatting the USB stick will delete all data currently stored on the USB stick.
	Apps	Formatting the Apps will delete all currently loaded apps.
	System	Formatting the System RAM will delete the following objects - Working Styles, Stations to Dial lists & Server lists.

30.6 View contents of ASCII files

Description	Allows ASCII files selected for From file in Import ASCII Data to be viewed in WordPad.
Access	Select Main Menu: User\Tools & other utilities\View contents of ASCII files . WordPad opens.

30.7 Leica Exchange

30.7.1 Overview

Availability	Leica Exchange is available on your TS11/TS15/TS12 Lite/MS50/TS50/TM50 instrument or CS10/CS15 field controller.
Description	Leica Exchange is an online service that allows the data exchange between two users of the service. For example: <ul style="list-style-type: none"> The user in the field sends the daily measured data to the user in the office. The user in the field sends a codelist to a second user in the field.
Requirements	<ul style="list-style-type: none"> Valid Leica Exchange subscription SmartWorx Viva 4.0 or higher Leica Exchange licence key loaded on a CS field controller/TS instrument AND / OR <ul style="list-style-type: none"> Leica Exchange entitlement ID loaded on a computer with Leica Exchange Office

Creating User name and Password step-by-step

Step	Description
1.	Order a Leica Exchange subscription. You will receive a subscription form.
2.	Take the subscription ID in the subscription form and log in to your myWorld account (https://myworld.leica-geosystems.com).
3.	Navigate to myTrustedServices.
4.	On the My Trusted Services tab, select Add Service and type in the subscription ID.
5.	The Leica Exchange Service is shown in the My Trusted Services tab. Once the Leica Exchange Service is registered, users can be assigned to the service on the My Users tab.

Step	Description
6.	<p>Click the Add button to define a new user and to assign services to the user. For each user:</p> <ul style="list-style-type: none"> • Enter contact information • Define a unique user name • Assign a password <p>The user name and password are needed each time you access the Leica Exchange Service. The Leica Exchange Service can be accessed from Smart-Worx Viva in the field or using Leica Exchange Office PC software.</p>
	After registering the subscription ID in your myWorld account, the subscription usage statistic is fully accessible. The total quota is shown and the consumed and remaining GB are displayed in total GB and GB/month.

Access

Select **Main Menu: User\Tools & other utilities\Leica Exchange**.

If a user is currently logged in then the **Leica Exchange Main Menu** screen is accessed. If no user is currently logged in then the **Leica Exchange Login** screen is accessed.

Leica Exchange Login

User name and password must be typed in each time the **Leica Exchange** service is accessed.

Description of fields

Field	Option	Description
User name	Editable field	The user ID created in MyWorld allows connection to the exchange server.
Password	Editable field	The password created in MyWorld to get access to the exchange server.

Next step

The first time you log into **Leica Exchange** you need to accept the license agreement. If a connection to the **Leica Exchange** server is active and if the user name and password are recognised, then **OK** accesses **Leica Exchange Main Menu**.

Leica Exchange Main Menu

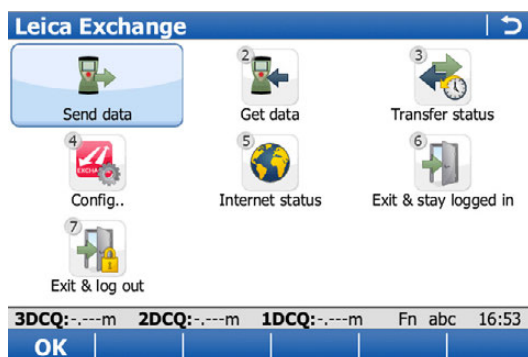

Key	Description
OK	To access the selected functionality.
Fn Quit	To exit the screen.

Description of options

Icon	Description
Send data..	To select objects to be uploaded to the server from the CS or TS and to start the upload. Access Leica Exchange Data Transfer .
Get data..	To select objects to be downloaded from the server to the CS or TS and to start the download. Access Select Data to Download . Data sent to a user are stored in the users "inbox" for two weeks.
Transfer status..	To check the transfer status for the last 20 transfers since login.
Config..	To access the Configuration screen for Leica Exchange .
Connection status..	To see details about the connection. The Internet Connection Status opens. A checked box for Connected to Leica Exchange indicates an established connection to the Leica Exchange Server.
Exit & stay logged in	To remain logged in but return to the Main Menu . Any transfer in progress continues in the background. You can see from anywhere inside SmartWorx when new files are received.
Exit & log out	To unlog and to return to the Main Menu . Any transfer in progress is stopped.

30.7.2

Configuring Leica Exchange

Access

Select **Config..** in **Leica Exchange Main Menu**.

OR

Press Fn **Config..** in **Select Data to Send, Select People to Send Data** or **Leica Exchange Data Transfer**.

Configuration, General page

This screen consists of two pages. The explanations for the softkeys given here are valid for all pages.

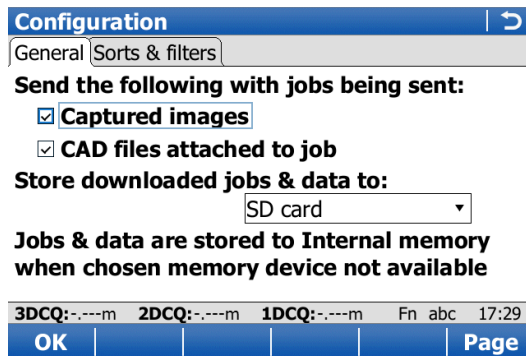

Key	Description
OK	To accept changes and return to the screen from where this screen was accessed.
Page	To change to another page on this screen.
Fn Quit	To exit the screen.

Description of fields

Field	Option	Description
Captured images	Check box	When this box is checked, the jobs are sent with the Images folder.
CAD files attached to job	Check box	When this box is checked, the jobs are sent with the Map files folder.
Store downloaded jobs & data to	Selectable list	The device on which the jobs and data are stored.  Jobs and data are stored in the internal memory when the chosen memory device is not available.

Next step

Page changes to the **Sorts & filters** page.

Configuration, Sorts & filters page

Description of fields

Field	Option	Description
Sort objects by	Time	The method points are sorted by. Sorts objects on the instrument by the time they were created. Sorts objects in the inbox by the time when they were uploaded to the server.
	Size	Sorts the objects by size in Kb.
	File name	Sorts the objects alphabetically by the object name.
	Type	Sorts the objects in alphabetical order of the object types. After applying the alphabetical order, the time is considered for the order of the files.
Display following objects for sending:	Check boxes	When a box is checked, the filter is active for that object type. The filter is valid for objects sent from the instrument. Objects on the server are always visible.

Next step

OK closes the screen.

Access

Select **Main Menu: User\Tools & other utilities\Leica Exchange\Send data...**

Select Data to Send

Name	Type	Selected
Railroad	CAD file	No
Verification Sample	2CAD file	No
Mont_030TR	DTM job	No
x-sec_oneLayer02	Job	No
Codelist 2	Codelist	No
Poster	Road job	No
TunnelJob_2Layers	Tunnel job	No
feet.gsi	Data file	No
comma1.txt	Data file	No

3DCQ:--m 2DCQ:--m 1DCQ:--m Fn abc 16:57

Next | Select | More

Key	Description
Next	To confirm the settings and to continue to the next screen. The Internet and server connection is checked.
Select	To set Yes or No in the Selected column for the highlighted object.
More	To change between type, size, modification date and source of the listed objects.
Fn Config..	To configure Leica Exchange .
Fn All or Fn None	To select or deselect all object for sending data.
Fn Quit	To exit the screen.

Description of columns

Column	Description
Name	The user-defined name of the objects.
Type	Supported are job, CAD files (dxf and shape files), data files, coordinate systems and codelists.
Size	The size of the selected object.
Modified date	The date when the object was last modified.
Source	The memory device where the object is stored.
Selected	For Yes : The selected object is used for sending data. For No : The selected object is not used for sending data.

Next step

Make a selection and press **Next**.

Select People to Send Data

Key	Description
Next	To confirm the settings and to continue to the next screen.
Select	To set Yes or No in the Selected column for the highlighted name.
Back	To return to the previous screen.
Fn Config..	To configure Leica Exchange .
Fn Quit	To exit the screen.

Description of columns

Column	Description
Name	The name of the person data can be send to. The list is downloaded from MyWorld. Refer to "Creating User name and Password step-by-step" for information on how to define user names.
Selected	For Yes : Data is sent to the person. Multiple selection is possible. For No : Data is not sent to the person.

Next step

Make a selection and press **Next**. The transfer starts.

While the transfer is in progress,

- the status can be checked by pressing **Status**. Refer to "30.7.5 Data Transfer Status".
- other tasks can be done. Press **Finish** to exit the wizard.

30.7.4

Getting Data

Access

Select **Main Menu: User\Tools & other utilities\Leica Exchange\Get data...**

Select Data to Send

The information shown is derived from the list of information retrieved from the server.

Select Data to Download		
Name	Type	Selected
1	Job	No
CH1903	Coordinate syst	No
UCS	CAD file	No
FONT Tahoma	CAD file	No
FONT Arial	CAD file	No
Mont_030TR	DTM job	No
FieldCodes	Codelist	No
comma1.txt	Data file	No

3DCQ:---m 2DCQ:---m 1DCQ:---m Fn abc 17:13

Next | Select | More

Key	Description
Next	To confirm the settings and to continue to the next screen. The Internet and server connection is checked.
Select	To set Yes or No in the Selected column for the highlighted object.
More	To change between type, size, modification date and source of the listed objects.
Fn Config..	To configure Leica Exchange .
Fn All or Fn None	To select or deselect all object for sending data.
Fn Quit	To exit the screen.

Description of columns

Column	Description
Name	The user-defined name of the objects.
Type	Supported are job, CAD files (dxf and shape files), data files, coordinate systems and codelists.

Column	Description
	Jobs downloaded from the server are stored in a subfolder of the DBX folder of the data storage device selected in Store downloaded jobs & data to in Configuration, General page. All files with unknown format, for example CAD or data files, are stored in the \DATA folder of the selected data storage device. Coordinate systems and codelists are stored to the internal memory of the CS or TS. From the internal memory, the codelist/coordinate system can be directly selected when creating/editing a job.
Size	The size of the selected object.
Modified date	The date when the object was last modified.
Selected	For Yes : The selected object is used for sending data. For No : The selected object is not used for sending data.

Next step

Make a selection and press **Next**. The transfer starts.

While the transfer is in progress,

- the status can be checked by pressing **Status**. Refer to "30.7.5 Data Transfer Status".
- other tasks can be done. Press **Finish** to exit the wizard.

30.7.5

Data Transfer Status

Access

Select **Transfer status..** in **Leica Exchange Main Menu**.

OR

Press **Status** in the wizard window while data is being send/received.

Data Transfer Status

The last 20 transfers since login are displayed.

Key	Description
OK	To return to Leica Exchange Main Menu .
Pause	To pause all transfers.
Resume	To restart all transfers.
Accept	Available when a row with status Conflict is highlighted. To choose between replacing or discarding the downloaded file.
Remov	Available for finished or cancelled transfers. To remove the transfer from the list.
Cancel	To cancel the highlighted transfer.
More	To change between user, size, date and expected time by when the transfer will be finished.
Fn Config..	To configure Leica Exchange .
Fn Quit	To exit the screen.

Description of columns

Column	Description
Type	The type of file transferred.
Name	The name of the file transferred.
Who	The user the file is transferred to or from.

Column	Description
Status	<p>... down/up - The downloading/uploading transfer is running is in progress.</p> <p>Sent - The upload has been successfully finished.</p> <p>Downloaded - The download has been successfully finished.</p> <p>Pending - A transfer is in progress and the current transfer has not been started.</p> <p>Paused - The transfer has been paused.</p> <p>Canceled - The transfer has been cancelled.</p> <p>Conflict - The transfer is finished, but there is another file with the same name in the designated folder. Press Accept.</p> <p>Interrup. - The transfer has been interrupted due to internet connection loss or other events that result in interrupting the transfer.</p>

30.7.6

In the Office

In the office

Step	Description
1.	After activating the Entitlement ID, login to Leica Exchange Office with your user name and password.
2.	Click on one of the icons to define the view in the right half of the window: Inbox, Status, History, Contacts . On the left side of the window, the data on the computer are displayed. Navigate to the folder you want to place received data or to where the data to be sent are stored.
3.	To get files from the inbox, click Inbox , select the files and drag them into the left half of the window. To send data, click Contacts and drag & drop the files from the left to the right. To send files to multiple users, select the users, drag & drop the files from the left to the right.
4.	To see the status of current transfers, click Status . To see all transfers done from both field and office and also the time when the objects were sent and received, click History .

Description

Leica Geosystems instruments are manufactured, assembled and adjusted to the best possible quality. Quick temperature changes, shock or stress can cause deviations and decrease the instrument accuracy. It is therefore recommended to check and adjust the instrument from time to time. This check and adjust can be done in the field by running through specific measurement procedures. The procedures are guided and must be followed carefully and precisely as described in the following chapters. Some other instrument errors and mechanical parts can be adjusted mechanically.

Electronic adjustment

The following instrument errors can be checked and adjusted electronically:

l, t	Compensator longitudinal and transversal index errors
i	Vertical index error, related to the standing axis
c	Horizontal collimation error, also called line of sight error
a	Tilting axis error
ATR	ATR zero point error for Hz and V - option
Telescope camera	Telescope camera zero point error, relation between principal point of telescope camera and crosshair in telescope in Hz and V - option

If the compensator and the horizontal corrections are activated in the instrument configuration, every angle measured in the daily work is corrected automatically. Select **Main Menu: Instrument\TPS settings\Level bubble & compensator** to check whether the tilt correction and the horizontal correction are turned on.

The results are displayed as errors but used with the opposite sign as corrections when applied to measurements.

Mechanical adjustment

The following instrument parts can be adjusted mechanically:

- Circular level on instrument and tribrach
- Optical plummet - option on tribrach
- Allen screws on tripod

Precise measurements

To get precise measurements in the daily work, it is important:

- To check and adjust the instrument from time to time.
- To take high precision measurements during the check and adjust procedures.
- To measure targets in two faces. Some of the instrument errors are eliminated by averaging the angles from both faces.



During the manufacturing process, the instrument errors are carefully determined and set to zero. As mentioned above, these errors can change and it is highly recommended to redetermine them in the following situations:

- Before the first use
- Before every high precision survey
- After rough or long transportation
- After long working periods
- After long storage periods
- If the temperature difference between current environment and the temperature at the last calibration is more than 20°C



Before determining the instrument errors, the instrument has to be levelled using the electronic level. Select **Main Menu: Instrument\TPS settings\Level bubble & compensator** to access the **Level Bubble & Compensator** screen.

The tribrach, the tripod and the underground should be stable and secure from vibrations or other disturbances.



The instrument should be protected from direct sunlight to avoid thermal warming.

It is also recommended to avoid strong heat shimmer and air turbulence. The best conditions are early in the morning or with overcast sky.



Before starting to work, the instrument has to become acclimatised to the ambient temperature. Approximately two minutes per °C of temperature difference from storage to working environment, but at least 15 min, should be taken into account.



Even after adjustment of the ATR, the crosshairs may not be positioned exactly on the centre of the prism after an ATR measurement has been completed. This outcome is a normal effect. The telescope is not normally positioned exactly on the centre of the prism, to speed up the ATR measurement. These small deviations/ATR offsets, are calculated individually for each measurement and corrected electronically. This means that the horizontal and vertical angles are corrected twice: first by the determined ATR errors for Hz and V, and then by the individual small deviations of the current aiming.

31.2

Details on Instrument Errors

Definition

Instrument errors occur, if the standing axis, the tilting axis and the line of sight are not precisely perpendicular to each other.

Horizontal collimation error (c)

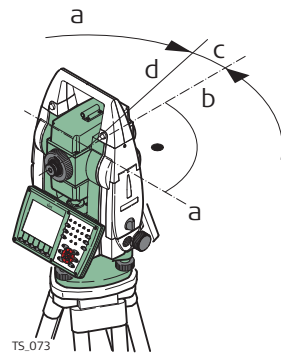

- a) Tilting axis
- b) Line perpendicular to tilting axis
- c) Horizontal collimation error (c), also called line of sight error
- d) Line of sight

The Horizontal collimation error (c) is also called line of sight error. It is caused by the deviation between the optical line of sight, which means the direction in which the crosshairs points and the line perpendicular to the tilting axis. This error affects all horizontal readings and increases with steep sightings.

Tilting axis error (a)

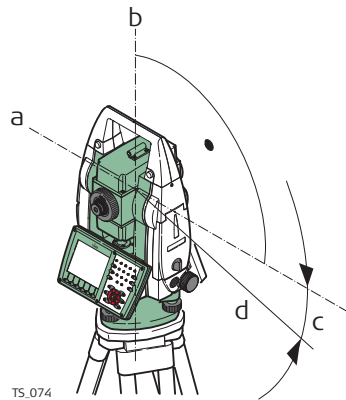

- a) Axis perpendicular to the vertical axis
- b) Mechanical vertical axis of the instrument, also called standing axis
- c) Tilting axis error
- d) Tilting axis

The deviation between the mechanical tilting axis and the line perpendicular to the vertical axis causes the tilting axis error (a).

This error affects horizontal angles. The effect is zero in the horizon and increases with steep sights. To determine this error, it is necessary to point to a target located significantly below or above the horizontal plane. To avoid influences from the horizontal collimation error (c), this has to be determined prior to the tilting axis error.

Vertical index error (i)

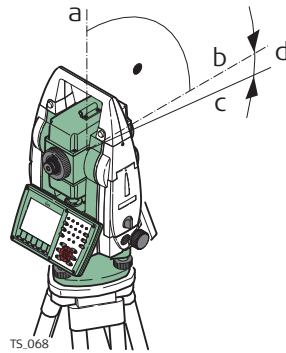

- a) Mechanical vertical axis of the instrument, also called standing axis
- b) Axis perpendicular to the vertical axis
- c) $V = 90^\circ$ reading in a specific face
- d) Vertical index error

A vertical index error (i) exists, if the 0° mark of the vertical circle reading does not coincide with the mechanical vertical axis of the instrument, also called standing axis. The V index error (i) is a constant error that affects all vertical angle readings.

Compensator index errors (l, t)

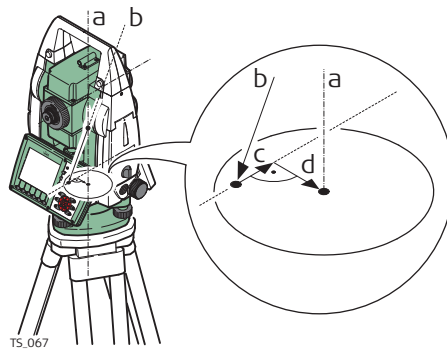

- a) Mechanical vertical axis of the instrument, also called standing axis
- b) Plumb line
- c) Longitudinal component (l) of the compensator index error
- d) Transversal component (t) of the compensator index error

The compensator index errors (l, t) occur, if the vertical axis of the instrument and the plumb line are parallel but the zero points of the compensator and the circular level do not coincide. The calibration procedure electronically adjusts the zero point of the compensator.

A longitudinal component in direction of the telescope and a transversal component perpendicular to the telescope define the plane of the dual axis compensator of the TS11/TS15/TS12 Lite/MS50/TS50/TM50.

The longitudinal compensator index error (l) has a similar effect as the vertical index error and affects all vertical angle readings.

The transversal compensator index error (t) is similar to the tilting axis error. The effect of this error to the horizontal angle readings is 0 at the horizon and increases with steep sightings.

Automatic aiming collimation errors

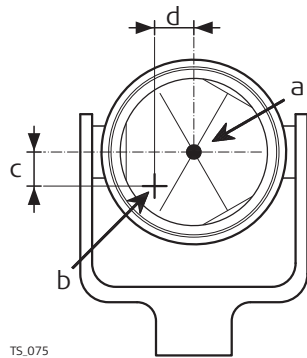

TS_075

- a) Centre of prism
- b) Crosshairs
- c) V component of ATR collimation error
- d) Hz component of ATR collimation error

The ATR collimation error is the angular divergence between the line of sight, which means the direction in which the crosshairs point, and the ATR CCD camera axis, which detects the centre of the prism. The horizontal and vertical components of the ATR calibration errors correct the horizontal and vertical angles to measure exactly to the centre of the prism.

Telescope camera collimation error

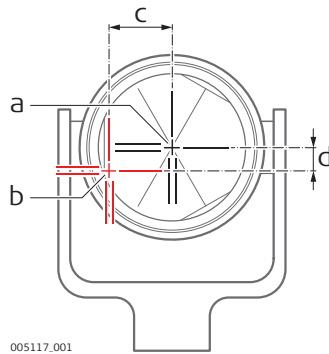

005117.001

- a) Physical crosshairs in the telescope
- b) Digital crosshairs in the telescope camera view
- c) Hz component of telescope camera collimation error
- d) V component of telescope camera collimation error

The telescope camera collimation error is the angular divergence between the physical crosshairs in the telescope and digital crosshairs in the telescope camera view. The determined horizontal and vertical offset values are applied as constant offset to the recent calibration values.

A full telescope camera calibration takes other camera parameters into account, for example focus position, rotation, scale and lens distortion. The full calibration is performed after production and in service.



Even after adjustment of the ATR, the crosshairs might not be positioned exactly on the centre of the prism after an ATR search. This is a normal effect. To speed up the ATR search, the telescope is not positioned exactly on the centre of the prism. The small rest deviations, the ATR offsets, are measured individually for each measurement and corrected electronically. This means that the horizontal and vertical angles are corrected twice: first by the determined ATR errors for horizontal and vertical and then by the individual small deviations of the current pointing, the ATR offsets.

Summary of errors to be adjusted electronically

Instrument error	Effects Hz	Effects V	Elimination with two face measurement	Automatically corrected with proper adjustment
c - Line of sight error	✓	-	✓	✓
a - Tilting axis error	✓	-	✓	✓
l - Compensator index error	-	✓	✓	✓
t - Compensator index error	✓	-	✓	✓
i - Vertical index error	-	✓	✓	✓
ATR Collimation error	✓	✓	-	✓
Co-axial camera collimation error	✓	✓	✓	✓

31.3

Accessing the Check & Adjust Wizard

Access

Select **Main Menu: User\Check & Adjust.**

Check & Adjust Wizard, What do you want to do?

Key	Description
Next	To accept changes and to continue with the subsequent screen within the wizard.
Fn Quit	To exit the wizard.

Next step

IF you want to	THEN
determine the instrument errors	select one of the three available check and adjust procedures and refer to the relevant subchapters.
view the current values	select View the current values. Refer to "31.7 Viewing the Current Values".
configure Check & Adjust	select Configure Check & Adjust. Refer to "31.8 Configuring Check & Adjust".
adjust the circular level	Refer to "31.9 Adjusting the Circular Level of the Instrument and Tribrach".
inspect the laser plummet	Refer to "31.11 Inspecting the Laser Plummet of the Instrument".
adjust the tripod	Refer to "31.12 Servicing the Tripod".

Access

In **Check & Adjust Wizard, What do you want to do?** select **Check & adjust the compensator, index error, line of sight error & automatic target aiming** or **Check & adjust the compensator, index error, line of sight error, automatic target aiming & telescope camera** for MS50/TS50/TM50 and press **Next**.

Description

The combined adjustment procedure determines the following instrument errors in one process:

l, t	Compensator longitudinal and transversal index errors
i	Vertical index error, related to the standing axis
c	Horizontal collimation error, also called line of sight error
ATR Hz	ATR zero point error for horizontal angle - option
ATR V	ATR zero point error for vertical angle - option
Telescope camera Hz	Telescope camera zero point error for horizontal angle - option
Telescope camera V	Telescope camera zero point error for vertical angle - option



Before determining the instrument errors, the instrument has to be:

- levelled up using the electronic level
- protected from direct sunlight
- acclimatised to the ambient temperature, approximately 2 minutes per °C difference compared to the storage place.



Check & Adjust Wizard, Step 1

Key	Description
Next	To measure the target.
Fn Quit	To exit the wizard.

Description of fields

Field	Option	Description
Calibrate the automatic target aiming	Check box	<p>When this box is checked, the determination of the ATR horizontal and vertical adjustment values is included.</p> <p> Use a clean Leica standard prism as target. Do not use a 360° prism.</p> <p>When this box is not checked, the determination of the ATR horizontal and vertical adjustment value is excluded.</p>
Calibrate the telescope camera	Check box	<p>When this box is checked, the determination of the telescope camera horizontal and vertical zero point adjustment values is included.</p> <p> In Camera Settings, TS overview page, Use TS overview camera must be checked.</p> <p> A prism is not required to run the procedure.</p> <p> Use a clean Leica standard prism as target. Do not use a 360° prism.</p>

Aim the telescope accurately at a target at a distance of about 100 m. The target must be positioned within $\pm 9^\circ/\pm 10$ gon of the horizontal plane

-  The procedure can be started in face I or II.
-  The fine pointing must be performed manually in both faces.

Meas to measure and to continue to the next screen.

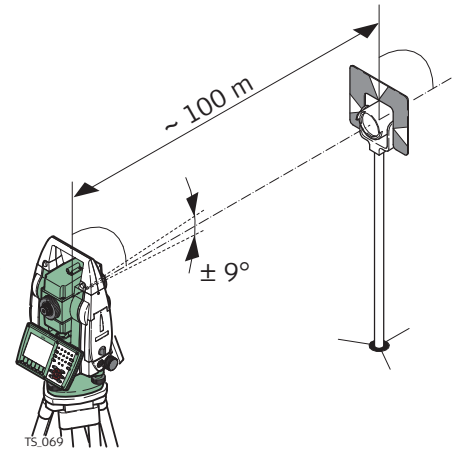

For MS50/TS50/TM50:

If **Calibrate the telescope camera** has been checked, aim at the same target accurately with the telescope camera using the view finder and the digital crosshair on the display.

Meas to measure and to continue to the next screen.

Motorised instruments change automatically to the other face.

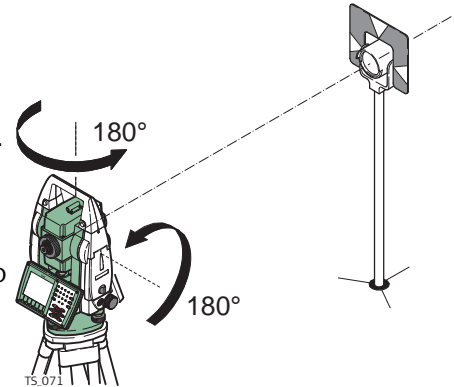

Non-motorised instruments guide to the other face using the **Telescope Positioning** screen.

Meas to measure the same target in the other face and to calculate the instrument errors.

-  If one or more errors are bigger than the predefined limits, the procedure must be repeated. All measurements of the current run are rejected and are not averaged with the results from previous runs.

Check & Adjust Wizard, Step 2

Key	Description
Next	To measure the target.
Fn Quit	To exit the wizard.

Description of fields

Field	Option	Description
No. of measurements	Display only	Shows the number of runs. One run consists of a measurement in face I and II.
All other fields	Display only	The standard deviations of the determined adjustment errors are displayed. The standard deviations can be calculated from the second run onwards.

Check & Adjust Wizard, It is recommended to repeat the last calibration routine at least three times.

Measure at least two more runs.

Next step

IF	THEN
more runs must be added	select Add another calibration loop and press Next .
no more runs must be added	select Finish the calibration & store the results and press Next to accept the measurements and to access the results screen.

Check & Adjust Wizard, Results

Key	Description
Finish	To accept and store the new determined instrument errors, where Yes is set in the Use column. If the report sheet recording has been enabled, then the results are written or appended to an existing report sheet.
Redo	To reject all results and to repeat the complete check and adjust procedure.
Use	To set Yes or No in the Use column for the highlighted set.
More	To view additional information about the current used old instrument errors.

Description of columns and fields

Column	Option	Description
New	Display only	The new determined and averaged instrument errors.
Use	Yes No	Stores the new adjustment error. Keeps the currently used error active on the instrument and rejects the new one.
Old	Display only	The old adjustment errors, which are currently valid on the instrument.

Access

In **Check & Adjust Wizard**, **What do you want to do?** select **Check & adjust the tilting axis** and press **Next**.

Description

This adjustment procedure determines the following instrument error:

a Tilting axis error



Before determining the tilting axis error, the instrument has to be:

- levelled up using the electronic level
- protected from direct sunlight
- acclimatised to the ambient temperature, approximately 2 minutes per °C difference compared to the storage place.
- The horizontal collimation error must be determined before.

Check & Adjust Wizard, Step 1

Key	Description
Next	To measure the target.
Fn Quit	To exit the wizard.

Aim the telescope accurately at a target at a distance of about 100 m. For distances less than 100 m, make sure to point to the target precisely. The target must be positioned within at least 27°/30 gon above or beneath the horizontal plane.

- The procedure can be started in face I or II.
- The fine pointing must be performed manually in both faces.

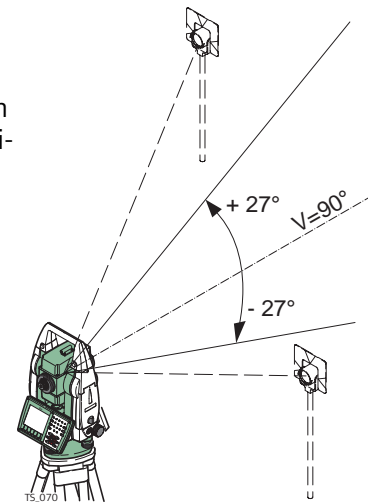

Meas to measure and to continue to the next screen.

Motorised instruments change automatically to the other face.

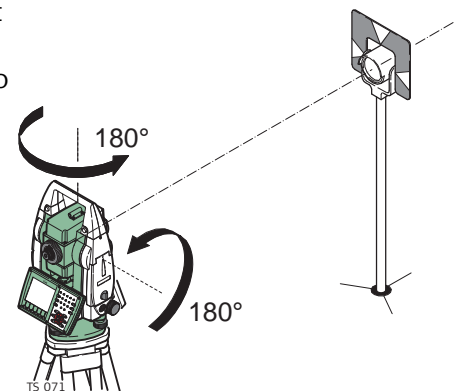

Non-motorised instruments guide to the other face using the **Telescope Positioning** screen.

Meas to measure the same target in the other face and to calculate the instrument errors.

- If one or more errors are bigger than the predefined limits, the procedure must be repeated. All measurements of the current run are rejected and are not averaged with the results from previous runs.

Check & Adjust Wizard, Step 2

Key	Description
Next	To measure the target.
Fn Quit	To exit the wizard.

Description of fields

Field	Option	Description
No. of measurements	Display only	The number of runs. One run consists of a measurement in face I and II.
σ a T-axis	Display only	The standard deviation of the determined tilting axis error. The standard deviation can be calculated from the second run onwards.

Check & Adjust Wizard, It is recommended to repeat the last calibration routine at least three times.

Measure at least two more runs.

Next step

IF	THEN
more runs must be added	select Add another calibration loop and press Next .
no more runs must be added	select Finish the calibration & store the results and press Next to accept the measurements and to access the results screen.

Check & Adjust Wizard, Results

Key	Description
Finish	To accept and record the new determined tilting axis error. If the report recording has been enabled, then the results are written to or appended to an existing report sheet.
Redo	To reject the result and to repeat the complete check and adjust procedure.
Fn Quit	To exit the wizard.

Description of columns and fields

Column	Option	Description
New	Display only	The new determined and averaged tilting axis error.
Old	Display only	The old instrument error, which is currently valid on the instrument.

Access

In **Check & Adjust Wizard**, **What do you want to do?** select **Check & adjust the compensator** and press **Next**.

Description

The compensator adjustment procedure determines the following instrument errors:

- l Compensator longitudinal index error
- t Compensator transversal index error



Before determining the compensator index errors, the instrument has to be:

- levelled up using the electronic level
- protected from direct sunlight
- acclimatised to the ambient temperature, approximately 2 minutes per °C difference compared to the storage place.

**Check & Adjust Wizard,
1st tilt measurement
in any face.**

Key	Description
Next	To measure the target.
Fn Quit	To exit the wizard.

Meas to measure the first face. No target has to be aimed at.

Motorised instruments change to the other face and release a measurement automatically.

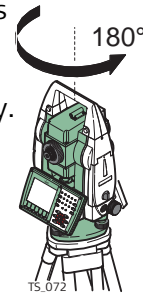

Non-motorised instruments guide to the other face using the **Telescope Positioning** screen.

Meas to release the measurement in the other face.

If one or more errors are bigger than the predefined limits, the procedure must be repeated. All measurements of the current run are rejected and are not averaged with the results from previous runs.

**Check & Adjust Wizard,
Step 2**

Key	Description
Next	To measure the target.
Fn Quit	To exit the wizard.

Description of fields

Field	Option	Description
No. of measurements	Display only	The number of runs. One run consists of a measurement in face I and II.
σ l Comp and σ t Comp	Display only	The standard deviations of the determined adjustment errors. The standard deviations can be calculated from the second run onwards.

Check & Adjust Wizard, It is recommended to repeat the last calibration routine at least three times.

Measure at least two more runs.

Next step

IF	THEN
more runs must be added	select Add another calibration loop and press Next .
no more runs must be added	select Finish the calibration & store the results and press Next to accept the measurements and to access the results screen.

Check & Adjust Wizard, Results

Key	Description
Finish	To accept and record the new determined instrument errors. If the report sheet recording has been enabled, then the results are written and appended to an existing report sheet.
Redo	To reject all results and to repeat the complete check and adjust procedure.
Fn Quit	To exit the wizard.

Description of columns and fields

Column	Option	Description
New	Display only	The new determined and averaged instrument errors.
Old	Display only	The old instrument errors, which are currently valid on the instrument.

31.7

Viewing the Current Values

Access

In **Check & Adjust Wizard, What do you want to do?** select **View the current values** and press **Next**.

Atmospheric Corrections

Check & Adjust Wizard		
Component	Current[g]	Date
l Comp	0.0000	03.12.2009
t Comp	0.0000	03.12.2009
i V-index	0.0000	03.12.2009
c Hz-col	0.0000	03.12.2009
a T-axis	0.0000	03.12.2009
ATR Hz	0.0000	03.12.2009
ATR V	0.0000	03.12.2009

Hz: 279.6447g V: 300.0315g Fn abc 16:45

OK	More
-----------	-------------

Key	Description
OK	To return to Check & Adjust Wizard, What do you want to do?
More	To display information about the date of the determination, the standard deviation of the errors and the temperature during the determination.
Fn Quit	To exit the wizard.



The temperature of the environment around the instrument can differ from the temperature shown on the screen as it is the internal temperature of the instrument.

Access

In **Check & Adjust Wizard**, **What do you want to do?** select **Configure Check & Adjust** and press **Next**.

Check & Adjust Wizard

Key	Description
Next	To accept changes and to continue with the subsequent screen within the wizard.
Back	To return to the previous screen.
Fn Quit	To exit the wizard.

Description of options

Option	Description
2 weeks, 1 month, 3 months, 6 months or 12 months	If one or more adjustment values were determined longer ago than the time specified with this parameter, then a reminder message is displayed each time the instrument is turned on. This helps to redetermine the instrument errors on a regular basis.
Never	A reminder message to readjust the instrument is never displayed. This setting is not recommended.

Next step

Next to change to the **Report sheet** screen.

Adjusting the circular level step-by-step

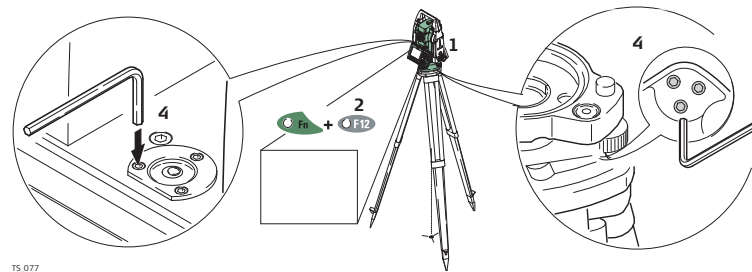

TS.077

Step	Description
1.	Place and secure the instrument into the tribrach and onto a tripod.
2.	Using the tribrach footscrews, level the instrument with the electronic level.
3.	Select Instrument \TPS settings \Level bubble & compensator to access the Level Bubble & Compensator screen.
4.	Check the position of the circular level on the instrument and tribrach.
5.	a) If both circular levels are centred, no adjustments are necessary b) If one or both circular levels are not centred, adjust as follows:
	Instrument: If it extends beyond the circle, use the supplied allen key to centre it with the adjustment screws. Turn the instrument by 200 gon (180°). Repeat the adjustment procedure if the circular level does not stay centred.
	Tribrach: If it extends beyond the circle, use the supplied allen key to centre it with the adjustment screws.
	After the adjustments, all adjusting screws must have the same tightening tension and no adjusting screw should be loose.

31.10

Adjusting the Circular Level of the Prism Pole

Adjusting the circular level step-by-step

Step	Description
1.	Suspend a plumb line.
2.	Use a pole bipod, to align the prism pole parallel to the plumb line.
3.	Check the position of the circular level on the prism pole.
4.	a) If the circular level is centred, no adjustment is necessary.
	b) If the circular level is not centred, use an allen key to centre it with the adjustment screws.
	After the adjustments, all adjusting screws must have the same tightening tension and no adjusting screw should be loose.

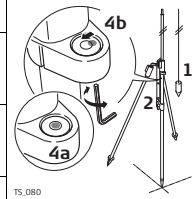

31.11

Inspecting the Laser Plummet of the Instrument



The laser plummet is located in the vertical axis of the instrument. Under normal conditions of use, the laser plummet does not need adjusting. If an adjustment is necessary due to external influences, return the instrument to any Leica Geosystems authorised service workshop.

Inspecting the laser plummet step-by-step

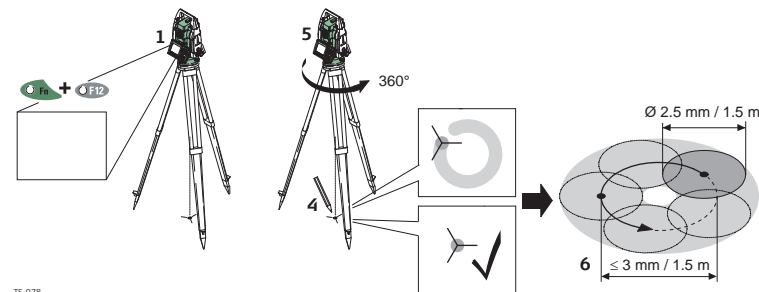

The following table explains the most common settings.

Step	Description
1.	Place and secure the instrument into the tribrach and onto a tripod.
2.	Using the tribrach footscrews, level the instrument with the electronic level.
3.	Select Instrument\TPS settings\Level bubble & compensator to access the Level Bubble & Compensator screen.
4.	The laser plummet is switched on when the Level Bubble & Compensator screen is entered. Adjust the laser plummet intensity. Inspection of the laser plummet should be carried out on a bright, smooth and horizontal surface, like a sheet of paper.
5.	Mark the centre of the red dot on the ground.
6.	Turn the instrument through 360° slowly, carefully observing the movement of the red laser dot.
	The maximum diameter of the circular movement described by the centre of the laser point must not exceed 3 mm at a distance of 1.5 m.
7.	If the centre of the laser dot describes a perceptible circular movement, or moves more than 3 mm away from the point which was first marked, an adjustment may be required. Inform your nearest Leica Geosystems authorised service workshop. Depending on brightness and surface, the diameter of the laser dot can vary. At 1.5 m, it is about 2.5 mm.

Servicing the tripod step-by-step

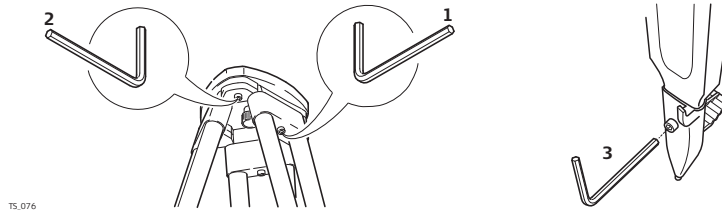

The following table explains the most common settings.

Step	Description
	The connections between metal and timber components must always be firm and tight.
1.	Tighten the leg cap screws moderately, with the supplied allen key.
2.	Tighten the articulated joints on the tripod head enough to keep the tripod legs open when lifting the tripod off the ground.
3.	Tighten the allen screws of the tripod legs.

Access

Select **Main Menu: User\About Leica Viva**.

About Leica Viva, CS controller page

The information relates to the field controller. This screen shows, depending on the controller type:

- The serial number,
- The equipment number,
- The firmware version of the boot software,
- The firmware version for the **Electric Front Interface**,
- If a total station radio installed,
- If Wireless LAN is installed,
- If the internal GSM/CS 3.5G modem is installed.

Next step

Page changes to the **Total station** page.

About Leica Viva, Total station page TPS

The information relates to the TPS instrument. This screen shows:

- The type of instrument,
- Additional instrument hardware options such as EDM or PowerSearch.

Next step

Page changes to the **GS sensor** page.

About Leica Viva, GS sensor page GPS

The information relates to the GPS instrument. This screen shows:

- The currently active system language,
- The serial number of the measurement engine,
- The availability of additional instrument hardware options,
- If the protected OWI commands and the ability to track GPS L5, GLONASS, Galileo and BeiDou have been activated by a licence key.

Next step

Page changes to the **SmartWorx Viva** page.

About Leica Viva, SmartWorx Viva page

The information relates to the SmartWorx Viva instrument. This screen shows the applications installed on the instrument, and the following information.

Description of fields

Field	Description
WinCE version	Firmware version for WinCE.
SmartWorx Viva	Firmware version for the onboard software.
API version	Firmware version for the application interface.
CCP end	Expiry date of the software maintenance.
Load licence keys	The information listed here indicates for which applications the licence keys are loaded.

Next step

Page changes to another page on this screen.

Description

Instruments can be equipped with up to two cameras:

Type	Available on
Overview camera	TS11 I, TS15 I, MS50, TM50 I, TS50 I, CS
Telescope camera	TM50 I, TS50 I, MS50

The camera & imaging functionality is an interactive feature embedded in SmartWorx Viva but used by some applications as well as data management. A licence key is required to store overview and telescope camera images.

- The cameras can be used to take images of survey relevant objects for documentation purposes.
- The images can be linked to points, lines and areas stored in the working job.
- Screenshots can be taken from the display as additional information.
- Images, screenshots and digital sketches can be edited and sketched on. This functionality is also available on instruments which do not have a camera or a imaging licence.
- Overview and telescope camera images can be transferred can be transferred from the TPS to the CS.
- Images can be exported in DXF and LandXML format.
- The cameras can be switched.

Depending on where the camera & imaging functionality is accessed from, different functionality is available.

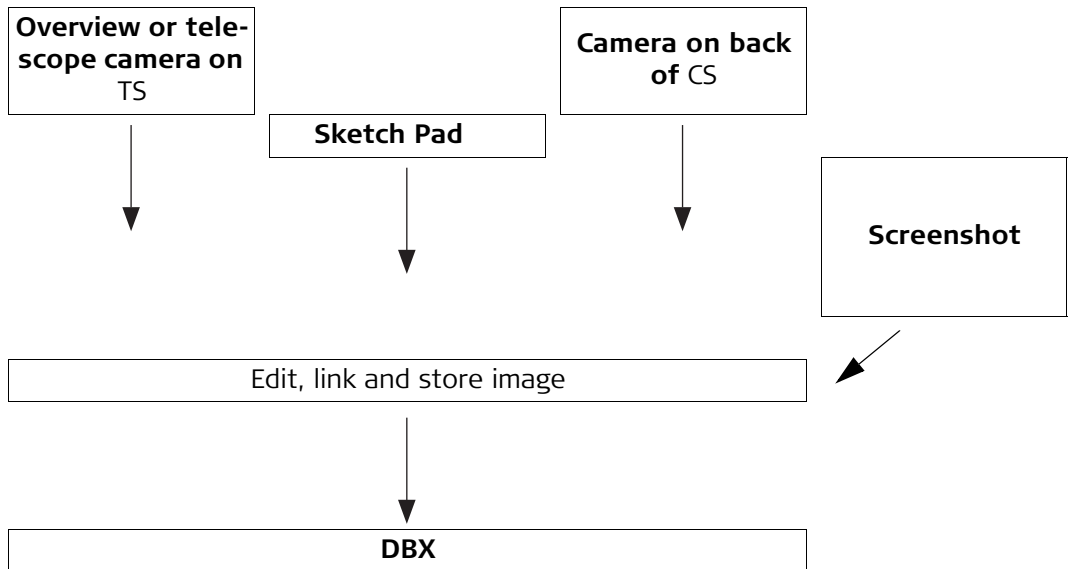

Camera & imaging workflow on the TS

Step	Description
	The camera functionality on the TS must be licensed.
1.	Select Main Menu: Jobs & Data\New job . Create a working job. Return to the Main Menu .
2.	Select Main Menu: Instrument\TPS camera settings . On the TS overview/TS telescope page, check Use overview camera/Use TS overview & telescope cameras . Return to the Main Menu .

Step	Description
3.	Select Main Menu: Go to Work!\Setup . Define the station setup. Return to the Main Menu .
4.	Select Main Menu: Go to Work!\Survey . Measure a point.
5.	Page until the Camera page is active. Capture to take an image on demand.
6.	The image is only displayed, not stored yet.
7.	To draw on the image, press the sketching icon on the toolbar.
8.	To store the image, press Store .
9.	Decide how to link the image: <ul style="list-style-type: none"> • With the last measured point • With any point, line or area • No link at all • Cancel

33.2

Instrument - TPS camera settings TS CS

Access

Select **Main Menu: Instrument\TPS camera settings**.

Camera Settings, TS overview/TS telescope (for TS50) page

Key	Description
OK	To accept changes and return to Main Menu .
Page	To change to another page on this screen.
Fn Quit	To exit the screen.

Description of fields

Field	Option	Description
Use TS overview camera	Check box	Available for TS11 I/TS15 I. The overview camera can be physically switched on and off. When this box is checked, the camera is switched on.
Use TS overview & telescope cameras	Check box	Available for MS50/TS50 I/TM50 I. The overview AND the telescope camera can be physically switched on and off. The order of images taken is: 1. telescope camera, 2. overview camera. When this box is checked, the cameras are switched on.

Field	Option	Description
Resolution	Selectable list	The resolution has a direct influence on the file size. When images are transferred between TS and CS, select Medium or Small . Small is recommended to save transfer time.
White balance	Selectable list	This setting defines the colour impression. If Automatic does not provide satisfying results, select Indoor or Outdoor depending on the surveying environment.
Image quality	Highest quality Standard quality	<p>The grade of compression of the image.</p> <p>Low jpg compression, better image quality, larger file size</p> <p>Higher jpg compression, standard image quality, smaller file size</p>



Next step

Page to change to the **Image documentation** page.

Camera Settings, Image documentation page

Key	Description
OK	To accept changes and return to Main Menu .
Page	To change to another page on this screen.
Fn Quit	To exit the screen.

Description of fields

Field	Option	Description
Capture image with every measurement	Check box	<p>When this box is checked, an image is taken automatically with every measurement.</p> <p>When this box is not checked, pictures can be taken on demand. Use this option to save power. In the Survey, Reference Plane and Setup applications, use Capture on the Camera page to take pictures.</p> <p>Outside of applications, set a hot key to User - Use camera. Press the defined hot key to take a picture on demand. Or use the  icon.</p> <p> Images taken with the camera are always stored related to the active working job. The images are stored in a subfolder of the active working job. The images can be viewed in the Data Management.</p>
Link image with measurement	Check box	<p>Available when Capture image with every measurement is checked.</p> <p>When this box is checked, the image taken with a measurement is automatically linked to the last measurement taken.</p>

Field	Option	Description
		 One measured point can be linked to several images. One image can be linked to several measured points. When this box is not checked, the image taken with a measurement is not automatically linked to a measurement. The image can be linked manually in data management.
Store cross-hair on image	Check box	Available for TS11 I/TS15 I/MS50/TS50 I/TM50. When this box is checked, the crosshairs are stored on the picture.

33.3

Taking an Image

33.3.1

Overview

Description

- The camera can be used to take images of survey relevant objects.
- The images can be linked to points, lines and areas stored in the job.
- Screenshots can be taken from the display as additional information in support cases.

Standard functionality is provided by softkeys, keys and a toolbar.

The softkeys are available regardless of where the camera functionality was accessed from and always perform the same functions.

If **Display TS camera focussing toolbar** is checked in **Camera View Settings**, icons are available in a toolbar. One toolbar is located on the right side of the screen. A second toolbar on the left side of the screen is available when the telescope camera is active. Some of the functions performed by the icons can also be replicated using a softkey or key in the same mode as when the icon appears.

Requirements

- A TS11 I/TS15 I/MS50/TM50 I/TS50 I must be used.
- The camera configuration must be active. Refer to "33.2 Instrument - TPS camera settings".
- The documentation configuration must be set. Refer to "33.2 Instrument - TPS camera settings".

33.3.2

Outside of Applications

Access

Press a function key configured with the option **User - Use camera**.

OR

Click .



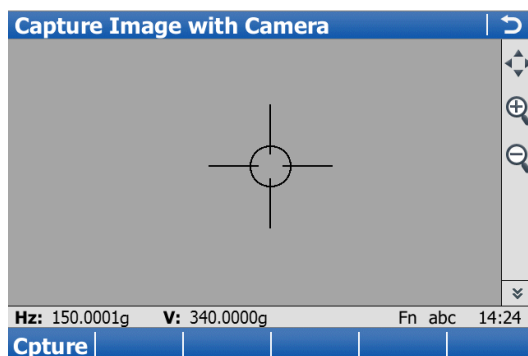









Capture Image with Camera



Key	Description
Capture	To take an image with the current pixel resolution. The image is then displayed but not stored on the memory device yet.
Fn Config..	To configure what is displayed on the Camera page. Refer to "Camera View Settings, General page".
Fn Quit	To exit the screen.

Overview of keys, softkeys and icons

The softkeys described in this table are standard on all camera & imaging screens. For descriptions of mode-specific softkeys, see appropriate chapters.

Icon	Key or Softkey	Description
	-	To scroll the camera & imaging toolbar.
	1	The fit icon displays, after zooming in/out, the complete image in VGA resolution.
	2	To zoom into the image.
	3	To zoom out of the image.
	5	To zoom to the maximum in the current viewing direction.
	-	<p>To define a range by a minimum and a maximum distance. Three-dimensional points within the defined range are displayed.</p> <p> This functionality is only available on the Camera page within the Survey application.</p> <div style="display: flex; align-items: center;">  <div> <p>Top slider The maximum distance from the instrument, for example set to 400.</p> <p>Bottom slider The minimum distance from the instrument, for example set to 10.</p> <p>Result Points between 10 m and 400 m from the instrument are displayed on the image.</p> </div> </div> <p> To move the slider, tap on the slider, hold and drag it or use the up and down arrow keys.</p>
	Fn Config..	To access Camera View Settings . Refer to "Camera View Settings, General page".
	-	To increase the brightness from the current value.
	-	To decrease the brightness from the current value.

Icon	Key or Softkey	Description
	-	To return to automatic brightness of the image.
	-	To configure the camera. Refer to "33.2 Instrument - TPS camera settings".
	-	To switch between overview and telescope camera. After turning the instrument on the overview camera is in use. The style of the cross-hairs changes with the camera in use. Or use the hot key/favourites menu function TPS - Toggle overview/telescope camera .
	-	To switch continuous autofocus on and off.
	-	Continuous autofocus is active.
	Focus	To activate a single autofocus. Single autofocus deactivates continuous autofocus. Same functionality as pressing the autofocus button on the side cover of the instrument. Or use the hot key/favourites menu function TPS - Single auto focus . While continuous autofocus is active, any manually measured distance updates the focus position.
-	+	Available on CS. To focus manually: <ul style="list-style-type: none"> • Up and down arrow: To focus in big steps. • Right and left arrow: To focus in small steps.
-	Pressing 2x auto-focus button on side cover - short	To perform an automatic contrast based re-focus.
-	Pressing autofocus button on side cover - long	To start continuous autofocus.

Access

In the Survey, Reference Plane and Setup application, go to the **Camera** page.

In Survey

A **Camera** page is displayed.

The style of the crosshairs changes with the camera in use.

Refer to "Overview of keys, softkeys and icons" for information on the toolbar.



Key	Description
Meas	To measure and store distances and angles. If configured, an image is taken automatically. If configured, the image is linked to the point measurement automatically.
Stop	Available if Measure mode: Continuous and Dist was pressed. Stops the distance measurements. The key changes back to Meas .
Dist	To measure and display distances.
Store	To record data. If Measure mode: Continuous and/or Log auto points is checked, measured points are recorded and tracking continues.  Depending on the configuration, crosshairs are stored on top of the image. If a valid distance measurement is available, then the parallax is corrected and the crosshairs are overlaid on the image on their true position.
Capture	To take an image with the current pixel resolution. The image is then displayed but not stored on the memory device yet.
Page	To change to another page on this screen.
Fn Config..	To configure what is displayed on the Camera page. Refer to "Camera View Settings, General page".
Fn 2Store	Available for Measure mode: Single and Measure mode: Single (fast) . To take an angle only measurement in Face I and Face II and automatically store an average of the two measurements. When using instruments fitted with auto aiming, the point is automatically measured in both faces. The resulting point is stored and the instrument is returned to the first face.
Fn 2 Face	Available for Measure mode: Single and Measure mode: Single (fast) . To take an angle and distance measurement in Face I and Face II. The point stored is an average of the two measurements. When using instruments fitted with auto aiming, the point is automatically measured in both faces. The resulting point is stored and the instrument is returned to the first face.

Key	Description
Fn IndivID and Fn Run	To change between entering an individual point ID different to the defined ID template and the running point ID according to the ID template. Refer to "25.1 ID templates".
Fn Quit	To exit the application.

In Setup TS

In the setup application, points can be linked with images. Depending on the configuration the images are linked either automatically or manually.

A **Camera** page is displayed. Depending on the screen, the available keys differ.

The style of the crosshairs changes with the camera in use.

Refer to "Overview of keys, softkeys and icons" for information on the toolbar.

For Set Station Orientation and Measure Target

Key	Description
Set	For Setup method: Set orientation : To set the station and orientation and exit the Setup application. If configured, an image is taken automatically, also for two face measurements. If configured, the image is linked to the point measurement automatically.
Meas	For Setup method: Multiple backsights : To measure and store the distances and angles made to the control points. If configured, an image is taken automatically, also for two face measurements. If configured, the image is linked to the point measurement automatically. For measurements in two faces, two images are linked with one point.
Dist	To measure and display distances.
Store	For Setup method: Set orientation : To store the measurement with or without a distance. For Setup method: Multiple backsights : To record display values temporarily. The target measurements will not be stored to the current job until the station is set. If configured, an image is taken automatically, also for two face measurements. If configured, the image is linked to the point measurement automatically. For measurements in two faces, two images are linked with one point.
Capture	To take an image with the current pixel resolution. The image is then displayed but not stored on the memory device yet. For Setup method: Multiple backsights , Setup method: Transfer height and Setup method: Resection : Images which are to be linked with 'target n' must be taken on 'Measure target n-1' screen.
Page	To change to another page on this screen.
Fn Config..	To configure what is displayed on the Camera page. Refer to "Camera View Settings, General page".
Fn Quit	To exit the screen.

For the Results screen

Key	Description
Cpture	To take an image with the current pixel resolution. The image can then be linked to the calculated setup point.
Page	To change to another page on this screen.
Fn Config..	To configure what is displayed on the Camera page. Refer to "Camera View Settings, General page".
Fn Quit	To exit the screen.

Camera View Settings, General page

Description of fields

Field	Option	Description
Display TS camera zooming toolbar / Display TS camera focus-ing toolbar	Check box	Determines if the toolbar of icons is displayed. Refer to "Overview of keys, softkeys and icons".
Display cross-hairs	Check box	<p>TS</p> <p>If no distance is measured, then the coarse style crosshair is indicated which is approximately the field of view.</p> <p>If a valid distance is measured and the parallax can be resolved, then the fine style crosshair is indicated as two intersecting lines on the true position. When the instrument turns about three gon in horizontal or vertical direction after measuring a distance, then the crosshair style changes back to the field of view variant.</p> <p>In tracking mode or when locked onto a prism, the crosshairs are always on the correct position and displayed as two intersecting lines.</p>
Crosshair colour	Selectable list	Available if Display crosshairs is checked. Defines the colour of the crosshairs.

Next step

Page to change to the **Points display** page.

Camera View Settings, Points display page

Description of fields

Field	Option	Description
Display points	Check box	<p>When this box is checked, points from the working job with 3D local grid coordinates are displayed on the view finder. Use the display of points to check completeness and reliability of the survey.</p> <p>Points are displayed with a visual 3D effect: Points further away from the instrument are displayed smaller than points closer to the instrument.</p>

Field	Option	Description
		 Points are only displayed on the image. They are not saved with the image.
Point ID, Point code, Height of point or Quality of point	Check box	When this box is checked, the relevant information of a measured point is displayed next to the point symbol.
Point symbol colour	Selectable list	Available if Display points is checked. Defines the colour of the points.
Number of points	Selectable list	Available if Display points is checked. The maximum number of overlaid points. The last points stored in the DBX are displayed, regardless of the point class. If 20 is selected and a new point is measured, then the first point of the previous 20 is no longer displayed.
Only display points measured from current station	Check box	In addition to the selected number of points, the points displayed can be restricted further by showing only points measured from the current station.

Next step

Page changes to the **Lines / areas display** page.

Camera View Settings, Lines / areas display page

Description of fields

Field	Option	Description
Display lines & area	Check box	When this box is checked, lines/areas from the working job with 3D local grid coordinates are displayed on the view finder. Use the display of points to check completeness and reliability of the survey. Points are displayed with a visual 3D effect: Points in further away from the instrument are displayed smaller than points closer to the instrument.  Points are only displayed on the image. They are not saved with the image.
Display line & area IDs	Check box	When this box is checked, then the line/area IDs are displayed with the lines/areas.
Use fixed colour for lines & areas	Check box	When this box is checked, a colour for displaying lines/areas can be selected. When this box is not checked, the lines/areas are displayed in the line/area code colour.
Colour	Selectable list	This colour is used for the lines/areas and for the text related to the line and area IDs.
Number of lines / areas to show	Selectable list	Available if Display lines & area is checked. The maximum number of overlaid lines/areas. The last lines/areas stored in the DBX are displayed. If 20 is selected and a new line/area is measured, then the first line/area of the previous 20 is no longer displayed.

Field	Option	Description
		 The selected number is the sum of lines and areas. For example, if 20 is selected, this can be 5 lines and 15 areas.

Next step

Page changes to another page on this screen.

For MS50: **Page** changes to the **ScanArea display** page.

Camera View Settings, ScanArea display page

Available for MS50.

Description of fields

Field	Option	Description
Current scan definition colour	Selectable list	This colour is used in Scan Viewer for the scan area currently defined.
Show existing scan definitions	Check box	When this box is checked, then scan areas previously defined are displayed in Scan Viewer .
Colour	Selectable list	This colour is used for the previously defined scan areas.

Next step

Page changes to another page on this screen.

33.3.4

Screenshot

Description

A screenshot can be taken and stored when SmartWorx is running on the TS11/TS15/TS12 Lite and CS.

Press a hot key configured to **User - Screenshot capture** or Fn and '.'. The screenshot is displayed and can be edited by sketching.

The screenshot can be linked with points manually. Sketching on the screenshot is possible.

The screenshot is stored as jpg with a predefined compression rate. The resolution is 640 x 480. Screenshots can be georeferenced by linking to a point. Screenshots cannot be orientated and calibrated.

Description

A panoramic image is a combination of single images. Panorama images show the area of what can be seen from the instrument station. Panorama images are used for documentation purposes and support the evaluation of the surveying data directly in the field or in the office. Panorama images can be imported into LGO.

Panoramic images can be generated independent of any application.

A panorama is organised with a panorama instance within the DBX. The single images are stored in the DBX\JOB\IMAGES folder of the data storage device. The single images are named Img_Pano_x_y_date_time.jpg where as

Field	Description
x	Number of the row, starts with upper left corner
y	Number of columns, starts with upper left corner data
Date	Same as with normal images
Time	Same as with normal images



Panoramic images can only be generated with motorized instruments with overview camera (TS15).

Access

In **Leica TPS Favourites** click **Panoramic image**.

OR

Press a function key configured with the option **User - Use camera**.

OR

At the end of Setup, a panoramic image can be taken.

Select Panoramic Image Type**Description of fields**

Field	Option	Description
Image type	Rectangular area	Area defined by upper left and lower right corner
	Multi-row 360° image	360° with one or more rows above each other
	Single row 360° image	360° in one row
	Polygonal area	Area defined by three or more corners in clockwise direction.

Next step

OK and follow the instructions on the screen to define the area.

Once the panoramic image area is defined then the **Panoramic Image Capture** screen opens.

Panoramic Image Capture

Panoramic Image Capture
↻

Status

Images taken: 0

Images remaining: 1

% completed: 0%

Brightness control: From first image ▼

Hz: 77°18'37" V: 90°43'51" Fn abc 12:13

Start

Key	Description
Start	To start taking the panorama images.
Stop	To end taking the panorama images.
Pause	To pause taking the panorama images.
Resume	To continue taking panorama images after Pause has been pressed.
Fn Quit	To exit the screen.

Description of fields

Field	Option	Description
Images taken	Display only	The number of captured images.
Images remaining	Display only	The number of images remaining to be taken.
% completed	Display only	In percent, the number of images taken against the total number of images which must be taken.
Image file name	Display only	The name of the file where the image is stored to.
Brightness control	From first image	To control the brightness of each tile of the panorama image. The brightness is measured for first image of the panorama. The value is applied to all further tiles. Recommended for panorama images taken under normal conditions
	From each image	The brightness is measured for each image of the panorama. Recommended for panorama images with diverse brightness.

Next step

The panorama and the images are stored in the images folder of the working job, either with or without link to the reference triplet of the current station.



An image belonging to a panorama image can be linked manually with another object without affecting the panorama image.



Image Management is available on instruments which have a camera or a camera license.

Access

Step	Description
1.	Select Main Menu: Jobs & Data\ View & edit data.
2.	Page until the Images page is active.

Data:, Images page

Data: 11061005	
Points	Lines (0)
Areas (0)	Images
Map	
Image	Size (kB)
Img_Area0001_110610_0653.3	
Img_110610_064759	412.5
Img_Line0001_110610_06466.2	
Img_Line0001_110610_0651.9	

Hz: 79.6380g	V: 99.9686g	Fn abc	16:40
OK	Link..	View..	Delete
More	Page		

Key	Description
OK	To close the screen and return to the screen from where this screen was accessed.
Link..	To display a points list and to link the image to a point.
View..	To display an image. Refer to "Image Notes".
Delete	To delete the highlighted image and all its links.
More	To display information about the image size and the time and the date of when the image was stored.
Page	To change to another page on this screen.
Fn Filter..	To define sort and filter settings. Refer to "Sorts & Filters, Images page".
Fn Quit	To exit the screen.

Next step

IF	THEN
an image is to be viewed or edited	Open. Refer to "Image Notes".
sort and filter settings are to be defined	Fn Filter... Refer to "Sorts & Filters, Images page".

Image Notes

Use the arrow keys on the keypad to move the image on the screen.

Key	Description
Store	To store the image with the added link or a sketch created. If no sketch was created, then the image is not stored a second time to avoid a loss of quality.
Prev	To display the previous image in the list of images displayed in Data:, Images page. Available unless the beginning of the list is reached.

Key	Description
Next	To display the next image in the list of images displayed in Data:, Images page. Available unless the end of the list is reached.
Fn Config..	To activate or deactivate a toolbar with icons for sketching.
Fn Quit	To exit the screen.

Next step

Store returns to **Data:, Images** page.

Sorts & Filters, Images page

Key	Description
OK	To close the screen and return to the screen from where this screen was accessed. The selected sort and filter settings are applied.
Page	To change to another page on this screen.
Fn Quit	To exit the screen.

Description of fields

Field	Option	Description
Sort by	Ascending filename , Descending filename , Forward time and Backward time	Always available. The method the images are sorted by.
Filter by	No filter Image source Camera type Linked / unlinked	Always available. The method by which the images are filtered. Shows all images. Shows photos taken with the camera or screenshots. Make the selection in the Image source field. Shows images taken with the TS11/TS15 or CS camera. Make the selection in the Camera type field. Shows linked or unlinked images. Make the selection in the Image field.
Image source	Camera	Available for Filter by: Image source . Shows images taken with the camera on the TS11/TS15 or CS.

Field	Option	Description
	Screenshot	Shows pictures taken from the instrument screen.
	Field sketch	Shows field sketches created.
Camera type		Available for Filter by: Camera type.
	Overview camera	Shows images taken with the camera on the TS11/TS15.
	CS camera	Shows images taken with the camera on the CS.
Image	Selectable list	Available for Filter by: Linked / unlinked. Either linked or unlinked images are displayed.

Next step

OK returns to **Data: Images** page.

33.5

Sketching

33.5.1

Sketching on Images

Description

A sketch can be overlaid on an image taken with a camera.

A sketch can be made on every jpg file stored in the DBXJOBIMAGES folder of the working job.

The sketch is stored together with the image in jpg format. The compression rate is specified in the **Camera Settings** screen. The image with the sketch is stored by pressing **Store**.

Access step-by-step **In data management** (the image is already stored and possibly linked)

Step	Description
1.	Select Main Menu: Jobs & Data View & edit data.
2.	Page until the Images page is active.
3.	Press View .
4.	In Sketch Pad , click the  icon in the toolbar.















For images

Step	Description
1.	Click  . OR Start the Survey or Setup application and go to the Camera page.
2.	Press Capture . The image is taken as with a digital camera.

For screenshots (the image is already stored and possibly linked)

Press a hot key configured to **User - Screenshot capture**. The screenshot is displayed and can be edited by sketching.

Overview of keys, softkeys and icons for sketching

Icon	Key or Softkey	Description
	-	To scroll the camera & imaging toolbar.
	1	The fit icon displays, after zooming in/out, the complete image in VGA resolution.
	2	To zoom into the image.  Pressing ESC stops the zooming process.
	3	To zoom out of the image.  Pressing ESC stops the zooming process.
	-	The windowing icon zooms to a specified area window. An area window can be drawn by dragging the stylus on the screen in a diagonal line to make a rectangular area or by tapping twice on the screen to define diagonally opposite corners of a rectangular area. This action causes the screen to zoom to the selected area.
	-	To activate sketching. The  icon is displayed. The image cannot be moved.
	-	To quit sketching. The  icon is displayed. The image can be moved.
	-	To change the line style. Tap the icon to open a window displaying line styles for selection. The selected line style is remembered.
	-	To change the line colour. Tap the icon to open a window displaying line colours for selection. The selected line colour is remembered.
	-	To change the line width. Tap the icon to open a window displaying line widths for selection. The selected line width is remembered.
	-	To undo all changes since the last saving.

33.5.2

Field Sketching

Description

The field sketch functionality is used to create a sketch on a virtual paper. Sketching is possible on predefined or on customer templates. Custom templates can, for example, include a company logo or check boxes for tasks that must be done.

The sketch is stored as image in jpg format. The jpg file is stored in the DBX\JOB\IMAGES folder of the data storage device.

The predefined templates are optimised for A4 printout. Customer templates can be optimised for any format.

A screenshot cannot be made from the field sketch.

Access

In **Leica TPS Favourites** or **Leica GPS Favourites** click **Sketch pad**.

OR

Press a hot key configured to access the screen **Choose Sketch Template**. Refer to "25.4 Hot keys & favourites" for information on hot keys.

Choose Sketch Template

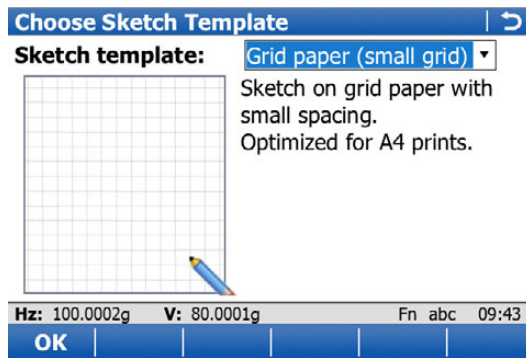

Key	Description
OK	To create a copy of the selected sketch template and to start sketching.
Fn Delete	To delete the selected custom template.
Fn Quit	To exit the screen.

Description of fields

Field	Option	Description
Sketch template	Plain paper, Lined paper-narrow, Lined paper-wide, Grid paper (small grid) or Grid paper (large grid) Custom templates	The predefined sketch templates. The custom templates must be jpg files with a maximum of five megapixel. The templates are stored in the CONFIG\SKETCH_TEMPLATES folder of the data storage device. To make a custom template selectable in the list, transfer the template to the internal memory in Main Menu: User\Tools & other utilities\Transfer user objects . Refer to "30.1 Transfer user objects".

Next step

Select a template. **OK** to access **Sketch pad**.

Sketch Pad

Refer to "Overview of keys, softkeys and icons" for information on the toolbar.

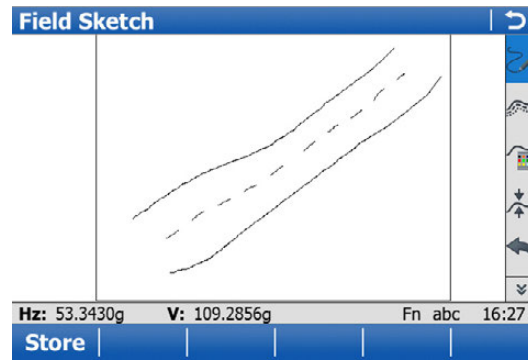

Key	Description
Store	To store and link the field sketch.
Fn Quit	To exit the screen.

33.6

Exporting Images

Exporting images in DXF format

Step	Description
1.	Select Main Menu: Jobs & Data\Export & copy data\Export DXF Data.
2.	Config.. goes to Configuration, Export page.
3.	Checking Export images activates the export of images linked with any point, line or area.
	If multiple images are linked with one point, one line or one area, then all images linked are exported.
	Images are exported according to the filter settings. Press Filter.. to check the settings.

Exporting images in XML format

Step	Description
1.	Select Main Menu: Jobs & Data\Export & copy data\Export XML Data.
2.	Config.. accesses Configuration, Export page.
3.	Checking Images activates the export of images linked with any point, line or area.
	Images are exported according to the filter settings. Press Filter.. to check the settings.

Description

Electronic **D**istance **M**easurement **EDM** is the function used for distance measurements.

There are different modes the instrument can work in. Refer to **Measure & Target Settings**.

34.2

Prism Search Methods

34.2.1

Automatic aiming**Description**

Automatic aiming is the function which recognises and measures the position of a prism using a CCD array. A laser beam is transmitted and the reflected beam is received by the built-in CCD array. The position of the reflected spot with respect to the centre of the CCD is computed. These automatic aiming offsets are used to correct the horizontal and vertical angles. The automatic aiming offsets are also used to control the motors which turn the instrument to centre the crosshairs to the prism. In order to minimise the time for measuring, the crosshairs are not moved to the exact centre of the prism. The automatic aiming offset can be up to 500 cc depending on selected **Measure mode**. The automatic aiming function measures the offsets between the crosshairs and prism centre and corrects the horizontal and vertical angles accordingly. Therefore the horizontal and vertical angles are measured to the prism-centre, even if the crosshairs are not aimed precisely at the centre of the prism.

Motorised instruments can be equipped with automatic aiming. For **Target aiming: Automatic** the instrument can find a static prism and measure a distance once **Meas** or **Dist** is pressed. The instrument does not follow a moving prism.

Field of view

The telescope field of view is the region seen when looking through the telescope. The automatic aiming field of view is the region seen by the automatic aiming. Both are identical on TPS instruments.

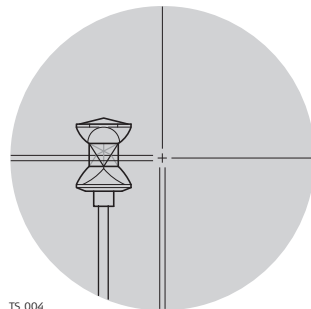
Automatic aiming measurement

TS_004

If the prism is in the field of view with **Target aiming: Automatic** the crosshairs are automatically positioned to the prism when, for example **Meas** or **Dist** is pressed. No automatic aiming search is started.



The displayed values are always related to the centre of the prism after **Meas** or **Dist** is pressed. For **Meas**, these values are displayed only shortly after the key press.

The crosshairs of the telescope may not fully coincide with the centre of the prism when viewed through the telescope. The remaining automatic aiming offsets for the horizontal and vertical angles are measured by the automatic aiming function and applied to the measured and displayed angles.

Automatic aiming search

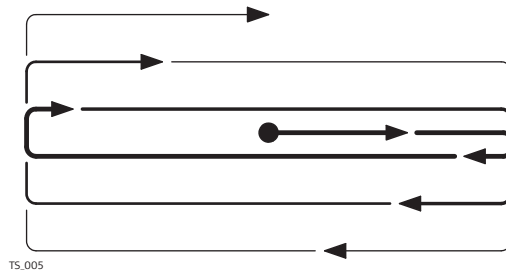

If the prism is not in the field of view when **Meas** or **Dist** is pressed, an automatic aiming search is started. For the automatic aiming search the automatic aiming window is scanned line by line starting at the current telescope position.

- prism was not found: **Retry** can be pressed to search for the prism in an increased area.
- prism was found: The automatic aiming measurement is performed to position the telescope to the centre of the prism.

Automatic aiming window

The automatic aiming window is a relative window based on the current telescope position. The horizontal and vertical extent can be defined.

Fine search window

If no target is found after the prediction time and **If no target found after prediction then: Start fine search** is set, then the prism is searched for with automatic aiming using a dynamic automatic aiming window. This window covers a horizontal region from the position of loss of lock to the current telescope position, and the same extent on the other side. The vertical dimension of the dynamic window is one third of the horizontal expansion.

Targeting modes

Refer to **Measure & Target Settings**.

34.2.2

PowerSearch

Description

The PowerSearch module allows an automatic prism detection within a short time period. The PowerSearch function can be started in the **Leica TPS Favourites** screen and configured in **TPS settings\Prism search settings, PowerSearch window**.

Functionality

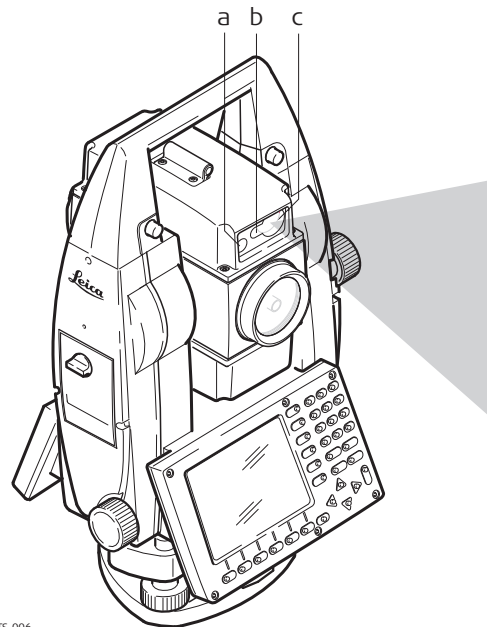

The PowerSearch function consists of a transmitter (a) and a receiver (b). Both are installed in the telescope.

When PowerSearch is activated, the instrument starts to rotate around its standing axis. The transmitter emits a vertical laser swath. If the laser swath detects a prism, the rotation of the instrument is stopped. Afterwards an automatic aiming measurement in the vertical direction is performed.

- a) EGL
- b) Transmitter
- c) Receiver



If a PS window is defined and active, PowerSearch is executed within the defined limits.

360° search	If the search window is not defined and PowerSearch is started, the prism is searched for with PowerSearch in the 360° window. The default search with PowerSearch consists of a short swing in anti-clockwise direction followed by a complete 360° turn in clockwise direction. If a prism is detected the movement is stopped and an automatic aiming search is performed.
PowerSearch window	The PowerSearch window can be defined individually. It is specified by absolute angle values and does not change its position. The PowerSearch window can be set in the Prism Search Settings, PowerSearch window page by aiming at two opposite points of the PowerSearch window. When Use PowerSearch window is checked and a PowerSearch is started, a prism is searched for within the defined window.
Dynamic Power-Search window	When Use PowerSearch window is not checked and the instrument has lost lock, after the prediction time, the prism is searched for in a dynamic PowerSearch window. This window covers a region at the position after prediction of horizontal 100 gon by vertical 40 gon.
Direction of search	The PowerSearch routine can be activated clockwise or anticlockwise by using hotkeys. This action will have no influence on the prism search settings.

34.3 Follow Moving Prisms - Lock

Description	Lock enables instruments equipped with automatic aiming to follow a moving prism. The automatic aiming sensor is active when Lock is active. When Target lock on is selected in Leica TPS Favourites , an automatic aiming search is executed. The instrument locks onto the prism and follows its movements. Automatic aiming offsets are continuously applied to the angle measurements. When the instrument loses lock to the prism, a PowerSearch or fine search (auto aiming search) can be executed depending on the prism search settings. Lock is unavailable for SmartStation.
--------------------	---



If the speed of the prism is too fast, the target may be lost. Make sure that the speed does not exceed the figure given in the technical data.

Enable lock	Selecting Target lock on in Leica TPS Favourites , will immediately activate an automatic aiming search to find the prism. Alternatively, as long as Target aiming is set to Lock in Measure & Target Settings , then pressing Meas, Dist, PowerSearch right, OK in Check Point, Joystick, Turn to Hz/V and Orientation With Compass will start a PowerSearch or automatic aiming search to find the prism. When the prism is found, the instrument locks onto the prism. The instrument follows the moving prism and the automatic aiming function remains active.
--------------------	---

Loss of lock	When the instrument is locked onto a prism, lock may be lost if the movement of the prism is too fast for the instrument to follow or the prism is hidden behind an object. After lock is lost, the prediction, as set in Prism Search Settings is used to find the prism again. The automatic aiming function is still active.
---------------------	--



Whenever the prism is moved in the field of view during the prediction and any other search periods, the instrument locks automatically to the prism.

Prediction

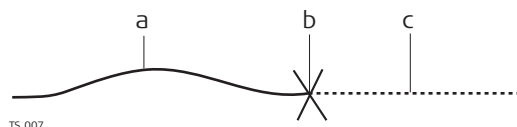

- a) Moving prism locked onto by the instrument
- b) Loss of lock
- c) Prediction

As long as the prism is being tracked by the instrument a mathematical filter continuously calculates the average speed and direction of the prism. If the line of sight between instrument and prism is disturbed, the instrument keeps on moving using these calculated values. This behaviour is called prediction. The prediction time can be configured. During prediction, the LOCK icon is displayed and if the prism comes into the instruments field of view again the automatic aiming will lock to the prism.

Prism search after prediction

After prediction, the prism is searched for depending on the settings in **Prism Search Settings**.

- **If no target found after prediction then: Stop searching.** If the prism moved in the field of view, the prism is not searched for until **Meas, Dist, Target lock on** is pressed.
- **If no target found after prediction then: Start fine search:** prism is searched for in the dynamic automatic aiming window with automatic aiming.
- **If no target found after prediction then: Start PowerSearch and Use PowerSearch window** is checked: prism is searched for in the PS window with PowerSearch.
- **If no target found after prediction then: Start PowerSearch and Use PowerSearch window** is NOT checked: prism is searched for in the dynamic PowerSearch window.

Relock

Independent of the setting for **If no target found after prediction then** the instrument can relock to the prism. Refer to paragraph "Enable lock".

34.4**RCS**

Description

The instrument can be controlled by the field controller via radio. The automatic aiming function does not necessarily have to be active when working in RCS mode. The field controller is used to remote control the instrument. No data can be stored on the field controller. The screen and content displayed on the field controller are a copy of the remote controlled instrument.

The communication between the total station and the field controller is established via radio modems. One radio modem has to be connected to the total station serial port.

34.5**EGL**

Description

The **Emitting Guide Light**, EGL, consists of two differently coloured flashing lights in the telescope housing of the TPS. The EGL is used for guidance into the line of sight. If the left light is seen, the prism must be moved right and vice versa. If both flashing lights can be seen, the prism is in the line of sight of the instrument.

Functionality

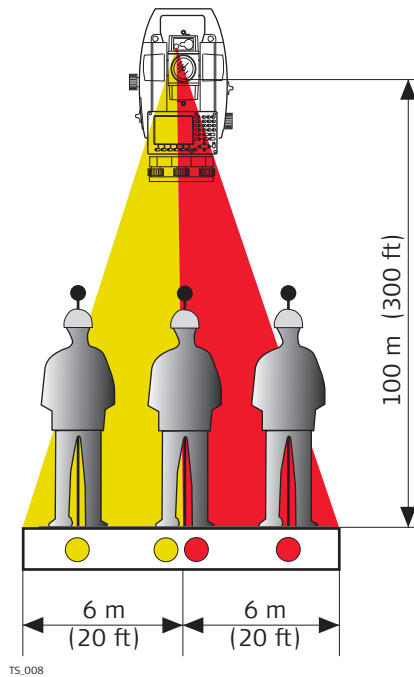

The EGL can be used

- to help guide the prism into the telescope line of sight when the instrument is controlled remotely and **Target aiming: Lock**.
- to stake out points.

The instrument emits two differently coloured flashing cones of light. At a target distance of 100 m, the cones have a width of 6 m. Between the two cones of light, a sector with a width of 30 mm is created where both guide lights are visible simultaneously. In this position, the prism is in the line of sight of the instrument.

Using the EGL step-by-step

Step	Description
1.	Check Use the instrument guide lights (EGL) in the Instrument Lights screen. OR Set Target aiming: Lock and press Comps or Turn to Hz/V or J Stick on the Leica TPS Favourites screen.
2.	Align instrument line of sight and prism, where both flashing EGL lights can be seen simultaneously.
3.	OK to lock onto the prism.
4.	If the instrument has locked onto the prism the EGL is turned off automatically.
	If the EGL was turned on in Instrument Lights , it has to be turned off by unchecking the check box.

34.6

Illumination

Description

There are several different illumination types built into the instrument that all fulfil different functions. Some are to support measurements, for example the visible red laser pointer. Others, such as the screen illumination, are for more convenient work with the instrument. These different types of illumination are described in this chapter.

Laser plummet

The laser plummet allows setting up the instrument over a marked point. The laser beam is emitted from the bottom of the instrument, pointing to the ground. When the instrument is levelled and the laser beam points exactly at the ground point, the instrument is set up correctly.

The laser plummet can be turned on and off. It is turned on automatically when opening the **Instrument\TPS settings\Level bubble & compensator** screen and turned off when leaving the screen.

Visible red laser pointer

The visible red laser pointer is used to measure to any surface. The visible red laser pointer is arranged coaxially with the line of sight of the telescope and emitted through the objective. If the instrument is correctly adjusted, the visible red laser beam coincides with the line of sight.



The direction of the beam should be inspected before precise distance measurements are executed. An excessive deviation of the laser beam from the line of sight can cause inaccurate results.

GUS74 Laser Guide

The GUS74 Laser Guide is an option for TPS instruments. It is built into a special telescope compartment and emits a visible red laser beam to visualise the line of sight over long ranges. The GUS74 Laser Guide is used for special applications such as tunnelling. Refer to GUS74 Laser Guide Manual for detailed information.

34.7

Connection to Other Total Stations

34.7.1

Leica Legacy Total Stations

Supported functions

Function	TPS300 TPS400 TPS700	TPS700A	TPS800	TPS1000 TPS1100
Robotic control	-	-	-	-
Auto aiming	-	✓	-	✓
Level bubble	-	-	-	-
Auto aiming in setup	-	✓ ¹	-	✓ ¹
Compensator on/off	✓	✓	✓	✓
Laser plummet on/off	✓	✓	✓	-
Laser pointer on/off	✓	✓	✓	-
EGL on/off	✓	✓	✓	✓
Connection status	✓	✓	✓	✓
TPS battery status	-	-	-	-
Move between reflectorless & prism measurements	✓	✓	✓	✓
Measure mode continuous	✓	✓	✓	✓
Auto logged points	✓	✓	✓	✓

✓ Supported

- Not supported

¹ The auto aiming function when doing a setup only works if a distance is measured. The **Meas** or **Dist** key must be used. When using the **Store** key only, the auto aiming function in setup is unavailable.



SmartPole and SmartStation are not supported with Leica Legacy instruments.



Prism constants and correction values set at the CS are applied to the raw measurement data taken from the total station.

34.7.2

Topcon

Supported functions

Function	GTS GPT GPT-L	GTS800 GTS820 GTS900	GPT8000 GPT8200 GPT9000
Robotic control	-	-	-
Auto aiming	-	-	-
Level bubble	-	-	-
Compensator on/off	-	-	-
Laser plummet on/off	-	-	-
Laser pointer on/off	-	-	-
EGL on/off	✓	✓	✓
Connection status	✓	✓	✓
TPS battery status	-	-	-
Move between reflectorless & prism measurements	✓	✓	✓
Measure mode continuous	-	-	-
Auto logged points	-	-	-

- ✓ Supported
- Not supported



Prism constants and correction values set at the CS are applied to the raw measurement data taken from the total station.

34.7.3

Sokkia

Supported functions

Function	Set 030R/220/010	Set 10/10K Series Set 20/20K Series Set 30R/30RK/130R	Set 110 Series Set 110R Set 120 Series	Set 110M Series	Set 230RM Series	Set 300/500/600 SRX Series	Set X Series Set SCT6
Robotic control	-	-	-	-	-	-	-
Auto aiming	-	-	-	-	-	-	-
Level bubble	-	-	-	-	-	-	-
Compensator on/off	-	-	-	-	-	-	-
Laser plummet on/off	-	-	-	-	-	-	-
Laser pointer on/off	-	-	-	-	-	-	✓
EGL on/off	-	-	-	✓	-	✓	-
Connection status	✓	✓	✓	✓	✓	✓	✓
TPS battery status	-	-	-	-	-	-	-
Move between reflectorless & prism measurements	1	-	-	-	✓	✓	✓
Measure mode continuous	✓	✓				✓	✓
Auto logged points	✓	✓				✓	✓
Others	2	-	-	-	-	-	-

- ✓ Supported
- Not supported
- Not available
- 1 Set **Prism** or **Any surface** measure modes at the instrument.
Set the correct prism constant at the controller.
- 2 Setup not available. Set horizontal angle at instrument.



Prism constants and correction values set at the CS are applied to the raw measurement data taken from the total station.

34.7.4

Nikon

Supported functions

Function	800 Series	Nikon A Series	DTM300 Series	DTM330 Series NPL330 Series	DTM500 Series	Nivo C Nivo M
Robotic control	-	-	-	-	-	-
Auto aiming	-	-	-	-	-	-
Level bubble	-	-	-	-	-	-
Compensator on/off	-	-	-	-	-	✓
Laser plummet on/off	-	-	-	-	-	-
Laser pointer on/off	-	-	-	-	-	-
EGL on/off	-	-	-	-	✓	-
Connection status	✓	✓	✓	✓	✓	✓
TPS battery status	-	-	-	-	-	-
Move between reflectorless & prism measurements	-	-	-	✓	-	✓
Measure mode continuous		✓	-	✓	✓	✓
Auto logged points			-	✓	✓	✓
Others	-	1	-	-	-	-

- ✓ Supported
- Not supported
- Not available
- 1 Setup not available. Set horizontal angle at instrument.



Prism constants and correction values set at the CS are applied to the raw measurement data taken from the total station.

35

Calculator

35.1

Accessing the Calculator

Description

The calculator can be used to perform the following arithmetic operations such as

- addition, subtraction, multiplication and division
- statistics
- trigonometry, hyperbolic trigonometry and calculations with Pi
- polar, rectangular and angle conversions
- powers, logs, roots and exponential functions.

Operating modes

The calculator has two operating modes - RPN mode and Standard mode. The arithmetic operations available are identical, the difference lies in the way information is entered, stored and displayed on the screen.

Type	Description
RPN	Reverse Polish Notation This operating mode was developed as a way of writing mathematical expressions without using parenthesis and brackets. Many scientific calculators, for example Hewlett Packard calculators, are implemented with this operating mode. Values are entered and kept in a working stack.
Standard	This operating mode is based on the principles of conventional pocket calculators. There is no stacking of values.

Access

Press **Calc** in any screen when editing an editable field for numeric characters, such as **Azimuth** in **Traverse Input**.

35.2

Configuring the Calculator

Access

In **RPN Calculator** or **Standard Calculator** press Fn **Config..** to access **Calculator Configuration**.

Calculator Configuration

Calculator Configuration | ↻

Operatng Mode: RPN

Angular unit: DEG

Display Dec: 5 decimals

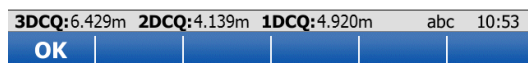

Key	Description
OK	To accept changes and return to the screen from where this screen was accessed.
Fn Quit	To exit the screen.

Description of fields

Field	Option	Description
Operating mode	RPN	The principle of, for example, Hewlett Packard calculators.
	Standard	The principle of conventional pocket calculators.
Angular unit	DEG	Degrees
	RAD	Radians
	GRAD	Gon
Display Dec	From 0 to 10 decimals	The number of decimal places shown.

Next step

OK confirms the selections made and returns to the screen from where this screen was accessed.

35.3

35.3.1

Using the Calculator

RPN Mode

Requirements

Operating mode: RPN in **Calculator Configuration**.

RPN Calculator

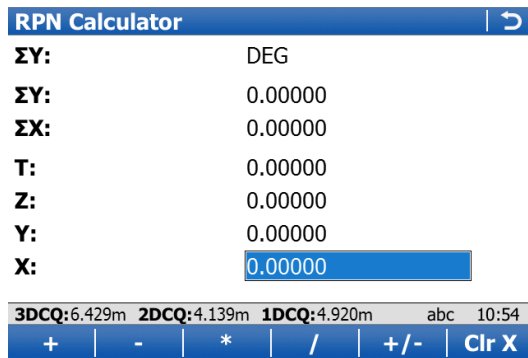

Key	Description
F1 - F6	The function keys are allocated seven times. Refer to Description of Softkeys .
	Using the up and down keys the various allocations can be accessed.

Description of fields

Field	Option	Description
First field on the screen	Display only	The unit used for trigonometric functions in the calculator as configured in Calculator Configuration .
	DEG	Degrees
	RAD	Radians

Field	Option	Description
	GRAD	Gon
ΣY	Display only	The result of the sum or difference of values in Y using Σ+ and Σ- .
ΣX	Display only	The result of the sum or difference of values in X using Σ+ and Σ- .
T	Display only	Third stack. After an operation, the value from Z is written here.
Z	Display only	Second stack. After an operation, the value from Y is written here.
Y	Display only	First stack. After an operation, the value from X is written here.
X	Editable field	The value for the next operation.

Next step

Fn **Quit** returns to **Main Menu**.

35.3.2

Standard Mode

Requirements

Operating mode: **Standard** in **Calculator Configuration**.

Standard Calculator

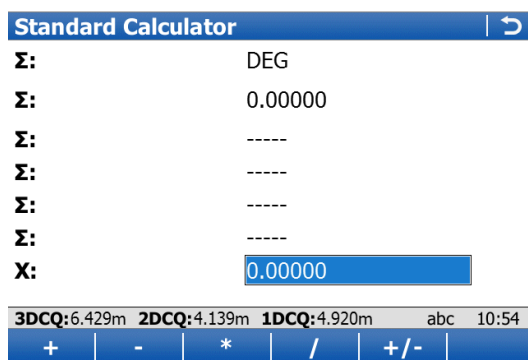

Key	Description
F1 - F6	The function keys are allocated seven times. Refer to Description of Softkeys .
	Using the up and down keys the various allocations can be accessed.

Description of fields

Field	Option	Description
First field on the screen	Display only	The unit used for trigonometric functions in the calculator as configured in Calculator Configuration . DEG Degrees RAD Radians GRAD Gon
Σ	Display only	The result of the sum or difference of values in the last field on the screen using Σ+ and Σ- .

Field	Option	Description
Third to sixth field on the screen	Display only	Previously entered value OR Latest operation including result. # indicates that the value is cut after the third decimal.
Last field on the screen	Editable field	The value for next operation or result from latest operation.

Next step

Fn **Quit** returns to **Main Menu**.

35.3.3

Description of Softkeys

Overview of softkeys

The softkeys shown and described are from **Operating mode: RPN**. Most of the softkeys are identical and their functionality is similar to the softkeys from **Operating mode: Standard**.

RPN Calculator					
ΣY:	DEG				
ΣY:	0.00000				
ΣX:	0.00000				
T:	0.00000				
Z:	0.00000				
Y:	0.00000				
X:	0.00000				
3DCQ:6.429m 2DCQ:4.139m 1DCQ:4.920m abc 11:06					
+	-	*	/	+/-	Clr X
Σ+	Σ-	Mean	SDev	Clr Σ	
Sin	Cos	Tan	Asin	Acos	Atan
°DMS	°Dec	PI	D->R		R->D
Polar	Rect	Sqrt	X^2	1/X	Y^X
Log	10^X	LN	e^X	Y^X	
Sto	Rcl	X<>Y	Last X	Clear	

Key	Description
F1 - F6	The function keys are allocated seven times.
	Using the up and down keys the various allocations can be accessed.

Description of softkeys

First level

+	-	*	/	+/-	Clr X
---	---	---	---	-----	-------

Key	Description
+	To add X and Y .
-	To subtract X from Y .
*	To multiply X by Y .
/	To divide Y by X .

Key	Description
+/-	To change between positive and negative algebraic sign for X .
Clr X	To clear X .

Second level

$\Sigma+$	$\Sigma-$	Mean	SDev	Clr Σ
-----------	-----------	------	------	--------------

Key	Description
$\Sigma+$	To add X to ΣX and Y to ΣY .
$\Sigma-$	To subtract X from ΣX and Y from ΣY .
Mean	To calculate the mean ΣX .
SDev	To calculate the standard deviation for ΣX .
Clr Σ	To clear ΣX and T .

Third level

Sin	Cos	Tan	Asin	Acos	Atan
-----	-----	-----	------	------	------

Key	Description
Sin	To calculate sine of X .
Cos	To calculate cosine of X .
Tan	To calculate tangent of X .
Asin	To calculate arcsine of X .
Acos	To calculate arccosine of X .
Atan	To calculate arctangent of X .

Fourth level

$^{\circ}$ DMS	$^{\circ}$ Dec	PI	D->R	R->D
----------------	----------------	----	------	------

Key	Description
$^{\circ}$ DMS	To convert decimal degrees into dd.mm.ss.
$^{\circ}$ Dec	To convert dd.mm.ss into decimal degrees.
PI	To insert X: 3.1415926536 . The number of decimals depends on the selection for Display Dec in Calculator Configuration .
D->R	To convert degrees into radians.
R->D	To convert radians into degrees.

Fifth level

Polar	Rect	Sqrt	X^2	1/X	Y^X
-------	------	------	-----	-----	-----

Key	Description
Polar	Conversion of rectangular coordinates into polar coordinates. The y coordinate must be visible in Y and the x coordinate in X when pressing this key. The angle is displayed in Y and the distance in X .

Key	Description
Rect	Conversion of polar coordinates into rectangular coordinates. The angle must be visible in Y and the distance in X when pressing this key. The y coordinate is displayed in Y , the x coordinate in X .
Sqrt	To calculate \sqrt{X} .
X^2	To calculate X^2 .
1/X	To inverse X .
Y^X	To calculate Y^X .

Sixth level

Log	10^X	LN	e^X	Y^X
------------	-------------	-----------	------------	------------

Key	Description
Log	To calculate the $\log_{10}X$.
10^X	To calculate 10^X .
LN	To calculate the $\log_e X$.
e^X	To calculate e^X .
Y^X	To calculate Y^X .

Seventh level

Sto	Rcl	X<>Y	Last X	Clear
------------	------------	-------------------	---------------	--------------

Key	Description
Sto	To store X to the memory. Up to ten values can be stored.
Rcl	To recall a value for X from the memory. Up to ten values can be recalled.
X<>Y	To swap the values for X and Y .
Last X	To recall the last X before recent calculation.
Clear	To delete everything.

F_n to access the second level of function keys

Help	Config..	Done	Quit
-------------	-----------------	-------------	-------------

Key	Description
F _n Config..	To configure the calculator.
F _n Done	To return to Main Menu .
F _n Quit	To exit the screen.



It is recommended to configure an Ntrip connection via the **RTK Rover Wizard**. Select **Main Menu\Instrument\GPS settings\RTK rover wizard** and follow the on-screen instructions.

The remainder of this chapter describes each of the steps and screens when configuring without the use of the **RTK Rover Wizard**.



TPS One Internet interface is available - the **CS Internet**.

GPS Two Internet interfaces are available - the **CS Internet** and the **GS Internet**. The **CS Internet** is used as an example. The explanations are also valid for the **GS Internet**.



To access the Internet with a GPS or TPS instrument, **General Packet Radio System** devices will normally be used. GPRS is a telecommunication standard for transmitting data packages using the Internet Protocol (IP).

Select the internet interface

Select **Main Menu: Instrument\Connections..\All other connections**.
On the **CS connections** page highlight **CS Internet**.
Press **Edit...**

Configure the Internet interface

Step	Description
1.	Select a port (Connect using).
2.	Select a device (Devce..).
3.	If necessary enter User ID and Password . Some providers ask for a User ID and a Password to allow connecting to the Internet via GPRS. Contact your provider if a user ID and password needs to be used.
4.	OK to return to Connection Settings .
5.	In Connection Settings press Cntrl... Continue with the next paragraph.

Configure the GPRS/Internet Connection

GPRS/Internet Connection | ↻

GPRS details | Sim codes | **Advanced**

Device: Manufact ModelId

APN:

(continued):

3DCQ:5.339m 2DCQ:3.169m 1DCQ:4.297m Fn abc 09:52

OK | | | | **Page**

GPRS/Internet Connection | ↻

GPRS details | Sim codes | **Advanced**

PIN code:

PUK code:

3DCQ:5.335m 2DCQ:3.176m 1DCQ:4.287m Fn abc 09:52

OK | | | | **Clear** | **Page**

Step	Description
1.	On the GPRS details page, type in the APN (A ccess P oint N ame of a server from the network provider). Contact your provider to get the correct APN.
2.	On the Sim codes page, type in the PIN code for the Sim card. If the PIN is locked for any reason, for example the wrong PIN was entered, input the Personal UnbloCking code for access to the PIN.
3.	OK twice to return to the Main Menu . The instrument is now online to the Internet. The Internet online status icon is displayed. But because GPRS is being used, no charges are yet made since no data transfer from the Internet has yet taken place.

Check the status of the Internet connection

Connection Status | ↻

CS connections | **GS connections**

Connection	Port	Device
CS Internet	CS Bluetooth 1	Nokia Phone
Total Station	-	-
GPS Rover	Cable	GS
ASCII Input	-	-
GPS Hidden Pt	-	-
GSI Output	-	-
Export Job	-	-

3DCQ:6.436m 2DCQ:3.494m 1DCQ:5.404m Fn abc 09:53

OK | | **Intfce** | | **Devce..** | **Page**

Step	Description
1.	Select Main Menu: Instrument\Instrument status info\Connection status .
2.	On the CS connections page highlight CS Internet .
3.	Press Intfce .
4.	Check the Internet online status.
5.	OK twice to return to the Main Menu .

Select the internet interface

Select **Main Menu: Instrument\Connections..\All other connections.**
On the **GS connections** page highlight **RTK Rover.**
Press **Edit...**

Settings for the RTK rover

RTK Rover Settings | ↻

General | RTK base | RTK network | Advanced

Receive RTK data

Connect using: CS Internet 1

RTK device: Internet

RTK data format: Leica 4G

Use auto coordinate system

Receive RTK network information

Auto connect when measuring

3DCQ:5.519m 2DCQ:3.292m 1DCQ:4.430m Fn abc 09:55

OK | Devce.. | Page

RTK Rover Settings | ↻

General | RTK base | RTK network | Advanced

Use RTK network

Network type: MAX

Send user ID

3DCQ:5.519m 2DCQ:3.296m 1DCQ:4.426m Fn abc 09:56

OK | Page

Step	Description
1.	On the General page, make sure that an Internet port is selected for Connect using .
2.	On the RTK network page, enable Use RTK network .
3.	Press OK to return to Connection Settings, GS connections page.
4.	Press Cntrl.. to access Internet Port Connection . Continue with the next paragraph.

Select the server to be accessed in the Internet

Internet Port Connection | ↻

Internet port: CS Internet 1

Server to use: <None>

3DCQ:7.125m 2DCQ:3.807m 1DCQ:6.023m Fn abc 10:00

OK

New Server | ↻

General | NTRIP

Server name: MyServer

Address: www.myserver.com

Port: 1000

3DCQ:7.017m 2DCQ:3.752m 1DCQ:5.930m Fn abc 10:01

Store | Page

New Server | ↻

General | NTRIP

Use NTRIP with this server

NTRIP user ID: NTRIP User

NTRIP password: *****

3DCQ:6.915m 2DCQ:3.700m 1DCQ:5.843m Fn abc 10:01

Store | Page

Step	Description
1.	The Server to use , must be Ntrip enabled. To create a new server click into the selectable list.
2.	In New Server, General page, type in the address and the port of the server through which the data is provided. Each server has several ports for various services.
3.	In New Server, NTRIP page, activate the use of Ntrip.
4.	Type in the NTRIP user ID and the NTRIP password . A user ID and the password are required to receive data from the Ntrip Caster. Contact the Ntrip administrator for information.
5.	Store followed by OK to return to Internet Port Connection .

Select the Ntrip mountpoint

Internet Port Connection | ↻

Internet port: CS Internet 1

Server to use: MyServer

NTRIP mountpoint: -----

Press Source to get a list of mountpoints

3DCQ:6.832m 2DCQ:3.679m 1DCQ:5.757m Fn abc 10:05

OK | Source

NTRIP Source Table	
Mountpoint	Identifier
MAX-RTCM3	MAX-RTCM3
iMAX-RTCM3	iMAX-RTCM3
iMAX-CMR	iMAX-CMR
iMAX-LEICA	iMAX-LEICA
iMAX-2021	iMAX-2021
iMAX-1819	iMAX-1819
VRS-RTCM3	VRS-RTCM3
VRS-CMR	VRS-CMR
VRS-LEICA	VRS-LEICA
3DCQ:6.829m 2DCQ:3.666m 1DCQ:5.762m Fn abc 10:04	
OK	Info

Step	Description
1.	If the selected server is Ntrip enabled, Ntrip mountpoint is available.
2.	Press Source to access NTRIP Source Table .
3.	All mountpoints are listed. Mountpoints are the Ntrip servers sending out real-time data. This screen consists of two columns. The first column shows the abbreviations for the Mountpoints, the second the city where the Mountpoint is located.
4.	Highlight a mountpoint.
5.	Press OK twice to return to Connection Settings, GS connections page.
6.	Fn Conect and Fn Disco are now available in all applications to connect to and disconnect from the Ntrip server.

37

MapView Interactive Display Feature

37.1

Overview

Description

MapView is an interactive display feature embedded in the firmware. MapView provides a graphical display of the survey elements which allows for a better overall understanding of how the data being used and measured relates to each other. Depending on the application and where in the application MapView is accessed from, different functionality is available. The displayed data in all modes of MapView can be shifted by using both the arrow keys and the touchscreen.

Displayable data

The data displayed in MapView is defined by the application through which it was accessed, filters set in **Sorts & Filters**, and the selections made in **Map View Settings**.



The datum view is always considered as local.



If negative coordinates are used in CAD files to suit projections with the origin in North-East and the axes going South and West, use the setting **Switch Easting for CAD files** and **Switch Northing for CAD files** in **Regional Settings, Coords** page to mirror the CAD file in MapView.

37.2

Accessing MapView

Description

The MapView interactive display feature is provided as a page within all applications and data management. It is accessed through the application itself. Depending on the application and from where in the application MapView is accessed, different MapView modes are available.

Access step-by-step

Example for data management

Step	Description
1.	Select Main Menu: Jobs & Data\ View & edit data.
2.	Page until the Map page is active.

Example for an application

Step	Description
1.	Select Main Menu: Go to Work!\ COGO\Intersection.
2.	COGO Intersection Choose a method and enter appropriate data.
3.	Calc to access Intersection Result, Results page.
4.	Page until the Plot page is active.

37.3

Configuring MapView

Description

Allows options to be set which are used as default options within MapView. These settings are stored within the working style and apply to all Map and Plot pages, regardless of how MapView is accessed.



Any changes made in **Map View Settings** affect the appearance of MapView in all applications, not just the active application.

Access step-by-step Press Fn **Config..** on any **Map** or **Plot** page.

**Map View Settings,
General page**

Description of fields

Field	Option	Description
Display map-view toolbar	Check box	Determines if the toolbar of icons is displayed. Refer to "37.4.2 Keys, Softkeys and Toolbar".
Show my path	Check box	Displays the path of the rover as a dashed line.
Centre to <input type="text" value="TPS"/>	Target	To centre the map on the target. For Measure mode: Standard and Measure mode: Single (fast) , the map will centre onto the last measured point. For Measure mode: Continuous and Measure mode: Long range (>4km) , the map will centre onto the current reflector position.
	TPS instrument	To centre the map on the instrument.
Rotate data in map by 180°	Check box	To rotate the map by 180°. The north arrow is not rotated and still orientated towards the top of the screen.

Next step

Page changes to the **Points** page.

**Map View Settings,
Points page**

Key	Description
OK	To confirm the selections and to return to the screen from where this screen was accessed.
Symbol	To view all point symbols and their descriptions.
Page	To change to another page on this screen.

Description of fields

Field	Option	Description
Display points	Check box	Determines if points are displayed in MapView.
Point ID	Check box	Available if Display points is checked. Determines if the ID of a point is displayed.
Point code	Check box	Available if Display points is checked. Determines if the code of a point is displayed.
Height of point	Check box	Available if Display points is checked. Determines if the height of a point is displayed.
Quality of point	Check box	Available if Display points is checked. Determines if the coordinate quality of a point is displayed.
Show pt info for a maximum of 200 pts	Check box	If checked, point information is not shown when more than 200 points are displayed. If not checked, the point information as configured is shown regardless of the number of points being displayed.

Displayable point information

- | | |
|--|----------------------------|
| <input checked="" type="checkbox"/> 1001 | a) Point ID |
| HOUS | b) Point code |
| 400.1741 | c) Height of point |
| 0.0255 | d) Quality of point |

Next step

Page changes to the **Lines & areas** page.

Map View Settings, Lines & areas page

Description of fields

Field	Option	Description
Display lines	Check box	Determines if lines are displayed in MapView.
Line ID	Check box	Available if Display lines is ticked. Determines if the ID of a line is displayed.
Line code	Check box	Available if Display lines is ticked. Determines if the code of a line is displayed.
Display areas	Check box	Determines if areas are displayed in MapView.
Area ID	Check box	Available if Display areas is ticked. Determines if the ID of an area is displayed.
Area code	Check box	Available if Display areas is ticked. Determines if the code of an area is displayed.

Displayable line/area information

A line is shown as example.



- a) **Line ID**
- b) **Line code**

Next step

Page changes to the **DTM** page.

Map View Settings, DTM page

Description of fields

Field	Option	Description
Display DTM in map	Check box	When this box is checked, DTM triangles are shown within the Map page of the Stakeout, Reference Line, Road or Rail application.  The setting of for this check box is linked to the setting for the Show DTM on map check box in Use heights from DTM (Roads, Tools Menu) .
Colour	Selectable list	Defines the colour of the active DTM layer boundary.

Next step

Page changes to the **Alignments** page.

Map View Settings, Alignments page

Description of fields

Field	Option	Description
Vertical exaggeration of profiles	Editable field	The exaggeration factor of the map. The value can be between 0.1 and 50.  This setting only has an effect in applications where cross-section views are displayed.
Display all layers in cross-section view	Check box	When this box is checked, all layers of an alignment are displayed in a cross section view.

Next step

Page changes to the **CAD import** page.

Map View Settings, CAD import page

Description of fields

Field	Option	Description
Point prefix, Line prefix or Area prefix	Editable field	The identifier with up to four characters is added in front of the ID of the imported CAD points, lines or areas.
Create points at the vertices of lines	Check box	Option if points will be created at vertices of the imported line/arc/polyline elements.
Height to exclude	Editable field	Height values inside the DXF file are considered invalid and will not be converted.
Apply height to 2D CAD data on import	Check box	When this box is checked, a height can be defined which is then applied to all imported 2D CAD points.
Height to apply	Editable field	Available when Apply height to 2D CAD data on import is checked. The height to apply to 2D CAD points.

Next step

OK confirms the selections and returns to the previous screen.

37.4
37.4.1

MapView Components
Screen Area

Standard screen

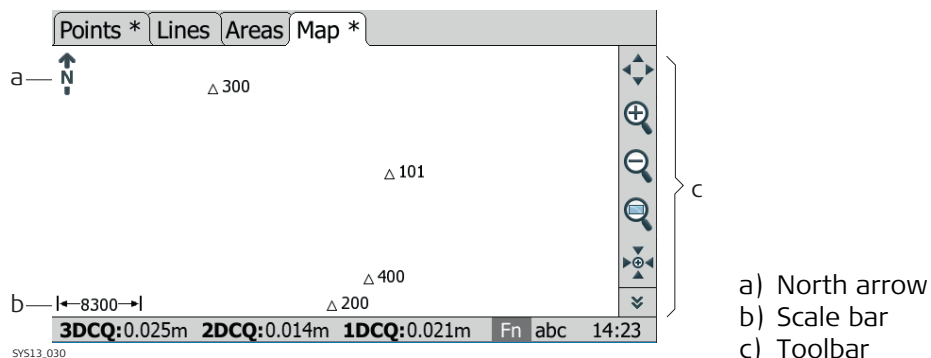

Scale bar

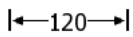
Symbol	Description
	Scale of the current screen. The minimum is 0.1 m. There is no maximum for the zoom but the scale cannot display values greater than 99000 m. In this case the value displayed will be >99000 m.

North arrow

Symbol	Description
	North arrow. North is always orientated towards the top of the screen.

Toolbar

Symbol	Description
	Icon toolbar. Refer to "37.4.2 Keys, Softkeys and Toolbar" for more information about the functionality of the icons in the toolbar.

Point with focus

Symbol	Description
	The point that has the focus.

Line/area with focus

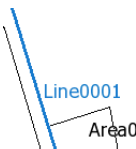
Symbol	Description
	The line/area that has the focus is bolder than other lines shown in blue for the full and in orange for Lite version of SmartWorx Viva.

Rover

Symbol	Description
	Available in survey mode. Position of the rover. The rover path is shown as dotted line.

Prism

Symbol	Description
	Measured position. The orientation of the instrument is shown as dotted line.

Instrument station













Symbol	Description
	Position of the instrument station.

Description

Standard functionality is provided by softkeys, keys and a toolbar within MapView. The softkeys are available regardless of the mode in which MapView was accessed and always perform the same functions. Icons are available in a toolbar. The toolbar is always located on the right side of the screen. Some of the functions performed by the icons can also be replicated using a softkey or key in the same mode as when the icon appears. The softkey/key equivalent of each icon, if one exists, are indicated in the following table.

Overview of keys, softkeys and icons

The softkeys described in this table are standard on all MapView screens. For descriptions of mode-specific softkeys, see appropriate chapters.

Icon	Key or Softkey	Description
	-	To scroll the MapView toolbar.
	1 or Fn Refrsh in some applications	The fit icon fits all displayable data, according to filters and the map configuration, into the screen area, using the largest possible scale.
	2	To zoom into the map.  Pressing ESC stops the zooming process.
	3	To zoom out of the map.  Pressing ESC stops the zooming process.
	-	The windowing icon zooms to a specified area window. An area window can be drawn by dragging the stylus on the screen in a diagonal line to make a rectangular area or by tapping twice on the screen to define diagonally opposite corners of a rectangular area. This action causes the screen to zoom to the selected area.
	5	To centre the selected point, the GPS rover, the TPS target or TPS instrument.
	-	To select multiple objects. Points within the rectangular area are always selected. Depending on the application also lines, for example dbx lines, Road/Rail job lines or lines from background maps, and areas are selected. Drag the stylus on the screen in a diagonal line to make a rectangular area. <ul style="list-style-type: none"> • Drag from top left to bottom right to select all lines inside the rectangular window. • Drag from bottom right to top left to select all lines crossing the rectangular window.
	Fn Config..	To configure MapView. Refer to "37.3 Configuring MapView".
	Fn Layrs..	To turn layers of background maps (CAD files) on and off. Refer to "5.2 Creating a New Job" for information on CAD files.
	-	To import CAD files for background only maps. Refer to "5.2 Creating a New Job".

Icon	Key or Softkey	Description
	-	To switch the view. Available in some applications, for example Reference Plane, Road or Rail.
-	0	To make the MapView do a complete redraw.
-	Fn Filter..	To change the filter settings. Refer to "6.6 Point Sorting and Filters".

37.4.3 Point Symbols

Description When **Display points** is checked in **Map View Settings, Points** page, points are displayed, in all modes, according to their class. A list of the point types available, and their description, is available.

Access Press **Symbol** in **Map View Settings, Points** page.

Symbols

Symbol	Description
△	3D control point is a point of class CTRL with full coordinate triplet.
△	2D control point is a position only point of class CTRL .
⊕	Adjusted point is a point of class ADJ .
▽	Base point is a point of class REF .
⊙	Average point is a point of class AVGE .
⊙	Measured point is a point of class MEAS .
⊗	Single Point Position uploaded from LGO.
□	Navigated point is a point of class NAV .
+	Estimated point is a point of class EST .







Points of class **None** or points of class **Ctrl/Meas** with a height only component cannot be displayed in MapView.

37.5 Selecting Points, Lines and Areas

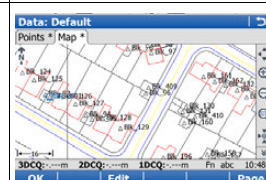
Selecting a point/line/area using the touch screen step-by-step

The instructions for selecting a point using the softkeys can be applied for lines and areas.

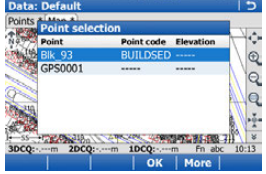
Step	Description	Display
1.	Go to Data:, Map page.	
	If no point field is highlighted on the previous page when the Map page is accessed, then any point that is selected will be assigned to the first point field on the previous page, the second point to the second point field, etc. If a point field is highlighted when the Map page is accessed then the point selected will be assigned to that field.	
2.	Tap on the point to be selected.	

Step	Description	Display
	When there are multiple points within the same area and the precise selection is unclear, tapping on the point will access Select Point .	
3.	Have multiple points been selected? <ul style="list-style-type: none"> If yes, continue with step 4. If no, continue with step 5. 	
4.	Select Point Point ID The ID of the points within range of the point selection. Point code The code of the points within range of the point selection. Select the desired point.	
	More to display information about the point code, the 3D coordinate quality and class, the time the point was stored and the date the point was stored.	
5.	OK returns to Data: Map page with the focus on the selected point.	
6.	A square is centred on the selected point and the point parameter text is highlighted.	

Select a point/line/area without touch screen

Without touch screen or when **Use the touch screen** is not checked in **Screen & Audio Settings, Screen** page, points, lines and areas can only be selected using the selectable lists.

37.6

Context Menu

Access

The context menu is available in Survey, COGO, Stakeout (points and DTM), Reference Line, Roads and Data Management.
On a **Map** page hold down the supplied stylus on an object for 0.5 second.

Options in the context menu

The options available in the context menu depend on the object and the application.

Option	Available in	Description
Import	<ul style="list-style-type: none"> Data Management COGO Reference Line Stakeout Survey Roads 	Imports the selected CAD object into the DBX. The object is imported to the job the CAD is attached to. The entities the object is imported with are displayed. The import settings are configured in Map View Settings, CAD import page. Refer to "37.3 Configuring MapView".
Information..	<ul style="list-style-type: none"> Data Management COGO Reference Line Stakeout Survey Roads 	Displays the entities of the object.



Option	Available in	Description
Manage layers..	<ul style="list-style-type: none"> Data Management COGO Reference Line Stakeout Survey Roads 	Opens the CAD Layers screen and highlights the layer to which the object belongs. Refer to "CAD Layers".
Stake point..	<ul style="list-style-type: none"> Stakeout 	Imports the selected point to the control job and selects it for staking immediately.
Stake vertices..	<ul style="list-style-type: none"> Stakeout 	<p>Available when Create points at the vertices of lines is checked in Map View Settings, CAD import page.</p> <p>Imports the selected line/area, along with the new points being created at the vertices.</p> <p>The vertices are imported in a sequential order following the direction of the line. The first point created is the point automatically selected to be staked. The next point to be staked is the next vertex along the line.</p>
Use as CL	<ul style="list-style-type: none"> Import Alignment Data 	To select/deselect the highlighted line as external chainage centreline.
Use as Track CL	<ul style="list-style-type: none"> Import Alignment Data 	To select/deselect the highlighted line as track centreline.
Use as left Rail/Use as right Rail	<ul style="list-style-type: none"> Import Alignment Data 	To select/deselect the highlighted line as left/right rail.
Clear selected object	<ul style="list-style-type: none"> Import Alignment Data 	To remove the highlight from the highlighted line.
Turn to point	<ul style="list-style-type: none"> TPS in survey mode. 	<p>To display the current direction as dashed line. A point on the Map page can then be tapped and the instrument turns to this direction.</p> <p>If Target aiming: Automatic the instrument does an ATR search. If Target aiming: Lock the instrument tries to lock on to a prism.</p>
Turn to here	<ul style="list-style-type: none"> TPS in survey mode. 	To display the current direction as dashed line. A location on the Map page can then be tapped and the instrument turns to this direction.

Description

MapView can be used to view the results of an application. Results are shown in black, all other information, that is displayable, is shown in grey.

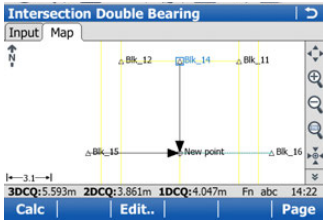
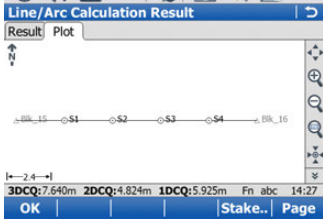
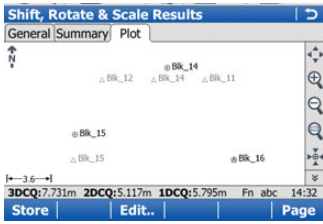
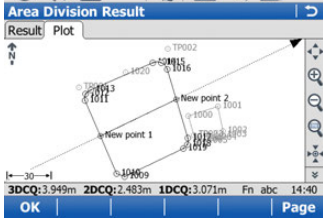
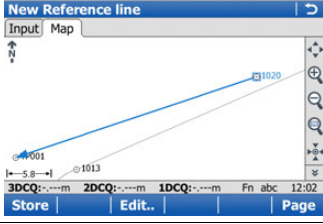
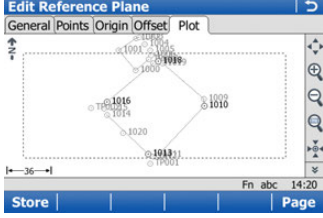
Example of results displayed in MapView

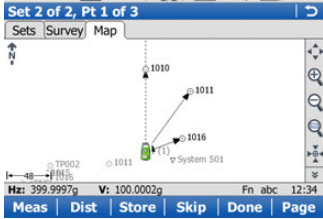
Application	Display	Description
COGO Intersection, Double bearing		Intersecting lines with known bearings from known points
COGO line calculation, Segmentation		Points defining the line and those points created on the line
COGO Shift, Rotate & Scale		Original points in grey, calculated COGO points in black
COGO Area Division		Points from the area and the area division are black, other points are grey
Reference Line, Edit Reference Line		Reference line with target point as offset from reference line
Reference Plane, Edit Reference Plane		A dashed rectangle indicates the face view of the plane.

Application	Display	Description
Sets of Angles, Calculating Angles TPS		Directions from station to sets of angle points
Setup TPS		Directions to resection points.

Description

Tap Map is an extended MapView regarding the context menus. Tap Map can easily be accessed from the **Main Menu**. The configuration and the toolbar of Tap Map are identical with those of MapView.

Access

In **Main Menu**, press **Map**.

Tap Map

Hold down the supplied stylus on an object for 0.5 second.

Refer to "37.4.1 Screen Area" for information on the screen area and the toolbar.

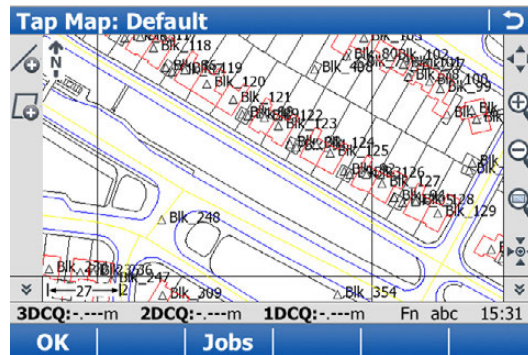

Key	Description
OK	To return to the Main Menu .
Jobs	To define if data from the active working or control job, Road job or DTM job is shown. And, for Road and DTM jobs to define the layer of which data is displayed in the Tap Map screen.
Fn Config..	To configure Tap Map. Refer to "37.3 Configuring MapView".
Fn Layrs..	To turn layers of background maps (CAD files) on and off. Refer to "5.2 Creating a New Job" for information on CAD files and CAD background maps.

Options in the context menu

The options available in the context menu depend on the object.
 Multi selection is only possible when lines are closed.

Tap and hold on no object and no other object is currently selected

Option	Description
Create point here	To open the New Point screen. Refer to "New Point, Coords page".
Turn to here	TPS The instrument turns to the direction of the tapped point or pixel. The CAD element that was tapped is NOT imported. If Target aiming: Automatic the instrument does an ATR search. If Target aiming: Lock the instrument tries to lock on to a prism.

Tap on a point

Option	Description
Turn to here	TPS The instrument turns to the direction of the tapped point or pixel. The CAD element that was tapped is NOT imported. If Target aiming: Automatic the instrument does an ATR search. If Target aiming: Lock the instrument tries to lock on to a prism.
Bearing & dist from pt..	To open the Traverse Input of COGO . The tapped point is displayed in the field From . Refer to "Traverse Input, Input page".
Check point..	TPS To open the Check Point screen. Refer to "Check Point".
Stake point..	Available when a DBX or CAD point was tapped. To open the Stakeout application. The tapped point is the point to be staked. Refer to "Stakeout, Stake page".
Change to arc (mid pt)	Not for CAD points. To create an arc in the line to which the point belongs. The arc is created running through the selected point and the point before and the point after. This functionality is only possible if the point: <ul style="list-style-type: none"> • belongs to a line or area. • is not the first or last point in the line or area. • is not currently the middle point of an arc in that line.
Remove arc	Not for CAD points. To remove the arc of which the tapped point is the centre point. This functionality is only possible if the selected point belongs to a DBX line or area and is currently the middle point of an arc in that line.
Edit point..	To open the Edit Point: screen. Refer to "Edit Point:, Coords page".
Import	For CAD points. Imports the selected point into the DBX. The point is imported to the job the CAD is attached to. The entities the point is imported with are displayed. The import settings are configured in Map View Settings, CAD import page. Refer to "Map View Settings, CAD import page".
Information..	For CAD points. Displays the entities of the point.
Manage layers..	For CAD points. To open the CAD Layers screen. Refer to "CAD Layers".
Delete point	To delete the tapped point.
Clear selected object	To remove the highlight from all highlighted objects.

Two points selected

Option	Description
Create line	To create a line from the selected points. The points are added in the order in which they were tapped.
Compute inverse..	To open the Inverse Point to Point screen. Refer to "Inverse Point to Point/Inverse Point to Current Pos, Inverse page".
Segment line..	To open the Define Line Segmentation screen. Refer to "Create Line, Input page".

Option	Description
Import	For CAD points. Imports the selected point into the DBX. The point is imported to the job the CAD is attached to. The entities the point is imported with are displayed. The import settings are configured in Map View Settings, CAD import page. Refer to "Map View Settings, CAD import page".
Delete point	To delete the tapped point.
Clear selected objects	To remove the highlight from all highlighted objects.

Three points selected

Option	Description
Create line	For CAD points. To create a line from the selected points. The points are added in the order in which they were tapped.
Create area	For CAD points. To create an area from the selected points. The points are added in the order in which they were tapped.
Clear selected objects	To remove the highlight from all highlighted objects.

One line/area selected

Option	Description
Use in Roads	To stake/check a (local) line/(local) manual slope.
Use in Reference Line	To stake/measure a line (with slope), to stake a grid from the line or to select a stake/measure task.
Open line/Open area	To open the selected line/area. If a CAD line/area was selected, then the CAD line is first imported to the DBX.
Edit line../Edit area..	To edit the line/area properties. Refer to "Edit Line, General page".
Stake vertices..	Available when Create points at the vertices of lines is checked in Map View Settings, CAD import page. Imports the selected line/area, along with the new points being created at the vertices. The vertices are imported in a sequential order following the direction of the line. The first point created is the point automatically selected to be staked. The next point to be staked is the next vertex along the line.
Measure to line/Stake to line	For CAD lines/areas. To measure/stake a line, segment, slope line or slope segment or to stake a grid.
Import	For CAD lines/areas. Imports the selected line/area into the DBX. The line/area is imported to the job the CAD is attached to. The entities the line/area is imported with are displayed. The import settings are configured in Map View Settings, CAD import page. Refer to "Map View Settings, CAD import page".
Information..	For CAD lines/areas. Displays the entities of the line/area.
Manage layers..	For CAD lines/areas. To open the CAD Layers screen. Refer to "CAD Layers".
View line details..	For Road lines. To view and edit the design data. Refer to "View & Edit Data".
Delete line/Delete area	To delete the line/area.









Option	Description
Clear selected object	To remove the highlight from all highlighted objects.

Several lines selected

Option	Description
Delete objects	To delete all highlighted objects.
Clear selected object	To remove the highlight from all highlighted objects.

Overview of icons in the drawing toolbar

If **Display drawing toolbar** is checked in **Map View Settings, General** page, icons are available in the drawing toolbar. The drawing toolbar is always located on the left side of the screen.

Icon	Description
	To scroll the MapView toolbar.
	To create a line. After storing the new line, all existing lines which are open are closed. If a line is open, then measured points are assigned to the line.
	To create an area. After storing the new area, all existing areas which are open are closed. If an area is open, then measured points are assigned to the area.
	Available if objects are closed. To open the highlighted object (lines/areas).
	Available if objects are open. To close the highlighted object (lines/areas).
	Available if a line/area is open. To create a straight line between the last point of a line to the new point being tapped or surveyed.
	Available if a line/area is open. To create an arc from the next two points which are tapped or surveyed. This icon is unavailable if the currently open line or area contains no points.
	Available if a line/area is open. To create an arc from the next three points which are tapped or surveyed.

Description	<p>Applications are software packages supporting specific tasks. Available for both GPS and TPS are:</p> <ul style="list-style-type: none"> • COGO • Determine coord system • TPS hidden point for TPS • Ref plane & grid scan • Roads (Alignment Editor, Roads - Stakeout, Roads - As built check, Rail - Stakeout, Rail - As built check, Tunnel - Stakeout for TPS, Tunnel - As built check for TPS) • Scanning for MS50 R2000 • Setup for TPS • Sets of angles for TPS including monitoring • Stakeout DTM • Stakeout • Stake points & DTM • Measure to ref line / Stake to ref line • Survey, including auto point and for GPS also hidden points • Cross Section • Traverse for TPS • QuickVolume • Volume calculations • Customised applications • Start base over known point for GPS • Start base over last setup for GPS • Start base over any point for GPS
--------------------	---

For an explanation of the applications refer to the relevant chapters.

Loadable and non-loadable applications	<table border="0"> <tr> <td style="vertical-align: top;">Loadable applications:</td> <td> <ul style="list-style-type: none"> • Can be loaded onto the instrument. • Can be deleted from the instrument. </td> </tr> <tr> <td style="vertical-align: top;">Non-loadable application:</td> <td> <ul style="list-style-type: none"> • Are always available on the instrument. • Survey is a non-loadable application. To get an update for the application, the system software has to be reloaded. </td> </tr> </table>	Loadable applications:	<ul style="list-style-type: none"> • Can be loaded onto the instrument. • Can be deleted from the instrument. 	Non-loadable application:	<ul style="list-style-type: none"> • Are always available on the instrument. • Survey is a non-loadable application. To get an update for the application, the system software has to be reloaded.
Loadable applications:	<ul style="list-style-type: none"> • Can be loaded onto the instrument. • Can be deleted from the instrument. 				
Non-loadable application:	<ul style="list-style-type: none"> • Are always available on the instrument. • Survey is a non-loadable application. To get an update for the application, the system software has to be reloaded. 				

Licence key	<p>Some loadable applications are protected. They are activated through a specific licence key, which can either be typed in Main Menu: User\Tools & other utilities\Load licence keys or the first time the application is started. Refer to "30.3 Load licence keys" for information on how to type in or upload a licence key.</p>
--------------------	--

Customised applications	<p>Customised applications can be developed locally using the GeoC++ development environment. Information on the GeoC++ development environment is available on request from the Leica Geosystems representative.</p>
--------------------------------	---

Access to the Go to Work! drop-down menu	<p>Select Main Menu: Go to Work!.</p> <p>OR</p> <p>Press .</p>
---	--



The screens for each COGO.. calculation method can be accessed directly by pressing a configured hot key or via the  key. The currently active configuration set and job are used.

Description

COGO is an application to perform **coordinate geometry** calculations such as

- coordinates of points.
- bearings between points.
- distances between points.

The calculations can be made from

- existing point data in the job, known distances or known azimuths.
- manually measured points.
- entered coordinates.

In contrast to hidden point measurements within the Survey application, COGO is more of a calculation program than a measuring program.



Changing coordinates of a point which has been previously used in COGO does not result in the point being recomputed.

COGO calculation methods

The COGO calculation methods are:

- Inverse
- Traverse
- Intersection
- Line and arc calculations
- Area division
- Shift, rotate & scale
- Angle
- Horizontal curve
- Triangle

Distances and azimuths

Type of distances: The choices are

- Ground
- Grid
- Ellipsoidal

Type of azimuths: The azimuths are grid azimuths relative to the local grid.

Coding of COGO points

- Thematical coding is available in the results screen after the COGO calculation. Thematical coding of COGO points is identical to coding manually measured points. Refer to "26 Coding" for information on coding.
- For the COGO calculation shift, rotate & scale, the codes from the original points are taken over for the calculated COGO points.

Access

Select **Main Menu: Go to Work!** **COGO** and select a COGO calculation method.

COGO calculation methods

Description of the COGO calculation methods

COGO calculation methods	Description
Inverse	<p>To calculate the direction, the distance and the 3D coordinate differences between two known points (or one known point and the current GPS position).</p> <p>To calculate the direction, the distance and the 3D coordinate differences between a known point (or the current GPS position) and a user-defined line.</p> <p>To calculate the direction, the distance and the 3D coordinate differences between a known point (or the current GPS position) and a user-defined arc.</p> <p>For these calculations, only points with full coordinate triplets or position only points can be used.</p>
Traverse	<p>To calculate the position of new points using</p> <ul style="list-style-type: none"> the azimuth/bearing and the distance from a known point. Offset optional. the angle and the distance from a known point. Offset optional. <p>For these calculations, only points with full coordinate triplets or position only points can be used.</p>
Intersection	<p>To calculate the position of an intersection point using</p> <ul style="list-style-type: none"> bearings from two known points. a bearing and a distance from two known points. distances from two known points. four points. two TPS observation lines. <p>For these calculations, only points with full coordinate triplets or position only points can be used.</p>
Line & arc calculations	<p>To calculate;</p> <ul style="list-style-type: none"> the centre point of an arc. an offset point from a distance along, and offset from, an arc. an offset point from a distance along, and offset from, a line. a base point on an arc of a known offset point. a base point on a line of a known offset point. new points along an arc by segmentation. new points along a line by segmentation.
Area division	<p>To divide an area by a</p> <ul style="list-style-type: none"> defined line. percentage. defined area size.

COGO calculation methods	Description
Shift, rotate & scale	To calculate the coordinates of new points using shifts, rotation and scale. The values for the shift, rotation and/or scale can either be entered manually or computed using selected matching points. For these calculations, points with full coordinate triplets, position only points or height only points can be used.
Angle	To calculate the angles that are defined by three points.
Horizontal curve	To calculate the missing parameters of a curve by the input of the known parameters.
Triangle	To define a triangle by entering the three sides of the triangle or by selecting three points.

40.3

Configuring COGO

Access

Press Fn **Config..** in the Input screen of any COGO calculation method.

Configuration, General page

This screen consists of the **General** page, **Points & Quality** page, **TPS specific** page, **Residuals** page and the **Report sheet** page. The explanations given for the softkeys given are valid for all pages.

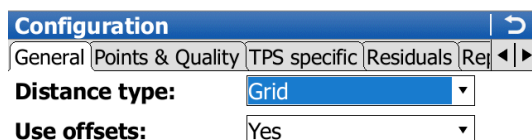

Key	Description
OK	To accept changes and return to the screen from where this screen was accessed.
Page	To change to another page on this screen.
Fn About	To display information about the program name, the version number, the date of the version, the copyright and the article number.
Fn Quit	To exit COGO calculation.

Description of fields

Field	Option	Description
Distance type	Grid	The type of distances and offsets to be accepted as input or displayed in the fields, and used in the calculation. Distances are calculated as the trigonometric distance between the position of two points. The distance field is Horiz distance .

Field	Option	Description
	Ground	Distances are horizontal distances between two points at the mean elevation parallel to the ellipsoid of the active coordinate system. The distance field is Horiz dist (ground) .
	Ellipsoid	Distances are reduced to the ellipsoid. They are calculated as the shortest distance between the two points on the ellipsoid. A scale factor is applied. The distance field is Horiz dist (ell) .  In the attached coordinate system, a projection, an ellipsoid and a transformation have to be defined to calculate grid, ground and ellipsoid coordinates.
Use offsets	Yes or No	Activates the use of offsets in the COGO calculations. Editable fields for the offsets are available in the Input screen of any COGO calculation method.

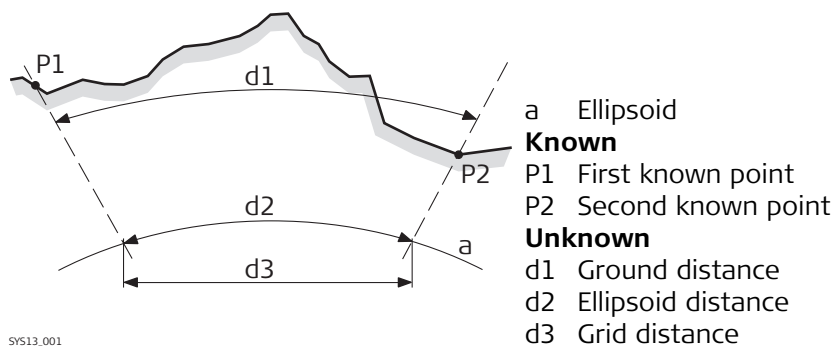

Next step

Page changes to the **Points & Quality** page.

Configuration, Points & Quality page

Description of fields

Field	Option	Description
Store computed COGO points with class	Measured (Meas) or Control (Ctrl)	Defines the point class of COGO calculated and stored points as Measured (Meas) or Control (Ctrl) triplets.
Position quality for computed COGO point	Editable field	The estimated value for the position quality assigned to all calculated COGO points which is used for the averaging calculation.
Height quality for computed COGO point	Editable field	The estimated value for the height quality assigned to all calculated heights which is used for the averaging calculation.

Next step

Page changes to the **TPS specific** page.

Description of fields

Field	Option	Description
Measure in two faces	Yes	Defines if the instrument measures the second face automatically after storing the first. After storing a measurement with Meas or Store motorised instruments change face automatically, non-motorised instruments access Telescope Positioning . The measurements of face I and face II are averaged on the base of face I. The averaged value is stored.
	No	No automatic measurement in two faces.
TPS observation Compute height		Defines the height being used within TPS observations.
	Using average	Using an average of the two observations.
	Use upper height	Using the upper height.
	Use lower height	Using the lower height.

Next step

Page changes to the **Residuals** page.

This page applies to **Shift, Rotate & Scale (Match Pts)**.

Description of fields

Field	Option	Description
Easting	Editable field	The limit above which Easting residuals will be flagged as possible outliers.
Northing	Editable field	The limit above which Northing residuals will be flagged as possible outliers.
Elevation	Editable field	The limit above which Height residuals will be flagged as possible outliers.
Residual Distbtn	None	The method by which the residuals of the control points will be distributed throughout the transformation area. No distribution is made. Residuals remain with their associated points.
	1/distance, 1/distance² or 1/distance^{3/2}	Distributes the residuals according to the distance between each control point and the newly transformed point.
	Multiquadratic	Distributes the residuals using a multiquadratic interpolation approach.

Next step

Page changes to the **Report sheet** page.

Description of fields

Field	Option	Description
Create report sheet	Check box	To generate a report sheet when the application is exited. A report sheet is a file to which data from an application is written to. It is generated using the selected format file.
Report sheet	Selectable list	Available when Create report sheet is ticked. The name of the file to which the data will be written. A report sheet is stored in the \DATA directory of the active memory device. The data is always appended to the file. Opening the selectable list accesses the Report Sheets screen. On this screen, a name for a new report sheet can be created and an existing report sheet can be selected or deleted.
Format file to use	Selectable list	Available when Create report sheet is ticked. A format file defines which and how data is written to a report sheet. Format files are created using LGO. A format file must first be transferred from the data storage device to the internal memory before it can be selected. Refer to "30.1 Transfer user objects" for information on how to transfer a format file. Opening the selectable list accesses the Format Files screen where an existing format file can be selected or deleted.

Next step

Page changes to the first page on this screen.



Azimuth is used throughout this chapter. This term should also always be considered to mean **Bearing**.

40.4

COGO Calculation - Inverse Method

40.4.1

Selecting the Inverse Method

Access

Select **Main Menu: Go to Work!\COGO\Inverse**.

COGO Inverse

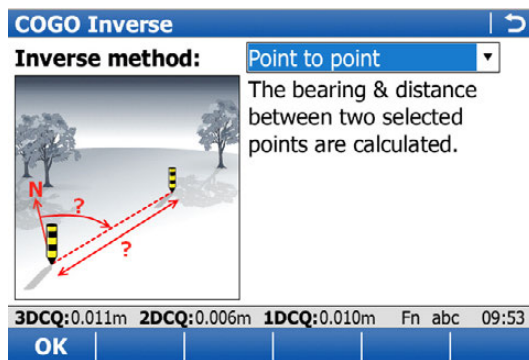

Key	Description
OK	To select a method and to continue with the subsequent screen.

Description of the Inverse methods

Inverse methods	Description
<p>Point to point</p>	<p>The direction, the distance and the coordinate differences between the two known points can be calculated depending on the data available. Points with full coordinate triplets, position only points and height only points can be used.</p> <p>Elements that must be known are</p> <ul style="list-style-type: none"> • coordinates of two points. <p>The coordinates of the known points</p> <ul style="list-style-type: none"> • can be taken from the working job. • can be manually measured during the COGO calculation. • can be entered.
<p>Point to current pos</p>	<p>The direction, distance and coordinate differences between the current rover position and a known point can be calculated depending on the data available. Points with full coordinate triplets, position only points and height only points can be used.</p> <p>Elements that must be known are</p> <ul style="list-style-type: none"> • coordinates of one point. <p>The coordinates of the known point</p> <ul style="list-style-type: none"> • can be taken from the working job. • can be manually measured during the COGO calculation. • can be entered.
<p>Current pos to line</p>	<p>The direction, distance and coordinate differences between the current position and a given line can be calculated depending on the data available. Points with full coordinate triplets, position only points and height only points can be used.</p> <p>Sufficient information must be known to define a line.</p> <p>The coordinates of the known points</p> <ul style="list-style-type: none"> • can be taken from the working job. • can be measured during the COGO calculation. • can be entered.
<p>Point to line</p>	<p>The direction, distance and coordinate differences between a known point and a given line can be calculated depending on the data available. Points with full coordinate triplets, position only points and height only points can be used.</p> <p>Sufficient information to define a line and the coordinates of one point must be known.</p> <p>The coordinates of the known points</p> <ul style="list-style-type: none"> • can be taken from the working job. • can be measured during the COGO calculation. • can be entered.

Inverse methods	Description
Point to arc	<p>The direction, distance and coordinate differences between the current position and a given arc can be calculated depending on the data available. Points with full coordinate triplets, position only points and height only points can be used.</p> <p>Sufficient information to define an arc and the coordinates of one point must be known.</p> <p>The coordinates of the known points</p> <ul style="list-style-type: none"> • can be taken from the working job. • can be measured during the COGO calculation. • can be entered.
Current pos to arc	<p>The direction, distance and coordinate differences between a known point and a given arc can be calculated depending on the data available. Points with full coordinate triplets, position only points and height only points can be used.</p> <p>Sufficient information must be known to define an arc.</p> <p>The coordinates of the known points</p> <ul style="list-style-type: none"> • can be taken from the working job. • can be measured during the COGO calculation. • can be entered.

40.4.2

Point to Point and Current Position to Point

Diagram

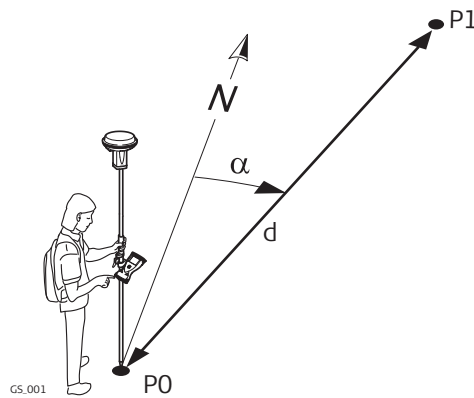

Known

- P0 First known point/current position
- P1 Second known point

Unknown

- α Direction from P0 to P1
- d Horizontal distance between P0 and P1

Inverse Point to Point/Inverse Point to Current Pos, Inverse page

For all point fields, the MapView interactive display on the **Map** page can be used to select the desired point.
 To type in coordinates for a known point open a selectable list. Press **New..** to create a new point.
 ---- is displayed for unavailable information, for example **Δ height** cannot be calculated if a position only point is used.

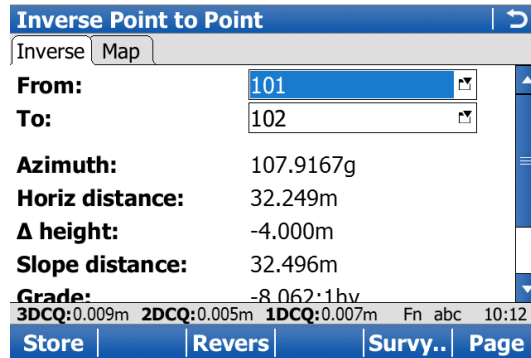

Key	Description
Store	To store the result.
Revers	To swap the From and To points around.
Survy..	To manually measure a point for the COGO calculation. Available when From or To is highlighted.
Page	To change to another page on this screen.
Fn Config..	To configure the COGO application.
Fn Quit	To exit COGO calculation.

Description of fields

Field	Option	Description
From	Selectable list	The point ID of the first known point for the COGO calculation.
	Current position	Available for Inverse method: Point to current pos.
To	Selectable list	The point ID of the second known point for the COGO calculation.
	Current position	Available for Inverse method: Point to current pos.
Azimuth	Display only	The direction from the first to the second known point.
Horiz distance, Horiz dist (ground) or Horiz dist (ell)	Display only	The horizontal distance between the two known points.
Δ height	Display only	The height difference between the two known points.
Slope distance	Display only	The slope distance between the two known points.
Grade	Display only	The grade between the two known points.

Field	Option	Description
Δ easting	Display only	The difference in Easting between the two known points.
Δ northing	Display only	The difference in Northing between the two known points.

Next step

Page changes to the **Map** page. The calculated distance between the two known points is indicated.

40.4.3

Point to Line and Current Position to Line

Diagram

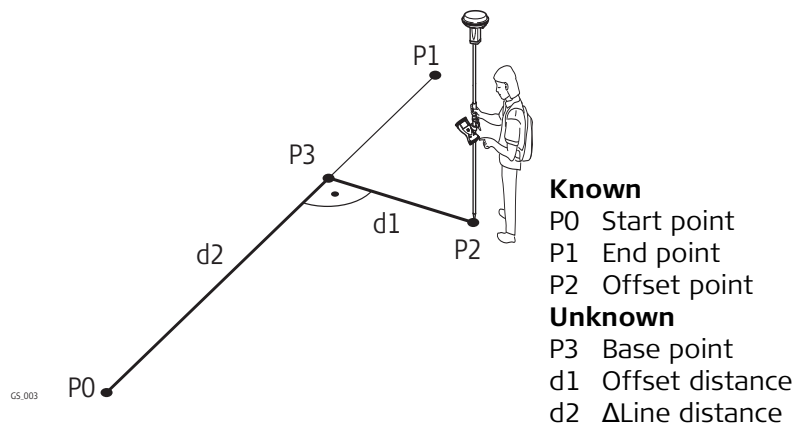

Inverse Point to Line/Inverse Current Pos to Line, Input page

For all point fields, the MapView interactive display on the **Map** page can be used to select the desired point.

To type in coordinates for a known point open a selectable list. Press **New..** to create a new point.

----- is displayed for unavailable information, for example **Δ height** cannot be calculated if a position only point is used.

Inverse Point to Line ↩

Input Map

Offset point: 103 ↕

Create line using: 2 points ▼

Start point: 101 ↕

End point: 102 ↕

3DCQ:0.012m 2DCQ:0.007m 1DCQ:0.010m Fn abc 10:12

Calc | | | | Survy.. | Page

Key	Description
Calc	To calculate COGO point.
Inv..	To calculate the values for the distance and the offset from two existing points. Available if Azimuth or Horiz distance is highlighted.
Last..	To recall previous results from COGO inverse calculations. Available if Azimuth or Horiz distance is highlighted.

Key	Description
Survyy..	To manually measure a point for the COGO calculation. Available if Start point , End point or Offset point is highlighted.
Page	To change to another page on this screen.
Fn Config..	To configure the COGO application.
Fn Modif..	To mathematically modify the values. Available if Azimuth or Horiz distance is highlighted.
Fn Quit	To exit COGO calculation.

Description of fields

Field	Option	Description
Offset point	Selectable list	Available for Inverse to: Known Point . The offset point.
	Current position	Available for Inverse method: Current pos to line .
Create line using		The method by which the line will be defined.
	2 points Pt, bearing & dist	Uses two known points to define the line. Defines the line using a known point, a distance and an azimuth of the line.
Start point	Selectable list	The start point of the line.
End point	Selectable list	Available for Method: 2 points . The end point of the line.
Azimuth	Editable field	Available for Method: Pt, bearing & dist . The azimuth of the line.
Horiz distance, Horiz dist (ground) or Horiz dist (ell)	Editable field	Available for Method: Pt, bearing & dist . The horizontal distance from the start point to the end point of the line.

Next step

Calc calculates and accesses **Inverse Result**.

Inverse Result, Result page

The screenshot shows the 'Inverse Result' screen with the following data:

Field	Value
Offset point:	103
Distance along line:	8.682m
Offset:	-3.101m
Bearing to offset pt:	7.9167g
Line length:	32.249m
Line bearing:	107.9167g

At the bottom, there is a status bar with: 3DCQ:0.009m 2DCQ:0.005m 1DCQ:0.007m Fn abc 10:13. Below the status bar are buttons for Store, Coord, and Page.

Key	Description
Store	To store the result.
Coord	To view other coordinate types.

Key	Description
Page	To change to another page on this screen.
Fn Ell Ht and Fn Elev	To change between the ellipsoidal and the orthometric height.

Description of fields

Field	Option	Description
Offset point	Display only	Point ID of offset point or Current position .
Distance along line	Display only	Horizontal distance from start point to base point.
Offset	Display only	Offset from base point to offset point. Positive to the right and negative to the left of the line.
Bearing to offset pt	Display only	Bearing from base point to offset point.
Line length	Display only	Length of line from start point to end point.
Line bearing	Display only	Bearing of line from start point to end point.
Easting and Northing	Display only	The calculated coordinates.
Elevation	Display only	The height of the calculated point.

Next step

Page changes to the **Plot** page.

40.4.4

Point to Arc and Current Position to Arc

Diagram

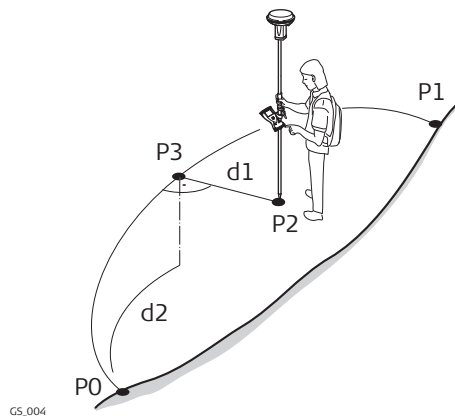

Known

- P0 Start point
- P1 End point
- P2 Offset point

Unknown

- P3 Base point
- d1 Offset-XX
- d2 Δ ArcDist-XX

Inverse Point to Arc/Inverse Current Pos to Arc, Input page

For all point fields, the MapView interactive display on the **Map** page can be used to select the desired point.

To type in coordinates for a known point open a selectable list. Press **New..** to create a new point.

---- is displayed for unavailable information, for example **Δ height** cannot be calculated if a position only point is used.

Inverse Point to Arc | ↻

Input | Map

Offset point: 103

Create arc using: 2 points & radius

Start point: 101

End point: 102

Radius: 17.500 m

3DCQ:0.009m 2DCQ:0.005m 1DCQ:0.007m Fn abc 10:14

Calc | Inv.. | Last.. | Page

Key	Description
Calc	To calculate COGO point.
Inv..	To calculate the values for the distance and the offset from two existing points. Available if Radius, Arc length or Chord length is highlighted.
Last..	To recall previous results from COGO inverse calculations. Available if Radius, Arc length or Chord length is highlighted.
Survy..	To manually measure a point for the COGO calculation. Available if Start point, Second point, End point, Offset point or PI point is highlighted.
Page	To change to another page on this screen.
Fn Config..	To configure the COGO application.
Fn Modif..	To mathematically modify the values. Available if Radius, Arc length or Chord length is highlighted.
Fn Quit	To exit COGO calculation.

Description of fields

Field	Option	Description
Offset point	Selectable list	Available for Point to arc: Point to line . The offset point.
	Current position	Available for Inverse method: Current pos to arc .
Create arc using		The method by which the arc will be defined.
	3 points	Uses three known points to define the arc.
	2 points & radius	Defines the arc using two known points and a radius of the arc.
	2 tngnts & radius	Defines the arc using two tangents and a radius of the arc.
	2 tngnts & arc lngth	Defines the arc using two tangents and the length of the arc.
	2 tngnts & crd lngth	Defines the arc using two tangents and the chord of the arc.

Field	Option	Description
Start point	Selectable list	The start point of the arc. Available for Method: 3 points and Method: 2 points & radius .
Second point	Selectable list	The second point of the arc. Available for Method: 3 points .
End point	Selectable list	The end point of the arc. Available for Method: 3 points and Method: 2 points & radius .
Point 1	Selectable list	A point on the first tangent. Available for Method: 2 tngnts & radius , Method: 2 tngnts & arc lngth and Method: 2 tngnts & crd lngth .
PI point	Selectable list	The point of intersection of the two tangents. Available for Method: 2 tngnts & radius , Method: 2 tngnts & arc lngth and Method: 2 tngnts & crd lngth .
Point 2	Selectable list	A point on the second tangent. Available for Method: 2 tngnts & radius , Method: 2 tngnts & arc lngth and Method: 2 tngnts & crd lngth .
Radius	Editable field	The radius of the arc. Available for Method: 2 points & radius and Method: 2 tngnts & radius .
Arc length	Editable field	The length of the arc. Available for Method: 2 tngnts & arc lngth .
Chord length	Editable field	The length of the chord. Available for Method: 2 tngnts & crd lngth .

Next step

Calc calculates the result and accesses **Inverse Result**.

Inverse Result, Result page

Inverse Result	
Result	Plot
Offset point:	103
Distance along arc:	9.225m
Offset:	5.113m
Bearing to offset pt:	166.8848g
Arc radius:	17.500m
Arc length:	41.008m
3DCQ:0.010m 2DCQ:0.005m 1DCQ:0.008m Fn abc 10:15	
Store	Coord
Page	

Key	Description
Store	To store the result.
Coord	To view other coordinate types.
Page	To change to another page on this screen.
Fn Ell Ht and Fn Elev	To change between the ellipsoidal and the orthometric height.

Description of fields

Field	Option	Description
Offset point	Display only	Point ID of offset point for Inverse to: Known Point or current position.
Distance along arc	Display only	Horizontal distance along the arc from start point to base point.
Offset	Display only	Offset from base point to offset point. Positive to the right and negative to the left of the line.
Bearing to offset pt	Display only	Bearing of offset point from base point to offset point.
Arc radius	Display only	Computed radius of arc.
Arc length	Display only	Computed length of arc.
Easting and Northing	Display only	The calculated coordinates.
Elevation	Display only	The height of the calculated point.

Next step

Page changes to the **Plot** page.

40.5

COGO Calculation - Traverse Method

Description

Elements that must be known are

- the coordinates of one point.
- the direction from the known point to the COGO point.
- the distance from the known point to the COGO point.
- offsets, if necessary and configured.

The coordinates of the known point

- can be taken from the working job.
- can be manually measured during the COGO calculation.
- can be entered.

The direction from the known point to the COGO point can be an azimuth or an angle.

Points with full coordinate triplets and position only points can be used. Position only is calculated, height can be typed in.

A COGO traverse calculation can be calculated for

- a single point.
- multiple points. Several single points are calculated in one sequence.
- sideshots.

Diagram

COGO traverse calculation with offset for a single point

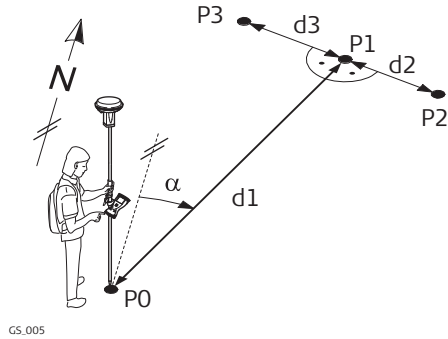

Known

- P0 Known point
- α Direction from P0 to P1
- d1 Distance between P0 and P1
- d2 Positive offset to the right
- d3 Negative offset to the left

Unknown

- P1 COGO point without offset
- P2 COGO point with positive offset
- P3 COGO point with negative offset

COGO traverse calculation without offset for multiple points

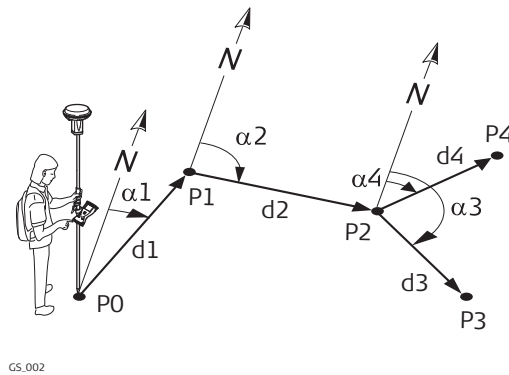

Known

- P0 Known point
- $\alpha1$ Direction from P0 to P1
- $\alpha2$ Direction from P1 to P2
- $\alpha3$ Direction from P2 to P3
- $\alpha4$ Direction from P2 to P4
- d1 Distance between P0 and P1
- d2 Distance between P1 and P2
- d3 Distance between P2 and P3
- d4 Distance between P2 and P4

Unknown

- P1 First COGO point
- P2 Second COGO point
- P3 Third COGO point - sideshot
- P4 Fourth COGO point

Traverse Input, Input page

For all point fields, the MapView interactive display on the **Map** page can be used to select the desired point.
 To type in coordinates for a known point open a selectable list. Press **New..** to create a new point.

Traverse Input ↩

Input Map

Method: Azimuth

From: 101

Azimuth: 20.2000 g

Horiz distance: 16.920 m

Offset: 0.500 m

3DCQ:0.009m 2DCQ:0.005m 1DCQ:0.008m Fn abc 10:17

Calc |
 Inv.. |
 SShot |
 Last.. |
 Page

Key	Description
Calc	To calculate the result.

Key	Description
Inv..	To calculate the values for the distance and the offset from two existing points. Available when Azimuth , Horiz distance , Offset or Angle right is highlighted.
SShot	To calculate the point as a sideshot.
Last..	To recall previous results from COGO inverse calculations. Available when Azimuth , Horiz distance , Offset or Angle right is highlighted.
Survy..	To manually measure a point for the COGO calculation. Available when From or Backsight is highlighted.
Page	To change to another page on this screen.
Fn Config..	To configure the COGO application.
Fn Modif..	To add, subtract, multiply and divide values. Available when Azimuth , Horiz distance , Offset or Angle right is highlighted.
Fn Quit	To exit COGO calculation.

Description of fields

Field	Option	Description
Method	Azimuth	The direction from the known point to the COGO point is an azimuth.
	Angle right	The direction from the known point to the COGO point is an angle.
From	Selectable list	The point ID of the known point for the COGO calculation.
Backsight	Selectable list	The point ID of a point used as backsight. Available for Angle right .
Angle right	Editable field	The angle between Backsight and the new COGO point to be calculated from the point selected as From : A positive value is for clockwise angles. A negative value is for anticlockwise angles. Available for Angle right .
Azimuth	Editable field	The direction from the known point to the COGO point.
Horiz distance, Horiz dist (ground) or Horiz dist (ell)	Editable field	The horizontal distance between the known point and the COGO point.
Offset	Editable field	The offset of the COGO point from the line of direction. A positive offset is to the right, a negative offset is to the left. Available for Use offsets: Yes in Configuration, General page.

Next step

Calc calculates the result and accesses **Traverse Results**.

Traverse Results, Result page

Traverse Results	
Result	Code Plot
Point ID:	104
Easting:	0.754m
Northing:	23.919m
Elevation:	7.000 m

3DCQ:0.009m	2DCQ:0.005m	1DCQ:0.007m	Fn abc	10:17
Store	Coord		Stake..	Page

Key	Description
Store	To store the result.
Coord	To view other coordinate types.
Stake..	To access the Stakeout application and stake out the calculated COGO point.
Page	To change to another page on this screen.
Fn Ell Ht and Fn Elev	To change between the ellipsoidal and the orthometric height. Available for local coordinates.
Fn Individ	For an individual point ID independent of the ID template. Fn Run changes back to the next ID from the configured ID template.
Fn Quit	To not store the COGO point and to exit COGO calculations.

Description of fields

Field	Option	Description
Point ID	Editable field	The identifier for the COGO point depending on the point ID template configured for the currently active instrument type in ID Templates . The point ID can be changed.
Easting and Northing	Display only	The calculated coordinates.
Elevation	Editable field	The height of the known point used in the COGO calculation is suggested. A height value to be stored with the calculated point can be typed in.

Next step

On the **Code** page, type in a code if desired.

On the **Plot** page, an arrow points from the known point to the calculated COGO point.

Store stores the result.

40.6
40.6.1

COGO Calculation - Intersection Method
Selecting the Intersection Method

Access

Select **Main Menu: Go to Work!\COGO\Intersection.**

COGO Intersection

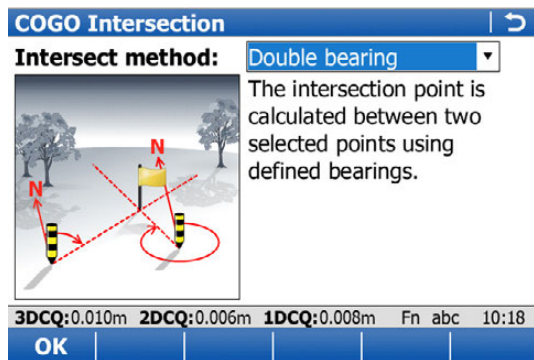

Key	Description
OK	To select a method and to continue with the subsequent screen.

Description of the Intersection methods

Intersection methods	Description
Double bearing	<p>Calculates the intersection point of two lines. A line is defined by a point and a direction.</p> <p>Elements that must be known are</p> <ul style="list-style-type: none"> the coordinates of two points. the direction from these known points to the COGO point. offsets if necessary and configured. <p>The coordinates of the known points</p> <ul style="list-style-type: none"> can be taken from the working job. can be manually measured during the COGO calculation. can be entered. <p>Points with full coordinate triplets and position only points can be used. Position only is calculated, height can be typed in.</p>

Intersection methods	Description
<p>Double distance</p>	<p>Calculates the intersection point of two circles. The circles are defined by the known point as the centre point and the distance from the known point to the COGO point as the radius.</p> <p>Elements that must be known are</p> <ul style="list-style-type: none"> • the coordinates of two points. • the distance from the known points to the COGO point. <p>The coordinates of the known points</p> <ul style="list-style-type: none"> • can be taken from the working job. • can be manually measured during the COGO calculation. • can be entered. <p>Points with full coordinate triplets and position only points can be used.</p>
<p>Bearing & distance</p>	<p>Calculates the intersection point of a line and a circle. The line is defined by a point and a direction. The circle is defined by the centre point and the radius.</p> <p>Elements that must be known are</p> <ul style="list-style-type: none"> • the coordinates of points. • the direction from one known point to the COGO point. • the distance from the second known point to the COGO point. • offsets if necessary and configured. <p>The coordinates of the known points</p> <ul style="list-style-type: none"> • can be taken from the working job. • can be manually measured during the COGO calculation. • can be entered. <p>Points with full coordinate triplets and position only points can be used.</p>
<p>By points</p>	<p>Calculates the intersection point of two lines. A line is defined by two points.</p> <p>Elements that must be known are</p> <ul style="list-style-type: none"> • the coordinates of four points. • offsets of the lines if necessary and configured. <p>The coordinates of the known points</p> <ul style="list-style-type: none"> • can be taken from the working job. • can be manually measured during the COGO calculation. • can be entered. <p>Points with full coordinate triplets and position only points can be used.</p>

Intersection methods	Description
TPS observations	<p>Calculates the intersection point of two lines. A line is defined by a TPS station and a TPS measurement from this station.</p> <p>Elements that must be known are</p> <ul style="list-style-type: none"> the coordinates of two points. azimuths of the lines. <p>The coordinates of the known points</p> <ul style="list-style-type: none"> must be taken from the working job. must be TPS station points. <p>The azimuths of the lines</p> <ul style="list-style-type: none"> must be TPS measurements from the known points. <p>Points with full coordinate triplets and position only points can be used.</p>

40.6.2 Intersection with Double Bearing

Diagram

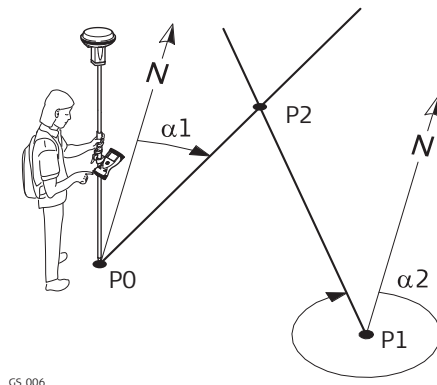

Known

- P0 First known point
- P1 Second known point
- $\alpha 1$ Direction from P0 to P2
- $\alpha 2$ Direction from P1 to P2

Unknown

- P2 COGO point

Intersection Double Bearing, Input page

For all point fields, the MapView interactive display on the **Map** page can be used to select the desired point. To type in coordinates for a known point open a selectable list. Press **New..** to create a new point.

Intersection Double Bearing ↻

Input Map

1st point: ↻

Azimuth: g

Offset: m

2nd point: ↻

Azimuth: g

Offset: m

3DCQ:0.009m 2DCQ:0.005m 1DCQ:0.008m Fn abc 10:19

Calc Inv.. Last.. Page

Key	Description
Calc	To calculate the result.
Inv..	To calculate the values for the distance and the offset from two existing points. Available when Azimuth or Offset is highlighted.
Last..	To recall previous results from COGO inverse calculations. Available when Azimuth or Offset is highlighted.
Survy..	To manually measure a point for the COGO calculation. Available when 1st point or 2nd point is highlighted.
Page	To change to another page on this screen.
Fn Config..	To configure the COGO application.
Fn Modif..	To add, subtract, multiply and divide values. Available when Azimuth or Offset is highlighted.
Fn Quit	To exit COGO calculation.

Description of fields

Field	Option	Description
1st point	Selectable list	The point ID of the first known point for the COGO calculation.
2nd point	Selectable list	The point ID of the second known point for the COGO calculation.
Azimuth	Editable field	The direction from the first known point to the COGO point.
Offset	Editable field	The offset of the COGO point from the line of direction. A positive offset is to the right, a negative offset is to the left. Available for Use offsets: Yes in Configuration, General page.

Next step

Calc calculates the result and accesses **Intersection Result**.

Intersection Result, Result page

Intersection Result ↻

Result Code Plot

Point ID:

Easting:

Northing:

Elevation: m

3DCQ:0.010m 2DCQ:0.006m 1DCQ:0.008m Fn abc 10:22

Store Coord Stake.. Page

Key	Description
Store	To store the result.
Coord	To view other coordinate types.
Stake..	To access the Stakeout application and stake out the calculated COGO point.
Page	To change to another page on this screen.

Key	Description
Fn Ell Ht and Fn Elev	To change between the ellipsoidal and the orthometric height. Available for local coordinates.
Fn IndivID	For an individual point ID independent of the ID template. Fn Run changes back to the next ID from the configured ID template.
Fn Quit	To not store the COGO point and to exit COGO calculations.

Description of fields

Field	Option	Description
Point ID	Editable field	The identifier for the COGO point depending on the point ID template configured for Auxiliary points in ID Templates . The point ID can be changed.
Easting and Northing	Display only	The calculated coordinates.
Elevation	Editable field	The height of the first point used in the COGO calculation is suggested. A height value to be stored with the calculated point can be typed in.

Next step

On the **Code** page, type in a code if desired.

On the **Plot** page, arrows point from the known points to the calculated COGO point.

Store stores the result.

40.6.3

Intersection with Double Distance

Diagram

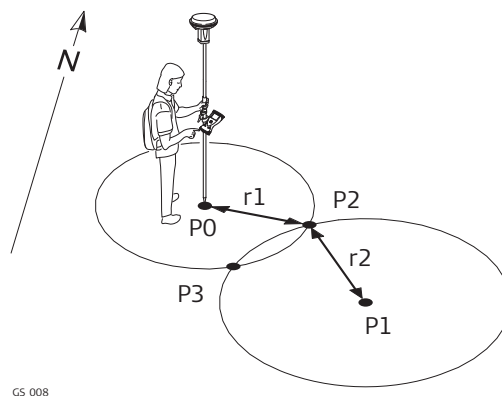

Known

P0 First known point

P1 Second known point

r1 Radius, as defined by the distance from P0 to P2

r2 Radius, as defined by the distance from P1 to P2

Unknown

P2 First COGO point

P3 Second COGO point

Intersection Double Distance, Input page

For all point fields, the MapView interactive display on the **Map** page can be used to select the desired point.
 To type in coordinates for a known point open a selectable list. Press **New..** to create a new point.

Key	Description
Calc	To calculate the result.
Inv..	To calculate the values for the distance and the offset from two existing points. Available when Horiz distance is highlighted.
Last..	To recall previous results from COGO inverse calculations. Available when Horiz distance is highlighted.
Survy..	To manually measure a point for the COGO calculation. Available when 1st point or 2nd point is highlighted.
Page	To change to another page on this screen.
Fn Config..	To configure the COGO application.
Fn Modif..	To add, subtract, multiply and divide values. Available when Horiz distance is highlighted.
Fn Quit	To exit COGO calculation.

Description of fields

Field	Option	Description
1st point	Selectable list	The point ID of the first known point for the COGO calculation.
2nd point	Selectable list	The point ID of the second known point for the COGO calculation.
Horiz distance, Horiz dist (ground) or Horiz dist (ell)	Editable field	The horizontal distance between the known points and the COGO point.

Next step

Calc calculates the result and accesses **Intersection Result**.

**Intersection Result,
Result 1/Result 2
page**

Intersection Result	
Result 1	Code Plot
Point ID:	104
Easting:	12.501m
Northing:	3.793m
Elevation:	7.000 m

3DCQ:0.010m	2DCQ:0.006m	1DCQ:0.008m	Fn abc	10:23
Store	Coord	Result2	Stake..	Page

Key	Description
Store	To store the result.
Coord	To view other coordinate types.
Result1 or Result2	To view the first and second result.
Stake..	To access the Stakeout application and stake out the calculated COGO point.
Page	To change to another page on this screen.
Fn Ell Ht and Fn Elev	To change between the ellipsoidal and the orthometric height. Available for local coordinates.
Fn Individ	For an individual point ID independent of the ID template. Fn Run changes back to the next ID from the configured ID template.
Fn Quit	To not store the COGO point and to exit COGO calculations.

Description of fields

Field	Option	Description
Point ID	Editable field	The identifier for the COGO point depending on the point ID template configured for GPS / TPS in ID Templates . The point ID can be changed.
Easting and Northing	Display only	The calculated coordinates.
Elevation	Editable field	The height of the first point used in the COGO calculation is suggested. A height value to be stored with the calculated point can be typed in.

Next step

On the **Code** page, type in a code if desired.

On the **Plot** page, the calculated COGO points are shown.

Store stores the result.

Diagram

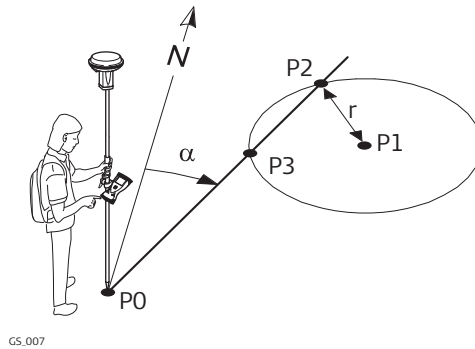

Known

- P0 First known point
- P1 Second known point
- α Direction from P0 to P2
- r Radius, as defined by the distance from P1 to P2

Unknown

- P2 First COGO point
- P3 Second COGO point

Intersection Bearing & Dist, Input page

For all point fields, the MapView interactive display on the **Map** page can be used to select the desired point.
 To type in coordinates for a known point open a selectable list. Press **New..** to create a new point.

Intersection Bearing & Dist | ↻

Input | Map

1st point:

Azimuth: g

Offset: m

2nd point:

Horiz distance: m

3DCQ:0.009m 2DCQ:0.005m 1DCQ:0.007m Fn abc 10:25

Calc
Inv..
Last..
Page

Key	Description
Calc	To calculate the result.
Inv..	To calculate the values for the distance and the offset from two existing points. Available when Azimuth , Horiz distance or Offset is highlighted.
Last..	To recall previous results from COGO inverse calculations. Available when Azimuth , Horiz distance or Offset is highlighted.
Survy..	To manually measure a point for the COGO calculation. Available when 1st point or 2nd point is highlighted.
Page	To change to another page on this screen.
Fn Config..	To configure the COGO application.
Fn Modif..	To add, subtract, multiply and divide values. Available when Azimuth , Horiz distance or Offset is highlighted.
Fn Quit	To exit COGO calculation.

Description of fields

Field	Option	Description
1st point	Selectable list	The point ID of the first known point for the COGO calculation.
2nd point	Selectable list	The point ID of the second known point for the COGO calculation.
Azimuth	Editable field	The direction from the first known point to the COGO point.
Offset	Editable field	The offset of the COGO point from the line of direction. A positive offset is to the right, a negative offset is to the left. Available for Use offsets: Yes in Configuration, General page.
Horiz distance, Horiz dist (ground) or Horiz dist (ell)	Editable field	The horizontal distance between the known point and the COGO point.

Next step

Calc calculates the result and accesses **Intersection Result**.

Intersection Result, Result 1 page

Intersection Result ↶ ↷

Result 1 Code Plot

Point ID:

Easting:

Northing:

Elevation: m

3DCQ:0.010m 2DCQ:0.006m 1DCQ:0.008m Fn abc 10:27

Store
Coord
Result2
Stake..
Page

Key	Description
Store	To store the result.
Coord	To view other coordinate types.
Result1 or Result2	To view the first and second result.
Stake..	To access the Stakeout application and stake out the calculated COGO point.
Page	To change to another page on this screen.
Fn EII Ht and Fn Elev	To change between the ellipsoidal and the orthometric height. Available for local coordinates.
Fn IndivID	For an individual point ID independent of the ID template. Fn Run changes back to the next ID from the configured ID template.
Fn Quit	To not store the COGO point and to exit COGO calculations.

Description of fields

Field	Option	Description
Point ID	Editable field	The identifier for the COGO point depending on the point ID template configured for GPS / TPS in ID Templates . The point ID can be changed.
Easting and Northing	Display only	The calculated coordinates.
Elevation	Editable field	The height of the first point used in the COGO calculation is suggested. A height value to be stored with the calculated point can be typed in.

Next step

On the **Code** page, type in a code if desired.

On the **Plot** page, an arrow points from the first known points to the calculated COGO point.

Store stores the result.

40.6.5

Intersection with By Points

Diagram

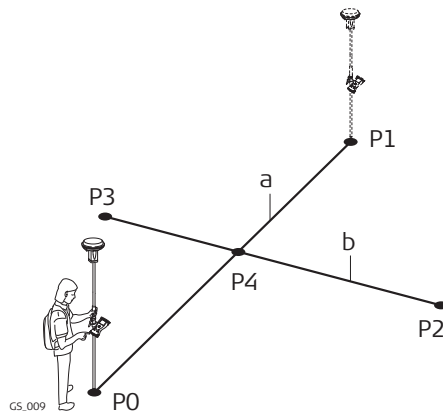

Known

- P0 First known point
- P1 Second known point
- P2 Third known point
- P3 Fourth known point
- a Line from P0 to P1
- b Line from P2 to P3

Unknown

- P4 COGO point

Intersection By Points, Input page

For all point fields, the MapView interactive display on the **Map** page can be used to select the desired point.

To type in coordinates for a known point open a selectable list. Press **New..** to create a new point.

Intersection By Points ↩

Input Map

1st point: ↕

2nd point: ↕

Offset: m

3rd point: ↕

4th point: ↕

Offset: m

3DCQ:0.011m 2DCQ:0.007m 1DCQ:0.009m Fn abc 10:29

Calc Inv.. Last.. Page

Key	Description
Calc	To calculate the result.

Key	Description
Inv..	To calculate the values for the distance and the offset from two existing points. Available when Offset is highlighted.
Last..	To recall previous results from COGO inverse calculations. Available when Offset is highlighted.
Survy..	To manually measure a point for the COGO calculation. Available when 1st point , 2nd point , 3rd point or 4th point is highlighted.
Page	To change to another page on this screen.
Fn Config..	To configure the COGO application.
Fn Modif..	To add, subtract, multiply and divide values. Available when Offset is highlighted.
Fn Quit	To exit COGO calculation.

Description of fields

Field	Option	Description
1st point	Selectable list	The point ID of the known start point of the first line for the COGO calculation.
2nd point	Selectable list	The point ID of the known end point of the first line for the COGO calculation.
3rd point	Selectable list	The point ID of the known start point of the second line for the COGO calculation.
4th point	Selectable list	The point ID of the known end point of the second line for the COGO calculation.
Offset	Editable field	The offset of the line in the direction 1st point to 2nd point or 3rd point to 4th point . A positive offset is to the right, a negative offset is to the left. Available for Use offsets: Yes in Configuration, General page.

Next step

Calc calculates the result and accesses **Intersection Result**.

Intersection Result, Result page

Intersection Result ↻

Result Code Plot

Point ID:

Easting: 1.693m

Northing: 6.660m

Elevation: m

3DCQ:0.010m 2DCQ:0.006m 1DCQ:0.008m Fn abc 10:30

Store Coord Stake.. Page

Key	Description
Store	To store the result.
Coord	To view other coordinate types.
Stake..	To access the Stakeout application and stake out the calculated COGO point.

Key	Description
Page	To change to another page on this screen.
Fn Ell Ht and Fn Elev	To change between the ellipsoidal and the orthometric height. Available for local coordinates.
Fn IndivID	For an individual point ID independent of the ID template. Fn Run changes back to the next ID from the configured ID template.
Fn Quit	To not store the COGO point and to exit COGO calculations.

Description of fields

Field	Option	Description
Point ID	Editable field	The identifier for the COGO point depending on the point ID template configured for GPS / TPS in ID Templates . The point ID can be changed.
Easting and Northing	Display only	The calculated coordinates.
Elevation	Editable field	The height of the first point used in the COGO calculation is suggested. A height value to be stored with the calculated point can be typed in.

Next step

On the **Code** page, type in a code if desired.

On the **Plot** page, two solid lines are displayed.

Store stores the result.

40.6.6

Intersection with TPS Observation - TPS Observation

Diagram

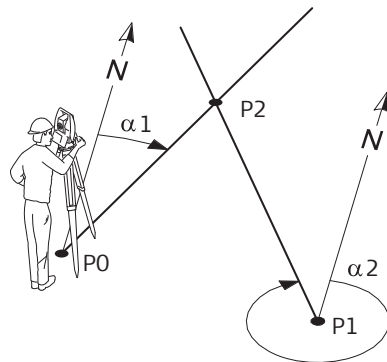

TS_001

Known

P0 First known point (TPS station)

P1 Second known point (TPS station)

$\alpha 1$ Direction from P0 to P2

$\alpha 2$ Direction from P1 to P2

Unknown

P2 COGO point

**Intersection TPS
Obs,
Input page**

For all point fields, the MapView interactive display on the **Map** page can be used to select the desired point.
To type in coordinates for a known point open a selectable list. Press **New..** to create a new point.

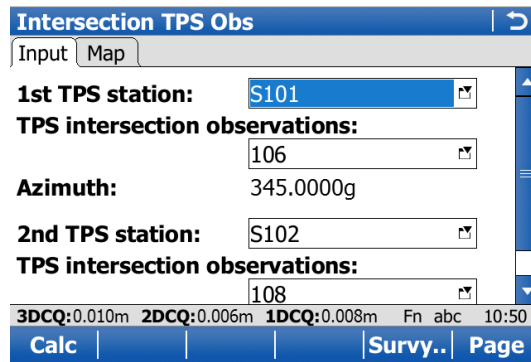

Key	Description
Calc	To calculate the result.
Survy..	To manually measure a point for the COGO calculation. Available when 1st TPS station or 2nd TPS station is highlighted and the selected station is the active TPS setup.
Page	To change to another page on this screen.
Fn Config..	To configure the COGO application.
Fn Quit	To exit COGO calculation.

Description of fields

Field	Option	Description
1st TPS station	Selectable list	The point ID of the first TPS station which is the known start point of the first line for the COGO calculation.
TPS intersection observations	Selectable list	The point ID of the TPS measurement which is the known end point of the first line for the COGO calculation.
Azimuth	Display only	The azimuth related to the known end point of the first/second line for the COGO calculation.
2nd TPS station	Selectable list	The point ID of the second TPS station which is the known start point of the second line for the COGO calculation.
TPS intersection observations	Selectable list	The point ID of the TPS measurement which is the known end point of the second line for the COGO calculation.

Next step

Calc calculates the result and accesses **Intersection Result**.

40.7
40.7.1

COGO Calculation - Line/Arc Calculations Method
Selecting the Line/Arc Method

Access

Select **Main Menu: Go to Work!\COGO\Line & arc calculations.**

COGO Line/Arc Calculations

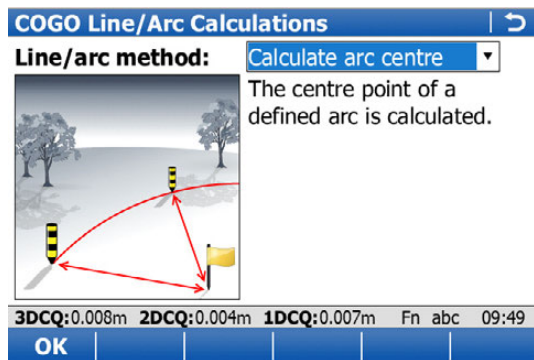

Key	Description
OK	To select a method and to continue with the subsequent screen.

Description of the Line/Arc methods

Line/Arc Methods	Description
Calculate arc centre	<p>Calculates the coordinates of the centre of the arc.</p> <p>Elements that must be known are</p> <ul style="list-style-type: none"> • coordinates of three points <p>OR</p> <ul style="list-style-type: none"> • coordinates of two points • radius to the two points <p>The coordinates of the known points</p> <ul style="list-style-type: none"> • can be taken from the working job. • can be measured during the COGO calculation. • can be entered.
Calculate arc offset pt	<p>Calculates the coordinates of a new point after input of arc and offset values in relation to an arc.</p> <p>Elements that must be known are</p> <ul style="list-style-type: none"> • coordinates of three points. • offsets. <p>OR</p> <ul style="list-style-type: none"> • coordinates of two points. • radius to the two points. • offsets. <p>The coordinates of the known points</p> <ul style="list-style-type: none"> • can be taken from the working job. • can be measured during the COGO calculation. • can be entered.

Line/Arc Methods	Description
Calculate line offset pt	<p>Calculates the coordinates of a new point after input of station and offset values in relation to a line.</p> <p>Elements that must be known are</p> <ul style="list-style-type: none"> • coordinates of two points. • offsets. <p>OR</p> <ul style="list-style-type: none"> • coordinates of one point. • bearing and distance from one point. • offsets. <p>The coordinates of the known points</p> <ul style="list-style-type: none"> • can be taken from the working job. • can be measured during the COGO calculation. • can be entered.
Calculate arc base pt	<p>Calculates the coordinates of the base point, station and offset of a point in relation to an arc.</p> <p>Elements that must be known are</p> <ul style="list-style-type: none"> • coordinates of three points • coordinates of an offset point <p>OR</p> <ul style="list-style-type: none"> • coordinates of two points • radius to the two points • coordinates of an offset point <p>The coordinates of the known points</p> <ul style="list-style-type: none"> • can be taken from the working job. • can be measured during the COGO calculation. • can be entered.
Calculate line base pt	<p>Calculates the base point, station and offset of a point in relation to a line.</p> <p>Elements that must be known are</p> <ul style="list-style-type: none"> • coordinates of two points and an offset point. <p>OR</p> <ul style="list-style-type: none"> • coordinates of one point and an offset point • bearing and distance from one point <p>The coordinates of the known points</p> <ul style="list-style-type: none"> • can be taken from the working job. • can be measured during the COGO calculation. • can be entered.
Segment an arc	<p>This method is similar to Segment a line. See the following row.</p>

Line/Arc Methods	Description
Segment a line	<p>Calculates the coordinates of new points on a line.</p> <p>Elements that must be known are</p> <ul style="list-style-type: none"> coordinates of the start and the end point of the line <p>OR</p> <ul style="list-style-type: none"> a bearing and distance from a known point that define the line <p>AND EITHER</p> <ul style="list-style-type: none"> the number of segments dividing the line <p>OR</p> <ul style="list-style-type: none"> a segment length for the line. <p>The coordinates of the known points</p> <ul style="list-style-type: none"> can be taken from the working job. can be measured during the COGO calculation. can be entered.

40.7.2

Arc Calculation

Diagram for arc centre

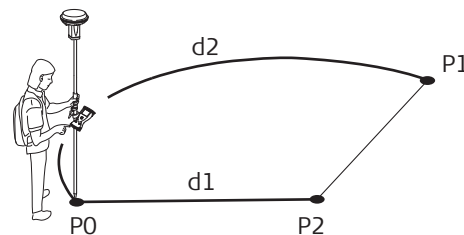

GS_010

- P0 **Start point**
- P1 **End point**
- P2 **Arc centre**
- d1 **Arc radius**
- d2 **Arc length**

Diagram for arc base point and offset point

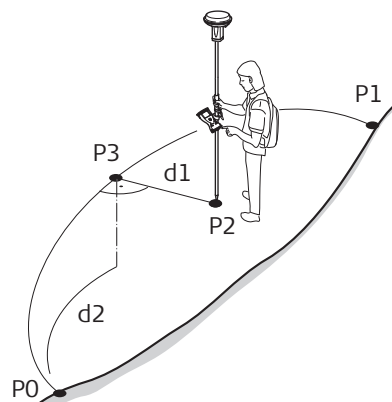

GS_004

- P0 **Start point**
- P1 **End point**
- P2 **Offset point**
- P3 **Base point**
- d1 **Offset**
- d2 **Distance along arc**

Description of fields

Field	Option	Description
Create arc using	3 points	The method by which the arc will be defined. Uses three known points to define the arc.
	2 points & radius	Defines the arc using two known points and a radius of the arc.
	2 tngnts & radius	Defines the arc using two tangents and a radius of the arc.
	2 tngnts & arc lngth	Defines the arc using two tangents and the length of the arc.
	2 tngnts & crd lngth	Defines the arc using two tangents and the chord of the arc.
Start point	Selectable list	The start point of the arc. Available for Create arc using: 3 points and Create arc using: 2 points & radius .
Second point	Selectable list	The second point of the arc. Available for Create arc using: 3 points .
End point	Selectable list	The end point of the arc. Available for Create arc using: 3 points and Create arc using: 2 points & radius .
Point 1	Selectable list	A point on the first tangent. Available for Create arc using: 2 tngnts & radius , Create arc using: 2 tngnts & arc lngth and Create arc using: 2 tngnts & crd lngth .
PI point	Selectable list	The point of intersection of the two tangents. Available for Create arc using: 2 tngnts & radius , Create arc using: 2 tngnts & arc lngth and Create arc using: 2 tngnts & crd lngth .
Point 2	Selectable list	A point on the second tangent. Available for Create arc using: 2 tngnts & radius , Create arc using: 2 tngnts & arc lngth and Create arc using: 2 tngnts & crd lngth .
Radius	Editable field	The radius of the arc. Available for Create arc using: 2 points & radius and Create arc using: 2 tngnts & radius .
Arc length	Editable field	The length of the arc. Available for Create arc using: 2 tngnts & arc lngth .
Chord length	Editable field	The length of the chord. Available for Create arc using: 2 tngnts & crd lngth .

Next step

IF	THEN
Line/arc method: Calculate arc centre	Calc accesses Centre of Arc Result .

IF	THEN
Line/arc method: Calculate arc offset pt	OK accesses Calculations Input .
Line/arc method: Calculate arc base pt	OK accesses Calculations Input .

**Calculations Input,
Input page**

Description of fields

Field	Option	Description
Distance along arc	Editable field	Horizontal distance along the arc from start point to base point. Available for Line/arc method: Calculate arc offset pt .
Offset, Offset (ground) or Offset (ell)	Editable field	Offset from base point to offset point. Positive to the right and negative to the left of the arc. Available for Line/arc method: Calculate arc offset pt .
Offset point	Selectable list	Point ID of offset point. Available for Line/arc method: Calculate arc base pt .

Next step

IF	THEN
Line/arc method: Calculate arc offset pt	Calc accesses Line/Arc Calculation Result .
Line/arc method: Calculate arc base pt	Calc accesses Line/Arc Calculation Result .

**Centre of Arc
Result/Line/Arc
Calculation Result,
Result page**

The result screens for base point and offset point are similar. Refer to paragraph "Line/Arc Calculation Result, Result page" for information on soft-keys.

Description of fields

Field	Option	Description
Point ID	Editable field	The identifier for the COGO point depending on the point ID template configured for GPS / TPS in ID Templates .
Elevation or Local ellipsoid ht	Editable field	The height of the start point of the arc is suggested. A height value to be stored with the calculated point can be typed in.
Arc radius	Display only	Computed radius of arc.
Arc length	Display only	Computed length of arc.
Bearing to offset pt	Display only	Bearing of offset point from base point to offset point. Available for Line/arc method: Calculate arc offset pt .
Offset point	Display only	Point ID of offset point. Available for Line/arc method: Calculate arc base pt .

Field	Option	Description
Distance along arc, Distance along arc (grnd) or Distance along arc (ell)	Display only	Horizontal distance along the arc from start point to base point. Available for Line/arc method: Calculate arc offset pt.
Offset, Offset (ground) or Offset (ell)	Display only	Offset from base point to offset point. Positive to the right and negative to the left of the line. Available for Line/arc method: Calculate arc offset pt.

Next step

On the **Code** page, type in a code if desired.

On the **Plot** page, the arc and the new point is shown.

Store stores the result

40.7.3

Calculate Line Offset Point and Calculate Line Base Point

Diagram

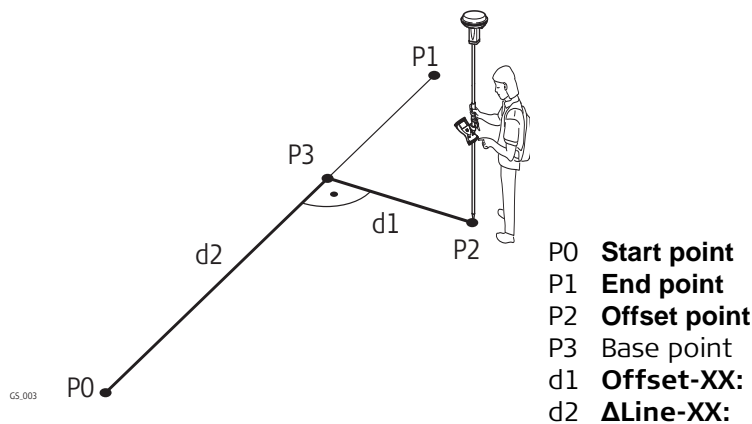

Line management is not available for COGO line calculations.

Create Line, Input page

Create Line ↩

Input
Map

Create line using: 2 points

Start point: 101

End point: 102

3DCQ:0.008m 2DCQ:0.004m 1DCQ:0.007m Fn abc 09:50

OK
Survy..
Page

Key	Description
OK	To change to the second layer of editable fields.

Key	Description
Inv..	To calculate the values for the distance and the offset from two existing points. Available if Azimuth or Horiz distance is highlighted.
Last..	To select the values for the distance and the offset from previous COGO inverse calculations. Available if Azimuth or Horiz distance is highlighted.
Survy..	To measure a point manually for the COGO calculation. Available if Start point or End point is highlighted.
Fn Config..	To configure the COGO application.
Fn Modif..	To mathematically modify the values. Available if, Azimuth or Horiz distance is highlighted.
Page	To change to another page on this screen.
Fn Quit	To exit COGO calculation.

Description of fields

Field	Option	Description
Create line using		The method by which the line will be defined.
	2 points Pt, bearing & dist	Uses two known points to define the line. Defines the line using a known point, a distance and an azimuth of the line.
Start point	Selectable list	The start point of the line.
End point	Selectable list	The end point of the line. Available for Create line using: 2 points .
Azimuth	Editable field	The azimuth of the line. Available for Create line using: Pt, bearing & dist .
Horiz distance, Horiz dist (ground) or Horiz dist (ell)	Editable field	The horizontal distance from the start point to the end point of the line. Available for Create line using: Pt, bearing & dist .

Next step

OK accesses **Calculations Input**.

Calculations Input, Input page

Description of fields

Field	Option	Description
Distance along line, Distance along line (ground) or Distance along line (ell)	Editable field	Available for Line/arc method: Calculate line offset pt . Horizontal distance from start point to base point.
Offset, Offset (ground) or Offset (ell)	Editable field	Available for Line/arc method: Calculate line offset pt . Offset from base point to offset point. Positive to the right and negative to the left of the line.

Field	Option	Description
Offset point	Selectable list	Available for Line/arc method: Calculate line base pt. The offset point.

Next step

Calc accesses **Line/Arc Calculation Result**.

Line/Arc Calculation Result, Result page

The result screens for base point and offset point are similar. The explanations given for the softkeys are valid for the **Result** page.

Key	Description
Store	To store the result.
Coord	To view other coordinate types.
Stake..	To access the Stakeout application and stake out the calculated COGO point.
Page	To change to another page on this screen.
Fn Ell Ht and Fn Elev	To change between the ellipsoidal and the orthometric height.
Fn IndivID and Fn Run	To change between entering an individual point ID different to the defined ID template and the running point ID according to the ID template.

Description of fields

Field	Option	Description
Point ID	Editable field	The identifier for the COGO point depending on the point ID template configured for GPS / TPS in ID Templates .
Elevation or Local ellipsoid ht	Editable field	The height of the start point of the line is suggested. A height value to be stored with the calculated point can be typed in.
Offset point	Display only	Point ID of offset point. Available for Line/arc method: Calculate line base pt.
Distance along line , Distance along line (ground) or Distance along line (ell)	Display only	Horizontal distance from start point to base point. Available for Line/arc method: Calculate line base pt.

Field	Option	Description
Offset, Offset (ground) or Offset (ell)	Display only	Offset from base point to offset point. Positive to the right and negative to the left of the line. Available for Line/arc method: Calculate line base pt.
Line length	Display only	Length of line from start point to end point.
Line bearing	Display only	Bearing of line from start point to end point.
Bearing to offset pt	Display only	Bearing of offset point from base point to offset point.

Next step

On the **Code** page, type in a code if desired.

On the **Plot** page, the line and the new point is shown.

Store stores the result.

40.7.4

Segment an Arc

Exceptions to line calculation segmentation

The arc segmentation and the functionality of all screens and fields are similar to those for line segmentation. Refer to "40.7.5 Segment a Line"

New field and option in Define Arc Segmentation

Field	Option	Description
Method	Delta angle	To divide the arc by an angular value.
Delta angle	Editable field	The angular value by which new points will be defined on the arc.

40.7.5

Segment a Line

Diagram

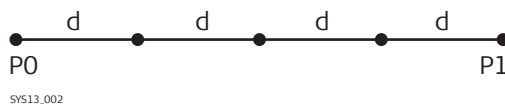

Line divided by **Method: No. of segments**

P0 **Start point**

P1 **End point**

d Equally spaced segments result from dividing a line by a certain number of points.

Line divided by **Method Segment length**

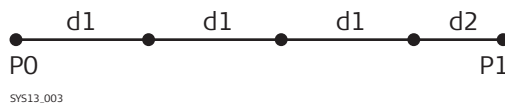

P0 **Start point**

P1 **End point**

d1 **Segment length**

d2 Remaining segment



For a description of the **Create Line, Input** page, refer to "40.7.3 Calculate Line Offset Point and Calculate Line Base Point".

Define Line Segmentation

Description of fields

Field	Option	Description
Method	Selectable list	How the line is to be divided. Depending on the selection, the following fields are editable or display only fields.

Field	Option	Description
Line length	Display only	Calculated line length between the selected Start point and End point .
No. of segments	Editable field or display only	For Method: No. of segments type in the number of segments for the line. For Method: Segment length this field indicates the calculated number of segments. This method can result in a remaining segment.
Segment length	Editable field or display only	For Method: No. of segments this field is the calculated length of each segment. For Method: Segment length type in the required segment length.
Last segment	Display only	Available for Method: Segment length . The length of the remaining segment.
Starting pt ID	Editable field	The point ID to be assigned to the first new point on the line. The selected point ID templates from ID Templates are not applied.
Pt ID increment	Editable field	Is incremented numerically for the second, third, etc. point on the line.

Next step

Calc calculates the coordinates of the new points. The heights are computed along the line assuming a linear slope between **Start point** and **End point**.

On the **Plot** page, the known points defining the line and those points created on the line are shown.

40.8

COGO Calculation - Area Division

40.8.1

Selecting the Division Method

Description

The COGO calculation area division divides an area by a defined line, by percentage or by the size of a subarea.

Elements that must be known for the calculation depend on the area division method. At least three points are required to form an area.

The coordinates of the known points

- can be taken from the working job.
- can be measured during the COGO calculation.
- can be entered.

Access

Select **Main Menu: Go to Work!\COGO\Area division**.

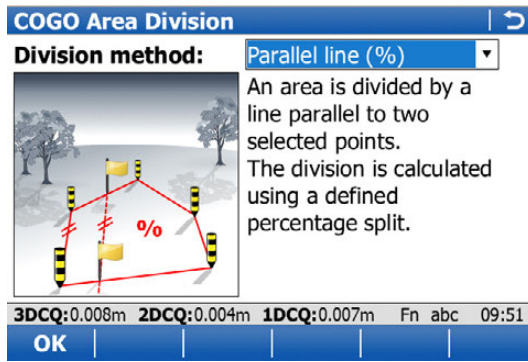

Key	Description
OK	To select a method and to continue with the subsequent screen.

Description of the Area Division methods

Area Division method	Description
Parallel line (%)	The border will be parallel to a line defined by two points. The division is calculated using a defined percentage split.
Parallel line (area)	The border will be parallel to a line defined by two points. The division is calculated using a defined area size.
Parallel line (line)	The border will be parallel to a line defined by two points. The division is calculated by defining the position of the dividing line.
Perpendic line (%)	The border will be perpendicular to a line defined by two points. The division is calculated using a defined percentage split.
Perpendic line (area)	The border will be perpendicular to a line defined by two points. The division is calculated using a defined area size.
Perpendic line (line)	The border will be perpendicular to a line defined by two points. The division is calculated by defining the position of the dividing line.
Swing line (%)	The border will be a line rotated around a rotation point by an azimuth. The division is calculated using a defined percentage split.
Swing line (area)	The border will be a line rotated around a rotation point by an azimuth. The division is calculated using a defined area size.

Elements required

Divide by	Using	Elements required	
Line	Parallel line	Through a point	<ul style="list-style-type: none"> Two points defining the line One point on the dividing line
		By a distance	<ul style="list-style-type: none"> Two points defining the line Distance
	Perpendicular line	Through a point	<ul style="list-style-type: none"> Two points defining the line One point on the dividing line
		By a distance	<ul style="list-style-type: none"> Two points defining the line Distance

Divide by	Using		Elements required
Percentage	Parallel line	-	<ul style="list-style-type: none"> Percentage size of new area Two points defining the line
	Perpendicular line	-	<ul style="list-style-type: none"> Percentage size of new area Two points defining the line
	Swing line	Rotation point	<ul style="list-style-type: none"> Percentage size of new area Rotation point of the swing line
Area	Parallel line	-	<ul style="list-style-type: none"> Size of new area Two points defining the line
	Perpendicular line	-	<ul style="list-style-type: none"> Size of new area Two points defining the line
	Swing line	Rotation point	<ul style="list-style-type: none"> Size of new area Rotation point of the swing line

Diagram

The diagrams show the area division methods. Some diagrams apply to several area division methods.

Area division method	Using	Divide	Shift
1.	Parallel Line	By Defined Line	By Distance
2.	Parallel Line	By Percentage	-
3.	Parallel Line	By Area	-

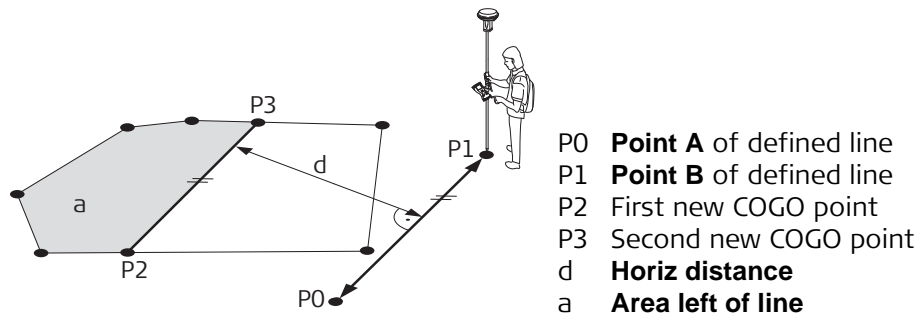

Area division method	Using	Divide	Shift
1.	Perpendic Line	By Defined Line	By Distance
2.	Perpendic Line	By Percentage	-
3.	Perpendic Line	By Area	-

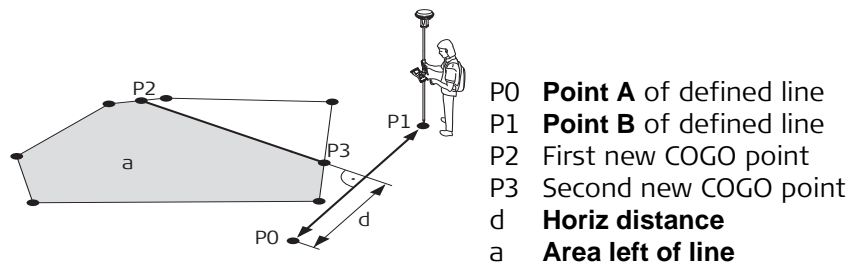

Area division method	Using	Divide	Shift
1.	Parallel Line	By Defined Line	Through Point

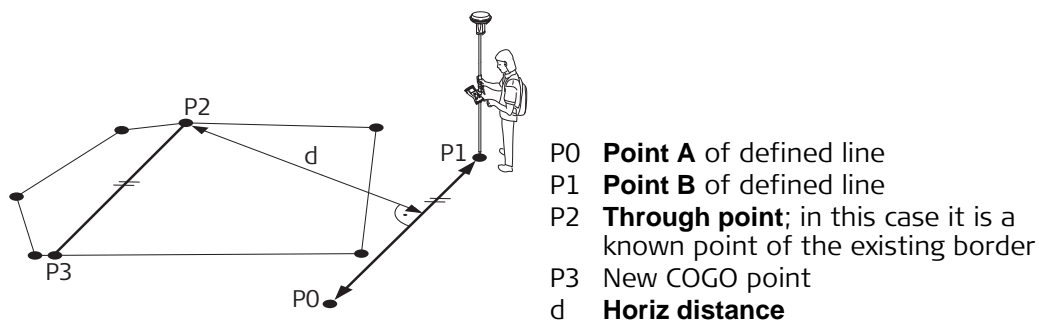

Area division method	Using	Divide	Shift
1.	Perpentic Line	By Defined Line	Through Point

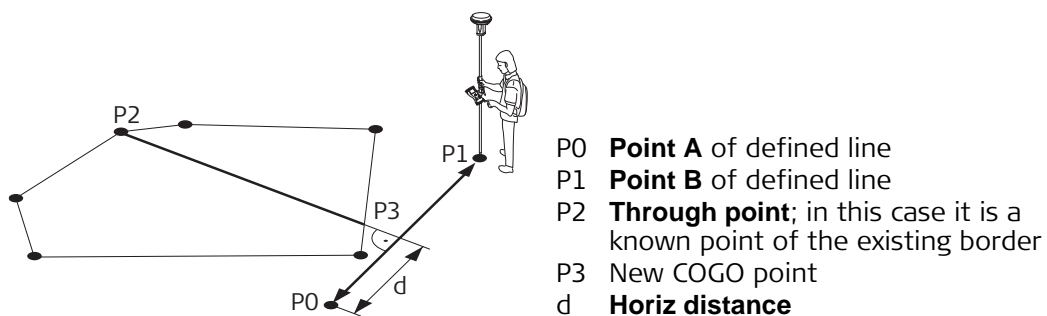

Area division method	Using	Divide	Shift
1.	Swing Line	By Percentage	-
2.	Swing Line	By Area	-

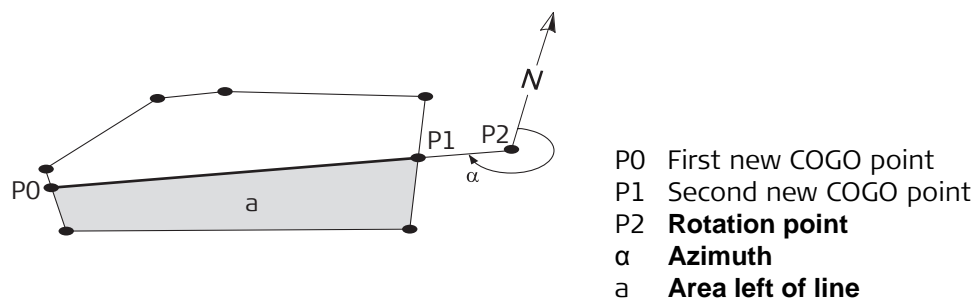

Choose Area to be Divided

Choose Area to be Divided	
Area to use:	Select existing area ▾
Area ID:	A001
No. of points:	4
Area:	55.000m ²
Perimeter:	105.168m

3DCQ:0.011m	2DCQ:0.006m	1DCQ:0.010m	Fn abc	09:53
OK				

Key	Description
OK	To accept the changes and access the subsequent screen.

Description of fields

Field	Option	Description
Area to use	Select existing area	The setting determines the availability of the subsequent fields and screen. To use an area from the working job. The area can be edited and a new area can be created from points existing in the job.
	Survey new area	To survey points that do not exist in the job yet. The points will be added to a new area.
	Create new with pts	To create a new area by selecting points from the job.
Area ID	Selectable list	For Area to use: Select existing area . To select the area to be divided.
	Editable field	For Area to use: Survey new area and Area to use: Create new with pts . To enter a name for the new area.
No. of points	Display only	Number of points forming the area.
Area	Display only	The size of the selected area.
Perimeter	Display only	The perimeter of the area.

Next step

IF	THEN
Area to use: Select existing area	OK accesses Define How to Divide Area . Refer to "40.8.3 Dividing an Area".
Area to use: Survey new area	OK accesses Survey Job name . Refer to "56 Survey - General".
Area to use: Create new with pts	OK accesses Edit Area . Refer to "6.4.3 Editing a Line/Area".

Define How to Divide Area, Input page

After each change of parameters on this screen, the values in the display only fields are recalculated and updated.

Key	Description
Calc	To perform the area division and to continue with the subsequent screen. Calculated COGO points are not yet stored.
Inv..	To calculate the value for the distance from two existing points. Available if Horiz distance is highlighted.
Size and %	To display the size and the percentage of the subarea.
Last..	To select the value for the distance from previous COGO inverse calculations. Available if Horiz distance is highlighted.
Survy..	To manually measure a point for the COGO calculation. Available if Point A , Point B , Rotation point or Through point is highlighted.
Page	To change to another page on this screen.
Fn Config..	To configure the COGO application.
Fn Quit	To exit COGO calculation.

Description of fields

Field	Option	Description
Area left of line	Editable field	For dividing by percentage or area. The size of the sub area must be typed either in % or in m ² . When dividing the area using a parallel or perpendicular line, a reference line is defined by Point A and Point B . The direction of the new dividing line is always the same as the direction of the reference line. The direction of a perpendicular line is the same as the reference line rotated 90° anticlockwise. The sub area is always to the left of the new dividing line. When dividing an area using a swing line, the direction of the new dividing line is defined by the Rotation point and the Azimuth . The sub area is always to the left of the new dividing line.
	Display only	For dividing by a line. The size of the sub area is calculated and displayed.
Point A	Selectable list	The first point of the line which is used as the reference for a new parallel or perpendicular border.

Field	Option	Description
Point B	Selectable list	The second point of the line which is used as the reference for a new parallel or perpendicular border.
Shift	By distance Through point	Available for dividing by a line. The new border will run in a certain distance from the line defined by Point A and Point B . The new border will run through a point defined in Through point .
Through point	Selectable list	Available for Shift: Through point . The point through which the new border will run.
Rotation point	Selectable list	Available for using a swing line. The point around which the new border will rotate by Azimuth .
Azimuth	Display only	Available for using a swing line. The angle of the new border from Rotation point to the new COGO point.
Horiz distance, Horiz dist (ground) or Horiz dist (ell)	Display only	The distance from the line defined by Point A and Point B to the new border.

Next step

Calc performs the area division and accesses **Area Division Result**.

40.8.4

Results of the Area Division

Area Division Result, Result page

Area Division Result	
Result	Plot
Area ratio:	50%:50%
Area left of line:	27.497m ²
Area right of line:	27.503m ²
3DCQ:0.009m 2DCQ:0.005m 1DCQ:0.007m Fn abc 09:55	
OK	Page

Key	Description
OK	To accept the calculation and to continue with the subsequent screen. Calculated COGO points are not yet stored.
Page	To change to another page on this screen.
Fn Quit	To exit COGO calculation.

Description of fields

Field	Option	Description
Area ratio	Display only	The ratio of the size of the two sub areas in percent.
Area left of line	Display only	The size of the first sub area in m ² .

Field	Option	Description
Area right of line	Display only	The size of the second sub area in m ² .

Next step

On the **Plot** page, the points defining the area and the calculated COGO points are shown in black.

OK accesses **Area Divisions Results**.

Area Divisions Results, Result page

The coordinates of the intersection points of the new border with the original area are displayed.

Area Divisions Results	
Result 1	Code Plot
Point ID:	109
Easting:	0.100m
Northing:	-3.001m
Elevation:	7.000 m

3DCQ:0.009m	2DCQ:0.005m	1DCQ:0.008m	Fn abc	09:56
Store	Coord	Result2	Stake..	Page

Key	Description
Store	To store the two results and to return to Choose Area to be Divided once both points are stored.
Coord	To view other coordinate types.
Result1 or Result2	To view the first and second result.
Stake..	To access the Stakeout application and stake out the calculated COGO point.
Page	To change to another page on this screen.
Fn Ell Ht and Fn Elev	To change between the ellipsoidal and the orthometric height.
Fn Individ and Fn Run	To change between entering an individual point ID different to the defined ID template and the running point ID according to the ID template. Refer to "25.1 ID templates".
Fn Quit	To exit COGO calculation.

Next step

On the **Code** page, type in a code if desired.

On the **Plot** page, The points defining the area and the points of the new border are shown in black.

Store stores the results.

40.9
40.9.1

COGO Calculation - Shift, Rotate & Scale
Selecting the Shift, Rotate & Scale Method and the Points to be Moved

Access

Select **Main Menu: Go to Work!\COGO\Shift, rotate & scale.**

COGO Shift, Rotate & Scale

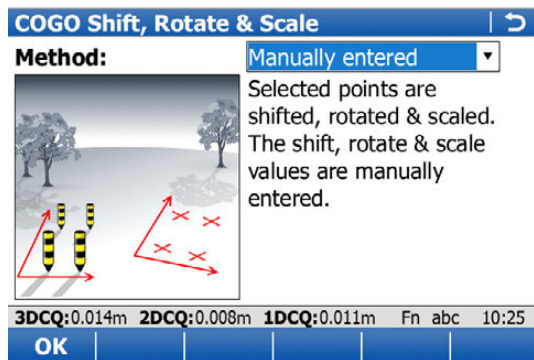

Key	Description
OK	To select a method and to continue with the subsequent screen.

Description of the Shift, Rotate & Scale methods

Shift, Rotate & Scale methods	Description
Manually entered	<p>Applies shifts and/or rotation and/or scale to one or several known points. The values for shifts and/or rotation and/or scale are typed in manually.</p> <p>Elements that must be known are</p> <ul style="list-style-type: none"> • the coordinates of the points to be shifted, rotated and/or scaled. They must be stored in the working job. • the shift values. They can be defined as: the direction of Easting, Northing and Height, or as an azimuth and a grid distance, or as shift from one point to another. • the rotation value. It can be defined by a point as rotation centre plus a rotation or by an existing and new azimuth. • the scale. It is only applied to the position, not to the height. <p>Points with full coordinate triplets, position only points and height only points can be used.</p>

Shift, Rotate & Scale methods	Description
Matching points	<p>Applies shifts and/or rotation and/or scale to one or several known points. The shifts and/or rotation and/or scale are calculated from selected points using a 2D Helmert transformation.</p> <p>Elements that must be known are</p> <ul style="list-style-type: none"> the coordinates of at least two matching points for the calculation of the shifts and/or rotation and/or scale. the coordinates of the points to be shifted, rotated and/or scaled. They must be stored in the working job. <p>Points with full coordinate triplets, position only points and height only points can be used.</p> <p>The number of pairs of points matched determines whether the shift, rotation and scale values are computed. For only one point, only shifts are calculated, rotation and scale are not.</p>

Next step

OK accesses **Point Selection** which is the same for **Method: Manually entered** and **Method: Matching points**.

Point Selection

Listed are points which have been selected for shifting, rotating and/or scaling.

Point Selection	
Points	Code
101	TR
102	TR
103	BU
104	MH

3DCQ:0.010m	2DCQ:0.006m	1DCQ:0.008m	Fn abc	10:26
OK	+ All..	+ One..	Remov	More

Key	Description
OK	To perform the shift, rotation and scale calculation and to continue with the subsequent screen. Calculated COGO points are not yet stored.
+ All..	To add all points from the working job to the list. Selected sort and filter settings apply. OK adds all displayed points to the list in Point Selection and returns to that screen.
+ One..	To add one point from the working job to the list. Selected sort and filter settings apply. OK adds the currently highlighted point to the list in Point Selection and returns to that screen.
Remov	To remove the highlighted point from the list. The point itself is not deleted.

Key	Description
More	To display information about the codes if stored with any point, the time and the date of when the point was stored and the 3D coordinate quality and the class.
Fn Rem A	To remove all points from the list. The points themselves are not deleted.
Fn Range	To define a range of points from the working job to be added to the list.
Fn Quit	To exit COGO calculation.

Next step

IF	AND	THEN
all points are to be added	-	+ All...
one point is to be added	-	+ One...
a range of points is to be added	-	Fn Range accesses Select points by range .
all points are added	Method:Manually entered Method:Matching points	OK accesses Computed Parameters . Refer to "40.9.2 Manually Entered". OK accesses Match Common Points (%d) . Refer to "40.9.3 Matching Points".

Select points by range

Select points by range | ↻

From pt ID:

To pt ID:

3DCQ:0.009m 2DCQ:0.005m 1DCQ:0.007m Fn abc 10:26

OK | **Next** | | |

Key	Description
OK	To add the points within the selected range to the list in Point Selection . Returns to the screen from where this screen was accessed.
Next	To add the points within the selected range to the list in Point Selection without quitting this screen. Another range of point IDs can be selected.

Description of fields

Field	Option	Description
From pt ID and To pt ID	Editable field	<ul style="list-style-type: none"> Numeric point IDs in both fields: Points with numeric point IDs falling within the range are selected. Example: From pt ID: 1, To pt ID: 50 Selected are point IDs 1, 2, 3, 4, 5, 6, 7, 8, 9, 10.... 49, 50 as well as 001, 01, 0000045, ... Not selected are point IDs 100,200,300, ... Alphanumeric point IDs in both fields: The left most character of both entries is used as the basis for the range. The standard ASCII numerical range is used. Points with alphanumeric point IDs falling within the range are selected. Example: From pt ID: a9, To pt ID: c200 Selected are point IDs a, b, c, aa, bb, cc, a1, b2, c3, c4, c5, a610, ... Not selected are point IDs d100, e, 200, 300, tzz ...

Next step

Select a range of points.

OK returns to **Point Selection**.

Diagram

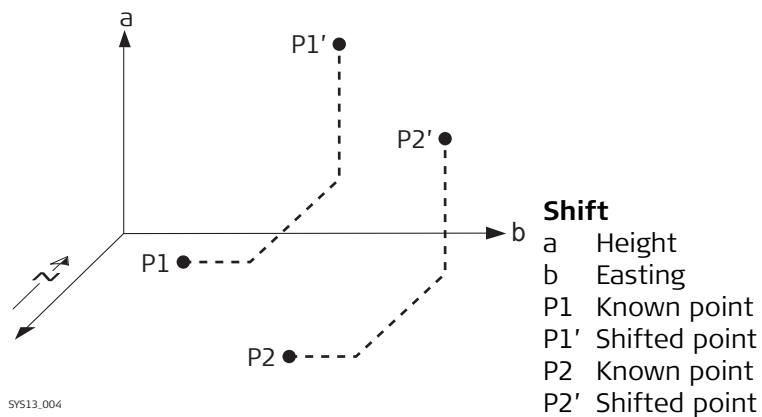

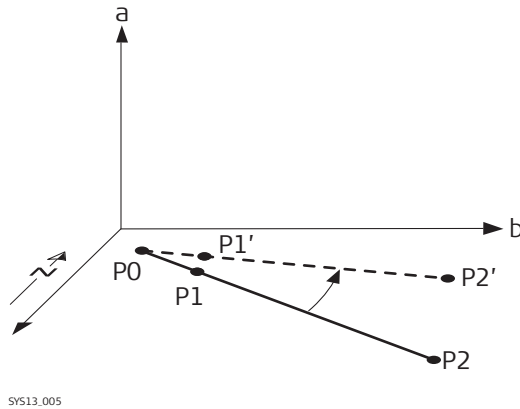

SY513.005

Rotation

- a Height
- b Easting
- P0 **Rotation point**
- P1 Known point
- P1' Rotated point
- P2 Known point
- P2' Rotated point

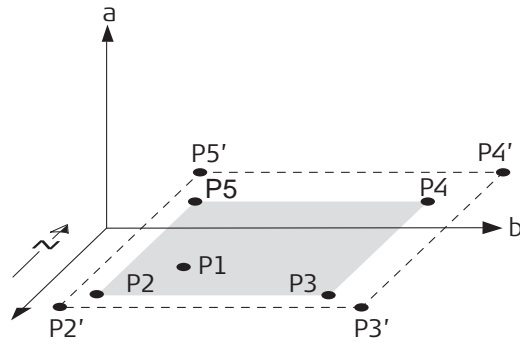

SY513.006

Scale

- a Height
- b Easting
- P1 **Rotation point**, can be held fixed, all other points are then scaled from here
- P2 Known point
- P2' Scaled point
- P3 Known point
- P3' Scaled point
- P4 Known point
- P4' Scaled point
- P5 Known point
- P5' Scaled point

40.9.2

Manually Entered

Computed Parameters,
Shift page

Parameters ↻

Shift Rotate Scale

Method: Δeast, Δnorth, Δht

Δ easting: 10.000 m

Δ northing: 0.000 m

Δ height: 0.000 m

3DCQ:0.009m 2DCQ:0.005m 1DCQ:0.007m Fn abc 10:26

Calc Inv.. Last.. Page

Key	Description
Calc	To perform the shift, rotation and scale calculation and to continue with the subsequent screen. Calculated COGO points are not yet stored.
Inv..	To calculate the amount of shift in Easting, Northing and height from two existing points. Available if Azimuth, Horiz distance, Δ easting, Δ northing or Δ height is highlighted.
Last..	To select the value for the shift from previous COGO inverse calculations. Available if Azimuth, Horiz distance, Δ easting, Δ northing or Δ height is highlighted.

Key	Description
Survy..	To manually measure a point for the COGO calculation. Available for Method: Use 2 points if From or To is highlighted.
Page	To change to another page on this screen.
Fn Config..	To configure the COGO application. Refer to "40.3 Configuring COGO".
Fn Modif..	To mathematically modify the values. Available if Azimuth, Horiz distance, Δ easting, Δ northing or Δ height is highlighted.
Fn Quit	To exit COGO calculation.

Description of fields

Field	Option	Description
Method	Δeast, Δnorth, Δht	The method by which the shift in Δ Easting, Δ Northing and Δ Height will be determined. Defines the shift using coordinate differences.
	Bearing, dist, height	Defines the shift using an azimuth, a distance and a height difference.
	Use 2 points	Computes the shift from the coordinate differences between two known points.
From	Selectable list	Available for Method: Use 2 points . The point ID of the first known point for calculating the shift.
To	Selectable list	Available for Method: Use 2 points . The point ID of the second known point for calculating the shift.
Azimuth	Editable field	Available for Method: Bearing, dist, height . The azimuth defines the direction of the shift.
Horiz distance, Horiz dist (ground) or Horiz dist (ell)	Editable field	Available for Method: Bearing, dist, height . The amount of shift from the original point to the calculated COGO points.
Δ easting	Editable field or display only	The amount of shift in East direction.
Δ northing	Editable field or display only	The amount of shift in North direction.
Δ height	Editable field or display only	The amount of shift in height.

Next step

Page accesses **Computed Parameters, Rotate** page.

**Computed Parameters,
Rotate page**

The softkeys are the same as on the **Shift** page.

Description of fields

Field	Option	Description
Method	User entered	The method by which the rotation angle will be determined. The rotation can be manually typed in.
	Computed	The rotation will be calculated as New azimuth minus Existing azimuth .
Rotation point	Selectable list	The point around which all points will be rotated.
Existing azimuth	Editable field	Available for Method: Computed . A known direction before rotating.
New azimuth	Editable field	Available for Method: Computed . A known direction after rotating.
Rotation	Editable field or display only	The amount by which the points will be rotated.

Next step

Page accesses **Computed Parameters, Scale** page.

**Computed Parameters,
Scale page**

The softkeys are the same as on the **Shift** page.

Description of fields

Field	Option	Description
Method	User entered	The method by which the scale factor will be determined. The scale factor can be manually typed in.
	Computed	The scale factor will be calculated as New distance divided by Existing distance .
Existing distance	Editable field	Available for Method: Computed . A known distance before scaling. This value is used for calculating the scale factor.
New distance	Editable field	Available for Method: Computed . A known distance after scaling. This value is used for calculating the scale factor.
Scale	Editable field or display only	The scale factor used in the calculation.
Scale from point	No	Scaling is performed by multiplying the original coordinates of the points by Scale .
	Yes	Scale is applied to the coordinate difference of all points relative to Rotation point selected on the Rotation page. The coordinates of Rotation point will not change.

Next step

Calc performs the shift, rotation and scale calculation and accesses **Shift, Rotate & Scale Results**.

Shift, Rotate & Scale Results, General page

Shift, Rotate & Scale Results	
General	Summary Plot
Points selected:	4
Store points to job:	Cogo job
Store Point ID with:	Prefix
Prefix / suffix:	S

3DCQ:0.010m	2DCQ:0.006m	1DCQ:0.008m	Fn abc	10:26
Store				Page

Key	Description
Store	To store the results and continue with the next screen.
Page	To change to another page on this screen.
Fn Quit	To exit COGO calculation.

Description of fields

Field	Option	Description
Points selected	Display only	The number of selected points having been shifted, rotated and/or scaled.
Store points to job	Selectable list	The calculated COGO points will be stored in this job. The original points are not copied to this job.
Store Point ID with	Prefix	Adds the setting for Store Point ID with in front of the original point IDs.
	Suffix	Adds the setting for Store Point ID with at the end of the original point IDs.
Prefix / suffix	Editable field	The identifier with up to four characters is added in front of or at the end of the ID of the calculated COGO points.

Next step

IF	THEN
the used parameters are to be viewed	Page accesses Shift, Rotate & Scale Results, Summary page.
the calculated COGO points are to be viewed graphically	Page accesses Shift, Rotate & Scale Results, Plot page. Original points are displayed in grey, calculated COGO points are displayed in black.
the calculated COGO points are to be stored	Store accesses Shift, Rotate & Scale Results, Result page. Refer to paragraph "Shift, Rotate & Scale Results, Result page".

Shift, Rotate & Scale Results, Result page

Description of fields

Field	Option	Description
No. of new points	Display only	Number of new points created.
No. of skipped pts	Display only	Number of points which were skipped either due to not being able to convert coordinates, or points with identical point IDs already in the Store points to job .

Next step

OK returns to **COGO Shift, Rotate & Scale**.

40.9.3

Matching Points

Point Selection

Listed are points which have been selected for shifting, rotating and/or scaling.

Point Selection	
Points	Code
101	TR
102	TR
103	BU
104	MH



Key	Description
OK	To perform the shift, rotation and scale calculation and to continue with the subsequent screen. Calculated COGO points are not yet stored.
+ All..	To add all points from the working job to the list. Selected sort and filter settings apply. OK adds all displayed points to the list in Point Selection and returns to that screen.
+ One..	To add one point from the working job to the list. Selected sort and filter settings apply. OK adds the currently highlighted point to the list in Point Selection and returns to that screen.
Remov	To remove the highlighted point from the list. The point itself is not deleted.
More	To display information about the codes if stored with any point, the time and the date of when the point was stored and the 3D coordinate quality and the class.
Fn Rem A	To remove all points from the list. The points themselves are not deleted.
Fn Range	To define a range of points from the working job to be added to the list.
Fn Quit	To exit COGO calculation.

Next step

IF	AND	THEN
all points are to be added	-	+ All...

IF	AND	THEN
one point is to be added	-	+ One...
a range of points is to be added	-	Fn Range accesses Select points by range .
all points are added	Method:Manually entered Method:Matching points	OK accesses Computed Parameters . Refer to "40.9.2 Manually Entered". OK accesses Match Common Points (%d) . Refer to "40.9.3 Matching Points".

Match Points

This screen provides a list of points chosen from the working job. The points are used for the determination of the 2D Helmert transformation. The number of points matched is indicated in the title, for example (2). Unless there is no pair of matching points in the list all softkeys are available.

Match Points (2) ↻		
Source point	Target point	Match
101	107	P & H
102	108	P only

3DCQ:0.008m	2DCQ:0.005m	1DCQ:0.007m	Fn abc	10:28	
Calc	New..	Edit..	Delete	Match	Resid

Key	Description
Calc	To confirm the selections, compute the transformation and continue with the subsequent screen.
New..	To match a new pair of points. This pair is added to the list. A new point can be manually measured. Refer to paragraph "Choose Matching Points or Edit Matching Points".
Edit..	To edit the highlighted pair of matched points.
Delete	To delete the highlighted pair of matched points from the list.
Match	To change the type of match for a highlighted pair of matched points.
Resid	To display a list of the matched points used in the transformation calculation and their associated residuals. Refer to paragraph "Fix Parameters".
Fn Param	To define the parameters to be fixed in the 2D transformation.
Fn Quit	To exit COGO calculation.

Description of columns

Column	Description
Source point	The point ID of the points of origin for the calculation of the shifts and/or rotation and/or scale.
Target point	The point ID of the target points for the calculation of the shifts and/or rotation and/or scale.

Column	Description
Match	The type of match to be made between the points. This information is used in the transformation calculation. Position & Height , Position only , Height only or None . None removes matched common points from the transformation calculation but does not delete them from the list. This option can be used to help improve residuals.

Next step

IF	THEN
the transformation is to be computed	Calc. The calculated shift, rotation and scale values are displayed in Point Selection . They cannot be edited. The remaining functionality of the calculation is similar to shift, rotate & scale (manual). Refer to "40.9 COGO Calculation - Shift, Rotate & Scale".
a pair of points is to be matched or edited	New.. or Info. Refer to paragraph "Choose Matching Points or Edit Matching Points".
parameters for the transformation are to be fixed	Fn Param. Refer to paragraph "Fix Parameters".

Choose Matching Points or Edit Matching Points

Choose Matching Points
↩ ↪

Source point:

Target point:

Match type:

3DCQ:0.011m 2DCQ:0.006m 1DCQ:0.009m Fn abc 10:27

OK
Survy..

Key	Description
OK	To confirm the selections.
Fn Quit	To exit COGO calculation.

Description of fields

Field	Option	Description
Source point	Selectable list	A point of origin for the calculation of the shifts and/or rotation and/or scale.
Target point	Selectable list	A target point for the calculation of the shifts and/or rotation and/or scale.
Match type	Pos & height Pos only	The type of match to be made between the points selected. Position and height Position only

Field	Option	Description
	Height only	Height only
	None	None

Fix Parameters

The settings on this screen define the parameters to be used in the transformation.

IF the value for a field is	THEN the value for this parameter will be
-----	calculated.
any number	fixed to that value.

Description of fields

Field	Option	Description
Δ easting	Editable field	Shift in Easting direction.
Δ northing	Editable field	Shift in Northing direction.
Δ height	Editable field	Shift in Height direction.
Rotation	Editable field	Rotation around the vertical axis.
Scale	Editable field	Scale factor.

Next step

IF	AND	THEN
a field displays -----	the parameter must be fixed to a value	highlight the field. Enter the value of the parameter. Fix.
a field displays a value	the parameter must be calculated	highlight the field. Adjst.
all parameters are configured	-	OK to return to Match Points.

40.10

COGO Calculation - Angle Method

COGO Angle, Input page

For all point fields, the MapView interactive display on the **Map** page can be used to select the desired point.

To type in coordinates for a known point open a selectable list. Press **New..** to create a new point.

Key	Description
Calc	To calculate the result.
Survvy..	To manually measure a point for the COGO calculation.
Page	To change to another page on this screen.
Fn Quit	To exit COGO calculation.

Description of fields

Field	Option	Description
Point ID	Selectable list	The backsight point.

Field	Option	Description
At point	Selectable list	The point of intersection of the backsight and foresight direction.
To point	Selectable list	The foresight point.

Next step

Calc calculates the result and accesses **COGO Angle, Results**.

COGO Angle,
Results page

Key	Description
OK	To accept changes and return to the Input page.
Page	To change to another page on this screen.
Fn Quit	To not store the COGO point and to exit COGO calculations.

Description of fields

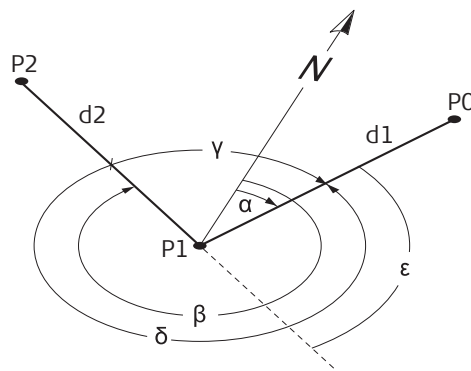

- α Azimuth at-from
- β Azimuth at-to
- γ Deflection angle
- δ Angle right
- ϵ Angle left
- P0 Point ID
- P1 At point
- P2 To point
- d1 Horiz distance at-from
- d2 Horiz distance at-to

TS_131

40.11

COGO Calculation - Horizontal Curve Method

Horizontal Curve
Calculator,
Input page

For all point fields, the MapView interactive display on the **Map** page can be used to select the desired point.

To type in coordinates for a known point open a selectable list. Press **New..** to create a new point.

Key	Description
Calc	To calculate the result.
Inv..	To calculate the values for a distance and an angle from two existing points. Available when a distance field or an angle field is highlighted.
Last..	To recall previous results from COGO inverse calculations. Available when a distance field or an angle field is highlighted.
Survy..	To manually measure a point for the COGO calculation.
Page	To change to another page on this screen.
Fn Quit	To exit COGO calculation.

Description of fields

Field	Option	Description
Method	Selectable list	The horizontal curve can either be defined by three points or by two parameters.

Field	Option	Description
Parameter 1, Parameter 2		Select which parameters are known. Available for Method: 2 parameters.
	Radius	Radius of the curve.
	Delta angle	Angle in the radius point.
	DOC - Arc	The degree of curve defines the sharpness or flatness of the curve. Degree of curvature in arc definition. The central angle subtended by one station of circular arc. Mainly used in highway design. SI units: 1 station = 20 m) English system: 1 station = 100 ft
	DOC - Chord	The degree of curve defines the sharpness or flatness of the curve. Degree of curvature in chord definition. The central angle subtended by one station length of chord. Mainly used in railway design.
	Arc length	Total length of the circular curve from start point to end point measured along its arc.
	Tangent	Length of the tangent from the tangent point to the point of intersection.
	External secant	The distance from the point of intersection to the midpoint of the curve. The external distance bisects the interior angle at the point of intersection.
	Mid ordinate	The distance from the midpoint of the curve to the midpoint of the long chord. The extension of the middle ordinate bisects the central angle.
	Delta angle	The angle where the two tangents intersect. The angle between the tangents is also equal to the angle at the centre of the curve

Next step

Calc calculates the result and accesses **Horizontal Curve Calculator, Results.**

Horizontal Curve Calculator, Results page

Key	Description
OK	To accept changes and return to the Input page.
Page	To change to another page on this screen.
Fn Quit	To not store the COGO point and to exit COGO calculations.

Description of fields

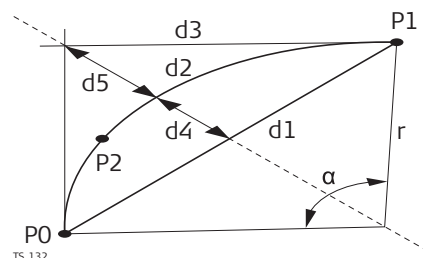

- α **Delta angle**
- P0 **Start point**
- P1 **End point**
- P2 **Second point**
- r **Radius**
- d1 **Chord length**
- d2 **Arc length**
- d3 **Tangent**
- d4 **Mid ordinate**
- d5 **External secant**

Key	Description
OK	To accept changes and return to the Input page.
Page	To change to another page on this screen.
Fn Quit	To not store the COGO point and to exit COGO calculations.

Description of fields

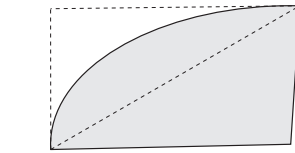

Sector

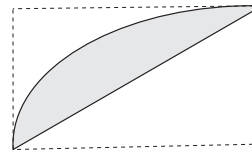

Segment

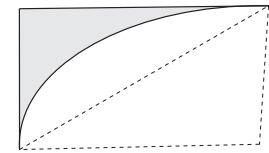

Fillet

40.12

COGO Calculation - Triangle Method

COGO Triangle, Input page

For all point fields, the MapView interactive display on the **Map** page can be used to select the desired point.

To type in coordinates for a known point open a selectable list. Press **New..** to create a new point.

Key	Description
Calc	To calculate the result.
Inv..	To calculate the values for a distance and an angle from two existing points. Available when a distance field or an angle field is highlighted.
Last..	To recall previous results from COGO inverse calculations. Available when a distance field or an angle field is highlighted.
Surv..	To manually measure a point for the COGO calculation.
Page	To change to another page on this screen.
Fn Quit	To exit COGO calculation.

Description of fields

Field	Option	Description
Method	Selectable list	The triangle can either be defined by three points or by three parameters.
Parameters	Selectable list	Select which combination of angle value and side length are known. Available for Method: 3 parameters .
Side a, Side b, Side c	Editable field	The side lengths of the triangle.
Angle A, Angle C	Editable field	The angle values of the triangle.
Point A, Point B, Point C	Selectable list	The points forming the triangle.

Next step

Calc calculates the result and accesses **COGO Triangle, Results**.

**COGO Triangle,
Results page**

Key	Description
OK	To accept changes and return to the Input page.
Result1 or Result2	To view the first and second result.
Page	To change to another page on this screen.
Fn Quit	To not store the COGO point and to exit COGO calculations.

Description of fields

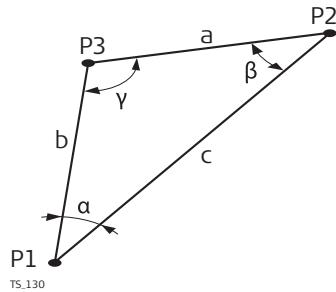

- α **Angle A**
- β **Angle B**
- γ **Angle C**
- P1 **Point A**
- P2 **Point B**
- P3 **Point C**
- a **Side a**
- b **Side b**
- c **Side c**

40.13

Selecting a Result from Previous COGO Inverse Calculations

Description

Azimuths, distances and offsets required within the COGO traverse and intersection calculations can be selected from previously calculated inverse results.

Access

In Traverse or Intersection, highlight **Azimuth**, **Horiz distance** or **Offset** and press **Last...**

Last Inverse Calculations

All previous COGO inverse calculations stored in the working job are displayed, sorted by time with the most recent at the top. This screen consists of three columns. The information displayed can vary. ----- is displayed for unavailable information, for example the **Azimuth** cannot be calculated if a height only point is used.

Last Inverse Calculations		
From	To	Azimuth [g]
103	104	218.5547
101	102	107.9167

3DCQ:0.012m	2DCQ:0.007m	1DCQ:0.010m	Fn abc	10:28
OK	View	Delete	More	

Key	Description
OK	To return to the previous screen.
View	To view all calculated values for the highlighted COGO inverse calculation. Includes the height difference, the slope distance, the grade and the coordinate differences between the two known points.
Delete	To delete the highlighted COGO inverse calculation.
More	To display other information in the third column.
Fn Quit	To exit COGO calculation.

Description of columns

Column	Description
From	The point ID of the first known point for the COGO inverse calculation.
To	The point ID of the second known point for the COGO inverse calculation.
Azimuth	The direction from the first to the second known point.
HDist	The horizontal distance between the two known points.
Date and Time	When the COGO inverse calculation was stored.

Next step

Highlight the COGO inverse calculation of which a result is to be taken over.

OK. The relevant result of the highlighted COGO inverse calculation is copied into the field which was initially highlighted on the **Input** page.

40.14

Modifying Values for Azimuths, Distances and Offsets

Description

The values for the azimuth, the distance and the offset required within the COGO traverse and intersection calculation can be mathematically modified.

Access step-by-step

In Traverse or Intersection, highlight **Azimuth**, **Horiz distance** or **Offset** and press Fn Modif...

Modify Value

On this screen, numbers can be typed in for the multiplication, division, addition and subtraction with the original azimuth, distance or offset value. The standard rules of mathematical operations apply.

Key	Description
OK	To accept the modified value and to return to the screen from where this screen was accessed. The modified value is copied into the field which was initially highlighted on the Input page.
Fn Quit	To exit COGO calculation.

Description of fields

Field	Option	Description
Azimuth, Horiz distance or Offset	Display only	The name of the field and the value which was highlighted before accessing Modify Value .
Multiply	Editable field	The number to multiply by.

Field	Option	Description
		<ul style="list-style-type: none"> • Minimum: -3000 • Maximum: 3000 • ----- performs a multiplication by 1.
Divide	Editable field	The number to divide by. <ul style="list-style-type: none"> • Minimum: -3000 • Maximum: 3000 • ----- performs a division by 1.
Add	Editable field	The number to be added. <ul style="list-style-type: none"> • For azimuths Minimum: 0 Maximum: Full circle • For distances and offsets Minimum: 0 m Maximum: 30000000 m • ----- performs an addition of 0.000.
Subtract	Editable field	The number to be subtracted. <ul style="list-style-type: none"> • For azimuths Minimum: 0 Maximum: Full circle • For distances and offsets Minimum: 0 m Maximum: 30000000 m • ----- performs a subtraction of 0.000.
Azimuth, Horiz distance or Offset	Display only	The modified value for the field in the first line. This field is updated with every mathematical operation. Angles greater than the full circle are reduced accordingly.

Next step

OK accepts the modified value and returns to the screen from where this screen was accessed.

Example: Calculations for an azimuth

Step	Editable field	Value as calculated	Value as displayed
			Azimuth: 250.0000 g
1.	Multiply: 2	500	Azimuth: 100.0000 g
2.	Divide: 3	166.667	Azimuth: 166.6670 g
3.	Add: 300	466.667	Azimuth: 66.6670 g
4.	Subtract: 100	366.667	Azimuth: 366.6670 g

Example: Calculations for a distance

The behaviour for an offset is identical.

Step	Editable field	Value as calculated	Value as displayed
			Horiz distance: 250.000 m
1.	Multiply: 2	500	Horiz distance: 500.000 m

Step	Editable field	Value as calculated	Value as displayed
2.	Divide: 3	166.667	Horiz distance: 166.667 m
3.	Add: 300	466.667	Horiz distance: 466.667 m
4.	Subtract: 100	366.667	Horiz distance: 366.667 m

Description

GPS measured points are always stored based on the global geocentric datum known as WGS 1984. Most surveys require coordinates in a local grid system. For example, based on a country's official mapping datum or an arbitrary grid system used in a particular area such as a construction site. To convert the WGS 1984 coordinates into local coordinates a coordinate system must be created. Part of the coordinate system is the transformation used to convert coordinates from the WGS 1984 datum to the local datum.

The Determine Coordinate System application allows:

- the parameters of a new transformation to be determined.
- the parameters of an existing transformation to be recomputed.



With one common control point, it is still possible to calculate a Classic 3D transformation, as long as the rotations and the scale parameter are fixed. Such a transformation fits perfectly in the vicinity of the common control point, but is degraded by the distance from that point. This degradation is because the orientation of the local reference frame or any scale factor within the local datum cannot be taken into account.

Requirements to determine a transformation

To determine a transformation it is necessary to have common control points whose positions are known in both WGS 1984 coordinates and local coordinates. The more points that are common between datum, the more accurately the transformation parameters can be calculated. Depending on the type of transformation used, details about the map projection, the local ellipsoid and a local geoid model can also be needed.

Requirements for control points

- The control points used for the transformation should surround the area for which the transformation is to be applied. It is not good practice to survey or convert coordinates outside of the area covered by the control points as extrapolation errors can be introduced.
- When a geoid field file, and/or a CSCS field file is used in the determination of a coordinate system, the control points for the calculation must fall within the areas of the field files.

Description

Determine Coordinate System is the conventional method of determining a coordinate system. Parameters such as the height mode must be set by the user. One or more control points for both the WGS 1984 and the local datum are needed. Depending on the number of control points and available information, a Onestep, Twostep or Classic 3D transformation can be used.

Access

Select **Main Menu: Go to Work!\Survey+\Determine coord system.**

Determine Coord System**Description of fields**

Field	Option	Description
Method	Onestep	<p>The type of transformation to be used when determining a coordinate system.</p> <p>Transforms coordinates directly from WGS 1984 to local grid and vice versa without knowledge about the local ellipsoid or the map projection. Procedure:</p> <ol style="list-style-type: none"> 1 The WGS 1984 coordinates are projected onto a temporary Transverse Mercator Projection. The central meridian of this projection passes through the centre of gravity of the common control points. 2 The results of 1. are preliminary grid coordinates for the WGS 1984 points. 3 These preliminary grid coordinates are matched with the local grid control points. The Easting and Northing shifts, the rotation and the scale factor between these two sets of points are then computed. This process is known as a classic 2D transformation. 4 The height transformation is a single dimension height approximation. <p>Refer to "Appendix J Glossary".</p>
	Twostep	<p>Combines the advantages of the Onestep and the Classic 3D transformation. It allows treating position and height separately, but is not restricted to smaller areas. Procedure:</p> <ol style="list-style-type: none"> 1 The WGS 1984 coordinates of the common control points are shifted closely to the local datum using a given Classic 3D pre-transformation. This Classic 3D transformation is typically a rough transformation valid for the country of the local datum. 2 The coordinates are projected onto a preliminary grid, but this time using the true map projection of the local points. 3 A 2D transformation is applied, exactly as with the Onestep transformation. <p>Refer to "Appendix J Glossary".</p>

Field	Option	Description
	Classic 3D	Also known as Helmert transformation. Transforms coordinates from WGS 1984 cartesian to local cartesian coordinates and vice versa. A map projection can then be applied to obtain grid coordinates. As a similarity transformation, it is the most rigorous transformation type and keeps the full geometrical information. Refer to "Appendix J Glossary".
	Modify existing	To modify an existing determine coordinate system. Refer to "41.3.3 Modifying a Coordinate System".

Next step

IF the selected method is	THEN
Onestep, Twostep or Classic 3D	OK to access Choose WGS84 & Local Jobs . Refer to the following paragraph: Choose WGS84 & Local Jobs .
Modify existing	OK to access Coordinate Systems . Refer to "41.3.3 Modifying a Coordinate System".

Choose WGS84 & Local Jobs

Choose WGS84 & Local Jobs | ↻

Name:

WGS84 points job: ↕

Local points job: ↕

Use one point localisation method

3DCQ:0.016m 2DCQ:0.009m 1DCQ:0.013m Fn abc 14:18

OK Config..

Key	Description
OK	To confirm the selections and to continue with the subsequent screen.
Config..	To configure the selected coordinate system determination method.
Fn Quit	To exit the screen.

Description of fields

Field	Option	Description
Name	Editable field	A unique name for the coordinate system. The name can be up to 16 characters in length and can include spaces. Input is mandatory.  Entering the name of a coordinate system will allow that existing system to be updated.
WGS84 points job	Selectable list	The job from which the points with WGS 1984 coordinates will be taken.

Field	Option	Description
Local points job	Selectable list	The job from which the points with local coordinates will be taken.
Use one point localisation method	Check box	Number of control points needed: One control point for both the WGS 1984 and the local datum. Transformation to use: <ul style="list-style-type: none"> • Onestep or Twostep when information about the necessary rotations and scale factor is known. • Classic 3D when the rotations are to be set to zero and the scale factor to one.

Next step

Press **Config..** with **Use one point localisation method** NOT checked to access **Configuration**.

41.3

41.3.1

The Normal Method

Configuring the Normal Method

Description

The configuration allows options to be set, which are used in the Determine Coordinate System application. These settings are stored within the active working style.

Access

Press **Config..** in **Choose WGS84 & Local Jobs** with **Use one point localisation method** NOT checked.

Configuration, Residuals page

The explanations for the softkeys given here are valid for all pages, unless otherwise stated.

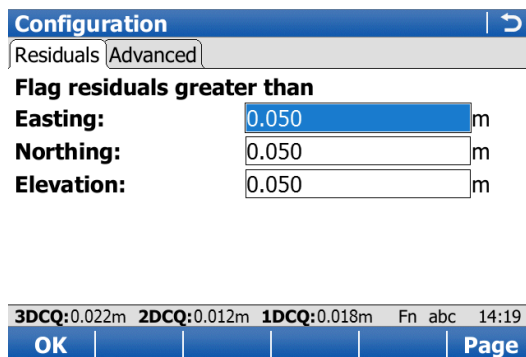

Key	Description
OK	To accept changes and return to the screen from where this screen was accessed.
Page	To change to another page on this screen.
Fn Quit	To exit the screen.

Description of fields

Field	Option	Description
Easting	Editable field	The limit above which Easting residuals will be flagged as possible outliers.

Field	Option	Description
Northing	Editable field	The limit above which Northing residuals will be flagged as possible outliers.
Elevation	Editable field	The limit above which Height residuals will be flagged as possible outliers.

Next step

Page changes to the **Advanced** page.

Configuration, Advanced page

Description of fields

Field	Option	Description
Model	Bursa-Wolf or Molodensky-Badakis	The transformation model to be used. Refer to standard surveying literature for details on the models.
Prompt me to enter fixed transformation parameters	Check box	To configure Classic 3D transformation parameters during the process of calculation.

Next step

OK returns to **Choose WGS84 & Local Jobs**.

41.3.2

Determining a New Coordinate System

Access

Press **OK** in **Choose WGS84 & Local Jobs** with **Use one point localisation method** NOT checked.

Set Height Mode

Key	Description
OK	To confirm the selections and to continue with the subsequent screen.
Fn Quit	To exit the screen.

Description of fields

Field	Option	Description
Transformation name	Editable field	A unique name for the transformation. The name can be up to 16 characters in length and include spaces. If a coordinate system is being updated then its name is displayed.
Transfrm Type	Display only	The type of transformation to be used when determining a coordinate system.
Height mode	Orthometric or Ellipsoidal Display only	The height mode to be used in the determination of a coordinate system. Available when determining a new coordinate system. Available when updating a coordinate system. The height mode shown is the same as the mode used in the existing system.

Next step

OK continues to **Choose System Components**.



If a coordinate system was chosen to be edited in **Choose WGS84 & Local Jobs**, pressing **OK** accesses **Matched Points (n)**. Pressing **ESC** does not reaccess **Choose WGS84 & Local Jobs** but accesses **Choose System Components** and **Set Height Mode**.

Choose System Components

This screen contains different fields, depending on what method was chosen in **Determine Coord System**.

Choose System Components | ↻

Ellipsoid: Bessel

Projection: Swiss

Geoid model: <None>

CSCS model: <None>

3DCQ:0.018m 2DCQ:0.010m 1DCQ:0.015m Fn abc 14:20

OK

Key	Description
OK	To confirm the selections and to continue with the subsequent screen.
Fn Quit	To exit the screen.

For Onestep

Description of fields

Field	Option	Description
Geoid model	Selectable list	The geoid model to be used in the transformation.
Pre Transform	Selectable list	For Twostep: The pre-transformation to use for the preliminary 3D transformation.

Field	Option	Description
Ellipsoid	Selectable list	For Twostep and Classic 3D: The ellipsoid to use in the transformation.
	Display only	For Twostep and Classic 3D: The ellipsoid being used by a fixed projection when selected in Projection .
Projection	Selectable list	For Twostep and Classic 3D: The projection to use in the transformation.
CSCS model	Selectable list	For Classic 3D: The CSCS model to use in the transformation.

Next step

OK continues to **Matched Points (n)**.

Matched Points (n)

This screen provides a list of points chosen from **WGS84 points job** and **Local pts**. The number of control points matched between both jobs is indicated in the title. Unless there is no pair of matching points in the list all softkeys are available. Refer to "41.3.4 Matching Points: Selecting/ Editing a Pair of Matching Points" for information on how to match points.

Matched Points (4) 		
WGS84 pts	Local pts	Match
101	101	P & H
200	200	P & H
300	300	P & H
400	400	P & H

3DCQ:0.016m	2DCQ:0.009m	1DCQ:0.013m	Fn	abc	14:21
Calc	New..	Edit..	Delete	Match	Auto

Key	Description
Calc	To confirm the selections, compute the transformation and continue with the subsequent screen.
New..	To match a new pair of points. This pair is added to the list. A new point can be manually occupied. Refer to " Choose Matching Points/Edit Matching Points".
Edit..	To edit the highlighted pair of matched points. Refer to " Choose Matching Points/Edit Matching Points".  If a coordinate system to be updated contains a point that was deleted from the working job and a new point was created in that job with the same point ID but different coordinates, the coordinates of the old point will still be used for the calculation. Pressing Edit.. to edit a highlighted pair of matched points containing the deleted point, will overwrite the coordinates of the old point. The coordinates of the new point will be used in the calculation.
Delete	To delete the highlighted pair of matched points from the list.
Match	To change the type of match for a highlighted pair of matched points. Refer to "41.3.4 Matching Points: Selecting/ Editing a Pair of Matching Points".

Key	Description
Auto	To scan both jobs for points that have the same point ID. Points with matching point IDs are added to the list.
Fn Quit	To exit the screen.

Description of columns

Column	Description
WGS84 pts	The point ID of the points chosen from WGS84 points job .
Local pts	The point ID of the points chosen from Local points job .
Match	<p>The type of match to be made between the points. This information is used in the transformation calculation. Position & Height, Position only, Height only or None.</p> <ul style="list-style-type: none"> For Onestep or Twostep possible options are P & H, P only, H only or None. For Classic 3D, possible options are P & H or None. <p>None removes matched common points from the transformation calculation but does not delete them from the list. This option can be used to help improve residuals.</p>

Next step

Calc computes the transformation and continues to **Check Residuals** or to **Classic 3D Parameters** if **Prompt me to enter fixed transformation parameters** was checked during the configuration.

Classic 3D Parameters

The settings on this page define the parameters to be used in a Classic 3D transformation. Refer to "Appendix J Glossary" for more information about how many transformation parameters are computed, based on the number of points common to both datum.

IF the value for a field is	THEN the value for this parameter will be
-----	calculated.
any number	fixed to that value.

Description of fields

Field	Option	Description
Model	Bursa-Wolf or Molodensky-Badakis	The transformation model to be used. Refer to standard surveying literature for details on the models.
Shift dX	Editable field	Shift in X direction.
Shift dY	Editable field	Shift in Y direction.
Shift dZ	Editable field	Shift in Z direction.
Rotation X	Editable field	Rotation around the X axis.
Rotation Y	Editable field	Rotation around the Y axis.
Rotation Z	Editable field	Rotation around the Z axis.
Scale	Editable field	Scale factor.

Next step

IF	AND	THEN
a field displays -----	the parameter must be fixed to a value	highlight the field. Fix. Enter the value of the parameter.
a field displays a value	the parameter must be calculated	highlight the field. Adjust.
all parameters are configured	-	OK computes the transformation and continues to Check Residuals .

Check Residuals

Displays a list of the matched points used in the transformation calculation and their associated residuals.

Check Residuals		
WGS84 pts	East[m]	North[m]
101	0.009!	0.004!
200	0.001	0.003
300	-0.002	-0.004
400	-0.008	-0.003

3DCQ:0.014m	2DCQ:0.008m	1DCQ:0.012m	Fn abc	14:21
OK	Result	More		

Key	Description
OK	To accept the residuals and to continue with the subsequent screen.
Result	To view results of the transformation. Refer to "41.3.5 Transformation Results for Onestep and Twostep".
More	To display information about height residuals.
Fn Quit	To exit the screen.

Description of columns

Column	Description
WGS84 pts	The point ID of the points chosen from WGS84 points job .
East	The Easting residual. If positions are not used in the transformation calculation then ----- will be displayed.
North	The Northing residual. If positions are not used in the transformation calculation then ----- will be displayed.
Height	The Height residual. If heights are not used in the transformation calculation then ----- will be displayed.
!	Indicates residuals that exceed the residual limit defined in Configuration, Residuals page.
!	Indicates the largest residual in East, North and Height .

Next step

IF the residuals are	THEN
unacceptable	ESC returns to Matched Points (n) . Matched points can be edited, deleted or temporarily removed from the list and the transformation recalculated.
acceptable	OK continues to Store Coordinate System .

Store Coordinate System, Summary page

Store Coordinate System | ↻

Name: 123

Shift dX: -674.508m

Shift dY: -16.130m

Shift dZ: -404.908m

3DCQ:0.015m 2DCQ:0.008m 1DCQ:0.012m Fn abc 14:37

Store | Coord | | | |

Key	Description
Store	To store the coordinate system to the DBX and return to Main Menu .
Page	To change to another page on this screen.
Fn Quit	To exit the screen.

Description of fields

Field	Option	Description
Name	Editable field	The name of the coordinate system can be changed. The name can be up to 16 characters in length and include spaces.
Transformation type	Display only	The type of transformation used.
No. of matched pts	Display only	Number of matched points.
Easting	Display only	Largest Easting residual from the transformation calculation.
Northing	Display only	Largest Northing residual from the transformation calculation.
Elevation	Display only	Largest Height residual from the transformation calculation.

Next step

Page changes to the **Coord system** page.

Store Coordinate System, Coord system page

Description of fields

Field	Option	Description
Residuals	None, 1/distance, 1/distance² or 1/distance^{3/2}	The method by which the residuals of the control points will be distributed throughout the transformation area.
Geoid model	Display only	Name of geoid model used.
Pre Transform	Display only	For Twostep: Name of the pre-transformation used.
Transformation	Display only	For Classic 3D: Name of transformation used.
Ellipsoid	Display only	For Twostep and Classic 3D: Name of ellipsoid used.
Projection	Display only	For Twostep and Classic 3D: Name of projection used.
CSCS model	Display only	For Classic 3D: Name of CSCS model used.

Next step

Store stores the coordinate system to the DBX and attaches it to the **WGS84 points job** selected in **Choose WGS84 & Local Jobs**, replacing any coordinate system attached to this job. **WGS84 points job** becomes the working job.

Determine Coord System

Description of fields

Field	Option	Description
Method	Onestep	<p>The type of transformation to be used when determining a coordinate system.</p> <p>Transforms coordinates directly from WGS 1984 to local grid and vice versa without knowledge about the local ellipsoid or the map projection. Procedure:</p> <ol style="list-style-type: none"> 1 The WGS 1984 coordinates are projected onto a temporary Transverse Mercator Projection. The central meridian of this projection passes through the centre of gravity of the common control points. 2 The results of 1. are preliminary grid coordinates for the WGS 1984 points. 3 These preliminary grid coordinates are matched with the local grid control points. The Easting and Northing shifts, the rotation and the scale factor between these two sets of points are then computed. This process is known as a classic 2D transformation. 4 The height transformation is a single dimension height approximation. <p>Refer to "J.20 T".</p>
	Twostep	<p>Combines the advantages of the Onestep and the Classic 3D transformation. It allows treating position and height separately, but is not restricted to smaller areas. Procedure:</p>

Field	Option	Description
	Classic 3D	<p>1 The WGS 1984 coordinates of the common control points are shifted closely to the local datum using a given Classic 3D pre-transformation. This Classic 3D transformation is typically a rough transformation valid for the country of the local datum.</p> <p>2 The coordinates are projected onto a preliminary grid, but this time using the true map projection of the local points.</p> <p>3 A 2D transformation is applied, exactly as with the Onestep transformation.</p> <p>Refer to "J.20 T".</p> <p>Also known as Helmert transformation. Transforms coordinates from WGS 1984 cartesian to local cartesian coordinates and vice versa. A map projection can then be applied to obtain grid coordinates. As a similarity transformation, it is the most rigorous transformation type and keeps the full geometrical information. Refer to "J.20 T".</p>
	Modify existing	To modify an existing determine coordinate system. Refer to "41.3.3 Modifying a Coordinate System".

Next step

IF the selected method is	THEN
Onestep, Twostep or Classic 3D	OK to access Choose WGS84 & Local Jobs . Refer to the following paragraph: Choose WGS84 & Local Jobs .
Modify existing	OK to access Coordinate Systems . Refer to "41.3.3 Modifying a Coordinate System".

41.3.3 Modifying a Coordinate System

Access **OK** in **Determine Coord System** when **Method: Modify existing**.

Coordinate Systems Select an existing coordinate system and press **OK**.

All the following steps are identical with the determination of a new coordinate system from the **Matched Points (n)** screen onwards. Refer to "41.3.2 Determining a New Coordinate System"

Description

Before calculating a transformation, it must be defined which points in **WGS84 points job** and **Local points job** are to be matched. Pairs of matched points are displayed in one line in **Matched Points (n)**. New pairs of matched points can be created, existing pairs of matched points can be edited and pairs of matched points can be deleted.

Access

Press **New..** or **Edit..** in **Matched Points (n)**.

Choose Matching Points/Edit Matching Points

Choose Matching Points | ↩

WGS84 point: 

Local point: 

Match in: ▾

3DCQ:0.024m 2DCQ:0.013m 1DCQ:0.020m Fn abc 14:23

OK | | | | Survy.. |

Key	Description
OK	To return to Matched Points (n) and to adds a new line of matched points to the matched points list.
Survy..	To manually occupy a point and store it in WGS84 points job . Available when WGS84 point is highlighted.
Fn Quit	To exit the screen.

Description of fields

Field	Option	Description
WGS84 point	Selectable list	A WGS 1984 control point.
Local point	Selectable list	A local control point.
Match in		The type of match to be made between the points selected.
	P & H, P only, H only or None.	Available for Onestep and Twostep.
	P & H or None	Available for Classic 3D.

Access

Press **Result** in **Check Residuals**.

Transformation Results, Position page

Results of the transformation between the WGS 1984 datum and the local datum are shown for each of the transformation parameters. This screen consists of the **Position** page and the **Height** page. The explanations for the softkeys given here are valid for the pages as indicated.

Transformation Results	
Position	Height
Shift dX:	249519.001m
Shift dY:	758220.240m
Rotation:	-5511.36960"
Scale:	34.6518ppm
Rotation orgn X:	3.684m
Rotation orgn Y:	5.879m
3DCQ:0.017m 2DCQ:0.008m 1DCQ:0.015m Fn abc 14:32	
OK	Scale Rms Page

Key	Description
OK	To return to Check Residuals .
Scale.. or Ppm	Available on the Position page. To switch between displaying the true scale and displaying the ppm.
Rms or Param..	To switch between the root mean square values of the parameters and the actual parameter values. The name of the screen changes to Transformation Results rms when displaying rms values.
Page	To change to another page on this screen.
Fn Quit	To exit the screen.

Description of fields

Field	Option	Description
Shift dX	Display only	Shift in X direction.
Shift dY	Display only	Shift in Y direction.
Rotation	Display only	Rotation of transformation.
Scale	Display only	Scale factor used in transformation. Either true scale or ppm.
Rotation orgn X	Display only	Position in the X direction of the origin of rotation.
Rotation orgn Y	Display only	Position in the Y direction of the origin of rotation.

Next step

Page changes to the **Height** page.

Transformation Results, Height page

Description of fields

Field	Option	Description
Slope in X	Display only	Tilt of the transformation in the X direction.
Slope in Y	Display only	Tilt of the transformation in the Y direction.

Field	Option	Description
Height shift	Display only	Shift in height between WGS 1984 datum and local datum.

Next step

OK returns to **Check Residuals**.

41.3.6

Transformation Results for Classic 3D

Access

Press **Result** in **Check Residuals**.

Transformation Results, Parameters page

Results of the transformation between the WGS 1984 datum and the local datum are shown for each of the transformation parameters. This screen consists of the **Parameters** page and the **Rotation origin** page. The explanations for the softkeys given here are valid for the pages as indicated.

The screenshot shows a handheld device screen titled "Transformation Results" with a back arrow icon. Below the title, there are two tabs: "Parameters" and "Rotation origin", with "Rotation origin" selected. The screen displays the following data:

Shift dX:	-665.283m
Shift dY:	-1.960m
Shift dZ:	-365.798m
Rotation X:	-0.97097"
Rotation Y:	-0.76252"
Rotation Z:	-0.57553"
Scale:	-5.7251ppm

At the bottom of the screen, there is a status bar with the text: "3DCQ:0.014m 2DCQ:0.008m 1DCQ:0.012m Fn abc 14:33". Below the status bar is a navigation bar with four softkeys: "OK", "Scale", "Rms", and "Page".

Key	Description
OK	To return to Check Residuals .
Scale.. or Ppm	Available on the Position page. To switch between displaying the true scale and displaying the ppm.
Rms or Param..	To switch between the root mean square values of the parameters and the actual parameter values. The name of the screen changes to Transformation Results rms when displaying rms values.
Page	To change to another page on this screen.
Fn Quit	To exit the screen.

Description of fields

Field	Option	Description
Shift dX	Display only	Shift in X direction.
Shift dY	Display only	Shift in Y direction.
Shift dZ	Display only	Shift in Z direction.
Rotation X	Display only	Rotation around the X axis.
Rotation Y	Display only	Rotation around the Y axis.

Field	Option	Description
Rotation Z	Display only	Rotation around the Z axis.
Scale	Display only	Scale factor used in transformation. Either true scale or ppm.

Next step

Page changes to the **Rotation origin** page.

Transformation Results, Rotation origin page

Description of fields

Field	Option	Description
Model	Display only	Classic 3D transformation model used for the transformation.
Rotation orgn X	Display only	Available for Model: Molodensky-Badakus . Position in the X direction of the origin of rotation.
Rotation orgn Y	Display only	Available for Model: Molodensky-Badakus . Position in the Y direction of the origin of rotation.
Rotation orgn Z	Display only	Available for Model: Molodensky-Badakus . Position in the Z direction of the origin of rotation.

Next step

OK returns to **Check Residuals**.

41.4
41.4.1

The One Point Localisation Method
Determining a New Coordinate System

Access

Press **OK** in **Choose WGS84 & Local Jobs** with **Use one point localisation method** being checked.

Set Height Mode

Key	Description
OK	To confirm the selections and to continue with the subsequent screen.
Fn Quit	To exit the screen.

Description of fields

Field	Option	Description
Transformation name	Editable field	A unique name for the transformation. The name can be up to 16 characters in length and include spaces. If a coordinate system is being updated then its name is displayed.
Transfrm Type	Display only	The type of transformation to be used when determining a coordinate system.
Height mode	Orthometric or Ellipsoidal Display only	The height mode to be used in the determination of a coordinate system. Available when determining a new coordinate system. Available when updating a coordinate system. The height mode shown is the same as the mode used in the existing system.

Next step

OK continues to **Choose System Components**.



Azimuth is used throughout this chapter. This term must always be considered to mean also **Bearing**.

Choose System Components

This screen contains different fields, depending on what method was chosen in **Determine Coord System**.

Choose System Components | ↻

Ellipsoid: Bessel

Projection: Swiss

Geoid model: <None>

CSCS model: <None>

3DCQ:0.013m 2DCQ:0.008m 1DCQ:0.011m Fn abc 14:35

OK

Key	Description
OK	To confirm the selections and to continue with the subsequent screen.
Fn Quit	To exit the screen.

For Onestep

Description of fields

Field	Option	Description
Geoid model	Selectable list	The geoid model to be used in the transformation.
Pre Transform	Selectable list	For Twostep: The pre-transformation to be used for the preliminary 3D transformation.
Ellipsoid	Selectable list	For Twostep and Classic 3D: The ellipsoid to be used in the transformation.

Field	Option	Description
	Display only	For Twostep: The ellipsoid being used by a fixed projection when selected in Projection .
Projection	Selectable list	For Twostep and Classic 3D: The projection to be used in the transformation.
CSCS model	Selectable list	For Classic 3D: The CSCS model to be used in the transformation.

Next step

OK continues to **Choose Common Point**.

Choose Common Point

Choose Common Point
↩

WGS84 point:

Local point:

Local height:

3DCQ:0.017m 2DCQ:0.009m 1DCQ:0.014m Fn abc 14:36

OK
Survy..

Key	Description
OK	To confirm the selections and to continue with the subsequent screen.
Survy..	Available for WGS84 point being highlighted. To occupy a point manually and store it in WGS84 points job .
Fn Quit	To exit the screen.

Description of fields

Field	Option	Description
Match in	Position & height	For Onestep and Twostep: How the horizontal and vertical shifts of the transformation will be computed. Position and height are taken from the same pair of matching points.
	Position only	Position is taken from one pair of matching points. The height can be taken from another pair of matching points.
WGS84 point	Selectable list	The point ID of the horizontal and/or vertical control point chosen from WGS84 points job .
Local point	Selectable list	The point ID of the horizontal and/or vertical control point chosen from Local points job .
Match height	Check box	For Onestep and Twostep: Available for Match in: Position only . Activates the determination of the vertical shift from a separate pair of matching points.

Field	Option	Description
Local height	Use WGS84 point ht or Use Local point ht	For Classic 3D: The source of the height information to use in the transformation.

Next step

For Onestep and Twostep: **OK** continues to **Determine Rotation**.

For Classic 3D: **OK** continues to **Store Coordinate System**.

Determine Rotation

For Onestep and Twostep only.

Key	Description
OK	To confirm the selections and to continue with the subsequent screen.
Inv	Available for Method: Two WGS84 points and Method: User entered . To compute an azimuth between two local points. Refer to "41.4.2 Computing Required Azimuth".
Survy..	To manually occupy a point and store it in WGS84 points job . Available when Point 1 or Point 2 are highlighted for Method: Two WGS84 points or when WGS84 point is highlighted for Method: Convergence angle .
Fn Quit	To exit the screen.

Description of fields

Field	Option	Description
Method	Use WGS84 north, User entered, Convergence angle or Two WGS84 points	Method by which the rotation angle for the transformation is determined.
Rotation	Display only	<ul style="list-style-type: none"> For Method: Use WGS84 north: Transformation will be rotated to North as defined by the WGS 1984 datum. North is 0.00000 °. For Method: Convergence angle: The rotation of the transformation calculated as 0.00000 ° minus the computed convergence angle. The field is updated as Coord system and WGS84 point are changed.

Field	Option	Description
	Editable field	<ul style="list-style-type: none"> For Method: Two WGS84 points: The rotation of the transformation calculated as required azimuth minus azimuth. The field is updated as Point 1, Point 2 and Required azimuth are changed. For Method: User entered: Allows the orientation of the transformation to be manually typed in or calculated in Compute Required Azimuth.
Coord system	Selectable list	Coordinate system to provide the direction of grid North in the area where the control point used for determining the local coordinate system, is located. Available for Method: Convergence angle .
WGS84 point	Selectable list	WGS 1984 point of which the convergence angle will be calculated. Available for Method: Convergence angle .
Point 1	Selectable list	First point to use for computation of Azimuth . Available for Method: Two WGS84 points .
Point 2	Selectable list	Second point to use for computation of Azimuth . Available for Method: Two WGS84 points .
Azimuth	Display only	Computed azimuth between Point 1 and Point 2 . Available for Method: Two WGS84 points .
Required azimuth	Editable field	The required grid azimuth, computed between two local points. Refer to "41.4.2 Computing Required Azimuth". Available for Method: Two WGS84 points .

Diagram for Onestep, Method: Convergence angle

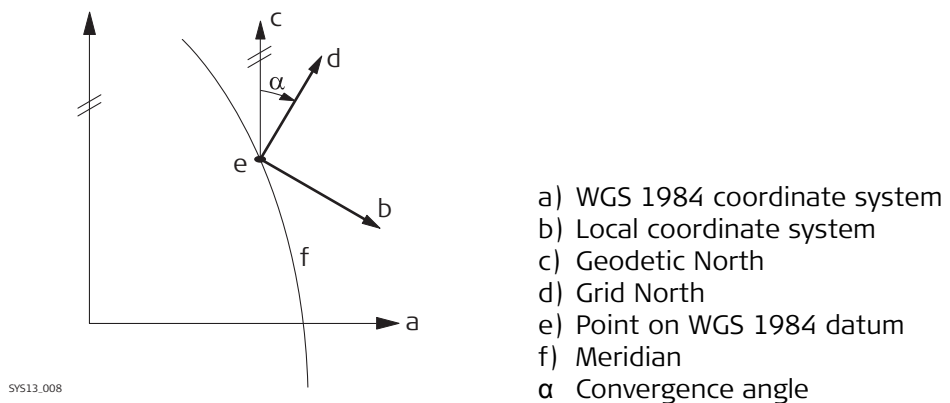

SY513.008

Diagram for Onestep, Method: Two WGS84 points

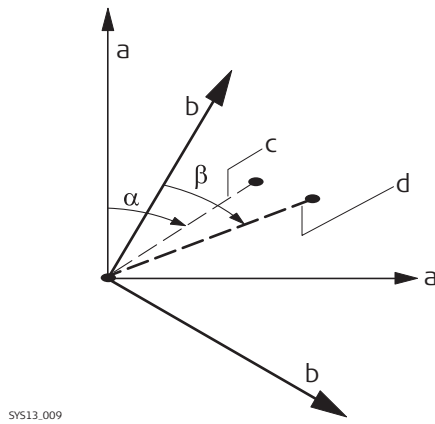

- a) WGS 1984 coordinate system
- b) Local coordinate system
- c) Line between two WGS 1984 points
- d) Line between two local points
- α Azimuth of two WGS 1984 points
- β Known azimuth or azimuth of two local points

Next step

OK continues to **Determine Scale**.

Determine Scale

For Onestep and Twostep only.

The scale is calculated using the formula $(r + h)/r$ where

r is the distance from the centre of the ellipsoid to the WGS 1984 point selected in **Choose Common Point**, and

h is the height of this point above the WGS 1984 ellipsoid.

Determine Scale | ↩

Method:

WGS84 point:

Scale: 0.9999262

(Reducing points to the ground)

3DCQ:0.012m 2DCQ:0.007m 1DCQ:0.010m Fn abc 14:39

OK | **Ppm**

Key	Description
OK	To confirm the selections and to continue with the subsequent screen.
Grid..	Available Twostep and for Method: Combined SF . To compute the grid scale factor. Refer to "41.4.3 Computing the Grid Scale Factor".
Hgt..	Available Twostep and for Method: Combined SF . To compute the height scale factor. Refer to "41.4.4 Computing the Height Scale Factor".
Scale or Ppm	To switch between displaying the true scale and displaying the ppm.
Survy..	To manually occupy a point and store it in WGS84 points job . Method: Convergence angle when WGS84 point is highlighted.
Fn Quit	To exit the screen.

Description of fields

Field	Option	Description
Method	Known WGS84 pt, Known WGS84 ht or User entered	Available for Onestep: Method of determining the scale factor of the transformation.
	User entered or Combined SF	Available for Twostep. The default method for determining the Combined Scale Factor to be used in the transformation process.
Scale (Reducing points to the ground)	Editable field	Available for Onestep. Allows the scale factor to be typed in manually. Available for Method: User entered .
	Display only	Available for Onestep. The calculated scale factor. Available for Method: Known WGS84 pt and Method: Known WGS84 ht .
WGS84 point	Selectable list	Available for Onestep. WGS 1984 point from which the scale factor will be calculated. The scale factor is calculated using the height of the known WGS 1984 point. Available for Method: Known WGS84 pt .
Known height	Editable field	Available for Onestep. The WGS 1984 height of a point can be typed in. The scale factor is calculated using this height. Available for Method: Known WGS84 ht .
Grid SF	Display only	Available for Twostep and Method: Combined SF . The grid scale factor as computed in Compute Grid Scale Factor . Refer to "41.4.3 Computing the Grid Scale Factor".
Height SF	Display only	Available for Twostep and Method: Combined SF . The height scale factor as computed in Compute Height Scale Factor . Refer to "41.4.4 Computing the Height Scale Factor".
Combined SF	Editable field	Available for Twostep. The combined scale factor of the transformation. Available for Method: User entered . The scale factor can be typed in.
	Display only	Available for Method: Combined SF . The product of the grid scale factor and the height scale factor.

Next step

OK continues to **Store Coordinate System**.

Store Coordinate System

Store Coordinate System	
Name:	123
Shift dX:	-674.508m
Shift dY:	-16.130m
Shift dZ:	-404.908m

3DCQ:0.015m	2DCQ:0.008m	1DCQ:0.012m	Fn abc	14:37
Store	Coord			

Key	Description
Store	To store the coordinate system to the DBX, attach the system to WGS84 points job that was selected in Choose WGS84 & Local Jobs and return to Main Menu .
Scale or Ppm	For Onestep and Twostep. To switch between displaying the true scale and displaying the ppm.
Coord	For Classic 3D: To view other coordinate types.
Fn Quit	To exit the screen.

For Onestep

Description of fields

Field	Option	Description
Name	Editable field	A unique name for the coordinate system. The name can be up to 16 characters in length and include spaces.
Shift dX	Display only	For Onestep and Twostep: Shift in X direction.
Shift dY	Display only	For Onestep and Twostep: Shift in Y direction.
Shift dZ	Display only	For Classic 3D: Shift in Z direction.
Rotation	Display only	For Onestep and Twostep: Rotation of transformation.
Scale	Display only	For Onestep and Twostep: Scale factor of transformation.
Rotation orgn X	Display only	For Onestep and Twostep: Position in the X direction of the origin of rotation.
Rotation orgn Y	Display only	For Onestep and Twostep: Position in the Y direction of the origin of rotation.

Next step

Store stores the coordinate system and returns to **Main Menu**.

Description

Available for:

- One Point Localisation method with Onestep or Twostep transformation.
- **Method: Two WGS84 points** and **Method: User entered** in **Determine Rotation**.

Allows two local points to be chosen from local job between which the required azimuth will be computed. This azimuth is then used with an azimuth computed between two WGS 1984 points chosen from the WGS84 job to calculate the rotation of the transformation.

The computed required azimuth appears in the **Required azimuth** field for **Method: Two WGS84 points** and the **Rotation** field for **Method: User entered** in **Determine Rotation**.

Access

Press **Inv** in **Determine Rotation**.

Compute Required Azimuth

From: 400

To: 400

Azimuth: -0--'

3DCQ:0.014m 2DCQ:0.008m 1DCQ:0.011m Fn abc 14:48

OK

Key	Description
OK	To calculate the required azimuth and return to the screen from where this screen was accessed.
Fn Quit	To exit the screen.

Description of fields

Field	Option	Description
From	Selectable list	The point ID of the first known point for the azimuth calculation.
To	Selectable list	The point ID of the second known point for the azimuth calculation.
Azimuth	Display only	The calculated azimuth.

Next step

OK returns to **Determine Rotation**.

Description

For One Step Localisation method with Twostep transformation. Calculates the grid scale factor. The grid scale factor is the scale factor of the point chosen, relative to the projection being used.

Access

Press **Grid..** in **Determine Scale**.

Compute Grid Scale Factor

Key	Description
OK	To confirm the selections and return to the screen from where this screen was accessed.
Scale or Ppm	To switch between displaying the true scale and displaying the ppm.
Fn Quit	To exit the screen.

Description of fields

Field	Option	Description
Method	User entered	Method by which the grid scale factor is to be calculated. Grid scale factor can be manually typed in.
	Known local pt	Grid scale factor is computed using the position of a known local point.
Local point	Selectable list	Available for Method: Known local pt . The point ID of the point chosen from the local job from which the grid scale factor is computed using the projection selected.
Grid SF	Editable field	The grid scale factor. Available for Method: User entered . To type in the grid scale factor.
	Display only	Available for Method: Known local pt . The computed grid scale factor.

Next step

OK returns to **Determine Scale**.

Description

For One Point Localisation method with Twostep transformation. Calculates the height scale factor of the point chosen.

Access

Press **Hgt..** in **Determine Scale.**

Compute Height Scale Factor

Compute Height Scale Factor | ↻

Method:

Local point:

Height SF: 0.9999334
(Reducing points to the ground)

3DCQ:0.012m 2DCQ:0.007m 1DCQ:0.010m Fn abc 14:51

OK | Ppm

Key	Description
OK	To confirm the selections and return to the screen from where this screen was accessed.
Scale or Ppm	To switch between displaying the true scale and displaying the ppm.
Fn Quit	To exit the screen.

Description of fields

Field	Option	Description
Method	User entered	Method by which the height scale factor is to be calculated. Height scale factor can be manually typed in.
	Known local pt	Height scale factor is computed using the position of a known local point.
	Known local ht	Height scale factor is computed using an entered height value.
Known Point	Selectable list	Available for Method: Known local pt . The point ID of the point chosen from the local job from which the height scale factor is computed.
Known height	Editable field	Available for Method: Known local ht . A known local height.
Height SF	Editable field	The height scale factor. Available for Method: User entered . To type in the height scale factor.
	Display only	Available for Method: Known local pt and Method: Known local ht . The computed height scale factor.

Next step

OK returns to **Determine Scale.**



For an overview of determine coordinate systems, refer to "41.1 Overview"

Description

QuickGrid is designed to allow for quick coordinate system determination on site. Particularly for those users who must combine GPS and TPS data. All points must be measured by GPS, and therefore this method is not available in TPS mode. There are five different methods to choose from, Single point, Multi point, Single point from base, Orientate to line & Quickshift.

Access

Select **Main Menu: Go to Work!\Survey+\QuickGrid.**

Choose QuickGrid Method

Description of fields

Field	Option	Description
Method	Single point	This method is fast and targeted at the basic customer who wants to set up a local coordinate system based on a single point. The orientation is fixed to WGS 1984 north. A height scale is applied to bring GPS distances to "ground" using measured point WGS 1984 height.
	Multiple points	This method is fast and targeted at the more rigorous customer who wants to set up a local coordinate system based on multiple points. Rotation and scale are as calculated.
	Single point base	This method is fast and targeted at the basic customer who wants to set up a local coordinate system based on the base station position. The orientation is fixed to WGS 1984 north. A height scale is applied to bring GPS distances to "ground" using measured point WGS 1984 height.
	Orientate to line	This method is fast and targeted at the more advanced customer who wants to set up a local coordinate system based on a single point, but set the orientation of the resulting grid by measuring a second point. The rotation is as calculated. A height scale is applied to bring GPS distances to "ground" using measured point WGS 1984 height.
	QuickShift	This method is fast and targeted at the more advanced customer who wants to shift their existing coordinate system based on a single point. A 3D transformation is calculated.

Next step

IF the selected method is	THEN
Single point, Multiple points, Single point base or Orientate to line	OK to access Define Local Quickgrid Point . Refer to paragraph Define Local Quickgrid Point .
QuickShift	OK to access Select Coordinate System . Refer to paragraph Select Coordinate System .

Select Coordinate System

This screen is only available for **Method: QuickShift**.

Select Coordinate System | ↻

Select coordinate system to be shifted

Coord system:

Transformation: Local

Ellipsoid: Bessel

Projection: Swiss

Geoid model: <None>

CSCS model: <None>

3DCQ:0.016m 2DCQ:0.009m 1DCQ:0.014m abc 14:18

OK

Key	Description
OK	To confirm the selections and to continue with the subsequent screen.
Fn Quit	To exit the screen.

Description of fields

Field	Option	Description
Coord system	Selectable list	Select the coordinate system to be shifted.
Transformation	Display only	The type of transformation.
Ellipsoid	Display only	The coordinates are based on this ellipsoid.
Projection	Display only	The map projection.
Geoid model	Display only	The geoid model.
CSCS model	Display only	The Country Specific Coordinate System model.

Next step

OK accesses **Define Local Quickgrid Point**.

Define Local Quick-grid Point

Define Local Quickgrid Point	
Local point:	From working job
Point ID:	400
Easting:	762455.052m
Northing:	242995.406m
Elevation:	424.725m
<input checked="" type="checkbox"/> Use geoid	
Geoid model:	<None>

3DCQ:0.015m 2DCQ:0.007m 1DCQ:0.013m abc 14:16

OK

Key	Description
OK	To confirm the selections and to continue with the subsequent screen.
Fn Quit	To exit the screen.

Description of fields

Field	Option	Description
Local point	User entered	The local QuickGrid point is entered by the user.
	From working job	The local QuickGrid point is selected from the working job.
	From control job	The local QuickGrid point is selected from the control job.
Point ID	Editable field Selectable list	The point ID of the local QuickGrid point. For Local point: User entered . For Local point: From working job and Local point: From control job .
Easting	Editable field	The Easting coordinate of the local QuickGrid point. For Local point: User entered .
	Display only	For Local point: From working job and Local point: From control job .
Northing	Editable field	The Northing coordinate of the local QuickGrid point. For Local point: User entered .
	Display only	For Local point: From working job and Local point: From control job .
Elevation	Editable field	The orthometric height of the local QuickGrid point. For Local point: User entered .
	Display only	For Local point: From working job and Local point: From control job .
Ignore local height & use WGS84 height	Check box	When this box is checked, no height adjustment is calculated. When this box is not checked, a height adjustment is calculated.
Use geoid	Check box	Check this box to select a geoid model for the calculation.

Field	Option	Description
Geoid model	Selectable list	Available when Use geoid is checked. To select a geoid model.

Next step

OK accesses **Measure QuickGrid Point**.

42.2

Determining a New Coordinate System

Access

Press **OK** in **Define Local Quickgrid Point**.

Measure QuickGrid Point

This screen is similar to the standard Survey screen. Refer to "56.1.2 Real-Time Rover Operations".

Next step

- For **Method: Multiple points**: After measuring and storing a point, **Matched Pts & Residuals** is accessed.
- For **Method: Orientate to line**: Measure the points of the line. Then **Store Coordinate System** is accessed.
- For all other QuickGrid methods: After measuring and storing a point, **Store Coordinate System** is accessed.

Matched Pts & Residuals

This screen shows what points have been matched so far. More points can be added, matched points can be deleted.

Matched Pts & Residuals			
WGS84 pts	Match	East[m]	North[m]
GPS0004	P & H	0.000	0.000

3DCQ:0.020m	2DCQ:0.011m	1DCQ:0.016m	abc	14:22
OK	New..	Match	Rmove	More

Key	Description
OK	To confirm the selections, compute the transformation and continue with the subsequent screen.
New..	To survey another point and return to the Survey screen.
Match	To change the type of match for the highlighted point.
Delete	To delete the highlighted point from the list.
More	To display information about height residuals.
Fn Quit	To exit the screen.

Description of columns

Column	Description
WGS84 pts	The point ID of the points chosen from WGS84 points job .

Column	Description
Match	The type of match to be made between the QuickGrid point and the surveyed point. This information is used in the transformation calculation. Position & Height , Position only , Height only or None .
East, North and Height	The residuals of the matched points.

Next step

Press **New..** to return to **Measure QuickGrid Point** and to survey another point for the calculation.

Press **OK** to continue with **Store Coordinate System**.

Store Coordinate System, Summary page

The available fields, keys and pages depend on the selected QuickGrid method.

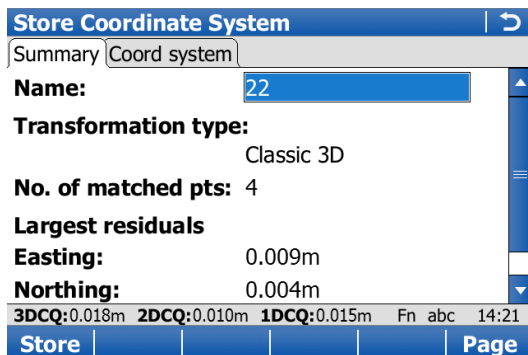

Key	Description
Store	To store the coordinate system and to exit the Determine Coordinate System application.
Page	To change to another page on this screen.
Fn Quit	To exit the screen.

Description of fields

Field	Option	Description
Name	Editable field	The name of the new coordinate system.
No. of matched pts	Display only	Available for Multiple points . The number of matched points.
Largest residuals East, North and Height	Display only	Available for Multiple points . The largest residuals of the transformation.
Rotation from north	Display only	Available for Orientate to line . The rotation is shown in the configured angle units.
Shift dX	Display only	Available for QuickShift . Shift in X direction.
Shift dY	Display only	Available for QuickShift . Shift in Y direction.
Shift dZ	Display only	Available for QuickShift . Shift in Z direction.

Next step

Page changes to the **Coord system** page.

Store Coordinate System, Coord system page

The available fields, keys and pages depend on the selected QuickGrid method.

Store Coordinate System | ↩

Summary | Coord system

Transformation: Local
Ellipsoid: Bessel
Projection: Swiss
Geoid model: <None>
CSCS model: <None>

3DCQ:0.014m 2DCQ:0.008m 1DCQ:0.012m abc 14:20

Store | | | | Page

Key	Description
Store	To store the coordinate system and to exit the Determine Coordinate System application.
Page	To change to another page on this screen.
Fn Quit	To exit the screen.

Description of fields

Field	Option	Description
Residuals	None	For Multiple points . The method by which the residuals of the control points will be distributed throughout the transformation area. No distribution is made. Residuals remain with their associated points.
	1/distance, 1/distance² or 1/distance^{3/2}	Distributes the residuals according to the distance between each control point and the newly transformed point.
	Multiquadratic	Distributes the residuals using a multiquadratic interpolation approach.
Transformation	Display only	Available for QuickShift . The type of transformation.
Ellipsoid	Display only	Available for QuickShift . The coordinates are based on this ellipsoid.
Projection	Display only	Available for QuickShift . The map projection.
Geoid model	Display only	Available for Multiple points and QuickShift . The geoid model used.
CSCS model	Display only	Available for QuickShift . The Country Specific Coordinate System model.

Next step

Store saves the new coordinate system.

Description

The Reference Line application can be used to set out or measure points relative to a line.

Reference line tasks

The Reference Line application can be used for the following tasks:

- Measuring to a reference line where the coordinates of a design point can be calculated from its position relative to the defined reference line.
- Staking to a reference line where the position of a design point is known and instructions to locate the point are given relative to the reference line.
- Gridstaking a reference line where a grid can be staked relative to a reference line.
- Viewing the position relative to a slope defined from the reference line.

Other functionality available includes:

- Shifting the reference line with parallel offsets.
- Referencing to a specific segment of a line.
- Reversing the direction of a reference line.

Activating the application

If the message panel appears which requires that the application must be activated via a license key then refer to "30.3 Load licence keys".



Measuring and staking out of points is possible for GPS and TPS.

Point types

Reference lines/arcs can be created from points stored as:

- WGS 1984 geodetic
- Local grid

A local grid must always be available when using the application.

Terms

Reference point: Used in this chapter to refer to the point from which the perpendicular offset, from the reference line to the design point, is measured.

Design point: The design point.

- For measuring to a reference line, this term refers to the point with the coordinates of the current position and the designed or calculated height.
- For staking or grid staking to a reference line, this term refers to the point to be staked, defined by the user

Measured point: The current position.

Line:

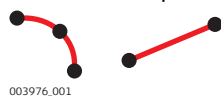

A line can be a straight line between two points, an arc or a multi-point line made up of multiple individual line sections. It may be constructed by joining many "point to points", by creating the sections segment-by-segment, or by creating an alignment.

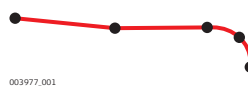

Line segment:



A line segment is an individual component of a multi-line such as a polyline or an alignment. The segment can be a straight or an arc.

Preparing the data

Line data can be created by one of the following methods:

Method	Description
Create lines onboard	
 The Reference Line application supports DBX polylines. Lines created with SmartWorx Viva 4.50 or higher are DBX polylines. DBX areas can be also used as closed polylines.	
Data management	Refer to "6 Jobs & Data - Data".
Create Control Data	Lines can be created using the Create line function. Refer to "Create new line/arc".
Tap Map	From Tap Map, lines can be created, imported or selected to be used in Reference Line. Refer to "38 Tap Map".
Survey linework	Lines can be created by measuring points in the field. Lines can be made using the linework commands in the Survey page. Also, taking measurements with line objects open as well using Jobs & Data or line codes can create lines.
Road data in Alignment Editor	Using the Alignment Editor application, a simple centreline alignment can be created and be imported.  Only straight and curve elements are supported. The alignment created with the Alignment Editor application has to be converted to a RoadRunner Job.
Import lines	
Import an individual line from DXF background map	Using a DXF file attached as a background map, lines can be selected and imported within the map screens of Tap Map, Survey or Reference Line applications.
Import all objects including lines from DXF	Copy the DXF files to the \Data directory on the data storage device of the Viva Series instrument. Once the card is back in the instrument the DXF import program can be used to bring the lines into the job.
Import from XML	Copy the DXF files to the \Data directory on the data storage device of the Viva Series instrument. Once the card is back in the instrument the XML import program can be used to bring the lines into the job.
Import Road alignments	The Import alignment data application in Jobs & Data supports various different formats like dxf, LandXml, MxGenio, Terramodel, Carlson.
Create lines externally	
Leica Geo Office	Refer to LGO Online Help.
Design to Field	Using the Design to Field tool of Leica Geo Office, the user is able to bring in lines from multitudes of formats. For example, XML, DXF, Microstation XML and many more. Refer to LGO Online Help for information on Design to Field.
Some 3 rd party software export to Leica database	-



Refer to "Appendix C Directory Structure of the Memory Device" for the placements of the data files on the data storage device.

Defining chainage

The chainage of the start point of a reference line can be defined.

Coordinate systems

Lines and points defining the lines can be read from the control job using the active coordinate system. For this reason, the coordinate system in the control job must match the active one in the working job.

If using TPS, select the **<None>** or a local grid coordinate system.

If using GPS, a local grid coordinate system must be used. Working in WGS84 coordinates is not supported. Measured WGS84 coordinates are converted to grid using the active coordinate system.

It is possible to use a valid coordinate system, but have the line or part of it lying outside the projection or CSCS model being used.

In these cases, the field values relating to the difference in coordinates between the design point and current position are shown as -----.



Azimuth is used throughout this chapter. This term must always be considered to mean also **Bearing**.

Direction of values

The following diagram shows the direction of positive and negative values for distance and height differences between the design point and the reference point for reference lines.

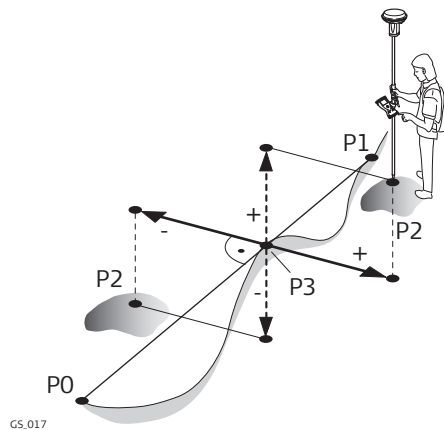

GPS

- P0 Start point
- P1 End point
- P2 Design point
- P3 Reference point

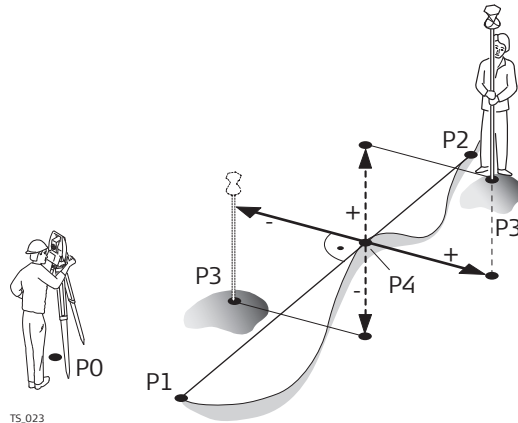

TPS

- P0 Instrument station
- P1 Start point
- P2 End point
- P3 Design point
- P4 Reference point

Shifts

A reference line can be shifted. A shift is permanently applied to the reference line for the duration of the Reference Line task.

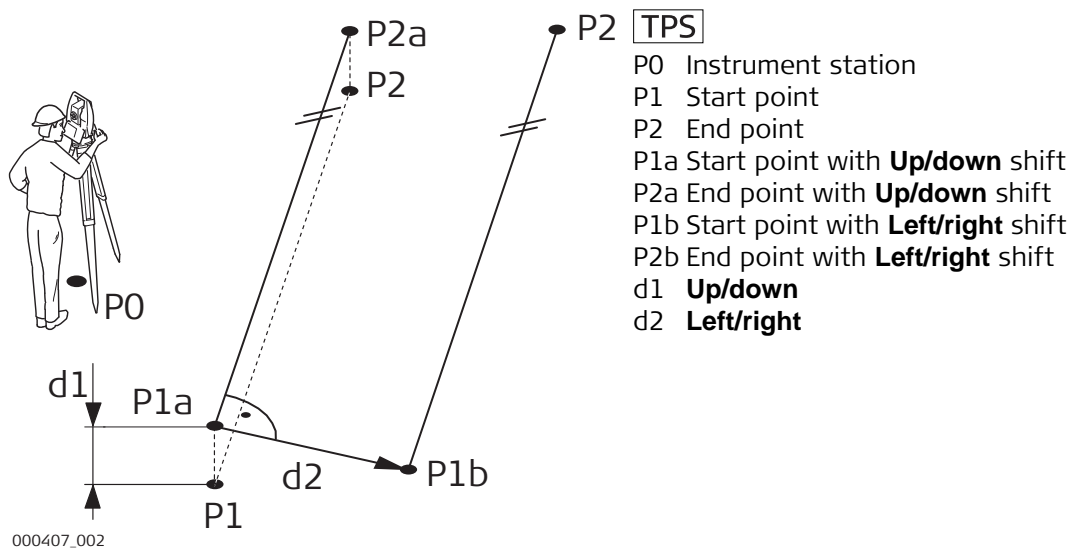
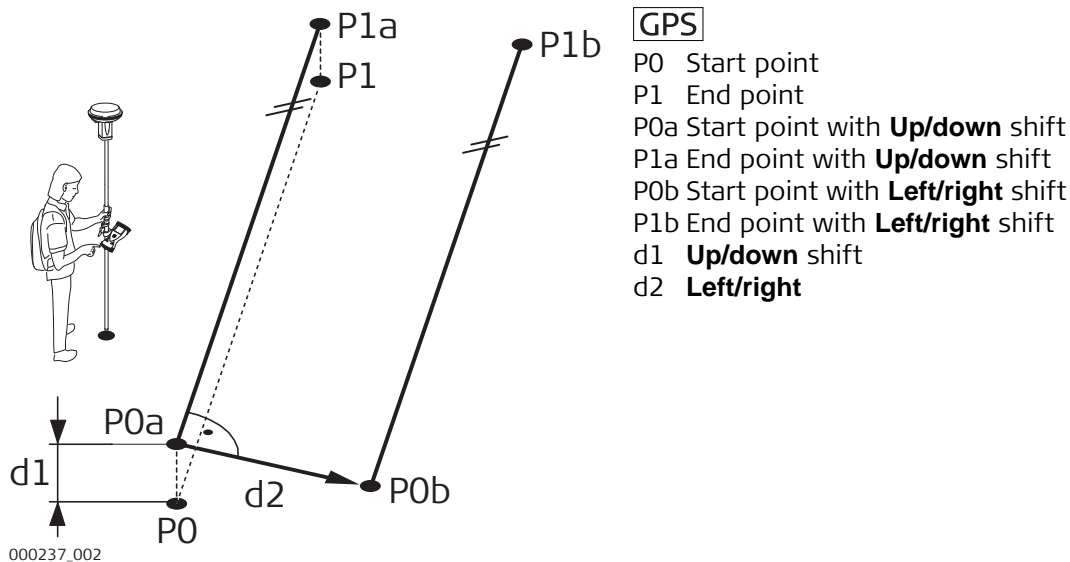

Access

- For measuring tasks:
Select **Main Menu: Go to Work!\Survey+\Measure to ref line.**
- For staking tasks:
Select **Main Menu: Go to Work!\Stakeout+\Stake to ref line.**
- From Tap Map:
Tap & hold on a line from the displayed job or attached CAD. Select **Use in Reference Line** from the context menu. Select how to enter the application: **Stake task selection, Measure task selection, Stake line, Measure line with slope, Measure line, Stake line with slope**

Job Selection

Job Selection | ↻

Choose control job: Innsbruck

Choose a DTM

3DCQ:-:---m 2DCQ:-:---m 1DCQ:-:---m Fn abc 15:03

OK

Key	Description
OK	To select the highlighted option and to continue with the subsequent screen.
Fn Config..	To configure the Reference Line application.
Fn Quit	To exit the screen.

Description of fields

Field	Option	Description
Choose control job	Selectable list	The reference lines are stored in this job.  The measurements are stored to the working job. The coordinate systems in the control job and in the working job must match, otherwise a warning message appears to prevent any further step.
Use a DTM job	Check box	When this box is checked, a DTM job can be selected. A DTM job holds DTM (Digital Terrain Model) or TIN (Triangular Irregular Network) data. The files are stored in the \DBX folder or a subfolder of \DBX.
DTM job	Selectable list	Holds DTM (D igital T errain M odel) data or TIN (T riangular I rrregular N etwork) data. The DTM job to be used must be stored in the \DBX directory on the active memory device. The DTM job is a read-only source of information and cannot be selected as a working or control job.

Field	Option	Description
DTM layer	Selectable list	To choose the DTM layer.

Next step

OK accesses **Reference Line Task**.

Reference Line Task

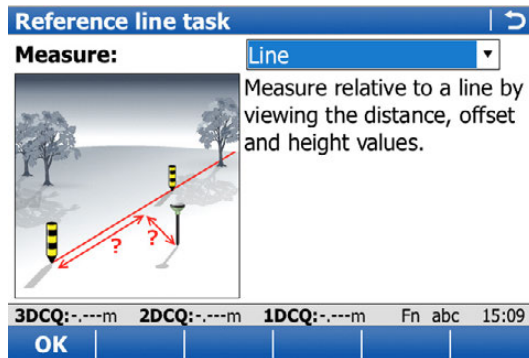

Key	Description
OK	To select the highlighted option and to continue with the subsequent screen.
Fn Config..	To configure the Reference Line application.
Fn Quit	To exit the screen.

Description of the Reference Line tasks

For measuring to a reference line

Task	Description
Line	Measure relative to a line by viewing the distance, offset & height values.
Line with slope	Measure relative to a line by viewing the distance, offset & height values. Additionally view position relative to a defined slope from the line.
Segment	Measure relative to a line segment by viewing the distance, offset & height values. A segment may be an individual straight or arc, or a segment within a line.
Segment with slope	Measure relative to a line segment by viewing the distance, offset & height values. Additionally view position relative to a defined slope from the line.
Quick Line	Create a temporary line from 2 points & measure relative to it by viewing the distance, offset & height values.

For staking to a reference line

Task	Description
Line	Stakeout relative to a line by defining the distance, offset & height.
Line with slope	Stakeout relative to a line by defining the distance, offset & height. Additionally view position relative to a defined slope from the line.

Task	Description
Grid	Define & stakeout a grid of points relative to a line.
Segment	Stakeout relative to a line segment, by defining the distance, offset & height. A segment may be an individual straight or arc, or a segment within a line.
Segment with slope	Stakeout relative to a line segment, by defining the distance, offset & height. Additionally view position relative to a defined slope from the line.
Quick Line	Create a temporary line from 2 points & stakeout relative to it by defining the distance, offset & height.

Next step

OK accesses **Define Line**.

43.3

Configuring Reference Line

Access

Press Fn **Config..** in the input screens of the Reference Line application.

Configuration, General page

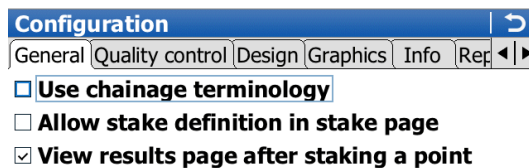

Key	Description
OK	To accept changes and return to the screen from where this screen was accessed.
Page	To change to another page on this screen.
Fn About	To display information about the application name, the version number, the date of the version, the copyright and the article number.
Fn Quit	To exit the screen.

Description of fields

Field	Option	Description
Use chainages	Check box	Activates the use of chainages within the reference line application. If this is deactivated, Dist along line will be used for data input purposes.
Allow stake definition in stake page	Check box	When this box is checked, stake values can be defined on the Stake page.

Field	Option	Description
Always enable editing of design height	Check box	When this box is checked, the design height can be changed manually for Heights to use: From line or Heights to use: Start point . Available when Allow stake definition in stake page is checked.
View results page after staking a point	Check box	When this box is checked, the stake results are displayed after staking a point.
Only update stakeout values when distance is measured	Check box	TPS When this box is checked, angles and stakeout values are updated after a distance was measured. Then all values are frozen until the next distance is taken.
Turn to point automatically	Check box	TPS When this box is checked, the instrument positions automatically to the point to be staked.
Turn to	Selectable list	TPS Available when Turn to point automatically is checked.
	Position only	TPS Instrument positions horizontally to the point to be staked.
	Position & height	TPS Instrument positions horizontally and vertically to the point to be staked.
Use two face measurements	Check box	TPS To take a measurement in Face I and Face II. The point stored is an average of the two measurements. When using instruments fitted with auto aiming, the point is automatically measured in both faces. The resulting point is stored and the instrument is returned to the first face.

Next step

Page changes to the **Quality control** page.

Configuration, Quality control page

Description

Especially when checking points it is useful to enable the **Quality control** criteria available. For every point stored the chosen parameters are checked. When **Quality control** criteria is fulfilled, green ticks are shown in the stake page, and the measured point can be directly stored. If the check limits are exceeded a warning is shown. This function guarantees a higher productivity as it is no longer necessary to check the values for every shot taken.

Description of fields

Field	Option	Description
Check deltas to point before storing (set Limit to 0 if you wish to always be shown differences before storing)	Check box	When this box is checked, a position check is done when storing a staked point. When the defined tolerance is exceeded, the stake out can be repeated, skipped or stored. When this box is not checked, no quality check is done during stake out of points.

Field	Option	Description
Delta values		 Depending on this selection the following lines are enabled/disabled.
	Ch, offset & height	Check for chainage, horizontal offset and height.
	Ch & offset	Check for chainage and horizontal offset.
	Position & height	Check for 2D position and height.
	Position	Check for 2D position.
Height	Check for height.	
Chainage limit	From 0.001 to 100	Maximum difference in chainage.
Offset limit	From 0.001 to 100	Maximum horizontal offset from defined position.
Position limit	From 0.001 to 100	Maximum radial horizontal distance.
Height limit	From 0.001 to 100	Maximum height difference.

Next step

Page changes to the **Design** page.

Configuration, Design page

On this page, additional design points to be staked are set. Refer to "43.6 Staking to a Reference Line" for a graphic.

Description of fields

Field	Option	Description
Horizontal (PC, PT, AP)	Check box	Horizontal type points occur at the junction between two segments in a line.
Mid curve (MCP)	Check box	Occurs in arc segments.
Curve radius (RP)	Check box	Occurs in arc segments.
Offset bisected point (BP)	Check box	Occurs when the junction between two segments in a line is not tangent AND when offsets are active.
Offset in average direction (Avg)	Check box	Occurs when the junction between two segments in a line is not tangent AND when offsets are active.
Vertical (VPI, Low, High, VPC, VPT)	Check box	Vertical type points occur at the junction between two segments in the vertical alignment of the line, or when a high or low element is found. Example: In a curve between two grades

Description of fields

Field	Option	Description
Navigate direction		The reference direction to be used to stakeout points. The stakeout elements and the graphical display shown in the Reference Line application are based on this selection.
	From instrument	[TPS] The direction of the orientation is from the instrument to the point to be staked.
	To instrument	[TPS] The direction of the orientation is from the point to be staked to the instrument.
	To north	[GPS] The North direction shown in the graphical display based on the active coordinate system.
	To sun	[GPS] The position of the sun calculated from the current position, the time and the date.
	To last point	Time-wise, the last recorded point.
	To point (cntrl job)	A point from the control job selected in Job Selection .
	To point	A point from the working job.
	To reference line	The direction of the orientation is parallel to the reference line.
	Following arrow	The direction of the orientation is from the current position to the point to be staked. The graphical display shows an arrow pointing in the direction of the point to be staked.
Point	Selectable list	Available for Navigate direction: To point (cntrl job) and Navigate direction: To point . To select the point to be used for orientation.
Navigate using		The method of staking out.
	Direction & distance In/out, left/right	The direction from the orientation reference, the horizontal distance and the cut/fill is displayed. The distance forwards/backwards to the point, the distance right/left to the point and the cut/fill is displayed.
Switch to bulls eye when 0.5m from target	Check box	When this box is checked, a bulls eye bubble is shown in the stakeout graphic when less than half a metre from the point being staked.
Beep faster when getting close to point	Check box	The instrument beeps when the horizontal radial distance from the current position to the point to be staked, is equal to or less than defined in Start within .
Distance to use	Height	The distance in height is used as indicator.
	Horizontal distance	The distance from Easting and Northing is used as indicator.
	Position & height	The distance from Easting, Northing and Height is used as indicator.

Field	Option	Description
Start within	Editable field	The horizontal radial distance from the current position to the point to be staked when a beep will be heard.

Next step

Page changes to the **Info** page.

Configuration, Info page

Two things can be configured on this page:

- 1) The required information for the stake or measure method to be displayed on the **Info** page.
- 2) If and which additional user-defined survey screen page is displayed.

Key	Description
OK	To confirm the changes and continue.
Clear	To clear all parameters from all lines.
Default	To set the default value for all lines.
Fn About	To display information about the application name, the version number, the date of the version, the copyright and the article number.
Fn Quit	To exit the screen.

Description of fields

Field	Option	Description
Show additional page from My Survey Screen	Check box	Shows a selectable list for the survey screen pages.
Page to show	Selectable list	The user-defined survey screen page to be shown. All survey screens defined in My Survey Screen Settings can be selected.
Method	Display only	The method is based on the selected Reference Line task. The settings in the following lines can only be changed for the current task. The method defines the parameters available to view on the Info page of the application. Different combinations of the parameters to view can be stored.
1st line to 16th line	Selectable list	To modify the selection on any particular line, place the cursor on the line to modify using the arrow keys and press the ENTER key. Use the arrow keys to select the required parameter and press the ENTER key to confirm the choice. Define which parameters are viewed on each line. Up to 16 lines of parameters can be defined.  Some of the options are explained in graphics in the following chapters.
	Always available	
	Point ID	To enter the point ID.

Field	Option	Description
	Antenna height	GPS To enter the antenna height.
	Target height	TPS To enter the target height.
	Code	Editable field for codes.
	Code desc (free)	Displays the description of free codes.
	Attrib 01 and Attrib 02	Editable field for attributes for codes.
	Chainage	Displays the current chainage.
	Dist along line	Displays the horizontal distance from the start point to the reference point along the reference line.
	Line offset	Displays the horizontal offset perpendicular from the line to the current position.
	Line height diff	Displays the height difference from the defined line to the current position.
	Line name	Displays the name of the reference line.
	Line type	Displays the line type as straight, arc or polyline.
	Easting	Displays the Easting coordinate of the current position.
	Northing	Displays the Northing coordinate of the current position.
	Height	Displays the height of the current position.
	Quality 3D	GPS Display only field for the current 3D coordinate quality of computed position.
	Cut/fill	Displays the height difference between the design height and the measured height.
	Line space full	Insert full line space.
	Line space half	Insert half line space.
	For measure with/without slope also available	
	Dist to start point	Displays the horizontal distance from the measured point to the start point of the line.
	Dist to end point	Displays the horizontal distance from the measured point to the end point of the line.
	Line dist to end	Displays the horizontal distance from the end point of the line to the base point of the measured point, along the line.
	Perp distance	Displays the slope distance between the reference point and the measured point, perpendicular to the reference line. Not displayed when shifts are applied.
	Perp ht to line	Displays the height difference perpendicular from the reference line to the horizontal base point. Not displayed when shifts are applied.
	Spatial dist	Displays the slope distance between the start point and the reference point. Not displayed when shifts are applied.
	For stake with/without slope also available	

Field	Option	Description
	Δ dist along line	Displays the horizontal distance along the reference line from the current position to the defined design point.
	Δ chainage	Displays the difference between the defined chainage and the current chainage.
	Δ height	Displays the vertical offset between the defined position and the current position.
	Defined chainage	Displays the defined chainage of the point to be staked out.
	Defined line dist	Displays the defined horizontal distance along the reference line from the start point to the design point.
	Defined offset	Displays the defined horizontal offset perpendicular from the reference line to design point.
	Direction to point	Displays the direction from the current position to the design point.
	Distance to point	Displays the distance from the current position to the design point.
	Design easting	Displays the Easting of the design point.
	Design northing	Displays the Northing of the design point.
	Design height	Displays the height of the design point, depending on the defined heights to use.
	For slope only also available	
	Slope ratio meas	Displays the ratio of the slope from the current position to the hinge.
	Slope ratio defined	Displays the ratio of the slope from the design point to the hinge, as defined by the user.
	Slope dist hinge	Displays the slope distance offset from the hinge to measured point.
	Slope dist line	Displays the slope distance offset from line to measured point.
	Slope height diff	Displays the height difference between the current position and the height of the slope at that position. A cut is above the slope. A fill is below the slope.
	Hinge offset	Displays the horizontal offset from the hinge point of the slope to the current position.
	Hinge height diff	Displays the height difference from the hinge point of the slope to the current position.

Next step

Page changes to the **Report sheet** page.

Description of fields

Field	Option	Description
Create report sheet	Check box	To generate a report sheet when the application is exited. A report sheet is a file to which data from an application is written to. It is generated using the selected format file.
Report sheet	Selectable list	Available when Create report sheet is ticked. The name of the file to which the data will be written. A report sheet is stored in the \DATA directory of the active memory device. The data is always appended to the file. Opening the selectable list accesses the Report Sheets screen. On this screen, a name for a new report sheet can be created and an existing report sheet can be selected or deleted.
Format file to use	Selectable list	Available when Create report sheet is ticked. A format file defines which and how data is written to a report sheet. Format files are created using LGO. A format file must first be transferred from the data storage device to the internal memory before it can be selected. Refer to "30.1 Transfer user objects" for information on how to transfer a format file. Opening the selectable list accesses the Format Files screen where an existing format file can be selected or deleted.

Next step

Page changes to the first page on this screen.

43.4
43.4.1

Defining the Reference Line
Overview

Description

The definition of the reference line to be used can require up to three steps, depending on the selected task:

Task	Define Line	Define Segment	Define Slope
Line Quick Line	✓	-	-
Segment Grid	✓	✓	-
Line with slope	✓	-	✓
Segment with slope	✓	✓	✓

Access

- 1) Select **Main Menu: Go to Work!\Survey+\Measure to ref line** or **Stake to ref line**.
- 2) In the job selection screen, select the required job and press **OK**.
- 3) In **Reference Line Task**, select the required task and press **OK**.

Define Line,
Line page

Key	Description
OK	To accept changes and continue with the subsequent screen.
Create..	To create a line. Refer to "9 Jobs & Data - Create control data".
Shifts..	To apply horizontal and vertical shifts to the selected line. Refer to "Shift Settings". Available for lines only. If using line segments, shifts are applied in the Define Segment screen.
Page	To change to another page on this screen.
Fn Config..	To configure the Reference Line application.
Fn Report	To view an alignment report. Refer to "Line Report, Points page".
Fn Quit	To exit the screen.

Description of fields

Field	Option	Description
Line to use	Selectable list	To select a line. Open the selectable list to access the Line Selection screen showing all selectable lines from the control job.
Type	Display only	The selected line type as straight, arc or polyline.
Length	Display only	The horizontal grid distance between the two points of the line.
Start chainage	Display only	The beginning chainage of the line.
Heights to use	Selectable list	Depending on the task chosen this parameter determines the design height. <ul style="list-style-type: none"> • When measuring to a line, it affects the height difference value. • When staking, it affects the delta height value.
	From line	Heights are computed along the reference line.
	Manually enter	Heights are typed in manually into the Design height field.
	Start point	Heights are computed relative to the height of the starting point of the line.

Field	Option	Description
	DTM	The height computed from the DTM at the position of the reference point.

Next step

OK accesses **Define Slope**, **Define Segment**, **Measure to Line** or **Define Stake**.

Define Line, Map page

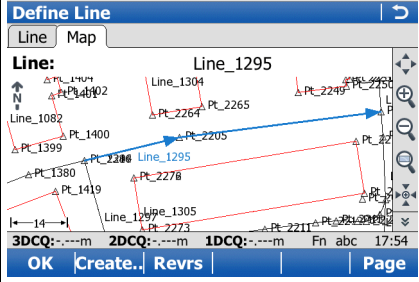
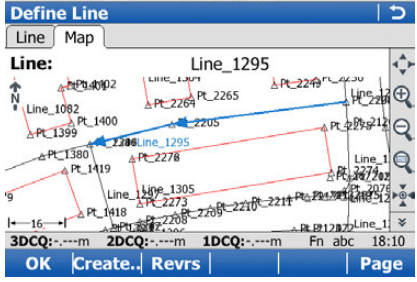
Key	Description
Revs	To reverse the direction of the lines, so that the distance along line/chainage increment is in the opposite direction to the original: Original:  Reverse: 

Define Quick Line

When **Quick Line** is the selected task, the line is defined by two points from the control job, instead of an existing line.

☞ When the task is finished or a new quick line is defined, the previously defined quick line is automatically deleted from the database.

Key	Description
OK	To accept changes and continue with the subsequent screen.
Shifts..	To apply horizontal and vertical shifts to the defined line. Refer to "Shift Settings".
Survy..	To measure a point. Available when Start point or End point is highlighted.
Fn Config..	To configure the Reference Line application.
Fn Quit	To exit the screen.

Description of fields

Field	Option	Description
Start point	Selectable list	The first point forming the line.
End point	Selectable list	The last point forming the line.
Length	Display only	The horizontal grid distance between the two points of the line.
Heights to use	Selectable list	Depending on the task chosen this parameter determines the design height. <ul style="list-style-type: none"> When measuring to a line, it affects the height difference value. When staking, it affects the delta height value.
	From line	Heights are computed along the reference line.

Field	Option	Description
	Manually enter	Heights are typed in manually into the Design height field.
	Start point	Heights are computed relative to the height of the starting point of the line.
	DTM	The height computed from the DTM at the position of the reference point.

Line selection and importing lines

Selecting lines

In **Define Line**, open the selectable list for **Line to use**.

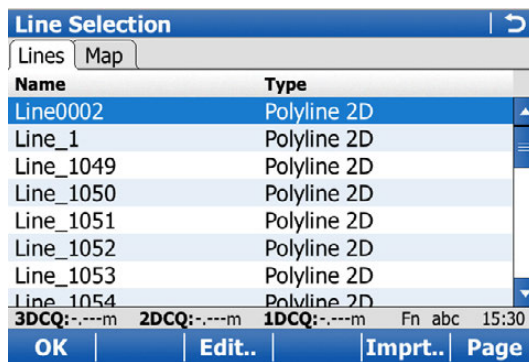

The list contains all selectable lines from the control job. The line ID and the start chainages of lines can be edited.



Key	Description
OK	To select the highlighted reference line and to return to the screen from where this screen was accessed.
Edit..	To edit line ID and the start chainage.
Import	To import a line from a Road/Rail job or from an external survey job.
Fn Quit	To exit the screen.

Importing lines

Press **Import** to import a single alignment from a Road or Rail job, or a line/area from another survey job, to a line to be used in the application. The **Import Line** screen opens.

-  Only alignment geometry that contains lines and simple curves are supported. Clothoids are not supported and can not be imported.
-  If the source survey job for the importation is the same as the control job, for example when you want to import areas, the imported element is converted to a line with the suffix `_001`.

Key	Description
OK	To import the selected alignment data to active raw alignment.
Fn Quit	To exit the screen.

Description of fields

Field	Option	Description
Data source		The file type of the data source.
	Road job	To import lines from an existing Road job.

Field	Option	Description
	Rail job Survey job Road+ (GSI format)	To import lines from an existing Rail job. To import lines/areas from an existing survey job. To import lines from an existing Road job defined in GSI format.
From job	Selectable list	All jobs are available for selection.
Line	Selectable list	Line from the selected Road job. The line must be stored in the \dbx folder of the memory device to be selectable.

Line Report, Points page

The report displays information on the points that have been measured with the current selected control job, and current select line.

Key	Description
OK	To return to the screen from which this screen was accessed.
Edit..	To edit details of the highlighted point.
Save..	To save the alignment report.
More	To change the values displayed between Offset, Cut/fill, Measured height, Design height, Point ID and Pt code.
Page	To change to another page on this screen.
Fn Quit	To exit the screen.

Next step

Page changes to the **Map** page. Use **Prev** and **Next** to the previous or next measured point.

Shift Settings

 The **Map** page is not updated with shifts.

Shift Settings | 

Apply shift

Left/right: m

Vertical: m

3DCQ:-:---m 2DCQ:-:---m 1DCQ:-:---m Fn abc 15:22

OK | | | | |

Key	Description
OK	To confirm the selections and to return to the previous screen.
Fn Quit	To exit Reference Line application.

Description of fields

Field	Option	Description
Shift line	Check box	Check to apply a shift.
Left/right	Editable field	Distance to shift the reference line horizontally to the left or right.

Field	Option	Description
Up/down	Editable field	The vertical shift of the reference line.
Rotate line	Editable field	Available for Measure: Quick Line . To rotate the line by the defined angle value - clockwise if not defined otherwise in Regional settings .  If values are entered for both Rotate line and Left/right , the horizontal shift is applied to the rotated line.

43.4.3

Defining a Segment of a Line

Description

Define Segment, Segment page appears when the selected method is **Segment, Segment with slope** or **Grid**. A segment can be a straight or an arc.

Define Segment, Segment page

Key	Description
OK	To accept changes and continue with the subsequent screen.
Shifts..	To apply horizontal and vertical shifts to the selected segment. Refer to "Shift Settings".
Seg- or Seg+	To select the previous/next segment in the line.
Page	To change to another page on this screen.
Fn Config..	To configure the Reference Line application.
Fn Quit	To exit the screen.

Description of fields

Field	Option	Description
Line to use	Display only	The current line.
Segment no	Editable field	The line segment number to work with. A polyline is split into segments, naming from 1 upwards.
Segment type	Display only	The selected line type as straight or arc.
Segment length	Display only	The horizontal grid distance between the two points of the line segment.
Start chainage	Display only	The beginning chainage of the line segment.

Next step

Page changes to the **Map** page. Refer to "Define Line, Map page".

43.4.4

Defining Reference Line Slopes

Description

It is possible to define slopes for reference line. When measuring or staking to the reference line, additional information about the position relative to the slope is displayed.

Stakeout values still refer to the reference line. For the **Info** page, additional information relative to the slope can be configured in **Configuration, Info** page.

Define Slope

Define Slope
↩

Line: Line0002

Slope direction: Left down ▼

Slope grade: 1:1 hv

Hinge hz offset: 2.000 m

Hinge vt offset: 2.000 m

3DCQ:--m
2DCQ:--m
1DCQ:--m
Fn abc
15:18

OK

Key	Description
OK	To accept changes and to continue with the subsequent screen.
Fn Config..	To configure the Reference Line application.
Fn Quit	To exit Reference Line application.

Description of fields

Field	Option	Description
Line to use	Selectable list	To select a line. Or select a line on the Map page.
Slope direction	<p>Left down</p> <p>Right down</p> <p>Left up</p> <p>Right up</p>	<p>The method how the slope is created.</p> <p>Creates a downward plane extending to the left of the defined reference line.</p> <p>Creates a downward plane extending to the right of the defined reference line.</p> <p>Creates an upward plane extending to the left of the defined reference line.</p> <p>Creates an upward plane extending to the right of the defined reference line.</p>
Slope grade	Editable field	Inclination of the slope.
Hinge hz offset	Editable field	Horizontal offset from the line that sets where the slope starts.
Hinge vt offset	Editable field	Vertical offset from the line that sets where the slope starts.

Description

The horizontal and vertical position and the distance along line/chainage of a manually measured point can be calculated relative to the defined reference line. Information can be measured and displayed in the **Info** page, and then exported. Refer to "Configuration, Info page".

Measure to line - straight segment - horizontal measurements

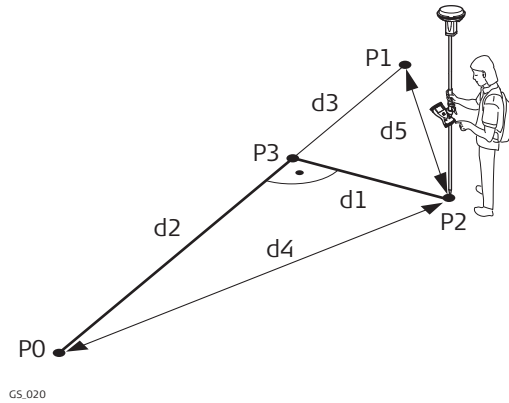

GS_020

GPS

- P0 Start point
- P1 End point
- P2 Measured point
- P3 Reference point
- d1 **Line offset**
- d2 **Dist along line**
- d3 **Line dist to end**
- d4 **Dist to start point**
- d5 **Dist to end point**

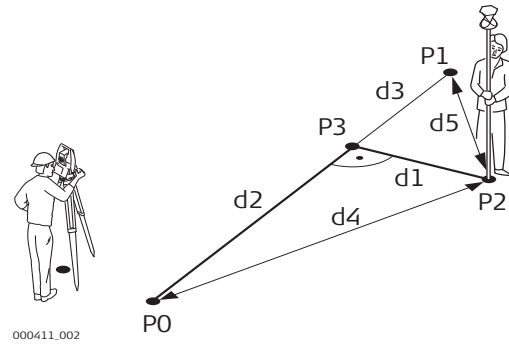

000411_002

TPS

- P0 Start point
- P1 End point
- P2 Measured point
- P3 Reference point
- d1 **Line offset**
- d2 **Dist along line**
- d3 **Line dist to end**
- d4 **Dist to start point**
- d5 **Dist to end point**

Measure to line - straight segment - vertical measurements

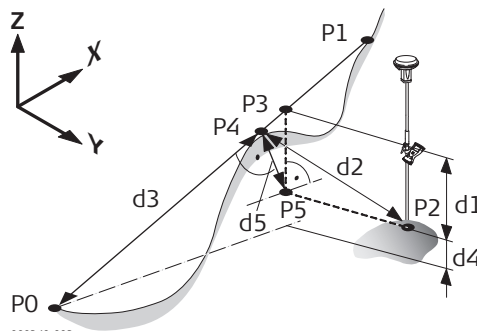

000240_002

GPS

- P0 Start point
- P1 End point
- P2 Measured point
- P3 Reference point
- P4 Perpendicular point
- P5 Horizontal base point
- d1 **Line height diff**
- d2 **Perp distance**
- d3 **Spatial dist**
- d4 **Δ ht start of line**
- d5 **Perp ht to line**

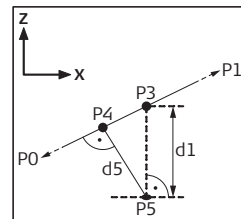

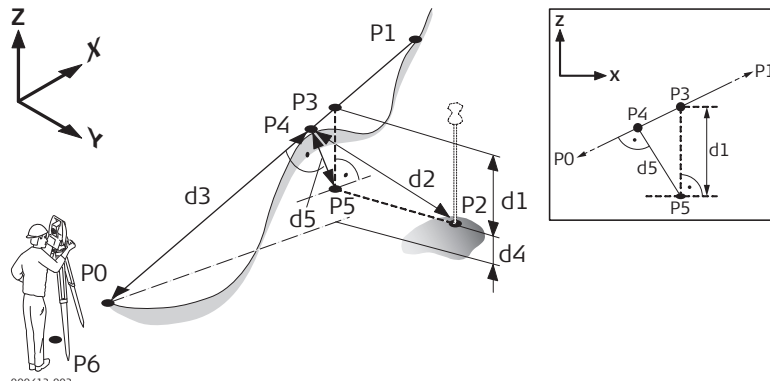

000412.002
TPS

- P0 Start point
- P1 End point
- P2 Measured point
- P3 Reference point
- P4 Perpendicular point
- P5 Horizontal base point
- P6 Instrument station
- d1 **Line height diff**
- d2 **Perp distance**
- d3 **Spatial dist**
- d4 **Δ ht start of line**
- d5 **Perp ht to line**

Measure to line - arc segment - horizontal measurements

Design point inside arc

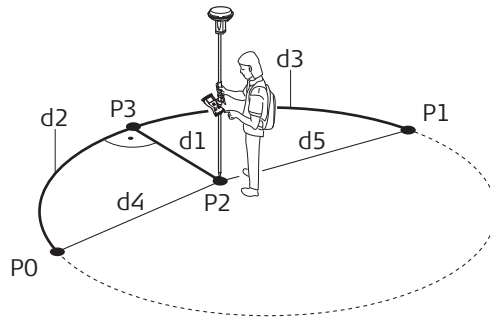

GS.022

GPS

- P0 Start point
- P1 End point
- P2 Measured point
- P3 Reference point
- d1 **Line offset**
- d2 **Dist along line**
- d3 **Line dist to end**
- d4 **Dist to start point**
- d5 **Dist to end point**

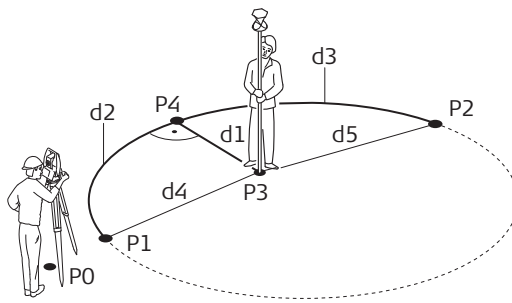

TS.028

TPS

- P0 Instrument station
- P1 Start point
- P2 End point
- P3 Measured point
- P4 Reference point
- d1 **Line offset**
- d2 **Dist along line**
- d3 **Line dist to end**
- d4 **Dist to start point**
- d5 **Dist to end point**

Measure to line - arc segment - vertical measurements

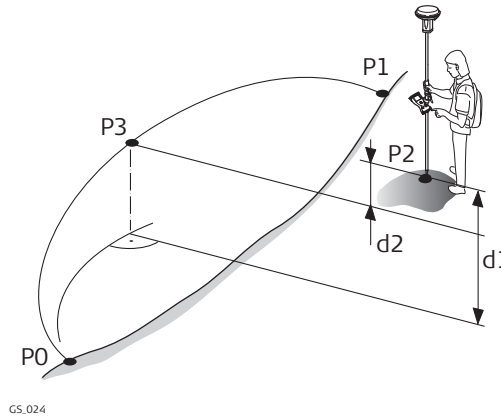

GPS

- P0 Start point
- P1 End point
- P2 Measured point
- P3 Reference point
- d1 Δ ht start of line
- d2 **Line height diff**

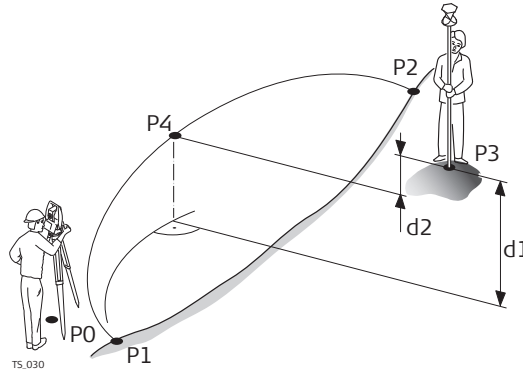

TPS

- P0 Instrument station
- P1 Start point
- P2 End point
- P3 Measured point
- P4 Reference point
- d1 Δ ht start of line
- d2 **Line height diff**



Design point outside the range of the selected element:

When measuring outside of the defined lines, lines and arcs are extended in a straight projection tangent to the start/end of the line. For **Heights to use: From line**, the start/end grade of the line is also extended. A warning appears when this is the case. When working with segments, the same extension rules are applicable to the selected segment beyond its limits. For lines imported from a road alignment, heights are not extended outside the segment.

Measure to Line, Measure page

An additional page is available when a user-defined survey screen page is used.

Measure to Line	
Measure	Info Map
Point ID:	GPS0002
Antenna height:	0.000 m
Dist along line:	1.454m
Line offset:	15.071m
Line height diff:	0.237m
3DCQ:--m 2DCQ:--m 1DCQ:--m Fn abc 15:45	
Meas	Page

Key	Description
Meas	<p>GPS To start measuring the point being staked. The key changes to Stop. The difference between the current position and the point being staked is still displayed.</p> <p>TPS To measure a distance and store distance and angles.</p>

Key	Description
Stop <input type="checkbox"/> GPS	To end measuring the point being staked. When Automatically stop point measurement is checked in Quality Control, General page recording of positions ends automatically as defined by the stop criteria. The position mode icon changes to the moving icon. The key changes to Store .
Store	<input type="checkbox"/> GPS To store the measured point. When Automatically store point is checked in Quality Control, General page, the measured point is stored automatically. The key changes to Meas . <input type="checkbox"/> TPS To store angles and distance. Distance must be measured before.
Dist <input type="checkbox"/> TPS	To measure a distance.
Page	To change to another page on this screen.
Fn Config..	To configure the Reference Line application. Available when Meas is displayed. Refer to "43.3 Configuring Reference Line".
Fn Conect and Fn Disco <input type="checkbox"/> GPS	To connect/disconnect from the GPS reference data.
Fn Init <input type="checkbox"/> GPS	To select an initialisation method and to force a new initialisation. Available when Meas or Store is displayed and for working styles allowing phase fixed solutions. Refer to "56.4 Initialisation for Real-Time Rover Operations".
Fn IndivID and Fn Run	To change between entering an individual point ID different to the defined ID template and the running point ID according to the ID template. Refer to "25.1 ID templates".
Fn Quit	To exit the screen.

Description of fields

Field	Option	Description
Point ID	Selectable list	The point ID of the point to be measured.
Antenna height	Editable field	<input type="checkbox"/> GPS The default antenna height. Changing the antenna height here does not update the default antenna height as defined in the active working style. The changed antenna height is used until the application is exited.
Target height	Editable field	<input type="checkbox"/> TPS The last used target height is suggested. An individual target height can be typed in.
Chainage	Display only	Chainage of the current position along the line. This value is the chainage of the start of the reference line plus Dist along line .
Defined line dist	Display only	Horizontal distance from the start point to the reference point along the reference line.
Line offset	Display only	Perpendicular offset from the reference line measured from the reference point to the measured point.
Height diff	Display only	Difference between measured height and design height.

Next step

Page changes to the user definable **Info** page. Refer to "43.3 Configuring Reference Line" for information on all available items.

Page changes to the **Map** page. Displayed is

- the horizontal distance or chainage along the reference line from the start point to the reference point.
- the perpendicular offset from the reference line measured from the reference point to the measured point.
- the cut/fill value.

43.6

Staking to a Reference Line

Description

Allows for the position of a point to be defined relative to a reference line and then staked.

Stake to line - horizontal measurements

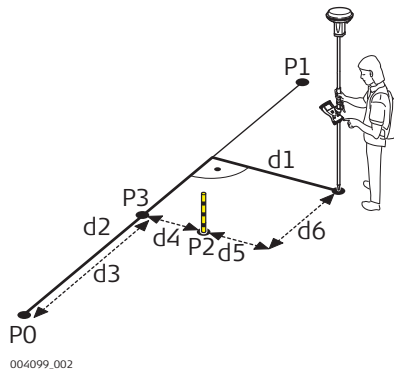

GPS

- P0 Start point
- P1 End point
- P2 Design point
- P3 Reference point
- d1 **Line offset**
- d2 **Dist along line**
- d3 **Defined line dist**
- d4 **Defined offset**
- d5 **Δ offset**
- d6 **Δ dist along line**

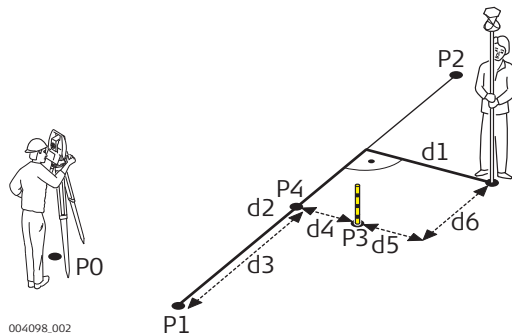

TPS

- P0 Instrument station
- P1 Start point
- P2 End point
- P3 Design point
- P4 Reference point
- d1 **Line offset**
- d2 **Dist along line**
- d3 **Defined line dist**
- d4 **Defined offset**
- d5 **Δ offset**
- d6 **Δ dist along line**

Stake to line - vertical measurements

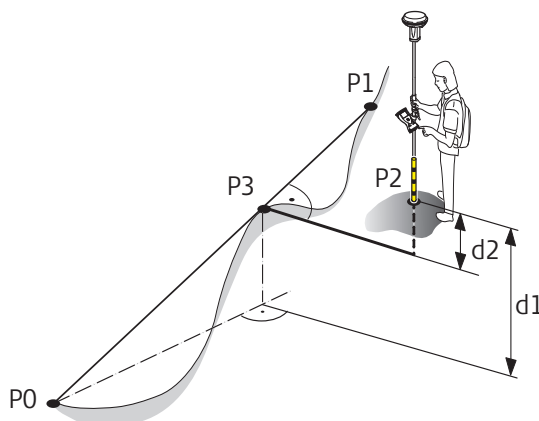

GPS

- P0 Start point
- P1 End point
- P2 Design point
- P3 Reference point
- d1 **Height offset, for Heights to use: Start point**
- d2 **Height offset, for Heights to use: From line**

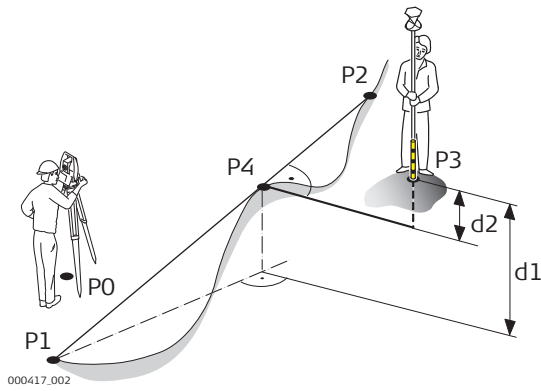

TPS

- P0 Instrument station
- P1 Start point
- P2 End point
- P3 Design point
- P4 Reference point
- d1 **Height offset, for Heights to use: Start point**
- d2 **Height offset, for Heights to use: From line**

Define Stake

This screen is for typing in the stakeout values for a point relative to the reference line. The fields available depend on the options chosen in the **Configuration** screen.

Define Stake [Back] [Forward]

Line: Line0002

Dist along line: 5.000 m

Offset: 0.500 m

Height offset: 1.000 m

Use stake increments

Increment: 0.200 m

After storing: Do nothing

Use different increment on curves

3DCQ:---m 2DCQ:---m 1DCQ:---m Fn abc 15:52

OK | Stk- | Stk+

Key	Description
OK	To confirm the selections and to continue with the subsequent screen.
Stk-/Ch-	To decrease the distance along line/the chainage by Increment .
Stk+/Ch+	To increase the distance along line/the chainage by Increment .
Fn Config..	To configure the Reference Line application. Refer to "43.3 Configuring Reference Line".
Fn Report	To view an alignment report. Refer to " Line Report, Points page".
Fn Start and Fn End	To change between the start point and the end point of the line.
Fn Quit	To exit the screen.

Description of fields

Field	Option	Description
Line	Display only	The name of the selected reference line.
Start chainage	Display only	The chainage of the start point of a reference line.
Chainage	Editable field	Chainage along the line. Define this value as chainage of the start of the reference line plus a distance along the line.
Dist along line	Editable field	Horizontal distance from the start point along the line to the design point.

Field	Option	Description
Offset	Editable field	The offset from the reference line to the design point
Height offset	Display only	The height offset of the design point. <ul style="list-style-type: none"> • For Heights to use: Start point The height of the design point is calculated as the height of the start point plus Height offset. • For Heights to use: From line The height of the design point is calculated as the height of the reference point plus Height offset.
Design height	Editable field	<ul style="list-style-type: none"> • For Heights to use: Manually enter The height of the design point is entered manually.
Use stake increments/Use chainage increments	Check box	Activates the use of stake/chainage increments.
After storing	Do nothing Move forwards Move backwards	Sets behaviour of the stake/chainage after a point is stored. Do nothing Does not change the stake/chainage after a point is stored. Move forwards Proceeds to the next point up stake/chainage after each stored staked point. Move backwards Proceeds to the next point down stake/chainage after each stored staked point.
Use different increment on curves	Check box	Option to use a different chainage increment along a curve.
Increment	Editable field	Available when Use different increment on curves is checked. Chainage increment to be used along the small radius curve.
Radius under	Editable field	Available when Use different increment on curves is checked. Defines the threshold value of a small radius curve. For example, a curve with a radius smaller than this value, uses the chainage increment defined in the following field.

Next step

OK to accept changes and continue to **Stakeout**. Refer to "53.4 Staking Out".

Stakeout, Stake page

Once in the **Stakeout** screens, the user is guided to reach design positions. The functionality of this screen is similar to the **Stakeout** screen. Differences between the two screens are outlined here. Refer to paragraph "53.4 Staking Out" for all other key and field explanations.

In the title bar is a description of where the stake point is on the alignment. This description can come from the position of the defined stake point somewhere along the line or a point of interest. For points of interest refer to "Points of interest".

The availability of the fields depends on the configuration in **Configuration, General** page.

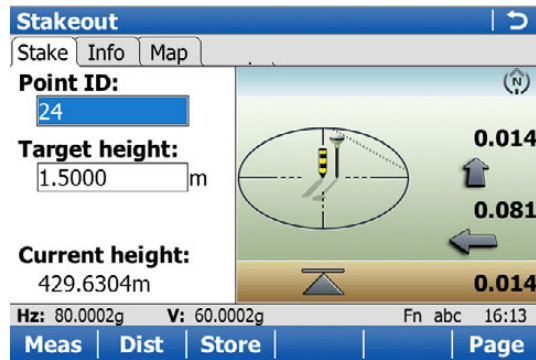

Key	Description
Stk-/Ch-	To decrease the distance along line/the chainage by Increment .
Stk+/Ch+	To increase the distance along line/the chainage by Increment .
Fn Individ and Fn Run	To change between entering an individual point ID different to the defined ID template and the running point ID according to the ID template. Refer to "25.1.1 Accessing ID Template Configuration".

Description of fields

Field	Option	Description
Point ID/ Pt	Editable field	The point ID of the point to be staked.
Target height	Editable field	TPS The last used target height as defined is suggested. An individual target height can be typed in.
Antenna ht	Editable field	GPS The default antenna height as defined in the active working style is suggested.
Ch	Editable field	The current chainage to be staked.
Off	Editable field	Current offset being staked.
Current height	Display only	Measured elevation. The orthometric height of the current position is displayed.
Design height	Editable field	Design elevation. The orthometric height of the point to be staked is displayed.

Next step

Page changes to the **Results** page, if configured.

Points of interest

Points of interest are staked out if they appear within the defined **Ch-/Ch+ /Stk-/Stk+** range and if checked in **Configuration, Design** page. Refer to "Configuration, Design page".

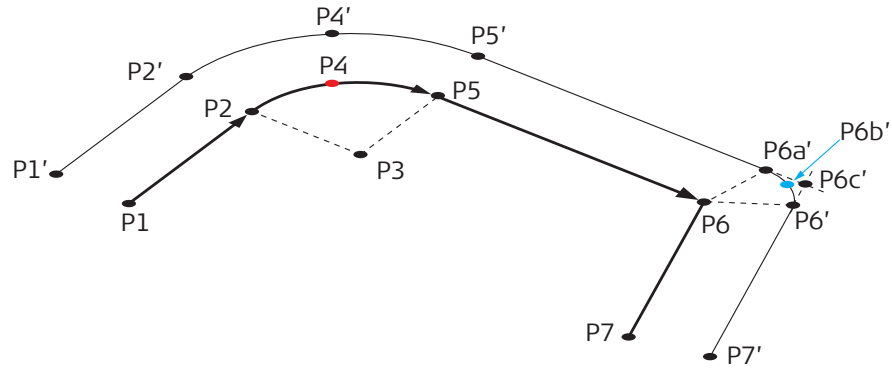

000262.002

On the original line:

- P1 BOP - Beginning of project
- P2 PC - Beginning of curve
- P3 RP - Radius point of the centre of the curve
- P4 MCP - Mid point curve
- P5 PT - End of curve section - Start of straight segment
- P6 AP - Angle point

P7 EOP - End of project

On the offsetted line:

- P1' Offset BOP - Beginning of project
- P2' Offset PC - Beginning of curve
- P4' Offset MCP - Mid point curve
- P5' Offset PT - End of curve section - Start of straight segment
- P6' AP-F - Offset angle point projected to the next segment
- P6a'AP-B - Offset angle point projected to the previous segment
- P6b'AVG - Offset in average direction
- P6c'BP - Offset bisected point
- P7' EOP - End of project

General terms:

- Curve - Along a curve section
- Extension - Along an extended part of the line
- Curve mid point - Mid curve point
- Straight - Along a straight section
- VPI - Vertical intersection point
- Offset PI avg - Offset intersection point average element

Results, General page

If **View results page after staking a point** is checked in **Configuration, General** page, this screen opens automatically once a point is measured and stored.

Results	
General	Coords
Point ID:	22
Chainage:	15.069m
Msd offset:	1.454m
Design height:	19.909m
Msd elevation:	19.899m
Cut:	0.010m
Annot 1:	STA15.07 R1.45 F0.01
Hz: 80.0000g	V: 60.0002g
Fn abc 16:04	
OK	Edit..
Page	

Key	Description
OK	To return to the stake screen.

Key	Description
Edit..	To add a vertical offset to the design height and to display the new height.
Page	To change to another page on this screen.
Fn Quit	To exit the screen.

Description of fields

Field	Option	Description
Point ID	Editable field	The point ID of the point staked.
Chainage	Display only	The chainage measured at the stored point.
Offset	Display only	The offset from the alignment measured at the stored point.
Design height	Display only	The entered design elevation.
Measured height	Display only	The height measured at the stored point.
Cut/Fill	Display only	The height difference between the Design height and the Measured height .
Annot 1	Display only	Fixed value recorded for certain software packages.
Annot 2 to Annot 4	Editable field	Available for additional notes.

Next step

Page changes to the **Coords** page. This page displays the design coordinates as well as the differences between design and measured coordinates.

Page changes to the **Code** where codes can be selected or typed in.

Page changes to the **Map** page. This page provides an interactive display of the data.

Description

A grid can be defined relative to a reference line and points staked out in that defined grid.

Stake grid from line In same direction

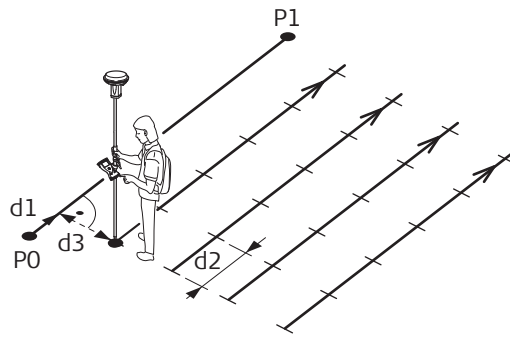

GS_026

GPS

- P0 Start point
- P1 End point
- d1 **Distance along line to first grid point**
- d2 Grid spacing along line
- d3 Grid spacing across line

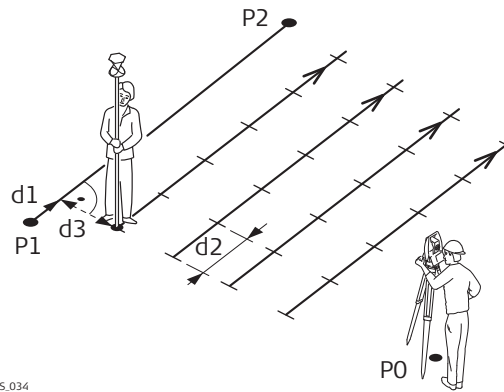

TS_034

TPS

- P0 Instrument station
- P1 Start point
- P2 End point
- d1 **Distance along line to first grid point**
- d2 Grid spacing along line
- d3 Grid spacing across line

In reverse direction

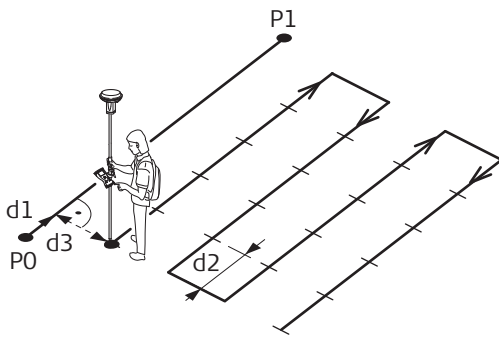

GS_027

GPS

- P0 Start point
- P1 End point
- d1 **Distance along line to first grid point**
- d2 Grid spacing along line
- d3 Grid spacing across line

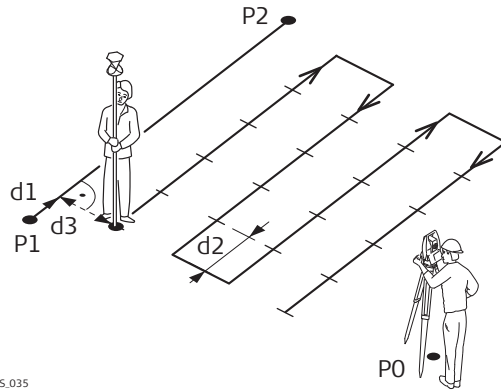

TPS

- P0 Instrument station
- P1 Start point
- P2 End point
- d1 **Distance along line to first grid point**
- d2 Grid spacing along line
- d3 Grid spacing across line

TS_035

Define Grid

Define Grid | >

Chainage: m

Grid spacing:

Across line: m

Along line: m

Stake next grid line: ▾

Store point using: ▾

3DCQ:----m 2DCQ:----m 1DCQ:----m Fn abc 10:58

OK | | | | |

Key	Description
OK	To confirm the selections and to continue with the subsequent screen.
Fn Quit	To exit the screen.

Description of fields

Field	Option	Description
Chainage	Editable field	Chainage of the first design point to be staked along the line.
Across line	Editable field	Spacing between grid lines.
Along line	Editable field	Spacing between points on the grid line.
Stake next grid line	In same direction In reverse direction	Method by which the grid will be staked out. Each new grid line is started at the same end as where the previous grid line started. Each new grid line is started at the same end as where the previous grid line finished.
Store point using	Grid reference Pt ID template	Determines the format of the point ID for grid points. Grid reference : Point ID is shown as the position of the grid being staked, where +yyy.yy is the chainage position along the grid line, and +xxx.xx is the grid line offset. Pt ID template : The point ID template as defined in the active working style is used. The point ID template can be defined in Main Menu: User\Work settings .

Next step

OK to accept changes and continue to the stakeout screen.

**Stake +yyy.yy
+xxx.xx**

The title of this screen indicates the position of the grid being staked, where +yyy.yy is the chainage position along the grid line, and +xxx.xx is the grid line offset. The functionality of this screen is similar to the **Stakeout** screen. Differences between the two screens are outlined here. Refer to paragraph "53.4 Staking Out" for all other key and field explanations.



Key	Description
Skip	To skip the currently displayed chainage and increment to the next chainage. Available when Meas is displayed.
Line+	To start staking the next grid line. Moves grid stake point to the next line (right) in the grid. There is no automatic Line+ when the end of the line is reached.

Description of fields

Field	Option	Description
First field on the screen	Editable field	The point ID of the grid point to be staked. The point ID is based on the selection for Store point using in Define Grid . If a different point ID is typed in, the next point ID will still be shown as the next automatically computed point ID.
Target height	Editable field	TPS The last used target height as defined is suggested. An individual target height can be typed in.
Antenna ht	Editable field	GPS The default antenna height as defined in the active working style is suggested.
Current height	Display only	Measured elevation. The orthometric height of the current position is displayed.
Design height	Editable field	Design elevation. The orthometric height of the point to be staked is displayed.

Next step

Page changes to the **Map** page. Displayed is

- the horizontal distance from the current position to the point to be staked.
- the height difference from the height of the current position to the height of the point to be staked.

Description

The Reference Plane & Grid Scan application can be used to measure points relative to a reference plane.

TPS Any surface can also be grid scanned. It is possible to measure either a regular grid on a predefined reference plane or any surface with an angle based resolution.

Reference Plane & Grid Scan tasks

- The Reference Plane & Grid Scan application can be used for the following tasks:
- Measuring points to calculate and store the perpendicular distance to the plane.
- Viewing and storing the instrument and/or local coordinates of the measured points.
- Viewing and storing the height difference from the measured points to the plane.
- **TPS** Grid Scan a defined area on a predefined reference plane with a regular grid or on any surface with an angle based resolution.



Planes can only be computed with grid coordinates.



TPS Face scan is available for instruments with reflectorless EDM.

Activating the application

The Reference Plane & Grid Scan application must be activated via a licence key. Refer to "30.3 Load licence keys" for information on how to activate the application.

Defining a reference plane

Reference planes are created using a right hand system. For two points defining a plane, a vertical plane is used. A reference plane is defined with the X axis and the Z axis of the plane. The Y axis of the plane defines the positive direction of the plane. A reference plane can be defined in the following ways:

- vertical
- tilted
- horizontal

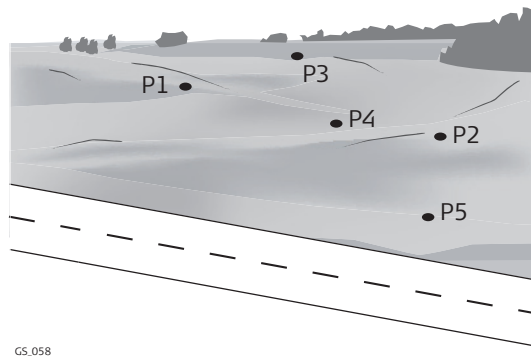

GS_058

GPS

- P1 Point defining reference plane
- P2 Point defining reference plane
- P3 Point defining reference plane
- P4 Point defining reference plane
- P5 Point defining reference plane

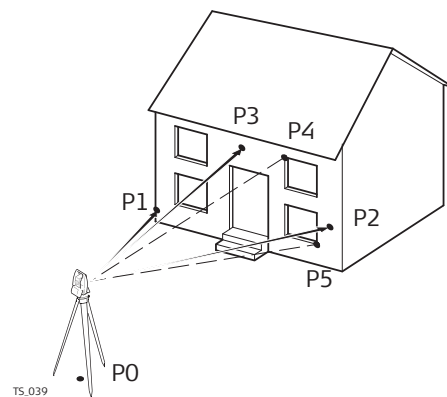

TS_039

TPS

- P0 Instrument station
- P1 Point defining reference plane
- P2 Point defining reference plane
- P3 Point defining reference plane
- P4 Measured point
- P5 Measured point



- **GPS Measure to plane** is applicable for tilted and horizontal plane definitions.
- **TPS Measure to plane** and **Grid scan on plane** is applicable for tilted and horizontal plane definitions.

Tilted plane

Any number of points define the plane. The axes of the tilted reference plane are:

- X axis: Horizontal and parallel to the plane
 - Z axis: Defined by steepest direction of the plane
 - Y axis: Perpendicular to the plane; increases in the direction as defined
- Offsets are applied in the direction of the Y axis.

For **GPS**:

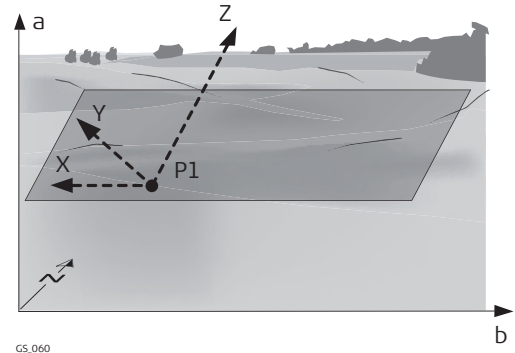
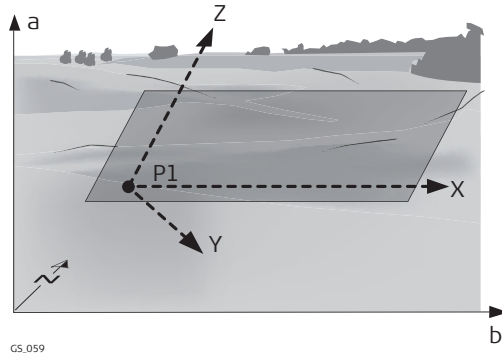

For **TPS**:

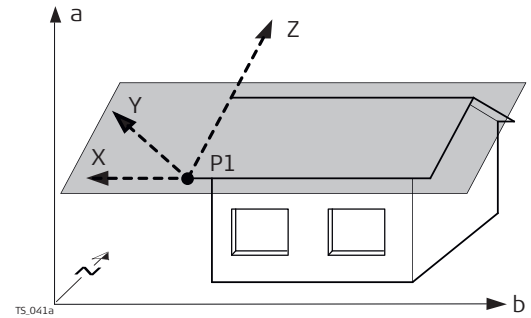
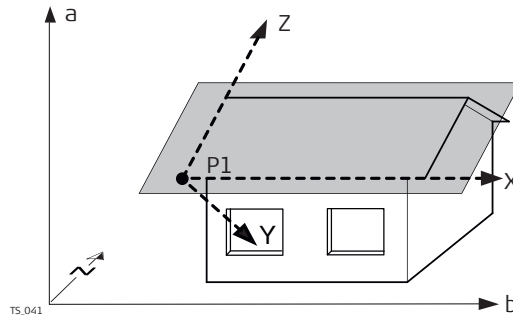

- a Height
- b Easting
- N Northing
- P1 Origin of plane
- X X axis of plane
- Y Y axis of plane
- Z Z axis of plane

Horizontal plane

The axes of the horizontal reference plane are:

- X axis: Horizontal and parallel to the plane
 - Z axis: Perpendicular to the plane; increases in the direction as defined
 - Y axis: Parallel to the plane
- Offsets are applied in the direction of the Z axis.

For **GPS**:

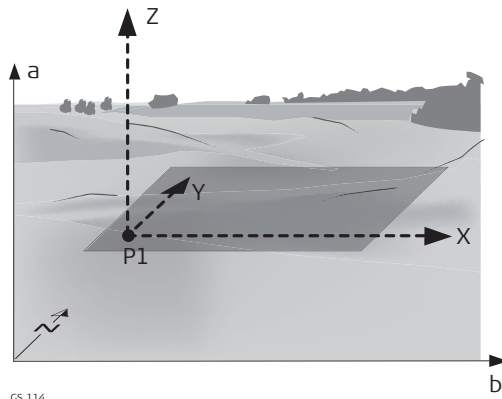

GS.114

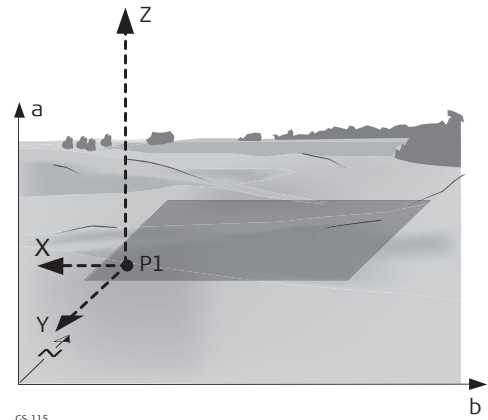

GS.115

- a Height
- b Easting
- N Northing
- P1 Origin of plane
- X X axis of plane
- Y Y axis of plane
- Z Z axis of plane

For **TPS**:

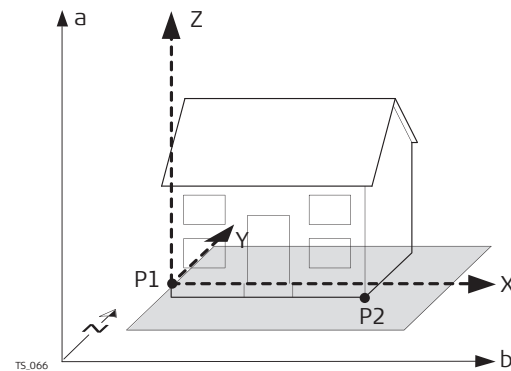

TS.066

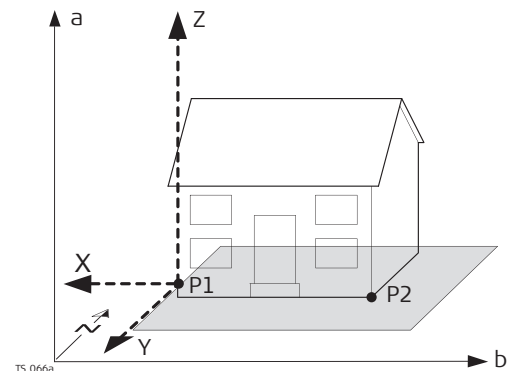

TS.066a

- a Height
- b Easting
- N Northing
- P1 Origin of plane
- P2 Point of plane
- X X axis of plane
- Y Y axis of plane
- Z Z axis of plane

Vertical plane **TPS**

The axes of the vertical reference plane are:

- X axis: Horizontal and parallel to the plane; X axis starts in point defined as origin point
 - Z axis: Parallel to the instrument zenith and parallel to the plane
 - Y axis: Perpendicular to the plane; increases in the direction as defined
- ☞ Offsets are applied in the direction of the Y axis.

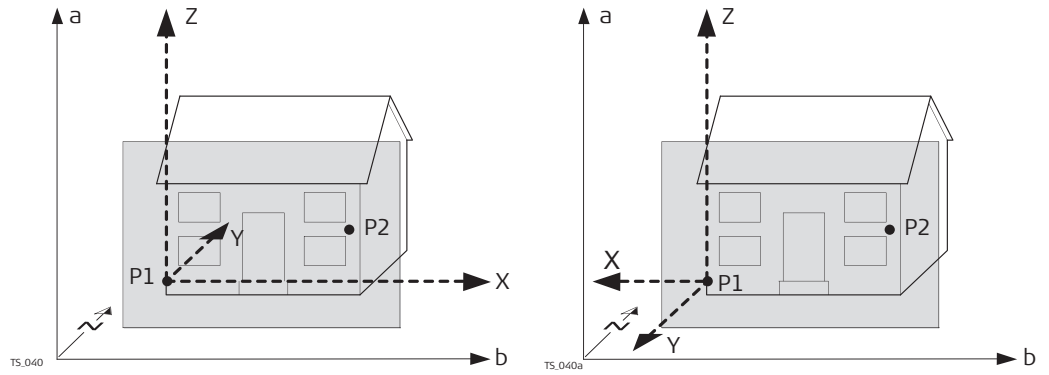

- a Height
- b Easting
- N Northing
- P1 Origin of plane
- P2 Point of plane
- X X axis of plane
- Y Y axis of plane
- Z Z axis of plane



With four or more points, a least squares adjustment is calculated resulting in a best fit plane.

Origin

The origin of the reference plane can be defined to be in the plane coordinates or in relation to the national coordinate system.

Grid orientation

The orientation of the grid is part of a reference plane. The orientation is defined during the reference plane definition and can be changed when editing a reference plane.

Positive direction of plane

The positive direction of the plane is defined by the direction of the Y axis. The direction of the Y axis can be redefined by selecting a point on the desired side of the plane.

Offset of the plane

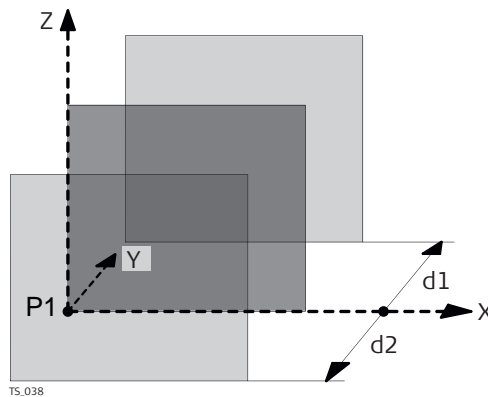

- P1 Origin of plane
- X X axis of plane
- Y Y axis of plane
- Z Z axis of plane
- d1 Positive offset
- d2 Negative offset

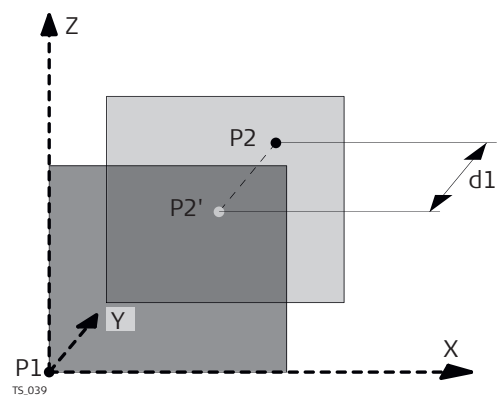

- P1 Origin of plane
- P2 Point defining offset of plane
- P2' P2 projected on original plane
- d1 Offset defined by P2
- X X axis of plane
- Y Y axis of plane
- Z Z axis of plane

Access

Select **Main Menu: Go to Work!\ Survey+\ Ref plane & grid scan.**

Ref Plane & Grid Scan

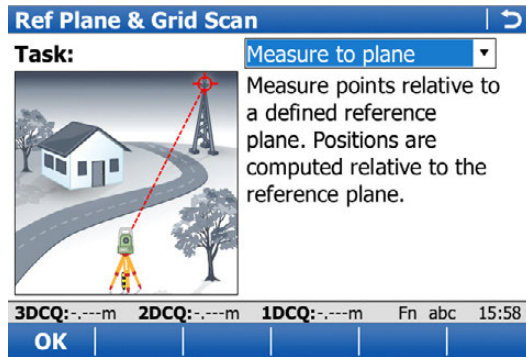

Key	Description
OK	To accept changes and to continue with the subsequent screen.
Fn Config..	To configure the reference plane. Refer to "44.5 Configuring Reference Plane & Grid Scan".
Fn Quit	To exit the application.

Description of the Reference Plane & Grid Scan tasks

Task	Description
Measure to plane	The coordinates of measured points are calculated relative to the reference plane.
Grid scan on plane	TPS Measures a regular grid on a defined reference plane within a defined area.
Grid scan on surface	TPS Measures any surface within a defined area.

Next step

IF	THEN
Task: Measure to plane or Grid scan on plane	OK. <ul style="list-style-type: none"> To create a new plane by measuring points, enter a name for the reference plane. New points can be measured by starting the Survey application. To create a new plane from previously stored points, enter a name for the reference plane. Refer to "44.3 Creating a Reference Plane From Previously Stored Points". For selecting an existing reference plane from a job, refer to "44.4 Selecting a Reference Plane from a Job". Only available when a reference plane has already been stored in the actual working job.
Task: Grid scan on surface	OK accesses Define Grid Scan Area . Refer to "44.9 Grid Scan on Surface".

Access

In **Ref Plane & Grid Scan**, select **Create a new plane from previously stored points**. Press **OK**.

**New Reference Plane,
General page**

New Reference Plane	
General	Points Plot
Ref plane name:	333
No. of points:	0
Std deviation:	-----
Max Δd:	-----
Hz: 0.0001g V: 109.2857g Fn abc 16:53	
OK	Page

Key	Description
OK	To continue to the next screen.
Page	To change to another page on this screen.
Fn Quit	To exit the application.

Description of fields

Field	Option	Description
Ref plane name	Display only	The name of the new reference plane.
No. of points	Display only	Number of points used for plane definition.
Std deviation	Display only	Standard deviation of used points for plane definition. ----- is displayed unless more than four points are used to define the plane.
Max Δd	Display only	Maximum distance between measured point and defined plane. ----- is displayed unless more than four points are used to define the plane.

Next step

Page changes to the **Points** page.

**New Reference Plane,
Points page**

- * is shown to the right of the point for a point which will be used as origin of the plane.
- ! is shown to the left of the point if the point is outside maximum distance between a point and the calculated plane as defined on the **General** page.
- The column **Δd** displays the perpendicular distance of the point from the definition of the plane.

New Reference Plane			
General		Points	Plot
!	Point ID	$\Delta d(m)$	Use
	1020	0.0000	Yes
	1016	-0.0000	Yes
	1010	*	0.0000 Yes

Hz: 0.0001g	V: 109.2857g	Fn abc	17:15
OK	+Point	Use	Delete
			Page

Key	Description
OK	To continue to the next screen.
+Point	To add points from the working job to define the reference plane. Available when creating a new plane from previously stored points.
Use	To change between Yes and No in the Use for the highlighted point.
Delete	To remove the highlighted point from the list.
Survvy..	To measure a point to be used for the plane. Available when creating a new plane by measuring new points.
Page	To change to another page on this screen.
Fn Origin	To use the highlighted point as the origin of the plane.
Fn Quit	To exit the application.

Next step

Page changes to the **Plot** page.

New Reference Plane, Plot page

Points displayed depend on the settings in **Configuration, Parameters** page. Points defining the plane are displayed in black, the other points are displayed in grey.

Select the  icon to change between the face view and the plan view of the plane.

Next step

OK changes to the **Ref Plane Coordinate System**.

Ref Plane Coordinate System

This screen is displayed if **Use local plane coordinate system** is checked in **Configuration, Parameters** page.

Ref Plane Coordinate System	
Currently selected origin point:	
TPS0003	
Enter local coordinates of origin point (point with *)	
X coordinate:	<input type="text" value="0.000"/> m
Z coordinate:	<input type="text" value="0.000"/> m
Point defining direction of Y-axis	
Point:	<input type="text" value="TPS0014"/>
3DCQ:--m	2DCQ:--m
1DCQ:--m	Fn abc
09:27	
OK	

Key	Description
OK	To compute and store the reference plane.
Survvy..	Available when Point is highlighted. To measure a point to define the plane direction.
Fn Quit	To exit the application.

Description of fields

Field	Option	Description
Currently selected origin point	Display only	Point which has been selected as origin point. To change the origin point, press ESC and Fn Origin .
X coordinate	Editable field	Enter local X coordinate of origin. The origin is defined as the projection of the measured point onto the calculated plane.
Z coordinate	Editable field	Enter local Z coordinate of origin. The origin is defined as the projection of the measured point onto the calculated plane.
Point	Selectable list	Defines the direction of the Y axis.

Ref Plane Grid Orientation

Choose how you want to define the grid orientation on the reference plane.

Key	Description
OK	To continue to the next screen.
Fn Quit	To exit the application.

Description of fields

Field	Option	Description
Currently selected origin point	Display only	Point which has been selected as origin point. To change the origin point, return to the previous screen and press ESC and Fn Origin .
Use the fall line of the reference plane	Check box	The fall line is the line of greatest slope. The fall line is a curve following the steepest slope. It is always orthogonal to the contour lines. Mathematically it is determined by the gradient of the height.
Select a point of the reference plane besides the origin point	Check box	The orientation is defined by the origin point and another point on the reference plane.
Orientation Point	Selectable list	The point which defines the orientation together with the origin point.

Next step

OK changes to the **Offset of Reference Plane**.

Offset of Reference Plane

Offset of Reference Plane | ↻

Use offset for reference plane

Offset plane: Offset by distance ▾

Offset: 2.0000 m

Hz: 0.0001g V: 109.2857g Fn abc 17:27

OK | | | | |

Key	Description
OK	To compute and store the reference plane.
Surv..	Available when Offset pt ID is highlighted. To measure a point to define the offset point.
Fn Quit	To exit the application.

Description of fields

Field	Option	Description
Offset plane	Selectable list	An offset can be defined by a point or a distance. The defined plane is shifted along the Y axis by the offset.
Offset pt ID	Selectable list	Available for Offset plane: Offset to a point . Point ID of offset point.
Offset	Display only or editable field	Distance by which to offset the plane along the Y axis. For Offset plane: Offset by distance , the distance can be entered. For Offset plane: Offset to a point , the calculated distance to the adjusted plane is displayed. ----- if no values are available.

44.4

Selecting a Reference Plane from a Job

Access

In **Ref Plane & Grid Scan**, select **Create a new surface from previously stored points**. Press **OK**. Highlight **Ref plane name**. Press ENTER. Available if a reference plane has already been stored in the actual working job.

Manage Reference Planes

Manage Reference Planes | ↻

Name	Date
123	13.05.2010
253	11.06.2010

3DCQ:----m 2DCQ:----m 1DCQ:----m Fn abc 10:03

OK | | | **Delete** | **More** |

Key	Description
OK	To select the highlighted reference plane.
Delete	To delete the highlighted reference plane.
More	To display information about date and time of when the reference plane was created and the number of points defining the plane.
Fn Quit	To exit the application.

44.5 Configuring Reference Plane & Grid Scan

Description Allows options to be set which are used within the Reference Plane & Grid Scan application. These settings are stored within the working style.

Access Select **Main Menu: Go to Work!\ Survey+\ Ref plane & grid scan**. Press **Fn Config...**

Configuration, Parameters page

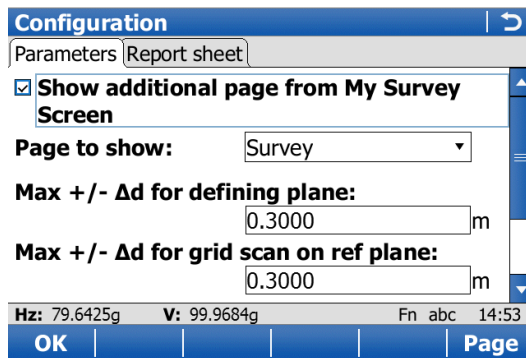

Key	Description
OK	To accept changes and return to the screen from where this screen was accessed.
Config..	To edit the survey screen page currently being displayed. Available when a list item in Page to show is highlighted. Refer to "25.3 My Survey Screen".
Page	To change to another page on this screen.
Fn About	To display information about the application name, the version number, the date of the version, the copyright and the article number.
Fn Quit	To exit the application.

Description of fields

Field	Option	Description
Page to show	Selectable list	The names of the available survey screen pages.
Max +/- Δd for defining plane	Editable field	The maximum perpendicular deviation of a point from the calculated plane.
Max +/- Δd for grid scan on ref plane	Editable field	TPS The maximum perpendicular deviation of a measured point in grid scan on plane from defined plane. Measured points outside the defined limit are not stored.

Field	Option	Description
Display		This parameter defines the points displayed in the Plot and Map pages of the Reference Plane & Grid Scan application in the plan view.
	All points	Displays all points in the plan view.
	Points within slice	Displays points within the defined Slice width in the plan view.
Slice width	Editable field	Available for Display: Points within slice . This parameter defines the distance from the plane in which points are displayed. This distance is applied to both sides of the plane. If lines and areas are displayed in a Map page, then the parts of lines and areas that fall within the defined slice are also displayed.
Use local plane coordinate system	Check box	When this box is checked, then point results are additionally stored with X, Y, Z coordinates based on the local plane coordinate system. The screen Ref Plane Coordinate System is displayed in the reference plane definition workflow. Local coordinates and the positive direction of the reference plane can be defined. When this box is not checked, then points on the plane are transformed into the global coordinate system.

Next step

Page changes to the **Report sheet** page.

Configuration, Report sheet page

Description of fields

Field	Option	Description
Create report sheet	Check box	To generate a report sheet when the application is exited. A report sheet is a file to which data from an application is written to. It is generated using the selected format file.
Report sheet	Selectable list	Available when Create report sheet is ticked. The name of the file to which the data will be written. A report sheet is stored in the \DATA directory of the active memory device. The data is always appended to the file. Opening the selectable list accesses the Report Sheets screen. On this screen, a name for a new report sheet can be created and an existing report sheet can be selected or deleted.

Field	Option	Description
Format file to use	Selectable list	Available when Create report sheet is ticked. A format file defines which and how data is written to a report sheet. Format files are created using LGO. A format file must first be transferred from the data storage device to the internal memory before it can be selected. Refer to "30.1 Transfer user objects" for information on how to transfer a format file. Opening the selectable list accesses the Format Files screen where an existing format file can be selected or deleted.

Next step

Page changes to the first page on this screen.

44.6

Editing a Reference Plane

Access

After creating or selecting a reference plane, select **Edit Reference Plane** in **Measure to Plane** or **Grid Scan on Reference Plane**.

Edit Reference Plane, General page

Key	Description
OK	To compute and store the reference plane.
Page	To change to another page on this screen.
Fn Quit	To exit the application.

Description of fields

Field	Option	Description
Ref plane name	Editable field	The name of the reference plane.
No. of points	Display only	Number of points used for plane definition.
Std deviation	Display only	Standard deviation of used points for plane definition. ----- is displayed unless more than four points are used to define the plane.
Max Δd	Display only	Maximum distance between measured point and defined plane. ----- is displayed unless more than four points are used to define the plane.

Next step

Page changes to the **Points** page.

Edit Reference Plane, Points page

- * is shown to the right of the point for a point which will be used as origin of the plane.
- ! is shown to the left of the point if the point is outside maximum distance between a point and the calculated plane as defined on the **General** page.
- The column **Δd** displays the perpendicular distance of the point from the definition of the plane.

Key	Description
OK	To compute and store the reference plane.

Key	Description
+Point	To add points from the working job to define the reference plane.
Use	To change between Yes and No in the Use for the highlighted point.
Delete	To remove the highlighted point from the list.
Survy..	To measure a point to be used for the plane.
Page	To change to another page on this screen.
Fn Origin	To use the highlighted point as the origin of the plane.
Fn Quit	To exit the application.

Next step

Page changes to the **Origin** page.

Edit Reference Plane, Origin page

Key	Description
OK	To compute and store the reference plane.
Survy..	Available when Point is highlighted. To measure a point to define the plane direction.
Page	To change to another page on this screen.
Fn Quit	To exit the application.

Description of fields

Field	Option	Description
Use local plane coordinate system	Check box	When this box is checked, then point results are additionally stored with X, Y, Z coordinates based on the local plane coordinate system. When this box is not checked, then points on the plane are transformed into the global coordinate system.
Currently selected origin point	Display only	The point which has been selected as origin point. To change the origin point, change to the Points page and Fn Origin . Set the highlighted point as the origin point.
X coordinate	Editable field	Enter local X coordinate of origin. The origin is defined as the projection of the measured point onto the calculated plane.
Z coordinate	Editable field	Enter local Z coordinate of origin. The origin is defined as the projection of the measured point onto the calculated plane.
Point	Selectable list	Defines the direction of the Y axis.

Next step

Page changes to the **Offset** page.

Edit Reference Plane, Offset page

Key	Description
OK	To compute and store the reference plane.
Survvy..	Available when Offset pt ID is highlighted. To measure a point to define the offset point.
Page	To change to another page on this screen.
Fn Quit	To exit the application.

Description of fields

Field	Option	Description
Use offset for reference plane	Check box	When this box is checked, an offset can be defined for the reference plane.
Offset plane	Selectable list	An offset can be defined by a point or a distance. The defined plane is shifted along the Y axis by the offset.
Offset pt ID	Selectable list	Available for Offset plane: Offset to a point . Point ID of offset point.
Offset	Display only or editable field	Distance by which to offset the plane along the Y axis. For Offset plane: Offset by distance , the distance can be entered. For Offset plane: Offset to a point , the calculated distance to the adjusted plane is displayed. ----- if no values are available.

Next step

Page changes to the **Plot** page.

Edit Reference Plane, Plot page

Points displayed depend on the settings in **Configuration, Parameters** page. Points defining the plane are displayed in black, the other points are displayed in grey.

Select the  icon to change between the face view and the plan view of the plane.

Access

After creating or selecting a reference plane, select **Measure to plane** in **Measure to Plane**.

Measure Points to Plane,
Reference page

Key	Description
Meas <input type="text" value="GPS"/>	To start measuring the point. The key changes to Stop . The difference between the current position and the adjusted plane is displayed.
Stop <input type="text" value="GPS"/>	To end measuring the point. The key changes to Store . After ending the measurement, the differences between the measured point and the adjusted plane are displayed.
Meas <input type="text" value="TPS"/>	To measure a distance and store distance and angles.
Dist <input type="text" value="TPS"/>	To measure a distance.
Store	To store the point information.
Cmpare	To calculate offsets to previously measured points.
Plane	To edit the selected reference plane.
Page	To change to another page on this screen.
Fn IndivID and Fn Run	To change between entering an individual point ID different to the defined ID template and the running point ID according to the ID template. Refer to "25.1 ID templates".
Fn Quit	To exit the application.

Description of fields

Field	Option	Description
Point ID	Editable field	The number of the measured point.
Target height	Editable field	<input type="text" value="TPS"/> The target height.
Antenna height	Editable field	<input type="text" value="GPS"/> The height of the antenna.
Offset perp dist	Display only	The perpendicular distance between the measured point and the adjusted plane.
Offset ht	Display only	The vertical distance between the measured point and the adjusted plane.
X coordinate, Y coordinate, Z coordinate	Display only	For Use as origin: Plane coordinates .

Field	Option	Description
Easting, Northing, Elevation	Display only	For Use as origin: Instrument coords.

Next step

Page changes to the **Map** page.

Select the  icon to change between the face view and the plan view of the plane.

44.8

Grid Scan on Plane TPS

Description

Grid scan on plane automates the process of measuring a sequence of points along the defined vertical, tilted or horizontal reference plane. The window of interest can be either rectangular or polygonal. The boundaries of the window of interest and the increment values can be defined. Grid scan on plane can be run on instruments with the option "reflectorless EDM" only.

Access step-by-step

Step	Description
1.	After creating or selecting a reference plane, select Grid scan reference plane in Grid Scan on Reference Plane .
2.	Press OK .
3.	Choose between: <ul style="list-style-type: none"> • Rectangular area: Two opposite corner points define the rectangular grid scan area. The area must be defined from the first to the second point. Grid scan areas bigger than 180° are not allowed. • Polygonal area: Three or more clockwise measured points define the polygonal grid scan area. The polygonal grid scan area is calculated based on the sequence of the points. Grid scan areas bigger than 180° are not allowed.
4.	Press OK .

Diagram

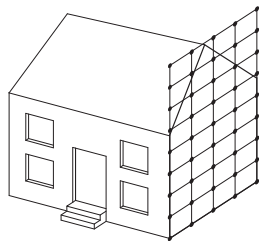

TS_120



Known

PO Station

Unknown

Grid point coordinates

Measure corner

For a rectangular grid scan area, measure two points at opposite corners.
For a polygonal grid scan area, measure all corner points in consecutive order.

Key	Description
OK	To either measure another corner point of the grid scan area or to start grid scanning the area.
Dist	Available on the Camera page. To measure distances for displaying the fine-style crosshairs.
Done	For polygonal areas, this key appears for the first time after the third measured point.
Capture	Available on the Camera page. To take an image with the current pixel resolution. The image is then displayed but not stored on the memory device yet.
Fn Config..	To configure what is displayed on the Camera page. Refer to "Camera View Settings, General page".
Page	To change to another page on this screen.
Fn Quit	To exit the application.
ESC	To delete the last measured point of the rectangular or polygonal grid scan area. This allows the remeasurement of scan area points.

Grid Scan Settings, Define grid spacing on the reference plane.

Description of fields

Field	Option	Description
Left / right	Editable field	For tilted and vertical planes. Horizontal grid distance.
Up / down	Editable field	Up slope grid distance.
Grid scan area	Display only	Size of the grid scan area.
Estimated points	Display only	Estimated number of points to be grid scanned. >20'000 is shown for all resolution bigger than 20'000 points.  It is not checked if all points from the scan resolution fall within the defined grid scan area. For more than 20'000 points, grid scanning the defined grid scan area with the selected resolution may take very long.
Also measure the boundary of the defined scan area	Check box	When this box is checked, the boundary of the grid scan area is also measured.

**Grid Scan Settings,
Define start point ID
& increment.**

Description of fields

Field	Option	Description
Start point	Editable field	The point ID to start with.
Increment	Editable field	The incrementation used for Start point . No point ID template used <ul style="list-style-type: none"> For Start point: RMS and Increment: 10 the points are RMS, RMS10, RMS20, ..., RMS100, ... For Start point: 100 and Increment: 10 the points are 100, 110, ..., 200, 210, ... For Start point: abcdefghijklmn89 and Increment: 10 the points are abcdefghijklmn99, point ID incrementing fails.

**Grid Scan Settings,
Choose the grid scan
mode to be used.**

This screen is only displayed for motorised instruments. For all other instrument types, the standard measurement mode is set.

Description of fields

Field	Option	Description
Standard - accuracy & range optimised	Check box	This measurement mode is accuracy and range optimized. It uses the reflectorless single distance measurement mode.
Fast - speed & performance optimised	Check box	Available for TS15. This measurement mode is speed and performance optimized. It uses the reflectorless continuous distance measurement mode.

**Grid Scan Status,
Progress page**

Grid Scan Status ↩

Progress | Plot

Points measured: 15
Points remaining: 13
Points rejected: 0

% completed: 53.6%
Time remaining: 0:00:17

Point ID: Scan0016

Fn abc 13:38

Stop | **Pause** | **Page**

Key	Description
Stop	To stop the grid scanning of points.
Pause	To pause the grid scanning of points.
Scan	To continue grid scanning.
Page	To change to another page on this screen.
Fn Quit	To exit the application.

Description of fields

Field	Option	Description
Points measured	Display only	Number of points being measured.
Points remaining	Display only	Number of points remaining to be grid scanned.
Points rejected	Display only	Number of skipped points.
% completed	Display only	Percentage of points measured.
Time left	Display only	Estimated time remaining until grid scan is finished.
Point ID	Display only	Point ID of last stored point.

Next step

If the instrument has a camera and the camera functionality is activated, **Page** changes to the **Camera** page. Refer to "33 Camera & Imaging" for information on camera and imaging.

Page changes to the **Plot** page. Points currently scanned are displayed in black, previously measured points, lines and areas are displayed in grey.

Select the  icon to change between the face view and the plan view of the plane.

44.9

Grid Scan on Surface TPS

Description

Grid Scan on Surface allows the measurement of a grid on any surface based on an angular resolution (constant delta horizontal and delta vertical values). No reference plane is required. The grid scan area can be either rectangular or polygonal. Optionally, the boundary of the grid scan area can be measured.

Grid Scan on Surface can be run on instruments with the option "reflectorless EDM" only.

Diagram

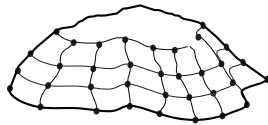

TS.121



Known

P0 Station

Unknown

Grid point coordinates

Access step-by-step

Step	Description
1.	In Ref Plane & Grid Scan , select Grid scan on surface .
2.	Press OK .
3.	Choose between: <ul style="list-style-type: none"> • Rectangular area: Two opposite corner points define the grid scan area. The area must be defined by pointing the instrument to opposite corners of the area. Grid scan areas bigger than 180° are allowed. • Polygonal area: Three or more clockwise measured points define the grid scan area. The polygonal grid scan area is calculated based on the sequence of the points. Grid scan areas bigger than 180° are allowed.

Step	Description
4.	Press OK .



Most steps are identical with the steps for **Grid scan on plane**. Refer to "44.8 Grid Scan on Plane" for a description of the screens.

Surface Scan Settings, Define grid scan spacing.

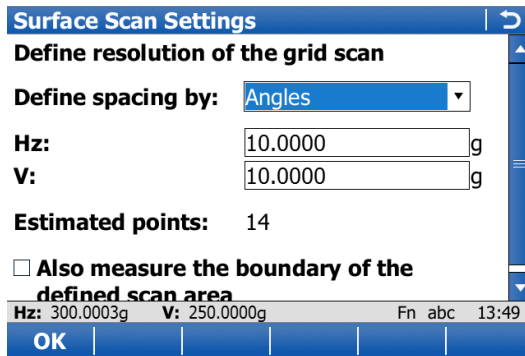

Key	Description
OK	To continue with the next screen.
Dist	Available when Define spacing by: Distances is selected. To take a reflectorless distance measurement. The measured value is displayed in the Horiz distance field.
Fn Quit	To exit the application.

Description of fields

Field	Option	Description
Define spacing by	Angles	The scan resolution is defined by horizontal and vertical angle values.
	Distances	The scan resolution is defined by horizontal and vertical spacings at a certain range.
Hz and V	Editable field	Available for Define spacing by: Angles . The horizontal and vertical angle values defining the scan resolution.
Horiz distance	Editable field	Available for Define spacing by: Distances . The range for which the horizontal and vertical spacing are valid.
Horizontal spacing and Vertical spacing	Editable field	Available for Define spacing by: Distances . The horizontal and vertical spacing defining the scan resolution at the defined range.
Also measure the boundary of the defined scan area	Check box	When this box is checked, then the boundary of the grid scan area is also measured.
Estimated points	Display only	The number of points to be scanned according to the defined scan resolution. >20'000 is displayed for all scan resolution exceeding 20'000 points.

Field	Option	Description
		 It is not checked if all points from the scan resolution fall within the defined grid scan area. For more than 20'000 points, grid scanning the defined grid scan area with the selected resolution may take very long.



Please be aware that the terminology or workflow used on different construction sites can vary from the one used in this manual. However, basic principles remain the same.

Description

Roads is an umbrella term for four subapplications.

Name of subapplication	Description
Alignment Editor	<ul style="list-style-type: none"> • Alignment Editor is an "add-on" component to the Roads application. It is only intended for quick and easy modification of existing alignments, or creation of new ones. Alignment Editor is not an onboard road planning and design application. • This application supports the following alignment types: <ul style="list-style-type: none"> • Horizontal alignments • Vertical alignments • Cross section templates • Cross section assignments • Chainage equations • This application is a free application provided by Leica Geosystems AG. If the application does not appear on your menu or you are otherwise unable to access it, please contact your Leica Geosystems AG representative.
Roads	<ul style="list-style-type: none"> • This subapplication allows the measuring and staking of roads and other alignments. • It can be used with GPS and with total stations. • It consists of two main functions: <ul style="list-style-type: none"> • Roads - As built check for checking or measuring existing lines, surface grade, slopes or surfaces and comparing the measurements against design data. • Roads - Stakeout for setting or staking out and adjusting road elements during construction using design data. • The data can be typed in manually by using the Alignment Editor or data created in a design package can be converted. The Import alignment data application and the Design to Field component of Leica Geo Office offer converters from several road design and CAD packages.
Rail	<ul style="list-style-type: none"> • This subapplication allows the measuring and staking of railways and other alignments. • It can be used with GPS and with total stations. • It consists of two main functions: <ul style="list-style-type: none"> • Rail - As built check for checking or measuring an existing track and comparing the measurements against design data. • Rail - Stakeout for setting or staking out and adjusting track features during construction using design data.

Name of subapplication	Description
	<ul style="list-style-type: none"> • Single track or multiple track designs can be imported for use with this application. • For horizontal and vertical alignments, the data can be typed in manually by using the Alignment Editor application or data created in a design package can be converted. • For multiple track designs, it is possible to define one centreline which is common to all tracks. • A superelevation table can be created for each track using the Rail Editor computer application. This application is part of the Design to Field component in Leica Geo Office.
Tunnel TPS	<ul style="list-style-type: none"> • This subapplication allows the measuring and staking of tunnels. • It is for use with total stations only. • It consists of two main functions: <ul style="list-style-type: none"> • Tunnel - As built check for checking a built or excavated tunnel with a tunnel design. • Tunnel - Stakeout for setting out tunnel features during construction. • The centreline of the tunnel can be imported for use onboard the instrument using the industry standard LandXML data format. Alternatively the centreline can be imported in formats exported from many other tunnel design packages using the Design to Field component of the Leica Geo Office. • Tunnel design profiles can be created using the Tunnel Profile Editor computer application. This application is integrated into the Design to Field component in Leica Geo Office.



Roads, Rail and Tunnel subapplications are licence protected. They can be activated through a licence key which is specific to the instrument. This licence key can be entered either through **Main Menu: User\Tools & other utilities\Load licence keys** or alternatively, the first time the program is started.

Access

Select **Main Menu: Go to Work!\Roads**.
Then select the subapplication required to access the job selection screen.
 For the **Alignment Editor**, refer to "46.2.1 Accessing Alignment Editor".

Job selection

When the application is resumed, the last active selections are remembered and can be accessed again. This ability means the settings do not need to be reselected every time after turning off the instrument.

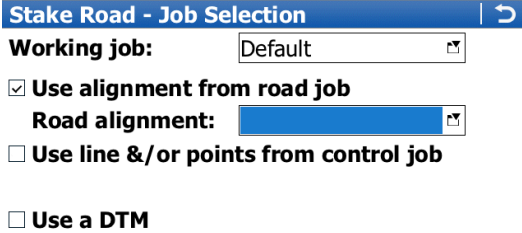



Key	Description
OK	To continue with the next screen.
Fn Quit	To exit the application.

Description of fields

 The methods available in the **Define the Work to be Done** screen depend on the selected job types (road or control job). Refer to **Define the Work to be Done**.

Field	Option	Description
Working job	Selectable list	Available for Road. The working job is the one data is stored to. If a CAD file is attached to this job and no Control job is used, then the CAD file is displayed in the background of Map pages.
Use alignment from road job	Check box	Available for Road. When this box is checked, a road alignment file can be selected. Contains all the information about the road design. For example, the geometry of the line, the formation layer of the road or the information related to the construction of cuttings and embankments.
Road alignment	Selectable list	Available for Road. The files are stored in the \DBX folder or a subfolder of \DBX. The data is either typed in manually in the Alignment Editor application or converted from a road design package. For tunnel projects, all road design information for road data outside of the tunnel must be stored in the road job. The road job is a read-only source of information and cannot be selected as a working or control job.

Field	Option	Description
Rail job	Selectable list	Available for Rail. Contains all the information about the rail design including the geometry of the centreline and the rail definition (superelevation). The files are stored in the \DBX folder or a subfolder of \DBX. The rail job is a read-only source of information and cannot be selected as a working or control job.
Tunnel job	Selectable list	Available for Tunnel. Contains all the information about the tunnel design including the geometry of the centreline and the tunnel profile. The files are stored in the \DBX folder or a subfolder of \DBX. The tunnel job is a read-only source of information.
Use line &/or points from control job		When this box is checked, a control job can be selected. Individual lines and/or points of a control job can be staked out and set in relation to the alignment.
Control job	Selectable list	The control job is the one control points are stored in. The control job holds all control point information needed in the field, for example, control points, points with known coordinates used for a TPS setup. Lines of the control job can be used for Roads - Stakeout or Roads - As built check . A CAD file attached to a control job can be used to view and import the CAD lines for working with. The CAD lines are viewable in any Map page of the Stake/Check screen.
Use a DTM	Check box	Available for Roads and Rail. When this box is checked, a DTM job can be selected. A DTM job holds DTM (Digital Terrain Model) or TIN (Triangular Irregular Network) data. The files are stored in the \DBX folder or a subfolder of \DBX.
DTM	Selectable list	Available for Roads and Rail. Holds DTM (D igital T errain M odel) data or TIN (T riangular I rrregular N etwork) data. The DTM job to be used must be stored in the \DBX directory on the active memory device. The DTM job is a read-only source of information and cannot be selected as a working or control job.  If only a DTM job is selected, then only check measurements relative to the selected DTM layer can be done.

Next step

IF you want to continue with	THEN refer to
configuration	"45.3 Configuring Roads Applications".

IF you want to continue with	THEN refer to
Roads	"47 Roads - Road".
Rail	"48 Roads - Rail".
Tunnel	"49 Roads - Tunnel".

45.2.2

Working with a DTM Job

Access

Start the Roads or Rail subapplication.
In the job selection screen check **Use a DTM**.
Open the selectable list for **DTM**.

DTM

DTM (SD card)	
Name	Date
Soccer DTM	31.03.04

Hz: 399.7618g	V: 99.9997g	Fn abc	14:48
OK	Layrs..	Delete	USB

Key	Description
OK	To select the highlighted DTM job and continue.
Layrs..	To view the DTM layers and the number of triangles of the highlighted DTM job. A DTM job can consist of multiple DTM layers or surfaces. These DTM layers can cover different locations, be on top of each other or intersect each other.
Delete	To delete the highlighted DTM job.
CF card, SD card, USB or Intrnl	To change between viewing jobs stored on another data storage device or internal memory.
Fn Quit	To exit the application.

45.2.3

Design Data

Design data for Road

2D and 3D lines

Depending on the method to be used, the design in all road jobs must consist of either 2D or 3D lines.

2D lines are required at least when working with lines, local lines, manual slope, local manual slope or layer. If the design consists of 2D lines, heights can be considered manually.

3D lines are required when working with slope, surface grade or crown. 3D lines can also be used when working with lines, local lines, manual slope, local manual slope or layer.

Description

Depending on the complexity of the road job, the design data can vary from a single horizontal alignment to a design containing profiles with dozens of defined vertices. Design elements can be grouped logically for faster access.

Lines

When manually typing in a road job, alignments and cross sections are used. Alignments are defined by geometric elements, for example straights and arcs, and the cross sections by vertices. Furthermore, at which chainage a certain cross section is used is also defined. By defining these elements the vertices are connected to create a series of lines representing the three-dimensional design of the road.

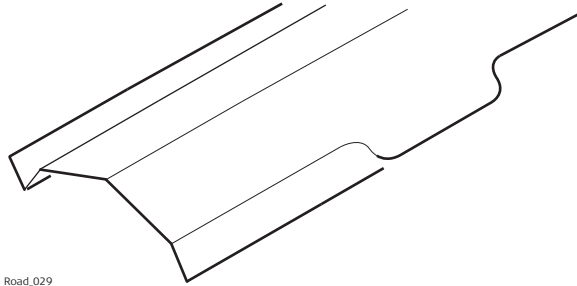

Line representation of a road design.

In **Roads**, such lines defining the design are called lines. Lines are the base elements used for stakeout and check activities. Lines have a project unique name by which they are identified and selected. Whenever a new road design is typed in or imported from a design package these lines are generated automatically in the background.



A cross section can be derived from the line model by slicing the group of lines with a vertical plane orthogonal to the centreline.

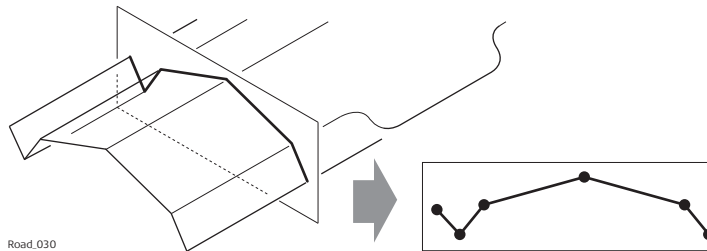

Vertical cut of a line group defines a cross section.



Lines are referenced by layers and can be used in more than one layer.



Every layer is relative to a centreline. This centreline does not have to be a part of the layer. In the previous example, layer one - general fill - uses the centreline for calculation even though the centreline is not part of the layer surface. Whereas the centreline is part of layer three - final surface.

Design data for Rail **Horizontal and vertical alignments**

All rail jobs must consist of at least one horizontal alignment. Each horizontal alignment can either be typed in manually using the **Alignment Editor** application, or converted from a rail design package using **Import alignment data** application or the Design To Field component within the Leica Geo Office program.

Horizontal alignments can consist of straights, circular curves, clothoids, parabolic curves and blossom curves.

Vertical alignments can consist of straights, circular curves and parabolic curves.

If a design comprises multiple tracks, one horizontal alignment can be defined as the chainage centreline. From the chainage centreline all chainages will be calculated and additional horizontal and vertical alignments can be used to define each track.

Rail definition

Rails can be defined by:

- entering the design data manually in the field
- by using the **Alignment Editor**
- by using **Import alignment data** application
- by converting data from a rail design package using the Design To Field component and if required the Rail Editor (for defining the superelevation) component within the Leica Geo Office program

Rails are stored as lines (continuous 2D or 3D lines) within the rail job.

Tracks

Tracks are used to group related lines (centreline and rails) together.

In the case of a single track, the track centreline and the two rails are grouped together in one track.

In the case of multiple tracks where one chainage centreline is used for all tracks, each track consists of four lines: the track centreline, the chainage centreline and the left and right rails.

In the case of multiple tracks where chainage is calculated relative to the track centreline, each track is stored as a single track as described previously.

Design data for Tunnel

Horizontal and vertical alignments

All tunnel jobs must consist of at least a horizontal and a vertical alignment. This data can be converted from a road design package using the Design To Field component within the Leica Geo Office application.

Profiles

Depending on the complexity of the tunnel job, the design data can vary from a single horizontal and vertical alignment to a design containing many different design profiles with dozens of defined vertices.

Design profiles can be defined and edited using the Design To Field component within the Leica Geo Office application.

Layers

Tunnels generally consist of layers made of different materials, for example a shotcrete surface or a lining. At different times throughout a project, it may be required to work with different layers of the tunnel.

The Tunnel Profile Editor allows the possibility of creating such layers by grouping together design profiles that will be used at the same chainage.

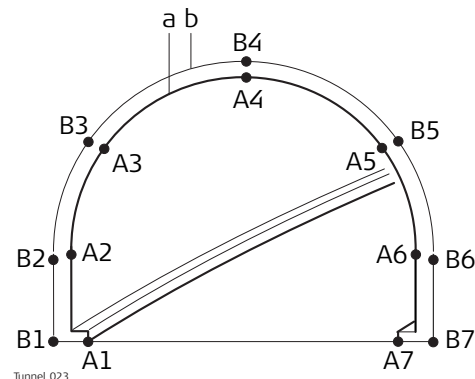

- The vertices **A1-A7** could be grouped together in a layer (**a**) and represent the final lining of the tunnel.
- The vertices **B1-B7** could be grouped together in a layer (**b**) and represent the inner shotcrete layer of the tunnel.

Design Profile Layers can be assigned to chainages along the centreline using the Tunnel Profile Editor within the Design To Field component.

The layer of the tunnel to set out or check can be defined when creating a task.

45.2.4

Viewing and Editing the Design Data

Access

Start the Roads subapplication required.

In the job selection screen highlight **Road Jobs**, **Rail job** or **Tunnel job**. Open the selectable list

In **Road Jobs/Rail jobs/Tunnel jobs** highlight a job and press **Data**.

View & Edit Data

The design data stored within the road/rail/tunnel job contains all information about the road/rail/tunnel design. This information includes the lines and layers, for example, the geometry of the centreline or the layers of the different materials/surfaces which form the road/tunnel. The design data can be viewed and partially edited on this screen.

The screenshot shows a window titled "View & Edit Data" with a refresh icon. The data is as follows:

Job name:	road
Layer:	Test Strings
No. of stringlines:	9
Centreline:	Centreline
Chainage:	<input type="text" value="100.0000"/> m
Ch increment:	<input type="text" value="10.0000"/> m

At the bottom, there is a status bar with: Hz: 399.7618g V: 99.9997g Fn abc 16:22. Below the status bar are buttons: OK, Edit.., View.

Key	Description
OK	To return to the job selection.
Edit..	To edit the general job details and the start chainage of the centreline of the selected layer. For Road additionally to select another centreline and include/exclude lines from the selected layer.
View	To view geometry details of the lines and to view cross-section plots. For Road and Rail additionally to view the list of all lines in the layer.
Fn Config..	To access the configuration settings. Refer to "45.3 Configuring Roads Applications".
Fn Quit	To exit the application.

Description of fields

Field	Option	Description
Job name	Display only	The name of the active road/rail/tunnel job, as selected in the job selection screen.
Layer	Display only	To select a layer from the active road/rail/tunnel job. All layers within the active road/rail/tunnel job can be selected.
No. of lines	Display only	Available for Road and Rail. The number of lines from the selected layer.

Field	Option	Description
Number of profiles	Display only	Available for Tunnel. The number of profiles from the selected layer.
Centreline	Display only	The name of the layer centreline. ☞ Every layer must have a centreline.
Chainage	Editable field	To enter chainage to use when viewing the data. The default value is the start chainage of the layer centreline.
Ch increment	Editable field	To enter a chainage increment to use when stepping through the data.

Next step

IF you want to	THEN press
edit data	Edit.. to access the screen Edit.. . Refer to "Edit:, Layer page".
view data	View to access the screen View at . Refer to "View at, Line Info page".

Edit:, Layer page

Only available for Road.

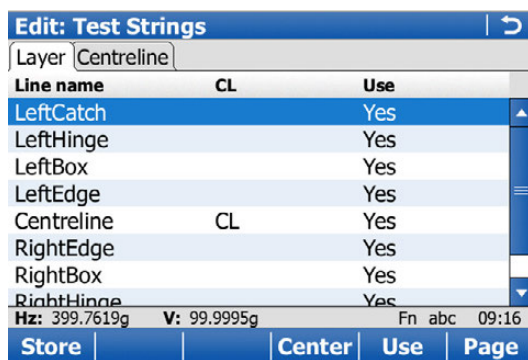

Key	Description
Store	To store data and return to the previous screen.
Centre	To set the highlighted line as centreline.
Use	To set Yes or No in the Use column for excluding/including the highlighted line of selected layer.
Page	To change to the next page.
Fn Quit	To exit the application.

Description of columns

Column	Description
Line name	Displays the name of all the lines in the layer.
CL	Shows CL for the line selected as centreline.
Use	For Yes : The selected line is used for stake/check. For No : The selected line is not used for stake/check.

Next step

Page changes to the **Centreline** page.

Edit:,
Centreline/Chainage
line page

Edit: Test Strings | ↩
Layer Centreline
Centreline: Centreline
Set start chainage: 100.0000 m
End chainage: 285.7462m

Hz: 399.7614g V: 99.9995g Fn abc 09:20
Store | **Reset** | **Page**

Key	Description
Store	To store changes and return to the previous screen.
Reset	To clear all changes made and to reset to the original start chainage. The original start chainage is always remembered.
Page	To change to the next page.
Fn Quit	To exit the application.

Description of fields

Field	Option	Description
Centre-line/Chainage line	Display only	The name of the centreline.
Set start chainage	Editable field	To enter a start chainage for the layer centreline.
End chainage	Display only	The end chainage of the layer centreline. By using the centreline length, the end chainage is automatically calculated.

Next step

Store to store the changes.

View to access the screen **View at**.

View at,
Line Info page

If a value is unavailable in the design data, the field is shown as -----.

View at 100.0000 | ↩
Line Info Lines Plot
Line name: Centreline
Easting: -19846.7901m
Northing: 5301045.9737m
Height: -----
Hz tangent: 374.7362g
Hz radius: -----
Hz type: Straight
Hz: 399.7612g V: 99.9996g Fn abc 09:23
OK | **Ch-** | **Ch+** | **Segmnt** | **Vt** | **Page**

Key	Description
OK	To return to the previous screen.
Ch-	To decrease the chainage by the chainage increment, as defined in the View & Edit Data screen.
Ch+	To increase the chainage by the chainage increment, as defined in the View & Edit Data screen.
Segmnt	To access Segment Info - Start Point .
Hz or Vt	To change between the vertical alignment data and the horizontal alignment data.
Page	To change to another page on this screen.
Fn Quit	To exit the application.

Description of fields

Field	Option	Description
Line name	Selectable list	All lines available at the defined chainage are displayed and can be selected.
Easting, Northing and Height	Display only	The East/North coordinate and height of the line at defined chainage.
Hz tangent	Display only	The tangent direction of the line at defined chainage.
Grade	Display only	The grade of the line at defined chainage.
Hz radius	Display only	The horizontal radius of the line segment at defined chainage.
Vertical radius	Display only	The vertical radius of the line segment at defined chainage.
Hz type	Display only	The horizontal segment type at defined chainage.
Vertical type	Display only	The vertical segment type at defined chainage.
Hz offset	Display only	The horizontal offset to the layer centreline at defined chainage.
Vertical offset	Display only	The vertical offset to the layer centreline at defined chainage.

Next step

Page to change to the **Lines** page.

View at,
Lines page

Unavailable for Tunnel.

View at 150.0000		
Line name	CL offset	Ht diff
LeftCatch	-4.2375	-0.5288
LeftHinge	-3.0000	0.0900
LeftBox	-2.0050	0.2787
LeftEdge	-2.0000	-0.0600
Centreline	-0.0000	0.0000
RightEdge	2.0000	-0.0600
RightBox	2.0050	0.0900
RightHinge	3.0000	0.1866

Hz: 199.7619g V: 159.9967g Fn abc 15:46

OK | Ch- | Ch+ | Segmnt | More | Page

Key	Description
OK	To return to the previous screen.
Ch-	To decrease the chainage by the chainage increment, as defined in the View & Edit Data screen.
Ch+	To increase the chainage by the chainage increment, as defined in the View & Edit Data screen.
Segmnt	To access Segment Info - Start Point .
More	To change between the height differences or absolute heights at the selected chainage.
Page	To change to another page on this screen.
Fn Quit	To exit the application.

Description of columns

Column	Description
Line name	The name of the lines available at defined chainage in the selected layer.
CL offset	The horizontal offset of the line from the layer centreline.
Ht diff	The height difference of the line to the layer centreline.
Height	The absolute height of the line.

Next step

Page to change to the **Map** page.

The **Map** page shows a cross section, profile and planar view of the design data at the selected chainage.

Segmnt to access **Segment Info - Start Point/Segment Info - End Point**.

Segment Info - Start Point/Segment Info - End Point, Hz alignment page

If a value is unavailable in the design data, the field is shown as -----.

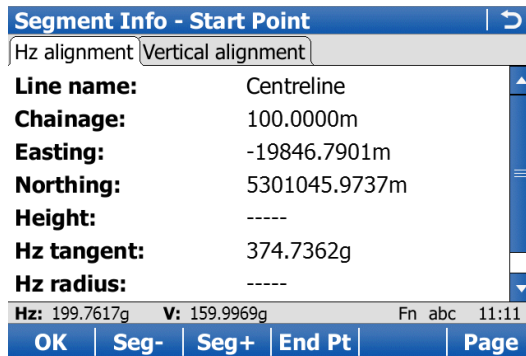

Key	Description
OK	To return to the previous screen.
Seg-	To move to the previous segment.
Seg+	To move to the next segment.
End Pt or Start Pt	To change between the start point and the end point of the segment.
Page	To change to another page on this screen.
Fn Quit	To exit the application.

Description of fields

Field	Option	Description
Line name	Display only	The name of the selected line.
Chainage	Display only	The chainage of start/end point of the segment.
Easting Northing and Height	Display only	The East/North coordinate and height of the start/end point of the segment.
Hz tangent	Display only	The tangent direction at the start/end point of the segment.
Hz radius	Display only	The radius at the start/end point of the segment.
Hz type	Display only	The current segment type.

Next step

Page to change to the **Vertical alignment** page.

Segment Info - Start Point/Segment Info - End Point, Vertical alignment page

Refer to "Segment Info - Start Point/Segment Info - End Point, Hz alignment page" for a description of keys.

If a value has not been defined, the field is shown as -----.

Description of fields

Field	Option	Description
Line name	Display only	The name of the selected line.
Chainage	Display only	The chainage of start/end point of the segment.
Easting, Northing and Height	Display only	The East/North coordinate and height of the start/end point of the segment.
Grade	Display only	The grade at the start/end point of the segment.
Vertical radius	Display only	The radius at the start/end point of the segment.
Vertical type	Display only	The current segment type.

Next step

OK returns to the previous screen.

45.3
45.3.1

Configuring Roads Applications
Configuration Settings

Access

In the job selection screen press **OK** and then, depending on the subapplication **Config..** or **Fn Config..**

Configuration,
Graphics page

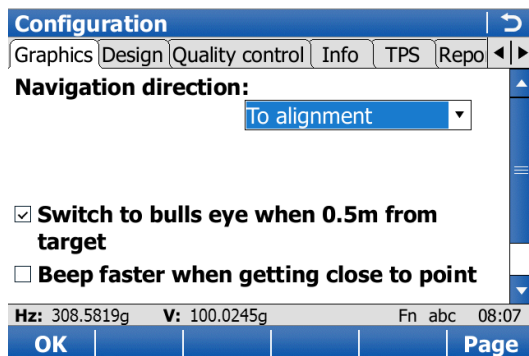

Key	Description
OK	To confirm the changes and move to the previous screen.
Page	To change to another page on this screen.
Fn About	To display information about the application name, the version number, the date of the version, the copyright and the article number.
Fn Quit	To exit the screen.

Description of fields

Field	Option	Description
Navigation direction	To alignment	The reference direction used to stakeout points. The stakeout elements and the graphics displayed are based on this selection.
	To north	The stake out is relative to the alignment.
	To sun	The North direction shown in the graphical display based on the active coordinate system.
	To last point	GPS The position of the sun calculated from the current position, the time and the date.
	To point (cntrl job)	Time-wise, the last recorded point. If no points are yet staked, Navigation direction: To north is used for the first point to be staked.
	Following arrow	A point from the control job is selected.
	From station	The direction of the orientation is from the current position to the point to be staked. The graphical display shows an arrow pointing in the direction of the point to be staked.
	To station	TPS The reference direction is from the station to the current position.
		TPS The reference direction is from the current position to the station.

Field	Option	Description
Point ID	Selectable list	Available for Navigation direction: To point (cntrl job) . To select the point or line to be used for orientation.
Navigate using	Direction & distance In/out, left/right	The method of staking out. The direction from the orientation reference, the horizontal distance and the cut/fill is displayed. The distance forwards to/backwards from the point, the distance right/left to the point and the cut/fill is displayed.
Switch to bulls eye when 0.5m from target	Check box	When this box is checked, a bulls eye bubble is shown in the stakeout graphic when less than half a metre from the point being staked.
Beep faster when getting close to point	Check box	The instrument beeps when the distance from the current position to the point to be staked is equal to or less than defined in Start within . The closer the instrument is to the point to be staked the faster the beeps will be.
Distance to use	Height, Horizontal distance or Position & height	Available when Beep faster when getting close to point is checked. The type of distance to use for the stake beep.
Start within	Editable field	Available when Beep faster when getting close to point is checked. The horizontal radial distance, from the current position to the point to be staked, when a beep is to be heard.



Next step

Page changes to the **Design** page.

Configuration, Design page

Description of fields

Field	Option	Description
Working corridor	Editable field	Valid offset range defined by the working corridor left and right of the centreline. If a measured point is further away from the working corridor distance, an error message is displayed. Refer to "45.6 Understanding Terms and Expressions" for more information on the working corridor.
Show tangent points	Check box	When this box is checked, a message box is shown when a tangent point (PI or PVI) has been detected within the chainage increment range. This tangent point can be selected for stakeout. Refer to "47.3.1 The Stake/Check Screen" for further details. When this box is not checked, no tangent points are indicated.
Type	Horizontal	Available when Show tangent points is checked. Indicates tangent points of the horizontal alignment only.

Field	Option	Description
	Vertical	Indicates tangent points of the vertical alignment only.
	Horizontal & vertical	Indicates all tangent points.
Slope signs	Mathematical	Available for Road only. Selects sign definition method for slopes and surface grades. All slope signs defined from left to right, independent of whether left or right of the centreline.  Road_054c
	Relative to CL	Slope signs defined relative to the centreline.  Road_054a
	Relative from CL	Slope signs defined relative from the centreline.  Road_054b
Extend slopes	Yes (with warning)	When using slopes generated by a design package, the quality of the change from cut to fill or where slopes start and end, depends on the terrain model used for the project. Occasionally, one of the lines defining the slope ends before intersecting with the natural surface. A message appears asking to extended the slope, as soon as a measurement is taken outside of the defined design slope. The slope is expanded beyond and above or below the hinge point. A warning is shown as soon as leaving the defined slope.
	Yes	The slope is expanded beyond and above or below the hinge point. No warning is when leaving the defined slope.
	No	The slope is not expanded beyond and above or below the hinge point.
Extend lines	Check box	Extend each line or curve at its beginning and end with a tangent. The extension is used for projecting a point to the line and for intersecting the line.

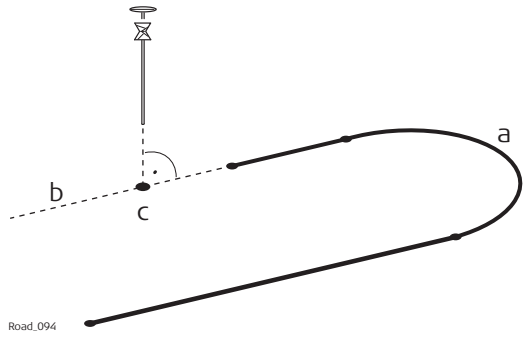
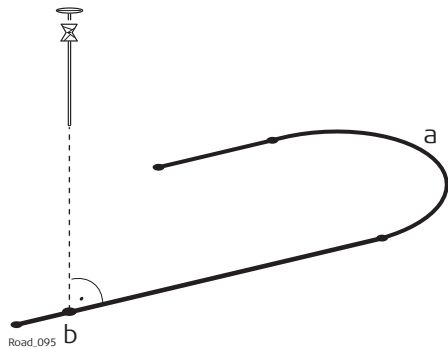
Field	Option	Description
	Checked	<p>☞ Intersection points on extended lines/curves are not shown in cross-sections and cannot be staked out.</p>  <p>Road_094</p> <p>a) Any type of line or curve b) Extended line c) Projected point on extended line</p>
	Not checked	<p>☞ This option is recommended when working with closed alignments (for example roundabout, slip road, motorway exit).</p>  <p>Road_095</p> <p>a) Any type of line or curve b) Projected point on line</p>
Project scale for length values	Check box	<p>When this box is not checked, no scale factor is applied to length values. Length values are displayed in the grid format.</p> <p>When this box is checked, a defined scale factor is applied to length values. All distance values (chainages, chainage increments, offsets, Δ chainage, Δ offset, Δ height, ...) are displayed in ground using the Scale factor.</p> <p>☞ The Road job data is still in grid format.</p> <p>☞ All data is saved to the DBX in ground format. Only ground data is written to the log file.</p>
Scale factor	Editable field	<p>To apply an appropriate geodetic map projection to scale over the ground. The scale factor is only applied to Road, not to Rail or Tunnel.</p>

Next step

IF you work with	THEN Page changes to the
Road	Quality control page.
Rail	Rail design page.
Tunnel <input type="checkbox"/> TPS	Tunnel design page.

**Configuration,
Rail design page**

Available for Rail only.

Description of fields

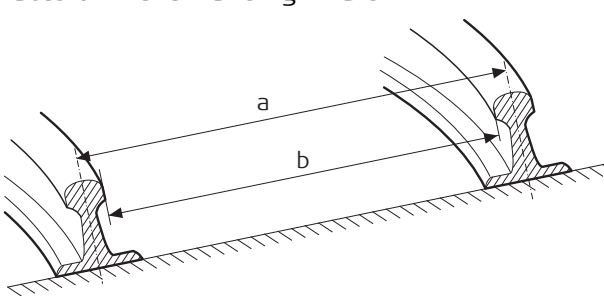
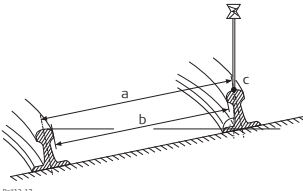
Field	Option	Description
Nominal gauge	Editable field	<p>Nominal distance between the active (internal) faces of the left and right rails.</p>  <p>Rail_014</p> <p>a) Super-elevation base b) Nominal gauge</p>
Super-elevation base	Editable field	<p>Distance over which the super-elevation is to be applied. This distance normally corresponds to the distance between the rail axes.</p>
Super-elevation	<p>Design</p> <p>Manual</p> <p>None</p>	<p>To use the super-elevation values from the design. If these values don't exist in the design, then all super-elevation values are ignored.</p> <p>To ignore all super-elevation values from the design and to enter them manually.</p> <p>All super-elevation values are ignored.</p>
Apply target height	<p>Plumbline</p> <p>Perpendicular</p>	<p>The target height is applied in plumbline to the measured position.</p>  <p>Rail2_17</p> <p>a) Super-elevation base b) Nominal gauge c) Measured point (Easting, Northing, Height)</p> <p>Use this setting when working with a rail bar (solar gauge) with a fix mounted prism.</p> <p>Easting, Northing and Elevation of the measured point is calculated using the design cant or, if enabled, the manually defined cant.</p>

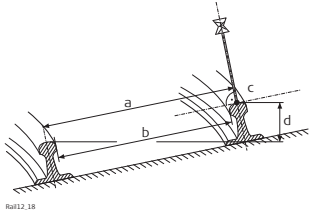
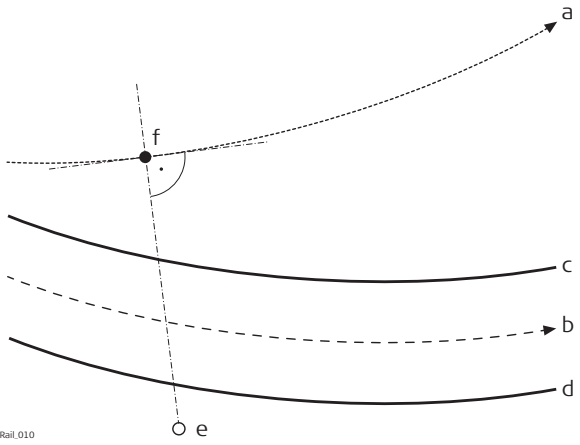
Field	Option	Description
		 <p>a) Superelevation base b) Nominal gauge c) Measured point (Easting, Northing, Height) d) Superelevation</p>
CL height	CL geometry	The centreline height is taken from the alignment centreline.
	Rail interpolated	The centreline height is interpolated between the left rail height and right rail height.
	Lower rail	The height of the lower rail is used as centreline height.
Calculate chainage directly onto chainage centreline	Check box	<p>Chainage calculation method when checking points of multiple tracks with respect to a chainage centreline.</p> <p>The direct measurement method is when the chainage is calculated by projecting the measured point directly onto the chainage centreline.</p> <p>The indirect measurement method is when the chainage is calculated by first projecting the measured point onto the track centreline, and then projecting the point onto the chainage centreline.</p>
	Checked	<p>Project measured point directly onto the chainage centreline.</p>  <p>a) Chainage centreline b) Track centreline c) Left rail d) Right rail e) Measured point f) Direct chainage</p>

Field	Option	Description
	Not checked	<p>Project measured point onto track centreline and then make a second projection onto the chainage centreline.</p> <p>a) Chainage centreline b) Track centreline c) Left rail d) Right rail e) Measured point f) Indirect chainage g) Measured point projected onto track centreline</p>
Disable chainage centreline	Check box	Only affecting multiple track designs. The defined chainage centreline is disabled and the track centreline is used for chainage calculations.

Next step

Page changes to the **Quality control** page.

Configuration, Tunnel design page

TPS

Available for Tunnel only.

Description of fields

Field	Option	Description
Theoretical profile direction	Clockwise	The design profile is defined in a clockwise direction. In underbreak areas the profile offset values are negative where as in overbreak areas they are positive.
	Counter-clockwise	The design profile is defined in a counter-clockwise direction. In underbreak areas the profile offset values are positive where as in overbreak areas they are negative.
Profile definition	Vertical	Profiles are always defined as vertical.
	Tilted	Profiles are always defined perpendicular to the vertical alignment of the tunnel axis.

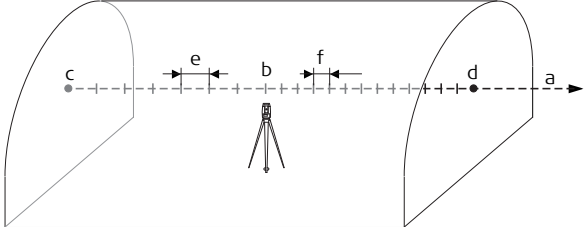
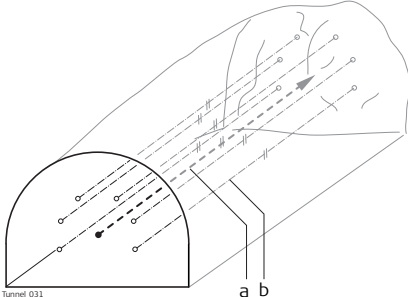
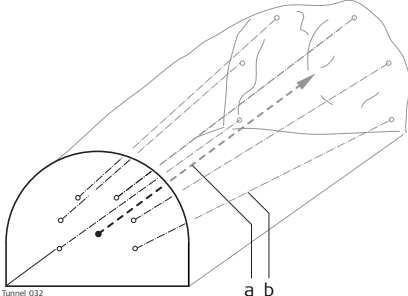
Field	Option	Description
<p>Scan area defnd by</p>	<p>Chainage</p> <p>Distance</p>	<p>Available for Method to use: Scan profile. When measuring tunnel profiles, it is possible to scan various profiles from one instrument position.</p> <p>Allows a scan area to be defined by entering a back and forward chainage.</p> <p>Allow a scan area to be defined by measuring/entering a back distance and forward distance from the station chainage.</p> <p>Plan view</p>  <p>Tunnel.030</p> <p>a) Alignment b) Station chainage c) Start chainage or Start distance d) End chainage or End distance e) Before stn every f) After stn every</p>
<p>Drilling rig orientation</p>	<p>Parallel to alignment</p> <p>Drill Pattern</p>	<p>Guides a jumbo to drill in the direction parallel to the alignment.</p>  <p>Tunnel.031</p> <p>a) Alignment b) Drill direction</p> <p>Guides a jumbo to drill in the user defined direction. This must not be parallel to the alignment.</p>  <p>Tunnel.032</p> <p>a) Alignment b) Drill direction</p>

Next step

Page changes to the **Quality control** page.

Configuration, Quality control page

Description

Especially when checking points in an as-built control or when staking out it is useful to enable the **Quality control** criteria available. For every point stored the chosen parameters are checked and if the check limits are exceeded a warning is shown. This function guarantees a higher productivity as it is no longer necessary to check the values for every shot taken. When checking layers of a road, a too thick layer results in higher costs as more material is used. Alternatively, a too thin layer can lead to problems and could cause serious damage. Therefore different check limits for above and below the design can be defined.

Graphic

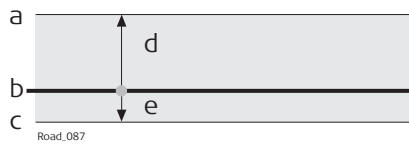

- a) Layer is too thick
- b) Design surface
- c) Layer is too thin
- d) **Upper ht limit**
- e) **Lower ht limit**

Height limits below the design surface are entered as negative values (for example, the **Lower ht limit** with -10 mm in the previous diagram). By using the signs of the height limits, it is also possible to cover situations like the one shown in the following diagram, with a valid range between -10 to -50 mm below the design surface.

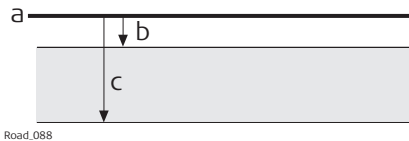

- a) Design surface
- b) **Upper ht limit**
- c) **Lower ht limit**

Description of fields

Field	Option	Description
Check deltas to point before storing	Check box	When this box is checked, a position check is done when storing a staked or checked point. When the defined tolerance is exceeded, the stake out/check can be repeated, skipped or stored. When this box is not checked, no quality check is done during stake out/check of points.
Delta values	Ch, offset & height Ch & offset Position & height Position Height Profile	 Depending on this selection the following lines are enabled/disabled. Check for chainage, horizontal offset and height. Check for chainage and horizontal offset. Check for 2D position and height. Check for 2D position. Check for height. Available for Tunnel. Check for distance from design profile.

Field	Option	Description
Chainage limit	From 0.001 to 100	Maximum difference in chainage.
Offset limit	From 0.001 to 100	Maximum horizontal offset from defined position.
Position limit	From 0.001 to 100	Maximum radial horizontal distance.
Upper ht limit	From -100 to +100	Maximum height difference.
Lower ht limit	From -100 to +100	Maximum height difference.
Profile tolerance	From 0.001 to 100	Available for Tunnel. Permitted distance from design profile.

Next step

Page changes to the **Info** page.

Configuration, Info page

Two things can be configured on this page:

- 1) The required information for each stakeout and check method to be displayed on the **Info** page. Depending on the working method used on the construction site, different information is written on the stakes. The information to be written on the stake is displayed on the **Info** page.
- 2) If and which additional user-defined survey screen page is displayed.

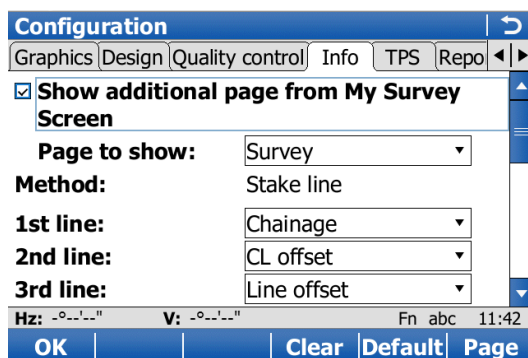

Key	Description
OK	To confirm the changes and continue.
Clear	To clear all parameters from all lines.
Default	To set the default value for all lines.
Fn About	To display information about the application name, the version number, the date of the version, the copyright and the article number.
Fn Quit	To exit the screen.

Description of fields

Field	Option	Description
Show additional page from My Survey Screen	Check box	The user-defined survey screen page to be shown in the stake or check screen.



Field	Option	Description
Page to show	Selectable list	The names of the available survey screen pages.
Method	Display only	The method is based on the selected subapplication and, if available, the setting for Method to use . The settings in the following lines can only be changed for the current method. The method defines the parameters available to view on the Info page of the application. Different combinations of the parameters to view can be stored
1st line to 16th line	Selectable list	<p>To modify the selection on any particular line, place the cursor on the line to modify using the arrow keys and press the ENTER key. Use the arrow keys to select the required parameter and press the ENTER key to confirm the choice.</p> <p>Define which parameters are viewed on each line. Up to 16 lines of parameters can be defined.</p> <p>The available parameters depending on the Method selected are explained separately:</p> <ul style="list-style-type: none"> • For Road Line, refer to "45.3.2 Road Line - Info Page". • For Road Local line, refer to "45.3.3 Road Local Line - Info Page". • For Road Surface grade, refer to "45.3.4 Road Surface Grade - Info Page". • For Road Manual slope, Local manual slope and Slope, refer to "45.3.5 Road Manual Slope, Local Manual Slope and Slope - Info Page". • For Road Crown, refer to "45.3.6 Road Crown - Info Page". • For Road Layer, refer to "45.3.7 Road Layer - Info Page". • For Road DTM, refer to "45.3.8 Road DTM - Info Page". • For Rail refer to "45.3.9 Rail - Info Page". • For Tunnel refer to "45.3.10 Tunnel - Info Page".

Next step

TPS Page changes to the **TPS** page.

GPS Page changes to the **Report sheet** page.

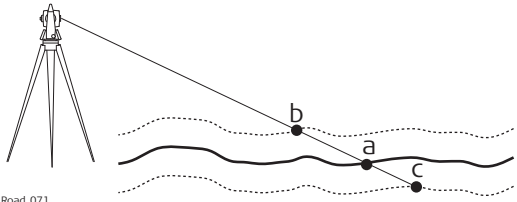
Description of fields

Field	Option	Description
Only update stakeout values when distance is measured	Check box	When this box is checked, angles and stakeout values are updated after a distance measurement. All values are then frozen until the next distance is taken. When Target aiming: Lock is selected and the instrument is locked onto a target the angular values do not change. When this box is not checked, angles are updated with telescope movement after a distance was measured.
Turn to point	Check box	Available for Road and Rail. To make stake out of points even more efficient, a motorised instrument offers you the possibility to aim automatically at the stakeout position.
Turn to	<p>Position only</p> <p>Position & height</p> <p>Position & measure</p>	<p>Available for Road and Rail and when Turn to point is checked.</p> <p>The instrument positions horizontally in the direction of the point to stake out.</p> <p>The instrument positions horizontally and vertically to the point to stake out.</p> <p>The instrument only points to the correct position on the ground if the point to stake out has the same height as the natural surface. If the natural surface is higher than the point to stake out, the measured point would be closer than the stakeout point. If the natural surface is lower than the point, the measured point would be further away.</p> <p>With Position & measure, the possibility of iterative positioning using the auto position, this problem can be avoided.</p>  <p>a) Point to stake out, defined with 3D coordinates</p> <p>b) Position if natural surface is higher than point to stake out</p> <p>c) Position if natural surface is lower than point to stake out</p> <p>Allows the instrument to aim at a 2D position. As the natural surface height is unknown the correct position is calculated via iterations.</p> <p> Depending on the settings chosen for Red laser pointer the instrument will turn on the red laser as soon as the position is found.</p>

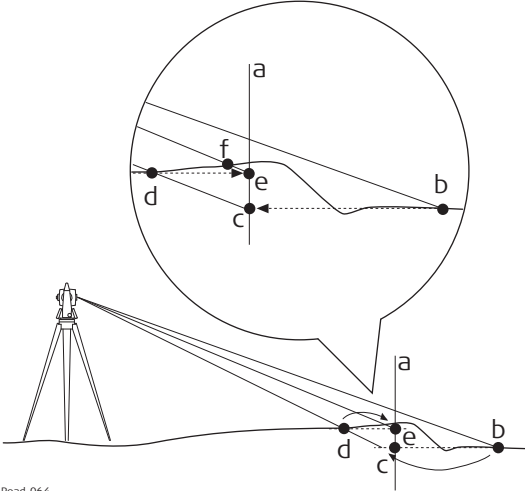
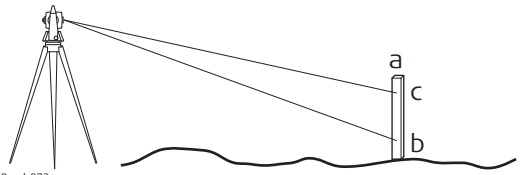
Field	Option	Description
		<p>The first position (b) the instrument points to is defined by the 2D coordinates (a) of the point to stake out (= horizontal direction) and the current vertical angle. Therefore, aim the instrument at the approximate position of the point to stake out. The measured 2D position is compared with the stakeout position to determine a new position (c) to aim at. As no information about the natural surface is available, a point at the same height as the measured position is calculated. The new position (d) is measured and compared again with the point to stake out (a). This iteration process runs until the tolerances defined for the stakeout are reached.</p>  <p>Road_064</p> <p>a) 2D position to stake out b) First position measured defined by 2D coordinates and current vertical angle c) New position calculated based on height of b d) Second position measured e) New position calculated based on height of d. The measured position for this point is within the defined tolerance, the correct position is found.</p> <p>Prompt before turn</p> <p>The method how the instrument turns is not fixed but is selected when pressing Positn. Additionally to the three methods listed above, an option allowing the instrument to find the height on the peg is available:</p>  <p>Road_072</p> <p>a) Peg placed at the correct position b) First height, manually chosen direction c) Required height on the peg</p>

Field	Option	Description
		For more information refer to "45.3.11 Workflow for Height (aim to stake ht)".
Position limit	From 0.001 to 10	Maximum permitted radial horizontal distance. Available for Tunnel and for Road/Rail with Turn to: Position & measure or Turn to: Prompt before turn .
Height limit	From 0.001 to 10	Maximum height difference. Available for Road and Rail.
Chainage limit	From 0.001 to 10	Chainage tolerance of the position to stake out. Available for Tunnel and for Road/Rail with Turn to: Position & measure or Turn to: Prompt before turn .
Offset limit	From 0.001 to 10	Maximum horizontal offset from defined position. Available for Road and Rail.
Red laser pointer	<p>Always off</p> <p>On at point only</p> <p>Always on</p>	<p>Defines when the visible red laser beam is turned on during the automatic search of the position.</p> <p>Available for Tunnel and for Road/Rail with Turn to: Position & measure or Turn to: Prompt before turn.</p> <p>Visible red laser is turned off.</p> <p>Visible red laser is turned on as soon as the point is found.</p> <p>Visible red laser is turned on during the whole search.</p> <p> The laser can also be permanently turned on by using the instrument settings. Refer to "12.6 Lights / Lights & accessories" for more information.</p>
Max iterations	From 2 to 10	Maximum number of iterations for the distance measurement before stopping. Available for Tunnel and for Road/Rail with Turn to: Position & measure or Turn to: Prompt before turn .

Next step

Page changes to the **Report sheet** page.

Configuration, Report sheet page

Description of fields

Field	Option	Description
Create report sheet	Check box	To generate a report sheet when the application is exited. A report sheet is a file to which data from an application is written to. It is generated using the selected format file.

Field	Option	Description
Report sheet	Selectable list	Available when Create report sheet is ticked. The name of the file to which the data will be written. A report sheet is stored in the \DATA directory of the active memory device. The data is always appended to the file. Opening the selectable list accesses the Report Sheets screen. On this screen, a name for a new report sheet can be created and an existing report sheet can be selected or deleted.
Format file to use	Selectable list	Available when Create report sheet is ticked. A format file defines which and how data is written to a report sheet. Format files are created using LGO. A format file must first be transferred from the data storage device to the internal memory before it can be selected. Refer to "30.1 Transfer user objects" for information on how to transfer a format file. Opening the selectable list accesses the Format Files screen where an existing format file can be selected or deleted.

Next step

Page changes to the first page on this screen.

45.3.2

Road Line - Info Page

Description

This info page is used for staking and checking Road lines.

Available fields

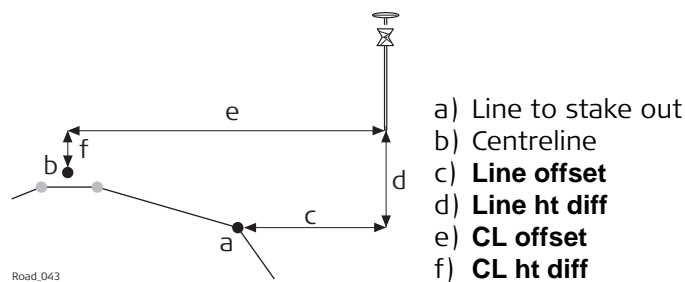

The following parameters are available. All fields are display only.

Field	Description
Line task	Name defined for the line task.
Δ offset	Horizontal offset between the defined position and the current position.
Δ height	Vertical offset between the defined position and the current position.
Δ chainage	Difference between the defined chainage Stake chainage on the General page and the current chainage Chainage shown on the Stake page.  If no defined chainage exists, for example if staking out random chainages or checking, this field reads Δ chainage: ----- .

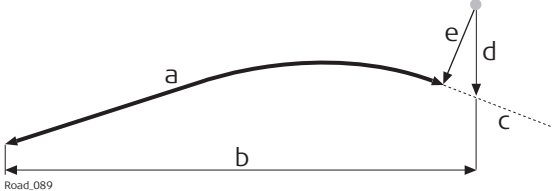
Field	Description
Chainage	The current chainage. This field is independent of the chosen settings for Navigation direction and Navigate using in Configuration, Graphics page.
Stake chainage	Chainage to stake out.
Line offset	Horizontal offset from the line.
Line ht diff	Height difference from the defined line.
Line name	Name of the line to stake out or the stake out is relative to.
Additional line	The name of an additional line.
Additnl line chnge	Current local chainage of additional line.
Additnl line offset	Current perpendicular offset to the additional line including the defined stake/check offset of additional line of the Offsets page.
Additnl line ht diff	Current height difference to the additional line including the defined stake/check height difference of the additional line of Offsets page.
CL ht diff	Height difference from the centreline.
CL height	Height of the centreline at the current chainage.
CL radius	Radius of the centreline at the current chainage.
CL type	Element type of the centreline.
CL offset	Perpendicular horizontal offset from the centreline. This field is independent of the chosen settings for Navigation direction and Navigate using in Configuration, Graphics page.
CL tangent	Tangent direction of the centreline at the current chainage.
Offset angle	The current angle to selected line.
Nearest hz tngnt pt	Refer to "47.3.1 The Stake/Check Screen" for details on this field.
Nearst vt tngnt pt	Distance to the nearest vertical tangent point of the design.
Vertical sqr offset	Offset perpendicular to the vertical component of the selected line. This value can be useful when dealing with pipelines, cables and in the construction segment.
Vertical chainage	Chainage of the measured point is projected perpendicular to the vertical component of the selected line.  a) Vertical chainage b) Chainage c) Centreline d) Centreline height difference e) Vertical square offset

Field	Description
CL grade	Grade of the centreline at the current position.
Direction to point	Direction from the current position to the point to stake out.
Distance to point	Distance from the current position to the point to stake out.
Defined easting	Easting of the point to stake out.
Defined northing	Northing of the point to stake out.
Defined height	Height of the point to stake out.
Current dsgn east	Easting of the design for the current position (relevant point at the selected line).
Current dsgn north	Northing of the design for the current position (relevant point at the selected line).
Current dsgn ht	Height of the design for the current position (relevant point at the selected line).
Actual easting	Easting of the current position.
Actual northing	Northing of the current position.
Actual height	Height of the current position.
Quality 3D	Standard deviation of the point measurement.
Line space half and Line space full	Empty line.

45.3.3

Road Local Line - Info Page

Available fields

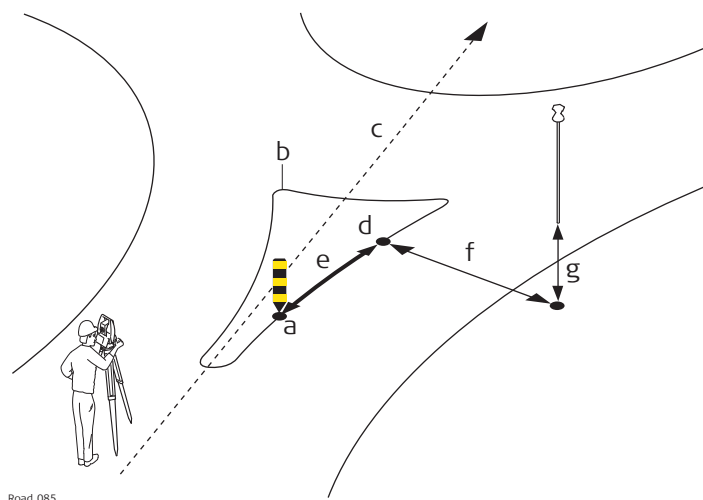

- Stake out of roundabout**
- a) Position to stake out
 - b) Line to stake out
 - c) Centreline
 - d) **Chainage**
 - e) Δ **chainage**
 - f) Δ **offset**
 - g) Δ **height**

The following parameters are available. All fields are display only.

Field	Description
Line task	Name defined for the local line task.
Additional line	The name of an additional line.
Additnl line chnge	Current local chainage of additional line.
Additnl line offset	Current perpendicular offset to the additional line including the defined stake/check offset of additional line of the Offsets page.

Field	Description
Additnl line ht diff	Current height difference to the additional line including the defined stake/check height difference of the additional line of Offsets page.
Δ offset	Horizontal offset between the defined position and the current position.
Δ height	Vertical offset between the defined position and the current position.
Δ chainage	Difference between the defined chainage Stake chainage on the General page and the current chainage Chainage shown on the Stake page.  If no defined chainage exists, for example if staking out random chainages or checking, this field reads Δ chainage: ----- .
Chainage	The current chainage. This field is independent of the chosen settings for Navigation direction and Navigate using in Configuration, Graphics page.
Stake chainage	Chainage to stake out.
Line offset	Horizontal offset from the line.
Line ht diff	Height difference from the defined line.
Line name	Name of the line to stake out or the stake out is relative to.
CL ht diff	Height difference from the centreline.
CL height	Height of the centreline at the current chainage.
CL radius	Radius of the centreline at the current chainage.
CL type	Element type of the centreline.
CL offset	Perpendicular horizontal offset from the centreline. This field is independent of the chosen settings for Navigation direction and Navigate using in Configuration, Graphics page.
CL tangent	Tangent direction of the centreline at the current chainage.
Offset angle	The current angle to selected line.
Nearest hz tngnt pt	Distance to the nearest horizontal tangent point of the design. Refer to "47.3.1 The Stake/Check Screen" for details on this field.
Nearst vt tngnt pt	Distance to the nearest vertical tangent point of the design.
Vertical sqr offset	Offset perpendicular to the vertical component of the selected line. This value can be useful when dealing with pipelines, cables and in the construction segment.
Vertical chainage	Chainage of the measured point is projected perpendicular to the vertical component of the selected line.

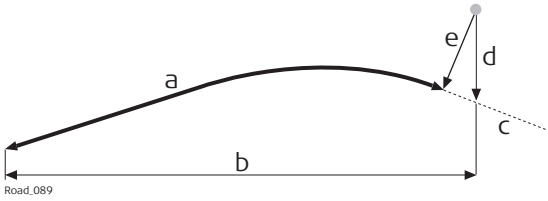
Field	Description
	 <p>a) Vertical chainage b) Chainage c) Centreline d) Centreline height difference e) Vertical square offset</p>
CL grade	Grade of the centreline at the current position.
Direction to point	Direction from the current position to the point to stake out.
Distance to point	Distance from the current position to the point to stake out.
Defined easting	Easting of the point to stake out.
Defined northing	Northing of the point to stake out.
Defined height	Height of the point to stake out.
Actual easting	Easting of the current position.
Actual northing	Northing of the current position.
Actual height	Height of the current position.
Current dsgn east	Easting of the design for the current position (relevant point at the line).
Current dsgn north	Northing of the design for the current position (relevant point at the line).
Current dsgn ht	Height of the design for the current position (relevant point at the line).
Ht end vert align	Height at the endpoint of the vertical alignment of the line.
Δ ht end of v align	Height difference to the endpoint of the vertical alignment of the line.
Quality 3D	Standard deviation of the point measurement.
Line space half and Line space full	Empty line.

Working with pipe-lines

Description

When staking/checking pipes, a common task is to use height differences at the start/end of the pipe. The two **Info** page items for local lines enable the height difference to be added to the end of the vertical alignments **Δ ht end of v align** and **Ht end vert align**.

Available fields

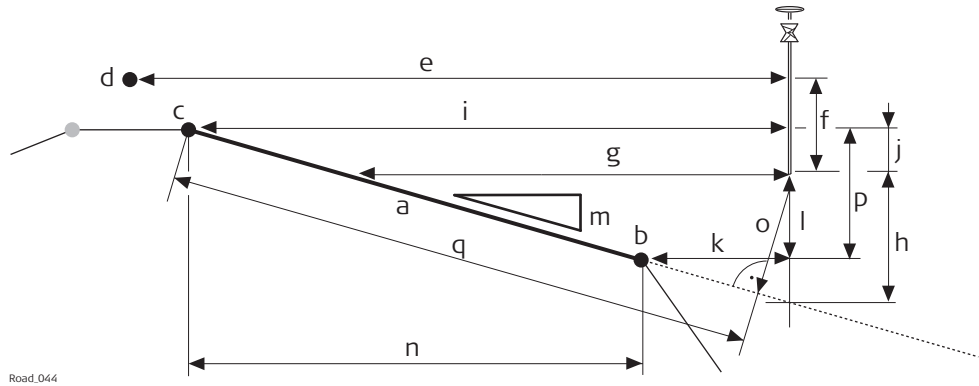

- a) Surface grade to stake out
- b) Right line of the surface grade **Right name**
- c) Left line of the surface grade **Left name**
- d) Centreline
- e) **CL offset**
- f) **CL ht diff**
- g) **Surf. grade offset**
- h) **Surf. grade ht diff**
- i) **Left offset**
- j) **Left ht diff**
- k) **Right offset**
- l) **Right ht diff**
- m) **Surface grade ratio**
- n) **Width**
- o) **Square offset**
- p) **Camber** (in this case negative)
- q) **Square slope dist**

The following parameters are available. All fields are display only.

Field	Description
Surface grade task	Name defined for the surface grade task.
Additional line	The name of an additional line.
Additnl line chnge	Current local chainage of additional line.
Additnl line offset	Current perpendicular offset to the additional line including the defined stake/check offset of additional line of the Offsets page.
Additnl line ht diff	Current height difference to the additional line including the defined stake/check height difference of the additional line of Offsets page.
Δ offset	Horizontal offset between the defined position and the current position.
Δ height	Vertical offset between the defined position and the current position.
Δ chainage	Difference between the defined chainage Stake chainage on the General page and the current chainage Chainage shown on the Stake page. 🖱️ If no defined chainage exists, for example if staking out random chainages or checking, this field reads Δ chainage: ----- .
Chainage	The current chainage. This field is independent of the chosen settings for Navigation direction and Navigate using in Configuration, Graphics page.
Stake chainage	Chainage to stake out.
Surf. grade offset	Horizontal offset from the surface grade.
Surf. grade ht diff	Height difference to the surface grade. If no stake height difference is used Surf. grade ht diff = Δ height .

Field	Description
Camber	The superelevation of the active surface grade. The calculation is always in relation to the defined reference line of the surface grade: Camber = line – reference line
Left name	Name of the left line defining the surface grade.
Left offset	Horizontal offset from the left point of the surface grade.
Left ht diff	Height difference from the left point of the surface grade.
Right name	Name of the right line defining the surface grade.
Right offset	Horizontal offset from the right point of the surface grade.
Right ht diff	Height difference from the right point of the surface grade.
Ref line	Indicates which side of the surface grade the stake out is relative to.
Ref offset	Horizontal offset from the line of the surface grade used as reference. Depends on Ref line and is identical to Right offset or Left offset .
Ref ht diff	Height difference from the line of the surface grade used as reference. Depends on Ref line and is identical to Right ht diff or Left ht diff .
Surface grade ratio	Slope ratio of the surface grade.
Square offset	Offset from the surface grade, perpendicular to the surface grade.
Square slope dist	Slope distance from the slope reference line to the current position perpendicular to the slope. The slope distance is always at the same grade as the defined or current slope. If the current position is above or below the slope, the slope distance is projected square to the slope, and then the slope distance is calculated to the defined reference point. The Square slope dist is measured from the current position to the reference line.
CL ht diff	Height difference from the centreline.
CL ht	Height of the centreline at the current chainage.
CL radius	Radius of the centreline at the current chainage.
CL type	Element type of the centreline.
CL offset	Perpendicular horizontal offset from the centreline. This field is independent of the chosen settings for Navigate direction and Navigate using in Configuration, Graphics page.
CL tangent	Tangent direction of the centreline at the current chainage.
Width	Horizontal width of the surface grade.
Nearest hz tngnt pt	Distance to the nearest horizontal tangent point of the design. Refer to "47.3.1 The Stake/Check Screen" for details on this field.

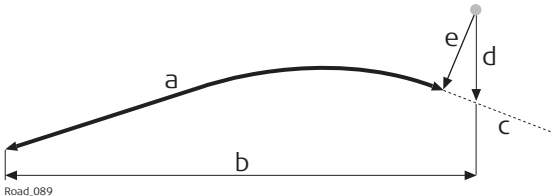
Field	Description
Nearst vt tngnt pt	Distance to the nearest vertical tangent point of the design.
CL grade	Grade of the centreline at the current position.
Vertical sqr offset	Offset perpendicular to the vertical component of the selected line. This value can be useful when dealing with pipelines, cables and in the construction segment.
Vertical chainage	Chainage of the measured point is projected perpendicular to the vertical component of the selected line.  a) Vertical chainage b) Chainage c) Centreline d) Centreline height difference e) Vertical square offset
Direction to point	Direction from the current position to the point to stake out.
Distance to point	Distance from the current position to the point to stake out.
Defined easting	Easting of the point to stake out.
Defined northing	Northing of the point to stake out.
Defined height	Height of the point to stake out.
Actual easting	Easting of the current position.
Actual northing	Northing of the current position.
Actual height	Height of the current position.
Current dsgn east	Easting of the design for the current position (relevant point on the surface grade = Actual easting).
Current dsgn north	Northing of the design for the current position relevant point on the surface grade = Actual northing).
Current dsgn ht	Height of the design for the current position (relevant point on the surface grade).
Quality 3D	Standard deviation of the point measurement.
Line space half and Line space full	Empty line.

Available fields

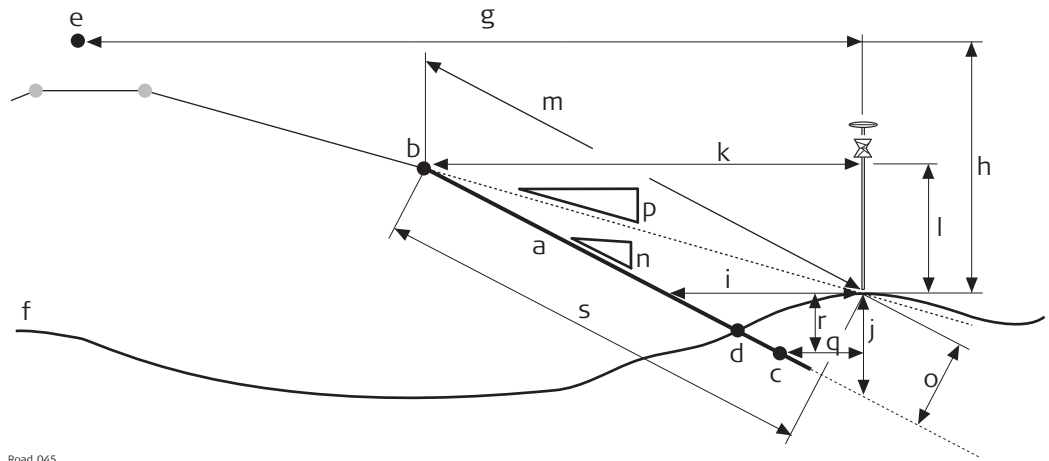



Road_045

- a) Slope to stake out/check
- b) Hinge point **Hinge name**, reference line
- c) Second line of slope **Additnl line name**
- d) Real catch point
- e) Centreline
- f) Natural surface
- g) **CL offset**
- h) **CL ht diff**
- i) **Slope offset**
- j) **Slope height diff**
- k) **Hinge offset**
- l) **Hinge ht diff**
- m) **Slope dist hinge**
- n) **Slope ratio**
- o) **Square offset**
- p) **Current ratio**
- q) **Additnl line offset**
- r) **Additnl line ht diff**
- s) **Square slope dist**

The following parameters are available. All fields are display only.

Field	Description
Slope task	Name defined for the slope task.
Δ offset	Horizontal offset between the defined position and the current position.
Δ height	Vertical offset between the defined position and the current position.
Δ chainage	Difference between the defined Stake chainage on the General page and the current chainage Chainage shown on the Stake page. 🖱️ If no defined chainage exists, for example if staking out random chainages or checking, this field reads Δ chainage: ---- .
Chainage	The current chainage. This field is independent of the chosen settings for Navigation direction and Navigate using in Configuration, Graphics page.
Stake chainage	Chainage to stake out.
Slope offset	Horizontal offset from the slope.
Slope height diff	Height difference from the slope. If no stake height difference is used Slope height diff = Δ height .
Ht diff rail	Height difference from the batter rail to mark the slope (for Type: Batter rail vertical in Slope Stakeout Settings).
Hinge name	Name of the line defining the hinge of the slope.
Hinge offset	Horizontal offset from the hinge point of the slope.

Field	Description
Hinge ht diff	Height difference from the hinge point of the slope.
Additnl line name	Name of the second line defining the slope.
Additnl line offset	Horizontal offset from the second line of the slope.
Additnl line ht diff	Height difference from the second line of the slope.
Slope ratio	Ratio of the slope.  The display format is defined as system setting in Regional Settings, Slope page.
Slope dist hinge	Slope distance to the hinge point.  All defined settings for a batter rail or reference point are already taken into account. This value is the information to write on the stake.
Slope ratio gon	Slope ratio in gon.
Slope ratio degree	Slope ratio in decimal degrees.
Slope ratio %	Slope ratio in percent.
Current ratio	Ratio of the slope from the current position to the hinge.  For the catch point the Current ratio is identical to the Slope ratio .
Square offset	Offset from the slope, perpendicular to the slope.
Square slope dist	Slope distance from the slope reference line to the current position perpendicular to the slope. The slope distance is always at the same grade as the defined or current slope. If the current position is above or below the slope, the slope distance is projected square to the slope, and then the slope distance is calculated to the defined reference point. For slope, the Square slope dist is measured from the current position to the reference line. For manual slope and local manual slope, Square slope dist is measured from the current position to the hinge line.
CL ht diff	Height difference from the centreline.
CL height	Height of the centreline at the current chainage.
CL radius	Radius of the centreline at the current chainage.
CL type	Element type of the centreline.
CL offset	Perpendicular horizontal offset from the centreline. This field is independent of the chosen settings for Navigation direction and Navigate using in Configuration, Graphics page.
CL tangent	Tangent direction of the centreline at the current chainage.
Offset angle	Available for manual slope. The defined value for the angle to alignment.
Traveller height	Height of the traveller in use. Refer to "47.2.3 Advanced Slope Settings" for information on the different methods of slope staking.
Nearest hz tngnt pt	Distance to the nearest horizontal tangent point of the design. Refer to "47.3.1 The Stake/Check Screen" for details on this field.

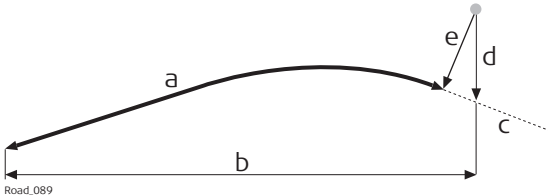
Field	Description
Nearst vt tngnt pt	Distance to the nearest vertical tangent point of the design.
Vertical sqr offset	Offset perpendicular to the vertical component of the selected line. This value can be useful when dealing with pipelines, cables and in the construction segment.
Vertical chainage	Chainage of the measured point is projected perpendicular to the vertical component of the selected line.  <p>a) Vertical chainage b) Chainage c) Centreline d) Centreline height difference e) Vertical square offset</p>
CL grade	Grade of the centreline at the current position.
Direction to point	Direction from the current position to the point to stake out.
Distance to point	Distance from the current position to the point to stake out.
Defined easting	Easting of the point to stake out.
Defined northing	Northing of the point to stake out.
Defined height	Height of the point to stake out.
Actual easting	Easting of the current position.
Actual northing	Northing of the current position.
Actual height	Height of the current position.
Current dsgn east	Easting of the design for the current position (relevant point on the slope = Act Easting).
Current dsgn north	Northing of the design for the current position relevant point on the slope = Act Northing).
Current dsgn ht	Height of the design for the current position (relevant point on the slope).
Quality 3D	Standard deviation of the point measurement.
Line space half and Line space full	Empty line.

Available fields

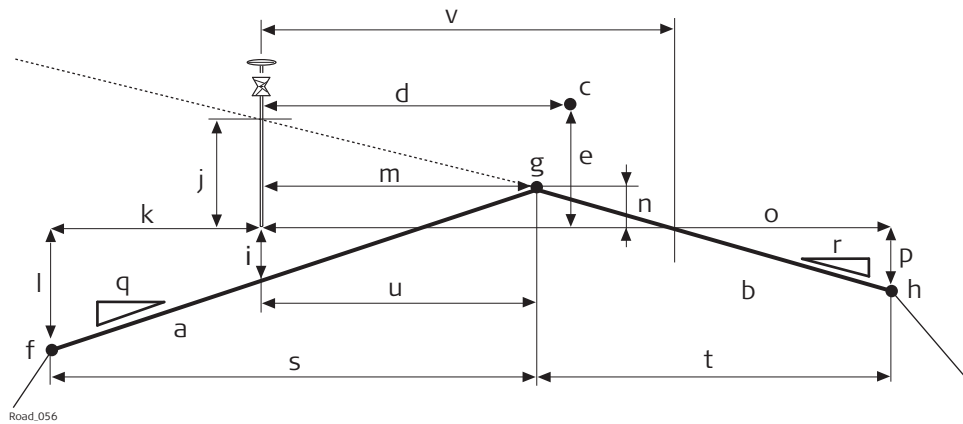

- a) Left surface grade of road crown
- b) Right surface grade of road crown
- c) Centreline
- d) **CL offset**
- e) **CL ht diff**
- f) Left most line of the crown **Left name**
- g) Middle line of the crown **Mid name**
- h) Right most line of the crown **Right name**
- i) **L surf. grade Δ ht**
- j) **R surf. grade Δ ht**
- k) **Left offset**
- l) **Left ht diff**
- m) **Mid offset**
- n) **Mid ht diff**
- o) **Right offset**
- p) **Right ht diff**
- q) **L surf. grade ratio**
- r) **R surf. grade ratio**
- s) **Left width**
- t) **Right width**

The following parameters are available. All fields are display only.

Field	Description
Crown task	Name defined for the road crown task.
Additional line	The name of an additional line.
Additnl line chnge	Current local chainage of additional line.
Additnl line offset	Current perpendicular offset to the additional line including the defined stake/check offset of additional line of the Offsets page.
Additnl line ht diff	Current height difference to the additional line including the defined stake/check height difference of the additional line of Offsets page.
Δ offset	Horizontal offset to the line of the crown defined as the reference line. If working in the toggle offset left/right mode, the correct line is automatically selected as the reference depending on whether the measured point is to the left or right of the middle line. Refer to "47.3.8 Measuring Road Crowns" for more information on the toggle offset left/right mode.
Δ ht left	Vertical offset to the left/right surface grade defining the road crown.
Δ ht right	Vertical offset to the left/right surface grade defining the road crown.

Field	Description
Δ chainage	Difference between the defined Stake chainage on the General page and the current chainage Chainage shown on the Stake page.  If no defined chainage exists, for example if staking out random chainages or checking, this field reads Δ chainage: ----- .
Chainage	The current chainage. This field is independent of the chosen settings for Navigation direction and Navigate using in Configuration, Graphics page.
Stake chainage	Chainage to stake out.
L surf. grade Δ ht	Height difference from the road crowns left surface grade.
R surf. grade Δ ht	Height difference from the road crowns right surface grade.
Ht diff crown	Height difference from Active surf. grade of the crown.
Active surf. grade	Indicates if you are on the left or right surface grade of the road crown.
Actv surf. grade ratio	Slope ratio of Active surf. grade . This value is equal to L surf. grade ratio or R surf. grade ratio depending on the value of Active surf. grade .
Left name	Name of the left most line defining the road crown.
Left offset	Horizontal offset from the left line of the road crown.
Left ht diff	Height difference from the left line of the road crown.
Right name	Name of the left most line defining the road crown.
Right offset	Horizontal offset from the right line of the road crown.
Right ht diff	Height difference from the right line of the road crown.
Mid name	Name of the mid line defining the road crown.
Mid offset	Horizontal offset from the mid line of the road crown.
Mid ht diff	Height difference from the mid line of the road crown.
L surf. grade ratio	Slope ratio of the road crowns left surface grade.
R surf. grade ratio	Slope ratio of the road crowns right surface grade.
Left width	Horizontal width of the road crowns left surface grade.
Right width	Horizontal width of the road crowns right surface grade.
CL ht diff	Height difference from the centreline.
CL height	Height of the centreline at the current chainage.
CL radius	Radius of the centreline at the current chainage.
CL type	Curve type of the centreline.
CL offset	Perpendicular horizontal offset from the centreline. This field is independent of the chosen settings for Navigation direction and Navigate using in Configuration, Graphics page.
CL tangent	Tangent direction of the centreline at the current chainage.
Nearest hz tngnt pt	Distance to the nearest horizontal tangent point of the design. Refer to "47.3.1 The Stake/Check Screen" for details on this field.

Field	Description
Nearst vt tngnt pt	Distance to the nearest vertical tangent point of the design.
CL grade	Grade of the centreline at the current position.
Direction to point	Direction from the current position to the point to stake out.
Distance to point	Distance from the current position to the point to stake out.
Defined easting	Easting of the point to stake out.
Defined northing	Northing of the point to stake out.
Defined height	Height of the point to stake out.
Actual easting	Easting of the current position.
Actual northing	Northing of the current position.
Actual height	Height of the current position.
Current dsgn east	Easting of the design for the current position (relevant point on the crown = Actual easting).
Current dsgn north	Northing of the design for the current position relevant point on the crown = Actual northing).
Current dsgn ht	Height of the design for the current position (relevant point on the crown).
Quality 3D	Standard deviation of the point measurement.
Line space half and Line space full	Empty line.

45.3.7

Road Layer - Info Page

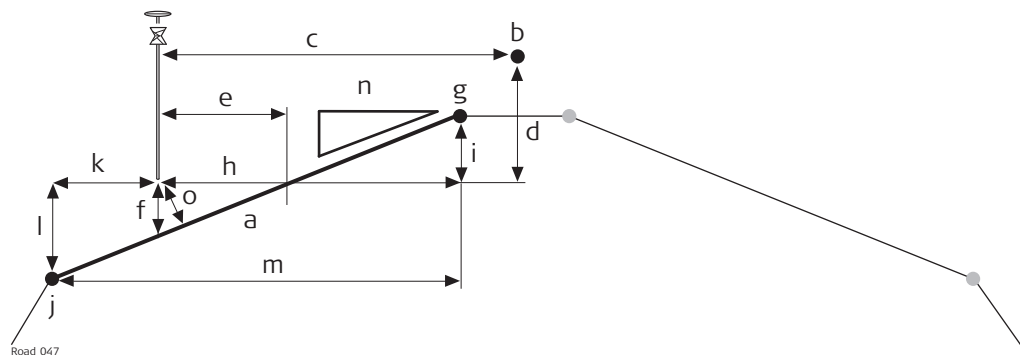

Available fields



- | | | |
|-------------------------------|-------------------------|---|
| a) Relevant part of the layer | g) Right name | m) Width |
| b) Centreline | h) Right offset | n) Slope ratio or Surface grade ratio |
| c) CL offset | i) Right ht diff | o) Square offset |
| d) CL ht diff | j) Left name | |
| e) Slope offset | k) Left offset | |
| f) Layer ht diff | l) Left ht diff | |

The following parameters are available. All fields are display only.

Field	Description
Layer task	Name defined for the layer task.
Layer name	Name of the layer to check.

Field	Description
Chainage	Chainage of the current measured position.
Δ chainage	Difference between the defined Stake chainage on the General page and the current chainage Chainage shown on the Stake page.  If no defined chainage exists, for example if staking out random chainages or checking, this field reads Δ chainage: ----- .
Stake chainage	Chainage to stake out.
Layer offset	Horizontal offset from the layer. Surface between Left line and Right line .
Layer ht diff	Height difference of the measured position to the layer
Δ height	Height difference to the layer, including the stake or check height difference.
Left name	Name of the line next to the current position on the left side.
Left offset	Horizontal offset from the left line Left name .
Layer ht diff	Height difference to the left line Left name .
Right name	Name of the line next to the current position on the right side.
Right offset	Horizontal offset from the right line Right name .
Right ht diff	Height difference to the right line Right name .
Slope ratio	Ratio of the slope between the left line Left name and the right line Right name .  The display format is defined as system setting in Regional Settings, Slope page.
Surface grade ratio	Ratio of the surface grade between the left line Left name and the right line Right name .  The display format of the Surface grade ratio depends on the type chosen for Surface grade on Regional Settings, Slope page.
Square offset	Offset from the slope, perpendicular to the slope.
CL ht diff	Height difference from the centreline.
CL height	Height of the centreline at the current chainage.
CL radius	Radius of the centreline at the current chainage.
CL type	Curve type of the centreline.
CL offset	Horizontal offset from the centreline at the current chainage.
CL tangent	Tangent direction of the centreline at the current chainage.
Traveller height	The height of the traveller.
Nearest hz tngnt pt	Distance to the nearest horizontal tangent point of the design. Refer to "47.3.1 The Stake/Check Screen" for details on this field.
Nearst vt tngnt pt	Distance to the nearest vertical tangent point of the design.

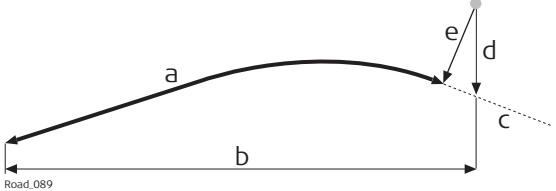
Field	Description
Vertical sqr offset	Offset perpendicular to the vertical component of the selected line. This value can be useful when dealing with pipelines, cables and in the construction segment.
Vertical chainage	Chainage of the measured point is projected perpendicular to the vertical component of the selected line.  a) Vertical chainage b) Chainage c) Centreline d) Centreline height difference e) Vertical square offset
CL grade	Grade of the centreline at the current position.
Direction to point	Direction from the current position to the point to stake out.
Distance to point	Distance from the current position to the point to stake out.
Defined easting	Easting of the point to stake out.
Defined northing	Northing of the point to stake out.
Defined height	Height of the point to stake out.
Actual easting	Easting of the current position.
Actual northing	Northing of the current position.
Actual height	Height of the current position.
Current dsgn east	Easting of the design for the current position (relevant point on the crown = Actual easting).
Current dsgn north	Northing of the design for the current position relevant point on the crown = Actual northing).
Current dsgn ht	Height of the design for the current position (relevant point on the crown).
Quality 3D	Standard deviation of the point measurement.
Line space half and Line space full	Empty line.



An **Info** page for Road DTM is only available for **Roads - As built check**.

Available fields

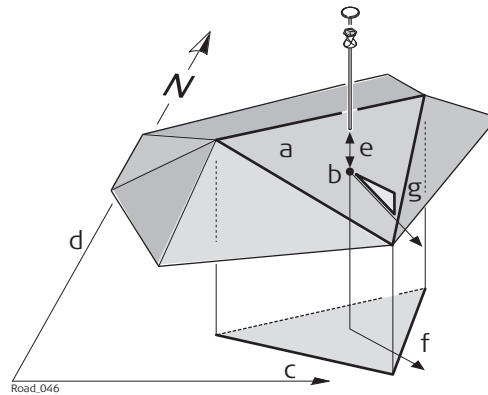

- a) Relevant triangle of the DTM
- b) Projected point on DTM
- c) Easting
- d) Northing
- e) **DTM height diff**
- f) **Flow direction**
- g) **Flow ratio**

The following parameters are available. All fields are display only.

Field	Description
DTM task	Name defined for the DTM task.
DTM height diff	Vertical height difference to the DTM.
Δ height	Height difference to the layer including the stake or check height difference.
DTM height	Height of the DTM at the current measured position.
Flow direction	Direction of maximum slope ratio on the current DTM triangle. This direction is the direction water would flow toward from the projected point.
Flow ratio	Slope ratio of the DTM. This ratio is the maximum slope ratio of the triangle.
DTM name	Name of the DTM surface.
Actual easting	Easting of the current position.
Actual northing	Northing of the current position.
Actual height	Height of the current position.
Current dsgn east	Easting of the DTM for the current position (= Actual easting).
Current dsgn north	Northing of the DTM for the current position (= Actual northing).
Current dsgn ht	Height of the DTM for the current position.
Quality 3D	Standard deviation of the point measurement.
Line space half and Line space full	Empty line.

Available fields

The following parameters are available. All fields are display only.

Field	Description
Δ offset	Distance from the measured point to the point to set out in a direction perpendicular to the horizontal alignment.
Δ height	Vertical offset between the defined position and the current position.
Δ chainage	Difference between the defined Stake chainage on the General page and the current chainage Chainage shown on the Stake page.  If no defined chainage exists, for example if staking out random chainages or checking, this field reads Δ chainage : -----.
Chainage	The current chainage. This field is independent of the chosen settings for Navigation direction and Navigate using in Configuration, Graphics page.
CL ht diff	Height difference from the centreline.
CL height	Height of the centreline at the current chainage.
CL radius	Radius of the horizontal alignment at the chainage of the measured point.
CL type	Element type of the centreline.
CL offset	Perpendicular horizontal offset from the centreline. This field is independent of the chosen settings for Navigation direction and Navigate using in Configuration, Graphics page.
CL tangent	Tangent direction of the centreline at the current chainage.
Nearest hz tngnt pt	Refer to "47.3.1 The Stake/Check Screen" for details on this field.
Nearst vt tngnt pt	Distance to the nearest vertical tangent point of the design.
CL grade	Grade of the centreline at the current position.
Direction to point	Direction from the current position to the point to stake out.
Distance to point	Distance from the current position to the point to stake out.
Defined easting	Easting of the point to stake out.
Defined northing	Northing of the point to stake out.
Defined height	Height of the point to stake out.
Actual easting	Easting of the current position.
Actual northing	Northing of the current position.
Current dsgn east	Easting of the design for the current position (relevant point at the selected line).
Current dsgn north	Northing of the design for the current position (relevant point at the selected line).
Current dsgn ht	Height of the design for the current position (relevant point at the selected line).
Quality 3D	Standard deviation of the point measurement.

Field	Description
Ht diff lower rail	Height difference between the measured point and the lower rail.
Ht lower rail	Height of the lower rail at current chainage.
Current design cant	Design cant at the current position.
Ref offset	Horizontal distance between the measured point and the rail or centreline being used as a reference.
Ref ht diff	Height difference between the measured point and the rail or centreline being used as a reference.
Offset (using cant)	Offset calculated regarding the cant.
Ht diff (using cant)	Height difference calculated regarding the cant.
Rail task	Name of the current task.
Rail name	Name of the centreline or rail being used as a reference.
Defined desgn cant	Design cant at the defined chainage.
Pendular length	The pendulum length as distance value: The difference in elevation of the pendulum centre on the original track and above the axis point.
Def pendulum displacement	The defined horizontal displacement for the track.
Def pendulum angle	The pendulum angle is defined by the pendulum displacement and the superelevation (cant).
Actl pendulum displacement	The current horizontal displacement for the track.
Line space half and Line space full	Empty line.
Current cant	Available for Check. Superelevation of the current position. This value is calculated by using the 'Second Point of Cant' option, which is located in the Tools menu.
Measured cant	<p>Displays the value entered on Check Track, General page. The value is usually measured with a camber measurement instrument.</p> <p> Using Second Point of Cant of the Tools menu, Measured cant on the Info page is set to ---- and is not stored in the DBX. This means, that the cant value of Second Point of Cant (current cant) is used and not the manually entered measured cant value.</p>
Cant difference	<p>The calculation depends on the setting for Superelevation in Configuration, Rail design page:</p> <ul style="list-style-type: none"> For Superelevation: Design: Cant difference = Measured cant - Current design cant For Superelevation: Manual: Cant difference = Measured cant - Manually defined cant of Check Track, General page For Superelevation: None: Cant difference = ----

Available fields

The following parameters are available. All fields are display only.

Field	Description
Line task	Name of the current task.
Δ offset	Horizontal offset between the defined position and the current position.
Δ height	Vertical offset between the defined position and the current position.
Δ chainage	Difference between the defined chainage Stake chainage on the General page and the current chainage Chainage shown on the Stake page.  If no defined chainage exists, for example if staking out random chainages or checking, this field reads Δ chainage: ----- .
Chainage	The current chainage. This field is independent of the chosen settings for Navigation direction and Navigate using in Configuration, Graphics page.
Line offset	Horizontal offset from the line.
Line ht diff	Height difference from the defined line.
Line name	Name of the line to stake out or the stake out is relative to.
CL ht diff	Height difference from the centreline.
Vertical sqr offset	Offset perpendicular to the vertical component of the selected line. This value can be useful when dealing with pipelines, cables and in the construction segment.
CL height	Height of the centreline at the current chainage.
CL radius	Radius of the centreline at the current chainage.
CL type	Element type of the centreline.
CL offset	Perpendicular horizontal offset from the centreline. This field is independent of the chosen settings for Navigation direction and Navigate using in Configuration, Graphics page.
CL tangent	Tangent direction of the centreline at the current chainage.
Nearest hz tngnt pt	Distance to the nearest horizontal tangent point of the design. Refer to "The Stake/Check Screen" for details on this field.
Nearst vt tngnt pt	Distance to the nearest vertical tangent point of the design.
CL grade	Grade of the centreline at the current position.
Direction to point	Direction from the current position to the point to stake out.
Distance to point	Distance from the current position to the point to stake out.
Defined easting	Easting of the point to stake out.
Defined northing	Northing of the point to stake out.
Defined height	Height of the point to stake out.

Field	Description
Actual easting	Easting of the design for the current position (relevant point at the selected line).
Actual northing	Northing of the design for the current position (relevant point at the selected line).
Actual height	Height of the design for the current position (relevant point at the selected line).
Quality 3D	Standard deviation of the point measurement.
Line space half and Line space full	Empty line.
ΔProf	Distance from the design profile to the measured point.
Profile element no.	Element number of the closest design profile element to the measured point.
Profile element(%)	Distance in percentage terms of the measured point along the design profile element.
Dist along profile	Distance of the measured point along the design profile starting at the origin of the profile.
Top distance	Distance of the measured point along the design profile starting at the top of the profile.
CL Off Rotated	Perpendicular horizontal offset from the current position to the centreline, along the X-axis of the rotated tunnel profile
CL Ht Diff Rotated	Height difference from the current position to the centreline along the Y-axis of the rotated tunnel profile.

45.3.11



Workflow for Height (aim to stake ht) TPS

Step-by-step

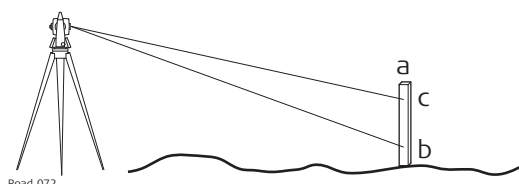
In this example, the height of the surface grade is marked on a peg by using the auto position function.



- a) Peg placed at the correct position
- b) First height, manually chosen direction
- c) Required height on the peg

Step	Description
1.	In the Configuration, TPS page, select Turn to: Prompt before turn.
	Make sure that the instrument uses the reflectorless EDM mode.
2.	After staking out the peg at the correct position with Stake Surface Grade , aim the instrument at the peg.
3.	Press Fn Positn to open the Configuration screen.
4.	Configuration Highlight Height (aim to stake ht).
5.	Press OK.
	The instrument searches for the point on the peg at the required height without changing the horizontal direction.
	As soon as the defined Upper ht limit/Lower ht limit from Configuration, Quality control is reached, the instrument stops.

Step	Description
	Depending on the settings chosen, the instrument turns on the red laser to mark the height.

45.4

Working with Shifts

Description

When working on site, often design data does not match the measured data. For example, an existing road surface that should intersect with the design surface may be 15 cm higher than the plans indicate. To guarantee a smooth intersection, this difference has to be distributed over the remaining 100m of paving. To handle these situations, shifts can be added to the existing design data. A shift is applied when selecting the element to stake out/check.

Horizontal and vertical shifts can be applied to the selected element. By using these shifts the design can be lifted/lowered and moved horizontally.

A shift is always an overlay of the existing design and is stored with the task. For a horizontal alignment, the shift is applied perpendicular to the centreline. For the vertical part of the alignment, shifts are applied following the plumb line.



Shifts are applied temporarily to the design data. The original design data is not modified when a shift is applied.

Access

Press **Shifts..** in the Define screen.

Shift Settings, Horizontal shift/Vertical shift/Scale profile/Apply an expand or shrink value to scale the tunnel profile page

The parameters required for applying the shift are identical for all entities.

Description of fields

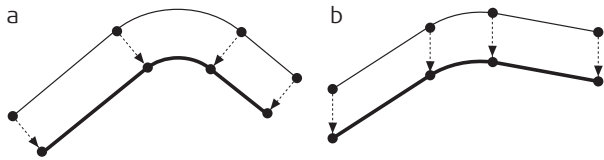
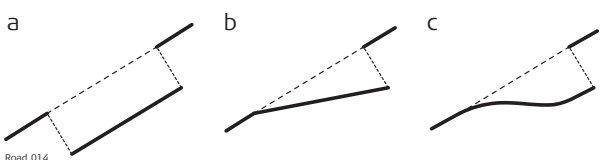
Field	Option	Description
Apply horizontal shift/Apply vertical shift	Check box	<p>When this box is checked, shifts can be defined. Horizontal shifts are always rectangular to the centreline of the element being worked with. Whereas vertical shifts are defined along the plumb line.</p>  <p>a) Horizontal alignment with constant shift b) Vertical alignment with constant shift</p>
Shift type		 <p>a) Constant shift b) Linear shift c) Parabolic shift and reverse curve</p>

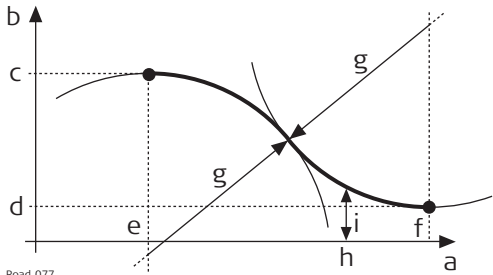
Field	Option	Description
	Linear	The difference between the shift at the begin chainage and the shift defined at the end chainage is distributed in a linear fashion.
	Constant	A constant shift is applied from the begin chainage of the shift to the end chainage of the shift. The shift stays the same from its start chainage or station to the end chainage or station.
	Parabolic	Available for Road and Rail. The difference between the shift at the begin chainage and the shift defined at the end chainage is distributed using a cubic parabola. Parabolic shifts allow a smooth transition between the existing curve and the shifted part.
	Reverse curve	Available for Road and Rail. Two arcs with the same radius are used to distribute the shift. As for parabolic shifts, reverse curves guarantee a smooth transition between the existing curve and the shifted part.
		 <p>a) Chainage b) Shift c) Start shift at chainage (e) d) End shift at chainage (f) e) Start chainage of the shift f) End chainage of the shift g) Radius of the two arcs used as transition curve h) Random chainage between (e) and (f) i) Shift applied at chainage (h)</p>
Begin chainage	Editable field	Chainage from which the shift is applied.
Begin shift	Editable field	Magnitude of the shift to apply at the begin chainage.
Shift value	Editable field	Available for Shift type: Constant . The magnitude of shift.
End chainage	Editable field	Chainage at which the shift ends.
End shift	Editable field	Magnitude of the shift to apply at the end chainage.

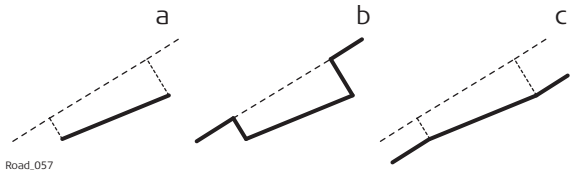
Field	Option	Description
Before / after		Available for Road and Rail. Defines the object outside of the defined shift range.  Road_057
	None	The object only exists within the defined shift range.
	Parallel	The begin shift and the end shift are continued parallel. The start shift is used from the start of the alignment until the start chainage. The end shift is used from the end chainage until the end of the alignment.
	Step	Before/after the defined shift range, no shift is added. Outside of the defined shift area the original design is used. This option means a "step" will appear at the start and/or end of the shifted area.

Plot page with shifts

The application offers for all stakeout and check methods a page showing a graphical representation of the measured position in relation to the design. If shifts are applied to the design the plot shows the original unshifted cross section view of the design as well as the shifted element. The current element is shown in blue.

Sign convention for shifts

The sign convention for design shifts is identical to the convention used for stake offset and height difference.

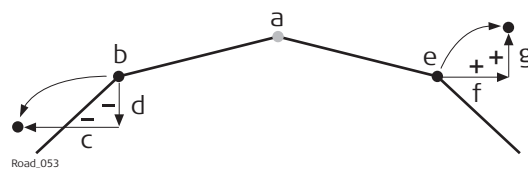

- a) Centreline
- b) Line on left side
- c) Negative horizontal shift
- d) Negative vertical shift
- e) Line on right side
- f) Positive horizontal shift
- g) Positive vertical shift



Horizontal stake offsets are always defined perpendicular to the centreline of the layer the line/s belongs to.

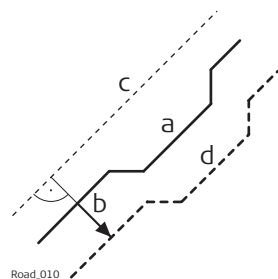

- a) Line the horizontal shift is applied to
- b) User defined horizontal shift for the line
- c) Centreline
- d) Shifted line

Shifts for lines, slopes, layers and DTMs

The shifts applied to lines, slopes, road crowns layers and DTMs are identical with one exception: Given that DTMs are not defined relative to a centreline and hold no orientation information, no horizontal shift is possible for a DTM.

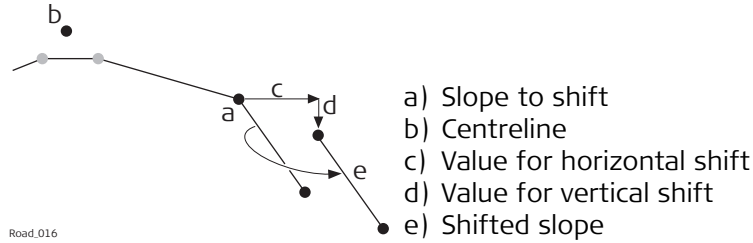

- a) Slope to shift
- b) Centreline
- c) Value for horizontal shift
- d) Value for vertical shift
- e) Shifted slope

Shift for surface grade and road crowns

Description

To allow widening and narrowing of surface grade and road crowns, only one of the two lines defining the surface grade or crown, is shifted when adding a horizontal shift. This behaviour is useful for small changes to the original design, for example to bus stops or emergency bays.

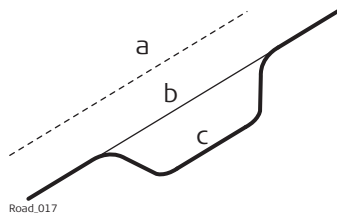

- a) Centreline
- b) Original line of the design
- c) Line with horizontal parabolic shift

Horizontal shift

For surface grades and crowns, the horizontal shift is added to the line that is defined as the reference line. To maintain the original surface grade/crown ratio the line is shifted along the surface grade/crown.

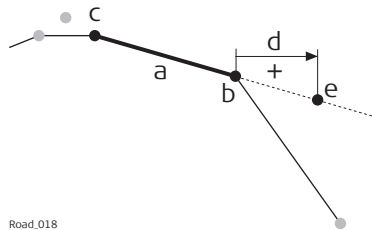

- a) Surface grade to shift
- b) Reference line of the surface grade
- c) Second line of the surface grade
- d) Positive horizontal shift
- e) Position of the shifted reference line

Vertical shift

The vertical component of the shift for a surface grade or crown is applied to all lines.

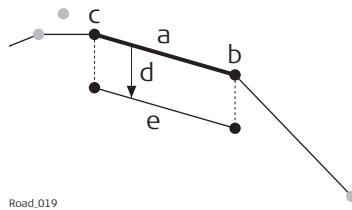

- a) Surface grade to shift
- b) Right line of the surface grade
- c) Left line of the surface grade
- d) Negative vertical shift
- e) Shifted surface grade

Horizontal alignment with constant horizontal shift

Horizontal shifts are always perpendicular to the centreline.

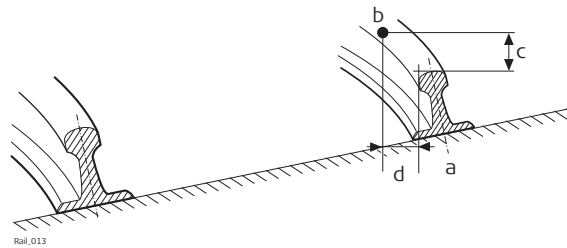

Plan view

- a) Reference line
- b) Point to stake
- c) Stake height difference
- d) Stake offset

45.5

Tasks

Description

When staking out or checking a road/rail/tunnel, often it is not possible to finish a particular task in one go. The element to be staked out or checked can be stored together with all defined settings as a work task.

Stored in a task are:

- Selected layer
- Working chainage
- Selected line(s) or element
- Shifts

Tasks are stored within the selected Road/Rail/Tunnel job. They can be created at any time when working in the field or during preparation in the office.

Deleting a task does not delete the referenced jobs.

Deleting a Road/Rail/Tunnel job deletes all referencing tasks.

Tasks are method-specific.

Creating a task

Step	Description
1.	Start the Roads/Rail/Tunnel application.
2.	In the job selection screen, select the required jobs and press OK .
3.	Select a method, if required, and press OK .
4.	In the Define screen press Save...
5.	Type in a name for the task and press OK .

Loading a task

Access

Press **Load..** in the Define screen.

Load a Defined Task

Load a Defined Task	
Name	Date
Line2	03.03.2011
Line1	03.03.2011

Hz: 0°00'00"	V: 135°00'00"	Fn abc	13:04
OK	Delete	More	

Key	Description
OK	To select the highlighted task and continue.
Delete	To delete the selected task.
More	To display information about Date , Time , Creator and Description .
Fn Name or Time	To sort task list by name or time.
Fn Quit	To exit the application.

45.6

45.6.1

Understanding Terms and Expressions

Road - Basic Terms

Terms and expressions

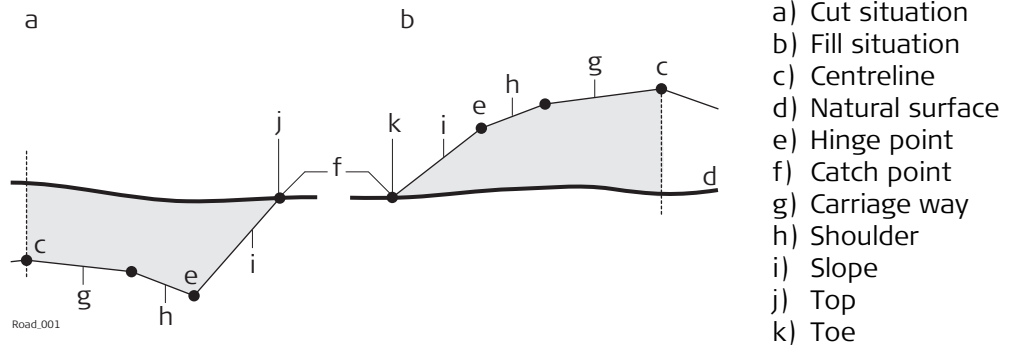

Term / expression	Description
Carriage way	The part of the road on which users drive once the road is finished.
Shoulder or Verge	Often located next to the carriage way, usually with a slightly higher slope ratio than the carriage way.
Slope	Located next to the verge and can be thought of as linking the road level with the natural surface. The ratio of the slope is greater than the ratio of the verge. A slope starts at the hinge point.
Natural surface or original ground	The undisturbed surface before project construction.
Finished road level	Describes the final road surface.
Catch point or daylight point	Indicates the point of intersection between the slope and the natural surface. Both the hinge point and the catch point lie on the slope. For a cut slope, the catch point forms part of the top of a bank. For a fill slope, the catch point forms part of the bottom of a bank.
Chainage or station	The cumulative distance along the centreline, frequently but not always starting at zero.

45.6.2

Road - Horizontal and Vertical Geometry Elements

Horizontal alignment

The application supports the following elements in the horizontal component of alignments:

- Straights
- Arcs
- Clothoids, entry and exit as well as partial
- Cubic parabolas, entry and exit as well as partial
- Bloss curves, entry and exit as well as partial; only available for Rail
- Multipoints, all elements that cannot be described by one of the previous types are represented by discrete points along the curve. For example, a line parallel to a clothoid.

Vertical alignment

The application supports the following elements in the vertical component of alignments:

- Straights
- Arcs
- Quadratic parabolas
- Asymmetric quadratic parabola
- Multipoints, all elements that cannot be described by one of the previous types are represented by discrete points along the curve.

45.6.3

Road - Basic Elements for Stake and Check Measurements

Description

In general, there are four different basic stakeout and check elements:

- Surface grades, for example, the final carriage way
- Lines, for example, a centreline
- Slopes, for example, the end-slopes of a cross section
- Surfaces, for example, a DTM surface

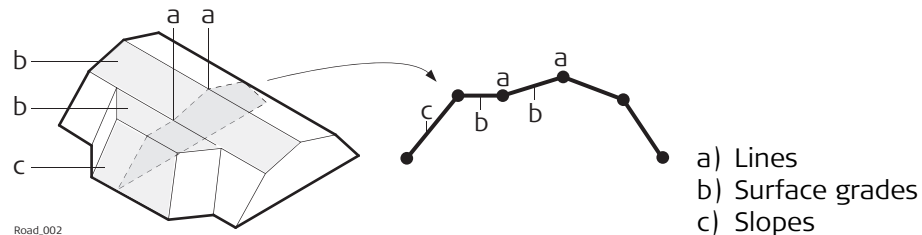

Every stakeout or check is based on one or more of these four base elements. For example, a road crown consists of two surface grades with one common line.

Lines

The stake out of a line is used in different situations:

- Centre line of a road
- Edges of a road or any other change in slope
- Gutters
- Pipelines, cables and any other line-related design feature

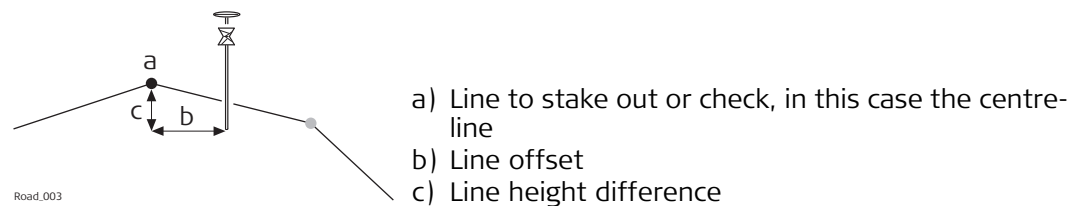

Surface grades

Surface grades are defined by two lines. The two lines define the right and left edge of the surface grade. One of the two lines is used as the reference line.

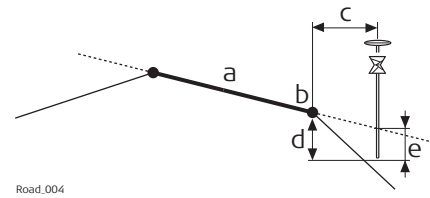

Road.004

- a) Surface grade to stake out or check
- b) Reference line
- c) Horizontal offset to reference line
- d) Height difference to reference line
- e) Height difference to expanded surface grade

Slopes

Slopes, like surface grades, are defined by two lines. Different to surface grades, only one edge of the slope, the hinge point, is known. The second edge, catch point or daylight point, is defined by the intersection of the slope and the natural surface. As the natural surface is unknown this edge can only be staked out in the field. Finding and staking out the catch point is the most important task when working with slopes.

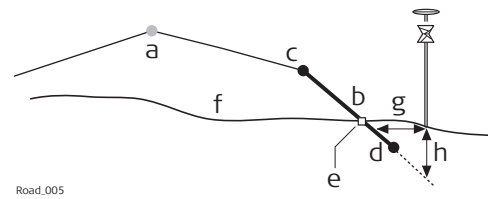

Road.005

- a) Centreline
- b) Slope
- c) Hinge Point
- d) Second line defining the slope
- e) Catch point
- f) Natural surface
- g) Δ Offset from the slope
- h) Height difference from the slope

Surfaces

There are two types of surfaces supported that represent a three-dimensional design:

- DTM / TIN (**D**igital **T**errain **M**odel; **T**riangular **I**rregular **N**etwork)
- Layer

A DTM consists of several 3D triangles. DTMs do not include information relating the DTM to a centreline. Positions are defined by easting, northing and height values.

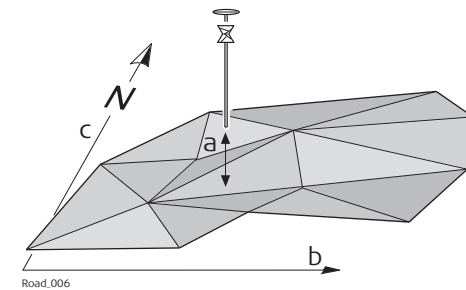

Road.006

- a) Height difference from the triangle of the DTM found in the same vertical line as the measured point
- b) Easting of coordinate system
- c) Northing of the coordinate system

A layer is a combination of lines that form a 3D surface relative to a centreline. Thus it is possible to define points by chainage or station, offset and height. Refer to "45.2.3 Design Data" for more information.

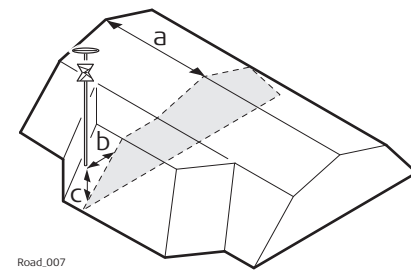

Road.007

- a) Chainage or station
- b) Layer Offset
- c) Layer height difference

Description

When conducting a stake out, the aim is usually to mark the position of geometric elements defined by the design. For example, in the graphic below, the catch point of a slope. A point can be staked either directly or indirectly. For a directly staked point, the peg ends up at exactly the position of the point to be staked. Staking the same point indirectly, the peg will be placed with a certain offset to the point.

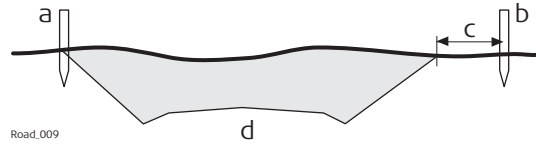

One reason to stake out a point indirectly is that the peg would not last long at the position of the actual point. In this example, the peg staked directly would be removed as soon as the excavation work starts.



Horizontal stake offsets are, like shifts, defined perpendicular to the centreline of the layer the line(s) belongs to, if no offset angle on **Offsets** page has been defined. For surface grades and road crowns, the stake offset is applied following the same rules as stated for horizontal shifts. Refer to "45.4 Working with Shifts" for more information.

Stake offset

For each stakeout method, a horizontal and/or vertical offset can be defined. The stake offset and stake height difference are defined on the **Offsets** page of the stake screen.

Sign convention for stake offset and stake height difference

The sign convention for stake offsets and height differences is identical to the convention used for design shifts.

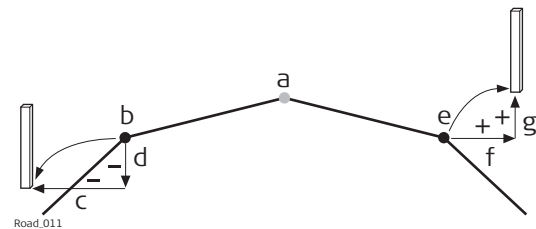

- a) Centreline
- b) Line on left side
- c) Negative stake offset
- d) Negative stake height difference
- e) Line on right side
- f) Positive stake offset
- g) Positive stake height difference

Plot page with stake offset and stake height difference

The application offers for all stake out methods a page showing a graphical representation of the measured position in relation to the design. If stake offset and/or stake height difference are used, the plot shows the original cross section view of the design as well as the position to stake out. The position to stake out is marked by a yellow/black peg.

Description

Chainage or station equations are used to adjust the alignment chainage or station. The most common reason for doing so is the insertion or removal of curves during the design process. Inserting or removing a curve would require recalculating the chainage or station of an entire alignment. Using chainage or station equations eliminates this need. Chainage or station equations can create either a gap or an overlap as shown in the following diagrams.

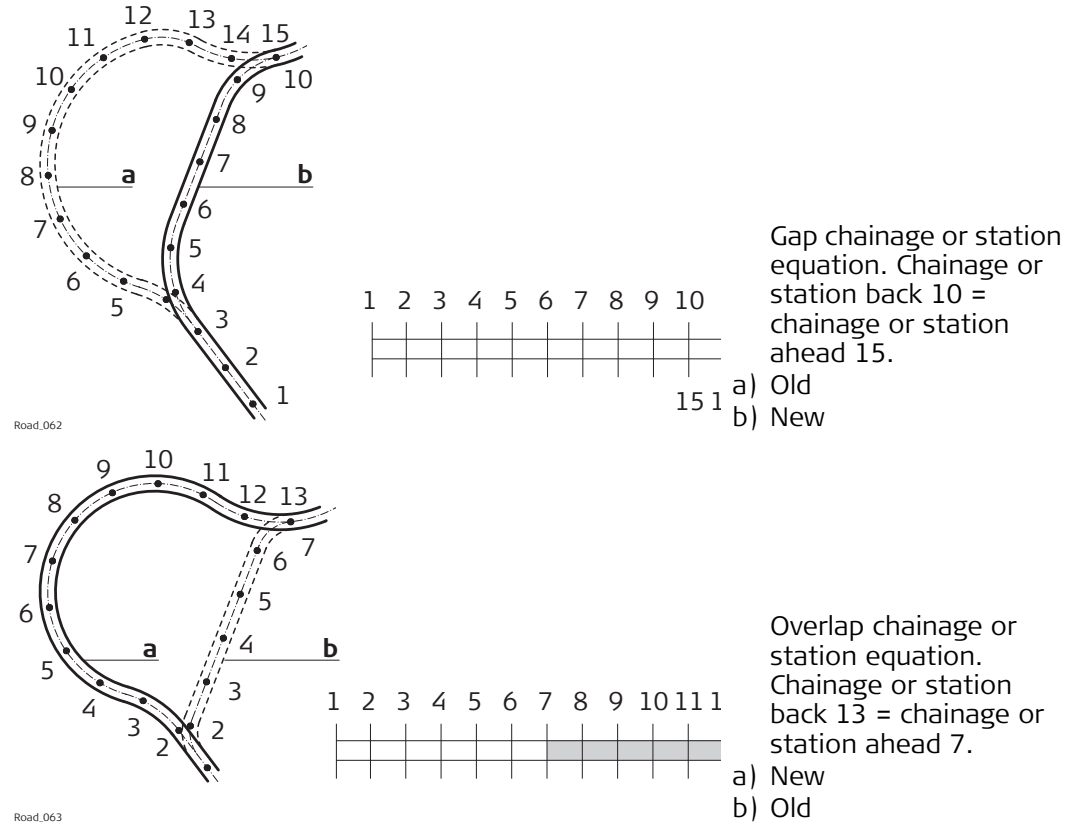

Multiple chainage or station

In the case of the overlap shown in the example, the chainages or stations between seven and thirteen appear twice. When a duplicate chainage or station is entered, a message asks which one is to be used.

Example

As more than one chainage or station equation is possible, a chainage or station can appear more than twice on a design. In this example, the chainages or stations 11 to 13 appear three times.

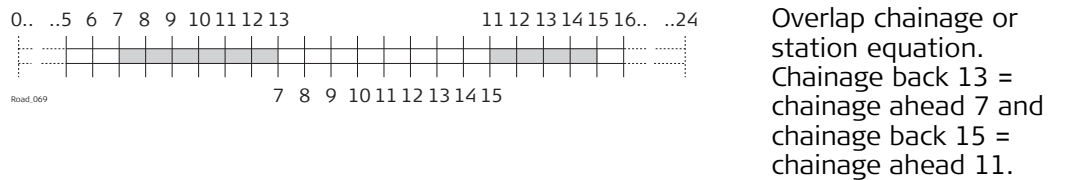

In this example, when chainage or station 12 is entered in **Road - Multiple Chainage**, the following screen shows how the option to select the right chainage or station is displayed:

Road - Multiple Chainage		
Nr.	Ahead	End
1	70.0000	90.0000
2	80.0000	95.0000

3DCQ:--m	2DCQ:--m	1DCQ:--m	Fn abc	15:14
OK			More	

Key	Description
OK	To select the highlighted chainage or station equation and return to the stake out screen.
More	To switch the value displayed in the last column to show the end chainage or station of the chainage or station equation.

Description of columns

Column	Description
End	Shows the end chainage or station for the chainage or station equation. In this example, the field shows 13.000 for Nr. 1 , 15.000 for Nr. 2 and 24.000 for Nr. 3 . End shows to which chainage or station, the current chainage or station equation is valid. As for the first part of the alignment, no chainage or station equation exists, Ahead stays empty for the first row.

Description

A working corridor defines the valid offset range left and right of the centreline. When working with irregular alignments such as traffic islands and parking lots, working corridors are useful to avoid displaying results from the wrong centreline element. The following example shows the result if working without a defined working corridor. For the measured position (b), the application finds the centreline point (c) with the minimum perpendicular offset (f).

With a defined working corridor (e), the application would display a message advising that the measured position is outside of the defined centreline.

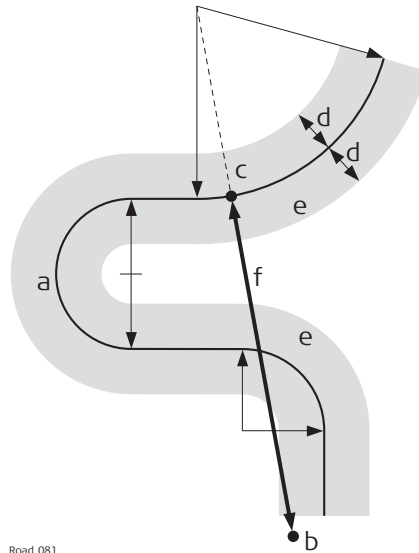

Road_081

- a) Centreline
- b) Measured position
- c) Projected point on the centreline
- d) Defined offset range for the working corridor
- e) Working corridor
- f) Offset from the centreline, if no working corridor is used

The working corridor is defined in **Configuration, Design** page. Refer to "45.3 Configuring Roads Applications" for more information.

Description

Whenever centrelines must be extended, for example, at the start and end area of an alignment or slope. The projection of the measured position to the centreline is made using the tangent of the start/end point of the centreline.

In this case a warning appears informing that the original design is exceeded. The application will advise as soon as a measured position is within the design area once again.

Concept

When expanding the centreline the geometry will be continued using the tangent of the start/end point of the centreline.



Road_090

- a) Centreline
- b) Extended centreline

Method**Description**

When staking out in the region of the start/end area of the design centreline, situations occur where an expansion of the centreline is useful. As soon as measurements are outside the defined centreline, the application will prompt if, and with which method, the centreline should be expanded.



The extension of a centreline is made following its start/end tangent. Outside of the original design area correct results cannot be guaranteed.

45.6.8

Road/Rail - Working with Heights

Description

Normally, heights stored with the design data are used. The Rail application offers the possibility to switch to either:

- a height which is entered manually by the user,
This option enables the manual definition of a height, which can be applied for staking out or checking. This height is entered in the General page.
- a height which is retrieved from an existing Height Layer, as defined in the DTM job associated with the project. The layer from the DTM is applied and used as a height reference for the staking out or checking of alignments. 2D and 3D are possible. This option is configured in the Tools menu.

Understanding priorities of various heights

Type of height	Overrules	Stake Height Diff
Manually entered	All other heights	Considered
Of individual point	All other heights	Considered
From height layer of DTM	Design height	Considered
From design	No other heights	Considered

45.6.9

Rail - Working with a Single Track

Terms and expressions

Term / expression	Description
Track	A track comprises two separate rails.
Single track	A single track is defined as one track with one centreline and two rails. All chainages are calculated from the centreline.
Track centreline	Geometric alignment in two or three dimensions to which all design elements of the project are referenced. It could be that the vertical component of the alignment does not coincide with the plan component. In this case the vertical part of the alignment will generally coincide with the lowest rail.
Chainage or station	The cumulative distance along the centreline, frequently but not always starting at zero.
Left/right rail	Planimetric position of the left/right rail of a track.
	The sense of the left/right rail is given by the direction of increasing chainage.
	When a section of the track is viewed in the direction of increasing chainage, the left rail is to the left of the centre of the track.
Nominal gauge	The nominal distance between the active (internal) faces of the left and right rails.
Superelevation base	The distance over which the superelevation is applied. This distance is normally the distance between the centre of the left and right rail.
Left/right superelevation Left/right cant	The superelevation or height difference of each rail with respect to the track centreline. Usually expressed in millimetres.

Term / expression	Description
	<p>If one of the rails is used to rotate the track section, or the height of the vertical alignment coincides with the lowest rail, the superelevation of the rotation point or lowest rail will be zero.</p> <p>Superelevation is also known by the term cant. These two words can be interchanged.</p>

Diagram - Plan

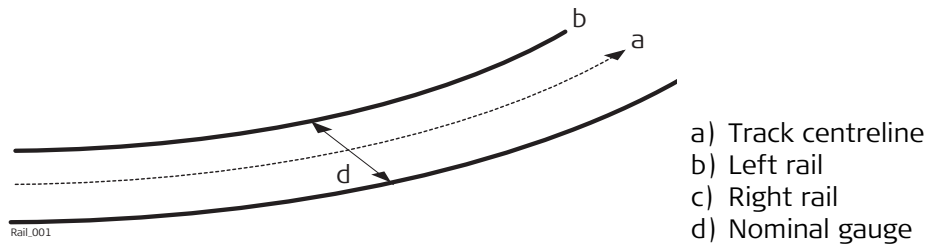
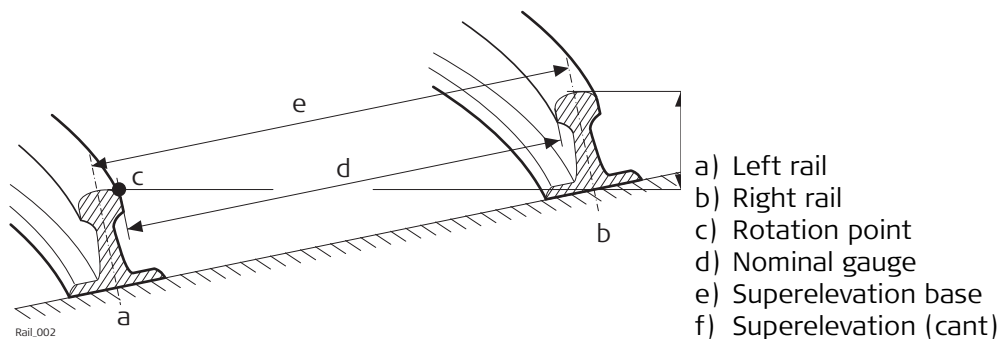

Diagram - Section

Two generic methods can be used to define the section of the track.

Method 1 - A definition using rotation around a known point

This method involves rotating the section around a known point, normally the lowest rail.



Method 2 - A definition using relative height distances

This method uses height differences relative to the vertical alignment to define the height of the left and right rail.

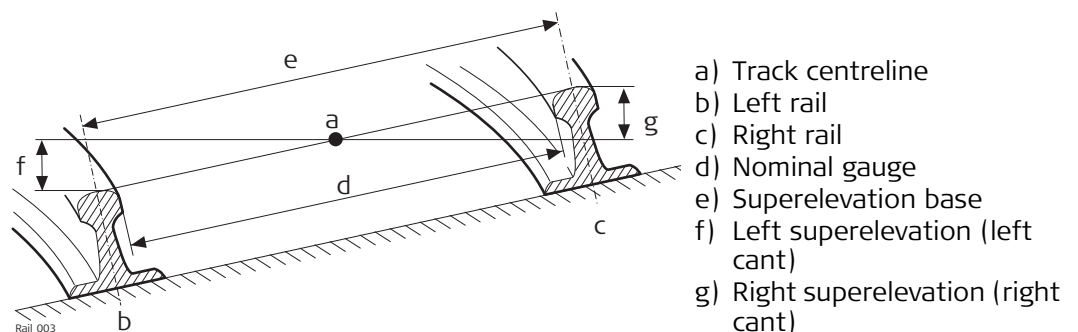

Description

Multiple tracks are used when more than one track share a common centreline, from which all chainages are calculated.

When there are multiple tracks with independent centrelines for each track, each track is then considered as a single track. Refer to "45.6.9 Rail - Working with a Single Track" for details on single tracks.

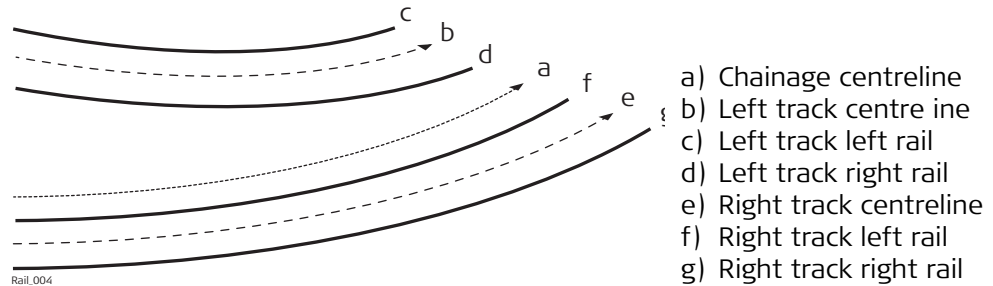
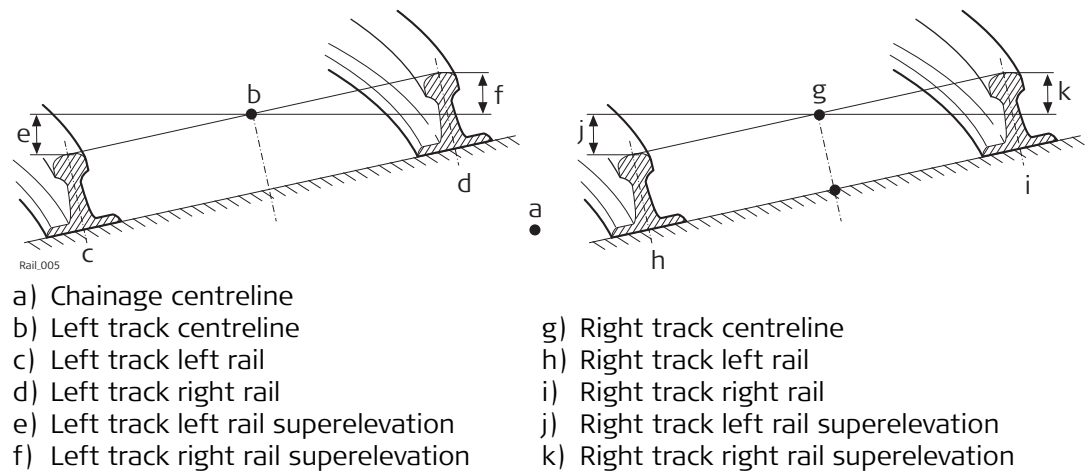
Diagram - Plan**Diagram - Section****Calculations**

For multiple tracks, the chainage centreline is used only to calculate the chainage. The superlevation of each track is calculated with respect to the corresponding (left / right) vertical alignment. The chainage centreline can consist of a plan and a vertical component. Although the vertical component of the chainage centreline is not used for any calculation.

Description

Points can be staked with respect to three basic elements of the track:

- Track centreline
- Left rail
- Right rail

Centreline stakeout**Description**

The line to stake out can be a track centreline or, in the case of multiple tracks, the left or right track centreline. In both cases, a horizontal offset with respect to the centreline can be applied. Additionally, if a vertical alignment is available for a track centreline, a vertical offset can be applied.

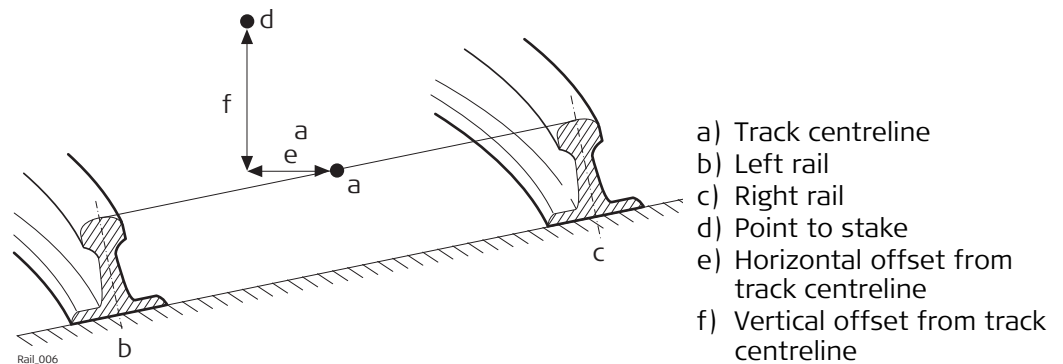
Diagram - Single track elements**Left/right rail stakeout****Description**

The left or right rail of a track can be staked out:

- directly,
- horizontal and/or vertical offsets can be used to stake any point relative to either rail.

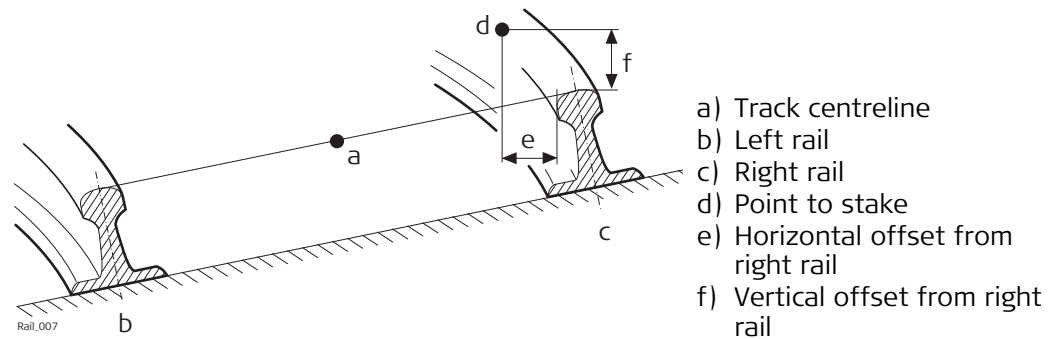
Diagram - Staking out a point relative to the right rail

☞ The position from which the horizontal and rail offsets will be applied depends on how the left and right rails were defined in the imported design data. Using standard practice, the horizontal offset would be defined from the active face of the rail, and the height offset would be defined from the highest part of the rail, as shown in the diagram.

45.6.12

Rail - Working with Offsets

Sign convention for offsets

The sign convention for offsets is:

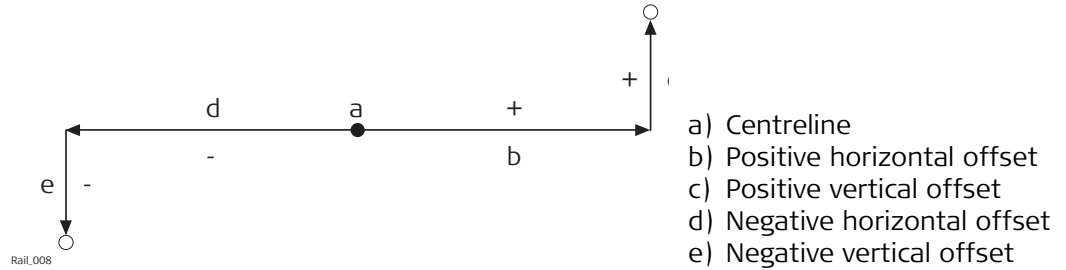

45.6.13

Tunnel - Basic Terms TPS

Terms and expressions

Term / expression	Description
Centreline	Geometric alignment in two or three dimensions to which all design elements of the project are referenced.
Chainage or station	The cumulative distance along the centreline, frequently but not always starting at zero.
Design Profile	Geometric description of the designed shape of the cross-section of the tunnel. The design profile can contain straight or curve elements.
Excavated Profile	Shape of the cross-section of the tunnel that has been excavated.
Underbreak	When the excavated profile is inside the design profile, the underbreak is the perpendicular distance between the design profile and the excavated profile.
Overbreak	When the excavated profile is outside of the design profile, the overbreak is the perpendicular distance between the design profile and the excavated profile.
Tunnel Portal	The open end of a tunnel.
Tunnel Face	The point where the excavated tunnel meets existing terrain.
Superelevation (Rotation)	Angle of rotation of a design profile. Used to take into account the velocity of a moving vehicle through a curve.
Rotation Point	The point about which the design profile is rotated. This point may or may not coincide with the centreline.

General terms

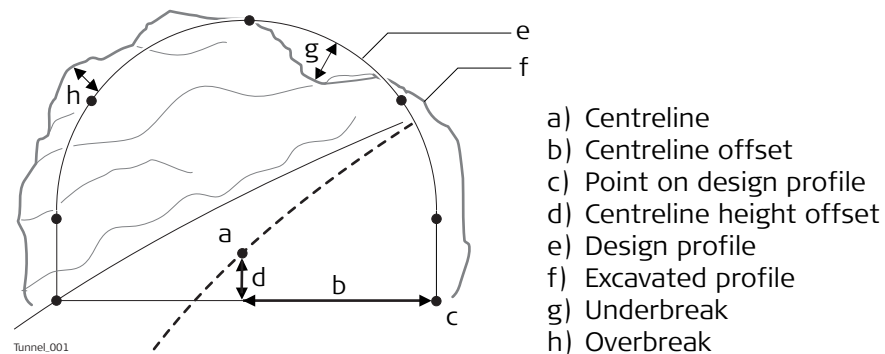

3D View

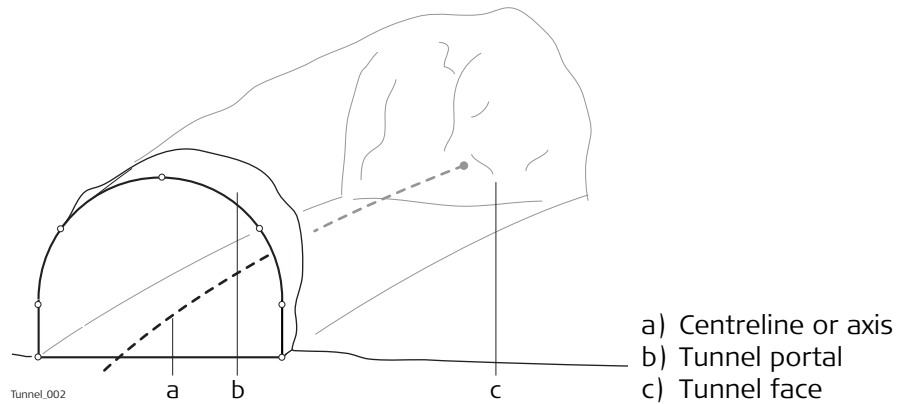

Superelevation

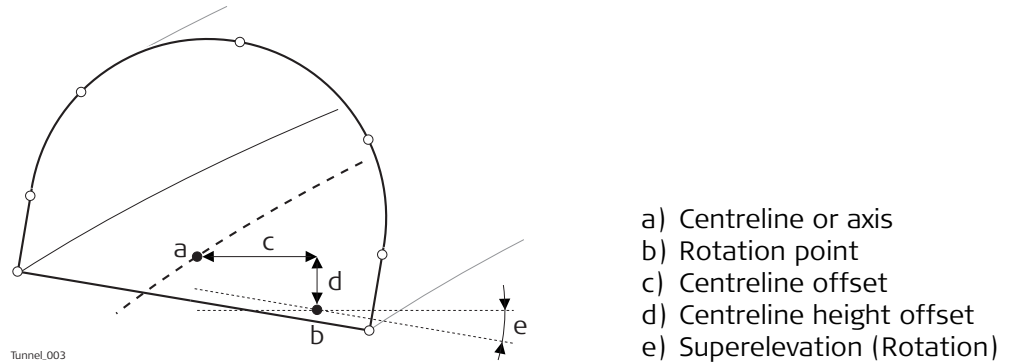

45.6.14

Tunnel - Elements for Stake Out and Check Measurements TPS

Tunnel face

Staking tunnel faces

It is usually required to stake out the tunnel face to indicate the position to excavate when certain tunnelling methods are used. For example, Drill and Blast or excavation using a roadheader.

The points to stake on the tunnel face can be defined in various ways:

Horizontal and vertical offsets

By horizontal and vertical offsets with respect to the centreline:

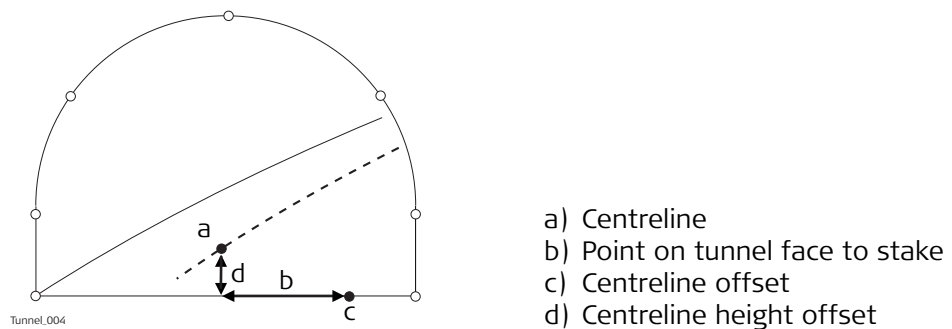

Distance along profile

By the distance from the start of the design profile and an offset from the design profile.

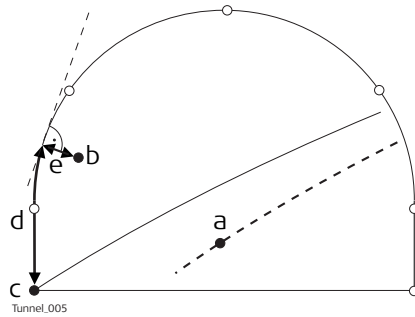

- a) Centreline
- b) Point on tunnel face to stake
- c) Point defining start of design profile
- d) Distance from start of design profile
- e) Offset perpendicular to design profile

Distance along a particular element

By the distance along a particular element of the design profile and an offset from the element.

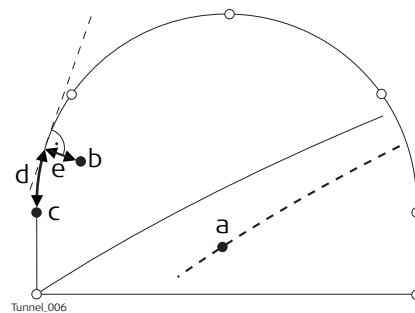

- a) Centreline
- b) Point on tunnel face to stake
- c) Element of design profile to stake
- d) Distance from start of design profile element
- e) Offset perpendicular to design profile

Tunnel profiles

Staking tunnel profiles

Tunnel profiles are normally staked after excavation to indicate the position of tunnel design elements or services such as lighting or ventilation.

Basic terms

Usually a tunnel under construction is designed and built in various stages such that a given chainage can have various design profiles. For example shotcrete or final lining. Each design profile is called a layer.

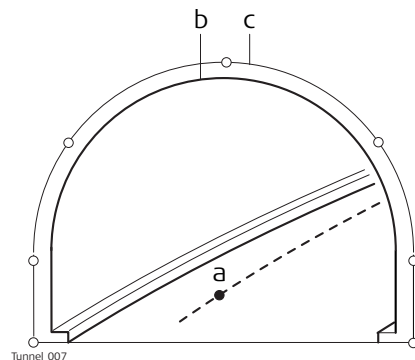

- a) Centreline or axis
- b) Final lining
- c) Shotcrete

Measuring tunnel profiles

Tunnel profiles are normally measured after excavation to compare the excavated profile with the design profile. This check can occur during the excavation phase of the project or for quality control checks of the built tunnel.

When measuring tunnel profiles, it is possible to scan various profiles from one instrument position. The profiles to scan are defined with respect to a defined chainage. Profiles can be scanned at a given forward and back interval within a given forward and back distance from the defined profile.

Measuring tunnel profiles - Plan view

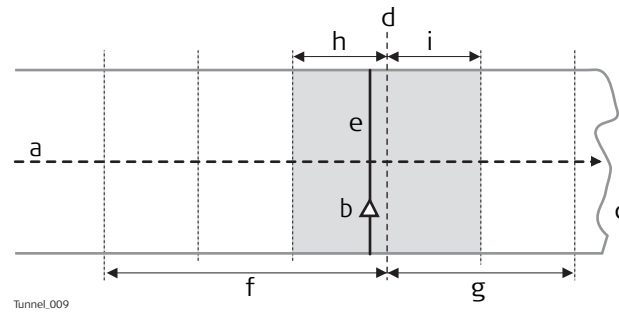

- a) Centreline
- b) Instrument position
- c) Tunnel face
- d) Defined profile to scan
- e) Instrument profile
- f) Back distance
- g) Forward distance
- h) Back interval
- i) Forward interval

Profile view

Tunnel profiles can be measured vertically, horizontally or perpendicular to the tunnel centreline.

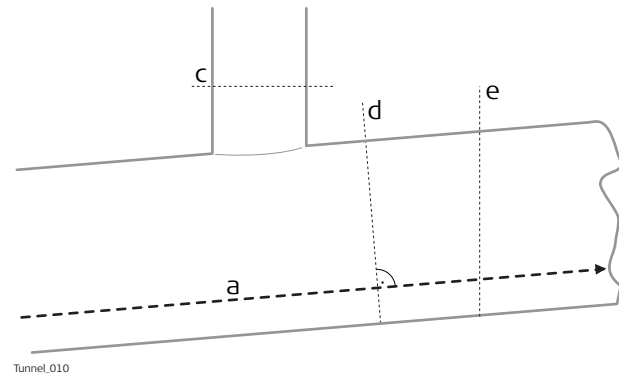

- a) Centreline
- b) Tunnel face
- c) Horizontal profile
- d) Profile perpendicular to centreline
- e) Vertical profile

45.6.15

Tunnel - Shifts TPS

Description

When working on site, often design data does not match the measured data. For example, an existing road surface that should intersect with the design surface may be 15 cm higher than the plans indicate. To guarantee a smooth intersection, this difference has to be distributed over the remaining 100 m of paving. To handle these situations, the application allows the possibility of adding shifts to the existing design data. A shift is applied when selecting the element to stake out/check.



Shifts do not change the stored design. They are applied temporarily for stake out purposes.

Centreline shifts

Horizontal and vertical shifts

Horizontal shifts are always perpendicular to the centreline whereas vertical shifts are applied along the plumb line.

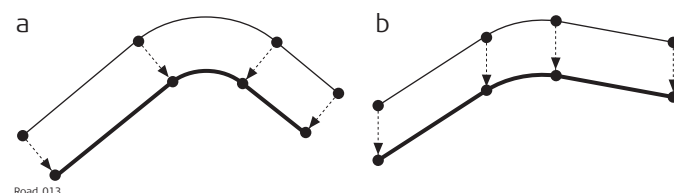

- a) Horizontal alignment with constant shift (plan view)
- b) Vertical alignment with constant shift (profile view)

Constant and linear shifts are supported

For both horizontal and vertical shifts, two different types can be applied:

Constant: The shift remains the same from its start chainage or station to the end chainage or station.

Linear: The shift is linearly interpolated along the chainage or station.

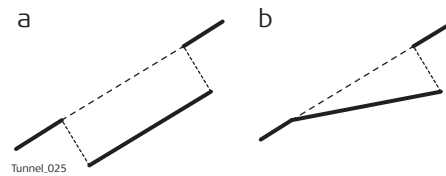

- a) Constant shift
- b) Linear shift

Sign convention

The sign convention for design shifts is identical to the conventions used for centreline offset and height shifts difference.

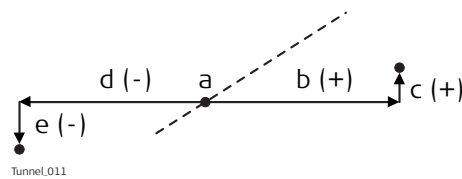

- a) Centreline
- b) Positive horizontal shift
- c) Positive vertical shift
- d) Negative horizontal shift
- e) Negative vertical shift

Design profile shift

A shift can be applied to the design profile. The shift is applied perpendicularly to the design profile at any point along the design profile.

A positive shift will increase the size of the profile, a negative shift will decrease the size of the profile.

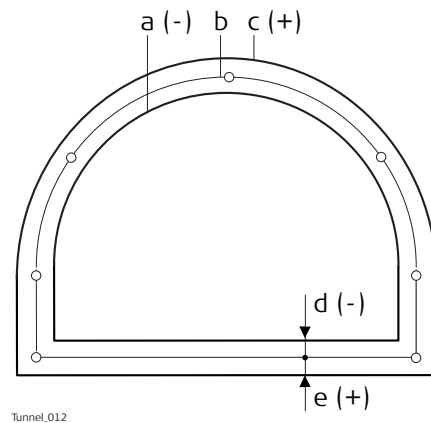

- a) Design profile with negative shift
- b) Original design profile
- c) Design profile with positive shift
- d) Negative shift
- e) Positive shift

Description

A road surface can be thought of three different types of design elements:

- the horizontal alignment
- the vertical alignment
- the cross section

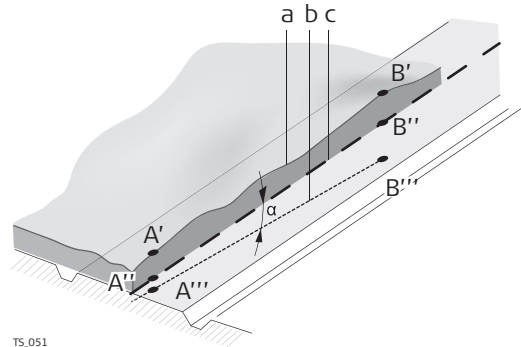
Basic concepts

TS_051

- a - Natural surface.
- b - The vertical alignment.
- c - The horizontal alignment.
- A''/B'' - Points on horizontal alignment
- A'/B' - Points on real surface
- A'''/B''' - Points on vertical alignment

Any point A in a project has ENH coordinates in a determined coordinate system. Each point has three different positions:

- A' - Point on real surface
- A'' - Point on horizontal alignment
- A''' - Point on vertical alignment

By adding a second point B to the project an alignment is defined. The alignment can be thought in three ways:

- Horizontal alignment (A''-B'')
- Projection of the horizontal alignment onto the real surface (A'-B')
- Vertical alignment (A'''-B''')

The angle between the horizontal and the vertical alignment is the grade (α).

Geometric elements

A road design is fitted to a base plan or map using the three basic geometric elements:

- Straight
- Curve
- Spiral



Refer to "Appendix J Glossary" for a definition of the terms.

46.2
46.2.1

Starting Alignment Editor
Accessing Alignment Editor

Access

Select **Main Menu: Go to Work!\Roads\Alignment Editor**.

Alignment Editor Startup

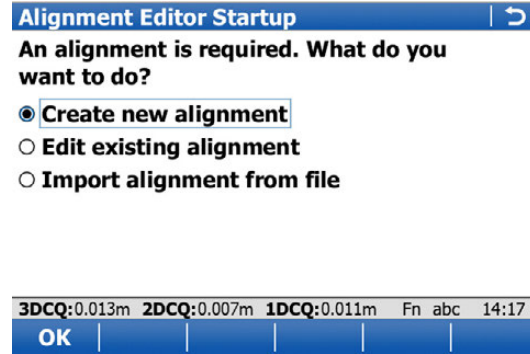

Key	Description
OK	To select the highlighted option and to continue with the subsequent screen.
Fn Config..	To configure the Alignment editor application. Refer to "46.3 Configuring Alignment Editor".
Fn Quit	To exit the application.

Next step

Select an option and press **OK**.

46.2.2

Creating a New Alignment

Access

Select **Create new alignment** in **Alignment Editor Startup** and press **OK**.

New Alignment

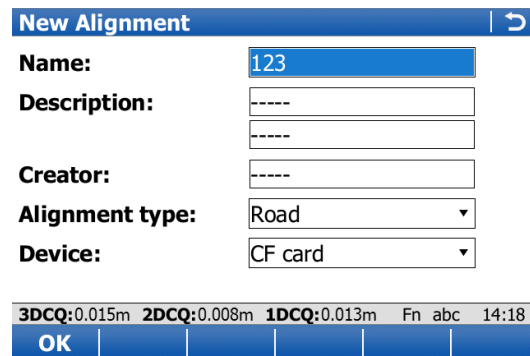

Key	Description
OK	To accept the screen entries and continue.
Fn Config..	To configure the Alignment editor application. Refer to "46.3 Configuring Alignment Editor".
Fn Quit	To exit the application.

Description of fields

Field	Option	Description
Name	Editable field	The name of the new Alignment editor raw alignment.
Description	Editable field	Optional description of the new raw alignment.
Creator	Editable field	Optional description of the creator of this alignment.
Alignment type	Selectable list	Defines if the alignment is for Roadrunner Road or Rail applications.
Device	Selectable list	The device on which the new Alignment editor raw alignment will be stored. Depending on the inserted memory devices, this field may be a display only field.

Next step

Press **OK** to access the **Alignment Editor Menu**. Refer to "46.2.5 Alignment Editor Menu".

46.2.3

Modifying an Existing Alignment

Access

Select **Edit existing alignment** in **Alignment Editor Startup** and press **OK**.

Select Alignment

Description of fields

Field	Option	Description
Alignment name	Selectable list	All existing Alignment editor raw alignments currently stored in the \Data\XML folder with the file extension *.xml.
Alignment type	Selectable list	Defines if the alignment is for Roadrunner Road or Rail applications.

Next step

Highlight the **Alignment name** field and press ENTER.

Alignments

Alignments (CF card) ↩	
Name	Date
123	24.08.09

3DCQ:0.017m	2DCQ:0.009m	1DCQ:0.014m	Fn	abc	14:18
OK	New..	Edit..	Delete	More	SD card

Key	Description
OK	To select the highlighted raw alignment and continue.
New..	To create a new raw alignment. Refer to "46.2.2 Creating a New Alignment".
Edit..	To edit the name and description of an existing raw alignment.

Key	Description
Delete	To delete an existing raw alignment.
More	To switch the last column between Date, Time and Size .
CF card, SD card or Intrnl	To change between viewing jobs stored on another data storage device or internal memory.
Fn Backup	To restore a raw alignment file with the extension *.xmb currently stored in the \Data\XML folder.
Fn Quit	To exit the application.

Next step

Press **OK** to select the highlighted raw alignment and return to the **Select Alignment** screen.

Press **OK** to access the **Alignment Editor Menu**. Refer to "46.2.5 Alignment Editor Menu".

46.2.4 Importing Alignment Data

Access

- 1) Select **Import alignment from file** in **Alignment Editor Startup** and press **OK**.
- 2) Create a new alignment in the **New Alignment** screen. Refer to "46.2.2 Creating a New Alignment".
- 3) Press **OK**.

Import Line

Import Line ↩

Data source:

From job:

Coord system:

Line:

3DCQ:0.015m 2DCQ:0.009m 1DCQ:0.012m Fn abc 14:19

OK

Key	Description
OK	To import the selected alignment data to active raw alignment.
Fn Config..	To configure the Alignment editor application. Refer to "46.3 Configuring Alignment Editor".
Fn Quit	To exit the application.

Description of fields

Field	Option	Description
Data source	Survey job	To import lines or areas from the selected job.
	Road job	To import lines from an existing Road job.
	Road+ (GSI format)	To import GSI alignment data.
	Rail job	To import lines from an existing Rail job.

Field	Option	Description
From job	Selectable list	All jobs are available for selection. Available for Survey job, Road job and Rail job .
Coord system	Display only	The coordinate system currently attached to the selected Survey job, Road job or Rail job .
Line	Selectable list	Line or area element from the selected job. Available for Survey job .
Alignment	Selectable list	Line from the selected Road job. The line must be stored in the \dbx folder of the memory device to be selectable. Available for Road job and Rail job .
Alignment (.aln) file	Selectable list	Horizontal alignment file in GSI format. The GSI alignment file must be stored in the \GSI folder of the memory device to be selectable. Available for Road+ (GSI format) .
Vertical (.prf) file	Selectable list	Vertical alignment file in GSI format. The GSI alignment file must be stored in the \GSI folder of the memory device to be selectable. Available for Road+ (GSI format) .

Next step

OK imports the selected alignment data and accesses the **Alignment Editor Menu**. Refer to "46.2.5 Alignment Editor Menu".

46.2.5

Alignment Editor Menu

Access

This screen is always accessed after successfully creating, editing or importing an alignment file from the **Alignment Editor Startup** screen.

Alignment Editor Menu

Description of options

Option	Description
Edit horizontal alignment	Depending on the setting for Use PI instead of element for horizontal alignment definition in Configuration, Advanced page: <ul style="list-style-type: none"> To create, edit and delete elements of a horizontal alignment. Refer to "46.4 Edit Horizontal Alignments Using Elements". To create, edit and delete PIs of a horizontal alignment. Refer to "46.5 Edit Horizontal Alignments Using PIs".
Edit vertical alignment	Depending on the setting for Use PVI instead of element for vertical alignment definition in Configuration, Advanced page: <ul style="list-style-type: none"> To create, edit and delete elements of a vertical alignment. Refer to "46.6 Edit Vertical Alignments Using Elements". To create, edit and delete PVIs of a vertical alignment. Refer to "46.7 Edit Vertical Alignments Using PIs".
Edit cross section templates	To create, edit and delete cross section templates. Refer to "46.8 Edit Cross Section Templates". Only available for road jobs.

Option	Description
Edit cross section assignments	To create, edit and delete cross section assignments. Refer to "46.9 Edit Cross Section Assignments". Only available for road jobs.
Edit chainage equation	To create, edit and delete chainage equations. Refer to "46.10 Edit Chainage Equation".
Convert to job	To convert existing LandXML alignments to a Road-Runner job. Refer to "46.11 Convert to job".

To be able to convert alignments to a Roadrunner job, at least a horizontal alignment must exist.

46.3

Configuring Alignment Editor

Access

Select **Main Menu: Go to Work!\Roads\Alignment Editor**. Press Fn **Config...**

Configuration, Quality control page

Key	Description
OK	To accept the screen entries and continue.
Page	To change to another page on this screen.
Fn About	To display information about the program name, the version number, the date of the version, the copyright and the article number.
Fn Quit	To exit the application.

Description of fields

Field	Option	Description
Check horizontal deflection	Check box	Possibility to do a deflection check for the horizontal alignment.
Horiz limit	Editable field	The deflection tolerance for horizontal alignments. The tolerance value used for determining deflection errors. A deflection error occurs when the beginning curve tangent of an element does not match the ending tangent of the previous element. If the actual error in deflection is greater than this value, the error will be reported.
Check vertical deflection	Check box	Possibility to do a deflection check for the vertical alignment.
Vert limit	Editable field	The deflection tolerance for vertical alignments.

Field	Option	Description
Confirm end coordinates of segment before storing	Check box	If this box is checked, then each time a new alignment element has been entered, a confirmation message displays the end coordinates for confirmation.

Next step

Page changes to the **Advanced** page.

Configuration, Advanced page

Description of fields

Field	Option	Description
Vertical parabola definition		Parameter defining the parabola.
	Parameter p K factor	K factor = Parameter p/100.
Use PI instead of element for horizontal alignment definition	Check box	When this box is not checked, elements such as straights, curves and parabolas define the horizontal alignment.
		When this box is checked, the horizontal alignment is defined by Points of Intersection (tangent/geometrical points). <ul style="list-style-type: none"> • Horizontal alignments are defined by the coordinates of the PI and the curve radius (for circular curves). • Horizontal transitions are defined by coordinate of PI, the circular curve radius plus tangent length in and tangent length out.
Use PVI instead of element for vertical alignment definition	Check box	When this box is not checked, elements such as straights, curves and parabolas define the vertical alignment.
		When this box is checked, the vertical alignment is defined by Points of Vertical Intersection (tangent/geometrical points). <ul style="list-style-type: none"> • Vertical alignments with symmetrical curves are defined by the PVI chainage, the elevation of PVI and the total length of curve, where the tangent length is half the total length of the VC. • Vertical Alignments with non-symmetrical curves are defined by the PVI chainage, the elevation of the PVI and both tangent lengths.

46.4
46.4.1

Edit Horizontal Alignments Using Elements
Overview

Description

Allows creating, editing and deleting of the following elements:

- Start Point
- Straight (Tangent)
- Curve
- Clothoid
- Cubic Parabola
- Partial Bloss

as well as checking the horizontal alignment.

Access

In **Alignment Editor Menu** highlight **Edit horizontal alignment**. Press **OK**.



Use PI instead of element for horizontal alignment definition must be unchecked in **Configuration, Advanced** page.

Horizontal Alignment, Elements page

Horizontal Alignment	
Elements	Map
Chainage	Element type
0.000	Start point
0.000	End point

3DCQ:0.020m	2DCQ:0.011m	1DCQ:0.016m	Fn abc	14:21	
OK	Add	Edit..	Delete	Check	Page

Key	Description
OK	To accept the screen entries and return to the Alignment Editor Menu .
Add	To add a new horizontal element after the highlighted element.
Edit..	To edit the highlighted element of the horizontal alignment.
Delete	To delete the highlighted element of the horizontal alignment. Either all following elements or only the next element can be adjusted.
Check	To check the horizontal alignment.
Page	To change to another page on this screen.
Fn Quit	To exit the application.

Access

In **Horizontal Alignment**, highlight the start point and press **Edit...**

Horizontal Start Point

Horizontal Start Point		
Easting:	0.000	m
Northing:	0.000	m
Start chainage:	0.000	m

3DCQ:0.012m 2DCQ:0.007m 1DCQ:0.010m Fn abc 15:00			
OK		Get Pt	Survy..

Key	Description
OK	To accept the screen entries and continue.
Get Pt	To apply coordinates or heights from an existing point in the working job.
Survy..	To go to Survey and measure a point.
Fn Config..	To configure the Alignment editor application. Refer to "46.3 Configuring Alignment Editor".
Fn Reset	To reset all screen entries.
Fn Quit	To exit the application.

Description of fields

Field	Option	Description
Easting	Editable field	Easting of the start point of the horizontal alignment.
Northing	Editable field	Northing of the start point of the horizontal alignment.
Start chainage	Editable field	Start chainage of the horizontal alignment.

Access

In **Horizontal Alignment, Elements** page, highlight the start point, or an element if one exists, and press **Add** or **Edit...**

 Elements can be added after the start point and either before or after other elements.



Creating and editing an alignment element are similar processes. For simplicity, only the creation of an alignment element is explained and differences are clearly outlined.

Add Horizontal Element

Description of fields

Field	Option	Description
Element type	Straight	To insert/edit a straight to/in a horizontal alignment.

Field	Option	Description
	Curve	To insert/edit a curve to/in a horizontal alignment.
	Spiral	To insert/edit a clothoid to/in a horizontal alignment.
	Cubic parabola	To insert/edit a cubic parabola to/in a horizontal alignment.
	Bloss	To insert/edit a blossom curve to/in a horizontal alignment.

The options available for the field **Method** depend on the **Element type** selected.

For **Element type: Straight**

Field	Option	Description
Method	Azimuth & length	Using the azimuth and the length of the straight.
	Azi & end chainage	Using the azimuth and the end chainage of the straight.
	End coords	Using the end coordinates of the straight.

For **Element type: Curve**

Field	Option	Description
Method	Radius & length	Using the radius of the curve and its length.
	Radius & delta	Using the radius and the delta angle of the curve.
	Radius & end chain	Using the radius of the curve and the end chainage.
	Radius & end coords	Using the radius and the end coordinates of the curve.
	Center & end coords	Using the coordinates of the centre point and the end point of the curve.
	3 points	Using three points.

For **Element type: Spiral**

Field	Option	Description
Method	Radius & length	Using the radius of the clothoid and its length.
	Radius & end chain	Using the radius of the clothoid and the end chainage.
	Param & length	Using the parameter A and the length of the connecting curve.
	Param & end chain	Using the parameter A and the end chainage of the spiral.
	Radius & parameter	Using the parameter A and the radius.

For **Element type: Cubic parabola**

Field	Option	Description
Method	Radius & length	Using the radius of the cubic parabola and its length.
	Radius & end chain	Using the radius of the cubic parabola and the end chainage.

For **Element type: Bloss**

Field	Option	Description
Method	Radius & length	Using the radius of the connecting curve and its length.
	Radius & end chain	Using the radius of the connecting curve and its end chainage.
	Rad,lngth,end coord	Using the radius, length and end coordinates of the blossom curve.

Next step

OK to access the next screen.

Horizontal
Straight/Horizontal
Curve/Horizontal
Clothoid/Horizontal
Cubic Parabola/Hori-
zontal Bloss,
Input page

Key	Description
OK	To accept the screen entries and continue.
Inv..	To calculate the distance and angle between two points from the working job.
Last..	To select values from the last inverse calculations.
Get Pt	To apply coordinates or heights from an existing point in the working job. Available when coordinates must be typed in.
Survy..	To go to Survey and measure a point. Available when coordinates must be typed in.
Page	To change to another page on this screen.
Fn Config..	To access the Alignment Editor configuration.
Fn Reset	To reset all screen entries.
Fn Quit	To exit the application.

Description of fields

Field	Option	Description
Start chainage	Display only	The end chainage of the start point / previous element is automatically used and cannot be edited.

The other fields and options available depend on the **Method** and **Element type** selected in **Add Horizontal Element**.

For **Element type: Straight**

Field	Option	Description
Azimuth	Editable field	The azimuth displayed is from the previous element. Another value can be entered manually. Available for Method: Azimuth & length or Method: Azi & end chainage .
End chainage	Editable field	Chainage at the end of the element. Available for Method: Azi & end chainage .
End easting	Editable field	Easting for the end chainage. Available for Method: End coords .
End northing	Editable field	Northing for the end chainage. Available for Method: End coords .
Length	Editable field	Length of the straight element. Available for Method: Azimuth & length .

For **Element type: Curve**

Field	Option	Description
Start azimuth	Editable field	The azimuth of the tangent in the start point. This azimuth is used from the previous element. The value can be edited. Available for Method: Radius & length , Method: Radius & delta or Method: Radius & end chain .
CP easting	Editable field	Easting of the centre point of the curve. Available for Method: Center & end coords .
CP northing	Editable field	Northing of the centre point of the curve. Available for Method: Center & end coords .
Curve direction	Right or Left	The direction of the curve when looking in the direction of increasing chainage. Available for Method: Radius & length , Method: Radius & delta , Method: Radius & end chain or Method: Radius & end coords .
Radius	Editable field	Radius of the curve. The signs are set by the system depending on the curve direction defined in Curve direction . Available for Method: Radius & length , Method: Radius & delta , Method: Radius & end chain or Method: Radius & end coords .
Delta	Editable field	The deflection angle. Available for Method: Radius & delta .
Length	Editable field	Length from the start to the end point of the curve. Available for Method: Radius & length .

Field	Option	Description
End chainage	Editable field	The end chainage of the curve element can be typed in. Available for Method: Radius & end chain .
Int easting	Editable field	Easting of the intermediate point of the 3-pt-arc. Available for Method: 3 points .
Int northing	Editable field	Northing of the intermediate point of the 3-pt-arc. Available for Method: 3 points .
End easting	Editable field	Easting for the end chainage. Available for Method: Radius & end coords, Method: Center & end coords and Method: 3 points .
End northing	Editable field	Northing for the end chainage. Available for Method: Radius & end coords, Method: Center & end coords and Method: 3 points .

For **Element type: Spiral**

Field	Option	Description
Start azimuth	Editable field	The azimuth of the tangent in the start point. This azimuth is used from the previous element. The value can be edited.
Spiral direction	Right or Left	The direction of the clothoid looking in the direction of increasing chainage.
Spiral in/out	Spiral in Spiral out	For transition from tangent to curve. For transition from curve to tangent.
Radius	Editable field	Radius of the clothoid. Available for Method: Radius & length, Method: Radius & end chain and Method: Radius & parameter .
Parameter A	Editable field	The parameter A defining the clothoids. Available for Method: Param & end chain, Method: Param & length and Method: Radius & parameter .
Length	Editable field	Length of the clothoid element. Available for Method: Param & length and Method: Radius & length .
Start radius	Editable field	The entry radius of the spiral. The signs are set by the system depending on the spiral direction defined in Spiral direction . Available for Method: Radius & length and Method: Radius & end chain when Use partial spiral is checked.
End radius	Editable field	The exit radius of the spiral. The signs are set by the system depending on the spiral direction defined in Spiral direction . Available for Method: Radius & length and Method: Radius & end chain when Use partial spiral is checked.
End chainage	Editable field	The end chainage of the clothoid can be typed in. Available for Method: Radius & end chain and Method: Param & end chain .
Use partial spiral	Check box	To create partial clothoids. Available for Method: Radius & length and Method: Radius & end chain .

For **Element type: Cubic parabola**

Field	Option	Description
Start azimuth	Editable field	The azimuth of the tangent in the start point. This azimuth is used from the previous element. The value can be edited.
Spiral direction	Right or Left	The direction of the cubic parabola looking in the direction of increasing chainage.
Spiral in/out	Spiral in Spiral out	For a transition from tangent to curve. For a transition from curve to tangent.
Radius	Editable field	Radius of the cubic parabola.
Start radius	Editable field	The entry radius of the spiral. The signs are set by the system depending on the spiral direction defined in Spiral direction . Available when Use partial spiral is checked.
End radius	Editable field	The exit radius of the spiral. The signs are set by the system depending on the spiral direction defined in Spiral direction . Available when Use partial spiral is checked.
Length	Editable field	Length of the cubic parabola element. Available for Method: Radius & length .
End chainage	Editable field	The end chainage of the cubic parabola element can be typed in. Available for Method: Radius & end chain .
Use partial spiral	Check box	To create partial cubic parabolas.

For **Element type: Bloss**

Field	Option	Description
Start azimuth	Editable field	The azimuth of the tangent in the start point. This azimuth is used from the previous element. The value can be edited.
Spiral direction	Right or Left	The direction of the blossom looking in the direction of increasing chainage.
Spiral in/out	Spiral in Spiral out	For a transition from tangent to curve. For a transition from curve to tangent.
Radius	Editable field	Radius of the blossom.
Start radius	Editable field	The entry radius of the spiral. The signs are set by the system depending on the spiral direction defined in Spiral direction . Available for Method: Rad,lngh,end coord .
End radius	Editable field	The exit radius of the spiral. The signs are set by the system depending on the spiral direction defined in Spiral direction . Available for Method: Rad,lngh,end coord .
Length	Editable field	Length of the blossom curve element. Available for Method: Radius & length and Method: Rad,lngh,end coord .

Field	Option	Description
End chainage	Editable field	The end chainage of the blossom curve element can be typed in. Available for Method: Radius & end chain.
End easting	Editable field	Easting for the end chainage. Available for Method: Rad,lngth,end coord.
End northing	Editable field	Northing for the end chainage. Available for Method: Rad,lngth,end coord.

Next step

Page changes to the **Details** page, where all entered and calculated elements are displayed.

46.5

46.5.1

Edit Horizontal Alignments Using PIs

Overview

Description

Allows creating, editing and deleting PIs by chainage, easting and northing.

Access

In **Alignment Editor Menu** highlight **Edit horizontal alignment**. Press **OK**.



Use PI instead of element for horizontal alignment definition must be checked in **Configuration, Advanced** page.

Horizontal Alignment, PI page

Horizontal Alignment			
Easting	Northing	Radius	Length in
0.000	0.000	----	----
0.000	500.000	----	----

Hz: 177°30'27"	V: 90°00'02"	Fn abc	09:26
OK	Add	Edit..	Delete More Page

Key	Description
OK	To accept the screen entries and return to the Alignment Editor Menu .
Add	To add a new horizontal PI after the highlighted PI. The chainage values must be added in the correct order.
Edit..	To edit the highlighted PI of the horizontal alignment.
Delete	To delete the highlighted PI of the horizontal alignment. Either all following elements or only the next element can be adjusted.
More	To display information about the length in/out and the parameter in/out in the fourth column.
Page	To change to another page on this screen.
Fn Quit	To exit the application.

Access

In **Horizontal Alignment, PI** page, highlight a PI and press **Add** or **Edit...**



A PI can also be selected on the **Map** page.



Elements are added after the highlighted PI.



Creating and editing an alignment PI are similar processes. For simplicity, only the creation of an alignment PI is explained and differences are clearly outlined.

Add PI

Key	Description
OK	To accept the screen entries and return to the Alignment Editor Menu .
Get Pt	To apply coordinates from an existing point in the working job. Available when Easting or Northing is highlighted.
Survy..	To go to Survey and measure a point. Available when Easting or Northing is highlighted.
Inv..	To calculate the values for the distance and the offset from two existing points. Available when Radius , Length in , Length out , Param in or Param out is highlighted.
Last..	To recall previous results from COGO inverse calculations. Available when Radius , Length in , Length out , Param in or Param out is highlighted.
Page	To change to another page on this screen.
Fn Config..	To configure the Alignment editor application. Refer to "46.3 Configuring Alignment Editor".
Fn Reset	To reset all screen entries.
Fn Quit	To exit the application.

Description of fields

Field	Option	Description
Easting and Northing	Editable field	The coordinates of the PI.
Element type at PI	None	No element is defined at the PI.
	Curve	A curve is defined at the PI.
	Spiral	A spiral is defined at the PI.
	Spiral-Curve	Spiral - curve is defined at the PI.
	Curve-Spiral	Curve - spiral is defined at the PI.

Field	Option	Description
	Spiral-Spiral	Two spirals are defined at the PI.
	Spiral-Curve-Spiral	Spiral - curve - spiral is defined at the PI.

The other fields on the screen depend on the **Element type at PI** selected.

For **Element type at PI: Curve**

Field	Option	Description
Radius	Editable field	Using the radius of the curve.

For **Element type at PI: Spiral**

Field	Option	Description
Spiral type	Clothoid, Cubic parabola or Bloss	Bloss is available for Rail jobs only.
Spiral in/out	Selectable list	The type of spiral.
Method	Radius & lengths Radius & parameters	Available for Spiral type: Clothoid . Using the radius of the clothoid and its length. Using the radius of the clothoid and its parameters.
Radius	Editable field	The radius of the clothoid, parabola or blossom. Available unless Use partial spiral is checked.
Radius in and Radius out	Editable field	The radius of the partial spiral for a clothoid or parabola. Available when Use partial spiral is checked.
Length in and Length out	Editable field	The lengths of the clothoid, parabola or blossom.
Param in and Param out	Editable field	Depending on the configuration, the parameters P or factors K of the clothoid. Available for Spiral type: Clothoid with Method: Radius & parameters .
Use partial spiral	Check box	To create a partial clothoid. Available for Spiral type: Clothoid and Spiral type: Cubic parabola .

For **Element type at PI: Spiral-Curve** and **Element type at PI: Curve-Spiral**

Field	Option	Description
Method	Radius & lengths Radius & parameters	Available for Spiral type: Clothoid . Using the radius of the clothoid and its length. Using the radius of the clothoid and its parameters.
Radius	Editable field	The radius of the curve.
Length in	Editable field	The lengths of the connecting curve.
Param in	Editable field	Depending on the configuration, the parameters P or factors K of the clothoid. Available for Spiral type: Clothoid with Method: Radius & parameters .

For **Element type at PI: Spiral-Spiral** and **Element type at PI: Spiral-Curve-Spiral**

Field	Option	Description
Method	Radius & lengths	Available for Spiral type: Clothoid . Using the radius of the clothoid and its length.
	Radius & parameters	Using the radius of the clothoid and its parameters.
Radius	Editable field	The radius of the curve.
Length in and Length out	Editable field	The lengths of the connecting curve.
Param in and Param out	Editable field	Depending on the configuration, the parameters P or factors K of the clothoid. Available for Spiral type: Clothoid with Method: Radius & parameters .

Next step

OK to access the next screen.

46.6

46.6.1

Edit Vertical Alignments Using Elements

Overview

Description

Allows creating, editing and deleting of the following elements:

- Start Point
- Straight (Tangent)
- Parabola
- Asymmetric parabola
- Curve

as well as checking the vertical alignment.

Throughout the whole component height and elevation is used for local orthometric height. If no local orthometric height is available, the local ellipsoidal height is used instead.

Access

In **Alignment Editor Menu** highlight **Edit vertical alignment**. Press **OK**.



Use PVI instead of element for vertical alignment definition must be unchecked in **Configuration, Advanced** page.

Vertical Alignment, Elements page

The available keys are identical to the keys in **Horizontal Alignment**. Refer to the paragraph "Horizontal Alignment, Elements page".

Access

In **Vertical Alignment**, highlight the start point and press **Edit...**

Vertical Start Point

Vertical Start Point	
Elevation:	<input type="text" value="3.000"/> m
Start chainage:	<input type="text" value="5.000"/> m

3DCQ:0.018m	2DCQ:0.010m	1DCQ:0.015m	Fn abc	14:58
OK		Get Pt	Survy..	

Key	Description
OK	To accept the screen entries and continue.
Get Pt	To apply heights from an existing point in the working job.
Survy..	To go to Survey and measure a point.
Fn Reset	To reset all screen entries.
Fn Quit	To exit the application.

Description of fields

Field	Option	Description
Elevation	Editable field	Elevation at the start chainage of the vertical alignment.
Start chainage	Editable field	Start chainage of the vertical alignment.

Access

In **Vertical Alignment, Elements** page, highlight the start point and press **Add** or **Edit...**



Creating and editing an alignment element are similar processes. For simplicity, only the creation of an alignment element is explained and differences are clearly outlined.



For grade units, the system settings are applied. Refer to "29.1 Regional settings" to change the system setting.

Add Vertical Element

Description of fields

Field	Option	Description
Element type	Straight	To insert/edit a straight to/in a vertical alignment.
	Parabola	To insert/edit a quadratic parabola to/in a vertical alignment.
	Curve	To insert/edit a curve to/in a vertical alignment.

The options available for the field **Method** depend on the **Element type** selected.

For **Element type: Straight**

Field	Option	Description
Method	Length & end elev	Using the length and the end elevation of the straight.
	End chain & elev	Using the end chainage and the elevation of the straight.
	Length & grade	Using the length and the grade of the straight.
	End chain & grade	Using the end chainage and the grade of the straight.

For **Element type: Parabola**

Field	Option	Description
Method	Length & grades	Using the length and the grades of the parabola.
	End chain & grades	Using the end chainage and the grades of the parabola.
	Param & end elev	Using the parameter and the end elevation of the parabola.
	3 elevations	Using three elevations at defined chainages of the parabola.

For **Element type: Curve**

Field	Option	Description
Method	Radius & length	Using the radius of the curve and its length.
	Radius & end chain	Using the radius and the end chainage of the curve.
	Radius & grades	Using the radius and the grades of the curve.
	Length & grades	Using the length and the grades of the curve.
	End chain & grades	Using start, intermediate and end elevation and chainage of the curve.

Next step

OK to access the next screen.

Vertical
Straight/Vertical
Parabola/Vertical
Curve,
Input page

Vertical Straight ↩

Input Details Plot

Start chainage: 0.000m

Start elevation: 0.000m

Length: m

End elevation: m

3DCQ:0.011m **2DCQ:**0.006m **1DCQ:**0.009m Fn abc 15:08

OK Get Pt Surv.. Page

Key	Description
OK	To accept the screen entries and continue.

Key	Description
Inv..	To calculate the distance and angle between two points from the working job.
Last..	To select values from the last inverse calculations.
Get Pt	To apply coordinates or heights from an existing point in the working job. Available when coordinates must be typed in.
Survy..	To go to Survey and measure a point. Available when elevation must be typed in.
Page	To change to another page on this screen.
Fn Config..	To access the Alignment Editor configuration.
Fn Reset	To reset all screen entries.
Fn %/V:H/H:V	To switch between h:v , v:h and %(v/h x 100) for the grade unit.
Fn Quit	To exit the application.

Description of fields

Field	Option	Description
Start chainage	Display only	The end chainage of the previous element is automatically used and cannot be edited.
Start elevation	Display only	The end height of the previous element is automatically used and cannot be edited.

The other fields and options available depend on the **Method** and **Element type** selected in **Add Vertical Element**.

For Element type: Straight

Field	Option	Description
Length	Editable field	Length of the straight element as slope distance. Available for Method: Length & end elev and Method: Length & grade .
End chainage	Editable field	Chainage at the end of the element. Available for Method: End chain & elev and Method: End chain & grade .
End elevation	Editable field	Height at the end of the element. Type in manually or, alternatively, press Get Pt when the focus is on this line to select the height from an existing point in the working job. Available for Method: Length & end elev and Method: End chain & elev .
Grade	Editable field	The grade of the straight element. Positive inclines have positive values, negative inclines have negative values. Available for Method: Length & grade and Method: End chain & grade .

For Element type: Parabola

Field	Option	Description
Curve type	Crest	The curve type is convex. Available for Method: Param & end elev .

Field	Option	Description
	Sag	The curve type is concave. Available for Method: Param & end elev.
Parameter p or K factor	Editable field	Parameter of the parabola. Available for Method: Param & end elev. The field name depends on the value chosen for the Vertical parabola definition in the Configuration, Advanced page.
Length	Editable field	Length of the parabola as horizontal distance. Available for Method: Length & grades and Method: Param & end elev.
Int chainage	Editable field	Chainage of the second elevation. Available for Method: 3 elevations.
Int elevation	Editable field	Second elevation. Type in manually or press Get Pt when the focus is on this line to select the height from an existing point in the working job. Available for Method: 3 elevations.
End chainage	Editable field	Chainage at the end of the element. Available for Method: End chain & grades and Method: 3 elevations.
End elevation	Editable field	Height at the end of the element. Type in manually or, alternatively, press Get Pt when the focus is on this line to select the height from an existing point in the working job. Available for Method: Param & end elev and Method: 3 elevations.
Grade in	Editable field	The grade at the beginning of the parabola. Positive inclines have positive values, negative inclines have negative values. Available for parabolas with Method: Length & grades and Method: End chain & grades.
Grade out	Editable field	The grade at the end of the parabola. Positive inclines have positive values, negative inclines have negative values. Available for Method: Length & grades and Method: End chain & grades.

For **Element type: Curve**

Field	Option	Description
Curve type	Crest	The curve type is convex.
	Sag	The curve type is concave.
Radius	Editable field	Radius of the curve. Available for Method: Radius & length, Method: Radius & end chain and Method: Radius & grades.
Length	Editable field	Length of the curve along the segment. Available for Method: Radius & length and Method: Length & grades.
End chainage	Editable field	Chainage at the end of the element. Available for Method: End chain & grades and Method: Radius & end chain.

Field	Option	Description
End elevation	Editable field	Height at the end of the element. Type in manually or, alternatively, press Get Pt when the focus is on this line to select the height from an existing point in the working job. Available for Method: Radius & length and Method: Radius & end chain .
Grade in	Editable field	The grade at the beginning of the parabola. Positive inclines have positive values, negative inclines have negative values. Available for Method: Radius & grades , Method: Length & grades and Method: End chain & grades .
Grade out	Editable field	The grade at the end of the parabola. Positive inclines have positive values, negative inclines have negative values. Available for Method: Radius & grades , Method: Length & grades and Method: End chain & grades .

Next step

Page changes to the **Details** page, where all entered and calculated elements are displayed.

46.7

46.7.1

Edit Vertical Alignments Using PIs

Overview

Description

Allows creating, editing and deleting PIs by chainage, elevation and if required an element type (parabola, curve).

Access

In **Alignment Editor Menu** highlight **Edit vertical alignment**. Press **OK**.



Use PVI instead of element for vertical alignment definition must be checked in **Configuration, Advanced** page.

Vertical Alignment, PVI page

The available keys are identical to the keys in **Horizontal Alignment**. Refer to the paragraph "Horizontal Alignment, PI page".

46.7.2

Inserting/Editing a PVI in a Vertical Alignment

Access

In **Vertical Alignment, PVI** page, highlight a PVI and press **Add** or **Edit...**



Creating and editing an alignment PVI are similar processes. For simplicity, only the creation of an alignment PVI is explained and differences are clearly outlined.

Add PVI

Add PVI
↩

Chainage: m

Elevation: m

Element type at PVI:

Method:

Length: m

Hz: 177°30'26" V: 90°00'01" Fn abc 15:59

OK

Key	Description
OK	To accept the screen entries and return to the Alignment Editor Menu .
Get Pt	To apply heights from an existing point in the working job. Available when Elevation is highlighted.
Survy..	To go to Survey and measure a point. Available when Elevation is highlighted.
Inv..	To calculate the values for the distance and the offset from two existing points. Available when Radius or Length is highlighted.
Last..	To recall previous results from COGO inverse calculations. Available if Radius or Length is highlighted.
Page	To change to another page on this screen.
Fn Config..	To configure the Alignment editor application. Refer to "46.3 Configuring Alignment Editor".
Fn Reset	To reset all screen entries.
Fn Quit	To exit the application.

Description of fields

Field	Option	Description
Chainage	Editable field	The chainage of the vertical PVI.
Elevation	Editable field	The elevation of the vertical PVI.
Element type at PVI	None	No element is defined at the vertical PVI.
	Curve	A curve is defined at the vertical PVI.
	Parabola	A quadratic parabola is defined at the vertical PVI.

The other fields on the screen depend on the **Element type at PVI** selected.

For **Element type at PVI: Curve**

Field	Option	Description
Method	Length	To define the curve by its length.
	Radius	To define the curve by its radius.
Length	Editable field	The length of the curve.
Radius	Editable field	The radius of the curve.

For **Element type at PVI: Parabola**

Field	Option	Description
Method	Length	To define the parabola by its length.
	Parameter	To define the parabola by its parameter.
Length	Editable field	The length of the parabola.
Parameter p	Editable field	Depending on the configuration, the parameters P or factors K of the parabola.

Next step
OK to access the next screen.

46.8

46.8.1

Edit Cross Section Templates

Overview

Description

Allows creating, editing, deleting and duplicating of cross section templates.

Access

In **Alignment Editor Menu** highlight **Edit cross section templates**. Press **OK**.

Templates



Name	No. of layers
123	1



OK	New..	Edit..	Delete	Duplct	Page
----	-------	--------	--------	--------	------

Key	Description
OK	To accept the screen entries and continue.
New..	To create a new cross section template.
Edit..	To edit the highlighted cross section template.
Delete	To delete the highlighted cross section template.
Duplct	To duplicate the highlighted template.
Page	To change to another page on this screen.
Fn Quit	To exit the application.

46.8.2

Creating/Editing a Cross Section Template

Access

In **Templates**

press **New..** to create a new cross section template

OR

highlight an existing template and press **Edit..**



Creating and editing a cross section template are similar processes. For simplicity, only the creation of a cross section template is explained and differences are clearly outlined.

New Template, General page

New Template: 55 | ↻

General | Layers | Plot

Template name:

Allow absolute heights for cross section definition

Center height: m

3DCQ:0.011m 2DCQ:0.006m 1DCQ:0.009m Fn abc 15:10

OK | Page

Key	Description
OK	To accept the screen entries and continue.
Page	To change to another page on this screen.
Fn Config..	To access the Alignment Editor configuration.
Fn Quit	To exit the application.

Description of fields

Field	Option	Description
Template name	Editable field	Name of the cross section template to be created/edited.
Allow absolute heights for cross section definition	Check box	If this box is checked, in addition to relative to line input methods, absolute heights can also be entered to define cross section segments.
Center height	Editable field	To be able to create segments using absolute heights, a centre height must be defined. Available if Allow absolute heights for cross section definition is checked.

Next step

Page changes to the **Layers** page where the layers of the template are listed.

Access

In **New Template/Edit Template, Layers** page, press **New..** or **Edit..**



Creating and editing a layer of a cross section template are similar processes. For simplicity, only the creation of a layer is explained and differences are clearly outlined.

New Layer, Segments

New Layer		
Name	Horiz distance	Slope ratio
CL:	0.000	1:0

3DCQ:0.011m 2DCQ:0.006m 1DCQ:0.009m Fn abc 15:10					
OK	Add	Edit..	Delete	More	Page

Key	Description
OK	To accept the screen entries and continue.
Add	To create and add a new segment.
Edit..	To edit the highlighted segment.
Delete	To delete the highlighted segment.
More	To switch between CL horizontal offset, Slope distance, Horiz distance in the second column and between CL vertical offset, Slope ratio, Vertical distance in the third column.
Page	To change to another page on this screen.
Fn Mirror	To mirror the entered segments to the other side of the cross section.
Fn Quit	To exit the application.

Description of columns

Column	Description
Name	The name of the segment.
CL horizontal offset	Horizontal offset to the centre line of the segment.
CL vertical offset	Vertical offset to the centre line of the segment.
Slope distance	Slope distance to the neighbouring vertex.
Slope ratio	Slope ratio of the segment.
Horiz distance	Horizontal distance to the neighbouring vertex.
Vertical distance	Vertical distance to the neighbouring vertex.

Next step

Add to add a segment.

Add Segment, Input page

Add Segment	
Input	Details Plot
Template name:	55
Layer name:	-----
Method:	Horiz dist & slope
Horiz distance:	-----m
Slope ratio:	1:0hv
3DCQ:0.011m 2DCQ:0.006m 1DCQ:0.009m Fn abc 15:10	
OK	Page

Key	Description
OK	To accept the screen entries and continue.
Inv..	Available when Horiz distance , CL horizontal offset or Slope distance is highlighted. To calculate the distance and angle between two points from the working job.
Last..	Available when Horiz distance , CL horizontal offset or Slope distance is highlighted. To select values from the last inverse calculations.
%/V:H/H:V	To switch between h:v , v:h and %(v/h x 100) for the slope ratio.
Page	To change to another page on this screen.
Fn Config..	To access the Alignment Editor configuration.
Fn Reset	To reset all screen entries.
Fn Quit	To exit the application.

Description of fields

Field	Option	Description
Template name	Display only	Name of the cross section template to be edited.
Layer name	Display only	Name of the layer to be edited.
Method	Horiz dist & slope Horiz dist & vert dist CL offsets Slope dist & ratio Horiz dist & height CL offset & height	Method to be used for defining the segment. Using a horizontal distance and slope ratio to define the segment. Using a horizontal distance and a vertical distance to define the segment. Using a horizontal and vertical offset in relation to the centre line. Using a slope distance and slope ratio to define the segment. Using a horizontal and absolute height to define the segment. Only available for templates with Allow absolute heights for cross section definition enabled. Using a horizontal offset in relation to the centre line and absolute height. Only available for templates with Allow absolute heights for cross section definition enabled.

Field	Option	Description
Horiz distance	Editable field	Horizontal distance of the segment. Available for Method: Horiz dist & slope and Method: Horiz dist & vert dist .
Vertical distance	Editable field	Vertical distance of the segment. Available for Method: Horiz dist & vert dist .
CL horizontal offset	Editable field	Horizontal centre line offset of the segment. Only available for Method: CL offsets .
CL vertical offset	Editable field	Vertical centre line offset of the segment. Only available for Method: CL offsets .
Slope distance	Editable field	Slope distance of the segment. Only available for Method: Slope dist & ratio .
Slope ratio	Editable field	Slope ratio of the segment. Available for Method: Horiz dist & slope and Method: Slope dist & ratio .

Next step

Page changes to the **Details** page, where all entered and calculated elements are displayed.

46.9

46.9.1

Edit Cross Section Assignments Overview

Description

Allows the creation, editing and deleting of cross section assignments as well as checking the cross section assignments.
A cross section assignment defines from which chainage on a cross section template is to be used.

Access

In **Alignment Editor Menu** highlight **Edit cross section assignment**. Press **OK**.

Cross Section Assignments

Chainage	Template name
50.000	123

OK	New..	Edit..	Delete	Check
----	-------	--------	--------	-------

Key	Description
OK	To accept the screen entries and continue.
New..	To create a new cross section assignment.
Edit..	To edit a cross section assignment.
Delete	To delete a cross section assignment.
Check	To check the cross section assignments.
Fn Quit	To exit the application.

Access

In **Cross Section Assignments** press **New..** or **Edit...**



Creating and editing a cross section assignment are similar processes. For simplicity, only the creation of a cross section assignment is explained and differences are clearly outlined.



Assigned cross section templates must contain the same number of vertices.

New Cross Section Assgmnmt

New Cross Section Assgmnmt | ↻

Chainage: m

Template name: ↕

3DCQ:0.011m 2DCQ:0.006m 1DCQ:0.009m Fn abc 15:12

OK

Key	Description
OK	To accept the screen entries and continue.
StartCh	To take the start chainage of the vertical alignment for Chainage .
End Ch	To take the end chainage of the vertical alignment for Chainage .
Fn Config..	To access Alignment Editor configuration.
Fn Quit	To exit the application.

Description of fields

Field	Option	Description
Chainage	Editable field	The chainage to which the cross section template is assigned to. Type in or edit the value for Chainage. Alternatively press StartCh or End Ch to apply the start or end chainage of the vertical alignment.
Template name	Selectable list	The cross section template to be assigned to. All existing cross section templates currently stored to the alignment can be selected. Select an existing template from the list or create a new one to be assigned to the Chainage .

46.10

46.10.1

Edit Chainage Equation

Overview

Description Allows creating, editing and deleting of:

- Gaps
- Overlaps

Access In **Alignment Editor Menu** highlight **Edit chainage equation**. Press **OK**.

Chainage Equation



Chainage Back	Chainage Ahead
40.000	50.000



3DCQ:0.011m	2DCQ:0.006m	1DCQ:0.009m	Fn abc	15:12
OK	New..	Edit..	Delete	

Key	Description
OK	To accept the screen entries and continue.
New..	To create a new chainage equation.
Edit..	To edit a chainage equation.
Delete	To delete a chainage equation.
Fn Quit	To exit the application.

46.10.2

Creating/Editing a Chainage Equation

Access In **Chainage Equation** press **New..** or **Edit..**



Creating and editing a Chainage equation are similar processes. For simplicity, only the creation of a Chainage equation is explained and differences are clearly outlined.

New Chainage Equation

Description of fields

Field	Option	Description
Chainage back	Editable field	Chainage back. Type in or edit the value.
Chainage ahead	Editable field	Chainage ahead. Type in or edit the value.

Next step

OK to create the chainage equation or to store the edited chainage equation.



Description

Allows the onboard conversion of existing LandXML alignments including horizontal alignment, vertical alignment, cross sections and chainage equations to a RoadRunner job.

Access

In **Alignment Editor Menu** highlight **Convert to job**. Press **OK**.

**Convert to Road Job/
Convert to Rail Job****Description of fields**

Field	Option	Description
From alignment	Display only	Displays the modified or newly created alignment to be converted.
To road job	Selectable list	The Road job to which the alignment will be converted. Create a new job. Available if the Alignment type is set to Road in Select Alignment .  If a new job with the same name as an existing job must be created, then the existing job must be deleted first.
To rail job	Selectable list	The Rail job to which the alignment will be converted. Create a new job. Available if the Alignment type is set to Rail in Select Alignment .  If a new job with the same name as an existing job must be created, then the existing job must be deleted first.
Conversion mode	Horiz & vert Horizontal only Hz,vert,cross section	Defines the mode to be used for the conversion process. Only horizontal and vertical alignment will be converted. Only horizontal alignment will be converted. Horizontal alignment, vertical alignment and cross sections will be converted. Only available for road jobs.

Next step

Press **OK** to start the conversion.

Alignment Editor creates a report sheet during the conversion. The file LandXml2Dbx.log can be found in the \Data\XML folder on the data storage device.

After the successful conversion, press **OK** to return to the **Main Menu** on the instrument.

Description

There are two ways of creating road/rail jobs:
 Typing them in manually by using the **Alignment Editor** application.
 OR
 Converting data created in a design package.

Manually entered data

Data can be typed in and edited with **Alignment Editor**. Refer to "46 Roads - Alignment Editor" for information on how to enter data manually.

Converted data

The **Import alignment data** application in **Jobs & Data** supports various different formats like dxf, LandXml, MxGenio, Terramodel, Carlson.
 The Design to Field component of Leica Geo Office offers converters from several road/rail design and CAD packages. Several design packages also include a built-in converter to Roads/Rail. As different design packages follow different philosophies in representation, creation and storage of data the conversion process differs slightly.



Leica Geo Office can be found on the Leica Geo Office DVD.

The latest version of the Design to Field importers can be found in the downloads section of:

- myWorld@Leica Geosystems
<https://myworld.leica-geosystems.com>

Job selection

Refer to "45.2.1 Accessing Roads Applications".

47.2
47.2.1

Defining the Work
Defining the Method and the Task

Access

- 1) Select **Main Menu: Go to Work!\Roads\Roads - Stakeout** or **Roads - As built check**.
- 2) In the job selection screen, select the required jobs. Refer to "45.2.1 Accessing Roads Applications".
- 3) Press **OK**.

Define the Work to be Done

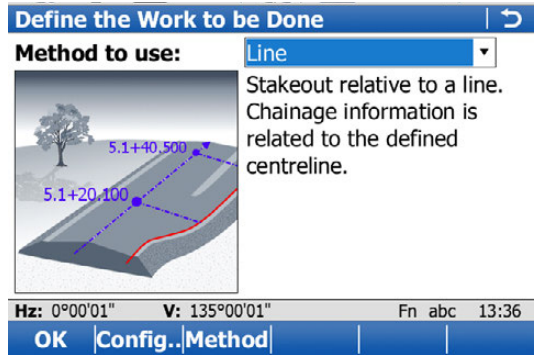

Key	Description
OK	To continue to the next screen.
Fn Config..	To access the configuration settings. Refer to "45.3 Configuring Roads Applications".
Method	To define what is shown in the selectable list for Method to use . Local line can not be hidden.
Fn Quit	To exit the screen.

Description of the methods

Method	Description
Line	To stake/check any type of line, for example a centreline or kerb. Chainage information is related to the centreline.
Local line	Like the previous method when staking/checking any line of a layer. The stake/check is always in relation to the chainage of the line itself and not the centreline of the layer.
Surface grade	To stake/check a surface grade defined by the road design. Two lines define the surface grade (a lane or running surface).
Manual slope	To stake/check a manually defined slope relative to an existing centreline. The slope is defined by one line (hinge point) and the slope direction with ratio. The stake/check is always in relation to the chainage of the line itself and not the centreline of the layer.
Local manual slope	To stake/check a manually defined slope relative to an existing hinge line. The slope is defined by one line (hinge point) and the slope direction with ratio.
Slope	To stake/check a slope defined by two lines of the 3D road design.

Method	Description
Crown	To stake/check a road crown defined by two surface grades and one common line. The information for both surface grades is displayed at the same time.
Layer	To stake/check a layer surface defined by the road design relative to the layer centreline.
DTM	To check a DTM surface. Available for Roads - As built check only.

The available methods depend on the selected job types (road or control job):



Available method	Road job only	Control job only	Road job & control job	DTM job only
Line	✓	-	✓	-
Local line	✓	✓	✓	-
Surface grade	✓	-	-	-
Manual slope	✓	-	✓	-
Local manual slope	✓	✓	✓	-
Slope	✓	-	-	-
Crown	✓	-	-	-
Layer	✓	-	-	-
DTM	-	-	-	✓

Next step

OK accesses the **Define Task** screen.

Define Task screen

Key	Description
OK	To continue to the next screen.
Slope	Available for Method to use: Manual slope , Method to use: Local manual slope and Method to use: Slope . To define the slope parameters. Refer to "47.2.3 Advanced Slope Settings".
Shifts..	To apply horizontal and vertical shifts to the selected element. Refer to "45.4 Working with Shifts".
Load..	To load a task. Refer to "45.5 Tasks".
Save..	To save the settings as a task. Refer to "45.5 Tasks".
Page	To change, depending on the selected method, to Hinge offset and/or Map page.

Key	Description
	 Any line can be selected on the Map page.  Dxf lines have to be imported to a control job before they can be used for Roads. Refer to "37.6 Context Menu".
Fn Config..	To access the configuration settings. Refer to "45.3 Configuring Roads Applications".
Fn Quit	To exit the application.

The fields available depend on the selection for **Method to use** in **Define the Work to be Done**.

Description of fields

Common to all methods

Field	Option	Description
Layer	Display only or selectable list	The selected layer in the Road job.

For **Method to use: Line**

Field	Option	Description
Working chainage	Editable field	The chainage for the stake/check survey. The chainage can range between the start chainage and the end chainage. The default is the setup point for TPS and the current position for GPS.
Line to use	Selectable list	To select a line at the Working chainage . Or select a line on the Map page. Refer to "47.2.2 Selecting a Line".
Refer to an additional line	Check box	<p>When this box is checked, a second line can be selected.</p> <p>Allows chainage, offset and height difference information to be obtained from any other string of the layer, independent from those strings currently selected for the chosen method. For example: Staking a surface grade where the height information comes from the surface grade, but the chainage information comes from a string which is not the centreline of the current layer.</p> <p>For the additional line, an offset and a height difference can be defined on the Offsets page.</p>
Line to use	Selectable list	The lines available as second lines, independent of the Working chainage . Or select a line on the Map page. Refer to "47.2.2 Selecting a Line".

For **Method to use: Local line**



Field	Option	Description
Line to use	Selectable list	To select a line at the Working chainage . Or select a line on the Map page. Refer to "47.2.2 Selecting a Line".
Refer to an additional line	Check box	When this box is checked, a second line can be selected. Allows chainage, offset and height difference information to be obtained from any other string of the layer independent from those strings currently used. For example: Staking a surface grade where the height information comes from the surface grade but the chainage information comes from a string which is not the centreline of the current layer.
Line to use	Selectable list	The lines available as second lines, independent of the Working chainage . Or select a line on the Map page. Refer to "47.2.2 Selecting a Line".

For **Method to use: Surface grade**

Field	Option	Description
Working chainage	Editable field	The chainage for the stake/check survey. The chainage can range between the start chainage and the end chainage. The default is the setup point for TPS and the current position for GPS.
Left line	Selectable list	The name of the left line defining the surface grade. Refer to "47.2.2 Selecting a Line".
Right line	Display only	The name of the right line defining the surface grade.
Reference line	Left line or Right line	To select one of the lines to be used as the reference line.
Refer to an additional line	Check box	When this box is checked, a second line can be selected. Allows chainage, offset and height difference information to be obtained from any other string of the layer independent from those strings currently used. For example: Staking a surface grade where the height information comes from the surface grade but the chainage information comes from a string which is not the centreline of the current layer.
Line to use	Selectable list	The lines available as second lines, independent of the Working chainage . Or select a line on the Map page. Refer to "47.2.2 Selecting a Line".

For **Method to use: Manual slope** and **Method to use: Local manual slope**

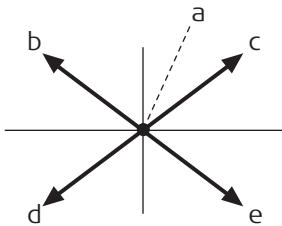
Field	Option	Description
On the Slope page:		

Field	Option	Description
Chainage of slope	Editable field	The chainage for the stake/check survey. The chainage can range between the start chainage and the end chainage of selected line.
Hinge line	Selectable list	To select the hinge point of the slope. Or select a line on the Map page. Refer to "47.2.2 Selecting a Line".  For Manual slope , only lines from the Road job can be selected.
Slope location	Left or Right	Defines if the slope is left or right of the hinge point.  <small>Road_079</small> a) Hinge Point b) Left, cut c) Right, cut d) Left, fill e) Right, fill
Use cut and Use fill	Check box	When the box is checked, a cut/fill is used for the calculation. During the surveying process, the system calculates if it is a cut or a fill. Check only one box to work only with cut or fill.
Slope cut ratio and Slope fill ratio	Editable field	Defines the cut/fill ratio of the slope.  The slope ratio format is defined as system setting in Regional Settings, Slope page.
On the Hinge offset page:		
Apply hinge offsets	Check box	When this box is checked, a horizontal and vertical offset of the hinge point can be defined.
Ht offset type	Absolute Relative to line or Relative to DTM Relativ to surf grade	The vertical offset type for the hinge point. The only option available for 2D lines. Available for 3D lines. Available for Method to use: Manual slope . The manual slope is defined by the: <ul style="list-style-type: none"> • Hinge offset relative to the selected hinge reference line • Hinge height, calculated by using the hinge offset on the selected surface grade (left or right selected surface grade, depending on Offset - or +)

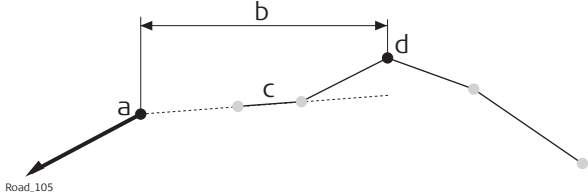
Field	Option	Description
		 <p>a) Hinge point of manual slope b) Defined hinge offset (-) c) Left surface grade of design d) Selected hinge reference</p>
Offset	Editable field	The horizontal offset of the hinge point from the centreline/reference line.
Elevation	Editable field	The elevation of the hinge point (absolute height). Available for Ht offset type: Absolute .
Left line	Editable field	The name of the left line. Available for Ht offset type: Relativ to surf grade .
Right line	Display only	The name of the right line. Available for Ht offset type: Relativ to surf grade .
Height difference	Editable field	<p>For Ht offset type: Relative to line: A vertical offset for the hinge point using a height difference can be defined.</p> <p>For Ht offset type: Relative to DTM: A height difference to the DTM height can be applied.</p> <p>For Ht offset type: Relativ to surf grade: Height difference of the hinge point to the calculated height on the end slope.</p>

For **Method to use: Slope**

Field	Option	Description
Working chainage	Editable field	The chainage for the stake/check survey. The chainage can range between the start chainage and the end chainage. The default is the setup point for TPS and the current position for GPS.
Left line	Selectable list	The name of the left line defining the slope.
Right line	Display only	The name of the right line defining the slope.
Reference line	Left line or Right line	To select one of the lines to be used as the reference line (= hinge line).

For **Method to use: Crown**

Field	Option	Description
Working chainage	Editable field	The chainage for the stake/check survey. The chainage can range between the start chainage and the end chainage. The default is the setup point for TPS and the current position for GPS.
Crown line	Selectable list	Line defining the middle line of the crown. Refer to "47.2.2 Selecting a Line".
Left line	Display only	The name of the line defining left line of the crown.

Field	Option	Description
Right line	Display only	The name of the line defining right line of the crown.
Reference line	Left line or Right line	To select one of the lines to be used as the reference line.
Refer to an additional line	Check box	When this box is checked, a second line can be selected. Allows chainage, offset and height difference information to be obtained from any other string of the layer independent from those strings currently used. For example: Staking a surface grade where the height information comes from the surface grade but the chainage information comes from a string which is not the centreline of the current layer.
Line to use	Selectable list	The lines available as second lines.

For **Method to use: Layer**

Field	Option	Description
Layer	Selectable list	A list of all available layers of the selected Road job .
Centreline	Display only	Active centreline of the selected layer.
Extend end slopes	Check box	When this box is checked, the left most and right most end slopes of the design are extended.

For **Method to use: DTM**, available for **Roads - As built check**

Field	Option	Description
DTM layer	Display only	A list of all DTM surfaces available in the selected DTM job.
Number of triangles	Display only	Number of triangles the selected DTM consists of.

Next step

OK to access the **Stake** or **Check** screen.

47.2.2

Selecting a Line

Access

- In the Define screen, open a selectable list for a line, for example for **Line to use** or **Left line**.
- Or, tab on a line on the **Map** page.
- Or, for dxf lines, hold down the supplied stylus on an object for 0.5 second and select **Select Line**.



The selection of lines depends on:

- Availability of horizontal alignments
- Availability of vertical alignment information
- View (plan or cross section view)
- Working chainage defined or not
- Selected method

Lines

The screen can have a **Lines** page (if control job is selected), an **Alignments** page (if road alignment is selected) and a **Map** page.

If no working chainage has been entered, the lists show all lines of the current layer. If a working chainage is available, all lines existing at that chainage are listed only.

Select Line		
Lines	Alignments	Map
Line name	CL offset	Height
<None>	----	----
LeftCatch	-4.308	417.653
LeftHinge	-3.003	417.000
LeftBox	-2.008	416.816
LeftEdge	-2.003	416.850
Centreline	-0.000	416.910
RightEdge	1.996	416.850
RightBox	2.001	417.000
Hz: 0°00'01" V: 134°59'59" Fn abc 14:53		
OK		More Page

Key	Description
OK	To return to the previous screen.
More	On the Lines and Areas page: To display information about the codes if stored with any line, the start time, the end time of when the last point was added to the line and the length of the line. On the Alignments page: To display information about the absolute height or the height difference. Unavailable for local lines.
Page	To change to another page on this screen.
Fn Quit	To exit the application.

Description of columns

Column	Description
Line name	The name of the line.
CL offset	The offset from the centreline. The format is defined as system setting in Regional Settings .
Height	The absolute height of the line.
Ht diff	The height difference to the centreline.



In addition to the list selection the required lines and slopes can also be selected on **Map** page.

Lines can be selected in a graphical way by using the

- cross section view. The cross section view is available if a working chainage has been defined. The selected line (3D only) or area from the control job is also displayed. Unavailable for **Method to use: Local manual slope**.
- planar view which is always available. The defined working chainage is displayed as a grey line. The size corresponds to the working corridor settings.

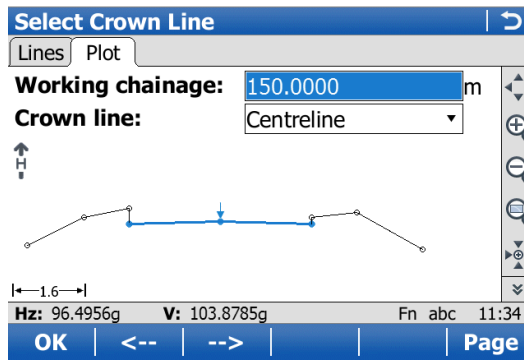

Key	Description
<--	For lines from Road jobs: To select the previous line.
-->	For lines from Road jobs: To select the next line.

47.2.3 Advanced Slope Settings

Access Press **Slope** in the Define screen.

General slope stakeout

Description

This method involves a generic approach to slope stakeout for direct stakeout of the catch point. No special batter rails or reference point parameters are defined.

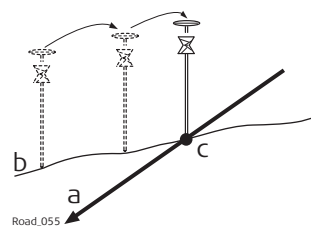

- a) Slope to stake out
- b) Natural surface
- c) Catch point

Workflow

As the natural surface is unknown the catch point can only be staked out iteratively. If staking out on a horizontal natural surface, the values shown for Δ **offset** indicate how far the catch point is away. If the natural surface is not horizontal, more iterations could be needed.

Slope Stakeout Settings

Key	Description
OK	To return to the Define screen.
Types	To define which slope stakeout types are shown and which are hidden.
Fn Quit	To exit the screen.

Description of fields

Common to all types

Field	Option	Description
Use advanced slope stakeout	Check box	When this box is checked, slope stakeout settings are available.

Field	Option	Description
Type	Reference point	Stakeout of a reference peg with a defined offset from the catch point. Refer to "Slope staking using Reference point".
	Batter rail vertical	Stakeout of batter rails using defined rail heights vertically above the batter. Refer to "Slope staking using Batter rail vertical or Batter rail perpend".
	Batter rail perpend	Stakeout of batter rails using defined rail heights perpendicularly above the batter. Refer to "Slope staking using Batter rail vertical or Batter rail perpend".
	Ref batter vertical	Stakeout of batter rails using defined rail heights vertically above the batter. The innermost peg/stake is offset at a defined horizontal distance from the catch point. Refer to "Slope staking using Ref batter vertical or Ref batter perpend".
	Ref batter perpend	Stakeout of batter rails using defined rail heights perpendicularly above the batter. The innermost peg/stake is offset at a defined horizontal distance from the catch point. Refer to "Slope staking using Ref batter vertical or Ref batter perpend".
	Ref point surface	Stakeout of a reference peg in the slope surface with a defined height difference to the hinge point. Slope values for the reference point cannot be entered. Refer to "Slope staking using Ref point surface".

For **Type: Reference point**

Field	Option	Description
Ref offset	Editable field	The defined offset of the reference point from the catch point.

For **Type: Batter rail vertical** and **Type: Batter rail perpend**

Field	Option	Description
Batter type	Cut or Fill	Defines the cut or fill rail.
Traveller height	Editable field	Depending on the selected Type , the vertical or perpendicular height of the rail top above the batter.
Rail over ground	Editable field	The vertical height of the rail over the ground.

For **Type: Ref batter vertical** and **Type: Ref batter perpend**

Field	Option	Description
Ref offset	Editable field	The defined offset of the inner peg from the catch point.

Field	Option	Description
Traveller height	Editable field	Depending on the selected Type , the vertical or perpendicular height of the rail above the batter.

For **Type: Ref point surface**

The only available fields are **Use advanced slope stakeout** and **Type**.

Next step

OK returns to the Define screen.

Slope staking using Reference point

Description

When staking out slopes using the reference point method, the catch point of the slope is marked with a reference peg using a defined offset. The grade of the slope is marked and controlled by "grade checkers".

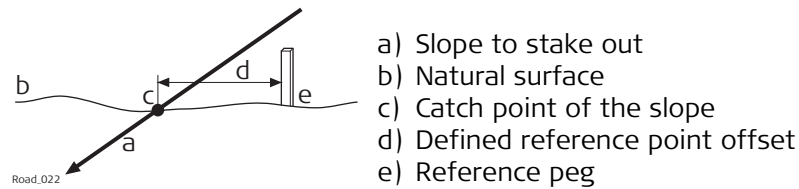

The reference point offset guarantees that all pegs are placed with the same horizontal offset to the catch point.

Workflow

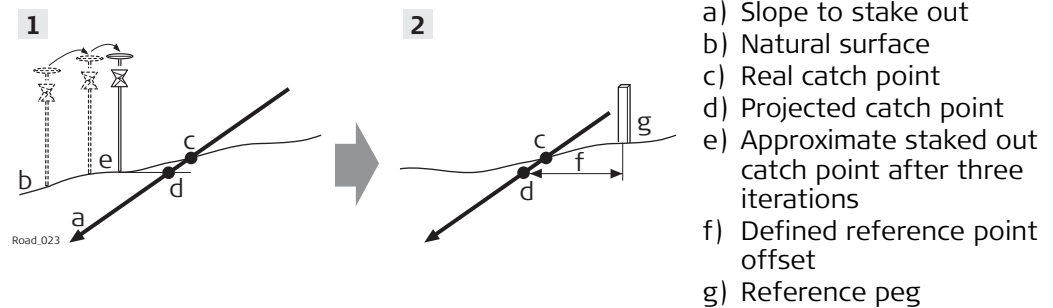

Step	Description
1.	The first step when staking out is to find the catch point of the slope. As the natural surface is unknown, this process has to be done iteratively. As soon as the measured position (e) is close enough to the real catch point (c), it can be used as the approximate catch point. Based on this approximate catch point, the projected catch point (d) on the slope is calculated. No reference point offset and no traveller height are taken into account for this step. The projected catch point (d) is then used as a starting point for the stakeout of the reference peg (g).

Step	Description
2.	The second step is to stake out the reference point relative to the projected catch point. Select Place reference peg from the Tools menu. Values in Stake Slope Reference Point, Stake page will guide the user to the position to place the peg. The defined reference point offset (f) is already taken into account. The catch point is marked indirectly via the reference peg. Values to be marked on the reference peg can be found on Stake Slope Reference Point, Info page.

The closer the real catch point and the approximated stakeout catch point are, the closer the projected catch point gets to the real catch point.

Slope staking using Batter rail vertical or Batter rail perpend

Description

When staking out slopes with the **Batter rail vertical** or **Batter rail perpend** method, the grade of the slope is marked with a board. Using this method it is not necessary to stake out the catch point first.

For Batter rail vertical

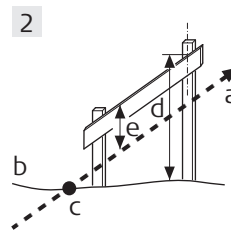
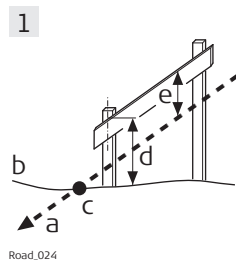

- 1 Batter rail for a cut
- 2 Batter rail for a fill
- a) Slope to stake out
- b) Natural surface
- c) Catch point of the slope
- d) Rail over ground
- e) Rail over batter, vertical

For Batter rail perpend

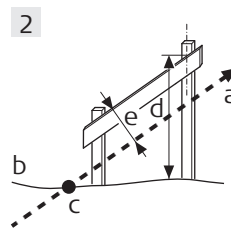
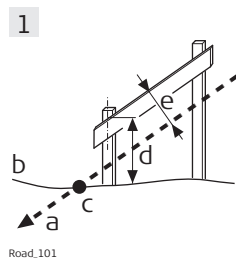

- 1 Batter rail for a cut
- 2 Batter rail for a fill
- a) Slope to stake out
- b) Natural surface
- c) Catch point of the slope
- d) Rail over ground
- e) Rail over batter, perpendicular

The defined rail over ground should guarantee that the rails are positioned as high as possible, to make them easier to use.

Step	Description
1.	The first peg to stake out is always the peg closest to the hinge point. Stake out the position of the first peg of the batter by using Δ offset on the Stake page of the Stake/Check screen. The height of the rail over ground Rail over ground is taken into account for Δ offset . This action means that when Δ offset is equal to zero the first peg is in the correct position.
2.	Place the pole on top of the first peg. The value for Δ height indicates how far below the top of the batter has to be placed.
3.	Stake out the second peg of the batter rail by using Δ chainage and place the peg.

Step	Description
4.	Place the pole on the position of the batter rail to be used as a reference for the slope values to mark on the batter rail. Δ height should now read zero.  All values shown under the Info page are relative to the original slope.

Slope staking using Ref batter vertical or Ref batter perpend

Description

This method is used if batter rails with a constant distance from the inner peg to the catch point are required.

For Ref batter vertical

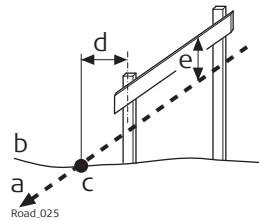

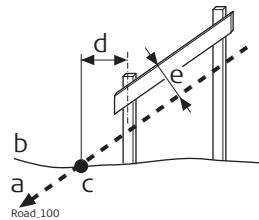

- a) Slope to stake out
- b) Natural surface
- c) Catch point of the slope
- d) Defined reference point offset
- e) Height of the "traveller", vertical

For Ref batter perpend



- a) Slope to stake out
- b) Natural surface
- c) Catch point of the slope
- d) Defined reference point offset
- e) Height of the "traveller", perpendicular

Workflow

Step	Description
	The first step is to stake out the catch point of the slope. The reference point offset and traveller height are not taken in account in this step. Based on this approximate catch point the projected catch point on the slope is calculated. The projected catch point is used as a starting point for the stakeout of the reference peg.
1.	Stake out the position of the catch point by using Δ offset and/or Δ height on the Stake page of the Stake/Check screen. When Δ offset and Δ height are equal to zero, the catch point has been located.
2.	Fn Tools.. to access the Tools screen. The measured position is used as the catch point for the stake out of the reference point.
3.	Select Place reference peg to access the stakeout screen for the reference peg.
4.	Stake out the reference point using Δ offset . When Δ offset is equal to zero the reference peg position has been found.
5.	Place the pole on top of the reference peg. The value for Δ height indicates how far below the top of the peg the batter has to be placed.
6.	Place the pole on the position of the batter rail to be used as a reference for the slope values to mark on the batter rail. Δ height should now read zero. All values shown under the Info page are relative to the original slope.
7.	 to return to Stake Slope . Stake out the next catch point from this screen.

Slope staking using Ref point surface

Description

When staking out slopes using the reference point surface method, the reference peg is staked out with a defined height difference to the hinge point.

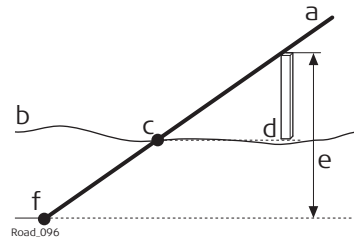

- a) Slope to stake out
- b) Natural surface
- c) Catch point of the slope
- d) Reference peg
- e) Defined hinge height difference
- f) Hinge point

Workflow

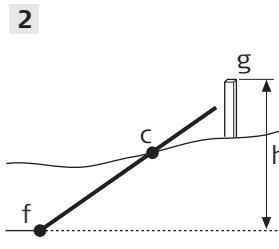
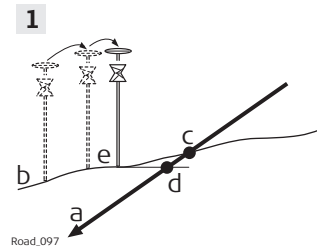

- a) Slope to stake out
- b) Natural surface
- c) Real catch point
- d) Projected catch point
- e) Approximate staked out catch point after three iterations
- f) Hinge point
- g) Reference peg
- h) Defined hinge height difference

Step	Description
	The first step when staking out is to find the catch point of the slope. As the natural surface is unknown, this process has to be done iteratively. As soon as the measured position (e) is close enough to the real catch point (c), it can be used as the approximate catch point. Based on this approximate catch point, the projected catch point (d) on the slope is calculated. The projected catch point (d) is then used as a starting point for the stakeout of the surface reference peg (g).
1.	Stake out the position of the catch point by using Δ offset and/or Δ height on the Stake page of the Stake/Check screen. When Δ offset and Δ height are equal to zero, the catch point has been located.
2.	Define the hinge height difference. Fn Tools.. to access the Tools screen.
3.	Select Place surface reference peg to access the define screen for the reference peg field. The measured position from step 1. is used as the catch point for the stake out of the reference point. The Actual hinge ht diff field displays the Hinge ht diff value from the Stake page of the Stake/Check screen. Type in the appropriate value for Defined hinge ht diff .
4.	Stake out the surface reference point relative to the projected catch point. Values in Stake Slope Ref Point Surface, Stake page guide you to the position to place the peg. The defined hinge height difference (h) is already taken into account. Values to be marked on the reference peg can be found on Stake Slope Ref Point Surface, Info page.
5.	to return to Stake Slope . Stake out the next catch point from this screen.

The closer the real catch point and the approximated stakeout catch point are, the closer the projected catch point gets to the real catch point.

47.3
47.3.1

Staking/Checking the Road
The Stake/Check Screen

Stake/Check screen,
General page

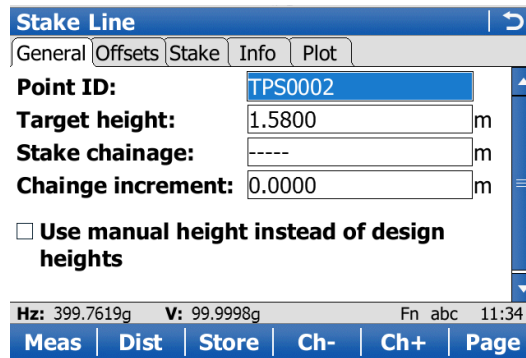

The **Stake Line** is shown as example.



Key	Description
Meas	<p>GPS To start measuring the point being staked. The key changes to Stop.</p> <p>TPS To measure a distance and store distance and angles.</p>
Stop GPS	To end measuring the point being staked. When Automatically stop point measurement is checked in Quality Control, General page recording of positions ends automatically as defined by the stop criteria. The key changes to Store . After ending the measurements, the differences between the measured point and the point to be staked are displayed.
Store	<p>GPS To store the measured point. When Automatically store point is checked in Quality Control, General page, the measured point is stored automatically. The key changes to Meas.</p> <p>TPS To store angles and distance. Distance must be measured before.</p>
Dist TPS	To measure a distance.
Ch-	Available for Roads - Stakeout . To decrease the chainage as defined by Change increment .
Ch+	Available for Roads - Stakeout . To increase the chainage as defined by Change increment .
Page	To change to another page on this screen.
Fn Config..	To access configuration settings. Refer to "45.3 Configuring Roads Applications".
Fn Positn TPS	To position the total station to the defined stakeout point, including defined offsets. This depends on the settings for Turn to point in Configuration, TPS page. Refer to " Configuration, TPS page".
Fn Tools..	To access the method-specific Tools Menu. Refer to "47.4 The Tools Menu".
Fn Quit	To exit the application.

Description of fields

Field	Option	Description
		The following fields are always shown in all Stake and Check methods.

Field	Option	Description
Point ID	Editable field	Name of the next point to be stored. The ID is incremented/decremented whenever a point gets stored.
Antenna height <input type="checkbox"/> GPS	Editable field	Height of the antenna.
Target height <input type="checkbox"/> TPS	Editable field	Height of the prism.
 The following fields are always shown in all Stake methods, except for method Layer .		
Stake chainage	Editable field	Nominal chainage of the point to be staked out.
Chainage increment	Editable field	Chainage increment. Value by which the nominal chainage increases/decreases when pressing Ch-/Ch+ .
 The following field is shown in the Stake and Check methods except for Slope and Manual slope .		
Use manual height instead of design heights	Check box	When this box is checked, a height value typed in manually is used instead of design height or DTM height. When this box is not checked, the height from design is used.
Manual height	Editable field	The height to be used.

Next step



Page changes to the **Offsets** page.

Stake/Check screen, Offsets page

Refer to "Stake/Check screen, General page" for a description of keys.

Description of fields

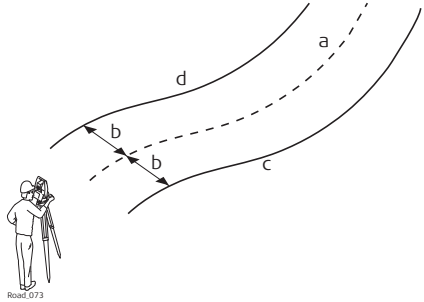
Field	Option	Description
Apply offsets	Check box	When this box is checked, the defined stake/check offsets are applied.
Stake offset	Editable field	<p>Available for Stake. Horizontal offset from the reference line (as defined by the chosen method) of the point to stake.</p> <p> When a stake offset is entered for line, local line, manual slope and local manual slope and Work with non-perpendicular offset is checked on the Offsets page: When coming to a corner when working at a stake chainage along an alignment, choose one of the following from the message:</p> <ul style="list-style-type: none"> • Prev: To stake out the point according to the tangent direction of the previous line. • Avg: To stake the average tangent direction. The stake distance from the corner is the offset value defined. • Next: To stake out the point according to the tangent direction of the next line.

Field	Option	Description
CL stake offset	Editable field	Available for Stake with Layer . The Easting and Northing values for staking are calculated by the horizontal offset from the centreline. The height is derived from the layer.
Stake height diff	Editable field	Available for Stake. Vertical offset from the reference line or surface (as defined by the chosen method) of the point to stake.
Toggle offsets left/right	Check box	<p>When this box is checked, points can be staked/checked on the left/right side of the selected line in one process.</p>  <p>a) Line b) Defined Stake offset c) Parallel right line d) Parallel left line</p> <p>This functionality is available for the following stake out/check methods:</p> <ul style="list-style-type: none"> • Line: Toggle between line left and right. • Surface grade: Toggle between left and right line of the surface grade. • Crown: Toggle between left and right surface grade. <p>The application automatically detects which side of the centreline is being used and selects the appropriate line as a reference.</p> <p>Auto position When pressing auto position Fn Positn, available in total station mode, a message box comes up prompting if either the left or right side should be staked out/checked.</p>
Check offset	Editable field	Available for Check. Horizontal offset from the reference line, as defined by the chosen method, of the point to stake.
CL check offset	Editable field	Available for Check with Layer . The Easting and Northing values for checking are calculated by the horizontal offset from the centreline. The height is derived from the layer.
Check height diff	Editable field	Available for Check. Vertical offset from the reference line or surface, as defined by the chosen method, of the point to stake.
 The following field is shown for the Stake methods Line , Local line , Local manual slope and Manual slope .		

Field	Option	Description
Work with non-perpendicular offset	Check box	When this box is not checked the measured point is projected in a right angle to the selected line. When this box is checked, any projection angle can be defined.
Offset angle	Editable field	Manually defined projection angle.
 The following fields are shown in the Line , Local line , Surface grade and Crown methods when Refer to an additional line is checked in the Define screen.		
Apply offsets to additional line	Check box	When this box is checked, an offset to the additional line can be defined.
Offset	Editable field	Horizontal stake/check offset to the additional line.
Height difference	Editable field	Vertical stake/check height difference to the additional line.

Next step

Page changes to the **Stake** page.

Understanding priorities of various heights

Type of height	Overrules	Stake height diff
Manually entered OR Obtained from individual point	All other heights	Considered
Use DTM height for stakeout (Tools menu: Use heights from DTM)	Design height	Considered
From design	No other heights	Considered
Show DTM height difference on Info page (Tools menu: Use heights from DTM)	No influence on priorities For additional info only	-

Stake screen, Stake page

 This page is available for Roads - Stakeout only.

This page displays the differences between the measured points and stakeout points (delta values). If these values are zero, the measured point coincides with the stakeout point.

Refer to "Stake/Check screen, General page" for a description of keys.

Refer to "53.4 Staking Out" for a description of the elements of the graphical display.

Description of fields

Field	Option	Description
Chainage	Display only	The current chainage.
CL O	Display only	Perpendicular horizontal offset to the centreline.
Δ chainage	Display only	Difference between the defined Stake chainage and the current chainage Chainage of the measured position. If no defined chainage exists, for example if staking out random chainages or checking, this field shows -----.

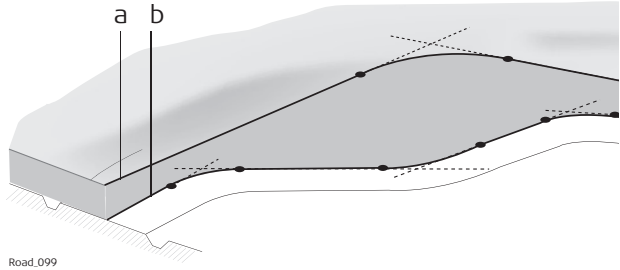
Field	Option	Description
NrTP	Display only	<p>The chainage difference between the measured point and the nearest tangent point (start/end point of a road segment) of the design is displayed.</p>  <p>a) Vertical alignment b) Horizontal alignment</p> <p>Only tangent points (start/end point of a road segment) are detected.</p>
ΔO	Display only	Horizontal offset between the defined position and the current position. The Stake offset defined on the Offsets page is taken into account.
Δ height	Display only	Vertical offset between the defined position and the current position. The Stake height diff defined on the Offsets page is taken into account.

Next step

Page changes to the **Info** page.

Stake/Check screen, Info page

A user definable **Info** page exists for each of the stake methods and check methods. Refer to the chapters from "45.3.2 Road Line - Info Page" to "45.3.8 Road DTM - Info Page".

Refer to "Configuration, Info page" for information on all available items for the **Info** page and how to select them.

Stake/Check screen, Map page

The **Map** page for Stake shows information about the measured point relative to the design. The design is defined by the selected layer and line, and the values entered on the **General** page.

The **Map** page for Check and Stake are similar. The only difference is that the current chainage is always shown instead of Δ chainage.

For Check and when only a DTM job is used, the **Map** page shows the DTM and the lines of selected Road layer - always in plan view. At the top of the page, DTM height and delta height are shown.

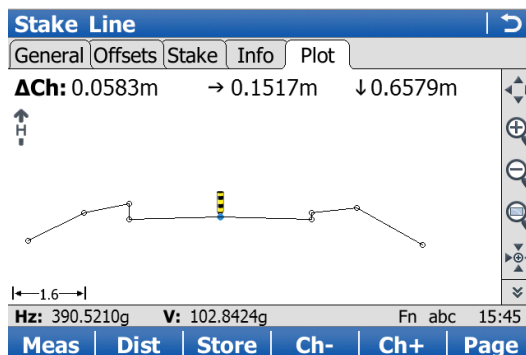

Key	Description
	Refer to "Stake/Check screen, General page" for a description of keys.
Fn Layrs..	To turn layers of background maps (CAD files) on and off. Refer to "5.2 Creating a New Job" for information on CAD files and CAD background maps.

The following information is shown:

- Chainage difference between the measured point and the defined chainage. When working with random chainages, for instance if no defined chainage has been entered on the **General** page, ΔCh changes to **Ch**. **Ch** is the current chainage as shown on the **Stake** page.
- Horizontal offset (left/right arrow) to the design
- Height difference (up/down arrow) to the design
- The measured point (prism pole or GPS antenna)
- The element to stake is shown in bold and blue. The position to stake is marked with a yellow-black peg.
- The plot can be shown as a cross plot or plan view by using the  eye icon on second level of MapView toolbar. Displayed is:
 - Cross plot:
 - Road job lines of the selected layer
 - Only selected line of the control job (not all lines)
 - Plan view:
 - Road job lines of the selected layer
 - Lines of control job
 - Background maps, for example dxf(s), attached to control job
 - Working job items are displayed in grey

47.3.2

Measuring Points by Chainage and Offset

Graphical overview

Roads - Stakeout

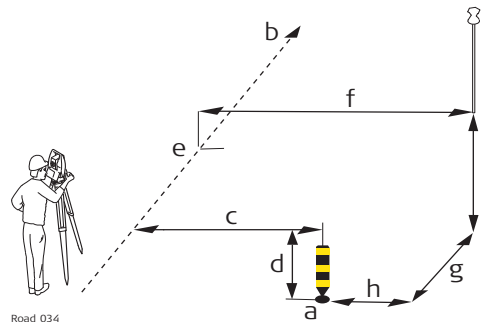

- Position to stake out, defined by chainage, stake offset and, optionally, stake height difference
- Centreline/line the position is defined relative to
- Stake offset**
- Stake height diff**
- Chainage**
- CL offset/Ref offset**
- Δ **chainage**
- Δ **offset**
- Δ **height**

Roads - As built check

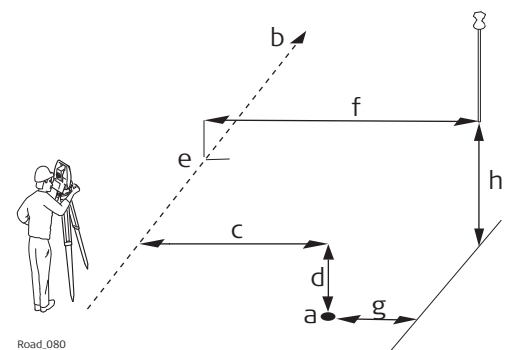

- Position to check, defined by check offset and, optionally, check height difference
- Centreline/line the position is defined relative to
- Check offset**
- Check height diff**
- Chainage**
- CL offset/Ref offset**
- Δ **offset**
- Δ **height**

Description

- When staking points, the points are defined by the stake chainage and, if enabled, by the stake offset and the stake height difference relative to an existing 2D or 3D centreline or line.
- When checking points, the points are defined by the check offset and the check height difference relative to an existing 2D or 3D centreline or line.

Required elements

- For 2D, a horizontal centreline is required.
- For 3D, a 3D centreline is required.

47.3.3

Measuring Lines Relative to a Centreline

Graphical overview

Roads - Stakeout

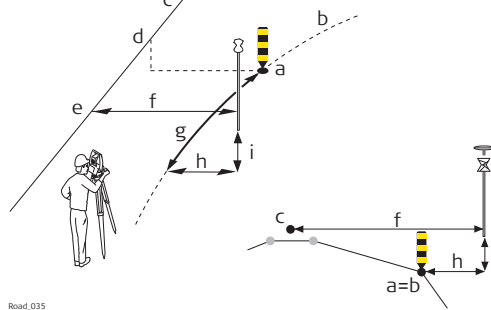

Road_035

- a) Position to stake out
- b) Line to stake out
- c) Centreline
- d) **Stake chainage**
- e) **Chainage**
- f) **CL offset**
- g) Δ **chainage**
- h) Δ **offset**
- i) Δ **height**

Roads - As built check

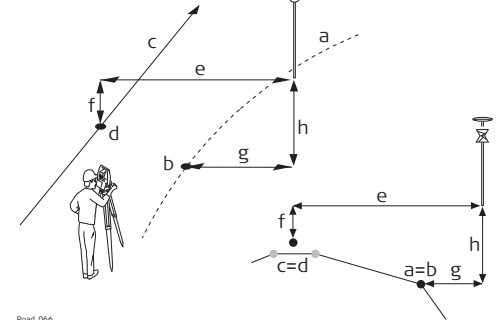

Road_066

- a) Line to check
- b) Projected point on line
- c) Centreline
- d) **Chainage**
- e) **CL offset**
- f) **CL ht diff**
- g) Δ **offset**
- h) Δ **height**

Description

- Lines define various elements, including:
 - Centreline of the design
 - Change in slope ratio, for example, the edge of a carriage way
 - Gutter, cable, pipeline or any other type of alignment element
- Refer to "45.6.3 Road - Basic Elements for Stake and Check Measurements" for information on the usage of lines.

Required elements

- For 2D, at least a 2D line and a 2D centreline are required.
- For 3D, a 3D line and a 2D or 3D centreline are required.

Graphical overview

Roads - Stakeout

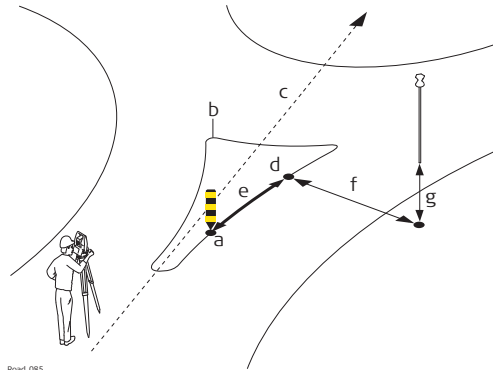

Stakeout of Roundabout

- a) Position to stake out
- b) Line to stake out
- c) Centreline of the layer- is not used for the local line
- d) **Chainage**
- e) Δ **chainage**
- f) Δ **offset**
- g) Δ **height**

Roads - As built check

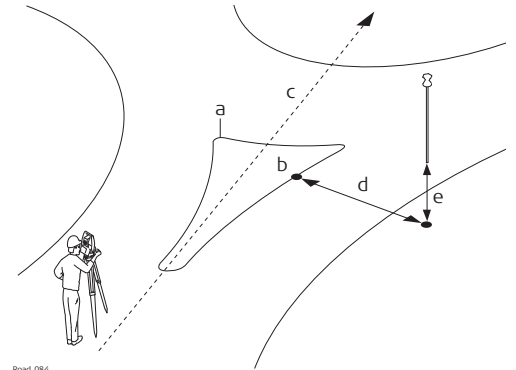

Checking a Roundabout

- a) Line to check
- b) **Chainage**
- c) Centreline of the layer- is not used for the local line
- d) Δ **offset**
- e) Δ **height**

Description

This process is different to lines, where the stake/check is always relative to the centreline defined for the layer. Local lines no longer have a relationship to an overall centreline. Local lines are used to check roundabouts, parking bays, subdivision works and any other type of lines. The different lines to stake/check can be stored within one layer, which does not require a defined centreline. This ability is different to the stake/check of any other type which always require a centreline.

Required elements

A 2D or 3D design of the line to stake/check is required.

47.3.5

Indefinite Triangle

Description

In almost all situations, a measured position is shown relative to the local line by the line chainage and a square offset to the line. However, situations can arise where a road design has extreme changes in the deflection angle of tangent points. In these cases, it is not always possible to show a measured position by the nominal chainage and offset. An indefinite triangle is a region in which these situations arise. Points measured within an indefinite triangle are shown relative to the tangent point.

Graphic

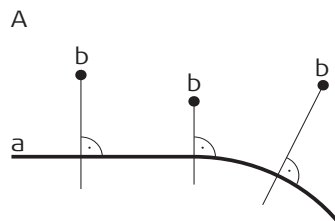

Road_091

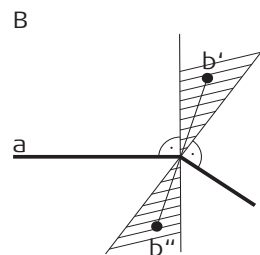

Road Design A

- a) Local line
- b) Measured position (displayed relative to the line by chainage and square offset)

Road Design B

- a) Local line with extreme changes in the deflection angle of tangent points
- b) Measured position within indefinite triangle
This position **cannot** be shown in the usual manner and is displayed relative to the tangent point
- b") Measured position within indefinite triangle
This position **can** be shown in the usual manner and is displayed by chainage and square offset

Screen

Points measured within an indefinite triangle are always shown relative to the tangent point.

47.3.6

Measuring Surface Grades

Graphical overview

Roads - Stakeout

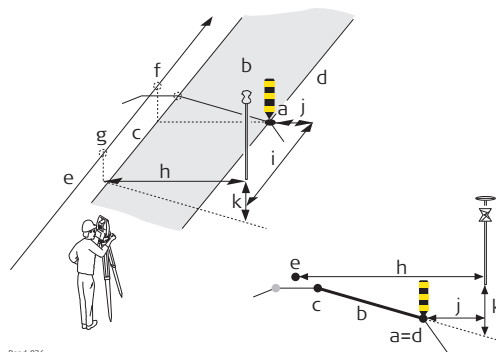

- a) Position to stake out
- b) Surface grade to stake out
- c) Left line
- d) Right line
- e) Centreline
- f) **Working chainage**
- g) **Chainage**
- h) **CL offset**
- i) **Δ chainage**
- j) **Δ offset**
- k) **Δ height**

Roads - As built check

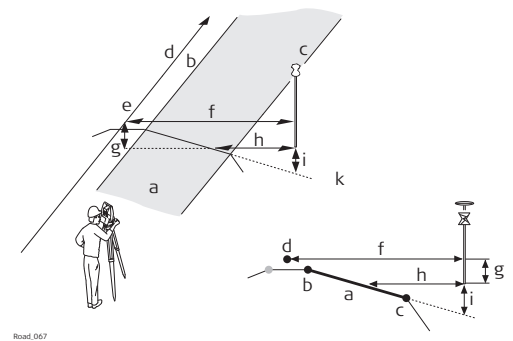

- a) Surface grade to check
- b) Left line
- c) Right line
- d) Centreline
- e) **Chainage**
- f) **Δ offset**
- g) **Δ height**
- h) **Surf. grade offset**
- i) **Surf. grade ht diff**

Description

- Surfaces such as the final carriage way, are often staked/checked using surface grades. A surface grade consists of a combination of two lines.
- Refer to "45.6.3 Road - Basic Elements for Stake and Check Measurements" for information on the usage of surface grades.

Required elements

A 3D design of the road is required.

Graphical overview

Roads - Stakeout

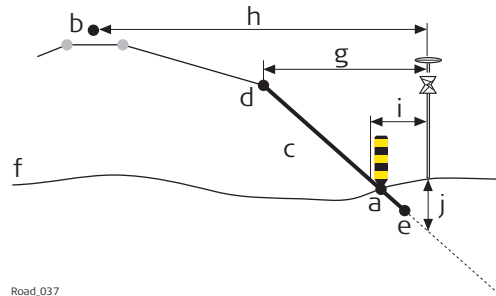

Road_037

- a) Catch point
- b) Centreline
- c) Slope to stake out
- d) Hinge point = left line
- e) Second / right line
- f) Natural surface
- g) **Hinge offset**
- h) **CL offset**
- i) Δ **offset**
- j) Δ **height**

Roads - As built check

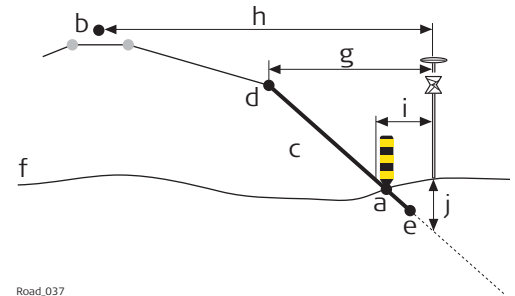

Road_037

- a) Catch point
- b) Centreline
- c) Slope to check
- d) Hinge point
- e) Second line of the slope
- f) Natural surface
- g) **Hinge offset**
- h) **CL offset**
- i) **Slope offset**
- j) **Slope height diff**

Description

- Surfaces, such as the end slopes of a cut or fill, are staked/checked using slope methods.
- Slopes are defined by two lines. Refer to "45.6.3 Road - Basic Elements for Stake and Check Measurements".
- When staking slopes, the point of interest is the intersection of the defined slope with the natural surface (= catch point). Refer to "47.2.3 Advanced Slope Settings" for information on the slope staking methods supported.
- When checking slopes, the slope check is independent of the slope method selected.

Description of manual slopes

The slope is defined manually relative to a selected 3D centreline, slope direction and slope ratio or relative to a 2D line using a manual height, slope direction and slope ratio. Chainage information is related to the centreline.

Description of local manual slopes

The slope is defined manually relative to a selected 3D line, slope direction and slope ratio or relative to a 2D line using a manual height, slope direction and slope ratio. Chainage information is related to the selected line itself and not the centreline of the layer.

Description of design slopes

For this method, a 3D representation of the slope, defined by two lines, is required.

Graphical overview

Roads - Stakeout

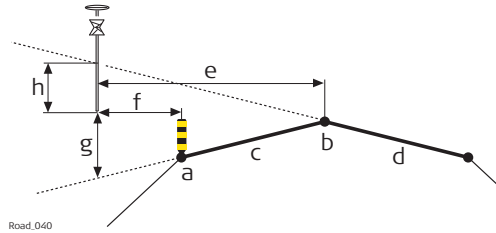

- a) Position to stake out, in this case the left line of the crown
- b) Middle line of the crown, in this case also the centreline
- c) Left surface grade to stake out
- d) Right surface grade to stake out
- e) **CL offset**
- f) Δ **offset**
- g) Δ **ht left**
- h) Δ **ht right**

Roads - As built check

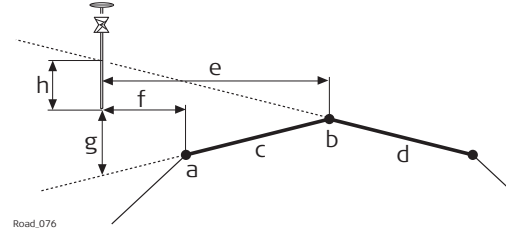

- a) Left line of the crown
- b) Middle line of the crown, common for both surface grades
- c) Left surface grade to check
- d) Right surface grade to check
- e) **CL offset**
- f) Δ **offset**
- g) Δ **ht left**
- h) Δ **ht right**

Description

- Staking road crowns allows the stake out of two surface grades at the same time. If **Toggle offsets left/right** is checked, the reference for Δ **offset** is automatically switched between the right and left surface grade depending on whether the measured position is to the right or left of the middle line.
- When checking road crowns, it allows the check of two surface grades at the same time. The information for both surface grades is shown at the same time.

Required elements

A 3D design of the road, defining a crown consisting of three lines, is required.

Specific fields

The following fields vary from the description used in "47.3.1 The Stake/Check Screen":

Field	Option	Description
Δ ht left / Δ ht right or Δ HtL / Δ HtR	Display only	Vertical offset to the left/right surface grade defining the road crown.

Graphical overview

Roads - Stakeout

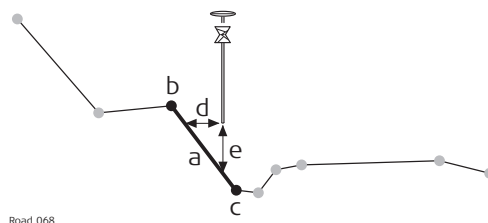

- a) Relevant part of the layer for the current position
- b) Left line **Left name**
- c) Right line **Right name**
- d) Δ **offset**
- e) Δ **height**

Roads - As built check

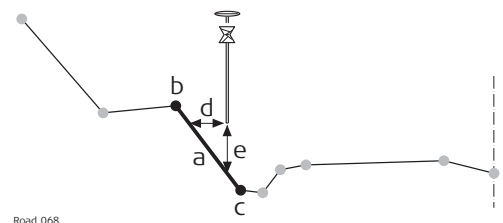

- a) Relevant part of the layer for the current position
- b) Left line **Left name**
- c) Right line **Right name**
- d) **Slope offset**
- e) **Layer ht diff**

Description All lines are grouped in layers. Such a layer describes a surface of the road. When staking/checking out a layer, it is automatically detected the line left and right of the measured position.

Required elements A 3D design of the road is required.

47.3.10 Measuring Digital Terrain Models (DTM)

Graphical overview Roads - As built check

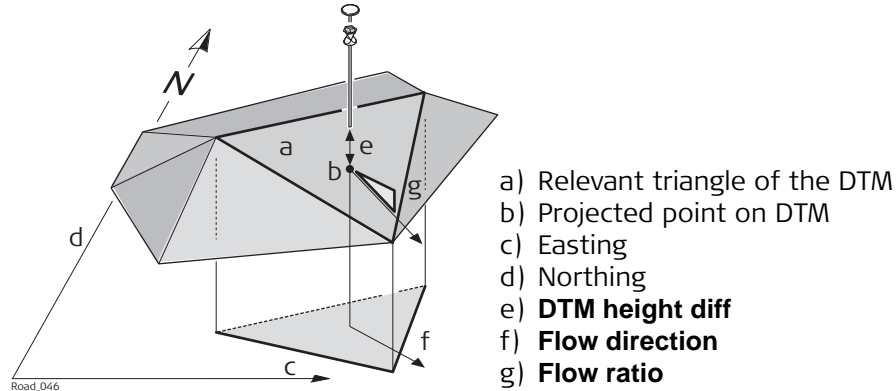

Description A DTM check returns the height difference between the current height and the height of the DTM at the measured position.

Required elements A DTM job is required.

47.4 The Tools Menu

47.4.1 Overview

Access Press Fn **Tools..** on any page of the Stake/Check screen.

Description The Tools menu contains additional functionality for each of the stake and check methods. This functionality is additional to those already existing functions which are available via the function keys.

The functionality differs between the stake and check methods. Refer to these subchapters for a detailed description of the functionalities:

- "47.4.2 Use heights from DTM"
- "47.4.3 Apply current chainage"
- "47.4.4 Get current angle to alignment"
- "47.4.5 Stake individual point"
- "47.4.6 COGO Road - Alignment Information"
- "47.4.7 Additional Layer Information"
- "47.4.8 Box / base definition"
- "47.4.9 Get current slope"
- "47.4.10 Manual Slope"
- "47.4.11 Reset slope to design"
- "47.4.12 Shift reference line"
- "47.4.13 Re-initialise search"
- "47.4.14 Stake intersection point"

Availability

This menu function is available for the following stake/check methods: Line, local line, surface grade, crown, layer.

Description

The application offers the possibility to

- switch to a height which is retrieved from an existing height layer, as defined in the selected DTM job. The layer from the DTM is applied and used as a height reference for the staking out or checking of alignments.
- retrieve heights from an existing layer, as defined in the DTM job associated with the project. The DTM used is not considered for the stake values. Three new information lines are added to the **Info** page: **DTM Ht Diff**, **DTM Height** and **DTM Layer**.
- show the DTM triangles in the planar view and in the cross section view on the **Map** page.

Once defined, each layer remains active until it is turned off. DTM heights can be used for both 2D and 3D alignments.

Use heights from DTM

Use heights from DTM | ↻

DTM: Soccer DTM

Use DTM height for stake out

DTM layer: Existing ▾

Show DTM height difference on Info page

DTM layer: Existing ▾

Show DTM on map

DTM layer: Existing ▾

Hz: 390.1879g V: 99.9999g Fn abc 14:24

OK

Key	Description
OK	To confirm the settings and return to the Stake/Check screen.
Fn Quit	To exit the application.

Description of fields

Field	Option	Description
DTM	Display only	DTM from the selected DTM job.
Use DTM height for stake out	Check box	When this box is checked, a layer of the DTM is used as a height reference. When this box is not checked, no DTM heights are applied for stakeout or check.
DTM layer	Selectable list	Available when Use DTM height for stake out is checked. When selecting a DTM layer the relevant triangle of the DTM is shown on the Map page.
Show DTM height difference on Info page	Check box	When this box is checked, a layer of the DTM to be used as a height reference on the Info page. When this box is not checked, no additional height information relative to the DTM is shown on the Info page.

Field	Option	Description
DTM layer	Selectable list	Available when Show DTM height difference on Info page is checked. Layer of the DTM to be used as a height reference. When selecting a DTM layer the relevant triangle of the DTM is shown in cross section view on the Map page.
Show DTM on map	Check box	When this box is checked, the DTM triangles are displayed in planar view on the Map page.  The setting of for this check box is linked to the setting for the Display DTM in map check box in Map View Settings, DTM page.
DTM layer	Selectable list	All available layers are selectable.

47.4.3 Apply current chainage

Availability This menu function is available for all stake methods except layer.

Description To set **Stake chainage** on the **General** page of the stakeout to the current chainage.

47.4.4 Get current angle to alignment

Availability This menu function is available for the stake/check of lines and local lines.

Description To project a measured point to the alignment considering the entered **Stake chainage**. This functionality is only available when **Work with non-perpendicular offset** is checked in the Stake screen on the **Offsets** page.

Graphic

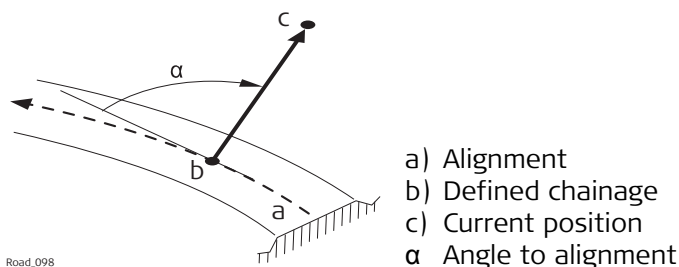

Workflow

Step	Description
1.	Measure a point: <input type="checkbox"/> TPS Dist <input type="checkbox"/> GPS Meas and Stop
2.	Press Fn Tools.. to access the Tools menu.
3.	Select Get current angle to alignment.
4.	At the defined chainage, the angle between the tangent direction and the direction to the current position is calculated. This angle is set as Offset angle for Work with non-perpendicular offset on the Offsets page.
5.	Continue with staking out using the calculated Stake chainage and Offset angle values. These values are valid until new values are defined manually or by using Get current angle to alignment.

47.4.5

Stake individual point

Availability

This menu function is available for the stake/check of lines and local lines.

Description

To select the point to stake from the selected **Working job**.

If a control job has been selected on the job selection screen, a point from the control job can be selected. When staking out/checking an individual point, the selected point is set in relation to the alignment and all line relevant values are calculated and displayed.

To access **Data: Points** page, which allows staking out points with known Easting, Northing and Height. Points can either be selected from the **Working job** or manually typed in.

The **Stake chainage** and **Stake offset** of the Stake screen are calculated based on the coordinates of the selected point.

The height for the stakeout can be set as **Manual height**.



If the chosen point has no height the design height will be used. If the point has a height it is possible to use that one or continue working with the design height.

47.4.6

COGO Road - Alignment Information

Availability

This menu function is available for staking/checking a line/local line.

Description

This function allows

- the selection of existing single or multiple points from a job.
- viewing the selected points along the alignment.
- displaying the respective alignment chainage and offset information.

Any job containing points from any data storage device can be used.

The calculated alignment information is stored and a report sheet can be used for extracting the data.



Point Selection

Point ID	Code	Use
GPS0001	----	No
Blk_454	GLASSEED	No
Blk_453	BUILDSED	No
Blk_452	BUILDSED	No
Blk_451	BUILDSED	No
Blk_450	BUILDSED	No
Blk_449	BUILDSED	No
Blk_448	BUILDSED	No

3DCQ:6.788m 2DCQ:3.703m 1DCQ:5.689m Fn abc 10:10

Calc Use More Page

Key	Description
Calc	To perform the chainage and offset calculation and to continue with the subsequent screen. Calculated COGO points are not yet stored.

Key	Description
Use	To change between Yes and No in the Use column for the highlighted point.
More	To display information about the codes if stored with any point, the Easting, Northing, Elevation, time, date and 3D coordinate quality.  The order in which the Easting and Northing columns are shown depends on the Grid format configured to be used in Regional Settings, Coords page.  The Easting, Northing and Elevation values are shown in the unit configured in Regional Settings, Distance page.
Page	To change to another page on this screen.
Fn None or Fn All	To deactivate or activate all points for the COGO calculation.
Fn Quit	To exit the application.

 Point selection/deselection is possible on the **Map** page.

IF	THEN
a single point is to be selected/deselected	tap on the point.
multiple points are to be selected/deselected	click the  icon, drag the stylus on the screen in a diagonal line to make a rectangular area.
all points are to be selected	press All or None .

Next step

Calc computes the alignment information.

Alignment Results, Points page

Key	Description
Store	To store the results. Points are stored in the working job together with the alignment information. The points can be exported with a report sheet later. The information is the same as if the points had been measured along the alignment.
More	To display information about the calculated alignment information: Horizontal offset from the line, height difference from the defined line and horizontal offset from the centreline.
Page	To change to another page on this screen.
Config..	To configure if the calculated points are stored with the original point ID, a prefix or a suffix.
Fn Quit	To exit the application.

Next step

Page changes to another page.

The fields and information displayed on the **Info** page are as defined in **Configuration, Info** page. Refer to "Configuration, Info page".

The **Plot** page displays all the calculated points against the design data.

Field	Option	Description
Store point ID with	Same point ID	The same point ID from the selected job is used when storing to the working job. If a point exists with the same point ID in the working job a warning appears. Choose to overwrite the existing point or not.
	Prefix	Adds the setting for Store point ID with in front of the original point IDs.
	Suffix	Adds the setting for Store point ID with at the end of the original point IDs.
Prefix / suffix	Editable field	The identifier with up to four characters is added in front of or at the end of the ID of the calculated COGO points.

47.4.7

Additional Layer Information

Availability

This menu function is available for all stake/check methods except layer.

Description

This function allows additional road data to be obtained during a check or stake survey of a road element.

Road elements include centrelines, kerb and gutters and slopes.

The map shows cross section view only and allows setting the vertical exaggeration.

Additional Layer Information

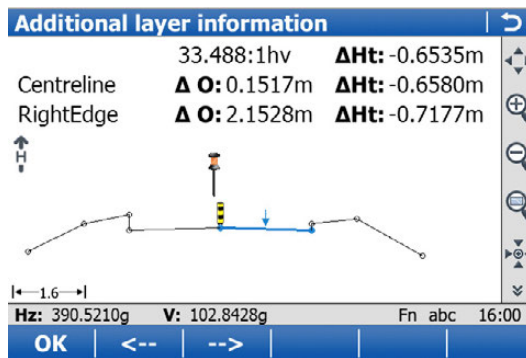

Key	Description
OK	To store the selected element, which is then automatically recalled.
<-- or -->	To select the relevant element in the plot. The information displayed shows the current slope ratio and the height difference of the element. Also displayed are the offset and height differences from the left and right vertices of the element.
Fn Config..	To configure MapView. Refer to "37.3 Configuring MapView".
Fn Layrs..	To turn layers of background maps (CAD files) on and off. Refer to "5.2 Creating a New Job" for information on CAD files and CAD background maps.
Fn Quit	To exit the application.

Availability

This menu function is available for the stake/check of lines and local lines.

Description

This function allows a box or similar structure to be set out during a check or stake survey of a road element. The box is set out relative to a line chainage and parallel offset. A base point of the box, user-defined dimensions of the box (a base distance and a base offset) are required.

Diagram

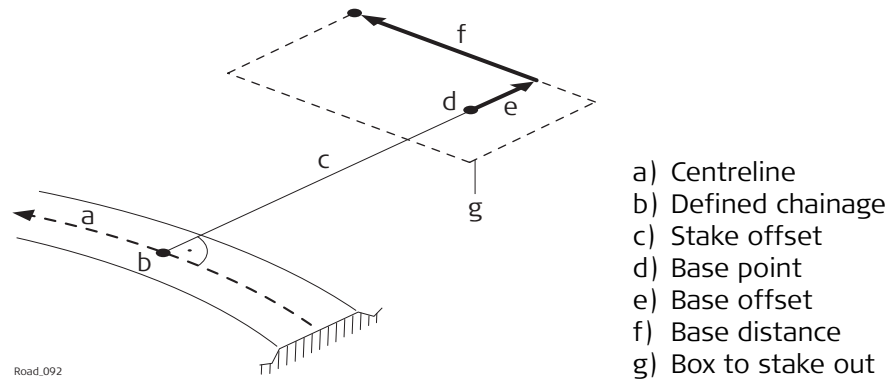

Box / base definition

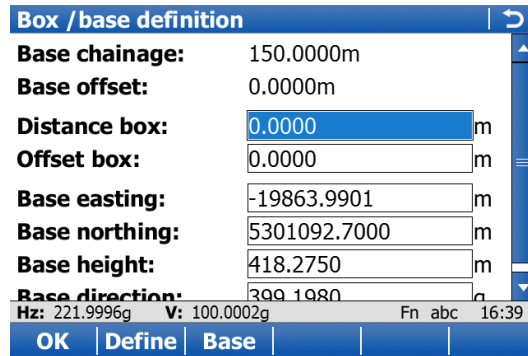

Key	Description
OK	To store the selected element, which is then automatically recalled.
Define	To overwrite the values before pressing Base if a different base had been defined before.
Base or Clear	To freeze or unfreeze the values of the base point.
Fn Quit	To exit the application.

Description of fields

Field	Option	Description
Base chainage	Display only	The position defined by Stake chainage .
Base offset	Display only	The position defined by Stake offset .
Distance box	Editable field	The distance in the direction of increasing chainage of base point is positive.
Offset box	Editable field	The offset to the right of base point is positive.
Base easting, Base northing and Base height	Editable field	The coordinates of the base point, either from the Working job or from a surveyed point.

Field	Option	Description
Base direction	Editable field	The orientation of the local coordinate system (azimuth).

Example

The following steps describe the stakeout of two reference pegs from a centreline chainage and offset.

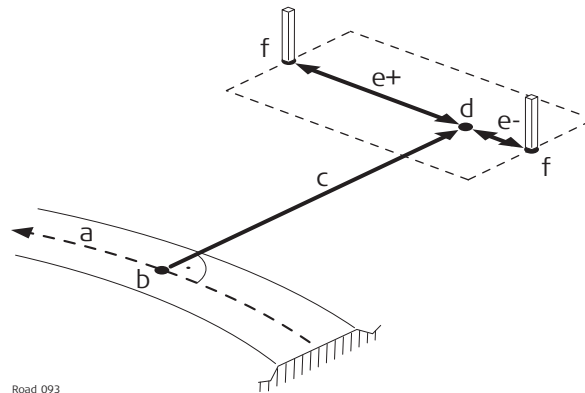

Road_093

- a) Centreline
- b) Defined chainage
- c) Stake offset
- d) Base point
- e) Base distance, positive (e+), negative (e-)
- f) Peg to stake out

Step	Description
1.	Define the base point for the box/base stakeout using Stake offset and Stake height diff from the Offsets page.
2.	Press Fn Tools.. to access the Tools menu.
3.	Select Box / base definition . Press OK to continue to the next screen.
4.	The position defined by Stake chainage and Stake offset is used as Base chainage and Base offset when accessing Box / base definition for the first time within a stakeout session.
5.	Similar to the stakeout of individual points in the Tools menu. The Box/Base functionality calculates the new point to stake out and changes the according values of Stake chainage and Stake offset . The Box/Base functionality also activates the Manual height functionality.
6.	To avoid these values being used as the next base point when accessing the box/base menu, press Base in the Box/Base Definition screen. Pressing this key freezes the values of the base point. Base is now replaced by Clear . If a different base had been defined before, use Define to overwrite the values before pressing Base .
7.	Define the Distance box and Offset box . Both follow the same rules as used for the definition of offsets and chainages in general. That is; offset to the right = positive; distance in direction of increasing chainage = positive.
8.	Press OK to continue to the next screen.
9.	The values of Stake chainage , Stake offset and the Manual height are adjusted accordingly.
10.	The fields Δ chainage , Δ offset and Δ height on the Stake page guide you to the new position to stake out. Press Fn Tools.. to access Tools menu.
11.	Select Box / base definition . Press OK to continue to the next screen.

Step	Description
12.	The next point of the box to stake out can now be defined. To change back to the original chainage and offset defined for the base point definition use Clear .
13.	Start with step 1. to define a new box/base.

47.4.9

Get current slope

Availability

This menu function is available for the stake/check of slopes, local manual slopes and manual slopes.

Description

To access **Slope Definition**. The slope ratio **Current ratio** of the last measured position is used as the defined **Slope ratio**. All other values in **Slope Definition** are filled in with the last measured position. The defined manual slope is used for all points to stake out or check.

 The manual slope is active until it is turned off with **Reset slope to design** from the Tools menu.

Graphic

Slopes are defined relative to the centreline.

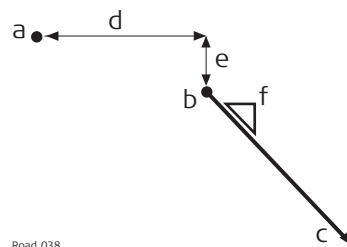

Road_038

- a) Centreline
- b) Hinge point
- c) New slope
- d) Defined hinge offset **Offset**
- e) Defined hinge height difference **Height difference**
- f) **Slope ratio**



Slope Definition

Slope Definition	
Hinge line:	Centreline
Hinge offset:	Absolute
Offset:	0.0000 m
Height difference:	416.7632 m
Slope type:	Fill right
Slope ratio:	1:0 hv
Hz: 221.9996g V: 100.0002g Fn abc 08:26	
OK Config..	

Key	Description
OK	To accept changes and move to the next screen depending on the settings for slope staking.
Config..	To access the configuration settings. Refer to "45.3 Configuring Roads Applications".
Fn Quit	To exit the application.

Description of fields

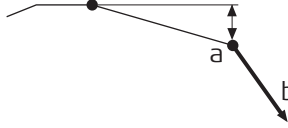
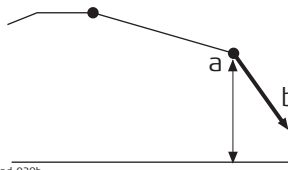
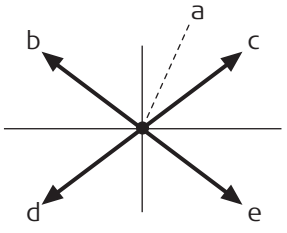
Field	Option	Description
Hinge line	Display only	The line the slope is defined relative to.

Field	Option	Description
Hinge offset	Relative to line	<p>The vertical offset type for the hinge point.</p> <p>Define the hinge point by the height difference relative to the selected Reference line.</p>  <p>a) Hinge point b) Slope</p> <p><small>Road_039a</small></p>
	Absolute	<p>Define the hinge point using its absolute height.</p>  <p>a) Hinge point b) Slope</p> <p><small>Road_039b</small></p>
	Hold hinge	<p>The hinge point of the slope stays fixed at the defined line.</p>
Offset	Editable field	The horizontal offset of the hinge point from the centreline/reference line.
Height difference	Editable field	The height difference of the hinge point from the centreline/reference line. Available for Hinge offset: Relative to line .
Elevation	Editable field	The absolute height of the hinge point. Available for Hinge offset: Absolute .
Slope type	Selectable list	<p>Differentiates if the defined slope is a cut/fill and left/right.</p>  <p>a) Hinge point b) Left cut c) Right cut d) Left fill e) Right fill</p> <p><small>Road_079</small></p>
Slope ratio	Editable field	<p>Defines the ratio of the slope. The measured slope ratio is the default value. This value can be edited manually.</p> <p> The display format is defined as system setting in Regional Settings, Slope page.</p>

47.4.10

Manual Slope

Availability

This function is available for stake/check of slopes.

Description

To access **Slope Definition**. Allows a manual slope to be defined. The defined manual slope is then used for all points to stake out or check. Refer to "Slope Definition" for a description of the screen.

 The manual slope is active until it is turned off with **Reset slope to design** from the Tools menu.

47.4.11

Reset slope to design

Availability

This function is available for stake/check of slopes.

Description

This option is only available if a slope has been defined by using **Get current slope**. The manually defined slope is deactivated and reset to the design slope.

47.4.12

Shift reference line

Availability

This menu function is available for the stake/check of slopes and surface grades. The **Shift reference line** item of the Tools menu stays disabled until the first measured position is available. The current chainage is used for the cross section shown to pick the reference line.

Description

When staking out or checking different layers of the road strata, such as the subgrade, gravel or asphalt, it is often found that not all these layers are available in the design. For such cases, the application offers the possibility to apply either a negative or positive height shift to the design values.

Example

A gravel layer with a thickness of 10 cm is to be staked out. A negative vertical shift to the final design surface is applied. This shift is applied:

- by pressing **Shifts..** in the **Define** screen and
- by applying a vertical shift of -10 cm.

As shown, the selected surface grade is shifted by 10 cm.

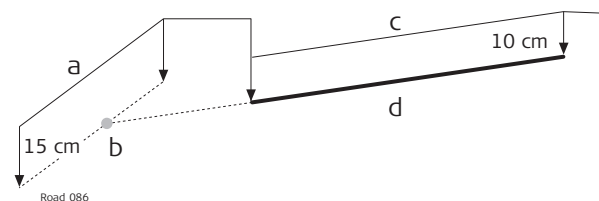

- a) Reference surface
- b) Shifted reference point
- c) Original surface grade
- d) Shifted surface grade

When staking out the newly shifted surface grade, the original left edge of the shifted surface grade is of little interest. It is the intersection with the left end slope that is of greater interest.

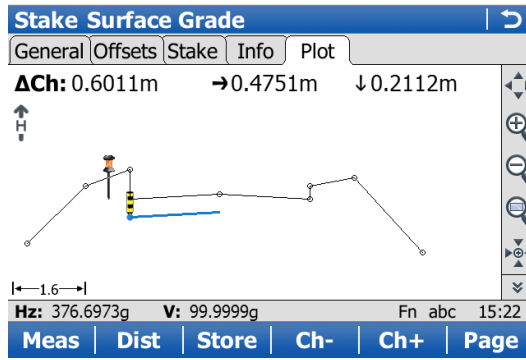

Reference Shift

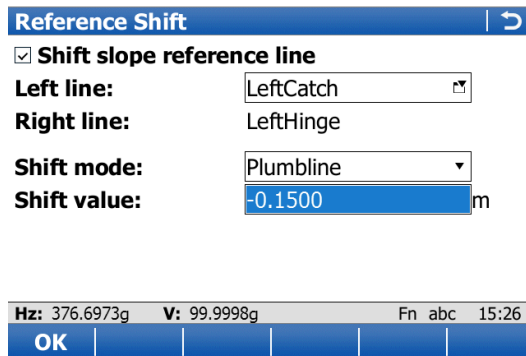

Key	Description
OK	To confirm the settings and return to the Stake/Check screen.
Fn Quit	To exit the application.

Description of fields

Field	Option	Description
Shift slope reference line	Check box	When this box is checked, the settings for the shift can be set.
Left line	Display only	Shows the name of the left line from the surface.
Right line	Display only	Shows the name of the right line from the surface.
Shift mode	<p>Plumbline</p> <p>Perpendicular</p>	<p>The vertical shift applied to the surface selected.</p> <p>The shift defined under Shift value gets applied following the plumb line.</p> <p>The shift defined under Shift value gets applied perpendicular to the selected surface.</p>
Shift value	Editable field	Value the selected surface gets shifted following the chosen Shift mode .

The graphical selection.

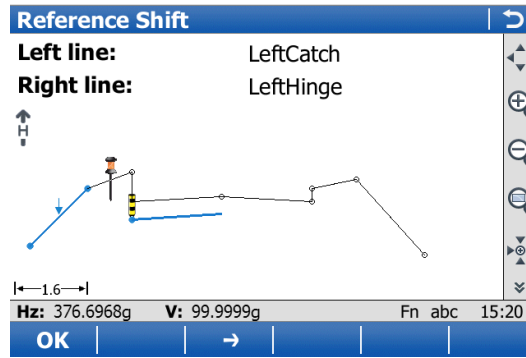

The expanded element and the shifted reference line, marked with a cross, are shown in the **Map** page in the **Stake/Check** screen.

On the **Stake** page, the Δ **offset** and Δ **height** guide you to the new shifted position.

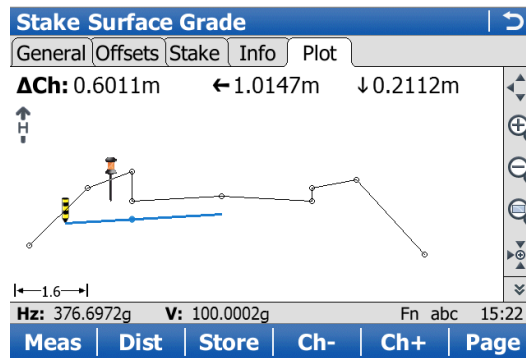

47.4.13

Re-initialise search

Availability

This menu function is available for all stake/check methods except layer.

Description

When staking or checking complex road designs it can happen that the current position is not projected to the desired segment of the alignment. The **Re-initialise search** forces a re-projection of the current position.

Example

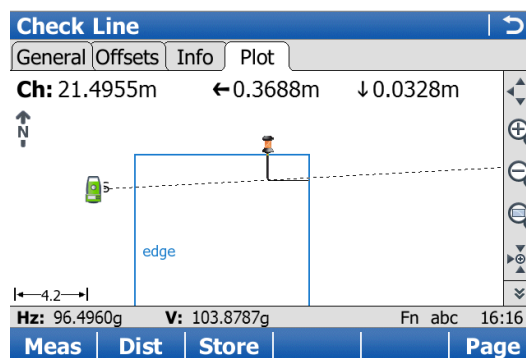

Before initialisation

This screen shows the projection of the current position to the left segment, although the distance to the right segment is shorter.

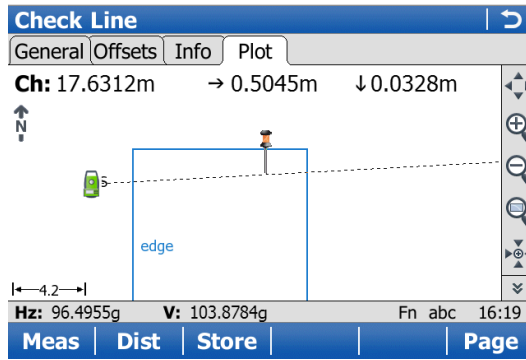

After initialisation

This screen shows the projection after the reinitialisation.

47.4.14

Stake intersection point

Availability

This menu function is available for staking a line with **Refer to an additional line** checked in **Define Line Task**

The additional line must be a **Straight**.

Offsets for the selected line and the additional line can be defined.



The menu function **Stake intersection point** is only available if the offsets are defined perpendicular to the selected line. **Work with non-perpendicular offset** must not be checked.

Description

Stake intersection point is commonly used to stake out bridge abutment positions. The graphic shows an example.

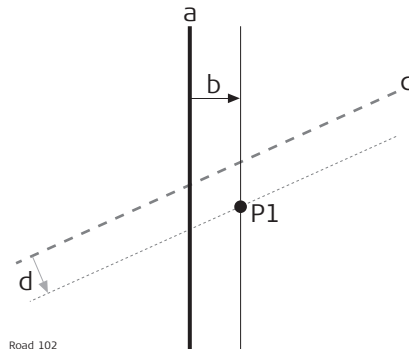

- a) Selected line, for example bridge centreline
- b) Perpendicular offset from the selected line
- c) Selected additional line, for example abutment line
- d) Perpendicular offset from the selected line
- P1 Required intersection point for stakeout

Calculation of the stake intersection point and chainage

The calculation of the intersection point is based on:

- A perpendicular offset from the selected line, for example bridge centreline
- A perpendicular offset from the additional line

Step-by-step

Step	Description
1.	Define Line Task Select the line to work with (bridge centreline) and select a second intersecting line (abutment centreline) under Refer to an additional line .
2.	Stake Line, Offsets page If necessary, check Apply offsets . Type in the offset of the intersection point in relation to selected line (bridge centreline).  Non-perpendicular offsets are not allowed. If necessary, check Apply offsets to additional line . Type in the offset of the intersection point in relation to selected additional line (abutment centreline).

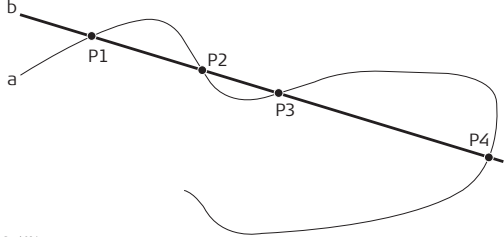
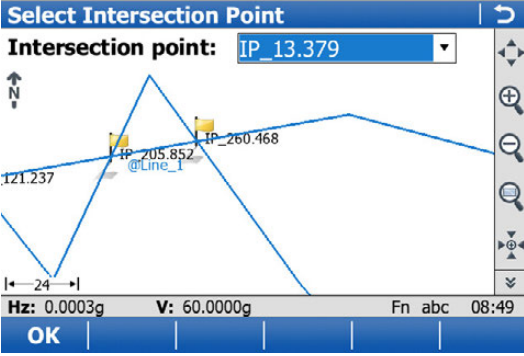
Step	Description
3.	<p data-bbox="528 138 1437 170">Fn Tools.. to access the Tools menu and select Stake intersection point.</p> <p data-bbox="528 180 1366 212">In some cases, more than one intersection point can be calculated.</p>  <p data-bbox="528 474 831 663"> a) Selected line b) Additional line P1 Intersection point 1 P2 Intersection point 2 P3 Intersection point 3 P4 Intersection point 4 </p> <p data-bbox="528 680 1473 774">In this case a plot with the possibility to select the desired intersection point appears. The selection is made using the touch screen and a selectable list. All intersection points are marked with a yellow flag.</p> <p data-bbox="528 779 1406 842">The point ID and the point symbol of a selected intersection point are displayed in blue.</p> 
4.	<p data-bbox="528 1255 804 1287">Height confirmation</p> <p data-bbox="528 1291 1461 1381">Depending on the available height information of the selected lines the following possibilities are available to define the height of the intersection point which has been selected for stakeout.</p> <ul data-bbox="568 1392 1473 1682" style="list-style-type: none"> <li data-bbox="568 1392 1473 1455">• Using the design height, which is the height of the selected line (bridge centreline). This option is used by default or by pressing None. <li data-bbox="568 1459 1473 1522">• Using the height of the additional line as manual height. This option appears when the additional line contains height information. <li data-bbox="568 1526 1473 1619">• Using the average height of the selected line and of the additional line as manual height. This option appears when the additional line contains height information. <li data-bbox="568 1623 1473 1686">• Using Use heights from DTM from the Tools Menu. This option is only available if a DTM has been selected in the job selection screen.
5.	<p data-bbox="528 1703 847 1734">Stake Line, General page</p> <p data-bbox="528 1745 1473 1835">Depending on the height selection, the check box Use manual height instead of design heights is enabled automatically and the selected height is used for staking out.</p>

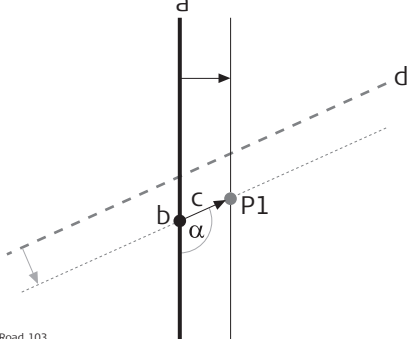
Step	Description
	<p>Stake chainage is the intersection of the original line (bridge centreline) and the line which is offset from the additional line. This value is updated automatically.</p>  <p>Road_103</p> <p>a) Selected line, for example bridge centreline b) Stake chainage of intersection point c) Non-perpendicular offset from the selected line d) Selected additional line, for example abutment line α Non-perpendicular offset angle P1 Required intersection point for stakeout</p>
6.	<p>Stake Line, Offsets page</p> <p>Stake offset: After pressing Fn Tools.. and selecting Stake intersection point, the value is updated automatically to the non-perpendicular offset of the intersection point to the selected line (bridge centreline).</p> <p>Work with non-perpendicular offset: The check box is checked automatically after pressing Fn Tools.. and selecting Stake intersection point. Offset angle is updated automatically to the non-perpendicular offset angle of the intersection point to the selected line (bridge centreline).</p> <p>☞ To stake further points along the same alignment to the additional line, update the value for Stake offset by the required distances. In this case, Stake offset is the distance along/parallel to the additional alignment.</p>
7.	<p>Stake Line, Stake page</p> <p>To stake out the selected intersection point, all delta values must be 0.000.</p>

48

Roads - Rail

48.1

Creating a New Rail Job

48.1.1

Overview

Description

There are two ways of creating road/rail jobs:
Typing them in manually by using the **Alignment Editor** application.
OR
Converting data created in a design package.

Manually entered data

Data can be typed in and edited with **Alignment Editor**. Refer to "46 Roads - Alignment Editor" for information on how to enter data manually.

Converted data

The **Import alignment data** application in **Jobs & Data** supports various different formats like dxf, LandXml, MxGenio, Terramodel, Carlson.
The Design to Field component of Leica Geo Office offers converters from several road/rail design and CAD packages. Several design packages also include a built-in converter to Roads/Rail. As different design packages follow different philosophies in representation, creation and storage of data the conversion process differs slightly.



Leica Geo Office can be found on the Leica Geo Office DVD.
The latest version of the Design to Field importers can be found in the downloads section of:

- myWorld@Leica Geosystems
<https://myworld.leica-geosystems.com>

48.1.2

Installing all necessary Software

Install Leica Geo Office

LGO runs under WindowsXP or Windows Vista and can only be installed successfully if the user is logged in as the Administrator. To install LGO, run the setup file from the DVD and follow the instructions on the screen.

Install Design To Field

To prepare the track design for use on the instrument successfully, the data must first be converted from its original format to an onboard job. This conversion is achieved using Design to Field, a component of LGO which is automatically installed with LGO.

Install Importers

The field importers are used by Design to Field to read in the track design. These importers are installed separately and have the file extension *.rri.
The latest version of the Design to Field importers can be found in the downloads section of:

- myWorld@Leica Geosystems:
<https://myworld.leica-geosystems.com>

Install Rail Editor

Rail Editor is a computer program for defining the height of the rails relative to the horizontal and vertical alignments (superelevation). Rail Editor is automatically installed into LGO from the Field Importers install package, which can be found in the downloads section of the Leica Geosystems website. Rail Editor can be run either externally or within Design To Field.

Install Roads and Rail

Roads and Rail are the onboard programs which are loaded onto the instrument:

- via a data storage device (under the System folder), which is inserted into the instrument,
- via a serial cable and LGO.

48.1.3



Importing the Track Design with Leica Geo Office

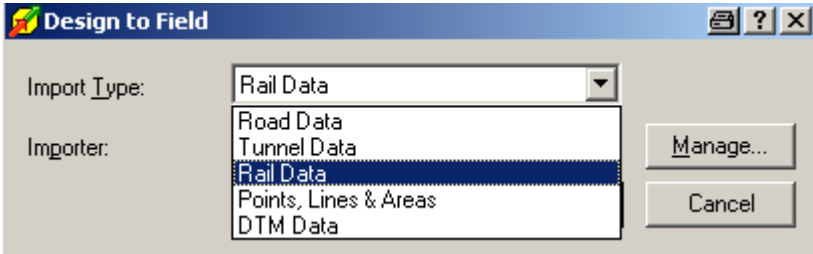
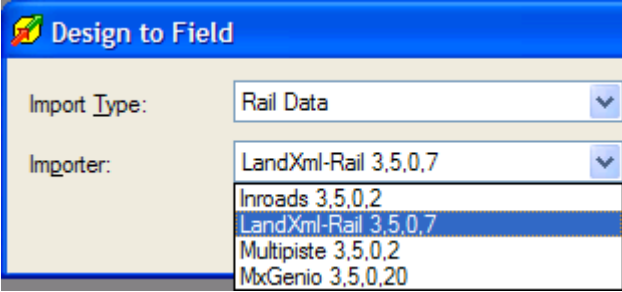

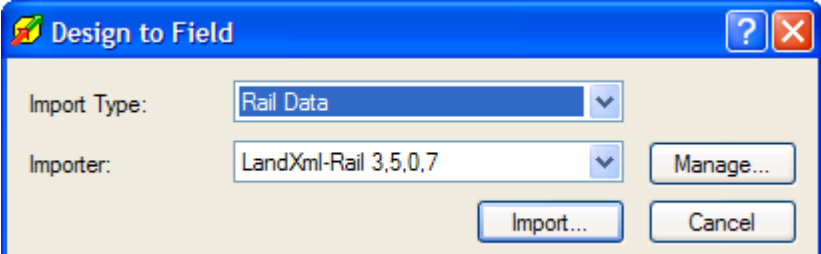
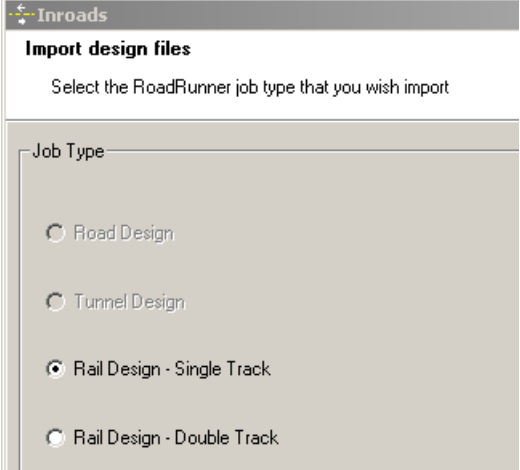
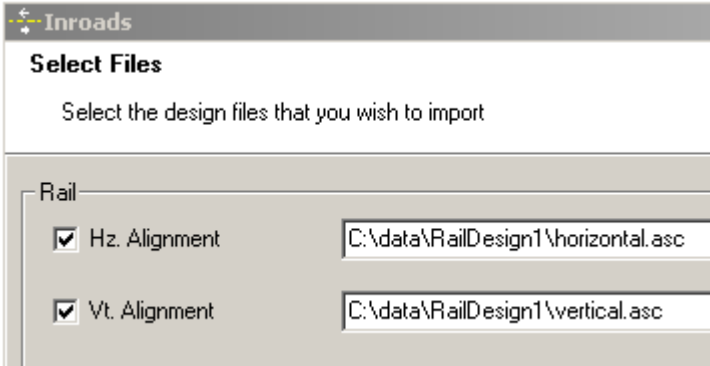
Importing the design

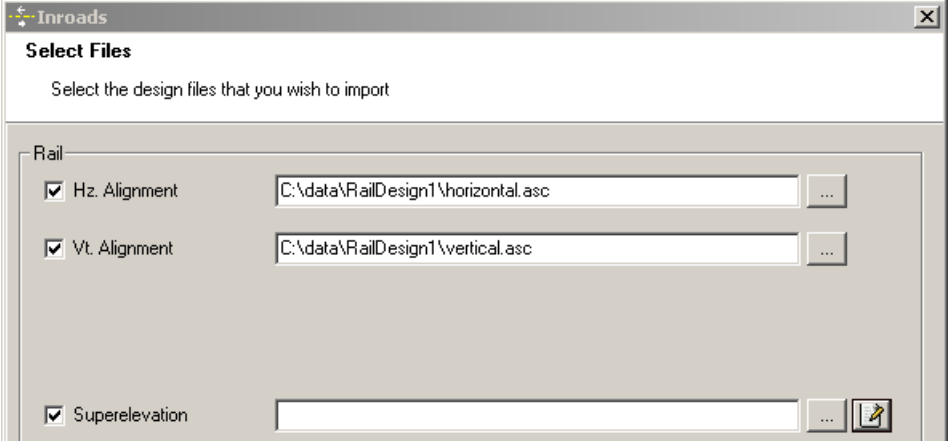

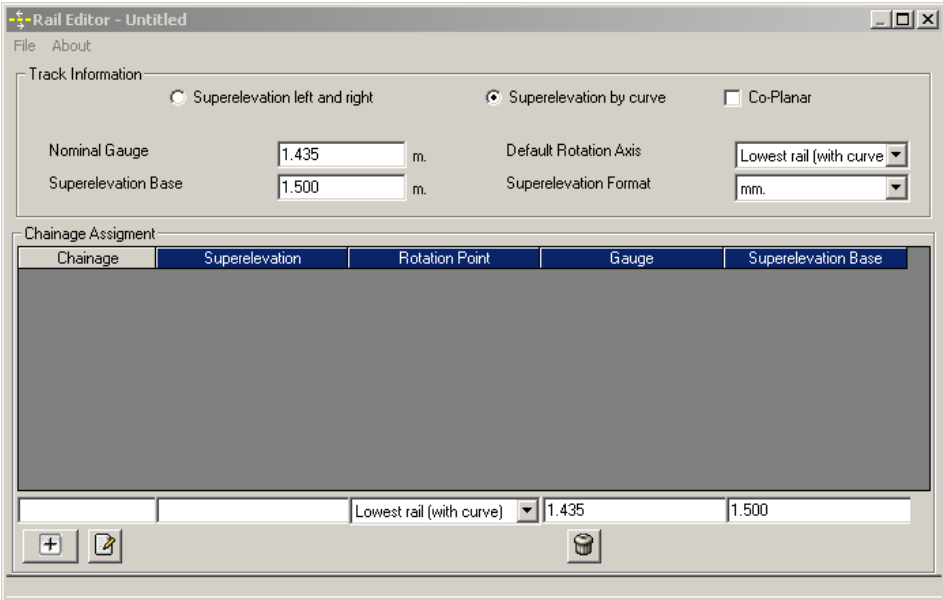
Step	Description
1.	<p>Starting the Design to Field program</p> <p>To import a track centreline select Design to Field from the Tools menu in LGO.</p> 
2.	<p>Selecting an Import Type</p> <p>To prepare track design for onboard use successfully, it has to be converted from its original data format to an onboard job which will run on the instrument.</p> <p>Select Importer Type: Rail Data</p> 
3.	<p>Selecting a Field Importer</p> <p>Importers are used to convert the data. Additional importer formats can be added to the selectable list by clicking Manage.</p> <p>Select the importer related to the track design from the selectable list of available importers.</p> 

Step	Description
4.	<p>Importing Click Import to start the file selection wizard.</p> 
5.	<p>Selecting the job type</p>  <ul style="list-style-type: none"> • For single tracks, select Rail Design-Single Track. A single track design can consist of a horizontal alignment, a vertical alignment and superelevation. • For double tracks, select Rail Design-Double Track. A double track design can consist of a horizontal alignment, a vertical alignment and superelevation for each track. Alternatively, a third horizontal alignment can also be defined and used for calculating the chainage of both tracks (chainage centreline). <p>Click Next to move to the next page of the wizard.</p>
6.	<p>Selecting the horizontal and vertical alignment files</p> 

Step	Description
	<ul style="list-style-type: none"> For a single track, select the horizontal and vertical alignments using the browse button. For a double track, three screens are used to define the design data. The arrows at the bottom of the screens can be used to move between the different screens. <p>First screen - Centreline: The first screen defines the horizontal and vertical alignment of the chainage centreline. If the chainage for each track is to be calculated relative to each track centreline, then it is not mandatory to select a chainage centreline. The horizontal and vertical alignment on the first screen can be left blank.</p> <p>Second screen - Left track: The second screen defines the horizontal and vertical alignments and the rail definition (superelevation) of the left track.</p> <p>Third screen - Right track: The third screen defines the horizontal and vertical alignments and the rail definition (superelevation) of the right track.</p> <p>Click Next to move to the next page of the wizard.</p>
7.	<p>Superelevation (rail definition)</p> <ul style="list-style-type: none"> Design data which is compulsory: A track design must contain a horizontal alignment. Design data which is optional: A track design can include a vertical alignment and a rail definition (superelevation). Superelevation is only possible when the track design includes a vertical alignment. <p>A superelevation file can be obtained in the following ways:</p> <ul style="list-style-type: none"> by selecting an existing superelevation file. by selecting an existing superelevation file and modifying it with Rail Editor. by creating a new superelevation file with Rail Editor. <p>Creating a superelevation (rail definition)</p> <p> To create a rail definition (superelevation) for any track, click the Edit button next to the Superelevation file name. This action starts the Rail Editor program.</p> 

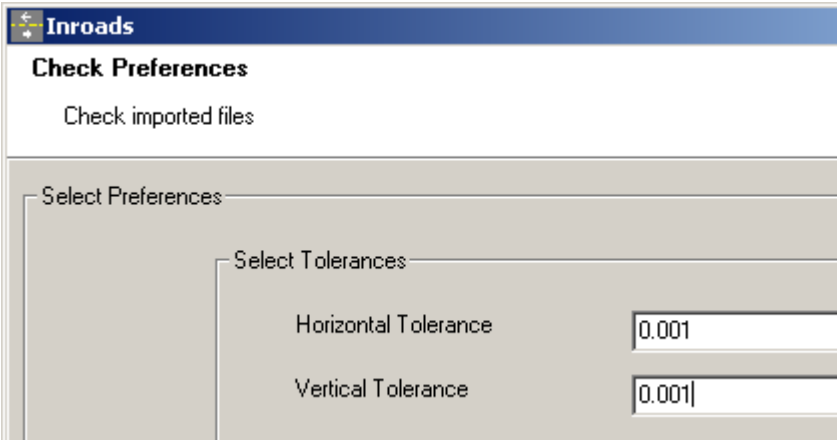
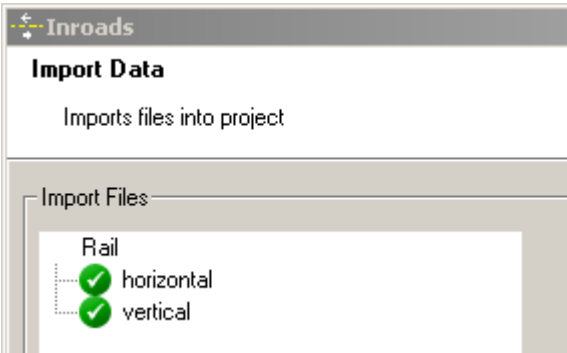
Step	Description
	<p data-bbox="523 134 1453 233">The Rail Editor program is used to define the height of the rails at a given chainage. The height of the rails can be defined by a rotation point and a cant or by a left and right cant.</p>  <p data-bbox="523 869 1355 905">Describing the screen elements - Entering Track Information</p> <p data-bbox="523 911 852 976">Superelevation left and right</p> <p data-bbox="874 911 1481 1010">To define the height of the rails using one superelevation value for the left rail and another superelevation value for the right rail.</p> <p data-bbox="523 1016 858 1052">Superelevation by curve</p> <p data-bbox="874 1016 1481 1081">To define the rails using a rotation point and a superelevation value.</p> <p data-bbox="528 1094 584 1129"></p> <p data-bbox="874 1094 1481 1192">Once the method by which the superelevation values are defined has been selected, it cannot be changed</p> <p data-bbox="523 1199 842 1264">Co-Planar (for multiple tracks)</p> <p data-bbox="874 1199 1481 1297">To define the height of the rails of the second track by extending the plane which runs through the rails of the first track.</p> <p data-bbox="523 1304 735 1339">Nominal Gauge</p> <p data-bbox="874 1304 1481 1436">The default nominal distance between the active (internal) faces of the left and right rails. This value can be changed if necessary for any rail definition (superelevation).</p> <p data-bbox="523 1442 810 1478">Superelevation Base</p> <p data-bbox="874 1442 1481 1604">The distance over which the superlevation is applied. This distance is normally the distance between the centre of the left and right rail. This value can be changed if necessary for any rail definition (superelevation).</p> <p data-bbox="523 1610 826 1646">Default Rotation Axis</p> <p data-bbox="874 1610 1481 1743">If a rotation point is used, this selection will be used as the default for all new rail definitions. This value can be changed if necessary for any rail definition (superelevation).</p> <p data-bbox="523 1749 842 1785">Superelevation Format</p> <p data-bbox="874 1749 1481 1814">The format in which the superelevation values are entered.</p> <p data-bbox="528 1829 584 1885"></p> <p data-bbox="596 1829 1481 1894">Once all superelevation data has been entered, press the button to add the data to the chainage assignment screen.</p>

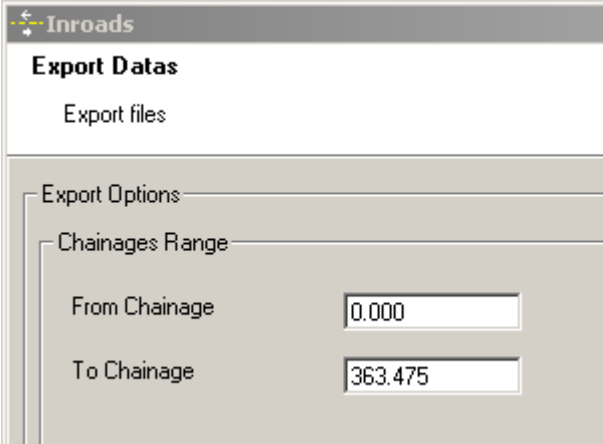
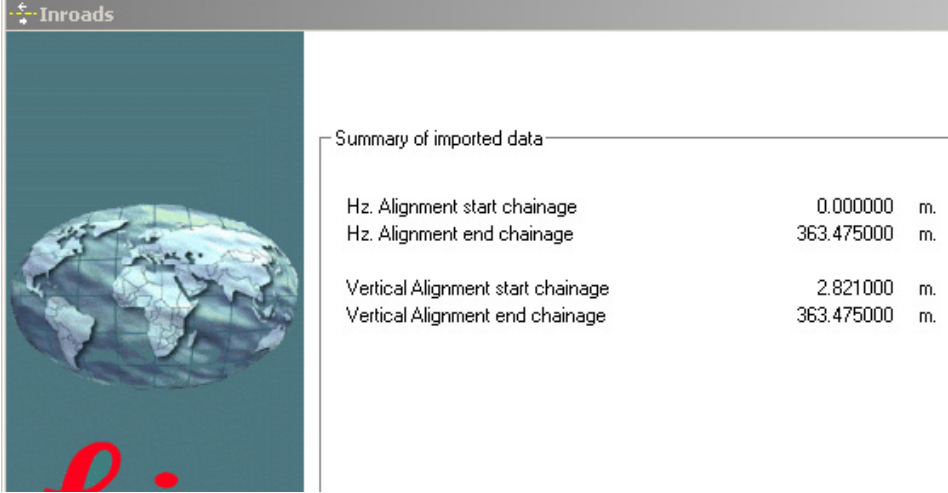
Step	Description
	<p> To delete an element, select the element and press the button.</p> <p> To modify an existing element, select the element, modify the data and press the button.</p> <p>Once all values have been entered for the entire alignment, the file can be saved in an XML format using Save from the File menu.</p> <p>To return to the Design To Field converter, select Exit from the File menu.</p> <p>To modify an existing rail definition (superelevation) file, for example XML files, use Load option from the File menu.</p>
8.	<p>Entering the alignment tolerances</p> <p>Enter the appropriate horizontal and vertical tolerances to be used during the checking of the alignments.</p>  <p>Click Next to move to the next page of the wizard.</p>
9.	<p>Checking the track design</p> <p>When the track design has been imported, information is displayed to show the success or failure of the import.</p>  <ul style="list-style-type: none"> • When the import is successful: Click Next to move to the next page of the wizard. • When the import is unsuccessful: Click Back to step back through the wizard. • If a problem is encountered a red symbol appears. Double click on the red symbol and a window containing a description of the problem appears.

Step	Description
10.	<p>Entering the range of chainages to be used Enter the range of chainages to be exported.</p>  <p>Click Next to move to the next page of the wizard.</p>
11.	<p>Checking the summary report</p> <ul style="list-style-type: none"> • When the report is correct: Click Finish to complete the wizard. • When the report is incorrect: Click Back to step back through the wizard. 
12.	<p>Viewing the track design The track design can be viewed graphically.</p>  <p>Click Export to create the files for onboard use.</p>

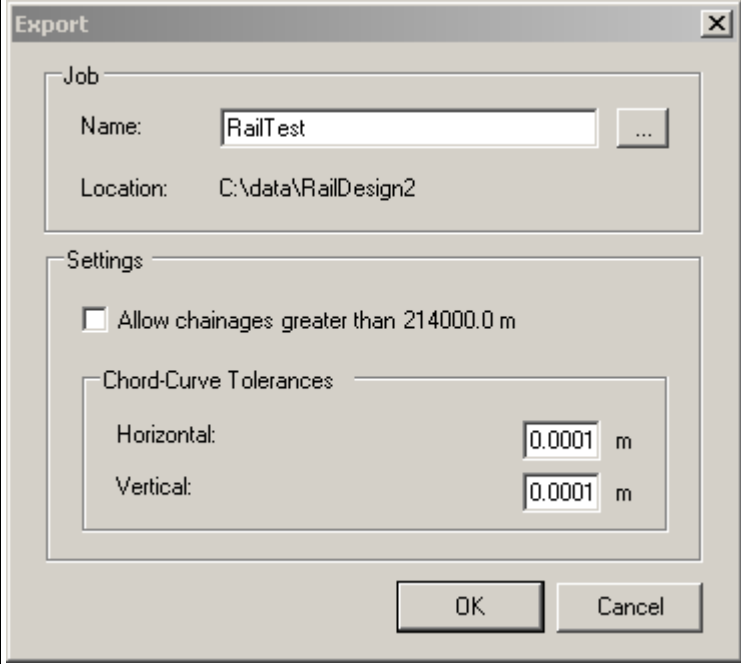
Step	Description
13.	<p>Creating the files for onboard use The track design can now be prepared.</p>  <p>Click OK to create the files for onboard use. The database files are created and are located in the same folder as the source alignment files.</p>



Refer to the Design to Field User Manual for details on importing various types of data with various field importers. This manual is included in the Design to Field Converters install application RR_Design_to_Field.exe, which can be downloaded.

48.1.4

Loading the Track Design onto the Instrument

Loading the design

Once the track design has been converted, copy all the database files to the \DBX folder of the data storage device of the instrument. Refer to "Appendix C Directory Structure of the Memory Device".

48.2

Defining the Work

Access

- 1) Select **Main Menu: Go to Work!\Roads/Rail - Stakeout** or **Rail - As built check**.
- 2) In the job selection screen, select the required jobs. Refer to "45.2.1 Accessing Roads Applications".
- 3) Press **OK**.

Define

Define		↩
Layer:	Rechtes Gleis	
Chainage stringline:	Centerline	
Working chainage:	150.0000	m
Line:	Centre line	
<hr/> H: 221.9996g V: 100.0001g Fn abc 15:22		
OK	Shifts..	Save..

Key	Description
OK	To continue to the next screen.
Shifts..	To apply horizontal and vertical shifts to the selected element. Refer to "45.4 Working with Shifts".
Load..	To load a task. Refer to "45.5 Tasks".
Save..	To save the settings as a task. Refer to "45.5 Tasks".
Fn Config..	To access the Rail configuration settings. Refer to "45.3 Configuring Roads Applications".
Fn Quit	To exit the application.

Description of fields

Field	Option	Description
Layer	Display only or selectable list	Layers contained in the active rail job can be selected, for example layer of left or right track design.
Chainage line	Display only	Shows the name of the chainage line, at the selected layer.
Working chainage	Editable field	To enter a chainage (ranging between the start chainage and end chainage) of the chainage centreline. The default is the setup point for TPS and the current position for GPS. Only those elements which appear at this chainage can then be selected from Line to use .
Line to use	<p>Centre line</p> <p>Left rail or Right rail</p>	<p>The measured point values can be compared with the left rail, the right rail or the track centreline. The selectable list allows the selection of the line with which measured values are then compared.</p> <p>The track centreline.</p> <ul style="list-style-type: none"> For design data including the rails: When working with design data including the rails, the horizontal and vertical alignment of the design is used. Depending on the rail design configuration setting, the superelevation of the design or the manually defined superelevation can be used. For design data without rails (only track centreline): If the design data does not contain the rail design, then the position of the left rail is calculated. The nominal gauge entered in the program configuration is used for the calculation. When working with horizontal alignments only: The height of the rails is calculated by using the values for Manual cant definition defined on Stake Track/Check Track, General page.

48.3
48.3.1

Staking/Checking the Track
The Stake/Check Screen

Staking points

It is possible to stakeout points using a rail job with and without a stored rail design.

When the position of the rails is not stored in the rail job, it is possible to stake out:

- The horizontal and vertical alignment of the track centreline
- Points with a known horizontal and vertical offset from the horizontal and vertical alignment of track centreline
- The rails of the track by entering the track superelevation, superelevation base and nominal gauge
- Points with known horizontal and vertical offsets from the manually defined rails.

When the position of the rails is stored in the rail job, it is possible to stake out:

- The horizontal and vertical alignment of track centreline
- Points with a known horizontal and vertical offset from the horizontal and vertical alignment of track centreline
- The rails of the track
- Points with known horizontal and vertical offsets from the defined rails.

Checking points

Besides checking points, it is also possible to work with cants (superelevation):

- The cant value can be entered manually. The value is measured using a device to measure the cant with an inclination sensor (camber measurement instrument).
- The difference of the manually entered cant value and the current design cant can be displayed on Info page and is stored in the DBX.
- The cant value can be measured by using the option **Second point of cant** of the Tools menu. A second point on the track is measured to calculate the cant using the measured height difference and the configured superelevation base.

Stake Track/Check Track, General page

Information regarding the measured point can be entered. This screen allows any point of the track to be checked against design values.

The screenshot shows the 'Stake Track' screen with the following elements:



- Header: Stake Track
- Tabs: General, Offsets, Stake, Info, Plot
- Point ID: TPS0002
- Target height: 1.5600 m
- Stake chainage: 150.0000 m
- Change increment: 0.0000 m
- Checkbox: Use manual height instead of design heights
- Status bar: Hz: 221.9996g V: 99.9998g Fn abc 16:35
- Bottom bar: Meas | Dist | Store | Ch- | Ch+ | Page

Key	Description
Meas	GPS To start measuring the point being staked. The key changes to Stop .
	TPS To measure a distance and store distance and angles.

Key	Description
Stop <input type="checkbox"/> GPS	To end measuring the point being staked. When Automatically stop point measurement is checked in GPS Settings Quality Control, General page recording of positions ends automatically as defined by the stop criteria. The key changes to Store . After ending the measurements, the differences between the measured point and the point to be staked are displayed.
Store	<input type="checkbox"/> GPS To store the measured point. When Automatically store point is checked in GPS Settings Quality Control, General page, the measured point is stored automatically. The key changes to Meas . <input type="checkbox"/> TPS To store angles and distance. Distance must be measured before.
Dist <input type="checkbox"/> TPS	To measure a distance.
Ch-	Available for Rail - Stakeout . To decrease the chainage as defined by Change increment .
Ch+	Available for Rail - Stakeout . To increase the chainage as defined by Change increment .
Page	To change to another page on this screen.
Fn Config..	To access Rail configuration settings. Refer to "45.3 Configuring Roads Applications".
Fn Positn <input type="checkbox"/> TPS	To position the total station to the defined stakeout point, including defined offsets. This depends on the settings for Turn to point in Configuration, TPS page. Refer to " Configuration, TPS page".
Fn Tools..	To access the Tools Menu. Refer to "48.4 The Tools Menu".
Fn Quit	To exit the application.

Description of fields

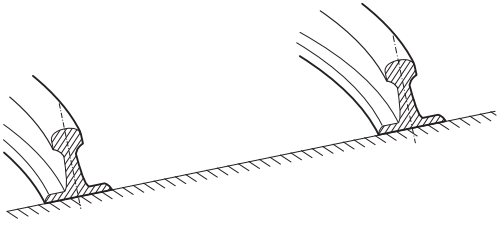
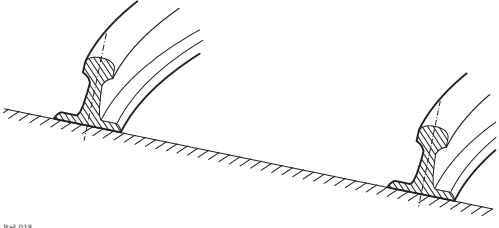
Field	Option	Description
Point ID	Editable field	Name of the next point to be stored. The ID is incremented/decremented whenever a point gets stored.
Antenna height <input type="checkbox"/> GPS	Editable field	Height of the antenna.
Perp. antenna ht <input type="checkbox"/> GPS	Editable field	Perpendicular height of the antenna. Available when the perpendicular height is configured. Refer to " Configuration, Rail design page".
Target height <input type="checkbox"/> TPS	Editable field	Height of the prism.
Perp. target height <input type="checkbox"/> TPS	Editable field	Perpendicular height of the prism. Available when the perpendicular height is configured. Refer to " Configuration, Rail design page".
Stake chainage	Editable field	The defined chainage of the point to be staked out. For multiple tracks that have a defined chainage centreline, the chainage to be staked out always refers to the chainage of the chainage centreline, not to the chainage of the track centreline.

Field	Option	Description
Change increment	Editable field	Value by which the nominal chainage increases/decreases when pressing Ch-/Ch+ . If a point is to be staked at more than one chainage, a chainage increment can be defined.
Use cant device	Check box	<p>When this box is checked, the cant value (superelevation) which was measured with an inclination sensor can be entered manually. The difference of the manually entered cant value and the current design cant is displayed on Info page.</p> <p>When this box is not checked, no cant difference (superelevation) is calculated of the current design cant and the measured cant. The current cant can be measured using the option Second point of cant from the Tools menu.</p>
Measured cant	Editable field	<p>Available when Use cant device is checked. Positive or negative signs must be entered. Seen in increasing chainage direction:</p> <ul style="list-style-type: none"> Negative cant value (example: -0.1900 m)  <p style="text-align: center;"><small>Rail_017</small></p> <ul style="list-style-type: none"> Positive cant value (example: 0.1900 m)  <p style="text-align: center;"><small>Rail_018</small></p> <p> When Second Point of Cant of the Tools menu is active, the current cant value is used for the cant difference calculation, not the value for Measured cant.</p>
Use manual height instead of design heights	Check box	<p>When this box is checked, a height value typed in manually is used instead of design height or DTM height.</p> <p>When this box is not checked, the height from design is used.</p> <p>Available for Superelevation: Design in Configuration, Rail design page.</p>
Manual height	Editable field	Available when Use manual height instead of design heights is checked. The height to be used.
Manual cant definition	Display only	This field and the following fields are available for Superelevation: Manual in Configuration, Rail design page.

Field	Option	Description
Ht lower rail	Editable field	Defines the absolute height of the lowest rail at the defined chainage.
Cant left	Editable field	Defines the superelevation at the left rail. <ul style="list-style-type: none"> • When working with horizontal alignments only: If the superelevation is rotated around the left rail, the superelevation would be zero. • When working with horizontal and vertical alignments: If the track is rotated around the left rail, the vertical alignment would coincide with the left rail and the superelevation would thus be zero.
Cant right	Editable field	Defines the superelevation at the right rail. <ul style="list-style-type: none"> • When working with horizontal alignments only: If the track is rotated around the right rail, the superelevation would be zero. The total superelevation (left + right) is applied across the distance defined as the superelevation base in the configuration. • When working with horizontal and vertical alignments: If the track is rotated around the right rail, the vertical alignment would coincide with the right rail and the superelevation would thus be zero. The total superelevation (left + right) is applied across the distance defined as the superelevation base in the configuration.

Next step

Page changes to the **Offsets** page.

Stake Track/Check Track, Offsets page

Refer to "Stake Track/Check Track, General page" for a description of keys.

Description of fields

Field	Option	Description
Apply offsets	Check box	When this box is checked, offsets can be typed in. Often it is necessary to set out points with a fixed plan offset and fixed height offset from a known reference line (track centreline or rail). Offsets are applied in the same way, irrespective of how the rail design has been entered, whether the offsets are manually entered or if library offsets are used. The sign of the offsets conforms to the offset sign convention described in "45.6 Understanding Terms and Expressions".

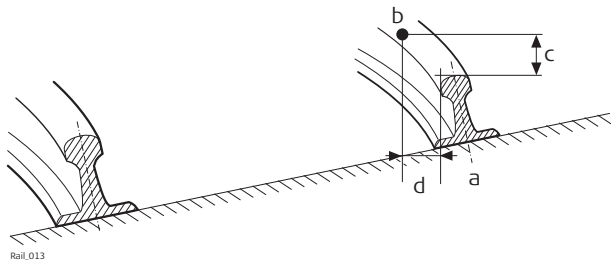
Field	Option	Description
		 <p>a) Reference line (right rail) b) Point to stake c) Stake height diff d) Stake offset</p>
Offsets	Manual From library	Offsets can be entered in Stake offset/Check offset or Stake height diff/Check height diff . The offset is stored as part of the rail job and recalled whenever required.
Offsets	Selectable list	Available for Offsets: From library . The point ID of the stored stake offsets. To select a different stored offset or to create a new point, highlight this field and open the selectable list. Refer to "48.3.2 Offset Library".
Stake offset	Editable field	Available for Stake. Horizontal offset applied to the position of the reference line as defined by the design data or as calculated from manually entered data using the nominal gauge.
Stake height diff	Editable field	Available for Stake. Vertical offset applied to the height of the reference line as defined by the design data or as calculated from manually entered data using the superelevation and super-elevation base.
Check offset	Editable field	Available for Check. Horizontal offset applied to the position of the reference line as defined by the design data or as calculated using manually entered data using the nominal gauge.
Check height diff	Editable field	Available for Check. Vertical offset applied to the height of the reference line as defined by the design data or as calculated from manually entered data using the superelevation and super-elevation base.
Work with pendular displacement	Check box	This functionality is used in railway tunnels. The functionality is available for Rail - Stakeout and Rail - As built check . Some rail projects require additional pendular displacement calculation for the design axis. The track is rotated based on a line with a defined height offset (pendulum length) from the track centreline. This action defines a horizontal displacement for the track. The vertical alignment is independent from the pendular displacement and does not change.

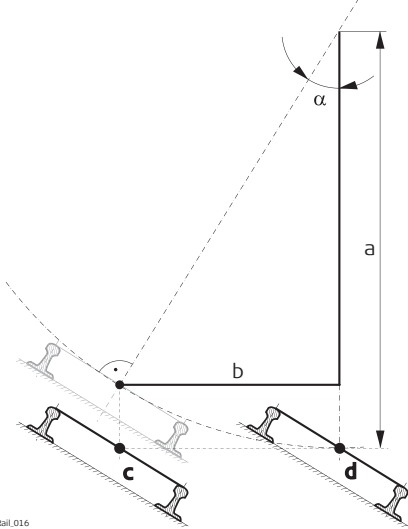
Field	Option	Description
		<p> The pendular displacement calculation only influences the horizontal position of the design axis. It does not change the height of the track.</p> <p>When this box is checked, a pendulum length can be entered. From the original track definition, a pendulum centre is defined exactly above the axis point. The difference in elevation of the pendulum centre is the pendulum length. With the help of the superelevation, a displacement is calculated. The effect of the pendular displacement is displayed on the Info page.</p>  <p>a) Pendulum length: The difference in elevation of the pendulum centre on the original track and above the axis point b) Resulting pendular displacement c) Displaced design axis based on pendular displacement calculation d) Design axis defined in horizontal alignment α Pendulum angle</p>
Pendular length	Editable field	Available when Work with pendular displacement is checked. The pendulum length as distance value. Positive values (0 - 9999.9999) point upwards. Negative values are not allowed.

Next step

IF you work with	THEN Page changes to the
Rail - Stakeout	Stake page.
Rail - As built check	Info page.

 This page is available for Rail - Stakeout only.

This page displays the differences between the measured point and the defined point. The position of the point to stake is reached when all difference values are close to zero.

The chainage can be de-/incremented by pressing left/right arrow key. The defined value for chainage increment is applied.

Refer to "Stake Track/Check Track, General page" for a description of keys.

Refer to "53.4 Staking Out" for a description of the elements of the graphical display.

Description of fields

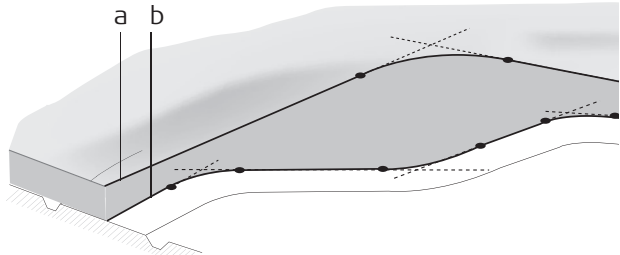
Field	Option	Description
Chainage	Display only	The current track chainage.
CL O	Display only	Perpendicular horizontal offset from the centre-line.
Δ chainage	Display only	Difference between the defined Stake chainage and the current chainage Chainage of the measured position. If no defined chainage exists, for example if staking out random chainages or checking, this field shows -----.
NrTP	Display only	The chainage difference between the measured point and the nearest tangent point (start/end point of a road segment) of the design is displayed.  <small>Road_099</small> a) Vertical alignment b) Horizontal alignment Only tangent points (start/end point of a road segment) are detected.
Δ O	Display only	Horizontal offset between the defined position and the current position. The Stake offset defined on the Offsets page is taken into account.
Δ height	Display only	Vertical offset between the defined position and the current position. The Stake height diff defined on the Offsets page is taken into account.

Next step

Page changes to the **Info** page.

Stake Track/Check Track, Info page

The **Info** page displays the differences between the measured and design data. The fields viewed on this page can be configured in **Rail Configuration, Info** page. Refer to "Configuration, Info page" for information on all available items for the **Info** page and how to select them.

Stake Track/Check Track, Map page

The **Map** page displays a plot of the measured point with respect to the track design. The design is defined by the selected rail or track centreline, and the values entered on the **General** page.

The **Map** page for Check and Stake are similar. The only difference is that the current chainage is always shown, as shown on the **Info** page.

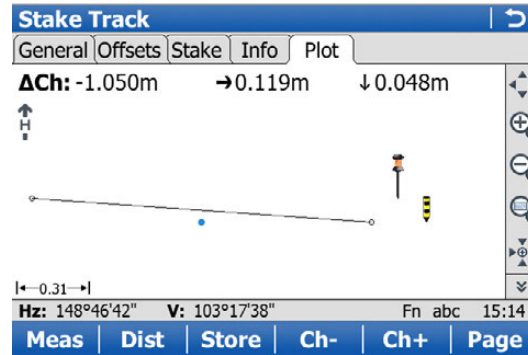

Key	Description
	Refer to "Stake Track/Check Track, General page" for a description of keys.
Fn Layrs..	To turn layers of background maps (CAD files) on and off. Refer to "5.2 Creating a New Job" for information on CAD files and CAD background maps.

The following information is shown:

- 1) Chainage difference between the measured point and the defined chainage. When working with random chainages, for instance if no defined chainage has been entered on the **General** page, ΔCh changes to **Ch**. **Ch** is the current chainage as shown on the **Stake** page.
- 2) Horizontal offset (left/right arrow) to the design
- 3) Height difference (up/down arrow) to the design
- 4) The measured point
- 5) The element to stake is shown in bold and blue. The position to stake is marked with a yellow-black peg.
- 6) The plot can be shown as a cross plot or plan view by using the  eye icon on second level of MapView toolbar.

Description	To select a different stored offset or to create a new point.
Access	1) In Stake Track/Check track, Offsets page, select Offsets: From library . 2) Highlight Offsets and open the selectable list.

Rail job: Job name This screen allows offsets relative to a reference line to be defined and stored in the rail job. These points can be recalled at any time.

Rail job: eingleisig+CL_D2F		
Point ID	Offset	Height difference
<None>	-----	-----
Aux0002	2.0000m	5.0000m

Hz: 222.0003g	V: 100.0001g	Fn abc	09:20
OK	Add	Edit..	Delete More

Key	Description
OK	To select a defined offset and to continue.
Add	To enter an offset.
Edit..	To edit an existing offset.
Delete	To delete an existing offset.
More	To display information about the reference rail or the Offset and the height difference.
Fn Quit	To exit the application.

Next step

Press **Add** or **Edit...**

Rail job: Job name, Offsets This screen allows the values of the stake/check offsets to be entered/edited. In addition to the horizontal and vertical offsets, an offset name (point ID) can be entered for each item.

Next step

Press **OK** twice to return to **Stake Track/Check track**.

48.3.3

Working with Pendular Displacements

Requirements

In **Stake Track/Check Track, Offsets** page, check **Work with pendular displacement** and type in a value for **Pendular length**.

Specific values on the Info page

Value	Description
Pendular length	The defined pendulum length as entered on Offsets page.
Def pendulum displacement	Resulting horizontal displacement at defined chainage.
Actl pendulum displacement	Resulting horizontal displacement at current chainage.
Def pendulum angle	Resulting pendulum angle at defined chainage.
Actl pendulum angle	Resulting pendulum angle at current chainage.

48.4

The Tools Menu

48.4.1

Overview

Access

Press Fn **Tools..** on any page of the Stake/Check screen.

Description

Additional functions for staking/checking the track can be accessed through the Tools menu. This functionality is additional to those already existing functions which are available via the function keys.

The functionality differs between the stake and check methods. Refer to these subchapters for a detailed description of the functionalities:

- "48.4.2 Use heights from DTM"
- "48.4.3 Apply current chainage"
- "48.4.4 Stake individual point"
- "48.4.5 Second point of cant"
- "48.4.6 COGO Rail"

48.4.2

Use heights from DTM

Availability

This menu function is available for stake and check.

Description

The application offers the possibility to

- switch to a height which is retrieved from an existing height layer, as defined in the selected DTM job. The layer from the DTM is applied and used as a height reference for the staking out or checking of alignments.
- retrieve heights from an existing layer, as defined in the DTM job associated with the project. The DTM used is not considered for the stake values. Three new information lines are added to the **Info** page: **DTM Ht Diff**, **DTM Height** and **DTM Layer**.
- show the DTM triangles in the planar view and in the cross section view on the **Map** page.

Once defined, each layer remains active until it is turned off. DTM heights can be used for both 2D and 3D alignments.

Use heights from DTM

Use heights from DTM | ↻

DTM: Soccer DTM

Use DTM height for stake out

DTM layer: Existing ▾

Show DTM height difference on Info page

DTM layer: Existing ▾

Show DTM on map

DTM layer: Existing ▾

Hz: 390.1879g V: 99.9999g Fn abc 14:24

OK

Key	Description
OK	To confirm the settings and return to the Stake/Check screen.
Fn Quit	To exit the application.

Description of fields

Field	Option	Description
DTM	Display only	DTM from the selected DTM job.
Use DTM height for stake out	Check box	When this box is checked, a layer of the DTM is used as a height reference. When this box is not checked, no DTM heights are applied for stakeout or check.
DTM layer	Selectable list	Available when Use DTM height for stake out is checked. When selecting a DTM layer the relevant triangle of the DTM is shown on the Map page.
Show DTM height difference on Info page	Check box	When this box is checked, a layer of the DTM to be used as a height reference on the Info page. When this box is not checked, no additional height information relative to the DTM is shown on the Info page.
DTM layer	Selectable list	Available when Show DTM height difference on Info page is checked. Layer of the DTM to be used as a height reference. When selecting a DTM layer the relevant triangle of the DTM is shown in cross section view on the Map page.
Show DTM on map	Check box	When this box is checked, the DTM triangles are displayed in planar view on the Map page.  The setting of for this check box is linked to the setting for the Display DTM in map check box in Map View Settings, DTM page.
DTM layer	Selectable list	All available layers are selectable.

48.4.3

Apply current chainage

Availability

This menu function is available for stake.

Description

To set **Stake chainage** on the **General** page of the stakeout to the current chainage.

48.4.4

Stake individual point

Availability

This menu function is available for stake.

Description

To select the point to stake from the selected **Working job**.

If a control job has been selected on the job selection screen, a point from the control job can be selected. When staking out/checking an individual point, the selected point is set in relation to the alignment and all line relevant values are calculated and displayed.

To access **Data: Points** page, which allows staking out points with known Easting, Northing and Height. Points can either be selected from the **Working job** or manually typed in.

The **Stake chainage** and **Stake offset** of the Stake screen are calculated based on the coordinates of the selected point.

The height for the stakeout can be set as **Manual height**.



If the chosen point has no height the design height will be used. If the point has a height it is possible to use that one or continue working with the design height.

48.4.5

Second point of cant

Availability

This menu function is only available for check.

Description

To determine the current cant of two rails.

In order to calculate the current cant, it is necessary to measure two points, one on each rail. A mechanical device can be used to measure these points if necessary.

Additionally, the current cant can be calculated by first measuring any two points (example, the track centreline and lower rail) and then using the superelevation base. The calculation is dependent upon the superelevation base.



When **Second point of cant** is active, the **Current cant** is used for the calculation of the cant difference, not the measured cant value from a cant device as seen in **Check Track, General** page.

Diagram

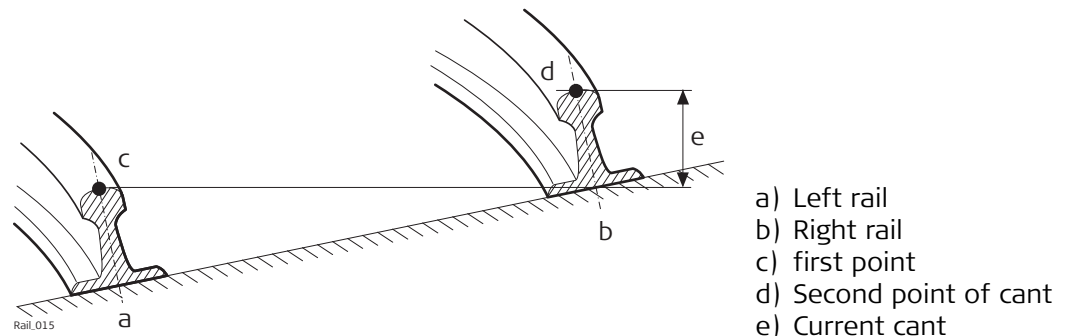

Procedure

Measuring the first point

The first point can be measured directly from the **Check Track** screen.

Measuring the second point

The second point is measured after accessing the **Second point of cant** in the Tools menu. Once the second point has been measured, the value **Current cant** is displayed on the **Info** page.

48.4.6

COGO Rail



The functionality of **COGO Rail** is identical with **COGO Road**. Refer to "47.4.6 COGO Road - Alignment Information".

49

Roads - Tunnel TPS

49.1

Creating a New Tunnel Job

49.1.1

Preparing Design Data

Downloads section

The tunnel design data is imported for use onboard the instrument using

- the industry standard LandXML data format
- formats exported from some other design packages using the Design to Field component of the Leica Geo Office computer application.

Converters are available for more than 15 different design packages.



The latest version of the Design to Field importers can be found in the downloads section of:

- myWorld@Leica Geosystems
<https://myworld.leica-geosystems.com>

49.1.2

Tunnel Centreline

Basics

The tunnel centreline is defined in two or three dimensions. If design profiles are to be used, a three-dimensional centreline is required.

Design to field

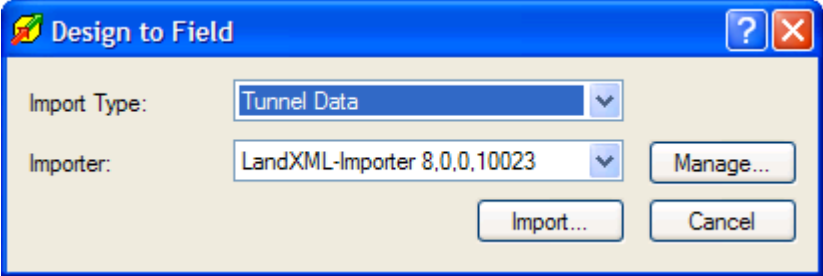
Step	Description
1.	To import a centreline using the Design to Field component select the Tools/Design to Field option of the Leica Geo Office computer application. 
2.	



For general information about Design to Field, please refer to the Leica Geo Office manual or Online Help.

Tunnel design profiles

If tunnel design profiles are available, they are created using the Tunnel Profile Editor computer application. This application is integrated in the Design to Field viewer. It allows users to import or create tunnel data like profiles, layers and rotations. Refer to the Tunnel Profile Editor online help for more information.

Tunnel Profile Editor, Profile details view

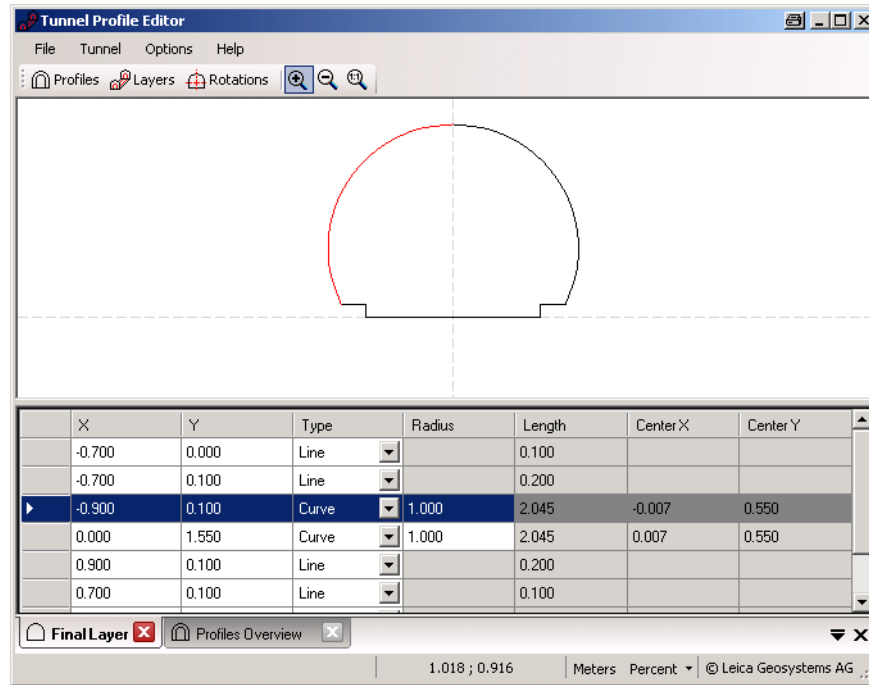

Tunnel Profile Editor, Layer details view

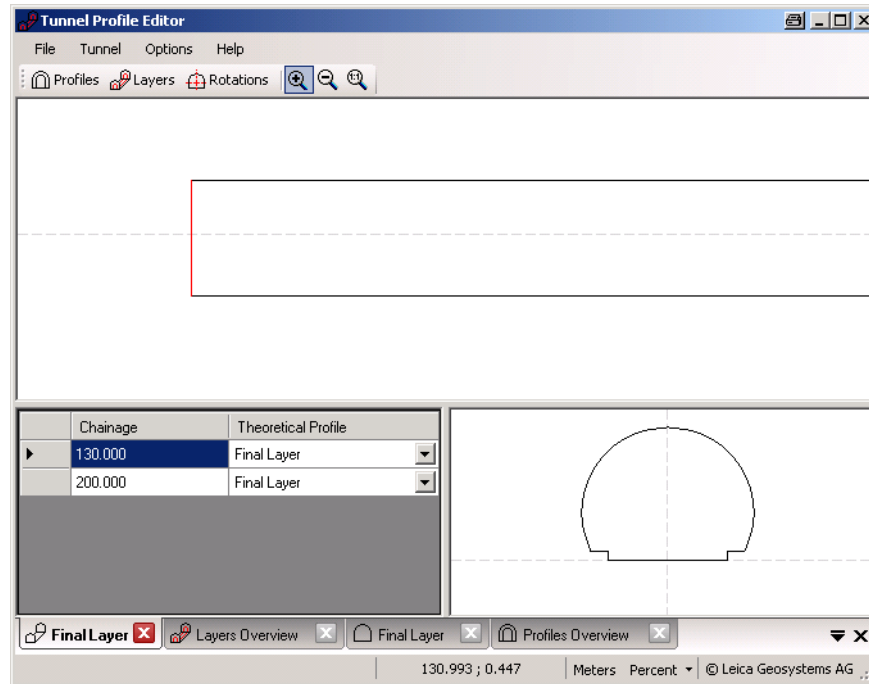

Vertical or perpendicular profiles

The Tunnel Profile Editor allows users to define tunnel profiles vertically or perpendicular to the vertical alignment of the tunnel axis. This results in different tunnel sizes for equal profile definitions as shown in the graphic.

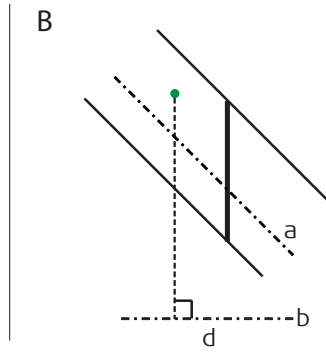
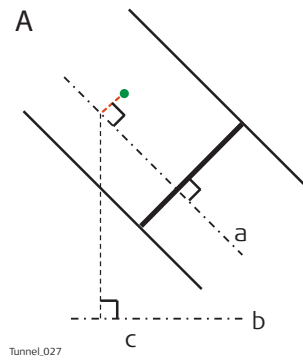

- A Perpendicular (tilted) profile
- B Vertical profile
- a) Vertical alignment of tunnel axis
- b) Horizontal alignment of tunnel axis
- c) Chainage for perpendicular profile definition
- d) Chainage for vertical profile definition

49.1.4

Data Transfer to Instrument

Getting data onboard

Once the design data have been converted, copy the database files to the DBX folder of the data storage device that is used on the instrument. The file names are jobname.x**.

49.2

Defining the Work

Access

- 1) Select **Main Menu: Go to Work!\Roads\Tunnel - Stakeout** or **Tunnel - As built check**.
- 2) In the job selection screen, select the required jobs. Refer to "45.2.1 Accessing Roads Applications".
- 3) Press **OK**.

Define the Work to be Done

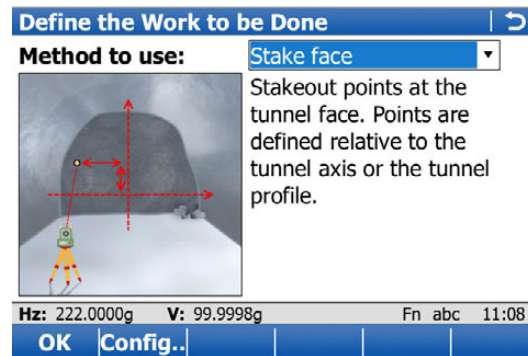

Key	Description
OK	To continue to the next screen.
Config..	To access the configuration settings. Refer to "45.3 Configuring Roads Applications".
Fn Quit	To exit the screen.

Description of the methods

Method	Description
Stake face	Stakeout points at the tunnel face. Points are defined relative to the tunnel axis or the tunnel profile.

Method	Description
Stake profile	Stakeout points at defined chainages. Points are defined relative to the tunnel axis or the tunnel profile.
Check profile	Measure deviations of the built tunnel to the original design.
Scan profile	Automatically scan profiles in a defined section of the tunnel

Next step

OK accesses the **Define** screen.

Define

The screen is an example valid for **Method to use: Stake face**.

Key	Description
OK	To continue to the next screen.
Shifts..	To apply horizontal, vertical and profile shifts to the selected element. Refer to "45.4 Working with Shifts".
Load..	To load a task. Refer to "45.5 Tasks".
Save..	To save the settings as task. Refer to "45.5 Tasks".
Fn Config..	To access the configuration settings. Refer to "45.3 Configuring Roads Applications".
Fn Quit	To exit the application.

Description of fields

Common to all methods

Field	Option	Description
Layer	Display only or selectable list	Layers contained in the active tunnel job can be selected.
Centreline	Display only	The name of the layer centreline.

For **Method to use: Stake face**

Field	Option	Description
Drilling rig orientation	Check box	Available for Method to use: Stake face . This functionality helps to orientate the drilling rig when drilling holes parallel to the tunnel axis direction. The entry point at the tunnel face is marked and delta angles to align the drilling rig are provided.

Field	Option	Description
The following fields are available when Drilling rig orientation: Parallel to alignment is selected in Tunnel Configuration, Tunnel design page:		
Drilling distance	Editable field	The bore hole length. Available when Drilling rig orientation is checked and used to calculate the direction parallel to the alignment.
Check Jumbo position	Check box	When this box is checked, the jumbo position is checked after measuring to the back of the boom.
Boom length	Editable field	The length of the boom is used for calculating and checking the jumbo position when Check Jumbo position is checked.
Tolerance	Editable field	Defines how accurately the boom must be positioned to calculate the delta angles (max 10% of boom length). Available when Check Jumbo position is checked.
The following fields are available when Drilling rig orientation: Drill Pattern is selected in Tunnel Configuration, Tunnel design page:		
Apply drill pattern from	Meas Chainage	The drill pattern is directly applied to the measured chainage. To acquire the measured chainage, take a measurement, press Fn Tools.. and select Apply current chainage .
	Defined Chainage	This chainage is typed manually into the Stake chainage editable field. It is used to calculate the corresponding position and drill direction at the measured chainage.

For **Method to use: Check profile**

Field	Option	Description
Apply target radius	Check box	Available for Method to use: Check profile . When using a prism to check a design profile, it is important to take the prism radius into account. The measured point is projected by a distance equivalent to the radius of the prism in a direction perpendicular to the tangent of the design profile. When this box is not checked, the design profile is compared to the coordinates of the centre of the prism at the measured position.

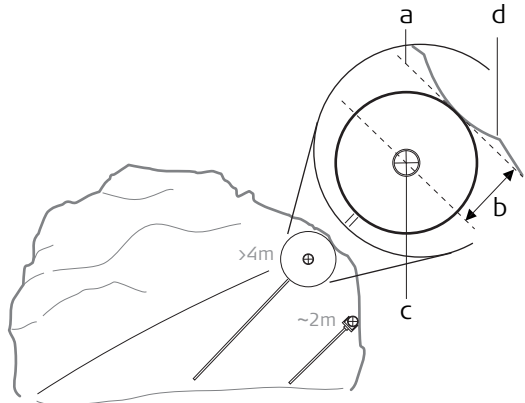
Field	Option	Description
		 <p>Tunnel_013</p> <p>a) Tangent to design profile b) Prism radius c) Prism d) Design profile</p> <p>If reflectorless measurements are used or no design profile has been defined, the prism radius parameter will not be used in the calculation.</p> <p>In Check Profile, Map page a plot of the measured point regarding the design profile is displayed.</p>
Target radius	Editable field	Available for Method to use: Check profile and when Apply target radius is checked. The radius of the prism.

For **Method to use: Scan profile**

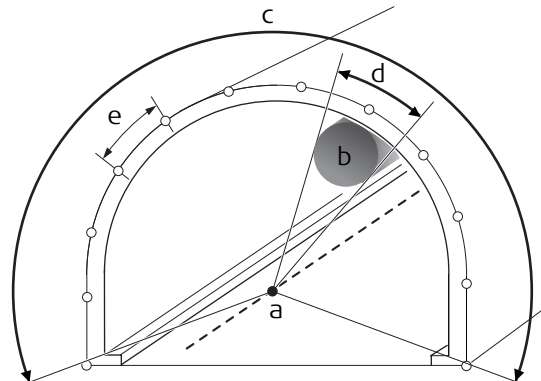
Field	Option	Description
Define a scan task	Scan whole profile Scan using segment	<p>Each profile is scanned 360°/400 gon.</p> <p>The tunnel profile can be split into user-defined segments. Each segment can be assigned as a scan segment or non scan segment.</p>  <p>Tunnel_014</p> <p>a) Instrument axis b) Ventilation shaft c) Scan segment, included d) Scan segment, excluded e) Scan interval</p>

Field	Option	Description
Scan interval	Editable fields	Available for Define a scan task: Scan whole profile . Defines at what interval to measure a point around the profile.
Scan Mode	Accuracy optimised	This measurement mode is accuracy and range optimized. It uses the reflectorless single distance measurement mode.
	Speed optimised	Available for TS15. This measurement mode is speed and performance optimized. It uses the reflectorless continuous distance measurement mode.
TPS handle is on	Check box	When this box is checked, scanning a segment above the instrument is excluded automatically. The TPS handle would otherwise interfere with measurements.  If scanning at the station chainage, then the scan does not include the profile segment beneath the total station.
Handle type	Normal handle	If this option is selected, then it is not scanned between 386 gon and 7 gon.
	Radio handle	If this option is selected, then it is not scanned between 380 gon and 25 gon.

49.3

49.3.1

Staking/Checking the Tunnel

Overview

Stake face/Stake profile/Check profile, General page

This screen is an example valid for **Method to use: Stake profile**.

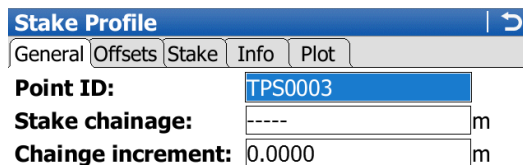

Stake Profile | ↻

General | Offsets | Stake | Info | Plot

Point ID:

Stake chainage: m

Change increment: m



Hz: 199.7619g V: 159.9972g Fn abc 09:04

Meas | Dist | Store | Ch- | Ch+ | Page

Key	Description
Meas	To measure a distance and store distance and angles.
Dist	To measure a distance.
Store	To store angles and distance. Distance must be measured before.
Ch-	Available for Tunnel - Stakeout . To decrease the chainage as defined by Change increment .
Dist+	To increase the distance along the profile. Available for Input method: Profile, dist & offset and Input method: Dist from top&offset .
Ch+	Available for Tunnel - Stakeout . To increase the chainage as defined by Change increment .

Key	Description
Page	To change to another page on this screen.
Fn Config..	To access configuration settings. Refer to "45.3 Configuring Roads Applications".
Fn Positn	Available for Tunnel - Stakeout . To stake the point automatically. The instrument aims toward the point at the given chainage and offsets and measures a distance. If this distance is not within the required tolerance an iterative process is started until: <ul style="list-style-type: none"> the number of iterations set as the configuration parameter Max iterations is reached, or the difference between the measured point and the design point is less than the value set as the configuration parameter Position limit.
Fn Tools..	Available for Tunnel - Stakeout . To access the tools menu. Refer to "47.4 The Tools Menu".
Fn Quit	To exit the application.

Description of fields

Field	Option	Description
Point ID	Editable field	The point identifier of the point to be staked.
Stake chainage	Editable field	Available for Tunnel - Stakeout . The defined or approximate chainage of the point to be staked out.
Change increment	Editable field	Available for Method to use: Stake profile . Chainage increment. Value by which the nominal chainage increases/decreases when pressing Ch+/Ch- . If a point is to be staked at more than one chainage, a chainage increment can be defined.
Target height	Editable field	Available for Method to use: Check profile . The height of the prism. If a prism is used, type in the vertical difference between the point to be measured and the point of the prism pole.

Next step

Page changes to the **Offsets** page.

Scan profile, Scan area page

The screenshot shows the 'Scan Profile' screen with the following fields and values:

- Point ID:** TPS0153
- Station chainage:** 2.437m
- Start chainage:** 2.000 m
- End chainage:** 4.000 m
- How often do you want to scan a profile?**
 - Before stn every:** 0.100 m
 - After stn every:** 1.000 m

At the bottom, there is a status bar showing 'Hz: 365.4825g V: 109.9390g Fn abc 11:14' and a row of navigation buttons: Stop, Resum, Pt+, Manual, Prof+, Page.

Key	Description
Scan	Available for automatic scanning. To start the scanning process. Refer to "During a scan".
Stop	Available for automatic scanning. To stop the scanning process.
Pause	To pause the scan.
Resum	To re-start scanning.
Get Ch	Point the telescope to the start or end chainage and press Get Ch to measure to the start/end chainage.
Meas	Available for manual scanning. To measure a distance and store distance and angles.
Dist	Available for manual scanning. To measure a distance.
Store	Available for manual scanning. To store angles and distance. Distance must be measured before.
Pt+	To skip the point being measured and move onto the next profile point.
Prof+	To stop scanning the current profile and move onto the next profile.
Manual or Auto	To switch between manual and automatic scanning.
Page	To change to another page on this screen.
Fn Config..	To access configuration settings. Refer to "45.3 Configuring Roads Applications".
Fn Temp	To define a temporary scan interval. This will result in all scan segments being scanned at the defined temporary scan interval until the temporary scan interval is disabled.
Fn Tools..	To access the tools menu. Refer to "49.4 The Tools Menu".
Fn Quit	To exit the application.

Description of fields

Field	Option	Description
Point ID	Editable field	The point identifier of the point to be staked.
Station chainage	Editable field	The chainage of the instrument station.
Start chainage and Start distance	Editable field	Enter/measure a chainage/distance value where scanning starts along the alignment. This can be before or after the station chainage. If entering a distance value to indicate start scanning before the station chainage use a negative. If entering a distance value to indicate start scanning after the station chainage use positive.
End chainage and End distance	Editable field	Enter/measure a chainage/distance value where scanning ends along the alignment. This can be before or after the station chainage. If entering a distance value to indicate end scanning before the station chainage use a negative. If entering a distance value to indicate end scanning after the station chainage use positive.

Field	Option	Description
Before stn every	Editable field	If the scan area starts before the station chainage then define how often to scan a profile along the alignment from this chainage until the defined end chainage or station chainage (which ever comes first).
After stn every	Editable field	If the scan area ends after the station chainage then define how often to scan a profile along the alignment from the station chainage or start chainage (which ever has a greater chainage) until the defined end chainage/distance.

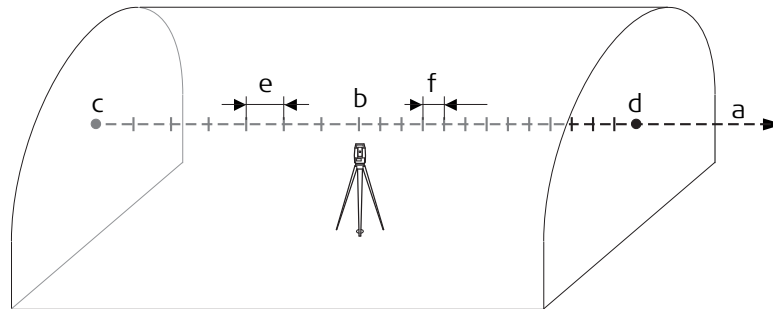

Tunnel_030

- a) Alignment
- b) **Station chainage**
- c) **Start chainage** or **Start distance**
- d) **End chainage** or **End distance**
- e) **Before stn every**
- f) **After stn every**

Next step

Page changes to the **Offsets** page.

Stake face/Stake profile/Check profile/Scan profile, Offsets page

Refer to "Stake face/Stake profile/Check profile, General page" for a description of keys.

Description of fields

Common for all methods

Field	Option	Description
Apply offsets	Check box	When this box is checked, horizontal and vertical offsets can be applied.  For Scan profile this does NOT offset or expand/shrink the design profile.

For Tunnel - Stakeout

Field	Option	Description
Input method		To define the position of the point to be staked out.
	Offset & height	The point is staked out with a known perpendicular and vertical offset from the horizontal and vertical alignments respectively.

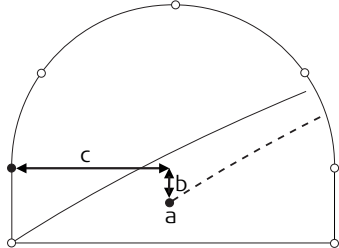
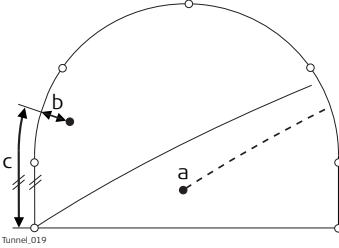
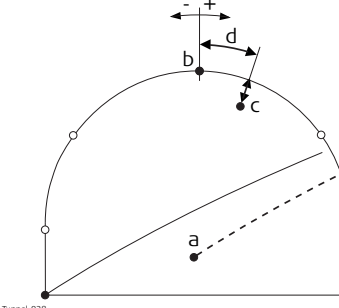
Field	Option	Description
	<p data-bbox="620 520 738 552">From job</p> <p data-bbox="620 657 798 720">Profile, dist & offset</p>	 <p data-bbox="863 401 911 415">Tunnel.018</p> <p data-bbox="863 422 1249 510"> a) Centreline b) Centreline height difference c) Centreline offset </p> <p data-bbox="863 520 1481 646">The offsets of the point are stored as coordinates in the Working job. The Stake offset is stored as the X coordinate and the Stake height diffis stored as the Y coordinate.</p> <p data-bbox="863 657 1481 756">The point is defined by the distance from the start of the profile and an offset perpendicular to the design profile.</p>
	<p data-bbox="620 1129 759 1192">Dist from top&offset</p>	 <p data-bbox="863 1010 911 1024">Tunnel.019</p> <p data-bbox="863 1031 1358 1119"> a) Centreline b) Profile offset c) Distance from start of design profile </p> <p data-bbox="863 1129 1481 1228">The point is defined by the distance from the top of the tunnel and an offset perpendicular to the design profile.</p>
	<p data-bbox="620 1707 836 1738">Element & offset</p>	 <p data-bbox="863 1556 911 1570">Tunnel.028</p> <p data-bbox="863 1577 1453 1696"> a) Centreline b) Top of profile c) Offset perpendicular to the profile segment d) Distance from the top of the profile </p> <p data-bbox="863 1707 1481 1934">The point to stake out is defined by:</p> <ol data-bbox="898 1738 1453 1934" style="list-style-type: none"> 1) The number of the element on which the point lies 2) The percentage of the distance along the element of the point to stake out 3) The offset perpendicular to the design profile.

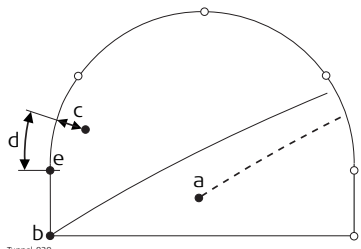
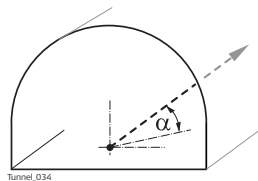
Field	Option	Description
		 <p>Tunnel_020</p> <p>a) Centreline b) Point defining start of design profile c) Offset perpendicular to profile segment d) Distance from start of start point of segment in % e) Start point of segment</p>
Stake offset	Editable field	Applies a horizontal offset perpendicular to the centreline. Available for Input method: Offset & height.
Stake height diff	Editable field	Applies a vertical offset to the centreline. Available for Input method: Offset & height.
Point ID	Selectable list	Available for Input method: From job.
Profile distance	Editable field	The distance from start of design profile. Available for Input method: Profile, dist & offset.
Top distance	Editable field	The distance from the top of the tunnel. Available for Input method: Dist from top&offset.
Profile offset	Editable field	The offset from the design profile. Available for Input method: Profile, dist & offset, Input method: Dist from top&offset and Input method: Element & offset.
Increment	Editable field	To increment the distance for offset definitions as distance and offset. Available for Input method: Profile, dist & offset and Input method: Dist from top&offset.
Element no.	Editable field	Element number 1 is the first element of the design profile.
% Element	Editable field	Distance in percentage terms of the measured point along the design profile element.
Check offset	Editable field	Available for Method to use: Check profile. Applies a horizontal offset perpendicular to the centreline used for comparing to the measured point.
Check height diff	Editable field	Available for Method to use: Check profile. Applies a vertical offset to the centreline used for comparing to the measured point.
Drill hz angle	Editable field	The horizontal direction 0 is along the centreline of the tunnel alignment.
		 <p>Tunnel_034</p>

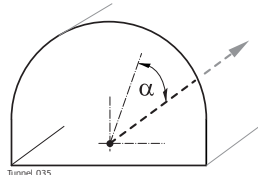
Field	Option	Description
		α Drill hz angle
Drill v angle	Editable field	The vertical direction 0 is along the centreline of the tunnel alignment.  α Drill v angle

For Tunnel - As built check

Field	Option	Description
Check offset	Editable field	Applies a horizontal offset perpendicular to the centreline used for comparing to the measured point.
Check height diff	Editable field	Applies a vertical offset to the centreline used for comparing to the measured point.

Next step

IF you work with	THEN Page changes to the
Tunnel - Stakeout	Stake page.
Tunnel - As built check	Info page.

Stake face/Stake profile, Stake page

 This page is available for Tunnel - Stakeout only.

This page displays the differences between the measured point and the defined point. The position of the point to stake is reached when all difference values are close to zero.

Refer to "Stake face/Stake profile/Check profile, General page" for a description of keys.

Refer to "53.4 Staking Out" for a description of the elements of the graphical display.

Description of fields

Field	Option	Description
Chainage	Display only	The current chainage.
CL O	Display only	Perpendicular horizontal offset from the centreline.
Δ chainage	Display only	Difference between the Stake chainage and the current chainage. If no defined chainage exists, for example if staking out random chainages or checking, this field shows -----.
Δ O	Display only	Horizontal offset between the defined position and the current position. The offset defined on the Offsets page is taken into account.

Field	Option	Description
Δ height	Display only	Vertical offset between the defined position and the current position. The height difference defined on the Offsets page is taken into account.

Next step

Page changes to the **Info** page.

Stake face/Stake profile/Check profile/Scan profile, Info page

The **Info** page displays the differences between the measured and design data. The fields viewed on this page are configurable. Refer to "Configuration, Info page" for information on all available items for the **Info** page and how to select them.

Stake face/Stake profile/Check profile/Scan profile, Map page

The **Map** page displays a plot of the measured point regarding the tunnel design. This screen is an example valid for **Method to use: Stake profile**.

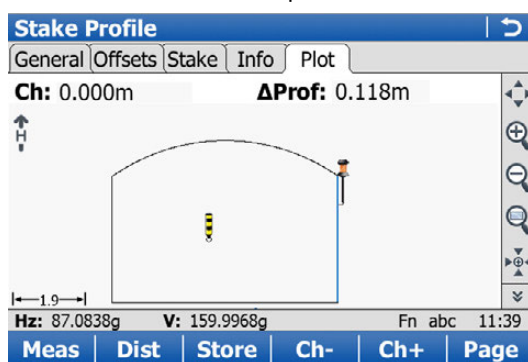

Key	Description
Ch-	Available for Tunnel - Stakeout . To decrease the chainage as defined by Chainge increment .
Ch+	Available for Tunnel - Stakeout . To increase the chainage as defined by Chainge increment .

49.3.2

Stake face

Stake face

Overview

When excavating a tunnel, it is required to stake out the tunnel portal before excavation can begin. In addition, for excavation methods other than those involving tunnel boring machines (TBMs), it is then required to stake out the tunnel face at given intervals during the excavation.

The tunnel face can be staked out at any time within the Tunnel application using **Stake face**.

This function allows the setting out of a series of points perpendicular to the horizontal alignment. The horizontal alignment indicates the position of the design profile at the chainage of the tunnel face.

Cross section view

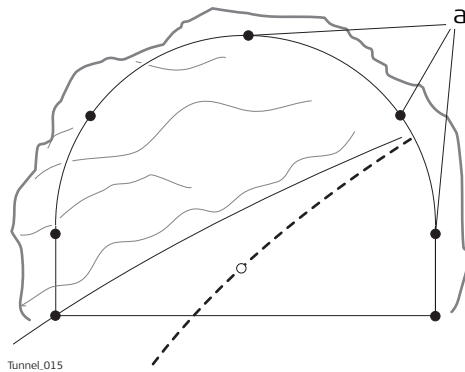

Tunnel_015

a) Points to stake out

Given that it is likely that a degree of rock debris is present at the tunnel face or that inexact excavation techniques such as blasting are used, it cannot be assumed that the tunnel face at any stage of the excavation is perpendicular to the horizontal alignment.

This situation in turn implies that we cannot stake out a point on the tunnel face at a given chainage as the chainage of the tunnel face at any particular point is unknown. Iterative techniques are necessary to enable any defined point on the tunnel face to be staked out accurately.

The **Stake face** function involves setting out a point on the tunnel face at this unknown chainage. First of all the point to stake out on the tunnel face is staked out at an approximate chainage (e).

The point is defined by offsets regarding the centreline or by its position along the design profile and its offset from the profile. Given that the excavated tunnel face does not intersect the defined chainage, another point (e') is measured.

First iteration

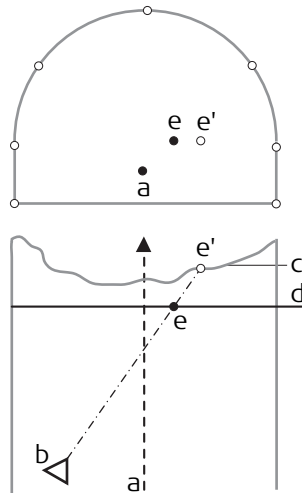

Tunnel_016

- a) Centreline
- b) Instrument position
- c) Tunnel face
- d) Approximate chainage to stake out
- e) Point to stake out at approximate chainage
- e') Point to stake out on tunnel face

The true chainage of the measured point of the first iteration (e') is then calculated. The defined point (e) is staked out at the calculated chainage (d).

Second iteration

This process is repeated until the differences between staked point and the defined point are within a tolerance set by the user.

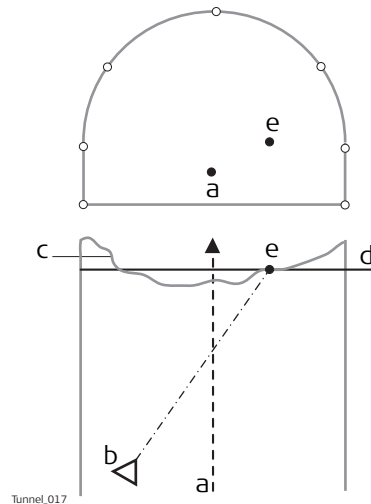

- a) Centreline
- b) Instrument position
- c) Tunnel face
- d) Calculated chainage from first iteration
- e) Point to stake out at calculated chainage

Tunnel_017

Drilling rig orientation

Description



This functionality helps to orientate the drilling rig when drilling holes parallel to the tunnel axis or using a drilling pattern, that is manual entry of drill direction.

Drilling rig orientation step-by-step with Drilling rig orientation: Parallel to alignment

Step	Description
1.	Make sure that Tunnel - Stakeout and Method to use: Stake face is selected.
2.	In Tunnel Configuration, Tunnel design page, set Drilling rig orientation: Parallel to alignment . Refer to "Configuration, Tunnel design page".
3.	In the Define screen check Drilling rig orientation and type in the values. Refer to "Defining the Work".
4.	If Drilling rig orientation: Parallel to alignment was selected in Tunnel Configuration, Tunnel design page and Check Jumbo position was checked in the Define screen, then proceed to define the drill entry position on the tunnel face by entering the respective centreline offset in Stake Face, Offsets page.
5.	In Stake Face, General page, enter the approximate tunnel face chainage. To position the laser pointer to the drill entry point press Fn Positn to find the point.
6.	Position the drill bit to the laser point on the tunnel face.
7.	Now the jumbo boom moves onto line between the laser point on wall and the telescope so that the laser now points at the back of the boom. Press Fn Tools... Select Check Jumbo position to get the delta angles which will be used by the drilling rig to move the boom parallel to the alignment. α Horizontal angle β Vertical angle

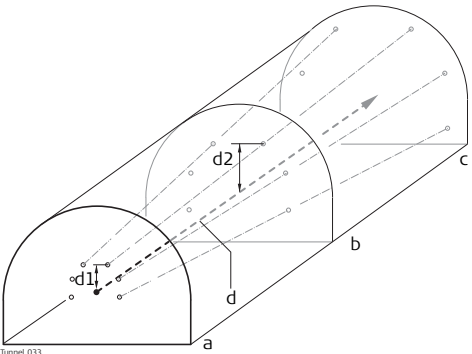

Drilling rig orientation step-by-step with Drilling rig orientation: Drill Pattern

Step	Description
1.	Make sure that Tunnel - Stakeout and Method to use: Stake face is selected.
2.	In Tunnel Configuration, Tunnel design page, set Drilling rig orientation: Drill Pattern . Refer to "Configuration, Tunnel design page".
3.	In the Define screen, check Drilling rig orientation and select the application of the drill pattern. Refer to "Defining the Work".
4.	If Apply drill pattern from: Defined Chainage was selected, then proceed to define the drill entry position for the measured chainage by entering the defined chainage centreline offsets in the Stake Face, Offsets page and the drill angles according to the defined chainage.
5.	In the Stake Face, General page, enter the defined chainage value in the Stake chainage editable field. To position the laser pointer correctly on the measured tunnel face press Fn Positn .  The delta chainage value after using Fn Positn is the difference between the defined and measured chainage. It is normal if this is large. The delta position and delta height values after this step should equal zero.
6.	Position the drill bit to the laser point on the tunnel face.
	<p>Example:</p>  <p>a Chainage 10 b Chainage 15 c Chainage 20 d Centreline d1 Stake height diff at defined chainage 10 d2 Stake height diff at defined chainage 15</p> <p> Stake face point 1 at chainage 10 (point1). Stake face point 1 at chainage 15 as defined at chainage 10. Position and direction at chainage 15 are a result of the Stake offset, Stake height diff and drilling angles as defined for chainage 10.</p>
7.	Now the jumbo boom moves onto line between the laser point on wall and the telescope so that the laser now points at the back of the boom. Press Fn Tools... Select Check Jumbo position to get the delta values which will be used by the drilling rig to move the boom for the correct drilling direction.

Stake/Check point on surface

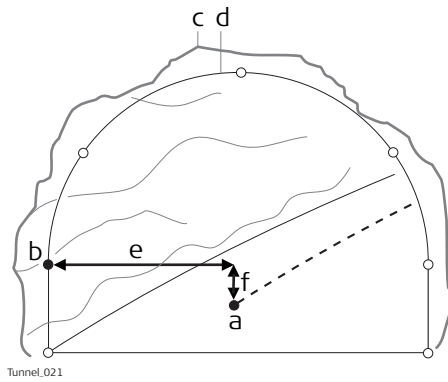

Tunnel_021

- a) Centreline
- b) Design point to stake out
- c) Excavated profile
- d) Design profile
- e) Centreline offset
- f) Centreline height difference

If it is not possible to stake out the defined point between successive iterations, the instrument will maintain the chainage and height difference from the vertical alignment fixed. The horizontal offset from the centreline to calculate the new position of the point are modified. The point that will be staked out will thus maintain the defined chainage and height difference but will have a modified offset value from the centreline.

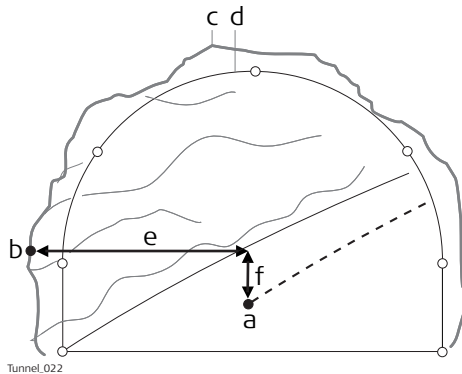

Tunnel_022

- a) Centreline
- b) Point to stake out on excavated profile
- c) Excavated profile
- d) Design profile
- e) Centreline offset
- f) Centreline height difference

Rotated profile

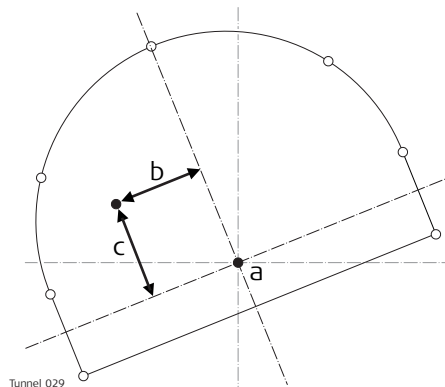

Tunnel_029

- a) Centreline
- b) Rotated centreline offset
- c) Rotated centre height difference

Overview

A tunnel surface is scanned in detail during construction and/or at the completion of construction to detect overbreak, underbreak and/or to create an 'as built plan' of the finished tunnel surface.

Scan profile allows measuring a user-defined number of tunnel profiles along an existing tunnel alignment.

It can be defined:

- Whether to scan the whole tunnel profile or just a segment of it.
- The interval between measurements around the profile.

It does not matter if a design profile exists in the job or not.



If the job does not contain a design profile, then before scanning the defined scan area the instrument will first scan a profile at the instrument chainage.



For a description of the **Scan profile, Scan area** page, refer to "49.3.1 Overview".

During a scan**During a scan**

- **Pt+:** To skip the point being measured and move onto the next profile point.
- **Prof+:** To stop scanning the current profile and move onto the next profile.
- **Temp:** To enter a temporary scan interval.

Pause and options before continuing

It is possible to end the scan once started using **Stop**. To pause the scan, for example to allow passing site traffic through, use **Pause**.

Once the scan has been paused, several options are available before continuing:

- **Stop:** To end the scan.
- **Resum:** To continue the scan at the next position.
- **Manual:** To interrupt the current scan so aiming can be done manually and points added.
- **Auto:** After measuring points manually, press **Auto** to continue scanning where you finished before pressing **Manual**.

Define Temp Scan Interval

By pausing the current scan and pressing **Temp**, a temporary scan interval can be entered. This results in all scan segments being scanned at the defined temporary scan interval until the **Define Temp Scan Interval** screen is re-entered and **Use a temporary scan interval** is unchecked.

Description of fields

Field	Option	Description
Use a temporary scan interval	Check box	If this box is checked, then scanning stops and any defined scan interval is ignored and replaced by the temporary scan interval.
Temporary scan interval	Editable field	How often a point is measured around a profile.

Invalid measurements

This process is repeated until the measured point is within the chainage limit or the maximum number of iterations has been reached.

Invalid measurement situations could occur, for example:

- in irregular tunnel surfaces, where the horizontal alignment is formed by a curve with a small radius.
- if the end distance or start distance defined in **Scan Profile**, **Scan area** page were too large.

Scan Segments

If **Define a scan task: Scan using segment** was selected in the **Define** screen, then the **Scan Segments** screen allows creating, editing or deleting scan segments.

Scan Segments		
Name	Scan	Interval
1	Yes	0.500m
2	No	0.500m

Hz: 165.9934g	V: 240.0003g	Fn abc	16:34	
OK	New..	Edit..	Delete	Scan

Key	Description
OK	To continue to Scan Profile after defining the scan segments.
New..	To create a new scan segment.
Edit..	To edit a defined scan segment.
Delete	To delete a defined scan segment.
Scan	To set Yes or No in the Scan column for the highlighted segment.
Fn Quit	To exit the application.

Description of columns

Column	Description
Name	Name of the scan segment.
Scan	Status to scan or not scan a segment.
Interval	How often a point is measured around the profile.

Next step

New.. to access **New Scan Segment**.

New Scan Segment

This screen allows the definition of one or multiple segment(s) of the scan profile as opposed to scanning the whole profile.

New Scan Segment | ↩

Segment name:

Start angle: 0.0001g

End angle:

Scan this segment

Scan interval: m

Hz: 0.0003g V: 74.9998g Fn abc 16:35

OK | **Dist** | **Positn** |

 When defining the scan segment, define the start and end angles in the station profile. The vertical circle values are used not the horizontal circle values so transit the telescope between face 1 and 2 as needed.

Key	Description
OK	To store the defined scan segment and return to Scan Segments .
Dist	To measure the distance to points at the starting angle and the end angle of a segment. When Start angle or End angle is highlighted, set the vertical circle values by aiming the telescope at the relevant point and press Dist .
Positn	To review the position of the segment once it has been defined. The instrument turns to the corresponding angle. Available when Start angle or End angle is highlighted.
Fn Quit	To exit the application.

Description of fields

Field	Option	Description
Segment name	Editable field	The name of the scan segment.
Start angle	Display only	The angle measured to the point at the beginning of the segment. Highlight this field, aim at the start of the segment and press Dist to see the angle value in this field.
End angle	Display only	The angle measured to the point at the end of the segment. Highlight this field, aim at the end of the segment and press Dist to see the angle value in this field.
Scan this segment	Check box	When this box is checked, the segment is scanned. When this box is not checked, the segment is not scanned.
Scan interval	Editable field	Defines how often a point is measured in this segment of the profile.

 If overlapping segments are defined, then a non scan segment has priority over a scan segment.

49.4

49.4.1

The Tools Menu

Profile Viewer

Availability

This menu function is available for the check method **Scan profile**. This menu option is always available. The data that can be viewed depends on those data available in the working job. It is independent of the currently measured **Scan Profile** points.



The measured profiles to be viewed must be saved in the working job.

Access

Press Fn **Tools..** on the **Scan Profile** page.

View at - Layer Name, Profiles page

View at 1.437 - LayerName		
Profiles	Points	Plot
Chainage	N° Points	Date
1.437	27	25.02.2010
1.937	26	25.02.2010
2.437	27	25.02.2010
2.737	28	25.02.2010
3.037	27	25.02.2010
3.337	28	25.02.2010
3.637	28	25.02.2010

Hz: 57°17'45" V: 143°59'51" Fn abc 10:43

OK	Delete	More	Page
----	--------	------	------

Key	Description
OK	To confirm the settings and return to the Scan Profile screen.
Delete	To delete the highlighted profile.
More	To display information about the time and the date of when the profile was stored.
Page	To change to another page on this screen.
Fn Quit	To exit the application.

Description of columns

Column	Description
Chainage	The chainage of the profile.
N° Points	The number of points in the profile.
Time and Date	The time and the date of when the profile was stored.

Next step

Page changes to the **Points** page. The points belonging to the profile which is highlighted on the **Profiles** page are displayed. Points can be deleted from the profile. **Page** changes to the **Map** page.

View at - Layer Name, Map page

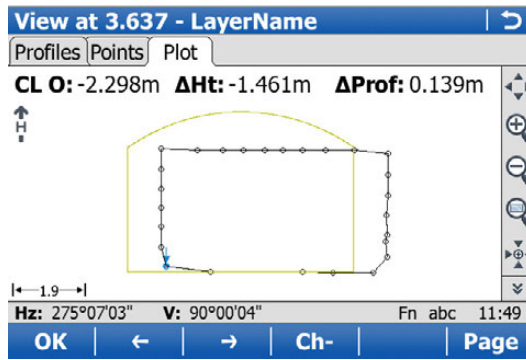

Key	Description
OK	To accept the settings and return to the Scan Profile screen.
<-- or -->	To select the relevant point in the plot. The information displayed shows the centreline offset, the delta height and delta profile of the point. Points can also be selected on the touch screen.
Ch- or Ch+	To decrease/increase the chainage.
Page	To change to another page on this screen.
Fn Config..	To access MapView configuration settings. Refer to "37.3 Configuring MapView".
Fn Positn	To position the total station to the defined point, including defined offsets.
Fn Quit	To exit the application.

49.4.2

Stake face auto

Description

To stakeout tunnel face points automatically. The surveyor configures and selects the points to use in the stakeout. The person driving the drilling machine can see the stakeout points looking to the current position of the laser.

Availability

This menu function is available for the stake method **Stake face**.
This menu option is available if the defined chainage has a valid value.
Measure mode: Continuous is supported.

Access

Step	Description
1.	Press Fn Tools.. in Stake Face .
2.	Select Stake Face Auto in Stake Face Toolbox .

Stake Face Auto, General page

Key	Description
OK	To access the Stake Face Auto screen.
Page	To change to another page on this screen.
Fn Quit	To exit the application.

Description of fields

Field	Option	Description
Store staked points	Check box	When this box is checked, the staked points are stored.
Wait time after staked point	Check box	When this box is checked, a time delay is active after staking a point and before staking the next point starts.
Delay	Editable field	The time delay after staking a point and before staking the next point starts. Available when Wait time after staked point is checked.
Verify orientation	Check box	When this box is checked, the system checks orientation automatically in a defined interval. If the orientation error is greater than the defined Hz tolerance , then the auto mode is stopped.
Orientation job	Selectable list	A point for the orientation check can be selected from a job on a data storage device. Available when Verify orientation is checked.
Orientation point	Selectable list	The point ID of the point for the orientation check. Available when Verify orientation is checked.
Hz tolerance	Editable field	Tolerance for horizontal directions. If the orientation error is greater than the defined angle, then the auto mode is stopped. Available when Verify orientation is checked.

Next step

Page changes to the **Points** page.

Stake Face Auto, Points page

Select the points to include in the stakeout.

Key	Description
OK	To access the Stake Face Auto screen.
Use	To set Yes or No in the Use column for excluding/including the highlighted point.  Any line can be selected on the Map page.
Page	To change to another page on this screen.
Fn Quit	To exit the application.

Description of columns

Column	Description
Point ID	Displays the name of all points in the selected Tunnel job .
Use	For Yes : The selected point is used for stake. For No : The selected point is not used for stake.
CL offset	The horizontal offset of the point from the layer centreline.
CL ht diff	The height difference of the point to the layer centreline.

Next step

Page changes to the **Map** page.

The **Map** page shows a cross section, profile and planar view of the design data at the selected chainage.

 Point selection/deselection is possible on the **Map** page.

IF	THEN
a single point is to be selected/deselected	tap on the point.
multiple points are to be selected	click the  icon, drag the stylus on the screen in a diagonal line to make a rectangular area.

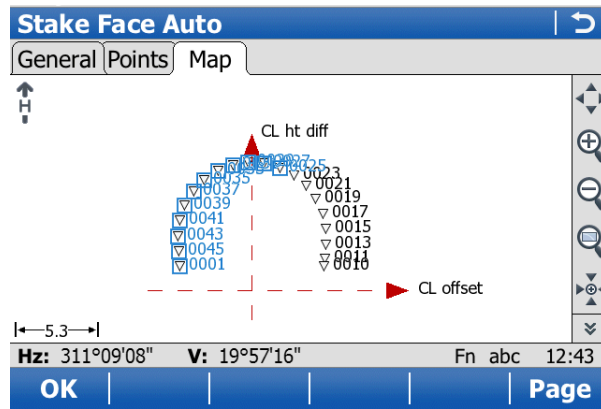

Stake Face Auto

When **Stake face auto** is activated, the measurement screen opens. In a loop, all selected points are automatically staked indefinitely until the user stops the measurement, or the orientation check is out of tolerance.

Key	Description
Stop	To stop the automatic stakeout.
Pause	To pause the automatic stakeout.
Resum	To re-start the automatic stakeout.
<--	To select the previous point.
-->	To select the next point.
Page	To change to another page on this screen.
Fn Config..	To access configuration settings. Refer to "45.3 Configuring Roads Applications".
Fn Quit	To exit the application.

50

Scanning

50.1

Accessing Scanning

Availability	Available for MS50 R2000 and on CS when connected to MS50 R2000.
Access	Select Main Menu: Go to Work!\Survey+\Scanning .
Scanning	Depending on the status of the job and actual instrument setup, the icons are active or not. If a new working job and a new setup have been created, then only Create scan definition and Scan settings are active.



50.2

Defining a Scan

Access	Select Create scan definition in Scanning . The New Scan Definition wizard starts.
Create Scan Definition	A unique name for the new scan definition. The name can be up to 16 characters long and include spaces. Input required. Next changes to the next screen.

Choose Scanning Method

Description of fields

Field	Option	Description
Method	Rectangular area	Select one of the following options to define a scan area. Area defined by upper left and lower right corner. Either turn the telescope manually. Or use the Turn to point option from the context menu. Refer to "37.6 Context Menu". If the first point is the top left corner, then the second point is then to the bottom right corner point. Or the first corner is the bottom left corner point and the second point is then the top right corner point.
	Polygonal area	Area defined by three or more corners in clockwise direction. Either point the telescope to the corners (actual position of the crosshair). Or draw the polygonal scan area on the Camera tab.  The closing line between the first and the last point has a different line style.
	Manually entered	To define a scan area manually by typing in the HZ and V value of two diagonal corners of a rectangle.  If scan definitions have already been defined from the current instrument setup, the scan areas are displayed on the Camera tab in Manually Entered Extents . A new scan area can be defined in addition to the existing scan areas.
	Full dome scan area	The scan area is the full field of view of the instrument.

Next step

Next changes to the next screen.

Camera view and Camera page

The scan area can be defined on the camera view/**Camera** page of the telescope camera and overview camera. Switching between both cameras is possible.





Description of keys

Key	Description
Next	Available when defining rectangular areas. To accept the selected point and to continue with the subsequent screen within the wizard. Available when defining a scan area manually. To accept the defined extension of the scan area and to continue with the subsequent screen within the wizard.
Add	Available when defining polygonal areas. To add the current crosshair position as a next point to the polygonal area.
Dist	To correct the paralaxe by taking a reflectorless distance measurement. The crosshair style changes from the coarse style to the fine style.
Done	Available when defining polygonal areas. To confirm the defined scan area and to proceed to the subsequent screen. At least three points must be defined.
Back	To return to the previous screen where the definition mode can be selected.
Fn Config..	To configure the camera view. Refer to "Camera View Settings, General page".
Fn Quit	To exit the screen.

Description of icons

If **Display TS camera zooming toolbar** is checked in **Camera View Settings, General** page, icons are available in a toolbar located on the right side of the screen. Refer to "Overview of keys, softkeys and icons" for the right toolbar icons.

The toolbar on the left side of the screen is always active.

Icon	Description
	To scroll the toolbar.
	Drawing mode is active. To add a point to the polygonal area tap the point on the display. Moving by joystick is active in the drawing mode.
	Tab and turn mode is active. To add a point to the polygonal area tab a point on the display. The instrument turns so that the digital crosshairs on the display point to the tapped point. Check the point and press Add .
	To delete the last selected point of the polygonal area.
	To delete the whole boundary of the polygonal area and to re-start the definition of the polygonal scan area.

Scan Resolution

The resolution has a direct influence on the file size.

Key	Description
Next	To accept changes and to continue with the subsequent screen within the wizard.
Dist	Available when Define spacing by: Distances is selected. To take a reflectorless distance measurement. The measured value is displayed in the Slope distance .
Back	To return to the previous screen.
Fn Quit	To exit the screen.

Description of fields

Field	Option	Description
Define spacing by	Angles	The scan resolution is defined by horizontal and vertical angle values.
	Distances	The scan resolution is defined by horizontal and vertical spacings at a certain range.
Hz and V	Editable field	Available for Define spacing by: Angles . The horizontal and vertical angle values defining the scan resolution.
Slope distance	Editable field	Available for Define spacing by: Distances . The range for which the horizontal and vertical spacing are valid.
Horizontal spacing and Vertical spacing	Editable field	Available for Define spacing by: Distances . The horizontal and vertical spacing defining the scan resolution at the defined range.
Estimated points	Display only	The estimated number of points to be scanned according to the defined scan resolution.

Next step

Next changes to the next screen.

Scan Mode

Key	Description
Next	To accept and record the scan mode.
Dist	To measure and display distances.
Back	To return to the previous screen.
Fn Quit	To exit the screen.

Description of fields

Field	Option	Description
Optimise scan for..	1000 pts/s, up to 300m	<ul style="list-style-type: none">• 1000 Hz scanning mode.• Range up to 300 m.• Optimal to use when time is critical.

Field	Option	Description
	250 pts/s, up to 400m	<ul style="list-style-type: none"> • 250 Hz scanning mode. • Range up to 400 m. • Optimal for use when time and accuracy are critical.
	62 pts/s, up to 500m	<ul style="list-style-type: none"> • 62 Hz scanning mode. • Range up to 500 m. • Optimal for use when accuracy and range are critical.
	Approx 1 pt/s, up to 1000m	<ul style="list-style-type: none"> • 1 Hz long range mode. • Range up to 1000 m. • Optimal for long range applications
Time required	Display only	The time that the measurement needed.
Average scan distance (optional)	Editable field	Slope distance to the scanning object. This distance is optional. By knowing the distance to the object, the system optimises the scanning speed.

Next step

Next changes to the next screen.

Scan Distance Filter

Key	Description
Finish	To exit the wizard.
Back	To return to the previous screen.
Fn Quit	To exit the screen.

Description of fields

Field	Option	Description
Use distance filter - only objects within the minimum & maximum distance will be scanned	Check box	When this box is checked, only objects within the defined distance range are scanned.
Min distance	Editable field	Minimum distance of the scan distance.
Max distance	Editable field	Maximum distance of the scan distance.

Next step

Finish to exit the wizard.

Access

Select **Scan settings** in **Scanning**.

Scan Settings

Key	Description
OK	To return to Scanning .
Fn Quit	To exit the screen.

Description of fields

Field	Option	Description
Store signal to noise ratio (SNR) values with scan points	Check box	When this box is checked, the value of the Signal to Noise Ratio of the returned signal is stored as additional information to the scan area.
Store scan area on panoramic image (if panoramic image is captured)	Check box	When this box is checked, the scan area is laid over the image and stored with the image when a panoramic image is captured.
Pause scanning when a message is shown	Check box	When this box is checked, a scan is paused when a message is shown.
Apply filter to optimise the point cloud	Check box	When this box is checked, the filter creates an optimum of the point cloud regarding data quality.

Access

Select **Start scan** in **Scanning**.

**Scan Status,
Progress page**

Key	Description
Start	To start scanning.
Stop	To end scanning. By stopping the scan, the already scanned points are stored in a file. The scan gets the status Scan completed .
Pause and Scan	To pause/re-start scanning.
Capture	Available as long as the scan has not yet started. To take an image with the current pixel resolution.
Page	To change to another page on this screen.
Fn Quit	To exit the screen.

Description of fields

Field	Option	Description
Scan name	Display only	Then name of the first or current scan.
Points scanned	Display only	The total number of scanned points.
% completed	Display only	In percent, the number of scans taken against the total number of scans which must be taken.
Time remaining	Display only	Estimated time remaining until the scan is finished.
Scans completed	Display only	Number of scans being measured / Number of total scans

Description

Sets of Angles:

- This application is used to measure multiple sets of directions and distances (optional) to pre-defined target points in one or two faces. The application can include Monitoring as an option.
- The mean direction and mean distance (optional) to each target point, within a set is calculated. The residual for each direction and distance (optional) within a set is also calculated.
- The reduced average direction and average distance (optional) to each target point, for all active sets is calculated.
- Coordinates to each target point are calculated using the reduced average direction and average distance (optional).

Monitoring:

- This module can be integrated within the Sets of Angles program.
- With this module, it is possible to use a timer to enable repeated and automated angle and distances measurements to pre-defined target points at defined intervals.

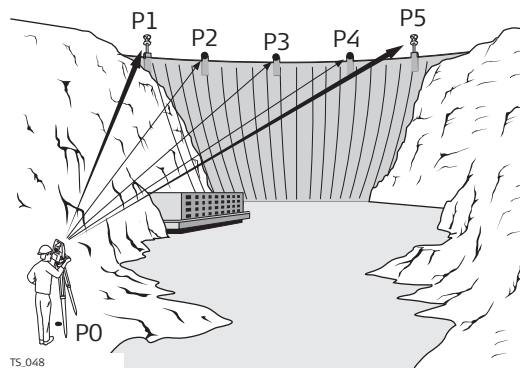

If the message panel appears which requires that the application must be activated via a license key then refer to "30.3 Load licence keys".

Diagram**Known:**

- P1 Pre-defined target point - E,N,Height (optional)
- P2 Pre-defined target point - E,N,Height (optional)
- P3 Pre-defined target point - E,N,Height (optional)
- P4 Pre-defined target point - E,N,Height (optional)
- P5 Pre-defined target point - E,N,Height (optional)

Unknown:

- a) Mean direction and mean distance (optional) to each target point, within a set
- b) Mean coordinates (optional) for each target point, for all active sets
- c) Residual for each direction and distance (optional), within a set
- d) Reduced average direction and average distance (optional) to each target point, for all active sets

Automatic aiming

Automatic aiming (search and measurements) can be performed to a prism. After completing the first measurements to each target point, the measurements to the target points in subsequent sets are automated.

Station setup and station orientation

If oriented grid coordinates are to be recorded, a station set up and station orientation is required before starting the Sets of Angles application.

Point averaging

Sets of Angles points are never calculated as an average, even if a measured point of class **Meas** already exists with the same point ID.

51.2

Sets of Angles

51.2.1

Accessing Sets of Angles

Access

Select **Main Menu: Go to Work!\Survey+\Sets of angles.**

Sets of Angles

Sets of Angles | ↩

One or more point groups already exist in this job.

What do you want to do?

- Create a new group**
- Select an existing group**

Hz: 180°00'00" V: 270°00'00" Fn abc 10:47

OK | | | | |

Key	Description
OK	To select the highlighted option and to continue with the next screen.
Fn Config..	To configure the Sets of Angles application. Refer to "51.2.2 Configuring Sets of Angles".
Fn Quit	To exit the application.

Description of options

Options	Description
Create a new group	To define the target points. Refer to "51.2.3 Creating New Point Groups".
Select an existing group	To select, edit and manage a points group of the target points for the survey. Refer to "51.2.4 Managing Existing Point Groups".

Access

Select **Main Menu: Go to Work!\Survey+\Sets of angles**. Press Fn **Config...**

Configuration, Parameters page

The explanations for the softkeys given here are valid for all pages, unless otherwise stated.

Key	Description
OK	To accept changes and return to the screen from where this screen was accessed.
Config..	To edit the survey screen page currently being displayed. Available when a list item in Page to show is highlighted. Refer to "25.3 My Survey Screen".
Page	To change to another page on this screen.
Fn About	To display information about the program name, the version number, the date of the version, the copyright and the article number.
Fn Quit	To exit the application.

Description of fields

Field	Option	Description
Page to show	Selectable list	The names of the available survey screen pages.
Stop for messages	All messages To exceeded only Never stop	<p>To define what action is taken when a message screen appears during a measurement set.</p> <p>All messages All message screens are displayed as per normal and are closed as defined by the settings in Time out.</p> <p>To exceeded only Only the message screen relating to the exceeding of tolerances is displayed and is closed as defined by the settings in Time out.</p> <p>Never stop No message screens are displayed except for specific warnings. Specific warnings which affect the instrument and its ability to continue with the monitoring process will be displayed and will remain on the screen. These warnings include the overheating of the instrument, low battery levels, or unavailable space on the data storage device.</p>

Field	Option	Description
Time out	No time out	To define the time delay for the automatic closing of message screens during a measurement set. This selectable list is not available when Stop for messages: Never stop . There is no automatic closure, only by user interaction in a message screen. When a message screen appears, press Yes to close.
	1 sec to 60 sec	All message screens are automatically closed as defined by these individual time settings.
Re-measure points	Never	To define the action if a target point cannot be measured. The target point is skipped and the next target point in the list is measured.
	Automatically	The measurement to the target point is repeated automatically.  The option for Measure mode in Measure & Target Settings is also changed for the repeated measurement. If the option is changed, then it is applied to all following sets.
	Manually	The measurement to the target point can be repeated manually or the target point can be skipped.
Sort points by Hz angle	Check box	Check this box to sort the target points automatically. The instrument will work in a clockwise direction and find the shortest path to move between the target points.
Define time when sets should be measured (timer monitoring)	Check box	This field is only available when Monitoring is registered through the licence key. When this box is checked, automatic monitoring of target points is activated. When this box is not checked, automatic monitoring of target points is not activated. The Sets of Angles application will apply.

Next step

Page changes to the **Tolerances** page.

Configuration, Tolerances page

Description of fields

Field	Option	Description
Use tolerances	Check box	If checked, the entered horizontal, vertical and distance tolerances are checked during the measurements to verify accurate pointing and measurements.
Hz tolerance	Editable field	Tolerance for horizontal directions.
V tolerance	Editable field	Tolerance for vertical directions
Distance tolerance	Editable field	Tolerance for distances.

Next step

Page changes to the **Defaults** page.

Configuration, Defaults page

Define the default target properties for points that are added to the point group by importing.

Description of fields

Field	Option	Description
Target height	Editable field	The default prism height.
Target	Selectable list	Target names as configured in the Targets screen.
Leica constant	Display only	The additive constant as stored for the selected prism in the SmartWorx Viva software.
Target aiming	Manual Automatic Lock	Measurements are done without any automation. ATR search and/or ATR measurement are not performed. Positioning to static prisms. The ATR sensor is used for measurements to static prisms. If needed an ATR measurement or ATR search is performed after pressing Meas or Dist . Availability depends on instrument type. The instrument locks onto and follows the moving prism.
Visibility	Good Rain & fog Rain & fog always Sun & reflections Sun & rflctns always	If weather conditions are normal, then select this mode. To increase the instrument measuring ability during suboptimal weather conditions. This mode is automatically deactivated when the instrument is turned off. As for Rain & fog , however this mode stays active when the instrument is turned off. To increase the instrument measuring ability during incident solar radiation and reflections, for example safety vests. This mode has a considerable influence on the range. This mode is automatically deactivated when the instrument is turned off. As for Sun & reflections , however this mode stays active when the instrument is turned off.
Use precise target aiming	Check box	Available for the 0.5" instruments of TS50/TM50. When this check box is checked, ATR measurements with higher accuracy are performed.
Use ultra fine aiming	Check box	Reduces the field of view of the ATR. The setting is only applied for Target aiming: Automatic in Measure & Target Settings .
Automatically survey points	Check box	Check this box to survey the target points automatically. The instrument will automatically turn and measure the target point. For instruments with automatic aiming.

Next step

Page changes to the **Report sheet** page.

**Configuration,
Report sheet page**
Description of fields

Field	Option	Description
Create report sheet	Check box	To generate a report sheet when the application is exited. A report sheet is a file to which data from an application is written to. It is generated using the selected format file.
Report sheet	Selectable list	Available when Create report sheet is ticked. The name of the file to which the data will be written. A report sheet is stored in the \DATA directory of the active memory device. The data is always appended to the file. Opening the selectable list accesses the Report Sheets screen. On this screen, a name for a new report sheet can be created and an existing report sheet can be selected or deleted.
Format file to use	Selectable list	Available when Create report sheet is ticked. A format file defines which and how data is written to a report sheet. Format files are created using LGO. A format file must first be transferred from the data storage device to the internal memory before it can be selected. Refer to "30.1 Transfer user objects" for information on how to transfer a format file. Opening the selectable list accesses the Format Files screen where an existing format file can be selected or deleted.

Next step

Page changes to the first page on this screen.

51.2.3

Creating New Point Groups

Description

The points to be used for Sets of Angles can be selected and the first set measured. The measurement settings of the first measurement to each point are used for all further sets.

Access

Highlight **Create a new group** in **Sets of Angles** and **OK**.

New Point Group

New Point Group | ↩

Enter a name for the new point group.

Point group name:

Hz: 0°00'00" V: 90°00'01" Fn abc 10:30

Store | | | | |

Key	Description
Store	To store the new points group.
Fn Config..	To configure the Sets of Angles application.
Fn Quit	To exit the application.

Description of fields

Field	Option	Description
Point group name	Editable field	The name of the points group.

Add Points To Group

Key	Description
OK	To select the checked option and to continue with the next screen.
Fn Quit	To exit the application.

Description of options

Option	Description
Measure points	When this box is checked, the points to be used for Sets of Angles can be measured.
Use for sets	Available when Measure points is checked. To select the measuring sequence.
Add individual points from a job	When this box is checked, a control job can be selected. Individual points can be selected from this job. Refer to "Select Points - Survey, Sets page".
Add all points from a job	When this box is checked, a control job can be selected. All points from the control job are added to the point group by pressing OK .

Select Points to be Added, Points page



The points are sorted in alphabetical order. To sort points by horizontal angle, check **Sort points by Hz angle** in **Configuration Parameters**, page.

Select Points to be Added		
Points	Map	
Point ID	Date	Select
TPS0001	16.01.2013	Yes
TPS0002	16.01.2013	No
TPS0003	16.01.2013	Yes

Hz: 0°00'00"	V: 90°00'01"	Fn abc	13:45
OK		Select	More Page

Key	Description
OK	To store the points to the group.
Select	To change the setting in the Select column for the highlighted point.
More	To display information about the 3D coordinate quality, the class, Easting, Northing and Elevation, the time and the date of when the point was stored,
Page	To change to another page on this screen.

Key	Description
Fn All or Fn None	To change the setting in the Select column for all scans at once.
Fn Quit	To exit the application.

Next step

Page changes to the **Plot** page. The points from the list are displayed in black. The other points from the working job are displayed in grey.

Define Points for Set

Key	Description
OK	To measure the entered point and to access Select Points - Survey .
Done	To finish selection of points and access Sets of Angles for further steps.
Fn Config..	To configure the Sets of Angles application.
Fn Get Pt	To select points stored in the database.
Fn IndivID and Fn Run	To change between entering an individual point ID different to the defined ID template and the running point ID according to the ID template. Refer to "25.1 ID templates".
Fn Quit	To exit the application.

Description of fields

Field	Option	Description
Use ultra fine aiming	Check box	Reduces the field of view of the ATR. The setting is only applied for Target aiming: Automatic in Measure & Target Settings .
Automatically survey points	Check box	Available for instruments with automatic aiming and Target aiming: Automatic . If checked, search and measurements are done to specified targets in additional sets.

Next step

IF	THEN
new or selected points are to be measured	OK to access Select Points - Survey .

IF	THEN
existing points are to be selected	Fn Get Pt to select a point from Data, Points page.
all desired points have been selected and measured	Done to return to the Manage Point Group .

Select Points - Survey, Sets page

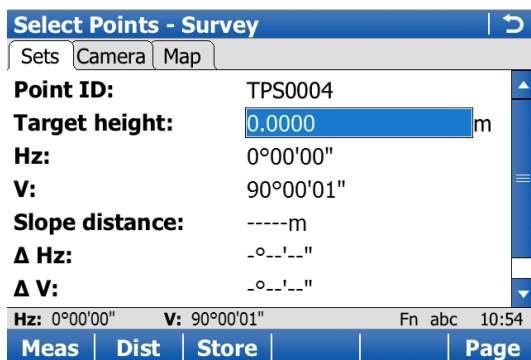

Key	Description
Meas	To measure and store the angles and distance, and to return to Define Points for Set .
Dist	To measure a distance.
Store	To store data and to return to Define Points for Set .
Page	To change to another page on this screen.
Fn Quit	To exit the application.

Description of fields

Field	Option	Description
Δ Hz	Display only	Difference between the current horizontal angle and the horizontal angle to this target when selected.
Δ AR	Display only	Available when Hz angle display: Angle right is configured in Regional Settings, Angle page. Difference between the current angle right and the angle right to this target when selected.
Δ V	Display only	Difference between the current vertical angle and the vertical angle to this target when selected.
Δ slope	Display only	Difference between the current slope distance to the target and the slope distance to this target when selected.

Next step

Meas to measure and store the angles and distance, and to return to **Define Points for Set**.

Description

A point group of the target points for the survey can be selected.

Access

Highlight **Select an existing group** in **Sets of Angles** and **OK**.

Existing Point Groups

Key	Description
OK	To continue with the next screen.
Fn Config..	To configure the Sets of Angles application. Refer to "51.2.2 Configuring Sets of Angles".
Fn Quit	To exit the application.

Description of fields

Field	Option	Description
Point Groups	Selectable list	The name of the points group.
No. of points	Display only	The number of points in the group.
Creation date	Display only	The date of when the point group was created.
Creation time	Display only	The time of when the point group was created.

Next step

OK to access **Point Groups**.

Point Groups

Point Groups	
Group	No. points
130116-GasStrt_6	3
130116-GasStrt_5	0
130116-GasStrt_4	0
130116-GasStrt_3	0
130116-GasStrt_2	0
130116-GasStrt_1	0
130116-GasStrt02	0



Hz: 0°00'00" V: 90°00'00" Fn abc 16:00

OK	New..	Edit..	Delete	More
-----------	--------------	---------------	---------------	-------------

Key	Description
OK	To continue with the next screen.
New..	To create a new point group.
Edit..	To edit the highlighted point group.
Delete	To delete an existing points group.
More	To display additional information.
Fn Quit	To exit the application.

Edit Point Group, Points page

Key	Description
OK	To store the points to the group.
+ Pts	To add points to the group.
Prop..	To view or change the settings for a point.

Key	Description
	<p> Prev to display the previous point of the point group. Available unless the beginning of the list is reached.</p> <p> Next to display the next point in the list of points. Available unless the end of the list is reached.</p>
More	To display information about the date, the 3D coordinate quality, the point code, the target height and fine aiming.
Page	To change to another page on this screen.
Fn - One	To remove all points from the group.
Fn - All	To remove the highlighted point from the group. The point itself is not deleted.
Fn Quit	To exit the application.

51.2.5

Measuring the Sets

Description

The points defined in the point group are measured with the defined measurement method and for the defined number of sets.

Access

Highlight **Measure Sets** in **Sets of Angles** and **OK**.

Measure Sets

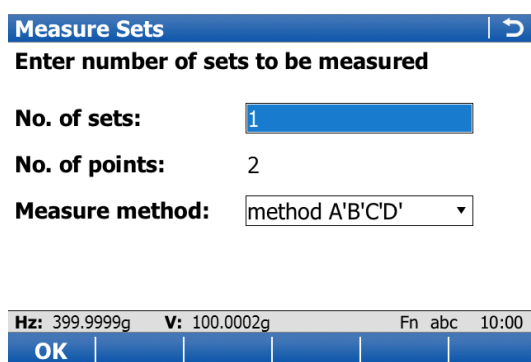

Key	Description
OK	Opens a screen to measure the points. When auto survey is activated, measurements are done automatically.
Fn Config..	To configure the Sets of Angles application. Refer to "51.2.2 Configuring Sets of Angles".
Fn Quit	To exit the application.

Description of fields

Field	Option	Description
No. of sets	Editable field	The number of sets to measure with the target points. The maximum of sets allowed is 200.
No. of points	Display only	The number of target points.
Measure method	A'A"B"B'	Determines the order in which the target points are to be measured. The target points are measured in face I and face II. point A I - point A II - point B II - point B I ...

Field	Option	Description
	A'A"B'B"	The target points are measured in face I and face II. point A I - point A II - point B I - point B II ...
	A'B'A"B"	The target points are measured in face I and face II. point A I - point B I... point A II - point B II ...
	A'B'B"A"	The target points are measured in face I and face II. point A I - point B I... point B II - point A II...
	A'B'C'D'	The target points are only measured in face I. point A I - point B I - point C I - point D I ...

Next step

OK to measure further sets of the defined points.

Set n of n, Pt n of n, Sets page

Set 1 of 1, Pt 2 of 2	
Sets	Camera Map
Point ID:	TPS0003
Target height:	0.0000m
Hz:	6.4087g
V:	299.9910g
Slope distance:	----m
Δ Hz:	-0.0003g
Δ V:	-0.0001g
Hz: 6.4087g V: 299.9910g Fn abc 10:19	
Meas	Dist Store Skip Pause Page

Key	Description
Meas	To measure and store the angles and distances, and to increment to the next point.
Dist	To measure a distance.
Store	To store data and to increment to the next point.
Skip	To skip measuring the displayed point and continue with the next point.
Pause or Resume	To pause/re-start the set measurement.
Page	To change to another page on this screen.
Fn Done	To end the sets of angles measurements and to return to Sets of Angles .
Fn Quit	To exit the application.

Description of fields

Field	Option	Description
Δ Hz	Display only	Difference between the current horizontal angle and the horizontal angle to this target when selected.
Δ V	Display only	Difference between the current vertical angle and the vertical angle to this target when selected.

Field	Option	Description
Δ slope	Display only	Difference between the current slope distance to the target and the slope distance to this target when selected.
Target aiming	Manual	Measurements are done without any automation. ATR search and/or ATR measurement are not performed.
	Automatic	Positioning to static prisms. The ATR sensor is used for measurements to static prisms. If needed an ATR measurement or ATR search is performed after pressing Meas or Dist .
	Lock	Availability depends on instrument type. The instrument locks onto and follows the moving prism.
Visibility	Good	If weather conditions are normal, then select this mode.
	Rain & fog	To increase the instrument measuring ability during suboptimal weather conditions. This mode is automatically deactivated when the instrument is turned off.
	Rain & fog always	As for Rain & fog , however this mode stays active when the instrument is turned off.
	Sun & reflections	To increase the instrument measuring ability during incident solar radiation and reflections, for example safety vests. This mode has a considerable influence on the range (restriction 100 - 150 m). This mode is automatically deactivated when the instrument is turned off.
	Sun & rflctns always	As for Sun & reflections , however this mode stays active when the instrument is turned off.
Use precise target aiming	Check box	Available for the 0.5" instruments of TS50/TM50. When this box is checked, four ATR measurements are performed and the mean value out the measurements is considered for the angle value.
Use ultra fine aiming	Check box	Reduces the field of view of the ATR. The setting is only applied for Target aiming: Automatic in Measure & Target Settings .

Next step

Meas to measure further sets of the selected points.



- Motorised instruments point automatically in the direction of the targets.
- Instruments with automatic aiming and auto survey activated, measure the targets automatically.

Measurement Summary

This screen is displayed automatically at the end of the sets measurement.

Key	Description
OK	To continue with the next screen.
Fn Quit	To exit the application.

Description of columns

Column	Description
Point	This column is always visible. Points of the point group in the same order as in the point group.
Compl meas	How many times the point was successfully measured. Example: 4/6 - The point was measured four times, six sets were measured.
In tolerance	How many times the tolerance configured was met. Example: 4/6 - The point falls within the defined tolerance four times, six sets were measured.
Compl sets	How many sets are completed. The value is the same for all points. Example: 4/6 - The point was measured in a complete set four times, six sets were measured.

After measuring sets

Depending on points skipped or not, select how to continue.

Key	Description
OK	To select the highlighted option and to continue with the next screen.
Fn Quit	To exit the application.

Description of options

Options	Description
Always available:	
Measure more sets	To measure additional sets.
Available for sets incomplete:	
Re-measure incomplete sets	To re-measure the skipped points in the face that was skipped. To fill in the missing measurements in the sets.
Remove incomplete points	To calculate results. The skipped points are discarded. Only points measured in all sets are used for the calculation.
Remove incomplete sets	To calculate results. The sets that contain skipped points are discarded. Only the complete sets are used for the calculation.
Available for sets complete:	
View and manage results	Available when no points are skipped. Refer to "51.2.6 Managing Results".
Compute points from results	Available when no points are skipped. To compute points from set results.
Exit Sets of Angles	To end the Sets of Angles program.

Description

For two and more sets measured with angles and distances in two faces, calculations for angles and distances can be done.

For sets measured in one face, the standard deviation and average values can be viewed.

If only one set or point is measured, only some of the values are displayed.

Manage Results

if points measured with method **A'B'C'D'**, the points results are limited and only standard deviation and average values are shown.

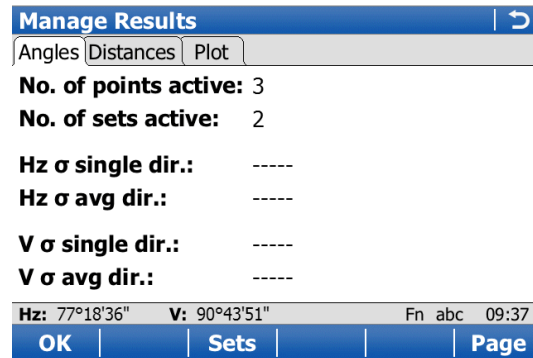

Key	Description
OK	To return to the previous screen.
sets	To view angle/distance results.
Use	To activate/deactivate sets.
Page	To change to another page on this screen.
Fn Quit	To exit the application.

Description of fields

Field	Option	Description
No. of points active	Display only	Number of active points which are set to Yes in the Use column in the Sets of Angles screen. Refer to "Residuals in Set n".
No. of sets active	Display only	Number of active sets which are set to Yes in the Use column in the Angle Results/Distance Results screen. Refer to "Angle Results/Distance Results".
Hz σ single dir.	Display only	Standard deviation of the single horizontal direction.
Hz σ avg dir.	Display only	Standard deviation of the average horizontal direction.
V σ single dir.	Display only	Standard deviation of a single vertical direction.
V σ avg dir.	Display only	Standard deviation of the average vertical direction.
σ single distance	Display only	Standard deviation of a single distance.
σ avg distance	Display only	Standard deviation of the average distance.

Next step

sets accesses the **Angle Results/Distance Results** screen.

Angle Results/Distance Results

Set	Hz Σr Residl	V Σr Residl	Use
1	0°00'00"	0°00'00"	Yes
2	0°00'00"	0°00'00"	Yes

Hz: 77°18'37"	V: 90°43'51"	Fn abc	09:54
OK	Points..	Use	

Key	Description
OK	To return to the previous screen.
Points..	To access Residuals in Set n .
Use	To set Yes or No in the Use column for the highlighted set.
Fn Quit	To exit the application.

Description of columns

Column	Description
Set	Displays the number of the sets.
Hz Σr Residl	Shows the calculated absolute sum of residuals in Hz of the selected set. The sum of residuals is the sum of the difference between the reduced average direction and each sets directions. For sets not used in the calculation, ----- is shown.
V Σr Residl	Shows the calculated absolute sum of residuals in V of the selected set. The sum of residuals is the sum of the difference between the average vertical angles and each sets vertical angles. For sets not used in the calculation, ----- is shown.
Max Residl SD	Shows the calculated maximum residuals in slope distance of the selected set. The sum of residuals is the sum of the difference between the average distance and each sets distance. For sets not used in the calculation, ----- is shown.
Use	For Yes : The selected set is used for calculations. For No : The selected set is not used for calculations.

Next step

Points.. to access **Residuals in Set n**.

Residuals in Set n

Residuals in Set 1			
Point ID	SD Residual	Avg SD	Use
TPS0001	0.0000m	88.5290m	Yes
TPS0002	0.0000m	88.5290m	Yes
TPS0003	0.0000m	88.5290m	Yes

Hz: 77°18'36"	V: 90°43'50"	Fn abc	10:21
OK		Use	More

Key	Description
OK	To return to the previous screen.
Use	To set Yes or No in the Use column for the highlighted point.
More	To view additional information.
Fn Quit	To exit the application.

Description of columns

Column	Description
Point	This column is always visible. Point ID of the measured points in the order they were defined and measured.
Hz Residual	Residual in the Hz value of the selected point within the single set.
V Residual	Residual in the V value of the selected point within the single set.
Avg Hz	Reduced Average Hz value of the point in all active sets.
Avg V	Average V value of the point in all active sets.
Mean Hz	Mean Hz value of the point within the single set.
Mean V	Mean V value of the point within the single set.
SD Residual	Residual in the distance value of the point within the single set.
Avg SD	Average distance value of the point in all active sets.
Mean SD	Mean distance value of the point within the single set.
Use	For Yes : The selected point is used for calculations in all sets. For No : The selected point is not used for calculations in any set.

Compute Points, General page

Key	Description
Store	To store the results and continue with the next screen.
Page	To change to another page on this screen. The functionality and softkeys available on the Plot page are described in the MapView chapter. Refer to "37.4.1 Screen Area" for information functionality.
Fn Quit	To exit the application.

Description of fields

Field	Option	Description
No. of points active	Display only	The number of selected points having been measured.
No. of sets active	Display only	The number of sets having been measured.
Store Point ID with	Prefix	Adds the setting for Prefix/suffix in front of the original point IDs.
	Suffix	Adds the setting for Prefix/suffix at the end of the original point IDs.
Prefix/suffix	Editable field	The identifier with up to four characters is added in front of or at the end of the ID of the calculated points.
Use a point as reference	Check box	When this box is checked, the point selected is considered fixed: known coordinates and therefore Δ Easting and Δ Northing are made equal to zero. The values shown on the Points page are updated accordingly.

Compute Points, Points page

Key	Description
Store	To store the calculated points which are set to Yes in the Accept column.
Accept	To set Yes or No in the Accept column for the highlighted point.
Fn Quit	To exit the application.

Description of columns

Column	Description
Point	Point ID of the measured points in the order they were defined and measured.
Δ Easting	The difference in Easting between the original and the calculated points.
Δ Northing	The difference in Northing between the original and the calculated points.
Accept	For Yes : The selected point is used for calculations in all sets. For No : The selected point is not used for calculations in any set.

Description

Monitoring is a module integrated within the Sets of Angles application. Monitoring uses a timer to enable repeated and automated angle and distances measurements to pre-defined target points at defined intervals. The ability to configure the handling of message screens during measurement sets is also enabled.

Important aspects

For monitoring, instruments must be motorised.



Monitoring is licence protected and is only activated through a licence key. The licence key can be entered manually or loaded from the data storage device.

Monitoring preparation

This step-by-step description is an example on preparing a set for monitoring.

Step	Description
1.	Select the control and the working job.
2.	Set station coordinates and station orientation.
3.	Select Main Menu: Go to Work!\Survey+\Sets of angles.
4.	In Sets of Angles press Fn Config.. to configure Sets of Angles for monitoring. For the Parameters page set: <ul style="list-style-type: none"> • Page to show: None (for example purposes only). • Stop for messages: All messages (for example purposes only). • Time out: 10 secs (for example purposes only). • Define time when sets should be measured (timer monitoring) (this option must be selected for monitoring). This setting will enable access to the Define Monitoring Timer screen.
5.	Press OK to access the Sets of Angles screen.
6.	Select Create a new group.
7.	Press OK to access the Define Points for Set screen.
8.	Enter details of the target point as required. For each target point, ensure that auto survey is activated. This setting will enable the automated measurement and recording of the target point in the other face. The setting also enables the automated measurement and recording of all target points during monitoring.
9.	Press OK to access the Select Points - Survey screen.
10.	Measure and record the measurement to the target point as required.
11.	Continue with steps 8. to 10. until all target points for the first measurement set have been measured and recorded.
12.	Press Done to complete the selection of the target points for the first measurement set in one face. This action then begins the measurement of the target points in the other face. On completion, the Sets of Angles screen will be accessed.
13.	Select Measure Sets.
14.	Press OK to access the Define Monitoring Timer screen.

Define Monitoring Timer

Description of fields

Field	Option	Description
Begin date	Editable field	Start date for monitoring.
Begin time	Editable field	Start time for monitoring.
End date	Editable field	End date for monitoring.
End time	Editable field	End time for monitoring.
Interval	Editable field	The time between the start of each scheduled measurement set.
Measure method	A'A"B"B' A'A"B"B" A'B'A"B" A'B'B"A" A'B'C'D'	Determines the order in which the target points are to be measured. The target points are measured in face I and face II. point A I - point A II - point B II - point B I ... The target points are measured in face I and face II. point A I - point A II - point B I - point B II ... The target points are measured in face I and face II. point A I - point B I... point A II - point B II ... The target points are measured in face I and face II. point A I - point B I... point B II - point A II... The target points are only measured in face I. point A I - point B I - point C I - point D I ...

Next step

When all required information is entered press **OK** to begin the monitoring process. A screen displays a notice that monitoring is in progress. If necessary, press **Cancel** to stop the monitoring process and return to **Sets of angles menu**.

Refer to "51.2 Sets of Angles" for information about calculations and the viewing of results.

Monitoring interval

Description

The dates and times entered define the timeframe for when the monitoring will take place.

The time interval defines the time between the start of each measurement set during the monitoring period. The interval time begins at the start of a measurement set and ends at the start of the next measurement set.

Example

Data;

- 3 target points
- Begin Date: 03.11.2010
- End Date: 06.11.2010
- Interval: 30 min
- 4 measure sets
- Begin Time: 14:00:00
- End Time: 14:00:00

Results;

- The time taken to measure 4 sets of 3 target points in both faces is 10 minutes.
- The measurements will start at 14:00:00 on 03.11.2010.
- At 14:10:00, the first measurement set is complete.
- The instrument will wait until 14:30:00 for the next scheduled measurement set.

Description

The Setup application is only available for use with TPS instruments. Setup determines the station coordinates and the instrument orientation using TPS measurements and/or GPS measurements.

Setup with GPS using SmartPole	Setup with GPS using SmartStation
SmartPole allows target points to be determined using GPS measurements. The new points are then used as control points for the TPS setup.	SmartStation allows TPS station coordinates (position and height) to be determined from GPS measurements.

Setup methods

Setup Method	"Standard" setup type	"On-the-Fly" setup type	Methods for TPS	Methods for SmartPole	Methods for SmartStation
Set orientation	✓	-	✓	-	✓
Known backsight	✓	-	✓	✓	✓
Multiple backsights	✓	✓	✓	✓	✓
Transfer height	✓	-	✓	✓	-
Resection	✓	✓	✓	✓	-
Orientate to line	✓	-	✓	-	✓

- Each setup method requires different input data and a different number of target points.
- All setup methods are described in "52.7 Setup Methods".

Setup types

"Standard" setup	"On-the-Fly" setup
This type of setup is the traditional type. The user must always measure all setup points consecutively to complete the setup. The TPS station coordinates and TPS orientation must be set before measuring survey points.	This setup type allows the user to move between setup and survey before completing the setup (working "on the fly"). When leaving setup the TPS station coordinates and orientation do not have to be final, they can be set at anytime during the survey. This setup can only be used when measuring survey points. When staking out points, the TPS station coordinates and TPS orientation must be set first.

Incomplete setups

- For a "Standard" setup, the user must always measure all setup points consecutively to complete the setup. This type of setup is always regarded as a complete setup.
- For "On-the-Fly" setups, the setup points can be measured together with the survey points. It is not necessary to complete the setup before measuring survey points. Until the user selects **Set** in **Station Results**, this type of setup is regarded as incomplete.

An incomplete setup, or a setup where more targets can be added, can be accessed in the following ways:

1. In the Survey application, Setup can be accessed by selecting the **Setup** softkey.
2. When entering any panel where it is possible to do a measurement, a message is displayed to notify that the setup is incomplete. It is then possible to:
 - a) continue with the existing application, or **OK**
 - b) start Setup and create a new station setup, or **New..**
 - c) start Setup and continue to measure additional fixpoints. **Setup**
3. Assigning the function **TPS - Continue open setup** to the favourites or a hot key.

52.2

Accessing Setup

Access

Select **Main Menu: Go to Work!\Setup**.

Total Station Setup

An illustration and a description is shown for each Setup method.

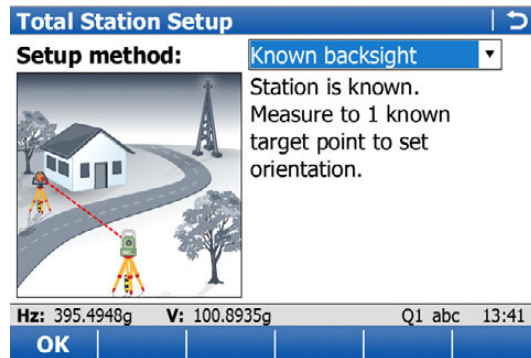

Key	Description
OK	To accept changes and access the subsequent screen. The chosen settings become active. Refer to "52.4 Set Station Point" or "52.5 Enter Station Information".
Fn Config..	To configure the Setup application. Refer to "52.3 Configuring Setup".
Fn Quit	To exit the wizard.

52.3

Configuring Setup

Access

Press Fn **Config..** in **Total Station Setup**.

Configuration, General page

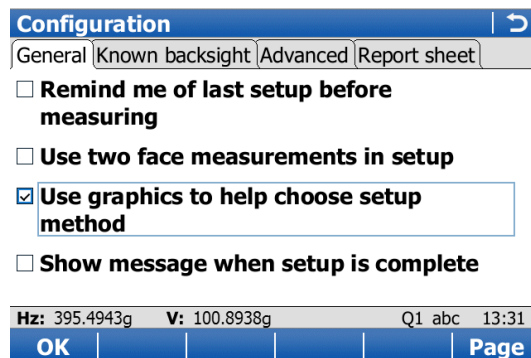

Key	Description
OK	To accept changes and return to the screen from where this screen was accessed.
Page	To change to another page on this screen.
Fn About	To display information about the application name, the version number, the date of the version, the copyright and the article number.
Fn Quit	To exit the screen.

Description of fields

Field	Option	Description
Remind me of last setup before measuring	Check box	Current instrument setup details can be displayed to remind the user to either keep the current instrument setup, check the backsight, or create a new setup. Refer to "52.6 Setup Reminder" for details.
Use two face measurements in setup	Check box	Defines if the instrument measures the second face automatically after storing the first. When this box is checked, after storing a measurement with All or Store motorised instruments change face automatically, non-motorised instruments access Telescope Positioning . The measurements of face I and face II are averaged. The averaged value is stored. When this box is not checked, no automatic measurement in two faces.  When using two face measurements, then the angle right value is averaged between both two face measurements.
Use graphics to help choose setup method	Check box	When this box is checked, the setup methods are displayed in a screen accompanied by a graphic and text describing each setup method. When this box is not checked, the setup methods are selected from the drop-down menu in Go to Work! .
Show message when setup is complete	Check box	When this box is checked, a message informs when the setup is finished.

Next step

Page changes to the **Known backsight** page.

**Configuration,
Known backsight
page**

For **Setup method: Known backsight**, the settings on this page apply.

Description of fields

Field	Option	Description
Check backsight position	Check box	Allows a check to be made on the horizontal coordinate difference between the existing and the measured known backsight point. If the defined Position limit is exceeded, the setup can be repeated, skipped or stored.
Position limit	Editable field	Available when Check backsight position is checked. Sets the maximum horizontal coordinate difference accepted in the position check.
Check backsight height	Check box	Allows a check to be made on the vertical difference between the existing and the measured known backsight point. If the Height limit is exceeded, the setup can be repeated, skipped or stored.
Height limit	Editable field	Available when Check backsight height is checked. Sets the maximum vertical difference accepted in the height check.

Next step

Page changes to the **Advanced** page.

**Configuration,
Advanced page**

For **Setup method: Resection** and **Setup method: Multiple backsights**, the settings on this page apply.

Description of fields

Field	Option	Description
Auto position to setup targets	Check box	When this box is checked, the instrument positions horizontally and vertically to the point.
Calculate scale from target observations	Check box	Only available if the job properties do not have Compute scale using set to Stn & coord system . If checked, a station scale will be calculated from the target observations. The user will have the option to apply this new scale (calculated ppm + current ppm = new ppm) to all survey observations, including the setup observations, from that setup. If not checked, then the calculated ppm will not be displayed and therefore not applied to any survey observations.
Use Helmert method for resection	Check box	Helmert calculation is used.
Height weighting	1/distance or 1/distance²	Available when Use Helmert method for resection is checked. To change the distance weighting that is used in the calculation of the station height in the resection.

Field	Option	Description
Edit default station quality checks	Check box	Check to type in values for standard deviation, position and height accuracy. If the limits are exceeded, a message will be shown when Calc is selected.
Orientation limit	Editable field	Available when Edit default station quality checks is checked. Define a limit for the standard deviation of the orientation.
Position limit	Editable field	Available when Edit default station quality checks is checked. Define a position accuracy of the target point.
Height limit	Editable field	Available when Edit default station quality checks is checked. Define a height accuracy of the target point.

Next step

Page changes to the **Report sheet** page.

Configuration, Report sheet page

Description of fields

Field	Option	Description
Create report sheet	Check box	To generate a report sheet when the application is exited. A report sheet is a file to which data from an application is written to. It is generated using the selected format file.
Report sheet	Selectable list	Available when Create report sheet is ticked. The name of the file to which the data will be written. A report sheet is stored in the \DATA directory of the active memory device. The data is always appended to the file. Opening the selectable list accesses the Report Sheets screen. On this screen, a name for a new report sheet can be created and an existing report sheet can be selected or deleted.
Format file to use	Selectable list	Available when Create report sheet is ticked. A format file defines which and how data is written to a report sheet. Format files are created using LGO. A format file must first be transferred from the data storage device to the internal memory before it can be selected. Refer to "30.1 Transfer user objects" for information on how to transfer a format file. Opening the selectable list accesses the Format Files screen where an existing format file can be selected or deleted.

Next step

Page changes to the first page on this screen.

Access

A station point must be selected for **Setup method: Set orientation**, **Setup method: Known backsight**, **Setup method: Multiple backsights** and **Setup method: Transfer height**. **Set Station Point** is then accessed automatically from **Setup**.

Set Station Point

Set Station Point | ↻

Station point from: GPS - SmartStation ▾

Instrument height: 1.580 m



Hz: 300.0003g V: 100.0002g Q1 abc 10:11

OK | Scale.. | Atmos..

Key	Description
OK	To accept changes and return to the screen from where this screen was accessed.
Scale..	To type in values for the scale corrections. Refer to "New Job, Scale page".
Atmos..	To type in values for the atmospheric corrections. Refer to "Atmospheric Corrections, Atmospheric ppm page".
Fn Quit	To exit the screen.

Description of fields

Field	Option	Description
Instrument height	Editable field	The height of the instrument.
Station point from	<p>Job</p> <p>Enter new point</p> <p>GPS - Smart-Station</p>	<p>The selection made here determines the availability of the other fields on this screen.</p> <p>A station point can be selected from a job on a data storage device.</p> <p>Pressing OK opens a screen where a new point can be typed in. After pressing Store there, the Setup application continues.</p> <p>Available when TPS and GPS are used. Pressing OK opens the GPS Survey application. After measuring a point with Meas, Stop, Store there, the Setup application continues. Refer to "56.1.2 Real-Time Rover Operations".</p> <p> In order to use GPS, a coordinate system for the setup is required and must be attached to the working job. If not, then a coordinate system must be selected, or local coordinates for the station must be typed in, during the setup process.</p>

Field	Option	Description
		 To obtain the correct elevation of the setup point, measure the instrument height as usual and ensure the antenna type is set to the relevant SmartStation antenna.  If SmartPole is used in the setup or later in Survey, remember to update the antenna type after finishing the SmartStation measurement.
	Last used station	The station used last in the Setup application is displayed.
Job	Selectable list	The job from which the station is to be selected. Refer to "5.4 Choosing a Job".
Point ID	Display only	The point ID of the station point.
Easting, Northing and Elevation	Display only	The coordinates of the station point.
Current scale	Display only	The scale according to the scale settings for the selected station.



Refer to "14 Antenna Heights" for further information regarding height values used in a SmartStation.

52.5

Enter Station Information

Access

Station information must be typed in for **Setup method: Resection** and **Setup method: Orientate to line**. **Enter Station Information** is accessed after selecting **OK** in **Total Station Setup** with one of these setup methods selected.

Enter Station Information

For a description of keys refer to "52.4 Set Station Point".

Description of fields

Field	Option	Description
Station ID	Editable field	Type in an ID for the station point.
Point code	Selectable list	Select a point code for the station point if desired.
Instrument height	Editable field	The height of the instrument.
Use control job for the target points	Check box	Target points can be selected from the control job.
Job	Selectable list	The control job from which the target points can be selected. Refer to "5.4 Choosing a Job".
Current scale	Display only	The scale according to the scale settings for the selected station.



Refer to "14 Antenna Heights" for further information regarding height values used in a SmartStation.

Description

When activated, the setup reminder appears whenever the user enters a measurement screen. The reminder allows the user to check the current station setup details before proceeding with the survey. When this reminder appears, three options are available to the user:

- 1) To keep the current station setup and proceed with the survey.
- 2) To check the backsight point.
- 3) To create a new station setup.

Current Setup Details

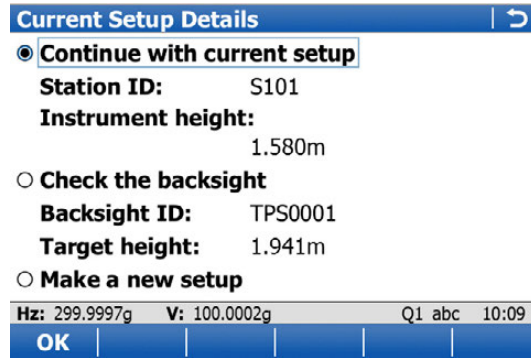

Key	Description
OK	To accept the selection.
Fn Quit	To exit the screen.

Description of fields

Field	Description
Continue with current setup	The last setup is used and recorded in the working job.
Check the backsight	To open the Check Point screen. The point suggested is the point which Setup uses as the reference orientation. For the setup methods Set orientation and Known backsight , the orientation target point is suggested. For the setup methods Multiple backsights , Transfer height , Resection and Orientate to line , the first target is suggested.
Make a new setup	To start the Setup application and create a new station setup.

52.7
52.7.1

Setup Methods
Set orientation and Known backsight

Requirements

The position coordinates of the station point are required.
 For **Set orientation**: The instrument is set up and oriented to either a known or unknown target point, to which a true or assumed azimuth is set.
 For **Known backsight**: The instrument is set up and oriented to a known backsight target.
 For SmartStation, the position coordinates of the station are unknown and are determined with GPS. The instrument is set and oriented to either a known or unknown target point, to which a true or assumed azimuth is set.

Updating Hz measurements

A station setup using the **Set orientation** method, is always automatically flagged with an 'update later' attribute. If the backsight point is measured again, for example from another station, and found to have different coordinates, then a message will appear. The user can then select whether to update the original setup or not. The update will use the backsight point coordinates to recalculate the orientation and subsequently update all measured points connected to the setup.



For information on camera and images refer to "33.3.3 Within Applications".

Access

In **Total Station Setup**, select **Setup method: Set orientation** or **Known backsight**. Press **OK**.
 In **Set Station Point**, select a station. Press **OK**.

Set Station Orientation, Orientation page

Key	Description
Set	To set the station and orientation and exit the Setup application.
Dist	To measure a distance to the point being used to set the azimuth. For Set orientation : A distance measurement is NOT required when setting the Station and the Orientation with Set .
GPS	For Known backsight applicable when using SmartPole. To enter the GPS Survey screen and measure a point with GPS. The antenna height is automatically converted from the target height.
Store	To store the measurement with or without a distance. Only available when Use two face measurements in setup is selected in the Setup configuration.
More	To change between the slope and the horizontal distance.
Page	To change to another page on this screen.
Fn Run / Individ	Available for Setup method: Set orientation only. Run automatically chooses the next available point ID from the list of points already stored. Individ allows the user to type in any value for Backsight ID .

Key	Description
Fn Quit	To exit the screen.

Description of fields

Field	Option	Description
Backsight ID	Editable field Selectable list	Point ID of the backsight point. For Set orientation . For Known backsight . Select a point from the points stored in the control job.
Target height	Editable field	Height of the target above or below the backsight point. The last setup target height is always remembered.
Direction	Editable field	Available for Set orientation . The direction is set to 0 by default. This value can be edited. The value is not set to the system until Set is pressed.
Slope distance	Display only	Available for Set orientation . The slope distance measured between the station point and the backsight point.
Horiz distance	Display only	Available for Set orientation . Press Dist to measure a distance to the target point being used to set the azimuth.
Height difference	Display only	Available for Set orientation . The vertical distance between the station point and the backsight point.
Computed direction	Display only	Available for Known backsight . Displays the calculated azimuth from the selected station to the backsight point.
Computed hz dist	Display only	Available for Known backsight . Displays the calculated horizontal distance between the selected station and backsight point.
Computed slp dist	Display only	Available for Known backsight . Displayed after More was pressed. The calculated slope distance to the backsight point.
Δ hz dist	Display only	Available for Known backsight . The difference between the calculated horizontal distance from station to backsight point and the measured horizontal distance.
Δ slope dist	Display only	Available for Known backsight . Displayed after More was pressed. The difference between the calculated slope distance from station to backsight point and the measured slope distance.
Δheight	Display only	Available for Known backsight . The difference between the control height of the backsight point and the measured height of the backsight point. If the backsight point is a 2D point, this field shows ---.
Angle right	Display only	Available when Hz angle display: Angle right is configured in Regional Settings, Angle page. Displays the horizontal angle difference between the backsight point and the current telescope position.

Next step

Page changes to the **Backsight** page.

Set Station Orientation, Backsight page

Set Station Orientation | ↻

Orientation | Backsight | Station | Plot

Backsight ID: TPS0001
Point code: SV
Description: -----

Hz: 300.0000g V: 99.9998g Q1 abc 10:16

Set | +Attrib | Last | Default | Page

Key	Description
Set	To set the station and orientation and exit the Setup application.
+Attrib	To create additional attributes for this point code.
Name or Value	Available for attributes for which an attribute name can be typed in. To highlight the field of the attribute name or the field for the attribute value. The name of the attribute can be edited and an attribute value can be typed in.
Last	To recall the last used attribute values for the selected code.
Default	To recall the default attribute values for the selected code.
Page	To change to another page on this screen.
Fn Quit	To exit the screen.

Description of fields

Field	Option	Description
Backsight ID	Editable field or display only	Point ID of the backsight point.
Point code	Selectable list	The code for the backsight point.
Description	Display only	A short description of the code.

Next step

Page changes to the **Station** page.

Set Station Orientation, Station page

Set Station Orientation | ↻

Orientation | Backsight | Station | Plot

Station ID: S101
Instrument height: 1.580 m
Point code: S
Current scale: 1.000000000000

Hz: 299.9996g V: 99.9997g Q1 abc 10:16

Set | Dist | ppm | Page

Key	Description
Set	To set the station and orientation and exit the Setup application.
Dist	To measure a distance to the point being used to set the azimuth. A distance measurement is NOT required when setting the Station and the Orientation with Set .
SF / Ppm	To switch between displaying the current scale as a scale factor or ppm value.
Page	To change to another page on this screen.
Fn Quit	To exit the screen.

Description of fields

Field	Option	Description
Station ID	Display only	Station ID as selected in Set Station Point .
Instrument height	Editable field	The instrument height.
Point code	Selectable list	The code for the backsight point.
Current PPM / Current scale	Display only	The current job scale. Refer to " New Job, Scale page" for more information on scale corrections.

Next step

Page changes to the **Plot** page.

52.7.2

Multiple backsights

Requirements

The position coordinates of the station point are required. The instrument is set up and oriented to one or more known backsight targets.
 For SmartStation, the position coordinates of the station are unknown and are determined with GPS. The instrument is set up and oriented to one or more known backsight targets.
 For TPS and SmartStation, the orientation is determined by sighting to one or more known target points (maximum of ten target points). Only angles or both angles and distances can be measured. The height of the station point can also be derived from the target points.



For information on camera and images refer to "33.3.3 Within Applications".

Access

In **Total Station Setup**, select **Setup method: Multiple backsights**. Press **OK**.
 In **Set Station Point**, select a station. Press **OK**.

Measure Target

Unless otherwise stated the following screen and description applies to the setup methods: **Multiple backsights**, **Transfer height**, **Resection**, and **Orientate to line**.

Measure Target 1	
Point ID:	TPS0001
Target height:	1.941 m
H_z angle:	300.0001g
V angle:	99.9999g
Slope distance:	10.000m
Δ azimuth:	----g
Δ h_z dist:	----m
Δ height:	----m
H_z: 300.0001g	V: 100.0001g
Q1 abc 10:19	
Meas	Dist Store GPS

Key	Description
Meas	To measure and store the distances and angles made to the control points. After storing the measurement data, the next point ID in the job is displayed. The instrument positions to the point if enough data is available.
Dist	To measure and display distances.
Store	Records displayed values temporarily. The target measurements will not be stored to the current job until the station is set. A distance measurement is not necessary before pressing Store . After recording the measurement data, the next point ID in the job is displayed. The instrument positions to the point if enough data is available and the instrument is robotic.
GPS	Applicable when using SmartPole. To enter the GPS Survey screen and measure a point with GPS. The antenna height is automatically converted from the target height.
Done	For Resection only. To temporarily exit the Setup application. The station setup will be incomplete but can be continued and completed at a later time. This softkey is replaced by Calc when sufficient data is available.
Calc	For Multiple backsights : Available after the first measurement. Allows the user to see the calculated station orientation and other results. For Resection : Available after measuring two target points or as soon as a preliminary station and orientation can be calculated. The calculated station coordinates and overall "quality" of the results are displayed.
Fn Find	Stakeout values are provided to guide the prism holder to the selected target point. For Resection : Available once sufficient data is available for calculation. Refer to "52.9 Finding a Target Point".
Fn Positn	To position the instrument to the selected target point. For Resection : Available once sufficient data is available for calculation.
Fn Quit	To exit the screen.

Description of fields

Field	Option	Description
Point ID	Selectable list	The point ID of the target point to be measured.
Target height	Editable field	The height of the target above or below the backsight point. The last setup target height is always remembered.
Hz angle	Display only	The current horizontal angle.
Angle right	Display only	Available when Hz angle display: Angle right is configured in Regional Settings, Angle page. Displays the horizontal angle difference between the backsight point and the current telescope position.
V angle	Display only	The current vertical angle.
Slope distance	Display only	The measured slope distance after Dist was pressed.

Field	Option	Description
Δ azimuth	Display only	Displays the difference between the calculated azimuth and the current horizontal angle. If Setup method: Resection , displays ----- until sufficient data for calculation is available.
Δ hz dist	Display only	The difference between the calculated and the measured horizontal distance.
Δ height	Display only	The difference between the given and the measured height of the target point.



A maximum of ten target points can be measured and used for the calculation. When the maximum number of points is exceeded, a message will appear. The user can remove previous points or finish the setup. Points can be removed from the **Station Results, Targets** page.

52.7.3

Transfer height

Requirements

This method is used to compute a station height to apply to the selected station. Only the height is updated, the orientation is not updated. The position coordinates of the station point are required.

Access

In **Total Station Setup**, select **Setup method: Transfer height**. Press **OK**.
In **Set Station Point**, select a station. Press **OK**.



For a description of the **Measure Target** screen, refer to "52.7.2 Multiple backsights".

52.7.4

Resection

Requirements

The coordinates of the station point are unknown. The coordinates and orientation are determined by sighting to at least two or more known target points (maximum of ten target points). Only angles or both angles and distances can be measured. For a resection, least squares or robust calculations are used. The resection calculations can be done using the Helmert method, robust method or least squares method, after three measurements to known backsights have been completed.

Access

In **Total Station Setup**, select **Setup method: Resection**. Press **OK**.
In **Enter Station Information**, type in the required information. Press **OK**.



For a description of the **Measure Target** screen, refer to "52.7.2 Multiple backsights".

Description

This method can be used to calculate the 2D or 3D local coordinates for the instrument station and the orientation of the horizontal circle. The calculation is done using the distance and angle measurements to two target points.
 The first target point always defines the origin of the local coordinate system. The second target point, in conjunction with the first target point, always defines the local direction of North or East (depending on the working style).

Requirements

- Important features:
- All coordinates calculated are local coordinates.
 - The first target point always defines the origin of the local coordinate system (North=0, East=0, Height=0 (optional))
 - The second target point, in conjunction with the first target point, always defines the local direction of North or East.

Access

In **Total Station Setup**, select **Setup method: Orientate to line**. Press **OK**.
 In **Enter Station Information** type in the required information. Press **OK**.

Define Station Ht & Axis

Define Station Ht & Axis | ↻

Use station height : User entered ▾

Station height: 1.580 m

Axis defined between target 1 & 2:
 North axis ▾

Hz: 300.0003g V: 100.0000g Q1 abc 10:20

OK

Key	Description
OK	To accept all settings and continue. The chosen settings are activated and the next screen, Measure Target , is displayed.
Fn Quit	To exit the screen.

Description of fields

Field	Option	Description
Use station height	User entered	The height value of the station will be entered by the user and used to calculate the height of the measured points.
	Transfer from trgt 1	The height of the station will be calculated relative to the first measured point.
Station height	Editable field	Available for Use station height: User entered . The elevation of the instrument station.
Target 1 height	Editable field	Available for Use station height: User entered . The height of the first measured point.
Axis defined between target 1 & 2		To define the positive North or positive East axis.

Field	Option	Description
	North axis	The second point measured defines the direction of the positive North axis.
	East axis	The second point measured defines the direction of the positive East axis.



For a description of the **Measure Target** screen, refer to "52.7.2 Multiple backsights".

52.8

Setup Results

Description

The results screen is displayed after pressing **Calc** in the **Measure Target** screen. The results screen is part of the **Multiple backsights**, **Transfer height**, **Resection** and **Orientate to line** setup methods.

Excluding **Orientate to line**, after three measurements to known targets, the calculations can be done using the robust method or the least squares method. For **Resection**, the calculations can also be done using the Helmert method. After the station is set, all following measurements will be related to this new station and orientation.



For information on camera and images refer to "33.3.3 Within Applications".

Station Results, Results page

Station Results	
Results	Station Quality Targets Plot
Easting:	-99.000m
Northing:	90.050m
Elevation:	10.361m
New orientation:	193.6234g
<input checked="" type="checkbox"/>	Apply the computed elevation for this station
Hz: 100.0000g V: 100.0000g Q1 abc 10:25	
Set	LSqrs Trgt+ Page

Key	Description
Set	To set the orientation, to store all setup data and exit the application. For Transfer height : To store all setup data and exit the application.
Done	To exit the setup without setting it, the setup is incomplete.
Robust or LSqrs	To display the results for the robust or the least squares calculation method.
Trgt+	To access Measure Target and to measure more target points.
Page	To change to another page on this screen.
Fn 3 par or Fn 4 par	Switches between a 3 parameter and 4 parameter calculation. For 3 parameter, the current scale is not applied to setup observations for a new station calculation. For 4 parameter, the current scale is applied. The station coordinates will be automatically updated according to the setting used. Defaults to 4 parameter.
SF or ppm	To display the scale results by scale factor or as a ppm value.
Fn Quit	To exit the screen.

Description of fields

Field	Option	Description
New orientation	Display only	New oriented azimuth with running angle as telescope moves. Not available for setup method Transfer height .
Angle right	Display only	Available when H_z angle display: Angle right is configured in Regional Settings, Angle page. Displays the horizontal angle difference between the backsight point and the current telescope position.
Δheight	Display only	The difference between the new calculated height and the old height. Available for setup methods Multiple backsights and Transfer height .
Use the new height	Check box	For setup method Multiple backsights : When this box is checked, both orientation and height are updated. If not checked, only the orientation is updated. For setup method Transfer height : When this box is checked, the station height is updated. If not checked, the station height does not change. Not available for any other setup methods.
New height	Display only	The calculated height is displayed. Available for setup methods Multiple backsights and Transfer height .
Old height	Display only	The original height is displayed. Available for setup methods Multiple backsights and Transfer height .
σ height	Display only	Standard deviation of the calculated station height. Available for setup methods Transfer height .
Easting	Display only	The calculated Easting is displayed. Available for setup methods Resection and Orientate to line .
Northing	Display only	The calculated Northing is displayed. Available for setup methods Resection and Orientate to line .
Elevation	Display only	The calculated Height is displayed. Available for setup methods Resection and Orientate to line .
Apply the computed elevation for this station	Check box	When this box is checked, then the height from the solution is set as the station height. When this box is not checked, then the height is not updated. Available for setup method Resection .

Next step

Page changes to the **Station** page.

Station Results, Station page

Station Results	
Results	Station
Quality	Targets
Plot	
Station ID:	S102
Instrument height:	1.580 m
Point code:	S
Current scale:	1.000000000000

Hz: 99.9996g	V: 99.9999g	Q1 abc	10:25
Set	Scale..	ppm	Page

Key	Description
Set	To set the orientation, to store all setup data and exit the application. For Transfer height : To store all setup data and exit the application.
Done	To exit the setup without setting it, the setup is incomplete.
Scale..	To type in values for the scale corrections. Refer to "New Job, Scale page".
Page	To change to another page on this screen.
Fn 3 par or Fn 4 par	Switches between a 3 parameter and 4 parameter calculation. For 3 parameter, the current scale is not applied to setup observations for a new station calculation. For 4 parameter, the current scale is applied. The station coordinates will be automatically updated according to the setting used. Defaults to 4 parameter.
Fn Quit	To exit the screen.

Description of fields

Field	Option	Description
Station ID	Display only	Station ID of the current station set up.
Instrument height	Editable field	The current instrument height.
Point code	Selectable list	Select a point code for the station point if desired.
Current PPM / Current scale	Display only	The current job scale. Refer to "New Job, Scale page" for more information on scale corrections.

Next step

Page changes to the **Quality** page.

Station Results, Quality page

For a description of the softkeys refer to "Station Results, Station page".
This page is not available for setup methods **Transfer height** or **Orientate to line**.

Description of fields

Field	Option	Description
New orientation	Display only	New oriented azimuth with running angle as telescope moves. Available for setup method Multiple backsights .
σ new orientation	Display only	Standard deviation of the calculated orientation.

Field	Option	Description
Δheight	Display only	Delta height, the difference between original and calculated height. Available for setup method Multiple backsights .
σ height	Display only	Standard deviation of the calculated station height.
σ easting	Display only	Standard deviation of the calculated station Easting. Available for setup method Resection .
σ northing	Display only	Standard deviation of the calculated station Northing. Available for setup method Resection .

Next step

Page changes to the **Targets** page.

Station Results, Targets page

This screen displays information about the accuracy of the measured target points and allows exclusion of measurements that are not to be used in the calculation. Additional measurements can be made and measurements can be deleted. This page is not available for setup method **Orientate to line**.

Station Results			
!	Point ID	Use	Δ Hz g
	TPS0003	3D	-0.0000
	TPS0002	3D	0.0002
	TPS0001	3D	0.0000

Hz: 100.0000g	V: 99.9999g	Q1 abc	10:29
Set	Use	Remov	More Page

Key	Description
Set	To recalculate the station data and update all values after target points have been deleted or excluded from the calculation.
Use	To change between using the selected point as 3D, 2D, 1D or not at all, in the calculation. The change automatically updates any new coordinate or orientation values.
Remov	To delete a point from the list of measured target points and exclude it from the Setup calculation.
More	To change the value displayed in the fourth column. For Resection : To change between ΔHz , Δ hz dist , Δ height , Δ easting and Δ northing . For Multiple backsights : To change between ΔHz and Δ height . For Transfer height : Only Δ height available.
Page	To change to another page on this screen.
Fn Quit	To exit the screen.

Description of columns

Column	Description
!	The ! indicates that the delta value of either measured horizontal angle, distance or height exceeds the calculation limit.
Point ID	The point ID of the measured target points.
Use	Indicates if and how a target point is used in the station calculation. Choices are 3D , 2D , 1D and No .
Δ Hz	Can be displayed by pressing More . Difference between calculated and measured horizontal angle for the target points. If a target point does not have coordinates, ----- are displayed. Differences exceeding the defined limit are indicated by a !.
Δ hz dist	Can be displayed by pressing More . Difference between calculated and measured distance from the station to the target points. If a target point does not have coordinates, ----- are displayed. Differences exceeding the defined limit are indicated by a !.
Δ height	Can be displayed by pressing More . Difference between the known control point height and the measured height of the target point. If a target point does not have a height coordinate, ----- are displayed. Differences exceeding the defined limit are indicated by a !.
Δ easting	Can be displayed by pressing More . Difference between control point and measured point, calculated from new station coordinates.
Δ northing	Can be displayed by pressing More . Difference between control point and measured point, calculated from new station coordinates.

Next step

Page changes to the **Plot** page.

52.9

Finding a Target Point

Description

The **Find Target** screen can be accessed, to guide the prism to the selected target point.

The screen is only available if the Stakeout application is available on the instrument. The functionality of this screen is similar to a stake out routine and is intended to help find hidden survey bench marks or base points.

Access

Press Fn **Find** in **Measure Target** once enough data is available to calculate roughly the new orientation.

Find Target

This screen is similar to the **Stakeout**, **Stake** page and is configured through the **Stakeout** configuration settings. Refer to "Stakeout, Stake page" for a detailed description of this screen.

Description

The Stakeout application is used to place marks in the field at predetermined points. These predetermined points are the points to be staked. The points to be staked can

- be uploaded to a job on the instrument using LGO.
- already exist in a job on the instrument.
- be uploaded from an ASCII file to a job on the instrument using **Main Menu: Jobs & Data\Import data\Import ASCII data**.

Diagram

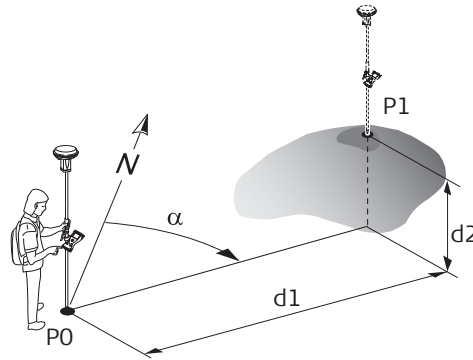

GS_057

GPS

- P0 Current position
- P1 Point to be staked
- d1 Stake out distance
- d2 Height difference between current position and point to be staked
- α Stake out direction

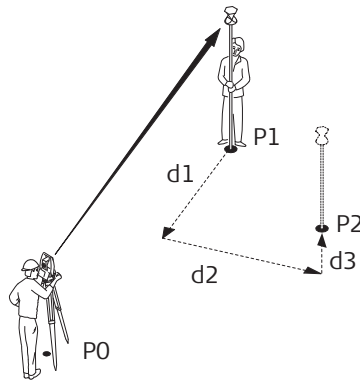

TS_009

TPS

- P0 Station
- P1 Current position
- P2 Point to be staked
- d1 Stake out element
- d2 Stake out element
- d3 Stake out element

Stakeout modes

Points can be staked using different modes:

- Polar mode.
- Orthogonal mode.



Staking out is possible for RTK rover and TPS.



The points to be staked must exist in a job on the active memory device or can be typed in.

Coordinate system

If staking local grid points with GNSS, always ensure that the correct coordinate system is being used. For example, if the points to be staked are stored in WGS 1984, the active coordinate system must also be WGS 1984.

Point types It is possible to stake:

- Position only points.
- Height only points.
- Points with full sets of coordinates.

Height types Height type of the point to be staked: Orthometric OR ellipsoidal
 Height type computed for current position: Orthometric OR ellipsoidal depending on the

- configured transformation,
- availability of a geoid model,
- height type of the point to be staked.

If possible, the height type of the point to be staked is computed for the current position.

Height source Heights can be taken into account from

- the vertical component of a coordinate triplet.
- a **Digital Terrain Model**.

The DTM licence key must be loaded. Refer to "30.3 Load licence keys" for information on how to enter the licence key.
 If loaded, the height of the points to be staked can be edited in the field.

Coding of staked points Codes can be attached to staked points, lines and areas. The behaviour of the coding functionality depends on the definition of a survey screen page with editable fields for coding and attributes.

Averaging of staked points The principles for averaging are identical to the averaging principles of the Survey application.

53.2 Accessing Stakeout

Access Select **Main Menu: Go to Work!\Stakeout**.

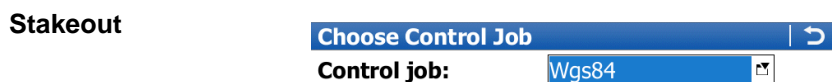

Key	Description
OK	To accept changes and access the subsequent screen. The chosen settings become active.
Fn Config..	To configure Stakeout application. Refer to "53.3 Configuring Stakeout".
Fn Quit	To exit the screen.

Description of fields

Field	Option	Description
Control job	Selectable list	The job containing the points to be staked.  Points which are measured during staking out are stored in the working job.

Next step

IF the Stakeout application	THEN
is to be accessed	OK accepts the changes and accesses Stakeout application. Refer to "53.4 Staking Out".
is to be configured	Config... Refer to "53.3 Configuring Stakeout".

53.3

Configuring Stakeout

Access

Select **Main Menu: Go to Work!\Stakeout**. Press Fn **Config...**

Configuration, General page

This screen consists of five pages. The explanations for the softkeys given here are valid for all pages, unless otherwise stated.

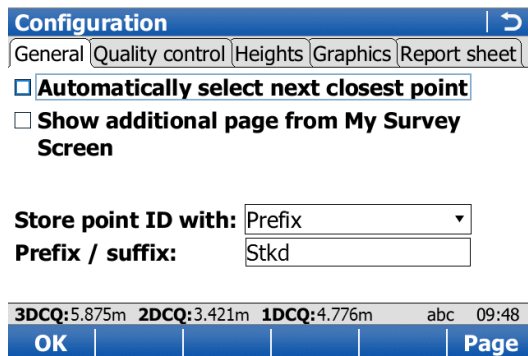

Key	Description
OK	To accept changes and return to the screen from where this screen was accessed.
Page	To change to another page on this screen.
Fn About	To display information about the program name, the version number, the date of the version, the copyright and the article number.
Fn Quit	To exit the screen.

Description of fields

Field	Option	Description
Automatically select next closest point	Check box	The order of the points suggested for staking out. When this box is checked, then the next point suggested for staking out is the point closest to the point which was staked. If there are many points in the job, the search can take a few seconds. When this box is not checked, the next point suggested for staking out is the subsequent one in the job.

Field	Option	Description
Show additional page from My Survey Screen	Check box	The user-defined survey screen page to be shown in the Stakeout screen.
Page to show	Selectable list	The names of the available survey screen pages.
Store point ID with	Stake point ID Prefix Suffix	The staked points are stored with the same point IDs as the points to be staked. Adds the setting for Prefix / suffix in front of the original point IDs. Adds the setting for Prefix / suffix at the end of the original point IDs.
Prefix / suffix	Editable field	Available for Store point ID with: Prefix and Store point ID with: Suffix . The identifier with up to four characters is added in front of or at the end of the ID of the staked point.
Only update stakeout values when distance is measured	Check box	TPS When this box is checked, angles and stakeout values are updated after a distance was measured. Then all values are frozen until the next distance is taken.
Automatically turn to point	Check box	TPS When this box is checked, the instrument positions automatically to the point to be staked.
Turn to	Horiz distance Position & height	Available when Automatically turn to point is checked. TPS Instrument positions horizontally to the point to be staked. TPS Instrument positions horizontally and vertically to the point to be staked.
Show direction message to next point	Instrument Last point	TPS For each point which is selected for staking, angle and distance information is momentarily displayed in the message line. The delta horizontal angle that the instrument must turn to the point, and the distance from the instrument to the point, is displayed in the message line. The delta horizontal angle that the instrument must turn to the point, and the distance from the last staked point, is displayed in the message line.
Use two face measurements	Check box	TPS To take a measurement in Face I and Face II. The point stored is an average of the two measurements. When using instruments fitted with auto aiming, the point is automatically measured in both faces. The resulting point is stored and the instrument is returned to the first face.

Next step

Page changes to the **Quality control** page.

Configuration,
Quality control page

Description of fields

Field	Option	Description
Check distance before storing (set Limit to 0 if you wish to always be shown differences before storing)	Check box	Allows a check to be made on the horizontal coordinate difference between the staked point and the point to be staked. If the defined Limit is exceeded, the stake out can be repeated, skipped or stored.
Limit	Editable field	Available when Check distance before storing (set Limit to 0 if you wish to always be shown differences before storing) is checked. Sets the maximum horizontal coordinate difference accepted in the position check.
Check cut/fill before storing	Check box	Allows a check to be made on the vertical difference between the staked point and the point to be staked. If the defined Limit is exceeded, the stake out can be repeated, skipped or stored.
Limit	Editable field	Available when Check cut/fill before storing is checked. Sets the maximum vertical difference accepted in the height check.

Next step

Page changes to the **Heights** page.

Configuration,
Heights page

Description of fields

Field	Option	Description
Allow height of point being staked to be edited	Check box	When this box is checked, the field Design height is displayed in Stakeout, Stake page. The design height is the height of the point to be staked. The value for Design height can be changed. When this box is not checked, the field Current height for the height of the current position is displayed in Stakeout, Stake page. The value for Current height cannot be changed.
Offset height of all points being staked	Check box	Allows a constant height offset to be applied to the height of the points being staked.
Height offset	Editable field	The height offset that is applied.

Next step

Page changes to the **Graphics** page.

Description of fields

Field	Option	Description
Navigate direction		The reference direction to be used to stakeout points. The stakeout elements and the graphical display shown in the Stakeout application are based on this selection.
	From instrument	TPS The direction of the orientation is from the instrument to the point to be staked.
	To instrument	TPS The direction of the orientation is from the point to be staked to the instrument.
	To north	The North direction shown in the graphical display based on the active coordinate system.
	From north	TPS The direction of the orientation is from the North direction to the point to be staked.
	To sun	GPS The position of the sun calculated from the current position, the time and the date.
	To last point	Time-wise, the last recorded point. If no points are yet staked, Navigate direction: To north is used for the first point to be staked.
	To point	A point from the working job.
	To point (cntrl job)	A point from the Control job selected in Stakeout .
	To line (cntrl job)	The direction of the orientation is parallel to a reference line from the Control job . Open the listbox to create, edit or delete a reference line.
	To line	The direction of the orientation is parallel to a reference line from the working job. Open the listbox to create, edit or delete a reference line.
	Following arrow	The direction of the orientation is from the current position to the point to be staked. The graphical display shows an arrow pointing in the direction of the point to be staked.
Point ID or Line	Selectable list	Available for Navigate direction: To point (cntrl job) , Navigate direction: To point , Navigate direction: To line and Navigate direction: To line (cntrl job) . To select the point or line to be used for orientation.
Navigate using		The method of staking out.
	Direction & distance In/out, left/right	The direction from the orientation reference, the horizontal distance and the cut/fill is displayed. The distance forwards to/backwards from the point, the distance right/left to the point and the cut/fill is displayed.
Switch to bulls eye when 0.5m from target	Check box	When this box is checked, a bulls eye bubble is shown in the stakeout graphic when less than half a metre from the point being staked.

Field	Option	Description
Beep faster when getting close to point	Check box	The instrument beeps when the distance from the current position to the point to be staked is equal to or less than defined in Start within . The closer the instrument is to the point to be staked the faster the beeps will be.
Distance to use	Height, Horizontal distance or Position & height	The type of distance to use for staking.
Start within	Editable field	Available when Beep faster when getting close to point is checked. The horizontal radial distance, from the current position to the point to be staked, when a beep is to be heard.

Next step

Page changes to the **Report sheet** page.

Configuration, Report sheet page

Description of fields

Field	Option	Description
Create report sheet	Check box	To generate a report sheet when the application is exited. A report sheet is a file to which data from an application is written to. It is generated using the selected format file.
Report sheet	Selectable list	Available when Create report sheet is ticked. The name of the file to which the data will be written. A report sheet is stored in the \DATA directory of the active memory device. The data is always appended to the file. Opening the selectable list accesses the Report Sheets screen. On this screen, a name for a new report sheet can be created and an existing report sheet can be selected or deleted.
Format file to use	Selectable list	Available when Create report sheet is ticked. A format file defines which and how data is written to a report sheet. Format files are created using LGO. A format file must first be transferred from the data storage device to the internal memory before it can be selected. Refer to "30.1 Transfer user objects" for information on how to transfer a format file. Opening the selectable list accesses the Format Files screen where an existing format file can be selected or deleted.

Next step

Page changes to the first page on this screen.

Diagram

This diagram shows an example for **Navigate using: In/out, left/right.**

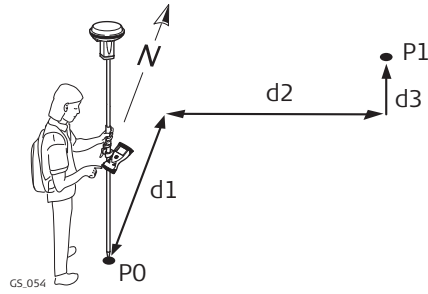

GPS

- P0 Current position
- P1 Point to be staked
- d1 Forwards or backwards
- d2 Right or left
- d3 Fill or cut

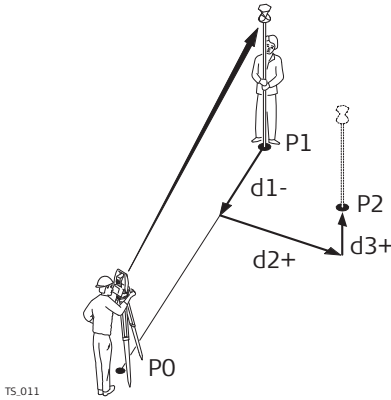

TPS

- P0 Station
- P1 Current position
- P2 Point to be staked
- d1 Forward or backwards
- d2 Right or left
- d3 Cut or fill

This diagram shows an example **Navigate using: Direction & distance.**

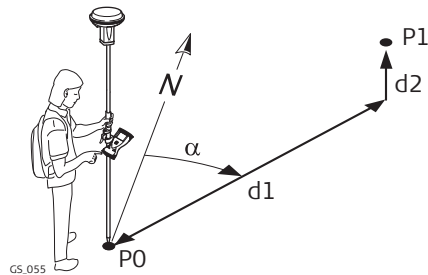

GPS

- P0 Current position
- P1 Point to be staked
- d1 Distance
- d2 Cut or fill
- α Direction

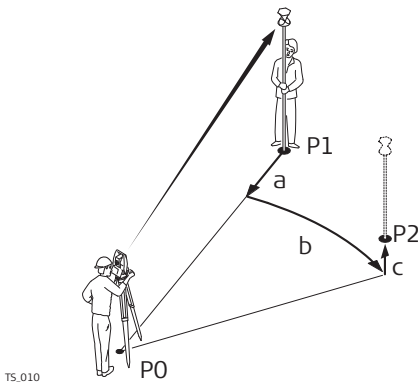

TPS

- P0 Station
- P1 Current position
- P2 Point to be staked
- a Distance
- b Horizontal angle
- c Cut or fill





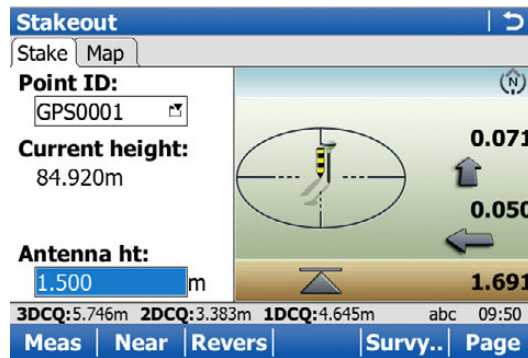

For information on camera and images refer to "33.3.3 Within Applications".

Stakeout, Stake page

The pages shown are from a typical working style. An additional page is available when a user-defined survey screen page is used.



Key	Description
Meas	<p>[GPS] To start measuring the point being staked. The key changes to Stop. The difference between the current position and the point being staked is still displayed.</p> <p>[TPS] To measure a distance and store distance and angles.</p>
Stop [GPS]	To end measuring the point being staked. When Automatically stop point measurement is checked in Quality Control, General page recording of positions ends automatically as defined by the stop criteria. The key changes to Store . After ending the measurements, the differences between the measured point and the point to be staked are displayed.
Store	<p>[GPS] To store the measured point. When Automatically store point is checked in Quality Control, General page, the measured point is stored automatically. The key changes to Meas.</p> <p>[TPS] To store angles and distance. Distance must be measured before.</p>
Dist [TPS]	To measure a distance.
Near [GPS]	To search the Control job for the point nearest to the current position when the key is pressed. The point is selected as the point to be staked and is displayed in the first field on the screen. After staking and storing the nearest point, the next point suggested for staking out is the one which was suggested before the key was pressed. Available when Meas is displayed.
Revers [GPS]	To reverse the graphical display top to bottom. A reversed graphical display can be used when the point to be staked lies behind the current position.
Survey..	To survey additional points which may be needed during staking out. To return to Stakeout application, press Fn Quit or ESC. Available when Meas is displayed.
Page	To change to another page on this screen.
Fn Config..	To configure the Stakeout application. Refer to "53.3 Configuring Stakeout".
Fn Conect and Fn Disco [GPS]	To connect/disconnect from the GPS reference data.

Key	Description
Fn Init 	To select an initialisation method and to force a new initialisation. Available when Meas or Store is displayed and for working styles allowing phase fixed solutions. Refer to "56.4 Initialisation for Real-Time Rover Operations".
Fn 2D Pos 	To position the telescope (X,Y) onto the point to be staked.
Fn 3D Pos 	To position the telescope (X,Y,Z) onto the point to be staked.
Fn Mnual.. 	To enter angle and distance values to stake out a point.
Fn Quit	To exit Stakeout application.

Description of the elements of the graphical display

The graphical display provides a guide to find the point to be staked out.

Element	Description
	Point to be staked / known point
	North
	Sun
	Defined line
	From instrument
	Follow arrow
	Forward arrow, distance to point
	Side arrow, distance to point
	Polar arrow, direction to point
	Height
	The current position and/or height is within the configured stake out limit for position and/or height.

Description of fields

Field	Option	Description
Point ID	Selectable list	The point ID of the point to be staked.
Antenna ht	Editable field	GPS The default antenna height. Changing the antenna height here does not update the default antenna height as defined in the active working style. The changed antenna height is used until the application is exited.
Target height	Editable field	TPS The default prism height.
Current height	Display only	Available when Allow height of point being staked to be edited is not checked in Configuration, Heights page. The orthometric height of the current position is displayed. If the orthometric height cannot be displayed, the local ellipsoidal height is displayed. If it is not possible to display the local ellipsoidal height, the WGS 1984 height is displayed. The value for Height offset configured in Configuration, Heights page is taken into account.
Design height	Editable field	Available when Allow height of point being staked to be edited is checked in Configuration, Heights . The design height, which is the orthometric height of the point to be staked, is displayed. If the orthometric height cannot be displayed, the local ellipsoidal height is displayed. If it is not possible to display the local ellipsoidal height, the WGS 1984 height is displayed. The value for Height offset configured in Configuration, Heights page is not taken into account. Changing the value for Design height changes the values displayed for cut and fill.

Next step

Page changes to the **Map** page. Refer to "37 MapView Interactive Display Feature" for information on the functionality and softkeys available.

Description

If configured a check is made on the horizontal and/or vertical coordinate distance from the staked point to the point to be staked. Refer to "53.3 Configuring Stakeout" for information on configuring the check and the limits.

Access

If either of the configured difference limits are exceeded, the following screen is accessed automatically when the point is stored.

Stakeout Limit Exceeded

The availability of the fields depends on the configuration for **Navigate using**. The limits that have been exceeded are shown in bold and indicated by a !.

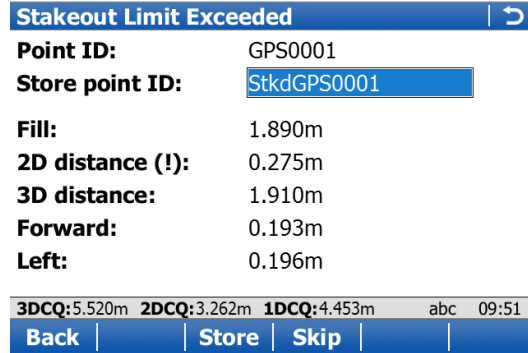

Key	Description
Back	To return to the Stakeout screen without storing the point. Staking out of the same point continues.
Store	To accept the coordinate differences, store the point information and return to the Stakeout screen.
Skip	To return to the Stakeout screen without storing the point. According to filter and sort settings the next point is suggested for staking out.
Fn Quit	To exit the screen.

Description of fields

Field	Option	Description
Point ID	Display only	The point ID of the point to be staked.
Store point ID	Editable field	The unique number which is used to store the staked point. Allows a different point ID to be typed in, if needed.
Cut	Display only	The negative height difference from the height of the staked point to the height of the point to be staked. To move down.
Fill	Display only	The positive height difference from the height of the staked point to the height of the point to be staked. To move up.
2D distance	Display only	Displays the horizontal difference from the staked point to the point to be staked.
3D distance	Display only	Displays the spatial difference from the staked point to the point to be staked.
ΔHz	Display only	The bearing from the staked point to the point to be staked.

Field	Option	Description
Δ Dist	Display only	Horizontal distance from the staked point to the point to be staked.
Forward	Display only	The horizontal distance from the current position to the point to be staked in the direction of the orientation.
Back	Display only	The horizontal distance from the current position to the point to be staked in the reverse direction of the orientation.
Right	Display only	Horizontal distance from the staked point to the point to be staked orthogonal to the right of the orientation direction.
Left	Display only	Horizontal distance from the staked point to the point to be staked orthogonal to the left of the orientation direction.

53.6

Staking Out a DTM or Points & DTM

Description

A **D**igital **T**errain **M**odel can be staked alone or together with points. The heights of the current positions are compared against the heights of a selected DTM job. The height differences are calculated and displayed.

Staking a DTM can be used for

- staking out where the DTM represents the surface to be staked.
- quality control purposes where the DTM represents the final project surface.

DTM jobs are created in LGO. DTM jobs are stored in the \DBX directory on the active memory device.

Diagram

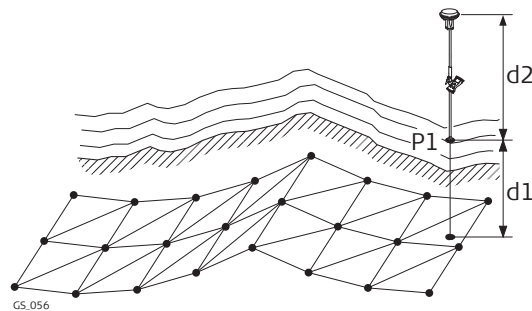

GPS

P1 Point to be staked
d1 Antenna height
d2 Cut or fill

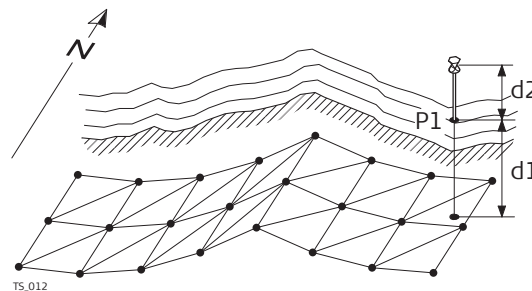

TPS

P1 Point to be staked
d1 Cut or fill
d2 Reflector height

Access

If the message panel appears which requires that the application must be activated via a license key then refer to "30.3 Load licence keys".

To stake out DTM heights only:

Select **Main Menu:Go to Work!\Stakeout+\Stakeout DTM.**

To stake out positions of points and DTM heights:

Select **Main Menu:Go to Work!\Stakeout+\Stake points & DTM.**

Stakeout

Description of fields

Field	Option	Description
Control job	Selectable list	The positions of points in the job selected here are staked out. Heights to be staked out are taken from the DTM job.  Points which are measured during staking out are stored in the working job.
DTM	Selectable list	The DTM job to be used must be stored in the \DBX directory on the active memory device. Heights without positions are staked out relative to the selected DTM job.



The stake out procedure is identical as for the normal Stakeout application but the heights to be staked are taken from the selected DTM job. The negative or positive height differences from the current position to the equivalent point in the selected DTM job is calculated and displayed. Height offsets apply.

Refer to "53.3 Configuring Stakeout", "53.4 Staking Out" and "53.5 Stakeout Difference Limit Exceeded".

Description

The Seismic Stakeout application includes all the standard stakeout functionality plus extra features that are specific to seismic survey. It supports exclusion zone files in order to warn users when the selected preplot point position or the current measured position falls inside a protected area. It provides a specific **Offset** page in the main stakeout screen to help staking, offsetting or skidding preplot points. A "default line width annotation" feature is available for users who need to report the width of the cut line.

Terms

- Exclusion zone: Protected area where drilling is not allowed.
- Preplot: Refers to design. For example preplot points and preplot job - not control points or control job.
- Track and bin: The preplot point IDs are comprised of a track(line) and bin(station). For example, if the point ID 162304 has 3 bin characters then its track would be 162 and its station 304.

Access

Select **Main Menu: Go to Work!\Stakeout+\Seismic stakeout.**

Choose Control Job (Preplot)

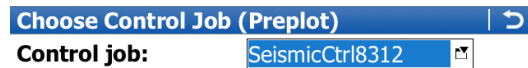

Key	Description
OK	To activate the selected control job (preplot job).
Fn Config..	To configure Seismic Stakeout application.
Fn Quit	To exit the screen.

Description of fields

Field	Option	Description
Control job	Selectable list	Job that contains preplot points to be staked.

Choose Exclusion Zone

Choose Exclusion Zone | ↻

File type: ESRI SHP ▾

Exclusion zone file: Infra8312 ▾

No. of zones: 276

Description: -----

3DCQ:-:---m 2DCQ:-:---m 1DCQ:-:---m Fn abc 11:24

OK | View

Key	Description
OK	To validate the selected exclusion zone file. Opens the Define Line Settings screen. The file is converted to an internal format (*.xnz) when used for the first time.
View	To open the Exclusion zone viewer after loading the zones in memory. The file is converted to an internal format (*.xnz) when used for the first time. Refer to "Exclusion zone viewer".
Fn Config..	To configure Seismic Stakeout application.
Fn Quit	To exit the screen.

Description of fields

Field	Option	Description
File type	ESRI SHP GPSeismic LZO	Polygon shapefile in local grid coordinate system Leica exclusion zone format by GPSeismic software
Exclusion zone file	Selectable list	The file that contains exclusion zones against which the measured or selected preplot position will be tested. The file must be stored in the DATA\ZONE directory on the data storage device. Open the selectable list to change the memory device as needed. Select <None> if no file is available for a given project area. Refer to "Exclusion Zone Files - SHP".
No. of zones	Display only	Numbers of exclusion zones included in the selected file.
Description	Display only	File description as read in the file's header.

Exclusion Zone Files - SHP

Exclusion Zone Files - SHP (CF card) | ↻

Name	Date
<None>	-----
8312axzn	18.03.2013
8312multipart	18.03.2013
Exclusion_8311	24.01.2013
Infra2Lamb	19.02.2013
Infra8312	18.03.2013
InfraLamb	28.01.2013
InfraUtm18	28.01.2013
MontZoneLamb	09.04.2013

3DCQ:8.553m 2DCQ:2.919m 1DCQ:8.039m Fn abc 13:16

OK | More | SD card

Key	Description
OK	To accept the selection.
More	To display information about the file name, size and last modification date/time.
CF card, SD card or Intrnl	To change between viewing exclusion zone files stored on another data storage device or internal memory.
Fn Quit	To exit the screen.

Exclusion zone viewer

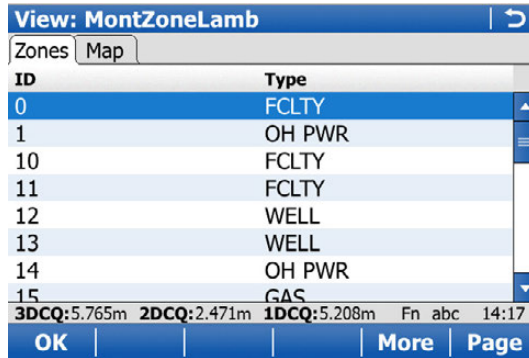

Key	Description
OK	To return to the previous screen.
More	To display information about the zone ID, type and geometry.
Fn Quit	To exit the screen.

Define Line Settings

Seismic stakeout is usually done following a line of preplot points. The application can take advantage of line settings definitions to improve the seismic stakeout.

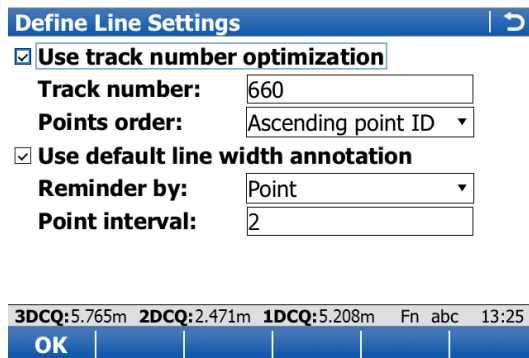

Key	Description
OK	To open the Seismic Stakeout screen.
Fn Config..	To configure Seismic Stakeout application.
Fn Quit	To exit the screen.

Description of fields

Field	Option	Description
Use track number optimization	Check box	The track(line) number can be used internally by the application to filter preplot points that belong to the current line being staked. This option also increase the performance of the preplot point test by reducing the number of exclusion zones loaded into memory.
Track number	Editable field	Track number of the line being staked. Common prefix identifier of all preplot points that belong to a given line.
Points order	Selectable list	Line walking direction as defined by preplot point IDs.
Use default line width annotation	Check box	This option is for users who need to report the width of the cut line. It allows to store automatically the last entered line width in the staked point annotation (Annot 4). Depending on the reminder method, a dialog will show-up after point store that recall the user to measure and update the line width value.
Reminder by		Reminder method for line width annotation update. Point Reminds after a point interval Distance Reminds after a distance interval
Point interval	Editable field	Number of staked point after which the default line width annotation must be updated.
Distance interval	Editable field	The distance after which the default line width annotation must be updated.

54.3

Configuring Stakeout

Access

Select **Main Menu: Go to Work!\Stakeout+\Seismic stakeout**. Press Fn **Config...**





Configuration, Seismic stakeout page

For all other pages on this screen, refer to "53.3 Configuring Stakeout".

Key	Description
OK	To accept changes and return to the screen from where this screen was accessed.
Page	To change to another page on this screen.

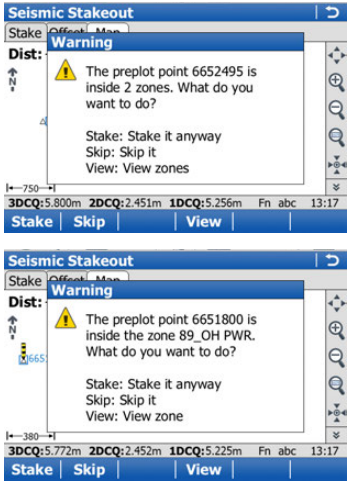
Key	Description
Fn About	To display information about the program name, the version number, the date of the version, the copyright and the article number.
Fn Quit	To exit the screen.

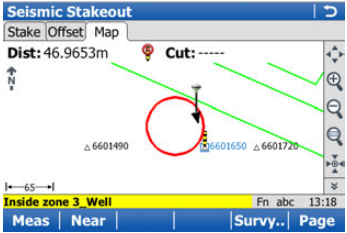
Description of fields

Field	Option	Description
Enable preplot point test	Check box	<p>The preplot point test is done each time the current point ID selection changes (in Stake or Map page from Seismic Stakeout screen). The preplot point position is tested against exclusion zones and an appropriate warning message appears when the position is inside one or more zones.</p> 
Enable navigation test	Check box	<p>The navigation test is done continuously on the current measured position. The current position is tested against all exclusion zones in the surrounding area as defined by Display radius.</p> <p> Appears in the Stake and Map page when the measured position falls inside one or more exclusion zones.</p> <p>In addition, the touched zone is highlighted in red in the map (that could be more than one zone).</p>  <p> Appears in the Stake and Map page when an exclusion zone file is active and the navigation test is disabled.</p>

Field	Option	Description
Show message line warning	Check box	Inside zone warning displayed at the message line when the current measured position falls inside one or more exclusion zones. The message line stays on for seven seconds when triggered even if the user gets out of the zone(s).
Display radius	Editable field	This radius defines the area around the current measured position for which the exclusion zones will be added to the stakeout map.  It is better to keep this value as small as possible to not load too many exclusion zones in memory. The application automatically readjusts this radius when more than 200 zones overlap the defined area
Show LZO inner polygons	Check box	An inner polygon is created when adding an offset to an exclusion zone in GPSeismic (LZO format). Use this option to display inner polygons on the stakeout map. Inner polygons are displayed in yellow and no inclusion test is done against them.

54.4



Staking Out

Seismic Stakeout, Stake page

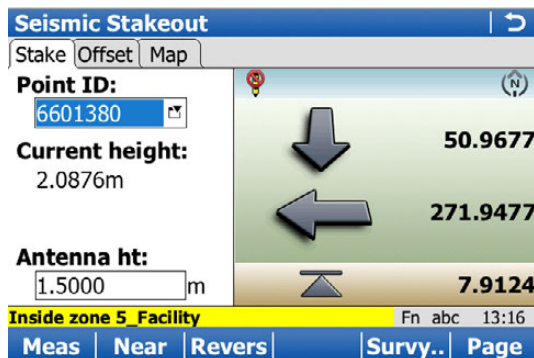
Same as standard Stakeout application, except for specific warning icons that appear in the left upper corner of the bulls-eye. Refer to "53.4 Staking Out" for a description of keys, fields and standard elements of the graphical display.



Description of specific elements of the graphical display

Element	Description
	Indicates that current measured position falls inside one or more exclusion zones.
	Indicates that an exclusion zone file is active but navigation test is disabled.

Seismic Stakeout, Offset page

Refer to "53.4 Staking Out" for a description of keys.

Seismic Stakeout	
Stake	Offset
Map	
Azimuth:	90°00'00.0"
In-line:	44.6177m
Cross-line:	-46.1861m
Radius:	64.2176m
Slope to point:	2000
Slope distance:	7.8965m

Inside zone 5_Facility	
Meas	Near
Survy..	Page

Description of fields

Field	Option	Description
Azimuth	Editable field	Direction from the current preplot point for which the In-line and Cross-line offsets are computed. This azimuth value is automatically updated each time the selected preplot point changes in the Stake and Map page. The computed azimuth is based on the next preplot point in the list. If no next point is available then it will be from previous point to current one. Or enter an azimuth value for specific validation.
In-line	Display only	Measured position in/out offset based on the line from the current preplot point to the given azimuth direction. Negative value is in.
Cross-line	Display only	Measured position left/right offset based on the line from the current preplot point to the given azimuth direction. Negative value is left.
Radius	Display only	Horizontal distance from the measured position to the current preplot point.
Slope to point	Selectable list	Point stored in the working job for which the slope distance from the current measured position is required. Useful when offsetting a preplot point to validate cable length from previous staked point.
Slope distance	Display only	Slope distance from measured position to selected Slope to point .

Description In this option, a known point stored in the working job is used to set up the RTK base.

Access Select **Base Menu\Go to Work!\Start base over known point**.

Set antenna height & type. Type in the antenna height and select the antenna being used.

Key	Description
Next	To accept changes and access the subsequent screen.
Fn Quit	To exit the screen.



Description of fields



Field	Option	Description
Antenna height	Editable field	The height of the antenna that is being used.
RTK base antenna	Selectable list	Leica Geosystems antennas are predefined as default and can be selected from the list. Default antennas contain an elevation-dependent correction model. New antenna correction models can be set up and transferred to the instrument using LGO. Open the list to define or edit additional antennas. Refer to Antennas for information on antennas.
Vertical offset	Display only	The vertical offset of the measurement reference point.

Next step
Next to access **Select known point**.

Select known point

Select the point to be used as base station.

-  A point could already be stored in the control job either by manual entry, by measuring or by transfer from LGO.
-  If a new point is to be created, open the selectable list for **Point ID** and press **Point ID**.
-  If an existing point is to be edited, open the selectable list for **Point ID** and press **Edit...**

Base Over Known Point 
Select known point 

Point ID: 00999 
Easting: 546750.075m
Northing: 5250395.063m
Elevation: 427.673m

3DCQ:--m 2DCQ:--m 1DCQ:--m abc 10:47
Next **Coord** **Back**

Key	Description
Next	To accept changes and access the subsequent screen.
Coord	To view other coordinate types. Local coordinates are available when a local coordinate system is active.
Back	To return to the previous screen.
Fn Quit	To exit the screen.

Next step

Next to access **Base setup complete..** Follow the instructions on the screen.

55.2

Start base over last setup

Description

To use the same coordinates as when the instrument was last used as a base. Available when the instrument has previously been used as a base and no point in the control job has the same point ID as the one last used.

After turning off, the base coordinates are stored in the System RAM. They can be used again the next time the instrument is used as a base. This functionality means that even if the data storage device that previously contained the base coordinates is formatted, the last used coordinates can still be used.

Access

Select **Base Menu\Go to Work!\Start base over last setup.**

Set antenna height & type.

This screen is identical with the one in **Start base over known point.** Refer to **Start base over any point.**

Next step

Next to access **Last used RTK base point..**

Last used RTK base point.

The point ID and coordinates of the last used base are displayed in grid. When no local coordinate system is active, WGS 1984 coordinates are displayed. Refer to **Start base over any point** for information on the keys.

Next step

Next to access **Base setup complete..** Follow the instructions on the screen.

55.3

Start base over any point

Description

To use the coordinates of the current navigation position as base coordinates.

Access

Select **Base Menu\Go to Work!\Start base over any point.**

Set antenna height & type.

This screen is identical with the one in **Start base over known point.** Refer to **Start base over any point.**

Next step

Next to access **Measure new point..**

Measure new point.

Type in a point ID for this new point. Refer to **Start base over any point** for information on the keys.
Code information or annotations can be added in the rover menu in **View & edit data.**

Next step

Next to access **Base setup complete..** Follow the instructions on the screen.

56

Survey - General GPS

56.1

Surveying Points

56.1.1

Post-Processed Kinematic and Static Operations

Requirements

- A typical working style for a static or post-processed kinematic operation is used. Ensure that the working style has **Log data for post-processing** selected in the **Raw Data Logging Settings** screen.



For information on camera and images refer to "33.3.3 Within Applications".

Access

For RTK rover:

Select **Main Menu: Go to Work!, Survey**.



If configured for post-processed kinematic operations, the logging of moving observations begins.

Survey, Survey page

The fields shown are from a typical working style for static or post-processed kinematic operations. The screen described consists of four pages. The explanations for the softkeys given here are valid for the **Survey** page, the **Code** page and the **Annot** page. Refer to "37 MapView Interactive Display Feature" for information on the keys on the **Map** page.

The fields and functionality of this screen vary slightly when accessed from other applications where individual point measurements are needed.

The screenshot shows the 'Survey: Job name' screen with the following elements:

- Header: Survey: Job name | ↻
- Page tabs: Survey | Code | Annot | Map
- Point ID: GPS0001
- Antenna height: 2.000 m
- 3D CQ: 5.797m
- Status bar: 3DCQ:5.797m 2DCQ:3.410m 1DCQ:4.688m Q1 abc 09:50
- Softkeys: Meas | Near | HdnPt.. | Page

Key	Description
Meas	To start logging of static observations. The key changes to Stop .
Stop	To end recording of positions when enough data is collected. When Automatically stop point measurement is checked in Quality Control, General , recording of positions ends automatically as defined by the stop criteria. The key changes to Store .
Store	To store the point information. When Automatically store point is checked in Quality Control, General , the measured point is stored automatically. The key changes to Meas .
Near	To compare the user's current position with the coordinates of all points already stored in the job and find the nearest point. This point ID is then suggested as the next point ID to be used.
HdnPt..	To measure a hidden point. Refer to "60 Survey - Hidden Points".
Page	To change to another page on this screen.
Fn Config..	To configure SmartCodes, auto points and hidden point measurements. Refer to "26.5 SmartCodes", "58 Survey - Auto Points" and "60 Survey - Hidden Points".

Key	Description
Fn IndivID and Fn Run	To change between entering an individual point ID different to the defined ID template and the running point ID according to the ID template. Refer to "25.1 ID templates".
Fn Quit	To exit the screen.

Description of fields

Field	Option	Description
Point ID	Editable field	The identifier for manually measured points. The configured point ID template is used. The ID can be changed in the following ways: <ul style="list-style-type: none"> To start a new sequence of point IDs type over the point ID. For an individual point ID independent of the ID template Fn IndivID. Fn Run changes back to the next ID from the configured ID template.
Antenna height	Editable field	The default antenna height as defined in the active working style is suggested. Changing the antenna height here does not update the default antenna height as defined in the active working style. The changed antenna height is used until the application is exited.
3D CQ	Display only	The current 3D coordinate quality of the computed position.

56.1.2

Real-Time Rover Operations

Requirements

- A typical working style for real-time rover operations is used.
- The appropriate real-time device is attached and working properly.



For information on camera and images refer to "33.3.3 Within Applications".

Access

For RTK rover:

Select **Main Menu: Go to Work!, Survey**.

Survey, Survey page

The fields shown are from a typical working style for real-time rover operations. The screen described consists of four pages. The explanations for the softkeys given here are valid for the **Survey** page, the **Code** page and the **Annot** page. Refer to "37 MapView Interactive Display Feature" for information on the keys on the **Map** page. The fields and functionality of this screen vary slightly when accessed from other applications where individual point measurements are needed.

Survey: Job name | ↻

Survey Code Annot Map

Point ID: GPS0001

Antenna height: 2.000 m

3D CQ: 5.619m

3DCQ:5.619m 2DCQ:3.444m 1DCQ:4.439m Q1 abc 10:30

Meas Near HdnPt.. Page

Key	Description
Meas	To start logging of static observations. The key changes to Stop .
Stop	To end recording of positions when enough data is collected. When Automatically stop point measurement is checked in Quality Control, General , recording of positions ends automatically as defined by the stop criteria. The key changes to Store .
Store	To store the point information. When Automatically store point is checked in Quality Control, General , the measured point is stored automatically. The key changes to Meas . It may happen that a point with the same point ID exists in the job. If the codes and/or attribute values of the new and the existing point do not match, a screen opens where they can be corrected. Refer to "26.6 Code and Attribute Mismatch".
Near	To compare the user's current position with the coordinates of all points already stored in the job and find the nearest point. This point ID is then suggested as the next point ID to be used.
HdnPt..	To measure a hidden point. Refer to "60 Survey - Hidden Points".
Page	To change to another page on this screen.
Fn Config..	To configure SmartCodes, auto points and hidden point measurements. Refer to "26.5 SmartCodes", "58 Survey - Auto Points" and "60 Survey - Hidden Points".
Fn Avg	To check the residuals for the averaged position. Available for Mode: Average in Job Properties: Averaging page and for more than one measured coordinate triplet recorded for the same point. Refer to "6.3.3 Mean Page".
Fn Abs	To check the absolute difference between measurements. Available for Mode: Average in Job Properties: Absolute differences page and for more than one measured coordinate triplet recorded for the same point. Refer to "6.3.3 Mean Page".
Fn Conect and Fn Disco	To connect/disconnect from the GPS reference data.
Fn Init..	To select an initialisation method and to force a new initialisation. Available for working styles allowing phase fixed solutions. Refer to "56.4 Initialisation for Real-Time Rover Operations".
Fn Individ and Fn Run	To change between entering an individual point ID different to the defined ID template and the running point ID according to the ID template. Refer to "25.1 ID templates".
Fn Quit	To exit the screen.

Description of fields

Field	Option	Description
Point ID	Editable field	The identifier for manually measured points. The configured point ID template is used. The ID can be changed in the following ways: <ul style="list-style-type: none"> To start a new sequence of point IDs type over the point ID. For an individual point ID independent of the ID template Fn IndivID. Fn Run changes back to the next ID from the configured ID template.
Antenna height	Editable field	The default antenna height as defined in the active working style is suggested. Changing the antenna height here does not update the default antenna height as defined in the active working style. The changed antenna height is used until the application is exited.
3D CQ	Display only	The current 3D coordinate quality of the computed position.

56.2

Adding Annotations

Description

Annotations can be used to add either field notes or comments to points being surveyed.

Access





For RTK rover:

Select **Main Menu: Go to Work!**, **Survey**. Go to the **Annot** page.

-  If it is not already displayed, the **Annot** page can be configured to appear in the Survey application through the **My Survey Screen Settings** screen. Refer to "25.3 My Survey Screen" for more information.

Survey, Annot page

Description of fields

Field	Option	Description
Annot 1 to Annot 4	Editable field	Type in the annotation. The annotation can be up to 16 characters long and include spaces. <ul style="list-style-type: none">  When the ASCII input interface is configured to be used and an annotation is reserved for the incoming ASCII string, then no other information can be typed in for the particular annotation.  CE to clear the entry.  Last to recall all annotations entered for the previously surveyed point. Any annotations just entered are overwritten.  ENTER. The next line is highlighted.

Next step

Step	Description
1.	Meas to start the point measurement.
2.	Stop to end the point measurement.

Step	Description
3.	Store to store the point information including the annotations.

56.3

Timed Measurements

Description

Surveying regulations in some countries require that several instruments in a session start the point measurement simultaneously at a predefined time. Timed measurements are possible for all types of GPS operations, except for real-time base operations.

Requirements

- **Automatically start measuring point on entering survey: Timed** is configured in **Quality Control, Advanced** page. Refer to "13.4 Quality control".
- **Time at point** is configured for one of the lines in one of the survey screen pages. Refer to "25.3 My Survey Screen".

Access

For RTK rover:

Select **Main Menu: Go to Work!, Survey**.

Survey, Survey page

The screenshot shows the Survey screen with the following fields and values:

- Survey: Job name**: [Survey] Code Annot Map []
- Point ID:** GPS0001
- Antenna height:** 2.000 m
- Start time:** 10:32:00
- 3D CQ:** 5.566m

At the bottom, there is a status bar showing: **3DCQ:5.566m 2DCQ:3.416m 1DCQ:4.395m Q1 abc 10:32** and a navigation bar with **Meas**, **Near**, **HdnPt..**, and **Page**.

Refer to "56.1 Surveying Points" for a description of keys.

Description of fields

Field	Option	Description
Start time	Editable field	The current local time with the seconds rounded to 00, for example for the current local time 07:37:12 it is 07:38:00. Type in the start time in hours, minutes and seconds for when the point measurement will begin. Press Meas . The point measurement does not start yet. The name of the field changes to Time to go .
Time to go	Display only	The countdown time in hours, minutes and seconds before the point measurement starts automatically. The point measurement starts when it is 00:00:00. Then, data is logged as configured in the working style. Any measurement counter defined to be used in survey screen page is displayed and starts incrementing. The name of the field changes to Time at point .

Field	Option	Description
Time at point	Display only	The time in hours, minutes and seconds from when the point is measured until point measurement is stopped. Press Stop and Store when enough data is collected. The name of the field changes to Start time .

56.4

Initialisation for Real-Time Rover Operations

56.4.1

Accessing Initialisation for Real-Time Rover Operations

Requirements



- The active working style is a real-time rover configuration.

Access

For RTK rover:

- Select **Main Menu: Go to Work!, Survey**. Press **Init...**
- Access is possible from other screens where individual point measurements are needed, for example from **Inverse Pt - Pt** with **Surv...**



Re-initialise the RTK

Initialisation method	Description	Refer to chapter
Initialise while moving	The rover antenna can be moved during the initialisation process.	"56.4.2 Initialise while Moving"
Initialise while static	 The antenna setup must be static on a pillar, a tripod or on a pole with a quick-stand.	"56.4.3 Initialise while Static"
Initialise on a known point	 The antenna setup must be static on a pillar, a tripod or on a pole with a quick-stand.  The coordinates of the point must be stored in, or able to be converted to, the WGS 1984. They must be stored in the working job either by manual entry or by measuring.	"56.4.4 Initialise on Known Point"

56.4.2

Initialise while Moving



Initialise while moving step-by-step

Step	Description
1.	Does the instrument currently have a fixed solution? <ul style="list-style-type: none"> If yes, continue with step 3. If no, continue with the next row.
	The initialisation starts automatically.
2.	Continue with the row after step 3.
3.	Yes to start the initialisation. The current ambiguity solution is discarded.
	Meas is available but must not be pressed until the ambiguity solution is gained.
4.	The initialisation is gained when the ambiguities are solved.
5.	Continue with the surveying operation.

56.4.3

Initialise while Static







Initialise while static step-by-step

Step	Description
1.	Does the instrument currently have a fixed solution? <ul style="list-style-type: none"> • If yes, continue with step 3. • If no, continue with the next row.
	The initialisation starts automatically.
2.	Continue with step 6.
3.	Yes to start the initialisation. The current ambiguity solution is discarded.
	Stop is available but must not be pressed until the ambiguity solution is gained.
	The initialisation is gained when the ambiguities are solved.
4.	Any configurations for Automatically stop point measurement in Quality Control, General page are ignored. Stop when enough data is collected.
5.	When Automatically stop point measurement is not checked in Quality Control, General page, Store to store the point information.
6.	Continue with the surveying operation.

56.4.4

Initialise on Known Point

Initialise on known point step-by-step

Step	Description
1.	Does the instrument currently have a fixed solution? <ul style="list-style-type: none"> • If yes, continue with step 3. • If no, continue with step 4.
2.	Yes to start the initialisation. The current ambiguity solution is discarded.
3.	In Data:, Points page, highlight the known point for the initialisation.
4.	OK starts the initialisation.
	Survey screen Point ID: The ID of the selected known point is displayed. Antenna height: The default antenna height as defined in the active working style is suggested. Changing the antenna height here does not update the default antenna height as defined in the active working style. The changed antenna height is used until the application is exited. Enter the correct antenna height.
	If desired, add a code.
	If desired, add an annotation.
	Stop is available but must not be pressed until the ambiguity solution is gained.
	The initialisation is gained when the ambiguities are solved.
5.	Any configurations for Automatically stop point measurement in Quality Control, General page are ignored. Stop when enough data is collected.
6.	When Automatically stop point measurement is not checked in Quality Control, General page, Store to store the point information.
	An average is automatically calculated with the known coordinates.
7.	Continue with the surveying operation.

Description

The Survey application is used for point measurement. Angles and distances for points can be measured and the calculated coordinates stored using **Meas**, **Dist** and **Store**.



For information on camera and images refer to "33.3.3 Within Applications".

Access

Select **Main Menu: Go to Work!\Survey**.

Survey, Survey page

The fields shown are from a typical working style. The screen described consists of four pages. The explanations for the softkeys given here are valid for the **Survey** page, the **Offset** page, and the **Code** page. Refer to "37 MapView Interactive Display Feature" for information on the keys on the **Map** page.

The fields and functionality of this screen vary slightly when accessed from other applications where individual point measurements are needed.

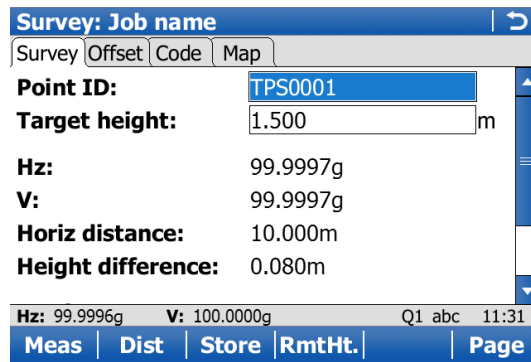

Key	Description
Meas	To measure and store distances and angles.
Stop	Available if Measure mode: Continuous and Dist was pressed. Stops the distance measurements. The key changes back to Meas .
Dist	To measure and display distances.
Store	To record data. If Measure mode: Continuous and/or Log auto points is checked, records measured point and continues tracking.
RmtHt.	To access Survey Remote Point . Available if Measure remote points is checked in Configuration, Remote points page.
Page	To change to another page on this screen.
Fn Config..	To configure SmartCodes, auto points and remote point measurements. When Fn Avg or Fn Abs are active, this key is not available. Refer to "26.5 SmartCodes", "58 Survey - Auto Points" and to "62 Survey - Remote Point" for information on the fields and keys.
Fn Avg	To check the residuals for the averaged point. Available for Mode: Average in Job Properties:, Averaging page and for more than one measured coordinate triplet recorded for the same point. Refer to "6.3.3 Mean Page".
Fn Abs	To check the absolute difference between the measurements. Available for Mode: Average in Job Properties:, Absolute differences and for more than one measured coordinate triplet recorded for the same point. Refer to "6.3.3 Mean Page".

Key	Description
Fn 2Store	To aim manually at the target and only record the angle measurement (Hz/V) in face I and face II. The point stored is an average of the two measurements.
Fn 2Face	Available for Measure mode: Single and Measure mode: Single (fast) . To take a measurement in Face I and Face II. The point stored is an average of the two measurements. When using instruments fitted with auto aiming, the point is automatically measured in both faces. The resulting point is stored and the instrument is returned to the first face.
Fn IndivID and Fn Run	To change between entering an individual point ID different to the defined ID template and the running point ID according to the ID template. Refer to "25.1 ID templates".
Fn Quit	To exit the application.

Description of fields

Field	Option	Description
Point ID	Editable field	The identifier for measured points. The configured point ID template is used. The ID can be changed: <ul style="list-style-type: none"> To start a new sequence of point IDs overwrite the point ID. For an individual number independent of the ID template Fn IndivID. Fn Run changes back to the next ID from the configured ID template.
Target height	Editable field	The last used target height is suggested when accessing the Survey application. An individual target height can be typed in.
Hz	Display only	The current horizontal angle.
V	Display only	The current vertical angle.
Horiz distance	Display only	The horizontal distance after Dist was pressed. No distance is displayed when accessing the screen and after Store or Meas .
Height difference	Display only	The height difference between station and measured point after Dist . Displays ----- when accessing the screen and after Store or Meas .
Easting	Display only	Easting coordinate of the measured point.
Northing	Display only	Northing coordinate of the measured point.
Elevation	Display only	Elevation of the measured point.

Description

Auto points are used to automatically log points at a specified rate. Additionally, individual auto points can be stored outside the defined rate.

Auto points can be collected in the Survey application. An **Auto** page is visible when logging of auto points is active.

Auto points are used in moving applications to document a track which was walked or driven along. Auto points that are logged between starting and stopping logging of auto points form one chain. A new chain is formed each time logging of auto points is started.

Up to two offset points related to one auto point can be logged. The offset points can be both to the left or right and they can be coded independently of each other and of the auto points.



Logging of auto points is possible for TPS and in the GPS rover menu.

Coding of auto points

Coding of auto points is similar to coding manually occupied points. Refer to "26 Coding" for information on coding.

The differences are:

- Thematical coding: **GPS** Available for **Store points:To DBX (pts&codes)** in **Configuration, Log auto points** page.
- **TPS** Always available.
- Free coding: Always available.
- Quick coding: Not available.
- Codes of auto points overwrite the codes of points with the same point ID but a different code, existing in the working job.
- Codes of auto points can be changed when no auto points are being logged.
- Up to three attributes can be stored with a code.

Averaging of auto points

An average is never calculated for auto points even if a manually occupied point of class **Meas** already exists with the same point ID.

58.2

Configuring Auto Points

Access

Select **Main Menu: Go to Work!, Survey**. Press Fn **Config...**

Configuration, Auto points page

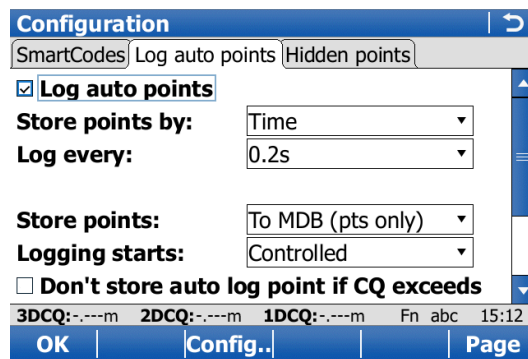

Key	Description
OK	To accept changes and return to the screen from where this screen was accessed.

Key	Description
Config..	To configure what is viewed in the Auto page in the Survey application. Available for Log auto points checked.
Page	To change to another page on this screen.
Fn Quit	To exit the screen.

Description of fields

Field	Option	Description
Log auto points	Check box	Activates the logging of auto points.  All other fields on the screen are active and can be edited.
Store points by	Time Distance Height difference Distance or height Stop & go User decides	<p>Auto points are logged according to a time interval. The time interval is independent from the update interval for the position on the screen.</p> <p>The difference in distance from the last stored auto point, which must be reached before the next auto point is logged. The auto point is logged with the next available computed position.</p> <p>The height difference from the last stored auto point, which must be reached before the next auto point is logged. The auto point is logged with the next available computed position.</p> <p>Before the next auto point is logged, either the difference in distance or the difference in height must be reached. The auto point is logged with the next available computed position.</p> <p>An auto point is stored when the position of the antenna/prism does not move more than the distance configured in Minimum distance between points within the Stop time. Once a point has been stored, the position must change more than the distance configured in Minimum distance between points before the routine starts again.</p> <p>An auto point is stored upon pressing Meas (GPS) / Store (TPS) in Survey, Auto page. In the beginning, the chain to which the auto points will be assigned must be started with Start. In the end, the chain must be closed with Stop.</p>
Log every	Editable field From 0.05s to 60.0s	<p>Available unless Store points by: Distance or height.</p> <p>For Store points by: Distance and Store points by: Height difference. The difference in distance or height before the next auto point is logged.</p> <p>For Store points by: Time. The time interval before the next auto point is logged.</p> <p>For GS05/GS06/GS08plus/GS12 logging rates of 0.2s and slower are supported.</p>

Field	Option	Description
Max distance	Editable field	Available for Store points by: Distance or height . The value for the difference in distance before the next auto point is logged.
Max height	Editable field	Available for Store points by: Distance or height . The value for the height difference before the next auto point is logged.
Minimum distance between points	Editable field	Available for Store points by: Stop & go . The distance within which the position is considered stationary.
Stop time	Editable field	Available for Store points by: Stop & go . The time while the position must be stationary until an auto point is stored.
Store points <input type="checkbox"/> GPS		 Changing this setting while auto points are being logged stops the logging. It must then be restarted.
	To MDB (pts only)	Logs auto point to a job file. Point logging at up to 20 Hz. Coding and logging of offset points is not possible. Points cannot be displayed in MapView or output via format files.
	To DBX (pts&codes)	Logs auto points to the DBX. Point logging at up to 1 Hz. Coding and logging of offset points is possible. Points can be displayed in MapView or output via format files.
Logging starts <input type="checkbox"/> GPS	Automatically	Logging of auto points starts immediately when the Survey screen is accessed.
	Controlled	Logging of auto points starts upon pressing Start on the Auto page in Survey .
Don't store auto log point if CQ exceeds limit <input type="checkbox"/> GPS	Check box	If checked, monitoring of the coordinate quality is activated. Auto points are stored when the coordinate quality is within the defined limit. For example, only phase fixed solutions can be logged by defining a CQ limit.
3D CQ limit <input type="checkbox"/> GPS	Editable field	Available if Don't store auto log point if CQ exceeds limit is checked. Limit for the coordinate quality above which an auto point is no longer automatically stored. When the CQ of the auto point falls again below the defined value then the storing of auto points begins again.
Beep when auto logged point is stored <input type="checkbox"/> GPS	Logging	Instrument beeps when storing an auto point.
	Never	Instrument never beeps.

Next step

IF the survey screen mask	THEN
is not to be configured	OK closes the screen and returns to the previous screen.
is to be configured	Config...

Configure Page

Key	Description
OK	To accept changes and to return to previous screen.
Clear	To set all fields to Line space full .
Default	To recall the default settings.
Fn Quit	To exit the screen.

Description of fields

Field	Option	Description
Name	Editable field	The name of the page is shown as page name in Survey .
Show in the Survey application	Check box	Shows or hides the page as a page in Survey .
1st line	Display only	Fixed to Point ID .
2nd line to 16th line	<p>Angle right [TPS]</p> <p>% completed [GPS]</p> <p>Annotation 1 to Annotation 4</p> <p>Antenna height [GPS]</p> <p>Attrib (free) 01 to Attrib (free) 20</p>	<p>For each line, one of the following options can be selected.</p> <p>Displays the horizontal angle difference between the backsight point and the current telescope position.</p> <p>Display only field for the percentage of the time for which the point has been occupied based on the setting for Stop criteria in screen Quality Control. Appears in the page during the point occupation if Quality Control is checked.</p> <p>Editable field for comments to be stored with the point.</p> <p>Input field for antenna height for static observations.</p> <p>Display only field for attributes for free codes.</p>

Field	Option	Description
	Attrib 01 to Attrib 20	Editable field for attributes for codes.
	Automation <input type="checkbox"/> TPS	Unavailable for SmartStation. Select automation type.
	Avg max #distances <input type="checkbox"/> TPS	Input field for maximum number of distance measurements in the averaging EDM mode.
	Azimuth <input type="checkbox"/> TPS	Display only field for the azimuth.
	Backsight pt ID <input type="checkbox"/> TPS	Display only field for the point ID of the backsight point.
	Code	Editable field for codes.
	Code (free)	Editable field for free codes.
	Code desc (free)	Display only field for the description of free codes.
	Code information	Editable field for additional information relating to the code, such as instructions to the CAD package to start a line and string number and curve information.
	Description	Display only field for the description of codes.
	Easting <input type="checkbox"/> TPS	Display only field for Easting coordinate of measured point.
	GDOP <input type="checkbox"/> GPS	Display only field for the current GDOP of the computed position.
	HDOP <input type="checkbox"/> GPS	Display only field for the current HDOP of the computed position.
	Elevation <input type="checkbox"/> TPS	Display only field for the height coordinate of the measured point.
	Height difference <input type="checkbox"/> TPS	Display only field for the height difference between station and reflector.
	Horiz distance <input type="checkbox"/> TPS	Display only field for horizontal distance.
	Humidity <input type="checkbox"/> GPS	Editable field for relative humidity to be stored with point.
	Hz angle <input type="checkbox"/> TPS	Display only field for the horizontal angle.
	Instrument height <input type="checkbox"/> TPS	Display only field for the instrument height.
	Line space full	Insert full line space.
	Line space half	Insert half line space.
	Linework	Selectable list with option for flagging a line/area.
	Local ellipsoid ht <input type="checkbox"/> GPS	Display only field for the elevation of the current GNSS position.
	Measure mode <input type="checkbox"/> TPS	Select EDM measurement mode.
	Measure <input type="checkbox"/> TPS	Select EDM type.
	Moving antenna ht <input type="checkbox"/> GPS	Input field for antenna height for moving observations.

Field	Option	Description
	Msd PP obs <input type="checkbox"/> GPS	Display only field for the number of static observations recorded over the period of point occupation. Appears in the page when recording of static observations is configured.
	Northing <input type="checkbox"/> TPS	Display only field for Northing coordinate of measured point.
	Number of dists <input type="checkbox"/> TPS	Display only field for number of averaged distances measured with EDM mode averaging.
	Offset left/right <input type="checkbox"/> TPS	Input field for horizontal distance offset for measured point, perpendicular to the line of sight.
	Offset height <input type="checkbox"/> TPS	Input field for height offset for measured point.
	Offset in/out <input type="checkbox"/> TPS	Input field for horizontal distance offset, in the direction of line of sight.
	Offset mode <input type="checkbox"/> TPS	Select offset mode.
	PDOP <input type="checkbox"/> GPS	Display only field for the current PDOP of the computed position.
	PPM atmos <input type="checkbox"/> TPS	Display only field for atmospheric ppm.
	PPM geometric <input type="checkbox"/> TPS	Display only field for geometric ppm value.
	PPM total <input type="checkbox"/> TPS	Display only field for the total ppm value.
	Point ID	Editable field for the point ID.
	Pressure <input type="checkbox"/> GPS	Editable field for atmospheric pressure.
	Prism constant <input type="checkbox"/> TPS	Display only field for additive constant of currently selected reflector.
	Quality 1D <input type="checkbox"/> GPS	Display only field for the current height coordinate quality of computed position.
	Quality 2D <input type="checkbox"/> GPS	Display only field for the current 2D coordinate quality of computed position.
	Quality 3D <input type="checkbox"/> GPS	Display only field for the current 3D coordinate quality of computed position.
	RTK positions <input type="checkbox"/> GPS	Display only field for the number of positions recorded over the period of point occupation. Appears in the page of real-time rover configurations.
	SD (last recorded) <input type="checkbox"/> TPS	Display only field for the last recorded distance.
	Slope distance <input type="checkbox"/> TPS	Display only field for measured slope distance.
	Station ID <input type="checkbox"/> TPS	Display only field for current station ID.
	Station easting <input type="checkbox"/> TPS	Display only field for current station Easting coordinates.
	Station height <input type="checkbox"/> TPS	Display only field for current station height coordinates.
	Station northing <input type="checkbox"/> TPS	Display only field for current station Northing coordinates.

Field	Option	Description
	Std deviation <input type="checkbox"/> TPS	Display only field of standard deviation in millimetres of averaged distances.
	Target <input type="checkbox"/> TPS	Select a prism.
	Target height <input type="checkbox"/> TPS	Input field for prism height.
	Temp dry <input type="checkbox"/> GPS	Editable field for dry temperature to be stored with point.
	Temp wet <input type="checkbox"/> GPS	Editable field for wet temperature to be stored with point.
	Time at point <input type="checkbox"/> GPS	Display only field for the time from when the point is occupied until point occupation is stopped. Appears in the page during the point occupation.
	Type	Display only field for the type of code, for example point code, line code or area code.
	V angle <input type="checkbox"/> TPS	Display only field for vertical angle.
	V angle display <input type="checkbox"/> TPS	Select vertical angle display.
	VDOP <input type="checkbox"/> GPS	Display only field for the current VDOP of the computed position.
	WGS84 ellipsoid ht <input type="checkbox"/> GPS	Display only field for the current GNSS position.
	WGS84 latitude <input type="checkbox"/> GPS	Display only field for the current GNSS position.
	WGS84 longitude <input type="checkbox"/> GPS	Display only field for the current GNSS position.

58.3

Measuring Auto Points

Requirements

- **Log auto points** in **Configuration, Log auto points** page.
- GPS The rover menu must be used.

Access

Select **Main Menu: Go to Work!**, **Survey**. Go to the **Auto** page.

Survey, Auto page

Before logging of auto points has started, the page appears as shown:

Survey: My first job | ↻

Survey | Code | Auto | Map

Auto point ID: Time & date

Free Code: ----

Moving antenna ht: m

Msd auto points: 0

3D CQ: ----m

3DCQ:----m 2DCQ:----m 1DCQ:----m Fn abc 15:14

Stop | Meas | Page

Key	Description
Start	For Logging starts: Automatically in Configuration, Log auto points page, logging of auto points starts immediately when the Survey screen is accessed and Start need not be pressed. To start logging of auto points and offset points if configured or, for Store points by: User decides , to start the chain to which the auto points will be assigned. The first auto point is stored. TPS Measure mode: Continuous becomes active. For Measure: Prism instrument locks onto prism. For Measure mode-Long range (>4km) , Measure: Prism is set and instrument locks onto the prism.
Stop	To end recording of auto points and offset points if configured or, for Store points by: User decides , to end the chain to which the auto points are assigned.
Meas GPS	Available for Stop . To store an auto point at any time.
Store TPS	Available for Stop . To store an auto point at any time.
Offst1..	To configure recording of the first type of offset points. Refer to "58.4.2 Configuring Offset Points". GPS Available for Store points: To DBX (pts&codes) in Configuration, Log auto points page.
Offst2..	To configure recording of a second type of offset points. Refer to "58.4.2 Configuring Offset Points". GPS Available for Store points: To DBX (pts&codes) in Configuration, Log auto points page.
Page	To change to another page on this screen.
Fn Config..	To configure auto points. Refer to "58.2 Configuring Auto Points".
Fn Quit	To exit the Survey application. Point information logged until pressing Fn Quit is saved in the database.

Description of fields

Field	Option	Description
Auto point ID	Editable field	Available unless GPS auto points: Date & time/TPS auto points: Date & time in ID Templates . The identifier for auto points. The configured ID template for auto points is used. The ID can be changed. To start a new sequence of point IDs, type over the point ID.
	Date & time	Available for GPS auto points: Date & time/TPS auto points: Date & time in ID Templates . The current local time and date is used as identifier for auto points.
Moving antenna ht GPS	Editable field	The default antenna height for auto points as defined in the active working style is suggested.
Target height TPS	Editable field	The default reflector height as defined in the active configuration set is suggested.
Code (auto)		The thematical code for the auto point.

Field	Option	Description
	Selectable list	<ul style="list-style-type: none"> If a point code is selected then any open line/area is closed. The occupied point is stored with the selected code independently of any line/area. If a line code is selected then any open line is closed and a new line with the selected code is created. The line ID is defined by the configured line ID template. The occupied point is assigned to that line. The line stays open until it is closed manually or another line code is selected. If an area code is selected then the behaviour is as for lines.
	Editable field	<p>Available if Use a list box to view codes is checked. The attributes are shown as display only, editable field or selectable list fields depending on their definition.</p> <p>Available if Use a list box to view codes is not checked. Codes can be typed in but not selected from a codelist. A check is performed to see if a code of this name already exists in the job. If so, the according attributes are shown.</p> <p>Configure a survey screen mask with a selectable list for code types to define if a point, line or area code is typed in.</p>
Description	Display only	The description of the code.
Msd auto points	Display only	Available after pressing Start . The number of auto points logged since Start has been pressed.
3D CQ <input type="text" value="GPS"/>	Display only	The current 3D coordinate quality of the computed position.
Slope distance	Display only	The measured slope distance. When Start is pressed, Measure mode: Continuous is set and the slope distance is constantly updated.
Hz	Display only	The current horizontal angle.
V	Display only	The current vertical angle.

Next step

IF	THEN
auto points are to be logged	Start . Then, for Store points by: User decides, Meas whenever an auto point is to be logged.
offset points are to be configured	Offst1.. or Offst2... Refer to "58.4 Offset Points of Auto Points".

Description

Offset points

- can be created with auto points when auto points are stored to the DBX.
- can be to the left or to the right of auto points.
- are automatically computed with the logging of auto points, if configured.
- form a chain relative to the chain of auto points to which they are related. Subsequent computed chains are independent from each other.
- can be coded independently of auto points.
- have the same time of when they were stored as the auto points to which they are related.
- have the same coding functionality, properties and averaging functionality as auto points.

Up to two offset points can be related to one auto point.

The screens for the configuration of offset points are identical except for the title **Auto Points - Offset 1** and **Auto Points - Offset 2**. For simplicity, the title **Auto Points - Offset 1** is used in the following description.

Computation of offset points

The computation of offset points depends on the number of auto points in one chain.

One auto point

No offset points are computed or stored.

Two auto points

The configured offsets are applied perpendicular to the line between two auto points.

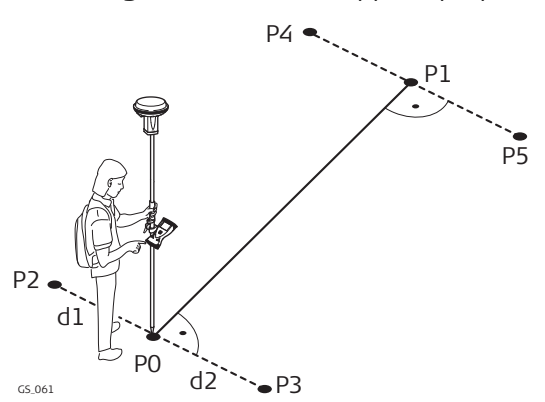

GPS

- P0 First auto point
- P1 Second auto point
- P2 First offset point for P0
- P3 Second offset point for P0
- P4 First offset point for P1
- P5 Second offset point for P1
- d1 Horizontal offset to the left
- d2 Horizontal offset to the right

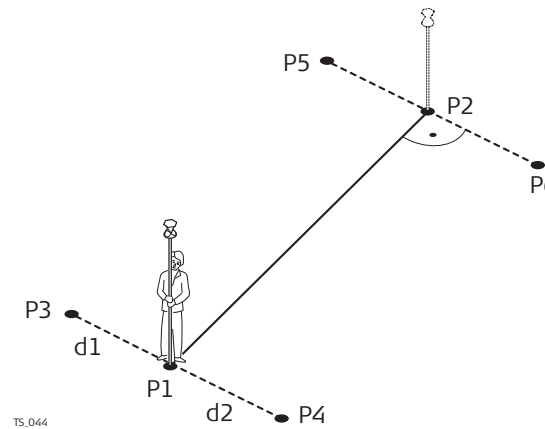

TPS

- P1 First auto point
- P2 Second auto point
- P4 First offset point for P1
- P3 Second offset point for P1
- P5 First offset point for P2
- P6 Second offset point for P2
- d1 Horizontal offset to the left
- d2 Horizontal offset to the right

Three or more auto points

The first offset points are computed perpendicular to the line between the first and the second auto point.

The last offset point is computed perpendicular to the line between the last auto point and the one before.

All other offset points are computed on a bearing. The bearing is half of the angle between the last and the next measured auto point.

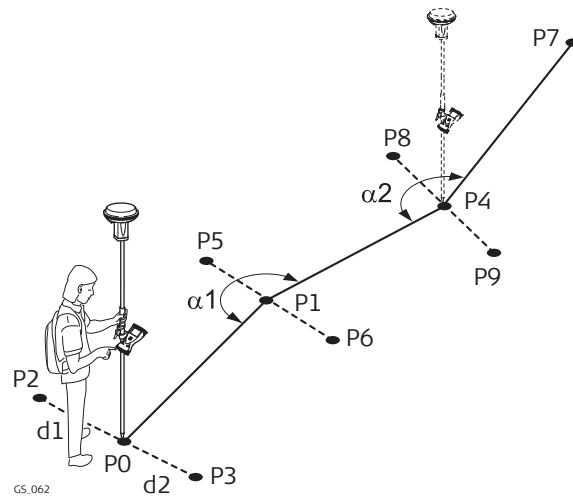

GS_062

GPS

- P0 First auto point
- P1 Second auto point
- P2 First offset point for P0
- P3 Second offset point for P0
- P4 Third auto point
- P5 First offset point for P1
- P6 Second offset point for P1
- P7 Fourth auto point
- P8 First offset point for P4
- P9 Second offset point for P4
- d1 Horizontal offset to the left
- d2 Horizontal offset to the right
- α_1 Angle between P0 and P4
- α_2 Angle between P1 and P7

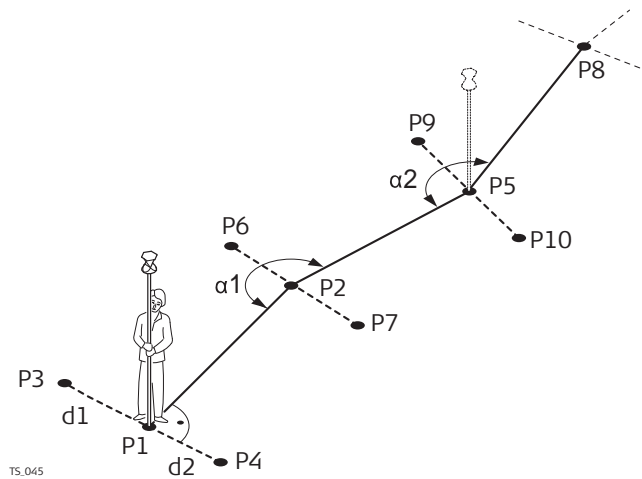

TS_045

TPS

- P1 First auto point
- P2 Second auto point
- P3 First offset point for P1
- P4 Second offset point for P1
- P5 Third auto point
- P6 First offset point for P2
- P7 Second offset point for P2
- P8 Fourth auto point
- P9 First offset point for P5
- P10 Second offset point for P5
- d1 Horizontal offset to the left
- d2 Horizontal offset to the right
- α_1 Angle between P1 and P5
- α_2 Angle between P2 and P8

Requirements

GPS Available for **Store points: To DBX (pts&codes)** in **Configuration, Log auto points** page.

Access

Press **Offst1..** or **Offst2..** in **Survey, Auto** page.

Auto Points - Offset
1,
General page

Auto Points - Offset 1 | ↩

General | Code

Store offset 1 points

Horiz distance: m

Height offset: m

Identifier:

Prefix/suffix:

3DCQ:0.016m 2DCQ:0.008m 1DCQ:0.013m Fn abc 14:18

OK | Offst2.. | Page

Key	Description
OK	To accept changes and return to the screen from where this screen was accessed.
Offst2.. and Offst1..	To switch between configuring offset point type one and two.
Page	To change to another page on this screen.
Fn Quit	To exit the screen.

Description of fields

Field	Option	Description
Store offset 1 points and Store offset 2 points	Check box	Activates logging of offset points.  All other fields on the screen are active and can be edited with this setting.
Horiz distance	Editable field	The horizontal offset between -1000 m and 1000 m at which the offset point is collected.
Height offset	Editable field	The height offset between -100 m and 100 m from the related auto point.
Identifier	Editable field	The identifier with up to four characters is added in front of or at the end of the ID of the auto point. This ID is then used as the point ID for the related offset point. This functionality could support an automatic workflow into CAD packages including setting symbols and stringing lines.
Prefix/suffix	Prefix	Adds the setting for Identifier in front of the auto point ID.
	Suffix	Adds the setting for Identifier at the end of the auto point ID.

Next step

Page changes to the **Code** page.

Auto Points - Offset
1,
Code page

Auto Points - Offset 1	
General	Code
Point code:	BM
Description:	Bench Mark

3DCQ:0.020m	2DCQ:0.011m	1DCQ:0.016m	Fn abc	14:18
OK	+Attrib	Last	Default	Page

Key	Description
OK	To accept changes and return to the screen from where this screen was accessed.
+Attrib	To create additional attributes for the selected code. Available if Use a list box to view codes is checked.
Name or Value	To highlight the attribute field or the field for the attribute value. The name of the attribute can be edited and an attribute value can be typed in. Available if Use a list box to view codes is checked. Available for attributes for which an attribute name can be typed in.
Last	To recall the last used attribute values for the selected code. Available if Use a list box to view codes is checked.
Default	To recall the default attribute values for the selected code. Available if Use a list box to view codes is checked.
Page	To change to another page on this screen.
Fn Quit	To exit the screen.

Description of fields

Field	Option	Description
Point code	Selectable list	The thematical code for the offset point. Available if Use a list box to view codes is checked. The attributes are shown as display only, editable field or selectable list fields depending on their definition.
Code	Editable field	The thematical code for the offset point. Available if Use a list box to view codes is checked. Codes can be typed in but not selected from a codelist. A check is performed to see if a point code of this name already exists in the job. If so, the according attributes are shown.
Description	Display only	Available if Use a list box to view codes is checked. The description of the code.
Attributes	Editable field	Available if Use a list box to view codes is checked. Up to three attribute values can be stored.

Next step

IF	THEN
offset point configuration is finished	OK to return to the survey screen.
a second offset point is to be configured	Page and then Offst2.. or Offst1.. to change to configuration screen for the second point.

Example for offset point IDs

The offset point ID is a combination of the auto point ID and an identifier as a prefix or suffix.

The right most part of the auto point ID is incremented within the point ID. If the length of the auto point ID plus identifier is greater than 16 characters, then the auto point ID is truncated from the left.

Auto point ID	Identifier	Prefix/Suffix	Offset point ID
Auto1234 Auto1235	OS1	Prefix	OS1Auto1234 OS1Auto1235 ...
Auto1234 Auto1235	OS1	Suffix	Auto1234OS1 Auto1235OS1 ...



Refer to "25.1 ID templates" for more information on point IDs.

Description

The Survey Cross Section application allows for the automatic changing of codes during a survey. This function is useful when surveying multiple cross sections. Examples could include surveys of railway lines, roads, small waterways, driveways and paths.

The codes for the elements in the cross section to be surveyed are all stored and pre-defined in a template. The codes are then automatically changed after each point observation.

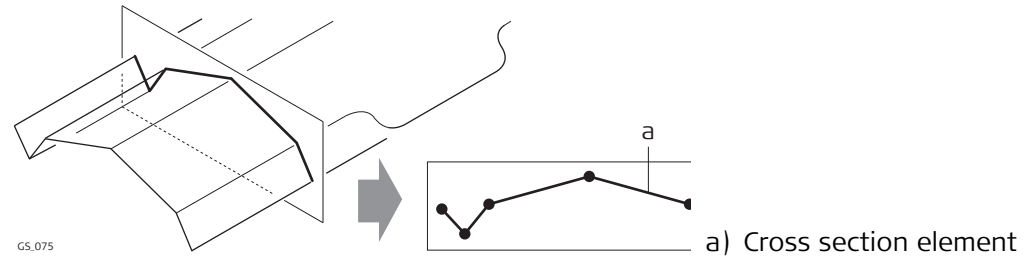
Diagram**Template**

Templates are used to pre-define the order of the codes for the survey.

A template pre-defines

- the coding sequence of a cross section.
- the type of coding.

Cross section methods and directions

Templates can be applied

- to the ZigZag method or the Same Direction method.
- in either a forward direction or in a backward direction.

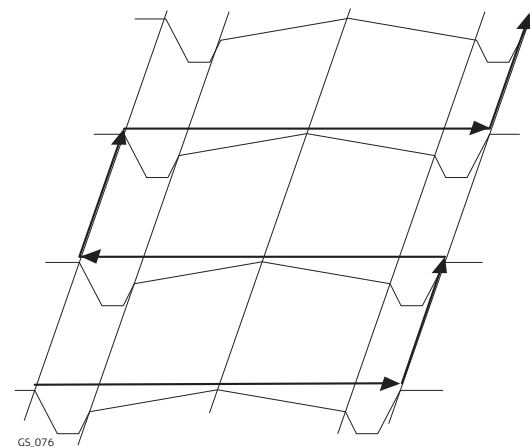
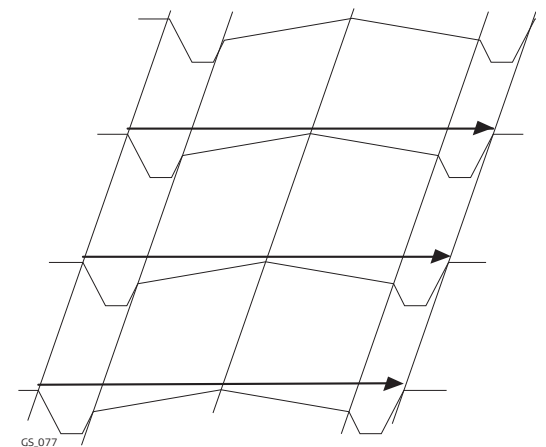
ZigZag**Same Direction**

Survey Cross Section is possible for RTK rover and TPS.

Coding of cross section elements

Codes can be attached to cross section elements. Refer to "26 Coding" for information on coding.

- Thematical coding: Available
- Free coding: Available
- Quick coding: Not available

Averaging of cross section elements

The principles for averaging are identical to the principles use in the Survey application. Refer to "6.3.3 Mean Page" for information on averaging.

Exporting data

The points and lines are recorded as for all other applications. The data can be exported as normal.

59.2

Accessing Survey Cross Section

Access

Select **Main Menu: Go to Work!\Survey+\Survey cross section.**

Description

Cross section templates

- pre-define the sequence of codes for a cross section.
- consist of elements.

Elements can be defined such that the surveyed points of a cross section are

- stored with a point code.
- stored with a free code.

During the process of surveying a cross section, the code for the next element to be measured is then selected and suggested automatically.

Survey X Section - Templates

All cross section templates stored in the working job are listed in alphabetical order, including the number of elements in each cross section template.



Templates	No. elements
Template 1	2
Template 2	4



OK	New..	Edit..	Delete	Copy..
----	-------	--------	--------	--------

Key	Description
OK	To select the highlighted cross section template and to start surveying a cross section.
New..	To create a cross section template.
Edit..	To edit the highlighted cross section template.
Delete	To delete the highlighted cross section template.
Copy..	To create a cross section template based on the one currently highlighted.
Fn Quit	To exit the application.

Access

In **Survey X Section - Templates**, press **New..**, **Copy..** or **Edit..**

**New Template/Edit
Template/Copy
Template,
General page**

Type in a name for the new cross section template.

Next step

Page changes to the **Elements** page.

**New Template/Edit
Template/Copy
Template,
Elements page**

New Template		
General		Elements
No.	Code	Code type
1	EL	Point
2	LHP	Free
3	KD	Free
4	SV	Point

3DCQ:0.009m	2DCQ:0.005m	1DCQ:0.008m	Fn abc	10:01	
Store	Add	Edit..	Delete	Insert	Page

Key	Description
Store	To store the cross section template and to return to the screen from where this screen was accessed.
Add	To add one or more elements to the end of the current list.
Edit..	To edit the highlighted element.
Delete	To delete the highlighted element from the list.
Insert	To insert one element before the currently highlighted element of the list.
Page	To change to another page on this screen.
Fn Quit	To exit the application.

Description of columns

Field	Description
No.	The number of the element.
Code	The code assigned to the element. If no code is assigned to the element, ----- is displayed.
Code type	The type of the code assigned to the element.

Next step

Add, **Edit..** or **Insert** accesses **Add Element/Edit Element/Insert Element**.

Add Element/Edit Element/Insert Element

The functionality of the screens adding, editing and inserting an element are similar. Differences are outlined.

Add Element | ↻

Element number: 5

Code type: Free codes ▾

Store free code: Before pt is stored ▾

Code (free): FL ↕

Description: FenceLine

3DCQ:0.009m 2DCQ:0.005m 1DCQ:0.008m Fn abc 10:01

OK | Next

Key	Description
OK	To add the element at the end of the cross section template or to store the changes. To return to the screen from where this screen was accessed.
Next	In Add Element : To add the element to the end of the Elements list and stay in the Add Element screen to add further elements. In Edit Element : To update the element in the Elements list and stay in the Edit Element screen to edit details of the next element in the list.
Prev	Available in Edit Element . To update the element in the Elements list and stay in the Edit Element screen to edit details of the previous element in the list.
Fn Quit	To exit the application.

Description of fields

Field	Option	Description
Element number	Display only	For Add Element and Insert Element : The number of the element to be added. For Edit Element : Displayed as x/y. x Number of the element to be edited. y Total number of elements on the active template.
Code type	Free codes Thematic codes	The type of code to be used with the element. To store a code independent of the element as time-related information. To store a code together with the element.
Store free code	After pt is stored or Before pt is stored	Determines if a free code is stored before or after the point. Available for Code type: Free codes .
Code (free)	Selectable list	The code which will be stored before or after the point/line. Available for Code type: Free codes .
Code	Selectable list	The code which will be stored with the next point/line. Available for Code type: Thematic codes .
Description	Display only	A line for a detailed description of the code.

Next step
OK adds the element or stores the changes.

59.4

Surveying Cross Sections

Description

The fields on this screen indicate which cross section element is to be surveyed next.

Access

Press **OK** in **Survey X Section - Templates**.

Survey, General page

The pages shown are from a typical working style. An additional page is available when a user-defined survey screen page is used.

Survey: Job name	
General	Code Map
Point ID:	GPS0001
Antenna height:	2.000 m
Template:	Template 3
Element:	1/5
Code:	EL
Distance to last:	-----m
3D CQ:	0.009m
3DCQ:0.009m 2DCQ:0.005m 1DCQ:0.008m Fn abc 10:02	
Meas	End Survey.. Page

Key	Description
Meas	Available if a template has been opened with Start . GPS To start measuring the next point of the cross section. The key changes to Stop . TPS To measure a distance and store distance and angles.
Stop GPS	To end measuring the point. The key changes to Store .
Store	GPS To store the measured point. The key changes to Meas . TPS To store angles and distance. Distance must be measured before.
Dist TPS	To measure a distance.
Start and End	To open and close the selected cross section template. While the template is open, the elements of the cross section can be surveyed.
Survey..	To manually measure a point that is not part of the cross section. The point is not treated as an element of the cross section. The open template remains open. Available if a template has been opened with Start .
Page	To change to another page on this screen.
Fn Config..	To configure the Cross Section Survey application. Refer to "59.5 Configuring Survey Cross Section".
Fn Prev	To select the previous element of the cross section template. The currently measured element will not be stored. Available when End is displayed.
Fn Next	To select the next element of the cross section template. The currently measured element will not be stored. Available when End is displayed.

Key	Description
Fn IndivID and Fn Run	To change between entering an individual point ID different to the defined ID template and the running point ID according to the ID template. Refer to "25.1 ID templates".
Fn Quit	To exit the application.

Description of fields

Field	Option	Description
Point ID	Editable field	The identifier for manually measured points. The configured point ID template is used. The ID can be changed in the following ways: <ul style="list-style-type: none"> To start a new sequence of point IDs type over the point ID. For an individual point ID independent of the ID template Fn IndivID. Fn Run changes back to the next ID from the configured ID template.
Antenna ht	Editable field	GPS The default antenna height. Changing the antenna height here does not update the default antenna height as defined in the active working style. The changed antenna height is used until the application is exited.
Target height	Editable field	TPS The default prism height.
Template	Selectable list	The active template for the cross section. The cross section template is closed. Opening the selectable list accesses Survey X Section - Templates where a new template can be created and an existing template can be selected or deleted. Refer to "59.3 Creating/Editing a Cross Section Template".
	Display only	The cross section template is open.
Element	Display only	Displayed as x/y. x The number of the next element on active template. The number increases/decreases as moving across the cross section depending on the selection for Method in Configuration . y Total number of elements on active template.
Code	Display only	The name of the code. Point codes will be stored with the measured point. Free codes will be stored, depending on the configuration, before or after the measured point.
Distance to last	Display only	The horizontal distance from the current position to the last surveyed element position in the previous cross section. ----- is displayed for unavailable information.

Next step

IF	THEN
a cross section template is to be opened	select the desired template and press Start .
an element of a cross section is to be surveyed	<p>GPS Meas, Stop and then Store.</p> <p>TPS Meas, or Dist and then Store.</p> <p>Once the end of a cross section is surveyed then the next cross section will be measured. Depending on the Method selected in Configuration, General page, the measurement is either in the same direction or in the reverse direction.</p>
a cross section template is to be closed	select the desired template and press End .
data is to be viewed graphically	Page . An element of a cross section template can also be surveyed from the Map page. Refer to "37 MapView Interactive Display Feature" for information on the functionality and softkeys available.
the application is to be exited	Fn Quit .

59.5

Configuring Survey Cross Section

Access

In the survey screen of the cross section application, press **Config...**

Configuration, General page

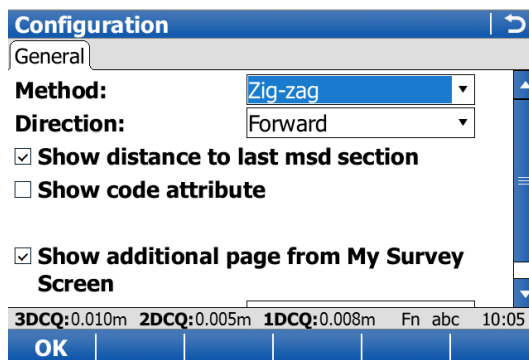

Key	Description
OK	To accept changes and return to the screen from where this screen was accessed.
Config..	To edit the survey screen page currently being displayed. Available when a list item in Page to show is highlighted. Refer to "25.3 My Survey Screen".
Fn About	To display information about the program name, the version number, the date of the version, the copyright and the article number.
Fn Quit	To exit the application.

Description of fields

Field	Option	Description
Method	Zig-zag	Method by which subsequent cross sections will be surveyed. Refer to "59.1 Overview" for a diagram. Each new cross section is started at the same end as where the previous cross section finished.
	Same direction	Each new cross section is started at the same end as where the previous cross section started.
Direction	Forward	The way of surveying the cross section. This influences in which order the elements of a template will be applied. Refer to "59.1 Overview" for a diagram. The cross sections will be surveyed in the same way as the elements are defined in the selected template.
	Backward	The cross sections will be surveyed in the reverse way as the elements are defined in the selected template.
Show distance to last msd section	Check box	Activates a display only field in the survey screen. The horizontal distance from the current position to the last surveyed element position in the previous cross section will be displayed.
Show code attribute	Check box	When this box is checked, some attribute fields are displayed in the survey screen. Useful if the surveyor is stringing, to see that the correct string attribute value is being used.
Attribute to show	From 1 to 20	The number of attribute fields which is displayed in the survey screen. Available when Show code attribute is checked.
Show additional page from My Survey Screen	Check box	When this box is checked, a user-defined survey screen page is shown in the survey screen.
Page to show	Selectable list	The names of the available survey screen pages. Available when Show additional page from My Survey Screen is checked.

Next step

OK returns to the screen from where this screen was accessed.

Description

Hidden points are points which cannot be measured directly by GPS, because, either they cannot be physically reached, or because satellites are obstructed, for example by trees or tall buildings.

- A hidden point can be calculated by measuring distances and/or azimuths to the hidden point using a hidden point measurement device. Or for distances a tape can be used.
- Additional auxiliary points can be manually measured.
- Bearings can be computed from previously measured points.

In contrast to the COGO application, hidden point measurements is more of a measuring application than a calculation application.

Example

Application:	Completing a survey of telegraph poles for a telecommunication company.
Aim:	The telegraph poles must be surveyed to 0.3 m accuracy in plan but height is not of concern.
Use of hidden point measurements:	For poles surrounded by heavy undergrowth, where it is not possible to measure the pole directly without taking time to cut a path through the undergrowth.



Changing coordinates of a point which has been previously used in hidden point measurements does not result in the hidden point being recomputed.

Hidden point measurement methods

A hidden point can be measured by

- | | |
|---|---|
| <ul style="list-style-type: none"> • Bearing and distance • Two bearings • Two distances | <ul style="list-style-type: none"> • Chainage and offset • Backwards bearing and distance |
|---|---|



A hidden point measurement device can be attached to the instrument such that the measurements are automatically transferred to the instrument.

Heights

If configured, heights are taken into account. Refer to "60.7 Hidden Point Measurement Including Heights" for information on configuring height offsets.

Device height and **Target height** configured in **Hidden Point Device Offsets** are applied when the hidden points are computed. **Δ height** in **Hidden Point Connection** is the value directly from the hidden point measuring device.

Coding of hidden points

- Thematical coding: Available in **Hidden Point Result** after the calculation of a hidden point. Thematical coding of hidden points is identical to coding of manually measured points.
- Free coding: Can be started while in **Hidden Point Connection**. Free coding of hidden points is identical to coding of manually measured points.
- Quick coding: Not available.

Averaging of hidden points

An average is calculated for hidden points if a point of class **Meas** already exists with the same point ID.



Azimuth is used throughout this chapter. This term must always be considered to mean also **Bearing**.

Auxiliary points

Auxiliary points are used to compute azimuths required for the calculation of hidden point coordinates. Auxiliary points can be points existing in the job or they can be manually measured. The point ID template configured for **Auxiliary points** in **ID Templates** is applied.

60.2

Hidden Point Methods

60.2.1

Bearing & Distance

Description

One point must be known. It

- can already exist in the job.
- can be manually measured during the hidden point measurements.
- can be manually typed in.

The distance and the bearing from the known point to the hidden point are to be determined. An auxiliary point helps compute the bearing which might not be known. The auxiliary point can be determined in the direction from the known point to the hidden point.

Diagram

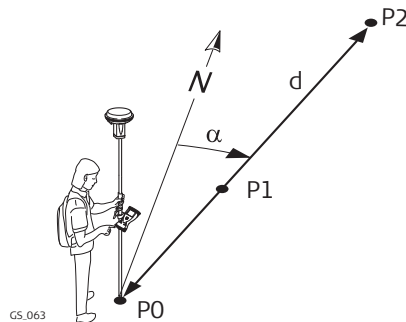

Known

P0 Known point

To be measured

d Distance from P0 to P2

α Bearing from P0 to P2

P1 Auxiliary point, optional

Unknown

P2 Hidden point

60.2.2

Using 2 Bearings

Description

Two points must be known. They

- can already exist in the job.
- can be manually measured during the hidden point measurements.
- can be manually typed in.

The bearings from the known points to the hidden point are to be determined. Auxiliary points help compute the bearings which might not be known. Auxiliary points can be measured in the direction from the known points to the hidden point.

Diagram

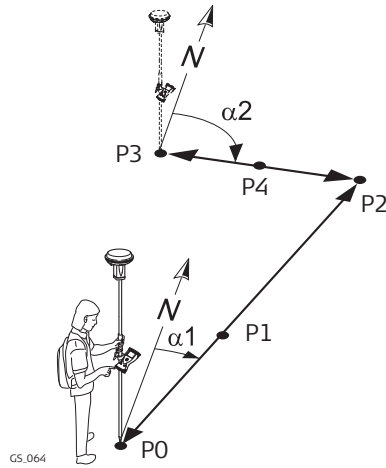

Known

P0 First known point

P3 Second known point

To be measured

α_1 Bearing from P0 to P2

α_2 Bearing from P3 to P2

P1 First auxiliary point, optional

P4 Second auxiliary point, optional

Unknown

P2 Hidden point

60.2.3

Using 2 Distances

Description

Two points must be known. They

- can already exist in the job.
- can be manually measured during the hidden point measurements.
- can be manually typed in.

The distances from the known points to the hidden points are to be determined. The location of the hidden point relative to the line between the two known points is to be defined.

Diagram

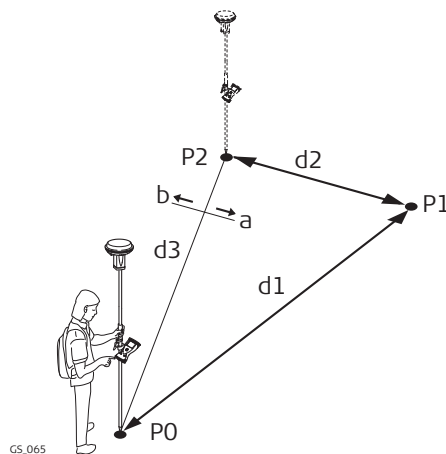

Known

P0 First known point

P2 Second known point

d3 Line from P0 to P2

a Right of d3

b Left of d3

To be measured

d1 Distance from P0 to P1

d2 Distance from P2 to P1

Unknown

P1 Hidden point

60.2.4

Chainage & Offset

Description

Two points must be known. They

- can already exist in the job.
- can be manually measured during the hidden point measurements.
- can be manually typed in.

The chainage from one known point along the line between the two known points must be determined. The offset of the hidden point to the line between the two known points must be determined.

Diagram

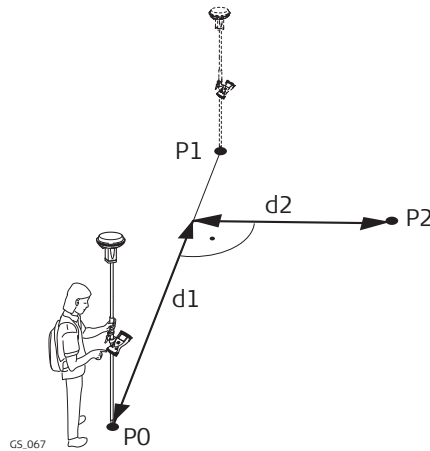

Known

P0 First known point

P1 Second known point

To be measured

d1 Chainage

d2 Offset

Unknown

P2 Hidden point

60.2.5

Backwards Bearing & Distance

Description

In order to compute the hidden point, the measurements are taken from the hidden point.

One point must be known. It

- can already exist in the job.
- can be manually measured during the hidden point measurements.
- can be manually typed in.

The distance and the bearing from the hidden point to the known point are to be determined. An auxiliary point helps compute the bearing which might not be known. An auxiliary point can be measured in the direction from the hidden point to the known point.

Diagram

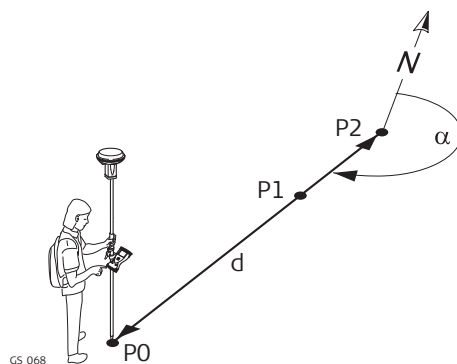

Known

P0 Known point

To be measured

α Bearing from P2 to P0

d Distance from P2 to P0

P1 Auxiliary point, optional

Unknown

P2 Hidden point



Hidden point measurements are possible from the Survey application and when the Survey application screen is called from another application, for example from Stakeout.

Access

Press **HdnPt..** in the survey screen.

Hidden Point Measurement

The setting for **Method** on this screen determines the availability of the subsequent fields and softkeys.

Hidden Point Interface | ↻

Method: Bearing & distance ▾

Point: P101 ↕

Azimuth: 20.0000 g

Horiz distance: 26.000 m



3DCQ:6.429m 2DCQ:4.139m 1DCQ:4.920m Q1 abc 10:47

Calc | | | | Survy..

Key	Description
Calc	To calculate the hidden point and to display the results.
EAO	Available for Angle offset: New for each point or Angle offset: Permanent in Hidden Point Device Offsets . To change or enter an External Angle Offset .
Hts..	To type in the device and target heights to be considered.
Sun	Available when Azimuth is highlighted. The azimuth from the direction of the sun to the known point is computed.
Azmth	Available when Azimuth is highlighted. To select or manually measure an auxiliary point and to compute the azimuth.
Posn ?	To determine chainage and offset of the current position relative to the line between the two known points. The values are displayed in Chainage and Offset . The point from where the chainage has been measured is selected in Chainage from .
Slope	Available when Horiz distance or Chainage is highlighted. To measure a slope distance and an elevation angle or percentage grade. The values are used to compute the horizontal distance.
Survy..	Available when a point field is highlighted. To measure the known point manually for the calculation of the hidden point.
Fn Config..	To configure hidden point measurements. Refer to "19 Connections.. - All other connections".
Fn Quit	To exit the screen.

Description of fields

Field	Option	Description
Method	Selectable list	The method for measuring hidden points. Refer to "60.2 Hidden Point Methods" for a description of the methods.

Field	Option	Description
Point	Selectable list	The point ID of the current position. This point is the known point for the calculation of the hidden point.  To type in coordinates manually for the known point open the selectable list and create a new point.
Point A	Selectable list	The point ID of the current position. This point is the first known point for the calculation of the hidden point.  To type in coordinates manually for the known point open the selectable list and create a new point.
Point B	Selectable list	The point ID of the current position. This point is the second known point for the calculation of the hidden point.  To type in coordinates manually for the known point open the selectable list and create a new point.
Azimuth	Editable field	The azimuth from the known point to the hidden point. Type in an azimuth. When a hidden point measurement device is attached to the instrument to measure the azimuth, the value is automatically transferred.
Horiz distance	Editable field	The horizontal distance from the known point to the hidden point. Type in a distance. When a hidden point measurement device is attached to the instrument to measure the distance, the value is automatically transferred.
Location	Selectable list	Available for Method: Using 2 distances . The location of the hidden point relative to the line from Point A to Point B .
Chainage from	Selectable list	Available for Method: Chainage & offset . The chainage from one known point along the line between the two known points. Looking from the point selected in Chainage from , a positive chainage is towards the second known point. A negative chainage is into the opposite direction of the second known point.

Next step

Calc calculates the hidden point and displays the results in **Hidden Point Result**.

Computed distances on Hidden Point Result

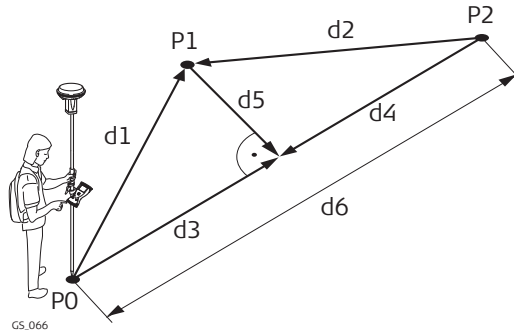

- P0 First known point
- P1 Hidden point
- P2 Second known point
- d1 Distance from P0 to P1
- d2 Distance from P2 to P1
- d3 **Check chainage A**
- d4 **Check chainage B**
- d5 **Check offset**
- d6 **Check distance AB**

Hidden Point Result

Hidden Point Result ↩

Result	Code	Plot
Point ID: GPS0001		

3DCQ:0.008m **2DCQ:**0.004m **1DCQ:**0.007m Q1 abc 09:50

Store
Next
Page

Key	Description
Store	To store the result.
Fn IndivID and Fn Run	To change between entering an individual point ID different to the defined ID template and the running point ID according to the ID template.
Next	To store the hidden point and to return to Hidden Point Measurement . Another hidden point can be measured.
Fn Quit	To not store the hidden point and to exit the screen.

Description of fields

Field	Option	Description
Point ID	Editable field	The identifier for the hidden point. The configured point ID template is used. The ID can be changed. Type in a point ID.
Check distance AB	Display only	Available for Method: Using 2 bearings and Method: Using 2 distances . The computed horizontal distance between Point A and Point B .
Check bearing AB	Display only	Available for Method: Using 2 bearings and Method: Chainage & offset . The computed bearing from Point A to Point B .
Check distance A	Display only	Available for Method: Using 2 bearings and Method: Chainage & offset . The computed horizontal distance between Point A and the hidden point.

Field	Option	Description
Check distance B	Display only	Available for Method: Using 2 bearings and Method: Chainage & offset . The computed horizontal distance between Point B and the hidden point.
Check chainage A	Display only	Available for Method: Using 2 distances . The computed distance on the line from Point A to Point B from Point A to the point of intersection with Check offset .
Check chainage B	Display only	Available for Method: Using 2 distances . The computed distance on the line from Point B to Point A from Point B to the point of intersection with Check offset .
Check offset	Display only	Available for Method: Using 2 distances . The computed perpendicular distance from the hidden point to the line from Point A to Point B .

Next step

On the **Code** page, type in a code if desired.

On the **Map** page, measured distances are indicated by solid arrows, bearings are indicated by half solid and half dashed arrows.

Store stores the hidden point.

60.5

60.5.1

Computing an Azimuth

Using the Sun

Description

The azimuth for a hidden point measurement can be computed using a known point and the sun. The known point can be manually measured. The location of the hidden point can be away from the sun or in the direction towards the sun. Ensure that the shadow of the pole falls in the direction of the point.

Diagram

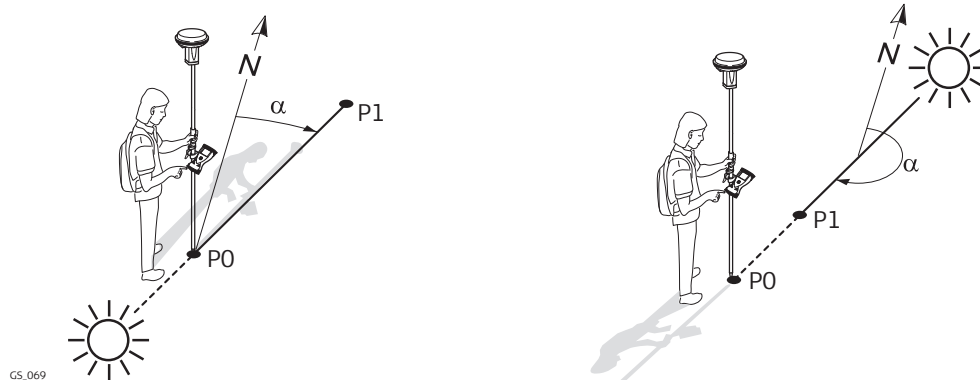

P0 Known point
P1 Hidden point
 α Bearing from P0 to P1

P0 Known point
P1 Hidden point
 α Bearing from P0 to P1

Requirements

Bearing & distance, Using 2 bearings or **Back brng & distance** must be selected for **Method**.

Access

In **Hidden Point Measurement** highlight **Azimuth**. Press **Sun**. Follow the instructions on the screen.

60.5.2

Using Auxiliary Point

Description

The azimuth for a hidden point measurement can be computed using an auxiliary point. The auxiliary point

- can already exist in the job.
- can be manually measured during the hidden point measurements.
- can be manually typed in.

The location of the auxiliary point can be in the direction towards the hidden point or away from the hidden point.

Diagram

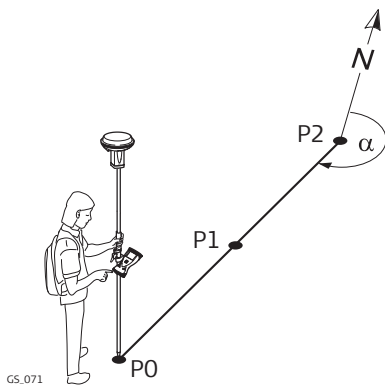

P0 Known point
P1 Auxiliary point, **Azimuth Pt**
P2 Hidden point
 α Bearing from P2 to P0

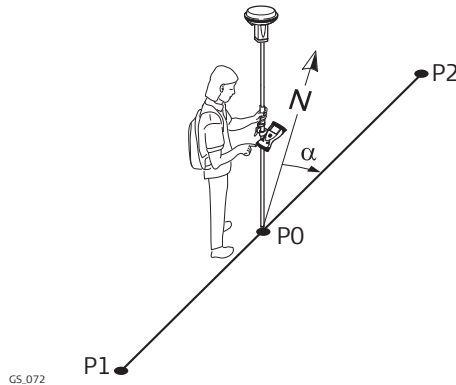

P0 Known point
P1 Auxiliary point, **Azimuth Pt**
P2 Hidden point
 α Bearing from P0 to P2

Requirements

Bearing & distance, Using 2 bearings or **Back brng & distance** must be selected for **Method**.

Access

In **Hidden Point Measurement** highlight **Azimuth**. Press **Azmth**.

Choose Azimuth Point

Choose Azimuth Point | ↻

Azimuth Pt:

Direction:

3DCQ:0.010m 2DCQ:0.005m 1DCQ:0.009m Q1 abc 09:51

Key	Description
OK	To accept changes and return to the screen from where this screen was accessed. The azimuth is computed and displayed in Azimuth in Hidden Point Measurement .
Survey..	Available for Azimuth Pt being highlighted. To measure the auxiliary point manually for the calculation of the azimuth.
Fn Quit	To exit the screen.

Description of fields

Field	Option	Description
Azimuth Pt	Selectable list	The auxiliary point for the calculation of the azimuth.
Direction	Selectable list	The location of the auxiliary point relative to the hidden point.

Next step

OK closes the screen.

60.6

Computing Horizontal Distances from Slope Distances

Description

The horizontal distance for a hidden point measurement can be computed using a slope distance, and an elevation angle or percentage grade. The slope distance and the elevation angle can either be typed in or measured with a hidden point measurement device.

Diagram

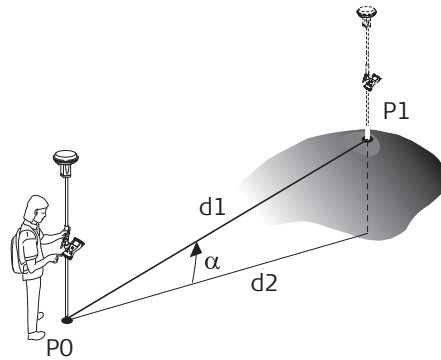

GS_073

- P0 Known point
- P1 Hidden point
- d1 Slope distance
- d2 Horizontal distance
- α Elevation angle

Requirements

Bearing & distance, Using 2 bearings or **Back brng & distance** must be selected for **Method**.

Access

In **Hidden Point Measurement** highlight **Horiz distance**. Press **Slope**.

Slope distance

Slope distance	
Slope distance:	<input type="text" value="5.850"/> m
Elevation angle:	<input type="text" value="25.0000"/> g
Grade (%):	<input type="text" value="41.4"/> %
Horiz distance:	5.405m

3DCQ:0.010m 2DCQ:0.005m 1DCQ:0.009m Q1 abc 09:53

OK

Key	Description
OK	To take over the result.
Fn Quit	To exit the screen.

Description of fields

Field	Option	Description
Slope distance	Editable field	Type in a distance from the known point to the hidden point. When a hidden point measurement device is attached to the instrument to measure the distance, the value is automatically transferred.
Elevation angle	Editable field	Type in the elevation angle from the known point to the hidden point. When a hidden point measurement device is attached to the instrument to measure the elevation angle, the value is automatically transferred.
Grade (%)	Editable field	The grade from the known point to the hidden point is automatically computed from the slope distance and the elevation angle.  The value for Grade (%) can be typed in instead of the value for Elevation angle . Then Elevation angle is computed automatically.
Horiz distance	Display only	The horizontal distance from the known point to the hidden point is automatically computed from the slope distance and the elevation angle.
Δ height	Display only	Available if using heights is configured. The height difference between the known point and the hidden point is automatically computed from the slope distance and the elevation angle.

Next step

OK returns to **Hidden Point Measurement**. The horizontal distance is displayed in **Horiz distance**.

Diagram

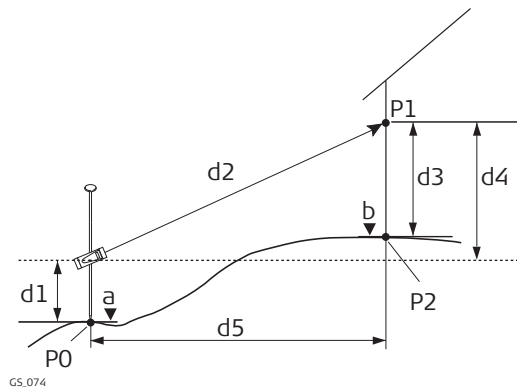

- P0 Known point
- P1 Target point
- P2 Hidden point
- a Height of P0
- b Height of P2 = $a + d1 + d4 - d3$
- d1 Device height: Height of hidden point measurement device above P0
- d2 Slope distance
- d3 Target height: Height of P1 above P2
- d4 Height difference between hidden point measurement device and P1
- d5 Horizontal distance

Configuration step-by-step

Step	Description
1.	Compute height for hidden points is checked in Configuration.
2.	Height offset: Device & target ht in Hidden Point Device Offsets.

Hidden Point Measurement

Description of fields

Field	Option	Description
Δ height	Selectable list	The positive or negative height difference between the centre of the hidden point measurement device and the target point. Type in the value. When a hidden point measurement device is attached to the instrument to measure the height difference, the value is automatically transferred. ☞ For hidden point measurement methods using two known points, Δ height must be determined from each known point. Refer to "60.3 Hidden Point Measurements" for a description of all other fields on the screen.

Next step
Press **Hts...**

Device & Target Height

Description of fields

Field	Option	Description
Device ht at pt A	Editable field	The height of the hidden point measurement device above Point A .
Target height	Editable field	The height of the target point above the hidden point when measured from Point A .
Device ht at pt B	Editable field	Available for hidden point measurement methods using two known points. The height of the hidden point measurement device above Point B .

Field	Option	Description
Target height	Editable field	Available for hidden point measurement methods using two known points. The height of the target point above the hidden point when measured from Point B .

Next step

OK closes the screen and returns to **Hidden Point Measurement**.

There, **Δ height** still displays the positive or negative height difference between the centre of the hidden point measurement device and the target point. The heights of the hidden point measurement device above the ground, and the target point above the hidden point, are applied when the hidden point is computed. For hidden point measurement methods using two known points, this computation is done for each known point. In this case, the height of the hidden point is the average.

Description

Hidden points cannot be measured directly by a TPS instrument, because they are not directly visible.

A hidden point can be calculated from measurements to prisms mounted on a hidden point rod. The spacing and length of the hidden point rod are known. The hidden point rod can be held at any angle, as long as it is stationary for all measurements.

Measurements for the hidden point are calculated as if the hidden point was observed directly. These calculated measurements can also be recorded.

The hidden point rod can have either two or three prisms. If three prisms are used the average will be calculated.

Hidden point rod

The prisms on the hidden point rod are also called auxiliary points after they have been measured.

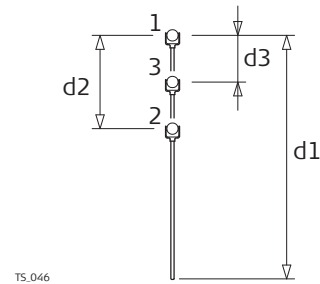

TS_046

- 1 Prism 1
- 2 Prism 2
- 3 Prism 3
- d1 Rod length
- d2 Distance from prism 1 to prism 2
- d3 Distance from prism 1 to prism 3

Hidden point tasks

The Hidden Point application can be used for the following tasks:

- The hidden point application can be used to obtain accurate three-dimensional coordinates for a point that is blocked from direct measurement by an obstruction.
- Determination of flow line locations and elevations in manholes, without measuring from the manhole rim to the flow line, and then estimating corrections for nonverticality of the measuring tape and eccentricity from the rim measurement to the flow line.
- Determination of recesses in building corners for detailed surveys, without estimating right angle offsets, with or without taping of the dimensions.
- Measurements behind overhangs, buttresses and columns for quantity determinations in underground construction or mining, without estimating right angle offsets, with or without taping of the dimensions.
- Measurements of industrial process piping or other equipment in close quarters.
- Detailed architectural surveys for remodelling or cultural preservation or restoration work
- Any place where accurate measurements would require many more instrument setups in order to achieve line of sight from the instrument to the points being measured.



The TPS Hidden Point application does not generate a report sheet.

Access

Select **Main Menu: Go to Work!**\Survey+\TPS hidden point.

Diagram

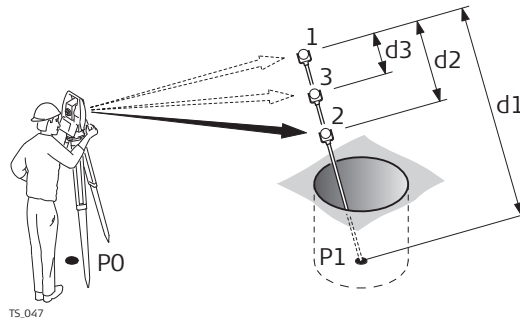

- d1 Rod length
- d2 Distance from prism 1 to prism 2
- d3 Distance from prism 1 to prism 3

Measure Reflector 1, Hidden pt page

Measure Reflector 1	
Hidden pt	Survey Map
Aux point ID:	Aux0001
Hz:	99.9997g
V:	100.1002g
Slope distance:	10.000m
Height difference:	1.564m
Rod length:	2.500 m
Hz: 99.9996g V: 100.1000g Q1 abc 14:19	
Meas	Dist Store Page

Key	Description
Meas	To measure and store the prism, and access the next screen.
Dist	To measure a distance.
Store	To store data.
Page	To change to another page on this screen.
Fn Config..	To configure the TPS hidden point application. Refer to "61.3 Configuring Hidden Point".
Fn IndivID and Fn Run	To change between entering an individual point ID different to the defined ID template and the running point ID according to the ID template. Refer to "25.1 ID templates".
Fn Quit	To exit the screen.

Description of fields

Field	Option	Description
Aux point ID	Editable field	The point ID of the auxiliary point, the prism on the hidden point rod. The Auxiliary Points ID template is used.
Hz	Display only	The horizontal angle to prism 1, the auxiliary point, is displayed.
V	Display only	The vertical angle to prism 1, the auxiliary point, is displayed.
Slope distance	Display only	The slope distance to prism 1, the auxiliary point, is displayed.

Field	Option	Description
Height difference	Display only	The height difference to prism 1, the auxiliary point, is displayed.
Rod length	Editable field	The length of the rod can be adjusted before the hidden point result is displayed. The rod length always keeps the distances R1-R2 for two prisms and R1-R3 for three prisms into account.

Next step

Take the measurements to prism 2 and, if desired, to prism 3. After the last prism of the hidden point rod is measured, **Hidden Point Result, Result** page is accessed.

Hidden Point Result, Result page

Hidden Point Result

Result Code Plot

Point ID: TPS0001

Hz: 115.7667g

V: 100.0981g

Slope distance: 10.185m

Ht Diff: 1.564m

Easting: 510.086m

Northing: 498.373m

Hz: 106.4000g V: 100.1001g Q1 abc 14:26

Store Next Page

Key	Description
Store	To measure the prism and exit the application.
Next	To store the hidden point and to access Measure Reflector 1 to take more hidden point measurements.
Page	To change to another page on this screen.
Fn INDIVID and Fn Run	To change between entering an individual point ID different to the defined ID template and the running point ID according to the ID template. Refer to "25.1 ID templates".
Fn Quit	To exit the screen.

Description of fields

Field	Option	Description
Point ID	Editable field	The name of the hidden point. The configured point ID template is used.
Hz	Display only	The calculated horizontal angle to the computed hidden point. ----- is displayed for unavailable information.
V	Display only	The calculated vertical angle to the computed hidden point. ----- is displayed for unavailable information.
Slope distance	Display only	The calculated slope distance to the computed hidden point. ----- is displayed for unavailable information.
Height difference	Display only	The calculated height difference from instrument to computed hidden point. ----- is displayed for unavailable information.

Field	Option	Description
Easting, Northing and Height	Display only	The calculated coordinates of the computed hidden point. ----- is displayed for unavailable information.

Next step

Page changes to the **Code** page. Type in a code if desired. **Page** changes to the **Plot** page. Measured distances are indicated by solid arrows.

61.3 Configuring Hidden Point

Access

Select **Main Menu: Go to Work!\Survey+TPS hidden point**. Press Fn **Config..**

Configuration

Key	Description
OK	To accept changes and return to the screen from where this screen was accessed.
Config..	To configure the selected survey screen page. Refer to "25.3 My Survey Screen".
Fn About	To display information about the program name, the version number, the date of the version, the copyright and the article number.
Fn Quit	To exit the screen.

Description of fields

Field	Option	Description
Page to show	Selectable list	The user-defined survey screen page to be shown in Measure Reflector 1 , Measure Reflector 2 and Measure Reflector 3 .
Measure tolerance	Editable field	Limit of the difference between input and measured spacing of the prisms.  For three prisms being used, limit for maximum deviation of the three measurements.
Delete aux points	Yes or No	The auxiliary points are deleted when the hidden point is stored. The auxiliary points are prism 1, prism 2 and prism 3 of the hidden point rod.

Field	Option	Description
		The Auxiliary Points ID template is used for the auxiliary points. The Survey Points ID template is used for the computed hidden point.
No. of reflectors	2 or 3	Two or three prisms are used on the rod.
Auto position	Yes or No	Available for No. of reflectors: 3 . The third prism is aimed at automatically.
Rod length	Editable field	Total length of hidden point rod.
Distance R1-R2	Editable field	Spacing between the centres of prism 1 and prism 2.
Distance R1-R3	Editable field	Available for No. of reflectors: 3 . Spacing between the centres of prism 1 and prism 3. Prism 3 is situated between prism 1 and prism 2.

Next step

OK returns to the screen from where this screen was accessed from.

Description

Remote point is used to determine the 3D coordinates of inaccessible points, for example on bridges. The horizontal distance to a base point directly underneath or above the remote point is measured. Then the instrument is aimed at the remote point. The coordinates of the remote point are calculated with the distance measured to the base point and the angles measured to the remote point.

Diagram

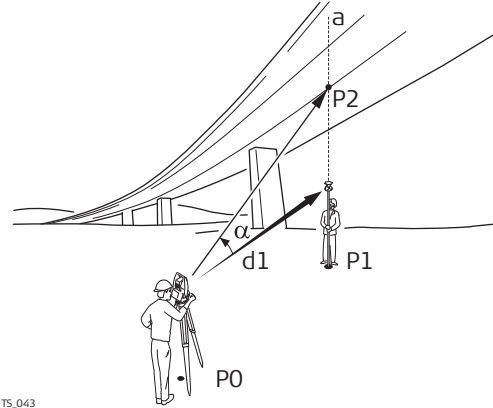

- P0 Instrument station
- P1 Base point
- P2 Remote point
- d1 Horizontal distance to the base point
- α Vertical angle between base point and remote point
- a Vertical axis from P1 to P2

TS_043



To ensure correct results, the remote point and the prism must be lined up vertically. If it is not possible to maintain an exactly vertical line, the acceptable **H_z dist tolerance** must be chosen. The horizontal distance to the remote point and to the base point should coincide.

Averaging of remote points

An average can be calculated for remote points if a measured point of class **Meas** already exists with the same point ID. The average flag for the point is **Auto**.

Description

Remote point measurements are possible from the Survey application when **Measure remote points** is checked in the **Configuration, Remote points** page and a valid distance measurement is available.

Access

Press **RmtHt.** in **Survey, Survey** page after one point is measured with **Dist.**

Survey Remote Point, Remote points page

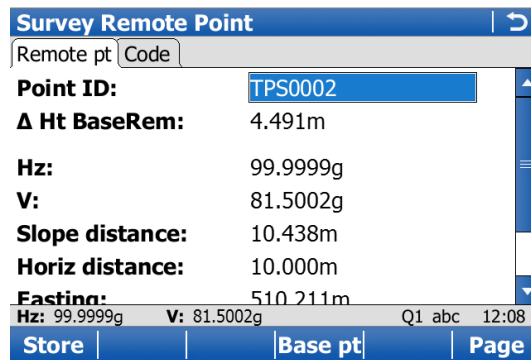

Key	Description
Store	Stores the remote point. Stays in this screen.

Key	Description
Base pt	Returns to the Survey screen. The distance measurement is cleared.
Page	To change to another page on this screen. The page available depends on the Page to show selected in the Configuration, Remote points screen. Refer to "62.3 Configuring Remote Point".
Fn IndivID and Fn Run	To change between entering an individual point ID different to the defined ID template and the running point ID according to the ID template. Refer to "25.1 ID templates".
Fn Quit	To exit the application.

Description of fields

Field	Option	Description
Point ID	Editable field	Displays the point ID for the remote point. The point ID in Survey Remote Point is always identical to the point ID in Survey .
Δ height - remote to base	Display only	The elevation difference between the base point and the remote point.
Hz	Display only	The current horizontal angle.
V	Display only	The current vertical angle.
Slope distance	Display only	The current slope distance to the remote point calculated from the horizontal distance to the base point and the current vertical angle.
Horiz distance	Display only	The horizontal distance measured to the base point.
Easting	Display only	Calculated Easting coordinate for the remote point.
Northing	Display only	Calculated Northing coordinate for the remote point.
Elevation	Display only	Calculated height for the remote point.

Next step

IF	THEN
if a remote point is to be stored	Store.
a new base point is to be measured	Base pt to return to the Survey screen.

Access

In **Survey** press Fn **Config..** to access **Configuration**.

Configuration,
Remote points page

Key	Description
OK	To accept changes and return to the screen from where this screen was accessed.
Page	To change to another page on this screen.
Config..	To configure the selected survey screen page. Available when Page to show is highlighted. Refer to "25.3 My Survey Screen".
Fn Quit	To exit the application.

Description of fields

Field	Option	Description
Measure remote points	Check box	If checked, the remote point function is active. RmtHt. is added to the function keys in Survey after Dist is pressed.
Hz dist tolerance	Editable field	The horizontal distance to the remote point is equal to the horizontal distance of the base point. The value for Hz dist tolerance is the maximum tolerated length of the chord between the base point and the remote point.
Page to show	Selectable list	All survey screen pages from Main Menu: User\Work settings\My Survey Screen can be selected.

Description

The Traverse application is used to fulfil one of the most common operations done by surveyors; to establish a control point base system to be used as a skeleton for other survey operations. For example, topographic survey, point stakeout, line stakeout or road stakeout.



If the message panel appears which requires that the application must be activated via a license key then refer to "30.3 Load licence keys".

Types of traverse

- External reference & closed loop
- Internal reference & position check
- Open end & position check
- Closed end traverse

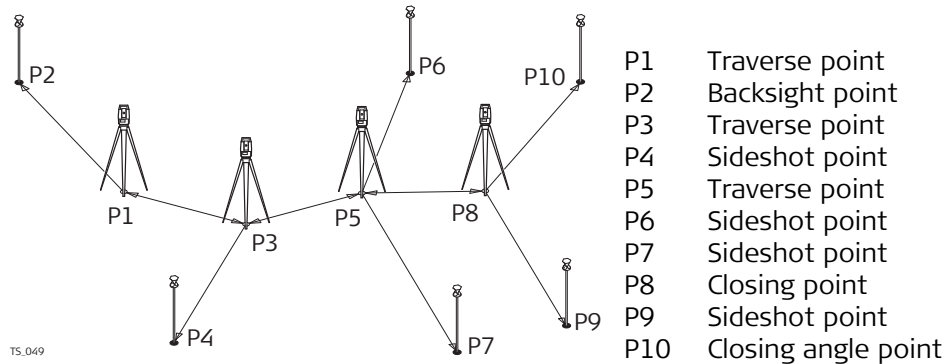

Averaging of Traverse points

An average point of class **Meas** is calculated by the Traverse application.

Access

Select **Main Menu:Go to Work!\Survey+\Traverse**.

Traverse

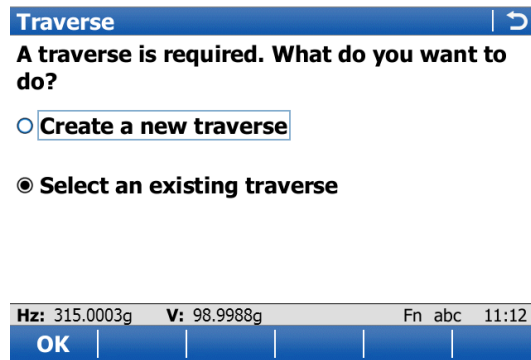

Key	Description
OK	To select the highlighted option and to continue with the subsequent screen.
Fn Config..	To configure the Traverse application. Refer to "63.6 Configuring Traverse".

Key	Description
Fn Quit	To exit the application.

Next step

IF	THEN
a traverse is to be created or selected	highlight the relevant option and press OK .
Traverse is to be configured	Fn Config... Refer to "63.6 Configuring Traverse".

63.3

Creating/Editing a Traverse

Access

- In **Traverse**, select **Create a new traverse**. Press **OK**.
- In **Manage Traverses**, press **New..** or **Edit...**

New Traverse/Edit Traverse

New Traverse	
Traverse ID:	Trav2
Description:	Field work
Operator:	ABC

Hz: 315.0002g	V: 98.9984g	Fn abc	11:12
OK			

Key	Description
OK	To store the settings.
Fn Config..	To configure the Traverse application. Refer to "63.6 Configuring Traverse".
Fn Quit	To exit the application.

Description of fields

Field	Option	Description
Traverse ID	Editable field	The ID of the traverse.
Description	Editable field	A line for a detailed description of the traverse, for example, work to be performed. Optional.
Operator	Editable field	The person's name who is creating the traverse. Optional.
Date	Display only	The date of when the traverse was created. Available in the Edit Traverse screen.
Time	Display only	The time of when the traverse was created. Available in the Edit Traverse screen.
Status	Open	The traverse is not closed in position. Available in the Edit Traverse screen.

Field	Option	Description
	Position closed	The traverse has been closed in position on a control point. Available in the Edit Traverse screen.
	Posn & angle closed	The traverse has been closed both in position and angularly. Available in the Edit Traverse screen.
	Adjusted	The traverse data is the result from an adjustment. Available in the Edit Traverse screen.

63.4

Selecting an Existing Traverse

Access

In **Traverse**, select **Existing Traverse**. Press **OK**.

Existing Traverse

Existing Traverse	
Traverse ID:	Trav2
Description:	Field work
Operator:	ABC
Date:	29.09.09
Time:	11:11:23
Status:	Open

Hz: 314.9998g V: 98.9986g Fn abc 11:14

OK | Data..

Key	Description
OK	To accept the settings.
Data..	To display traverse data. Refer to "63.5 Traverse Data". Not available for adjusted traverses.
Fn Config..	To configure the Traverse application. Refer to "63.6 Configuring Traverse".
Fn Quit	To exit the application.

Description of fields

The fields are identical with those fields in the **Edit Traverse** screen. Refer to "63.3 Creating/Editing a Traverse".

Next step

ENTER when **Traverse ID** is highlighted. Accesses **Manage Traverses**.

Manage Traverses

All traverses of the working job are displayed.

Manage Traverses	
Traverse ID	Date
Trav1	29.09.09
Trav2	29.09.09

Hz: 314.9997g	V: 98.9986g	Fn abc	11:14
OK	New..	Edit..	Data..

Key	Description
OK	To confirm selection of highlighted traverse and return to Select an existing traverse .
New..	To create a new traverse. Refer to "63.3 Creating/Editing a Traverse".
Edit..	To edit the traverse ID and description of the highlighted traverse. Refer to "63.3 Creating/Editing a Traverse".
Data..	To display traverse data. Refer to "63.5 Traverse Data" for more information.
Fn Quit	To exit the application.

63.5

Traverse Data

Description

This screen allows the review and editing of traverse stations inside of a traverse and allows the user to access **Point Results** for editing.

Access

Data.. in **Manage Traverses**.
OR
Data.. in a **Confirmation** window of the **Point Results** screen.

Traverse Data

Traverse Data			
Points	Map		
Station ID	Backsight ID	No. sets	No. FS
BS1	PT01	1	1
PT02	BS1	1	1
PT03	PT02	1	1
PT04	PT03	1	1

Hz: 99.9997g	V: 98.9972g	Fn abc	13:19
OK	Edit..	Delete	Page

Key	Description
OK	To return to where this screen was accessed from.
Edit..	To access the Point Results screen. Refer to "63.8 Traverse Point Results".
Delete	To permanently delete the LAST traverse station.
Page	To change to another page on this screen.
Fn Quit	To exit the application.

Description of columns

Column	Description
Station ID	Point ID of the station.
Backsight ID	The backsight point measured from the current station ID.
No. sets	Number of measured sets.
No. FS	Number of measured foresight points.

63.6

Configuring Traverse

Access

Select **Main Menu:Go to Work!\Survey+\Traverse**. Press Fn **Config...**

Configuration, Parameters page

Key	Description
OK	To accept changes and to return to the screen from where this screen was accessed.
Config..	To edit the survey screen page currently being displayed. Available when a list item in Page to show is highlighted. Refer to "25.3 My Survey Screen". Available on the Parameters page.
Page	To change to another page on this screen.
Fn Quit	To exit the application.

Description of fields

Field	Option	Description
Measure sequence	B'F'...F'B''	All points are measured in face I, then measured in face II in reverse sequential order.
	B'F'...B''F''	All points are measured in face I, then measured in face II.
	B'B''F'F'...	Backsight point is measured in face I immediately followed by face II. Other points are measured in face I, face II order.
	B'B''F''F'...	Backsight point is measured in face I immediately followed by face II. Other points are measured in alternating face order.
	B'F'...	All points are measured in face I only.
Foresight	Check box	Option to define if only one foresight point or multiple points are used during the sets.

Field	Option	Description
When using automatic target aiming, automatically measure the targets	Check box	For instruments with automatic aiming and this option checked, automatic aiming search and automatic aiming measurements are done to specified targets and subsequent sets.
Show additional page from My Survey Screen	Check box	The user-defined survey screen page to be shown in the Traverse screen.
Page to show	Selectable list	The names of the available survey screen pages.

Next step

Page changes to the **Quality control** page.

Configuration, Quality control page

Description of fields

Field	Option	Description
Check for errors before storing	Check box	The entered horizontal, vertical and distance tolerances are checked during the measurements to verify accurate pointing and measurements.
Hz tolerance	Editable field	Tolerance for horizontal directions.
V tolerance	Editable field	Tolerance for vertical directions.
Distance tolerance	Editable field	Tolerance for distance.
Check for backsight height	Check box	The entered height tolerance for the backsight point is checked during the measurements to verify accurate pointing and measurements.
Height limit	Editable field	Tolerance for the backsight height.

Next step

Page changes to the **Report sheet** page.

Configuration, Report sheet page

Description of fields

Field	Option	Description
Create report sheet	Check box	To generate a report sheet when the application is exited. A report sheet is a file to which data from an application is written to. It is generated using the selected format file.
Report sheet	Selectable list	Available when Create report sheet is ticked. The name of the file to which the data will be written. A report sheet is stored in the \DATA directory of the active memory device. The data is always appended to the file. Opening the selectable list accesses the Report Sheets screen. On this screen, a name for a new report sheet can be created and an existing report sheet can be selected or deleted.

Field	Option	Description
Format file to use	Selectable list	Available when Create report sheet is ticked. A format file defines which and how data is written to a report sheet. Format files are created using LGO. A format file must first be transferred from the data storage device to the internal memory before it can be selected. Refer to "30.1 Transfer user objects" for information on how to transfer a format file. Opening the selectable list accesses the Format Files screen where an existing format file can be selected or deleted.

Next step

Page changes to the first page on this screen.

63.7

63.7.1

Traverse Methods





Starting Traverse

Start traverse step-by-step



The quickest setup method is described.

Step	Description
1.	Start the Traverse application.
2.	Traverse Select Create a new traverse .
3.	OK to access New Traverse .
4.	New Traverse Type in the name of the new traverse.
5.	OK to access Configuration . Check the settings.
6.	OK to access Total Station Setup . Any standard setup method can be used.
7.	Set to set the station and orientation.
8.	A confirmation window is displayed. FS Pt..
9.	Foresight, Set: Foresight ID The name of the foresight point. Target height The target height of the foresight point. Number of sets The number of sets to be measured.
10.	Meas to measure and record. The measurement settings for the first measurement to each point are used for all further sets.
11.	Point Results OK to move to the next station, to return to the Point Results screen (and set a point as a closing point), to survey a sideshot, to view traverse data or to end the traverse.
12.	Move to move to the next station.
	After pressing Move , Traverse is exited. To continue with the traverse from the next station refer to "63.7.2 Continuing an Existing Traverse".

Measure traverse
step-by-step

Step	Description
1.	Start the Traverse application.
2.	Traverse Select Select an existing traverse .
3.	OK to access Existing Traverse .
4.	Existing Traverse Traverse ID The name of the traverse. ENTER to select a different existing traverse.
	Data.. to view data of the active traverse.
	Fn Config.. to change the working style settings.
5.	OK to access Backsight, Set:. Enter Instrument height . Hz, V and Horiz distance The measured values are displayed. Calc azimuth The calculated azimuth from the current station point to the backsight point. Δ hz dist and Δ height The difference between the computed and measured values.
	More to change between the displayed values.
6.	Meas to measure and record the backsight point.
7.	FS Pt.. to measure a foresight point.
8.	Foresight, Set: Foresight ID The name of the foresight point. Target height The target height of the foresight point. Number of sets The number of sets to be measured.
	Survy.. to measure sideshot points.
9.	Meas to measure and record the foresight points. The measurement settings for the first measurement to each point are used for all further sets.
10.	Point Results OK
11.	A confirmation window is displayed. Move to move to the next station.
12.	Repeat steps 1. to 11. until traverse is ready to be closed.

Close traverse step-by-step

Step	Description
1.	Refer to paragraph "63.7.2 Continuing an Existing Traverse" to measure a traverse. Measure a backsight on a new station.
2.	The confirmation window in Foresight, Set: is displayed. Close.. to begin the process for closing the traverse.
3.	The confirmation window to select a known point is displayed. OK
4.	The Data: screen for the control job is displayed. Highlight the closing point.
5.	OK to select the highlighted point.
6.	Foresight, Set: Meas to measure and record the closing point.
7.	Point Results OK to view traverse results.
8.	Traverse Results OK to display the confirmation window.
9.	C Ang.. to close the traverse with angular closure.
	Optionally the traverse can be adjusted.
10.	Move to the closure point and start Traverse application.
11.	Traverse Select Select an existing traverse.
12.	OK to access Existing Traverse.
13.	Existing Traverse Traverse ID The name of the traverse to be closed is displayed.
14.	OK to access Close Angle.
15.	Close Angle Closing method To measure onto a known point or a known azimuth. Foresight ID The point ID of the foresight point. Known azimuth Available for Closing method : By known azimuth. Known azimuth for foresight point.
16.	OK to access Backsight, Set:.
17.	Meas to measure all sets.
18.	Point Results OK to view traverse results.
19.	Traverse Results OK to exit viewing traverse results.
20.	Quit to quit the Traverse application.
	Optionally the traverse can be adjusted.

Close traverse on internal reference

This option is used for determining the closure of a closed loop traverse, consisting of a single control point with an arbitrary backsight azimuth. This function allows completion of a traverse without having to reoccupy the initial station setup to measure a closing angle. The positional closure is calculated by comparing the control position of the initial station setup to the measured position of the final foresight. The angular closure is calculated by comparing the set azimuth of the initial backsight to the azimuth of the final measured leg.

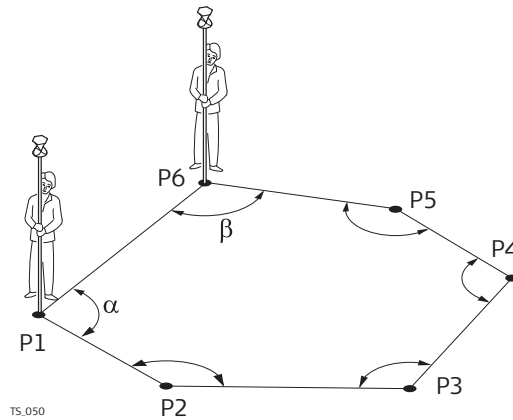

The first station setup is on P1, and an assumed direction to backsight P6. Upon closing this traverse, with the last setup over P6, the closing point is P1. In this case the only point that is considered as a control is P1.

Step	Description
1.	The first station setup is on P1 in the diagram shown. Begin the traverse, moving in the direction P1, P2...P6.
2.	When on the last setup point (P6 in the diagram shown), measure a back-sight.
3.	Close
4.	Data: Select the closing point from the available list (P1 in the diagram shown). OK
5.	Measure all the sets to the closing point as per a standard traverse.
6.	Point Results OK when the review of the results is completed.
7.	Yes to confirm the automatic calculation.
8.	Traverse Results The traverse closure is shown with positional and angular values.

Description

If a traverse is to be established on existing control points, two control points must be defined to start the traverse. If the traverse absolute position is arbitrary, it can be convenient to define the control in the field with arbitrary values. This functionality is an option to turn the averaged position value into a control point when a backsight by azimuth is collected.

Access

At the beginning of a traverse, when all the measurements are completed to the backsight: On the **Point Results** screen, select **Page** to reach the **Backsight** page. Fn **Ctrl**.

OR

Anytime during the traverse: On the **Traverse Data** screen, highlight the first station setup then **Edit...** On the **Point Results** screen, select **Page** to reach the **Backsight** page. Fn **Ctrl**.

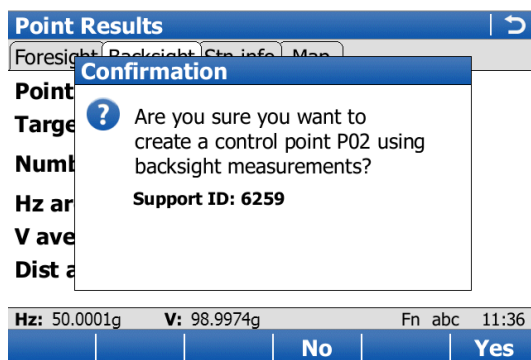
Point Results Confirmation

Key	Description
No	To close the confirmation window without further action.
Yes	To store the point as control point.

63.8

Traverse Point Results

Description

Point observation results are displayed on this screen.

Access

Is displayed automatically after measuring all sets from the current station.

OR

In **Traverse Data** press **Edit...**

Point Results, Foresight page and Backsight page

The softkeys are explained, except for the softkeys on the **Map** page.

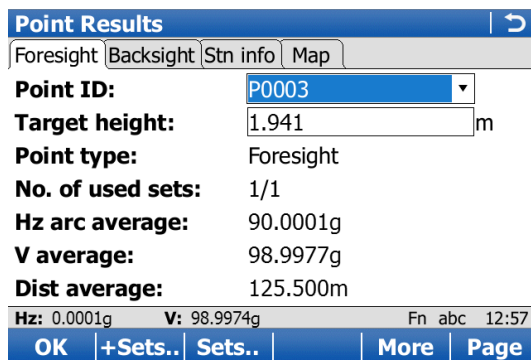

Key	Description
OK	While measuring a traverse: Displays a confirmation window with traverse measurement options. Otherwise: To return to Traverse Data .
+Sets..	To add more sets while still at the setup. It could be necessary on particular legs of a traverse that more than the designated number of sets is required. Possibly some of the sets from the first run exceeded the tolerance limit and must be disabled.
Sets..	To include or exclude measured sets in the calculation of a foresight point. In the Sets, Point screen press Use to include or exclude a set and Spread/Resid to review the effect of using the set.
Close..	To set a point as a closing point if not selected before measurement. Or to revert a closing point to a normal foresight.
More	To display additional information.
Page	To change to another page on this screen.
Fn Config..	To configure the Traverse application. Refer to "63.6 Configuring Traverse".
Fn Edit..	To edit point code and annotations.
Fn Check..	Available on the Foresight page. To check inverse distances and closure between the selected point and a point from the fixpoint job.
Fn Ctrl	Available on the Backsight page of the initial station. Refer to "63.7.4 Creating a Control Point from Backsight by Azimuth".
Fn Quit	To exit the application.

Description of fields

Field	Option	Description
Point ID	Selectable list or display only	Selected point ID.
Target height	Selectable list or display only	The target height of the target point.
Point type	Foresight , Closing point or Closing angle	The current point type. Available on the Foresight page.
No. of used sets	Display only	The number of sets out of all measured sets used for the calculation. Available on the Foresight page.
Number of sets	Display only	The number of sets the point was measured in. Available on the Backsight page.
Hz arc average	Display only	Average horizontal angle.
V average	Display only	Average vertical angle.
Dist average	Display only	Average distance.
Hz arc std dev	Display only	Standard deviation of horizontal angle.
V std dev	Display only	Standard deviation of vertical angle.
Dist std dev	Display only	Standard deviation of distance.
Hz spread	Display only	Spread of horizontal angle.

Field	Option	Description
V spread	Display only	Spread of vertical angle.
Dist spread	Display only	Spread of distance.

Next step

Page changes to the **Stn info** page.

**Point Results,
Stn info page**

Description of fields

Field	Option	Description
Station ID	Display only	The station ID of the instrument station.
Instrument height	Editable field	Current instrument height. Editable.
Easting	Display only	Easting value of the station position.
Northing	Display only	Northing value of the station position.
Elevation	Display only	Orthometric height of the station position.
Scale	Display only	Scale factor used in the calculation.
Temperature	Display only	Temperature set on the instrument.
Pressure	Display only	Atmospheric ppm set on the instrument.

Next step

Page changes to the **Map** page which provides an interactive display of the data.

IF accessed	THEN
after sets measurement	<p>OK opens a confirmation window with options that are dependent on traverse status:</p> <ul style="list-style-type: none"> For an open traverse: Move to next station, return to Point Results, to survey a sideshot, to view traverse data or to quit the traverse application. For a closed traverse: Move to close angle, return to Point Results, to survey a sideshot, to adjust the traverse or to quit the traverse application.
from Traverse Data	OK returns to Traverse Data .

Description

Traverse closure results are displayed on this screen.

Access

Is displayed automatically after the traverse closing point is measured or selected.
OR
Reslt.. in **Traverse Data** when a traverse is closed.

**Traverse Results,
Position page**

Traverse Results	
Position	Angle Map
Starting point:	P01
Closing point:	P01
Length of error:	0.000m
Direction of error:	0.0000g
Δ elevation:	0.000m
Total distance:	376.953m
2D accuracy:	1/5
Hz: 359.9996g	V: 98.9977g
Fn abc 13:01	
OK	N & E Data.. Page

Key	Description
OK	To move to close angle, to return to Traverse Results , to survey a sideshot, to adjust the traverse or to quit the Traverse application.
N & E or L & D	To view the misclosure error in north/east or length/direction.
Adjust..	To adjust the traverse.
Data..	To display traverse data.
Page	To change to another page on this screen.
Fn Config..	To configure the Traverse application. Refer to "63.6 Configuring Traverse".
Fn Quit	To exit the application.

Description of fields

Field	Option	Description
Starting point	Display only	The point ID of the traverse start point.
Closing point	Display only	The point ID of the traverse closing point.
Length of error	Display only	The length of the misclosure error.
Direction of error	Display only	The direction of the misclosure error.
Δ north	Display only	Error in north.
Δ east	Display only	Error in east.
Δ elevation	Display only	Error in height.
Total distance	Display only	Total length of the traverse.
2D accuracy	Display only	Position ratio of misclosure.
1D accuracy	Display only	Height ratio of misclosure.

Next step

Page changes to the **Angle** page.

Description of fields

Field	Option	Description
Foresight ID	Display only	Point ID of the closing angle point. Displays ----- if no values are available.
Known azimuth	Display only	Defined azimuth of closing line. Displays ----- if no values are available.
Azimuth average	Display only	Mean value of the measured azimuth closing line. Displays ----- if no values are available.
Angular misclosure	Display only	Angular misclosure of traverse. Displays ----- if no values are available.

Next step

OK to move to close angle, to return to **Traverse Results**, to survey a sideshot, to adjust the traverse or to quit the Traverse application.

63.10

63.10.1

Traverse Adjustment

Accessing Traverse Adjustment

Description

- A traverse adjustment can be performed on three components: 2D positions, angles and elevations.
- Various adjustment methods are available for selection. Once the adjustment is performed, the results can be reviewed. Adjusted points are stored into a new job, and a report can be generated.
- If the message panel appears which requires that the application must be activated via a license key then refer to "30.3 Load licence keys".



Survey points have to be measured while Traverse is running to be part of the adjustment calculations.

Access

The traverse adjustment option can be reached in different ways based on specific conditions.

Upon completing the observations onto the closing point, **Adjust..** to access **Traverse Adjustment**.

OR

After the measurements are done on the closing line for angular closure, **Adjust..** to access **Traverse Adjustment**.

OR

When the traverse is closed: **Reslt..** in **Traverse Data**, then **Adjust..** in **Traverse Results** to access **Traverse Adjustment**.

Traverse Adjustment, Method page

Traverse Adjustment	
Method	Map
Traverse ID:	Trav2
Horiz adjustment:	Compass rule
Angle balance:	No distribution
Vert adjustment:	Equally

Hz: 359.9998g	V: 98.9977g	Fn abc	11:32
OK			Page

Key	Description
OK	To calculate the result.
Page	To change to another page on this screen.
Fn Config..	To configure the Traverse application. Refer to "63.6 Configuring Traverse".
Fn Quit	To exit the application.

Description of fields

Field	Option	Description
Traverse ID	Display only	The ID of the traverse.
Horiz adjustment	Compass rule	Suitable for surveys, where angles and distances were measured with equal precision.
	Transit rule	Suitable for surveys, where angles were measured with a higher precision than the distances.
	No distribution	No distribution is made.
Angle balance	Equally	The angle misclosure is distributed equally.
	No distribution	No distribution is made.
Vert adjustment	Equally	The height error is distributed equally.
	By distance	The height error is distributed by distance.
	No distribution	No distribution is made.

Next step

OK starts the adjustment calculation.

Description

The results of the adjustment calculations can be reviewed by accessing the different pages.

Access

OK in **Traverse Adjustment**.

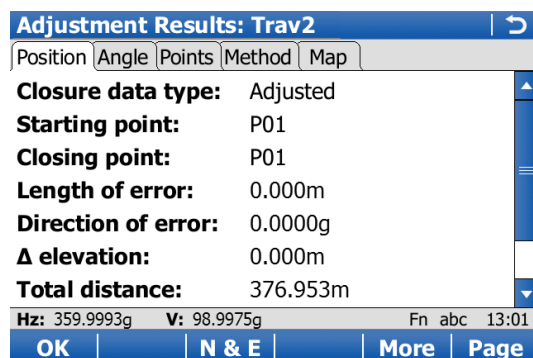
Adjustment Results, Position page

Key	Description
OK	To access the next screen.
N & E or L & D	To view the misclosure error in north/east or length/direction.
More	To display the values for the unadjusted, the balanced and the adjusted solution.
Page	To change to another page on this screen.
Fn Config..	To configure the Traverse application. Refer to "63.6 Configuring Traverse".
Fn Quit	To exit the application.

Description of fields

Field	Option	Description
Closure data type	Adjusted , Unadjusted or Balanced	More to change between the options and display the values accordingly.
Starting point	Display only	The point ID of the traverse start point.
Closing point	Display only	The point ID of the traverse close point.
Length of error	Display only	The length of the misclosure error.
Direction of error	Display only	The direction of the misclosure error.
Δ north	Display only	Error in north.
Δ east	Display only	Error in east.
Δ elevation	Display only	Error in height.
Total distance	Display only	Total length of the traverse.
2D accuracy	Display only	Position ratio of misclosure.
1D accuracy	Display only	Height ratio of misclosure.

Next step

Page changes to the **Angle** page.

Adjustment Results, Angle page

Description of fields

Field	Option	Description
Closure data type	Display only	More to change between the options.
Known azimuth	Display only	Defined azimuth of closing line. Displays ----- if no values are available.
Azimuth average	Display only	Mean value of the measured azimuth closing line. Displays ----- if no values are available.
Angular misclosure	Display only	Angular misclosure of traverse. Displays ----- if no values are available.

Next step

Page changes to the **Points** page.

Adjustment Results, Points page

The adjusted points are listed. The **Point type** column shows the function for each point.

View.. shows the coordinate values of the highlighted point.

Next step

Page changes to the **Method** page.

Adjustment Results, Method page

The adjustment methods previously selected in **Traverse Adjustment** and used for the adjustment are displayed.

Next step

Page changes to the **Map** page. The **Map** page provides an interactive display of the data.

OK accesses **Adjustment Store**.

Adjustment Store

Description of fields

Field	Option	Description
Traverse ID	Display only	The ID of the traverse.
Store adjusted job to	Selectable list	The location to save the adjusted job. The job can be saved to the CF card , SD card , USB or Internal memory .
New job	Editable field	The new job name. Once adjustment results have been reviewed and accepted, the adjusted position of the points are stored in a separate job.
Include survey points	Check box	Survey points can be included or not. Adjusted points are stored in the new job as a triplet of class ADJ (adjusted).
Store point ID with	Same point ID	Adjusted points are stored in the new job with the original point IDs.
	Prefix	Adjusted points are stored in the new job with a prefix in front of the original point IDs.
	Suffix	Adjusted points are stored in the new job with a suffix at the end of the original point IDs.
Prefix / suffix	Editable field	Available when Prefix or Suffix is selected in Store point ID with . The value that is added to the front or end of the original point ID.

Next step

Store.. stores the results.

Description

The Volume Calculations application allows surfaces to be measured and volumes (and other information) to be computed from these surfaces.

Volume calculations tasks

- The Volume calculations application can be used for the following tasks:
- Measuring points (surface points and boundary points) defining a new surface or extending existing surfaces from the working job.
 - Calculating the triangulation of the measured surface points to establish the surface.
 - Calculating volumes from a base (3D point, entered elevation) or by a stockpile method.

The surface calculation can be made from:

- existing point data in the job.
- manually occupied points.
- entered coordinates.

Activating the application

If the message panel appears which requires that the application must be activated via a license key then refer to "30.3 Load licence keys".



Volume Calculations are possible for RTK rover and TPS.

Point types

Surfaces can be created from points stored as:

- Local grid
- Height mode can be ellipsoidal or orthometric.

Heights and positions are always taken into account. Points must have full coordinate triplets.

Access

Select **Main Menu: Go to Work!\Survey+\Volume calculations.**

Volume Calculations

Key	Description
OK	To select the highlighted option and to continue with the subsequent screen.
Fn Config..	To configure the Volume Calculations application. Refer to "64.3 Configuring Volumes & Surfaces".
Fn Quit	To exit the screen.

Next step

IF	THEN
a Volume Calculations method is to be started	highlight the relevant option and press OK .
Volume Calculations is to be configured	Fn Config... Refer to "64.3 Configuring Volumes & Surfaces".

64.3

Configuring Volumes & Surfaces

Access

Select **Main Menu: Go to Work!\Survey+\Volume calculations**. Press Fn **Config...**

Configuration, Report sheet page

Description of fields

Field	Option	Description
Create report sheet	Check box	To generate a report sheet when the application is exited. A report sheet is a file to which data from an application is written to. It is generated using the selected format file.
Report sheet	Selectable list	Available when Create report sheet is ticked. The name of the file to which the data will be written. A report sheet is stored in the \DATA directory of the active memory device. The data is always appended to the file. Opening the selectable list accesses the Report Sheets screen. On this screen, a name for a new report sheet can be created and an existing report sheet can be selected or deleted.
Format file to use	Selectable list	Available when Create report sheet is ticked. A format file defines which and how data is written to a report sheet. Format files are created using LGO. A format file must first be transferred from the data storage device to the internal memory before it can be selected. Refer to "30.1 Transfer user objects" for information on how to transfer a format file. Opening the selectable list accesses the Format Files screen where an existing format file can be selected or deleted.

Next step

Page changes to the first page on this screen.

64.4
64.4.1

Calculating Volumes
Create a New Surface by Measuring New Points

Access

Select **Create a new surface by measuring points** in **Volume Calculations**.

New Surface

Description of fields

Field	Option	Description
Surface ID	Editable field	The name/number of the new surface.

Next step

OK to access **Survey Surface Points**. After measuring surface points, more points can be surveyed, points can be grid scanned or a surface can be reviewed and edited.

Survey Surface Points, Survey page

The pages shown are from a typical working style. An additional page is available when a user-defined survey screen page is used.

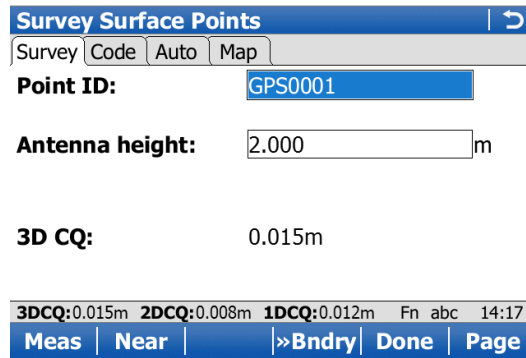

Key	Description
Meas	GPS To start measuring the surface point. The key changes to Stop . TPS To measure a distance and store distance and angles.
Stop GPS	To end measuring the surface point. When Automatically stop point measurement is checked in Quality Control, General page recording of positions ends automatically as defined by the stop criteria. The position mode icon changes to the moving icon. The key changes to Store .
Dist TPS	To measure a distance.
Store	To store the measured surface point. When Automatically store point is checked in Quality control, General , the measured point is stored automatically. The key changes to Meas .
Near GPS	To search the working job for the point nearest to the current position when the key is pressed. The point is selected as the point to be measured and is displayed in the first field on the screen. After measuring and storing the nearest point, the next point suggested is the one which was suggested before the key was pressed. Available when Meas is displayed.
>>Bndry and >>Surf	To change the type of point to be measured between surface point and boundary point.
Done	To finish measuring.
Page	To change to another page on this screen.

Key	Description
Fn 2Store TPS	To aim manually at the target and only record the angle measurement (Hz/V) in face I and face II. The point stored is an average of the two measurements.
Fn 2Face TPS	Available for Measure mode: Single and Measure mode: Single (fast) . To take a measurement in Face I and Face II. The point stored is an average of the two measurements. When using instruments fitted with auto aiming, the point is automatically measured in both faces. The resulting point is stored and the instrument is returned to the first face.
Fn Conect and Fn Disco GPS	To connect/disconnect from the GPS reference data.
Fn Init. GPS	To select an initialisation method and to force a new initialisation. Available when Meas or Store is displayed and for working styles allowing phase fixed solutions. Refer to "56.4 Initialisation for Real-Time Rover Operations".
Fn IndivID and Fn Run	To change between entering an individual point ID different to the defined ID template and the running point ID according to the ID template. Refer to "25.1 ID templates".
Fn Quit	To exit the screen.

Description of fields

Field	Option	Description
Point ID	Editable field	The identifier for manually occupied points. The configured point ID template is used. The ID can be changed in the following ways: <ul style="list-style-type: none"> To start a new sequence of point IDs type over the point ID. For an individual point ID independent of the ID template Fn IndivID. Fn Run changes back to the next ID from the configured ID template.
Antenna height	Editable field	GPS The default antenna height as defined in the active working style is suggested. Changing the antenna height here does not update the default antenna height as defined in the active working style. The changed antenna height is used until the application is exited.
3D CQ	Display only	The current 3D coordinate quality of the computed position.
Target height	Editable field	TPS The last used target height is suggested when accessing this screen. An individual target height can be typed in.
Hz	Display only	TPS The current horizontal angle.
V	Display only	TPS The current vertical angle.
Horiz distance	Display only	TPS The horizontal distance after Dist was pressed. No distance is displayed when accessing the screen and after Store or Meas .

Field	Option	Description
Height difference	Display only	TPS The height difference between station and measured point after Dist. Displays ----- when accessing the screen and after Store or Meas.

Next step

Measure all points. Then press **Done**.

64.4.2

Create a New Surface by Using Grid Scan **TS**

Access

Select **Create a new surface by using grid scan** in **Volume Calculations**.

New Surface

Description of fields

Field	Option	Description
Surface ID	Editable field	The name/number of the new surface.

Next step

OK to access **Survey Surface Points**. After measuring surface points, more points can be surveyed, points can be grid scanned or a surface can be reviewed and edited.

Grid scan points to surface

Refer to "44.9 Grid Scan on Surface" for defining the grid scan area, defining the scan settings as well as starting and ending grid scanning.

64.4.3

Create a New Surface from Previously Stored Points

Access

Select **Create a new surface from previously stored points** in **Volume Calculations**.



When accessing the **Edit Surface** screen after selecting **Create a new surface from previously stored points** the **Points** page is active. Any other time this screen is accessed the **General** page is active.

New Surface

Description of fields

Field	Option	Description
Surface ID	Editable field	The name/number of the new surface.

Next step

OK to access **Survey Surface Points**. After measuring surface points, more points can be surveyed, points can be grid scanned or a surface can be reviewed and edited.

Edit Surface, General page

Edit Surface | ↻

General | Points | Map

Surface ID: 222

No. of surface pts: 0

No. of boundary pts: 0

ID of last stored pt: ----

Date: ----

Time: ----

Surface status: Triangulation needed

3DCQ:0.012m 2DCQ:0.006m 1DCQ:0.010m Fn abc 14:18

OK | Page

Key	Description
OK	To accept all settings and continue with the next screen.
Page	To change to another page on this screen.
Fn Config..	To configure the Volume Calculations application. Refer to "64.3 Configuring Volumes & Surfaces".
Fn Del Srf	To delete the surface.
Fn Quit	To exit the screen.

Description of fields

Field	Option	Description
Surface ID	Selectable list	Name of the surface to be triangulated.
No. of surface pts	Display only	Number of points inside the surface.
No. of boundary pts	Display only	Number of boundary points of the surface.
ID of last stored pt	Display only	ID of the last measured point of the chosen surface.
Date	Display only	Date of the last measured point of the chosen surface.
Time	Display only	Time of the last measured point of the chosen surface.
Surface status	Triangulation done	The surface has been triangulated and not been modified since the last triangulation.
	Triangulation needed	The surface has been modified since the last triangulation or no triangulation exists.

Next step

Page changes to the **Points** page.

Surface status, Points page

Edit Surface			
Point ID	Boundary	Elevation	Point code
1032	No	1642.300	TOE
1008	No	1640.260	TOE
1018	No	1640.720	TOE
1033	No	1642.000	TOE

3DCQ:0.020m	2DCQ:0.011m	1DCQ:0.016m	Fn abc	14:19
OK	+All..	+One..	Bndry	Page

Key	Description
OK	To accept all settings and continue with the next screen.
+All..	To add all points from the working job to the surface.
+One..	To add one point from the working job to the surface.
Bndry	To use this point for the boundary.
Page	To change to another page on this screen.

Key	Description
Fn -One	To remove the marked point from the surface.
Fn -All	To remove all points from the surface.
Fn Quit	To exit the screen.

Next step

OK continues to **Surface Task Selection**. Refer to "64.4.5 Selecting the Surface Task".

64.4.4 Choosing an Existing Surface

Access Select **Create a new surface from previously stored points** in **Volume Calculations**.

Existing Surface The fields available are identical with the fields in **Surface status, General** page. Refer to "64.4.3 Create a New Surface from Previously Stored Points".

Next step

Select the desired surface ID then press **OK**. **OK** continues to **Surface Task Selection**. Refer to **Selecting the Surface Task**.

64.4.5 Selecting the Surface Task

Surface Task Selection

Description of the options

Options	Description
Measure more points to the surface	To measure points defining a new surface or extending existing surfaces and boundaries by surveying. Refer to "64.4.1 Create a New Surface by Measuring New Points".
Grid scan more points to the surface	To add more points to the surface by grid scanning new points. The grid scan procedure restarts.
Review & edit the surface	To view the surface summary and add/remove points from the surface. Refer to "64.4.3 Create a New Surface from Previously Stored Points".
Edit the boundary & triangulate surface	To define/redefine the boundary using manual point selection, or one of the existing automatic methods, and then create a triangulation. A DXF model can then be exported if desired. Refer to "64.4.6 Boundary Definition".
Calculate the volume	To compute the volume of a surface by a reference (3D point, entered elevation) or by the stockpile method. Refer to "64.4.7 Compute Volumes". Available when a valid triangulation of the surface exists.
Exit the Volumes app	To end the application and return to the screen from where Volume Calculations was accessed.

Next step

Select the task to do next. **OK** selects an option.

Edit Boundary, Points page

Point ID	Elevation	Point code
1044	1641.070	TOE
1000	1641.550	TOE
1001	1641.060	TOE
1007	1640.610	TOE
1008	1640.260	TOE
1009	1640.870	TOE
1010	1641.310	TOE
1011	1640.920	TOE

Key	Description
OK	To start calculating the triangulation.
+One..	To add points from the working job to the surface.
Move ↑	To move the focused point one step up within the boundary definition.
Move ↓	To move the focused point one step down within the boundary definition.
Tools	To access the Boundary Tools Menu .
Page	To change to another page on this screen.
Home	To move the focus to the first point within the boundary definition.
End	To move the focus to the last point within the boundary definition.
Fn -One	To remove the marked point from the boundary definition or completely from the surface.
Fn Quit	To exit the screen.

Next step

Page changes to the **Map** page.

IF you want to	THEN
change to the Map page	Page to change to the Map page.
check the triangulation results	OK to access Triangulation Results .
access the Tools menu	Tools accesses Boundary Tools Menu .

Edit Boundary, Map page

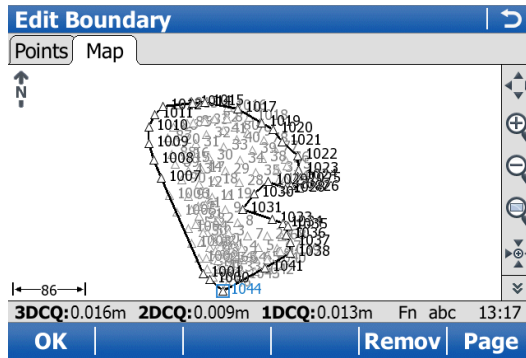

Key	Description
OK	To start calculating the triangulation.
Remov	To remove the marked point from the boundary definition or completely from the surface.
Page	To change to another page on this screen.
Fn Config..	To configure MapView. Refer to "37.3 Configuring MapView".
Fn Quit	To exit the screen.

Next step

IF you want to	THEN
check the triangulation results	OK to access Triangulation Results .

Triangulation Results

The **Summary** page and the **Details** page contain only display only fields. Information such as the number of triangles/surface points/boundary points, the minimum/maximum elevation or the 3D area is shown.

The **Map** page contains a plot of the triangles of the surface's triangulation and also its boundary.

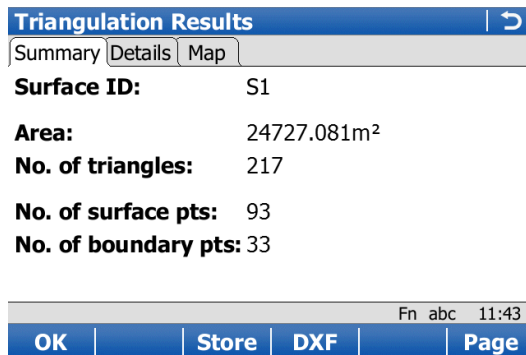

Key	Description
OK	To return to Surface Task Selection .
Store	To go to a screen where the surface can be saved as DTM job.
DXF	To go to a screen where the triangulation can be saved as a DXF.
Page	To change to another page on this screen.
Fn Config..	To configure the report sheet.
Fn Quit	To exit the screen.

Description of fields

Field	Description
Add many points	Lists all points in the working job.
Remove all points	Method to remove all points that are indicated in Edit Boundary, Points page.
Sort points by time	Method to sort all points in Edit Boundary, Points page by the time they were stored.
Sort points by proximity	Method to sort all points Edit Boundary, Points page by the closest proximity.
Compute rubber band bndry	Method to define a new boundary as if a rubber band was placed around the points. The current list of boundary points will be ignored.

Next step

Select the task to do next. **OK** selects an option and returns to **Edit Boundary**.

64.4.7

Compute Volumes

Volume Calculation

Volume Calculation | ↻

Surface ID: S1

No. of triangles: 217

Calculate using:

3DCQ:0.025m 2DCQ:0.014m 1DCQ:0.021m Fn abc 14:23

OK | | | | |

Key	Description
OK	To compute the volume.
Fn Config..	To configure the Volume Calculations application. Refer to "64.3 Configuring Volumes & Surfaces".
Fn Quit	To exit the screen.

Description of fields

Field	Option	Description
Surface ID	Selectable list	Surface chosen from the triangulated surfaces currently stored to the working job.
No. of triangles	Display only	Number of triangles from the triangulation of the surface.
Calculate using	Stockpile	To calculate the volume of the triangulated surface. Volume between the triangulated surface and the plane defined by the boundary points of the surface.
	Surface to elevation	Volume between the triangulated surface and the height entered by the user.

Field	Option	Description
	Surface to point	Volume between the triangulated surface and the height of a selected point.

Next step

OK calculates the volume and continues to **Volume Calculation Results**.

Volume Calculation Results, Summary page

Volume Calculation Results	
Summary	Details Map
Surface ID:	S1
Area:	24727.081m ²
Net volume:	228439.470m ³

3DCQ:0.015m	2DCQ:0.008m	1DCQ:0.013m	Fn abc	14:24
OK				Page

Key	Description
OK	To close the triangulation of the surface.
DXF	To export the triangulation results to a DXF file on the data or root directory of the CF Card.
Page	To change to another page on this screen.
Fn Config..	To configure the Volume Calculations application. Refer to "64.3 Configuring Volumes & Surfaces".
Fn Quit	To exit the screen.

Description of fields

Field	Option	Description
Surface ID	Display only	Name of the surface used for the calculation. Available for Calculate using: Surface to elevation and Calculate using: Surface to point .
Point ID	Display only	The point to which the volume is calculated. Available for Calculate using: Surface to point .
Elevation	Display only	The elevation of the point to which the volume is calculated. Available for Calculate using: Surface to elevation and Calculate using: Surface to point .
Area	Display only	Area of the base plane.
Net volume	Display only	Volume of the surface.
Volume cut	Display only	Cut of the volume. Available for Calculate using: Surface to elevation and Calculate using: Surface to point .
Volume fill	Display only	Fill of the volume. Available for Calculate using: Surface to elevation and Calculate using: Surface to point .

Next step

Page changes to the **Details** page.

**Volume Calculation
Results,
Details page**

Description of fields

Field	Option	Description
Minimum elevation	Display only	Minimal elevation of the triangulated surface.
Maximum elevation	Display only	Maximal elevation of the triangulated surface.
Average thickness	Display only	Average thickness of the calculated volume.
Perimeter	Display only	Perimeter of the measured surface area (intersection of the measured surface to the reference datum).

Next step

Page changes to the **Plot** page.

65

QuickVolume

65.1

Overview

Description

The application allows volumes to be computed from ALL scans and/or ALL measured points stored in a job.

65.2

Accessing Volume Calculations

Access

Select **Main Menu: Go to Work!\Survey+\QuickVolume**.

Choose Job

Key	Description
OK	To accept changes and access the subsequent screen. The chosen settings become active.
Fn Quit	To exit the screen.

Description of fields

Field	Option	Description
Job	Selectable list	The job from which a volume will be computed.

Surface Name

Key	Description
OK	To start the triangulation. All points and scans within the selected job are used in the triangulation.
Fn Quit	To exit the screen.

Description of fields

Field	Option	Description
Surface name	Selectable list	Name of the surface to be triangulated.

65.3

Volume Calculations

Volume Calculation

Key	Description
OK	To accept all settings and continue with the next screen.
MinElv	To set the minimum elevation point of the current surface as elevation value. Available for Calculate using: Surface to elevation .
Fn Quit	To exit the screen.

Description of fields

Field	Option	Description
Calculate using		To calculate the volume of the triangulated surface.
	Stockpile	Volume between the triangulated surface and the plane defined by the boundary points of the surface.
	Surface to elevation	Volume between the triangulated surface and the height entered by the user.

Field	Option	Description
	Surface to point	Volume between the triangulated surface and the height of a selected point.

Next step

OK calculates the volume and continues to **Volume Calculation Results**.

Volume Calculation Results, Summary page

Key	Description
Store	To return to Surface Task Selection .
Page	To change to another page on this screen.
Fn Quit	To exit the screen.

Description of fields

Field	Option	Description
Surface ID	Display only	Name of the surface used for the calculation.
Point ID	Display only	The point to which the volume is calculated. Available for Calculate using: Surface to point .
Elevation	Display only	The elevation of the point to which the volume is calculated. Available for Calculate using: Surface to elevation and Calculate using: Surface to point .
Area	Display only	Area of the base plane.
Net volume	Display only	Volume of the surface.
Volume cut	Display only	Cut of the volume. Available for Calculate using: Surface to elevation and Calculate using: Surface to point .
Volume fill	Display only	Fill of the volume. Available for Calculate using: Surface to elevation and Calculate using: Surface to point .

Next step

Page changes to the **Details** page.

Appendix A Menu Tree

Menu tree for GNSS RTK rover and TPS

- |--- Go to Work!
 - |--- Setup (TPS)
 - |--- Survey
 - |--- Stakeout
 - |--- Survey+
 - |--- Scanning for MS50
 - |--- Measure to ref line
 - |--- Ref plane & grid scan
 - |--- Volume calculations
 - |--- QuickVolume
 - |--- TPS hidden point (TPS)
 - |--- Sets of angles (TPS)
 - |--- Determine coord system
 - |--- QuickGrid (GPS)
 - |--- Traverse (TPS)
 - |--- Survey cross section
 - |--- Stakeout+
 - |--- Stake to ref line
 - |--- Stakeout DTM
 - |--- Stake points & DTM
 - |--- COGO..
 - |--- Inverse
 - |--- Traverse
 - |--- Intersection
 - |--- Line & arc calculations
 - |--- Area division
 - |--- Shift, rotate & scale
 - |--- Angle

- |
- |
- |
 - |--- Horizontal curve
 - |
 - |--- Triangle
 - |
 - |--- Roads..
 - |--- Alignment Editor
 - |--- Roads - Stakeout
 - |--- Roads - As built check
 - |--- Rail - Stakeout
 - |--- Rail - As built check
 - |--- Tunnel - Stakeout (TPS)
 - |--- Tunnel - As built check (TPS)
 - |--- Switch to Base menu (GPS)
Unavailable for GS05/GS06
- |--- Jobs & Data
 - |--- New job
 - |--- View & edit data
 - |--- Create control data
 - |--- Job properties
 - |--- Choose working job
 - |--- Choose control job
 - |--- Import data
 - |--- Import ASCII data
 - |--- Import alignment data
 - |--- Import DXF data
 - |--- Import DTM data
 - |--- Import XML data
 - |--- Export & copy data
 - |--- Export ASCII data
 - |--- Export custom data
 - |--- Export DXF data
- |

- |--- Export XML Data
- |--- Export Data Using Stylesheet
- |--- Export FBK/RW5/RAW data
- |--- Copy data between jobs
- |--- Instrument
 - |--- TPS settings (TPS)
 - |--- Measure mode & target
 - |--- Prism search settings
 - |--- Atmospheric corrections
 - |--- Level bubble & compensator
 - |--- Offsets & Quality Control
 - |--- Lights / Lights & accessories (TS)
 - |--- GPS settings
 - |--- RTK rover wizard
 - |--- Satellite tracking
 - |--- Antenna heights
 - |--- Quality control
 - |--- Raw data logging
 - |--- Connections..
 - |--- GPS connection wizard (GPS)
 - |--- TPS connection wizard (TPS)
 - |--- Internet wizard
 - |--- CS connection wizard (TS)
 - |--- All other connections
 - |--- Instrument status info
 - |--- Battery & memory
 - |--- Satellite tracking (GPS)
 - |--- RTK data link status (GPS)
 - |--- Current GPS position (GPS)

```

|-- Raw data logging (GPS)
|-- Connection status
|-- Internet connection status
|-- TPS current station info (TPS)
|-- TPS camera settings (TPS, CS)
|-- User
    |-- Work settings
        |-- ID templates
        |-- Coding & linework
        |-- My Survey Screen
        |-- Hot keys & favourites
        |-- Prompt before storing
    |-- Working style wizard
    |-- System settings
        |-- Regional settings
        |-- SmartWorx options
        |-- Screen & audio
        |-- Admin settings
    |-- Tools & other utilities
        |-- Transfer user objects
        |-- Load firmware & Apps
        |-- Load licence keys
        |-- Ftp data transfer
        |-- Format memory devices
        |-- View contents of ASCII files
        |-- Leica Exchange
    |-- Check & Adjust (TS)
    |-- About Leica Viva

```

**Menu tree for GPS
RTK base**

- |-- Go to Work!
 - |
 - |-- Start base over known point
 - |
 - |-- Start base over last setup
 - |
 - |-- Start base over any point
 - |
 - |-- Go to rover menu
 - |-- Instrument
 - |
 - |-- Base settings
 - |
 - |-- Satellite tracking
 - |
 - |-- Base raw data logging
 - |
 - |-- Base connections
 - |
 - |-- Connect to base sensor
 - |
 - |-- All other connections
 - |
 - |-- Base status info
 - |
 - |-- Battery & memory
 - |
 - |-- Satellite tracking
 - |
 - |-- Current position
 - |
 - |-- Raw data logging
 - |
 - |-- Connection status
-

Appendix B Internal Memory

Available memory > 500 MB.

Data stored to the internal memory The following are examples of the data types that can be stored to the internal memory.

- Applications
 - Codelists
 - Coordinate systems
 - Format files
 - Geoid and CPCS files
 - Jobs & Data
 - System languages
 - Working styles
-

Appendix C Directory Structure of the Memory Device

Description

On the memory device, files are stored in certain directories. The following diagram of the directory structure refers to the data storage devices and the internal memory.

All files are fully compatible with Leica System 1200 and vice versa, with the exception of the following listed files which are not compatible between the systems:

- Working styles and configuration sets
- System.ram and VivaSystem.zip
- Licence files
- Language files, and
- Application files.

Directory structure

--- CODE	• Codelists, various files
--- CONFIG	• Working style files (*.xfg)
--- RTK_PROFILE	• RTK profile files (*.rpr)
--- SKETCH_TEMPLATE	• Custom templates (*.jpg) for sketching
--- USERMANAGEMENT	• Administration settings files (*.usm)
--- CONVERT	• Format files (*.frt)
--- DATA	• ASCII (*.txt), DXF (*.dxf), LandXML (*.xml), Terramodel (*.xml), Carlson (*.cl) and Shape files (*.shp, *.shx and *.dbf and all other shape file components) for import/export to/from job
	• Section files for Carlson (*.sct) and ASCII report files for Terramodel (*.txt) for import to job
	• Report sheets created from applications
--- GPS	
--- CSCS	• CSCS field files (*.csc)
--- GEOID	• Geoid field files (*.gem)
--- RINEX	• RINEX files
--- XML	• Alignment Editor Alignments (*.xml)
--- DBX	• DTM jobs, various files
	• Coordinate system file (Trfset.dat)
	• Job files for System 1200
--- JOB	• Job files, various files. Jobs are stored in a folder per job.
--- MAP	• Map related files (for example *.mpl), stored in a subfolder per job.
--- IMAGES	• Image files (*.jpg), stored in a subfolder per job.
--- SCANS	• Scan database files (*.sdb files)
	• Bitmaps of intensity values (*.bmp files)
--- DOWNLOAD	• Various files, downloaded by the Ftp data transfer application (*.*)
--- GPS	• Antenna file (List.ant)

|
|
|
|-- GSI
|
|
|-- SYSTEM

- GSM/Modem station list (*.fil)
 - Server list (*.fil)

 - GSI files (*.gsi)
 - ASCII files for export from job (*.*)

 - Application files (*.axx)
 - Firmware files (*.fw)
 - Language files (*.s*)
 - Licence file (*.key)
 - System files (VivaSystem.zip)
-

Appendix D Pin Assignments and Sockets

D.1 GS08plus

Description

Some applications require knowledge of the pin assignments for the GS08plus/GS12 ports.

In this chapter, the pin assignments and sockets for the ports of the GS08plus/GS12 are explained.

Ports at the instrument underside

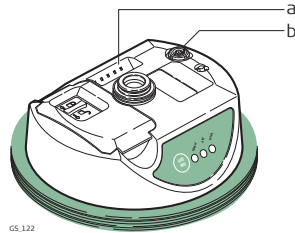

GS.122

- a) Clip on contacts (only GS12)
- b) Lemo port (USB and serial)

Pin assignments for 8 pin LEMO-1



PIN.001

Pin	Signal Name	Function	Direction
1	USB_D+	USB data line	In or out
2	USB_D-	USB data line	In or out
3	GND	Signal ground	-
4	RxD	RS232, receive data	In
5	TxD	RS232, transmit data	Out
6	ID	Identification pin	In or out
7	PWR	Power input, 10.5 V-28 V	In
8	TRM_ON/USB_ID	RS232, general purpose signal	In or out

Sockets

8 pin LEMO-1: LEMO-1, 8 pin, LEMO EGI.1B.308.CLN

D.2 GS10

Description

Some applications require knowledge of the pin assignments for the GS10 ports. In this chapter, the pin assignments and sockets for the ports of the GS10 are explained.

Ports at the instrument front panel

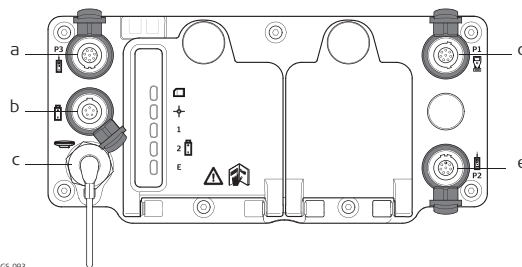

GS.093

- a) Port P3: Power out, data in/out or remote interface in/out. 8 pin LEMO
- b) Port PWR: Power in. 5 pin LEMO
- c) Port ANT: GNSS antenna in
- d) Port P1: CS field controller in/out or remote interface in/out. 8 pin LEMO
- e) Port P2: Power out, data in/out or remote interface in/out. 8 pin LEMO

Pin assignments for port P1

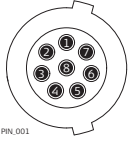

PIN.001

Pin	Signal Name	Function	Direction
1	USB_D+	USB data line	In or out
2	USB_D-	USB data line	In or out
3	GND	Signal ground	-
4	RxD	RS232, receive data	In
5	TxD	RS232, transmit data	Out
6	ID	Identification pin	In or out
7	PWR	Power input, 10.5 V-28 V	In
8	TRM_ON/USB_ID	RS232, general-purpose signal	In or out

Pin assignments for port P2, and port P3

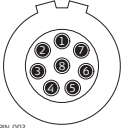

PIN.003

Pin	Signal Name	Function	Direction
1	RTS	RS232, ready to send	Out
2	CTS	RS232, clear to send	In
3	GND	Signal ground	-
4	RxD	RS232, receive data	In
5	TxD	RS232, transmit data	Out
6	ID	Identification pin	In
7	GPIO	RS232, configurable function	In or out
8	+12 V	12 V power supply out	Out

Pin assignments for port PWR

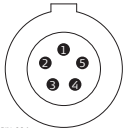

PIN.004

Pin	Signal Name	Function	Direction
1	PWR1	Power input, 11 V-28 V	In
2	ID1	Identification pin	In
3	GND	Signal ground	-
4	PWR2	Power input, 11 V-28 V	In
5	ID2	Identification pin	In

Sockets

Port P1	LEMO-1, 8 pin, LEMO EGI.1B.308.CLN
Port P2 and port P3:	LEMO-1, 8 pin, LEMO HMA.1B.308.CLNP
Port PWR:	LEMO-1, 5 pin, LEMO HMG.1B.305.CLNP

D.3

GS14

Description

Some applications require knowledge of the pin assignments for the instrument ports. In this chapter, the pin assignments and sockets for the instrument ports are explained.

Ports at the instrument underside

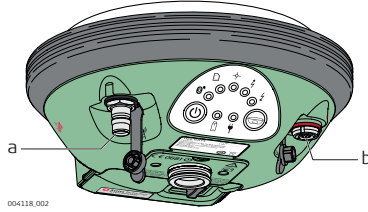

- a) QN-connector, only for models with UHF radio
- b) Port 1 (USB and serial)

Pin assignments for port P1

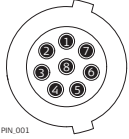

Pin	Signal Name	Function	Direction
1	USB_D+	USB data line	In or out
2	USB_D-	USB data line	In or out
3	GND	Signal ground	-
4	RxD	RS232, receive data	In
5	TxD	RS232, transmit data	Out
6	ID	Identification pin	In or out
7	PWR	Power input, 10.5 V-28 V	In
8	GPIO	RS232, general-purpose signal	In or out

Sockets

Port 1: LEMO-1, 8 pin, LEMO HMI.1B.308.CLWP

D.4

GS15

Description

Some applications require knowledge of the pin assignments for the GS15 ports. In this chapter, the pin assignments and sockets for the ports of the GS15 are explained.

Ports at the instrument underside

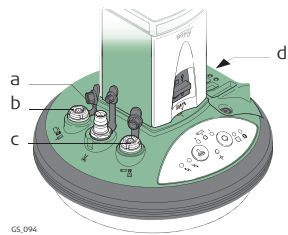

- a) QN-connector
- b) Port 2
- c) Port 1 (USB and serial)
- d) Port 3

Pin assignments for port P1



Pin	Signal Name	Function	Direction
1	USB_D+	USB data line	In or out
2	USB_D-	USB data line	In or out
3	GND	Signal ground	-
4	RxD	RS232, receive data	In
5	TxD	RS232, transmit data	Out
6	ID	Identification pin	In or out
7	PWR	Power input, 10.5 V-28 V	In

Pin	Signal Name	Function	Direction
8	TRM_ON/USB_ID	RS232, general-purpose signal	In or out

Pin assignments for port P2

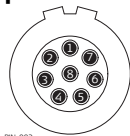

PKN.003

Pin	Signal Name	Function	Direction
1	RTS	RS232, ready to send	Out
2	CTS	RS232, clear to send	In
3	GND	Signal ground	-
4	RxD	RS232, receive data	In
5	TxD	RS232, transmit data	Out
6	ID	Identification pin	In
7	GPIO	RS232, configurable function	In or out
8	+12 V	12 V power supply out	Out

Pin assignments for port P3

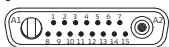

PKN.005

Pin	Signal Name	Function	Direction
1	PWR	4 V power supply in	In
2	Tx	Transmit data	In
3	Rx	Receive data	Out
4	GPO/DCD	General-purpose out, carrier detect out	Out
5	RTS	Request to send	In
6	CTS	Clear to send	Out
7	GPI/CFG	General-purpose in, config mode in	In
8	PWR	6 V power supply in	In
9	GPIO	General-purpose signal	In or out
10	GND	Signal and chassis ground	-
11	USB+	USB data line (+)	In or out
12	USB-	USB data line (-)	In or out
13	GND	Signal and chassis ground	-
14	ID	Identification pin	In or out
15	GPIO	General-purpose signal	In or out
A1	NC	Not used	-
A2	RF1	Antenna port, radio to antenna	-

Sockets

Port 1:	LEMO-1, 8 pin, LEMO EGI.1B.308.CLN
Port 2:	LEMO-1, 8 pin, LEMO HMA.1B.308.CLNP
Port 3:	15 pin RS232:RS232, 15 pin, DE15

Description

Some applications require knowledge of the pin assignments for the GS25 ports. In this chapter, the pin assignments and sockets for the ports of the GS25 are explained.

Ports at the instrument back panel

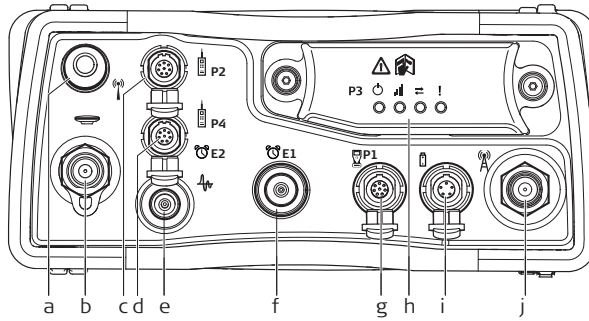

GS25.001

- a) Port BT: Bluetooth antenna
- b) Port ANT: GNSS antenna in
- c) Port P2: Power out, data in/out or remote interface in/out. 8 pin LEMO
- d) Port P4 and E2: Serial/Event port. 8 pin LEMO
- e) Port PPS: Puls per second output
- f) Port E1: Event 1
- g) Port P1: CS field controller in/out or remote interface in/out. 8 pin LEMO
- h) Port 3: Communication slot-in port and LEDs
- i) Port PWR: Power in. 5 pin LEMO
- j) Communication Slot-in port, Antenna, TNC

Pin assignments for port P1

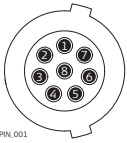

PN1.001

Pin	Signal Name	Function	Direction
1	USB_D+	USB data line	In or out
2	USB_D-	USB data line	In or out
3	GND	Signal ground	-
4	RxD	RS232, receive data	In
5	TxD	RS232, transmit data	Out
6	ID	Identification pin	In or out
7	PWR	Power input, 10.5 V-28 V	In
8	TRM_ON/USB_ID	RS232, general-purpose signal	In or out

Pin assignments for port P2

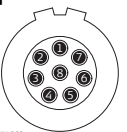

PN2.003

Pin	Signal Name	Function	Direction
1	RTS	RS232, ready to send	Out
2	CTS	RS232, clear to send	In
3	GND	Signal ground	-
4	RxD	RS232, receive data	In
5	TxD	RS232, transmit data	Out
6	ID	Identification pin	In
7	GPIO	RS232, configurable function	In or out
8	+12 V	12 V power supply out	Out

Pin assignments for port P3

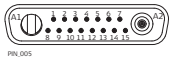

Pin	Signal Name	Function	Direction
1	PWR	4 V power supply in	In
2	Tx	Transmit data	In
3	Rx	Receive data	Out
4	GPO/DCD	General-purpose out, carrier detect out	Out
5	RTS	Request to send	In
6	CTS	Clear to send	Out
7	GPI/CFG	General-purpose in, config mode in	In
8	PWR	6 V power supply in	In
9	GPIO	General-purpose signal	In or out
10	GND	Signal and chassis ground	-
11	USB+	USB data line (+)	In or out
12	USB-	USB data line (-)	In or out
13	GND	Signal and chassis ground	-
14	ID	Identification pin	In or out
15	GPIO	General-purpose signal	In or out
A1	NC	Not used	-
A2	RF1	Antenna port, radio to antenna	-

Pin assignments for port P4/E2



Pin	Signal Name	Function	Direction
1	RTS	RS232, ready to send	Out
2	CTS	RS232, clear to send	In
3	GND	Signal ground	-
4	RxD	RS232, receive data	In
5	TxD	RS232, transmit data	Out
6	ID	Identification pin	In or out
7	GPIO/EVT2 IN	RS232, general purpose input/output	In or out
8	+12 V	12 V power supply out	Out

Pin assignments for port PWR

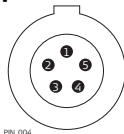

Pin	Signal Name	Function	Direction
1	PWR1	Power input, 11 V-28 V	In
2	ID1	Identification pin	In
3	GND	Signal ground	-
4	PWR2	Power input, 11 V-28 V	In
5	ID2	Identification pin	In

Sockets

Port P1	LEMO-1, 8 pin, LEMO EGI.1B.308.CLN
Port P2 and P4/E2:	LEMO-1, 8 pin, LEMO HMA.1B.308.CLNP
Port 3:	15 pin RS232:RS232, 15 pin, DE15
Port PWR:	LEMO-1, 5 pin, LEMO HMG.1B.305.CLNP
PPS:	LEMO REN.OS.250.CTL
E1:	LEMO HGP.00.250.CTL

Description

Some applications require knowledge of the pin assignments for the CS10/CS15 ports. In this chapter, the pin assignments and sockets for the ports of the CS10/CS15 are explained.

Ports at the instrument bottom panel - DSUB9 connector

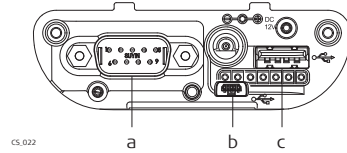

- a) DSUB9 port
- b) USB Mini port
- c) USB A Host port

Ports at the instrument bottom panel - Lemo connector

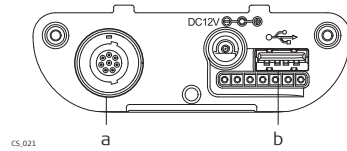

- a) Lemo port (USB and serial)
- b) USB A Host port

Pin assignments for RS232 serial port

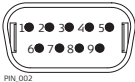

Pin	Signal Name	Function	Direction
1	NC	Not connected	-
2	RxD	RS232, receive data	In
3	TxD	RS232, transmit data	Out
4	NC	Not connected	-
5	GND	Signal Ground	-
6	NC	Not connected	-
7	RTS	RS232, request to send	Out
8	CTS	RS232, clear to send	In
9	NC	Not connected	-

Pin assignments for 8 pin LEMO-1



Pin	Signal Name	Function	Direction
1	USB_D+	USB data line	In or out
2	USB_D-	USB data line	In or out
3	GND	Signal ground	-
4	RxD	RS232, receive data	In
5	TxD	RS232, transmit data	Out
6	ID	Identification pin	In or out
7	PWR	Power input, 10.5 V-28 V	In
8	TRM_ON/USB_ID	RS232, general purpose signal	In or out

Sockets

- 9 pin RS232: RS232, 9 pin, DB9
- 8 pin LEMO-1: LEMO-1, 8 pin, LEMO EGI.1B.308.CLN

D.7

TS11/TS15/TS12 Lite

Description

Some applications require knowledge of the pin assignments for the instrument port. In this chapter, the pin assignments and socket for the port 1 of the TS11/TS15/TS12 Lite instrument are explained.

Ports at the TS11/TS15/TS12 Lite instrument

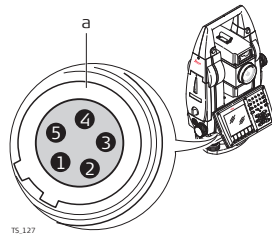

a) Port 1

Pin assignments for port P1

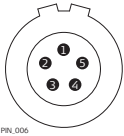

Pin	Signal Name	Function	Direction
1	PWR	Power input, + 12 V nominal (11 V - 16 V)	In
2	-	Not used	-
3	GND	Single ground	-
4	RxD	RS232, receive data	In
5	TxD	RS232, transmit data	Out

Sockets

Port 1: LEMO-0, 5 pin, LEMO ENA.OB.305.CLN

D.8

MS50/TS50/TM50

Description

Some applications require knowledge of the pin assignments for the instrument port. In this chapter, the pin assignments and socket for the port 1 of the MS50/TS50/TM50 instrument are explained.

Ports at the MS50/TS50/TM50 instrument

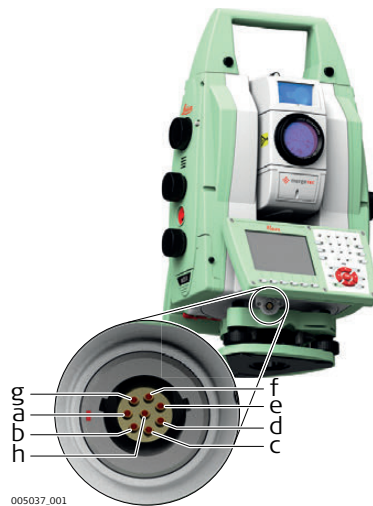

- a) Pin 1
- b) Pin 2
- c) Pin 3
- d) Pin 4
- e) Pin 5
- f) Pin 6
- g) Pin 7
- h) Pin 8

Pin assignments for 8 pin LEMO-1

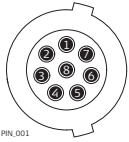

PNL.001

Pin	Signal Name	Function	Direction
1	USB_D+	USB data line	In or out
2	USB_D-	USB data line	In or out
3	GND	Signal ground	-
4	RxD	RS232, receive data	In
5	TxD	RS232, transmit data	Out
6	ID	Identification pin	In or out
7	PWR	Power input, nominal +12 V (11 V - 16 V)	In
8	NC	Not connected	-

Sockets

Port 1: LEMO-1, 8 pin, LEMO EGI.1B.308.CLN

D.9

TPS1200+

Description

Some applications require knowledge of the pin assignments for the instrument port. In this chapter, the pin assignments and socket for the port 1 of the TPS1200+ instrument are explained.

Ports at the TPS instrument

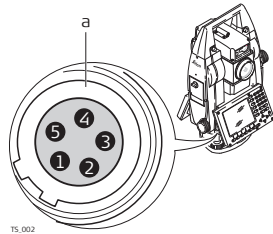

TS.002

a) Port 1

Pin assignments for port P1

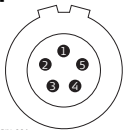

PNL.000

Pin	Signal Name	Function	Direction
1	PWR	Power input, + 12 V nominal (11 V - 16 V)	In
2	-	Not used	-
3	GND	Single ground	-
4	RxD	RS232, receive data	In
5	TxD	RS232, transmit data	Out

Sockets

Port 1: LEMO-0, 5 pin, LEMO ENA.OB.305.CLN

Appendix E

Cables

E.1

GPS Cables

Power cables

Name	Description
GEV97	<ul style="list-style-type: none">• Allows GS10 (power port) to be externally powered• LEMO-1, 5 pin, 30° / LEMO-1, 5 pin, 30°• 1.8 m
GEV71	<ul style="list-style-type: none">• Allows powering of any device from car battery.• Crocodile clips / LEMO-1, 5 pin, 30° (female)• 4.0 m
GEV172	<ul style="list-style-type: none">• Allows GS10 (power port) to be externally powered from two external batteries• LEMO-1, 5 pin / LEMO-1, 5 pin, 30°• 2.8 m
GEV219	<ul style="list-style-type: none">• Allows CS10/CS15 (with LEMO CBC01 connector module) to be externally powered via the LEMO port• Allows GS10/GS15 (port 1) to be externally powered• LEMO-1, 8 pin, 135° / LEMO-1, 5 pin, 30°• 1.8 m
GEV235	<ul style="list-style-type: none">• Allows CS10/CS15 (with either connector modules) to be externally powered via the power jack• Wall adapter / 3 mm barrel connector• 1.5 m

Y cables

Name	Description
GEV172	<ul style="list-style-type: none">• Allows GS10 (power port) to be externally powered from two external batteries• LEMO-1, 5 pin / LEMO-1, 5 pin, 30°• 2.8 m
GEV205	<ul style="list-style-type: none">• Allows connections between GS10/GS15 (port 1), an external radio in GFU1200 housing and the GEB71, with GS10/GS15 and a radio being externally powered• LEMO-1, 8 pin, 135° / LEMO-1, 8 pin, 135° (female) / LEMO-1, 5 pin• 1.8 m
GEV215	<ul style="list-style-type: none">• Allows connections between CS10/CS15 (with LEMO CBC01 connector module), the GS10/GS15 (port 1) and the GEB71, with the GS10/GS15 being powered from the GEB71.• LEMO-1, 8 pin, 135° / LEMO-1, 5 pin, 30° / LEMO-1, 5 pin, 30°• 2.0 m
GEV261	<ul style="list-style-type: none">• Allows connections between MS50/TS50/TM50, external battery GEB171 and a PC with either USB or 9 pin D-Sub RS232.• LEMO-1, 8 pin, 135° / LEMO-1, 5 pin/USB/9pin D-Sub• 1.8 m

Radio programming cables

Name	Description
GEV231	<ul style="list-style-type: none">• Allows an "SLR" radio device to be externally powered and programmed by a computer• 15 pin (GS15 slot-in port) (female) / 9 pin, RS232 serial / LEMO-1, 5 pin• 1.8 m

Name	Description
GEV171	<ul style="list-style-type: none"> Allows a radio within a GFU1200 device to be externally powered and programmed by a computer LEMO-1, 8 pin, 135° (female) / 9 pin, RS232 serial / LEMO-1, 5 pin 1.8 m

Radio cables

Name	Description
GEV67	<ul style="list-style-type: none"> Allows System 500 GFU housings to be connected to a GS10 (port 2 and 3), or GS15 (port 2) LEMO-1, 8 pin, 30° / LEMO-1, 8 pin, 135° / LEMO-1, 5 pin, 30° 0.5 m
GEV125	<ul style="list-style-type: none"> Allows a Satel modem (not inside housing) to be connected to a GS10 (port 2 and 3), or GS15 (port 2) LEMO-1, 8 pin, 30° / 15 pin, RS232 serial 1.8 m
GEV232	<ul style="list-style-type: none"> Allows System 1200 GFU housings to be connected to a GS10 (port 2 and 3), or GS15 (port 2) LEMO-1, 8 pin, 30° / LEMO-1, 8 pin, 30° (female) 2.8 m
GEV233	<ul style="list-style-type: none"> Allows System 1200 GFU housings to be connected to a GS10 (port 2 and 3), or GS15 (port 2) LEMO-1, 8 pin, 30° / LEMO-1, 8 pin, 30° (female) 0.8 m

Serial data transfer cables

Name	Description
GEV160	<ul style="list-style-type: none"> Allows serial connection between GS10 (port 2 and 3), or GS15 (port 2) to a computer to stream NMEA or RTK data LEMO-1, 8 pin, 30° / 9 pin, RS232 serial 2.8 m
GEV162	<ul style="list-style-type: none"> Allows serial connection between GS10/GS15 (port 1) to a computer to stream NMEA or RTK data Allows serial connection between CS10/CS15 (with LEMO CBC01 connector module) and, for example, a hidden point device, ASCII input device, or computer. Allows serial connection between CS10/CS15 (with 9 pin serial CBC02 connector module) and GS10/GS15 (port 1). This connection is useful when using third-party software such as Carlson SurvCE on the CS10/CS15 and a cable connection is required to the GS10/GS15. LEMO-1, 8 pin, 135° / 9 pin, RS232 serial 2.8 m
GEV163	<ul style="list-style-type: none"> Allows serial connection between CS10/CS15 (with LEMO CBC01 connector module) and GS10/GS15 port 1. This connection is useful when using third-party software such as Carlson SurvCE on the CS10/CS15 (with LEMO CBC01 connector module) and a cable connection is required to the GS10/GS15. LEMO-1, 8 pin, 30° / LEMO-1, 8 pin, 135° 1.8 m

USB to serial converter cables

Name	Description
GEV195	<ul style="list-style-type: none">Allows GS10 (port 2 and 3) or GS15 (port 2) to be connected to a computer where a serial connection is required, but no 9 pin RS232 port physically exists on the computer. This cable allows a serial connection through the USB port of the computer to the CS10/CS15 or GS10/GS15 hardware.LEMO-1, 8 pin, 30° / USB type A2.0 m
GEV269	<ul style="list-style-type: none">Allows CS10/CS15 (with LEMO CBC01 connector module) and GS10/GS15 (port 1) to be connected to a computer where a serial connection is required, but no 9 pin RS232 port physically exists on the computer. This cable allows a serial connection through the USB port of the computer to the CS10/CS15 or GS10/GS15 hardware.LEMO-1, 8 pin, 135° / USB type A2.0 m

USB data transfer cables

Name	Description
GEV223	<ul style="list-style-type: none">Allows USB data transfer between CS10/CS15 (both connector modules) and a computer.USB Type A / Mini USB Type B1.8 m
GEV234	<ul style="list-style-type: none">Allows a CS10/CS15 (with 9 pin serial CBC02 connector module) to connect to a GS10/GS15 (port 1). This cable is for when a cable connection is needed between CS10/CS15 and GS10/GS15 when the CS10/CS15 is using the CBC02 connector module.Allows a USB connection between the USB port of a computer and the GS10/GS15 (port 1)Allows a USB connection between the USB port of a computer and the CS10/CS15 (with LEMO CBC01 connector module)LEMO-1, 8 pin, 135° / USB type A1.65 m
GEV237	<ul style="list-style-type: none">Allows a CS10/CS15 (with LEMO CBC01 connector module) to connect to a GS10/GS15 (port 1). This cable is for when a cable connection is needed between CS10/CS15 and GS10/GS15 when the CS10/CS15 is using the CBC01 connector module.LEMO-1, 8 pin, 135° / LEMO-1, 8 pin, 135°1.65 m

Antenna cables

Name	Description
GEV108	<ul style="list-style-type: none">TNC connector / TNC connector30 m
GEV119	<ul style="list-style-type: none">TNC connector / TNC connector10 m
GEV120	<ul style="list-style-type: none">TNC connector / TNC connector2.8 m
GEV134	<ul style="list-style-type: none">TNC connector / TNC connector50 m
GEV141	<ul style="list-style-type: none">TNC connector / TNC connector1.2 m

Name	Description
GEV142	<ul style="list-style-type: none"> TNC connector / TNC connector (male) 1.6 m
-	<ul style="list-style-type: none"> TNC connector / TNC connector 70 m

E.2

TPS Cables

Power cables

Name	Description
GEV52	<ul style="list-style-type: none"> Allows TS11/TS12 Robotic/TS15 to be externally powered LEMO-0, 5 pin, 30° / LEMO-1, 5 pin 1.8 m
GEV219	<ul style="list-style-type: none"> Allows CS10/CS15 (with LEMO CBC01 connector module) to be externally powered via the LEMO port Allows GS10/GS15 (port 1) to be externally powered LEMO-1, 8 pin, 135° / LEMO-1, 5 pin, 30° 1.8 m

Radio / Y cables

Name	Description
GEV186	<ul style="list-style-type: none"> Allows connections between TS11/TS12 Robotic/TS15, an external battery and TCPS27/TCPS28/TCPS29 LEMO-0, 5 pin, 30° / LEMO-0, 8 pin, 30° / LEMO-1, 5 pin 1.8 m
GEV220	<ul style="list-style-type: none"> Allows connections between MS50/TS50/TM50, external battery GEB171 and a PC with 9 pin D-Sub RS232. LEMO-1, 8 pin, 135° / LEMO-1, 5 pin/USB/9pol D-Sub 1.8 m
GEV236	<ul style="list-style-type: none"> Allows connection between MS50/TS50/TM50, an external battery and TCPS27/TCPS28/TCPS29 LEMO-1, 8 pin, 15/150° / LEMO-1, 5pin / LEMO-1, 8 pin, 30° 1.8 m
GEV261	<ul style="list-style-type: none"> Allows connections between MS50/TS50/TM50, external battery GEB171 and a PC with either USB or 9 pin D-Sub RS232. LEMO-1, 8 pin, 135° / LEMO-1, 5 pin/USB/9pol D-Sub 1.8 m

Serial data transfer cables

Name	Description
GEV102	<ul style="list-style-type: none"> Allows serial connection between TS11/TS12 Robotic/TS15 and a computer Allows serial connection between TS11/TS12 Robotic/TS15 and CS10/CS15 (with 9 pin serial CBC02 connector module) LEMO-0, 5 pin, 30° / 9 pin, RS232 serial 2.0 m
GEV162	<ul style="list-style-type: none"> Allows serial connection between CS10/CS15 (with 9 pin serial CBC02 connector module) and a computer LEMO-1, 8 pin, 135° / 9 pin, RS232 serial 2.8 m

Name	Description
GEV163	<ul style="list-style-type: none"> Allows serial connection between CS10/CS15 (with LEMO CBC01 connector module) and GS10/GS15 port 1. This connection is useful when using third-party software such as Carlson SurvCE on the CS10/CS15 (with LEMO CBC01 connector module) and a cable connection is required to the GS10/GS15. LEMO-1, 8 pin, 30° / LEMO-1, 8 pin, 135° 1.8 m
GEV187	<ul style="list-style-type: none"> Allows connections between TS11/TS12 Robotic/TS15, an external battery and a computer LEMO-0, 5 pin, 30° / 9 pin, RS232 serial / LEMO-1, 5 pin, 30° 2.0 m
GEV217	<ul style="list-style-type: none"> Allows serial connection between TS11/TS12 Robotic/TS15 and CS10/CS15 (with LEMO CBC01 connector module) LEMO-1, 8 pin, 135° / LEMO-0, 5 pin, 30° 1.8 m

USB to serial converter cables

Name	Description
GEV189	<ul style="list-style-type: none"> Allows TS11/TS12 Robotic/TS15 to be connected to a computer where a serial connection is required, but no 9 pin RS232 port physically exists on the computer. This cable allows a serial connection through the USB port of the computer to the TS11/TS12 Robotic/TS15 or DNA hardware LEMO-0, 5 pin, 30° / USB type A 2.0 m

USB data transfer cables

Name	Description
GEV234	<ul style="list-style-type: none"> Allows a USB connection between the USB port of a computer and the CS10/CS15 (with LEMO CBC01 connector module) LEMO-1, 8 pin, 135° / USB type A 1.65 m
GEV237	<ul style="list-style-type: none"> Allows a CS10/CS15 (with LEMO CBC01 connector module) to connect to a GS10/GS15 (port 1). This cable is for when a cable connection is needed between CS10/CS15 and GS10/GS15 when the CS10/CS15 is using the CBC01 connector module. LEMO-1, 8 pin, 135° / LEMO-1, 8 pin, 135° 1.65 m

Appendix F NMEA Message Formats [GPS]

F.1 Overview

Description National Marine Electronics Association is a standard for interfacing marine electronic devices. This chapter describes all NMEA-0183 messages which can be output by the instrument.

Access Select **Main Menu: Instrument\Instrument\All other connections\NMEA 1** or **NMEA 2**. Press **Mesgs**.



A Talker ID appears at the beginning of the header of each NMEA message. The Talker ID can be user defined or standard (based on the NMEA 3.0). The standard is normally GP for GPS but can be changed in **NMEA Output 1** or **NMEA Output 2**.

F.2 Symbols Used for Describing the NMEA Formats

Description NMEA messages consist of various fields. The fields are:

- Header
- Special format fields
- Numeric value fields
- Information fields
- Null fields

Certain symbols are used as identifier for the field types. These symbols are described in this section.

Header

Symbol	Field	Description	Example
\$	-	Start of sentence	\$
--ccc	Address	<ul style="list-style-type: none">• -- = alphanumeric characters identifying the talkerOptions:<ul style="list-style-type: none">GP = GPS onlyGL = GLONASS onlyGN = Global Navigation Satellite System• ccc = alphanumeric characters identifying the data type and string format of the successive fields. Usually the name of the message.	GPGGA

Special format fields

Symbol	Field	Description	Example
A	Status	<ul style="list-style-type: none">• A = Yes, Data Valid, Warning Flag Clear• V = No, Data Invalid, Warning Flag Set	V
III.II	Latitude	<ul style="list-style-type: none">• Degreesminutes.decimal• Two fixed digits of degrees, two fixed digits of minutes and a variable number of digits for decimal fraction of minutes.	4724.538950

Symbol	Field	Description	Example
		<ul style="list-style-type: none"> Leading zeros are always included for degrees and minutes to maintain fixed length. 	
yyyy.yy	Longitude	<ul style="list-style-type: none"> Degreesminutes.decimal Three fixed digits of degrees, two fixed digits of minutes and a variable number of digits for decimal fraction of minutes. Leading zeros are always included for degrees and minutes to maintain fixed length. 	00937.04678 5
eeeeee.eee	Grid Easting	At the most six fixed digits for metres and three fixed digits for decimal fractions of metres.	195233.507
nnnnnn.nnn	Grid Northing	At the most six fixed digits for metres and three fixed digits for decimal fractions of metres.	127223.793
hhmmss.ss	Time	<ul style="list-style-type: none"> hoursminuteseconds.decimal Two fixed digits of hours, two fixed digits of minutes, two fixed digits of seconds and a variable number of digits for decimal fraction of seconds. Leading zeros are always included for hours, minutes and seconds to maintain fixed length. 	115744.00
mmddy	Date	<ul style="list-style-type: none"> Monthdayyear - two fixed digits of month, two fixed digits of day, two fixed digits of year. Leading zeros always included for month, day and year to maintain fixed length. 	093003
No specific symbol	Defined field	<ul style="list-style-type: none"> Some fields are specified to contain predefined constants, most often alpha characters. Such a field is indicated by the presence of one or more valid characters. Excluded from the list of valid characters are the following that are used to indicate other field types: A, a, c, x, hh, hhmmss.ss, llll.ll, yyyy.yy. 	M

Numeric value fields

Symbol	Field	Description	Example
x.x	Variable numbers	<ul style="list-style-type: none"> Integer or floating numeric field Optional leading and trailing zeros. Decimal point and associated decimal-fraction are optional if full resolution is not required. 	73.10 = 73.1 = 073.1 = 73

Symbol	Field	Description	Example
hh_	Fixed HEX field	Fixed length HEX numbers	3F

Information fields

Symbol	Field	Description	Example
c--c	Variable text	Variable length valid character field	A
aa_	Fixed alpha field	Fixed length field of upper case or lower case alpha characters	N
xx_	Fixed number field	Fixed length field of numeric characters	1

Null fields

Symbol	Field	Description	Example
No symbol	Information unavailable for output	Null fields do not contain any information.	„



Fields are always separated by a comma. Before the Checksum field there is never a comma.



When information for a field is not available, the position in the data string is empty.

F.3

GGA - Global Positioning System Fix Data

Syntax

\$--GGA,hhmmss.ss,llll.ll,a,yyyyy.yy,a,x,xx,x.x,x.x,M,x.x,M,x.x,xxxx*hh<CR><LF>

Description of fields

Field	Description
\$--GGA	Header including Talker ID
hhmmss.ss	UTC time of position
llll.ll	Latitude (WGS 1984)
a	Hemisphere, N orth or S outh
yyyyy.yy	Longitude (WGS 1984)
a	E ast or W est
x	Position quality indicator 0 = Fix not available or invalid 1 = No real-time position, navigation fix 2 = Real-time position, ambiguities not fixed 3 = Valid fix for GNSS P recise P ositioning S ervice mode, for example WAAS 4 = Real-time position, ambiguities fixed
xx	Number of satellites in use, 00 to 26.
x.x	HDOP
x.x	Altitude of position marker above/below mean sea level in metres. If no orthometric height is available the local ellipsoidal height will be exported. If the local ellipsoidal height is not available either, the WGS 1984 ellipsoidal height will be exported.
M	Units of altitude as fixed text M

Field	Description
x.x	Geoidal separation in metres. The Geoidal separation is the difference between the WGS 1984 earth ellipsoid surface and mean sea level.
M	Units of geoidal separation as fixed text M
x.x	Age of differential GNSS data, empty when DGPS not used
xxxx	Differential base station ID, 0000 to 1023
*hh	Checksum
<CR>	Carriage Return
<LF>	Line Feed

Examples

User-defined Talker ID = GN

```
$GNSSGA,113805.50,4724.5248541,N,00937.1063044,E,4,13,0.7,1171.281,M,-
703.398,
M,0.26,0000*42
```

F.4

GGK - Real-Time Position with DOP

Syntax

```
$--GGK,hhmmss.ss,mmddyy,llll.ll,a,yyyyy.yy,a,x,xx,x.x,EHTx.x,M*hh<CR><LF>
```

Description of fields

Field	Description
\$--GGK	Header including Talker ID
hhmmss.ss	UTC time of position
mmddyy	UTC date
llll.ll	Latitude (WGS 1984)
a	Hemisphere, N orth or S outh
yyyyy.yy	Longitude (WGS 1984)
a	E ast or W est
x	Position quality indicator 0 = Fix not available or invalid 1 = No real-time position, navigation fix 2 = Real-time position, ambiguities not fixed 3 = Real-time position, ambiguities fixed 5 = Real-time position, float
xx	Number of satellites in use, 00 to 26.
x.x	GDOP
EHT	Ellipsoidal height
x.x	Altitude of position marker as local ellipsoidal height. If the local ellipsoidal height is not available, the WGS 1984 ellipsoidal height will be exported.
M	Units of altitude as fixed text M
*hh	Checksum
<CR>	Carriage Return
<LF>	Line Feed

Examples

Standard Talker ID

```
$GNGGK,113616.00,041006,4724.5248557,N,00937.1063064,E,3,12,1.7,EHT1171.742,M*6D
```

User-defined Talker ID = GN

```
$GNGGK,113806.00,041006,4724.5248557,N,00937.1063064,E,3,13,1.4,EHT1171.746,M*66
```

F.5

GGK(PT) - Real-Time Position with DOP, Trimble Proprietary

Syntax

```
$PTNL,GGK,hhmmss.ss,mmddy,lll.l,a,yyyy.yy,a,x,xx,x.x,EHTx.x,M*hh<CR><LF>
```

Description of fields

Field	Description
\$PTNL	\$ = Start of sentence delimiter, talker ID fixed with PTNL
GGK	GGK sentence formatter
hhmmss.ss	UTC time of position
mmddy	UTC date
lll.l	Latitude (WGS 1984)
a	Hemisphere, N orth or S outh
yyyy.yy	Longitude (WGS 1984)
a	E ast or W est
x	Position quality indicator 0 = Fix not available or invalid 1 = No real-time position, navigation fix 2 = Not existing 3 = Real-time position, ambiguities fixed 4 = Real-time position, ambiguities not fixed
xx	Number of satellites in use, 00 to 26.
x.x	PDOP
EHT	Ellipsoidal height
x.x	Altitude of position marker as local ellipsoidal height. If the local ellipsoidal height is not available, the WGS 1984 ellipsoidal height will be exported.
M	Units of altitude as fixed text M
*hh	Checksum
<CR>	C arriage R eturn
<LF>	L ine F eed

Examples

Standard Talker ID

```
$PTNL,GGK,113616.00,041006,4724.5248557,N,00937.1063064,E,3,12,1.5,EHT1171.742,M*4C
```

User-defined Talker ID = GN

```
$PTNL,GGK,113806.00,041006,4724.5248557,N,00937.1063064,E,3,13,1.2,EHT1171.746,M*43
```

Syntax

```
$--GGQ,hhmmss.ss,mmddy,lll.ll,a,yyyy.yy,a,x,xx,x.x,x.x,M*hh<CR><LF>
```

Description of fields

Field	Description
\$--GGQ	Header including talker ID
hhmmss.ss	UTC time of position
mmddy	UTC date
lll.ll	Latitude (WGS 1984)
a	Hemisphere, N orth or S outh
yyyy.yy	Longitude (WGS 1984)
a	E ast or W est
x	Position quality indicator 0 = Fix not available or invalid 1 = No real-time position, navigation fix 2 = Real-time position, ambiguities not fixed 3 = Real-time position, ambiguities fixed 5 = Real-time position, float
xx	Number of satellites in use, 00 to 26.
x.x	Coordinate quality in metres
x.x	Altitude of position marker above/below mean sea level in metres. If no orthometric height is available the local ellipsoidal height will be exported. If the local ellipsoidal height is not available either, the WGS 1984 ellipsoidal height will be exported.
M	Units of altitude as fixed text M
*hh	Checksum
<CR>	C arriage R eturn
<LF>	L ine F eed

Examples

Standard Talker ID

```
$GNGGQ,113615.50,041006,4724.5248556,N,00937.1063059,E,3,12,0.009,1171.281,M*22
```

```
$GPGGQ,113615.50,041006,,,,08,,*67
```

```
$GLGGQ,113615.50,041006,,,,04,,*77
```

User-defined Talker ID = GN

```
$GNGGQ,113805.50,041006,4724.5248541,N,00937.1063044,E,3,13,0.010,1171.281,M*2E
```

F.7

GLL - Geographic Position Latitude/Longitude

Syntax

```
$--GLL,III.II,a,yyyy.yy,a,hhmmss.ss,A,a*hh<CR><LF>
```

Description of fields

Field	Description
\$--GLL	Header including talker ID
III.II	Latitude (WGS 1984)
a	Hemisphere, N orth or S outh
yyyy.yy	Longitude (WGS 1984)
a	E ast or W est
hhmmss.ss	UTC time of position
A	Status A = Data valid V = Data not valid
a	Mode indicator A = Autonomous mode D = Differential mode N = Data not valid
*hh	Checksum
<CR>	C arriage R eturn
<LF>	L ine F eed



The Mode indicator field supplements the Status field. The Status field is set to A for the Mode indicators A and D. The Status field is set to V for the Mode indicator N.

Examples

Standard Talker ID

```
$GNGLL,4724.5248556,N,00937.1063059,E,113615.50,A,D*7B
```

User-defined Talker ID = GN

```
$GNGLL,4724.5248541,N,00937.1063044,E,113805.50,A,D*7E
```

F.8

GNS - GNSS Fix Data

Syntax

```
$--GNS,hhmmss.ss,III.II,a,yyyy.yy,a,c--c,xx,x.x,x.x,x.x,x.x,xxx*hh<CR><LF>
```

Description of fields

Field	Description
\$--GNS	Header including talker ID
hhmmss.ss	UTC time of position
III.II	Latitude (WGS 1984)
a	Hemisphere, N orth or S outh
yyyy.yy	Longitude (WGS 1984)
a	E ast or W est
c--c	Mode indicator N = Satellite system not used in position fix or fix not valid A = Autonomous; navigation fix, no real-time fix D = Differential; real-time position, ambiguities not fixed R = Real-time kinematic; ambiguities fixed

Field	Description
xx	Number of satellites in use, 00 to 99
x.x	HDOP
x.x	Altitude of position marker above/below mean sea level in metres. If no orthometric height is available the local ellipsoidal height will be exported. If the local ellipsoidal height is not available either, the WGS 1984 ellipsoidal height will be exported.
x.x	Geoidal separation in metres
x.x	Age of differential data
xxxx	Differential base station ID, 0000 to 1023
*hh	Checksum
<CR>	Carriage Return
<LF>	Line Feed

Examples

Standard Talker ID

```
$GNGNS,113616.00,4724.5248557,N,00937.1063064,E,RR,12,0.9,1171.279,-703.398,0.76,0000*6C
```

```
$GPGNS,113616.00,,,,,08,,,,*69
```

```
$GLGNS,113616.00,,,,,04,,,,*79
```

User-defined Talker ID = GN

```
$GNGNS,113806.00,4724.5248547,N,00937.1063032,E,R,13,0.7,1171.283,-703.398,0.76,0000*39
```

F.9

GSA - GNSS DOP and Active Satellites

Syntax

```
$--GSA,a,x,xx,xx,xx,xx,xx,xx,xx,xx,xx,xx,xx,xx,x.x,x.x,x.x*x*hh<CR><LF>
```

Description of fields

Field	Description
\$--GSA	Header including talker ID
a	Mode M = Manual, forced to operate in 2D or 3D mode A = Automatic, allowed to change automatically between 2D and 3D
x	Mode 1 = Fix not available 2 = 2D 3 = 3D
xx	Numbers of the satellites used in the solution. This field is repeated 12 times. 1 to 32 = PRN numbers of GPS satellites 33 to 64 = Numbers of WAAS and WAAS like satellites 65 to 96 = Slot numbers of GLONASS satellites
x.x	PDOP
x.x	HDOP
x.x	VDOP
*hh	Checksum
<CR>	Carriage Return
<LF>	Line Feed

Examples

Standard Talker ID

\$GNGSA,A,3,01,11,14,17,19,20,24,28,,,,,1.5,0.9,1.2*26

\$GNGSA,A,3,65,66,67,81,,,,,,,,,1.5,0.9,1.2*29

User-defined Talker ID = GN

\$GNGSA,A,3,01,11,14,17,19,20,23,24,28,,,,,65,66,67,81,,,,,,,,,1.2,0.7,1.0*27

F.10

GSV - GNSS Satellites in View

Syntax

\$--GSV,x,x,xx,xx,xx,xxx,xx,.....*hh<CR><LF>

Description of fields

Field	Description
\$--GSV	Header including talker ID
x	Total number of messages, 1 to 4
x	Message number, 1 to 4
xx	Number of theoretically visible satellites according to the current almanac.
xx	PRN (GPS) / Slot (GLONASS) number of satellite
xx	Elevation in degrees, 90 maximum, empty when not tracking
xxx	Azimuth in degrees true north, 000 to 359, empty when not tracking
xx	Signal to Noise Ratio C/No in dB, 00 to 99 of L1 signal, null field when not tracking.
...	Repeat set PRN / Slot number, elevation, azimuth and SNR up to four times
*hh	Checksum
<CR>	Carriage Return
<LF>	Line Feed



Satellite information can require the transmission of multiple messages, specified by the total number of messages and the message number.



The fields for the PRN / Slot number, Elevation, Azimuth and SNR form one set. A variable number of these sets are allowed up to a maximum of four sets per message.

Examples

Standard Talker ID

\$GPGSV,3,1,11,01,55,102,51,11,85,270,50,14,31,049,47,17,21,316,46*7A

\$GPGSV,3,2,11,19,31,172,48,20,51,249,50,22,00,061,,23,11,190,42*7E

\$GPGSV,3,3,11,24,11,292,43,25,08,114,,28,14,275,44,,,,*45

\$GLGSV,2,1,06,65,16,055,42,66,64,025,48,67,46,262,42,68,01,245,*64

\$GLGSV,2,2,06,81,52,197,47,83,07,335,,,,,,,,*68

User-defined Talker ID = GN

\$GNGSV,3,1,10,01,55,100,51,11,86,263,50,14,31,049,47,17,22,316,46*65

\$GNGSV,3,2,10,19,30,172,48,20,52,249,51,23,12,190,42,24,12,292,42*6C

\$GNGSV,3,3,10,25,09,114,,28,14,274,44,,,,,,,,*62

Syntax

```
$--LLK,hhmmss.ss,mmddy,eeeeee.eee,M,nnnnn.nnn,M,x,xx,x.x,x.x,M*hh<CR><LF>
```

Description of fields

Field	Description
\$--LLK	Header including talker ID
hhmmss.ss	UTC time of position
mmddy	UTC date
eeeeee.eee	Grid Easting in metres
M	Units of grid Easting as fixed text M
nnnnn.nnn	Grid Northing in metres
M	Units of grid Northing as fixed text M
x	Position quality 0 = Fix not available or invalid 1 = No real-time position, navigation fix 2 = Real-time position, ambiguities not fixed 3 = Real-time position, ambiguities fixed 5 = Real-time position, float
xx	Number of satellites used in computation
x.x	GDOP
x.x	Altitude of position marker above/below mean sea level in metres. If no orthometric height is available the local ellipsoidal height will be exported.
M	Units of altitude as fixed text M
*hh	Checksum
<CR>	Carriage Return
<LF>	Line Feed

Examples**Standard Talker ID**

```
$GNLLK,113616.00,041006,764413.024,M,252946.774,M,3,12,1.7,1171.279,M*0F
$GPLLK,113616.00,041006,,,,,08,,,*57
$GLLLK,113616.00,041006,,,,,04,,,*47
```

User-defined Talker ID = GN

```
$GNLLK,113806.00,041006,764413.021,M,252946.772,M,3,13,1.4,1171.283,M*04
```

Syntax

```
$--LLQ,hhmmss.ss,mmddy,eeeeee.eee,M,nnnnn.nnn,M,x,xx,x.x,x.x,M*hh<CR><LF>
```

Description of fields

Field	Description
\$--LLQ	Header including talker ID
hhmmss.ss	UTC time of position
mmddy	UTC date
eeeeee.eee	Grid Easting in metres
M	Units of grid Easting as fixed text M
nnnnn.nnn	Grid Northing in metres
M	Units of grid Northing as fixed text M
x	Position quality 0 = Fix not available or invalid 1 = No real-time position, navigation fix 2 = Real-time position, ambiguities not fixed 3 = Real-time position, ambiguities fixed 5 = Real-time position, float
xx	Number of satellites used in computation
x.x	Coordinate quality in metres
x.x	Altitude of position marker above/below mean sea level in metres. If no orthometric height is available the local ellipsoidal height will be exported.
M	Units of altitude as fixed text M
*hh	Checksum
<CR>	Carriage Return
<LF>	Line Feed

Examples**Standard Talker ID**

```
$GNLLQ,113616.00,041006,764413.024,M,252946.774,M,3,12,0.010,1171.279,M*12
```

```
$GPLLQ,113616.00,041006,,,,,08,,,*4D
```

```
$GLLLQ,113616.00,041006,,,,,04,,,*5D
```

User-defined Talker ID = GN

```
$GNLLQ,113806.00,041006,764413.021,M,252946.772,M,3,13,0.010,1171.283,M*1A
```

Syntax

```
$--RMC,hhmmss.ss,A,IIII.II,a,yyyy.yy,a,x.x,x.x,xxxxx,x.x,a,a*hh<CR><LF>
```

Description of fields

Field	Description
\$--RMC	Header including talker ID
hhmmss.ss	UTC time of position fix
A	Status A = Data valid V = Navigation instrument warning
IIII.II	Latitude (WGS 1984)
a	Hemisphere, North or South
yyyy.yy	Longitude (WGS 1984)
a	East or West
x.x	Speed over ground in knots
x.x	Course over ground in degrees
xxxxx	Date: ddmmyy
x.x	Magnetic variation in degrees
a	East or West
a*hh	Mode Indicator A = Autonomous mode D = Differential mode N = Data not valid
<CR>	Carriage Return
<LF>	Line Feed

Examples**Standard Talker ID**

```
$GNRMC,113616.00,A,4724.5248557,N,00937.1063064,E,0.01,11.43,100406,11.43,E,D*1C
```

User-defined Talker ID = GN

```
$GNRMC,113806.00,A,4724.5248547,N,00937.1063032,E,0.00,287.73,100406,287.73,E,D*10
```

Syntax

```
$--VTG,x.x,T,x.x,M,x.x,N,x.x,K,a*hh<CR><LF>
```

Description of fields

Field	Description
\$--VTG	Header including talker ID
x.x	Course over ground in degrees true north, 0.0 to 359.9
T	Fixed text T for true north
x.x	Course over ground in degrees magnetic North, 0.0 to 359.9
M	Fixed text M for magnetic North
x.x	Speed over ground in knots
N	Fixed text N for knots
x.x	Speed over ground in km/h
K	Fixed text K for km/h
a	Mode Indicator A = Autonomous mode D = Differential mode N = Data not valid
*hh	Checksum
<CR>	Carriage Return
<LF>	Line Feed



The Magnetic declination is set in the instrument in **Regional Settings, Angle** page.

Examples

Standard Talker ID

```
$GNVTG,11.4285,T,11.4285,M,0.007,N,0.013,K,D*3D
```

User-defined Talker ID = GN

```
$GNVTG,287.7273,T,287.7273,M,0.002,N,0.004,K,D*3E
```

Syntax

```
$--ZDA,hhmmss.ss,xx,xx,xxxx,xx,xx*hh< CR >< LF >
```

Description of fields

Field	Description
\$--ZDA	Header including talker ID
hhmmss.ss	UTC time
xx	UTC day, 01 to 31
xx	UTC month, 01 to 12
xxxx	UTC year
xx	Local zone description in hours, 00 to ±13
xx	Local zone description in minutes, 00 to +59
*hh	Checksum
< CR >	Carriage Return
< LF >	Line Feed



This message is given high priority and is output as soon as it is created. Latency is therefore reduced to a minimum.

Examples**Standard Talker ID**

```
$GPZDA,091039.00,01,10,2003,-02,00*4B
```

User-defined Talker ID = GN

```
$GNZDA,113806.00,10,04,2006,02,00*76
```

Appendix G AT Commands

AT commands

Hayes Microcomputer Products is a leading manufacturer of modems that has developed a language called the AT command set for controlling digital cellular phones and modems. This AT command set has become the de facto standard.

List of selected AT commands

The characters in this table are the most commonly used AT commands when configuring a digital cellular phone or modem. Refer to the manual of the used digital cellular phone or modem for information on which AT commands to use.

AT command	Description
~	Inserts a delay of 1/4 second.
^#	Inserts the phone number as defined in digital cellular phone connection.
^^	Inserts character ^.
^C	Bearer Service: Connection Element.
^M	Inserts a carriage return and send command.
^S	Bearer Service: Speed including Protocol and NetDataRate.
AT	Starts a command line to be sent to phone.
AT&F[<value>]	Sets the configuration parameters to default values specified by manufacturer of phone. <value>: <ul style="list-style-type: none">• 0 = Factory default configuration profile
ATD<number>	Starts a call to the phone number given as parameter. If ";" is present, a voice call to the given number is performed.
AT+CBST=[<speed> [,<name> [,<ce>]]]	Sets the bearer service <name> with data rate <speed>, and the connection element <ce>. Refer to the manual of the used digital cellular phone or modem for a list of supported name, speed and connection element values.
AT+CREG=[<mode>]	Enables/disables network registration reports depending on the parameter <mode>.
AT+CREG?	Reports the <mode> and registration status <stat> of phone. <mode>: <ul style="list-style-type: none">• 0 = Disable network registration unsolicited result code• 1 = Enable network registration unsolicited result code <stat>: <ul style="list-style-type: none">• 0 = Not registered, ME is not currently searching a new operator to register to• 1 = Registered, home network• 2 = Not registered, but ME is currently searching a new operator to register to• 3 = Registration denied• 4 = Unknown• 5 = Registered, roaming

AT command	Description
AT+COPS=[<mode>[,<format>[,<oper>>[,<Act>]]]]	Forces an attempt to select and register the GSMUMTS network operator. <mode>: <ul style="list-style-type: none"> • 0 = Automatic choice • 1 = Manual choice <format>: <ul style="list-style-type: none"> • 0 = Alphanumeric long form • 1 = Short format alphanumeric • 2 = Numeric, 5 digits <oper>: <ul style="list-style-type: none"> • Network operator in format defined by <format> <Act>: <p>Access technology selected:</p> <ul style="list-style-type: none"> • 0 = GSM • 2 = UTRAN
AT+COPS?	Returns the currently registered network operator.
AT+COPS=?	Returns a list of all available network operators in form of: <stat>, long alphanumeric <oper>, short alphanumeric <oper>, numeric <oper>,<Act>: <stat>: Operator availability: <ul style="list-style-type: none"> • 0 = Unknown • 1 = Available • 2 = Current • 3 = Forbidden <Act>: Access technology selected: <ul style="list-style-type: none"> • 0 = GSM • 1 = GSM Compact • 2 = UTRAN
AT+CPIN=<pin>[,<newpin>]	Sends the PIN to the phone.
AT+CPIN?	Returns the status of the PIN request: <ul style="list-style-type: none"> • READY = Phone can be used • SIM PIN = PIN is not set, phone not ready for use. • SIM PUK = PUK is required to use the device • ERROR = No SIM card inserted
AT+CSQ	Reports received signal quality indicators in form of: <signal strength><bit error rate>
AT+CSQ=?	Returns the supported ranges.
AT+FLO=<type>	Selects the flow control behaviour of the serial port in both directions. <ul style="list-style-type: none"> • 0 = Flow control None • 1 = Flow control Software (XON-XOFF) • 2 = Flow control Hardware (CTS-RTS)

Appendix H Event Input Notify Message Format ^[GPS]

Description

With GS25, a message can be created. This message provides information about

- the fact that an event was detected by the receiver
- the time when the event was detected.

The message can be in ASCII or in binary format. It is sent to a connected device, for example a PC.

Refer to "19.12 Event Input 1/Event Input 2" for configuring the event input interface.

Example

```
$PLEIR,HPT,134210000,1203*17
```

Syntax in ASCII

```
$PLEIR,EIX,sssssssss,ttttttt,nnnn,cccc,ddd*hh<CR><LF>
```

Description of the fields

Field	Description
\$PLEIR	Header
EIX	Message identifier. X = 1 for port E1 X = 2 for port E2
sssssssss	GPS time of week of event in ms
ttttttt	GPS time of week of event in ns
nnnn	GPS week number
cccc	Event count
ddd	Event pulse count This is the count of all pulses including those violating the specified accuracy limit boundary conditions set in Event input 1/Event input 2, Event input page. This allows determination of missed events.
*hh	Checksum
<CR>	Carriage return
<LF>	Line feed

Example

```
$PLEIR,EI2,292412000,28932,1203,203,1*70
```

Appendix I PPS Output Notify Message Format [GPS]

Description With GS25, a message can be created. This message informs about the output of a PPS pulse. The message can be in ASCII or in binary format. It is sent to a connected device, for example a PC.
The message is sent at least 0.5 s before the next pulse. For this reason, notify messages are sent when the PPS output rate is greater than 1 s.
Refer to "19.11 PPS Output" for configuring the PPS output interface.

Syntax in binary format In binary, the notification message format is Leica Binary v2. Documentation for LB2 is available on request from the Leica Geosystems representative.

Syntax in ASCII \$PLEIR,HPT,ssssssss,nnnn*hh<CR><LF>

Description of the fields

Field	Description
\$PLEIR	Header
HPT	Message identifier, H igh P riority T ime
ssssssss	GPS time of week of next PPS output in ms
nnnn	GPS week number
*hh	Checksum
<CR>	Carriage return
<LF>	Line feed

Example \$PLEIR,HPT,134210000,1203*17

Index

3	
3D transformation	963
3rd party instruments	373
A	
Absolute coordinate difference	
Display	63
Limit exceeded	63
Absolute difference between two points	62
Access	
Find target point	791
GPS settings	28
Joystick	24
Known backsight	780
Multiple backsights	783
Orientate to line	786
Orientate with compass	26
Positioning Hz/V	25
Remote point	865
Resection	785
Set orientation	780
Sets of angles	753
Setup application	773
Survey	823
TPS settings	21
Transfer height	785
Access Point Name	245
Activate	
Code filter	75
Code group	75
Adapter, screw-to-stub	161
Add point to line	69
Adj, class	944
Adjustment	
Combined (l, t, i, c, ATR and OAC)	338
Compensator (l, t)	343
Electronic	333
Inspecting laser plummet	346
Inspecting the laser plummet	346
Mechanical	333
Of circular level on instrument	345, 345
Of circular level on prism pole	346
Of circular level on tribrach	345, 345
Tilting axis (a)	341
Adjustment results	884
Admin settings	315
Admin settings file, directory	906
Alignment	
Backup	628
Horizontal	625
Vertical	625
Alignment Editor	
Configuration	630
Menu	629
Alignment Editor Files, directory	906
Angle, COGO calculation method	462
Angle, display format	309
Annotations	
Add	819
Configuration	184
Recall	819
Antenna	
Calibration	159
Create	150
Edit	150
Recall deleted default	150
Antenna file, directory	906, 906
Antenna height	158
Determine	160
Antenna management, access	149
Antennas	149
Default	149
APN	245
Application	
COGO	403
Customised	402
Delete	319
Description	402
Determine coordinate system	
Traditional	470
Loadable and non-loadable	402
Reference Line	502
Reference Plane & Grid Scan	535
Sets of angles	752
Setup	772
Stakeout	792
Survey	
Auto points	825
Hidden points	847
Survey Cross Section	839
Survey GPS	
General	816
Survey TPS	
General	823
Remote point	865
TPS hidden point	860
Traverse	868
Upload	319
Application program file, directory	907
Applications, general information	402
Arc Calculations, COGO calculation method	434

Area		
Code	945	
Delete	55	
Edit	68	
Area management	65	
Areas, sorting and filter	71	
Arrow, orientate to		
Reference Line	511	
As built check, definition	556	
ASCII		
Export format	111	
Import format	99	
ASCII file, directory	906	
ASCII input		
Connection	183	
Status	264	
ASCII report file (Terramodel), directory	906	
Asymmetric parabola	642	
AT Msg	247	
Atmospheric ppm	134	
ATR		
Measurement	368	
Search	369	
Window	369	
ATR collimation error	336	
Attribute		
Add for		
Free code	291	
Thematical code	288, 296	
Description	942	
Type in new	81	
Attribute mismatch	298	
Attribute type	942	
Attribute value region	943	
Attribute value type	943	
Auto points		
Averaging	825	
Coding	825	
Configure	825	
Store	827	
Auto position, Roads	580	
Automatic aiming	368	
Automatic aiming collimation error	336	
Automatic Prism Search	131	
Automatic Target Aiming ATR		
Positioning of crosshairs	334	
Automatic targeting mode	128, 756, 764	
Auxiliary points		
Azimuth computation	855	
Hidden point measurements	848	
Averaging	62	
Auto points	825	
Configure	44	
Cross section elements	840	
Hidden points	848	
Include/exclude coordinate triplet	63	
Limit, exceeded	64	
Offset points	834	
Sets of angles	753	
Staked points	793	
Traverse points	868	
Averaging mode	943	
Define	62	
Avge, class	944	
Azimuth, compute		
Determine coordinate system	493	
Hidden point measurements	854	
Azimuth/bearing fields	309	
Azmth	855	
B		
Backsight point, check	23	
Backsight, traverse	875	
Backward in Survey Cross Section	846	
Backwards Bearing & Distance		
Hidden point measurements	850	
Backwards compatible	906	
Base pt	866	
Basic terms	625	
Batter rail	669	
Battery, status	251	
Bearing	309	
Bearing & Distance		
Hidden point measurements	848	
Bearing/azimuth fields	309	
Beep	314	
Auto points	827	
Hz-Sector	314	
Bitmaps of intensity values, directory	906	
C		
Cables	917	
CAD files, directory	906	
Calculator	376	
Operating mode	376	
Calibrate touch screen	314	
Calibration, antennas	159	
Camera	349	
Camera configuration	272, 350	
Cant Left/Right		
Description for Rail Check	711	
Cant value	708	
Carlson file, directory	906	
Carriage way	609	
Carrier	161	
Cassini projection	91	
Catch point	609	

CDMA	225	Code mismatch	297
Connection, configure	227	Code type	81, 945
Centreline	620	Codelist, directory	906
Chainage	618	Codelists	78
Extension	615	Codes	
Chainage	609	Manage	
Ahead	943, 950	Job codes	51
Back	943	Point, line, area codes	80
Centreline	618	Sort	
Equation	613	Codelist management	80
Format	307	Data management	75
Gap	613	Coding	
Overlap	613	Auto points	825
Reference Line	504, 508	COGO points	403
Chainage & Offset		Configure settings	276
Hidden point measurements	850	Cross section elements	840
Chainage equation	943	Hidden points	847
Edit	630	Offset points	834
Chainage, definition	616	Staked points	793
Change		Thematical	
Radio channel, requirements	230	With codelist	287
Change face	21	Without codelist	290
Channel changing, requirements	230	COGO	403
Check		Angle	405
Backsight point	23	Arc Calculations	404
Recorded point	23	Area Division	404
Check & Adjust Menu	337	Configure	405
Check and adjust instrument	333	Distance input/output	405
Check tunnel	557	Horizontal curve	405
Class	943	Intersections	404
Classic 3D transformation	963	Inverse	404
Results	484	Line Calculations	404
Classification of points, hierarchy	943	Modify values	467
Clear To Send	248	Shift, Rotate & Scale	405
Clockwise, Tunnel	732	Traverse	404
Cmdn..	184	Triangle	405
CMR/CMR+, data format	193	COGO points	
Cntrl..		Coding	403
Configure station to dial	237, 239	Combined adjustment (l, t, i, c, ATR and telescope camera)	338
Code		Combined Scale Factor	491
Area	945	Command, send to device	185
Create	81	Compass	22
Description	944	Compass, orientate with	26
Edit	81	Compatible with Leica System1200	906
Free	945	Compensator	136
Line	945	Adjustment (l, t)	343
Point	945	Configuration	136
Quick	945	Index errors (l, t)	335
Code filter for lines and areas	74	Computation, offset point	834
Code group	945	Configuration	
Activate/deactivate	75	Camera	272, 350
Manage	82	Check & Adjust	345
Code information	299		

Compensator	136	Geoid model	94
Hidden point	863	ID template	274
Leica Exchange	327	Line	65
Offsets	138	Point	57
Remote point	867	Prism	130
Sets of angles	754	Projection	92
Setup	773	Transformation	88
Traverse	872	Traverse	869
Configuration file, directory	906	Create reference plane	
Configure		From measured points	539
SBAS	199	From stored points	540
Connection		Cross section assignment	950
Configure	179	Check	653
CS to TS with RH16 or TCPS29	168	Create	654
Leica Legacy TPS	171	Delete	653
Third Party TPS	171	Edit	630, 654
To GS05/GS06	165	Cross section element	
Connections, status	263	Average	840
Constant	624	Coding	840
Context Menu, MapView	394	Cross Section Survey, configure	845
Control points	470	Cross section template	951
Convert to RoadRunner	630, 656	Add a layer	651
Converters, Tunnel	721	Create	649
Coordinate geometry calculations	403	Delete	649
Coordinate Quality		Duplicate	649
GPS	947	Edit	629, 649
TPS	948	Crown Road	
Coordinate system	84	Info page	594
Active	84	Crown, Stakeout	682
Create	86	csc file	946
Default	84	CSCS field file	946
Determine	474, 485, 499	CSCS field file, directory	906
Edit	86	CSCS model	94
Recall deleted default	85	Create from data storage device	94
Turn into user defined default	85	Description	946
Update	481	Types	946
Coordinate system file, directory	906	CSF	491
Coordinate system management, access	85	CTR16 on CS15	168
Coordinate triplet	946	Ctrl	
Copy data	111	CDMA	227
Copy points/data between jobs	124	Class	943
Counterclockwise, Tunnel	732	GPS Real-Time	231
Country Specific Coordinate System models	946	GSM	225
CQ		Internet/Ethernet	234
GPS	947	Modem	229
TPS	948	Radios for remote control	233
Create		RS232	234
Area	65	CTS	248
Code	81	Current key	298
Codelist	79	Current position, status	259
Coordinate system	86	Curve	642
CSCS models	94	Custom template, directory	906
Ellipsoid	89	Custom, export format	111

Customised application	402	Points from profile	742
Cut-off angle	146, 269	Projection	90
D		Report sheet 408, 515, 545, 583, 757, 776, 798, 873, 887	
Data	951	RTK Profile	144, 145
Copy between jobs	124	Scan	56
Exchange between two users	325	Surface	891
Preparing for Reference Line	503	Target	130
Up-/download to/from exchange server	325	Transformation	88
Data export	111	Working style	305
Directory	112, 114, 115, 119, 121	Descr	264
Data format, real-time	193, 193	Design element	625
Data management	54	Bloss curve	955
Access	54	Parabola	951, 960
Data storage device	723	Spiral	962
Daylight point	609	Straight (tangent)	962, 963
DBX	723	Design height	616, 675
Deactivate		Design point	502
Code filter	75	Design to Field	
Code group	75	Description	699
Default prisms	129	Installing	699
Default targets	129	Details on instrument errors	334
Default, recall		Devce..	217, 245
Antenna	150	Device	
Coordinate system	85	Configure	247
Devices	246	Create	247
Projection	90	Description	951
Survey screen settings	280, 828	Edit	247
Target	130	Device height	
Deflection error	630	Hidden point measurements	858
Delete		Devices	
Antenna	150	Configuration	241
Application	319	Configure	245
Code	80	Control	225
Codelist	79	For Internet, configure	245
Coordinate system	85	Overview	241
Coordinate triplet	63	Recall deleted default	246
Cross section template	840	Difference limit exceeded in Stakeout	803
Element in alignment	632	Digital cellular phone	
Element in cross section template	841	Control	225
Format file .. 408, 515, 546, 583, 757, 776, 798, 874, 887		Version	256
From Data Log	70	Digital cellular phones	241
Geoid model	93	Requirements for using	241
ID template	273	Supported	242
Image	362	Dimensions, carrier and adapter	161
Inverse COGO calculation	466	Display	314
Job	51	Settings	279
Language	311	Distance input/output in COGO	405
Line/area	55	Distribution	
Matched points	460, 476	Residuals COGO Shift, Rotate & Scale	407
PI in alignment	639	Documentation	2
Point	54	Double Stereographic projection	91
Point from line	69	Download data from exchange server	325

Downloads, Tunnel	721	European Geostationary Navigation	
Drilling rig orientation	736	Overlay System	196, 199
DTM height	616, 675	Event input	
DTM job, directory	906	Interface	214
DTM layer, select	805	Notification message format	938
DXF	99	Status	265
Data export	115	Exceeded limit	
Data import	108	Absolute coordinate difference	63
Export format	111	Average	64
DXF file, directory	906	Coordinate quality	152
Dynamic ATR window	132	Difference in Stakeout	803
Dynamic PS window	132	Height	
		Stakeout	796
E		Position	
EAO		Stakeout	796
Configure	188	Exchange data	325
Hidden point measurements	851	Exclude coordinate triplet from averaging	63
Edit		Expiry date, software maintenance	348
Area	68	Export	48
Code	81	Images	367
Codelist	79	Export & copy data	111
Coordinate system	86	Export data	111
Ellipsoid	89	Export format	111
Job	47	Export Job, connection	190
Line	68	Export key	297
Measured coordinate triplet	63	Exporting cross section elements	840
Point	59	Extended RTK	199
Projection	92		
Transformation	88	F	
Traverse	869	Favourites, configuration	283
EDM	127, 368, 368	FBK	122
EGL	371	Field file	
EGNOS, real-time data format	196	CSCS	946
Electronic Adjustment	333	Geoid	952
Electronic Distance Measurement	368	Field of view	368
Electronic serial number	228	Field sketching	365
Elevation	951	Field to office	321
local ellipsoidal height	642	Filter	
local orthometric height	642	Activate/deactivate for codes	75
Elevation mask	146, 269	Height smoothing	199
Ellipsoid		Point, line and area codes	74
Create	89	Points, lines and areas	71
Edit	89	Filter setting, define	54, 362
Ellipsoid distance in COGO	406	Filter symbol	71
Ellipsoid management, access	89	Filter..	54, 362
Ellipsoidal height	952	Areas	55
Ellipsoids	89	Export	112, 114, 120
Emitting Guide Light EGL	371	Lines	55
End date, line/area	68	Finding a target point	791
End time, line/area	68	Fine search	369, 370
ESN number	228	Finished road level	609
Est, class	944	Firmware file, directory	907
		Firmware, CS 3.5G modem	319

Firmware, current version	348
Firmware, upload	319
Firmware, version	348
FKP, Flächenkorrekturparameter	198
Following arrow, orientate to	
Stakeout	797
Format	
Data storage device	324
Event input notify message	938
Export	111
Import	99
NMEA message	922
PPS output notify message	939
Format file, export ASCII	111
Format files, directory	906
Forward in Survey Cross Section	846
Free code	945
Delete	70
Free coding	286
Frequency, change for radio	230
Functions	368
Functions, main menu	30
G	
GAGAN	196, 199
gem file	952
GeoC++	402
GeoCOM Mode	223
Geoid field file	952
Geoid field file, directory	906, 906
Geoid model	92
Create from	
Data storage device / internal memory	94
Delete	93
Description	952
Management, access	93
View	93
Geoid separation	952
Geoid, height above	952
Geometric elements	625
Geometric ppm	45
GetPt	759
GGA	202, 924
GGK	925
GGK(PT)	926
GGQ	927
GLL	928
GNS	928
Go to Work!	30
Go To Work! Menu	
Description	31
GPRS	245
GPRS device	
Requirements for using	245
Supported	245
GPS Aided Geo Augmentation Navigation	196, 199
GPS Settings	28
GPS used for TPS Setup	777
Grade	
In	646, 647
Out	646, 647
Graph, showing satellites	253
Grid distance in COGO	405
Grid orientation	538
Ground distance in COGO	406
Group	
Codes	80
Coding	
Thematical	288, 291, 296
Job codes	52
GSA	929
GSI	
Data	217
Format	217
Output	217
Word information	219
GSI file, directory	907
GSI16	99
GSI8	99
GSM	225
GSM connection, configure	225
GSV	930
GUS74 Laser Guide	373
H	
HdnPt.	851
Height	
Design	616, 675
Ellipsoidal	952
Entered manually	616
Entered manually, Roads	675
Geoid	952
Height layer of DTM	616, 675
Hidden point measurement	858
Individual point	616, 616, 675
Info layer of DTM	675
Levelled	952
Mean sea level	952
Orthometric	952
Priorities	675
Road and Rail	616
Second height	675
Height (aim to stake ht)	603
Height filter	199
Height mode	89

Height offset, stakeout	796	Include coordinate triplet in averaging	63
Height smoothing	200	Increase point ID	274
Height type		Increasing NE, SE, SW, NW	309
Current position	793	Incrementation	275
Point to be staked	793	Point ID's	274
Hidden point measurement devices	244	Indefinite triangle	679
Supported	244	IndivID	759, 817, 818, 824, 866
Hidden point measurement, heights	858	Info page	578
Hidden point, connection	186	Information, additional to codes	299
Hidden points	847	Initialisation	818, 956
Averaging	848	Access	821
Coding	847	Methods	956
Method	848	Moving	821
Hinge point	609	On known point	822
Hlth..	146, 269	Static	822
Horizontal alignment	610, 955	Instrument	30
Create a bloss curve	635	Errors, details	334
Create a curve	635	Instrument source	957
Create a straight	635	Instrument, 3rd party TPS	373
Edit	629	Instrument, Leica Legacy TPS	373
Edit a bloss curve	635	Instrument, orientate to	
Edit a curve	635	Reference Line	511
Edit a straight	635	Stakeout	797
Delete element	632	Interface	
Delete PI	639	Status	
Horizontal collimation error (c)	334	Event input	265
Horizontal curve, COGO calculation method	463	Internet	263
Hot keys		Remote	264
Configure	283	Interface, description	957
Description	19	Interference	230
Hts..	100	Internal memory	905
I		Internet	
ID	959	Connection	180
ID template	272	Control	234
Create	274	Status	263
Identification number	312	Internet connection status	266
Illumination	372	Internet device	
Image		Requirements for using	245
Delete	362	Supported	245
Management	362	Intersection, COGO calculation method	421
Taking	352	Intfce	
Image files, directory	906	Status	
Images		Rover	264
Exporting	367	Inv..	419, 424, 426, 428, 431
Sketching	364	Inverse, COGO calculation method	408
Images, panorama	360	J	
Imaging	349	Job	
Import	48	Create	42
Format	99	Default	42
Importers		Digital Terrain Model (DTM) job, Roads	559
Description	699	Edit	47
Installing	699	Management	42

Management, (Road, Rail, Tunnel)	558	Codes	945
Rail job, Roads	559	CSCS field files	946
Tunnel job, Roads	559	DTM jobs	804
Working	42	Geoid field files	952
Job file, directory	906	Quick codes	287
Job files Sys1200, directory	906	Download	
Jobs & Data	30	Coordinate systems	84
Joystick, move by	24	Jobs	42
K		Upload	
Keys, configure	19	Coordinate systems	84
Known backsight	780	Jobs	42
Known point, initialisation method	956	Licence file, directory	907
L		Licence key	402
Lambert 1 Parallel projection	91	Limit, exceeded	
Lambert 2 Parallel projection	91	Absolute coordinate difference	63
LandXML		Average	64
Export format	111	Line	561, 610
LandXML file, directory	906	Create	65
Language		Delete	55
Delete	311	Edit	68
Select	311	Orientate to	
Upload	319	Reference line	511
Language file, directory	907	Stakeout	797, 797
Laser plummet	372	Reference	502
Inspect	346	Stake out	678
Last point, orientate to		Line calculations, COGO calculation method	434
Reference Line	511	Line code	945
Stakeout	797	Filter	74
Layer		Line management	65
Select DTM, Stakeout	805	Line of sight	334
Road, Info page	596	Line of sight error (c)	334
Stakeout	682	Line Road, Info page	583
Layers	562	Line style	
Left rail	616	Coding	82
Leica 4G, data format	193	For line/area code	53
Leica Exchange		New line	66
User name and password creation	325	Linear	624
Configuration	327	Lines, sorting and filter	71
Transfer status	331	Linework	82, 300
Leica Geosystems TPS prism system	131	Using the linework field	300
Leica legacy instruments	373	with thematical coding	301
Leica Legacy TPS		List reference stations	233
Connection	171	LLK	931
Leica SmartWorx Viva software, exit	30	LLQ	932
Leica, data format	193	Loadable application	402
Length	68	Local line	
Levelled height	952	Info page	585
LGO		Local Line	
Creation		Stakeout	679
Antenna records	159	Local Manual Slope Road, Info page	591
Attributes	942	Lock	370
		Lock settings	315
		Log of messages	211

Log raw observations	137, 156, 270	Access	63
Logging status	261	Mean sea level, height	952
Loss of Lock	370	Meas, class	944
M		Measure	
Main menu	30	Antenna height	158
Management		Sets, sets of angles	762
Antennas	149	Setup points	783
Area	65	Measure & target settings	126
Codelists	78	Measure mode	
Coordinate systems	84	Fast	127
Data	54	Long range	127
Images	362	Tracking	127
Jobs	42	Measure to	127
Jobs (Road, Rail, Tunnel)	558	Mechanical Adjustment	333
Line	65	Mechanical Reference Plane	159
Points	57	Memory	
Prisms	129	Device to be formatted	324
Manual slope Road, Info page	591	Status	251
Manual, validity	2	Menu	
Manually entered height	616, 675	Go To Work!	31
Map	398	My Favourites	20
Map files, directory	906	Mercator projection	91
MapView	387	Message log	211
Access	387	Mismatch	
Area with focus, symbol	391	Attribute	298
Configure	387	Code	297
Context Menu	394	Mode	
Example of results in plot mode	396	Targeting	369
Keys	392	Mode, Calculator	376
Line with focus, symbol	391	Modem	242
North arrow	391	Control	229
Point symbols	393	Requirements for using	242
Point with focus, symbol	391	Supported	242
Scale bar	391	Modify values in COGO	467
Screen area	390	Molodensky-Badekas	89
Select Lines and Areas	393	Mountpoint	235, 385
Select Points, Lines and Areas	393	Move by joystick	24
Softkeys	392	Moving initialisation method	956
Symbol		MRP	159
Instrument station	391	MSAS	196
Reflectors	391	MTSAT	
Rover	391	Satellite-based Augmentation System ...	196, 199
Toolbar		Multiple backsights	783
Description	392	Multiple chainage	613
Symbol	391	N	
View results	396	National Marine Electronics Association	922
Master-Auxiliary Correction	198, 198	Natural surface	609
Match points	460, 476	Nav, class	944
Matching points		Negative offset, COGO	418
Choose	482	Next available point ID	
Edit	482	Real-time rover operations	819
MAX	198	Static operations	817
Mean page	62		

Advantages	200
Description	200
Recommended settings	200
Preparing data for Reference Line	503
Priority of heights	616
Prism	
Create	130
Default	129
Prism search	368
After prediction	371
Prism system	
Leica Geosystems TPS	131
True zero	131
Prisms	
Management	129
PRN	252
Profile	951
Profile (tunnel), view	742
Projection	
Cassini	91
Create	92
Delete	90
Double Stereographic	91
Edit	92
Lambert 1 Parallel	91
Lambert 2 Parallel	91
Mercator	91
Oblique Mercator	91
Polar Stereographic	91
Recall deleted default	90
RSO	91
Transverse Mercator	91
UTM	91
Projection distortion	45
Projection management, access	90
Projections	90
Properties	
Offset points	834
PS	369
360° search	370
Window	370
Pseudorandom Noise	252
Q	
Quadrant	309
Quick access to screens, configure	283
Quick code	945
Quick coding	287
Quick Settings	
GPS	28
TPS	21

R

Radio	
Change channels	230
Default	243
For GPS	243
For TPS	243
Interference	230
Supported	243, 243
User defined	243
Version	256
Radio Link Protocol	227
Rail Check	
Check height of lower rail	711
Checking a track	708, 708
Rail Editor	
Description	700
Installing	700
Rail, Info page	600
RAW	122
Raw data logging	261
Raw observations, log	137, 156, 270
RCS	371
Ready To Send	248
Real-time	192
Base	955
Rover	955
Status	254
Recall	
Annotations	819
Default	
Attribute values	58, 66
Survey screen settings	280, 828
Deleted default	
Antenna	150
Coordinate system	85
Devices	246
Projection	90
Target	130
Last used attribute values	58, 66
Previous result, COGO ...	419, 424, 426, 428, 431
Receive data from third party device	183
Recorded point, check	23
Rectified Skewed Orthomorphic projection	91
Red laser	139
Visible	373
Ref, class	944
Reference datum	45
Reference line	
Configure	508
Measure to	522
Stake to	526
Reference plane	
Create from measured points	539

Tilted	536	RTK profile file, directory	906
Reference Plane		RTK with more availability	199
Create from stored points	540	RTS	248
Reference plane & scan		Run	759, 817, 818, 824
Application	535	RW5	122
Reference point	502, 668	S	
Reference point surface	671	S/N	252
Refraction		Same Direction, Survey Cross Section	839
Coefficient	135	Satellite status	252
Correction	135	Satellite tracking, settings	145, 268
Relock	371	Satellites	
Remote connection	222	Health	147, 269
Remote connection, configuration	211	Number used in solution	254, 254, 255, 255
Remote point	865	SBAS, description	199
Access	865	Scale	
Configuration	867	Roads	572
Use	867	Set for transformation	477
Report sheet, create name 408, 515, 545, 583, 757, 776, 798, 873, 887		Transformation results	483, 484
Report sheet, directory	906	Scale factor, combined	491
Resection	785	Scan	623
Residual		Delete	56
Distribution COGO Shift, Rotate & Scale	407	Scan database files, directory	906
Result1	427, 429, 466	Scan Viewer	76
Result2	427, 429, 466	Scanning	
Results	881	Configure	750
Traverse	878	Search Windows	131
Traverse adjustment	884	Second point of cant	708
Resurvey staked point	803	Section file (Carlson), directory	906
Reticule	139	Segment	
Reticule illumination	139	Slope distance	651
Retry	369	Slope ratio	651
Right rail	616	Select DTM layer	805
RLP	227	Serial number	348
RmtHt	823	Set orientation	780
Road alignment file	558	Set-D	
Road job, new	657	Coordinate system	85
Robotic targeting mode	128, 756, 764	Projection	90
Rotate, MapView	388	Transformation	88
Rotation Point	620	Sets of angles	752
Rotations, set for transformation	477	Access	753
RPN mode	376	Configuration	754
RS232	243	Measure sets	762
RSO projection	91	Measurement methods	762, 771
RTCM		Settings for communication with TPS	171
Data format	193	Settings, lock and unlock	315
V3	193	Setup	
RTK network info	60	Access	773
RTK Profile		Application	772
Create new	143	Configuration	773
Delete	144, 145	Known backsight	780
Edit	143	Measure target points	783
Select another	143	Methods	780

Resection	785	Spiral	
Set orientation	780	In	962
Setup on TPS using GPS	777	Out	962
Setup reminder	779	Spiral parameter A	942
Shape file, directory	906	SPP	393
Shape files, directory	906	Stake	
Shift		Height difference	674, 712
Constant	605	Offset	673, 712
Linear	605	Stake mode, Roads	570
Parabolic	605	Stake offset	612
Reverse	605	Sign convention	612
Sign convention	606	Stake out	
Surface grade	607	Chainage and offset	677
Shift, Rotate & Scale, COGO	451	Direct	612
Shifts	623	Indirect	612
For Roads	604	Line	678
Set for transformation	477	Surface grade	680
Shoulder	609	Stake tunnel	557
Sign convention	624	Staked points	
Signal to noise ratio	252	Average	793
Single Point Position	393	Coding	793
Sketching		Stakeout	
Field	365	Configure	794, 809
Sketching on images	364	Crown	682
Skip point		Definition	556, 556
Sets of Angles	763	Difference limit exceeded	803
Stakeout	803	Layer, Roads	682
Skyplot	253	Local line	679
Slope	611	To centre line	619
Distance		To rail	619
Hidden point measurements	856	Standard deviation	949
Slope Road		GPS	947
Info page	591	Standard mode	376
Slope, key	856	Standing axis	334
SmartAntenna firmware, upload	319	Start up	313
SmartCodes	293	Static	953
Assigning codes	295, 296	Initialisation method	956
Code Block	295	Station	609
Configuration	293	Station equation	
Copying code block	297	Delete	655
Smartkey	19	Term	613
Smoothing heights	199	Station setup, delete in Traverse	871
Socket	908	Station to dial	
Sockets	915, 916, 916	Configure	237
Soldner Cassini projection	91	Create	238
Sort		Edit	238
Codes		Station, definition	616
Codelist management	80	Status	250
Data management	75	Connections	263
Points, lines and areas	71	Internet connection	266
Sort settings, define	54, 362	Transfer via Leica Exchange Server	331
Source	960	Store, auto points	827
Space-Based Augmentation System	199	Stored key	298

Straight	642
Sub class	962
Sun	854
Azimuth computation	854
Orientate to	
Reference Line	511
Stakeout	797
Superelevation	616, 620
Superelevation base	616
Supported functions	
Nikon	375
Sokkia	374
Topcon	374
Supported functions, Leica Legacy TPS	373
Surface	611
DTM	611
Layer	611
Surface grade	611
Stake out	680
Surface grade Road, Info page	588
Surface, delete	891
Survey	
Access	816, 817, 820, 823
Auto points	825
Default screen	823
Hidden points	847
Post-processed kinematic operations	816
Real-time rover operations	817
Static operations	816
Status TPS	251
Survey Cross Section	
Direction	846
Methods	839
Survey GPS	
Application general	816
Points	816
Survey remote point, TPS	865
Survey screen page	279
Survey TPS	
Application general	823
Points	823
Remote point	865
Symbols, for points in MapView	393
System file, directory	907
System information, status	348
System1200, backwards compatible	906
T	
Taking an image	352
Talker ID	922
Tangent	642
Tap Map	398
Target	
Default	129
Recall deleted default	130
Target height, hidden point measurements	858
Target point	
Find	791
Task, Roads	608
Telescope camera collimation error	336
Template (customer for sketching), directory ...	906
Template, Survey Cross Section	839, 840
Terramodel file, directory	906
Text	314
Thematical coding	286
Third Party TPS	
Connection	171
Tilting axis	334
Adjustment (a)	341
Error (a)	335
Time slicing	206
Time stamp	287
Timed measurement	820
Toe	609
Tolerances, Traverse	873
Tools Menu	
For Rail	717
Top	609
Touch screen on, off	314
TPS Corrections	134
TPS Settings	21
Track	616
Centre line	616
Definition of a single track	616
Definition of multiple tracks	618
Transfer objects	317
Transformation	
Create	88
Delete	88
Description	963
Edit	88
Requirements	470, 963
Set parameters	477
Transformation management, access	87
Transformation model	89
Transformation parameters	963
Transformations	87
Transverse Mercator projection	91
Traveller	670
Traverse	
Application	868
Backsight screen	875
Close traverse	876
Configuration	872
Continuing an existing traverse	875

Create	869
Delete station setup	871
Edit	869
Point results	878
Start traverse	874
Traverse point, averaging	868
Traverse, COGO calculation method	417
Triangle, COGO calculation method	465
Triplet	946
Tripod setup	162
True zero prism system	131
Tunnel centreline	721
Tunnel Profile Editor	722
Layer details view	722
Profile details view	722
Two real-time devices	242, 243
Twostep transformation	966
Results	483
Type in new attribute	81

U

Underbreak	620
Universal Transverse Mercator projection	91
Unlock settings	315
Update coordinate system	472
Upload	
Application	319
Firmware	319
Language	319
Upload data to exchange server	325
USB	244
User	30
Check and adjust	333
User name for Leica Exchange, creation	325
Using 2 Bearings, hidden point measurements	848
Using 2 Distances, hidden point measurements	849
UTM projection	91

V

Verge	609
Versions of system firmware	348
Vertical alignment	610
Create a curve	644
Create a parabola	644
Create a straight	644
Delete an element	632, 639
Edit	629
Edit a curve	644
Edit a parabola	644
Edit a straight	644
Vertical index error (i)	335
Vertical offset, antenna	158, 162
Vertical plane	537

View	
File	325
Geoid model	93
Points, lines, areas, free code stored in job	54
View profile (tunnel)	742
Virtual Reference Station	198
Volume Calculations, end application	892
VRS	198
VTG	934

W

WAAS	196, 196, 199
WGS84	968
Wide Area Augmentation System	196, 199
Wildcard	72
Wizard for RTK Rover settings	143
Work Settings...	272
Working style	
Default	304
Description	304
User defined	304
Wizard	304

X

XML	
Data export	119
X-RTK	199

Z

ZDA	935
ZigZag, Survey Cross Section	839
Zoom	353, 392
Window	365, 392

Total Quality Management: Our commitment to total customer satisfaction.



Leica Geosystems AG, Heerbrugg, Switzerland, has been certified as being equipped with a quality system which meets the International Standards of Quality Management and Quality Systems (ISO standard 9001) and Environmental Management Systems (ISO standard 14001).

Ask your local Leica Geosystems dealer/sales representative for more information about our TQM program.

772940-5.0.0en

Original text

Published in Switzerland

© 2013 Leica Geosystems AG, Heerbrugg, Switzerland

Leica Geosystems AG
Heinrich-Wild-Strasse
CH-9435 Heerbrugg
Switzerland
Phone +41 71 727 31 31
www.leica-geosystems.com

- when it has to be **right**

Leica
Geosystems