

Renewal Parts for 800T NEMA Type 4/13 Operators

Mounting Hardware for Bulletin 800T NEMA Type 4/13 Operators

Locking or Mounting Ring



Thrust Washer



Trim Washer



Rubber Gasket



(Pictures are for illustration only. The exact size and dimensions will vary depending upon the catalog number)

CATALOG NUMBER	DESCRIPTION	LOCKING RING ①	THRUST WASHER	TRIM WASHER	GASKET
800T-A***	Flush Head Pushbutton	800T-N229	800T-N293	800T-N292	800T-N19
800T-B***	Extended Head Pushbutton	800T-N229	800T-N293	800T-N292	800T-N19
800T-D***	Mushroom Head Pushbutton	800T-N229	800T-N293	800T-N292	800T-N19
800T-D*L	Jumbo Metal Mushroom Head	800T-N241	800T-N293	800T-N292	800T-N19
800T-D*J	Jumbo Plastic Mushroom Head	800T-N241	800T-N293	800T-N292	800T-N19
800T-E***	Cylinder Lock Pushbutton	800T-N242	800T-N293	800T-N292	800T-N19
800T-FX**	Push Pull Devices (All)	800T-N236	800T-N293	800T-N292	800T-N19
800T-H, -J, 800T-N	Std Knob Selector Switch (2, 3 or 4 position)	800T-N230 ②	800T-N293	800T-N292	800T-N19
800T-H, -J, 800T-N	Knob Lever Selector Switch (2, 3 or 4 position)	800T-N231 ②	800T-N293	800T-N292	800T-N19
800T-H, -J, 800T-N	Cylinder Lock Selector Switch (2, 3 or 4 position)	800T-N232	800T-N293	800T-N292	800T-N19
800T-H, -J, 800T-N	Gray Wing Lever Selector Switch (2, 3 or 4 position)	800T-N238 ②	800T-N293	800T-N292	800T-N19
800T-H, -J, 800T-N	Red Wing Lever Selector Switch (2, 3 or 4 position)	800T-N238A ②	800T-N293	800T-N292	800T-N19
800T-H or 800T-J	Coin Slot Selector Switch (2 or 3 position)	800T-N239 ②	800T-N293	800T-N292	800T-N19
800T-K***	Selector Pushbutton	800T-N240	800T-N293	800T-N292	800T-N19
800T-L***	Wing Lever Pushbutton	800T-N244	800T-N293	800T-N292	800T-N19
800T-M***	Wobble Stick Unit	800T-N232	800T-N293	800T-N292	800T-N19
800T-P***	Pilot Light Transformer Unit	800T-N235	800T-N293	800T-N292	800T-N19
800T-PA***	Illum Pushbutton with Guard ③	800T-N234	800T-N293	800T-N292	800T-N19
800T-PB***	Illum Pushbutton w/o Guard	800T-N233	800T-N293	800T-N292	800T-N19
800T-PC***	Cluster Pilot Light	800T-N234	800T-N293	800T-N292	800T-N19
800T-PS***	Pilot Light Transformer Unit (18mm)	800T-N243	800T-N293	800T-N292	40271-095-01
800T-PT***	Push-to-Test Pilot Light	800T-N233	800T-N293	800T-N292	800T-N19
800T-Q***	Pilot Light Full Voltage Unit	800T-N235	800T-N293	800T-N292	800T-N19
800T-QA***	Illum Pushbutton with Guard ③	800T-N234	800T-N293	800T-N292	800T-N19
800T-QB***	Illum Pushbutton w/o Guard	800T-N233	800T-N293	800T-N292	800T-N19
800T-QS***	Pilot Light Transformer Unit (18mm)	800T-N243	800T-N293	800T-N292	40271-095-01
800T-QT***	Push-to-Test Pilot Light	800T-N233	800T-N293	800T-N292	800T-N19
800T-R***	Neon Pilot Light	800T-N235	800T-N293	800T-N292	800T-N19
800T-RS***	Neon Pilot Light (18mm)	800T-N243	800T-N293	800T-N292	800T-N19
800T-T****	Joy Stick Units	800T-N312	800T-N293	800T-N292	800T-N19
800T-U***	Potentiometer Units	800T-N229	800T-N293	800T-N292	800T-N19
800T-**H	Illum 2 Position Selector Switch	800T-N241 ④	800T-N293	800T-N292	800T-N19
800T-**J	Illum 3 Position Selector Switch	800T-N241 ④	800T-N293	800T-N292	800T-N19

① Locking Ring repair parts are for Series N and later devices. For illuminated selector switches, see footnote 4.

② Locking Ring repair part contains both the knob/actuator and the locking ring.

The locking ring only is not available separately.

③ The guard can be ordered separately as catalog number 800T-N93.

④ Locking Ring repair parts are for Series U units only. For Series T units, replace the entire device.

Renewal Parts for 800T NEMA Type 4/13 Operators

Replacement Parts for 1-2-3-4 Way Toggle Switches



2 Way Toggle Switch
Cat. No. 800T-T2H1EEXX

Replacement Knob Kit: Order part number 40274-533-01 (for series 'T' devices only, not available for earlier designs)

Replacement Boot Kit: Order part number 40274-533-02 (for series 'T' devices only, not available for earlier designs)

Replacement Hardware for Mounting 800T Snap Action Contact Blocks

The mounting hardware is provided as standard, when the 800T or 800H operator is built at the factory with the snap action contact block attached to the pushbutton. Catalog numbers 800T-NXM and 800T-NXN do not contain the mounting hardware required to mount them to the back of the pushbutton operator.

Hardware for 800T-NXM (1 N.O. – 1 N.C.) Contact Block

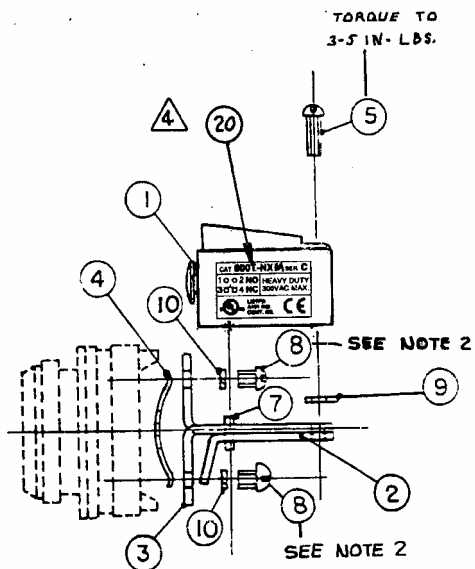

Item Number	Part Description	800T-NXM Hardware Repair Part No.
2	Support Bracket	B-32434
3	Mounting Bracket	40174-078-02
4	Flat Spring	40174-075-01
5	Mounting Screw	M-5517
7	Roll Pin	M-6063
20	Contact Block	800T-NXM

Renewal Parts for 800T NEMA Type 4/13 Operators

Replacement Hardware for Mounting 800T Snap Action Contact Blocks

The mounting hardware is provided as standard, when the 800T or 800H operator is built at the factory with the snap action contact block attached to the pushbutton. Catalog numbers 800T-NXM and 800T-NXN do not contain the mounting hardware required to mount them to the back of the pushbutton operator.

Hardware for 800T-NXN (2 N.O. – 2 N.C.) Contact Block

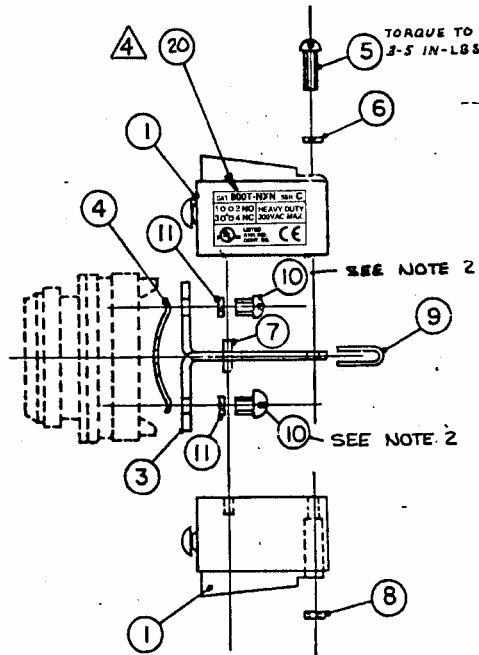

Item Number	Part Description	800T-NXN Hardware Repair Part No.
3	Mounting Bracket	40174-078-02
4	Flat Spring	40174-075-01
5	Mounting Screw	M-8100
6	Washer	M-1510
7	Roll Pin	M-6063
8	Nut	M-5719
9	Spacer	B-34458
20	Contact Block	800T-NXN

Renewal Parts for 800T NEMA Type 4/13 Operators

Replacement Parts Bulletin 800T Potentiometer Units

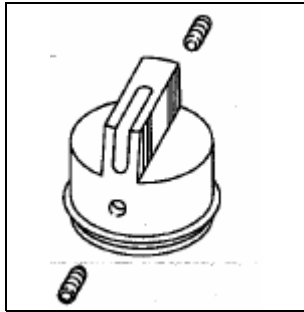

Potentiometer Knob Assembly (includes two set screws, o-ring).
Order part number 40274-073-55.

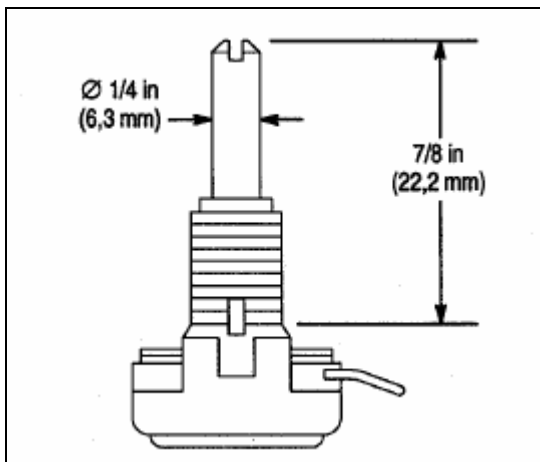

Resistive Element (Potentiometer)

Catalog Number	Replacement Potentiometer Unit	Resistance Value	Type of Taper
800T-U4	24752-221-03	150 ohm, 2.25 watts	Linear
800T-U12	24752-221-05	500 ohm, 2.25 watts	Linear
800T-U13	24752-221-06	1K ohm, 2.25 watts	Linear
800T-U16	24752-221-07	1.5K ohm, 2.25 watts	Linear
800T-U19	24752-221-08	2.5K ohm, 2.25 watts	Linear
800T-U24	24752-221-10	5K ohm, 2.25 watts	Linear
800T-U29	24752-221-12	10K ohm, 2.25 watts	Linear
800T-U34	24752-221-13	15K ohm, 2.25 watts	Linear
800T-U35	24752-221-14	20K ohm, 2.25 watts	Linear
800T-U37	24752-221-15	25K ohm, 2.25 watts	Linear
800T-U41	24752-221-17	50K ohm, 2.25 watts	Linear
800T-U46	24752-221-19	75K ohm, 2.25 watts	Linear
800T-U49	24752-221-21	100K ohm, 2.25 watts	Linear
800T-U50	24752-221-22	150K ohm, 2.25 watts	Linear
800T-U51	24752-221-23	200K ohm, 2.25 watts	Linear
800T-U54	24752-221-25	400K ohm, 2.25 watts	Linear
800T-U55	24752-221-26	500K ohm, 2.25 watts	Linear
800T-U56	24752-221-27	800K ohm, 2.25 watts	Linear
800T-U57	24752-221-28	1 Meg ohm, 2.25 watts	Linear
800T-U59	24752-221-29	2 Meg ohm, 2.25 watts	Linear
800T-U62	24752-221-30	3 Meg ohm, 2.25 watts	Linear
800T-U64	24752-221-31	4 Meg ohm, 2.25 watts	Linear
800T-U90	24752-221-38	400K ohm, 2.25 watts	Linear
800T-U91	24752-221-46	100K ohm, 2.25 watts	Modified Linear to 102 degrees, linear from 103 to 312 degrees

30.5 mm Push Buttons

Accessories

Contact Blocks

Packaged in kit form for field installation. All necessary mounting hardware is provided with each contact block kit. **Contact ratings are listed on page 10-52.**

Note: It is not recommended to mount more than four contact blocks on any one non-illuminated operator, (maximum two blocks deep). Contact blocks cannot be stacked onto power modules, so illuminated operators are limited to two contact blocks. Sealed switch contact blocks are not stackable, and are limited to two blocks per operator. Time delay contacts are only available as one circuit per operator.



Shallow Block

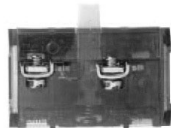

PenTUFF (Low Voltage) Contact Block



Logic Reed Block



Sealed Switch Block

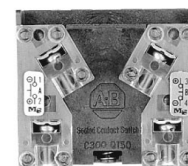

Stackable Sealed Switch Block

Contact Type	Shallow Block*†	PenTUFF (Low Voltage) Block*†	Logic Reed Block‡	Sealed Switch Block‡	Stackable Sealed Switch Block‡
	Cat. No.	Cat. No.	Cat. No.	Cat. No.	Cat. No.
1 N.O.	800T-XD1	800T-XD1V	800T-XD1R	800T-XD1P	800T-XD1Y
1 N.C.	800T-XD2	800T-XD2V	800T-XD2R	800T-XD2P	800T-XD2Y
1 N.O.E.M.	800T-XD3	800T-XD3V	—	—	—
1 N.C.L.B.	800T-XD4	800T-XD4V	—	—	—
1 N.O. - N.C.	800T-XA	800T-XAV	800T-XAR	800T-XAP	800T-XAY
2 N.O.	800T-XA2§	—	800T-XA2R§	—	800T-XA2Y
2 N.C.	800T-XA4	—	800T-XA4R	—	800T-XA4Y
1 N.C.L.B. - 1 N.O.	800T-XA1	—	—	—	—
1 N.C.L.B. - 1 N.C.	800T-XA7	—	—	—	—



Self Monitoring Contact Block



Mini Block



Time Delay Block



MaxDuty Block

Contact Type	S.M.C.B.*>
	Cat. No.
1 N.C.L.B. (wired in series with 1 N.O. monitoring contact)	800TC-XD4S

Contact Type	Mini Block*	Time Delay Block*	MaxDuty Block
	Cat. No.	Cat. No.	Cat. No.
1 N.O.	800T-XD5	800T-XT	800T-XD1M
1 N.C.	800T-XD6	800T-XS	800T-XD2M
1 N.C.L.B.	—	—	800T-XD4M

* Contact blocks with normally closed contacts meet direct drive positive opening standard requirements when properly fused to IEC 269-1 and 269-2. Shallow/mini contacts: 10 A gl or N type cartridge fuse. PenTUFF contacts: 6 A gl or N type cartridge fuse.

† Specify Bulletin 800TC for finger-safe contact blocks. Example: **Cat. No. 800T-XA becomes Cat. No. 800TC-XA.**

‡ 800T operator using sealed switch and logic reed contact blocks and installed in a suitable enclosure are UL Listed as suitable for use in Class I, Division 2/Zone 2 hazardous locations.

§ Additional contacts cannot be stacked on XA2 and XA2R contact blocks.

* For contact ratings, see page 10-51.

> For use with 2-position push-pull or push-pull/twist operators only. Must be mounted on the first level of the operator. The N.O. monitoring contact automatically closes when the S.M.C.B. is properly installed onto the operator. If the S.M.C.B. is separated from the operator, the N.O. monitoring contact automatically opens.



Shallow Contact Block Hardware

Description	Cat. No.
Contact Block Mounting Screw	800T-N335
Screw Retainer	800T-N336
Actuator Extender	800T-N337

30.5 mm Push Buttons

Accessories, Continued

Power Modules

Packaged in kit form for field installation. Lamps are listed on page 10-89.

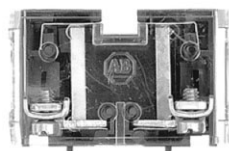

Full Voltage Power Module
Cat. No. 800T-N330



Transformer Power Module
Cat. No. 800T-N326



Dual Input Power Modules
Cat. No. 800T-N296 (Transformer)
Cat. No. 800T-N290N (Diode)

Full Voltage§		Transformer§		Dual Input		
Voltage	Cat. No.	Voltage	Cat. No.	Type	Voltage	Cat. No.
6V AC/DC 12V AC/DC 24V AC/DC 120V AC/DC	800T-N330	48V AC 50/60 Hz	800T-N325	Transformer*	120V AC	800T-N296
		120V AC 50/60 Hz	800T-N326	Diode Type†	24/120V AC/DC	800T-N290N
		240V AC 50/60 Hz	800T-N327	—	—	—
		277V AC 50/60 Hz	800T-N327Y	—	—	—
		480V AC 50/60 Hz	800T-N328	—	—	—
240V AC/DC‡	800T-N331	600V AC 50/60 Hz	800T-N329	—	—	—

* Transformer type dual input provides circuit isolation via a miniature type relay. This module is used in conjunction with a 120V transformer.

† Diode type dual input provides circuit isolation via opposing diodes. Not recommended for use with solid-state outputs and neon indicators.

‡ 240V full voltage module contains 50% dropping resistors for use with a 120V incandescent lamp.

§ Specify Bulletin 800TC for finger-safe power modules. Example: Cat. No. 800T-N330 becomes 800TC-N330.

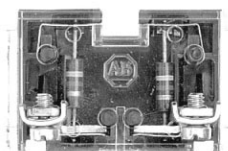

Resistor Power Module
Cat. No. 800T-N332

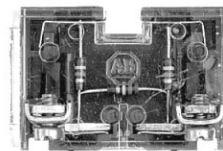

Neon Power Module
Cat. No. 800T-N333

Resistor (10% Drop)➤		Neon➤	
Voltage	Cat. No.	Voltage	Cat. No.
120V AC/DC	800T-N332	120V AC/DC	800T-N333
		240V AC/DC	800T-N334

➤ Neon modules contain resistors.

➤ Specify Bulletin 800TC for finger-safe power modules. Example: Cat. No. 800T-N332 becomes 800TC-N332.

30.5 mm Push Buttons

Accessories, Continued

Replacement Color Caps

Color caps listed below are for field replacement on installed devices or for completion of devices ordered with color caps omitted.



Push-Pull



Push-Pull/Twist



Push-Pull Jumbo



Push-Pull/Twist Jumbo

Push-Pull Color Caps, Illuminated

Color	800T Push-Pull	800H Push-Pull	800T/H Push-Pull/Twist	800T/H Push-Pull Jumbo	800T/H Push-Pull/Twist Jumbo
	Cat. No.	Cat. No.	Cat. No.	Cat. No.	Cat. No.
Amber	800T-N159A	800H-N112A	800T-N301A	800T-N209A	800T-N306A
Blue	800T-N159B	800H-N112B	800T-N301B	800T-N209B	800T-N306B
Clear	800T-N159C	800H-N112C	800T-N301C	800T-N209C	800T-N306C
Green	800T-N159G	800H-N112G	800T-N301G	800T-N209G	800T-N306G
Red	800T-N159R	800H-N112R	800T-N301R	800T-N209R	800T-N306R
White	800T-N159W	800H-N112W	800T-N301W	800T-N209W	800T-N306W



Illuminated Mushroom



Illuminated Jumbo Mushroom



Standard

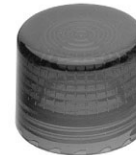

Push-to-Test



Glass Caps for Pilot Lights

Color	800T/H Push Button Color Caps, Illuminated		800T/H Pilot Light Color Caps		Glass Caps for 800T Pilot Lights
	Mushroom	Jumbo Mushroom	Standard*	Push-to-Test*	
	Cat. No.	Cat. No.	Cat. No.	Cat. No.	
Amber	800T-N304A	800T-N305A	800T-N26A	800T-N42	800T-N22
Blue	800T-N304B	800T-N305B	800T-N26B	800T-N43	800T-N23
Clear	800T-N304C	800T-N305C	800T-N26C	800T-N45	800T-N25
Green	800T-N304G	800T-N305G	800T-N26G	800T-N41	800T-N21
Red	800T-N304R	800T-N305R	800T-N26R	800T-N40	800T-N20
White	800T-N304W	800T-N305W	800T-N26W	800T-N44	800T-N24

* Available in bulk quantities of 20. Add suffix (-BP) to the cat. no. and order in multiples of 20.



Plastic Mushroom



Plastic Jumbo Mushroom



Padlocking Metal Mushroom



Metal Jumbo Mushroom

Push Button Color Caps, Non-Illuminated

Button Color	800T Plastic Mushroom	800H Plastic Mushroom	800T Plastic Jumbo Mushroom	800H Plastic Jumbo Mushroom	800T Padlocking Metal Mushroom	800T Metal Jumbo Mushroom*
	Cat. No.	Cat. No.	Cat. No.	Cat. No.	Cat. No.	Cat. No.
Red	800T-N246R	800H-N114A	800T-N247R	800H-N115A	800T-N311R	800T-N248R
Green	800T-N246G	800H-N114B	800T-N247G	800H-N115B	800T-N311G	800T-N248G
Black	800T-N246B	800H-N114H	800T-N247B	800H-N115H	800T-N311B	800T-N248B
Orange	800T-N246O	800H-N114F	800T-N247O	800H-N115F	800T-N311O	800T-N248O
Gray	800T-N246GR	800H-N114G	800T-N247GR	800H-N115G	800T-N311GR	800T-N248GR
Blue	800T-N246BL	800H-N114C	800T-N247BL	800H-N115C	800T-N311BL	800T-N248BL
Yellow	800T-N246Y	800H-N114E	800T-N247Y	800H-N115E	800T-N311Y	800T-N248Y
Natural	—	—	—	—	—	800T-N248
White	800T-N246W	800H-N114L	—	800H-N115L	—	—

* For padlocking jumbo mushroom style, change listed cat. no. from 248 to 313.

30.5 mm Push Buttons

Accessories, Continued

Replacement Color Caps, Continued



Push-Pull



Push-Pull/Twist



Push-Pull Jumbo



Push-Pull/Twist Jumbo

Color caps listed below are for field replacement on installed devices or for completion of devices ordered with color caps omitted.

Button Color	800T/H Push-Pull Color Caps, Non-Illuminated			
	Push-Pull	Push-Pull/Twist	Push-Pull Jumbo	Push-Pull/Twist Jumbo
	Cat. No.	Cat. No.	Cat. No.	Cat. No.
Red	800T-N160A	800T-N302A	800T-N208A	800T-N307A
Green	800T-N160B	800T-N302B	800T-N208B	800T-N307B
Blue	800T-N160C	800T-N302C	800T-N208C	800T-N307C
Yellow	800T-N160E	800T-N302E	800T-N208E	800T-N307E
Orange	800T-N160F	800T-N302F	800T-N208F	800T-N307F
Gray	800T-N160G	800T-N302G	800T-N208G	800T-N307G
Black	800T-N160H	800T-N302H	800T-N208H	800T-N307H
White	800T-N160L	800T-N302L	800T-N208L	800T-N307L

Selector Switch Knobs, Illuminated



Standard Knob



Knob Lever

Color	800T Knob Type		800H Knob Type	
	Standard Knob	Knob Lever	Standard Knob	Knob Lever
	Cat. No.	Cat. No.	Cat. No.	Cat. No.
Amber	800T-N297A	800T-N298A	800H-N154A	800H-N155A
Blue	800T-N297B	800T-N298B	800H-N154B	800H-N155B
Clear	800T-N297C	800T-N298C	800H-N154C	800H-N155C
Green	800T-N297G	800T-N298G	800H-N154G	800H-N155G
Red	800T-N297R	800T-N298R	800H-N154R	800H-N155R
White	800T-N297W	800T-N298W	800H-N154W	800H-N155W

Selector Switches

				Description	Item	Color	Cat. No.
standard knob lever coin slot wing lever 	800T Knobs and Actuators for Selector Switches Selector switch knobs can be changed in the field. Standard knob and knob levers can be ordered with white inserts or with a packet of colored inserts which includes one insert of each color.	Standard Knob Knob Lever Wing Lever Coin Slot	White	800T-N230F			
			Kit	800T-N230			
			White	800T-N231F			
			Kit	800T-N231			
			Gray	800T-N238			
	800T/H Color Insert Kits Available on Selector switches with removable color inserts. Standard knob and knob levers use the same insert. If color All is selected, a packet of color inserts will be furnished which includes one of each color. Color Insert kits can also be ordered with operators at no additional charge.	Standard Knob	Black Only	800T-N239			
			White	800H-N145F			
			Color	Cat. No.			
			Red	800T-N124			
			Green	800T-N125			
			Blue	800T-N126			
			Yellow	800T-N127			
White	800T-N128						
Orange	800T-N286						
All	800T-N123						

30.5 mm Push Buttons

Accessories, Continued

Booted Selector Switch Knobs, Non-Illuminated (800H only)



Booted Selector Switch Knob
Cat. No. 800H-NR5

Insert Material	Material			
	Hypalon Cat. No.	Silicone •† Cat. No.	Urethane ••† Cat. No.	Ethylene • Propylene ••† Cat. No.
Brass	800H-NR5*	800H-NR101*	800H-NR100*	800H-NR103*
Stainless Steel	800HS-NR5	800HS-NR101	800HS-NR100	800HS-NR103

* Color insert packet (Cat. No. 800T-N123) is included in each kit.

Protective Boots



Cat. No. 800H-N11



Cat. No. 800H-N12

Protective Boot for Illuminated Push Buttons		
Description	Type	Cat. No.
May be added to guarded units, units without guard or Push-to-Test devices. This protective boot guards against the entrance of foreign materials reaching the opening between the button and locking ring.	Boot without Guard	800H-N11
	Boot with Guard	800H-N12

Boots supplied with control stations and components are made of a hypalon material with brass insert ring. To order boots with silicone, urethane or ethylenepropylene material, see table below. Material application information shown below.



Protective Boot for Push Button
Cat. No. 800H-N5A

Protective Boots for Non-Illuminated Push Buttons†					
Insert Material	Boot Color	Material			
		Hypalon‡ Cat. No.	Silicone •‡ Cat. No.	Urethane ••‡ Cat. No.	Ethylene • Propylene ••‡ Cat. No.
Brass	Red	800H-N5A	800H-N101R	800H-N100R	800H-N103R
	Green	800H-N5B	800H-N101G	800H-N100G	800H-N103G
	Black	800H-N5H	800H-N101B	800H-N100B	800H-N103B
	Yellow	800H-N5E	800H-N101Y	800H-N100Y	—
	Blue	800H-N5C	800H-N101BL	800H-N100BL	—
Stainless Steel	Red	800HS-N5A	800HS-N101R	800HS-N100R	800HS-N103R
	Green	800HS-N5B	800HS-N101G	800HS-N100G	800HS-N103G
	Black	800HS-N5H	800HS-N101B	800HS-N100B	800HS-N103B
	Yellow	800HS-N5E	800HS-N101Y	800HS-N100Y	—
	Blue	800HS-N5C	800HS-N101BL	800HS-N100BL	—

† May be added to flush or extended head push button units to protect against foreign materials reaching the opening between the button and the locking ring.

‡ Dots printed on the inside of the boot identify the boot material.

Protective Boot Application Information

• Hypalon (synthetic rubber)

Very resistant to attack by oxidizing chemicals such as concentrated sulfuric acid and hypochlorite solutions. Also resistant to attack by oils and performs well in a wide range of other chemicals and solvents. Good flex and high impact resistance. This is the standard boot material supplied with 800H NEMA Type 4/4X push buttons unless otherwise specified.

• Silicone

Superior high temperature resistance. Particularly suited for use where organic acids or vegetable oils may be present. Also superior resistance to the effects of outdoor use, such as oxygen, ozone, and weather.

• Urethane

Excellent resistance to mechanical failure. Most durable boot material. Particularly suited for use where lubricating oils and automotive fuels may be present. Also well-suited for outdoor use.



• Ethylene-propylene

Particularly suited for high temperature applications. Resistant to attack by many acids and alkalis, detergents, phosphate esters, ketones, alcohols, and glycols. Outstanding service in areas with hot water and steam wash-downs.





30.5 mm Push Buttons

Accessories, Continued

Push Buttons

	Description	Cat. No.
 <p><i>Mechanical Interlock</i> Cat. No. 800T-N179 (Operators not included)</p>	<p>800T/H Mechanical Interlock Used on momentary contact push button units. Guards against closing the N.O. contacts of one button while the other button's N.O. contacts are closed. Buttons remain momentary. For maintained units, see page 10-70.</p>	800T-N179
 <p><i>Rocker Arm Operating Lever</i> Cat. No. 800T-N12</p>	<p>800T Rocker Arm Operating Lever The rocker arm lever operates two flush head or one flush with one extended head momentary contact push button units spaced 1-27/32 inch center to center. Legend plates must be ordered separately and should be inverted 180 °C prior to engraving and installation.</p>	800T-N12





Miscellaneous

	Description	Cat. No.
 <p><i>Mounting Ring Wrench</i> Cat. No. 800T-N245</p>	<p>800T/H Mounting Ring Wrench This wrench will simplify tightening or loosening the octagonal mounting ring used on Bulletin 800T units. This wrench is double ended and can be used for 18 mm and 30 mm pilot light mounting rings.</p>	800T-N245
 <p><i>E-Stop Jumbo Push-Pull Cap</i> Cat. No. 800T-N209RE1</p>	<p>800T/H Jumbo Push-Pull Cap For use on Bulletin 800T or 800H push-pull operators. Fits on illuminated and non-illuminated devices.</p>	800T-N209RE1
 <p><i>Bonding Bracket Kit</i> Cat. No. 800T-N300</p>	<p>800T Bonding Bracket The bonding bracket establishes an electrical circuit between the mounting surface and metal operator bushing for grounding purposes; recommended for installations which require CSA approval. Necessary mounting hardware is included. Order 800T-N300 for back-of-panel bracket. Order 800T-N300F for front-of-panel bracket.</p>	800T-N300 800T-N300F
 <p><i>Lamp Removal Tool</i> Cat. No. 800E-ALR1</p>	<p>800T/H Lamp Removal Tool This tool is used for installing or replacing bayonet base type lamps, including LEDs.</p>	800E-ALR1

30.5 mm Push Buttons

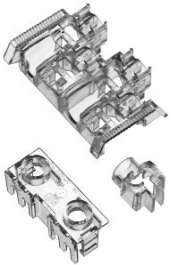
Accessories, Continued





Miscellaneous, Continued

Photo	Description	Cat. No.	
 <p style="text-align: center;">IEC Finger-Safe Accessories</p>	<p>800T/H IEC Finger-Safe Terminal Guards Snap-on accessories which provide IEC, IP2X and VGB finger-safe protection. Single terminal guards for single circuit contact blocks, full voltage modules, LED modules, etc. Note: Must be ordered in multiples of 100 pieces.</p>	<p>800T-N322</p>	<p>Cat. No. 800T-N323</p>
	<p>Transformer covers for transformer only. Note: Must be ordered in multiples of 25 pieces.</p>	<p>800T-N324</p>	<p>Cat. No. 800T-N322</p>
	<p>Multi-terminal side cover for use on single or double circuit contact blocks. Note: Must be ordered in multiples of 25 pieces.</p>	<p>800T-N323</p>	
 <p style="text-align: center;">Trim Washer Cat. No. 800T-N292</p>	<p>Gray 800T Trim Washer Used to mount the operator properly when a legend plate is not being used. Note: Must be ordered in multiples of 10 pieces.</p>	<p>800T-N292</p>	
	<p>Plastic 800H Trim Washer Used to mount the operator properly when a legend plate is not being used. Note: Must be ordered in multiples of 10 pieces.</p>	<p>800H-N148</p>	
 <p style="text-align: center;">Thrust Washer Cat. No. 800T-N293</p>	<p>Metal 800T Thrust Washer Used to prevent rotation of operators in a keyed or notched hole. Note: Must be ordered in multiples of 10 pieces.</p>	<p>800T-N293</p>	
	<p>Plastic 800H Thrust Washer Used to prevent rotation of operators in a keyed or notched hole. Note: Must be ordered in multiples of 10 pieces.</p>	<p>800H-N146</p>	
 <p style="text-align: center;">Etching Fluid Cat. No. 800T-N188</p>	<p>800T Etching Fluid Used to blacken freshly engraved aluminum legend plates.</p>	<p>800T-N188</p>	
Photo	Description	Color	Cat. No.
 <p style="text-align: center;">Closing Button Cat. No. 800T-N1</p>	<p>800T/H Closing Button Where an enclosure or flush plate with more than the required number of openings is used, this neat appearing button can be supplied to close the unused openings.</p>	<p>Gray</p>	<p>800T-N1</p>
		<p>Black</p>	<p>800T-N1B</p>

30.5 mm Push Buttons

Accessories, Continued







Locking Attachments

	Description	Cat. No.
 <p>Push Button Unit with Padlocking Attachment Cat. No. 800T-N2 (Padlock not included)</p>	<p>800T Extended Head Push Button Padlocking Attachments Permits locking in the depressed position. Locks the normally closed contact in the open position. For extended head non-illuminated momentary push buttons.</p>	800T-N2
 <p>Push Button Unit with Padlocking Attachment Cat. No. 800T-N10 (Padlock not included)</p>	<p>800T Flush Head Push Button Padlocking Attachments Permits locking in the depressed position. Locks the normally closed contact in the open position. For flush head push button.</p>	800T-N10
 <p>Momentary Mushroom Padlocking Attachment Cat. No. 800T-N315 (Padlock not included)</p>	<p>800T Momentary Mushroom Padlocking Attachments For Bulletin 800T non-illuminated momentary mushroom push button. Requires use of 800T-N311 mushroom cap. This device is used to lock the mushroom button in a depressed position.</p>	800T-N315
 <p>Push-Pull Padlocking Attachment Cat. No. 800T-N314 (Padlock not included)</p>	<p>800T/H Push-Pull Padlocking Attachment For 2-position push-pull and push-pull/twist release illuminated and non-illuminated operators. Use on standard head only (40 mm dia.). Locks the Normally Closed contacts open only. Conversion of Normally Closed Late Break contacts to standard Normally Closed contacts are recommended when using this accessory. Made of stainless steel.</p>	800T-N314
 <p>Padlocking Cover Cat. No. 800T-N163 (Padlock not included)</p>	<p>800T/H Padlocking Cover Guards against unauthorized operation for non-illuminated, standard knob selector switches and potentiometers. Stainless Steel and clear plastic construction.</p>	800T-N163

30.5 mm Push Buttons

Accessories, Continued







Locking Attachments, Continued

	Description	Cat. No.																										
 Padlocking Cover Cat. No. 800H-N140 (Padlock not included)	800T/H Padlocking Cover Guards against unauthorized operation. For push buttons, 2-position push-pull or twist-release units. When applying Cat. No. 800H-N140 on 2-position maintained push-pull units, cover will lock only when the button is in depressed position. Padlocking cover includes blank legend plate for customer marking. Note: A pre-marked legend plate is available. The words OPEN COVER TO OPERATE are on the front and PULL-TO-START-PUSH-TO-STOP are on the rear. To order legend plate only, specify Cat. No. 800H-W174L.	800H-N140																										
 Selector Switch Unit with Padlocking Attachment Cat. No. 800T-NX446 (Padlock not included)	800T 2- and 3-Position Non-illuminated Selector Switch Padlocking Attachment — Standard Knob Padlocking guard for 2- and 3-position selector switches with standard knob operators only. Locks selector switch in any maintained position.	800T-NX446																										
 Selector Switch Padlocking Guard Cat. No. 800H-N141R (Padlock not included)	<table border="1" style="width: 100%; border-collapse: collapse;"> <thead> <tr> <th style="width: 65%;">Description</th> <th style="width: 15%;">Position</th> <th style="width: 20%;">Cat. No.</th> </tr> </thead> <tbody> <tr> <td rowspan="4"> 800H 2- and 3-Position Selector Switch with Padlocking Guards Padlocking guard for 2- and 3-position selector switches with standard knob operators only. </td> <td style="text-align: center;">Left</td> <td style="text-align: center;">800H-N141L</td> </tr> <tr> <td style="text-align: center;">Center</td> <td style="text-align: center;">800H-N141C</td> </tr> <tr> <td style="text-align: center;">Right</td> <td style="text-align: center;">800H-N141R</td> </tr> <tr> <td style="text-align: center;">All</td> <td style="text-align: center;">800H-N141A</td> </tr> </tbody> </table>	Description	Position	Cat. No.	800H 2- and 3-Position Selector Switch with Padlocking Guards Padlocking guard for 2- and 3-position selector switches with standard knob operators only.	Left	800H-N141L	Center	800H-N141C	Right	800H-N141R	All	800H-N141A															
Description	Position	Cat. No.																										
800H 2- and 3-Position Selector Switch with Padlocking Guards Padlocking guard for 2- and 3-position selector switches with standard knob operators only.	Left	800H-N141L																										
	Center	800H-N141C																										
	Right	800H-N141R																										
	All	800H-N141A																										
 Cat. No. 800T-NX446A (Padlock not included)	800T 4-Position Selector Switch Attachment — Standard Knob Kit includes selector switch and guard (padlock not included). Padlocking Guard for 4-position selector switches with standard knob operators only. Locks selector switch in any maintained position.	800T-NX446A																										
 Non-Illuminated Selector Switch Padlocking Attachment Cat. No. 800H-N316J (Padlock not included)	<table border="1" style="width: 100%; border-collapse: collapse;"> <thead> <tr> <th style="width: 65%;">Description</th> <th style="width: 15%;">Position</th> <th style="width: 20%;">Cat. No.</th> </tr> </thead> <tbody> <tr> <td rowspan="10"> 800T/H Non-Illuminated Selector Switch Padlocking Attachment 2-, 3-, and 4-position selector switch padlocking attachments. Can be used to lock operators in a desired position. For 3-position selector switches, this device can also be used to lock out a left or right position as shown in the photo to the left. </td> <td colspan="2" style="text-align: center;">For 2- and 3-Position Selector Switches</td> </tr> <tr> <td style="text-align: center;">Left</td> <td style="text-align: center;">800T-N316L</td> </tr> <tr> <td style="text-align: center;">Center</td> <td style="text-align: center;">800T-N316C</td> </tr> <tr> <td style="text-align: center;">Right</td> <td style="text-align: center;">800T-N316R</td> </tr> <tr> <td style="text-align: center;">Window Center through Right - Prevent Left Operation</td> <td style="text-align: center;">800T-N316J</td> </tr> <tr> <td style="text-align: center;">Window Center through Left - Prevent Right Operation</td> <td style="text-align: center;">800T-N316K</td> </tr> <tr> <td colspan="2" style="text-align: center;">For 4-Position Selector Switches</td> </tr> <tr> <td style="text-align: center;">Left (Pos. 1)</td> <td style="text-align: center;">800T-N317L</td> </tr> <tr> <td style="text-align: center;">Center Left (Pos. 2)</td> <td style="text-align: center;">800T-N317CL</td> </tr> <tr> <td style="text-align: center;">Center Right (Pos. 3)</td> <td style="text-align: center;">800T-N317CR</td> </tr> <tr> <td style="text-align: center;">Right (Pos. 4)</td> <td style="text-align: center;">800T-N317R</td> </tr> </tbody> </table>	Description	Position	Cat. No.	800T/H Non-Illuminated Selector Switch Padlocking Attachment 2-, 3-, and 4-position selector switch padlocking attachments. Can be used to lock operators in a desired position. For 3-position selector switches, this device can also be used to lock out a left or right position as shown in the photo to the left.	For 2- and 3-Position Selector Switches		Left	800T-N316L	Center	800T-N316C	Right	800T-N316R	Window Center through Right - Prevent Left Operation	800T-N316J	Window Center through Left - Prevent Right Operation	800T-N316K	For 4-Position Selector Switches		Left (Pos. 1)	800T-N317L	Center Left (Pos. 2)	800T-N317CL	Center Right (Pos. 3)	800T-N317CR	Right (Pos. 4)	800T-N317R	
Description	Position	Cat. No.																										
800T/H Non-Illuminated Selector Switch Padlocking Attachment 2-, 3-, and 4-position selector switch padlocking attachments. Can be used to lock operators in a desired position. For 3-position selector switches, this device can also be used to lock out a left or right position as shown in the photo to the left.	For 2- and 3-Position Selector Switches																											
	Left	800T-N316L																										
	Center	800T-N316C																										
	Right	800T-N316R																										
	Window Center through Right - Prevent Left Operation	800T-N316J																										
	Window Center through Left - Prevent Right Operation	800T-N316K																										
	For 4-Position Selector Switches																											
	Left (Pos. 1)	800T-N317L																										
	Center Left (Pos. 2)	800T-N317CL																										
	Center Right (Pos. 3)	800T-N317CR																										
Right (Pos. 4)	800T-N317R																											
 Illuminated Selector Switch Padlocking Attachment Cat. No. 800H-N4162L (Padlock not included)	<table border="1" style="width: 100%; border-collapse: collapse;"> <thead> <tr> <th style="width: 65%;">Description</th> <th style="width: 15%;">Position</th> <th style="width: 20%;">Cat. No.</th> </tr> </thead> <tbody> <tr> <td rowspan="10"> 800T/H Illuminated Selector Switch Padlocking Attachment 2- and 3-position selector switch padlocking attachments for illuminated selector switches. Stainless steel material </td> <td colspan="2" style="text-align: center;">For 2-Position Selector Switches</td> </tr> <tr> <td style="text-align: center;">Left</td> <td style="text-align: center;">800T-N4162L</td> </tr> <tr> <td style="text-align: center;">Right</td> <td style="text-align: center;">800T-N4162R</td> </tr> <tr> <td colspan="2" style="text-align: center;">For 3-Position Selector Switches</td> </tr> <tr> <td style="text-align: center;">Left</td> <td style="text-align: center;">800T-N4163L</td> </tr> <tr> <td style="text-align: center;">Center</td> <td style="text-align: center;">800T-N4163C</td> </tr> <tr> <td style="text-align: center;">Right</td> <td style="text-align: center;">800T-N4163R</td> </tr> <tr> <td style="text-align: center;">Window Center through Right - Prevent Left Operation</td> <td style="text-align: center;">800T-N4163J</td> </tr> <tr> <td style="text-align: center;">Window Center through Left - Prevent Right Operation</td> <td style="text-align: center;">800T-N4163K</td> </tr> </tbody> </table>	Description	Position	Cat. No.	800T/H Illuminated Selector Switch Padlocking Attachment 2- and 3-position selector switch padlocking attachments for illuminated selector switches. Stainless steel material	For 2-Position Selector Switches		Left	800T-N4162L	Right	800T-N4162R	For 3-Position Selector Switches		Left	800T-N4163L	Center	800T-N4163C	Right	800T-N4163R	Window Center through Right - Prevent Left Operation	800T-N4163J	Window Center through Left - Prevent Right Operation	800T-N4163K					
Description	Position	Cat. No.																										
800T/H Illuminated Selector Switch Padlocking Attachment 2- and 3-position selector switch padlocking attachments for illuminated selector switches. Stainless steel material	For 2-Position Selector Switches																											
	Left	800T-N4162L																										
	Right	800T-N4162R																										
	For 3-Position Selector Switches																											
	Left	800T-N4163L																										
	Center	800T-N4163C																										
	Right	800T-N4163R																										
	Window Center through Right - Prevent Left Operation	800T-N4163J																										
	Window Center through Left - Prevent Right Operation	800T-N4163K																										

30.5 mm Push Buttons





Accessories, Continued

Guards

	Description	Type	Cat. No.
 <p>Push Button Unit with Cat. No. 800T-N13 1 in (25.4 mm) Extra Long Guard</p>	800T Push Button Guards Momentary push button guards to reduce the risk of accidental operation.	1 in Guard for Non-Illuminated	800T-N13
		1/2 in Guard for Non-Illuminated	800T-N143
		1-1/2 in Guard for Illuminated	800T-N93
		1-1/2 in Guard for Non-Illuminated with Locking Attachment	800T-N39
 <p>Illuminated Push Button Unit with Cat. No. 800H-N152 Guard</p>	800H Illuminated Push Button Guard This guard provides additional protection against accidental operation of the push button unit. 1-1/2 in (38.1 mm) guard for illumination units.		800H-N152
 <p>Stainless Steel Guard Cat. No. 800H-N153</p>	800H Stainless Steel Guard Used on non-illuminated push buttons that have protective boots as shown on page 10-83.		800H-N153
 <p>Standard Mushroom Push Button Unit with Cat. No. 800T-N129 Guard</p>	800T Mushroom Push Button Guards Momentary mushroom guards for standard and jumbo mushroom push buttons. Reduces the risk of accidental operation.	Standard Guard	800T-N129
		Standard Guard with Set Screw	800T-N165
		Jumbo Size Guard	800T-N151
		Jumbo Size Guard with Set Screw	800T-N154
 <p>Protective Ring for 2-Position Push-Pull Cat. No. 800T-N310 and 800T-NX1320</p>	800T/H Protective Guard Protective ring for 800T 2-position push-pull operators. Illuminated or non-illuminated. Often used to avoid unintentional tripping of E-stop operators. This guard is used with standard size button (40 mm dia.).	Stainless Steel	800T-N310
		Black	800T-NX1320
 <p>Protective Ring for 2-Position Push-Pull Cat. No. 800T-N310J</p>	800T/H Jumbo Protective Guard Protective ring for 800T 2-position push-pull operators. Illuminated or non-illuminated. Often used to avoid unintentional tripping of E-stop operators. This guard is used with jumbo size button (60 mm dia.).		800T-N310J
 <p>Ramp Guard Cat. No. 800T-N339</p>	800T/H Ramp Guard For Bulletin 800T/800H 2- and 3-position illuminated and non-illuminated push-pull units. Standard size button only (40 mm dia.).		800T-N339

Replacement Lamps

Pilot Lights, Illuminated Push Buttons, Illuminated Push-Pull, Illuminated Push-Pull/Twist to Release

Lamp	Type	Current, Typical	Lamp Voltage	ANSI No.	Cat. No.
	Full Voltage Transformer	150 mA/250 mA	6.3V AC	755/1866	800T-N65*
	Full Voltage	80 mA	14V AC/DC	756	800T-N141*
		70 mA	24V AC/DC	757	800T-N157*
		50 mA	48V AC/DC	1835	800T-N365*
	Full Voltage Resistor	22 mA	120V AC/DC	949	800T-N169*
	Flashing	150 mA	6V AC/DC	267	800T-N212*
Dual Input Diode	57 mA	24V AC/DC	24MB	800T-N180*	
	21 mA	120V AC	90MB	800T-N261*	
Neon 	—	2 mA	120V AC/DC	B2A	609-N9
Lamp	Type	Current, Typical†	Lamp Voltage	Leakage Current	Cat. No.
 	Full Voltage	13 mA/22 mA	12V AC/DC	3 mA	800T-N362x§
		13 mA/21 mA	24V AC/DC	3 mA	800T-N319x§
		12 mA/17 mA	32V AC/DC	3 mA	800T-N363x§
		9 mA/14 mA	48V AC/DC	3 mA	800T-N364x§
		3.3 mA/6 mA	120V AC/	—	800T-N320x§
		4.5 mA/6.2 mA	130V AC/DC	3 mA	800T-N321x§
	Transformer	14 mA/48 mA	6V AC	14 mA	800T-N318x§
	Flashing	18 mA	24V AC/DC	—	800T-N319Fx§*

* Item is sold in multiples of 5. Order quantity of 5 to receive package of 5 pieces.



† Typical current draw varies with LED color. The first mA value is for a green or blue LED and the second mA value is for a red or amber LED.

‡ All LEDs except 120V have an internal shunt resistor for use with solid-state outputs. LEDs will not illuminate below listed leakage current.



§ To complete the cat. no. replace the x with the first letter of the desired color: Amber, Green, Red, Blue, or White. White LEDs only available in 6V, 24V, 120V, and 130V.

* Flashing rate is 2 Hz.

Illuminated Selector Switches

Lamp	Type	Current, Typical	Lamp Voltage	ANSI No.	Cat. No.
	Full Voltage Transformer	150 mA/250 mA	6.3V AC	755/1866	800T-N65*
	Full Voltage	80 mA	14V AC/DC	756	800T-N141*
		70 mA	24V AC/DC	757	800T-N157*
Lamp	Type	Current, Typical†	Lamp Voltage	Leakage Current	Cat. No.
 	Full Voltage	13 mA/22 mA	12V AC/DC	3 mA	800T-N362x§
	Full Voltage	13 mA/21 mA	24V AC/DC	3 mA	800T-N319x§
		12 mA/17 mA	32V AC/DC	3 mA	800T-N363x§
		9 mA/14 mA	48V AC/DC	3 mA	800T-N364x§
		3.3 mA/6 mA	120V AC/DC	—	800T-N320x§
		4.5 mA/6.2 mA	130V AC/DC	3 mA	800T-N321x§
		14 mA/48 mA	6V AC	14 mA	800T-N318x§
	Flashing	18 mA	24V AC/DC	—	800T-N319Fx§*

Cluster Pilot Lights

Lamp	Type	Current, Typical	Lamp Voltage	ANSI No.	Cat. No.
	Full Voltage Transformer	195 mA	6V AC/DC	381	800T-N258*
	Full Voltage	73 mA	12V AC/DC	382	800T-N259*
		37 mA	24V AC/DC	387	800T-N260*
Lamp	Type	Current, Typical	Lamp Voltage	Polarity	Cat. No.
	Full Voltage Transformer	45 mA	6V AC/DC	Positive	800T-N340x>
	Full Voltage	36 mA	12V AC/DC	Positive	800T-N341x>
		14 mA	28V AC/DC	Bi-Polar	800T-N80x>

* Item is sold in multiples of 5. Order quantity of 5 to receive package of 5 pieces.

† Typical current draw varies with LED color. The first mA value is for a green or blue LED and the second mA value is for a red or amber LED.

‡ All LEDs except 120V have an internal shunt resistor for use with solid-state outputs. LEDs will not illuminate below listed leakage current.

§ To complete the Cat. no. replace the x with the first letter of the desired color: Amber, Green, Red, Blue, or White. White LEDs only available in 6V, 24V, 120V, and 130V.

* Flashing rate is 2 Hz.

> To complete the Cat. No., replace the "x" with the first letter of the desired color: Amber, Green, or Red only.

Important User Information

Because of the variety of uses for the products described in this publication, those responsible for the application and use of this control equipment must satisfy themselves that all necessary steps have been taken to assure that each application and use meets all performance and safety requirements, including any applicable laws, regulations, codes and standards.

The illustrations, charts, sample programs and layout examples shown in this guide are intended solely for purposes of example. Since there are many variables and requirements associated with any particular installation, Rockwell Automation does not assume responsibility or liability (to include intellectual property liability) for actual use based upon the examples shown in this publication.

Allen-Bradley publication SGI-1.1, *Safety Guidelines for the Application, Installation and Maintenance of Solid-State Control* (available from your local Allen-Bradley office), describes some important differences between solid-state equipment and electromechanical devices that should be taken into consideration when applying products such as those described in this publication.

Reproduction of the contents of this copyrighted publication, in whole or part, without written permission of Rockwell Automation, is prohibited.

Throughout this document we use notes to make you aware of safety considerations:

ATTENTION

Identifies information about practices or circumstances that can lead to personal injury or death, property damage or economic loss



IMPORTANT

Identifies information that is critical for successful application and understanding of the product.

Use only replacement parts and devices recommended by Rockwell Automation to maintain the integrity of the equipment. It is the user's responsibility to ensure that the renewal part number selected is properly matched to the model, series and revision level of the equipment being serviced.

ATTENTION

Servicing energized Industrial Control Equipment can be hazardous. Severe injury or death can result from electrical shock, burn, or unintended actuation of controlled equipment. Recommended practice is to disconnect and lockout control equipment from power sources, and release stored energy, if present.



Refer to **National Fire Protection Association Standard No. NFPA70E, Part 2 and (as applicable) OSHA rules for Control of Hazardous Energy Sources (Lockout/Tagout) and OSHA Electrical Safety Related Work Practices** for safety related work practices, including procedural requirements for lockout/tagout, and appropriate work practices, personnel qualifications and training requirements where it is not feasible to de-energize and lockout or tagout electric circuits and equipment before working on or near exposed circuit parts.

ROCKWELL DISCLAIMS ALL WARRANTIES WHETHER EXPRESSED OR IMPLIED IN RESPECT TO THE INFORMATION (INCLUDING SOFTWARE) PROVIDED HEREBY, INCLUDING THE IMPLIED WARRANTIES OF FITNESS FOR A PARTICULAR PURPOSE, MERCHANTABILITY, AND NON-INFRINGEMENT. Note that certain jurisdictions do not countenance the exclusion of implied warranties; thus, this disclaimer may not apply to you.

Allen-Bradley is a trademark of Rockwell Automation